COMPARISON
BUILDINGS

F10 House

all 10 comparison
buildings

Your Home

Building Forms and Massing

THE BIG
QUESTIONS

- 1 What are the big forms that make up buildings?
- 2 How do you read an elevation?
- 3 How do you draw an elevation?

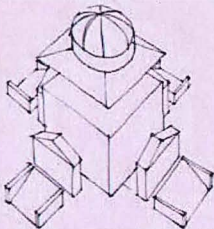

Villa Rotonda

In math classes over the years, you've learned about **geometric solids**: rectangular prisms, cubes (a type of rectangular prism), triangular prisms, pyramids, spheres, cones, and cylinders. All buildings are made from a combination of these **forms**. When we stand back and look at a building's exterior, our eyes may be drawn to the smaller details—such as doors, windows, colors, or materials—but the overall forms that make up the building are an architect's first consideration.

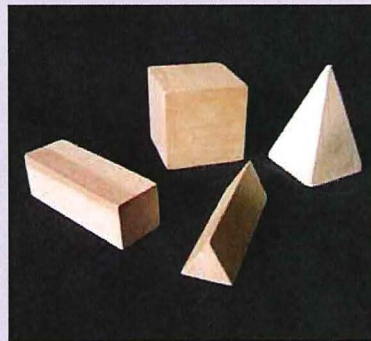

Geometric solids – left to right: rectangular prism, cube, triangular prism, and pyramid

When architects start to design buildings, they begin by thinking in terms of **three-dimensional** forms. They may select one form and add another to it; they may subtract a part of a form. They may rearrange the forms by pushing or pulling the proportions. The method in which smaller three-dimensional forms are combined to create an overall building form is called **massing**.

Of course a building isn't actually made from a solid geometric form. Rather, a building encloses a **volume** of space. Floor levels, furniture, fixtures, and people fill up the interior of a building's form.



Left to right: cylinder, cone, cylinder, hemisphere, and sphere

BOARD RECEIVED
SAN FRANCISCO
2014 DEC -5 AM 11:55

BY *ke*



Older suburban home, circa 1890



Newer suburban home, circa 1990

Two buildings may first appear to be very different because of the arrangement of windows or doors, and two buildings constructed in different centuries may not seem to

share any characteristics. However, when all the details are taken off and the pure geometric forms are seen clearly, two apparently unrelated structures might be strikingly similar.



Massing sketch of older suburban home

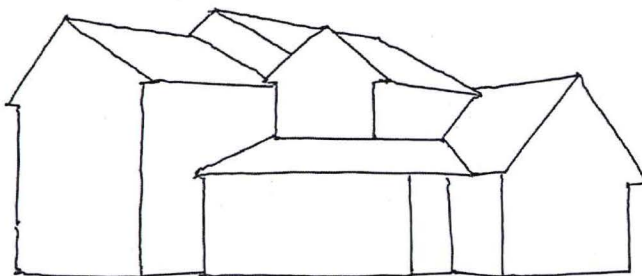

Massing sketch of newer suburban home

CHAPTER VOCABULARY

geometric solids a geometric figure that has three dimensions; examples include: rectangular prisms, cubes (a type of rectangular prism), triangular prisms, pyramids, spheres, cones, and cylinders

form another word for the 3-dimensional geometric solid shapes within the building

three-dimensional describing something with three dimensions: length, width, and height

massing (noun) the arrangement of forms of a building

massing (verb) the method in which smaller 3-dimensional building forms are combined to create an overall form

volume the size (or the amount of space) of a 3-dimensional form, measured in cubic units (length \times width \times height)

orthographic projection (also called **orthogonal projection**) a general term referring to a method of drawing where a 3-dimensional object is "flattened" and projected, or shown, on a piece of paper

two-dimensional describing something with only two dimensions: length and height

elevation drawing a scaled drawing of one side of a building, where the building is "flattened" when shown in two dimensions on paper; as a result, only the surfaces of the building (a 3-dimensional object) that are perpendicular to the viewer can be seen in the drawing; elevation can also describe the appearance of the side of a building

CONTINUED ON NEXT PAGE

perspective drawing / perspective view a drawing of a 3-dimensional object that attempts to show the object as your eye or a camera would see it

vanishing point the imaginary point at the back of the drawing where all the lines seem to converge

ground plane line (also called *grade line*) the heavy line that indicates the ground; on an elevation drawing anything below the ground plane line (underground) typically is shown in dashed lines

grade / below grade the ground on the construction site where the building's foundation meets the earth; "below grade" refers to the parts of the building that are located below the ground

west elevation the side of the building that faces west: when you look directly at the west elevation, your back is to the west and you are facing east

east elevation the side of the building that faces east: when you look directly at the east elevation, your back is to the east and you are facing west

north elevation the side of the building that faces north: when you look directly at the north elevation, your back is to the north and you are facing south

south elevation the side of the building that faces south: when you look directly at the south elevation, your back is to the south and you are facing north

elevation tag a small round symbol on an exterior elevation or section drawing that has been divided into four quadrants, with 2 opposing quadrants shaded in; the elevation tag indicates its distance in feet and inches from another reference point (often the first floor)

CONTINUED ON PAGE 248



Villa Rotunda and isometric massing sketch

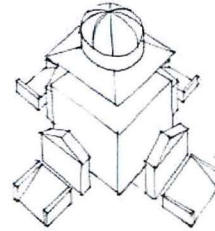

Glessner House and isometric massing sketch

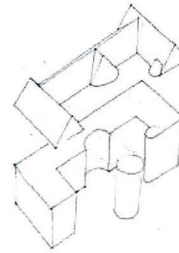

Farnsworth House and isometric massing sketch

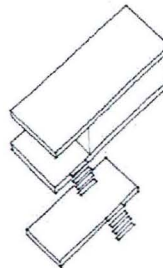

The Contemporaine and isometric massing sketch



Robie House and isometric massing sketch

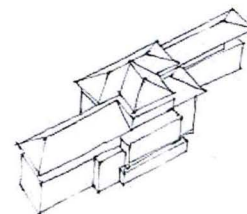

COMPARISONS **building forms and massing**

BUILDING NAME	MAJOR FORMS	OVERALL MASSING
F10 House 2000	rectangular prisms	a tall rectangular prism next to a shorter rectangular prism
Glessner House 1885	rectangular prisms, triangular prisms, cones, cylinders	three long rectangular prisms joined in a U-shape and topped with pyramidal roofs; smaller cylinders topped with cone roofs are attached to the side of the building
Robie House 1906	rectangular prisms, rectangular pyramids	two long rectangular prisms stacked on top of one another and each topped by a pyramidal roof
a Chicago bungalow 1920s	rectangular prism, rectangular pyramid	a long rectangular prism topped by a pyramidal roof
Farnsworth House 1946	rectangular prism	one long rectangular prism
The Contemporaine 2004	rectangular prisms	a rectangular prism at the base with several taller thinner rectangular prisms stacked on top
Villa Rotunda 1556	cube, half sphere, triangular prisms	a rectangular prism (cube) topped by a shallow half sphere; four triangular prisms make up the four entrance porches
Fallingwater 1935	rectangular prisms	rectangular prisms stacked on top of one another at 90° angles
Unité d'Habitation 1947	rectangular prism	one very large rectangular prism
Magney House 1982	rectangular prism, quarter sphere	one long rectangular prism topped by a quarter sphere
Legorreta House 1997	rectangular prisms	two rectangular prisms stacked on top of each other

interior elevation drawings

elevation drawings of the inside walls of a space; interior elevation drawings often are drawn for kitchens and bathrooms and indicate where fixtures or other built-in objects such as cabinets are mounted

exterior elevation drawings

elevation drawings of the outside of a building

isometric drawing (a type of orthographic projection) a drawing of a 3-dimensional object that shows three sides of the object; because parallel lines stay parallel and do not converge toward each other, an isometric drawing does not look quite as “real” as a perspective drawing does; an isometric drawing is most useful when it is used to help explain a detail of a building

Although buildings are three-dimensional forms, architects use a method of drawing called **orthographic projection**, which shows the building “flattened” on a **two-dimensional** piece of paper. An **elevation drawing** uses orthographic projection and shows

just one side of a building from a horizontal point of view. Elevation drawings are created using the floor plans. Each of the four sides of the F10 House floor plan becomes one elevation drawing. Each element of the floor plan’s exterior walls is seen in the elevations.

Elevation drawings of the F10 House created using the floor plans

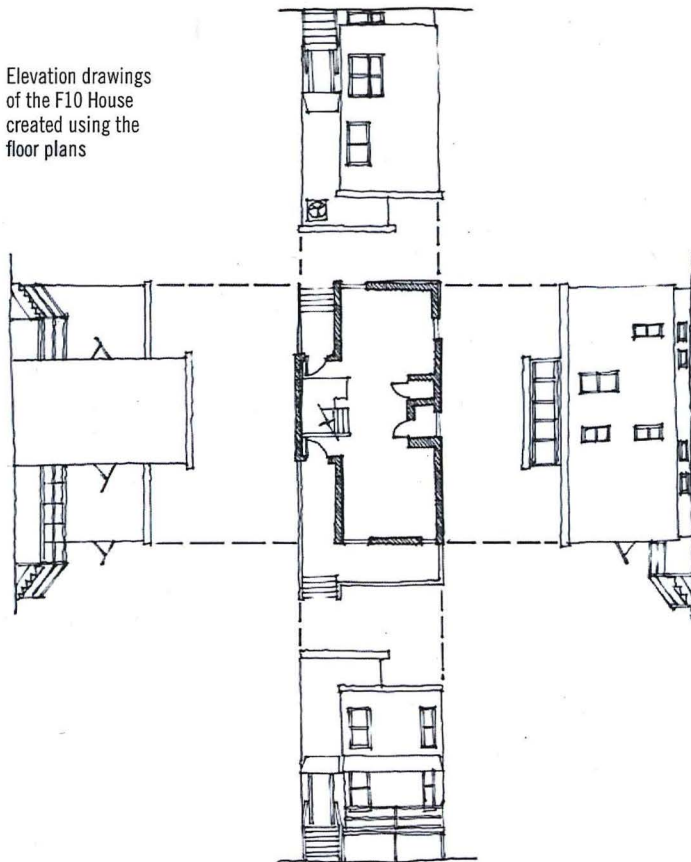

on your
way home
TODAY

Count how many different geometric solids you can find in the homes you pass. You may want to blur your vision a bit to notice the overall massing of a structure. Don't worry about the details: just look at how forms are arranged. Are they interlocked with each other? Or are they next to each other?

Perspective drawings are very different from elevation drawings. A perspective view imitates the view your eye and a camera sees. To your natural eye, objects farther away appear smaller, while objects closer to your eye appear larger. Perspective views include at least one **vanishing point**.



Courtyard building

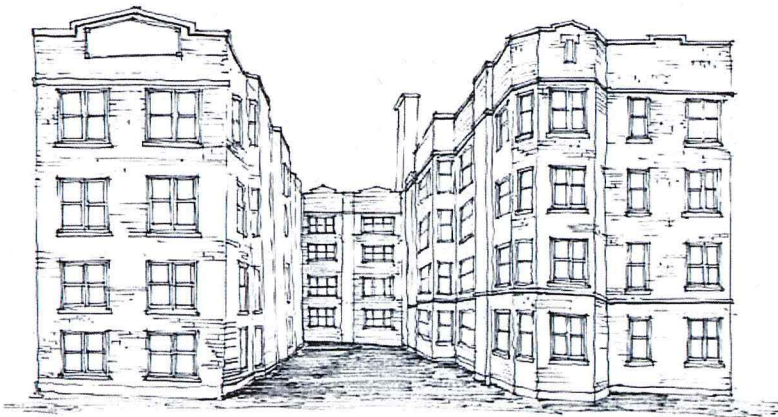

Perspective sketch of a courtyard building

Surfaces in an elevation drawing that are not exactly perpendicular to our eye will appear to be foreshortened. Notice the bay windows on the

courtyard apartment building below. The two angled side windows appear narrower than the front part of the bay window that is perpendicular to us.



Elevation drawing of a courtyard building. Note that the angled side windows of the bay windows appear narrower because they are not perpendicular to us.

DID YOU know?

Young Frank played with blocks, too



As a young child growing up in Wisconsin, Frank Lloyd Wright's mother, Anna, taught him at home. One year she presented him with a gift known as Froebel blocks, a set of children's educational toys developed by German educator Friedrich Froebel (pronounced *FRUR-bull*). The set included small wooden blocks and paper shapes for designing and constructing. Near the end of his life, Wright credited these blocks as having a very important influence on the design of his buildings.

"...for several years I sat at the little kindergarten table-top.... In the third dimension, the smooth maple blocks became the cube, the sphere and the tetrahedron; all mine to 'play' with.... all these forms were combined by the child into imaginative pattern. Design was recreation!" —Frank Lloyd Wright

A Testament, Frank Lloyd Wright, New York: Horizon Press, 1957. NA737.W7A33

in class

Mini F10 House model



You can practice sketching the elevations of the F10 House after assembling a fold-up model. You'll need scissors, tape, and a little patience to cut out and put together this small F10 House at $\frac{1}{8}'' = 1'-0''$ scale. After you've put the model together, place it on a table and view the house from eye level to get a view similar to a true elevation drawing. Your teacher has the instructions and templates for this in-class activity.

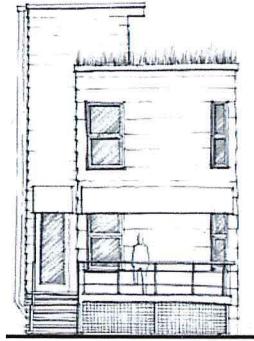

F10 House – west elevation

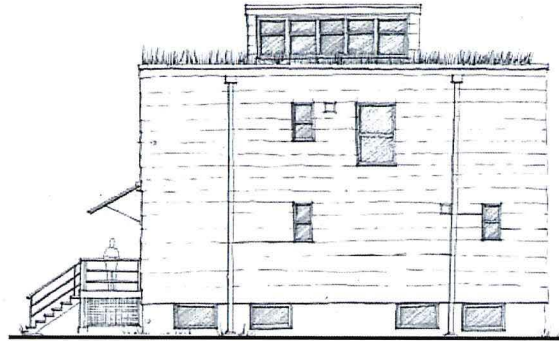

F10 House – south elevation

Although a perspective drawing may look more realistic, an elevation drawing is more accurate because all parts of the building are drawn to scale. Various parts of the building don't appear smaller just because they are farther away. Elevation drawings are extremely useful to a contractor, for example, who needs to know the exact size and proportions of a building.

One of the most easily recognizable differences between an elevation drawing and a perspective drawing is the heavy black **ground plane line** (or **grade line**) that is seen on an elevation drawing. The line shows the ground (or **grade**) where the building meets the earth. Any parts of the building located below grade are shown in dashed lines.

Elevation drawings are labeled according to compass directions. For example: the **west elevation** of the F10 House (A.06) is the side of the building's exterior that faces west, although a person standing and looking at the west elevation will actually be looking toward the east.

The dimensions on an elevation drawing tell the contractor only about vertical dimensions. (A contractor learns the horizontal distances between walls from the floor plan.) Vertical dimensions are listed along the edge of the building by an **elevation tag**. These symbols explain only the distance from floor to floor or from floor to ceiling, based on the height of that point above or below the first floor. Some drawings may reference heights from grade or another fixed point on the site.

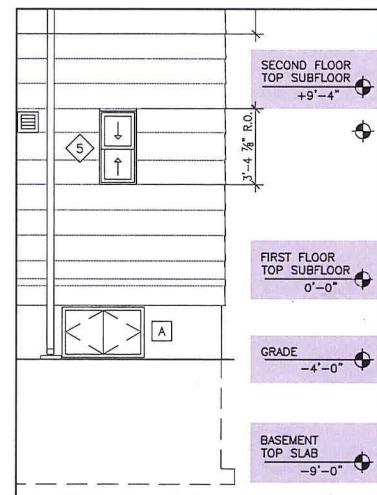

Elevation tags indicate distances between floors, based on the height of that point above or below the first floor

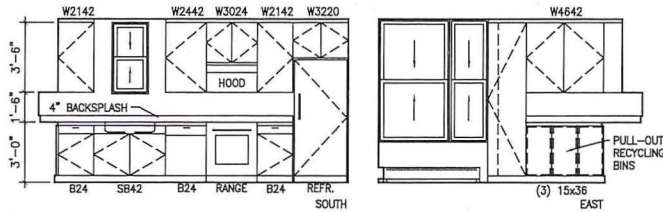

F10 House –
interior elevations

1
A12 KITCHEN/DINING
1/4"=1'-0"

Architects also create **interior elevation drawings** (for example, A.12) for contractors to use in finishing the interior of a room. They show the interior view of each wall and are commonly drawn for kitchens and bathrooms. A variety of construction workers responsible for installing cabinets, towel bars, mirrors, or light fixtures on a wall surface of a home will consult the interior elevation drawings.

As with all architectural drawings, lineweights are very important in elevation drawings. Varying lineweights help to distinguish different planes on the elevation. For example, heavier lines on an **exterior elevation drawing** indicate objects that are closer to the viewer. They are used around the profile of the building to help distinguish the overall form. In interior elevations, heavier lines are used to show the edges of an object that has been cut through. Thinner lines show objects that are farther from the viewer.

Sometimes, architects also use **isometric drawings** which show three dimensions (length, width, and height) of an object. A simple isometric drawing of the F10 House allows us to see three sides of the building. Parallel lines stay parallel to each other and do not converge in a vanishing point. As a result, an isometric drawing does not look as realistic as a perspective drawing, but it allows the viewer to see the top and two sides of the building.

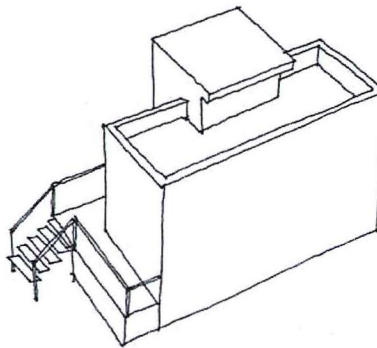

F10 House – isometric sketch

CHAPTER RESOURCES

Architectural Graphics, 3rd ed., Francis D.K. Ching. New York: Van Nostrand Reinhold, 1996. NA2700.C46

Precedents in Architecture, Roger H. Clark, illustr. Michael Pause. New York: Van Nostrand Reinhold, 1985. NA2750.C55

Sketch, Plan, Build: World Class Architects Show How It's Done, Alejandro Bahamon. New York: Harper Design, 2005. NA2700.B25

TALK about it

- When you look at the exterior form of the F10 House, what major geometric forms can you identify?
- What major geometric forms can you identify in your own home? In your school?