

File No. 150969

Committee Item No. 2

Board Item No. \_\_\_\_\_

# COMMITTEE/BOARD OF SUPERVISORS

## AGENDA PACKET CONTENTS LIST

Committee: Land Use and Transportation

Date May 8, 2017

Board of Supervisors Meeting

Date \_\_\_\_\_

### Cmte Board

- |                                     |                          |  |
|-------------------------------------|--------------------------|--|
| <input type="checkbox"/>            | <input type="checkbox"/> | Motion                                       |
| <input type="checkbox"/>            | <input type="checkbox"/> | Resolution                                   |
| <input checked="" type="checkbox"/> | <input type="checkbox"/> | Ordinance                                    |
| <input checked="" type="checkbox"/> | <input type="checkbox"/> | Legislative Digest                           |
| <input type="checkbox"/>            | <input type="checkbox"/> | Budget and Legislative Analyst Report        |
| <input type="checkbox"/>            | <input type="checkbox"/> | Youth Commission Report                      |
| <input checked="" type="checkbox"/> | <input type="checkbox"/> | Introduction Form                            |
| <input checked="" type="checkbox"/> | <input type="checkbox"/> | Department/Agency Cover Letter and/or Report |
| <input type="checkbox"/>            | <input type="checkbox"/> | Memorandum of Understanding (MOU)            |
| <input type="checkbox"/>            | <input type="checkbox"/> | Grant Information Form                       |
| <input type="checkbox"/>            | <input type="checkbox"/> | Grant Budget                                 |
| <input type="checkbox"/>            | <input type="checkbox"/> | Subcontract Budget                           |
| <input type="checkbox"/>            | <input type="checkbox"/> | Contract/Agreement                           |
| <input type="checkbox"/>            | <input type="checkbox"/> | Form 126 - Ethics Commission                 |
| <input type="checkbox"/>            | <input type="checkbox"/> | Award Letter                                 |
| <input type="checkbox"/>            | <input type="checkbox"/> | Application                                  |
| <input type="checkbox"/>            | <input type="checkbox"/> | Form 700                                     |
| <input type="checkbox"/>            | <input type="checkbox"/> | Vacancy Notice                               |
| <input type="checkbox"/>            | <input type="checkbox"/> | Information Sheet                            |
| <input checked="" type="checkbox"/> | <input type="checkbox"/> | Public Correspondence                        |

OTHER (Use back side if additional space is needed)

- |                                     |                          |  |
|-------------------------------------|--------------------------|--|
| <input checked="" type="checkbox"/> | <input type="checkbox"/> | <u>Planning Commission Resolution Nos. 19578 &amp; 19686</u> |
| <input checked="" type="checkbox"/> | <input type="checkbox"/> | <u>Addendum 3 to EIR</u>                                     |
| <input checked="" type="checkbox"/> | <input type="checkbox"/> | <u>Residential Density Bonus Study</u>                       |
| <input checked="" type="checkbox"/> | <input type="checkbox"/> | <u>Small Business Commission Recommendation</u>              |
| <input checked="" type="checkbox"/> | <input type="checkbox"/> | <u>Notice of Public Hearing (Fee Ad)</u>                     |
| <input type="checkbox"/>            | <input type="checkbox"/> | _____  |
| <input type="checkbox"/>            | <input type="checkbox"/> | _____  |
| <input type="checkbox"/>            | <input type="checkbox"/> | _____  |
| <input type="checkbox"/>            | <input type="checkbox"/> | _____  |
| <input type="checkbox"/>            | <input type="checkbox"/> | _____  |

Completed by: Alisa Somera Date May 4, 2017

Completed by: \_\_\_\_\_ Date \_\_\_\_\_

1 [Planning Code - Affordable Housing Bonus Programs]

2  
3 Ordinance amending Planning Code section 206 to amend the 100 Percent Affordable  
4 Housing Bonus Program to add the ~~Local Affordable Housing Bonus~~ HOME-SF Program,  
5 the Analyzed State Density Bonus Program, and the Individually Requested State  
6 Density Bonus Program, to provide for development bonuses and zoning modifications  
7 for increased affordable housing, in compliance with, and above those required by the  
8 State Density Bonus Law, Government Code, Section 65915, et seq.; to establish the  
9 procedures in which the ~~Local Affordable Housing Bonus~~ HOME-SF Program shall be  
10 reviewed and approved; adding a fee for applications under the Programs; and  
11 affirming the Planning Department's determination under the California Environmental  
12 Quality Act; and making findings of consistency with the General Plan, and the eight  
13 priority policies of Planning Code, Section 101.1.

14 NOTE: Unchanged Code text and uncodified text are in plain Arial font.  
15 Additions to Codes are in *single-underline italics Times New Roman font*.  
16 Deletions to Codes are in *strikethrough italics Times New Roman font*.  
17 Board amendment additions are in double-underlined Arial font.  
18 Board amendment deletions are in ~~strikethrough Arial font~~.  
19 Asterisks (\* \* \* \*) indicate the omission of unchanged Code  
20 subsections or parts of tables.

21 Be it ordained by the People of the City and County of San Francisco:

22 Section 1.

23 (a) The Planning Department has determined that the actions contemplated in this  
24 ordinance comply with the California Environmental Quality Act (California Public Resources  
25 Code Sections 21000 et seq.). Said determination is on file with the Clerk of the Board of

1 Supervisors in File No. 150969 and is incorporated herein by reference. The Board affirms  
2 this determination.

3 (b) On February 25, 2016 and June 30, 2016, the Planning Commission, in Resolution  
4 Nos. 19578 and 19686, adopted findings that the actions contemplated in this ordinance are  
5 consistent, on balance, with the City's General Plan and eight priority policies of Planning  
6 Code Section 101.1. The Board adopts these findings as its own. A copy of said Resolution  
7 is on file with the Clerk of the Board of Supervisors in File No. 150969, and is incorporated  
8 herein by reference.

9 (c) Pursuant to Planning Code Section 302, this Board finds that this Planning Code  
10 Amendment will serve the public necessity, convenience, and welfare for the reasons set forth  
11 in Planning Commission Resolution No. 19578 and 19686, and the Board incorporates such  
12 reasons herein by reference.

13  
14 Section 2. The Planning Code is hereby amended by revising Section 206, to read as  
15 follows:

16 SEC. 206. THE ~~100 PERCENT~~ AFFORDABLE HOUSING BONUS PROGRAMS.

17 *~~This Section 206 and Sections 206.1 through 206.4 shall be known as the 100 Percent~~*  
18 *~~Affordable Housing Bonus Program. References to "Section 206" shall include Sections 206.1 through~~*  
19 *~~206.4. This section shall be known as the Affordable Housing Bonus Programs, which include the~~*  
20 *~~Local Affordable Housing Bonus HOME-SF Program, the 100 Percent Affordable Housing Bonus~~*  
21 *~~Program, the Analyzed State Density Bonus Program and the Individually Requested State Density~~*  
22 *~~Bonus Program.~~*

23 SEC. 206.1. PURPOSE AND FINDINGS.

24 (a) The purpose of the ~~100 Percent~~ Affordable Housing Bonus Programs is to facilitate  
25 the development and construction of affordable housing in San Francisco. Affordable housing

1 is of paramount statewide concern, and the Legislature has declared that local and state  
2 governments have a responsibility to use the powers vested in them to facilitate the  
3 improvement and development of housing to make adequate provision for the housing needs  
4 of all economic segments of the community, especially families. The Legislature has found  
5 that local governments must encourage the development of a variety of types of housing for  
6 all income levels, including multifamily rental housing and assist in the development of  
7 adequate housing to meet the needs of low-and moderate-income households.

8 (b) Affordable housing is an especially paramount concern in San Francisco. San  
9 Francisco has one of the highest housing costs in the nation, but San Francisco's economy  
10 and culture rely on a diverse workforce at all income levels. It is the policy of the City to  
11 enable these workers to afford housing in San Francisco and ensure that they pay a  
12 reasonably proportionate share of their incomes to live in adequate housing and to not have to  
13 commute ever-increasing distances to their jobs. The Association of Bay Area Governments  
14 determined that San Francisco's share of the Regional Housing Need for January 2015 to  
15 June 2022 was the provision of 28,870 new housing units, with 6,234 (or 21.6%) as very low,  
16 4,639 (or 16.1%) as low, and 5,460 (or 18.9%) as moderate income units.

17 (c) The Board of Supervisors, and the voters in San Francisco, have long recognized  
18 the need for the production of affordable housing. The voters, in some cases, and the Board  
19 in others, have adopted measures to address this need, such as mandatory Inclusionary  
20 Affordable Housing Ordinance in Planning Code Section 415; the San Francisco Housing  
21 Trust Fund, adopted in 2012, which established a fund to create, support and rehabilitate  
22 affordable housing, and set aside \$20 million in its first year, with increasing allocations to  
23 reach \$50 million a year for affordable housing; the adoption of Proposition K in November  
24 2014, which established as City policy that the City, by 2020, will help construct or rehabilitate  
25 at least 30,000 homes, with more than 50% of the housing affordable for middle-income



1 households, and at least 33% as affordable for low-and moderate income households; and  
2 the multiple programs that rely on Federal, State and local funding sources as identified in the  
3 Mayor's Office of Housing and Community Development Comprehensive Plan. These  
4 programs enable the City to work towards the voter-mandated affordable housing goals.

5 *(d) Historically, in the United States and San Francisco, affordable housing requires high*  
6 *levels of public subsidy, including public investment and reliance on public dollars. Costs to subsidize*  
7 *an affordable housing unit vary greatly depending on a number of factors, such as household income of*  
8 *the residents, the type of housing, and the cost to acquire land acquisition. Currently, MOHCD*  
9 *estimates that the level of subsidy for an affordable housing units is approximately \$250,350,000 per*  
10 *unit. Given this high cost per unit, San Francisco can only meet its affordable housing goals through a*  
11 *combination of increased public dollars dedicated to affordable housing and other tools that do not*  
12 *rely on public money.*

13 *(e) Development bonuses incentives are a long standing zoning tool that enable cities to*  
14 *encourage private development projects to provide public benefits including affordable housing. By*  
15 *offering increased development potential, a project sponsor can offset the expenses necessary to*  
16 *provide additional public benefits. In 1979, the State of California adopted the Density Bonus Law,*  
17 *Government Code section 65915 et seq, which requires that density bonuses and other concessions and*  
18 *incentives be offered to projects that provide a minimum amount of on-site affordable housing.*

19 *(df) In recognition of the City's affordable housing goals, including the need to produce*  
20 *more affordable housing without the need for public subsidies, the Planning Department contracted*  
21 *with David Baker Architects and Seifel Consulting to determine a menu of zoning*  
22 *modifications and development bonuses that could offset a private developer's costs of*  
23 *providing various levels of additional on-site affordable housing. These experts analyzed various*  
24 *parcels in San Francisco, to determine the conditions in which a zoning accommodation*  
25 *would be necessary to achieve additional density. The analysis modeled various zoning*

1 districts and lot size configurations, consistent with current market conditions and the City's  
2 stated policy goals, including to achieve a mix of unit types, including larger units that can  
3 accommodate larger households. These reports are on file in Board of Supervisors File No.  
4 160687.

5 (eg) Based on these reports, the Planning Department developed ~~a~~ four programs to  
6 provide ~~an~~ options by which developers ~~of 100% affordable housing projects~~ can include  
7 additional affordable units on-site ~~in~~ through increased density and other zoning or design  
8 modifications. These programs are the Local Affordable Housing Bonus-HOME- SF Program, the  
9 100 Percent Affordable Housing Bonus Program, the Analyzed State Density Bonus Program and the  
10 Individually Requested Bonus Program. This program is the 100 Percent Affordable Housing Bonus  
11 Program, which provides additional incentives for developers of 100% affordable housing projects,  
12 thereby reducing the overall cost of such developments on a per unit basis.

13 (h) The goal of the Local Affordable Housing HOME-SF Program is to increase affordable  
14 housing production, especially housing affordable to Middle Income middle income households.  
15 Housing for Middle Income Households middle income households in San Francisco is necessary  
16 to stabilize San Francisco's households and families, ensure income and household diversity in the  
17 long term population of San Francisco, and reduce transportation impacts of middle income  
18 households working in San Francisco. Middle income Middle Income households do not  
19 traditionally benefit from public subsidies.

20 (i) The 100 Percent Affordable Housing Bonus Program provides additional incentives for  
21 developers of 100% affordable housing projects, thereby reducing the overall cost of such  
22 developments on a per unit basis.

23 (j) The Affordable Housing Bonus Program also establishes a clear local process for all  
24 projects seeking the density bonuses guaranteed through the State Density Bonus Law. The State  
25 Analyzed Program provides an expedited process for projects that comply with a pre-determined menu

1 of incentives, concessions and waivers of development standards that the Department has  
2 determined, in consultation with David Baker Architects and Seifel Consulting can appropriately  
3 respond to neighborhood context without causing adverse impacts on public health and safety, and  
4 provide affordable units through the City's already-established Inclusionary Housing Program.  
5 Projects requesting density or concessions, incentives and waivers outside of the City's preferred menu  
6 may seek a density bonus consistent with State law in the Individually Requested Density Bonus  
7 Program.

8 (k) San Francisco's small business community is an integral part of San Francisco's  
9 neighborhood commercial corridors, local economy, and rich culture. San Francisco is  
10 committed to maintaining small businesses in its neighborhoods. For this reason, the  
11 Affordable Housing Bonus HOME-SF Program acknowledges the need for general assistance  
12 and support for any business that might be impacted. Developments using the Affordable  
13 Housing Bonus Program will generally produce additional commercial spaces which may  
14 enhance existing commercial corridors. The Office of Economic and Workforce Development  
15 (OEWD), in coordination with the Office of Small Business, currently coordinate on referrals to  
16 and deployment of a range of services to small businesses including but not limited to: small  
17 business consulting, lease negotiation assistance, small business loans, ADA Certified  
18 Access Specialists (CASp) inspection services, legacy business registry, façade improvement  
19 assistance, commercial corridor management, grants and assessments, relocation and broker  
20 services for production, distribution and repair (PDR) businesses, business permit assistance,  
21 and coordination with city agencies.

22 (l) In fiscal year 2016 - 2017 the Mayor's Office of Economic and Workforce  
23 Development OEWD and the Office of Small Business will initiate and coordinate the  
24 implementation of a citywide small business retention and relocation program. This program  
25 will provide additional small business consulting and case management, real estate readiness

1 assessment, relocation assistance, broker services, real estate acquisition assistance,  
2 succession planning, legacy business grants and technical assistance, and restaurant sector  
3 permit coordination and assistance.

4 SEC. 206.2. DEFINITIONS.

5 The definitions of Section 102 and the definitions in Section 401 for "Area Median  
6 Income" or "AMI," "First Construction Document," "Housing Project," "Life of the Project," and  
7 "MOHCD," "On-site Unit," "Off-site Unit," "Principal Project," and "Procedures Manual" shall  
8 generally apply to Section 206. The following definitions shall also apply, and shall prevail if  
9 there is a conflict with other sections of the Planning Code.

10 "100 Percent Affordable Housing Project" shall be a project where all of the dwelling  
11 units with the exception of the manager's unit are "Affordable Units" as that term is defined in  
12 Section 406(b).

13 "Affordable to a Household of Lower, Very Low, or Moderate Income shall mean, at a  
14 minimum (1) a maximum purchase price that is affordable to a Household of Lower, Very Low, or  
15 Moderate Income, adjusted for the household size, assuming an annual payment for all housing costs of  
16 33 percent of the combined household annual gross income, a down payment recommended by the  
17 Mayor's Office of Housing and Community Development and set forth in the Procedures Manual, and  
18 available financing; and (2) an affordable rent as defined in Section 50053 of the Health and Safety  
19 Code sufficient to ensure continued affordability of all very low and low-income rental units that  
20 qualified the applicant for the award of the density bonus for 55 years or a longer period of time if  
21 required by the construction or mortgage financing assistance program, mortgage insurance program,  
22 or rental subsidy program.

23 "~~Affordable to a Household of Middle Income~~" shall mean, at a minimum, (1) a  
24 maximum purchase price that is affordable to a Household of Middle Income at 140% of Area  
25 Median Income, adjusted for the household size, assuming an annual payment for all housing

1 costs of 33 percent of the combined household annual gross income, a down payment  
2 recommended by the Mayor's Office of Housing and Community Development and set forth in  
3 the Procedures Manual, and available financing; and (2) the maximum annual rent for an  
4 affordable housing unit shall be no more than 30% of the annual gross income for a  
5 Household of Middle Income at an Area Median Income of 120%, as adjusted for the  
6 household size, as of the first date of the tenancy.

7 "Base Density" is lot area divided by the maximum lot area per unit permitted under existing  
8 density regulations (e.g 1 unit per 200, 400, 600, 800, or 1000 square feet of lot area). Calculations  
9 that result in a decimal point of 0.5 and above are rounded to the next whole number. In the Fillmore  
10 Neighborhood Commercial Transit District and the Divisadero Neighborhood Commercial Transit  
11 District, "Base Density" shall mean 1 unit per 600 square feet of lot area.

12 "Density Bonus" means a density increase over the Maximum Allowable Gross Residential  
13 Density granted pursuant to Government Code Section 65915 and Section 206 et seq.

14 "Density Bonus Units" means those market rate dwelling units granted pursuant to the  
15 provisions of this Section 206.3, 206.5 and 206.6 that exceed the otherwise Maximum Allowable Gross  
16 Residential Density for the development site.

17 "Development Standard" shall mean a site or construction condition, including, but not  
18 limited to, a height limitation, a setback requirement, a floor area ratio, an onsite open space  
19 requirement, or an accessory parking ratio that applies to a residential development pursuant  
20 to any ordinance, general plan element, specific plan, charter, or other local condition, law,  
21 policy, resolution or regulation.

22 "HOME-SF Unit" shall mean on-site income restricted residential unit provided within a  
23 HOME-SF project a meet the requirements set forth in Planning Code Section 206.3.

1 "Household of Middle Income" shall mean a household whose combined annual gross  
2 income for all members does not exceed 140% of AMI to qualify for ownership housing and  
3 120% of AMI to qualify for rental housing.

4 "Inclusionary Units" shall mean on-site income-restricted residential units provided within a  
5 development that meet the requirements of the Inclusionary Affordable Housing Program, Planning  
6 Code Section 415 et seq.

7 "Lower, ~~or~~ Very Low, or Moderate Income" means annual income of a household that  
8 does not exceed the maximum income limits for the income category, as adjusted for  
9 household size, applicable to San Francisco, as published and periodically updated by the  
10 State Department of Housing and Community Development pursuant to Sections 50079.5, ~~or~~  
11 50105 or 50093 of the California Health and Safety Code. Very Low Income is currently  
12 defined in California Health and Safety Code Section 50105 as 50% of area median income.  
13 Lower Income is currently defined in California Health and Safety Code Section 50079.5 as  
14 80% of area median income. Moderate Income is currently defined in California Health and Safety  
15 Code Section 50093 as 120% of area median income. If the State law definitions of these terms  
16 change, the definitions under Section 206 shall mirror the State law changes.

17 "Maximum Allowable Gross Residential Density" means the maximum number of dwelling  
18 units per square foot of lot area in zoning districts that have such a measurement, or, in zoning  
19 districts without such a density measurement, the maximum number of dwelling units that could be  
20 developed on a property while also meeting all other applicable Planning Code requirements and  
21 design guidelines, ~~and without obtaining an exception, modification, variance, or waiver from~~  
22 ~~the Zoning Administrator or Planning Commission for any Planning Code requirement.~~

23 "Middle Income Unit" shall mean a residential unit affordable to a Household of Middle  
24 Income.

1 "Qualifying Resident" means senior citizens or other persons eligible to reside in a Senior  
2 Citizen Housing Development.

3 "Regulatory Agreement" means a recorded and legally binding agreement between an applicant  
4 and the City to ensure that the requirements of this Chapter are satisfied. The Regulatory Agreement,  
5 among other things, shall establish: the number of Restricted Affordable Units, their size, location,  
6 terms and conditions of affordability, and production schedule.

7 "Restricted Affordable Unit" means a dwelling unit within a Housing Project which will be  
8 Affordable to Very Low, Lower or Moderate Income Households, as defined in this Section 206.2 for a  
9 minimum of 55 years. Restricted Affordable Units shall meet all of the requirements of Government  
10 Code 65915, except that Restricted Affordable Units that are ownership units shall not be restricted  
11 using an equity sharing agreement."

12 "Senior Citizen Housing Development" has the meaning in California Civil Code section 51.3.

13 SEC. 206.3. Housing Opportunities Mean Equity – San Francisco LOCAL  
14 AFFORDABLE HOUSING BONUS PROGRAM.

15 (a) Purpose. This Section sets forth the HOME-SF Local Affordable Housing Bonus  
16 Program. The Local Affordable Housing Bonus HOME-SF Program or "HOME-SF" "Local  
17 Program" provides benefits to project sponsors of housing projects that set aside a total of 30% of  
18 residential units onsite at below market rate rent or sales price, including a percentage of units  
19 affordable to low and moderate income households consistent with Section 415, the Inclusionary  
20 Housing Program, and the remaining percentage affordable to a range of incomes as described in  
21 Section 206.3(c)(2). Household of Middle Income. The purpose of the Local Affordable  
22 Housing Bonus Program HOME-SF is to expand the number of Inclusionary Units produced in San  
23 Francisco and provide housing opportunities to a wider range of incomes than traditional affordable  
24 housing programs, which typically provide housing only for very low, low or moderate income  
25 households. The Local Program HOME-SF allows market-rate projects to match the City's shared

1 Proposition K housing goals that 50% of new housing constructed or rehabilitated in the City by 2020  
2 be within the reach of working middle class San Franciscans, and at least 33% affordable for low and  
3 moderate income households.

4 (b) Applicability. A Local Affordable Housing Bonus HOME-SF Project or "Local  
5 Project" under this Section 206.3 shall be a project that:

6 (1) contains three or more residential units, as defined in Section 102, not including any  
7 Group Housing as defined in Section 102, efficiency dwelling units with reduced square footage defined  
8 in Section 318, and Density Bonus Units permitted through this Section 206.3, or any other density  
9 bonus;

10 (2) is located in any zoning district that: (A) is not designated as an RH-1 or RH-2  
11 Zoning Districts; and (B) establishes a maximum dwelling unit density through a ratio of number of  
12 units to lot area, including RH-3, RM, RC, C-2, Neighborhood Commercial, Named Neighborhood  
13 Commercial, Chinatown Mixed Use Districts, and SoMa Mixed Use Districts; but only if the SoMa  
14 Mixed Use District has a density measured by a maximum number of dwelling units per square foot of  
15 lot area; (C) is in the Fillmore Neighborhood Commercial Transit District and Divisadero  
16 Neighborhood Commercial Transit District; and (D) is not in the North of Market Residential Special  
17 Use District, Planning Code Section 249.5 until the Affordable Housing Incentive Study is completed at  
18 which time the Board will review whether the North of Market Residential Special Use District should  
19 continue to be excluded from this Program. The Study will explore opportunities to support and  
20 encourage the provision of housing at the low, moderate, and middle income range in neighborhoods  
21 where density controls have been eliminated. The goal of this analysis is to incentivize increased  
22 affordable housing production levels at deeper and wider ranges of AMI and larger unit sizes in these  
23 areas through 100% affordable housing development as well as below market rate units within market  
24 rate developments; (E) is not located within the boundaries of the Northeastern Waterfront Area  
25



1 Plan south of the centerline of Broadway; and (F) is not located on property under the  
2 jurisdiction of the Port of San Francisco; and.

3 (3) is not seeking and receiving a density or development bonus under the provisions of  
4 California Government Code Section 65915 et seq, Planning Code Section 207, Section 124(f), Section  
5 202.2(f), 304, or any other State or local program that provides development bonuses;

6 (4) includes at least 135% of the Base Density as calculated under Planning Code  
7 Section 206.5;

8 (5) in Neighborhood Commercial Districts is not a project that involves merging lots  
9 that result in more than 125 feet in lot frontage for projects located; and

10 (6) consists only of new construction, and excluding any project that includes an  
11 addition to an existing structure;

12 (7) is not located within the boundaries of the Northeastern Waterfront Area  
13 Plan south of the centerline of Broadway.

14 (c) Local Affordable Housing Bonus HOME-SF Project Eligibility Requirements. To  
15 receive the development bonuses granted under this Section, a Local HOME-SF Project must meet all  
16 of the following requirements:

17 (1) Comply with the Inclusionary Affordable Housing Program, Section 415 of this  
18 Code, by providing the applicable number of units on-site under Section 415.6. For projects not subject  
19 to the Inclusionary Affordable Housing Program, the applicable number of on-site units under this  
20 section shall be zero. ~~If the Dial Alternative currently proposed in an ordinance in Board of~~  
21 ~~Supervisors File No. 150911 is adopted and permits a project sponsor to provide more~~  
22 ~~Inclusionary Units at higher AMIs than currently required (referred to as “dialing up”), a project~~  
23 ~~sponsor may dial up and meet the requirements of this subsection (D). If the Dial Alternative~~  
24 ~~of the Inclusionary Affordable Housing Program is ever amended to allow a project sponsor to~~  
25

1 provide fewer Inclusionary Units at lower AMIs than currently required (referred to as “dialing  
2 down”), then a Project cannot qualify for this Section 206.5 if it elects to dial down;

3 (2) Provide an additional percentage of affordable units in the Local HOME-SF  
4 Project as Middle Income HOME-SF Units, as defined herein, such that the total percentage of  
5 Inclusionary Units and Middle Income HOME-SF Units equals 30%. The Middle Income HOME-  
6 SF Units shall be restricted for the Life of the Project and shall comply with all of the requirements of  
7 the Procedures Manual authorized in Section 415. Any unit required to satisfy requirements of  
8 Section 415 shall be affordable to a household in the income categories specified in Section  
9 415. Additional HOME-SF Units that are Owned Units shall have an average affordable  
10 purchase price set at 120% of Area Median Income, with units equally distributed at 90% of  
11 Area Median Income, 120% of Area Median Income and 140% of Area Median Income.  
12 Additional HOME-SF Units that are Rental Units shall have an average affordable rent set at  
13 80% or less of Area Median Income, with units equally distributed among households earning  
14 55% of Area Median Income, 80% of Area Median Income, and 110% of Area Median  
15 Income. As provided for in subsection (e), the Planning Department and MOHCD shall amend the  
16 Procedures Manual to provide policies and procedures for the implementation, including monitoring  
17 and enforcement, of the Middle Income units HOME-SF Units;

18 (3) Demonstrate to the satisfaction of the Environmental Review Officer that the Local  
19 Project does not:

20 (A) cause a substantial adverse change in the significance of an historic  
21 resource as defined by California Code of Regulations, Title 14, Section 15064.5.

22 (B) create new shadow in a manner that substantially affects outdoor recreation  
23 facilities or other public areas; and

24 (C) alter wind in a manner that substantially affects public areas;  
25

1 (4) Inclusive of Inclusionary Units and Middle Income Units HOME-SF Units,  
2 provides either (A) a minimum unit mix of at least 40% of all units as two bedroom units or larger; or  
3 (B) any unit mix which includes some three bedroom or larger units such that 50% of all  
4 bedrooms within the Local HOME-SF Project are provided in units with more than one bedroom.  
5 Larger units should be distributed on all floors, and prioritized in spaces adjacent to open  
6 spaces or play yards. Project that include three bedroom units are encouraged to incorporate  
7 family friendly amenities. Family friendly amenities shall include, but are not limited to,  
8 bathtubs, dedicated cargo bicycle parking, dedicated stroller storage, open space and yards  
9 designed for use by children. Local HOME-SF Projects are not eligible to modify this requirement  
10 under Planning Code Section 303(t), 328, or any other provision of this Code; and,

11 ~~(5) Provides replacement units for any units demolished or removed that are~~  
12 ~~subject to the San Francisco Rent Stabilization and Arbitration Ordinance, San Francisco~~  
13 ~~Administrative Code Section 37, or are units qualifying for replacement as units being~~  
14 ~~occupied by households of Low or Very Low Income, consistent with the requirements of~~  
15 ~~Government Code section 65915(c)(3).~~

16 (5) Does not demolish, remove or convert any residential units.

17 (6) Includes at the ground floor level active uses, as defined in Section 145.1, at  
18 the same square footages as any neighborhood commercial uses demolished or removed,  
19 unless the Planning Commission has granted an exception under Section 303(st)(2)(G).

20 (d) Development Bonuses. Any Local Project shall, at the project sponsor's request, receive  
21 any or all of the following:

22 (1) Form based density. Notwithstanding any zoning designation to the contrary,  
23 density of a Local HOME-SF Project shall not be limited by lot area but rather by the applicable  
24 requirements and limitations set forth elsewhere in this Code. Such requirements and limitations  
25 include, but are not limited to, height, including any additional height allowed by subsection (d)(2),

1 Bulk, Setbacks, Required Open Space, Exposure and unit mix as well as applicable design guidelines,  
2 elements and area plans of the General Plan and design review, including consistency with the  
3 Affordable Housing Bonus Program Design Guidelines, referenced in Section 328, as determined by  
4 the Planning Department.

5 (2) Height. Up to 20 additional feet above the height authorized for the Local HOME-  
6 SF Project under the Height Map of the Zoning Map. This additional height may only be used to  
7 provide up to two additional 10-foot stories to the project, or one additional story of no more than 10  
8 feet in height. Building features exempted from height controls under Planning Code Section 260(b)  
9 shall be measured from the roof level of the highest story provided under this section.

10 (3) Ground Floor Ceiling Height. In addition to the permitted height allowed under  
11 (d)(2), Local HOME-SF Projects with active uses on the ground floor as defined in Section  
12 145.1(b)(2) shall receive up to a maximum of 5 additional feet in height above the height limit, in  
13 addition to the additional 20 feet granted in subsection (2) above. However, the additional 5 feet may  
14 only be applied at the ground floor to provide a 14-foot (floor to ceiling) ceiling height for  
15 nonresidential uses, and to allow walk-up dwelling units to be consistent with the Ground Floor  
16 Residential Design Guidelines. This additional 5 feet shall not be granted to projects that already  
17 receive such a height increase under Planning Code Section 263.20.

18 (4) Zoning Modifications. HOME-SF Local Affordable Housing Bonus Projects  
19 may select up to three of the following zoning modifications:

20 (A) Rear yard: The required rear yard per Section 134 or any applicable  
21 special use district may be reduced to no less than 20 percent of the lot depth, or 15 feet, whichever is  
22 greater. Corner properties may provide 20 percent of the lot area at the interior corner of the property  
23 to meet the minimum rear yard requirement, provided that each horizontal dimension of the open area  
24 is a minimum of 15 feet; and that the open area is wholly or partially contiguous to the existing  
25 midblock open space, if any, formed by the rear yards of adjacent properties.

1                    (B) Dwelling Unit Exposure: The dwelling unit exposure requirements of  
2 Section 140(a)(2) may be satisfied through qualifying windows facing an unobstructed open area that  
3 is no less than 25 feet in every horizontal dimension, and such open area is not required to expand in  
4 every horizontal dimension at each subsequent floor.

5                    (C) Off-Street Loading: Off-street loading spaces per Section 152 shall not be  
6 required.

7                    (D) Automobile Parking: Up to a 75% reduction in the residential and  
8 commercial parking requirements in Section 151 or any applicable special use district.

9                    (E) Open Space: Up to a 5% reduction in common open space if provided  
10 under Section 135 or any applicable special use district.

11                    (F) Additional Open Space: Up to an additional 5% reduction in common open  
12 space if provided under Section 135 or any applicable special use district, beyond the 5% provided in  
13 subsection (E) above.

14                    (G) Inner Courts as Open Space: In order for an inner court to qualify as  
15 useable common open space, Section 135(g)(2) requires it to be at least 20 feet in every horizontal  
16 dimension, and for the height of the walls and projections above the court on at least three sides (or 75  
17 percent of the perimeter, whichever is greater) to be no higher than one foot for each foot that such  
18 point is horizontally distant from the opposite side of the clear space in the court. HOME-SF Local  
19 Affordable Housing Bonus Projects may instead provide an inner court that is at least 25 feet in  
20 every horizontal dimension, with no restriction on the heights of adjacent walls. All area within such an  
21 inner court shall qualify as common open space under Section 135.

22                    (e) Implementation.

23                    (1) Application. The following procedures shall govern the processing of a  
24 request for a project to qualify under the Local Program.  
25

1                   (A) An application to participate in the HOME-SF Local Program shall be  
2 submitted with the first application for approval of a Housing Project and processed concurrently with  
3 all other applications required for the Housing Project. The application shall be submitted on a form  
4 prescribed by the City and shall include at least the following information:

5                   (iA) A full plan set, including a site plan, elevations, sections and floor  
6 plans, showing total number of units, number of and location of Inclusionary Units, and Middle  
7 Income HOME-SF Units; and a draft Regulatory Agreement;

8                   (ii) ~~The number of dwelling units which are on the property, or if~~  
9 ~~the dwelling units have been vacated or demolished in the five year period preceding the~~  
10 ~~application, have been and which were subject to a recorded covenant, ordinance, or law that~~  
11 ~~restricts rents to levels affordable to persons and families of lower or very low income; subject~~  
12 ~~to any other form of rent or price control through the City or other public entity's valid exercise~~  
13 ~~of its police power; or occupied by lower or very low income households; and~~

14                   (iii) ~~If the property includes a parcel or parcels in which dwelling~~  
15 ~~units under subsection (ii) are located or were located in the five year period preceding the~~  
16 ~~application, the type and size of those units, and the incomes of the persons or families~~  
17 ~~occupying those units.~~

18                   (ivB) The requested development bonuses and/or zoning modifications  
19 from those listed in subsection (d).

20                   (C) A list of all on-site family friendly amenities. Family friendly  
21 amenities shall include, but are not limited to, dedicated cargo bicycle parking, dedicated  
22 stroller storage, open space and yards designed for use by children.

23                   (BD) Documentation that the applicant has provided written notification to all  
24 existing commercial or residential tenants that the applicant intends to develop the property pursuant  
25 to this section and has provided any existing commercial tenants with a copy of the Mayor's

1 Office of Economic and Workforce Development's Guide to Small Business Retention and  
2 Relocation Support. Any affected commercial tenants shall be given priority processing similar to the  
3 Department's Community Business Priority Processing Program, as adopted by the San Francisco  
4 Commission on February 12, 2015 under Resolution Number 19323, to support relocation of such  
5 business in concert with access to relevant local business support programs.

6 (2) Procedures Manual. The Planning Department and MOHCD shall amend the  
7 Procedures Manual, authorized in Section 415, to include policies and procedures for the  
8 implementation, including monitoring and enforcement, of the HOME-SF Units. Middle Income  
9 units. As an amendment to the Procedures Manual, such policies and procedures are subject to review  
10 and approval by the Planning Commission under Section 415. Amendments to the Procedures Manual  
11 shall include a requirement that project sponsors in specified areas complete a market survey of the  
12 area before marketing Middle Income Units HOME-SF Units. All HOME-SF Units affordable  
13 units that are affordable to households between 120 and 140% of AMI must be marketed at a  
14 price that is at least 20% less than the current market rate for that unit size and neighborhood, in  
15 addition to any other applicable Program requirements and MOHCD may reduce the Area Median  
16 Income levels set forth in subsection (c)(2) in order maintain such pricing.

17 (3) Notice and Hearing. Local Projects shall comply with Section 328 306 for review  
18 and approval.

19 (4) Controls. Local Projects shall be governed by the conditional use procedures  
20 of Section 303, comply with Section 328. Notwithstanding any other provision of this Code, no  
21 conditional use authorization shall be required for a Local Project unless such conditional use  
22 requirement was adopted by the voters.

23 (5) Regulatory Agreements. Recipients of a Density Bonus, Incentive, Concession,  
24 waiver, or modification shall enter into a Regulatory Agreement with the City, as follows.

1                   (A) The terms of the agreement shall be acceptable in form and content to the  
2 Planning Director, the Director of MOHCD, and the City Attorney. The Planning Director shall have  
3 the authority to execute such agreements.

4                   (B) Following execution of the agreement by all parties, the completed Density  
5 Bonus Regulatory Agreement, or memorandum thereof, shall be recorded and the conditions filed and  
6 recorded on the Housing Project.

7                   (C) The approval and recordation of the Regulatory Agreement shall take place  
8 prior to the issuance of the First Construction Document. The Regulatory Agreement shall be binding  
9 to all future owners and successors in interest.

10                   (D) The Regulatory Agreement shall be consistent with the guidelines of the  
11 City's Inclusionary Housing Program and shall include at a minimum the following:

12                   (i) The total number of dwelling units approved for the Housing Project,  
13 including the number of ~~Restricted-Affordable Units, Inclusionary Units, HOME-SF Units Middle~~  
14 Income Units or other restricted units;

15                   (ii) A description of the household income group to be accommodated by  
16 the ~~Restricted-Affordable Units~~Inclusionary Units and HOME-SF Units, and the standards for  
17 determining the corresponding Affordable Rent or Affordable Sales Price. If required by the  
18 Procedures Manual, the ~~The~~ project sponsor must commit to completing a market survey of the  
19 area before marketing ~~Middle Income~~HOME-SF Units. All affordable units that are affordable to  
20 households between 120 and 140% of AMI ~~HOME-SF Units~~ must be marketed at a price that is  
21 at least 20% less than the current market rate for that unit size and neighborhood, in addition to any  
22 other applicable Program requirements and MOHCD may reduce the Area Median Income  
23 levels set forth in subsection (c)(2) in order maintain such pricing;

24                   (iii) The location, dwelling unit sizes (in square feet), and number of  
25 bedrooms of the ~~Inclusionary Units and HOME-SF Units~~Restricted Affordable Units;



1 (iv) Term of use restrictions for the life of the project. Restricted  
2 Affordable Units of at least 55 years for Moderate Income units and at least 55 years for Low  
3 and Very Low units;

4 (v) A schedule for completion and occupancy of Inclusionary Units and  
5 HOME-SF Units Restricted Affordable Units;

6 (vi) A description of any Concession, Incentive, waiver, or modification,  
7 if any, being provided by the City;

8 (vii) A description of remedies for breach of the agreement (the City may  
9 identify tenants or qualified purchasers as third party beneficiaries under the agreement); and

10 (viii) Other provisions to ensure implementation and compliance with  
11 this Section.

12  
13 **SEC. ~~206.3~~206.4. THE 100 PERCENT AFFORDABLE HOUSING BONUS**  
14 **PROGRAM.**

15 \*\*\* \*\*

16 **206.5. STATE RESIDENTIAL DENSITY BONUS PROGRAM: ANALYZED**

17 (a) Purpose: Sections 206.5, 206.6, and 206.7 shall be referred to as the San Francisco State  
18 Residential Density Bonus Program or the State Density Bonus Program. First, the Analyzed State  
19 Density Bonus Program in Section 206.5 offers an expedited process for projects that seek a density  
20 bonus that is consistent with the pre-vetted menu of incentives, concessions and waivers that the  
21 Planning Department and its consultants have already determined are feasible, result in actual cost  
22 reductions, and do not have specific adverse impacts upon public health and safety of the physical  
23 environment. Second the Individually Requested State Density Bonus Program in Section 206.6 details  
24 the review, analysis and approval process for any project seeking a density bonus that is consistent  
25 with State Law, but is not consistent with the requirements for the Analyzed State Density Bonus

1 Program established in Section 206.5. Third, Sections 206.7, describes density bonuses available  
2 under the State code for the provision of childcare facilities.

3 This Section 206.5 implements the Analyzed State Density Bonus Program or "Analyzed State  
4 Program." The Analyzed State Program offers an expedited process for projects that seek a density  
5 bonus that is consistent with, among other requirements set forth below, the pre-vetted menu of  
6 incentives, waiver and concessions.

7 (b) Applicability:

8 (1) A Housing Project that meets all of the requirements of this subsection (b)(1) or is a  
9 Senior Housing Project meeting the criteria of (b)(2) shall be an Analyzed State Density Bonus Project  
10 or an "Analyzed Project" for purposes of Section 206 et seq. A Housing Project that does not meet all  
11 of the requirements of this subsection (b), but seeks a density bonus under State law may apply for a  
12 density bonus under Section 206.6 as an Individually Requested State Density Bonus Project. To  
13 qualify for the Analyzed State Density Bonus Program a Housing Project must meet all of the  
14 following:

15 (A) contain five or more residential units, as defined in Section 102, not  
16 including any Group Housing as defined in Section 102, efficiency dwelling units with reduced square  
17 footage defined in Section 318, and Density Bonus Units permitted through this Section 206.5 or other  
18 density program;

19 (B) is not seeking and receiving a density or development bonus under Section  
20 207; the HOME-SF Local Affordable Housing Bonus Program, Section 206.3; the 100 Percent  
21 Affordable Housing Bonus Program, Section 206.4; or any other local or State density bonus program  
22 that provides development bonuses;

23 (C) for projects located in Neighborhood Commercial Districts is not seeking to  
24 merge lots that result in more than 125 in lot frontage on any one street;

1 (D) is located in any zoning district that: (i) is not designated as an RH-1 or  
2 RH-2 Zoning District; (ii) establishes a maximum dwelling unit density through a ratio of number of  
3 units to lot area, including but not limited to, RH-3, RM, RC, C-2, Neighborhood Commercial, Named  
4 Neighborhood Commercial, Chinatown Mixed Use Districts, and SoMa Mixed Use Districts, but only if  
5 the SoMa Mixed Use District has a density measured by a maximum number of dwelling units per  
6 square foot of lot area; (iii) is in the Fillmore Neighborhood Commercial Transit District and  
7 Divisadero Neighborhood Commercial Transit District; and (D) is not in the North of Market  
8 Residential Special Use District, Planning Code Section 249.5 until the Affordable Housing Incentive  
9 Study is completed at which time the Board will review whether the North of Market Residential  
10 Special Use District should continue to be excluded from this Program. The Study will explore  
11 opportunities to support and encourage the provision of housing at the low, moderate, and middle  
12 income range in neighborhoods where density controls have been eliminated. The goal of this analysis  
13 is to incentivize increased affordable housing production levels at deeper and wider ranges of AMI and  
14 larger unit sizes in these areas through 100% affordable housing development as well as below market  
15 rate units within market rate developments; and (E) is not located within the boundaries of the  
16 Northeastern Waterfront Area Plan south of the centerline of Broadway; and (F) is not located  
17 on property under the jurisdiction of the Port of San Francisco.

18 (E) is providing all Inclusionary Units as On-site Units under Section 415.6. If  
19 the Dial Alternative currently proposed in an ordinance in Board of Supervisors File No.  
20 150911 is adopted and permits a project sponsor to provide more Inclusionary Units at higher  
21 AMIs than currently required (referred to as "dialing up"), a project sponsor may dial up and  
22 meet the requirements of this subsection (D). If the Dial Alternative of the Inclusionary  
23 Affordable Housing Program is ever amended to allow a project sponsor to provide fewer  
24 Inclusionary Units at lower AMIs than currently required (referred to as "dialing down"), then a  
25 Project cannot qualify for this Section 206.5 if it elects to dial down.

1 (F) includes a minimum of nine foot ceilings on all residential floors;

2 (G) is seeking only Concessions or Incentives set forth in subsection (c)(4);

3 (H) is seeking height increases only in the form of a waiver as described in  
4 subsection (c)(5); and,

5 (I) Does not demolish, remove, or convert any residential units; and,  
6 ~~provides replacement units for any units demolished or removed that are subject to the San~~  
7 ~~Francisco Residential Rent Stabilization and Arbitration Ordinance, San Francisco~~  
8 ~~Administrative Code Section 37, or are units qualifying for replacement as units being~~  
9 ~~occupied by households of low or very low income, consistent with the requirements of~~  
10 ~~Government Code section 65915(c)(3).~~

11 (J) consists only of new construction, and excluding any project that  
12 includes an addition to an existing structure.

13 (2) A Senior Housing Project, as defined in Section 102, may qualify as an Analyzed  
14 State Density Bonus Project if it follows all of the procedures and conditions set forth in Planning Code  
15 Section 202.2(f).

16 (c) Development Bonuses. All Analyzed State Law Density Bonus Projects shall receive, at the  
17 project sponsor's written request, any or all of the following:

18 (1) Priority Processing. Analyzed Projects that provide 30% or more of Units as On-  
19 site Inclusionary Housing Units or Restricted Affordable Units that meet all of the requirements of for  
20 an Inclusionary Housing Unit shall receive Priority Processing.

21 (2) Density Bonus. Analyzed Projects that provide On-site Inclusionary Housing Units  
22 or Restricted Affordable Units that meet all of the requirements of for an Inclusionary Housing Unit  
23 shall receive a density bonus as described in Table 206.5 A as follows:

24 Table 206.5A

25 Density Bonus Summary – Analyzed

<u>A</u>	<u>B</u>	<u>C</u>	<u>D</u>	<u>E</u>
<u>Restricted Affordable Units or Category</u>	<u>Minimum Percentage of Restricted Affordable Units</u>	<u>Percentage of Density Bonus Granted</u>	<u>Additional Bonus for Each 1% Increase In Restricted Affordable Units</u>	<u>Percentage of Restricted Units Required for Maximum 35% Density Bonus</u>
<u>Very Low Income</u>	<u>5%</u>	<u>20%</u>	<u>2.50%</u>	<u>11%</u>
<u>Lower Income</u>	<u>10%</u>	<u>20%</u>	<u>1.50%</u>	<u>20%</u>
<u>Moderate Income</u>	<u>10%</u>	<u>5%</u>	<u>1%</u>	<u>40%</u>
<u>Senior Citizen Housing, as defined in § 102, and meeting the requirements of § 202.2(f).</u>	<u>100%</u>	<u>50%</u>	<u>-----</u>	<u>-----</u>

Note: A density bonus may be selected from more than one category, up to a maximum of 35% of the Maximum Allowable Gross Residential Density.

In calculating density bonuses under this subsection 206.5(c)(2) the following shall apply:

(A) When calculating the number of permitted Density Bonus Units or Restricted Affordable Units, any fractions of units shall be rounded to the next highest number. Analyzed Density Bonus Program projects must include the minimum percentage of Restricted Affordable Units identified in Column B of Table 206.5A for at least one income category, but may combine density bonuses from more than one income category, up to a maximum of 35% of the Maximum Allowable Gross Residential Density.

(B) An applicant may elect to receive a Density Bonus that is less than the amount permitted by this Section; however, the City shall not be required to similarly reduce the number of Restricted Affordable Units required to be dedicated pursuant to this Section and Government Code Section 65915(b).

1 (C) In no case shall a Housing Project be entitled to a Density Bonus of more  
2 than 35%, unless it is a Senior Housing Project meeting the requirements of Section 202.2(f).

3 (D) The Density Bonus Units shall not be included when determining the  
4 number of Restricted Affordable Units required to qualify for a Density Bonus. Density bonuses shall  
5 be calculated as a percentage of the Maximum Allowable Gross Residential Density.

6 (E) Any Restricted Affordable Unit provided pursuant to the on-site  
7 requirements of the Inclusionary Affordable Housing Program, Section 415 et seq., shall be included  
8 when determining the number of Restricted Affordable Units required to qualify for a Development  
9 Bonus under this Section 206.5. The payment of the Affordable Housing Fee shall not qualify for a  
10 Development Bonus under this Section. The provision of Off-site Units shall not qualify the Principal  
11 Project for a Density Bonus under this Section; however an Off-site Unit may qualify as a Restricted  
12 Affordable Unit to obtain a density bonus for the Off-site Project.

13 (F) In accordance with state law, neither the granting of a Concession,  
14 Incentive, waiver, or modification, nor the granting of a Density Bonus, shall be interpreted, in and of  
15 itself, to require a general plan amendment, zoning change, variance, or other discretionary approval.

16 (3) Concessions and Incentives. Analyzed Projects shall receive concessions or  
17 incentives, in the amounts specified in Table 206.5B :

18 Table 206.5B

19 Concessions and Incentives Summary – Analyzed Projects

<u>Target Group</u>	<u>Restricted Affordable Units</u>		
<u>Very Low Income</u>	<u>5%</u>	<u>10%</u>	<u>15%</u>
<u>Lower Income</u>	<u>10%</u>	<u>20%</u>	<u>30%</u>
<u>Moderate Income (Common Interest Development)</u>	<u>10%</u>	<u>20%</u>	<u>30%</u>
<u>Maximum Incentive(s)/Concession(s)</u>	<u>1</u>	<u>2</u>	<u>3</u>

1 Notes: 1. Concessions or Incentives may be selected from only one category (very low, lower,  
2 or moderate) 2. Common Interest Development is defined in California Civil Code Section 4100.

3 (4) Menu of Concessions and Incentives: In submitting a request for Concessions or  
4 Incentives, an applicant for an Analyzed State Density Bonus Project may request the specific  
5 Concessions and Incentives set forth below. The Planning Department, based on Department research  
6 and a Residential Density Bonus Study prepared by David Baker Architects, Seifel Consulting, and the  
7 San Francisco Planning Department dated August 2015, on file with the Clerk of the Board of  
8 Supervisors in File No. 150969, has determined that the following Concessions and Incentives are  
9 generally consistent with Government Code Section 65915(d) because, in general, they: are required  
10 in order to provide for affordable housing costs; will not be deemed by the Department to have a  
11 specific adverse impact as defined in Government Code Section 65915(d); and are not contrary to State  
12 or Federal law.

13 (A) Rear yard: the required rear yard per Section 134 or any applicable special  
14 use district may be reduced to no less than 20% of the lot depth, or 15 feet, whichever is greater.  
15 Corner properties may provide 20% of the lot area at the interior corner of the property to meet the  
16 minimum rear yard requirement, provided that each horizontal dimension of the open area is a  
17 minimum of 15 feet; and that the open area is wholly or partially contiguous to the existing midblock  
18 open space, if any, formed by the rear yards of adjacent properties.

19 (B) Dwelling Unit Exposure: the dwelling unit exposure requirements of  
20 Section 140(a)(2) may be satisfied through qualifying windows facing an unobstructed open area that  
21 is no less than 25 feet in every horizontal dimension, and such open area is not required to expand in  
22 every horizontal dimension at each subsequent floor.

23 (C) Off-Street Loading: off-street loading spaces under Section 152 shall not  
24 be required.

1 (D) Parking: up to a 50% reduction in the residential and commercial parking  
2 requirement, per Section 151 or any applicable special use district.

3 (E) Open Space: up to a 5% reduction in required common open space per  
4 Section 135, or any applicable special use district.

5 (F) Additional Open Space: up to an additional 5% reduction in required  
6 common open space per Section 135 or any applicable special use district, beyond the 5% provided in  
7 subsection (E) above.

8 (5) Waiver or Modification of Height Limits. Analyzed Projects may request a waiver  
9 of the applicable height restrictions if the applicable height limitation will have the effect of physically  
10 precluding the construction of a Housing Project at the densities or with the Concessions or Incentives  
11 permitted by this subsection (c)(4). Analyzed Projects may receive a height bonus as of right of up to  
12 twenty feet or two stories, excluding exceptions permitted per Section 260(b), if the applicant  
13 demonstrates that it qualifies for a height waiver through the following formula:

14 **Step one: Calculate Base Density and Bonus Density Limits**

15 Calculate Base Density (BD), as defined in Section 206.2.

16 Bonus Density Limit (BD): ED multiplied by 1.XX where XX is the density bonus  
17 requested per Section 206.5 of this Code (e.g. 7%, 23%, 35%), not to exceed 1.35, the maximum density  
18 bonus available by this Section.

19 **Step two: Calculate Permitted Envelope (PE).** Buildable envelope available under  
20 existing height and bulk controls.

21 PE equals lot area multiplied by permitted lot coverage, where lot coverage equals .75,  
22 or .8 if the developer elects to request a rear yard modification under Section 206.5(c)(4)(A), multiplied  
23 by existing height limit (measured in number of stories), minus one story for projects in districts where  
24 non-residential uses are required on the ground floor, and minus any square footage subject to bulk  
25 limitations (for parcels that do not have an X bulk designation).



1                   Step three: Calculate Bonus Envelope (BE) Residential envelope necessary to  
2 accommodate additional density ("Bonus envelope" or "BE")

3                   BE equals Bonus Density multiplied by 1,000 gross square feet

4                   Step four: Calculate Additional Residential Floors. Determine the number of stories  
5 required to accommodate bonus:

6                   (A) If BE is less than or equal to PE, the project is not awarded height under  
7 this subsection (c)(5).

8                   (B) If BE is greater than PE, the project is awarded height, as follows:

9                   (i) If BE minus PE is less than the lot area multiplied by 0.75, project is  
10 allowed 1 extra story; total gross square footage of building not to exceed BE;

11                   (ii) If BE minus PE is greater than the lot area multiplied by 0.75 (i.e. if  
12 the difference is greater than one story), project is allowed two extra stories; total gross square footage  
13 of building not to exceed BE.

14                   (d) Application. An application for an Analyzed State Density Bonus Project under this  
15 Section 206.5 shall be submitted with the first application for approval of a Housing Project and shall  
16 be processed concurrently with all other applications required for the Housing Project. The  
17 application shall be on a form prescribed by the City and, in addition to any information required for  
18 other applications, shall include the following information:

19                   (1) A description of the proposed Housing Project, including the total number of  
20 dwelling units, Restricted Affordable Units, and Density Bonus Units proposed;

21                   (2) Any zoning district designation, Base Density, assessor's parcel number(s) of the  
22 project site, and a description of any Density Bonus, Concession or Incentive, or waiver requested;

23                   (3) A list of the requested Concessions and Incentives from Section 206.5(c)(4);

24                   (4) If a waiver or modification of height is requested under Section 206.5(c)(5), a  
25 calculation demonstrating how the project qualifies for such waiver under the formula;

1                    (5) A full plan set including site plan, elevations, sections, and floor plans, number of  
2 market-rate units, Restricted Affordable Units, and Density Bonus units within the proposed Housing  
3 Project. The location of all units must be approved by the Planning Department before the issuance of  
4 the building permit;

5                    (6) Level of affordability of the Restricted Affordable Units and a draft Regulatory  
6 Agreement;

7                    ~~(7) The number of rental dwelling units which are on the property, or if the~~  
8 ~~dwelling units have been vacated or demolished in the five-year period preceding the~~  
9 ~~application, have been and which were subject to a recorded covenant, ordinance, or law that~~  
10 ~~restricts rents to levels affordable to persons and families of lower or very low income; subject~~  
11 ~~to any other form of rent or price control through the City or other public entity's valid exercise~~  
12 ~~of its police power; or occupied by lower or very low income households; and~~

13                    ~~(8) If the property includes a parcel or parcels in which dwelling units under~~  
14 ~~subsection (7) are located or were located in the five-year period preceding the application,~~  
15 ~~the type and size of those units, and the incomes of the persons or families occupying those~~  
16 ~~units.~~

17                    (97) Documentation that the applicant has provided written notification to all existing  
18 commercial or residential tenants that the applicant intends to develop the property pursuant to this  
19 section. Any affected commercial tenants shall be given priority processing similar to the  
20 Department's Community Business Priority Processing Program, as adopted by the San Francisco  
21 Commission on February 12, 2015 under Resolution Number 19323 to support relocation of such  
22 business in concert with access to relevant local business support programs. In no case may a  
23 project receive a site permit or any demolition permit prior to 18 months from the date of  
24 written notification required by this Section 206.5(d)(7).

1           (e) Review Procedures. An application for an Analyzed State Density Bonus Project, shall be  
2 acted upon concurrently with the application for other permits related to the Housing Project.

3           (1) Before approving an application for an Analyzed Project, the Planning Department  
4 or Commission shall make written findings that the Housing Project is qualified as an Analyzed State  
5 Density Bonus Project.

6           (2) The review procedures for an Analyzed Project, including notice, hearings, and  
7 appeal, shall be the procedures applicable to the Housing Project regardless of whether it is applying  
8 for a State Density Bonus under this Section 206.5. However, any notice shall specify that the Housing  
9 Project is seeking a Development Bonus and shall provide a description of the Development Bonuses  
10 requested. Analyzed Projects shall also be reviewed for consistency with the Affordable Housing Bonus  
11 Program Design Guidelines.

12           (f) Regulatory Agreements. Recipients of a Density Bonus, Incentive, Concession, waiver, or  
13 modification shall enter into a Regulatory Agreement with the City, as follows.

14           (1) The terms of the agreement shall be acceptable in form and content to the  
15 Planning Director, the Director of MOHCD, and the City Attorney. The Planning Director shall have  
16 the authority to execute such agreements.

17           (2) Following execution of the agreement by all parties, the completed Density  
18 Bonus Regulatory Agreement, or memorandum thereof, shall be recorded and the conditions filed and  
19 recorded on the Housing Project.

20           (3) The approval and recordation of the Regulatory Agreement shall take place  
21 prior to the issuance of the First Construction Document. The Regulatory Agreement shall be binding  
22 to all future owners and successors in interest.

23           (4) The Regulatory Agreement shall be consistent with the guidelines of the  
24 City's Inclusionary Housing Program and shall include at a minimum the following: (4) The  
25

1 Regulatory Agreement shall be consistent with the guidelines of the City's Inclusionary Housing  
2 Program and shall include at a minimum the following:

3 (A) The total number of dwelling units approved for the Housing Project,  
4 including the number of Restricted Affordable Units, Inclusionary Units, HOME-SF Units -Middle  
5 Income Units or other restricted units;

6 (B) A description of the household income group to be accommodated by  
7 the Restricted Affordable Units, and the standards for determining the corresponding Affordable Rent  
8 or Affordable Sales Price;

9 (C) The location, dwelling unit sizes (in square feet), and number of  
10 bedrooms of the Restricted Affordable Units;

11 (D) Term of use restrictions for Restricted Affordable Units of at least 55  
12 years for Moderate Income units and at least 55 years for Low and Very Low units;

13 (E) A schedule for completion and occupancy of Restricted Affordable  
14 Units;

15 (F) A description of any Concession, Incentive, waiver, or modification,  
16 if any, being provided by the City;

17 (G) A description of remedies for breach of the agreement (the City may  
18 identify tenants or qualified purchasers as third party beneficiaries under the agreement); and

19 (H) Other provisions to ensure implementation and compliance with this  
20 Section.

21  
22 **SEC. 206.6. STATE DENSITY BONUS PROGRAM: INDIVIDUALLY REQUESTED**

23 (a) Purpose and Findings: This Section 206.6 details the review, analysis and approval  
24 process for any project seeking a density bonus that is consistent with State Law, Government Code  
25 section 65915 et seq., but is not consistent with the pre-vetted menu of concessions, incentives or

1 waivers, or other requirements established in Section 206.5 as analyzed by the Planning Department in  
2 coordination with David Baker and Seifel Consulting, and shall be known as the Individually Requested  
3 State Density Bonus Program

4 California State Density Bonus Law allows a housing developer to request parking ratios not to  
5 exceed the ratios set forth in Government Code section 65915(p)(1), which may further be reduced as  
6 an incentive or concession. Because in most cases San Francisco regulates parking by dwelling unit as  
7 described in Article 1.5 of this Code, the minimum parking ratios set forth in the Government Code are  
8 greater than those allowed in San Francisco. Given that San Francisco's parking ratios are already  
9 less than the State ratios, the City finds that the State's minimum parking ratio requirement does not  
10 apply.

11 (b) Applicability. A Housing Project that does not meet any one or more of the criteria of  
12 Section 206.5(b) under the Analyzed State Density Bonus Program, but meets the following  
13 requirements, may apply for a Development Bonus under this Section 206.6 as an "Individually  
14 Requested State Density Bonus Project" or "Individually Requested Project" if it meets all of the  
15 following criteria:

16 (1) contains five or more residential units, as defined in Section 102;

17 (2) is not seeking and receiving a density or development bonus under Section 207; the  
18 HOME-SF Local Affordable Housing Bonus Program, Section 206.3; the 100 Percent Affordable  
19 Housing Bonus Program, Section 206.4; Section 304, or any other local or state bonus program that  
20 provides development bonuses.

21 (3) provides Restricted Affordable Housing Units, including but not limited to  
22 Inclusionary Housing Units, at minimum levels as provided in Table 206.6A; and;

23 (4) provides replacement units for any units demolished or removed that are subject to  
24 the San Francisco Rent Stabilization and Arbitration Ordinance, San Francisco Administrative Code  
25

1 Section 37, or are units qualifying for replacement as units being occupied by households of low or  
2 very low income, consistent with the requirements of Government Code section 65915(c)(3).

3 (5) Is in any zoning district except for RH-1 or RH-2, unless the Code permits the  
4 development of a project of 5 units or more on a site or sites.

5 (c) Development Bonuses. Any Individually Requested Density Bonus Project shall, at the  
6 project sponsor's request, receive any or all of the following:

7 (1) Density Bonus. Individually Requested Projects that provide On-site Inclusionary  
8 Housing Units or Restricted Affordable Units shall receive a density bonus as described in Table  
9 206.6A as follows:

10 Table 206.6 A

11 Density Bonus Summary – Individually Requested Project

<u>Restricted Affordable Units or Category</u>	<u>Minimum Percentage of Restricted Affordable Units</u>	<u>Percentage of Density Bonus Granted</u>	<u>Additional Bonus for Each 1% Increase In Restricted Affordable Units</u>	<u>Percentage of Restricted Units Required for Maximum 35% Density Bonus</u>
<u>Very Low Income</u>	<u>5%</u>	<u>20%</u>	<u>2.50%</u>	<u>11%</u>
<u>Lower Income</u>	<u>10%</u>	<u>20%</u>	<u>1.50%</u>	<u>20%</u>
<u>Moderate Income</u>	<u>10%</u>	<u>5%</u>	<u>1%</u>	<u>40%</u>
<u>Senior Citizen Housing</u>	<u>100%</u>	<u>20%</u>	<u>-----</u>	<u>-----</u>

12 Note: A density bonus may be selected from only one category up to a maximum of 35% of the  
13 Maximum Allowable Gross Residential Density.

14 In calculating density bonuses under this subsection 206.6(c)(1) the following shall  
15 apply:

16 (A) When calculating the number of permitted Density Bonus Units or Restricted  
17 Affordable Units, any fractions of units shall be rounded to the next highest number.

1                   (B) An applicant may elect to receive a Density Bonus that is less than the  
2 amount permitted by this Section; however, the City shall not be required to similarly reduce the  
3 number of Restricted Affordable Units required to be dedicated pursuant to this Section and  
4 Government Code Section 65915(b).

5                   (C) Each Housing Project is entitled to only one Density Bonus, which shall be  
6 selected by the applicant based on the percentage of Very Low Income Restricted Affordable Units,  
7 Lower Income Restricted Affordable Units, or Moderate Income Restricted Affordable Units, or the  
8 Housing Project's status as a Senior Citizen Housing Development. Density bonuses from more than  
9 one category may not be combined. In no case shall a Housing Project be entitled to a Density Bonus  
10 of more than thirty-five percent (35%), unless it is a Senior Housing Project meeting the requirements  
11 of Section 202.2(f).

12                   (D) The Density Bonus Units shall not be included when determining the  
13 number of Restricted Affordable Units required to qualify for a Density Bonus. Density bonuses shall  
14 be calculated as a percentage of the Maximum Allowable Gross Residential Density.

15                   (E) Any Restricted Affordable Unit provided pursuant to the on-site  
16 requirements of the Inclusionary Affordable Housing Program, Section 415 et seq., shall be included  
17 when determining the number of Restricted Affordable Units required to qualify for a Development  
18 Bonus under this Section 206.6. The payment of the Affordable Housing Fee shall not qualify for a  
19 Development Bonus under this Section. The provision of Off-site Units shall not qualify the Principal  
20 Project for a Density Bonus under this Section; however an Off-site Unit may qualify as a Restricted  
21 Affordable Unit to obtain a density bonus for the Off-site Project.

22                   (F) In accordance with state law, neither the granting of a Concession,  
23 Incentive, waiver, or modification, nor the granting of a Density Bonus, shall be interpreted, in and of  
24 itself, to require a general plan amendment, zoning change, variance, or other discretionary approval.  
25

1 (G) No additional Density Bonus shall be authorized for a Senior Citizen  
2 Development beyond the Density Bonus authorized by subsection (1) of this Section.

3 (H) Certain other types of development activities are specifically eligible for a  
4 development bonuses pursuant to State law, including land donation under Government Code Section  
5 65915(g), condominium conversions under Government Code section 65915.5 and qualifying mobile  
6 home parks under Government Code section 65915(b)(1)(C). Such projects shall be considered  
7 Individually Requested State Density Bonus Projects.

8 (2) Concessions and Incentives. This Section includes provisions for providing  
9 Concessions or Incentives pursuant to Government Code Section 65915 et seq, as set forth in Table  
10 206.6B. For purposes of this Section 206.6, Concessions and Incentives as used interchangeably shall  
11 mean such regulatory concessions as specified in Government Code Section 65915(k) to include:

12 (A) A reduction of site Development Standards or architectural design  
13 requirements which exceed the minimum applicable building standards approved by the State  
14 Building Standards Commission pursuant to Part 2.5 (commencing with Section 18901) of Division 13  
15 of the Health and Safety Code, including, but not limited to, a reduction in setback, coverage, and/or  
16 parking requirements which result in identifiable, financially sufficient and actual cost reductions;

17 (B) Allowing mixed use development in conjunction with the proposed  
18 residential development, if nonresidential land uses will reduce the cost of the residential project and  
19 the nonresidential land uses are compatible with the residential project and existing or planned  
20 development in the area where the Housing Project will be located; and

21 (C) Other regulatory incentives or concessions proposed by the developer or the  
22 City that result in identifiable, financially sufficient, and actual cost reductions.

23 Table 206.6B

24 Concessions and Incentives Summary – Individually Requested Project

<u>Target Group</u>	<u>Restricted Affordable Units</u>
---------------------	------------------------------------



1	<u>Very Low Income</u>	<u>5%</u>	<u>10%</u>	<u>15%</u>
2	<u>Lower Income</u>	<u>10%</u>	<u>20%</u>	<u>30%</u>
3	<u>Moderate Income (Common Interest Development)</u>	<u>10%</u>	<u>20%</u>	<u>30%</u>
4	<u>Maximum Incentive(s)/Concession(s)</u>	<u>1</u>	<u>2</u>	<u>3</u>

5 Notes: 1. Concessions or Incentives may be selected from only one category (very low, lower, or  
6 moderate). 2. Common Interest Development is defined in California Civil Code Section 4100.

7 (3) Request for Concessions and Incentives. In submitting a request for Concessions or  
8 Incentives that are not specified in Section 206.5(c)(4), an applicant for an Individually Requested  
9 Density Bonus Project must provide documentation described in subsection (d) below in its application.  
10 The Planning Commission shall hold a hearing and shall approve the Concession or Incentive  
11 requested unless it makes written findings, based on substantial evidence that:

12 (A) The Concession or Incentive does not result in identifiable and actual  
13 cost reductions, consistent with Government Code section 65915(k) is not required in order to  
14 provide for affordable housing costs, as defined in Section 50052.5 of the California Health  
15 and Safety Code, or for rents for the Restricted Affordable Units to be as specified in this  
16 Section 206.6; or

17 (B) The Concession or Incentive would have a specific adverse impact, as  
18 defined in Government Code Section 65589.5(d)(2) upon public health and safety or the physical  
19 environment or any real property that is listed in the California Register of Historical Resources and  
20 for which there is no feasible method to satisfactorily mitigate or avoid the specific adverse impact  
21 without rendering the Housing Project unaffordable to low- and moderate-income households.

22 (C) The Concession or Incentive would be contrary to state or federal law.

23 (4) Waiver or Modification. An applicant may apply for a waiver or modification of  
24 Development Standards that will have the effect of physically precluding the construction of a Housing  
25 Project at the densities or with the Concessions or Incentives permitted by this Section 206.6. The  
Planning Commission will not grant a waiver or modification under this Section unless it is necessary

1 to achieve the additional density or the Concessions or Incentives permitted by this Section 206.6. The  
2 developer must submit sufficient information as determined by the Planning Department demonstrating  
3 that Development Standards that are requested to be waived or modified will have the effect of  
4 physically precluding the construction of a Housing Project meeting the criteria of this Section 206.6 at  
5 the densities or with the Concessions or Incentives permitted. The Planning Commission shall hold a  
6 hearing to determine if the project sponsor has demonstrated that the waiver is necessary. The  
7 Planning Commission may deny a waiver if it finds on the basis of substantial evidence that:

8 (A) It is not required to permit the construction of a Housing Project meeting the  
9 density permitted or with the Concessions and Incentives permitted under this Section 206.6;

10 (B) The Waiver is not required in order to provide for affordable housing  
11 costs, as defined in Section 50052.5 of the California Health and Safety Code, or for rents for  
12 the Restricted Affordable Units to be as specified in this Section 206.6;

13 (BC) The Waiver would have a specific adverse impact, as defined in  
14 Government Code Section 65589.5(d)(2) upon public health and safety or the physical environment or  
15 any real property that is listed in the California Register of Historical Resources and for which there is  
16 no feasible method to satisfactorily mitigate or avoid the specific adverse impact without rendering the  
17 Housing Project unaffordable to low- and moderate-income households; or,

18 (CD) The Waiver would be contrary to state or federal law.

19 (5) Nothing in this Section shall be construed to require the provision of direct financial  
20 incentives for the Project, including the provision of publicly owned land by the City or the waiver of  
21 fees or dedication requirements.

22 (d) Application. An application for a Density Bonus, Incentive, Concession, or waiver under  
23 this Section 206.6 shall be submitted with the first application for approval of a Housing Project and  
24 shall be processed concurrently with all other applications required for the Housing Project. The  
25

1 application shall be on a form prescribed by the City and, in addition to any information required for  
2 other applications, shall include the following information:

3 (1) A description of the proposed Project, and a full plan set, including a site plan,  
4 elevations, section and floor plans, with the total number and location of dwelling units, Restricted  
5 Affordable Units, and Density Bonus Units proposed;

6 (2) A plan set sufficient for the Planning Department to determine the project site's  
7 Maximum Allowable Gross Residential Density. The project sponsor shall submit plans for a base  
8 project that demonstrates a Code complying project on the Housing Project site without use of a  
9 modification, Conditional Use Authorization, Variance, Planned Unit Development, or other  
10 exception from of the Planning Code. Such plans shall include similar detail to the proposed Housing  
11 Project. The project sponsor shall demonstrate that site constraints do not limit the Maximum  
12 Allowable Gross Residential Density for the base project in practice. If the project sponsor cannot  
13 make such a showing, the Zoning Administrator shall determine whether the Maximum Allowable  
14 Gross Residential Density shall be adjusted for purposes of this Section.

15 (3) The zoning district designations, Maximum Allowable Gross Residential Density,  
16 assessor's parcel number(s) of the project site, and a description of any Density Bonus, Concession or  
17 Incentive, or waiver requested;

18 (4) If a Concession or Incentive is requested that is not included within the menu of  
19 Incentives/Concessions set forth in subsection 206.5(c), a submittal including financial information or  
20 other information providing evidence that the requested Concessions and Incentives result in  
21 identifiable, financially sufficient, and actual cost reductions required in order to provide for  
22 affordable housing costs as defined in Health and Safety Code Section 50052.5, or for rents for the  
23 Restricted Affordable Units to be provided as required under this Program. The cost of reviewing any  
24 required financial information, including, but not limited to, the cost to the City of hiring a consultant  
25

1 to review the financial data, shall be borne by the applicant. The financial information shall include  
2 all of the following items:

3 ~~(A) The actual cost reduction achieved through the Concession or~~  
4 ~~Incentive and;~~

5 ~~(B) Evidence that the cost reduction allows the applicant to provide~~  
6 ~~affordable rents or affordable sales prices; and~~

7 ~~(C) Any other information requested by the Planning Director. The~~  
8 ~~Planning Director may require any financial information including information regarding capital~~  
9 ~~costs, equity investment, debt service, projected revenues, operating expenses, and such~~  
10 ~~other information as is required to evaluate the financial information;~~

11 (5) If a waiver or modification is requested, information sufficient to demonstrate  
12 why a Development Standard would physically preclude the construction of the Development  
13 with the Density Bonus, Incentives, and Concessions requested. a submittal containing the  
14 following information. The cost of reviewing any required information supporting the request for a  
15 waiver, including, but not limited to, the cost to the City of hiring a consultant to review the  
16 architectural information, shall be borne by the applicant.

17 ~~(A) Why the Development Standard would physically preclude the~~  
18 ~~construction of the Development with the Density Bonus, Incentives, and Concessions~~  
19 ~~requested.~~

20 ~~(B) Any other information requested by the Planning Director as is~~  
21 ~~required to evaluate the request;~~

22 (6) Level of affordability of the Restricted Affordable Units and a draft Regulatory  
23 Agreement;

24 (7) The number of residential units which are on the property, or if the residential units  
25 have been vacated or demolished in the five year period preceding the application, have been and

1 which were subject to a recorded covenant, ordinance, or law that restricts rents to levels affordable to  
2 persons and families of lower or very low income; subject to any other form of rent or price control  
3 through the City or other public entity's valid exercise of its police power; or occupied by lower or very  
4 low income households;

5 (8) If the property includes a parcel or parcels in which dwelling units under (6) are  
6 located or were located in the five year period preceding the application, the type and size of those  
7 units, the incomes of the persons or families occupying those units.

8 (9) Documentation that the applicant has provided written notification to all existing  
9 commercial or residential tenants that the applicant intends to develop the property pursuant to this  
10 section. Any affected commercial tenants shall be given priority processing similar to the  
11 Department's Community Business Priority Processing Program, as adopted by the San Francisco  
12 Commission on February 12, 2015 under Resolution Number 19323 to support relocation of such  
13 business in concert with access to relevant local business support programs.

14 (10) If a Density Bonus or Concession is requested for a land donation under  
15 Government Code Section 65915(g), the application shall show the location of the land to be dedicated,  
16 provide proof of site control, and provide evidence that all of the requirements and each of the findings  
17 included in Government Code Section 65915(g) can be made;

18 (11) If a density bonus or Concession is requested for a Child Care Facility under  
19 Section 206.7, the application shall show the location and square footage of the child care facilities  
20 and provide evidence that all of the requirements and each of the findings included in Government  
21 Code Section 65915(h) can be made;

22 (12) If a Density Bonus or Concession is requested for a condominium conversion, the  
23 applicant shall provide evidence that all of the requirements found in Government Code Section  
24 65915.5 can be met.

1           (e) Review Procedures. An application for a Density Bonus, Incentive, Concession, or waiver  
2 shall be acted upon concurrently with the application other permits related to the Housing Project.

3           (1) Before approving an application for a Density Bonus, Incentive, Concession, or  
4 waiver, for any Individually Requested Density Bonus Project, the Planning Commission shall make the  
5 following findings as applicable.

6                   (A) The Housing Project is eligible for the Individually Requested Density  
7 Bonus Program Affordable Housing Bonus Program.

8                   (B) The Housing Project has demonstrated that any Concessions or Incentives  
9 are required in order to provide for affordable reduce actual housing costs, as defined in Section  
10 50052.5 of the California Health and Safety Code, or for rents for the targeted units, based upon the  
11 financial analysis and documentation provided.

12                   (C) If a waiver or modification is requested, a finding that the Development  
13 Standards for which the waiver is requested would have the effect of physically precluding the  
14 construction of the Housing Project with the Density Bonus or Concessions and Incentives permitted.

15                   (D) If the Density Bonus is based all or in part on donation of land, a finding  
16 that all the requirements included in Government Code Section 65915(g) have been met.

17                   (E) If the Density Bonus, Concession or Incentive is based all or in part on the  
18 inclusion of a Child Care Facility, a finding that all the requirements included in Government Code  
19 Section 65915(h) have been met.

20                   (F) If the Concession or Incentive includes mixed-use development, a finding  
21 that all the requirements included in Government Code Section 65915(k)(2) have been met.

22                   (2) If the findings required by subsection (a) of this Section cannot be made, the  
23 Planning Commission may deny an application for a Concession, Incentive, waiver or modification  
24 only if it makes one of the following written findings, supported by substantial evidence:  
25

1                    (A) The Concession, Incentive, waiver or modification is not required to provide  
2 for the affordability levels required for Restricted Affordable Units;

3                    (B) The Concession, Incentive, waiver or modification would have a specific,  
4 adverse impact upon public health or safety or the physical environment or on real property listed in  
5 the California Register of Historic Resources, and there is no feasible method to satisfactorily mitigate  
6 or avoid the specific adverse impact without rendering the Housing Project unaffordable to Low and  
7 Moderate Income households. For the purpose of this subsection, "specific adverse impact" means a  
8 significant, quantifiable, direct, and unavoidable impact, based on objective, identified, written public  
9 health or safety standards, policies, or conditions as they existed on the date that the application for the  
10 Housing Project was deemed complete; or

11                    (C) The Concession, Incentive, waiver or modification is contrary to state or  
12 federal law.

13                    (3) The review procedures for an Individually Requested Density Bonus Project,  
14 including notice, hearings, and appeal, shall be the procedures applicable to the Housing Project  
15 regardless of whether it is applying for a State Density Bonus under this Section 206.6. However, any  
16 notice shall specify that the Housing Project is seeking a Development Bonus and shall provide a  
17 description of the development bonuses requested. Individually Requested Projects shall also be  
18 reviewed for consistency with the Affordable Housing Bonus Program Design Guidelines.

19                    (4) In accordance with state law, neither the granting of a Concession, Incentive,  
20 waiver, or modification, nor the granting of a Density Bonus, shall be interpreted, in and of itself, to  
21 require a general plan amendment, zoning change, variance, or other discretionary approval.

22                    (f) Regulatory Agreements. Recipients of a Density Bonus, Incentive, Concession, waiver, or  
23 modification shall enter into a Regulatory Agreement with the City, as follows.

1                   (1) The terms of the agreement shall be acceptable in form and content to the Planning  
2 Director, the Director of MOHCD, and the City Attorney. The Planning Director shall have the  
3 authority to execute such agreements.

4                   (2) Following execution of the agreement by all parties, the completed Density Bonus  
5 Regulatory Agreement, or memorandum thereof, shall be recorded and the conditions filed and  
6 recorded on the Housing Project.

7                   (3) The approval and recordation of the Regulatory Agreement shall take place prior to  
8 the issuance of the First Construction Document. The Regulatory Agreement shall be binding to all  
9 future owners and successors in interest.

10                   (4) The Regulatory Agreement shall be consistent with the guidelines of the City's  
11 Inclusionary Housing Program and shall include at a minimum the following:

12                   (A) The total number of dwelling units approved for the Housing Project,  
13 including the number of Restricted Affordable Units, Inclusionary Units, Middle-Income HOME-SF  
14 Units or other restricted units;

15                   (B) A description of the household income group to be accommodated by the  
16 Restricted Affordable Units, and the standards for determining the corresponding Affordable Rent or  
17 Affordable Sales Price;

18                   (C) The location, dwelling unit sizes (in square feet), and number of bedrooms  
19 of the Restricted Affordable Units;

20                   (D) Term of use restrictions for Restricted Affordable Units of at least 55 years  
21 for Moderate Income units and at least 55 years for Low and Very Low units;

22                   (E) A schedule for completion and occupancy of Restricted Affordable Units;

23                   (F) A description of any Concession, Incentive, waiver, or modification, if any,  
24 being provided by the City;



1 (G) A description of remedies for breach of the agreement (the City may identify  
2 tenants or qualified purchasers as third party beneficiaries under the agreement); and

3 (H) Other provisions to ensure implementation and compliance with this  
4 Section.

5 **SEC. 206.7. CHILD CARE FACILITIES.**

6 (a) For purposes of this Section 206.7, "Child Care Facility" means a child day care facility  
7 other than a family day care home, including, but not limited to, infant centers, preschools, extended  
8 day care facilities, and school age child care centers

9 (b) When an applicant proposes to construct a Housing Project that is eligible for a Density  
10 Bonus under Section 206.6 and includes a Child Care Facility that will be located on the premises of,  
11 as part of, or adjacent to, the Housing Project, all of the provisions of this Section 206.7 shall apply  
12 and all of the provisions of Section 206.6 shall apply, except as specifically provided in this Section  
13 206.7.

14 (c) When an applicant proposes to construct a Housing Project that is eligible for a Density  
15 Bonus under Section 206.6 and includes a Child Care Facility that will be located on the premises of,  
16 as part of, or adjacent to, the Housing Project, the City shall grant either:

17 (1) An additional density bonus that is an amount of square feet of residential space  
18 that is equal to or greater than the square footage of the Child Care Facility; or

19 (2) An additional Concession or Incentive that contributes significantly to the economic  
20 feasibility of the construction of the Child Care Facility.

21 (d) The City shall require, as a condition of approving the Housing Project, that the following  
22 occur:

23 (1) The Child Care Facility shall remain in operation for a period of time that is as long  
24 as or longer than the period of time during which the Affordable Units are required to remain  
25

1 affordable. In the event the childcare operations cease to exist, the Zoning Administrator may approve  
2 in writing an alternative community service use for the child care facility.

3 (2) Of the children who attend the Child Care Facility, the children of Very Low, Lower  
4 and Moderate Income households shall equal a percentage that is equal to or greater than the  
5 percentage of Restricted Affordable Units in the Housing Project that are required for Very Low,  
6 Lower and Moderate Income households pursuant to Section 206.6.

7 (e) Notwithstanding subsections (a) and (b) above, the City shall not be required to provide a  
8 density bonus or a Concession or Incentive for a child care facility if it finds, based upon substantial  
9 evidence, that the community has adequate child care facilities.

10  
11 SEC. ~~206.4-206.8.~~ 100 PERCENT AFFORDABLE HOUSING BONUS PROGRAM  
12 EVALUATION.

13 (a) Within one year from the effective date of Section 206, the Planning Department  
14 shall provide an informational presentation to the Planning Commission, and any other City  
15 agency at their request, presenting an overview of all projects that request or receive  
16 development bonuses under the HOME-SF Local Affordable Housing Bonus Program, the 100  
17 Percent Affordable Housing Bonus Program and the Analyzed and Individually Requested State  
18 Density Bonus Program ("the Bonus Programs").

19 (b) Annual Reporting. The Planning Department, in coordination with MOHCD, shall  
20 include information on projects which request and receive development bonuses under the  
21 Bonus Programs, in the Housing Inventory Report.

22 (c) Report Contents. The Housing Inventory shall include, but not be limited to,  
23 information on the:

- 24 (1) number of projects utilizing the Bonus Programs;
- 25

1 (2) number of units approved and constructed under the Bonus Programs and  
2 the AMI levels of such units;

3 (3) number of additional affordable units in excess of that otherwise required by Section  
4 415;

5 (34) geographic distribution of projects, including the total number of units in  
6 each project, utilizing the Bonus Programs;

7 (45) number of larger unit types, including the number of 3-bedroom units;

8 (56) square feet of units by bedroom count;

9 (67) number of projects with nine or fewer units that participate; and

10 (78) Number of appeals of projects in the Bonus Program and stated reason for  
11 appeal.

12 (d) Program Evaluation and Update.

13 (1) Purpose and Contents. Every five years, beginning five years from the  
14 effective date of Section 206, the Department shall prepare a Program Evaluation and  
15 Update. The Program Evaluation and Update shall include an analysis of the Bonus  
16 Programs' effectiveness as it relates to City policy goals including, but not limited to  
17 Proposition K (November 2014) and the Housing Element. The Program Evaluation and  
18 Update shall include a review of all of the following:

19 (A) Target income levels for the HOME-SF Local Affordable Housing Bonus  
20 Program in relation to market values and assessed affordable housing needs.

21 (B) Feasibility of the Local Affordable Housing Bonus HOME-SF Program,  
22 in relation to housing policy goals, program production, and current market conditions.

23 (AC) Requested and granted concessions and incentives, including  
24 consideration of whether the menu of zoning modification or concessions and incentives set  
25 forth in Section 206.3(c)(5), 206.4(c)(5) and 206.5(c)(4) respond to the needs of projects

1 seeking approvals under the Bonus Program; consideration of whether the elected zoning  
2 modifications or incentives and concessions result in a residential project that responds to the  
3 surrounding neighborhood context; and review and recommendation for additions or  
4 modifications to the list of zoning modifications or concessions and incentives in 206.3(c)(5),  
5 206.4(c)(5) and 206.5(c)(4).

6 (BD) Geography and neighborhood specific considerations. Review and  
7 analysis of where Bonus Program projects are proposed and approved, including an analysis  
8 of land values, zoning, height controls, and neighborhood support.

9 (CE) Review of the process for considering projects under the Bonus  
10 Program, including a review of Section 328, the appeal process, Section 303(t) and other  
11 relevant process considerations.

12 ~~(F) Review and recommendations for additional provisions regarding the~~  
13 ~~protection of neighborhood serving small businesses, including feasibility of providing~~  
14 ~~relocation assistance and requiring rights of first refusal to displaced tenants.~~

15 (2) Public Hearing. The Program Evaluation and Update shall be prepared no  
16 less than every five years, beginning five years from the effective date of this Section 206, and  
17 may be completed as a series of reports and in coordination with ongoing monitoring of  
18 affordable housing policies, or feasibility analyses. The Planning Commission shall hold a  
19 hearing on the Program Evaluation and Update and any recommendations for modification to  
20 any of the Bonus Program.

21 (e) Program Expansion Report. The Board of Supervisors directs the Planning  
22 Department and MOHCD to research, analyze and provide recommendations for further  
23 density and development bonuses for 100% affordable or mixed-income developments. The  
24 Program Expansion Report shall be published within one year of the effective date of Section  
25 206.

1           ~~(f) By January 1, 2017, the Planning Department, in consultation with the Office of~~  
2 ~~Economic and Workforce Development, the Office of Small Business, and the Mayor's Office~~  
3 ~~of Housing and Community Development, non-profit housing developers, and the small~~  
4 ~~business community, shall report on best practices around small business relocation,~~  
5 ~~including but not limited to developing a small business relocation fee or program to provide~~  
6 ~~relocation services and support for all projects entitled under the 100 Percent Affordable~~  
7 ~~Housing Bonus Program.~~

8  
9           Section 3. The Planning Code is hereby amended by ~~adding~~ revising Sections 328, to  
10 read as follows:

11           SEC. 328. 100 PERCENT AFFORDABLE HOUSING BONUS PROJECT  
12 AUTHORIZATION

13           (a) Purpose. The purpose of this Section 328 is to ensure that all 100 Percent  
14 Affordable Housing Bonus projects under Section ~~206.3~~ 206.4 are reviewed in coordination  
15 with priority processing available for certain projects with 100 Percent affordable housing.  
16 While most projects in the 100 Percent Affordable Housing Program will likely be somewhat  
17 larger than their surroundings in order to facilitate higher levels of affordable housing, the  
18 Planning Commission and Department shall ensure that each project is consistent with the  
19 Affordable Housing Bonus Design Guidelines and any other applicable design guidelines, as  
20 adopted and periodically amended by the Planning Commission, so that projects respond to  
21 their surrounding context, while still meeting the City's affordable housing goals.

22           (b) Applicability. This section 328 applies to all qualifying 100 Percent Affordable  
23 Housing Bonus Projects that meet the requirements described in Planning Code Section ~~206.3~~  
24 206.4.

1 (c) Planning Commission Design Review: The Planning Commission shall review and  
2 evaluate all physical aspects of a 100 Percent Affordable Housing Bonus Project at a public  
3 hearing. The Planning Commission recognizes that most qualifying projects will need to be  
4 larger in height and mass than surrounding buildings in order to achieve the 100% Affordable  
5 Housing Bonus Program's affordable housing goals. However, the Planning Commission  
6 may, consistent with the ~~100%~~ Affordable Housing Bonus Program Design Guidelines, and  
7 any other applicable design guidelines, and upon recommendation from the Planning Director,  
8 make minor modifications to a project to reduce the impacts of such differences in scale. The  
9 Planning Commission, upon recommendation of the Planning Director, may also apply the  
10 standards of Section 261.1 to bonus floors for all projects on narrow streets and alleys in  
11 order to ensure that these streets do not become overshadowed, including potential upper  
12 story setbacks, and special consideration for the southern side of East-West streets, and Mid-  
13 block passages, as long as such setbacks do not result in a smaller number of residential  
14 units.

15 Additionally, as set forth in subsection (d) below, the Planning Commission may grant  
16 minor exceptions to the provisions of this Code. However, such exceptions should only be  
17 granted to allow building mass to appropriately shift to respond to surrounding context, and  
18 only when such modifications do not substantially reduce or increase the overall building  
19 envelope permitted by the Program under Section ~~206.3~~ 206.4. All modifications and  
20 exceptions should be consistent with the ~~100%~~ Affordable Housing Bonus Program Design  
21 Guidelines and any other applicable design guidelines. In case of a conflict with other  
22 applicable design guidelines, the ~~100%~~ Affordable Housing Bonus Program Design Guidelines  
23 shall prevail.

24 The Planning Commission may require these or other modifications or conditions, or  
25 disapprove a project, in order to achieve the objectives and policies of the 100 Affordable

1 Housing Bonus Program or the purposes of this Code. This review shall be limited to design  
2 issues including the following:

3 (1) whether the bulk and massing of the building is consistent with the ~~100%~~  
4 Affordable Housing Bonus Design Guidelines.

5 (2) whether building design elements including, but not limited to architectural  
6 treatments, façade design, and building materials, are consistent with the ~~100%~~ Affordable  
7 Housing Bonus Program Design Guidelines and any other applicable design guidelines.

8 (3) whether the design of lower floors, including building setback areas,  
9 commercial space, townhouses, entries, utilities, and parking and loading access is consistent  
10 with the ~~100%~~ Affordable Housing Bonus Program Design Guidelines, and any other  
11 applicable design guidelines.

12 (4) whether the required streetscape and other public improvements such as  
13 tree planting, street furniture, and lighting are consistent with the Better Streets Plan, and any  
14 other applicable design guidelines.

15 (d) Exceptions. As a component of the review process under this Section 328, the  
16 Planning Commission may grant minor exceptions to the provisions of this Code as provided  
17 for below, in addition to the development bonuses granted to the project in Section ~~206.3(e)~~  
18 206.4(c). Such exceptions, however, should only be granted to allow building mass to  
19 appropriately shift to respond to surrounding context, and only when the Planning  
20 Commission finds that such modifications do not substantially reduce or increase the overall  
21 building envelope permitted by the Program under Sections ~~206.3~~206.4 and also are consistent  
22 with the ~~100%~~ Affordable Housing Bonus Design Guidelines. These exceptions may include:

23 (1) Exception from residential usable open space requirements per Section 135,  
24 or any applicable special use district.

1 (2) Exception from satisfaction of loading requirements per Section 152.1, or  
2 any applicable special use district.

3 (3) Exception for rear yards, pursuant to the requirements of Section 134, or  
4 any applicable special use district.

5 (4) Exception from dwelling unit exposure requirements of Section 140, or any  
6 applicable special use district.

7 (5) Exception from satisfaction of accessory parking requirements per Section  
8 152.1, or any applicable special use district.

9 (6) Where not specified elsewhere in this subsection (d), modification of other  
10 Code requirements that could otherwise be modified as a Planned Unit Development (as set  
11 forth in Section 304), irrespective of the zoning district in which the property is located.

12 (e) Required Findings. In its review of any project pursuant to this Section 328, the  
13 Planning Commission shall make the following findings:

14 (1) the use as proposed will comply with the applicable provisions of this Code  
15 and is consistent with the General Plan;

16 (2) the use as proposed will provide development that is in conformity with the  
17 stated purposes of the applicable Use District; and,

18 (3) the use as proposed will contribute to the City's affordable housing goals as  
19 stated in the General Plan.

20 (f) If a 100 Percent Affordable Housing Bonus Project otherwise requires a conditional  
21 use authorization due only to 1) a specific land use, 2) use size limit, or 3) requirement  
22 adopted by the voters, then the Planning Commission shall make all findings and consider all  
23 criteria required by this Code for such use or use size as part of this 100 Percent Affordable  
24 Housing Bonus Project Authorization.

25 (g) Hearing and Decision.



1 (1) Hearing. The Planning Commission shall hold a public hearing for all  
2 projects that are subject to this Section 328.

3 (2) Notice of Hearing. Notice of such hearing shall be provided pursuant to the  
4 same requirements for Conditional Use requests, as set forth in Section 306.3 and 306.8.

5 (3) Director's Recommendations on Modifications and Exceptions. At the  
6 hearing, the Planning Director shall review for the Commission key issues related to the  
7 project based on the review of the project pursuant to subsection (c) and recommend to the  
8 Commission modifications, if any, to the project and conditions for approval as necessary. The  
9 Director shall also make recommendations to the Commission on any proposed exceptions  
10 pursuant to subsection (d).

11 (4) Decision and Imposition of Conditions. The Commission, after public  
12 hearing and, after making appropriate findings, may approve, disapprove or approve subject  
13 to conditions, the project and any associated requests for exceptions. As part of its review and  
14 decision, the Planning Commission may impose additional conditions, requirements,  
15 modifications, and limitations on a proposed project in order to achieve the objectives,  
16 policies, and intent of the General Plan or of this Code.

17 (5) Appeal. The decision of the Planning Commission may be appealed to the  
18 Board of Supervisors by any person aggrieved within 30 days after the date of the decision by  
19 filing a written notice of appeal with the Board of Supervisors, setting forth wherein it is alleged  
20 that there was an error in the interpretation of the provisions of this Section or abuse of  
21 discretion on the part of the Planning Commission. The procedures and requirements for  
22 conditional use appeals in Section 308.1(b) and (c) shall apply to appeals to the Board of  
23 Supervisors under this Section 328.

1 (6) Discretionary Review. No requests for discretionary review shall be  
2 accepted by the Planning Department or heard by the Planning Commission for projects  
3 subject to this Section.

4 (7) Change of Conditions. Once a project is approved, authorization of a  
5 change in any condition previously imposed by the Planning Commission shall require  
6 approval by the Planning Commission subject to the procedures set forth in this Section.

7  
8 Section 4. The Planning Code is hereby amended by amending Section 303, to read as  
9 follows:

10 SEC. 303. CONDITIONAL USES.

11 \*\*\* \*\*

12 (t) Local Affordable Housing Bonus Projects. The purpose of this Section is to ensure  
13 that all Local Affordable Housing Bonus HOME-SF Projects under Section 206.3 are reviewed  
14 in coordination with priority processing available for certain projects with greater levels of  
15 affordable housing. While most projects in the Program will likely be somewhat larger than  
16 their surroundings in order to facilitate higher levels of affordable housing, the Planning  
17 Commission and Department shall ensure that each project is consistent with the Affordable  
18 Housing Bonus Design Guidelines and any other applicable design guidelines, as adopted  
19 and periodically amended by the Planning Commission, so that projects respond to their  
20 surrounding context, while still meeting the City's affordable housing goals.

21 (1) Planning Commission Design Review: The Planning Commission shall  
22 review and evaluate all physical aspects of a Local Affordable Housing Bonus HOME-SF  
23 Project at a public hearing. The Planning Commission recognizes that most qualifying projects  
24 will need to be larger in height and mass than surrounding buildings in order to achieve the  
25 Affordable Housing Bonus Program's affordable housing goals. However, the Planning

1 Commission may, consistent with the Affordable Housing Bonus Program Design Guidelines,  
2 and any other applicable design guidelines, and upon recommendation from the Planning  
3 Director, make minor modifications to a project to reduce the impacts of such differences in  
4 scale. Additionally, as set forth in subsection (2) below, the Planning Commission may grant  
5 minor exceptions to the provisions of this Code. However, such exceptions should only be  
6 granted to allow building mass to appropriately shift to respond to surrounding context, and  
7 only when such modifications do not substantially reduce or increase the overall building  
8 envelope permitted by the Program under Section 206.3. All modifications and exceptions  
9 should be consistent with the Affordable Housing Bonus Program Design Guidelines and any  
10 other applicable design guidelines. In case of a conflict with other applicable design  
11 guidelines, the Affordable Housing Bonus Program Design Guidelines shall prevail. The  
12 Planning Commission may require these or other modifications or conditions, or disapprove a  
13 project, in order to achieve the objectives and policies of the Affordable Housing Bonus  
14 Program or the purposes of this Code. This review shall be limited to design issues including  
15 the following:

16 (A) whether the bulk and massing of the building is consistent with the  
17 Affordable Housing Bonus Design Guidelines.

18 (B) whether building design elements including, but not limited to architectural  
19 treatments, façade design, and building materials, are consistent with the Affordable Housing  
20 Bonus Program Design Guidelines and any other applicable design guidelines.

21 (C) whether the design of lower floors, including building setback areas,  
22 commercial space, townhouses, entries, utilities, and parking and loading access is consistent  
23 with the Affordable Housing Bonus Program Design Guidelines, and any other applicable  
24 design guidelines.

1           (D) whether the required streetscape and other public improvements such as  
2 tree planting, street furniture, and lighting are consistent with the Better Streets Plan, and any  
3 other applicable design guidelines.

4           (2) Exceptions. As a component of the review process under this Section 328303(t),  
5 the Planning Commission may grant minor exceptions to the provisions of this Code as  
6 provided for below, in addition to the development bonuses granted to the project in Section  
7 206.3(d). Such exceptions, however, should only be granted to allow building mass to  
8 appropriately shift to respond to surrounding context, and only when the Planning  
9 Commission finds that such modifications: 1) do not substantially reduce or increase the  
10 overall building envelope permitted by the Program under Sections 206.3; and 2) are  
11 consistent with the Affordable Housing Bonus Design Guidelines. These exceptions may  
12 include:

13           (A) Exception from residential usable open space requirements per Section  
14 135, or any applicable special use district.

15           (B) Exception from satisfaction of loading requirements per Section 152.1, or  
16 any applicable special use district.

17           (C) Exception for rear yards, pursuant to the requirements of Section 134, or  
18 any applicable special use district.

19           (D) Exception from dwelling unit exposure requirements of Section 140, or any  
20 applicable special use district.

21           (E) Exception from satisfaction of accessory parking requirements per Section  
22 152.1, or any applicable special use district.

23           (F) Where not specified elsewhere in this Subsection (2), modification of other  
24 Code requirements that could otherwise be modified as a Planned Unit Development (as set  
25 forth in Section 304), irrespective of the zoning district in which the property is located.

1 (G) Exception from active ground floor use requirements under 145.1(c)(3).

2 (3) Additional Criteria. In addition to the criteria set forth in (c)(2), the Planning  
3 Commission shall consider the extent to which the following criteria are met:

4 (A) whether the project would require the demolition of an existing building;

5 (B) whether the project would remove existing commercial or retail uses;

6 (C) If the project would remove existing commercial or retail uses, how recently  
7 the commercial or retail uses were occupied by a tenant or tenants;

8 (D) whether the project includes commercial or retail uses;

9 (E) whether there is an adverse impact on the public health, safety, and general  
10 welfare due to the loss of commercial or retail uses in the district where the project is located.

11 (34) In no case may a project receive a site permit or any demolition permit prior to  
12 18 months from the date of written notification required by 206.3(e)(1)(B).

13  
14 Section 5. This section is uncodified.

15 Affordable Housing Bonus Program (Section 206 and following) fees shall be set as  
16 follows. The initial fee amount is not to exceed 50% of the construction cost. A \$120  
17 surcharge shall be added to the fees for a conditional use or planned unit development to  
18 compensate the City for the costs of appeals to the Board of Supervisors.

19

Estimated Construction Cost	Initial Fee
No construction cost, excluding extension of hours	\$1,012.00
No construction cost, extension of hours	\$724.00
Wireless Telecommunications Services (WTS)	\$5,061.00
\$1.00 to \$9,999.00	\$724.00
\$10,000.00 to \$999,999.00	\$724.00 plus 0.328% of cost over \$10,000.00
\$1,000,000.00 to \$4,999,999.00	\$4,033.00 plus 0.391% of cost over \$1,000,000.00

20  
21  
22  
23  
24  
25

1	\$5,000,000.00 to \$9,999,999.00	\$19,986.00 plus 0.328% of cost over \$5,000,000.00
2	\$10,000,000.00 to \$19,999,999.00	\$36,701.00 plus 0.171% of cost over \$10,000,000.00
3	\$20,000,000.00 or more	\$54,120.00

4

5 Section 6. Effective Date. This ordinance shall become effective 30 days after

6 enactment. Enactment occurs when the Mayor signs the ordinance, the Mayor returns the

7 ordinance unsigned or does not sign the ordinance within ten days of receiving it, or the Board

8 of Supervisors overrides the Mayor's veto of the ordinance. This ordinance applies to projects

9 that the Planning Department or Planning Commission have not approved as of the effective

10 date. For projects that have not yet submitted applications to the Planning Department or

11 other City entity, all of the provisions of the ordinance apply. The Planning Department shall

12 develop a policy to apply the provisions of this ordinance to projects that have already

13 submitted applications, but have not obtained approvals, to permit such projects to amend

14 their applications.

15

16 Section 7. Scope of Ordinance. In enacting this ordinance, the Board of Supervisors

17 intends to amend only those words, phrases, paragraphs, subsections, sections, articles,

18 numbers, punctuation marks, charts, diagrams, or any other constituent parts of the Municipal

19 Code that are explicitly shown in this ordinance as additions, deletions, Board amendment

20 //

21 //

22 //

23 //

24 //

25 //

1 additions, and Board amendment deletions in accordance with the "Note" that appears under  
2 the official title of the ordinance.

3  
4  
5 APPROVED AS TO FORM:  
6 DENNIS J. HERRERA, City Attorney

7 By:

  
8 AUDREY PEARSON  
9 Deputy City Attorney

10 n:\legan\las2017\1600094\01175593.docx

**REVISED LEGISLATIVE DIGEST**  
(3/13/2017, Amended in Committee)

[Planning Code - Affordable Housing Bonus Programs]

**Ordinance amending Planning Code Section 206 to amend the 100 Percent Affordable Housing Bonus Program to add the HOME-SF Program, the Analyzed State Density Bonus Program and the Individually Requested State Density Bonus Program, to provide for development bonuses and zoning modifications for increased affordable housing, in compliance with, and above those required by the State Density Bonus Law, Government Code Section 65915 et seq.; to establish the procedures in which the HOME-SF Program shall be reviewed and approved; adding a fee for applications under the Program; and affirming the Planning Department's determination under the California Environmental Quality Act; and making findings of consistency with the General Plan and the eight priority policies of Planning Code Section 101.1.**

Existing Law

Planning Code Section 206, the 100% Affordable Housing Bonus Program, allows increased density and exceptions to otherwise applicable zoning requirements for residential projects where all of the dwelling units are affordable units. Planning Code section 328 sets forth the procedures by which the Planning Commission reviews 100% Affordable Housing Bonus Program projects. Planning Code Section 303 *et seq.* sets forth procedures for determinations regarding applications for the authorization of conditional uses.

Amendments to Current Law

The Proposed Legislation renames and adds three new programs to the 100% Affordable Housing Bonus Program ("AHBP"). As amended by this legislation, the AHBP consists of four separate programs to incentivize the construction of housing affordable to very low, low, moderate, and middle-income households by granting a range of development bonuses. The HOME-SF Program, the first program set forth below, and the existing 100% Affordable Housing Bonus Program operate independently from State law; the second two programs outlined below, taken together, implement the State Density Bonus Law.

- (1) The HOME – SF Program: a local density bonus program that provides up to two additional floors and other zoning incentives to a project sponsor who provides a total of 30 percent of its units as affordable units – generally by restricting the applicable number of units under the Inclusionary Affordable Housing Program ("Inclusionary Units") with the remaining number of units restricted to a range of households earning between 90% and 140% of Area Median Income ("AMI") for ownership projects, and between 55% and 100% AMI for rental projects. It applies to projects of three units or more and only in certain enumerated zoning districts on parcels that do not contain residential uses. Projects under this program would require conditional use approval.



- (2) The Analyzed State Density Bonus Program: a density bonus program under State law, which provides up to a 35 percent density bonus for projects that provide 12 percent or more on-site Inclusionary Units and meet other criteria beyond State law requirements. Projects receive process improvements and must choose from a menu of specific incentives. It applies to projects of five units or more units and only in certain enumerated zoning districts.
- (3) The Individually Requested State Density Bonus Program: a program that provides a density bonus under State law of up to 35 percent and other incentives requested by the project sponsor for projects consistent with all of the State's requirements. It applies in all zoning districts to projects of five units or more.

The Proposed Legislation also creates a new fee for applications for projects under the Program.

#### Background Information

This legislative digest reflects amendments to the Affordable Housing Bonus Program made at the Land Use and Transportation Committee on March 13, 2017. Generally, the March 13 amendments change the income levels supported by the HOME-SF program (formally called the Local Program), require HOME-SF projects to include family-friendly amenities, exclude use of the HOME-SF program in certain neighborhoods in the City, add conditional use criteria, and make additional changes to the State Analyzed and Individually Requested AHBP to reflect recent changes to the State Density Bonus Law.

In 1979, the State of California adopted the State Density Bonus Law, which requires all cities and counties to offer a density bonus and other incentives to housing developments that include a certain percentage of units available to very low, low, or moderate-income households. The Planning Code encourages increased density where project sponsors provide affordable housing through various mechanisms including through Special Use Districts, exceptions to the calculation of residential density, and the provision of additional Floor Area Ratio (FAR) in certain circumstances.

The AHBP is one of the tools put forward by the City to address its affordable housing goals. The HOME-SF and 100% Affordable Housing Programs were developed to go beyond the State Law affordability requirements. The proposed AHBP implements the 2014 Housing Element, builds on the City's Inclusionary Housing Ordinance, and helps the City meet the housing goals mandated in Proposition K to provide 30% of residential units as affordable.

#### **NOTE:**

The Proposed Legislation was originally introduced in September 2015, with substitute legislation introduced in January 2016. The Land Use and Transportation Committee heard the Proposed Legislation on June 13, 2016, wherein the legislation was amended, and the file was duplicated. In July 2016, in Ordinance 143-16, the Board of Supervisors adopted the

FILE NO. 150969

100% Affordable Housing Bonus Program. That ordinance created Planning Code Section 206 (the 100% AHBP) and Section 328, which sets forth the 100% AHBP review procedures. It also amended Planning Code Sections 250 and 260, both related to height limits; and Planning Code Section 352, related to permit application fees. In August 2016, in Ordinance 149-16, the Board repealed Planning Code Section 352.

A technical correction of the Legislation was submitted to reflect the changes made to the Planning Code in Ordinance Nos. 143-16 and 149-16. The amendments to the ordinance reflected in this Legislative Digest are shown as amendments to that technical correction.

n:\leganalas2015\1600094\01177428.doc



# SAN FRANCISCO PLANNING DEPARTMENT

**MEMO**

## NOTE TO FILE 3

**DATE:** April 17, 2017  
**TO:** File for Case No. 2014.1304E  
**FROM:** Michael Li  
**RE:** Affordable Housing Bonus Program  
June 2016 and March 2017 Amendments

1650 Mission St.  
Suite 400  
San Francisco,  
CA 94103-2479

Reception:  
**415.558.6378**

Fax:  
**415.558.6409**

Planning  
Information:  
**415.558.6377**

On January 14, 2016, the Planning Department published Addendum 3 to the 2004 and 2009 Housing Element FEIR. Addendum 3 analyzed the environmental impacts of the Affordable Housing Bonus Program (AHBP), which is legislation that was introduced by Mayor Lee and Supervisor Tang on September 29, 2015. Further amendments and substitute legislation were introduced and included in January and February 2016. The environmental impacts that could result from implementation of these further amendments were analyzed in a Note to File that was issued on February 18, 2016.

In June 2016, Supervisor Peskin introduced alternate legislation to one of the components of the AHBP. The environmental impacts that could result from implementation of the alternate legislation were analyzed in Note to File 2 that was issued on June 21, 2016. The alternate legislation was not adopted by the Board of Supervisors.

The "100% Affordable Housing Bonus Program" component of the AHBP was adopted by the Board of Supervisors on June 21, 2016, but no other components of the AHBP were adopted at that time.

Since June 2016, additional amendments to the AHBP have been introduced. This Note to File 3 analyzes the environmental impacts that could result from implementation of the additional amendments to the AHBP, which are discussed below.

### June 2016 Amendments

On June 13, 2016, the Land Use Committee of the Board of Supervisors recommended the following amendments to the AHBP:

- (1) prohibit the displacement of existing residential tenants;
- (2) prohibit the demolition, removal, or conversion of any existing residential uses;
- (3) require conditional use authorization pursuant to Planning Code Section 303 for all HOME-SF projects instead of project authorization pursuant to Planning Code Section 328;
- (4) require all HOME-SF projects to replace ground-floor active uses at like size when any neighborhood commercial uses would be affected; and
- (5) provide commercial tenant support, including early notification of no less than 18 months from relocation date, and observe commercial relocation best practices.

### **Environmental Impacts of June 2016 Amendments**

The first and second amendments listed above would reduce the number of sites in San Francisco that are eligible for the AHBP and would, therefore, reduce the theoretical maximum number of housing units that the AHBP could incentivize. Thus, these amendments would result in impacts that are the same as or less than the impacts discussed in Addendum 3 or Note to File 1.

The third and fifth amendments listed above address procedures related to implementing the "HOME-SF Program" component of the AHBP. These amendments would not result in any physical changes to the environment and would not result in changes to the impacts discussed in Addendum 3 or Note to File 1.

The fourth amendment listed above addresses the retention of existing neighborhood commercial uses that would be affected by HOME-SF projects. Thus, this amendment would result in impacts that are the same as or less than the impacts discussed in Addendum 3 or Note to File 1.

### **March 2017 Amendments**

On March 13, 2017, the Land Use Committee of the Board of Supervisors adopted the following amendments to the AHBP:

- (1) rename the "Local Affordable Housing Bonus Program" component as the "HOME-SF Program" component;
- (2) adjust the income levels, which are based on a percentage of Area Median Income (AMI), for below-market-rate (BMR) units to ensure equal distribution of low-, moderate-, and middle-income units as follows:
  - (a) rental BMR units would be offered at 55%, 80%, and 110% of AMI, and income qualification would be between 45% and 120% of AMI
  - (b) ownership BMR units would be offered at 90%, 120%, and 140% of AMI, and income qualification would be between 80% and 150% of AMI
- (3) encourage the inclusion of three-bedroom and larger units in the unit mix, the distribution of larger units on all floors and adjacent to open spaces or yards, and the incorporation of family-friendly amenities (e.g., bathtubs, stroller storage, open space, and yards);
- (4) enhance protections and options for existing commercial tenants;
- (5) exclude the Northeastern Waterfront Area Plan south of the centerline of Broadway from program eligibility; and
- (6) incorporate changes to the "Individually Requested State Density Bonus Program" component of the AHBP in response to the adoption of Assembly Bill 2501.

### **Environmental Impacts of March 2017 Amendments**

The first through fourth amendments and the sixth amendment listed above would not result in any physical changes to the environment and would not result in changes to the impacts discussed in Addendum 3 or Note to File 1.

The fifth amendment listed above would reduce the number of sites in San Francisco that are eligible for the AHBP and would, therefore, reduce the theoretical maximum number of housing units that the AHBP could incentivize. Thus, this amendment would result in impacts that are the same as or less than the impacts discussed in Addendum 3 or Note to File 1.



# SAN FRANCISCO PLANNING DEPARTMENT

MEMO

## NOTE TO FILE 2

**DATE:** June 21, 2016  
**TO:** File for Case No. 2014.1304E  
**FROM:** Michael Li  
**RE:** Affordable Housing Bonus Program  
Alternate Legislation

1650 Mission St.  
Suite 400  
San Francisco,  
CA 94103-2479

Reception:  
**415.558.6378**

Fax:  
**415.558.6409**

Planning  
Information:  
**415.558.6377**

On January 14, 2016, the Planning Department published Addendum 3 to the *2004 and 2009 Housing Element FEIR*. Addendum 3 analyzed the environmental impacts of the Affordable Housing Bonus Program (AHBP), which is proposed legislation that was introduced by Mayor Lee and Supervisor Tang on September 29, 2015. The analysis in Addendum 3 was based on the proposed AHBP legislation as it was originally introduced by Mayor Lee and Supervisor Tang.

The Planning Department introduced amendments to the proposed AHBP legislation on January 12, 2016, and Supervisor Breed introduced additional amendments during the Planning Commission hearing on January 28, 2016. In response to public testimony during the hearing on January 28, 2016, the Planning Department proposed additional amendments that were considered by the Planning Commission during a subsequent hearing on February 25, 2016. In response to all of the proposed amendments, the Planning Department issued Note to File 1 on February 18, 2016. Note to File 1 summarized the amendments and the environmental impacts of those amendments. In Note to File 1, the Planning Department concluded that the amendments would not result in new impacts that were not already identified in Addendum 3 or impacts that are more severe than those identified in Addendum 3.

### **Alternate Legislation for Consideration by the Board of Supervisors**

On June 7, 2016, Supervisor Peskin introduced alternate legislation (the "Density Done Right: Development Without Displacement Program"). The Density Done Right legislation, along with the AHBP legislation, was reviewed by the Board of Supervisors' Land Use and Transportation Committee on June 13, 2016. Both pieces of legislation will be considered by the full Board of Supervisors during a hearing scheduled for June 21, 2016.

The Density Done Right legislation would allow an additional 30 feet of height above the legislated height limit, plus other development bonuses, for projects in which 100 percent of the dwelling units are affordable to very-low, low-, or moderate-income households.<sup>1</sup>

---

<sup>1</sup> The other development bonuses consist of modifications to the rear yard, dwelling unit exposure, off-street loading, off-street parking, and usable open space requirements of the Planning Code, subject to approval by the Planning Commission.

The eligibility requirements for the Density Done Right legislation result in a smaller number of potential development sites (approximately 100) than under the AHBP (approximately 240), but a more site-specific analysis of the environmental impacts of the Density Done Right legislation would be speculative. It is not known how many of the property owners of these approximately 100 sites would actually utilize the Density Done Right legislation. Additionally, the conditions that currently disqualify potential sites could change over time such that some of these sites would later become eligible. For these reasons, the analysis contained in Addendum 3 adequately addresses the environmental impacts that could result from implementation of the Density Done Right legislation.

Under the AHBP, projects that could result in significant impacts on, or related to, historic resources, wind, and shadow would not be eligible for the AHBP. Based on the exclusion of such projects, Addendum 3 concluded that the AHBP would not result in significant impacts on, or related to, historic resources, wind, and shadow.

As originally introduced by Supervisor Peskin, the Density Done Right legislation does not exclude projects that could result in significant impacts on, or related to, historic resources, wind, and shadow. In order for the Density Done Right legislation to be adequately covered by the environmental impacts analysis in Addendum 3, the Density Done Right legislation would need to be amended to exclude projects that could result in significant impacts on, or related to, historic resources, wind, and shadow. Provided that this amendment is incorporated, the Density Done Right legislation would not result in new impacts that were not already identified in Addendum 3 or impacts that are more severe than those identified in Addendum 3, and no further environmental review would be required.



# SAN FRANCISCO PLANNING DEPARTMENT

---

April 11, 2016

Ms. Angela Calvillo, Clerk of the Board of Supervisors  
Honorable Mayor Lee  
Honorable Supervisor Tang  
Honorable Members of the Board of Supervisors  
City and County of San Francisco  
City Hall, Room 244  
1 Dr. Carlton B. Goodlett Place  
San Francisco, CA 94102

1650 Mission St.  
Suite 400  
San Francisco,  
CA 94103-2479

Reception:  
415.558.6378

Fax:  
415.558.6409

Planning  
Information:  
415.558.6377

Re: Transmittal of Planning Department Case Number 2014001503PCA  
Affordable Housing Bonus Program (AHBP)  
Board File No. 150969 Planning Code Amendment  
Planning Commission Recommendation: Forwarded to the Board of  
Supervisors with Suggested Amendments for Consideration but Without a  
Recommendation on the Program as a Whole.

Dear Clerk Calvillo and Mayor Edwin Lee:

On October 15, 2015, November 5, 2015, December 3, 2015, January 28, 2016, and February 25, 2016 the Planning Commission conducted duly noticed public hearings at regularly scheduled meetings to consider the proposed Ordinances that would create conforming General Plan Amendments and amend the San Francisco Planning Code for the Affordable Housing Bonus Program (AHBP) as introduced by Mayor Lee and Supervisor Tang.

#### General Plan Amendments.

The Commission unanimously recommended approval of the corresponding General Plan Amendments, contingent on the Affordable Housing Bonus Program Planning Code becoming effective. The General Plan Amendment Draft Ordinance, Planning Commission resolution, and related staff materials was transmitted to the Board of Supervisors on April 8, 2016.

At the February 25<sup>th</sup> hearing the Planning Commission took no action on the program as a whole, but provided the following recommendations to the Board of Supervisors on the six topics:

#### Topic 1 – Program Eligibility.

This topic reviewed what parcels could be eligible for the Affordable Housing Bonus Program. The Commission had a robust conversation that included which sites to prioritize for the program, protection of small businesses and historic resources. Some Commissioners wanted further study on the development of the soft sites, particularly the methodology used to identify what constitutes a soft site. Some Commissioner discussion centered on the other criteria for program eligibility, including if the parcel is on a corner lot, the intensity of the existing use on the lot, and the width of the street. After this discussion, the Commission voted to:



1. Recommends that any parcel with an existing residential unit is not eligible for the Affordable Housing Bonus Program.
2. Recommends a phased approach to implementation that starts with vacant soft sites and gas service stations and includes a community planning process for the remaining sites in the program area that focuses on existing small businesses, historic preservations, and maximum value capture for the Area Median Income (limits) in the program.

**Topic 2 – Infrastructure to Support New Growth.**

This topic reviewed the impact the program could have on infrastructure such as open space, pedestrian and bicycle infrastructure, schools, and transit. No suggested modifications were proposed. One Commissioner asked that the Board of Supervisors consider what fees or exactions project sponsors could provide to mitigate the impact of new development as a result of the Affordable Housing Bonus.

**Topic 3 – Urban Design.**

Besides the recommendations below, the Commission discussed that the AHBP Design Guidelines should not be one size fits all, in particular that taller buildings should consider setbacks for the higher floors to reflect the context of the neighborhood and that rear yards should be given special consideration. One Commissioner wanted site specific guidelines that specify building types based on the lot size. The Commission made the following recommendations:

3. After adoption of the AHBP as the Commission considers each development project that would use the AHBP, the Commission directs Planning staff to include analysis of the project's conformity to design guidelines in a Planning Commission staff report.
4. The ordinance should prohibit lot mergers for AHBP projects until such time the Planning Commission adopts new design guidelines; and
5. The Commission should consider light and air when reviewing AHBP projects.

**Topic 4 – Public Review and Commission Approval**

6. Require a Conditional Use Authorization for all AHBP projects.

**Topic 5 – Preserving Small Business.**

The Commission also asked that staff worked with the Small Business Commission on protection of existing small businesses in the program area.

7. The Planning Commission should be permitted to alter commercial uses associated with development proposals using the AHBP, including changes that would reduce commercial use sizes or require commercial uses in AHBP projects to protect neighborhood serving businesses.

**Topic 6 – Who are we serving with this program? Affordability.**

There was broad consensus to consider the staff recommendation to reduce the AMIs in the program within the constraints of feasibility, namely to:

8. Consider lowering AMI levels for the Local AHBP program for some of the units currently dedicated to middle income households (120% AMI for rental, 140% AMI for ownership).

9. Consider establishing neighborhood-specific AMIs for the Local AHBP.

On April 24, 2014, the San Francisco Planning Commission, in Resolution No. 19121, certified the 2004 and 2009 Housing Element Final Environmental Impact Report ("Final EIR"), prepared in compliance with the California Environmental Quality Act ("CEQA"), Public Resources Code Section 21000 et seq. In Resolution No. 19122, the Planning Commission adopted the findings and conclusions required by CEQA regarding alternatives, mitigation measures, and significant environmental impacts analyzed in the Final EIR, and adopted a Mitigation Monitoring and Reporting Program and a Statement of Overriding Considerations as part of its approval of the 2009 Housing Element.

On January 14, 2016, in response to the proposed Affordable Housing Bonus Program and related General Plan Amendments, the San Francisco Planning Department prepared an Addendum to the 2004 and 2009 Housing Element Final EIR under CEQA Guidelines Section 15164 ("the Addendum"). The Addendum accessed here and the Note to File is Exhibit H: [http://sfmea.sfplanning.org/2014.1304E\\_AHBP\\_Addendum03\\_011416%20Final.pdf](http://sfmea.sfplanning.org/2014.1304E_AHBP_Addendum03_011416%20Final.pdf)

I humbly remind the legislative sponsors, Mayor Edwin Lee and Supervisor Tang, to please advise the City Attorney at your earliest convenience if you wish to incorporate any of the changes recommended by the Commission.

Please find attached documents relating to the actions of the Commission. If you have any questions or require further information please do not hesitate to contact me.

Sincerely,



John Rahaim  
Director of Planning

cc:

Audrey Pearson, Deputy City Attorney  
Jeff Buckley, Senior Advisor, Office of Mayor Ed Lee  
Supervisor Kay Tang, Legislative Sponsor  
Ashley Summers, Aide to Supervisor Tang  
Alisa Somera, Office of the Clerk of the Board  
Kearstin Dischinger, Planning Department

Attachments:

1. Planning Commission Resolution No. 19578 – Proposed Planning Code Amendments
2. Planning Department Executive Summary
3. Addendum 3 to Environmental Impact Report
4. Note to File



# SAN FRANCISCO PLANNING DEPARTMENT

## Planning Commission Resolution No. 19578

HEARING DATE FEBRUARY 25, 2016

1650 Mission St.  
Suite 400  
San Francisco,  
CA 94103-2479

Reception:  
415.558.6378

Fax:  
415.558.6409

Planning  
Information:  
415.558.6377

*Project Name:* Affordable Housing Bonus Program  
*Case Number:* 2014-001503PCA [Board File No. 150969]  
*Initiated by:* Introduced September 29, 2015, December 16, 2015, and January 12, 2016  
*Staff Contact:* Menaka Mohan, Legislative Affairs  
menaka.mohan@sfgov.org, 415-575-9141  
Paolo Ikezoe, Citywide Division  
paolo.ikezoe@sfgov.org, 415-575-9137  
*Reviewed by:* Kearstin Dischinger, Manager of Housing Policy  
kearstin.dischinger@sfgov.org, 415-558-6362  
*Recommendation:* Forwarded to the Board of Supervisors with Suggested Amendments  
for Consideration but Without a Recommendation on the Program as a  
Whole

RECOMMENDING THAT THE BOARD OF SUPERVISORS CONSIDER AMENDMENTS TO THE PROPOSED ORDINANCE THAT WOULD AMEND THE PLANNING CODE TO CREATE THE AFFORDABLE HOUSING BONUS PROGRAM, CONSISTING OF THE LOCAL AFFORDABLE HOUSING BONUS PROGRAM, THE 100 PERCENT AFFORDABLE HOUSING BONUS PROGRAM, THE ANALYZED STATE DENSITY BONUS PROGRAM AND THE INDIVIDUALLY REQUESTED STATE DENSITY BONUS PROGRAM, TO PROVIDE FOR DEVELOPMENT BONUSES AND ZONING MODIFICATIONS FOR AFFORDABLE HOUSING, IN COMPLIANCE WITH, AND ABOVE THOSE REQUIRED BY THE STATE DENSITY BONUS LAW, GOVERNMENT CODE SECTION 65915 ET SEQ.; TO ESTABLISH THE PROCEDURES IN WHICH THE LOCAL AFFORDABLE HOUSING BONUS PROGRAM AND THE 100 PERCENT AFFORDABLE HOUSING BONUS PROGRAM SHALL BE REVIEWED AND APPROVED; AND AMENDING THE PLANNING CODE TO EXEMPT PROJECTS FROM THE HEIGHT LIMITS SPECIFIED IN THE PLANNING CODE AND THE ZONING MAPS; AND AFFIRMING THE PLANNING DEPARTMENT'S DETERMINATION UNDER THE CALIFORNIA ENVIRONMENTAL QUALITY ACT; AND MAKING FINDINGS OF CONSISTENCY WITH THE GENERAL PLAN, PLANNING CODE SECTION 302, AND THE EIGHT PRIORITY POLICIES OF PLANNING CODE SECTION 101.1.

WHEREAS, on September 29, 2015, Mayor Ed Lee and Supervisor Tang introduced a proposed Ordinance under Board of Supervisors (hereinafter "Board") File Number 15-0969, which would amend the Planning Code to create the Affordable Housing Bonus Programs, consisting of the Local Affordable Housing Bonus Program, the 100 Percent Affordable Housing Bonus Program, the Analyzed State Density Bonus Program and the Individually Requested State Density Bonus Program, to provide for development bonuses and zoning modifications for affordable housing.

WHEREAS, the Affordable Housing Bonus Program will implement the 2014 Housing Element Implementation Program 39b, and provide for development bonuses and zoning modifications for affordable housing as contemplated in Implementation Program 39b and in compliance with, and above those required by the State Density Bonus Law, Government Code Section 65915 et seq.; and will establish procedures by which the Local Affordable Housing Bonus Program and the 100 Percent Affordable Housing Bonus Program shall be reviewed and approved;

WHEREAS, the proposed ordinance creates the Affordable Housing Bonus Programs which will facilitate the development and construction of affordable housing in San Francisco; and

WHEREAS, the proposed ordinance creates the Local Affordable Housing Bonus Program, which provides up to three zoning modifications, form based zoning, a bedroom requirement, and a height waiver for projects providing 30 percent of housing as affordable on site; and

WHEREAS, the proposed ordinance creates the 100 Percent Affordable Housing Bonus Program, which provides zoning modifications, form based zoning, and a height waiver for projects providing 100 percent of housing as affordable on site; and

WHEREAS, the proposed ordinance creates the Analyzed State Density Bonus Program, which provides one to three incentives or concessions, a maximum of a thirty-five percent density bonus based on the percentage of affordable housing and the level of affordability, and up to two stories of height for projects providing at least 12 percent of affordable housing on site; and

WHEREAS, the proposed ordinance creates the Individually Requested State Density Bonus Program, which is available for any project seeking a density bonus consistent with Government Code section 65915 but is not consistent with the pre-vetted menu of concessions, incentives or waivers in the Local, 100 Percent, or State Analyzed Programs; and

WHEREAS, all projects utilizing the Affordable Housing Bonus Programs are subject to the Affordable Housing Bonus Design Guidelines; and

WHEREAS, the proposed ordinance creates a comprehensive review procedure for the 100 Percent and Local Affordable Housing Bonus Program to ensure compliance with the Affordable Housing Bonus Design Guidelines and a hearing before the Planning Commission; and

WHEREAS, The Planning Commission (hereinafter "Commission") conducted a duly noticed public hearing at a regularly scheduled meeting to consider the proposed Ordinance on November 5, 2015, December 3, 2015, January 28, 2016; and February 25 2016; and

WHEREAS, on April 24, 2014, the San Francisco Planning Commission, in Resolution No. 19121, certified the 2004 and 2009 Housing Element Final Environmental Impact Report ("Final EIR"), prepared in compliance with the California Environmental Quality Act ("CEQA"), Public Resources Code Section 21000 et seq. In Resolution No. 19122, the Planning Commission adopted the findings and conclusions required by CEQA regarding alternatives, mitigation measures, and significant environmental impacts

analyzed in the Final EIR, and adopted a Mitigation Monitoring and Reporting Program and a Statement of Overriding Considerations as part of its approval of the 2009 Housing Element; and,

WHEREAS, on March 24, 2015, in Ordinance No. 34-15, the San Francisco Board of Supervisors adopted the 2014 Housing Element, relying, in part, on the Final EIR and a January 22, 2015 Addendum published by the Planning Department; and

WHEREAS, on January 14, 2016, in response to the proposed Affordable Housing Bonus Program, the San Francisco Planning Department prepared an Addendum to the 2004 and 2009 Housing Element Final EIR under CEQA Guidelines Section 15164 ("the Addendum"); and

WHEREAS, the Planning Commission has heard and considered the testimony presented to it at the public hearing and has further considered written materials and oral testimony presented on behalf of Department staff and other interested parties; and

WHEREAS, all pertinent documents may be found in the files of the Department, as the custodian of records, at 1650 Mission Street, Suite 400, San Francisco; and

WHEREAS, the Planning Commission has reviewed the proposed Ordinance; and

MOVED, that the Planning Commission hereby forwards the draft Ordinance to the Board of Supervisors, and recommends that the Board **consider the following** proposed modifications ..

All of the Commission's suggested modifications were considered and voted on by topic. Some topics include several recommendations. The recommendations are organized by topic in the order in which they were discussed at the hearing.

#### Program Eligibility

1. Recommends that any parcel with an existing residential unit is not eligible for the Affordable Housing Bonus Program.
2. Recommends a phased approach to implementation that starts with vacant soft sites and gas service stations and includes a community planning process for the remaining sites in the program area that focuses on existing small businesses, historic preservation, and maximum value capture for the Area Median Income (limits) in the program.

#### Urban Design

3. After adoption of the AHBP, as the Commission considers each development project that would use the AHBP, the Commission directs Planning staff to include analysis of the project's conformity to design guidelines in a Planning Commission staff report.
4. The ordinance should prohibit lot mergers for AHBP projects until such time that the Planning Commission adopts new AHBP design guidelines; and
5. Consider light and air when reviewing AHBP projects.

Public Review and Commission Approval

6. Require a Conditional Use Authorization for all AHBP projects.

Preserving Small Business

7. The Planning Commission should be permitted to alter commercial uses associated with development proposals using the AHBP, including changes that would reduce commercial use sizes or require commercial uses in AHBP projects to protect neighborhood serving businesses.

Affordability Levels

8. Consider lowering AMI levels for the Local AHBP program for some of the units currently dedicated to middle income households (120% AMI for rental, 140% AMI for ownership).
9. Consider establishing neighborhood-specific AMIs for the Local AHBP.

**FINDINGS**

Having reviewed the materials identified in the preamble above, and having heard all testimony and arguments, this Commission finds, concludes, and determines as follows:

1. The purpose of the Affordable Housing Bonus Programs is to facilitate the development and construction of affordable housing in San Francisco, and implement 2014 Housing Element Implementation Program 39b.
2. Affordable housing is of paramount statewide concern, and the California State legislature has declared that local and state governments have a responsibility to use the powers vested in them to facilitate the improvement and development of housing to make adequate provision for the housing needs of all economic segments of the community.
3. The State Legislature has found that local governments must encourage the development of a variety of types of housing for all income levels, including multifamily rental housing and assist in the development of adequate housing to meet the needs of low- and moderate-income households.
4. San Francisco has one of the highest housing costs in the nation, but San Francisco's economy and culture rely on a diverse workforce at all income levels. It is the policy of the Board of Supervisors to provide housing to these workers and ensure that they pay a proportionate share of their incomes to live in adequate housing and to not commute ever-increasing distances to their jobs. The Association of Bay Area Governments determined that San Francisco's share of the Regional Housing Need for January 2015 to June 2022 was provision of 28,870 new housing units, with 6,234 (or 21.6%) as very low, 4,639 (or 16.1%) as low, and 5,460 (or 18.9%) as moderate income units.
5. This Board of Supervisors, and the voters in San Francisco, have long recognized the need for the production of affordable housing. The voters, or the Board have adopted measures such as the establishment of the mandatory Inclusionary Affordable Housing Ordinance in Planning Code

- section 415; the San Francisco Housing Trust Fund, adopted in 2012, which established a fund to create, support and rehabilitate affordable housing, and set aside \$20 million in its first year, with increasing allocations to reach \$50 million a year for affordable housing.
6. The adoption of Proposition K in 2014 which established as City policy that the City, by 2020, will help construct or rehabilitate at least 30,000 homes, with more than 50% of the housing affordable for middle-income households, and at least 33% as affordable for low-and moderate income households; and the multiple programs that rely on Federal, State and local funding sources as identified in the Mayor's Office of Housing and Community Development (MOHCD) Comprehensive Plan.
  7. Historically, in the United States and San Francisco, affordable housing requires high levels of public subsidy, including public investment and reliance on public dollars. Costs to subsidize an affordable housing unit vary greatly depending on a number of factors, such as household income of the residents, the type of housing, and the cost to acquire land acquisition. Currently, MOHCD estimates that the level of subsidy for an affordable housing unit is approximately \$250,000 per unit. Given this high cost per unit, San Francisco can only meet its affordable housing goals through a combination of increased public dollars dedicated to affordable housing and other tools that do not rely on public money.
  8. Development bonuses are a long standing zoning tool that enable cities to encourage private development projects to provide public benefits including affordable housing. When a municipality offers increased development potential, a project sponsor can offset the expenses necessary to provide additional public benefits. In 1979, the State of California adopted the Density Bonus Law, Government Code section 65915 et seq, which requires that density bonuses and other concessions and incentives be offered to projects that provide a minimum amount of on-site affordable housing.
  9. In recognition of the City's affordable housing goals, including the need to produce more affordable housing without need for public subsidies, the Planning Department contracted with David Baker Architects and Seifel Consulting to determine a menu of zoning modifications and development bonuses that could offset a private developer's costs of providing various levels of additional on-site affordable housing. David Baker Architects and Seifel Consulting analyzed various parcels in San Francisco, to determine the conditions in which a zoning accommodation would be necessary to achieve additional density. The analysis modeled various zoning districts and lot size configurations, consistent with current market conditions and the City's stated policy goals, including achieving a mix of unit types, including larger units that can accommodate larger households.
  10. **General Plan Compliance.** The proposed Ordinance and the Commission's recommended modifications are, *on balance*, consistent with the Objectives and Policies of the General Plan, as it is proposed for amendments in Planning Case 2014-001503GPA. Note that language in policies proposed for amendment in Planning Case 2014-001503GPA is shown in underlined text. (Staff discussion is added in *italic font* below):

## HOUSING ELEMENT

### OBJECTIVE 1

Identify and make available for development adequate sites to meet the City's housing needs, especially permanently affordable housing.

*The Affordable Housing Bonus Program (AHBP) would apply in zoning districts which a) allow residential uses and b) regulate density by a ratio of units to lot area. These districts contain roughly 30,500 of the city's 150,000+ parcels.*

*Affordable Housing Bonus Program eligible districts generally include the City's neighborhood commercial districts, where residents have easy access to daily services, and are located along major transit corridors. Affordable Housing Bonus Program eligible districts generally allow or encourage mixed uses and active ground floors. On balance the entire program area is located within a quarter-mile (or 5 minute-walk) of the proposed Muni Rapid Network, which serves almost 70% of Muni riders and will continue to receive major investments to prioritize frequency and reliability.*

**POLICY 1.1**

**Plan for the full range of housing needs in the City and County of San Francisco, especially affordable housing.**

*The AHBP increases the number of Below Market Rate units for households making 55% or 90% of AMI, and creates a new source of permanently affordable housing for middle-income households, defined as those making 120%-140% of AMI. To date, there are no other programs aimed at providing permanently affordable housing for households in this category. Finally, the AHBP includes process improvements and development bonuses for 100% Affordable Housing Projects.*

**POLICY 1.6**

**Consider greater flexibility in number and size of units within established building envelopes in community based planning processes, especially if it can increase the number of affordable units in multi-family structures.**

*The Local AHBP provides flexibility in the number and size of units and encourages multi-bedroom units by requiring 40% of all units to have two bedrooms or any unit mix such that 50% of all bedrooms within the Local Project are provided in units with more than one bedroom.*

**POLICY 1.8**

**Promote mixed use development, and include housing, particularly permanently affordable housing, in new commercial, institutional or other single use development projects.**

*The AHBP eligible districts generally include the city's neighborhood commercial districts, where residents have easy access to daily services, and are located along major transit corridors. Affordable Housing Bonus Program eligible districts generally allow or encourage mixed uses and active ground floors.*

**POLICY 1.10**

**Support new housing projects, especially affordable housing, where households can easily rely on public transportation, walking and bicycling for the majority of daily trips.**

*On balance the entire AHBP area is located within a quarter-mile (or 5 minute-walk) of the proposed Muni Rapid network, which serves almost 70% of Muni riders and will continue to receive major investments to prioritize frequency and reliability.*



**OBJECTIVE 3**

Protect the affordability of the existing housing stock, especially rental units.

**POLICY 3.3**

Maintain balance in affordability of existing housing stock by supporting affordable moderate ownership opportunities.

*The Local AHBP creates a middle income homeownership program that will be the first program in San Francisco to secure permanently affordable housing for middle income households without public subsidy.*

**OBJECTIVE 4**

Foster a housing stock that meets the needs of all residents across lifecycles.

**POLICY 4.1**

Develop new housing, and encourage the remodeling of existing housing, for families with children.

*The Local AHBP encourages the development of new housing at a variety of income levels and promotes flexibility in unit size by requiring 40% of all units to have two bedrooms or any unit mix such that 50% of all bedrooms within the Local Project are provided in units with more than one bedroom.*

**POLICY 4.4**

Encourage sufficient and suitable rental housing opportunities, emphasizing permanently affordable rental units wherever possible.

*The AHBP encourages the development of on-site permanently affordable rental units.*

**Policy 4.5**

Ensure that new permanently affordable housing is located in all of the city's neighborhoods, and encourage integrated neighborhoods, with a diversity of unit types provided at a range of income levels.

*The Housing Balance Report<sup>1</sup> reports the Cumulative Housing Balance by Supervisor District. The report documents affordable housing units in the City as well as new market rate housing. The first table in the report documents that District 1, District 2, and District 4 have entitled 39, 69, and 56 housing units respectively from 2005 to the last quarter of 2014. Other areas of the City such as District 5, 6, and 10 have entitled 444, 3,814, and 1,667 housing units respectively in the same time period. To improve the feasibility of sites the Local AHBP provides incentives for developers to distribute housing development more equitably through the City. Furthermore, the AHBP provides a range of permanently affordable housing for very low, low, moderate, and middle income households.*

**Policy 4.6**

Encourage an equitable distribution of growth according to infrastructure and site capacity.

---

<sup>1</sup> Housing Balance Report; July 7, 2015. Can be found: <http://www.sf-planning.org/Modules/ShowDocument.aspx?documentid=9376>

*On balance the AHBP area is located within a quarter-mile (or 5 minute-walk) of the proposed Muni Rapid network, which serves almost 70% of Muni riders and will continue to receive major investments to prioritize frequency and reliability, and the program is distributed equitably throughout the City.*

**OBJECTIVE 7**

Secure funding and resources for permanently affordable housing, including innovative programs that are not solely reliant on traditional mechanisms or capital.

**Policy 7.1**

Expand the financial resources available for permanently affordable housing, especially permanent sources.

**Policy 7.5**

Encourage the production of affordable housing through process and zoning accommodations, and prioritize affordable housing in the review and approval processes.

*The AHBP provides zoning and process accommodations including priority processing for projects that participate by providing on-site affordable housing.*

**Policy 7.7**

Support housing for middle income households, especially through programs that do not require a direct public subsidy such as providing development incentives for higher levels of affordability, including for middle income households.

*The AHBP will be the first program in San Francisco to support permanently affordable housing to middle income households without a public subsidy.*

**OBJECTIVE 8**

Build public and private sector capacity to support, facilitate, provide and maintain affordable housing.

**POLICY 8.1**

Support housing for middle income households, especially through programs that do not require a direct public subsidy.

*The AHBP will be the first program in San Francisco to support permanently affordable housing to middle income households without a public subsidy.*

**POLICY 8.3**

Support the production and management of permanently affordable housing.

*The AHBP could produce 5,000 permanently affordable, income restricted units: 2,000 homes for very-low, low and moderate income households, and 3,000 homes for middle-income households.*

**OBJECTIVE 10**

Ensure a streamlined, yet thorough, and transparent decision-making process.

**POLICY 10.1**

Create certainty in the development entitlement process, by providing clear community parameters for development and consistent application of these regulations.

**POLICY 10.2**

Implement planning process improvements to both reduce undue project delays and provide clear information to support community review.

*The entitlement process for both the Local AHBP and 100% Affordable Housing Bonus Programs is comprehensive, providing clear guidelines for approval for the Planning Commission that recognizes the design of AHBP buildings in neighborhoods. The comprehensive entitlement process directs the Planning Commission to make findings that AHBP projects are consistent with AHBP Design Guidelines so that projects respond to their surrounding context while still meeting the City's affordable housing goals.*

**OBJECTIVE 11**

Support and respect the diverse and distinct character of San Francisco's neighborhoods.

*In recognition that the projects utilizing the Affordable Housing Bonus Program (AHBP) will sometimes be taller or of differing mass than the surrounding context, the AHBP Design Guidelines clarify how projects shall both maintain their size and adapt to their neighborhood context.*

**POLICY 11.2**

Ensure implementation of accepted design standards in project approvals.

*In order to ensure consistency with the intent of the Planning Code and the General Plan, construct high quality buildings, as well as provide project sponsors with guidance and predictability in forming their building proposals, the project sponsors who use the AHBP are subject to the AHBP Design Guidelines.*

**POLICY 11.3**

Ensure growth is accommodated without substantially and adversely impacting existing residential neighborhood character.

*Accommodation of growth should be achieved without damaging existing residential neighborhood character. In existing residential neighborhoods, this means development projects should defer to the prevailing height and bulk of the area, while recognizing that the City may maintain neighborhood character while permitting larger overall building mass for projects including more affordable units on-site.*

*The AHBP only provides development bonuses which may permit a larger overall building mass for projects that include affordable housing on-site.*

**POLICY 11.5**

Ensure densities in established residential areas promote compatibility with prevailing neighborhood character.

Outside of RH-1 and RH-2 neighborhoods, the City may maintain neighborhood character while permitting larger overall building mass for projects including more affordable units on-site.

*The AHBP program only provides development bonuses which may permit more units for projects that include affordable housing on-site.*

**OBJECTIVE 12**

Balance housing growth with adequate infrastructure that serves the City's growing population.

**POLICY 12.1**

Encourage new housing that relies on transit use and environmentally sustainable patterns of movement.

*On balance the AHBP area is located within a quarter-mile (or 5 minute-walk) of the proposed Muni Rapid network, which serves almost 70% of Muni riders and will continue to receive major investments to prioritize frequency and reliability, and the program is distributed equitably throughout the City.*

**OBJECTIVE 13**

Prioritize sustainable development in planning for and constructing new housing.

**POLICY 13.1**

Support "smart" regional growth that locates new housing close to jobs and transit.

*On balance the AHBP area is located within a quarter-mile (or 5 minute-walk) of the proposed Muni Rapid network, which serves almost 70% of Muni riders and will continue to receive major investments to prioritize frequency and reliability, and the program is distributed equitably throughout the City.*

**URBAN DESIGN ELEMENT**

**OBJECTIVE 3**

Moderation of Major New Development to Complement the City Pattern, The Resources To Be Conserved, And The Neighborhood Environment.

*The amended Urban Design Element recognizes that to encourage greater levels of affordability on-site, the City may adopt affordable housing policies to permit projects heights that are several stories taller and building mass that is larger.*

**POLICY 4.15**

Protect the livability and character of residential properties from the intrusion of incompatible new buildings.

*In recognition that the projects utilizing the AHBP will sometimes be taller or of differing mass than the surrounding context, the AHBP Design Guidelines clarify how projects shall both maintain their size and adapt to their neighborhood context.*

**TRANSPORTATION**

**POLICY 11.3**

Encourage development that efficiently coordinates land use with transit service, requiring that developers address transit concerns as well as mitigate traffic problems.

*On balance the AHBP area is located within a quarter-mile (or 5 minute-walk) of the proposed Muni Rapid network, which serves almost 70% of Muni riders and will continue to receive major investments to prioritize frequency and reliability, and the program is distributed equitably throughout the City.*

#### COMMERCE AND INDUSTRY ELEMENT

##### **Policy 1.1**

Encourage development which provides substantial net benefits and minimizes undesirable consequences. Discourage development which has substantial undesirable consequences that cannot be mitigated.

*The AHBP could result in up to 2 million square feet of new commercial space in San Francisco's neighborhood commercial corridors, providing new space for neighborhood serving businesses, and the many thousands of jobs they support.*

#### VAN NESS AVENUE AREA PLAN

##### **OBJECTIVE 1**

Continue existing Commercial Use of the avenue and add a significant increment of new housing. Redwood to Broadway.

##### **Policy 5.1**

Establish height controls to emphasize topography and adequately frame the great width of the Avenue.

##### **POLICY 5.3**

Continue the street wall heights as defined by existing significant buildings and promote an adequate enclosure of the Avenue.

*The conforming General Plan Amendments for the AHBP have added the following text to all applicable policies and maps in the Van Ness Avenue Area Plan:*

*\*To encourage greater levels of affordability on-site, the City may adopt affordable housing policies to permit heights that are several stories taller and building mass that is larger than described here.*

#### CHINATOWN AREA PLAN

##### **POLICY 1.1**

Maintain the low-rise scale of Chinatown's buildings.

*The conforming General Plan Amendments for the AHBP have added the following text to all applicable policies and maps in the Chinatown Area Plan:*

*\*To encourage greater levels of affordability on-site, the City may adopt affordable housing policies to permit heights that are several stories taller and building mass that is larger than described here.*

NORTHEASTERN WATERFRONT AREA PLAN

**OBJECTIVE 10**

To develop the full potential of the northeastern waterfront in accord with the unusual opportunities presented by its relation to the bay, to the operating port, fishing industry, and downtown; and to enhance its unique aesthetic qualities offered by water, topography, views of the city and bay, and its historic maritime character

**POLICY 10.26**

Restrict development south of Broadway to the Height and Bulk Districts shown on Map 2.\*

**POLICY 26.27**

Change the Height and Bulk District on Block 3743 from 84-E to 40-X. Change the Height and Bulk District on the rest of the Rincon Park Site to open space

**POLICY 30.18**

Develop housing in small clusters of 100 to 200 units. Provide a range of building heights with no more than 40 feet in height along the Embarcadero and stepping up in height on the more inland portions to the maximum of 160 feet. In buildings fronting on Brannan Street in the 160 foot height area, create a strong base which maintains the street wall created by the residential complex to the east and the warehouse buildings to the west. Orient the mix of unit types to one and two bedrooms and include some three and four bedroom units. Pursue as the income and tenure goals, a mix of 20 percent low, 30 percent moderate and 50 percent middle and upper income, and a mix of rental, cooperative, and condominium units.\*

**POLICY 30.22**

Do not permit buildings to exceed 65 percent coverage of land or parking podium. To the maximum extent feasible, provide open space at ground level and provide planting in the ground. Ensure that any open space on top of a podium provides easy pedestrian and visual transition from the sidewalk.\*

*The conforming General Plan Amendments for the AHBP have added the following text to all applicable policies and maps in the Northwest Waterfront Area Plan:*

*\*To encourage greater levels of affordability on-site, the City may adopt affordable housing policies to permit heights that are several stories taller and building mass that is larger than described here.*

4. **Planning Code Section 101 Findings.** The proposed amendments to the Planning Code are consistent with the eight Priority Policies set forth in Section 101.1(b) of the Planning Code in that:
  1. That existing neighborhood-serving retail uses be preserved and enhanced and future opportunities for resident employment in and ownership of such businesses enhanced;

*The proposed program will create a net addition of neighborhood serving commercial uses, the program is estimated to produce up to 2 million square feet of commercial space. Many of the districts encourage or require that commercial uses be place on the ground floor. These existing requirements ensure the proposed amendments will not have a negative effect on neighborhood serving retail uses and will not affect opportunities for resident employment in and ownership of neighborhood-serving retail.*

2. That existing housing and neighborhood character be conserved and protected in order to preserve the cultural and economic diversity of our neighborhoods;

*The amendments will not affect existing housing and neighborhood character as existing design controls and new design controls-the AHBP Design Guidelines-apply to these projects.*

3. That the City's supply of affordable housing be preserved and enhanced;

*The proposed amendments will not affect the supply of affordable housing and in fact could produce 5,000 permanently affordable, income restricted units: 2,000 homes for very-low, low and moderate income households, and 3,000 homes for middle-income households.*

4. That commuter traffic not impede MUNI transit service or overburden our streets or neighborhood parking;

*The proposed amendments will not result in commuter traffic impeding MUNI transit service or overburdening the streets or neighborhood parking and on balance the entire program area is located within a quarter-mile (or 5 minute-walk) of the proposed Muni Rapid network, which serves almost 70% of Muni riders and will continue to receive major investments to prioritize frequency and reliability.*

5. That a diverse economic base be maintained by protecting our industrial and service sectors from displacement due to commercial office development, and that future opportunities for resident employment and ownership in these sectors be enhanced;

*The proposed amendments would not cause displacement of the industrial or service sectors due to office development, and future opportunities for resident employment or ownership in these sectors would not be impaired. The AHBP provides protections for small businesses by providing early notification and also produces up to 2 million square feet of potential new commercial space.*

6. That the City achieve the greatest possible preparedness to protect against injury and loss of life in an earthquake;

*The proposed ordinance would not negatively affect preparedness in the case of an earthquake.*

7. That the landmarks and historic buildings be preserved;

*Landmarks and historic buildings would not be negatively affected by the proposed amendments. The AHBP interface with historic resources may be rare. The State Density Bonus Law (Government Code Section 65915 et seq) provides consideration for historic resources, by stating that the City is not required to approve any projects that "would have a specific adverse impact. . . on any real property*

*that is listed in the California Register of Historical Resources and for which there is no feasible method to satisfactorily mitigate or avoid the specific adverse impact, without rendering the development unaffordable to low- and moderate-income households." (Government Code Sections 65915 (d)(1)(B))"*

*The State Density Bonus Law further states that "Nothing in this subdivision shall be interpreted to require a local government to grant an incentive or concession that would have an adverse impact on any real property that is listed in the California Register of Historical Resources. The city, county, or city and county shall establish procedures for carrying out this section, that shall include legislative body approval of the means of compliance with this section." (Government Code Sections 65915 (d)(3))*

*The Local AHBP is only available to new construction projects, and vertical additions to existing buildings are not allowed. This limitation further reduces any potential conflict between the Local Program and historic resources.*

8. That our parks and open space and their access to sunlight and vistas be protected from development;  
*The City's parks and open space and their access to sunlight and vistas would be unaffected by the proposed amendments. Projects would be ineligible to use the Local and 100% Affordable AHBP if they create new shadow in a manner that substantially affects outdoor recreation facilities or other public areas.*

5. **Planning Code Section 302 Findings.** The Planning Commission finds from the facts presented that the public necessity, convenience and general welfare require the proposed amendments to the Planning Code as set forth in Section 302.

NOW THEREFORE BE IT RESOLVED that the Commission has reviewed and considered the 2004 and 2009 Housing Element Final Environmental Impact Report (FEIR), the Addendum published by the Planning Department on January 14, 2016, and the record as a whole, and finds that the 2004 and 2009 Housing Element Final EIR is adequate for its use as the decision-making body for the action taken herein to approve the AHBP, and incorporates the CEQA findings contained in Planning Commission Resolution 19122, including the Statement of Overriding Considerations, and updated in Ordinance 34-15, by this reference thereto as though fully set forth herein; and be it

FURTHER RESOLVED, that the Commission finds that since the FEIR was finalized, there have been no substantial project changes and no substantial changes in project circumstances that would require major revisions to the FEIR due to the involvement of new significant environmental effects or an increase in the severity of previously identified significant impacts, and there is no new information of substantial importance that would change the conclusions set forth in the FEIR; and be it

FURTHER RESOLVED, that the Commission hereby has completed review of the proposed Ordinance and forwards the Ordinance to the Board with suggestions for consideration set forth above.



I hereby certify that the foregoing Resolution was adopted by the Commission at its meeting on February 25, 2016.

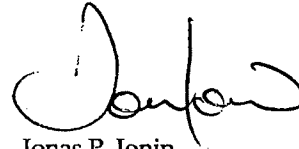

Jonas P. Ionin  
Commission Secretary

Topic	Recommendations	AYES	NOS	ABSENT
Program Eligibility	1,2	Antonini, Fong, Hillis, Richards	Moore, Wu	Johnson
Infrastructure to Support New Growth	NA	No action	No action	No action
Urban Design	3,4,5	Antonini, Fong, Hillis, Richards	Moore, Wu	Johnson
Public Review and Planning Commission Approval	6	Antonini, Fong, Hillis, Richards	Moore, Wu	Johnson
Preserving Small Business	7	Antonini, Fong, Hillis, Richards	Moore, Wu	Johnson
Affordability	8,9	Antonini, Fong, Hillis, Wu	Moore, Richards	Johnson

ADOPTED: February 25, 2016

## Exhibit D: Summary of Proposed General Plan Amendment

Summary of proposed revisions to the text, tables, and maps in the specified sections of the Housing Element, Urban Design Element, Van Ness Avenue Area Plan, Chinatown Area Plan, Downtown Area Plan, and Northeastern Waterfront Area Plan, as follows:

<b>Proposed additions</b>	<b>Existing General Plan Sections</b>
<p>To encourage greater levels of affordability on-site, the City may adopt affordable housing policies to permit general densities that are higher than shown here.</p> <p>Refer to the Affordable Housing Bonus Program Design Guidelines. (Urban Design Element Only)</p>	<p><b>Housing Element</b></p> <p>Map 6 Generalized Permitted Housing Densities by Zoning Districts</p> <p>Table I-58 - Generalized Permitted Housing Densities by Zoning Districts</p> <p><b>Urban Design Element</b></p> <p>Objective 3</p> <p>Map 4 - Urban Design Guidelines for Height and Bulk Districts</p> <p>Map 5 - Urban Design Guidelines for Bulk of Buildings</p>
<p>To encourage greater levels of affordability on-site, the City may adopt affordable housing policies to permit heights that are several stories taller than described here.</p>	<p><b>Van Ness Avenue Area Plan</b></p> <p>Objective 1</p> <p>POLICY 5.1 Establish height controls to emphasize topography and adequately frame the great width of the Avenue.</p>
<p>To encourage greater levels of affordability on-site, the City may adopt affordable housing policies to permit heights that are several stories taller and building mass that is larger than described here.</p>	<p><b>Van Ness Avenue Area Plan</b></p> <p>Policy 5.3 Continue the street wall heights as defined by existing significant buildings and promote an adequate enclosure of the Avenue.</p> <p>Map 1 - Van Ness Avenue Area Plan and Generalized Land Use and Density Plan</p> <p>Map 2 - Van Ness Avenues Area Plan Height and Bulk Districts</p>

Exhibit D: Summary of Proposed General Plan Amendment

	<p><b>Chinatown Area Plan</b></p> <p>POLICY 1.1 Maintain the low-rise scale of Chinatown's buildings.</p> <p>Map 1 - Chinatown Area Plan Generalized Height Plan</p> <p>Map 3 - Chinatown Area Plan Land Use and Density Plan</p> <p><b>Downtown Area Plan</b></p> <p>Map 1 – Downtown Land Use and Density Plan</p> <p>Map 5 - Downtown Area Plan Downtown Height and Bulk Districts</p>
<p>such as providing development incentives for higher levels of affordability, including for middle income households.</p>	<p><b>Housing Element</b></p> <p><b>Policy 7.7</b> Support housing for middle income households, especially through programs that do not require a direct public subsidy</p>
<p>while recognizing that the City may maintain neighborhood character while permitting larger overall building mass for projects including more affordable units on-site.</p>	<p><b>Housing Element</b></p> <p>POLICY 11.3 Ensure growth is accommodated without substantially and adversely impacting existing residential neighborhood character.</p>
<p>Outside of RH-1 and RH-2 neighborhoods, the City may maintain neighborhood character while permitting larger overall building mass for projects including more affordable units on-site.</p>	<p><b>Housing Element</b></p> <p>POLICY 11.5 Ensure densities in established residential areas promote compatibility with prevailing neighborhood character.</p>

Exhibit E. Planning Department Correspondence with Supervisor Peskin regarding Environmental Review Considerations for the Draft Density Done Right Development without Displacement Ordinance

**From:** Rodgers, AnMarie (CPC)  
**Sent:** Monday, June 20, 2016 5:28 PM  
**To:** Peskin, Aaron (BOS); Angulo, Sunny (BOS); Givner, Jon ([jon.givner@sfgov.org](mailto:jon.givner@sfgov.org))  
**Cc:** 'LISA GIBSON ([LISA.GIBSON@sfgov.org](mailto:LISA.GIBSON@sfgov.org))'  
**Subject:** FW: Amendments to Density Done Right Ordinance  
**Importance:** High

Dear Supervisor Peskin & Sunny,

In anticipation that Supervisor Peskin may want to duplicate the AHBP Planning Code Ordinance tomorrow and add in the language from the DDR ordinance, our CEQA staff are preparing a "note to file" for the addendum. This note will complete our CEQA review of the DDR ordinance should the BOS decide to act on DDR. In order for this note to file to cover the DDR proposal, the language in the attached document should be added into the duplicated file containing DDR. This language in the attachment is currently in Supervisor Tang's AHBP & should be duplicated in the DDR. Please contact me or acting ERO, Lisa Gibson, if you have any questions.

AnMarie Rodgers, Senior Policy Advisor  
SFPlanning 415-558-6395

Public access to property information and permit history is just a click away:  
<http://propertymap.sfplanning.org>

**From:** Li, Michael (CPC)  
**Sent:** Monday, June 20, 2016 5:16 PM  
**To:** Rodgers, AnMarie (CPC); Gibson, Lisa (CPC)  
**Cc:** Dischinger, Kearstin (CPC); Mohan, Menaka (CPC)  
**Subject:** Amendments to Density Done Right Ordinance  
**Importance:** High

AnMarie and Lisa,

In order for Supervisor Peskin's ordinance to fall under the scope of the analysis contained in Addendum 3, his ordinance will need to include the attached language under the "Applicability" provision. New language is underlined.

Michael Li  
Environmental Planning Division  
San Francisco Planning Department  
1650 Mission Street, Suite 400  
San Francisco, CA 94103  
(415) 575-9107  
[michael.i.li@sfgov.org](mailto:michael.i.li@sfgov.org)  
[www.sfplanning.org](http://www.sfplanning.org)



Exhibit E. Planning Department Correspondence with Supervisor Peskin regarding Environmental Review Considerations for the Draft Density Done Right Development without Displacement Ordinance

Attached Language, referred to in email from AnMarie Rodgers dated June 20, 2016.

**SEC. 206.3. APPLICABILITY.**

(a) **Applicability.** A Density Done Right: Development Without Displacement Project under this Section 206.3 shall be a Housing Project that:

(6) demonstrates to the satisfaction of the Environmental Review Officer that the Project does not:

(A) cause a substantial adverse change in the significance of an historic resource as defined by California Code of Regulations, Title 14, Section 15064.5.

(B) create new shadow in a manner that substantially affects outdoor recreation facilities or other public areas; and

(C) alter wind in a manner that substantially affects public areas.



# SAN FRANCISCO PLANNING DEPARTMENT

## Planning Commission Resolution No. 19686

HEARING DATE JUNE 30, 2016

1650 Mission St.  
Suite 400  
San Francisco,  
CA 94103-2479

Reception:  
**415.558.6378**

Fax:  
**415.558.6409**

Planning  
Information:  
**415.558.6377**

*Project Name:* 100% Affordable Housing Bonus Program and  
Density Done Right; Development Without Displacement Program

*Case Number:* 2014-001503PCA [Board File No. 150969] and  
2016-008024PCA [Board File No. 160668]

*Initiated by:* AHBP introduced September 29, 2015  
DDR introduced on June 7, 2016

*Staff Contact:*  
Kearstin Dischinger, Manager of Housing Policy  
kearstin.dischinger@sfgov.org, 415-558-6362

*Recommendation:* Find both Ordinances consistent with the General Plan

**MAKING FINDINGS OF CONSISTENCY WITH THE GENERAL PLAN AND THE EIGHT PRIORITY POLICIES OF PLANNING CODE SECTION 101.1 FOR THE 100% AFFORDABLE HOUSING BONUS PROGRAM AND DENSITY DONE RIGHT; DEVELOPMENT WITHOUT DISPLACEMENT PROGRAM.**

WHEREAS, on September 29, 2015, Mayor Ed Lee and Supervisor Tang introduced a proposed Ordinance under Board of Supervisors (hereinafter "Board") File Number 15-0969, which would amend the Planning Code to create the Affordable Housing Bonus Program, to provide various zoning modifications, form based zoning, and a height waiver for projects providing various levels of affordable housing, including a program entitled "the 100% Affordable Housing Bonus Program"; and

WHEREAS, on October 15, 2015 the Planning Commission voted to initiate an amendment to the General Plan to add language to certain policies, objectives and maps that clarified that the City could adopt policies or programs that allowed additional density and development potential if a project included increased amounts of on-site affordable housing; and

WHEREAS, on February 25, 2016, this Commission found that the Affordable Housing Bonus Program was, on balance, consistent with the San Francisco General Plan as amended, and forwarded the Affordable Housing Bonus Program, together with several recommended amendments, to the Board of Supervisors for their consideration; and

WHEREAS, on June 13, 2016, Supervisor Tang duplicated the AHBP ordinance file and amended the AHBP ordinance to include only the 100% Affordable Housing Bonus Program, and amended the 100% Affordable Housing Bonus Program to, among other items, prohibit the use of the program on parcels containing residential units and to allow an appeal to the Board of Supervisors; and

2. Affordable housing is of paramount statewide concern, and the California State legislature has declared that local and state governments have a responsibility to use the powers vested in them to facilitate the improvement and development of housing to make adequate provision for the housing needs of all economic segments of the community.
3. The State Legislature has found that local governments must encourage the development of a variety of types of housing for all income levels, including multifamily rental housing and assist in the development of adequate housing to meet the needs of low- and moderate-income households.
4. San Francisco has one of the highest housing costs in the nation, but San Francisco's economy and culture rely on a diverse workforce at all income levels. It is the policy of the Board of Supervisors to facilitate the provision of housing to these workers and help to ensure that they pay a proportionate share of their incomes to live in adequate housing and to not commute ever-increasing distances to their jobs. The Association of Bay Area Governments determined that San Francisco's share of the Regional Housing Need for January 2015 to June 2022 was the provision of 28,870 new housing units, with 6,234 (or 21.6%) as very low, 4,639 (or 16.1%) as low, and 5,460 (or 18.9%) as moderate income units.
5. This Board of Supervisors, and the voters in San Francisco, have long recognized the need for the production of affordable housing. The voters, or the Board have adopted measures such as the establishment of the mandatory Inclusionary Affordable Housing Ordinance in Planning Code section 415; the San Francisco Housing Trust Fund, adopted in 2012, which established a fund to create, support and rehabilitate affordable housing, and set aside \$20 million in its first year, with increasing allocations to reach \$50 million a year for affordable housing.
6. The adoption of Proposition K in 2014 which established as City policy that the City, by 2020, will help construct or rehabilitate at least 30,000 homes, with more than 50% of the housing affordable for middle-income households, and at least 33% as affordable for low-and moderate income households; and the multiple programs that rely on Federal, State and local funding sources as identified in the Mayor's Office of Housing and Community Development (MOHCD) Comprehensive Plan.
7. Development bonuses are a long standing zoning tool that enable cities to encourage private development projects to provide public benefits including affordable housing.
8. **General Plan Compliance.** The proposed Ordinances are, on balance, consistent with the Objectives and Policies of the General Plan . (Staff discussion is added in *italic font* below):

#### HOUSING ELEMENT

##### **OBJECTIVE 1**

**Identify and make available for development adequate sites to meet the City's housing needs, especially permanently affordable housing.**

*The 100% Affordable Housing Bonus Program (100% AHBP) would apply in zoning districts which a) allow residential use. The 100% Affordable Housing Bonus Program eligible districts generally include the City's neighborhood commercial districts, where residents have easy access to daily services, and are located along major transit corridors. 100% Affordable Housing Bonus Program eligible districts generally allow or encourage mixed uses and active ground floors. On balance the program area is located within a quarter-mile (or 5 minute-walk) of the proposed*

*The 100% AHBP and the DDR will facilitate affordable housing supply, including homeownership opportunities.*

**OBJECTIVE 4**

**Foster a housing stock that meets the needs of all residents across lifecycles.**

*The 100% AHBP and DDR can be utilized to increase housing supply for many household types including families, seniors, and emancipated youth.*

**POLICY 4.1**

**Develop new housing, and encourage the remodeling of existing housing, for families with children.**

*The 100% AHBP and DDR can increase the supply of new affordable housing, including new affordable housing for families.*

**POLICY 4.4**

**Encourage sufficient and suitable rental housing opportunities, emphasizing permanently affordable rental units wherever possible.**

*The 100% AHBP and DDR encourages the development of greater numbers of permanently affordable housing, including rental units.*

**Policy 4.5**

**Ensure that new permanently affordable housing is located in all of the city's neighborhoods, and encourage integrated neighborhoods, with a diversity of unit types provided at a range of income levels.**

*Parcels in most of the City's neighborhood commercial districts are eligible for the 100% AHBP, which enables the City to increase the number of very low, low and moderate income households and encourage integration of neighborhoods.*

*A smaller set of parcels would be eligible for DDR, depending on existing uses and other program eligibility requirements.*

**Policy 4.6**

**Encourage an equitable distribution of growth according to infrastructure and site capacity.**

*On balance the 100% AHBP and DDR eligible parcels are located within a quarter-mile (or 5 minute-walk) of the proposed Muni Rapid Network, which serves almost 70% of Muni riders and will continue to receive major investments to prioritize frequency and reliability.*

**OBJECTIVE 7**

**Secure funding and resources for permanently affordable housing, including innovative programs that are not solely reliant on traditional mechanisms or capital.**



*The DDR program requires a Conditional Use Permit which requires that the Commission find that entitled projects are consistent with the surrounding context, thus ensuring that the diverse and distinct character of San Francisco's neighborhoods are supported and respected.*

**POLICY 11.2**

**Ensure implementation of accepted design standards in project approvals.**

*In order to ensure consistency with the intent of the Planning Code and the General Plan, construct high quality buildings, as well as provide project sponsors with guidance and predictability in forming their building proposals, the project sponsors who use the 100% AHBP are subject to the AHBP Design Guidelines.*

**POLICY 11.3**

**Ensure growth is accommodated without substantially and adversely impacting existing residential neighborhood character.**

*The 100% AHBP and DDR only provide development bonuses which may permit a larger overall building mass for projects that include 100% affordable housing. Generally there are only two or three of these projects funded and entitled per year. Analysis conducted by staff and consultants on building heights in the eligible districts identified numerous buildings of varying heights in all height districts, including buildings substantially below the allowable height limit, and buildings substantially above the applicable height limits. Thus, the existing character in all eligible neighborhoods includes buildings of various heights. On balance, 100% affordable projects that exceed existing height limits by two or three stories would not substantially and adversely impact existing residential neighborhood character.*

*Further, establishing permanently affordable housing in the City's various neighborhoods would enable the City to stabilize very low, low and moderate income households. These households meaningfully contribute to the existing character of San Francisco's diverse neighborhoods.*

**POLICY 11.5**

**Ensure densities in established residential areas promote compatibility with prevailing neighborhood character.**

*The 100% AHBP and DDR only provide development bonuses which may permit a larger overall building mass for projects that include 100% affordable housing. Generally there are two or three of these projects funded and entitled per year. Analysis conducted by staff and consultants on the eligible districts identified many existing buildings, especially building built before the 1970's or 1980's, that exceed existing zoned density limits. Therefore, even housing with densities higher than the existing zoned density limit are usually consistent with neighborhood character in most parts of San Francisco. As both 100% AHBP and DDR offer increased density as a zoning modification; but still limit overall density permitted through height and other zoning considerations – on balance 100% AHBP projects and DDR projects would be generally consistent with prevailing neighborhood character.*

VAN NESS AVENUE AREA PLAN

**Policy 5.1**

Establish height controls to emphasize topography and adequately frame the great width of the Avenue.

**POLICY 5.3**

Continue the street wall heights as defined by existing significant buildings and promote an adequate enclosure of the Avenue.

*100% AHBP and DDR projects would continue the street wall heights, though may offer some degree of variation due to height exceptions available through the program. Established height controls would continue to be applicable for most projects, and therefore the topography and width of the Avenue would continue to be emphasized and adequately framed. The AHBP Design Guidelines and Planning Commission review process will ensure that on balance projects promote continue the street wall heights an adequate enclosure of the Avenue.*

**BALBOA PARK AREA PLAN**

**OBJECTIVE 4.5:** Provide increased housing opportunities affordable to a mix of households at varying income levels.

*The 100% AHBP and DDR provide zoning and process accommodations which would increase affordable housing opportunities for a mix of household incomes.*

**BAYVIEW AREA PLAN**

**OBJECTIVE 6** Encourage the construction of new affordable and market rate housing at locations and density levels that enhance the overall residential quality of Bayview Hunters Point.

*The 100% AHBP and DDR provide zoning and process accommodations which would increase affordable housing opportunities for a mix of household incomes.*

**CENTRAL WATERFRONT AREA PLAN**

**OBJECTIVE 2.1** Ensure that a significant percentage of new housing created in the central waterfront is affordable to people with a wide range of incomes.

*The 100% AHBP and DDR provide zoning and process accommodations which would increase affordable housing opportunities*

**CHINATOWN AREA PLAN**

**OBJECTIVE 3**

Stabilize and where possible increase the supply of housing.

*The 100% AHBP and DDR provide zoning and process accommodations which would increase affordable housing opportunities.*

**POLICY 11.3**

Continue the enforcement of citywide housing policies, ordinances and standards regarding the provision of safe and convenient housing to residents of all income levels, especially low- and moderate-income people.

*The 100% AHBP and DDR provide zoning and process accommodations which would increase affordable housing opportunities.*

**POLICY 11.4**

Strive to increase the amount of housing units citywide, especially units for low- and moderate-income people.

*The 100% AHBP and DDR provide zoning and process accommodations which would increase affordable housing opportunities.*

**WESTERN SOMA AREA PLAN**

**OBJECTIVE 3.3**

**ENSURE THAT A SIGNIFICANT PERCENTAGE OF THE NEW HOUSING CREATED IS AFFORDABLE TO PEOPLE WITH A WIDE RANGE OF INCOMES**

*The 100% AHBP provide zoning and process accommodations which would increase affordable housing opportunities to households making up to 80% of the area median income. The DDR provides zoning and process accommodations which would increase affordable housing opportunities to households earning up to 100% of the neighborhood median income.*

4. **Planning Code Section 101 Findings.** The proposed amendments to the Planning Code are, on balance, consistent with the eight Priority Policies set forth in Section 101.1(b) of the Planning Code in that:

1. That existing neighborhood-serving retail uses be preserved and enhanced and future opportunities for resident employment in and ownership of such businesses enhanced;

*The proposed programs will create a net addition of neighborhood serving commercial uses. Many of the districts encourage or require that commercial uses be placed on the ground floor. These existing requirements ensure the proposed amendments will not have a negative effect on neighborhood serving retail uses and will not affect opportunities for resident employment in and ownership of neighborhood-serving retail.*

2. That existing housing and neighborhood character be conserved and protected in order to preserve the cultural and economic diversity of our neighborhoods;

*The 100% AHBP and DDR both propose to conserve and protect the existing neighborhood character, by stabilizing very low, low and moderate income households who contribute greatly to the City's cultural and economic diversity, and by providing design review opportunities through the 100% Affordable Housing Bonus Program Design Review Guidelines and Board of Supervisors appeal process, and the conditional use review process for the DDR.*

*The DDR may also include a prohibition on projects that would create new shadow in a manner that substantially affects outdoor recreation facilities or other public areas.*

5. **Planning Code Section 302 Findings.** The Planning Commission finds from the facts presented that the public necessity, convenience and general welfare require the proposed amendments to the Planning Code as set forth in Section 302.

FURTHER RESOLVED, that the Commission hereby finds the proposed 100% AHBP ordinance; and the DDR ordinance, with proposed amendments to address historic resources, wind, and shadow concerns and if eligibility for the DDR to projects is limited to areas that are not within the boundaries of Northeast Waterfront Plan Area, south of Broadway, are consistent with the General Plan.

I hereby certify that the foregoing Resolution was adopted by the Commission at its meeting on June 30, 2016.

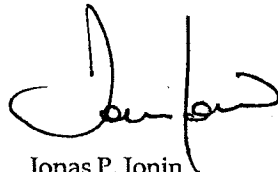

Jonas P. Ionin  
Commission Secretary

AYES: Antonini, Hillis, Johnson, Moore, Richards, Wu,

NOES: None

ABSENT: Fong

ADOPTED: June 30, 2016



# SAN FRANCISCO PLANNING DEPARTMENT

## Executive Summary Planning Code Amendment HEARING DATE: JUNE 30, 2016

1650 Mission St.  
Suite 400  
San Francisco,  
CA 94103-2479

Reception:  
415.558.6378

Fax:  
415.558.6409

Planning  
Information:  
415.558.6377

*Project Name:* Affordable Housing Bonus Program and Density Done Right  
*Case Number:* 2014-001503PCA [Board File No. 150969]  
*Initiated by:* Mayor Ed Lee  
Supervisor Katy Tang  
Introduced September 29, 2015

And

*Case Number:* 2016-008024PCA [Board File No. 160668]  
*Initiated by:* Supervisor Aaron Peskin  
Supervisor Eric Mar  
Introduced June 7, 2015,  
*Staff Contact:* Kearstin Dischinger, Manager of Housing Policy  
kearstin.dischinger@sfgov.org, 415-558-6284  
*Reviewed by:* AnMarie Rodgers, Senior Policy Advisor

*Recommendation:* **Recommend Adopt Consistency Findings for Both Ordinances**

The Board of Supervisors requests that the Planning Commission make General Plan Consistency Findings for two proposed ordinances: 100% Affordable Housing Bonus Program<sup>1</sup> (hereinafter "100% AHBP") and Density Done Right Development Without Displacement<sup>2</sup> (hereinafter "DDR"). Both programs propose similar development incentives for 100% affordable housing projects including: relief from density requirements, up to three additional stories of height, and several potential zoning concessions and incentives. Both draft ordinances limit eligibility to projects where all units are income restricted or permanently affordable. See Exhibit A for the 100% AHBP (inclusive of amendments made as of June 28, 2016) and Exhibit B for the DDR.

### BACKGROUND

This report will describe the one requested action of "General Plan Consistency Findings" for two separate ordinances by describing the background for each ordinance.

---

<sup>1</sup> Mayor Edwin Lee and Supervisor Katy Tang's proposal for a density bonus program that is limited to 100% affordable housing projects.

<sup>2</sup> Supervisor Aaron Peskin's and Supervisor Eric Mar's proposal which is currently under the Board of Supervisor's 30-day Hold Rule.

### Affordable Housing Bonus Program (AHBP) 100%

The draft AHBP ordinance includes several programs aimed at increasing the overall number of affordable housing units built in the city of San Francisco. Although the Planning Commission considered the full program earlier this year, today's hearing and proposed action on this program is limited to the 100% AHBP, which provides zoning incentives to 100% affordable projects, which are generally built with public subsidies.

1. Mayor Lee and Supervisor Tang introduced the draft AHBP ordinance on September 29, 2015. The Draft ordinance was developed based on consultant analysis, stakeholder input and guidance from the Mayor's Housing Working Group.
2. On October 15, 2015 the Planning Commission initiated hearings on proposed General Plan Amendments for the AHBP.
3. Following four public hearings, the Planning Commission took the following actions in relation to the proposed AHBP on February 25th, 2016:
  - The Planning Commission made several recommendations to the proposed AHBP Planning Code amendment (see Exhibit C for CPC resolution and recommendations). These recommendations were limited to the mixed income programs. The Planning Commission did not make any recommendations related to the 100% affordable component of the larger AHBP ordinance.
  - The Planning Commission made General Plan consistency findings for the entire proposed AHBP ordinance, including the three mixed income programs and the 100% AHBP. This consistency finding was made in concert with consideration of a proposed General Plan Amendment.
  - The Planning Commission unanimously voted to forward the proposed General Plan Amendment. The General Plan amendment incorporated footnotes into several text sections and into several maps of the General Plan. These notations say that the City may adopt affordable housing policies to permit heights that are several stories taller than described in the General Plan. (See Exhibit D for details of the proposed General Plan Amendment).
4. At the June 13, 2016 Land Use and Transportation Committee, Supervisor Tang duplicated the draft AHBP ordinance so that there are now two separate ordinances – (1) the 100% Affordable program; and (2) the originally drafted AHBP ordinance (which included all four programs: the 100% AHBP and the three mixed income<sup>3</sup> programs). Supervisor Tang introduced several amendments to the mixed income programs<sup>4</sup>. After

---

<sup>3</sup> The term mixed income programs refers to programs that provide benefits to market rate projects that include some proportion of permanently affordable housing, including the Local AHBP, the State Analyzed Program, and the Individually Requested Program.

<sup>4</sup> The Committee made the following amendments to the mixed income program: 1) prohibit the demolition of existing residential units (including rent-controlled units); 2) require approval of Local Program project through a conditional use authorization; 3) direct the City to explore establishing a small business preservation tools; 4) add a findings section with reference to existing tools and other support available to small business tenants; and 5) include certain active uses to be replaced at the same square footage.

accepting these amendments, the Committee tabled the mixed income portion of the AHBP to the call of the chair. The Committee amended the 100% AHBP ordinance to remove parcels with existing residential units from eligibility for the 100% Affordable program, and forwarded this proposal to the full Board of Supervisors. **Today's Planning Commission hearing and proposed action is limited to findings regarding only the 100% AHBP of Supervisor Tang and Mayor Edwin Lee's proposal** (and, as described in the next section, to the same findings for Supervisor Peskin and Supervisor Mar's DDR, which also only enables projects that are completely dedicated to affordable housing).

5. On June 21<sup>st</sup> the Board of Supervisor held a hearing on the 100% AHBP. Supervisor Tang made several amendments to the 100% AHBP including:
  - A requirement that projects include community serving uses on the ground floor.
  - A change in the review process to include 3 necessary Commission findings and changing the appeal body in the [new] Planning Code section 328 review process from the Board of Appeals to the Board of Supervisors.
6. On June 28, 2016, the Board of Supervisors voted to reject the proposed General Plan Amendment (Case Number 2014-001503GPA) associated with the AHBP by a vote of 5 to 6. Supervisor Peskin stated that the proposed General Plan Amendment was too broad, and could empower the Planning Department to pursue future upzonings. Supervisor Peskin and other dissenting Supervisors suggested they would support a more narrowly crafted General Plan Amendment at a future date. Supervisors Tang and Peskin discussed this pending Commission agenda item, as the next and most expedient step need to enable further consideration of the 100% AHBP.
7. On June 28, 2016 Supervisor Tang introduced an amendment to the 100% AHBP to exclude the Northeast Waterfront Plan Area south of Broadway from eligibility for the 100% AHBP, as a result of staff recommendations in anticipation of this hearing. The Board of Supervisors voted to continue hearings on the 100% AHBP to July 12th, pending the Planning Commission's findings (before you today) that the proposed Planning Code Ordinances are found consistent with the existing General Plan.

#### **Density Done Right Development without Displacement (BOS File No. 160668)**

1. On June 7, 2016 Supervisors Peskin and Mar introduced the Density Done Right; Development Without Displacement Program (DDR). This draft ordinance proposes development incentives for 100% affordable housing projects, similar to those proposed for the 100% AHBP. DDR proposes several additional eligibility criteria for 100% affordable projects such as restrictions on existing land uses. Under the DDR, units must be affordable to households earning no more than 100% of the "neighborhood median income," which until the MOHCD determines otherwise, is set by zip code.
2. On June 13<sup>th</sup> at the Land Use Committee Supervisor Peskin proposed duplicating Supervisor Tang's proposal so that he could delete much of the substance for the 100% AHBP and replace it with his alternative DDR Program. He stated that this amendment would still require CEQA review by the Planning Department, but would remove the need for a Planning Commission hearing. It would also allow the Board to consider his proposal alongside the Mayor and Supervisor Tang's proposal. The Committee rejected this motion.

3. On June 20, 2016 the Planning Department informed Supervisor's Peskin and Mar about initial environmental review considerations (see Exhibit E)
4. On June 15, 2016 the Board of Supervisors referred DDR to the Planning Department for review.
5. On June 29, 2016, Supervisor Peskin's office indicated an intention to move forward with the following amendments:
  - Limit eligibility for DDR to projects that demonstrates to the satisfaction of the Environmental Review Officer that the Project does not:
    - cause a substantial adverse change in the significance of an historic resource as defined by California Code of Regulations, Title 14, Section 15064.5.
    - create new shadow in a manner that substantially affects outdoor recreation facilities or other public areas; and
    - alter wind in a manner that substantially affects public areas.
6. On June 29, 2016 the Planning Department discussed with Supervisor Peskin's office additional potential amendments that would limit eligibility for the DDR to projects that are not within the boundaries of Northeast Waterfront Plan Area, south of Broadway (consistent with Supervisor Tang's amendment to the 100% AHBP on June 28, 2016). These additional amendments were discussed in light of the Board action to reject the proposed General Plan amendment. With that Board action, the Commission has been asked to consider if the proposals are consistent with the existing General Plan. Consistency findings cannot be made if a zoning ordinance conflicts with a general plan policy that is "fundamental, mandatory, and clear." Per staff's analysis, the existing General Plan is for the most part general and does not fundamentally conflict with either DDR or 100% AHBP. However, the NE Waterfront Area Plan does have some language that appears clear and mandatory concerning heights for sections of the plan area south of Broadway. Due to the short timeframe, a meeting with the legislative sponsor to discuss these issues has not yet occurred. For this reason, the draft resolution makes findings of consistency if eligibility for the DDR to projects is limited to areas that are not within the boundaries of Northeast Waterfront Plan Area, south of Broadway.

## ISSUES AND CONSIDERATIONS

On February 25<sup>th</sup>, 2016 the Planning Commission forwarded to the Board a proposed General Plan Amendment (hereinafter "GPA") with the draft AHBP Planning Code Amendment (hereinafter "PCA"). This proposed GPA amended several policies and maps of the General Plan, noting that the City *could* adopt affordable housing policies that offered zoning incentives to encourage greater levels of affordability. The proposed GPA clarifies the City's intended policy direction as it related to the proposed AHBP ordinance. Because the Board of Supervisors has rejected the proposed GPA, the Board referred the 100% AHBP to the Planning Commission for a finding of consistency with the General Plan without the clarifying amendments contained in the GPA.

Today the Commission is being asked to find the proposed 100% AHBP and the DDR ordinances consistent with the General Plan, as the General Plan exists today, without any amendments.



Many objectives and policies within the existing General Plan encourage and support the development of ordinances such as the 100% AHBP or DDR, which encourage the production of affordable housing. A detailed analysis of General Plan consistency is presented in Exhibit G—the Draft Resolution. Of specific note is Policy 7.5 of the Housing Element that specifically calls for encouraging process and zoning accommodations, such as those proposed in the two draft ordinances, as a City Policy to meet Objective 7 of the Housing Element.

#### **OBJECTIVE 7**

**Secure funding and resources for permanently affordable housing, including innovative programs that are not solely reliant on traditional mechanisms or capital.**

**7.5 Encourage the production of affordable housing through process and zoning accommodations, and prioritize affordable housing in the review and approval processes.**

The Housing Element consistently emphasizes the need for permanently affordable housing. Another theme in the Housing Element is the need to identify tools, sources and mechanisms outside of past practices to further respond to the affordable housing needs of San Francisco. Also of note is the occurrence of Objectives and/or Policies in almost every area plan or neighborhood plan emphasizing support for housing affordable to a variety of households.

The General Plan also includes some policies and maps which generally describe land use, heights and density strategies for the City as a whole or for particular neighborhoods. While the proposed GPA added clarifying information to the General Plan regarding the allowance of additional development potential for projects with added levels of on-site affordable housing, these policies and maps are general guidelines and were not mandatory in nature; most of the proposed amendments were not required to find consistency with the General Plan. Staff has reviewed the 100% AHBP, including the amendments from June 28, and finds that the proposed 100% AHBP ordinance, and the DDR ordinance as proposed and suggested to be amended, are generally consistent and do not conflict with the General Plan.

#### **REQUIRED COMMISSION ACTION**

The Board of Supervisors has requested the Commission make consistency findings for two draft ordinances. This Commission is being presented with a draft resolution finding *both* the 100% AHBP and the draft pending DDR as proposed to be amended consistent with the General Plan.

These items may be acted upon or may be continued, at the discretion of the Commission.

#### **RECOMMENDATION SUMMARY**

The Department recommends that the Commission find both the 100% AHBP and DDR, if amended as described above, consistent with the General Plan and adopt the attached Draft Resolution to that effect. Further information has been described in more detail earlier in the case report.

## ENVIRONMENTAL REVIEW

On January 14, 2016, in response to the proposed Affordable Housing Bonus Program and related General Plan Amendments, the San Francisco Planning Department prepared an Addendum to the 2004 and 2009 Housing Element Final EIR under CEQA Guidelines Section 15164 ("the Addendum"). The Addendum can be accessed here: [http://sfmea.sfplanning.org/2014.1304E\\_AHBP\\_Addendum03\\_011416%20Final.pdf](http://sfmea.sfplanning.org/2014.1304E_AHBP_Addendum03_011416%20Final.pdf). The Environmental Planning section of the Department has indicated that the amendments to the AHBP to include only the 100% AHBP do not change the conclusions in the Addendum.

Likewise, the DDR with proposed amendment discussed above would not change the conclusions in the Addendum. The Departments conclusions are attached as Exhibit E.

## PUBLIC COMMENT

The Department has not received any public comments on the General Plan Consistency Findings of the 100% AHBP or DDR.

<b>RECOMMENDATION:</b> <b>Adopt Findings of Consistency</b>
---

### Attachments:

- Exhibit A: Draft Ordinance 100% AHBP
- Exhibit B: Draft Ordinance Density Done Right Development without Displacement
- Exhibit C: Final Planning Commission Resolution on the Planning Code Amendments – February 25, 2016
- Exhibit D: Summary of Proposed/rejected General Plan Amendment
- Exhibit E: Planning Department Correspondence with Supervisor Peskin regarding Environmental Review Considerations for the Draft Density Done Right Development without Displacement Ordinance
- Exhibit F: Draft Planning Commission Resolution for BOS File 150969 and Board File No. 160668



# SAN FRANCISCO PLANNING DEPARTMENT

## Executive Summary Planning Code Amendment

HEARING DATE: FEBRUARY 25, 2016

90-DAY DEADLINE: APRIL 11, 2016

1650 Mission St.  
Suite 400  
San Francisco,  
CA 94103-2479

Reception:  
415.558.6378

Fax:  
415.558.6409

Planning  
Information:  
415.558.6377

*Project Name:* Affordable Housing Bonus Program  
*Case Number:* 2014-001503PCA [Board File No. 150969] and 2014-001503GPA  
*Initiated by:* Mayor Ed Lee  
Supervisor Katy Tang  
Introduced September 29, 2015, December 16, 2015, and  
January 12, 2016  
*Staff Contact:* Menaka Mohan, Legislative Affairs  
menaka.mohan@sfgov.org, 415-575-9141  
Paolo Ikezoe, Citywide Division  
paolo.ikezoe@sfgov.org, 415-575-9137  
*Reviewed by:* Kearstin Dischinger, Manager of Housing Policy  
kearstin.dischinger@sfgov.org, 415-558-6284  
*Recommendation:* **Recommend Approval with Modifications**

### BACKGROUND

On September 29, 2015, Mayor Edwin M. Lee and Supervisor Katy Tang introduced an ordinance to implement the Affordable Housing Bonus Program (AHBP). The Planning Commission has held four public hearings on the program to date:

- **October 15, 2015<sup>1</sup>**  
Initiation of General Plan Amendments: initiation at Planning Commission of the AHBP General Plan Amendments
- **November 5, 2015<sup>2</sup>**  
Initiation Hearing: introduced the basics of the program and feedback received to date.
- **December 3, 2015<sup>3</sup>**  
Initially scheduled for adoption. Response to public and Commissioner comments and concerns. Adoption hearing continued to January 28th.

<sup>1</sup>Case packet for initiation of AHBP General Plan Amendments:  
<http://commissions.sfplanning.org/cpcpackets/2014-001503GPA.pdf>

<sup>2</sup>Case packet for the Planning Code Amendment as presented to the Commission on November 5, 2015:  
[http://www.sf-planning.org/ftp/files/plans-and-programs/planning-for-the-city/ahbp/ahbp\\_memotoCPC\\_2014-001503PCA.pdf](http://www.sf-planning.org/ftp/files/plans-and-programs/planning-for-the-city/ahbp/ahbp_memotoCPC_2014-001503PCA.pdf)

<sup>3</sup>Presentation to Planning Commission: [http://www.sf-planning.org/ftp/files/plans-and-programs/planning-for-the-city/ahbp/AHBP\\_CPC\\_Presentation-120315.pdf](http://www.sf-planning.org/ftp/files/plans-and-programs/planning-for-the-city/ahbp/AHBP_CPC_Presentation-120315.pdf)

- **January 28, 2016<sup>4</sup>**  
Update to Commission on public on changes to the program, including Supervisor Breed's amendment removing existing rent-controlled units from AHBP eligibility.

## REPORT STRUCTURE

The January 28th, 2016 Planning Commission hearing on the Affordable Housing Bonus Program (AHBP or Program) included several public comments and a detailed discussion of the proposed program. In consultation with the Commission President, this case report focuses on six (6) key topics raised at that hearing. Each topic includes the following sections:

- **Topic** a brief summary of the topic and issue raised;
- **AHBP Current Response** a discussion of the AHBP's proposed strategy to address the issues raised.  
Note: the majority of these sections discuss the proposed Local Program which was crafted to respond to local housing policy goals. The Individually Requested and State Analyzed programs primarily implement the State Density Bonus Law; and
- **Recommended Amendments and Implications** a discussion of Amendment strategies to address the identified issues and potential implications of that Amendment. As proposed, the AHBP is intended to achieve increased levels of affordable housing production for low, moderate, and middle income households across San Francisco.

This program has been designed to: incentivize market-rate project applicants to choose a Local Program that achieves 30% affordability rather than the State density bonus program that allows for 12 to 18% affordability; increase the development of 100% affordable housing projects serving households below 60% AMI through the 100% AHBP program; and, increase the City's overall supply of affordable housing without drawing public resources away from existing affordable housing programs. All proposed Amendments to this program will be evaluated for their impact on project feasibility and on their ability to incentivize project sponsors to achieve the highest levels of affordability.

This case report is intended to provide a structure for the Commission to consider these six topics. To assist with this structure a summary Department recommendations has been provided as Exhibit C. These recommendations in no way limit the Commission's actions.

For more detail on the AHBP program goals, outcomes, and the proposed legislation please refer to the November 5, 2015<sup>2</sup> and January 28, 2016<sup>4</sup> Planning Commission Packets. Related studies and reports are available in those packets or on the program website.

---

<sup>4</sup> Case packet for the Planning Code Amendment and General Plan Amendment as presented to the Commission on January 28, 2016. <http://www.sf-planning.org/ftp/files/plans-and-programs/planning-for-the-city/ahbp/2014-001503PCA.pdf>

## ISSUES AND CONSIDERATIONS

### Topic 1 Program Eligibility

Commenters are generally supportive of encouraging housing on soft sites; however some have expressed concerns that the AHBP ordinance could incentivize development of parcels that house existing residents. The zoning districts within the AHBP area contain roughly 30,500 parcels, and cover neighborhoods throughout the city.

This section discusses the existing limitations on program eligibility, expected outcomes, and includes one recommendation for Commission consideration.

#### Current Proposal: AHBP and Limits to the Program Scale

To be eligible for the AHBP program, a site must meet several eligibility criteria. A parcel's zoning district has been the most discussed eligibility criterion for the Program; however there are a number of other legislated eligibility criteria proposed in the ordinance that further restrict the program's application. Furthermore, analysis of past development patterns under rezonings and the financial requirements of the program indicate that use of the program will be further limited in application. This section briefly discusses these limiting criteria and supporting analysis.

The Department estimates that of the eligible parcels, approximately 240 parcels citywide will potentially benefit from the AHBP. Generally, these are parcels that are currently developed to less than five percent of existing zoning, do not have any residential uses, and are not schools, churches, hospitals, or historic resources

#### Limiting Criterion 1: Program applies in only certain Zoning Districts ("Program Area")

The California State Density Bonus Law (State Law)<sup>5</sup> applies to residential projects of five or more units anywhere in the state of California.<sup>6</sup> The proposed San Francisco Affordable Housing Bonus Program focuses this broad law on zoning districts with all three of the following features: 1) allowance of residential uses; 2) control of density by a ratio of units to lot area; and 3) allowance of multi-unit residential buildings. The following districts are NOT eligible for the Local or State Analyzed Programs of the AHBP: RH-1 and RH-2 and any zoning districts where density is regulated by form (such as NCT, RTO, UMU, DTR, C-3, etc.).

#### Limiting Criterion 2: No demolition of Historic Resources (less 4,750 or More Parcels)

The AHBP ordinance explicitly disqualifies many parcels within eligible zoning districts based on a number of characteristics. Known historic resources, identified as CEQA Category A buildings by the Department's Historic Preservation division, cannot be demolished to build AHBP projects.<sup>7</sup> Generally, the State Law does not recognize locally designated resources; however the State does allow cities to deny requested incentives, concessions or waivers only for properties listed on National or California Registers. The Local Program protects both eligible and listed

---

<sup>5</sup>California Government Code Sections 65915 – 65918

<sup>6</sup> Please see Exhibit E which describes sponsor requested legislative changes.

<sup>7</sup>In addition, the Planning Commission does not approve demolition unless the proposed project is also approved.

resources under local, state and federal designations. Criterion 2 (exclusion of projects proposing to demolish historic resources) would reduce the number of eligible parcels by at least 4,750. Additional parcels could be excluded during the application or pre-application process as described below.

Properties in San Francisco are organized into three categories for the purposes of CEQA:

Status	Eligibility for AHBP
Category A Known Historic Resources	are not eligible
Category B Unknown (properties over 45 years of age)	may be eligible if determined not to have historic status
Category C Not a Resource	are eligible to participate

The existing proposal is clear that “Known Historic Resources” sites are not eligible for the program and “Not a Resource” sites are eligible for the program. The only uncertainty that remains is for “Unknown” sites. It is not possible to determine which “Unknown” properties may be reclassified as “Category A” or “C” until a historic resource evaluation is filed with the environmental evaluation. The uncertainty in time and invested resources may reduce the incentive for a project sponsor to participate in the Local AHBP. There are an estimated 4,570 “Category A” buildings in the AHBP area. There are also 22,100 “Category B” buildings - with unknown potential as historic resources. Before a project could be approved on these sites, the necessary historic evaluation would be completed to determine the resource status.

*Category B Properties – Initial Historic Resource Determination*

As part of the AHBP entitlement process the Department may offer an initial historic resource determination. The initial historic resource determination application would not require information on the proposed project as only the historic status of the property would be evaluated. This would allow a project sponsor an opportunity to determine eligibility for the local AHBP without investing resources into the design of the proposed project.

*Category B Properties - Citywide Historic Resources Survey*

Since the beginning of the City’s historic preservation program, small-scale surveys have been completed on a piecemeal basis, depending on funding and staff resources. Beginning in the summer of 2016, the Department will begin the first phase of a citywide historic resource survey documenting those areas of San Francisco that have not yet been evaluated. The first priority of this work will be areas potentially eligible for the AHBP and areas currently experiencing, or anticipated to have, heightened development. The citywide historic resource survey project is anticipated to take four to six years to complete. Early determination of either disqualification or eligibility will allow projects to be withdrawn if a resource is present or, if appropriate, designed with greater efficiency and compatibility. This survey work will minimize program uncertainties and associated costs for both the project and the City.

*Category B Properties - Neighborhood Commercial District Survey and Historic Context Statement*

The Department recently completed a Neighborhood Commercial Storefronts Historic Context Statement and data collection phase of a Neighborhood Commercial District Survey. The primary goal of the survey is to identify historic properties that may require future seismic or accessibility upgrades. The Department is currently preparing the community outreach phase of the survey. The survey examined approximately 83 current or formally-zoned neighborhood commercial areas, totaling 5,500 buildings. Along with recent area plan historic surveys, such as Market & Octavia, SoMa, and Mission, the Department will have determinations for virtually all neighborhood commercial corridors within the City. This information will provide upfront information on which properties are Category A or C.

**Limiting Criterion 3: No demolition of a Rent Control Unit**

Board President Supervisor London Breed proposed an amendment to the AHBP ordinance that bans the demolition of any rent control units through this program. The ordinance sponsors, Mayor Edwin Lee and Supervisor Katy Tang, as well as by the Department fully support this proposed amendment. Removing parcels with rent-controlled units is estimated to reduce the number of eligible parcels by 17,000.

**LIMITING CRITERIA TWO AND THREE REMOVE AN ESTIMATED 19,300 PARCELS FROM ELIGIBILITY (ROUGHLY 63% OF 30,500 PARCELS IN THE PROGRAM AREA).**

**Limiting Criterion 4: Cannot shadow a public park or open space**

The AHBP ordinance further limits the use of the Local Program for any project that would cause a significant shadow impact on a public park. It is difficult to estimate the exact limitation this restriction could cause on the program area, because shadow impacts would be determined during the environmental evaluation process, and could vary based on the specific building design. A preliminary shadow fan analysis indicates that up to 9,800 parcels could potentially be limited in their ability to build two additional stories of height due to this restriction and proximity to public parks. Specific analysis of a particular building proposal could change these initial results.

**Limiting Criterion 5: Gain Commission approval required to demolish a unit**

The City of San Francisco currently has very strict regulations around the demolition of a housing unit (Planning Code Section 317). Any project proposing to demolish a residential unit would be required to make the necessary findings and receive Planning Commission approval for the project.

**Past development patterns suggest development would primarily happen on underutilized (soft) sites**

The vast majority of eligible parcels contain healthy buildings and uses that would make them unlikely to be redeveloped. For example, the Market Octavia Area Plan rezoned every parcel in the Plan Area, removing density restrictions and increasing the zoned potential of most parcels. Despite this widespread rezoning, the plan resulted in new development on underutilized parcels such as former freeway parcels and large underutilized lots on Market Street. Other

parcels that were rezoned as part of Market and Octavia that host healthy older buildings including single family homes, apartment buildings and mixed uses have not attracted new development proposals because the current uses are highly valued by the community. It is anticipated that the AHBP would lead to similar development patterns. For purposes of estimating potential housing unit yields from the AHBP program, the Department identified approximately 240 underutilized (“soft”) sites – sites where the current built envelope comprises five percent or less of the allowable building envelope under current zoning. Also, parcels containing residential uses, schools, hospitals and historic resources were also excluded as potential development sites.

While the Local AHBP offers clear development incentives, such as two stories of height and increased density, it also requires that project sponsors provide: 1) 30% of all units as permanently affordable; 2) 40% of the units as two bedroom; and 3) meet specific new design requirements of the Program. Financial analysis tested the program’s value recapture to ensure the maximum affordable housing was required while still providing an incentive for projects to elect to provide 30% affordable housing. The analysis found the program is feasible, but only in some cases.

The financial feasibility analysis assumes current land values of the existing parcels remain constant with the implementation of the AHBP. The financial analysis assumes that land values would not increase due to program benefits; accordingly, there is little flexibility in the price projects can afford to pay for land. Further, the analysis assumes that the existing uses did not add to land value, so any existing use that would add value not considered by the financial analysis and would likely tip a project into infeasibility. In other words, the AHBP Local Program is financially feasible only for projects on sites where the existing building does not add costs to acquiring the property. A site with several residential units would command a higher market price than what was tested, and therefore the Local Program or State Analyzed Programs would likely not be financially feasible on sites with existing buildings.

#### **Department Recommended Amendment to Further Limit Program Eligibility**

To address concern around the program’s scale, the Department recommends the following amendment:

- ❖ **ADD LIMITING CRITERION: PROJECTS THAT PROPOSE TO DEMOLISH ANY RESIDENTIAL UNITS SHALL NOT BE ELIGIBLE FOR AHBP.**

Supervisor Breed’s amendment to the program already prevents parcels containing existing rent-controlled units from developing through the AHBP. The City could further limit the eligibility for AHBP to projects that do not demolish any existing residential units (regardless of rent-controlled status).



### Potential Implication of Proposed Amendment

If the AHBP was limited to projects that did *not have ANY residential units*:

The AHBP could still produce 5,000 affordable housing units on 240 potential soft sites over a 20 year period. None of the soft sites identified contain known existing housing units, as the Department considers the development of sites with existing units unlikely for the reasons discussed above. Should the Planning Commission recommend this amendment, the amendment would not reduce the development potential on the identified potential soft sites.

Smaller increases in density to parcels with existing residential uses would be prohibited. Generally, sites with existing residential uses are unlikely to redevelop under the AHBP. However in the occasional instance where an owner wanted to redevelop a property with residential uses, the density of the new building would be limited by existing regulations, and there would not be the incentive to provide 30% affordable housing. Especially on smaller sites, where total units are below the 10 unit threshold for inclusionary housing under Planning Code section 415, the amendment could mean a reduction or omission of affordable housing when these sites are developed. If even 5% of the sites with only one unit in the Program area chose to develop and add more units (as allowed under existing regulations), the City could gain an additional roughly 300 permanently affordable units.<sup>8</sup> **These units would not be built if this amendment is adopted. Additionally, these sites could redevelop under existing zoning controls producing zero affordable housing units.**

For projects that include five or more units, property owners could still avail themselves of the State Density Bonus Law and receive up a 35% increase in density, up to three incentives and concessions and waivers of development standards as defined by the State Law, while providing less affordable housing and no middle income housing. In addition, the State Law would limit the Department and Commission's ability to disapprove any incentives, concessions or waivers requested by the project sponsor.

### Topic 2: Infrastructure to Support New Growth

San Francisco residents enjoy a high level of public infrastructure including access to open space and parks, pedestrian and bicycle infrastructure, schools, and an urban transit system. As the City's population grows, these amenities must be managed and scaled to accommodate new residents and maintain the quality of life in San Francisco. Recent area plans have generally included a community improvements plan and commensurate revenue strategies to enable infrastructure growth with new development. Commenters have asked how transportation and other amenities will be provided to support new residential development enabled through the AHBP. This section describes the City's current strategy for planning infrastructure to support new growth, with a focus on transportation.

#### Current Proposal: AHBP and Transportation Services

---

<sup>8</sup> There are roughly 4,100 single-family homes in the AHBP program area in zoning districts that currently allow higher density development. Based on the Department's analysis, if only 5% of these sites were to redevelop they could produce upwards of 350 new permanently affordable units and a total net increase of 1,000 units.

The Program area is generally within walking distance to the Muni Rapid Network, the high level of service corridors such as Muni's light rail lines, Geary Boulevard and Mission Street. This means that the AHBP is encouraging new housing where the City is currently investing in increased levels of transportation services. This land use and transportation planning coordination ensures the City's investments will support new residents.

Area plans such as Market & Octavia and Eastern Neighborhoods include neighborhood specific impact fees to support concentrated development. For the more dispersed development associated with the AHBP, the City has subsequently completed a citywide infrastructure standards analysis and created commensurate citywide infrastructure funding mechanisms and plans. Many of the City's our infrastructure systems, especially transit and childcare, operate on a citywide basis and generally require a citywide approach when planning improvements.

In the past several years, San Francisco has made great progress on several citywide transportation planning efforts and has established several new transportation revenue sources. In addition to the ongoing revenue sources, in 2014 voters approved a \$500 Million transportation bond. Also in 2014, voters supported Proposition B which tethers additional transportation funding to the rate of population growth.

The Citywide Transportation Sustainability Fee (TSF), which applies to new residential and commercial development, is anticipated to generate \$1.2 billion in revenue over 30 years. TSF revenues will enable the City to "invest in our transportation network" and "shift modeshare by requiring new developments to prioritize more sustainable travel methods". The Department anticipates that over 80% of the projected projects that take advantage of the AHBP would include 20 units or more, and therefore would be subject to the recently established TSP fee. Thus, the AHBP could generate upwards of 99 million dollars<sup>9</sup> in new transportation funding to support new residents. These funds will contribute meaningfully to the City's overall transportation funding strategy and enable the City to accomplish planned improvements to the network.

In addition to the TSF, all projects entitled under the AHBP would be subject to existing citywide fees for Public Schools, Public Utilities Commission (sewer and water) and childcare facilities.

These fees enable the City to make initial investments in infrastructure systems to support new growth. Maintaining a high level of service for all infrastructure types is critical to the quality of life in San Francisco. Much of the AHBP area includes parts of the City with higher levels of service for open space and pedestrian amenities.<sup>10</sup>

### Topic 3: Urban Design

Some commenters have expressed concerns about the compatibility of potential AHBP buildings and neighborhood context. Some have expressed concern that the AHBP takes a 'one-size-fits-all'

---

<sup>9</sup> In today's dollars, at \$7.74 per GSF, this estimate does not account for annual indexing of fees to account for cost inflation.

<sup>10</sup>San Francisco Infrastructure Level of Service Analysis March 2014. [http://www.sf-planning.org/ftp/files/plans-and-programs/plan-implementation/20140403\\_SFInfrastructureLOSanalysis\\_March2014.pdf](http://www.sf-planning.org/ftp/files/plans-and-programs/plan-implementation/20140403_SFInfrastructureLOSanalysis_March2014.pdf)

approach, which applies too broadly across the City's many neighborhoods. Some have asked whether the consistent development incentives would cause a monotonous or "one size fits all" outcome in terms of urban form. The need for special consideration for infill projects in existing historic districts has been raised. Some commenters also raised questions about the relationship between potential heights and existing road widths, suggesting that narrow streets may warrant special consideration. And, some have suggested that the limits on lot mergers should relate to the neighborhood context more specifically.

#### **Current Proposal: AHBP and Urban Design**

As drafted, the AHBP includes several parameters to ensure neighborhood and context-specific urban form.

#### **Existing Controls Vary to Reflect Neighborhood Context**

The Local Program of the AHBP enables projects to include two additional stories of housing when 30% of affordable housing is provided. The height increases are based upon the existing height regulations. While the incentive is the same increment across the City, the outcomes of the program will vary based on the underlying height limits. In many districts, the program enables six-story buildings, in some seven-story buildings, and in others eight-story and above buildings. While an AHBP project providing 30% on-site affordable units in the Western Addition and one in the Sunset would both receive two extra stories of height; the former, in a 65-foot height district, would result in an eight story building and the latter, in a 40 foot height district, would result in a six-story building. Current variations in underlying height controls will continue to be expressed through the AHBP.

Urban design in many cities and neighborhood types follow different general principles. San Francisco considers building height in relation to street widths. In some areas, a building's maximum podium height might be related to a street width, while in less dense neighborhoods, the overall maximum height of a building might be related to the street width. Generally, a ratio of building heights and street widths between .75 to 1.5 is considered appropriate in San Francisco.<sup>11</sup> This means that streets that are 40 feet wide can comfortably host buildings from 30 to 60 feet tall. Streets 50 feet wide can host buildings 40 to 75 feet tall. Streets 55 feet wide can host buildings 41 to 83 feet tall. All of the Program area includes roads that are 50 feet or wider – meaning they can comfortably host buildings that are 60 feet or taller. Thus, **the AHBP does not currently allow buildings that would be considered too tall in relation to the street width, based on this ratio.**

#### **Design Guidelines**

AHBP projects will be subject to program specific design guidelines. The guidelines address four topic areas: tops of buildings, middle of buildings, ground floors, and infill projects within existing historic districts. These guidelines will ensure San Francisco's practice of emphasizing context-specific design in new construction. The AHBP draft Design Guidelines includes 25 design guidelines<sup>12</sup>. Three of the most relevant to context-specific design include:

---

<sup>11</sup> Allan B. Jacobs, *Great Streets*, Fourth Printing, 1996, pages 277 to 280.

<sup>12</sup> The complete AHBP draft design guidelines are available here: [http://www.sf-planning.org/ftp/files/plans-and-programs/planning-for-the-city/ahbp/AHBP\\_Draft\\_Design\\_Guidelines.pdf](http://www.sf-planning.org/ftp/files/plans-and-programs/planning-for-the-city/ahbp/AHBP_Draft_Design_Guidelines.pdf)

- T1. Sculpt tops of buildings to contribute to neighborhood quality (page 6 of the AHBP Design Guidelines).
- T3. Express Exceptional and Complementary Architectural Character (page 7 of the AHBP Design Guidelines).
- B3. The façades of new buildings should extend patterns (page 10 of the AHBP Design Guidelines).

*Development within Historic Districts*

Some historic districts maintain a strong uniformity while other exhibit varied character. AHBP projects will likely result in developments of greater density than the surrounding historic context. Increased density in historic districts does not inherently conflict with historic preservation principles. Historic districts are capable of allowing increased housing density without affecting the historic character and features of a district.

Infill projects within an eligible district will be reviewed by Planning Department Preservation staff in addition to the Planning Commission for compatibility with the AHBP Design Guidelines. There is no proposed change in process for an infill project within a locally-designated district under Article 10 or Article 11 of the Planning Code. Historic Preservation Commission review and approval through a Certificate of Appropriateness or Permit to Alter entitlement would continue to be required. Findings of compliance with local guidelines and the Secretary of the Interior's Standards would also continue to be required.

Projects proposed for sites of non-contributing buildings and vacant lots within historic districts are required to meet the AHBP Design Guidelines for compatibility with surrounding historic context and features. AHBP projects will likely result in developments that may be taller than the surrounding historic context, thus it is crucial that the design of infill construction within historic districts not be so differentiated that it becomes the primary focus. Application of the AHBP Design Guidelines, by the Department, decision-makers, and with oversight from the community, will assist in achieving innovative and exceptional design solutions where the scale and massing of a project must relate to the surrounding historic context.

Below are two of the nine AHBP Design Guidelines for projects within a historic district:

- H2. Strengthen the primary characteristics of the district through infill construction by referencing and relating to the historic design, landscape, use, and cultural expressions found within the district (page 18 of the AHBP Design Guidelines).
- H6. Design to be identifiable as contemporary and harmonious with the historic district in terms of general site characteristics, materials, and features (page 18 of the AHBP Design Guidelines).

**Lot Merger Limits and AHBP**

Current Planning Code controls only regulate lot mergers in a limited number of districts<sup>13</sup> in the AHBP area. The AHBP ordinance proposes to extend lot limit merger regulations. AHBP projects

---

<sup>13</sup> Inner and Outer Clement NCDs, and NC-2 Districts on Balboa Street between 2nd Avenue and 8th Avenues, and between 32nd Avenue and 38th Avenues.

that request a lot merger would be limited to less than 125 feet of street frontage. This generally reflects 50% of a typical San Francisco block, reflecting prevailing patterns in the program area neighborhoods.

The AHBP lot merger language is based on research that looked at past trends and the typical commercial corridor block length in the Sunset. Given that the typical commercial corridor block length in the Richmond and the Sunset is approximately 240 feet, 125 feet provides a good proximate for a building to not exceed. Note that this regulation would only apply to projects that participate in the AHBP. Current regulations would still apply to projects that are not participating in the AHBP. Currently, lot mergers are regulated in a few of the City's districts. Most commercial corridor zoning districts currently require a Conditional Use if the lot size is 10,000 square feet and above.

#### Department Recommended Amendments to Urban Design

- ❖ *ADD A DESIGN GUIDELINE TO MAXIMIZE LIGHT AND AIR TO THE SIDEWALKS AND FRONTAGES ALONG THE STREETS, INCLUDING ALLEYWAYS.*
- ❖ *BASE LOT MERGER LIMITATIONS ON 50% OF THE ACTUAL BLOCK LENGTH, RATHER THAN APPLY A CITYWIDE NUMERICAL CAP.*
- ❖ *DIRECT PLANNING STAFF TO INCLUDE ANALYSIS OF A PROJECT'S CONFORMITY TO DESIGN GUIDELINES IN A PLANNING COMMISSION CASE REPORT.*

#### Potential Implication of Proposed Amendments

Additional design guidelines would empower design review to focus on the relationship between street width and building heights. A design guideline to "maximize light and air to the sidewalks and frontages along the streets, including alleyways" would speak to the overall feel of a particular corridor and a specific housing proposal. The Planning Commission would be required to find projects consistent with all AHBP design guidelines as part of the approval process. This would enhance urban design outcomes and ensure that new buildings are context-sensitive.

Relating the lot merger limitations to block length rather than overall parcel size ensures that AHBP projects relate to the specific neighborhood context. Limitations on lot mergers could, in rare cases, reduce total units produced for an individual project. However the proposed ratio would result in good urban design consistent with prevailing patterns and would offer an appropriate limitation on the scale of potential AHBP projects.

#### Topic 4: Public Review and Commission Approval

Some commenters have expressed concern that AHBP projects will not have adequate public input, City review or Planning Commission review. In particular commenters raised questions about the appeals process proposed for the Local AHBP, the conditional use findings and the ability of the Commission to make modifications to the design of the building.

#### Current Proposal: The Local Affordable Housing Bonus Program Project Review

As drafted, the Local AHBP does not reduce public input nor public hearing requirements for projects entitled under this program. In fact, the Local Program increases the opportunity for public input because every Local AHBP project will require a Planning Commission hearing

under the Local and 100 percent Affordable Housing Bonus Project Authorization proposed in Section 328, including some projects that would not otherwise require Planning Commission approval. Under the proposal, only projects that provide 30% permanently affordable housing, or greater, would be eligible for the Local and 100 percent Affordable Housing Bonus Project Authorization process.

**Entitlement Process for AHBP State Analyzed Program**

Projects entitled under the State Analyzed Program will have no reduction in the City's current review process. These projects will either provide the minimum inclusionary amount, or may provide between 13% or 20% affordable housing in order to obtain a greater density bonus or an increased number of incentives and concessions. Projects entitled through the State-Analyzed program will be subject to the same review and approval processes as they would today – the triggers for Conditional Use Authorization or any other code section that requires a Planning Commission hearing will continue to have a Planning Commission hearing. Projects that use the State-Analyzed program and do not trigger a Planning Commission hearing under the Code are still subject to Discretionary Review (DR). Projects using the State-Analyzed program and choose an incentive off the pre-determined menu that would have required a variance would no longer be subject to a variance hearing. However, if the project seeks a variance that is not from the menu, a variance hearing would be required.

**Entitlement Process for AHBP Local Program and 100% Affordable**

Projects entitled under the Local Program and the 100% Affordable Program, which respectively provide 30% affordable units or are completely affordable developments, will be reviewed under the proposed "Local and 100 percent Affordable Housing Bonus Project Authorization," as proposed in Section 328. This entitlement process is similar to the existing Large Project Authorization (LPA) process in the Eastern Neighborhoods Mixed Use Districts set forth in Planning Code section 329. The goals of establishing a new process for projects that provide 30% affordable housing include: 1) create a single process for projects with clear requirements and procedures; 2) enable the Planning Commission to grant exceptions to proposed projects without requiring a variance; and 3) build on the success of the LPA process established as part of the Eastern Neighborhood Mixed Use Districts. Should a project include a component that would currently require a conditional use approval (CU), the Commission would continue to be required to make the necessary findings that would otherwise be made as part of a CU hearing under the new entitlement process, and in addition to the required findings set forth in the Local and 100 percent Affordable Housing Bonus Project Authorization.

Section 328 - the Local and 100 percent Affordable Housing Bonus Project Authorization process has a consistent review process for all Local Program projects. The review allows the Commission to grant minor exceptions to the Code to respond to design concerns raised by staff and the community in ways that would otherwise require a variance from the Zoning Administrator.

The Local and 100 percent Affordable Housing Bonus Project Authorization process recognizes that projects that take advantage of the Local Program of the AHBP may be larger than the surrounding neighborhood context in order to facilitate higher levels of affordability. Projects must comply with the AHBP Design Guidelines. The Commission can *disapprove a project* if it fails to meet the AHBP Design Guidelines, other applicable design guidelines, the Better Streets Plan or the General Plan. A project must have the required 30% or more onsite affordability to *qualify* for the Local and 100 percent Affordable Housing Bonus Project Authorization.

**CU findings and authority of CPC to change projects**

The Planning Commission will continue to have the authority to shape a building and revise certain components of a project, such as proposed land use, or other elements that might otherwise be approved under a particular Conditional Use Authorization permit.

The Local and 100 percent Affordable Housing Bonus Project Authorization is designed to allow the Planning Commission the ability to make minor modifications to a project's height, bulk, and mass. However, the process recognizes that these projects may be somewhat taller or bulkier than surrounding buildings, and the intent is to limit such modifications to ensure that projects meet the AHBP's affordability goals. Additionally, as mentioned above, the Planning Commission will be able to grant Planning Code exceptions to shift the mass of a project, if appropriate, as a tool to respond to surrounding context.

**Summary: Review Process Current Process and AHBP Projects**

	Current Process	State Analyzed	Local Program, 328 Affordable Housing Benefit Review
Preliminary Project Assessment (PPA)	x	x	x
Environmental Review	x	x	x
Pre-Application Meeting (with neighbors)	x	x	x
Design and Plan Review	x	x	x
Neighborhood notification (Section 311/312), or Planning Commission Hearing Notification	x	x	x
Required Planning Commission Hearing	Sometimes, DR optional	Sometimes, DR optional	x
Entitlement Appeals Body	Board of Appeals, or Board of Supervisors	Board of Appeals, or Board of Supervisors	Board of Appeals

**Priority Processing for Projects with High Levels of Affordability**

Projects that provide 20% affordable housing or more are currently eligible for priority processing – which means they are the first priority project for assigned staff. Priority processing does not change or reduce the steps in the review process. However, it can reduce time related to backlogs or high volumes of projects. Local AHBP projects would be eligible for priority processing.

**Department Recommended Amendments to Public Review and Commission Approval**

The following amendments regarding the entitlement process for Local AHBP projects could further address the identified issues:

- ❖ **MODIFY THE LOCAL AND 100 PERCENT AFFORDABLE HOUSING BONUS PROJECT AUTHORIZATION SUCH THAT APPEALS WOULD BE CONSIDERED BY THE BOARD OF SUPERVISORS.**

As currently drafted, projects that apply under the Local AHBP are subject to the Local and 100 percent Affordable Housing Bonus Project Authorization (Section 328) are appealable to the Board of Appeals. The appeal of a Section 328 decision could be directed to the Board of Supervisors, using the process found in Section 308 et seq. Under this code section Planning Commission decisions are appealable to the Board of Supervisors within 30 days after the date of action by the Planning Commission, and would be subscribed by either (i) the owners of at least 20 percent of the property affected by the proposed amendment or (ii) five members of the Board of Supervisors.

**Alternative Amendment:**

- ❖ **CONVERT THE 328 PROCESS TO A SEPARATE CONDITIONAL USE AUTHORIZATION PERMIT FOR ALL PROJECTS THAT PARTICIPATE IN THE LOCAL AHBP.**

**Potential Implications of Proposed Amendments**

Shifting appeals of entitlement to the Board of Supervisors for Local AHBP projects would not substantially impact the outcomes of the AHBP program in terms of unit production. There is some chance that project sponsors perceive this appeals process as offering less certainty or potentially an increased entitlement process, because the Board of appeals requires four out five votes to overturn a Planning Commission decision.

In contrast, appeals to the BOS require support of 20% of adjacent property owners or five Board members to be considered, however a two-thirds majority of Supervisors can overturn a Planning Commission decision. Therefore entitlement of projects likely would not be further burdened by this requirement.

**Topic 5: Preserving Small Business**

San Francisco's small business community is an integral part of our neighborhood commercial corridors, local economy and San Francisco's rich culture. Some commenters have expressed concerns around the potential impacts of the AHBP on existing small businesses and neighborhood commercial corridors. Will small businesses be afforded the opportunity to successfully transition to new locations when necessary? Will neighborhoods continue to have the neighborhood serving businesses?

**Current Proposal: Small Business Preservation and AHBP**

Generally, AHBP infill housing is anticipated on soft sites that are predominantly vacant, parking lots or garages, gas stations, or other uses that use only a small amount of the total development potential. That said some of these sites include existing businesses on neighborhood commercial corridors. New development requires a willing seller, buyer and developer. The potential impact



of this Program to specific businesses locations or business types cannot be quantified in any certain terms due to these factors. However it is generally understood that there are existing structures on less than half of the 240 potential soft sites.

The City is committed to maintaining small businesses in its neighborhoods. For this reason, the AHBP includes general assistance and support for any business that might be impacted, which can be tailored on a case-by-case basis. Staff anticipates that developments using the AHBP will produce additional commercial spaces and enhance existing commercial corridors.

#### **Protections for Existing Businesses**

As currently proposed, the AHBP addresses small business preservation in several ways.

Having adequate notification time when re-location is necessary has been one of the top concerns raised by small businesses in their recent quarterly meetings with the Mayor. Recently required seismic upgrades have forced many businesses to relocate with only a few months' notice. To address this concern and at the suggestion of OEWD and the Small Business Commission, the AHBP requires that project sponsors notify tenants of their first application to the Planning Department for environment review. Generally project construction starts two or three years after a project files for environmental review, but this can vary based on project size and other factors. This notification will guarantee tenants adequate time to develop an updated business plan, identify necessary capital, find an appropriate location, and complete necessary tenant improvements in a new location. The notification letter will also refer the business owner to OEWD and other agencies that can provide technical assistance and support. These services can help small businesses achieve a successful transition.

Relocating businesses may qualify for and take advantage of the Community Business Priority Processing Program (CB3P). Projects that qualify for and enroll in the CB3P are guaranteed a Planning Commission hearing date within 90 days of filing a complete application, and placement on the Consent Calendar. Certain limitations do apply<sup>14</sup>. All CB3P applications are subject to the same level of neighborhood notice, the same Planning Code provisions, and the same (if applicable) CEQA review requirements, and may still be shifted from Consent to Regular Calendar if requested by a Planning Commissioner or member of the public.

#### **Enhancing Neighborhood Commercial Corridors and AHBP**

Existing Planning Code controls encourage neighborhood appropriate new commercial spaces. Existing commercial size limits, listed below, will apply to new commercial space constructed as part of AHBP buildings. Existing use limitations (including formula retail regulations) will apply. These use size limitations were established through community planning processes to reflect neighborhood character. Any new or expanded uses above these amounts will continue to trigger a conditional use authorization.

---

<sup>14</sup> Generally, eligible businesses cannot be a formula retail store with more than 20 establishments and cannot expand or intensify the use and certain uses such as alcohol, adult entertainment, massage, fringe financial and certain other uses cannot participate. See the Planning Department website for more information: <http://www.sf-planning.org/Modules/ShowDocument.aspx?documentID=9130>.

The median independent retail size in San Francisco is 2,200 square feet and the median formula retail size in San Francisco is 6,500 square feet. Existing controls related to use size limitations generally encourage and support a continuation of small businesses on neighborhood commercial corridors. A sampling of use size controls is listed below.

NC District	Current Use Size Limit
North Beach, Castro Street, Pacific Avenue	2,000 sq. ft.
Inner Clement, Inner Sunset, Outer Clement, Upper Fillmore, Haight, Polk, Sacramento, Union, 24 <sup>th</sup> (Noe), West Portal	2,500 sq. ft.
NC-1, Broadway,	3,000 sq. ft.
NC-2	4,000 sq. ft.
NC-3, NC-S	6,000 sq. ft.

Most Neighborhood Commercial Districts encourage, but do not require, neighborhood commercial uses<sup>15</sup>. New infill projects would likely choose to include ground floor commercial uses. In fact, the AHBP Design Guidelines include eight specific controls for the ground floor (on page 13 of the AHBP Design Guidelines), which otherwise do not exist in many of our neighborhoods. For example, the AHBP Design Guidelines state that no more than 30 percent of the width of the ground floor may be devote to garage entries or blank walls; building entries and shop fronts should add to the character of the street by being clearly identifiable and inviting; and where present, retail frontages should occupy no less than 75 percent of a building frontage at the ground floor.

#### Department Recommended Amendments to Preserving Small Business

The Planning Department presented the AHBP to the Small Business Commission on February 8. Staff will return to the Small Business Commission on February 22 for further discussion. The following potential amendments have been identified by the Mayor's Office of Economic and Workforce Development (OEWD) staff and the Small Business Commission.

- ❖ *REQUIRE EXISTING BUSINESSES BE OFFERED FIRST RIGHT OF REFUSAL FOR COMMERCIAL SPACE IN NEW BUILDINGS.*
- ❖ *RECOMMEND THAT THE BOARD OF SUPERVISORS DIRECT THE CITY TO ESTABLISH A SMALL BUSINESS RELOCATION FEE TO BE PAID BY NEW*

<sup>15</sup> Planning Code Section 145.4 establishes requirements for ground floor retail on certain parts of streets such as along Market Street from Castro through the Downtown; along Hayes Street through the NCT; and along Fillmore Street from Bush Street to McAllister Street. See all such requirements in Planning Code Section 145.4.

*DEVELOPMENT CONSISTENT WITH THE VALUES OFFERED UNDER THE UNIFORM RELOCATION ACT.*

- ❖ *REQUIRE THAT EARLY NOTIFICATION TO COMMERCIAL TENANTS BE NO LESS THAN 18 MONTHS AND BE SENT TO BOTH THE TENANT AND THE OFFICE OF ECONOMIC AND WORKFORCE DEVELOPMENT (OEWD)*
- ❖ *ALLOW PLANNING COMMISSION TO REDUCE COMMERCIAL USE SIZES OR REQUIRE COMMERCIAL USES IN AHBP PROJECTS TO PROTECT NEIGHBORHOOD SERVING BUSINESSES*

**Potential Implications of Proposed Amendments**

A first right of refusal would enable existing businesses to have a competitive edge in securing space on their existing site. Businesses could participate in site design and potentially benefit from efficiencies in building the commercial spaces, for example, by making later tenant improvements unnecessary. While most businesses will likely not exercise this option because it would require relocating twice, the option offers the opportunity, especially for location sensitive businesses. This requirement would not reduce potential affordable housing production, but it may provide a developer with additional community support when valued businesses are retained.

Notifying OEWD will enable the City to take a proactive role in supporting small businesses and to coordinate support through various programs such as Invest and Neighborhoods and the Retention and Relocation Program. OEWD will know about proposed developments early enough in the process to effectively engage businesses and provide whatever supports are needed.

The Small Business Commission and OEWD staff suggest that the early notification would be most effective if businesses are afforded at least 18 months from first notification to required relocation date. Since relocation is required before environmental review commences, this required notification period should not delay a projects entitlement or development process.

The City can apply the standards of the federal Uniform Relocation Act to AHBP properties. For new construction that is funded all or in part with federal funds, the Act requires relocation advisory services for displaced businesses; a minimum 90 days written notice to vacate prior to requiring possession; and reimbursement for moving and reestablishment expenses. For a business, moving fees are based on a public bidding process plus a business is eligible for \$10,000 in reestablishment costs; or a business can receive a fixed payment of no more than \$20,000. The City could require project sponsors provide relocation costs consistent with the Uniform Relocation Act to existing commercial tenants. This payment would facilitate a business's successful transition to a new space in the neighborhood.

**Topic 6: Who are we serving with this program? Affordability**

Several commenters have asked if the affordable units generated through the AHBP are serving the right households. Some have suggested that the program should be adjusted to include a broader range of affordability. Some have suggested that households at 100 and 120% AMI should also be serviced through this program. Others have questioned whether affordability

targets should vary based on neighborhood demographics. In particular the following questions have been raised:

1. Why doesn't the program address the lowest income households?
2. Are middle income households served by market rate housing?
3. Should there be neighborhood specific elements of the program?

**Current proposal: Households served and AHBP**

The AHBP will be one of many affordable housing programs in San Francisco. The Program is unique in that it does not require public subsidy of the affordable units and incentivizes the private sector to provide a greater absolute number and greater percentage of affordable housing, similar to the City's inclusionary housing program. The AHBP proposes to increase the number of affordable units built to service low and moderate income households while also broadening the band of households eligible for permanently affordable housing to include middle income households. The AHBP proposes to increase low, moderate and middle income housing in San Francisco's neighborhoods.

**Affordable Housing Programs and Housing Supply in San Francisco**

The AHBP will be one of many tools to address housing affordability in San Francisco. Today, the majority (88% of affordable units produced) of the City's affordable housing programs<sup>16</sup> serve households earning less than 60% AMI (\$42,800 for a one-person household and \$55,000 for a three-person household). Less than 9% of the affordable units created under the City's current programs serve those households at 80% AMI and above.

San Francisco is a leader in developing local funding sources for affordable housing, and has one of the nation's oldest inclusionary housing programs. The City's recent efforts include establishing a Local Housing Trust Fund and the Hope SF program. San Francisco dedicated a high proportion (40%) of all tax increment funding (TIF) generated in Redevelopment Areas to affordable housing. However, given that it costs \$250,000 or more to subsidize a single affordable housing unit in San Francisco, the City would need to generate \$4 billion in local subsidies to fund the Regional Housing Needs Allocation (RHNA) target of 16,000 affordable units by 2022. Local subsidies cannot be the only approach to securing permanently affordable housing. This underscores the need for programs such as our existing inclusionary program and the AHBP.

Over the next ten years, the Mayor's Office of Housing and Community Development plans to build an additional 4,640 housing units permanently affordable to households earning below 120% AMI. These new affordable units will be in addition to the thousands of affordable units that will be rehabilitated or preserved as part of RAD or other affordability preservation efforts. Roughly 4,400 of these units will service households earning 60% of the AMI or below. The remaining 241 units, most of which will be funded by federal and State dollars that often have further affordability restrictions, would service households at 60% AMI or below. With the construction of these pipeline projects the City will have a total of 42,640 permanently affordable housing units for households earning 60% AMI or below. The AHBP will add an additional 2,000

---

<sup>16</sup>This includes units provided under the Multifamily Housing Program, the Inclusionary Program, Former SFRA, Inclusionary Condo Conversion, Public Housing, HUS-assisted Projects, Master Lease, and other Tax Credit Projects. This does not include the Down Payment Assistance Loan Program or Section 8 vouchers that are used in San Francisco.

units for low and moderate income households – bringing the total to 44,640. In addition, the AHBP will provide 3,000 permanently affordable middle income units.

Affordability Level	Existing Permanently Affordable Units	MOHCD Pipeline housing (10 years)	AHBP Affordable Units (20 years)	Projected Total Affordable Units (with MOHCD known pipeline and AHBP)	
<b>Very Low, Low and Moderate Income</b>	36,260 <sup>17</sup>				
Less than 60% AMI		4,640	2,000	44,640	94%
Less than 120% AMI	3,285 <sup>18</sup>				
<b>Middle Income</b>					
(120% rental and 140% owner)			3,000	3,000	6%
<b>Total</b>	<b>39,500</b>		<b>5,000</b>	<b>47,640</b>	<b>100%</b>

The Local AHBP Program complements these existing and ongoing programs by providing affordable housing units to serve low, moderate, and middle income households making above 55% of AMI.

**Affordable Housing Units encouraged through the AHBP**

The AHBP builds on the City’s existing Inclusionary Housing Program, which serves low and moderate income households earning up to 55% of AMI (rental) and 90% of AMI (ownership)<sup>19</sup>. Only projects that provide the affordable units on site are eligible for the AHBP. This will incentivize projects, that might otherwise elect to pay the in lieu fee, to elect to provide affordable units on-site within the project.

The AHBP is projected to enable 5,000 permanently affordable units over a 20 year period. The Department estimates that the AHBP could result in 2,000 low and moderate income inclusionary units over the next 20 years. This will be more than double the 900 possible inclusionary units enabled under current zoning on the same sites. This is a significant enhancement to San

<sup>17</sup> Roughly 13,180 of these units will service households earning 30% of the AMI or below.

<sup>18</sup> Most of the existing units for 120% AMI and below are affordable to households earning no more than 80% AMI.

<sup>19</sup> Note: the existing inclusionary program allows project sponsors to pay a fee in lieu of providing the affordable housing units.

Francisco’s ability to provide affordable housing for low and moderate income households.<sup>20</sup> This program will also generate an additional 3,000 permanently affordable middle income units.

**Potential Affordable Housing Units produced in AHBP Area, under current controls or under AHBP, by affordability, over 20 years.**

Affordability Levels	Current Controls (Units)	AHBP Maximum Potential (Units)
Low and Moderate Income Households (55% AMI for rental and 90% AMI for ownership)	900	2,000
Middle Income Households (120% AMI for rental and 140% AMI for ownership)	0	3,000
<b>Total Permanently Affordable Housing Units</b>	<b>900</b>	<b>5,000</b>

**Low and Moderate Income Households Served**

The AHBP could potentially double the number of inclusionary units serving low and moderate income households (55% or 90% of AMI) produced in the Program Area, compared to current zoning controls.

In 2015, a one-person household making 55%-90% of Area Median Income earns between \$39,250 and \$64,200. For a family of three, the range is \$50,450 to \$82,550. Households in this income category could include the following:

- A single housekeeper (55% AMI)
- A single entry level public school teacher (90% AMI)
- A single parent police officer or fire fighter with one child (90% AMI)
- A single parent postal clerk with two children (55% AMI)
- A construction worker and a dishwasher (90% AMI)
- Two cashiers and two children (55% AMI)
- A public school teacher and a housekeeping cleaner with two children (90% AMI)

**THE AHBP WILL PRODUCE AN ADDITIONAL 2,000 UNITS AFFORDABLE TO THESE HOUSEHOLDS.**

**Middle Income Households Served**

In 2015, a one-person household making 120% - 140% of Area Median Income earns between \$85,600 and \$99,900. For a family of three, the range is \$110,050 to \$128,400. This level of income

<sup>20</sup> Between 1992 through 2014 the inclusionary program has generated nearly 2,000 affordable units.

is significantly higher than households traditionally serviced by affordable housing programs; market rate housing is out of reach for these households in San Francisco. Households in this income category could include the following:

- A single Electrician (120% AMI)
- A single Electrical Engineer (140% AMI)
- A police officer or firefighter and a minimum wage worker (barista, etc.) (120% AMI)
- An ambulance dispatcher and a housekeeper (140% AMI)
- 2 Public School teachers with 1 child (140% AMI)
- 2 public school teachers with 2 children (120% AMI)
- A police officer and a firefighter with 2 children (140% AMI)

**THE AHBP WILL PRODUCE AN ADDITIONAL 3,000 UNITS AFFORDABLE TO THESE HOUSEHOLDS.**

**Need for Permanently Affordable Middle Income Housing**

Based on federal, state, and local standards, “affordable” housing costs no more than 30% of the household’s gross income. In 2015 middle income households earning 120% of AMI and 140% of AMI could afford the following maximum rents and sale prices:

	Affordable monthly rent <sup>21</sup>	Median Rents in San Francisco, 2015	Affordable sales price <sup>22</sup>
1-person household (studio unit)	\$2,100	\$3,490 (one bedroom)	\$398,295
3-person household (2 bedroom unit)	\$2,689	\$4,630 Two bedroom	\$518,737

Comparatively, median rents are \$3,490 for a 1 bedroom, and \$4,630 for a 2 bedroom apartment in San Francisco<sup>23</sup>. To afford these rents a middle income households (120% AMI) would be required to dedicate 50% or more of their income to housing costs, market San Francisco recently exceeded \$1 million<sup>24</sup>, again twice what a middle income (140% AMI) household can afford.

The income categories serviced by the AHBP are the household types that are declining in San Francisco. Census data show that households earning between 50% of AMI and 150% of AMI fell from 49% of all households in 1990 to just 37% in 2013. These are the income categories for which new, permanently affordable housing would be created under the AHBP. Middle-income households (120-150% AMI, the dark orange bar below) include a diminishing share of the City’s growing population, falling from 11% of the population in 1990 to 9% in 2013.

<sup>21</sup> MOHCD. 2015 Maximum Monthly Rent by Unit Type; Studio and 2-bedroom unit “without utilities” figure.

<sup>22</sup> MOHCD. 2015 Sample Sales Prices for the San Francisco Inclusionary Housing Program.

<sup>23</sup> <https://www.zumper.com/blog/2016/01/zumper-national-rent-report-january-2016/>

<sup>24</sup> <http://www.sfgate.com/business/networth/article/1-million-city-S-F-median-home-price-hits-7-5626591.php>

San Francisco's Households by AMI, 1990-2013

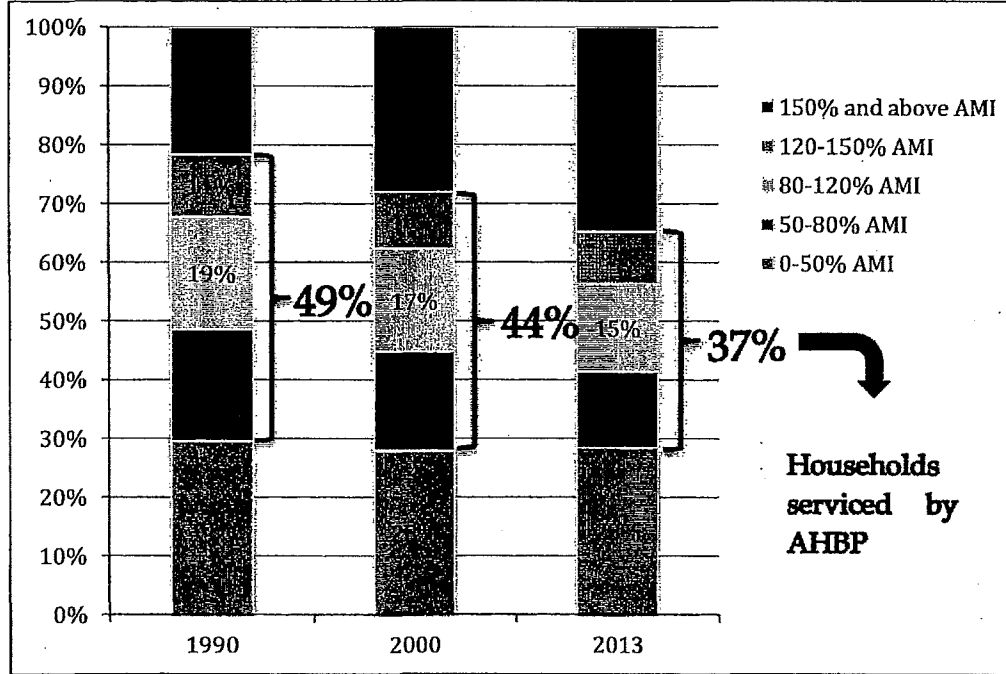

The last several RHNA cycles show that San Francisco has consistently under-produced housing for these income category over the same period of time.<sup>25</sup>

From the 2014 Housing Element:

Household Affordability	Housing Goals 2007-2014	Actual Production 2007-Q1 2014	% of Production Target Achieved 2007-Q1 2014	Production Deficit as of Q1 2014
	Total	Total		
Low Income (under 80% AMI)	12,124	4,978	41%	7,146
Moderate income (80% - 120% AMI)	6,754	1,107	16%	5,647
Market Rate	12,315	11,993	97%	322
<b>TOTALS</b>	<b>31,193</b>	<b>18,078</b>	<b>58%</b>	<b>13,115</b>

Table 1-64  
Annual Production Targets and Average Annual Production, San Francisco, 2007-Q1 2014

SOURCE: SF Planning Department; ABAC

<sup>25</sup> Note that since the City does not currently have a program which guarantees affordability for households above 120% of the Area Median Income, the Department does not have data on the production of housing for that income level. Based on current understanding of market sales and rental costs, staff believes that newly constructed housing is not affordable to middle income households.



Table I-63  
Annual Production Targets  
and Average Annual  
Production, San Francisco,  
1999-2006

Household Affordability	Housing Goals	Actual Production	% of Production Target Achieved	Production Deficit (Surplus)
	1999-2006	1999-2006		
	Total	Total		
Very Low Income (below 50% AMI)	5,244	4,342	82.6%	902
Low Income (50% - 79% AMI)	2,126	1,113	52.4%	1,013
Moderate Income (80% - 120% AMI)	5,639	725	12.9%	4,914
Market Rate	7,363	11,293	153.4%	(3,930)
<b>TOTALS</b>	<b>20,372</b>	<b>17,473</b>	<b>85.8%</b>	

From the 2004 Housing Element:

TABLE I-65

Annual Production Targets and Average Annual Housing Production, 1989-1998\*

Affordability Categories	Housing Goals		Actual Production		% of Annual Target Achieved
	1989-June 1995 (6.5 years)		1989-1998 (10 years)*		
	Total	Annual Targets	Total	Annual Average	
Very Low Income (below 50% AMI)	5,382	830	2,202	220	26.5%
Low Income (50% - 79% AMI)	3,595	553	1,515	152	27.4%
Moderate Income (80% - 120% AMI)	4,493	681	557	58	8.1%
Market Rate	8,987	1,383	9,893	989	71.6%
Annual Production Target, 1989 - June 1995	22,467	3,456	14,167	1,417	41.0%

\*ABAG Reporting Period

The Local AHBP program will increase the amount of inclusionary housing produced for households making 55% or 90% of AMI while creating a new source of housing for middle income households making 120% (rental) or 140% (ownership) of AMI.

**Why Provide Affordable Housing for Moderate and Middle Income Households?**

The AHBP is designed to complement the existing affordable housing programs and housing units, to ensure that the City of San Francisco can remain an equitable and inclusive City as we continue to welcome new residents. In the past several decades middle income households have benefited from affordability assured through rent control, however vacancy de-control and changes in tenure have reduced the affordability of this housing supply. Limited public subsidies for affordable housing can continue to service the very low, low and moderate income households, while mixed income development projects such as the AHBP and those enabled under the inclusionary housing program will service low, moderate and middle income households.

**How does the AHBP Respond to Specific Neighborhoods?**

The AHBP is a citywide program that addresses the affordability needs of all of San Francisco. Much like the City's inclusionary programs, the intention of the AHBP is to increase the production of privately-financed housing for the City as a whole, by leveraging market-driven

development that otherwise would provide fewer or no affordable units for low, moderate, and middle income residents.

**Neighborhood Specific AMI's: Focus on the Bayview**

Some have commented that in some neighborhoods, the Bayview Neighborhood, in particular, could warrant a neighborhood specific adjustment to the AHBP program.

Because the Bayview neighborhood has a history of industrial uses that has left several large, underutilized sites that, if those sites were developed under AHBP, they could result in a large number of new housing units. For example, one of the soft sites identified in the Bayview is 43,681 square feet, as compared to a typical 2,500 square foot (25ft. by 100ft) commercial lot in an NC district. The prevalence of large underutilized lots in the Bayview means more units could be developed there under AHBP when compared to other neighborhoods in the city.

Although new development potential under this program would come with increases in affordable housing units for low, moderate and middle income households, some commenters suggested that the AHBP affordability targets do not adequately serve existing low-income households in the Bayview. Census data<sup>26</sup> in the below table shows households by income level in the Bayview and citywide.

---

<sup>26</sup> American Community Survey, 2010-14 5-Year Average

**Households by Income Level, Bayview and San Francisco**

<b>% of AMI</b>	<b>Bayview</b>		<b>San Francisco</b>	
	<b>Households</b>	<b>% of HHs</b>	<b>Households</b>	<b>% of HHs</b>
30%	3,468	31.6%	80,447	23.1%
50%	1,787	16.3%	40,146	11.5%
80%	1,841	16.8%	52,299	15.0%
100%	1,045	9.5%	28,683	8.2%
120%	828	7.6%	26,436	7.6%
150%	685	6.3%	31,267	9.0%
200%	646	5.9%	33,305	9.5%
>200%	662	6.0%	56,249	16.1%
<b>Total</b>	<b>10,963</b>	<b>100.0%</b>	<b>348,832</b>	<b>100.0%</b>

Bayview has a higher share of households earning 30% of AMI<sup>27</sup> and below than the citywide average. These households are typically served by SFHA public housing, of which there is a high concentration in the Bayview neighborhood relative to other neighborhoods in San Francisco.

Roughly 56% of Bayview households earn between 50% of AMI and 150% of AMI – these are the household incomes that will be served by the AHBP. Bayview households qualify at a higher proportion than the citywide average where only 51% of households earn between 50% and 150% of AMI.

Below is a demographic portrait of the Bayview Households by Race and Ethnicity.

**Households by Race and Ethnicity, Bayview and San Francisco<sup>28</sup>**

<b>Race</b>	<b>Bayview</b>		<b>San Francisco</b>	
	<b>Households</b>	<b>% of HHs</b>	<b>Households</b>	<b>% of HHs</b>
Black HHs	4,760	44.6%	20,495	6.0%
Asian HHs	2,793	26.2%	95,032	27.9%
Hispanic HHs	1,666	15.6%	37,901	11.1%

<sup>27</sup> \$21,400 for a one-person household, \$27,500 for a household of three

<sup>28</sup> Source: U.S. Department of Housing and Urban Development. (October 28, 2015). Consolidated Planning/CHAS Data, 2008-12 ACS 5-Year Average.

White HHs	1,075	10.1%	176,841	51.9%
Other HHs	377	3.5%	10,156	3.0%
Total	10,671	100.0%	340,425	100.0%

The AHBP Local Program for mixed-income development is intended to complement existing and ongoing programs by providing affordable housing units to serve low, moderate, and middle income households making above 50% of AMI, including the half of Bayview households that fall into this income range. In addition, the 100% AHBP program is designed to yield a greater number of units affordable to households making below 60% of AMI, by allowing for greater density for 100% affordable housing developments.

**Serving Existing Residents with Below Market Housing**

There are two provisions to help ensure that existing residents can access below market housing in their neighborhood.

The first, which is recently adopted legislation separate from the AHBP, is often called ‘Neighborhood Preference’. The legislation prioritizes 40% of all affordable inclusionary units be to existing neighborhood residents. This provision enables existing residents to seek permanently affordable housing in their neighborhood. In the case of the Bayview – existing residents will be competitive for the low, moderate and middle income units.

The second provision is part of the draft AHBP ordinance. In order to ensure that the affordable units are below market rates the AHBP legislation requires that all affordable units be rented or sold at a price at least 20% below a particular neighborhood’s market housing costs. For example if a project in the Bayview was entitled under the Local AHBP program – before the 18% of units that are intended to service middle income households were marketed to residents (after construction) the project sponsors would be required to demonstrate that the middle income targets (120% and 140% AMI) were at least 20% below the prevailing market costs for housing in the Bayview. Should the City find that housing priced to be affordable to 140% AMI households was reflecting the market rate; the project sponsor would be required to reduce the cost to a price that is affordable to households at 120% AMI and market the units to qualifying households. This provision enables the program to be flexible to neighborhood specific market conditions and market variations over time.

**Department Recommended Amendments to Affordability**

- ❖ WITHIN THE CONSTRAINTS OF FEASIBLY CONVERT SOME OF THE 18% MIDDLE INCOME (120%/140%) UNITS TO 100%/120% AMI.

The AHBP Local Program for mixed-income developments could be modified to require that a higher share of affordable units are required to be provided for households making below 100% of AMI (rental) or 120% AMI (ownership). This approach would not impact the 100% AHBP program.

**Potential Implications of Proposed Amendment**

This amendment addresses the concern that a wider band of households’ affordable housing needs should be met through this program.

In general, lowering the income levels of required affordable units could have some impacts on financial feasibility for some projects. This approach could reduce participation in the Local

AHBP, in preference for the State Program or existing zoning requirements. A financial sensitivity analysis should be conducted in order to identify the exact relationship between lower income targets and project feasibility.

## REQUIRED COMMISSION ACTION

Two draft ordinances are before the Commission for consideration today. These items may be acted upon or may be continued, at the discretion of the Commission.

1. Mayor Lee and Supervisor Tang introduced the AHBP Ordinance amending the Planning Code on September 29, 2015; substitute legislation was introduced on January 12, 2016. The proposed Ordinance is before the Commission so that it may recommend adoption, rejection, or adoption with modifications to the Board of Supervisors.
2. On October 15, 2015 the Planning Commission initiated hearings on a proposed Ordinance amending the General Plan. The Planning Commission can recommend adoption, rejection, or adoption with modifications to the Board of Supervisors.

## RECOMMENDATION SUMMARY

The Department recommends that the Commission recommend approval with the amendments specified below to the Board of Supervisors of the proposed Ordinances and adopt the attached Draft Resolution to that effect. Further information; including the basis for the recommendations and potential implications of alternatives have been described in more detail earlier in the case report. The section merely summarizes the content to assist the Commission with voting on a potential recommendation. Please note the Commission's action is in no way constrained to the topics or recommendations listed below. This is only a summary of staff recommendations.

### Topic 1: Program Eligibility (pages 3-7)

- A. Recommend approval with scale limitations as currently drafted.
- B. STAFF RECOMMENDATION: Modify to add that projects that propose to demolish any residential units shall not be eligible for AHBP.
- C. Advise Board of Supervisors regarding benefits and concerns. Direct staff to continue work on these issues.

### Topic 2: Infrastructure to Support New Growth (pages 7-8)

- A. STAFF RECOMMENDATION: Recommend approval with infrastructure support as currently drafted.
- B. Advise Board of Supervisors of issues on concern and direct staff to continue work on these issues.

### Topic 3: Urban Design (pages 8-11)

- A. Recommend approval with urban design limitations as currently drafted.
- B. STAFF RECOMMENDATION: Modify to add a design guideline to maximize light and air to the sidewalks and frontages along the streets, including alleyways.

- C. STAFF RECOMMENDATION: Modify lot merger limitations on 50% of the actual block length, rather than apply a citywide numerical cap.
- D. STAFF RECOMMENDATION: Direct Planning Staff to include analysis of a project's conformity to design guidelines in a Planning Commission Case Report.
- E. Advise Board of Supervisors of issues on concern and direct staff to continue work on these issues.

**Topic 4: Public Review & Commission Approval (pages 11-14)**

- A. Recommend approval with new review process as proposed whereby appeals are considered by the Board of Appeals.
- B. STAFF RECOMMENDATION: Modify the appeals body for the Local and 100 Percent Affordable Housing Bonus Project Authorization-Section 328-to be the Board of Supervisors
- C. Modify the process such that Conditional Use Authorizations (CU) would not be considered as findings within the entitlement for AHBP projects, but would require a separate CU.
- D. Advise Board of Supervisors of issues on concern and direct staff to continue work on these issues.

**Topic 5: Preserving Small Business (pages 14-17)**

- A. Recommend approval with small business preservation tools as currently drafted.
- B. STAFF RECOMMENDATION: Modify to add that a requirement that existing businesses be offered first right of refusal for commercial space in new buildings.
- C. STAFF RECOMMENDATION: Modify to ask that the Board of Supervisors direct the City to establish a small business relocation fee to be paid by new development consistent with the uniform relocation act.
- D. STAFF RECOMMENDATION: Modify to require early notification to commercial tenants be no less than 18 months and also reported to the Office of Economic and Workforce Development.
- E. STAFF RECOMMENDATION: Allow Planning Commission to reduce commercial use sizes or require commercial uses in AHBP projects to protect neighborhood serving businesses.
- F. Advise Board of Supervisors of issues on concern and direct staff to continue work on these issues.

**Topic 6: Affordability (pages 17-27)**

- A. Recommend approval with new review process as proposed whereby the local program provides 12% low or moderate income housing and 18% middle income housing.
- B. STAFF RECOMMENDATION: Within the constraints of feasibility convert some of the 18% middle income (120%/140%) units to 100%/120% AMI.
- C. Within the constraints of feasibility provide affordable housing units for a broader range of households than are currently served, by deepening income level targets.

## ENVIRONMENTAL REVIEW

On April 24, 2014, the San Francisco Planning Commission, in Resolution No. 19121, certified the 2004 and 2009 Housing Element Final Environmental Impact Report ("Final EIR"), prepared in compliance with the California Environmental Quality Act ("CEQA"), Public Resources Code Section 21000 et seq. In Resolution No. 19122, the Planning Commission adopted the findings and conclusions required by CEQA regarding alternatives, mitigation measures, and significant environmental impacts analyzed in the Final EIR, and adopted a Mitigation Monitoring and Reporting Program and a Statement of Overriding Considerations as part of its approval of the 2009 Housing Element.

On January 14, 2016, in response to the proposed Affordable Housing Bonus Program and related General Plan Amendments, the San Francisco Planning Department prepared an Addendum to the 2004 and 2009 Housing Element Final EIR under CEQA Guidelines Section 15164 ("the Addendum"). The Addendum accessed here and the Note to File is Exhibit H: [http://sfmea.sfplanning.org/2014.1304E\\_AHBP\\_Addendum03\\_011416%20Final.pdf](http://sfmea.sfplanning.org/2014.1304E_AHBP_Addendum03_011416%20Final.pdf)

## PUBLIC COMMENT

Public comment on the proposed AHBP has been received through the 20 plus public outreach events, direct correspondence with the Planning Commission or Department staff, and through several public forums and media discussions. Staff have maintained a log of public comments and responded to questions as they are received.

Public comments range greatly and cover a variety of topics. Most frequently public comments include a request for more information or details on a specific item. Key topics of discussion are summarized in the discussions above.

Many commenters support the program's approach to providing more affordable housing, while others express a clear lack of support for the program. More nuanced comments include a series of suggested amendments. Generally these issues are addressed by the discussion above and the related proposed amendments.

<b>RECOMMENDATION:</b>	<b>Recommendation of Approval with Modifications</b>
------------------------	--

### Attachments:

- Exhibit A: ~~Draft Planning Commission Resolution for General Plan Amendments~~
- Exhibit B: Draft Planning Commission Resolution for BOS File 150969
- Exhibit C: ~~Department Recommendation Summary~~
- Exhibit D: ~~Public Comment received since November 5, 2015~~
- Exhibit E: Project Sponsors proposed Amendments to the Affordable Housing Bonus Program
- Exhibit F: ~~Ordinance Adopting General Plan Amendments~~
- Exhibit G: ~~Board of Supervisors File No. 150969~~
- Exhibit H: Note to File



# SAN FRANCISCO PLANNING DEPARTMENT

---

## Addendum 3 to Environmental Impact Report

*Addendum Date:* January 14, 2016  
*Case No.:* 2014.1304E; 2014-001503GPA  
*Project Title:* BOS File No. 150969 – Affordable Housing Bonus Program  
*EIR:* San Francisco 2004 and 2009 Housing Element, 2007.1275E  
SCL No. 2008102033, certified March 24, 2011, re-certified April 24, 2014  
*Project Sponsor:* Mayor Lee and Supervisor Tang  
*Sponsor Contact:* Kearstin Dischinger, (415) 558-6284, [kearstin.dischinger@sfgov.org](mailto:kearstin.dischinger@sfgov.org)  
*Lead Agency:* San Francisco Planning Department  
*Staff Contact:* Michael Li, (415) 575-9107, [michael.j.li@sfgov.org](mailto:michael.j.li@sfgov.org)

1650 Mission St.  
Suite 400  
San Francisco,  
CA 94103-2479

Reception:  
415.558.6378

Fax:  
415.558.6409

Planning  
Information:  
415.558.6377

### REMARKS

On April 24, 2014, the San Francisco Planning Commission certified the Final Environmental Impact Report for the 2004 and 2009 Housing Element ("2004 and 2009 Housing Element FEIR" or "FEIR") pursuant to the California Environmental Quality Act ("CEQA").<sup>1</sup> On June 17, 2014, the San Francisco Board of Supervisors ("Board") adopted the 2009 Housing Element as the Housing Element of the San Francisco General Plan. On April 27, 2015, the Board adopted the 2014 Housing Element, which updated the Data and Needs Analysis of the 2009 Housing Element and added five additional policies. Based on an addendum issued by the San Francisco Planning Department ("Planning Department" or "Department") for the 2014 Housing Element, the Board found that no additional environmental review was required beyond the review in the FEIR.<sup>2</sup>

This document is an addendum to the 2004 and 2009 Housing Element FEIR. Its purpose is to substantiate the Planning Department's determination that no supplemental or subsequent environmental review is required prior to adoption of the City and County of San Francisco ("City") Affordable Housing Bonus Program ("proposed program," "proposed project," or "AHBP") and related General Plan amendments. As described more fully below, the AHBP is an implementing program of the 2014 Housing Element. The Department has determined that the environmental effects of the AHBP have been adequately identified and analyzed under CEQA in the 2004 and 2009 Housing Element FEIR, and the proposed project would not result in any new or more severe environmental impacts than were identified in the FEIR.

---

<sup>1</sup> San Francisco Planning Department, *2004 and 2009 Housing Element Final Environmental Impact Report*, April 24, 2014. Case No. 2007.1275E, <http://www.sf-planning.org/index.aspx?page=1828>, accessed on January 13, 2016. Unless otherwise noted, all documents cited in this report are available for review at the San Francisco Planning Department, 1650 Mission Street, Suite 400, San Francisco, CA as part of Case No. 2014.1304E or the identified file number.

<sup>2</sup> San Francisco Planning Department, *Addendum to 2004 and 2009 Housing Element Final Environmental Impact Report, 2014 Housing Element*, January 22, 2015. Case No. 2014.1327E, <http://www.sf-planning.org/index.aspx?page=1828>, accessed on January 13, 2016.



## Background

### ***State Housing Element Law – Government Code Section 65580***

The Housing Element is an element of San Francisco's General Plan which sets forth the City's overall policies regarding residential development and retention. Since 1969, California State Housing Element law (Government Code Section 65580 et seq.) has required local jurisdictions to adequately plan for and address the housing needs of all segments of its population, including low and very low income households, such that all communities contribute to the attainment of the state housing goals. Housing Element law requires local governments to plan for their existing and projected housing needs by facilitating the improvement and development of housing, rather than constraining opportunities. Under State Housing Element law, San Francisco's 2014 Housing Element was required to plan for an existing and projected housing need of 28,869 new residential units, 56.6 percent (%) of which must be affordable to very low, low, or moderate income households.

### ***State Density Bonus Law – Government Code Section 65915***

Under Government Code Section 65915, the State Density Bonus Law ("State Law"), cities are required to grant density bonuses, waivers from development standards,<sup>3</sup> and concessions and incentives<sup>4</sup> when a developer of a housing project of five or more units includes at least 5% of those units as housing units affordable to moderate, low or very low income households (between 50% and 120% of area median income).<sup>5</sup> The increased development potential allowed under this law is intended to offset the private developer's expenses necessary to provide additional affordable units. The amount of the density bonus, and the number of concessions and incentives varies depending on the percentage of affordable units proposed and the level of affordability; generally, however, State Law requires that cities grant between a 7% to 35% density bonus, and up to three concessions and incentives, if a developer provides between 5% and 40% affordable units. Additionally, project sponsors are able to request waivers from development standards if the development standards physically preclude the project with the additional density or with the concessions and incentives.<sup>6</sup> State Law requires that rental units be affordable for a term of no less than 55 years, and that ownership units be affordable to at least the first buyer through a shared equity

---

<sup>3</sup> "Development standard" includes a site or construction condition, including but not limited to a height limitation, a setback requirement, a floor area ratio, an onsite open-space requirement, or a parking ratio that applies to a residential development pursuant to any ordinance, general plan element, specific plan, charter, or other local condition, law, policy, resolution, or regulation. (See Government Code Section 65915(0)(1).

<sup>4</sup> Concessions and incentives mean (1) a reduction in site development standards or a modification of zoning requirements or architectural design requirements that exceed the minimum building standards approved by the California Building Standards Commission as provided in Part 2.5 (commencing with Section 18901) of Division 13 of the Health and Safety Code, including, but not limited to, a reduction in setback and square footage requirements and in the ratio of vehicular parking spaces that would otherwise be required that results in identifiable, financially sufficient, and actual cost reductions; (2) Approval of mixed-use zoning in conjunction with the housing project if commercial, office, industrial, or other land uses will reduce the cost of the housing development and if the commercial, office, industrial, or other land uses are compatible with the housing project and the existing or planned development in the area where the proposed housing project will be located; or (3) Other regulatory incentives or concessions proposed by the developer or the city, county, or city and county that result in identifiable, financially sufficient, and actual cost reductions. (See Government Code Section 65915).

<sup>5</sup> See generally, Government Code Section 65915 et seq.

<sup>6</sup> See Government Code Section 65915(e).

agreement.<sup>7</sup> Local jurisdictions are required to adopt an ordinance implementing the State Density Bonus Law; however, absent an ordinance, local jurisdictions are still required to comply with the law.<sup>8</sup>

### **City and County of San Francisco 2014 Housing Element of the General Plan**

To support the development of affordable housing, the City's 2014 Housing Element anticipates the adoption of a "density bonus program" implementing the State Law. As envisioned in the 2014 Housing Element, such a program would allow density bonuses for projects that include certain percentages of affordable housing, as well as allow other incentives, concessions, and waivers for projects that include more affordable units than required under existing City programs.

Specifically, the 2014 Housing Element contains the following discussion of a density bonus program in Part I, on page A.6:

*The City has continued the policy of establishing special use districts (SUDs)<sup>9</sup> and height exceptions intended to support the development of affordable housing by allowing density bonuses for higher percentages of affordable or special needs housing. Almost all new Area Plans adopted during the 2007-2014 reporting period also include these policies, as well as additional affordable housing impact fees. Floor area ratio (FAR) limitations have been removed in the downtown areas to encourage housing development. The Board of Supervisors is currently considering legislation to exempt on-site inclusionary units from existing density limits in certain districts, essentially giving developers who include affordable units within their projects a density bonus.*

*In February 2014, the Department released an RFP [Request for Proposals] for consultant support to develop a more proactive program to implement Government Code Section 65915. For example, the proactive approach may follow the model of other municipalities which indicate which exemptions will be not be [sic] deemed as potentially having an adverse impact on health and safety.*

In addition, under the 2014 Housing Element Implementing Programs (Part I, Chapter C, on page C.11), the following Implementing Program is identified to meet the goal of establishing a density bonus program in the City:

*Implementing Program 39b. Planning will develop a density bonus program with the goal of increasing the production of affordable housing. The program will be structured to incentivize market rate projects to provide significantly greater levels of affordable housing than required by the existing City Programs.*

A related strategy for further review of this Implementation Program is listed on page C.13:

*Planning should examine incentives such as density bonuses, or other zoning related mechanisms that encourage long-term (i.e. deed-restricted) permanently affordable rental housing.*

---

<sup>7</sup> See Government Code Section 65915(c)(1) and (2).

<sup>8</sup> See Government Code Section 65915(a).

<sup>9</sup> Approximately a dozen SUDs have been established in order to provide density bonuses and zoning modifications for affordable housing projects. Examples include the Alabama and 18<sup>th</sup> Streets Affordable Housing SUD (Planning Code Section 249.27), the Third Street and Oakdale Avenue Affordable Housing SUD (Section 249.30), the Third Street and Le Conte Affordable Housing SUD (Section 249.43), the 1500 Page Street Affordable Housing SUD (Section 249.47, and the Lombard and Scott Street Affordable Group Housing SUD (Section 249.55).

## **City and County of San Francisco Inclusionary Affordable Housing Ordinance**

The Inclusionary Affordable Housing Ordinance is found in Planning Code Section 415 et seq. This ordinance requires project sponsors of residential projects with 10 units or more to pay an Affordable Housing Fee as a way of contributing to the City's affordable housing stock. Under certain circumstances, a project sponsor may choose to provide on- or off-site affordable housing units instead of paying the fee. The most common on-site requirement is 12% affordable units, although it is higher in some Area Plan zoning districts.<sup>10</sup>

### **PROPOSED REVISIONS TO 2014 HOUSING ELEMENT**

#### **Affordable Housing Bonus Program**

On September 29, 2015, Mayor Lee and Supervisor Tang introduced legislation (Board File No. 150969) to the San Francisco Board of Supervisors to amend the Planning Code to create the Affordable Housing Bonus Program. The proposed AHBP implements the density bonus program envisioned in the 2014 Housing Element.

In conjunction with the AHBP, the Planning Department has proposed minor amendments to the General Plan, including the Housing Element, so that the General Plan better and more specifically reflects the goals of the AHBP. The proposed amendments would add language to one Housing Element policy and descriptive text below two other Housing Element policies to recognize the City's need to allow development incentives for projects that include affordable housing units on-site. The proposed amendments, discussed in greater detail below, also include references to higher densities on Map 6 of the Housing Element and associated updates to the Land Use Index.

Overall, as reflected in the findings of the proposed AHBP ordinance, the goals of the proposed AHBP are to establish a program consistent with State Law; encourage the construction of a greater numbers of on-site affordable units; improve the feasibility of developing affordable units on underutilized sites; establish a program to provide housing for "middle income" households; and facilitate entitlement of 100 Percent affordable housing units. The AHBP would amend the San Francisco Planning Code by adding a new Section 206 to establish four avenues for project sponsors to receive a density bonus and other development bonuses, which would allow for a greater number of units to be built than would otherwise be permitted under existing zoning. The four programs are: 1) the Local Affordable Housing Bonus Program; 2) the 100 Percent Affordable Housing Bonus Program; 3) the Analyzed State Density Bonus Program; and 4) the Individually Requested State Density Bonus Program. **Table 1** summarizes the key features of the four programs, which are described in further detail below. The AHBP also establishes an approval process for AHBP projects, as well as specific AHBP Design Guidelines.

---

<sup>10</sup> See, for example, the Additional Affordable Housing Requirements for UMU districts in Planning Code Section 419 et seq.

**Table 1**  
**Comparison of Proposed Affordable Housing Bonus Program Characteristics**

<b>Characteristic</b>	<b>Local Affordable Housing Bonus Program</b>	<b>100 Percent Affordable Housing Bonus Program</b>	<b>Analyzed State Density Bonus Program</b>	<b>Individually Requested State Density Bonus Program</b>
<b>Pre-Program Density Requirement</b>	3 or more units	3 or more units	5 or more units	5 or more units
<b>Affordable Housing Requirement</b>	30% total inclusionary and middle income affordable units onsite (all middle income if no inclusionary requirement)	100% affordable to 80% AMI and below	Various affordability levels, ranging from 5% to 30% at various AMIs	Various affordability levels, ranging from 5% to 40% at various AMIs (100% for senior citizen housing)
<b>Location Requirement</b>	Zoning districts that regulate residential density by lot area, plus the Fillmore and Divisadero NCTDs; excludes RH-1 and RH-2 districts	Zoning districts that allow residential uses, excluding RH-1 and RH-2 districts	Zoning districts that regulate residential density by lot area, plus the Fillmore and Divisadero NCTDs; excludes RH-1 and RH-2 districts	Zoning districts that allow residential uses and can accommodate 5 or more units under existing zoning controls
<b>Unit Mix Requirement</b>	40% two or more bedrooms or 50% more than one bedroom	-	-	-
<b>Environmental Requirement</b>	No significant historic, shadow, or wind impact	No significant historic, shadow, or wind impact	-	-
<b>Density Bonus</b>	Form-based density controls	Form-based density controls	Up to 35% density bonus	Up to 35% density bonus
<b>Height Bonus</b>	Up to 25 feet/two stories with min. 9-foot floor-to-ceiling height for residential floors	Up to 35 feet/three stories with min. 9-foot floor-to-ceiling height for residential floors	Up to 25 feet/two stories with min. 9-foot floor-to-ceiling height for residential floors	Height increases allowed as necessary in order to develop at allowed increased density and with concessions requested
<b>Zoning Modifications/Concessions and Incentives</b>	Up to three: <ul style="list-style-type: none"> <li>• rear yard: min. 20%/15 feet</li> <li>• unit exposure: min. 25 feet</li> <li>• off street loading: none required</li> <li>• parking: up to 75% reduction</li> <li>• open space: up to 5% reduction in common open space</li> <li>• additional open space: up to another 5% reduction in common open space</li> </ul>	Any or all: <ul style="list-style-type: none"> <li>• rear yard min. 20%/15 feet</li> <li>• unit exposure: min. 15 feet</li> <li>• off street loading: none required</li> <li>• parking: up to 100% reduction</li> <li>• open space: up to 10% reduction in common open space (min. 36 sf/unit)</li> </ul>	Up to three depending on AMI: <ul style="list-style-type: none"> <li>• rear yard: min. 20%/15 feet</li> <li>• unit exposure: min. 25 feet</li> <li>• off street loading: none required</li> <li>• parking: up to 50% reduction</li> <li>• open space: up to 5% reduction in common open space</li> <li>• additional open space: up to another 5% reduction in common open space</li> </ul>	Up to three, to be negotiated on project-by-project basis

Source: San Francisco Planning Department, January 2016.

### **Local Affordable Housing Bonus Program**

**Eligibility Requirements.** The Local Affordable Housing Bonus Program (“Local Program”) would encourage construction of affordable housing by providing zoning modifications for projects that satisfy specified requirements. Local Program projects would be required to be all new construction (vertical additions to existing buildings would not qualify) with a pre-Program density (not including bonus units) of three or more residential units and to provide a total of 30% income restricted units on site. Local Program projects subject to the City’s Inclusionary Affordable Housing Ordinance would need to provide the required inclusionary units on-site, plus provide an additional 18% of the units as middle income units (units which are affordable to households earning 140% of area mean income (“AMI”) for ownership projects and 120% AMI for rental projects). For Local Program projects not subject to the Inclusionary Affordable Housing Ordinance, a total of 30% of the units would be required to be middle income units. The Local Program would be available in all zoning districts that regulate residential density by lot area, with the exception of RH-1 (House, One-Family) and RH-2 (House, Two-Family) districts, and also would be allowed in the Fillmore Neighborhood Commercial Transit District (“NCTD”) and the Divisadero NCTD. Local Program projects would be required to meet certain unit mix requirements (40% two or more bedrooms or 50% two-bedroom or larger units). The Program requires nine-foot floor to ceiling heights on all residential floors.

Projects would only be eligible for the Local Program if the Planning Department determines that they would not cause a substantial adverse change in the significance of a historic resource, create new shadow in a manner that substantially affects outdoor recreation facilities or other public areas, or alter wind in a manner that substantially affects public areas. This determination would be made by the Planning Department as part of the broader environmental review process to which AHBP projects would be subject. Environmental review for AHBP projects would include an evaluation of the projects’ potential for significant environmental impacts in all applicable resource areas, pursuant to CEQA and Chapter 31 of the San Francisco Administrative Code.<sup>11</sup>

Finally, Local Program projects would be required to comply with proposed AHBP Design Guidelines, described below.

**Development Bonuses.** Projects meeting the above requirements would be eligible to receive a height bonus (increase) of up to 20 feet above the existing height limit, or two stories with the required 9-foot floor-to-ceiling height.<sup>12</sup> In addition, Local Program projects with active ground floors would be granted up to an additional 5 feet in height at the ground floor, for a total maximum height bonus of 25 feet. Local Program projects also would be eligible to receive a density bonus through the application of form-based density controls rather than by lot area (i.e., by building volume rather than by units/square feet of lot

---

<sup>11</sup> In other words, historic resources, shadow, and wind would be only a few of the environmental topics reviewed; existing environmental review requirements would remain in place. The environmental review simply would inform the determination of whether projects would be eligible for the Local Program.

<sup>12</sup> All city parcels are subject to height and bulk limits, which set the maximum parameters for building height and bulk. For example, many residential (RH-1, RH-2, RH-3, etc.) districts are within the 40-X height and bulk limits, which mandate the maximum height of 40 feet, although most residential projects are also subject to the Planning Department’s Residential Design Guidelines, design review, and other requirements that may further limit the possible height of development.

area). Density of Local Program projects therefore would be limited by applicable requirements and limitations, including height (with the bonus), bulk, setbacks, open space requirements, exposure, and unit mix.

**Zoning Modifications.** Up to three other modifications to rear yard, dwelling unit exposure, off-street loading, parking, and open space requirements, in the amounts listed in Table 1, would be available to developers who pursue the Local Program.

#### ***100 Percent Affordable Housing Bonus Program***

**Eligibility Requirements.** The 100 Percent Affordable Housing Bonus Program (“100 Percent Affordable Program”) would apply to new construction projects only (vertical additions to existing buildings would not qualify) with a base density of three or more units in which 100% of the total units are income restricted to 80% AMI or below. The 100 Percent Affordable Program would be available throughout the City on any parcel zoned to allow residential uses, with the exception of RH-1 and RH-2 districts. Projects would be eligible for the 100 Percent Affordable Program only if the Planning Department determines that they would not result in significant historical resource, shadow, or wind impacts. In addition, 100 Percent Affordable Program projects would be required to comply with the proposed AHBP Design Guidelines.

**Development Bonuses.** 100 Percent Affordable Program projects would be entitled to a height bonus of up to 30 feet or 3 stories above existing height limits, plus an extra 5 feet for active ground floor uses. These projects would be eligible to receive a density bonus through application of form-based density controls.

**Zoning Modifications.** Modifications in the amounts listed in Table 1 to rear yard, dwelling unit exposure, off-street loading, parking, and open space requirements would be available to developers who pursue the 100 Percent Affordable Program. Projects in this program would be eligible to receive any or all of the offered zoning modifications.

#### ***Analyzed State Density Bonus Program***

**Eligibility Requirements.** The Analyzed State Density Bonus Program (“Analyzed State Program”) would apply to projects of five or more units that include various affordability levels, ranging from 5% to 30% at various AMIs. (These affordability requirements mirror the requirements of the State Density Bonus Law.) The Analyzed State Program would apply in the same locations as the Local Program, i.e., all zoning districts that regulate residential density by lot area, with the exception of RH-1 and RH-2 districts, plus the Fillmore and Divisadero NCTDs. The Program requires 9-foot floor to ceiling heights on all residential floors and Analyzed State Program projects would be required to comply with proposed AHBP Design Guidelines.

**Development Bonuses.** Analyzed State Program projects would be eligible to receive a waiver of height restrictions up to 25 feet above existing height limits (a maximum of two stories given the required minimum 9-foot floor to ceiling height), subject to the requirements of a specified formula, and a density bonus of up to 35% above that allowed under existing zoning.

**Zoning Modifications.** Developers who pursue the Analyzed State Program would be eligible to select up to three concessions and incentives (modifications to zoning controls), in the amounts listed in Table 1, to rear yard, dwelling unit exposure, off-street loading, parking, and open space requirements.

#### ***Individually Requested State Density Bonus Program***

The Individually Requested State Density Bonus Program (“Individually Requested Program”) would be available to projects that are consistent with the State Density Bonus Law, but that request a set of incentives, concessions, or waivers that are not offered through the Analyzed State Program. The Individually Requested Program is also for those seeking a bonus for land donations, condominium conversions, or mobile home parks (as specifically allowed by State Law),<sup>13</sup> and for projects in zoning districts not eligible for Analyzed State projects.

**Eligibility Requirements.** The Individually Requested Program would apply to projects of five or more units that include various affordability levels, ranging from 5% to 40% at various AMIs, as provided in State Law. The Individually Requested Program would apply in all districts that allow residential units and can accommodate five or more units under existing zoning controls. Projects under this program would be required to comply with the AHBP Design Guidelines

**Development Bonuses.** Individually Requested Program projects would be entitled to a density bonus of up to 35% above that allowed under existing zoning, depending on the amount and type of restricted affordable units proposed.

**Zoning Modifications.** Developers who pursue the Individually Requested Program would be eligible to receive up to three concessions and incentives as necessary to make the density bonus physically and financially feasible. Project sponsors could also request a waiver of a development standard that physically precludes the development at the density and with the concessions requested.

#### ***AHBP Project Authorization***

The proposed legislation would also amend the Planning Code to add Section 328, which would establish a review and approval process for Local Program and 100 Percent Affordable Program projects. In addition to zoning modifications offered under the Local Program and 100 Percent Affordable Program, the proposed Section 328 would allow the Planning Commission to make minor project modifications to ensure a project’s consistency with the AHBP Design Guidelines.

All AHBP projects would be evaluated for consistency with the AHBP Design Guidelines. In recognition that some projects utilizing the AHBP would be taller or of differing mass than the surrounding context, the AHBP Design Guidelines would clarify how projects should both maintain their size and be designed to be compatible with their neighborhood context. Specific design guidelines would address ground-floor design, tops of buildings, sidewalk articulation, and architectural character. Also, the AHBP Design Guidelines would articulate existing design principles from neighborhood- or district-specific design

---

<sup>13</sup> Density bonuses for “land donations” are regulated in Government Code Section 65915(g), “condominium conversions” are defined in Government Code Section 65915.5, and “mobile home parks” are defined under Government Code Section 65915(b)(1)(C).

guidelines that would be applied to all AHBP projects. These fundamental design principles would address such things as building massing and articulation, ground floors, and streets. Finally, the AHBP Design Guidelines would include historic preservation guidelines to ensure that AHBP projects preserve materials, features, and forms of historic districts, as applicable, and are compatible and differentiated. The draft AHBP Guidelines will be presented to the Planning Commission for adoption and forwarded to the BOS for approval.

All projects eligible to take advantage of the AHBP, under any of the four programs, would require review under CEQA.

### **AHBP General Plan Amendments**

In conjunction with the proposed AHBP ordinance, the Planning Department has proposed minor amendments to the General Plan. These amendments would add language to the Housing Element, Urban Design Element, Chinatown Area Plan, Downtown Area Plan, and Northeast Waterfront Area Plan and associated updates to the Land Use Index to specifically reflect the goals and intent of the AHBP, which allow greater height and bulk for projects that provide affordable units on site.

Generally, the proposed amendments would include the following language in the relevant sections of the General Plan:

*To encourage greater levels of affordability on-site, the City may adopt affordable housing policies to permit heights that are several stories taller and building mass that is larger than described here. Refer to the Affordable Housing Bonus Program Design Guidelines.*

The proposed amendments would add language to one Housing Element Policy and descriptive text to two other Housing Element policies to specifically reference and allow development incentives, such as additional height, density, and bulk, in exchange for higher levels of affordability. . The proposed amendments also include references to higher densities on Map 6 of the Housing Element and associated updates to the Land Use Index.

### **AHBP Approvals**

As amendments to the Planning Code and General Plan, the proposed AHBP and General Plan amendments would require review and recommendation by the Planning Commission to the Board of Supervisors, and approval of an ordinance by the Board of Supervisors.

### **SETTING**

San Francisco is a consolidated city and county located on the tip of the San Francisco Peninsula with the Golden Gate Strait to the north, San Francisco Bay to the east, San Mateo County to the south, and the Pacific Ocean to the west. The City is one of nine counties adjacent to San Francisco and San Pablo Bays. Daly City and the City of Brisbane abut San Francisco to the south. San Francisco is approximately 49 square miles in size. The City is made up of numerous planning districts and several plan areas (areas which have undergone, or are in the process of, a comprehensive community planning effort). Although San Francisco is densely developed, there remain developable vacant parcels, as well as underused parcels, which are currently zoned to allow housing in various locations throughout the City.



## ANALYSIS OF POTENTIAL ENVIRONMENTAL EFFECTS

San Francisco Administrative Code Section 31.19(c)(1) states that a modified project must be reevaluated and that “[i]f, on the basis of such reevaluation, the Environmental Review Officer (ERO) determines, based on the requirements of CEQA, that no additional environmental review is necessary, this determination and the reasons therefore shall be noted in writing in the case record, and no further evaluation shall be required by this Chapter.”

CEQA Guidelines Section 15164 provides for the use of an addendum to document the basis of a lead agency’s decision not to require a Subsequent or Supplemental EIR for a change to a project that has been analyzed in a certified EIR. The lead agency’s decision to use an addendum must be supported by substantial evidence that the conditions that would trigger the preparation of a Subsequent EIR, as provided in CEQA Guidelines Section 15162, are not present.

The proposed AHBP, which would implement the density bonus provisions referenced in the Housing Element, would not result in any new significant environmental impacts, substantially increase the severity of previously identified effects, or necessitate implementation of additional or considerably different mitigation measures than those identified in the FEIR. The effects associated with the proposed program would be substantially the same as those reported for the FEIR, and thus no supplemental or subsequent EIR is required. The following discussion provides the basis for this conclusion.

### 2004 and 2009 Housing Element FEIR Conclusions

The 2009 Housing Element adopted policies that, generally, encouraged housing and higher density housing along transit lines and other infrastructure, and in proximity to neighborhood services, such as open space and childcare. The 2009 Housing Element policies also encouraged higher density through a community planning process and, for affordable housing projects, promoted the construction of multifamily housing. The 2004 and 2009 Housing Element FEIR identified less-than significant environmental impacts in the following environmental topic areas:

- Land Use and Land Use Planning;
- Visual Quality and Urban Design;
- Population and Housing;
- Cultural and Paleontological Resources;
- Air Quality;
- Greenhouse Gas Emissions;
- Wind and Shadow;
- Recreation;
- Utilities and Service Systems;
- Public Services;
- Biological Resources;
- Geology and Soils;
- Hydrology and Soils;
- Hazards and Hazardous Materials;
- Mineral and Energy Resources; and
- Agricultural and Forest Resources.

The FEIR found that significant effects related to encouraging new residential development along streets with noise levels above 75 dBA  $L_{dn}$  can be avoided or reduced to a less-than-significant level with mitigation, and a mitigation measure addressing the issue was incorporated into the adopted Housing Element as an implementation measure.<sup>14</sup> The FEIR found also that adoption of the 2009 Housing Element

---

<sup>14</sup> *A-Weighted Sound Level (dBA)*: The sound pressure level in decibels as measured on a sound level meter using the internationally standardized A-weighting filter or as computed from sound spectral data to which A-weighting adjustments have been made. A-weighting de-emphasizes the low and very high frequency components of the sound in a manner similar to the response of the average human ear. A-weighted sound levels correlate well with

would potentially result in significant environmental effects on the transit network that could not be mitigated to a less-than-significant level with implementation of feasible mitigation measures. The policies in the 2014 Housing Element were substantially the same as those in the 2009 Housing Element, and the adoption of the 2014 Housing Element did not change the conclusions in the FEIR.

### **2004 and 2009 Housing Element EIR Alternative C**

The 2004 and 2009 Housing Element EIR, in the Revised Alternatives Analysis, discussed and analyzed Alternative C (“2009 Housing Element Intensified”), which included potential policies (described herein as “concepts”) that more actively encourage housing development through zoning accommodations than the policies in the 2009 Housing Element. These concepts were generated based on ideas and alternative concepts raised over the course of outreach for the 2009 Housing Element preparation process, but which were ultimately not included as policies in the 2009 Housing Element.

Alternative C included concepts intended to encourage housing by:

- 1) Allowing for limited expansion of allowable building envelope for developments meeting the City’s affordable housing requirement on site with units of two or more bedrooms;
- 2) Requiring development to the full allowable building envelope in locations that are directly on Transportation Effectiveness Project (“TEP”) rapid transit network lines;
- 3) Giving height and/or density bonuses for developments that exceed affordable housing requirements in locations that are directly on TEP rapid transit network lines;
- 4) Allowing height and/or density bonuses for 100 percent affordable housing in all areas of the City except in RH-1 and RH-2 zones; and
- 5) Granting of administrative (i.e., over the counter) variances for reduced parking spaces if the development is:
  - a) in an RH-2 zoning district that allows for greater residential density (e.g., adding a second unit without required parking);
  - b) in an area where additional curb cuts would restrict parking in areas with parking shortages; or
  - c) on a Transit Preferential Street.<sup>15</sup>

The 2004 and 2009 Housing Element EIR analyzed the environmental impacts of implementing a more intensified housing development program than what was proposed under the 2009 Housing Element. The FEIR concluded that Alternative C would not result in any greater significant environmental impacts than those identified for the 2009 Housing Element. Specifically, the FEIR noted that Alternative C could result in a significant and unavoidable impact to the City’s transit network – the same as the proposed 2009 Housing Element – and that, with respect to noise, Alternative C could result in a significant impact that could be mitigated to a less-than-significant level with implementation of Mitigation Measure M-NO-1 –

---

subjective reactions of people to noise and are universally used for community noise evaluations.

*Day-Night Sound Level (L<sub>dn</sub>):* The Leq of the A-weighted noise level over a 24-hour period with a 10 dB penalty applied to noise levels between 10 p.m. and 7 a.m.

<sup>15</sup> The Transportation Element of the San Francisco General Plan contains Policy 20.1, which calls for “giving priority to transit vehicles based on a rational classification system of transit preferential streets (TPS).” The policy discussion elaborates that the TPS classification system should consider the multi-modal functions of the street, the existing and potential levels of transit service and ridership, and the existing transit infrastructure. A map of Transit Preferential Streets is provided in Map 9 of the Transportation Element.

also, the same as for the proposed Housing Element. In sum, the significance of the environmental impacts associated with Alternative C were determined to be similar to the significance of the impacts for the 2009 Housing Element. The growth projected in San Francisco over the Housing Element EIR review period was driven by assumptions based on regional demand, and therefore the EIR concluded that the policies contained within the Housing Element could incrementally affect the type of housing developed and, to some extent, the size of individual projects, but would not affect the overall number of units expected. Therefore, while some environmental impacts associated with Alternative C were determined to be either incrementally more or incrementally less severe than the impacts that were identified for the 2009 Housing Element, the difference in the severity of effects of Alternative C as compared to the 2009 Housing Element was not substantial.

### **Changed Circumstances since Certification of FEIR**

Since certification of the FEIR, a number of revisions have been made to the Planning Code, General Plan, and other city policies and regulations (including the Inclusionary Housing Program, Standards for Bird-Safe Buildings, and others) related to housing and development in San Francisco. Most changes to the Planning Code and other documents can be found on the Planning Department's website: <http://www.sf-planning.org/index.aspx?page=2977>. Those changes were independent from the adoption of the Housing Element and have undergone independent review under CEQA. The revisions primarily pertain to neighborhood-specific issues, and none of them would result in changes that substantially deviate from the overarching goals and objectives that were articulated in the 2009 or 2014 Housing Element (such as directing growth to certain areas of the City, promoting preservation of residential buildings, etc.) in a way that could render the conclusions reached in the FEIR as invalid or inaccurate. These revisions to the regulatory environment also would not be expected to affect the severity of impacts discussed in the FEIR. Further, no new information has emerged that would materially change the analyses or conclusions set forth in the FEIR. Any additional draft amendments proposed for adoption, but not yet adopted, would be reviewed for environmental impacts prior to adoption.

### **Changes to Housing Projections**

The FEIR contains population and housing projections that have since been updated. As reported in the 2014 Housing Element,<sup>16</sup> the 2012 American Community Survey estimated San Francisco's population to be about 807,755. ABAG projects continued population growth to 981,800 by 2030 or an overall increase of about 174,045 people who will need to be housed over the next 18 years.<sup>17</sup> In comparison, the 2009 Housing Element projected San Francisco's population at 934,000 by 2030. Household growth, an approximation of the demand for housing, currently indicates a need for some 72,530 new units in the 18 years to 2030. As with the 2009 and 2014 Housing Elements, the proposed AHBP would not change the population and housing projections, as those projections are due to, and influenced by, births, deaths, migration rates, and employment growth, and under current zoning the City can meet that demand. Rather, the AHBP would influence the location and type of residential development that would be constructed to meet demand.

---

<sup>16</sup> 2014 Housing Element, Part I, p. I.4.

<sup>17</sup> Association of Bay Area Governments, Projections 2013, p. 75.

### **Approach to Analysis of AHBP Environmental Effects**

As discussed above, the Analyzed State Program and the Individually Requested Program (hereafter “the State Programs”) implement the State Law. Adoption of the State Programs would codify procedures that articulate the City’s preferences and priorities for implementing the State Law in San Francisco. Project sponsors of qualifying projects in San Francisco already are entitled to receive the density bonuses and concessions and incentives that would be offered by the State Programs. The State Programs would make it easier for project sponsors to take advantage of the State Law, since State Program projects would not be required to receive exceptions or other allowances from applicable Planning Code requirements, such as through a conditional use, variance or Planning Code amendment. The two AHBP State Law avenues, however, would not be expected to substantially increase the number of projects that are developed consistent with State Law, because the underlying financial feasibility of developing a particular parcel would not substantially change with adoption of the State Programs. Furthermore, Alternative C in the FEIR identified potential policies, including increased heights and expanded building envelopes, that would allow more intense housing development in certain areas of San Francisco. Alternative C thereby reflected the potential for construction of relatively larger buildings with higher affordability levels in particular locations, such as along rapid transit corridors. Thus, because the State Law was already assumed as part of the baseline regulatory environment for both the Housing Element and Alternative C, impacts from implementation of the State Law through the State Programs were included in the analysis of the Housing Element in the FEIR. It is worth noting, however, that future proposed projects seeking to take advantage of the State Programs, or any AHBP program, would be subject to additional project-specific environmental review.

The Local Program and 100 Percent Affordable Program (hereafter “the Local Programs”) contain additional eligibility requirements that are more restrictive than the requirements for the State Law. These include the affordability, location, unit mix, and environmental requirements. At the same time, the Local Programs have a lower threshold of eligibility regarding the pre-program density requirement (a minimum of three units versus five) and the density bonus offered under the Local Programs is not capped at a certain percentage, as is the State Law. In contrast to the State Programs, the Local Programs were not specifically included or assumed as part of the existing regulatory environment in the FEIR. The Department reasonably assumes, however, that projects constructed under the Local Programs would be generally similar to those that qualify for State Law development bonuses and, as with the State programs, would not substantially deviate from the development that the FEIR concluded could proceed under the concepts described in Alternative C.

Pursuant to CEQA, this document focuses specifically on the physical environmental effects that could result from implementing the proposed AHBP. The proposed program does not directly propose new housing development projects and thus, would not directly result in the construction of residential units. However, by allowing for and articulating the City’s preferences and priorities for density bonuses and establishing a defined menu of zoning modifications from which a developer could choose, the AHBP could encourage the production of a greater number of market-rate and affordable housing units at any given eligible site than would occur under existing land use controls. In other words, the program would allow for a greater number of residential units to be included in a given development project. This construction would occur because the program would make it more financially feasible for project sponsors to develop or redevelop underutilized sites and include affordable housing. Nonetheless, as noted above, the AHBP would not increase projected demand for housing, nor would it change the total

amount of residential growth (in terms of numbers of units) anticipated in the City. Rather, the program would influence the location, density, building envelope, and affordability of residential development that would be constructed to meet demand.

The program characteristics that have the greatest potential to result in physical environmental effects are the height and density bonuses and the zoning modifications, as they would influence the size of the building envelope and may necessitate deeper foundations and larger lot coverage.

### **Anticipated Development of AHBP Projects**

It is uncertain how many additional new units (affordable or market rate) would be built by project sponsors choosing to take advantage of the proposed AHBP. It is also uncertain precisely which parcels in the City would be developed or redeveloped with AHBP projects as opposed to traditional residential projects. Nonetheless, the Planning Department has estimated a theoretical maximum number of new units that would be built under the Program, based on the assumptions described below, and analyzed the distribution of sites throughout the City where such development would be most likely to occur.

### **Selection of AHBP Option by Developer**

The Planning Department crafted the four proposed AHBP options to provide for a range of program types suiting different project site conditions, project types, and project sponsor needs. The Department anticipates that the Local Program would be the most popular choice by developers because it would provide the greatest benefits, in the form of the bonuses and zoning modifications offered, relative to the costs to qualify (i.e., provision of affordable housing). The Analyzed State Program is anticipated to be the second most popular choice, for similar reasons, and it would be available to projects that do not meet the eligibility requirements for the Local Program. In addition, Local Program and Analyzed State Program projects would benefit from a more streamlined entitlement process, without the need to justify the financial or site constraints that merit specific zoning modifications, relative to Individually Requested Program projects. Although sponsors of projects meeting the affordability and other requirements of the 100 Percent Affordable Program would benefit from an additional 10-foot/one-story height bonus as compared to the Local Program and Analyzed State Program, the 100 Percent Affordable Program would be expected to attract a very small number of applicants on an annual basis due to the financing constraints for such projects. Most 100% affordable projects rely on some form of public funding, sources of which are very limited, and the AHBP would not increase public funding sources. The Individually Requested Program would be expected to attract a small number of projects due to the requirement to justify the financial and/or site constraints that merit the specifically requested zoning modifications, which are not required by the other three programs. Nonetheless, the Planning Department's estimate of theoretical maximum number of new AHBP units takes into account 100 Percent Affordable and Individually Requested Program units.

### **Development and Other Constraints**

In order to determine the likely number of new units that would be constructed under the AHBP, the Planning Department began by identifying the constraints to development of projects eligible to take advantage of the proposed AHBP. As noted above, it is anticipated that most developers would choose either the Local Program or the Analyzed State Program (hereafter "Local or Analyzed Programs"). Therefore these programs would be expected to incentivize the greatest number of residential units and the following discussion of development constraints focuses on these programs.

**Location.** Developers would be able to take advantage of the Local Program only in locations subject to quantified density limits and that allow three or more units per parcel. These locations, which total 30,850 parcels (“the study area”), constitute approximately 20 percent of all parcels in the City zoned for residential uses (see **Figure 1**). The Analyzed State Program would be available only in locations subject to quantified density limits and that allow five or more units per parcel; these parcels are encompassed within the study area.

Numerous areas of the City that benefit from more recent community plans are not subject to residential density limits, such as areas within the Market Octavia Area Plan, the Eastern Neighborhoods Area Plans, the Balboa Park Plan Area and the Glen Park Plan Area. In these areas, proposed developments are subject to form-based regulation, and are ineligible for the Local or Analyzed Programs. Some individual parcels in areas with form-based zoning where residential use is permitted are expected to take advantage of the 100 Percent Affordable Program, but for the reasons described above this would not constitute a substantial number of sites.

In addition, projects seeking density bonuses under the Local, 100 Percent Affordable, and Analyzed State Programs would not be permitted in RH-1 and RH-2 districts, which allow only one or two units per lot, respectively. RH-1 and RH-2 districts make up approximately 72% of all existing land parcels and 50% of the City’s developable acreage (meaning non-open space or land that is not federally owned).

As illustrated in **Figure 1**, the study area includes neighborhood commercial districts along Geary Boulevard, Van Ness Avenue, and Balboa, Fillmore, Divisadero, and Taraval streets. In addition, the study area includes some parcels along Van Ness Avenue and Mission, Third, Irving, and Judah streets.

The study area includes zoning districts in which mixed-use development is already encouraged or permitted (e.g., C (Commercial) districts, NC (Neighborhood Commercial), NCT (Neighborhood Commercial Transit) districts, and RC (Residential-Commercial Combined) districts, among others). Thus, AHBP projects would likely occur in zoning districts that have neighborhood-, city-, or regional-serving commercial uses in areas close to major transit lines (i.e., the Muni rapid network) and on major automobile arterials. **Figure 2** shows the location of the Muni rapid network in relation to the study area.

**Existing and Proposed Site Development.** The majority of parcels throughout San Francisco are already developed with existing buildings that are not anticipated to be redeveloped. A total of 13,800 parcels in the study area are currently developed to more than 30% of the permitted site capacity.<sup>18</sup> Even with the density and height bonuses offered to projects qualifying for the Local and Analyzed Programs, it is unlikely that the financial incentives of the programs would be sufficient to incentivize redevelopment of those parcels. This standard assumption applies because the value of the existing uses on those parcels most likely exceeds the relative value of the new development potential, less the cost of redeveloping the parcel. These costs include the monetary cost of project design, environmental review, entitlement processing, demolition, and construction. Furthermore, because redevelopment entails an inherent uncertainty about whether the project would successfully receive entitlements, parcels already developed 30% above the permitted site capacity are unlikely to undergo the redevelopment process.

---

<sup>18</sup> The Planning Department divides the square footage of a building or buildings on a given parcel by the total square footage theoretically allowed on that same parcel under existing zoning controls (i.e., height limit, rear yard requirement, bulk controls, etc.) to calculate to what percent of zoned capacity the parcel is currently developed.

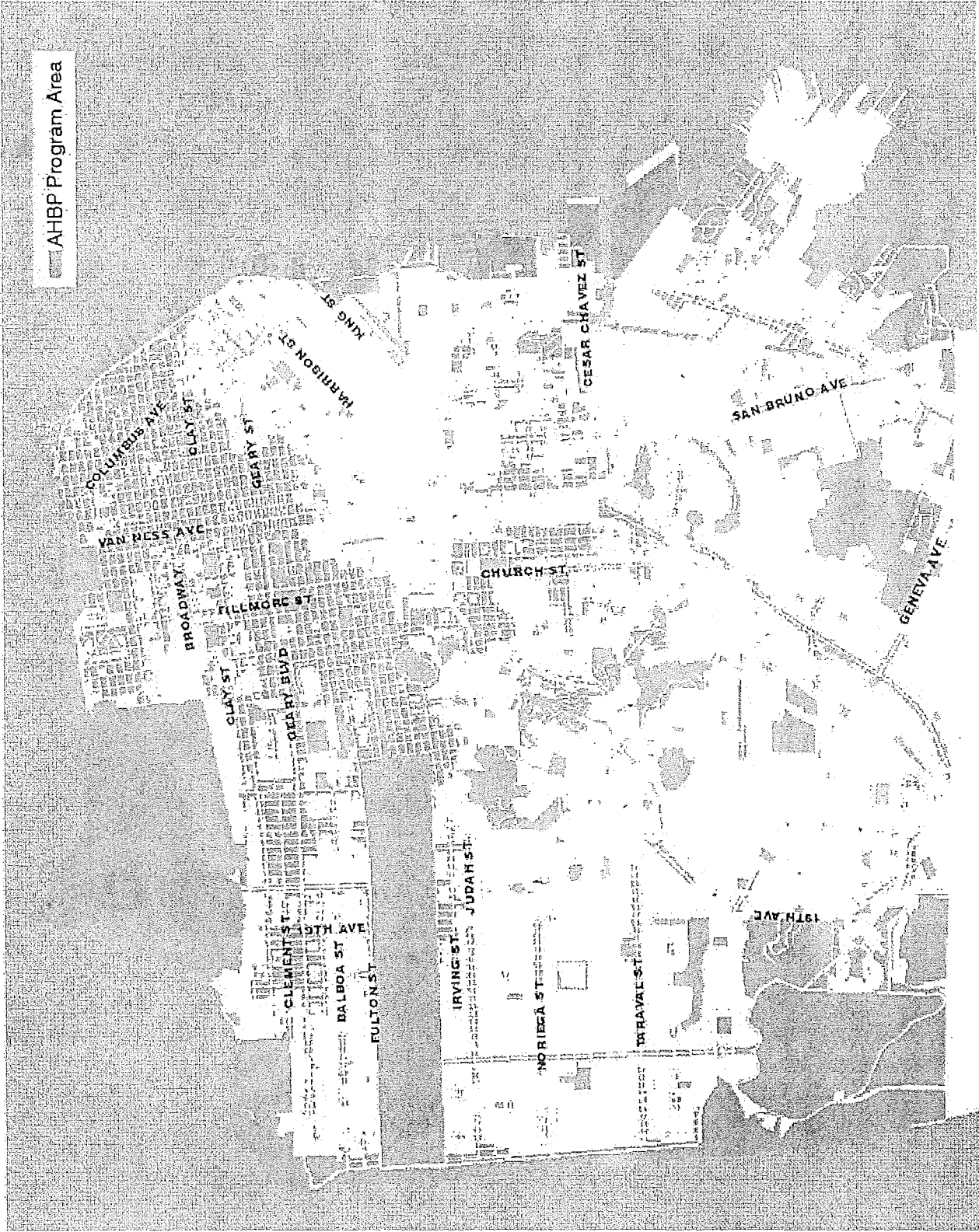
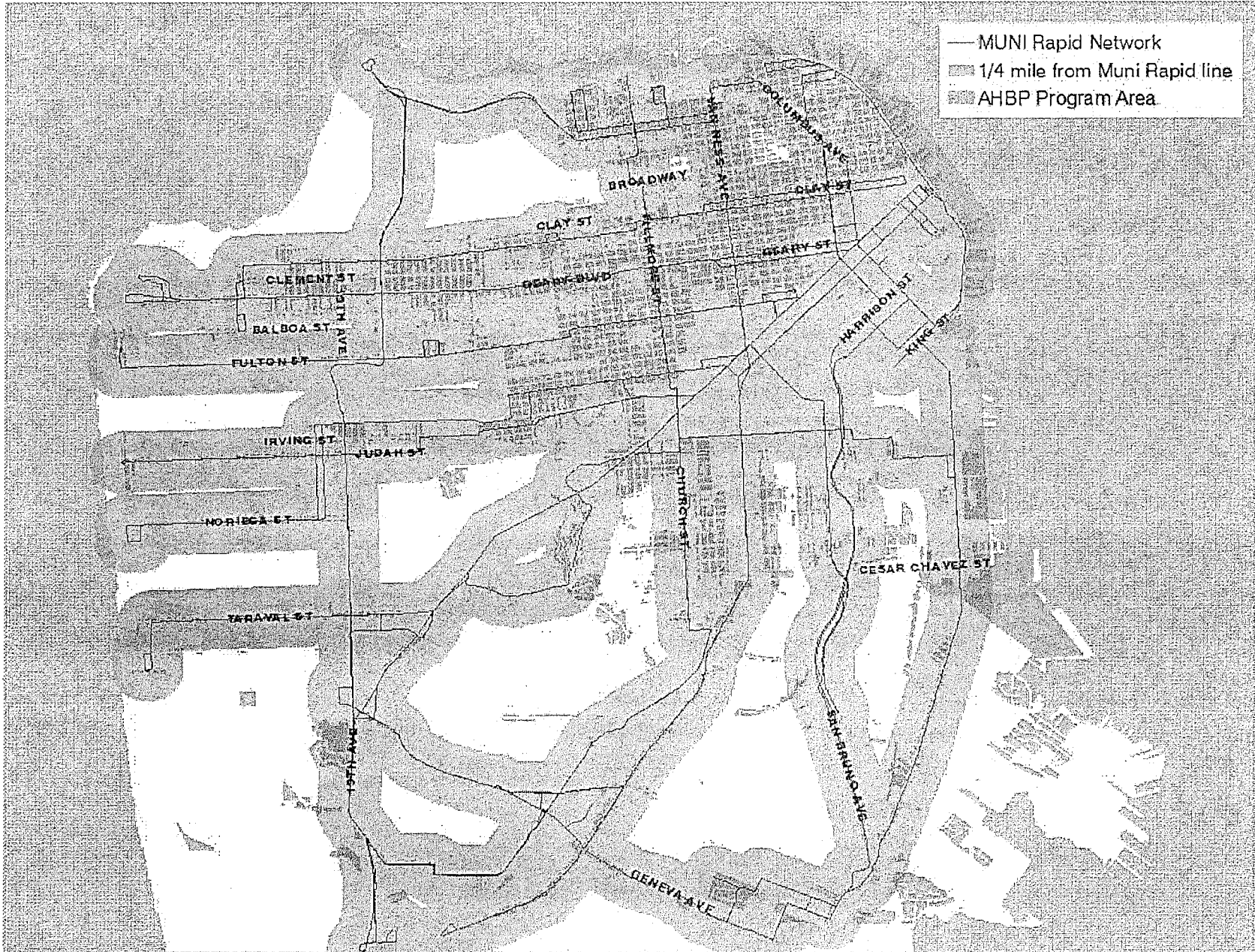

FIGURE 1: AHB STUDY AREA

SOURCE: San Francisco Planning Department, 2016





SOURCE: San Francisco Planning Department, 2016

FIGURE 2: AHBP STUDY AREA AND MUNI RAPID NETWORK



In addition to the above, the type and age of existing development is a factor in assessing the likelihood of a given parcel being redeveloped. Certain existing uses make redevelopment prohibitively costly or unlikely, either due to the nature of the existing uses or due to existing Planning Code regulations or policies that discourage demolition and reconstruction. Within the study area, these uses include: hospitals, San Francisco Housing Authority properties, single resident occupancy (SRO) hotels, schools, parcels containing rent-controlled residential units, parcels containing historic properties (those with Planning Department Historic Resource Status Code of A, signifying "Historic Resource Present"), churches, and parcels with existing residential units. These uses are strongly regulated and/or their redevelopment is discouraged, making them difficult to redevelop. As noted above, projects that would result in a significant impact to a historic resource would not be eligible for the Local Programs. Parcels with buildings constructed after 1990 are also less likely to be redeveloped due to the age and relative health of the existing building.

In addition, parcels that are currently vacant but where buildings are either under construction or have received their entitlements are unlikely to be modified and reapproved under the AHBP. Furthermore, projects that are moving through the entitlement process (so-called "pipeline projects") are very unlikely to be modified to be an entirely different project. This is because the sponsor's recent substantial investments in non-construction costs, including site acquisition, architectural design, engineering, legal fees, application fees, pursuit of entitlements, and carrying costs are strong incentives to stay the course and not risk the additional time and expense associated with project revisions to conform with the AHBP. Even if some project sponsors of pipeline projects opt to modify their project to take advantage of the AHBP, the increased development capacity on those sites would be negligible in the context of this EIR addendum analysis. Currently, there are only 26 pipeline projects in the project area. Individual AHBP projects will be subject to individual environmental review.

Exclusion of parcels with the aforementioned site development characteristics from the study area leaves a remainder of 3,475 parcels.

**Other Considerations.** To be eligible for the Local or Analyzed Programs, project sponsors would be required to provide affordable housing units on site, including inclusionary units under Planning Code Section 415. Some developers, however, would not find it desirable, for financial or business reasons, to provide onsite affordable housing and would rather elect to pay the in-lieu fee under Planning Code Section 415. Historically, approximately 21% of residential projects subject to Section 415 elect to pay the in-lieu fee.<sup>19</sup>

Lastly, on any given parcel, factors such as the shape of the parcel, topography, and other considerations, such as neighborhood opposition, would affect the likelihood of a given site being redeveloped.

#### ***Theoretical Maximum Number of Bonus Units***

As noted, of the 30,850 parcels in the City in locations that would permit Local Program projects (and, to a lesser degree, Analyzed State Program projects), 3,475 parcels are free of the above-described development constraints that would make their redevelopment unlikely.

---

<sup>19</sup> According to the San Francisco Mayor's Office of Housing, between 1992 and 2014, the inclusionary housing ordinance resulted in 1,787 onsite units, or 81 onsite units per year, on average. See <http://sf-moh.org/modules/showdocument.aspx?documentid=8736>, accessed January 7, 2016.

Planning Department staff then identified a subset of these 3,475 parcels that were either vacant or built to 5% or less of their zoned capacity. The number of parcels in the study area that contain existing buildings or are built to greater than 5% of their zoned capacity equals 3,235 parcels. Because the remaining 240 parcels, or “soft sites,” are either vacant or developed to less than 5% of zoned capacity, and are therefore deemed to have the characteristics that make them the most likely to be of sufficient appeal to developers seeking to take advantage of the Local Program.

Under existing density, height, and bulk controls, the 240 soft sites have the capacity to accommodate approximately 7,400 housing units, including 890 affordable units.<sup>20</sup> If all 240 sites were developed consistent with the Local Program, they could accommodate approximately 16,000 housing units, including 5,000 affordable units. If the 240 soft sites were developed consistent with the Analyzed State Program, they would have the capacity for up to 10,000 housing units, including approximately 1,500 affordable units. Thus, it is assumed that the AHBP could incentivize the development of between 10,000 and 16,000 housing units. For the purpose of this analysis, this addendum reasonably assumes that this development would occur over a 20-year period.<sup>21</sup>

It should be noted that the theoretical maximum development of up to 16,000 bonus units does not take into account the “Other Considerations” described above. In addition, this analysis assumes that developers of all 240 soft sites elect to participate in the Local Program and maximize the number of units built on those lots. In reality, for some sites, the Local Program would not provide sufficient additional development potential compared to current zoning or the Analyzed State Program. On such sites, development under existing zoning or the Analyzed State Program would yield fewer units.

As noted previously, implementation of the AHBP, in and of itself, would not result in new development; instead, the program would create a procedure for complying with the State Density Bonus Law, as well as establish additional incentives for including affordable housing above that required by the City’s Inclusionary Housing Program. Future impacts to the environment, however, could occur as a result of specific development projects on individual sites. Individual projects would be subject to site-specific environmental review.

Consistent with the 2004 and 2009 Housing Element FEIR, this addendum does not attribute any difference in environmental impacts to affordable housing as compared to market-rate housing; thus, the addendum analyzes the buildout of all residential units on the soft sites, regardless of their affordability level.

The above-described theoretical maximum development of AHBP units is a reasonable basis for assessing the physical environmental impacts of the program for CEQA purposes. In addition, it provides a basis for understanding the effectiveness of the program at meeting its goal of incentivizing affordable housing production pursuant to Implementing Program 39b of the 2014 Housing Element.

---

<sup>20</sup> This assumes that all required inclusionary affordable units would be provided onsite.

<sup>21</sup> Twenty years, or approximately so, is commonly used as a forecast horizon for growth projections in planning and CEQA documents. For example, the 2009 Housing Element projected population growth over a 21-year period.

## ***Land Use and Land Use Planning***

### **2009 Housing Element**

The FEIR concluded that the 2009 Housing Element would result in less-than-significant impacts related to land use and land use planning. The 2009 Housing Element would not conflict with applicable land use plans, policies, or regulations, including, but not limited to, the *San Francisco General Plan (General Plan)*, the *San Francisco Countywide Transportation Plan*, and the *San Francisco Bicycle Plan*. Individual development projects would be reviewed for consistency and compliance with applicable land use plans, policies, or regulations. The 2009 Housing Element would not physically divide established communities by promoting the construction of physical barriers to neighborhood access, such as new freeways, or by removing existing means of access, such as bridges or roadways. The 2009 Housing Element would not have a substantial impact upon the existing character of San Francisco. Individual development projects would undergo design review to ensure that new construction is compatible with the neighborhoods in which the projects are located. In addition, individual development projects would be reviewed for compliance with San Francisco Planning Code (Planning Code) regulations to ensure that the proposed land uses are permitted in the zoning districts in which the projects are located.

As discussed in the FEIR, Alternative C would promote taller and denser buildings than would the 2009 Housing Element. The FEIR concluded that these taller and denser buildings could result in incrementally greater impacts related to land use and land use planning, but these impacts would be less than significant.

### **Modified Project (AHBP)**

The AHBP would promote housing along or near transit corridors and on sites in established neighborhoods throughout San Francisco. The AHBP includes Planning Code amendments that would allow qualifying projects to exceed existing height limits, resulting in buildings that could be taller and denser than what is currently permitted under existing regulations.

Plans, policies, and regulations adopted for the purpose of avoiding or mitigating an environmental effect are those that directly address environmental issues and/or contain targets or standards that must be met in order to maintain or improve characteristics of the City's physical environment. Examples of such plans, policies, or regulations include the Bay Area Air Quality Management District's *2010 Clean Air Plan* and the San Francisco Regional Water Quality Control Board's *San Francisco Basin Plan*. The AHBP would not directly conflict with any plan, policy, or regulation adopted for the purpose of avoiding or mitigating an environmental effect. Individual development projects proposed under the AHBP would be evaluated by City decision-makers for their consistency with such plans, policies, or regulations, and conflicts would need to be addressed prior to the approval of any entitlements.

The AHBP would not physically divide established communities by calling for the construction of physical barriers to neighborhood access, such as freeways, or the removal of existing means of access, such as bridges and roadways. AHBP projects would generally be constructed on vacant or underutilized sites along or near transit corridors and in established residential neighborhoods. New freeways would not need to be constructed to provide access to and from these projects, and existing bridges and roadways would not need to be removed to accommodate the development of these projects.

The AHBP would not have a substantial impact on the existing land use character of San Francisco. The AHBP would promote housing in zoning districts that currently allow residential and neighborhood-serving commercial uses. AHBP projects would introduce new residential and neighborhood-serving commercial uses to established neighborhoods in which such land uses already exist. Therefore, AHBP projects would be largely compatible with the existing land use character of the neighborhoods in which they would be located. AHBP projects could be taller and denser than both non-AHBP projects and existing development. However, the increased height and density would not affect the land use character of a neighborhood in which an AHBP project is located, because new residential uses would be compatible with existing residential uses whether they are housed in a three-story building with fewer units or a five-story building with more units. The physical environmental impacts associated with taller buildings are discussed under the topics of Aesthetics and Wind and Shadow, and the physical environmental impacts associated with denser buildings are discussed under the topics of Population and Housing, Recreation, Utilities and Service Systems, and Public Services.

For these reasons, the AHBP would result in less-than-significant impacts related to land use and land use planning. The AHBP would not result in more severe impacts than the 2009 Housing Element or Alternative C, would not result in new significant impacts beyond those identified in the FEIR, and would not require new mitigation measures. Furthermore, there is no new information that would alter the FEIR's conclusions regarding impacts related to land use and land use planning.

### ***Aesthetics***

#### **2009 Housing Element**

The FEIR concluded that the 2009 Housing Element would result in less-than-significant impacts on aesthetics. The 2009 Housing Element would not have a substantial adverse effect on a scenic vista, would not damage scenic resources that contribute to a scenic public setting, and would not degrade the existing visual character of San Francisco. As discussed in the FEIR, future development would be required to comply with existing regulations adopted for the purpose of avoiding such impacts. The FEIR also found that the 2009 Housing Element would not create new sources of substantial light and glare that would adversely affect day or nighttime views or would substantially affect other people or properties. New exterior lighting associated with future development would be focused on specific areas rather than illuminating large areas that are currently not illuminated. Furthermore, all future development would be required to comply with Planning Commission Resolution No. 9212, which prohibits the use of highly reflective or mirrored glass in new construction.

As discussed in the FEIR, Alternative C would promote taller buildings than would the 2009 Housing Element. The FEIR concluded that these taller buildings could result in incrementally greater impacts related to aesthetics, but these impacts would be less than significant.

#### **Modified Project (AHBP)**

The AHBP would allow qualifying projects to exceed existing height limits in certain locations throughout San Francisco, resulting in buildings that could be taller than what is currently permitted under existing regulations. For this reason, adoption of the AHBP could indirectly affect the visual character of the areas in which AHBP projects are located.

CEQA was amended in 2013 to add Public Resources Code (“PRC”) Section 21099 regarding the analysis of aesthetics and parking impacts for certain urban infill projects in transit priority areas.<sup>22</sup> PRC Section 21099(d) provides that, “aesthetics and parking impacts of a residential, mixed-use residential, or employment center project on an infill site located within a transit priority area shall not be considered significant impacts on the environment.” Accordingly, aesthetics and parking are no longer to be considered in determining if a project has the potential to result in significant environmental effects for projects that meet all of the following three criteria:

- 1) The project is in a transit priority area;
- 2) The project is on an infill site; and
- 3) The project is residential, mixed-use residential, or an employment center.

Since the AHBP would promote housing on infill sites along or near transit corridors throughout San Francisco, most, if not all, AHBP projects would meet all three of the criteria listed above. Pursuant to PRC Section 21099, AHBP projects that meet the three criteria listed above would not result in significant impacts related to aesthetics. In addition, implementation of the AHBP Design Guidelines and Planning Commission Resolution No. 9212 would ensure that AHBP projects would be architecturally and visually compatible with the neighborhoods in which they are located. Since AHBP projects would likely be scattered throughout the City and not concentrated in any one neighborhood or particular block, adoption of the AHBP would not have significant impacts related to aesthetics. Buildings that are somewhat taller or denser than their surrounding context are common and expected in urban environments.

For these reasons, adoption of the AHBP would result in less-than-significant impacts related to aesthetics. The AHBP would not result in more severe impacts than the 2009 Housing Element or Alternative C, would not result in new significant impacts beyond those identified in the FEIR, and would not require new mitigation measures. Furthermore, there is no new information that would alter the FEIR’s conclusions regarding impacts related to aesthetics.

### ***Population and Housing***

#### **2009 Housing Element**

The FEIR concluded that the 2009 Housing Element would result in less-than-significant impacts related to population and housing. As noted above, population growth in San Francisco and the region is primarily a result of births, deaths, migration, and employment growth. The growth projections in the FEIR were not driven by assumptions regarding proposed development. The purpose of the 2009 Housing Element is to provide ways for housing supply to meet housing demand and need; if housing supply were the basis for the growth projections, there would be no need for a housing element. For this reason, the 2009 Housing Element would not induce a substantial amount of population growth above the level anticipated in regional growth projections generated by the Association of Bay Area Governments.

---

<sup>22</sup> A “transit priority area” is defined in as an area within one-half mile of an existing or planned major transit stop. A “major transit stop” is defined in Section 21064.3 of the California Public Resources Code as a rail transit station, a ferry terminal served by either a bus or rail transit service, or the intersection of two or more major bus routes with a frequency of service interval of 15 minutes or less during the morning and afternoon peak commute periods. A map of transit priority areas in San Francisco can be found at <http://sfmea.sfplanning.org/CEQA%20Update-SB%20743%20Summary.pdf>.

Implementation of the 2009 Housing Element would not displace substantial numbers of existing housing units or people. Individual development projects would be subject to regulations that limit the demolition and merger of existing housing units, which would reduce the need to construct replacement housing.

As discussed in the FEIR, Alternative C would promote taller and denser buildings than would the 2009 Housing Element. These taller and denser buildings could result in incrementally greater impacts related to population and housing, but these impacts would be less than significant.

### **Modified Project (AHBP)**

The AHBP would not directly induce population growth above that anticipated by regional growth projections due to births, deaths, migration and employment growth; rather, it would be a new mechanism for providing housing supply – particularly affordable housing – to meet demand. The AHBP would promote housing in certain areas of San Francisco and could influence the design or types of buildings in which projected population growth is housed. In addition, the AHBP would not indirectly induce substantial population growth by calling for the extension of roads, utilities, or other infrastructure. The AHBP would promote housing along or near transit corridors and in established neighborhoods that are already served by roads, utilities, and other infrastructure. Individual projects proposed under the AHBP would be evaluated for their impacts on demand for roads, utilities, and other infrastructure.

The AHBP would not displace substantial numbers of existing housing units or residents by calling for the demolition of existing housing stock. Individual AHBP projects that involve the conversion or demolition of existing housing units would be subject to local policies and regulations that protect existing housing stock. These policies and regulations include, but are not limited to, the Housing Element of the General Plan; Planning Code Section 317: Loss of Dwelling Units through Demolition, Merger, and Conversion; San Francisco Administrative Code (Administrative Code) Chapter 41: Residential Hotel Unit Conversion and Demolition Ordinance; Administrative Code Chapter 41A: Residential Unit Conversion Ordinance; and Administrative Code Chapter 41C: Time-Share Conversion Ordinance. Required compliance with these policies and regulations would ensure that AHBP projects would not displace substantial numbers of existing housing units or residents, thus minimizing the demand for replacement housing and the environmental impacts associated with the construction of replacement housing.

The AHBP would not directly displace businesses, but AHBP projects that involve demolition of existing buildings could displace businesses. The physical effects of business displacement would be considered on an individual basis as part of the environmental review process for each project, because such impacts are project-specific and location-specific. Without individual development proposals to evaluate, it would be speculative to conclude that the AHBP would result in significant overall impacts related to business displacement.

Although businesses are not afforded the same type of protection as residents where displacement is concerned, the City operates several programs to assist displaced businesses. The Office of Economic and Workforce Development runs the Invest in Neighborhoods program, which helps displaced businesses find relocation sites and, under certain circumstances, can provide funding for specific construction improvements, such as façade upgrades. The Small Business Development Center offers pro bono legal advice and technical assistance, and the Office of Small Business provides one-to-one case management assistance with licenses, permits, and financing. In addition to these existing programs, the AHBP includes additional protection for businesses that could be displaced. Sponsors of AHBP projects that

involve demolition of existing buildings and displacement of businesses would be required to notify the affected businesses prior to the start of environmental review, which would provide the affected businesses with more time (anywhere from one to two years) to develop and implement relocation plans. The addition of this notification requirement, in conjunction with the existing programs, would reduce impacts on businesses that could be displaced as a result of the development of AHBP projects.

For these reasons, the AHBP would result in less-than-significant impacts related to population and housing. The AHBP would not result in more severe impacts than the 2009 Housing Element or Alternative C, would not result in new significant impacts beyond those identified in the FEIR, and would not require new mitigation measures. Furthermore, there is no new information that would alter the FEIR's conclusions regarding impacts related to population and housing.

### ***Cultural and Paleontological Resources***

#### **2009 Housing Element**

The FEIR concluded that the 2009 Housing Element could result in a substantial adverse change to a historic resource if it promoted inappropriate alterations to or demolition of an existing building that is a historic resource, inappropriate new construction in a historic district, or demolition by neglect.<sup>23</sup> The FEIR also found that assessing such impacts on historic resources would be most appropriate during the review of individual development projects proposed under the 2009 Housing Element. Such impacts would be offset through required compliance with existing federal, state, and local regulations that protect historic resources.

The FEIR also found that the 2009 Housing Element would not result in a substantial adverse change to an archeological resource, would not destroy a paleontological resource or site or unique geologic feature, and would not disturb human remains. Individual development projects that could have potential impacts on archeological resources, paleontological resources, or human remains would be subject to existing regulations that protect such resources. These regulations include, but are not limited to, the National Historic Preservation Act and the California Public Resources Code. In addition, the Planning Department has established procedures to assess impacts on archeological resources as well as mitigation measures to reduce potentially significant impacts to less-than-significant levels.

As discussed in the FEIR, Alternative C would promote a larger number of development projects as well as taller and denser buildings than would the 2009 Housing Element. The FEIR concluded that this increased amount of development, combined with potentially taller buildings, in or adjacent to existing historic districts could result in incrementally greater impacts on cultural and paleontological resources, but these impacts would be less than significant.

#### **Modified Project (AHBP)**

The AHBP would not directly alter or encourage the alteration of existing historic resources. However, individual development projects proposed under the AHBP could result in direct effects on historic

---

<sup>23</sup> CEQA defines "substantial adverse change" as "demolition, destruction, relocation or alteration," activities that would impair the significance of a historical resource either directly or indirectly. Demolition by neglect is the gradual deterioration of a building when routine or major maintenance is not performed and/or when a building is allowed by the owner to remain vacant and open to vandals.

resources through demolition or alteration of existing buildings or through new construction in existing historic districts. AHBP projects would be evaluated for their potential impacts on historic resources during the environmental review process. In order to be eligible for the Local and 100 Percent Affordable programs, project sponsors must demonstrate that their projects would not result in a substantial adverse change in a historic resource. If the Planning Department determines that a project would result in a substantial adverse change in a historic resource, then the project would not be eligible for the Local and 100 Percent Affordable programs. The project would need to be modified in order to avoid causing such a change, or the project could not be approved under these programs. Given this constraint, projects proposed under the Local and 100 Percent Affordable programs would result in less-than-significant impacts on historic resources.

As discussed in the project description, there is an existing State Density Bonus Law that allows developers to seek density bonuses in exchange for providing affordable housing; this existing law does not require projects to avoid causing substantial adverse changes in historic resources. The AHBP would not change the existing law, but it would provide developers with two avenues (the Analyzed State Program and the Individually Requested Program) for seeking density bonuses in exchange for providing affordable housing; these two State Programs would be consistent with the existing law (i.e., they would not require projects to avoid causing substantial adverse changes in historic resources). Projects proposed under either of the State programs could result in potentially significant impacts on historic resources. These impacts would be evaluated on a project-by-project basis, because impacts on historic resources are project-specific and location-specific. Without individual development proposals to evaluate, it would be speculative to conclude that either of the State Programs would result in significant overall impacts on historic resources. The AHBP would not result in impacts that would be more severe than those that could result from development proposed under the existing State Density Bonus Law.

The AHBP would not directly place or encourage housing in areas of San Francisco that could be underlain by soils containing archeological resources, paleontological resources (i.e., fossils), or human remains. However, individual development projects proposed under the AHBP could be located in such areas. Required compliance with existing federal, state, and local regulations and procedures would ensure that AHBP projects would not result in a substantial adverse change to an archeological resource, would not destroy a paleontological resource or site or unique geologic feature, and would not disturb human remains.

For these reasons, the AHBP would result in less-than-significant impacts on cultural and paleontological resources. The AHBP would not result in more severe impacts than the 2009 Housing Element or Alternative C, would not result in new significant impacts beyond those identified in the FEIR, and would not require new mitigation measures. Furthermore, there is no new information that would alter the FEIR's conclusions regarding impacts on cultural and paleontological resources.



## ***Transportation and Circulation***

### **2009 Housing Element**

The FEIR concluded that the 2009 Housing Element would result in less-than-significant impacts on traffic, pedestrians, bicycles, loading, emergency access, and construction-related traffic. However, the FEIR concluded that the 2009 Housing Element would result in a significant and unavoidable transit impact, because policies in the 2009 Housing Element that encourage transit-oriented residential development could result in a mode shift toward transit. Such a shift could result in an exceedance of the San Francisco Municipal Railway's capacity utilization standard of 85 percent. The FEIR identified two mitigation measures to address this impact. The first mitigation measure called for the City to implement various transportation plans and programs that would reduce congestion and decrease transit travel times.<sup>24</sup> Since the certification of the FEIR, the Transit Effectiveness Project and the Van Ness Avenue Bus Rapid Transit Project have been approved and are being implemented. The second mitigation measure called for the San Francisco Municipal Transportation Agency to increase capacity by providing more buses. At the time that the FEIR was certified, the feasibility of these mitigation measures could not be established. For this reason, the FEIR concluded that the 2009 Housing Element's impact on transit would be significant and unavoidable.

As discussed in the FEIR, Alternative C would promote taller and denser buildings than would the 2009 Housing Element. In addition, Alternative C would encourage reduced parking requirements for future development and increased density along existing transit lines, resulting in fewer vehicle trips but more transit trips. The FEIR concluded that effects on the roadway network from future development under Alternative C would not be expected to exceed 2025 cumulative conditions. As with the 2009 Housing Element, Alternative C would result in a potentially significant impact on transit but would have no impact on pedestrians, bicycles, loading, emergency vehicle access, or construction-related traffic.

### **Modified Project (AHBP)**

The AHBP would promote housing along or near transit corridors and on sites in established neighborhoods throughout San Francisco, which is consistent with many local plans, policies, and regulations, including the General Plan, the *San Francisco Countywide Transportation Plan*, and the City's Transit First Policy. This type of transit-oriented development would help encourage residents to move away from the use of private automobiles and toward alternative modes of transportation, such as transit, bicycling, and walking. This mode shift would help reduce impacts on traffic, pedestrians, bicycles, loading, emergency access, and construction-related traffic. Although this mode shift is consistent with the 2009 Housing Element policies, it has the potential to increase the demand for transit service to the degree that the San Francisco Municipal Railway's capacity utilization of 85 percent would be exceeded.<sup>25</sup>

On November 17, 2015, the San Francisco Board of Supervisors adopted the Transportation Sustainability Fee ("TSF") (Ordinance No. 200-15, effective December 25, 2015) to replace the Transit Impact

---

<sup>24</sup> The FEIR noted that various transportation plans were adopted, but not implemented, or proposed. Adopted plans/programs included SF Park, SF Go, the *San Francisco Bicycle Plan*, the Transbay Terminal, Caltrain Electrification, and High Speed Rail project, and the Central Subway. Proposed plans included congestion pricing, SFMTA's Transit Effectiveness Project, the Van Ness Avenue and Geary Boulevard Bus Rapid Transit projects, and the *San Francisco Better Streets Plan*.

<sup>25</sup> Capacity utilization is the number of passengers on board a transit vehicle relative to the total capacity.

Development Fee.<sup>26</sup> The TSF applies to new commercial projects, market-rate residential projects with more than 20 units, and certain institutional projects. Developers of such projects would pay a fee that would fund various transit improvements, including additional buses and trains, the reengineering of streets and transit stops, and upgrades to bicycle, and pedestrian facilities. The AHBP could reasonably result in a higher number of market-rate residential projects with more than 20 units than under existing zoning regulations. Therefore, more projects would be subject to the TSF, and more revenue would be generated to mitigate transit impacts.

For these reasons, the AHBP would result in less-than-significant impacts on traffic, pedestrians, bicycles, loading, emergency access, and construction-related traffic, but it would result in a significant and unavoidable impact on transit. The AHBP would not result in more severe impacts than the 2009 Housing Element or Alternative C, would not result in new significant impacts beyond those identified in the FEIR, and would not require new mitigation measures. Furthermore, there is no new information that would alter the FEIR's conclusions regarding impacts on transportation and circulation.

## **Noise**

### **2009 Housing Element**

The FEIR concluded that the 2009 Housing Element would result in a less-than-significant impact related to a substantial temporary or periodic increase in ambient noise levels due to policies that discourage demolition and encourage maintenance of the City's existing housing stock. In addition, all construction activities are required to comply with the regulations set forth in the San Francisco Noise Ordinance (Noise Ordinance).

The FEIR concluded that the 2009 Housing Element would not result in the exposure of persons to or generation of excessive groundborne vibration or groundborne noise levels, because potential impacts resulting from groundborne vibration or groundborne noise due to construction activities would be reduced to less-than-significant levels through compliance with federal, state, and local regulations. The FEIR also found that the 2009 Housing Element would not result in a substantial permanent increase in ambient noise levels in the project vicinity above levels existing at the time of that the Notice of Preparation of an EIR was published.

Lastly, the FEIR concluded that the 2009 Housing Element would result in a significant but mitigable impact related to the exposure of persons to, or generation of, noise levels in excess of established standards. The FEIR concluded that by encouraging future growth along transit corridors within the City, such growth could be located in areas with existing ambient noise levels exceeding 60 dBA  $L_{dn}$ , which is the maximum satisfactory exterior noise level for residential areas.<sup>27,28</sup> Interior noise levels for residential uses are addressed through compliance with the noise standards set forth in Title 24 of the California Code of Regulations, as implemented during the design and review phase for individual development projects.

---

<sup>26</sup> San Francisco Board of Supervisors, Ordinance No. 200-15, adopted November 17, 2015. Available at <http://www.sfbos.org/ftp/uploadedfiles/bdsupvrs/ordinances15/o0200-15.pdf>, accessed January 13, 2016.

<sup>27</sup> The standard method used to quantify environmental noise involves evaluating the sound with an adjustment to reflect the fact that human hearing is less sensitive to low-frequency sound than to mid- and high-frequency sound. This measurement adjustment is called "A" weighting, and the data are reported in A-weighted decibels (dBA).

<sup>28</sup>  $L_{dn}$  is the average equivalent sound level during a 24-hour day, obtained after the addition of 10 dB to sound levels during nighttime hours (from 10:00 p.m. until 7:00 a.m.).

However, some areas of the City may be especially noisy. FEIR Mitigation Measure M-NO-1: Interior and Exterior Noise, requires the preparation of a noise analysis for new residential development projects located on streets with noise levels above 75 dBA L<sub>dn</sub>. The noise analysis shall include, at a minimum, (1) a site survey to identify potential noise-generating uses within two blocks of the project site and (2) at least one 24-hour noise measurement with maximum noise level readings taken at least every 15 minutes prior to completion of the environmental review. The analysis shall demonstrate with reasonable certainty that Title 24 standards, where applicable, can be met. FEIR Mitigation Measure M-NO-1 also requires that open space for new residential uses be protected, to the maximum extent feasible, from existing ambient noise levels that could prove annoying or disruptive to users of the open space. Implementation of this measure could involve designing the project in a way that uses the building itself to shield on-site open space from noise sources, constructing noise barriers between on-site open space and noise sources, and appropriately using both common and private open space in multi-unit residential buildings. Since the certification of the FEIR, this mitigation measure has been implemented as part of every proposed residential project that (1) is located on a street with ambient noise levels above 75 dBA L<sub>dn</sub> and/or (2) includes open space.

As discussed in the FEIR, Alternative C would promote taller and denser buildings than would the 2009 Housing Element. The FEIR concluded that these taller and denser buildings could result in incrementally greater noise and vibration impacts during both the construction and operational phases, but these impacts would be less than significant with implementation of FEIR Mitigation Measure M-NO-1.

#### **Modified Project (AHBP)**

The AHBP would promote housing in areas of San Francisco that could have existing ambient noise levels exceeding 60 dBA L<sub>dn</sub>. Individual development projects proposed under the AHBP would be required to comply with the noise standards set forth in Title 24 as well as the provisions of the Noise Ordinance. As discussed above, AHBP projects that are located on streets with ambient noise levels above 75 dBA L<sub>dn</sub> or that include open space would be required to implement FEIR Mitigation Measure M-NO-1. Required compliance with existing noise regulations and implementation of FEIR Mitigation Measure M-NO-1 would ensure that new noise-sensitive receptors occupying AHBP projects would not be substantially affected by existing noise levels. No additional mitigation measures to address noise impacts on noise-sensitive receptors are necessary.

Construction of AHBP projects would result in temporary site-specific increases in noise and vibration levels. Once construction has been completed, noise and vibration produced by construction equipment and construction vehicles would cease. In addition, all construction activities in San Francisco are required to comply with the Noise Ordinance, which prohibits construction between the hours of 8:00 p.m. and 7:00 a.m. Construction of AHBP projects would generate vibration that could damage adjacent or nearby buildings. The DBI is responsible for reviewing building permit applications to ensure that proposed construction activities, including pile driving, shoring, and underpinning, comply with all applicable procedures and requirements and would not materially impair adjacent or nearby buildings.

Vehicle traffic is a primary source of noise and vibration throughout San Francisco. Like the 2009 Housing Element, the AHBP would promote housing in some areas along or near major transportation corridors that have higher ambient noise and vibration levels than other areas of San Francisco. Although AHBP

projects could be taller and denser than development anticipated under the 2009 Housing Element, AHBP projects would not include substantially more units such that there would be a noticeable increase in traffic noise and vibration. Vehicle traffic generated by AHBP projects would result in localized increases in noise and vibration levels, but these increases would not be substantial given the elevated noise and vibration levels that already exist along major transportation corridors.

AHBP projects would include mechanical equipment, such as heating and ventilation systems, that could produce operational noise and potentially disturb adjacent and nearby noise-sensitive receptors. The operation of this mechanical equipment is subject to the provisions of the Noise Ordinance. Compliance with the Noise Ordinance would minimize noise from building operations.

For these reasons, the AHBP would result in less-than-significant noise and vibration impacts. The AHBP would not result in more severe impacts than the 2009 Housing Element or Alternative C, would not result in new significant impacts beyond those identified in the FEIR, and would not require new mitigation measures. Furthermore, there is no new information that would alter the FEIR's conclusions regarding noise and vibration impacts.

## ***Air Quality***

### **2009 Housing Element**

The FEIR concluded that the 2009 Housing Element would result in less-than-significant impacts on air quality. As discussed in the FEIR, the 2009 Housing Element would not increase the overall citywide population from 2009 to 2025 above the level assumed in the *Bay Area 2005 Ozone Strategy*, which was the applicable air quality plan at the time the FEIR was prepared. During this 16-year period, the number of vehicle-miles-traveled would increase at a lower rate than the rate of population growth, meaning that air pollution from vehicles would not outpace the population growth anticipated in the *Bay Area 2005 Ozone Strategy*. For these reasons, the 2009 Housing Element would not conflict with or obstruct implementation of the applicable air quality plan and would not violate an air quality standard or contribute substantially to an existing or projected air quality violation. In addition, all construction activities associated with individual development projects would be subject to the provisions of the Construction Dust Control Ordinance.

The FEIR concluded that the 2009 Housing Element would not expose sensitive receptors to substantial air pollutant concentrations. Increased housing development along or near transit corridors could increase concentrations of certain air pollutants, including PM<sub>2.5</sub>, NO<sub>2</sub>, and toxic air contaminants, on some roadways within San Francisco. At the same time, increased density and associated shifts from private automobiles to alternative modes of transportation, such as transit, bicycling, and walking, could reduce the overall expected growth of vehicle trips and vehicle-miles traveled. In addition, Article 38 of the San Francisco Health Code contains requirements for air quality assessment and mitigation when new residential exposures exceed action levels for acceptable air pollutant concentrations.

The FEIR also concluded that the 2009 Housing Element would result in less-than-significant impacts related to carbon monoxide (CO) concentrations. To support this conclusion, CO concentrations were calculated based on simplified CALINE4 screening procedures developed by the Bay Area Air Quality Management District (BAAQMD). Based on the modeling, under future 2025 cumulative traffic conditions, none of the 10 worst-performing intersections included in the model would exceed

CO standards. Thus, it was assumed that if CO levels at the 10 worst-performing intersections do not exceed the CO thresholds, then the remaining 50 intersections analyzed in the traffic study would not exceed the CO thresholds.

Lastly, the FEIR concluded that the 2009 Housing Element would result in less-than-significant impacts related to objectionable odors, because residential uses generally do not create objectionable odors.

As discussed in the FEIR, Alternative C would promote taller and denser buildings than would the 2009 Housing Element. In addition, Alternative C would encourage increased density along existing transit lines, resulting in fewer vehicle miles traveled but more transit trips. The FEIR concluded that overall air quality impacts associated with taller and denser transit-oriented development under Alternative C would be incrementally reduced when compared to the impacts under the 2009 Housing Element. The air quality impacts under Alternative C would be less than significant.

#### Modified Project (AHBP)

The AHBP would not directly contribute to air pollutant emissions, but individual development projects proposed under the AHBP would contribute to air pollutant emissions during their construction and operational phases. AHBP projects would be subject to state, regional, and local plans, policies, and regulations related to the protection of air quality. These plans, policies, and regulations include, but are not limited to, the BAAQMD's *2010 Clean Air Plan*, the San Francisco Construction Dust Control Ordinance, and Article 38 of the San Francisco Health Code. The Construction Dust Control Ordinance requires that all site preparation work, demolition, or other construction activities that have the potential to create dust or to expose or disturb more than 10 cubic yards or 500 square feet of soil comply with specified dust control measures. Such measures include watering all active construction areas sufficiently to prevent dust from becoming airborne, wet sweeping or vacuuming the streets, sidewalks, paths, and intersections where work is in progress at the end of the workday, and covering inactive stockpiles of excavated material, backfill material, gravel, sand, road base, and soil. Pursuant to Article 38, any project, AHBP or otherwise, located in an Air Pollutant Exposure Zone (APEZ) would be required to provide an enhanced ventilation system to protect its residents from exposure to toxic air contaminants. In addition, any project, AHBP or otherwise, located in an APEZ may be subject to mitigation measures that are necessary to reduce construction-related air quality impacts to less-than-significant levels. Required compliance with these plans, policies, and regulations would ensure that AHBP projects would not violate an air quality standard, contribute substantially to an existing or projected air quality violation, or expose sensitive receptors to substantial air pollutant concentrations.

Residential uses generally do not create objectionable odors. Land uses that commonly create objectionable odors include wastewater treatment plants, oil refineries, landfills, and composting facilities. Since AHBP projects would not include these types of land uses, AHBP projects would not create objectionable odors.

For these reasons, the AHBP would result in less-than-significant impacts on air quality. The AHBP would not result in more severe impacts than the 2009 Housing Element or Alternative C, would not result in new significant impacts beyond those identified in the FEIR, and would not require new mitigation measures. Furthermore, there is no new information that would alter the FEIR's conclusions regarding impacts on air quality.

## **Greenhouse Gas Emissions**

### **2009 Housing Element**

The FEIR concluded that the 2009 Housing Element would not generate greenhouse gas (GHG) emissions, either directly or indirectly, that may have a significant impact on the environment and would not conflict with any applicable plan, policy, or regulation adopted for the purpose of reducing GHG emissions. Moreover, implementation of the 2009 Housing Element would not conflict with Assembly Bill (AB) 32 or San Francisco's *Strategies to Address Greenhouse Gas Emissions*.

As discussed in the FEIR, Alternative C would promote taller and denser buildings than would the 2009 Housing Element. In addition, Alternative C would encourage increased density along existing transit lines and more energy-efficient buildings. The FEIR concluded that overall GHG impacts associated with taller, denser, and more energy-efficient transit-oriented development under Alternative C would be incrementally reduced when compared to the impacts under the 2009 Housing Element. The GHG impacts under Alternative C would be less than significant.

### **Modified Project (AHBP)**

Adoption of the AHBP would not directly generate GHG emissions, but individual development projects proposed under the AHBP would generate GHG emissions during their construction and operational phases. The AHBP would promote housing along or near transit corridors and in established neighborhoods where jobs and other services are easily accessible by public transit or are within walking distance. This type of transit-oriented development would encourage the use of alternative modes of transportation (transit, bicycling, walking) and help reduce GHG emissions from the use of private automobiles, which is one of the primary sources of GHG emissions. In addition, AHBP projects would be subject to state, regional, and local plans, policies, and regulations related to the reduction of GHG emissions. These plans, policies, and regulations include Executive Order S-3-05, Assembly Bill (AB) 32, the Bay Area Air Quality Management District's *2010 Clean Air Plan*, San Francisco's *Strategies to Address Greenhouse Gas Emissions*, and the San Francisco Green Building Ordinance. Required compliance with these plans, policies, and regulations would ensure that AHBP projects would not result in cumulatively considerable contributions to GHG emissions. To the degree that AHBP projects are concentrated closer to public transit and in taller and denser buildings (i.e., fewer buildings in fewer locations), GHG emissions would be reduced when compared to development patterns anticipated under the 2009 Housing Element.

For these reasons, the AHBP would result in less-than-significant impacts related to GHG emissions. The AHBP would not result in more severe impacts than the 2009 Housing Element or Alternative C, would not result in new significant impacts beyond those identified in the FEIR, and would not require new mitigation measures. Furthermore, there is no new information that would alter the FEIR's conclusions regarding impacts related to GHG emissions.

## **Wind and Shadow**

### **2009 Housing Element**

The FEIR concluded that the 2009 Housing Element would result in less-than-significant wind and shadow impacts, because the 2009 Housing Element would not directly result in the construction of projects that would alter wind or create new shadow. In addition, wind and shadow impacts are project-specific;

individual development projects would be subject to the Planning Department's procedures requiring modification of any new building or addition that would exceed the Planning Code's wind hazard criterion and would be evaluated for their shadow impacts under CEQA and for compliance with Planning Code Sections 146, 147, and 295.

As discussed in the FEIR, Alternative C would promote taller buildings than would the 2009 Housing Element. The FEIR concluded that these taller buildings could result in incrementally greater wind and shadow impacts, but required compliance with Planning Code wind and shadow regulations would reduce these impacts to less-than-significant levels.

### **Modified Project (AHBP)**

The AHBP would not directly result in the construction of any new development and thus would not alter wind or create new shadow. However, individual development projects proposed under the AHBP could alter wind or create new shadow in their respective vicinities. The AHBP would allow qualifying projects to exceed existing height limits in certain locations throughout San Francisco, resulting in buildings that could be taller than the existing scale of development or taller than what is currently permitted under existing regulations. AHBP projects would be evaluated for their wind and shadow impacts during the environmental review process and for compliance with Planning Code wind and shadow regulations during the entitlement process. In order to be eligible for the Local and 100 Percent Affordable programs, project sponsors must demonstrate that their projects would not alter wind in a manner that substantially affects public areas or create new shadow in a manner that substantially affects outdoor recreation facilities or other public areas. If it is determined that a project would result in a significant wind or shadow impact, then the project would need to be modified in order to avoid causing such an impact. If modifications are not feasible, then the project would not be eligible for the Local and 100 Percent Affordable programs. Given these constraints, projects proposed under the Local and 100 Percent Affordable programs would result in less-than-significant wind and shadow impacts.

As discussed in the project description, there is an existing State Density Bonus Law that allows developers to seek density bonuses in exchange for providing affordable housing; this existing law does not require projects to avoid altering wind in a manner that substantially affects public areas or creating new shadow in a manner that substantially affects outdoor recreation facilities or other public areas. The AHBP would not change the existing law, but it would provide developers with two avenues (the State Analyzed Density Bonus Program and the Individually Requested State Density Bonus Program) for seeking density bonuses in exchange for providing affordable housing; these two State programs would be consistent with the existing law (i.e., they would not require projects to avoid creating new shadow in a manner that substantially affects outdoor recreation facilities or other public areas). Projects proposed under either of the State programs could result in potentially significant wind and shadow impacts. These impacts would be evaluated on a project-by-project basis, because wind and shadow impacts are project-specific and location-specific. Without individual development proposals to evaluate, it would be speculative to conclude that either of the State programs would result in significant overall wind and shadow impacts. The AHBP would not result in impacts that would be more severe than those that could result from development proposed under the existing State Density Bonus Law.

For these reasons, the AHBP would result in less-than-significant wind and shadow impacts. The AHBP would not result in more severe impacts than the 2009 Housing Element or Alternative C, would not result

in new significant impacts beyond those identified in the FEIR, and would not require new mitigation measures. Furthermore, there is no new information that would alter the FEIR's conclusions regarding wind and shadow impacts.

## **Recreation**

### **2009 Housing Element**

The FEIR concluded that the 2009 Housing Element would result in less-than-significant impacts related to the increased use of existing parks or recreational facilities, the need to construct new or expand existing recreational facilities, and the physical degradation of existing recreational resources. While the FEIR concluded that the 2009 Housing Element contains policies that could result in an increase in demand for existing recreational facilities in certain areas, the 2009 Housing Element also contains policies that could reduce the need for construction or expansion of recreational facilities by encouraging quality-of-life elements in residential developments such as on-site usable open space. The 2009 Housing Element includes measures to ensure community plan areas are adequately served by recreation facilities, thereby indirectly promoting the construction or expansion of recreational facilities. The need for new or expanded recreational facilities and their associated impacts would be determined during the evaluation of specific community plan proposals.

As discussed in the FEIR, Alternative C would promote taller and denser buildings than would the 2009 Housing Element, potentially resulting in an increase in demand for and the use of recreational facilities in certain areas of San Francisco. The FEIR concluded that these taller and denser buildings could result in incrementally greater impacts related to recreation, but these impacts would be less than significant.

### **Modified Project (AHBP)**

As noted above, the AHBP would promote housing in certain areas of San Francisco but would not increase the overall citywide population above the level of future growth projected in the 2009 Housing Element. For this reason, AHBP projects would not increase the overall demand for recreational facilities above the level analyzed in the FEIR, but there could be localized fluctuations in demand for certain recreational facilities depending on where AHBP projects are constructed. In November 2000, San Francisco voters approved Proposition C, which extended the life of the Open Space Fund through Fiscal Year 2030-2031. The Open Space Fund is used to finance property acquisitions and capital improvement projects for the San Francisco Recreation and Park Department. A percentage of property tax revenues is set aside for the Open Space Fund, and such revenue would increase with the development of AHBP projects.

In addition, AHBP projects would be subject to Planning Code requirements for usable open space. Although AHBP projects would be eligible for certain modifications or waivers from these requirements, they would not be entirely exempt from complying with these requirements. The granting of open space modifications or waivers available to AHBP projects would not significantly increase demand for recreational facilities such that new open space or recreational facilities would be required. Most of the City's recreational facilities are located on properties zoned for public use (P Districts); the AHBP does not apply to sites in P Districts and would not reclassify any P Districts. Lastly, the AHBP would not convert existing recreational facilities to other uses or otherwise physically degrade recreational resources.



For these reasons, the AHBP would result in less-than-significant impacts related to recreation. The AHBP would not result in more severe impacts than the 2009 Housing Element or Alternative C, would not result in new significant impacts beyond those identified in the FEIR, and would not require new mitigation measures. Furthermore, there is no new information that would alter the FEIR's conclusions regarding impacts related to recreation.

### ***Utilities and Service Systems***

#### **2009 Housing Element**

The FEIR concluded that the 2009 Housing Element would result in less-than-significant impacts on utilities and service systems. The 2009 Housing Element would not exceed wastewater treatment requirements, would not exceed the capacity of the wastewater treatment provider, and would not require the construction of new or expansion of existing wastewater treatment or stormwater drainage facilities. Such impacts would be offset through required compliance with existing regulations that address wastewater and stormwater discharges. In addition, the 2009 Housing Element would not increase water demand above the level assumed for planning purposes in the San Francisco Public Utilities Commission's (SFPUC's) Water Supply Availability Study that was prepared for the FEIR. Lastly, the 2009 Housing Element would not exceed the permitted capacity of the City's designated landfill. Any incremental increases in waste at landfills would be offset through required compliance with existing regulations that address the generation and disposal of solid waste.

As discussed in the FEIR, Alternative C would promote taller and denser buildings than would the 2009 Housing Element. The FEIR concluded that these taller and denser buildings could result in similar but incrementally greater impacts on utilities and service systems, but these impacts would be less than significant.

#### **Modified Project (AHBP)**

The AHBP would not directly generate stormwater or wastewater, but individual development projects proposed under the AHBP would generate stormwater and wastewater during their construction and operational phases. All stormwater and wastewater generated by AHBP projects would flow to the City's combined stormwater/sewer system and would be treated to standards contained in the City's National Pollutant Discharge Elimination System (NPDES) Permits for the Southeast Treatment Plant and the Oceanside Treatment Plant prior to discharge into San Francisco Bay and the Pacific Ocean, respectively. The NPDES standards are set and regulated by the San Francisco Bay Area Regional Water Quality Control Board (RWQCB). Therefore, AHBP projects would not conflict with RWQCB requirements and would not exceed wastewater treatment requirements. In addition, AHBP projects would be subject to local regulations that include, but are not limited to, the Green Building Ordinance and the Stormwater Management Ordinance. Required compliance with these regulations would reduce stormwater and wastewater flows from AHBP projects, thereby ensuring that AHBP projects would not exceed the capacity of the wastewater treatment provider and would not require the construction of new or expansion of existing wastewater treatment and stormwater drainage facilities.

The AHBP would not directly consume water, but individual development projects proposed under the AHBP would consume water during their construction and operational phases. As noted above, the AHBP would promote housing in certain areas of San Francisco but would not increase the overall population beyond the future growth projected in the 2009 Housing Element. For this reason, AHBP

projects would not increase the overall demand for water above the level assumed for planning purposes in the SFPUC's Water Supply Availability Study prepared for the FEIR. In addition, AHBP projects would be subject to local regulations that include, but are not limited to, the Green Building Ordinance, the Green Landscaping Ordinance, and the Residential Water Conservation Ordinance. Required compliance with these regulations would reduce water consumption by AHBP projects, thereby ensuring that AHBP projects would not exceed the available water supply and would not require new or expanded water supply resources or entitlements.

The AHBP would not directly generate solid waste, but individual development projects proposed under the AHBP would generate solid waste during their construction and operational phases. The AHBP would promote housing in certain areas of San Francisco but would not increase the overall citywide population above the level of future growth projected in the 2009 Housing Element. For this reason, AHBP projects would not increase the overall amount of solid waste generated above the level analyzed in the FEIR. In addition, AHBP projects would be subject to local regulations that include, but are not limited to, the Mandatory Recycling and Composting Ordinance, the Construction and Demolition Debris Recovery Ordinance, and the Green Building Ordinance. Required compliance with these regulations would promote the composting and recycling of solid waste and reduce the amount of solid waste sent to the City's designated landfill, thereby ensuring that AHBP projects would not exceed the permitted capacity of the City's designated landfill.

For these reasons, the AHBP would result in less-than-significant impacts on utilities and service systems. The AHBP would not result in more severe impacts than the 2009 Housing Element or Alternative C, would not result in new significant impacts beyond those identified in the FEIR, and would not require new mitigation measures. Furthermore, there is no new information that would alter the FEIR's conclusions regarding impacts on utilities and service systems.

### **Public Services**

#### **2009 Housing Element**

The FEIR concluded that the 2009 Housing Element would result in less-than-significant impacts on fire protection, police protection, schools, or other public services, such as libraries or public health facilities. The San Francisco Fire Department and the San Francisco Police Department regularly redeploy their resources based on need to ensure that response times and service ratios do not fall below acceptable levels. New development projects are required to pay development impact fees to fund school and library facilities and operations, which would help offset potential impacts on school and library services. The 2009 Housing Element would not increase the overall citywide population above regional growth projections for which public health facilities have accounted, which would reduce the need to construct new or expand existing facilities.

As discussed in the FEIR, Alternative C would promote taller and denser buildings than would the 2009 Housing Element. The FEIR concluded that these taller and denser buildings could result in similar but incrementally greater impacts on public services, but these impacts would be less than significant.

#### **Modified Project (AHBP)**

As noted above, the AHBP would promote housing in certain areas of San Francisco but would not increase the overall citywide population above the level of future growth projected in the 2009 Housing

Element. For this reason, AHBP projects would not increase the overall demand for fire protection or police protection above the level analyzed in the FEIR. There could be localized fluctuations in demand for fire protection and police protection depending on where AHBP projects are constructed, but as discussed above, both the Fire Department and the Police Department regularly redeploy their resources based on need to ensure that response times and service ratios do not fall below acceptable levels. The AHBP would promote housing on sites in established neighborhoods that already receive fire protection and police protection, potentially allowing the Fire Department and the Police Department to maintain response times and service ratios at or close to their current levels and reducing the need to construct new or expand existing facilities.

As discussed in the FEIR, the San Francisco Unified School District (SFUSD) assigns students to schools based on a lottery system. This lottery system ensures that student enrollment is distributed to facilities that have sufficient capacity to adequately serve the educational needs of students. Directing growth to certain areas of San Francisco generally would not affect the school system, because students are not assigned to schools based on location. AHBP projects could affect school services if they create additional demand for school services that cannot be accommodated by the SFUSD's existing capacity, thereby requiring the need to construct new or expand existing facilities. At the time of the preparation of the FEIR, SFUSD facilities had a capacity of about 63,835 students, and about 56,446 students were enrolled in these facilities. More recently, approximately 58,400 students were enrolled in SFUSD facilities during the 2014-2015 school year. Pursuant to California Education Code Section 17620(a)(1), the governing board at any school district is authorized to levy a fee, charge, dedication, or other requirement against any construction within the boundaries of the district for the purpose of funding the construction or reconstruction of school facilities. AHBP projects would be subject to a development impact fee, and the payment of this fee would help fund school facilities and operations and offset potential impacts on school services.

The AHBP would promote housing in certain areas of San Francisco but would not increase the overall citywide population above the level of future growth projected in the 2009 Housing Element. For this reason, AHBP projects would not increase the overall demand for libraries or public health facilities, but there could be localized fluctuations in demand for libraries and public health facilities depending on where AHBP projects are constructed. In November 2000, San Francisco voters approved a bond measure to fund the Branch Library Improvement Program (BLIP). Among other objectives, the BLIP calls for the renovation of 16 existing branch libraries, the demolition and replacement of three branch libraries with newly constructed facilities, and the construction of a new branch library in the emerging Mission Bay neighborhood. In addition to the BLIP, AHBP projects would be subject to a development impact fee to fund library facilities and operations. The payment of this fee, as well as property tax revenue from AHBP projects, would help fund library facilities and operations and offset potential impacts on library services. The AHBP would promote housing on sites in established neighborhoods that are already served by public health facilities, potentially allowing such facilities to maintain response times and service ratios at or close to their current levels and reducing the need to construct new or expand existing facilities.

For these reasons, the AHBP would result in less-than-significant impacts on public services. The AHBP would not result in more severe impacts than the 2009 Housing Element or Alternative C, would not result in new significant impacts beyond those identified in the FEIR, and would not require new mitigation measures. Furthermore, there is no new information that would alter the FEIR's conclusions regarding impacts on public services.

## ***Biological Resources***

### **2009 Housing Element**

The FEIR concluded that the 2009 Housing Element would result in less-than-significant impacts on biological resources. The 2009 Housing Element would not have a substantial adverse effect on any candidate, sensitive, or special-status species, riparian habitat, other sensitive natural communities, or federally protected wetlands, and would not interfere with the movement of species. Some 2009 Housing Element policies would promote housing in certain areas of the City, consequently increasing the amount of new housing being constructed in those areas and resulting in impacts on biological resources (e.g., tree removal, construction on or near riparian habitat or sensitive natural communities, interference with migration, etc.). However, increasing density could accommodate more of the City's fair share of the Regional Housing Needs Allocation in fewer buildings, resulting in fewer construction sites and decreasing the potential for disturbance of or interference with biological resources. The FEIR also found that the 2009 Housing Element would not conflict with any local policies or ordinances protecting biological resources or conflict with the provisions of an adopted habitat conservation plan, because the 2009 Housing Element does not contain any policies that would directly or indirectly conflict with any policies protecting biological resources or any adopted habitat conservation plans.

As discussed in the FEIR, concluded that Alternative C would promote a larger number of development projects as well as taller buildings than would the 2009 Housing Element. The FEIR concluded that increased amount of development, combined with potentially taller buildings could result in greater impacts on biological resources, but required compliance with federal, state, and local regulations that protect biological resources would reduce these impacts to less-than-significant levels.

### **Modified Project (AHBP)**

The AHBP would not directly place housing in areas of San Francisco that are in or near riparian habitat or sensitive natural communities. However, individual development projects proposed under the AHBP could be in or near such areas. In addition, the AHBP would allow qualifying projects to exceed existing height limits in certain locations throughout San Francisco, resulting in buildings that could be taller than what is currently permitted under existing regulations. Multi-story buildings are potential obstacles that can injure or kill birds in the event of a collision. AHBP projects would be evaluated for their impacts on biological resources and would be required to comply with applicable federal, state, and local regulations that protect biological resources. These regulations include, but are not limited to, the federal Migratory Bird Treaty Act, Sections 3503 and 3503.5 of the California Fish and Game Code, the San Francisco Urban Forestry Ordinance, and San Francisco Planning Code Section 139: Standards for Bird-Safe Buildings. The AHBP would not conflict with the provisions of an adopted habitat conservation plan, because the AHBP does not contain any policies that would directly or indirectly conflict with any policies protecting biological resources or any adopted habitat conservation plans.

For these reasons, the AHBP would result in less-than-significant impacts on biological resources. The AHBP would not result in more severe impacts than the 2009 Housing Element or Alternative C, would not result in new significant impacts beyond those identified in the FEIR, and would not require new mitigation measures. Furthermore, there is no new information that would alter the FEIR's conclusions regarding impacts on biological resources.

## **Geology and Soils**

### **2009 Housing Element**

The FEIR concluded that the 2009 Housing Element would result in less-than-significant impacts on geology and soils. Individual development projects would be developed in a seismically sound manner because they would be required to comply with building regulations for seismic safety that are enforced through the City's interdepartmental review process. Compliance with these regulations would ensure that people or structures would not be exposed to substantial adverse effects, including the risk of loss, injury, or death involving rupture of a known earthquake fault, strong seismic ground shaking, seismic-related ground failure, landslides, unstable soil, or expansive soils. The FEIR also found that the 2009 Housing Element would result in less-than-significant impacts related to soil erosion or the loss of topsoil, because these impacts are site-specific. Individual development projects would be evaluated for their impacts related to soil erosion or the loss of topsoil and would be required to comply with applicable regulations related to the prevention of erosion and the discharge of sediment into construction site runoff. Lastly, the FEIR concluded that the 2009 Housing Element would not substantially change the topography or any unique geologic or physical features of development sites, because all permit applications for excavation and grading would be reviewed by City agencies for consistency with policies related to land alteration.

As discussed in the FEIR, Alternative C would promote taller and denser buildings than would the 2009 Housing Element. The FEIR concluded that these taller and denser buildings could result in greater impacts on geology and soils, but required compliance with federal, state, and local regulations that address geologic hazards would reduce these impacts to less-than-significant levels.

### **Modified Project (AHBP)**

The AHBP would allow qualifying projects to exceed existing height limits in certain locations throughout San Francisco, resulting in buildings that could be taller than what is currently permitted under existing regulations. Taller buildings may require deeper and more substantial foundations to support the additional building loads. Moreover, individual development projects proposed under the AHBP could be located in or near areas that are susceptible to geologic hazards (e.g., earthquake faults, landslide or liquefaction zones, unstable or expansive soils). AHBP projects would be required to comply with the seismic safety standards set forth in the San Francisco Building Code. The Department of Building Inspection is the City agency responsible for reviewing building permit applications, structural drawings and calculations, and geotechnical reports and ensuring that projects comply with the seismic safety standards and other applicable requirements of the Building Code. Project compliance with the Building Code would ensure that people or structures would not be exposed to substantial adverse effects, including the risk of loss, injury, or death involving rupture of a known earthquake fault, strong seismic ground shaking, seismic-related ground failure, landslides, unstable soil, or expansive soils. AHBP projects would be evaluated for their impacts related to soil erosion or the loss of topsoil and would be required to comply with applicable regulations related to the prevention of erosion and the discharge of sediment into construction site runoff. All permit applications for excavation and grading activities would be reviewed by City agencies for consistency with policies related to land alteration.

For these reasons, the AHBP would result in less-than-significant impacts related to geology and soils. The AHBP would not result in more severe impacts than the 2009 Housing Element or Alternative C,

would not result in new significant impacts beyond those identified in the FEIR, and would not require new mitigation measures. Furthermore, there is no new information that would alter the FEIR's conclusions regarding impacts on geology and soils.

### ***Hydrology and Water Quality***

#### **2009 Housing Element**

The FEIR concluded that the 2009 Housing Element would result in less-than-significant impacts on hydrology and water quality. The 2009 Housing Element would not violate any water quality standards or waste discharge requirements, would not alter existing drainage patterns or substantially increase the rate or amount of surface runoff in a manner that would result in substantial erosion, siltation, or flooding, and would not create or contribute runoff water which would exceed the capacity of existing or planned stormwater drainage systems or provide substantial additional sources of polluted runoff. Individual development projects would be required to comply with applicable regulations related to erosion prevention and stormwater management, treatment, and discharge.

The FEIR also concluded that the 2009 Housing Element would not substantially deplete groundwater supplies or substantially interfere with groundwater recharge, would not result in significant impacts related to placing housing in areas at risk of flooding, and would not expose people or structures to a significant risk of injury, loss, or death involving inundation by seiche, tsunami, mudflow, or the failure of a dam or levee.

As discussed in the FEIR, Alternative C would promote taller and denser buildings than would the 2009 Housing Element. The FEIR concluded that these taller and denser buildings could result in greater impacts on hydrology and water quality, but these impacts would be less than significant.

#### **Modified Project (AHBP)**

The AHBP would not directly result in the construction of housing in areas of San Francisco that are prone to flooding or are at risk of inundation by seiche, tsunami, mudflow, or the failure of a dam or levee. However, individual development projects proposed under the AHBP could be located in such areas. These projects would be required to comply with applicable regulations related to minimizing the risk of loss, injury, or death from hydrologic hazards. These regulations include, but are not limited to, the San Francisco Floodplain Management Ordinance and the San Francisco Building Code. Groundwater could be encountered during construction of AHBP projects. Dewatering of excavated areas during construction would lower groundwater levels, but these effects would be temporary. Once dewatering has been completed, groundwater levels would return to normal. Wastewater and stormwater generated by AHBP projects would flow to the City's combined stormwater/sewer system and would be treated to standards contained in the City's National Pollutant Discharge Elimination System Permit for the Oceanside Treatment Plant and the Southeast Treatment Plant prior to discharge into the Pacific Ocean and San Francisco Bay, respectively. Required compliance with the San Francisco Stormwater Management Ordinance would ensure that AHBP projects would not create or contribute runoff water which would exceed the capacity of existing or planned stormwater drainage systems or provide substantial additional sources of polluted runoff.

For these reasons, the AHBP would result in less-than-significant impacts on hydrology and water quality. The AHBP would not result in more severe impacts than the 2009 Housing Element or Alternative C,

would not result in new significant impacts beyond those identified in the FEIR, and would not require new mitigation measures. Furthermore, there is no new information that would alter the FEIR's conclusions regarding impacts on hydrology and water quality.

### ***Hazards and Hazardous Materials***

#### **2009 Housing Element**

The FEIR concluded that the 2009 Housing Element would result in a less-than-significant impact related to hazards and hazardous materials. The 2009 Housing Element would not transport, use, or dispose of hazardous materials and would not release hazardous materials into the environment. However, the construction of individual development projects would result in the emission of exhaust from construction equipment and vehicles as well as the demolition of older buildings that may contain asbestos, lead-based paint, or other hazardous building materials. In addition, the operation of individual development projects would involve the use of relatively small quantities of hazardous materials such as batteries, household cleaning products, and paint for routine purposes. Most of these materials are consumed through use, resulting in relatively little waste. Existing federal, state, and local regulations and programs address emissions from construction equipment and vehicles, the abatement of hazardous building materials during demolition and construction activities, and the transportation and disposal of hazardous materials. Individual development projects, including those that would be on sites on a list of hazardous materials sites compiled pursuant to Government Code Section 65962.5 or would handle hazardous materials within one-quarter mile of an existing or proposed school, would be required to comply with these existing regulations and programs.

The FEIR also concluded that the 2009 Housing Element would not impair implementation of or physically interfere with an adopted emergency response plan or emergency evacuation plan or expose people or structures to a significant risk of loss, injury, or death involving fires. In San Francisco, fire safety is ensured through compliance with the provisions of the Building Code and the Fire Code. The building permit applications for individual development projects would be reviewed by the Department of Building Inspection and the Fire Department for compliance with all regulations related to fire safety.

As discussed in the FEIR, Alternative C would promote residential development in commercial areas, near transit lines, or in other areas where hazardous materials are used. The FEIR concluded that residential development in such areas could result in greater impacts related to hazards and hazardous materials when compared to the impacts under the 2009, but required compliance with federal, state, and local regulations that address hazards and hazardous materials would reduce these impacts to less-than-significant levels.

#### **Modified Project (AHBP)**

The AHBP would not directly result in the construction of housing on sites that are included on a list of hazardous materials sites compiled pursuant to Government Code Section 65962.5. However, individual development projects proposed under the AHBP could be located on such sites. All AHBP projects, including those located on hazardous materials sites or those that would handle hazardous materials within one-quarter mile of an existing or proposed school, would be required to comply with applicable federal, state, and local regulations and programs related to the abatement of hazardous materials, the emission of exhaust from construction equipment and vehicles, and the transportation and disposal of hazardous materials. Required compliance with such regulations and programs would ensure that AHBP

projects would not emit hazardous materials into the environment and would not create a significant hazard to the public or the environment through the routine transport, use, or disposal of hazardous materials. Required compliance with fire safety regulations would ensure that AHBP projects would not impair implementation of or physically interfere with an adopted emergency response plan or emergency evacuation plan or expose people or structures to a significant risk of loss, injury, or death involving fires.

For these reasons, the AHBP would result in less-than-significant impacts related to hazards and hazardous materials. The AHBP would not result in more severe impacts than the 2009 Housing Element or Alternative C, would not result in new significant impacts beyond those identified in the FEIR, and would not require new mitigation measures. Furthermore, there is no new information that would alter the FEIR's conclusions on impacts regarding hazards and hazardous materials.

### ***Mineral and Energy Resources***

#### **2009 Housing Element**

The FEIR concluded that the 2009 Housing Element would result in a less-than-significant impact on mineral and energy resources. The 2009 Housing Element would not result in the loss of availability of a known mineral resource, the loss of availability of a locally important mineral resource recovery site, or the use of large amounts of fuel, water, or energy.

As discussed in the FEIR, Alternative C would promote taller and denser buildings than would the 2009 Housing Element. The FEIR concluded that these taller buildings could result in incrementally greater impacts on mineral and energy resources, but these impacts would be less than significant.

#### **Modified Project (AHBP)**

All land in San Francisco is designated Mineral Resource Zone 4 (MRZ-4) by the California Division of Mines and Geology (CDMG) under the Surface Mining and Reclamation Act of 1975.<sup>29</sup> This designation indicates that there is inadequate information available for assignment to any other MRZ. Thus, the AHBP-eligible development sites are not designated areas of significant mineral deposits or locally important mineral resource recovery sites and the AHBP would not result in the loss of availability of such resources. Furthermore, the AHBP would not encourage activities that result in the use of large amounts of fuel, water, or energy, or use these in a wasteful manner, because individual development projects proposed under the AHBP would be required to comply with state and local ordinances that regulate such activities. In California, energy consumption for the heating, cooling, ventilation, and lighting of buildings is regulated by Title 24 of the California Code of Regulations. As part of the building permit application process, project sponsors are required to submit documentation demonstrating project compliance with Title 24 standards. In addition, projects in San Francisco are subject to the requirements of the San Francisco Green Building Ordinance.

For these reasons, the AHBP would result in less-than-significant impacts on mineral and energy resources. The AHBP would not result in more severe impacts than the 2009 Housing Element or Alternative C, would not result in new significant impacts beyond those identified in the FEIR, and would not require new mitigation measures. Furthermore, there is no new information that would alter the FEIR's conclusions regarding impacts on mineral and energy resources.

---

<sup>29</sup> California Division of Mines and Geology, Open File Report 96-03, 1996, and Special Report 146 Parts I and II, 1986.



## ***Agriculture and Forest Resources***

### **2009 Housing Element**

The FEIR concluded that the 2009 Housing Element would result in a less-than-significant impact related to conflicts with existing zoning for agricultural use. Implementation of the 2009 Housing Element would not include any changes to the City's zoning districts and would not conflict with existing zoning for urban agricultural uses.

As discussed in the FEIR, Alternative C would not conflict with existing zoning for agricultural use but would promote taller and denser buildings than would the 2009 Housing Element. These taller buildings could block sunlight for longer periods of time and result in incrementally greater impacts on agriculture resources (community gardens), but these impacts would be less than significant.

### **Modified Project (AHBP)**

San Francisco is not zoned for agricultural use and is not subject to a Williamson Act contract.<sup>30</sup> The AHBP would not convert farmland to non-agricultural use and would not conflict with existing zoning related to agricultural use. The AHBP would not directly block sunlight to community gardens, but after they have been constructed, individual development projects proposed under the AHBP could block sunlight to community gardens. These projects would be evaluated for their specific shadow impacts on community gardens as part of their individual environmental review and entitlement processes.

At the time of the preparation of the FEIR, the topic of forest resources was not part of the Environmental Checklist Form (CEQA Guidelines, Appendix G). For this reason, the FEIR did not analyze impacts on forest resources. In 2010, the topic of forest resources was added to the Environmental Checklist Form. San Francisco does not contain forest land or timberland as defined in Public Resources Code Section 12220(g) and Public Resources Code Section 4526, respectively. The AHBP would not convert forest land or timberland to non-forest use and would not conflict with existing zoning related to forest use.

For these reasons, the AHBP would result in less-than-significant impacts on agriculture and forest resources. The AHBP would not result in more severe impacts than the 2009 Housing Element or Alternative C, would not result in new significant impacts beyond those identified in the FEIR, and would not require new mitigation measures. Furthermore, there is no new information that would alter the FEIR's conclusions regarding impacts on agriculture and forest resources.

---

<sup>30</sup> California Department of Conservation, *San Francisco Bay Area Important Farmland 2010*. Available online at [ftp://ftp.consrv.ca.gov/pub/dlrp/FMMP/pdf/regional/2010/bay\\_area\\_fmmp2010.pdf](ftp://ftp.consrv.ca.gov/pub/dlrp/FMMP/pdf/regional/2010/bay_area_fmmp2010.pdf), accessed January 6, 2016.

## MITIGATION MEASURES

The 2004 and 2009 Housing Element FEIR identified the following mitigation measure to mitigate the potentially significant impact related to interior and exterior noise to a less-than-significant level. This measure was adopted as Implementation Measures 17 and 18 in the 2009 Housing Element, which are continued as Implementation Measures 17 and 18 in the 2014 Housing Element.

### ***Mitigation Measure M-NO-1: Interior and Exterior Noise***

For new residential development located along streets with noise levels above 75 dBA  $L_{dn}$ , as shown in Figure V.G-3 of the 2004 and 2009 Housing Element FEIR, the Planning Department shall require the following:

1. The Planning Department shall require the preparation of an analysis that includes, at a minimum, a site survey to identify potential noise-generating uses within two blocks of the project site, and including at least one 24-hour noise measurement (with maximum noise level readings taken at least every 15 minutes), prior to completion of the environmental review. The analysis shall demonstrate with reasonable certainty that Title 24 standards, where applicable, can be met, and that there are no particular circumstances about the proposed project site that appear to warrant heightened concern about noise levels in the vicinity. Should such concerns be present, the Department may require the completion of a detailed noise assessment by person(s) qualified in acoustical analysis and/or engineering prior to the first project approval action, in order to demonstrate that acceptable interior noise levels consistent with those in the Title 24 standards can be attained; and
2. To minimize effects on development in noisy areas, for new residential uses, the Planning Department shall, through its building permit review process, in conjunction with noise analysis required above, require that open space required under the Planning Code for such uses be protected, to the maximum feasible extent, from existing ambient noise levels that could prove annoying or disruptive to users of the open space. Implementation of this measure could involve, among other things, site design that uses the building itself to shield on-site open space from the greatest noise sources, construction of noise barriers between noise sources and open space, and appropriate use of both common and private open space in multi-family dwellings, and implementation would also be undertaken consistent with other principles of urban design.

## CONCLUSION

I do hereby certify that the above determination has been made pursuant to State and Local requirements.

DATE January 14, 2016

  
Sarah B. Jones, Environmental Review Officer  
for John Rahaim, Director of Planning



# SAN FRANCISCO PLANNING DEPARTMENT

**MEMO**

## NOTE TO FILE

**DATE:** February 18, 2016  
**TO:** File for Case No. 2014.1304E  
**FROM:** Michael Li  
**RE:** Affordable Housing Bonus Program  
Amendments to Proposed Legislation

1650 Mission St.  
Suite 400  
San Francisco,  
CA 94103-2479

Reception:  
**415.558.6378**

Fax:  
**415.558.6409**

Planning  
Information:  
**415.558.6377**

On January 14, 2016, the Planning Department published an addendum to the *2004 and 2009 Housing Element FEIR*. The addendum analyzed the environmental impacts of the Affordable Housing Bonus Program (AHBP), which is proposed legislation that was introduced by Mayor Lee and Supervisor Tang on September 29, 2015. The analysis in the addendum was based on the proposed AHBP legislation as it was originally introduced by Mayor Lee and Supervisor Tang.

Amendments to the proposed AHBP legislation were introduced by the Planning Department on January 12, 2016, and Supervisor Breed introduced additional amendments during the Planning Commission hearing on January 28, 2016. This Note to File summarizes the proposed amendments and the environmental impacts of those amendments. For the reasons set forth below, the Planning Department has concluded that the amendments would not result in new impacts that were not already identified in the addendum or impacts that are more severe than those identified in the addendum. As discussed below under "January 2016 Amendments," the impacts of the project with the January 2016 amendments would be the same as or slightly less than the impacts discussed in the addendum; in some cases, the amendments would not result in any changes to the impacts discussed in the addendum.

In response to public testimony during the hearing on January 28, 2016, the Planning Department has proposed additional amendments that may be considered by the Planning Commission during the hearing scheduled for February 25, 2016. These amendments are discussed below under "Additional Amendments for Consideration by the Planning Commission."

### JANUARY 2016 AMENDMENTS

#### AHBP Definitions

##### *Amendments:*

The definitions of certain terms associated with the AHBP have been clarified.

##### *Impacts of Amendments:*

These amendments would not result in any physical changes to the environment and would not result in changes to the impacts discussed in the addendum.

## **Eligible Sites and Size of AHBP Study Area**

### *Amendments:*

1. The North of Market Residential Special Use District has been removed from the Local and State Analyzed programs.
2. Language has been added to clarify that for the Local and State Analyzed programs, only sites in South of Market Mixed-Use Districts in which residential density is based on the number of units per square foot of lot area would be eligible; sites in South of Market Mixed-Use Districts that regulate residential density by some other means would not be eligible.
3. Language has been added to clarify that sites in RH-1 and RH-2 Districts that can accommodate five or more dwelling units under current Planning Code controls are eligible for the AHBP under the State Individually Requested program.

### *Impacts of Amendments:*

The first two amendments listed above would reduce the number of sites that are eligible for the AHBP and would, therefore, reduce the theoretical maximum number of housing units that the AHBP could incentivize. The overall number of units developed under the AHBP on a citywide basis would not exceed the maximum of 16,000 units discussed in the addendum. The impacts of the first two amendments would be the same as or slightly less than the impacts discussed in the addendum.

The third amendment listed above clarifies that certain sites in RH-1 and RH-2 Districts would be eligible for the AHBP under the State Individually Requested program. The third amendment would not result in changes to the impacts discussed in the addendum, because the development of qualifying sites in RH-1 and RH-2 Districts can occur now under the existing State Density Bonus Law.

## **Ineligible or Prohibited Projects**

### *Amendments:*

1. Supervisor Breed introduced amendments related to the protection of existing rent-controlled residential units.
2. Language has been added to clarify that group housing units and efficiency dwelling units (a.k.a. micro units) would not be eligible for the Local or State Analyzed programs.
3. Language has been added under the Local and State Analyzed programs to prohibit lot mergers that would result in more than 125 feet of street frontage.
4. Language has been added to clarify that vertical additions to existing buildings would not be eligible for the Local or State Analyzed programs.

### *Impacts of Amendments:*

The amendments related to rent-controlled residential units and lot mergers would reduce potential impacts on rent-controlled residential units and limit the massing or scale of AHBP projects. The impacts of the project with these amendments would be slightly less than the impacts discussed in the

addendum. The amendment related to vertical additions to existing buildings would reduce the number of sites eligible for the Local or State Analyzed programs, thereby resulting in impacts that would be slightly less than the impacts discussed in the addendum. The amendment related to group housing units and efficiency dwelling units would not result in any physical changes to the environment and would not result in changes to the impacts discussed in the addendum.

### **Other Pending Legislation**

#### *Amendments:*

Language has been added to clarify how the eligibility of projects for the Local program would be affected by proposed legislation (the "Dial Legislation") to amend Planning Code Section 415.

#### *Impacts of Amendments:*

This amendment addresses how the pending Dial Legislation, if adopted, would affect the eligibility of projects for the AHBP. This amendment would not result in any physical changes to the environment and would not result in changes to the impacts discussed in the addendum.

### **AHBP Development Bonuses**

#### *Amendments:*

1. Language has been added to clarify how the 20-foot height bonus must be distributed within a building envelope under the Local program. Language has been added to clarify that the additional five-foot height bonus available under the Local program can only be utilized for the ground floor of a building when the project site is not in a zoning district that already allows the additional five-foot height bonus.
2. Language has been added to clarify that the parking reduction under the Local, 100% Affordable, and State Analyzed programs would only apply to automobile parking, not bicycle parking.
3. A new zoning modification related to the use of inner courts as open space has been added to the Local and 100% Affordable programs.

#### *Impacts of Amendments:*

These amendments clarify when certain development bonuses would be applicable and how those development bonuses would be implemented. The impacts of the project with these amendments would be the same as or slightly less than the impacts discussed in the addendum.

### **AHBP Implementation Procedures**

#### *Amendments:*

These amendments would address the procedures related to implementing the AHBP (e.g., documentation, fees, review of applications, pricing of units, periodic evaluation and monitoring of the AHBP).

*Impacts of Amendments:*

These amendments would not result in any physical changes to the environment and would not result in changes to the impacts discussed in the addendum.

**ADDITIONAL AMENDMENTS FOR CONSIDERATION BY THE PLANNING COMMISSION**

In response to public testimony during the hearing on January 28, 2016, the Planning Department has proposed potential amendments that may be considered by the Planning Commission during the hearing scheduled for February 25, 2016.

*Amendments:*

1. Any project proposing the demolition of an existing dwelling unit would not be eligible for the AHBP.
2. The AHBP Design Guidelines would be amended to add a new principle addressing building height along narrow streets.
3. New lots created by lot mergers would be limited in street frontage to no more than 50 percent of the length of the subject block.
4. In order to address the potential displacement of existing small businesses, notification requirements and relocation assistance would be expanded. Upon completion of an AHBP project with commercial space, the previous business(es) at the project site would be given the first right of refusal to occupy the new commercial space(s). As part of the AHBP entitlement process, the Planning Commission would be given the authority to reduce the size of proposed commercial uses or require proposed commercial uses to protect existing neighborhood-serving businesses.
5. AHBP entitlement actions under Planning Code Section 328 would be appealable to the Board of Supervisors instead of the Board of Appeals.
6. Each staff report for an AHBP project would include an analysis of how the project complies with the AHBP Design Guidelines.
7. The affordability range for some of the middle-income units proposed under the AHBP would be lowered.

*Impacts of Amendments:*

The first amendment listed above would reduce the number of sites that are eligible for the AHBP and would, therefore, reduce the theoretical maximum number of housing units that the AHBP could incentivize. The second and third amendments listed above would potentially limit the footprint, height, and/or massing of AHBP projects. Collectively, these amendments would result in impacts that are the same as or less than the impacts discussed in the addendum.

The amendments related to small businesses facing displacement would result in impacts that are the same as or less than the impacts discussed in the addendum.

The amendments related to procedural changes in how AHBP projects are reviewed or related to the affordability range of middle-income units would not result in any physical changes to the environment and would not result in changes to the impacts discussed in the addendum.



# RESIDENTIAL DENSITY BONUS STUDY

DAVID BAKER ARCHITECTS  
SEIFEL CONSULTING  
SF PLANNING DEPARTMENT

AUGUST 2015



FINAL DRAFT



In order to understand which waivers encouraged contextually appropriate increases in density — listed under the Menu of Waivers, on pages 20–29 — this study analyzes eleven prototypical sites throughout the city and explores how the State Density Bonus Law impacts the capacity, limitations, and potential of each parcel. Following the standard development process, the study started with a conceptual design for each parcel — a simple model of the project's scale, height, and overall volume. Digital modeling and representation were used to study a code-compliant development as exists under current zoning laws. Four to five additional iterations utilizing waivers helped illustrate the physical implications of incremental density increases within existing neighborhoods.

In conjunction with this design exploration, Libby Seifel of Seifel Consulting undertook a detailed financial analysis to calculate the economic feasibility of the proposed development scenarios on three of the eleven sites studied. This, along with the design analysis, helped identify which specific Planning Code waivers most effectively increase a parcel's overall development potential while producing contextually appropriate buildings.

The results from these studies make it clear that in our local market, the 35% increase as mandated by the State Density Bonus law may not provide enough incentive for developers to create more affordable housing. Therefore, the team also studied other ways to encourage developers to create more affordable housing through a proposed San Francisco policy known as the Affordable Housing Bonus Program.



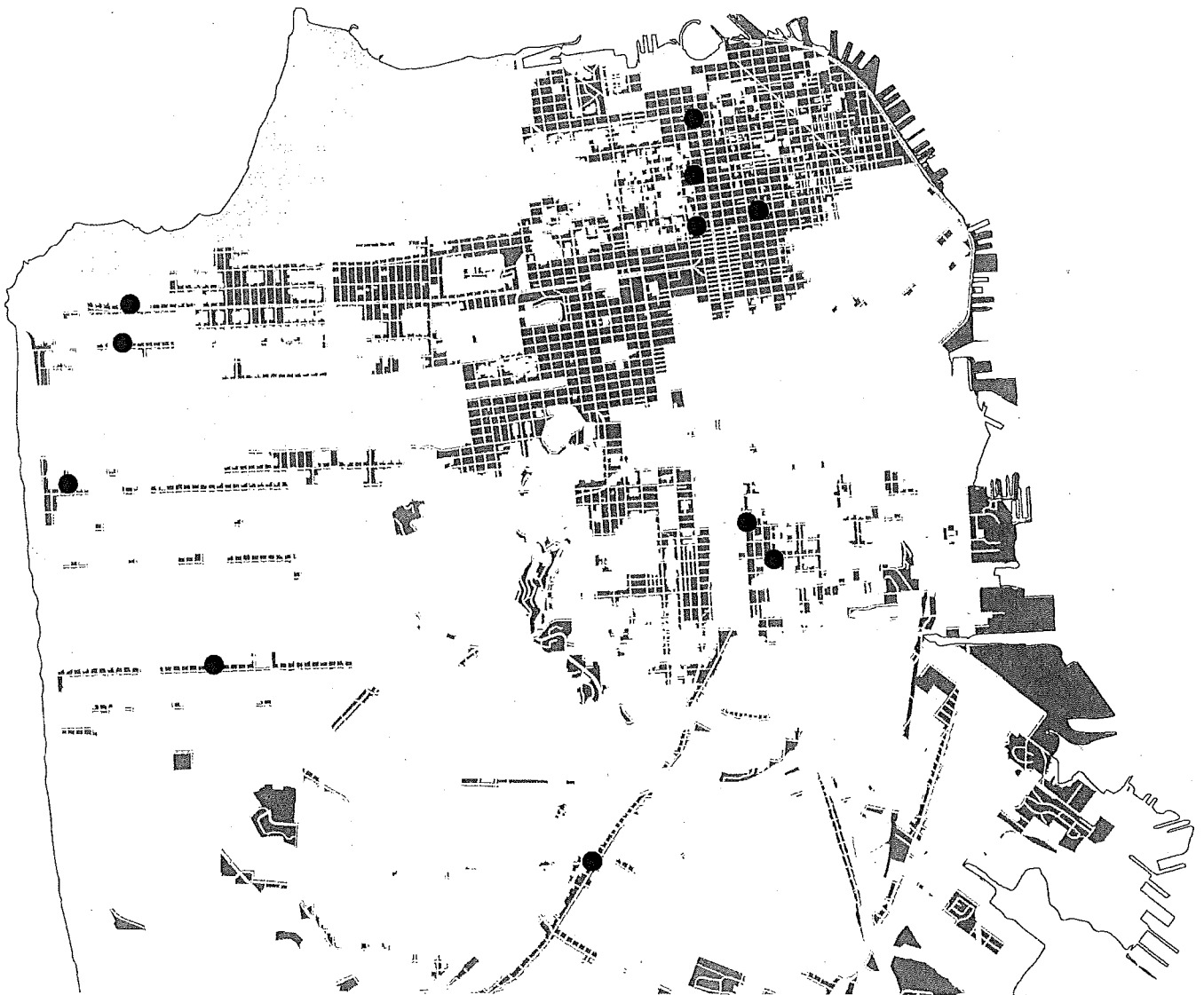

All the models in this study were executed at a conceptual level only. Any project electing to participate in either the State Density Bonus or Affordable Housing Bonus Programs will require more detailed design. To ensure that increased density will enhance rather than detract from the current urban fabric, an additional Design Guidelines publication is in development.

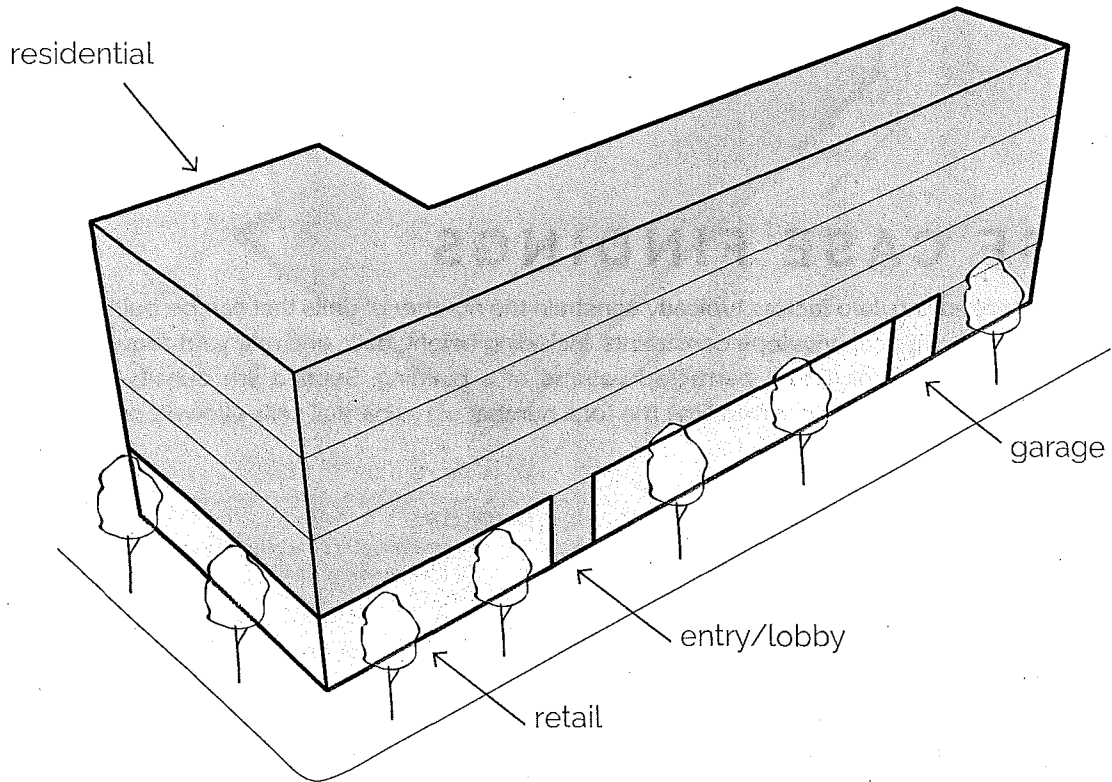
- Areas where density bonus would apply
- Prototype Site Locations





**SITE MODEL EXAMPLE**

KEY	
	RESIDENTIAL
	RETAIL
	GARAGE
	OPEN SPACE

**PLANNING CODE ASSUMPTIONS:**  
 Some of the sites within the study were corner lots. In these cases, the planning code allows for a rear yard modification (per PC Section 134(e)(2)). DBA did not utilize this modification in constructing the Base Cases. Instead, this modification is reserved for use as a waiver within either the State Density Bonus or Local Affordable Housing Bonus Program.

- DIGITAL MODELING ASSUMPTIONS:**
- Residential square footage includes common circulation, amenity spaces, and lobby spaces
  - Service spaces are assumed to be included within either the garage or residential gross square footage and have not been specifically designed
  - Parking stackers are used where noted to achieve required parking requirements
  - All square footages listed are gross square feet unless otherwise noted

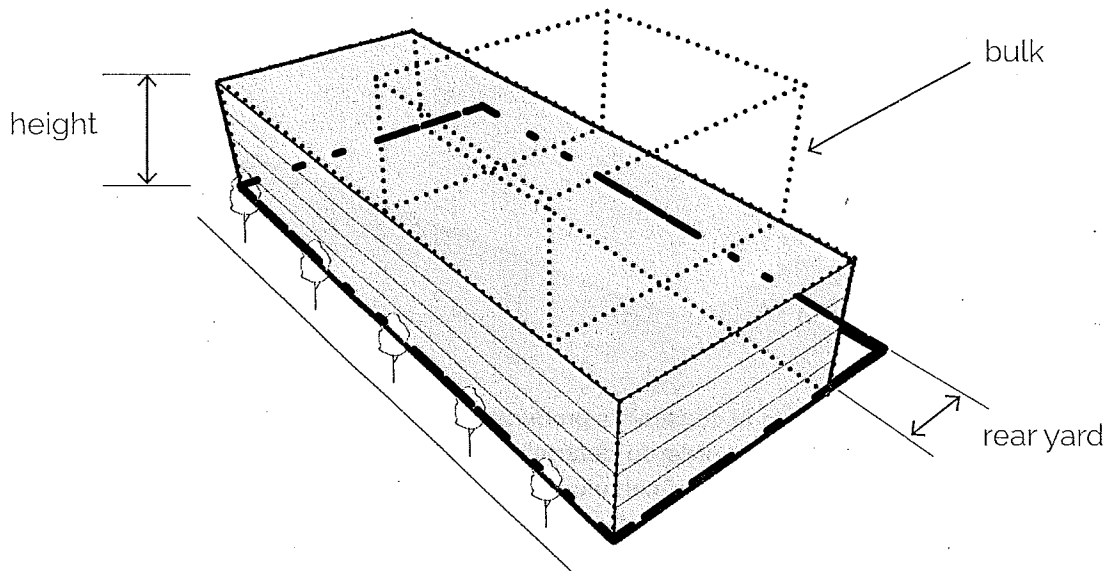

**PHYSICAL ENVELOPE**

Defined by a site's zoning parameters that determine the maximum permitted volume of a building (such as height, bulk, and rear yard, etc).

60,000 GSF CAN BE

25 UNITS

OR

100 UNITS

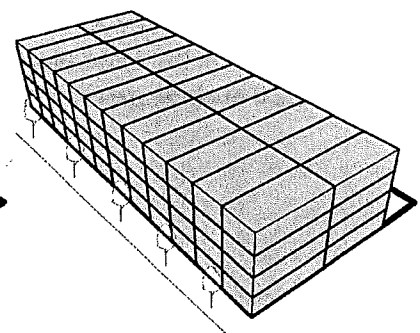
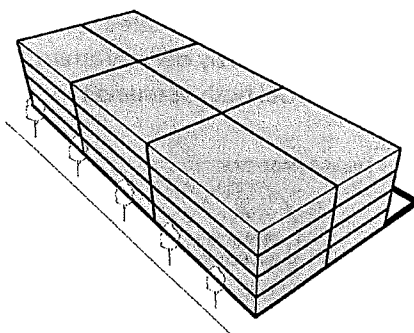
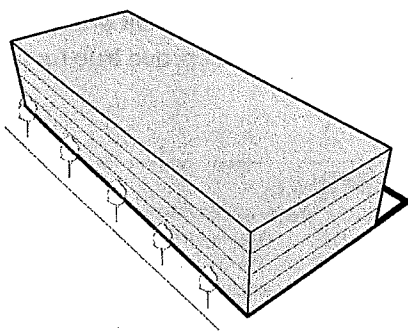

2,400 GSF  
UNIT SIZE

600 GSF  
UNIT SIZE

**DENSITY LIMITS**

Defined by the planning code to limit the total number of residential units (such as 1 unit per every 400 SF of lot area).

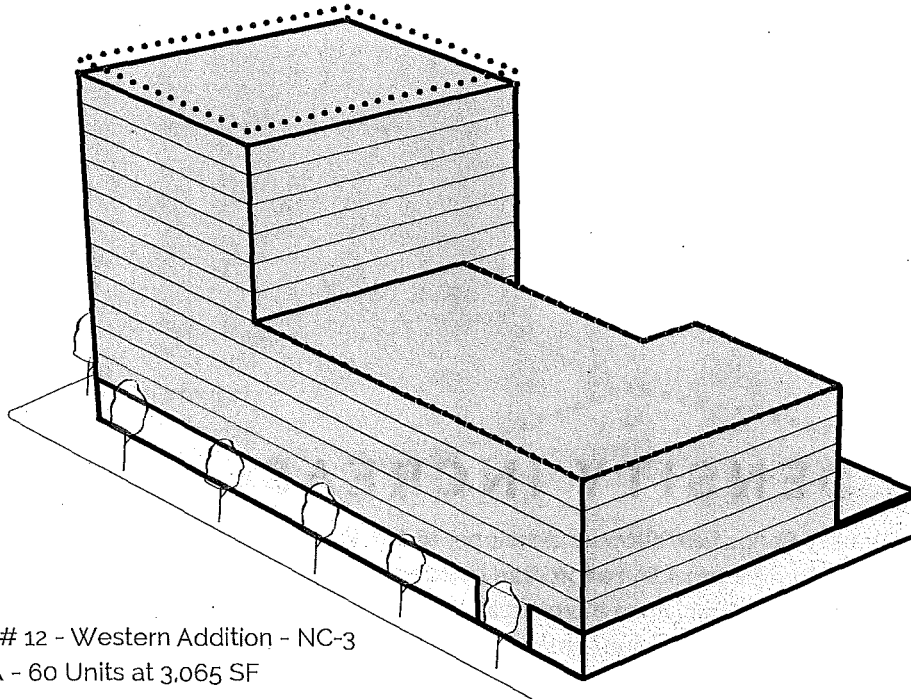



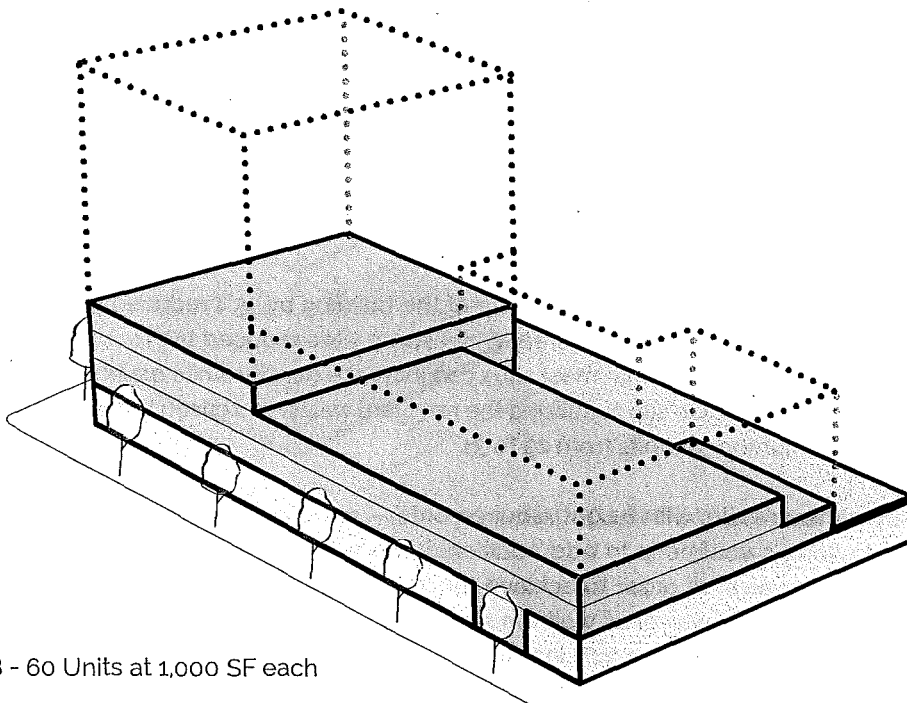

Prototype # 12 - Western Addition - NC-3  
Scenario A - 60 Units at 3,065 SF

**SCENARIO A - FULL ENVELOPE BASE CASE**  
Scenario A models the full physical envelope allowed by zoning constraints and complies with all other planning code requirements.



Scenario B - 60 Units at 1,000 SF each





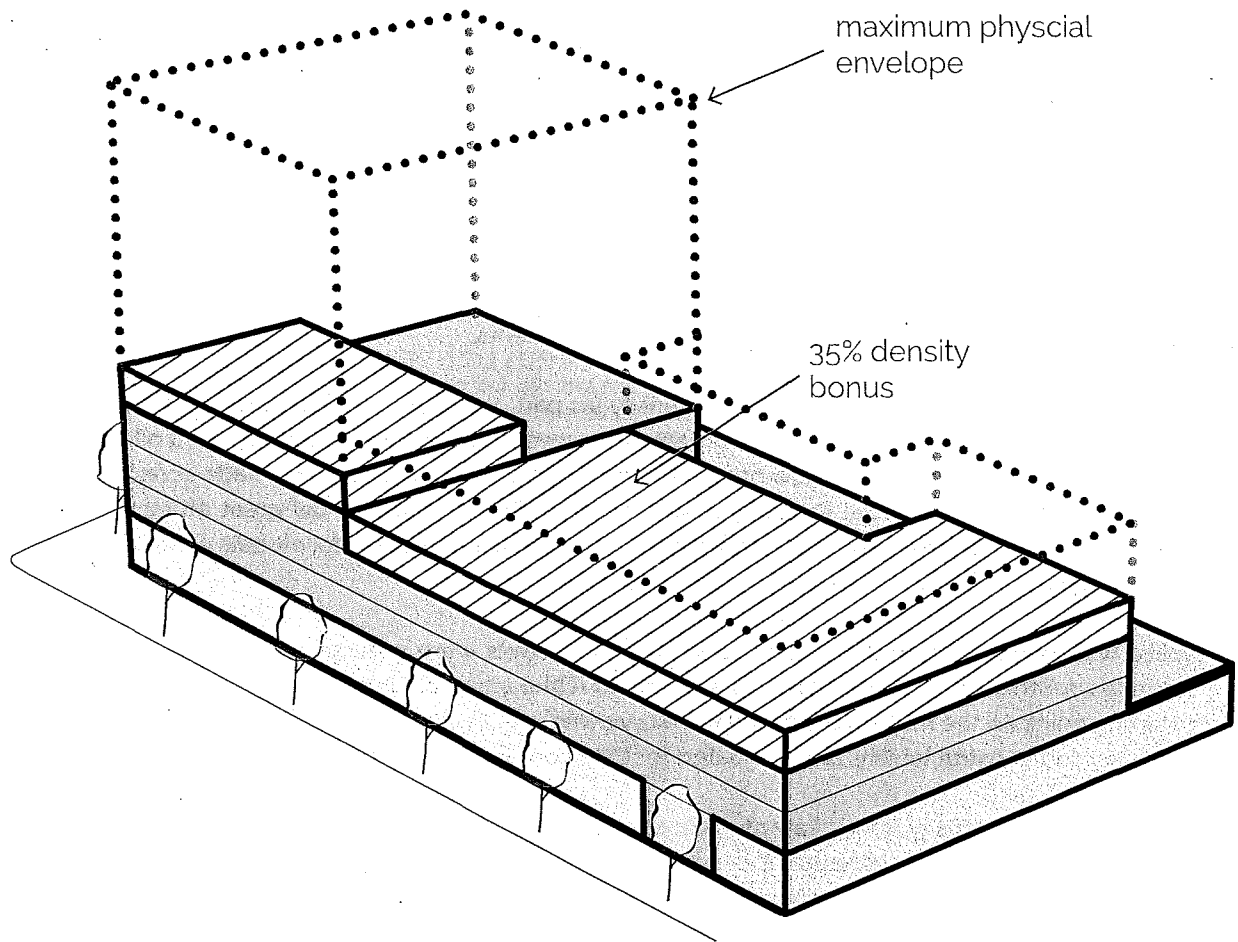

**KEY**

-  RESIDENTIAL
-  RETAIL
-  GARAGE
-  OPEN SPACE
-  MAX. ENVELOPE

**SCENARIO B - MARKET INFORMED BASE CASE**  
Scenario B was modeled first by computing the allowed number of units based on site density limitations and lot size. A target residential square footage was then identified by multiplying the number of units allowed by an assumed average unit size.



35% Density Increase - 81 Units at 1,000 SF

KEY	
	RESIDENTIAL
	RETAIL
	GARAGE
	OPEN SPACE
	35% INCREASE
	MAX. ENVELOPE

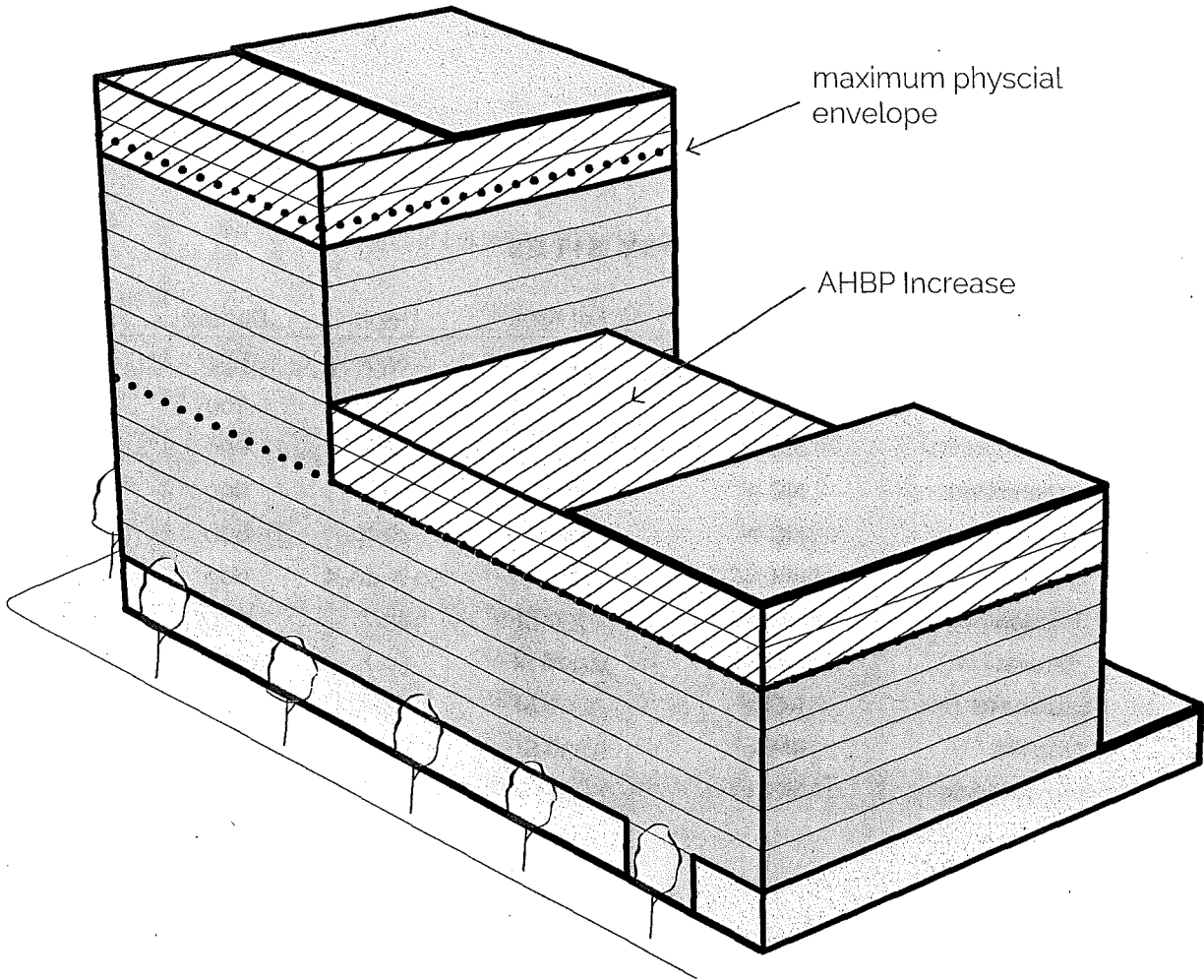

Local Affordable Housing Bonus Program - 233 Units at 1,000 SF

KEY	
	RESIDENTIAL
	RETAIL
	GARAGE
	OPEN SPACE
	AHBP INCREASE
	MAX. ENVELOPE

**MODELING THE LOCAL AFFORDABLE HOUSING BONUS PROGRAM**  
 All the studies of the Affordable Housing Bonus Program followed these rules:

- Increased height by two stories, not to exceed 20 feet
- Deviated as necessary from the Planning Code to reach the additional density goals by following the Menu of Waivers (see section below)

BASE CASE (CODE CONFORMING) FINDINGS					Height	Bulk	FAR	Rear Yard	Parking	Exposure
#	Neighborhood	Res. GSF	Units	Unit GSF	Waivers					
1	Outer Excelsior	40,008 SF	24	1667 SF	-	-	-	-	-	-
2	Van Ness	76,691 SF	60	1278 SF	-	-	-	-	-	-
3	Outer Sunset	28,339 SF	17	1667 SF	-	-	-	-	-	-
5	Inner Richmond	12,497 SF	8	1562 SF	-	-	-	-	-	-
6	Balboa	38,241 SF	23	1667 SF	-	-	-	-	-	-
7	Haight	57,000 SF	57	1000 SF	-	-	-	-	-	-
8	Mission	7,998 SF	6	1333 SF	-	-	-	-	-	-
9	Taraval	19,995 SF	15	1333 SF	-	-	-	-	-	-
10	Russian Hill	25,327 SF	19	1333 SF	-	-	-	-	-	-
11	Nob Hill	35,485 SF	47	755 SF	-	-	-	-	-	-
12	Western Addition	60,000 SF	60	1000 SF	-	-	-	-	-	-



LOCAL AFFORDABLE HOUSING BONUS PROGRAM FINDINGS						Height	Bulk	FAR	Rear Yard	Parking	Exposure
#	Neighborhood	Res. GSF	Units	Unit GSF	% Inc. B.C.*	Waivers					
1	Outer Excelsior	64,239 SF	56	1147 SF	133%	X	X	-	-	-	-
2	Van Ness	119,267 SF	123	970 SF	105%	X	X	X	X	-	X
3	Outer Sunset	56,651 SF	34	1667 SF	200%	X	-	-	X	X	X
5	Inner Richmond	20,137 SF	13	1562 SF	162%	X	-	-	-	X	-
6	Balboa	71,705 SF	43	1667 SF	187%	X	-	-	X	-	X
7	Haight	120,221 SF	134	897 SF	135%	X	-	-	-	X	-
8	Mission	18,270 SF	14	1333 SF	233%	X	-	-	-	X	-
9	Taraval	61,247 SF	46	1333 SF	207%	X	-	-	X	X	X
10	Russian Hill	43,292 SF	32	1333 SF	168%	X	-	-	-	-	-
11	Nob Hill	48,774 SF	65	755 SF	138%	X	-	-	-	X	-
12	Western Addition	232,809 SF	233	1000 SF	288%	X	X	-	-	X	-

\* % Unit Increase from Base Case

## REAR YARD

Planning Code Section 134, Rear Yards, was written to preserve the open space in the middle of smaller blocks where typical lots measure 25' x 100'. In most zones, Section 134 requires that rear yard depth shall be at least 25% of the lot's total depth, and no less than 15 feet deep. In the current code, rear yards must be either on grade or on the building's lowest level of residential dwelling. It is worth noting that any residential dwelling facing a code-complying rear yard is automatically considered to be in compliance with Section 140, as it relates to exposure.

This waiver does not eliminate the rear yard requirement entirely but instead provides greater flexibility while still fulfilling the code's original intent. A waiver of Section 134 modifies the requirement in three ways: first by reducing the percentage of open space from 25% to 20%; second, by allowing the open space to occur anywhere on the lot (similar to the current modification of code Sections 134e and 134f); and third, by never requiring the rear yard to be on grade but rather always allowing it to occur on the first level of residential dwelling.

In the majority of the prototypes, rear yard compliance was a major hurdle, and the study made it clear that flexibility with the rear yard would foster more effective and efficient development. Four of the prototypes (sites 2, 3, 6, 9) benefited from a rear yard waiver. Two of the five exceeded the 20% minimum but only when we were flexible with the configuration. One prototype, site 9, explored a 16% reduction but the project team felt this was too great.

## HEIGHT

San Francisco is divided into height and bulk districts as indicated on the Zoning Map and in Article 2.5 of the Planning Code. These districts define and restrict the maximum height and bulk allowed per parcel — in other words, how tall and big a parcel's building may be — and vary dramatically throughout the study area. In fact, the height restrictions studied ranged from 40 to 130 feet.

This waiver permits a project to apply for up to 20 feet (or two stories) of additional building height, yielding more residential units. This is allowed in addition to the 5-foot height increase designed to encourage a gracious ground floor (see Design Guidelines, a separate publication from this study).

The majority of the sites studied under the Local Affordable Housing Bonus program and all sites studied under the State Density Bonus program required a height waiver to achieve the desired increase in density. In many of the neighborhoods studied, buildings that exceed the height limits already exist; therefore there is some precedence for increased height on some parcels. Additionally, the 20-foot height increase will be a critical tool to incentivize use of the State and Local Density Bonus programs.

## FAR

Planning Code Section 124, Basic Floor Area Ratio, limits the ratio of building floor area to parcel area. This section does not typically apply to residential square footage but it does apply in some zoning districts and in Special Use Districts within the city.

Of the sites studied, only one had an FAR restriction (and FAR restrictions probably apply to a much smaller percentage of parcels city wide). This waiver allows a project to be relieved from FAR requirements, should they apply.

By utilizing the FAR waiver and the rear yard, exposure, height, and bulk waivers, site 2's unit count doubled, starting at 60 in the Base Case and increasing to 123 in the Local Density Bonus Program model.

## PARKING

Planning Code Section 151, Off-Street Parking, determines the maximum allowed or minimum required amount of off-street parking within new developments. As stated in the Planning Code, the intent of this section is to strike a balance between the need for private parking and the encouragement of walking, cycling, and the use of public transit.

Parking minimums have already been replaced with parking maximums in large areas of the city that have been recently rezoned. Most of the sites studied are in neighborhood commercial districts or on transit corridors that have not been rezoned for decades and still require minimum amounts of parking — often 1:1 for dwelling units, a much larger ratio than what would be required today. This waiver allows relief from minimum parking requirements where they occur.

Nine sites (3, 5, 6, 7, 8, 9, 10, 11, and 12) required parking lifts to satisfy parking requirements, and seven sites (3, 5, 7, 8, 9, 11, and 12) could not meet the parking requirement without a waiver or significant underground excavation (an option that would likely hurt the project's economic feasibility). Offering a parking requirement waiver increases the area dedicated to residential and active ground-floor use and reduces costs associated with parking lifts or excavation for additional parking levels. The waiver not only gives developers additional incentive to take advantage of these Density Bonus Programs but also helps activate the street edge, which DBA believes to be an important element in successful urban spaces.

## OBSTRUCTIONS OVER STREETS AND ALLEY

Planning Code Section 136, Obstructions over Streets and Alleys, regulates overhanging elements such as bay windows and cornices. This waiver provides flexibility of this Planning Code section by loosening the strict rules on bay window and cornice width, depth, and configurations. More flexibility in other architectural features (such as sunshades) is also allowed.

This planning code section works well for the 40-foot-high residential buildings that constitute the majority of San Francisco. These regulations are less successful when applied to taller buildings, especially those where a more contemporary expression is appropriate.

Amendments to the rules for bay windows can create room for increased density and livability. This waiver also helps with good urban design by allowing more flexibility in the configuration of the bays. Taller buildings might benefit from wider bays than those currently allowed, for instance, and all buildings might benefit by reconfiguring the space formerly dedicated to bays to more efficient living. Flexibility in the amount and configuration of glazing on bays should also be allowed. Currently bays require 50% glazing, which might actually be too much glazing for residential use as it can cause the unit to overheat.

Sunshades, awnings, and other projections that are used to shade buildings and provide visual texture are also strictly regulated by the current code. Allowing additional flexibility with these elements would help ensure that buildings designed to meet increased density goals also succeed aesthetically and contextually.

DBA and other industry leaders agree that flexibility with façades and bays can help encourage denser yet still innovative and well-designed buildings.



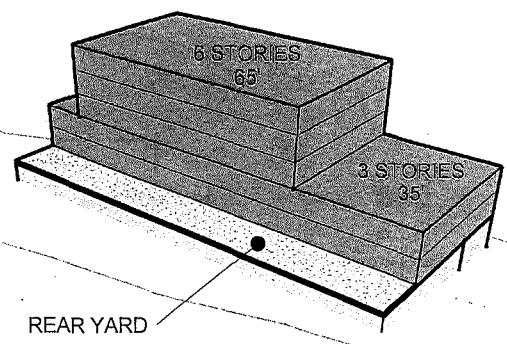
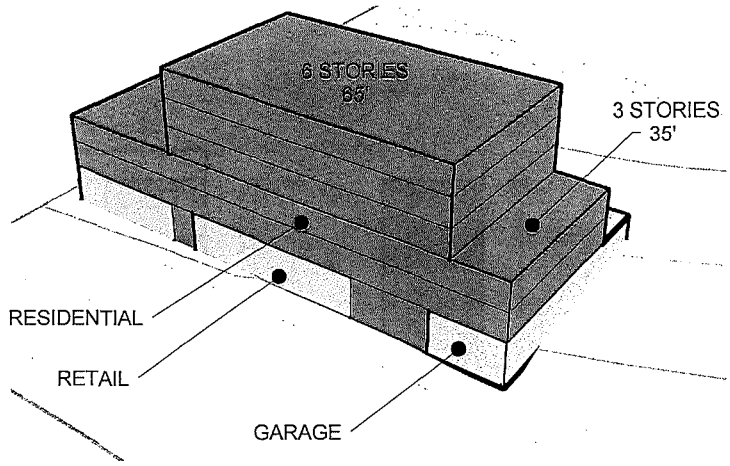

FE GROSS AREA	
Garage	10654 SF
Retail	2800 SF
Residential	42607 SF
Grand total	56061 SF

Open Space 3588 SF

Open Space Required: 24 UNITS X 100 SF = 2,400 SF

Residential Average Unit Size - 1775 GSF

19 Parking Spaces

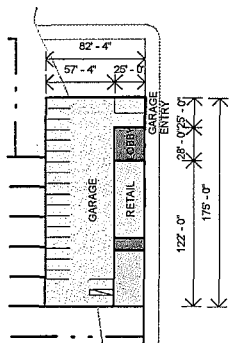

1 1" = 100'-0"

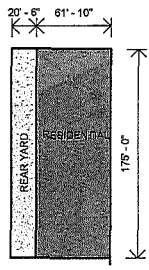

2 1" = 100'-0"

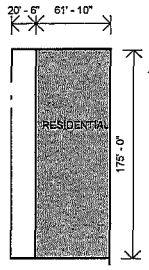

3 1" = 100'-0"

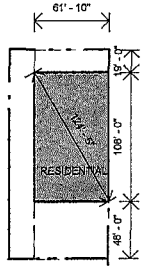

4-6 1" = 100'-0"

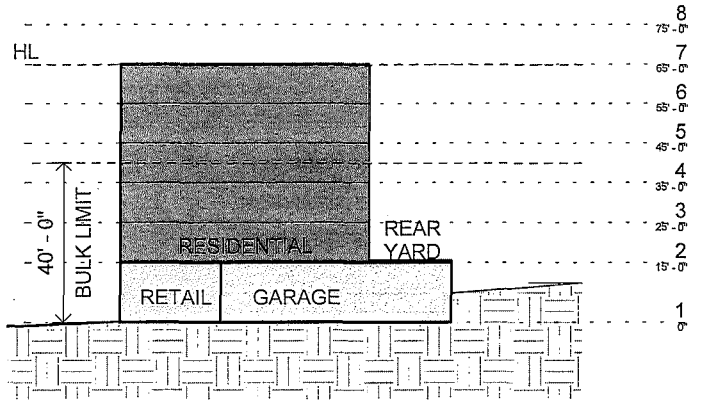

Section 1" = 30'-0"



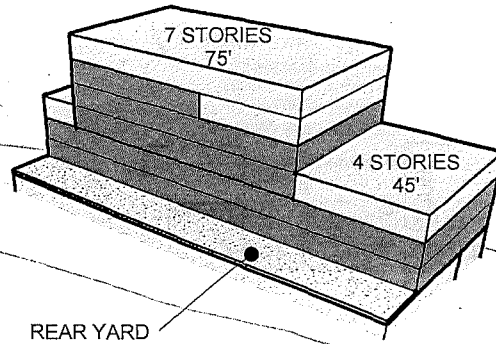
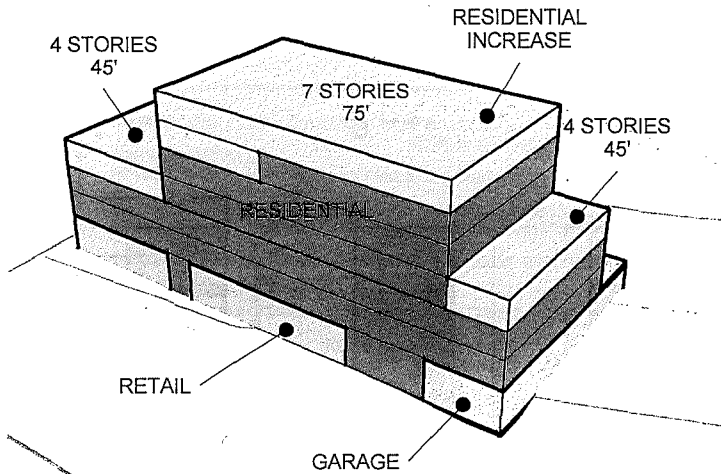

ACCOMMODATIONS NEEDED: HEIGHT, BULK

MARKET + 35% AREA	
Retail	2800 SF
Residential	53424 SF
Garage	10654 SF
Grand total	66877 SF

Residential Increase	13412 SF
Residential	40011 SF
	53424 SF

Open Space	3588 SF
------------	---------

Open Space Required: 32 UNITS X 100 SF = 3,200 SF  
 Residential Average Unit Size - 1667 GSF  
 19 Parking Spaces

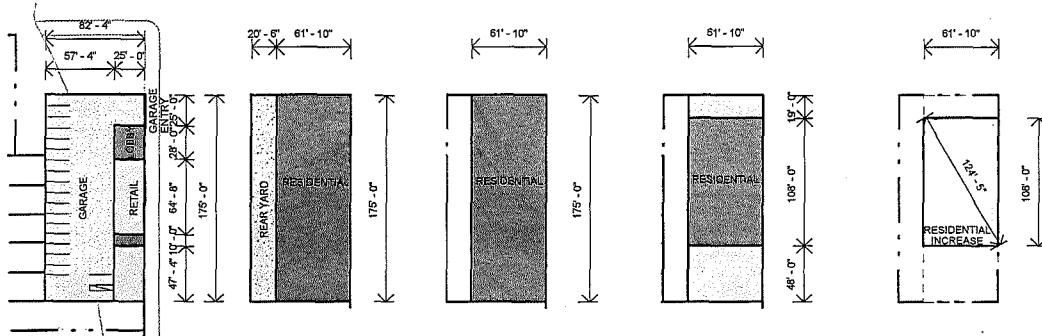

1 1" = 100'-0"      2 1" = 100'-0"      3 1" = 100'-0"      4 1" = 100'-0"      5-7 1" = 100'-0"

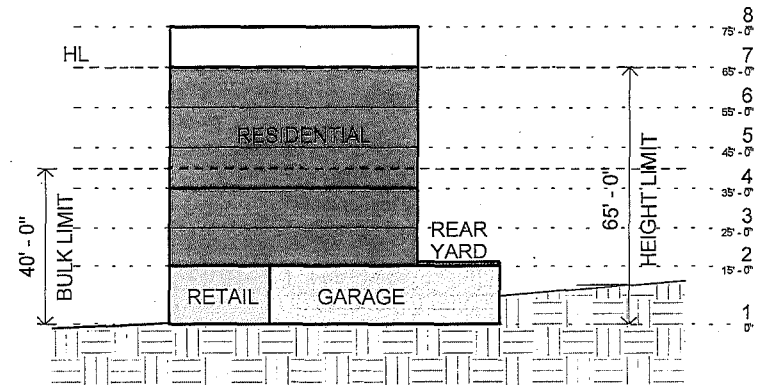

Section 1" = 30'-0"

# RC-4

VAN NESS SPECIAL USE DISTRICT

SCENARIO  
**A**

SCENARIO  
**B**

SCENARIO  
**C**

SCENARIO  
**D**

## FULL ENVELOPE BUILD OUT

PHYSICAL ENVELOPE ACHIEVABLE WITHIN ALLOWED HEIGHT AND ZONING REQUIREMENTS

**BASE FAR IS 4.8 X 24,201 (LOT AREA) = 116,165\* SF OF BLDG AREA ALLOWED (EXCLUDING GARAGE)**

\*BASE CASE IS UNABLE TO REACH MAX ALLOWED UNDER FAR BECAUSE OF HEIGHT AND BULK LIMITATIONS. Per PC Section 243, density constraints on this site are waived and FAR does apply to this site per the Van Ness SUD. It should be noted that this is a very unique condition because FAR rarely applies to residential.

**BASE AREA - MAXIMUM AMOUNT OF RESIDENTIAL DENSITY ACHIEVABLE WITHIN ALLOWED HEIGHT AND BULK REQUIREMENTS = 76,691 SF RESIDENTIAL (TOTAL FAR ACHIEVABLE = 86,682 SF)**

BASE RES. SF ACHIEVABLE / BASE # OF UNITS ALLOWED 76,691 SF / 121 UNITS = 634 GSF AVG. UNIT SIZE

## MARKET INFORMED BASE CASE

UNIT SIZE ASSUMPTION BASED ON CURRENT MARKET DATA

MAXIMUM AMOUNT OF RESIDENTIAL DENSITY ACHIEVABLE WITHIN ALLOWED HEIGHT AND BULK REQUIREMENTS = 76,691 SF RESIDENTIAL

ASSUMING 78% EFFICIENCY (PER TSP STUDY) = 60 UNITS ACHIEVABLE WITHIN ALLOWED HEIGHT AND BULK CONSTRAINTS

RES. SF ACHIEVABLE / BASE # OF UNITS ALLOWED 76,691 SF / 60 UNITS = 1278 SF AVG. GROSS UNIT

FULL ENVELOPE BUILD OUT AND MARKET BASE CASE ARE THE SAME AMOUNT OF RESIDENTIAL SF AND ARE BOTH INCLUDED ON SHEET 2.

## MARKET INFORMED BASE + 35 % INCREASE

MARKET BASE CASE FROM ABOVE WITH 35% DENSITY BONUS

60 UNITS ACHIEVABLE X 1.35% DENSITY INCREASE = 81 UNITS  
1,000 NET SF / 1,333 GROSS SF ASSUMED UNIT SIZE

81 UNITS ALLOWED X 1,333 GROSS SF ASSUMED UNIT SIZE = 107,973 ALLOWED RESIDENTIAL GSF  
ACCOMMODATIONS NEEDED: HEIGHT, BULK, FAR, REAR YARD

## AFFORDABLE HOUSING BONUS PROGRAM

DENSITY INCREASE TO FULL ENVELOPE

123 UNITS\*  
119,267 RESIDENTIAL GSF

119,267 GSF / 123 UNITS = 970 AVG GSF UNIT SIZE

ACCOMMODATIONS NEEDED: HEIGHT, BULK, FAR, REAR YARD  
HEIGHT INCREASED FROM 80' TO 100'  
123 UNITS IS 105 % INCREASE IN DENSITY FROM BASE CASE

\*NOTE: ASSUMED 123 UNITS NEEDED FOR FINANCIAL VIABILITY PER RESULTS OF FINANCIAL ANALYSIS

### ZONING PARAMETERS

ZONING CLASSIFICATIONS: RC-4, VAN NESS SPECIAL USE DISTRICT  
LOT: 0594001

LOT AREA: 24, 201 SF

HEIGHT AND BULK: 80-D

BULK DISTRICT	Height Above Which Maximum Dimensions Apply (in feet)	Maximum Plan Dimensions (in feet)	
		Length	Diagonal dim.
D	40	110	140

REAR YARD: 25% OF LOT DEPTH, NO LESS THAN 15 FEET (AT DWELLINGS LEVELS ONLY). MAY BE WAIVED 243 (C) (7) (25% OF LOT DEPTH = 34.5) PER PC SECT. 134 (a) (c) REAR YARD SHALL BE PROVIDED AT LOWEST STORY CONTAINING A DWELLING UNIT

DENSITY: 1 PER 200 SF OF LOT AREA = 24,201 SF / 200 = 121 UNITS MAX PER SECT. 243, DENSITY CONSTRAINTS ARE WAIVED.

FLOOR AREA RATIO: DOES NOT APPLY TO DWELLINGS PER RC-4 BUT DOES APPLY IN VAN NESS SUD = 4.8:1 (PARKING NOT INCLUDED)

4.8 X 24,201 SF TOTAL LOT AREA = 116,164.8 SF TOTAL BLDG AREA ALLOWED

FRONT SETBACK: NONE, NO REQ. PER RC-4 BUT PER VNSUD, SEC. 253.2 MAY APPLY WHERE ABOVE 50' ALONG VAN NESS, 20' IS REQ. - ASSUME NO SETBACK ALONG VAN NESS IS REQ.

USABLE OPEN SPACE: 36 SF PER UNIT IF ALL PRIVATE; 80 SF IF COMMON SPACE. 36 SF PER UNIT FOR LIVE/WORK

80 SF X 121 UNITS = 9680 SF

PARKING REQ: 1 PER 4 DWELLING UNITS, BUT POTENTIAL MODIFICATION/WAIVER BY ZA PER SECT. 161(J).

ACCOMMODATIONS NEEDED: HEIGHT, BULK, FAR, REAR YARD

### MARKET + 35% AREA

Garage	25672 SF
Residential	108252 SF
Retail	9991 SF
Grand total	143915 SF

Residential	69409 SF
Residential Increase	38844 SF
	108252 SF

Open Space	9986 SF
------------	---------

Open Space Required: 81 UNITS X 80 SF = 6,480 SF

Residential Average Unit Size - 1333 GSF

39 Parking Spaces / 39 Required

Garage - 18 Spaces Required for Commercial

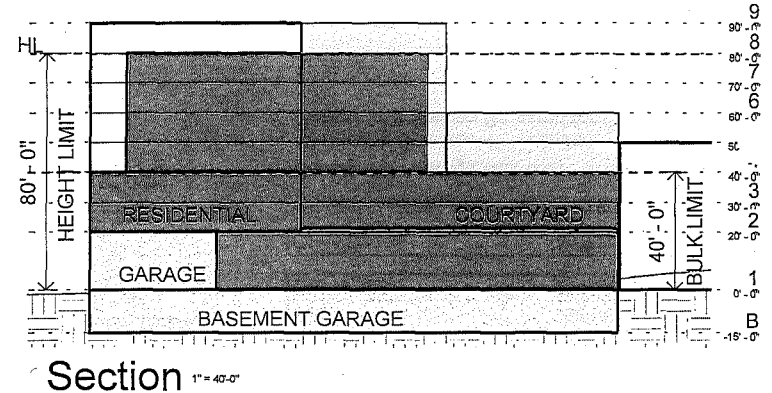
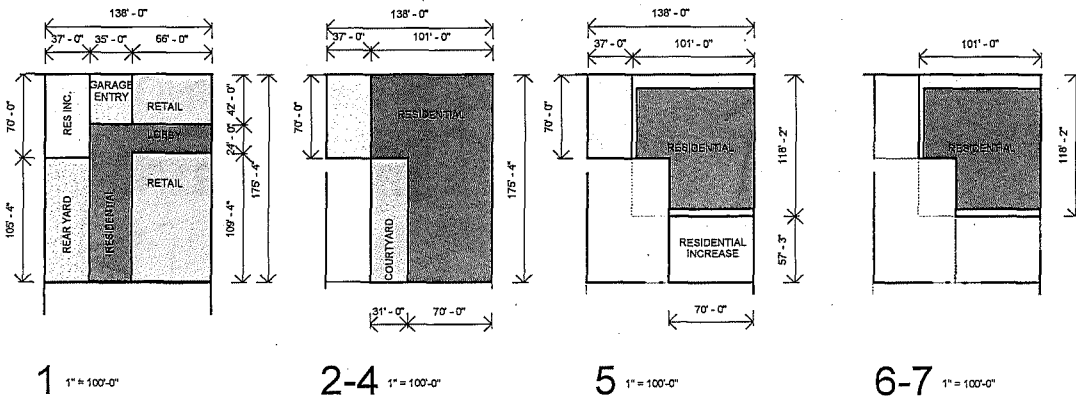
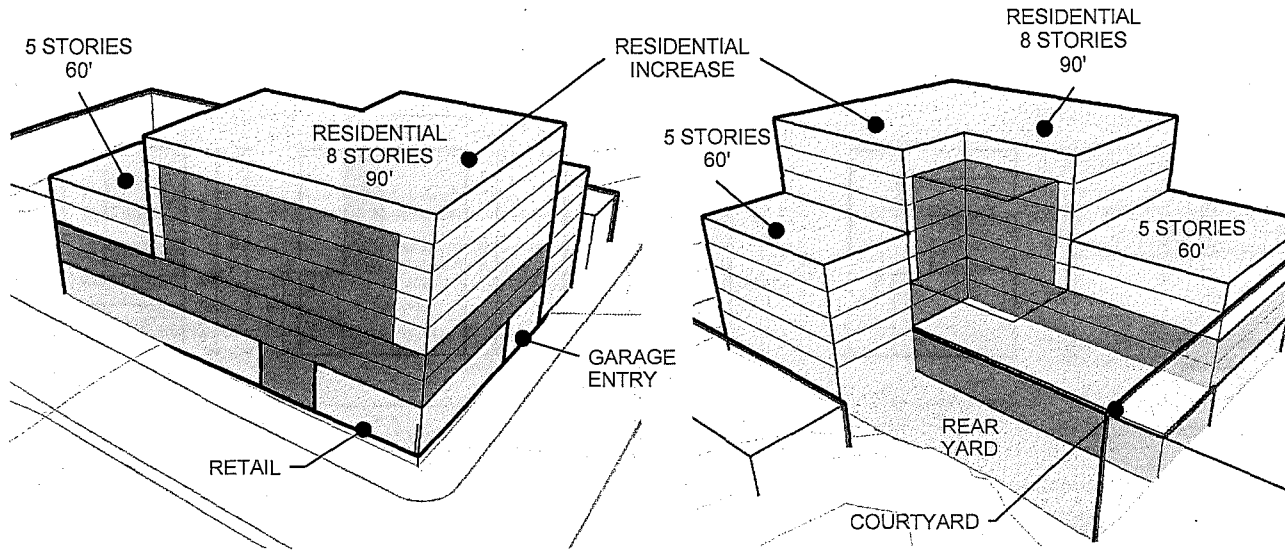

# NC-1

## OUTER SUNSET

### ZONING PARAMETERS

ZONING CLASSIFICATIONS: NC-1  
LOTS: 1800010D

LOT AREA: 13,500 SF

HEIGHT AND BULK: 40-X

REAR YARD: (SECT 134): 25% lot depth no less than 15 feet, AT GRADE. Can be a corner configuration per Sec. 134(e)(2).

DENSITY: 1 unit / 800 sq. ft lot area                      13,500/800 = 17 UNITS

FLOOR AREA RATIO: 1.8:1 (DOES NOT APPLY TO RESIDENTIAL USES)

FRONT SETBACK: NONE

STREET FRONTAGE: Commercial not required. Active uses required (res. or comm.)

- IF RESIDENTIAL, 50% OF STREET FRONTAGE SHOULD BE WALK UP UNITS
- LOBBY IS LESS THAN 40' OR 25% OF STREET FRONTAGE

USABLE OPEN SPACE: 100SF / DU if private, 133 SF if common (also consider min. dimension reqs.)  
17 UNITS x 133 SF = 2,261 SF

PARKING REQ.: 1:1 but potential modification/waiver by ZA per sec. 161(j)

GROUND FLOOR HEIGHT (SECT 145.1): 10' MINIMUM (Floor to floor)  
• 5' Ground floor height bump allowed per section 263.20

SCENARIO  
**A**

### FULL ENVELOPE BUILD OUT

PHYSICAL ENVELOPE ACHIEVABLE WITHIN ALLOWED HEIGHT AND ZONING REQUIREMENTS

LOT AREA 13,500 / 800 SF = 17 UNITS (MAX ALLOWED)

BASE RESIDENTIAL AREA - MAXIMUM AMOUNT OF RESIDENTIAL DENSITY ACHIEVABLE WITHIN ALLOWED HEIGHT AND ZONING REQUIREMENTS = 32,073 SF

BASE RES. SF ACHIEVABLE / BASE # OF UNITS ALLOWED 32,073 SF / 17 UNITS = 1,887 SF AVG. GROSS UNIT

SCENARIO  
**B**

### MARKET INFORMED BASE CASE

UNIT SIZE ASSUMPTION BASED ON CURRENT MARKET DATA

LOT AREA 13,500 / 800 SF = 17 UNITS (MAX ALLOWED)

1250 NET SF / 1667 GROSS SF ASSUMED UNIT SIZE

1667 GSF x 17 = 28,339 ALLOWED RESIDENTIAL GSF

THE MARKET INFORMED BASE CASE IS LESS THAN THE ALLOWABLE BUILDING ENVELOPE.

SCENARIO  
**C**

### MARKET INFORMED BASE + 35 % INCREASE

MARKET BASE CASE FROM ABOVE WITH 35% DENSITY BONUS

LOT AREA 13,500 / 800 SF = 17 UNITS (MAX ALLOWED)

1250 NET SF / 1667 GROSS SF ASSUMED UNIT SIZE

17 MAX UNITS ALLOWED X 1.35% DENSITY INCREASE = 23 UNITS ALLOWED

23 UNITS ALLOWED x 1667 GROSS SF ASSUMED UNIT SIZE = 38,341 ALLOWED RESIDENTIAL GSF

ACCOMMODATIONS NEEDED: HEIGHT, REAR YARD, PARKING

SCENARIO  
**D**

### AFFORDABLE HOUSING BONUS PROGRAM

DENSITY INCREASE TO FULL ENVELOPE

56,651 RESIDENTIAL GSF

ASSUMED UNIT SIZE FROM MARKET INFORMED BASE CASE = 1,667 GSF UNIT SIZE

56,651 SF / 1667 SF = 34 UNITS

ACCOMMODATIONS NEEDED: HEIGHT, REAR YARD, PARKING

HEIGHT INCREASED TO 65' FROM 45'

34 UNITS IS 200% INCREASE IN ALLOWED UNITS FROM BASE CASE

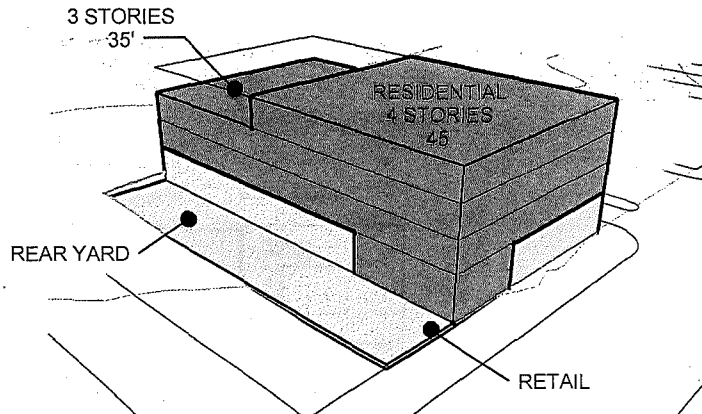
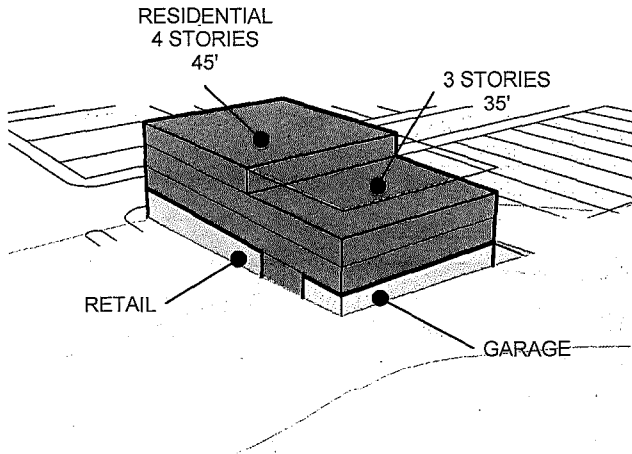

MARKET BASE CASE	
Garage	5102 SF
Residential	27862 SF
Retail	3404 SF
Grand total	36368 SF
Open Space	3386 SF

Open Space Required: 17 UNITS X 133 SF = 2,261 SF  
 Residential Average Unit Size - 1667 GSF  
 18 Parking Spaces (Lifts) / 17 Required

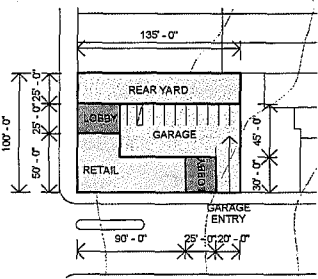

1 1" = 100'-0"

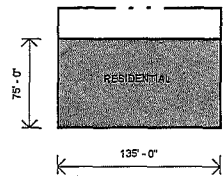

2-3 1" = 100'-0"

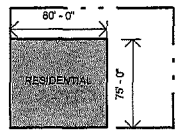

4 1" = 100'-0"

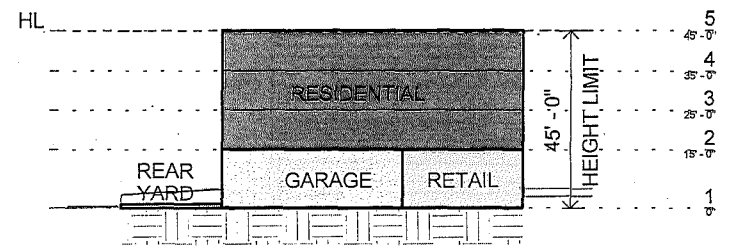

Section 1" = 30'-0"

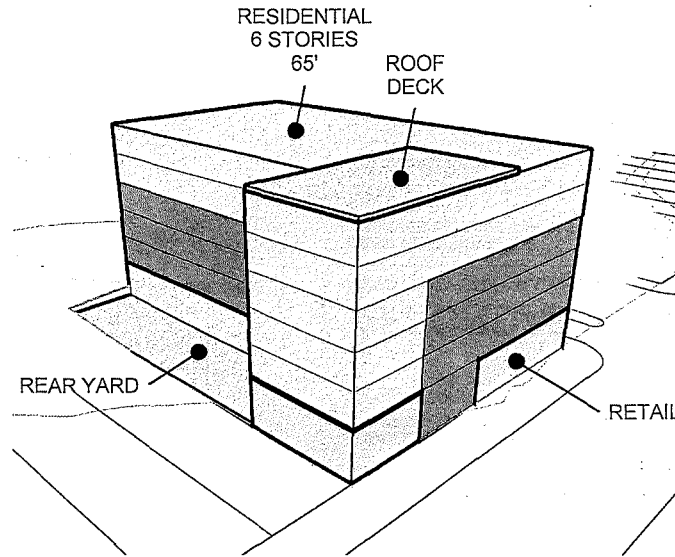
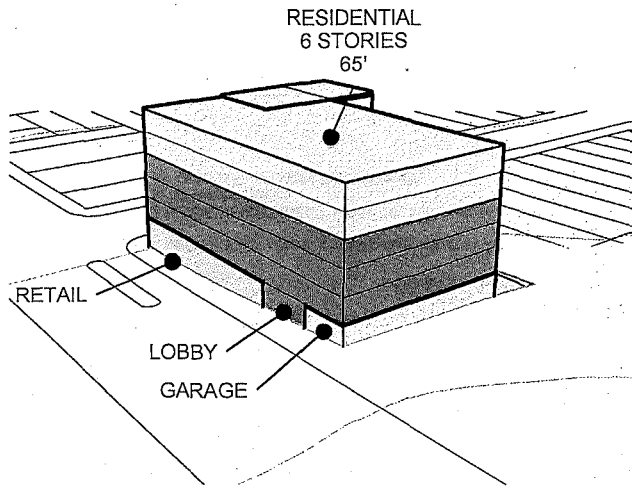

ACCOMMODATIONS NEEDED: HEIGHT, REAR YARD, PARKING

BONUS PROGRAM	
Retail	3403 SF
Residential	56651 SF
Garage	5103 SF
<b>Grand total</b>	<b>65157 SF</b>
<hr/>	
Open Space	4606 SF

Open Space Required: 34 UNITS X 133 SF = 4,522 SF  
 Residential Average Unit Size - 1667 GSF  
 18 Parking Spaces (Lifts) / 34 Required

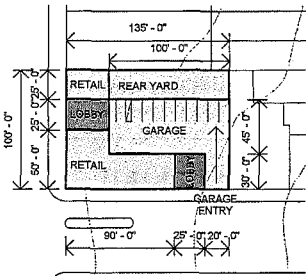

1 1" = 100'-0"

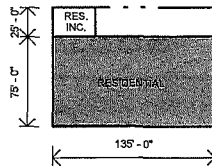

2-6 1" = 100'-0"

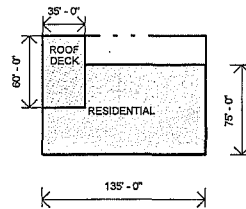

7 1" = 100'-0"

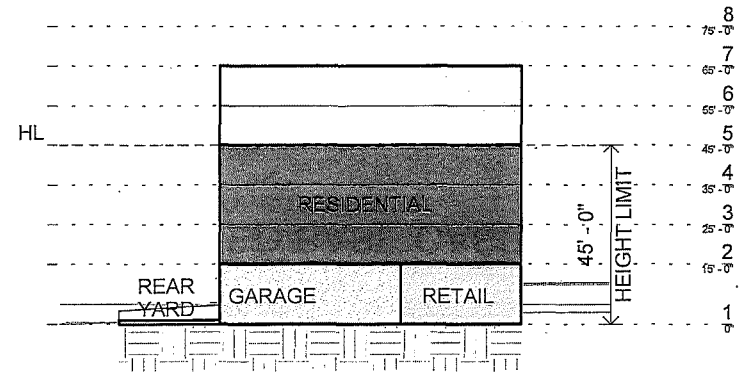

Section 1" = 30'-0"

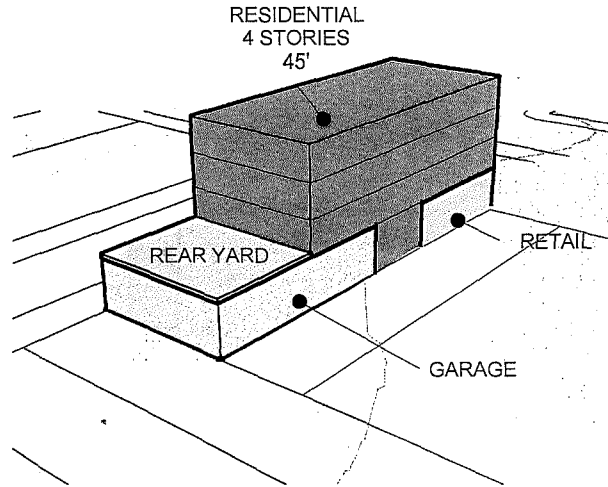
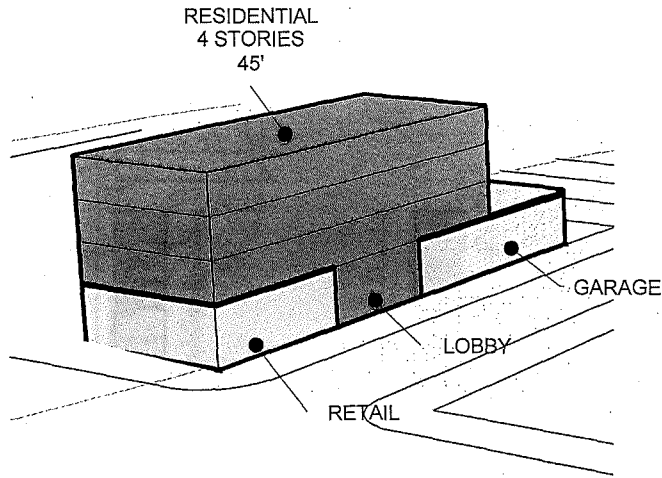

FE GROSS AREA	
Retail	1655 SF
Garage	2462 SF
Residential	12497 SF
Grand total	16614 SF

Open Space	1336 SF
------------	---------

Open Space Required: 8 UNITS X 133 SF = 1,064 SF  
 Residential Average Unit Size - 1562 GSF  
 10 Parking Spaces (Lifts) / 8 Required

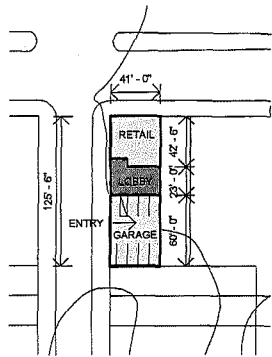

1 1"=100'-0"

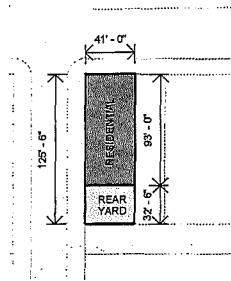

2 1"=100'-0"

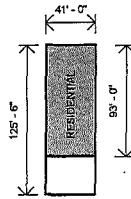

3 1"=100'-0"

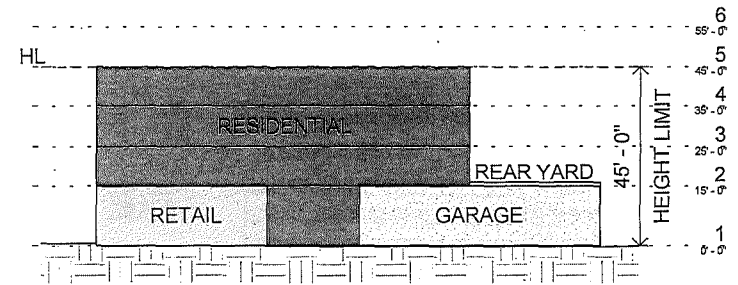

Section 1"=30'-0"

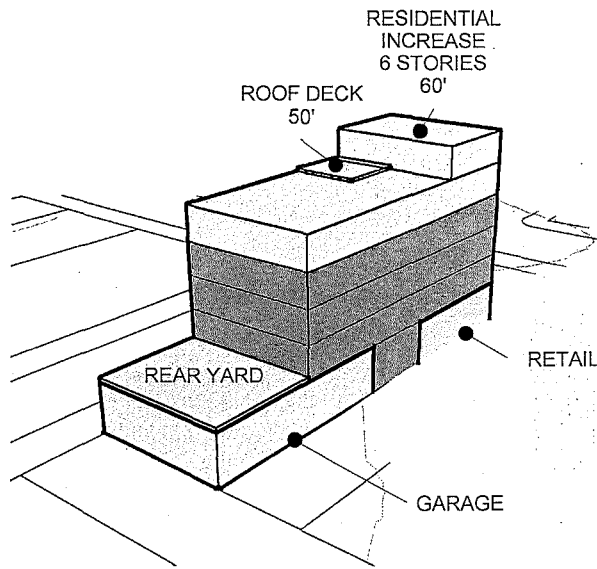
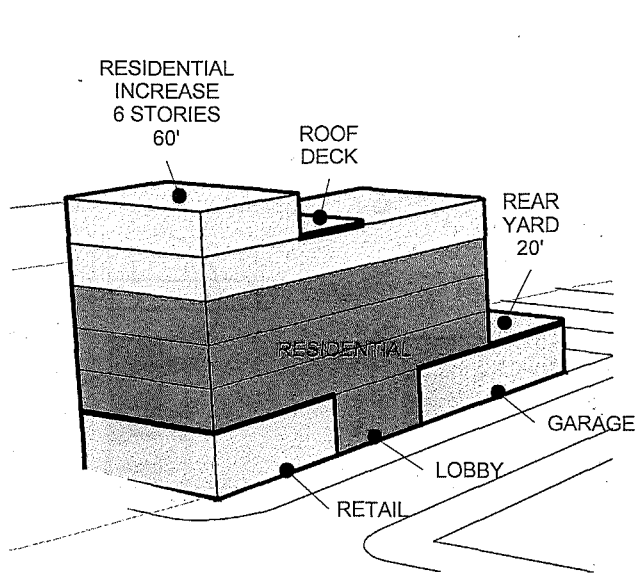

ACCOMMODATIONS NEEDED: HEIGHT

**MARKET + 35% AREA**

Garage	2462 SF
Residential	17458 SF
Retail	1655 SF
Grand total	21575 SF

Residential Increase	4961 SF
Residential	12497 SF
	17458 SF

Open Space	1733 SF
------------	---------

Open Space Required: 11 UNITS X 133 SF = 1,463 SF

Residential Average Unit Size - 1562 GSF

11 Parking Spaces (Lifts) / 11 Required

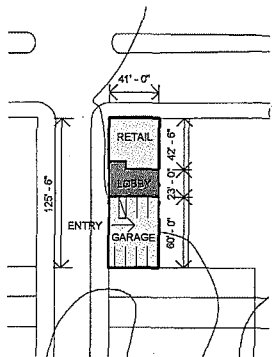

1 1" = 100'-0"

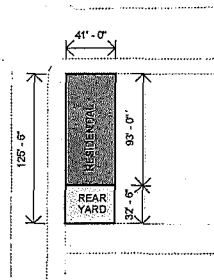

2 1" = 100'-0"

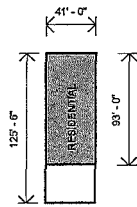

3-5 1" = 100'-0"

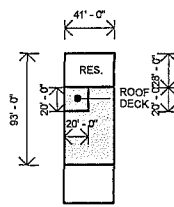

6 1" = 100'-0"

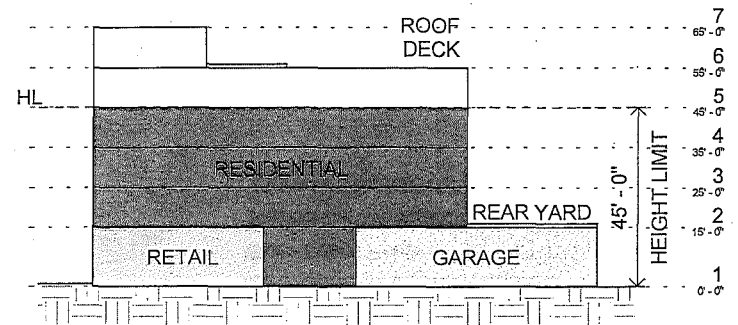

Section 1" = 30'-0"



# NC-2

BALBOA

## ZONING PARAMETERS

ZONING CLASSIFICATIONS: NC2 Balboa  
LOTS: 1606001, 1606046, 1606045, 1606044

LOT AREA: 18,620 SF

HEIGHT AND BULK: 40-X'

REAR YARD: 25% at 2nd Story and above, or at 1st Story if it contains a DU. Can be a corner configuration per Sect. 134(e)(2).

DENSITY: 1 unit / 800 SF lot area      18,620/800 = 23 UNITS

FLOOR AREA RATIO: 2.5:1 (DOES NOT APPLY FOR RESIDENTIAL USES)

STREET FRONTAGE: Active uses required (res or comm.)

- IF RESIDENTIAL, 50% OF STREET FRONTAGE SHOULD BE WALK UP UNITS
- LOBBY IS LESS THAN 40' OR 25% OF STREET FRONTAGE

OPEN SPACE: 100sf/DU if private, x 1.33 = 133 SF if common (also consider min. dimension reqs.)  
23 UNITS X 133 SF = 3,059 SF

PARKING REQ.: 1:1, but potential modification/waiver by ZA per Sect. 161(j)

GROUND FLOOR HEIGHT: 10' MINIMUM (FLOOR TO FLOOR)  
• 5' Ground floor height bump allowed per section 263.20



## FULL ENVELOPE BUILD OUT

PHYSICAL ENVELOPE ACHIEVABLE WITHIN ALLOWED HEIGHT AND ZONING REQUIREMENTS

LOT AREA 18,620/800 SF = 23 UNITS (MAX ALLOWED)

BASE AREA - MAXIMUM AMOUNT OF RESIDENTIAL DENSITY ACHIEVABLE WITHIN ALLOWED HEIGHT AND ZONING REQUIREMENTS = 39,831 SF

BASE RES. SF ACHIEVABLE / BASE # OF UNITS ALLOWED 39,381 SF / 23 UNITS = 1,732 SF AVG. GROSS UNIT

## MARKET INFORMED BASE CASE

UNIT SIZE ASSUMPTION BASED ON CURRENT MARKET DATA

LOT AREA 18,691/800 SF = 23 UNITS (MAX ALLOWED)

1250 NET SF / 1667 GROSS SF ASSUMED UNIT SIZE

1667 GSF x 23 = 38,341 ASSUMED RESIDENTIAL GSF

THE MARKET INFORMED BASE CASE IS HIGHER THAN WHAT ZONING ALLOWS, THEREFORE THE FULL ENVELOPE BUILD OUT WILL BE CONSIDERED THE BASE CASE.

## MARKET INFORMED BASE + 35 % INCREASE

MARKET BASE CASE FROM ABOVE WITH 35% DENSITY BONUS

LOT AREA 18,691/800 SF = 23 UNITS (MAX ALLOWED)

1250 NET SF / 1667 GROSS SF ASSUMED UNIT SIZE

23 MAX UNITS ALLOWED X 1.35% DENSITY INCREASE = 31 UNITS ALLOWED

31 UNITS ALLOWED x 1667 GROSS SF ASSUMED UNIT SIZE = 51,677 ALLOWED RESIDENTIAL GSF

ACCOMMODATIONS NEEDED: HEIGHT, REAR YARD

## AFFORDABLE HOUSING BONUS PROGRAM

DENSITY INCREASE TO FULL ENVELOPE

71,705 RESIDENTIAL GSF

ASSUMED UNIT SIZE TAKEN FROM MARKET INFORMED BASE CASE = 1,667 GSF UNIT SIZE

71,705 SF / 1667 SF = 43 UNITS

ACCOMMODATIONS NEEDED: HEIGHT, REAR YARD

HEIGHT INCREASED TO 65' FROM 45'

41 UNITS IS 187% INCREASE IN ALLOWED UNITS FROM BASE CASE

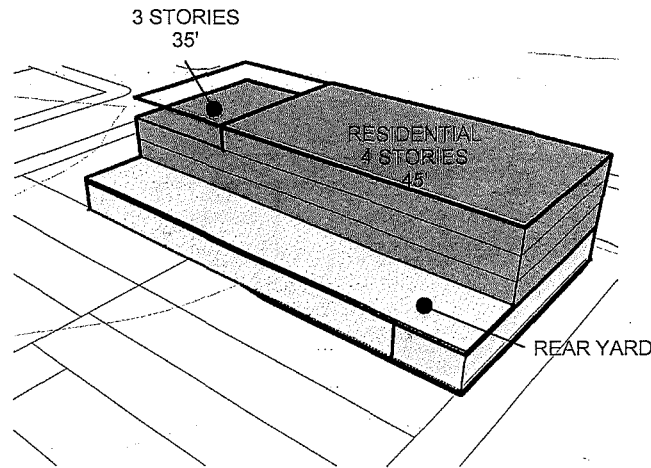
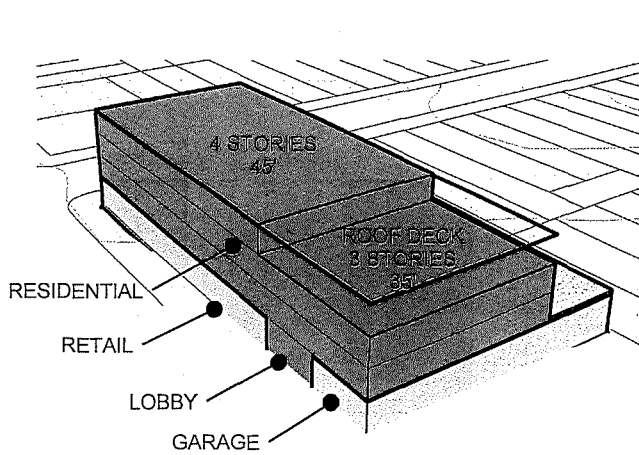

MARKET BASE CASE	
Retail	6900 SF
Residential	36000 SF
Garage	10600 SF
Grand total	53500 SF
Open Space	5550 SF

Open Space Required: 23 UNITS X 133 SF = 3,059 SF

Residential Average Unit Size - 1667 GSF

32 Parking Spaces / 23 Required

THE MARKET INFORMED BASE CASE IS HIGHER THAN WHAT ZONING ALLOWS, THEREFORE THE FULL ENVELOPE BUILD OUT WILL BE CONSIDERED THE BASE CASE.

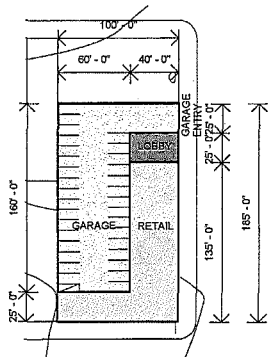

1 1" = 100'-0"

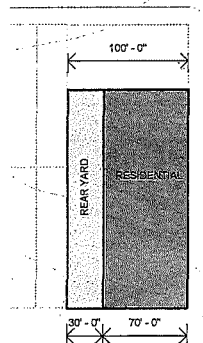

2 1" = 100'-0"

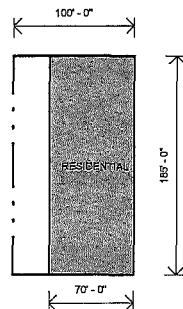

3 1" = 100'-0"

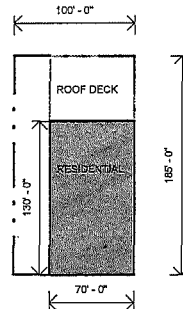

4 1" = 100'-0"

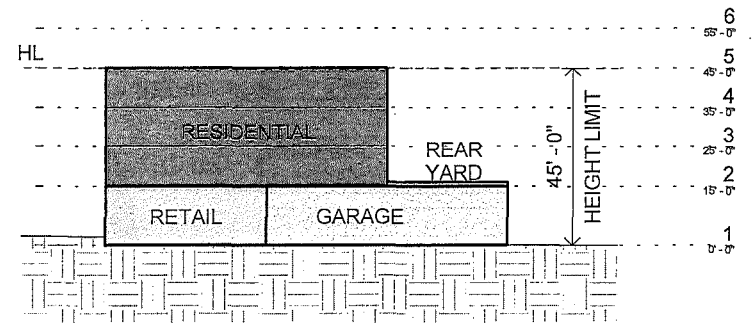

Section 1" = 30'-0"

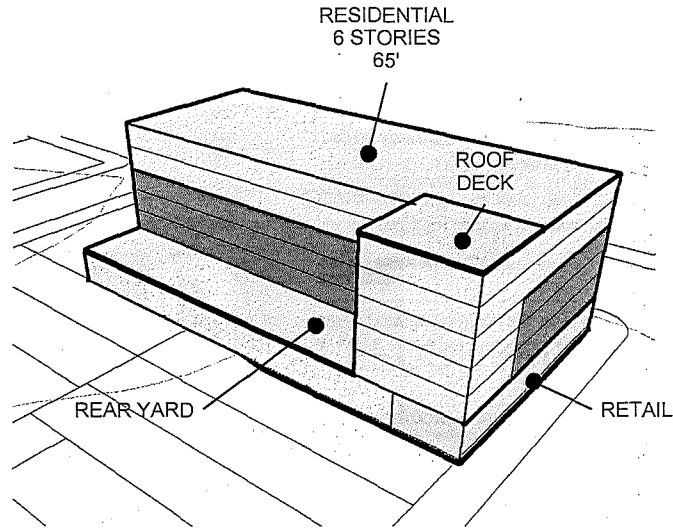
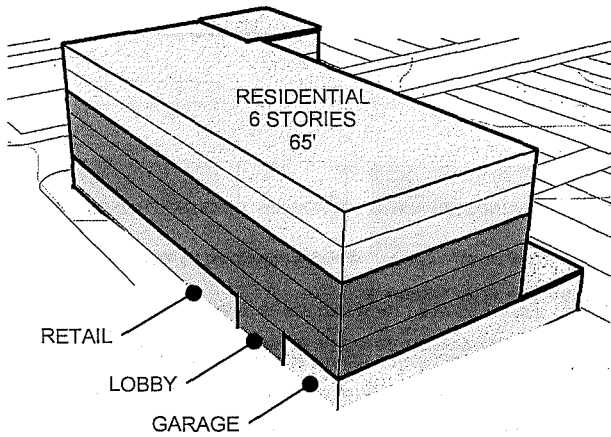

ACCOMMODATIONS NEEDED: HEIGHT, REAR YARD

BONUS PROGRAM	
Retail	6900 SF
Residential	71705 SF
Garage	10600 SF
Grand total	89205 SF
Open Space	5797 SF

Open Space Required: 43 UNITS X 133 SF = 5,719 SF  
 Residential Average Unit Size - 1667 GSF  
 46 Parking Spaces (Lifts) / 43 Required

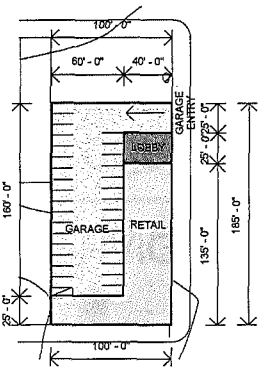

1 1" = 100'-0"

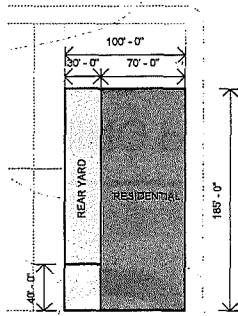

2 1" = 100'-0"

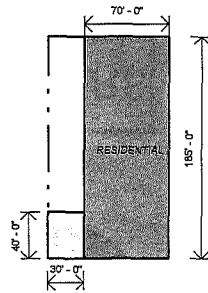

3-6 1" = 100'-0"

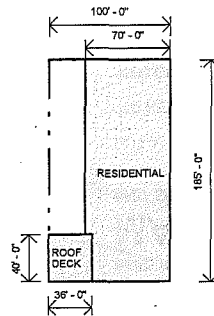

7 1" = 100'-0"

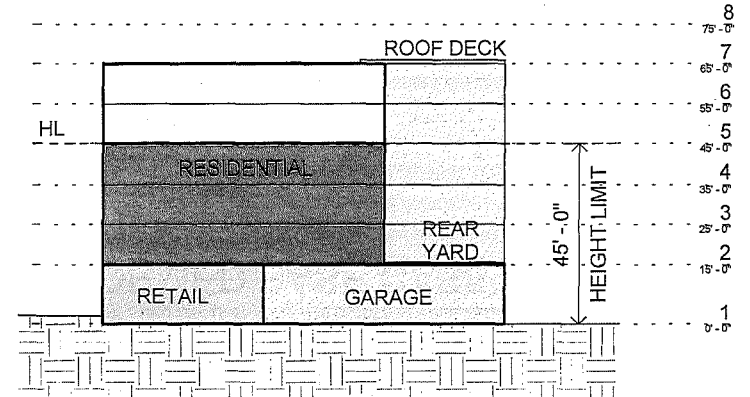

Section 1" = 30'-0"

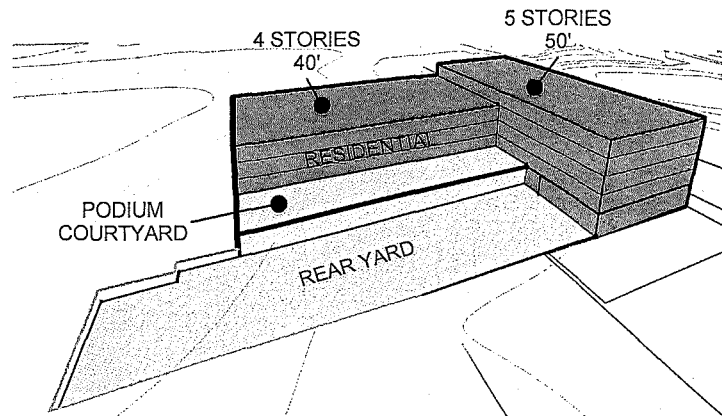
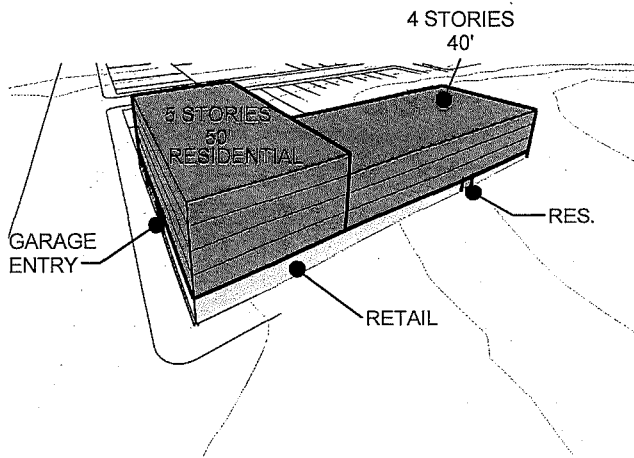

FE GROSS AREA	
Garage	13539 SF
Residential	77652 SF
Retail	7884 SF
Grand total	99074 SF

Open Space	13414 SF
------------	----------

Open Space Required: 67 UNITS X 100 SF = 6,700 SF  
 Residential Average Unit Size - 1362 GSF  
 83 Parking Spaces (Lifts) / 67 Required

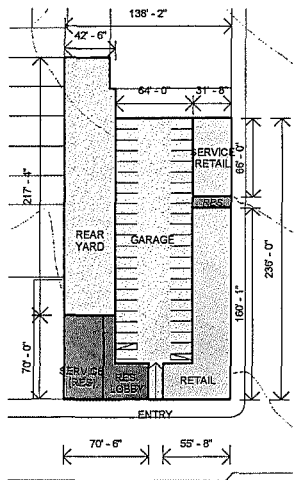

1 1" = 100'-0"

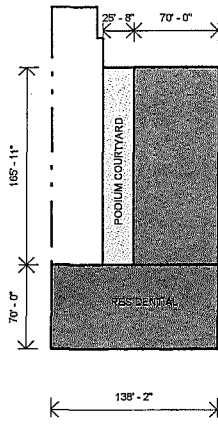

2 1" = 100'-0"

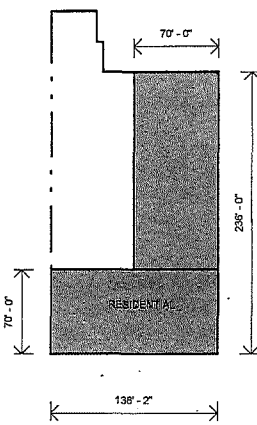

3-4 1" = 100'-0"

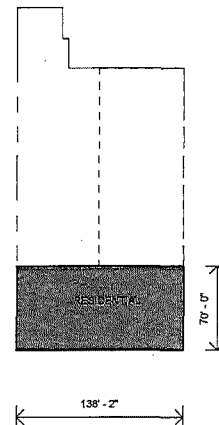

5 1" = 100'-0"

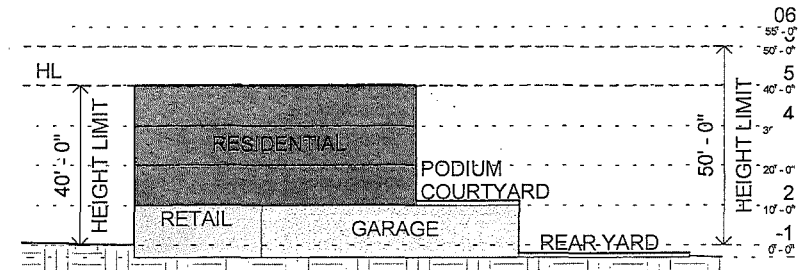

Section 1" = 30'-0"

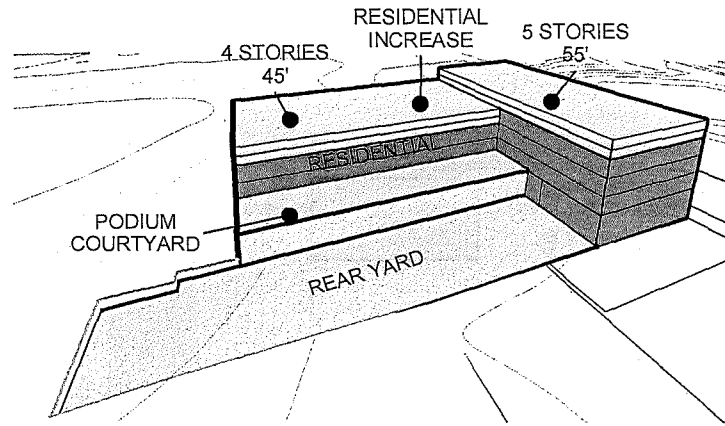
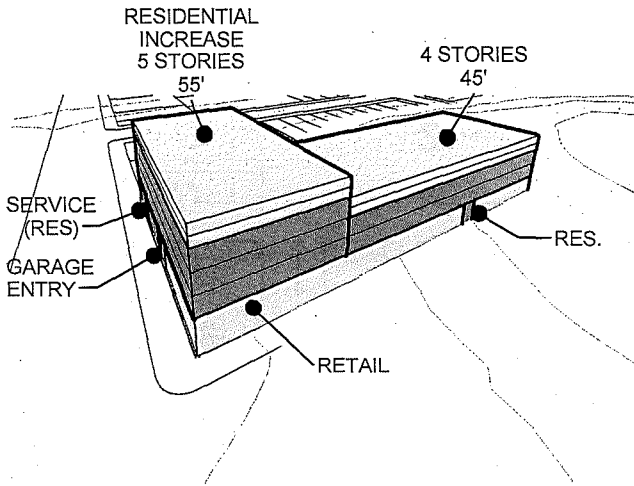

ACCOMMODATIONS NEEDED: HEIGHT, + 5'-0"  
HEIGHT BUMP AT GROUND FLOOR

MARKET + 35 % AREA	
Garage	13539 SF
Residential	77654 SF
Retail	7884 SF
Grand total	99077 SF
Residential	56367 SF
Residential Increase	21287 SF
	77654 SF
Open Space	13414 SF

Open Space Required: 77 UNITS X 100 SF = 7,700 SF  
Residential Average Unit Size - 1000 GSF  
83 Parking Spaces (Lifts) / 77 Required  
\* In order to avoid excavation and maximize parking, a 5' ground floor bump was assumed as part of this scenario

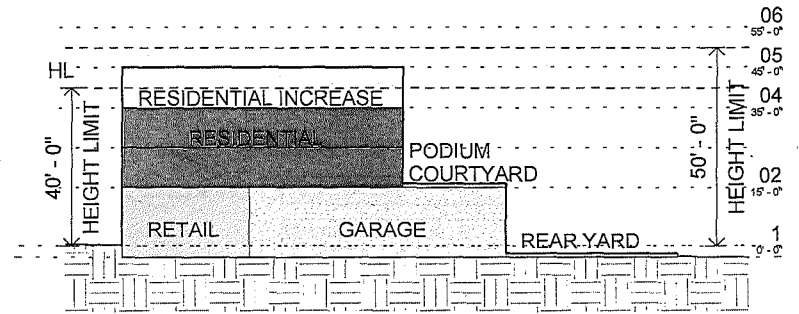
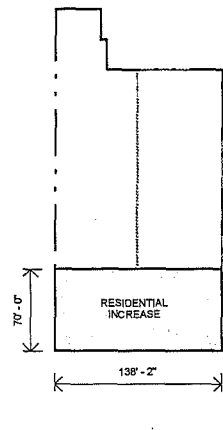
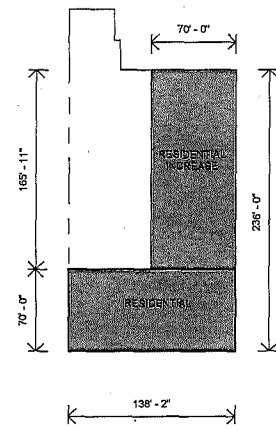
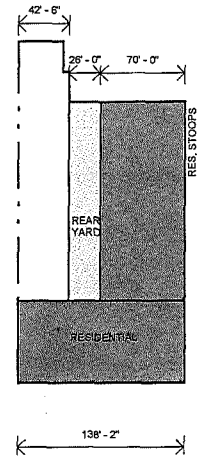
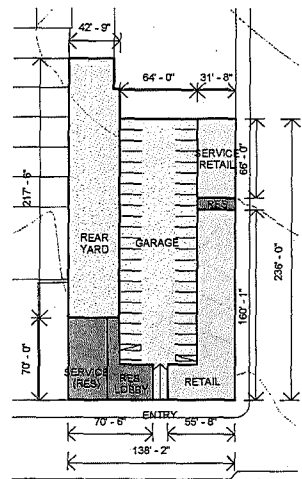

1 1" = 100'-0"

2 1" = 100'-0"

3-4 1" = 100'-0"

5 1" = 100'-0"

Section 1" = 30'-0"

# NC-2

## MISSION

### ZONING PARAMETERS

ZONING CLASSIFICATIONS: NC-2  
LOTS: 3594016

LOT AREA: 4,750 SF

HEIGHT AND BULK: 45-X

REAR YARD: (SECT 134): 25% at 2nd Story and above, or at 1st story if it contains a DU. Can be a corner configuration per Sect. 134(e)(2).

DENSITY : 1 unit / 800 sq. ft lot area                      4,750/800 = 6 UNITS

FLOOR AREA RATIO: 2.5:1 (DOES NOT APPLY FOR RESIDENTIAL USES)

FRONT SETBACK: NONE

STREET FRONTAGE: Active uses required (res. or comm.)

- IF RESIDENTIAL, 50% OF STREET FRONTAGE SHOULD BE WALK UP UNITS
- LOBBY IS LESS THAN 40' OR 25% OF STREET FRONTAGE

USABLE OPEN SPACE: 100SF / DU if private, 133 SF if common (also consider min. dimension reqs.)  
6 UNITS X 133 SF = 798 SF

PARKING REQ.: 1:1 but potential modification/waiver by ZA per sect. 161(j)

GROUND FLOOR HEIGHT (SECT 145.1): MINIMUM 14' FOR NON-RESIDENTIAL (FLOOR TO FLOOR)

SCENARIO  
**A**

### FULL ENVELOPE BUILD OUT

PHYSICAL ENVELOPE ACHIEVABLE WITHIN ALLOWED HEIGHT AND ZONING REQUIREMENTS

LOT AREA 4,750/800 SF = 6 UNITS (MAX ALLOWED)

BASE AREA - MAXIMUM AMOUNT OF RESIDENTIAL DENSITY ACHIEVABLE WITHIN ALLOWED HEIGHT AND ZONING REQUIREMENTS = 11,170 SF

BASE RES. SF ACHIEVABLE / BASE # OF UNITS ALLOWED 11,170 SF / 8 UNITS = 1,862 SF AVG. GROSS UNIT

SCENARIO  
**B**

### MARKET INFORMED BASE CASE

UNIT SIZE ASSUMPTION BASED ON CURRENT MARKET DATA

LOT AREA 4,750/800 SF = 6 UNITS (MAX ALLOWED)

1000 NET SF / 1333 GROSS SF ASSUMED UNIT SIZE

1333 GSF x 6 = 7,998 ALLOWED RESIDENTIAL GSF

THE MARKET INFORMED BASE CASE IS LESS THAN THE ALLOWABLE BUILDING ENVELOPE.

SCENARIO  
**C**

### MARKET INFORMED BASE + 35 % INCREASE

MARKET BASE CASE FROM ABOVE WITH 35% DENSITY BONUS

LOT AREA 4,750/800 SF = 6 UNITS (MAX ALLOWED)

1000 NET SF / 1333 GROSS SF ASSUMED UNIT SIZE

6 MAX UNITS ALLOWED X 1.35% DENSITY INCREASE = 8.1 ~ 8 UNITS ALLOWED

8 UNITS ALLOWED x 1333 GROSS SF ASSUMED UNIT SIZE = 10,664 ALLOWED RESIDENTIAL GSF

THE 35% DENSITY INCREASE IS LESS THAN THE ALLOWABLE BUILDING ENVELOPE, THEREFORE NO ACCOMMODATIONS ARE NEEDED.

SCENARIO  
**D**

### AFFORDABLE HOUSING BONUS PROGRAM

DENSITY INCREASE TO FULL ENVELOPE

18,270 RESIDENTIAL GSF

ASSUMED UNIT SIZE TAKEN FROM MARKET BASE CASE = 1,333 GSF UNIT SIZE

18,270 SF / 1333 SF = 14 UNITS

ACCOMMODATIONS NEEDED: HEIGHT, PARKING

HEIGHT INCREASED TO 65' FROM 45'

14 UNITS IS 233% INCREASE IN ALLOWED UNITS FROM BASE CASE

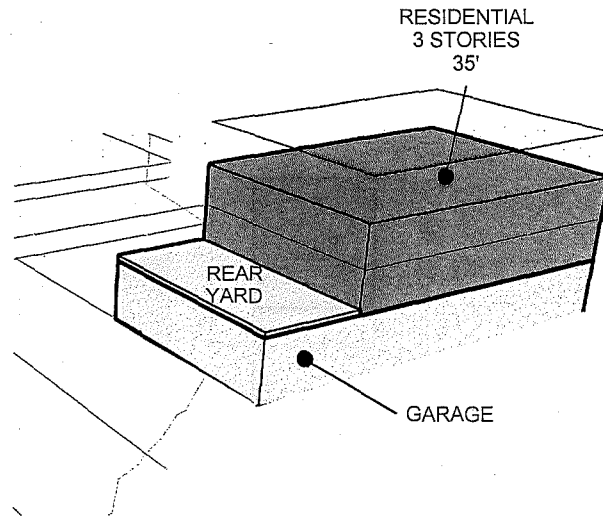
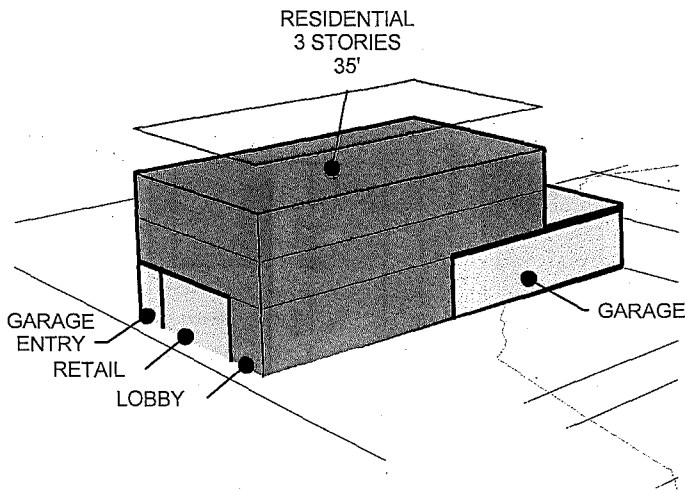

MARKET BASE CASE	
Residential	7626 SF
Garage	2949 SF
Retail	1258 SF
Grand total	11833 SF
Open Space	1200 SF

Open Space Required: 6 UNITS X 133 SF = 798 SF  
 Residential Average Unit Size - 1333 GSF  
 6 Parking Spaces / 6 Required

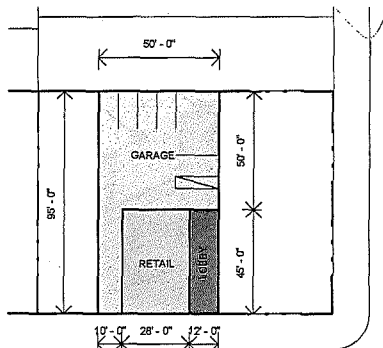

1 1" = 50'-0"

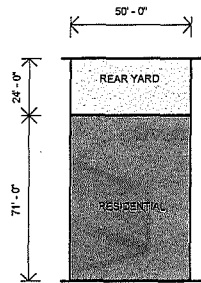

2 1" = 50'-0"

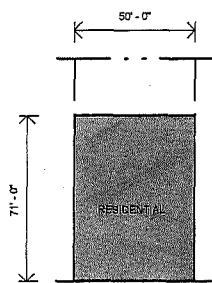

3 1" = 50'-0"

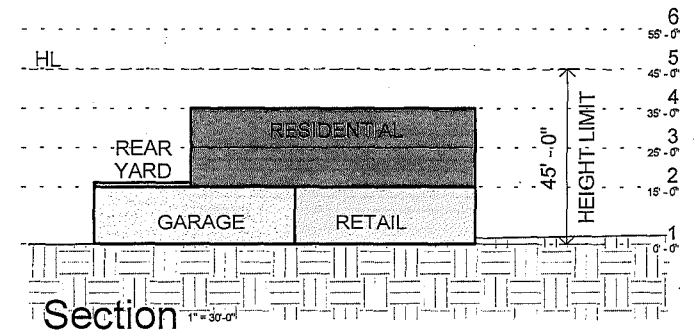

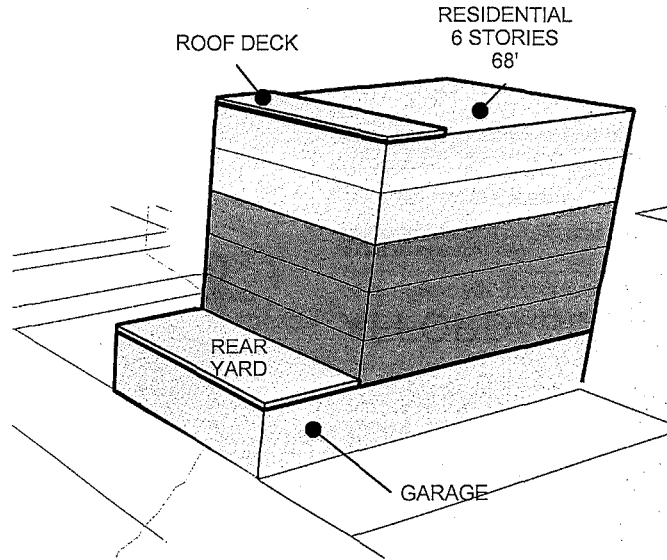
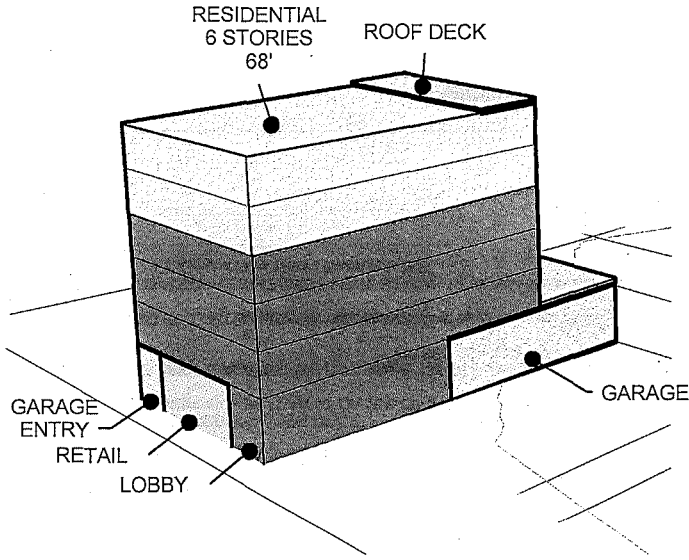

ACCOMMODATIONS NEEDED: HEIGHT, PARKING

### BONUS PROGRAM

Garage	2949 SF
Residential	18270 SF
Retail	1258 SF
<b>Grand total</b>	<b>22477 SF</b>

Open Space	1950 SF
------------	---------

Open Space Required: 14 UNITS X 133 SF = 1862 SF

Residential Average Unit Size - 1333 GSF

9 Parking Spaces (Lifts) / 14 Required

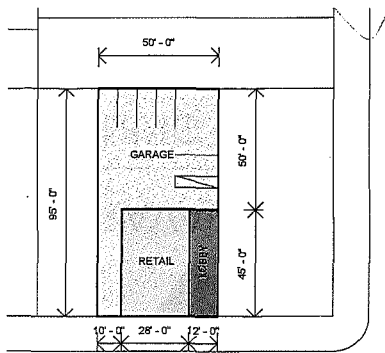

1 1" = 50'-0"

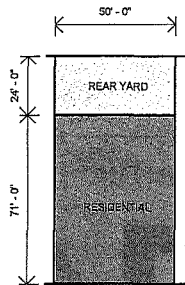

2 1" = 50'-0"

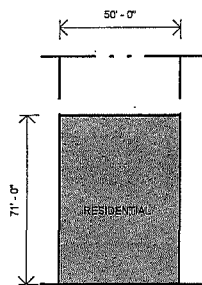

3-5 1" = 50'-0"

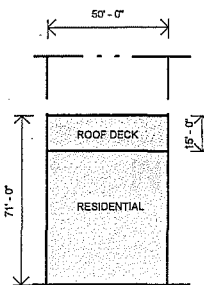

6 1" = 50'-0"

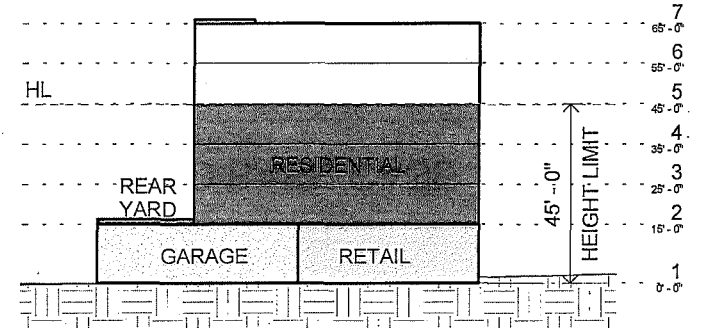

Section 1" = 30'-0"



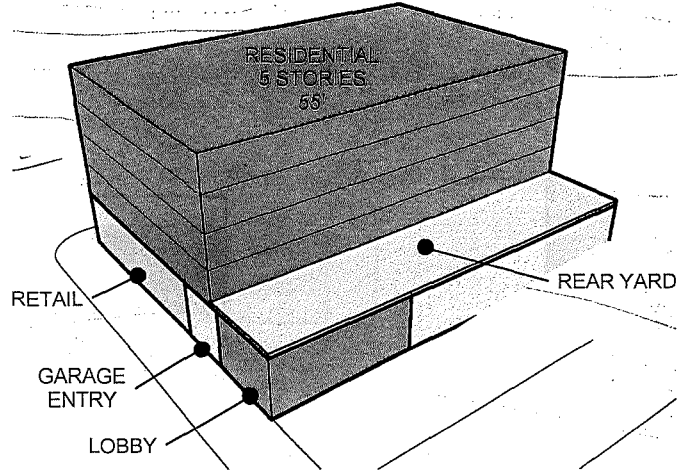
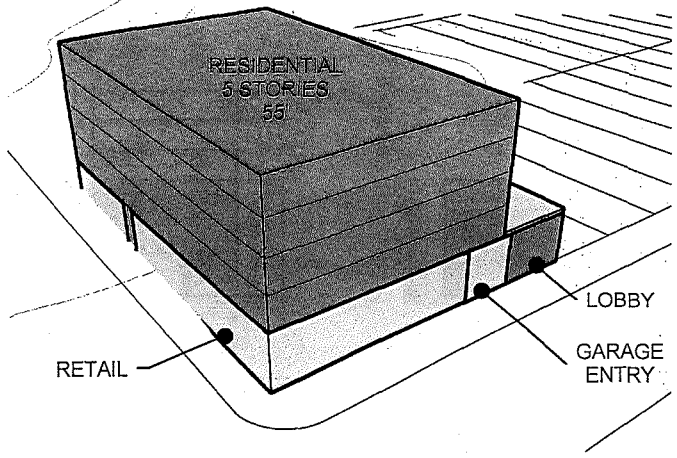

FE GROSS AREA	
Garage	5599 SF
Residential	37247 SF
Retail	5151 SF
Grand total	47998 SF
Open Space	3000 SF

Open Space Required: 15 UNITS X 133 SF = 1,995 SF  
 Residential Average Unit Size - 2483 GSF  
 16 Parking Spaces / 15 Required

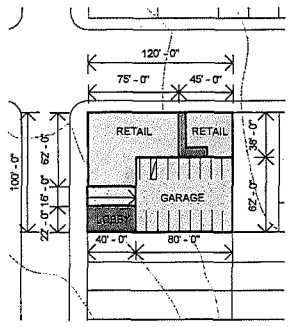

1 1" = 100'-0"

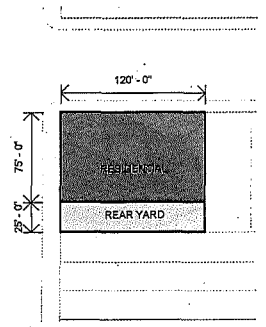

2 1" = 100'-0"

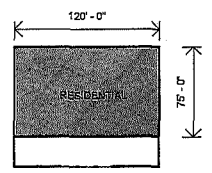

3-5 1" = 100'-0"

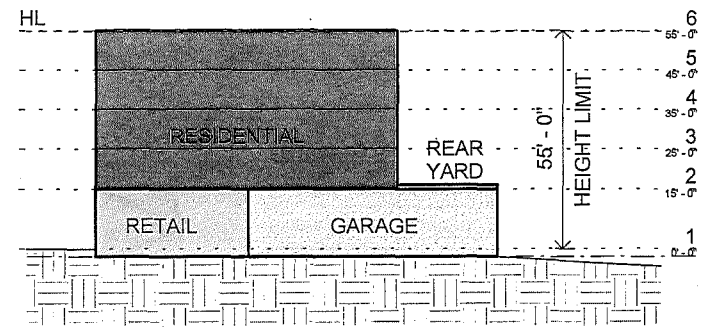

Section 1" = 30'-0"

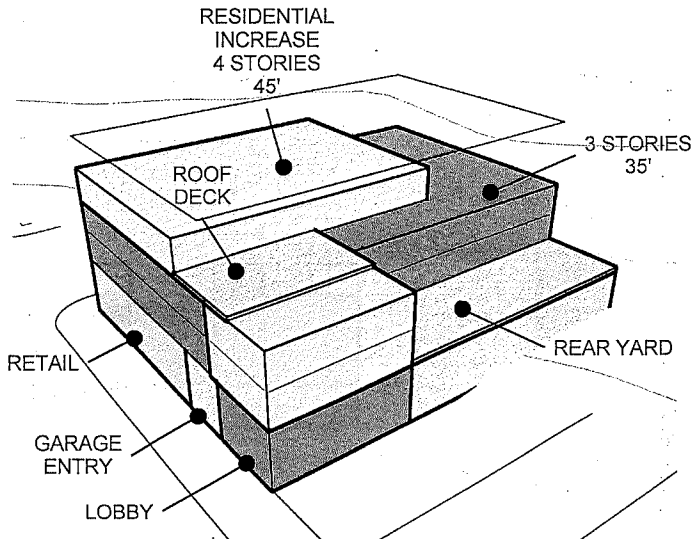
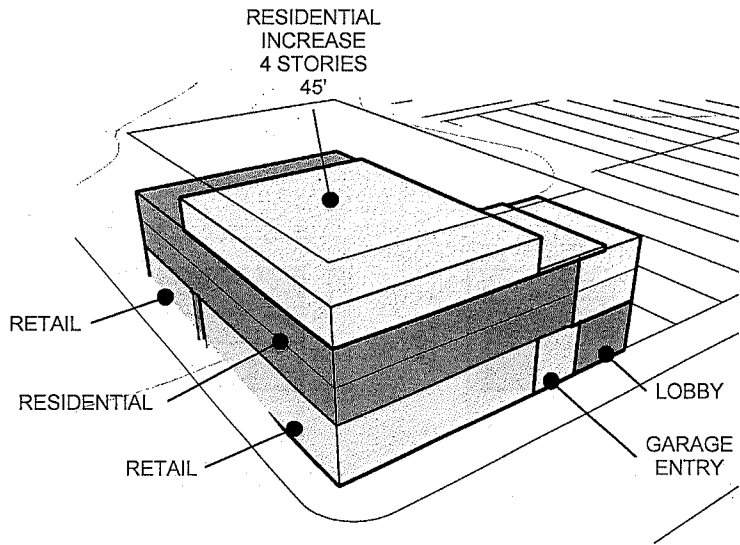

ACCOMMODATIONS NEEDED: REAR YARD

MARKET + 35% AREA	
Garage	5599 SF
Residential	26047 SF
Retail	5151 SF
Grand total	36798 SF

Residential Increase	6800 SF
Residential	19247 SF
	26047 SF

Open Space	3000 SF
------------	---------

Open Space Required: 20 UNITS X 133 SF = 2,660 SF  
 Residential Average Unit Size - 1333 GSF  
 29 Parking Spaces (Lifts) / 20 Required

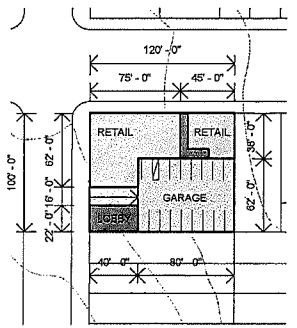

1 1" = 100'-0"

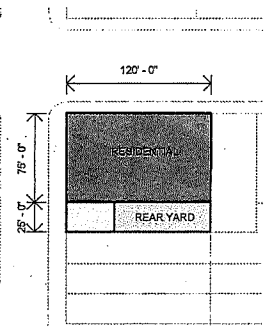

2 1" = 100'-0"

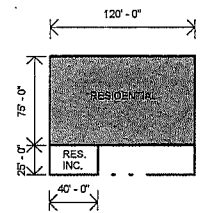

3-4 1" = 100'-0"

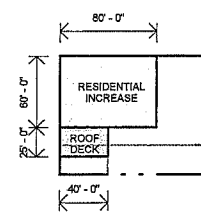

5 1" = 100'-0"

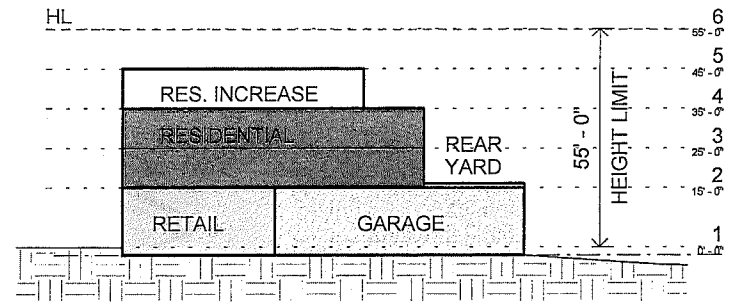

Section 1" = 30'-0"

# RC-3

RUSSIAN HILL

## ZONING PARAMETERS

ZONING CLASSIFICATIONS: RC-3  
LOTS: 0502005H

LOT AREA: 7,400 SF

HEIGHT AND BULK: 65-A

BULK DISTRICT	Height Above Which Maximum Dimensions Apply (in feet)	Maximum Plan Dimensions (in feet)	
		Length	Diagonal dim.
A	40	110	125

REAR YARD: (SECT 134): 25% OF LOT DEPTH, NO LESS THAN 15 FEET (AT DWELLING LEVELS ONLY). REAR YARD SHALL BE PROVIDED AT LOWEST STORY CONTAINING A DWELLING UNIT.

DENSITY (SECT 745) : 1 unit / 400 sq. ft lot area 7,400/400 = 19 UNITS

FLOOR AREA RATIO: 3.6:1 (DOES NOT APPLY)

STREET FRONTAGE: Commercial not required. Active uses required (res. or comm.)  
 • IF RESIDENTIAL, 50% OF STREET FRONTAGE SHOULD BE WALK UP UNITS  
 • LOBBY IS LESS THAN 40' OR 25% OF STREET FRONTAGE  
 • GROUND FLOOR DJUs SUBJECT TO GROUND FLOOR RESIDENTIAL DESIGN GUIDELINES INCLUDING SET BACK AND TWO STORY EXPRESSION

USABLE OPEN SPACE: 60 SF PER UNIT IF ALL PRIVATE; 80 SF IF COMMON SPACE.  
80 SF X 19 UNITS = 1,520 SF

PARKING REQ.: 1 PER 4 DWELLING UNITS

GROUND FLOOR HEIGHT (SECT 145.1): MINIMUM 14' FOR NON-RESIDENTIAL (FLOOR TO FLOOR)

SCENARIO  
**A**

## FULL ENVELOPE BUILD OUT

PHYSICAL ENVELOPE ACHIEVABLE WITHIN ALLOWED HEIGHT AND ZONING REQUIREMENTS

LOT AREA 7,400/400 SF = 18.5 ~ 19 UNITS (MAX ALLOWED)

BASE AREA - MAXIMUM AMOUNT OF RESIDENTIAL DENSITY ACHIEVABLE WITHIN ALLOWED HEIGHT AND ZONING REQUIREMENTS = 32,192 SF

BASE RES. SF ACHIEVABLE / BASE # OF UNITS ALLOWED 32,192 SF / 19 UNITS = 1,694 SF AVG. GROSS UNIT

SCENARIO  
**B**

## MARKET INFORMED BASE CASE

UNIT SIZE ASSUMPTION BASED ON CURRENT MARKET DATA

LOT AREA 7,400/400 SF = 19 UNITS (MAX ALLOWED)

1000 NET SF / 1333 GROSS SF ASSUMED UNIT SIZE

1333 GSF x 19 = 25,327 ASSUMED RESIDENTIAL GSF

MARKET BASE CASE IS LESS THAN FULL ENVELOPE BUILD OUT.

SCENARIO  
**C**

## MARKET INFORMED BASE + 35 % INCREASE

MARKET BASE CASE FROM ABOVE WITH 35% DENSITY BONUS

LOT AREA 7,400/400 SF = 19 UNITS (MAX ALLOWED)

1000 NET SF / 1333 GROSS SF ASSUMED UNIT SIZE

19 MAX UNITS ALLOWED X 1.35% DENSITY INCREASE = 25.65 ~ 26 UNITS ALLOWED  
 26 UNITS ALLOWED x 1333 GROSS SF ASSUMED UNIT SIZE = 34,658 ALLOWED RESIDENTIAL GSF  
 ACCOMMODATIONS NEEDED: HEIGHT

SCENARIO  
**D**

## AFFORDABLE HOUSING BONUS PROGRAM

DENSITY INCREASE TO FULL ENVELOPE

43,292 RESIDENTIAL GSF  
 ASSUMED UNIT SIZE TAKEN FROM MARKET BASE CASE = 1,333 GSF UNIT SIZE

43,292 SF / 1333 SF = 32 UNITS

ACCOMMODATIONS NEEDED: HEIGHT  
 HEIGHT INCREASED TO 85' FROM 65'  
 32 UNITS IS 168% INCREASE IN ALLOWED UNITS FROM BASE CASE

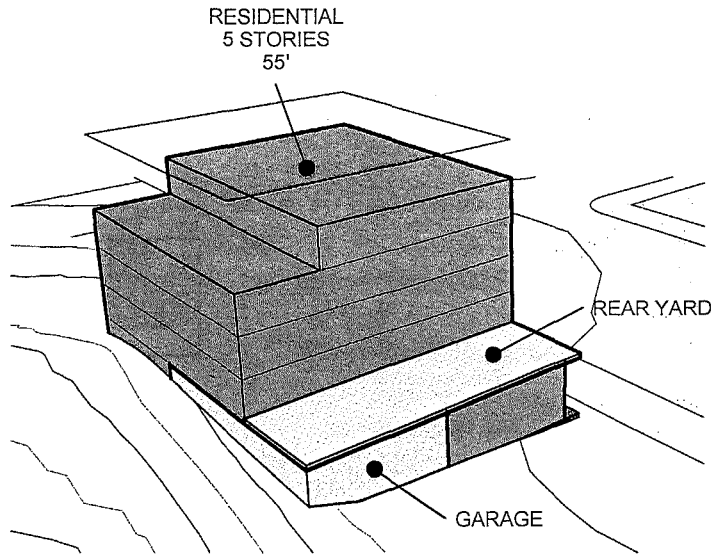
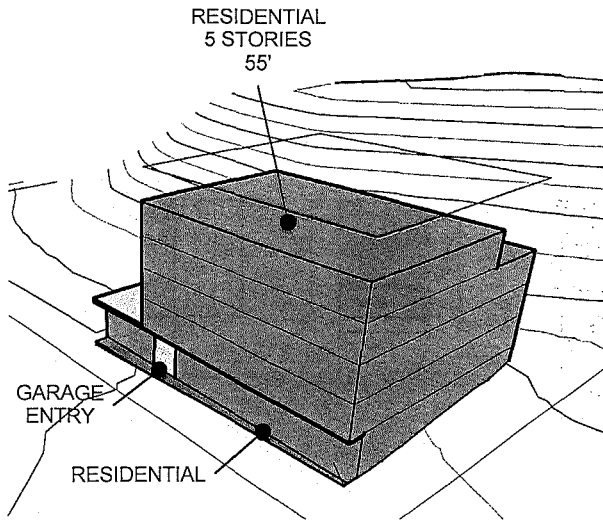

MARKET BASE CASE	
Garage	2459 SF
Residential	25142 SF
Grand total	27602 SF

Open Space 1850 SF

Open Space Required: 19 UNITS X 80 SF = 1,520 SF

Residential Average Unit Size - 1333 GSF

7 Parking Spaces / 5 Required

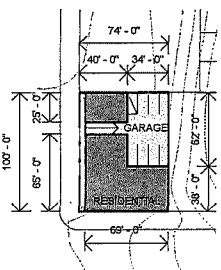

1 1" = 100'-0"

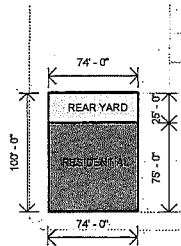

2 1" = 100'-0"

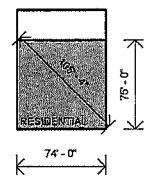

3-4 1" = 100'-0"

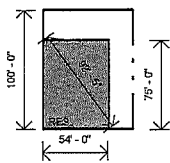

5 1" = 100'-0"

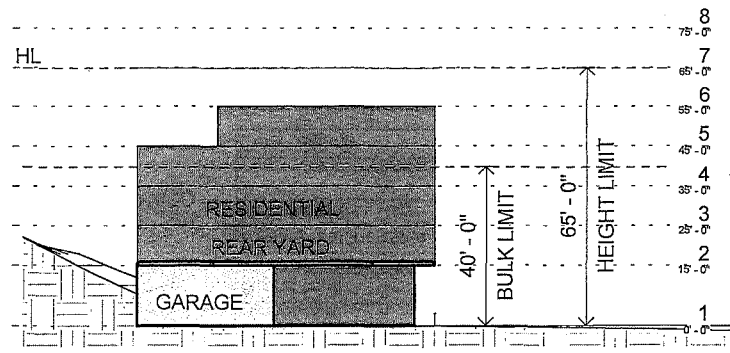

Section 1" = 30'-0"

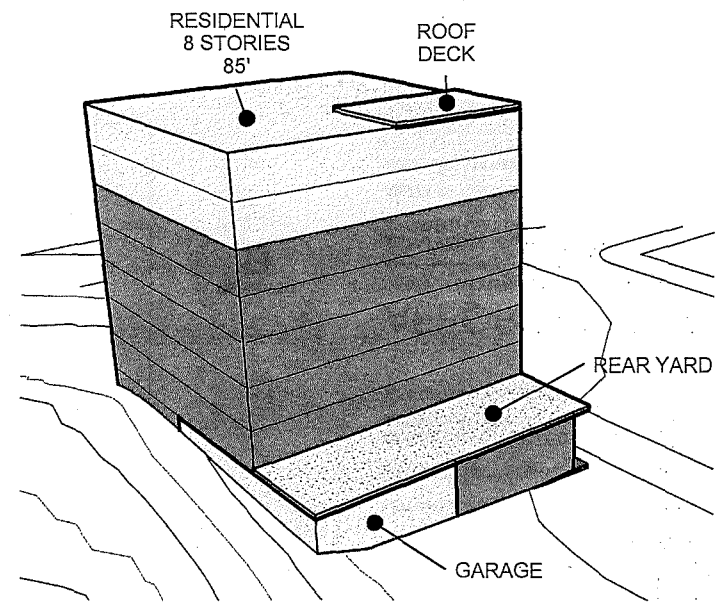
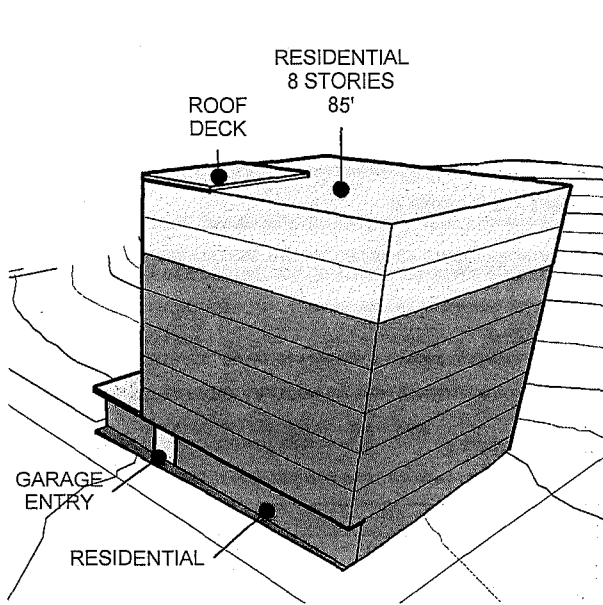

ACCOMMODATIONS NEEDED: HEIGHT

BONUS PROGRAM	
Garage	2459 SF
Residential	43292 SF
Grand total	45752 SF

Open Space 2725 SF

Open Space Required: 32 UNITS X 80 SF = 2,560 SF

Residential Average Unit Size - 1333 GSF

8 Parking Spaces (Lifts) / 8 Required

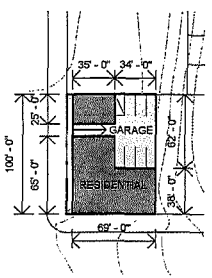

1 1" = 100'-0"

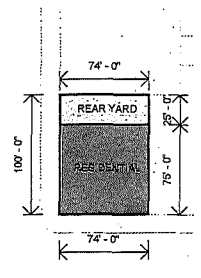

2 1" = 100'-0"

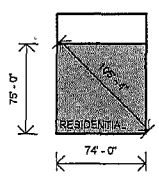

3-8 1" = 100'-0"

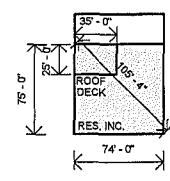

9 1" = 100'-0"

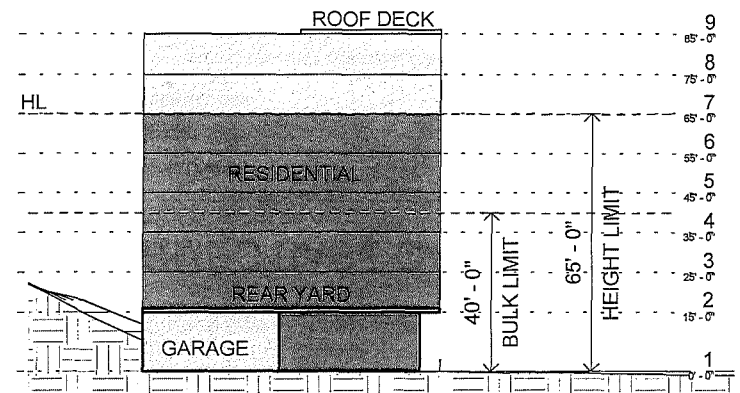

Section 1" = 30'-0"

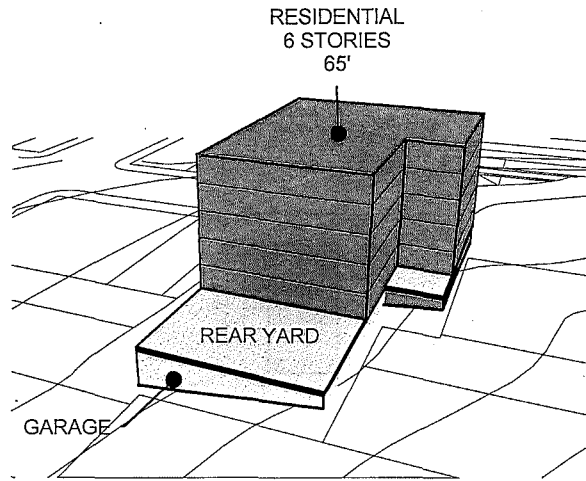
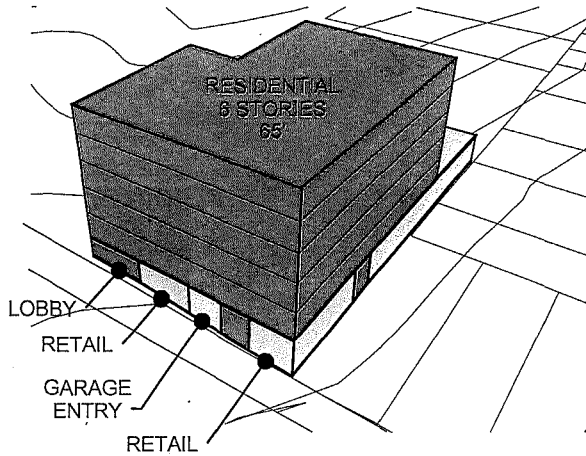

FE GROSS AREA	
Garage	5874 SF
Residential	35485 SF
Retail	1225 SF
Grand total	42584 SF
Open Space	2726 SF

Open Space Required: 47 UNITS X 48 SF = 2,256 SF

Residential Average Unit Size - 755 GSF

48 Spaces (Puzzle Lift with Pit) / 47 Required

THE MARKET INFORMED BASE CASE IS HIGHER THAN WHAT ZONING ALLOWS, THEREFORE THE FULL ENVELOPE BUILD OUT WILL BE CONSIDERED THE BASE CASE.

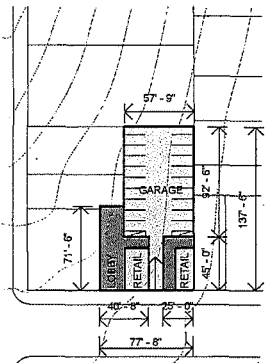

1 1" = 100'-0"

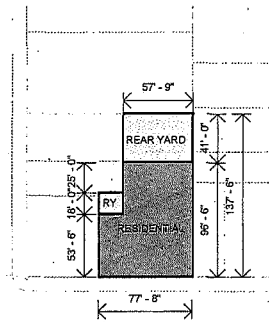

2 1" = 100'-0"

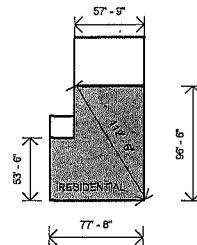

3-6 1" = 100'-0"

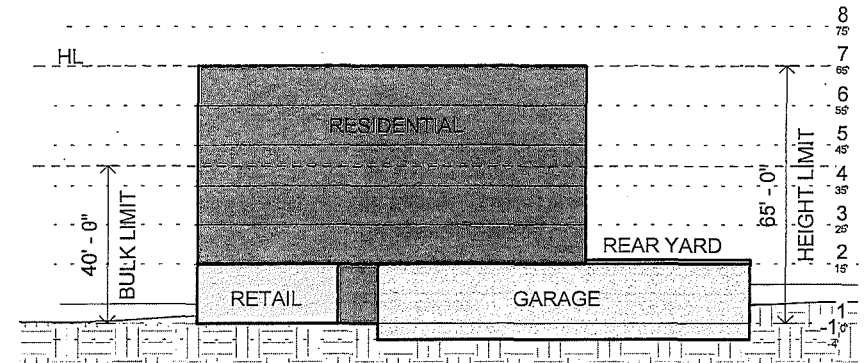

Section 1" = 30'-0"

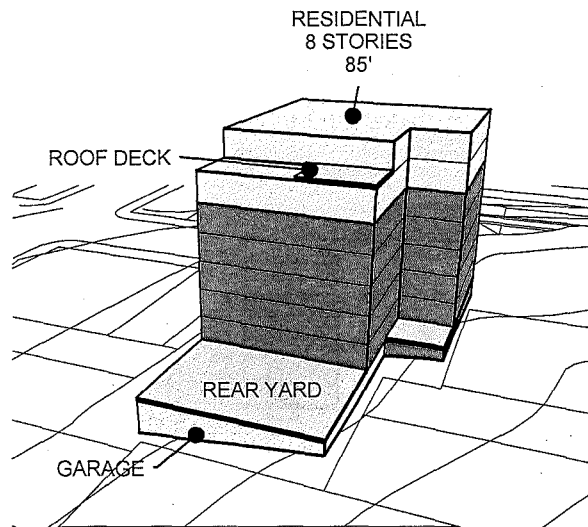
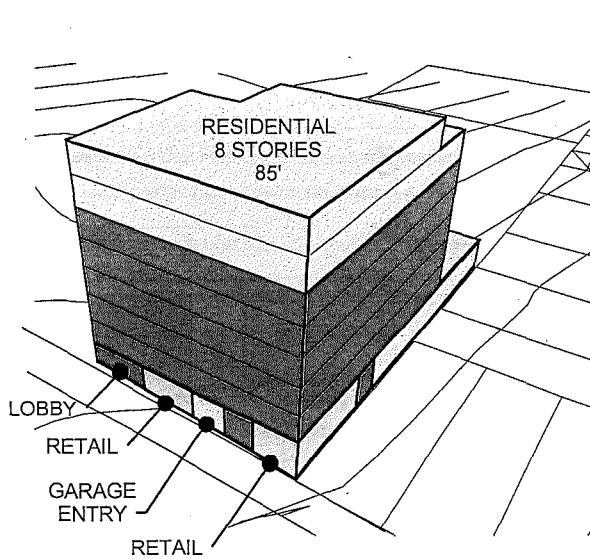

ACCOMMODATIONS NEEDED: HEIGHT, PARKING

MARKET + 35% AREA	
Garage	5872 SF
Residential	47617 SF
Retail	1225 SF
Grand total	54714 SF

Residential	35485 SF
Residential Increase	12132 SF
	47617 SF

Open Space	3226 SF
------------	---------

Open Space Required: 63 UNITS X 48 SF = 3,024 SF  
 Residential Average Unit Size - 755 GSF  
 48 Spaces (Puzzle Lift with Pit) / 63 Required

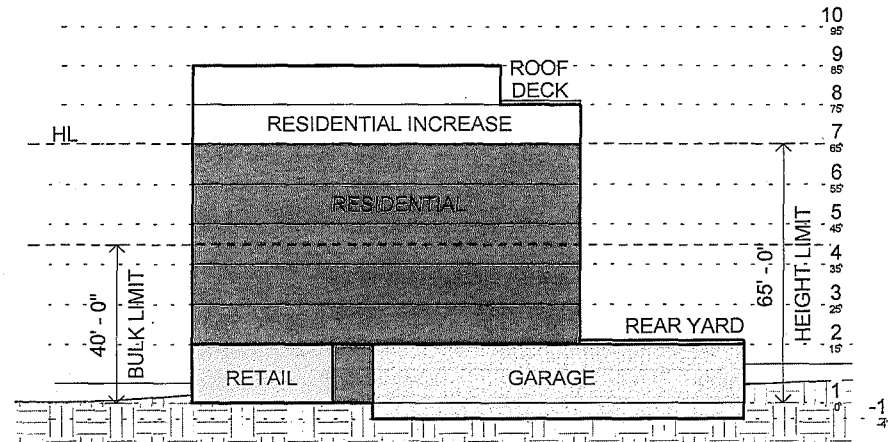
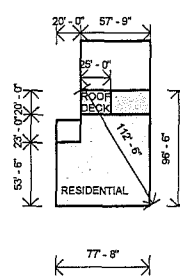
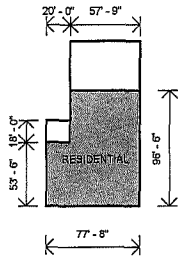
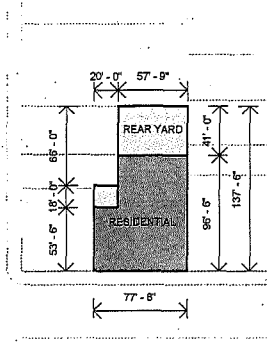
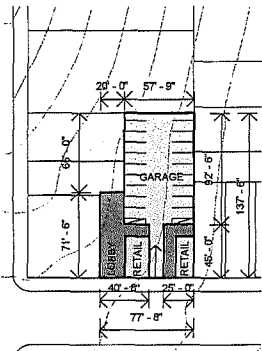

# NC-3

## WESTERN ADDITION

### ZONING PARAMETERS

ZONING CLASSIFICATIONS: NC-3  
 LOTS: 0647011A, 0647011, 0647010, 0647009, 0647008, 0647007

LOT AREA: 35,723 SF

HEIGHT AND BULK: 130-E

BULK DISTRICT	Height Above Which Maximum Dimensions Apply (in feet)	Maximum Plan Dimensions (in feet)	
		Length	Diagonal dim.
E	65	110	140

REAR YARD: (SECT 134): 25% at the lowest story containing a DU and above. Can be a corner configuration per Sec. 134(e)(2).

DENSITY (SECT 745) : 1 unit / 600 sq. ft lot area 35,723/600 = 60 UNITS

FLOOR AREA RATIO: 3.6:1 (DOES NOT APPLY TO RESIDENTIAL USES)

FRONT SETBACK: NONE

STREET FRONTAGE: Commercial not required. Active uses required (res. or comm.)

- IF RESIDENTIAL; 50% OF STREET FRONTAGE SHOULD BE WALK UP UNITS
- LOBBY IS LESS THAN 40' OR 25% OF STREET FRONTAGE

USABLE OPEN SPACE: 80SF / DU if private, 106 SF if common (also consider min. dimension reqs.)  
 60 UNITS X 106 SF = 6,360 SF

PARKING REQ.: 1:1 but potential modification/waiver by ZA per sect. 161(j)

GROUND FLOOR HEIGHT (SECT 145.1): MINIMUM 14' FOR NON-RESIDENTIAL (FLOOR TO FLOOR)



### FULL ENVELOPE BUILD OUT

PHYSICAL ENVELOPE ACHIEVABLE WITHIN ALLOWED HEIGHT AND ZONING REQUIREMENTS

LOT AREA 35,723/600 SF = 60 UNITS (MAX ALLOWED)

BASE AREA - MAXIMUM AMOUNT OF RESIDENTIAL DENSITY ACHIEVABLE WITHIN ALLOWED HEIGHT AND ZONING REQUIREMENTS = 183,887 SF

BASE RES. SF ACHIEVABLE / BASE # OF UNITS ALLOWED 183,887 SF / 60 UNITS = 3,065 SF AVG. GROSS UNIT

### MARKET INFORMED BASE CASE

UNIT SIZE ASSUMPTION BASED ON CURRENT MARKET DATA

LOT AREA 35,723/600 SF = 60 UNITS (MAX ALLOWED)

750 NET SF / 1000 GROSS SF ASSUMED UNIT SIZE

1000 GSF x 60 = 60,000 ASSUMED RESIDENTIAL GSF

THE MARKET INFORMED BASE CASE IS SIGNIFICANTLY LESS THAN THE ALLOWABLE ENVELOPE.

### MARKET INFORMED BASE + 35 % INCREASE

MARKET BASE CASE FROM ABOVE WITH 35% DENSITY BONUS

LOT AREA 35,723/600 SF = 60 UNITS (MAX ALLOWED)

750 NET SF / 1000 GROSS SF ASSUMED UNIT SIZE

60 MAX UNITS ALLOWED X 1.35% DENSITY INCREASE = 81 UNITS ALLOWED

81 UNITS ALLOWED x 1000 GROSS SF ASSUMED UNIT SIZE = 81,000 ALLOWED RESIDENTIAL GSF

A 35% INCREASE TO THE MARKET INFORMED BASE CASE IS SIGNIFICANTLY LESS THAN THE ALLOWABLE ENVELOPE, THEREFORE NO ACCOMMODATIONS ARE NEEDED

### AFFORDABLE HOUSING BONUS PROGRAM

DENSITY INCREASE TO FULL ENVELOPE

232,809 RESIDENTIAL GSF

ASSUMED UNIT SIZE TAKEN FROM MARKET INFORMED BASE CASE = 1,000 GSF UNIT SIZE

232,809 SF / 1000 SF = 233 UNITS

ACCOMMODATIONS NEEDED: HEIGHT, BULK, PARKING

HEIGHT INCREASED TO 145' FROM 125'

233 UNITS IS 288 % INCREASE IN ALLOWED UNITS FROM BASE CASE



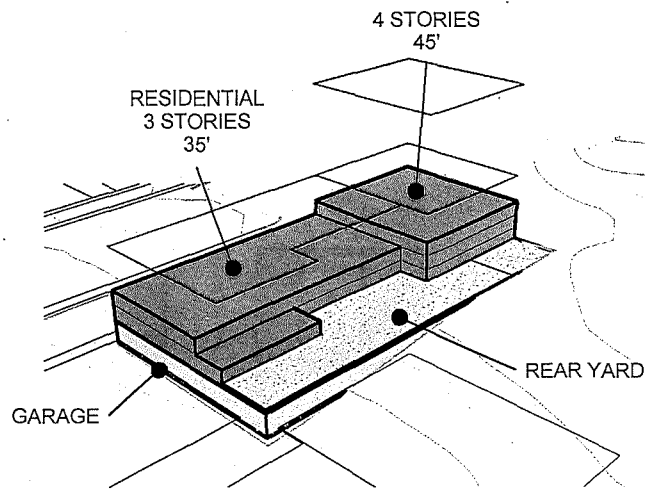
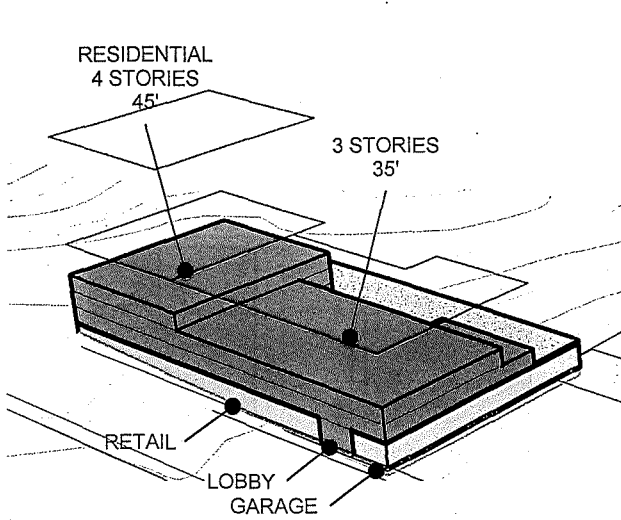

MARKET BASE CASE	
Retail	18431 SF
Residential	60053 SF
Garage	15381 SF
Grand total	93864 SF

Open Space	11195 SF
------------	----------

Open Space Required: 60 UNITS X 106 SF = 6,360 SF  
 Residential Average Unit Size - 1000 GSF  
 82 Parking Spaces (Lifts) / 60 Required

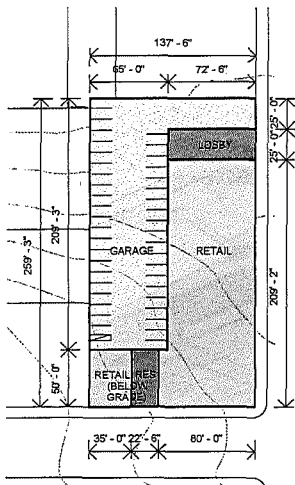

1 1" = 100'-0"

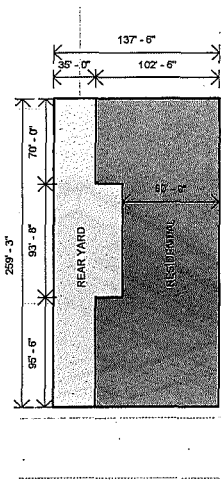

2 1" = 100'-0"

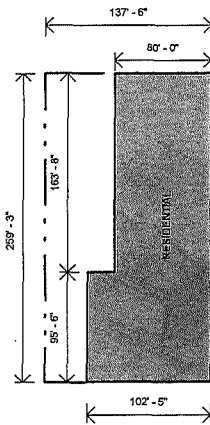

3 1" = 100'-0"

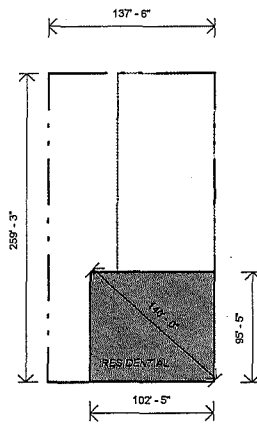

4 1" = 100'-0"

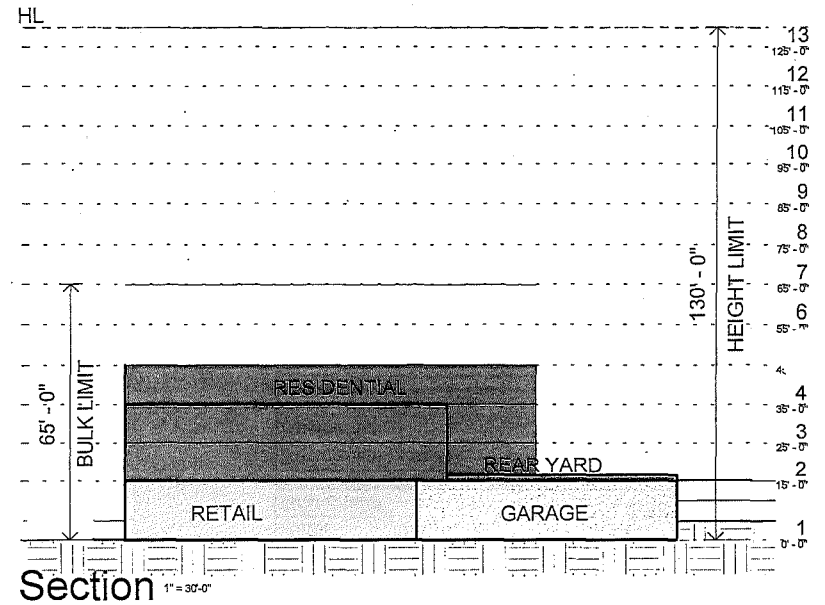

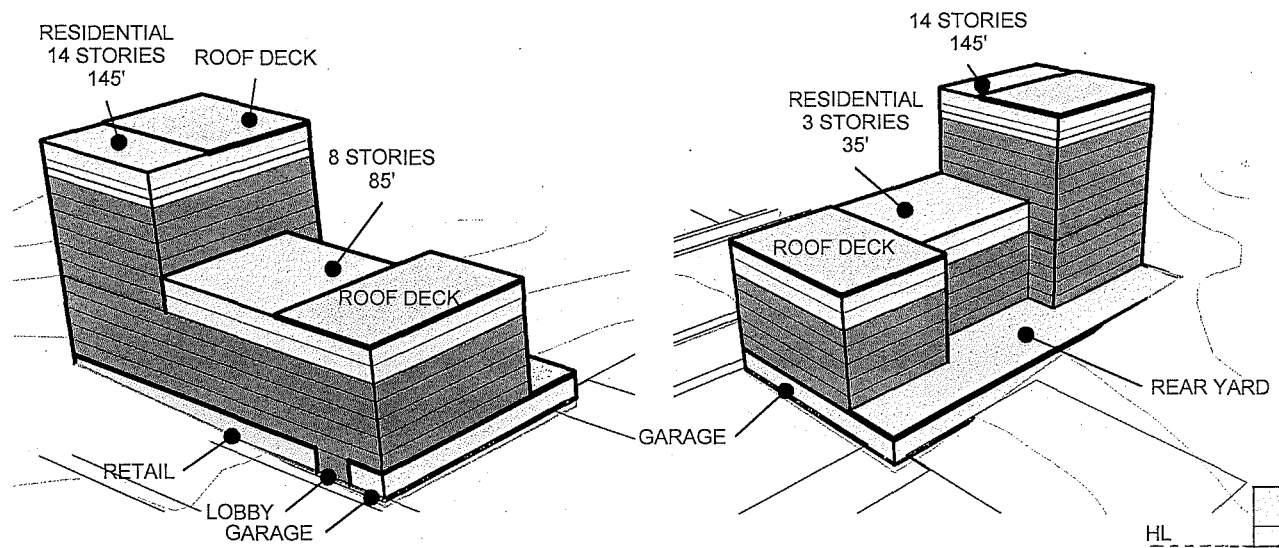

ACCOMMODATIONS NEEDED: HEIGHT, BULK, PARKING

BONUS PROGRAM	
Garage	15381 SF
Residential	232809 SF
Retail	18431 SF
Grand total	266620 SF
Open Space	24578 SF

Open Space Required: 233 UNITS X 106 SF = 24,698 SF  
 Residential Average Unit Size - 1000 GSF  
 77 Parking Spaces (Lifts) / 233 Required

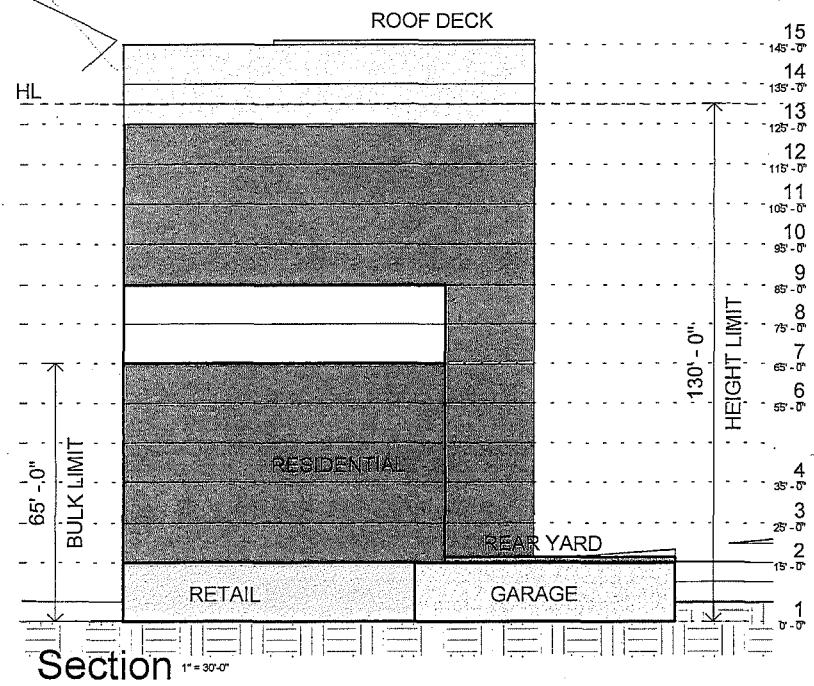
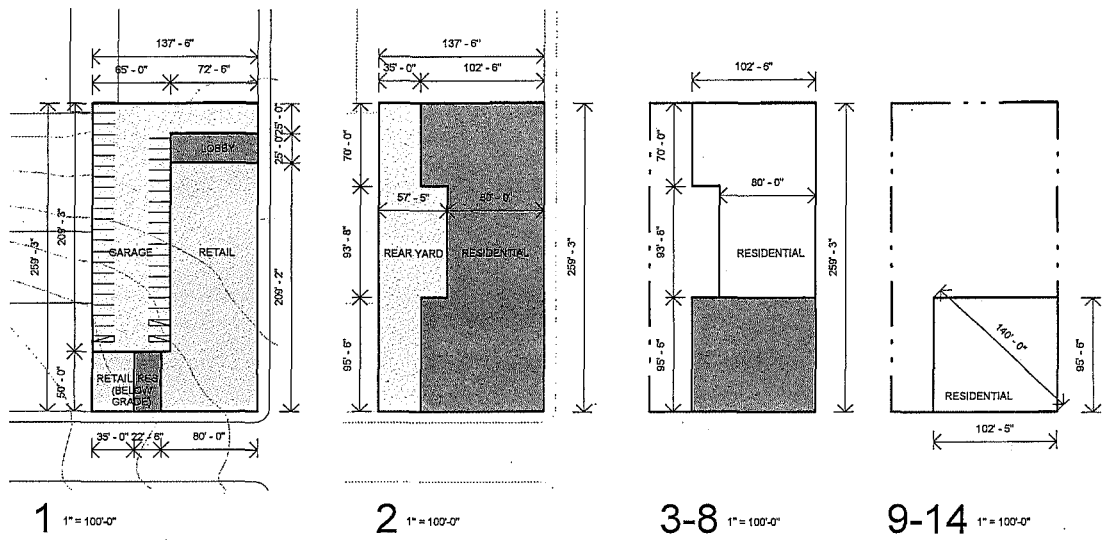



SMALL BUSINESS COMMISSION  
OFFICE OF SMALL BUSINESS



CITY AND COUNTY OF SAN FRANCISCO  
EDWIN M. LEE, MAYOR

February 24, 2016

Ms. Angela Calvillo, Clerk of the Board  
City Hall Room 244  
1 Dr. Carlton B. Goodlett Place  
San Francisco, CA 94102-4689

RE: BOS File No. 150969 [Planning Code - Affordable Housing Bonus Programs]

Small Business Commission Recommendation: **To continue as is and give the Office of Small Business Staff and Office of Economic and Workforce Development the authority to continue to work on the issue.**

Dear Ms. Calvillo,

On February 24, 2016, the Small Business Commission (SBC) unanimously voted to continue the discussion of the proposed Affordable Housing Bonus Program (AHBP) legislation and give the staffs of the Office of Small Business (OSB) and Office of Economic and Workforce Development (OEWD) the authority to continue working on recommendations to address the concerns of small business owners.

The SBC iterated its acknowledgement of the dire need for more affordable housing in the City and its enthusiastic support for the intent of the legislation to encourage construction of more affordable housing, as affordable housing is essential for small business owners and their employees. The SBC chose not to make a yes or no recommendation at this time, and expressed its desire to continue the dialog as the City develops and refines its plans to build more affordable housing.

In the two AHBP hearings held at the SBC, the Commission acknowledged the progress that the Planning Department has made in considering recommendations from the SBC and possible amendments and revisions to the legislation to address concerns of small business owners related to possible business interruption, displacement, relocation and closure.

The SBC's role is to represent the interests of the small business community, and advise the Mayor, Board of Supervisors, and City Departments on legislation and policy matters that affect small businesses in the City and County of San Francisco. Presently, the proposed legislation has met strong opposition from small business owners, several neighborhood merchant associations and the San Francisco Council of District Merchants, who are primarily concerned about potential interruption of their businesses that might result from demolition of their current locations to make way for new housing development. While the Planning Department has made progress addressing this issue in the past few weeks, the SBC determined that small business owners have not yet had sufficient opportunity to evaluate the possible legislation modifications. Therefore, the SBC voted to continue the discussion and allow for more public discussion and legislative consideration before making an official recommendation of support. The SBC requested that the staff of the OSB and OEWD continue to work with the staff of the Planning Department to address the concerns of the small business community.

The SBC's goal is to assure that the proposed legislation maximizes the benefits of affordable housing development while minimizing the negative impact on any small businesses displaced at development sites and providing support for adversely impacted small business owners.

The Small Business Commission extends its appreciation to Planning staff Kearstin Dischinger and Shelia Nickolopoulos for their time and thorough presentations to the Small Business Commission.

Sincerely,

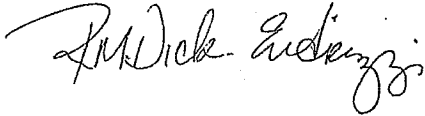

Regina Dick-Endrizzi  
Director, Office of Small Business

cc: Alisa Somera, Clerk of Land Use and Transportation Committee

150969

Member, Board of Supervisors  
District 4



City and County of San Francisco

## KATY TANG

### HOME-SF Overview

**HOME-SF:** *Optional program that incentivizes 30 percent affordable housing in market rate projects by offering up to two additional floors and other zoning incentives. Applies to projects of three units or more (RH-1 and RH-2 excluded from program), and prohibits demolition of existing residential units. Requires conditional use approval. Encourages new family-friendly housing in parts of the city well served by parks and transit.*

#### Goals

- 1) Incentivize the construction of housing affordable to moderate and middle-income workforce households and families.
- 2) Assist the City in meeting the housing goals mandated in Proposition K by enabling the potential for 5,000 permanently affordable units over 20 years.
- 3) Meet local housing policy goals beyond the State Density Bonus Law affordability requirements.

#### Overview of HOME-SF:

- Applies to buildings with 3+ units
  - RH-1 and RH-2 excluded
  - Area plans excluded
- 30% on-site permanently affordable housing
- Provides development bonuses, including 20 additional feet and other zoning incentives, if project meets affordability requirements
- 40% of new units required to include 2+ bedrooms
- Prohibits merging of lots that result in more than 125 feet in lot frontage in Neighborhood Commercial Districts
- Limits projects to new construction and excludes any project that includes an addition to an existing structure
- Allows projects to utilize the State Density Bonus Law, as is required under state law
- Requires the Planning Department to provide a program evaluation and update every five years

#### Amendments Adopted in Land Use Committee on June 13, 2016

- No displacement of existing residential tenants
- No demolition, removal or conversion of any existing residential uses
- Requires a conditional use permit
- Requires replacement of ground floor level active uses at like size of any neighborhood commercial space impacted by a project using HOME-SF
- Provides commercial tenant support, including early notification of no less than 18 months from relocation date and observance of commercial relocation best practices



## KATY TANG

### Amendments Introduced in Land Use Committee on March 13, 2017

- Renames the “Local Affordable Housing Bonus” program as the “HOME-SF” program given separate passage of 100% Affordable Housing Bonus Program
- Adjusts income levels for BMR units to ensure equal distribution of low, moderate and middle income units:
  - Rental BMR units would be offered at 3 income levels:
    - 55% AMI
    - 80% AMI
    - 110% AMI
    - Income qualification for BMR rental units: between 45% AMI – 120% AMI
  - Ownership BMR units would be offered at 3 income levels:
    - 90% AMI
    - 120% AMI
    - 140% AMI
    - Income qualification for BMR ownership units: between 80% AMI – 150% AMI
- **Family-friendly amenities:** Encourages the inclusion of 3+ bedroom units in unit mix, the distribution of larger units on all floors and adjacent to open spaces or play yards, and the incorporation of family-friendly amenities such as bathtubs, stroller storage, and open space and yards.
- Enhances protections and options for existing commercial tenants
- Several minor technical clean ups
  - Excludes Northeastern Waterfront Area Plan south of the centerline of Broadway to make consistent with General Plan
  - Makes technical changes for individually requested program in response to recently adopted State Laws (AB2501)

## Somera, Alisa (BOS)

---

**From:** Tang, Katy (BOS)  
**Sent:** Thursday, May 04, 2017 2:24 PM  
**To:** Somera, Alisa (BOS)  
**Subject:** FW: San Francisco Parents Support More Housing for Families and Teachers - HOME SF

For file 150969 – Land Use Committee – Monday, May 8th

Begin forwarded message:

**From:** SF Parent PAC <[sfparentpac@gmail.com](mailto:sfparentpac@gmail.com)>  
**Date:** May 4, 2017 at 10:53:50 AM PDT  
**To:** SF Parent PAC <[sfparentpac@gmail.com](mailto:sfparentpac@gmail.com)>  
**Subject:** San Francisco Parents Support More Housing for Families and Teachers - HOME SF



### FOR IMMEDIATE RELEASE

May 4, 2017

**Contact:**

Michelle Parker, President, SF Parent PAC  
[415/260-8572](tel:4152608572), [michdparker@gmail.com](mailto:michdparker@gmail.com)

### SAN FRANCISCO PARENTS SUPPORT MORE HOUSING FOR FAMILIES AND TEACHERS

**San Francisco, CA** -- The San Francisco Parent Political Action Committee announced its support this week for Supervisors Katy Tang's and Ahsha Safia's proposed legislation, HOME SF. "Creating opportunities for families and teachers to live in San Francisco will increase the quality of life for all and help our city thrive," said Parent PAC President Michelle Parker, "and HOME SF does more to increase housing opportunities for middle income residents than any policy in recent memory."

HOME SF incentivizes more middle income housing in parts of the city well served by parks and transit by upzoning commercial and transit corridors, particularly on the west side of the city, and will require 30 percent on-site permanently affordable housing, which will serve families of four with incomes between 55% and 140% AMI (approx. \$63,400-\$161,400/yr). Forty percent of these homes must be family friendly with two or more bedrooms included.

After building virtually no middle income housing over the past 30 years, San Francisco is currently at a mere 15 percent of its own middle-income housing goals. HOME SF

helps the city increase that number over the next 20 years, enabling teachers, firefighters, non-profit sector workers, and others a way to afford living here.

HOME SF will go before San Francisco's Land Use Committee on Monday, May 8 before being voted on by the full Board of Supervisors on Tuesday, May 16.

***About the San Francisco Parent PAC***

Founded by and for San Francisco parents in 2010, San Francisco Parent Political Action Committee (PAC) is committed to giving parents a voice in the political process to positively impact the lives of all San Francisco families. San Francisco Parent PAC supports and promotes city candidates, measures and policies that will most effectively:

1. Ensure high quality education for every child in every neighborhood;
2. Increase access to affordable youth programs that support working families and enrich the lives of our children; and
3. Sustain healthy, safe and vibrant communities citywide.

###

**San Francisco Parent PAC**

[sfparentpac@gmail.com](mailto:sfparentpac@gmail.com)

[www.sfparentpac.com](http://www.sfparentpac.com)





Middle Polk Neighborhood Association

PO Box 640918, San Francisco, CA 94164-0918

Re: Local Alternatives to the California State Density Bonus Program

March 12, 2017

Honorable Mayor Lee, President Breed, and Members of the Board of Supervisors  
City and County of San Francisco  
Room 200  
1 Dr. Carlton B. Goodlett Place  
San Francisco, CA 94102 (by-email)

Dear Mayor Lee, President Breed, and Members of the Board:

Since our last letter of June 16, 2016, the City has taken some decisive actions to combat the affordability and displacement crisis. These actions include the following:

- (1) A 100% Affordable Local Density Bonus program
- (2) A citywide Accessory Dwelling Unit (ADU) program
- (3) Development of the Mission Action Plan (MAP) 2020
- (4) The Calle 24 Cultural Heritage District and Special Use District
- (5) A stronger Single Room Occupancy (SRO) conversion ordinance
- (6) Approval of Mid-Market housing developments with significant affordable housing components
- (7) Increased enforcement against illegal short-term rentals

In the next 3 years, the City will also have more opportunities to take decisive action with the adoption of the Central SOMA plan, the Hub, and the implementation of the Southern Waterfront Strategy. These large plans and projects offer opportunities to build more housing and for the City to negotiate the maximum percentage of affordable housing units possible without compromising feasibility.

In the coming months, the City will adopt amendments to the City's inclusionary housing program that also offer an opportunity to maximize the production of affordable housing without compromising the feasibility of building more housing. We urge for more to be done to prevent housing stock being removed from the market by way of short-term rentals, vacant units, sham-OMI evictions. We further urge stronger controls to prevent the destruction of affordable smaller single-family homes by way of monster home expansions.

On the state level, we are pleased to see discussions of Costa Hawkins reform as well as more plans to fund affordable housing and remain cautiously optimistic on those fronts.

Somera, Alisa (BOS)

150969

**From:** Quizon, Dyanna (BOS)  
**Sent:** Tuesday, May 02, 2017 12:13 PM  
**Subject:** FW: Supervisor Katy Tang's legislation

**From:** Shabbir Safdar <[shabbir@safdar.net](mailto:shabbir@safdar.net)>  
**Date:** May 2, 2017 at 10:10:52 AM PDT  
**To:**  
**Subject:** Supervisor Katy Tang's legislation

Can you forward this letter to a leg person following Supervisor Tang's height limit + 30% affordable housing legislation? I can't be at the hearing but perhaps they can submit something in writing for me? Attached below is my letter.

-Shabbir

Dear Supervisors,

I am a homeowner, small business owner, and public school parent in the Inner Sunset. I feel incredibly fortunate to be a homeowner. The only reason I own this home is because the seller wanted to see a family raise children in it. She chose our offer from many others, some of which probably offered more money.

I write to you today in support of Supervisor Katy Tang's Housing Density legislation. While, as a homeowner, I might have to face buildings two stories taller in my neighborhood, it's the case that I've also had to watch countless friends have to leave San Francisco because of the housing crisis. I've even watched friends consider living in illegal units that were fire traps because they didn't want to leave all the support structure of the jobs they had, the fellow families they could depend upon to watch their children, and the friends they'd made.

The combination of extra floors of housing, along with the requirements that it include 30% affordable housing make Supervisor Tang's proposal attractive.

Sure, there might be more contention for parking spaces. Sure, I might be living next to a slightly taller building. But none of these things outweigh the grief of watching my friends take kids out of school and leave entire communities they were a part of because they couldn't find housing that my fellow residents block construction of. I'm just not that selfish.

I urge you to support Supervisor Tang's proposal.

Shabbir J. Safdar  
1471 5th Ave  
SF CA 94122

--

**Todd David 杜德偉**  
Executive Director | San Francisco Housing Action Coalition  
95 Brady Street, San Francisco, CA 94103  
Office (415) 541-9001 | Cell (415) 373-8879  
Email: [todd@sfhac.org](mailto:todd@sfhac.org) | Web: [sfhac.org](http://sfhac.org)



## Middle Polk Neighborhood Association

PO Box 640918, San Francisco, CA 94164-0918

With this context in mind, we turn to the question of local alternatives to the California state Affordable Housing Bonus Density Program which will be a topic of discussion at the Board of Supervisors Land Use Committee on Monday, March 13, 2017. As we said last year, *“A local alternative is preferable to state law because a local program would better represent the unique circumstances of our City. The question becomes what does that alternative look like.”*

We would urge the City to embrace a gradual consensus-based approach to the market-rate local affordable bonus density program focused on the City’s soft sites as a priority. With this goal in mind, we offer the following suggestions for the sponsors and the committee to consider for amendments and future analysis prior to moving forward.

- (1) Adopt a program for the **RC, C, NC-3, and NCT-3** zoning districts

These districts are well served by transit including the MUNI Metro, Van Ness and Geary BRT and also have wide expansive streets. They are best suited to take on added density and height in exchange for greater levels of affordability e.g. the Hub, Van Ness Avenue, Geary Blvd., Lombard Street without major impact to smaller scale pedestrian oriented neighborhood commercial corridors.

- (2) Target soft-sites by allowing the program to apply to **Named NCD, NC, and NCT districts only for lots over 18,000 sq feet and for lots less than 18,000 square feet that are currently parking lots/garages or gas/service stations.** In the Polk NCD, under this framework some examples of qualifying lots would be 1600 Jackson Street, 1200 Larkin Street and 1123 Sutter Street. It may also be worth exploring separate legislation to allow form-based density in certain **Named NCD and NC** districts.

The current draft of the program would incentive demolition and merger of many of the small lots throughout the City’s commercial districts that make up the fabric of San Francisco. This would be devastating for small business. Limiting the program to large lots, parking lots/garages and gas/service stations would allow the City to add more housing to the NCD’s where appropriate without causing massive disruption to the City’s neighborhoods and small businesses.

- (3) Remove **RH3 and RM** districts from the program but consider separate legislation to allow for form-based density in those districts in certain neighborhoods as well as further incentives to create ADU’s in the RH3 and RM zoning districts.
- (4) Remove the 120-foot frontage merger limit for **RC and C** districts but maintain or modify the 120-foot frontage limit to be tailored for **NC-3 and NCT-3**, do not allow mergers for



## Middle Polk Neighborhood Association

PO Box 640918, San Francisco, CA 94164-0918

**Named NCD, NC, and NCT** zoning districts unless each lot would separately qualify for the program.

- (5) Remove **Chinatown Mixed Use and North Beach NCD** from the program entirely.
- (6) Prohibit any lot that has a qualifying **Legacy Business** from program eligibility (e.g. House of Prime Rib or Harris's on Van Ness Avenue are both in our neighborhood)

Lastly, as we noted last June, the 30% number may be dated in light of Prop C and the City's inclusionary housing ordinance and a higher number is appropriate such as 40%:

Some thought should be given to what role a density bonus could play in market rate development now requiring 25% affordable units. Perhaps it is feasible to ask developers to build 40% affordable units on site in exchange for a density bonus. 40% on-site affordable housing at a variety of income targets while protecting our small businesses and allowing for sufficient neighborhood input via conditional use authorization is better than 25% percent for a particular project if the community is willing to take on the density that community consensus would manifest itself through the conditional use process. It may be the case that the economics of a market rate program may only work in large developments given a 40% on-site affordable target.

Thank you all for your continued service to our City and for your work on solving the housing affordability and displacement crisis. We believe that a gradual consensus-based approach to the market-rate local affordable bonus density program focused on the City's soft sites is in line with addressing this crisis while preserve what is the essence of San Francisco, our neighborhoods.

Sincerely,  
Moe Jamil,  
Chair  
Middle Polk Neighborhood Association

CC: John Rahaim, Director, San Francisco Planning Department  
Aaron Starr, Manger Legislative Affairs, San Francisco Planning Department  
Jeff Buckley, Senior Housing Advisor, Office of the Honorable Mayor Lee  
Planning Commission  
Small Business Commission



**SIERRA  
CLUB**  
FOUNDED 1892

**San Francisco Group of the San Francisco Bay Chapter**

June 8, 2016

**Supervisor Malia Cohen**

Land Use and Transportation Committee  
San Francisco Board of Supervisors  
San Francisco City Hall, Room 244  
1 Dr. Carlton B. Goodlett Plaza  
SF, CA 94102

**Reply to:**

2120 Clement Street, Apartment 10  
San Francisco, California 94121

*Re. The Affordable Housing Density Bonus Program*

Dear Supervisor Cohen:

The Sierra Club opposes permitting reductions in required backyard open space in exchange for greater percentages of below-market-rate housing as part of the proposed Affordable Housing Density Program. The Sierra Club supports the construction of affordable infill housing in walkable communities well served by neighborhood businesses and mass transit as a means to reduce vehicle miles traveled and limit habitat destruction from sprawl. However, backyards are necessary as both habitat and as a means to restore the aquifers below the City. Backyards also serve as important sanctuaries for the City's residents – one of the reasons that code requires open space.

The Sierra Club also opposes any density bonus plans that do not include protections against demolition of existing affordable housing and retail, that do not include reductions in car parking (which would reduce the cost of housing construction), and that do not increase the required amount that developers must pay to offset project impacts to public transportation. The Sierra Club has already taken positions in opposition to the demolition of rent controlled housing, in support of reducing parking ratios, and in support of requiring developers to pay for the full impacts of their projects to transit.

Sincerely,  
Susan Vaughan  
SF Group Chair



**SPUR**

San Francisco | San Jose | Oakland

June 7, 2016

Land Use & Transportation Committee  
San Francisco Board of Supervisors  
1650 Mission Street, Suite 400  
San Francisco, CA 94103

RE: **Affordable Housing Bonus Program**  
Files No. 150969 and 160347

Dear Supervisors Cohen, Peskin and Wiener:

Thank you for the opportunity to share support for the Affordable Housing Bonus Program. SPUR urges you to support the bonus program for many reasons: It will increase the overall supply of housing (both affordable and market-rate), it will encourage higher densities at appropriate locations near transit, it will create a much-needed middle-income housing program, and it will improve the feasibility of certain vacant and underutilized sites. All without public subsidy.

We applaud the Planning Department and Supervisor Katy Tang's open ears and willingness to make amendments in response to concerns about residential and commercial displacement, and we urge you to recommend the full program for approval. We understand that there is a competing proposal that would offer incentives only to 100 percent affordable projects. We are concerned by the limited applicability of a proposal like that. It would not address the state's required density bonus program — which was the impetus behind creating a local bonus program in the first place. It would be likely to create hundreds of affordable units rather than tens of thousands of them. And it would not take advantage of the available levers to encourage the construction of more affordable housing *without public subsidy*.

We urge you to approve the mayor and Supervisor Tang's full Affordable Housing Bonus Program. Like all housing affordability solutions, this program is not a magic bullet but a smart tool that could make a difference. Ultimately San Francisco is accountable for meeting the state's density bonus requirement, and pairing ambitious affordability targets with incentives to make them possible is one right way to grow the city's supply of housing, both affordable and market-rate.

Please feel free to contact me if you have any questions.

Best,

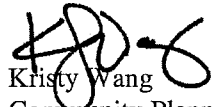

Kristy Wang

Community Planning Policy Director

Cc: Supervisor Katy Tang  
SPUR Board of Directors

SAN FRANCISCO  
654 Mission Street  
San Francisco, CA 94105  
(415) 781-8726

SAN JOSE  
76 South First Street  
San Jose, CA 95113  
(408) 638-0083

OAKLAND  
1544 Broadway  
Oakland, CA 94612  
(510) 827-1900

spur.org

## **Ausberry, Andrea**

---

**From:** Kristy Wang <kwang@spur.org>  
**Sent:** Monday, June 13, 2016 11:10 AM  
**To:** Peskin, Aaron (BOS); Cohen, Malia (BOS); Wiener, Scott  
**Cc:** Bruss, Andrea (BOS); Angulo, Sunny (BOS); Fryman, Ann (BOS); Tang, Katy (BOS); Dischinger, Kearstin (CPC); Rodgers, AnMarie (CPC); Buckley, Jeff (MYR); Ausberry, Andrea  
**Subject:** SPUR Supports the Affordable Housing Bonus Program  
**Attachments:** SPUR Supports AHBP.pdf

Dear Supervisors Cohen, Peskin and Wiener:

Thank you for the opportunity to share SPUR's support for the Affordable Housing Bonus Program.

This program will increase the overall supply of housing (both affordable and market-rate), it will encourage higher densities at appropriate locations near transit, it will create a much-needed middle-income housing program, and it will improve the feasibility of certain vacant and underutilized sites. All without public subsidy.

We applaud the Planning Department and Supervisor Katy Tang's open ears and willingness to make amendments in response to concerns about residential and commercial displacement, and we urge you to recommend the full program for approval in order to make the biggest dent in our affordability crisis.

Like all housing affordability solutions, this program is not a magic bullet but a smart tool that could make a difference. Ultimately San Francisco is accountable for meeting the state's density bonus requirement, and pairing ambitious affordability targets with incentives to make them possible is one right way to grow the city's supply of housing, both affordable and market-rate.

Please feel free to contact me if you have any questions.

Best,

Kristy Wang

Kristy Wang, LEED AP  
Community Planning Policy Director  
SPUR • Ideas + Action for a Better City  
(415) 644-4884  
(415) 425-8460 m  
[kwang@spur.org](mailto:kwang@spur.org)

[SPUR](#) | [Facebook](#) | [Twitter](#) | [Join](#) | [Get Newsletters](#)

Join us this summer for the SPUR Member Parties!  
[Reserve your spot today >>](#)



**Somera, Alisa (BOS)**

---

**From:** Board of Supervisors, (BOS)  
**Sent:** Thursday, February 25, 2016 9:27 AM  
**To:** BOS-Supervisors; Ausberry, Andrea; Somera, Alisa (BOS)  
**Subject:** File 150969 FW: No to AHBP

**From:** Anne Marie Donnelly [mailto:shortie102000@yahoo.com]  
**Sent:** Wednesday, February 24, 2016 10:06 PM  
**To:** Board of Supervisors, (BOS) <board.of.supervisors@sfgov.org>; Secretary, Commissions (CPC) <commissions.secretary@sfgov.org>  
**Subject:** No to AHBP

Dear Supervisors and Planning Commissioners,

Dear Supervisors and Planning Commissioners,

As a part of the Affordable Divis coalition, I am **opposed** to the Affordable Housing Bonus Program (AHBP). It threatens neighborhood character, fails to require sufficient affordability, and fails to protect existing rent controlled units and neighborhood serving retail businesses. **Instead, I support a community-focused approach to planning, as the Affordable Divis coalition has created with our Community Plan.**

**Thank you for hearing my voice,  
Anne Marie Donnelly**

## Somera, Alisa (BOS)

---

**From:** Board of Supervisors, (BOS)  
**Sent:** Thursday, February 25, 2016 9:27 AM  
**To:** BOS-Supervisors; Ausberry, Andrea; Somera, Alisa (BOS)  
**Subject:** File 150969 FW: No approval for AHBP

-----Original Message-----

**From:** Kersti Abrams [mailto:kerstia@earthlink.net]  
**Sent:** Wednesday, February 24, 2016 10:22 PM  
**To:** Secretary, Commissions (CPC) <commissions.secretary@sfgov.org>  
**Cc:** Board of Supervisors, (BOS) <board.of.supervisors@sfgov.org>  
**Subject:** No approval for AHBP

Dear Planning Commissioners,

As a long-time resident of District 5 and a member of the Affordable Divis Coalition, I am writing to voice my opposition to the Affordable Housing Bonus Program and to ask that you not approve this plan at the 2/25/16 meeting which I will unfortunately be unable to attend. To impose this proposed plan on the entire city will only further the ongoing loss of cultural and economic diversity which is threatening to erase the unique character of San Francisco. Under the guise of increasing affordable housing, this plan will result in the loss of existing rent-controlled units and of existing businesses which serve and are connected with the neighborhoods in which they exist. The increased density proposed in this plan would come with no improvements to transit or infrastructure. To turn the Divisadero corridor where I live into another version of the worst aspects of Van Ness, i.e. constant and frequently gridlocked traffic flowing between massive walls of concrete, is not a vision supported by anyone who actually lives here, but that seems to be what this plan is aiming at.

This plan has been put forward with virtually no input from those residents of San Francisco who will be most affected by it. The Community Plan created by the Affordable Divis Coalition through a series of meetings over the past couple of months is a positive example of how neighborhoods can be involved in planning the future of San Francisco in a way that serves the needs of the people who have actually been living here and not just the needs of developers aiming to profit from the creation of yet more high-end housing before the bubble bursts. I support planning and development which takes into account the wants and needs of existing communitites, increases truly affordable housing and supports neighborhood businesses. The AHBP will do none of that, and I hope you do not approve it.

Sincerely,

Kersti Abrams

## Somera, Alisa (BOS)

---

**From:** Board of Supervisors, (BOS)  
**Sent:** Thursday, February 25, 2016 9:28 AM  
**To:** BOS-Supervisors; Somera, Alisa (BOS); Ausberry, Andrea  
**Subject:** File 150969 FW: yes to community focused planning, no to the AHBP

**From:** aida jones [mailto:joneswest@mac.com]  
**Sent:** Wednesday, February 24, 2016 10:27 PM  
**To:** Board of Supervisors, (BOS) <board.of.supervisors@sfgov.org>; Breed, London (BOS) <london.breed@sfgov.org>  
**Subject:** yes to community focused planning, no to the AHBP

dear supervisors,

i am a long term resident of san francisco and now live in the alamo square neighborhood. i love the diverse neighborhoods from north beach to chinatown, from soma to the inner sunset. . .san francisco is wonderous in its collection of unique places.

one size legislation is not what san francisco is about otherwise we'd not have district elections for our supervisors. you do not run a city wide campaign, why would you blanket the city with one size development?

that's why i'm writing to ask you to oppose the affordable housing bonus program (ahbp) as it is currently written. nor should any development plan be city wide and without community inputs.

there was no canvassing of the neighbors no real education program, only presentations without true conversations. please let's follow the example of the affordable divis coalition and take into account the residents of each unique area within the city.

i support affordable housing, i support new housing and i support community-focused city planning.

thank you.

regards,  
aida jones

## Somera, Alisa (BOS)

---

**From:** Board of Supervisors, (BOS)  
**Sent:** Thursday, February 25, 2016 9:31 AM  
**To:** BOS-Supervisors; Somera, Alisa (BOS); Ausberry, Andrea  
**Subject:** file 150969 FW: Stop Affordable Housing Bonus Program

-----Original Message-----

**From:** Stacy Thompson [mailto:stacyt.thompson@gmail.com]  
**Sent:** Thursday, February 25, 2016 7:11 AM  
**To:** Board of Supervisors, (BOS) <board.of.supervisors@sfgov.org>  
**Subject:** Stop Affordable Housing Bonus Program

Dear Supervisors,

As a part of the Affordable Divis coalition, I am opposed to the Affordable Housing Bonus Program (AHBP). It threatens neighborhood character, fails to require sufficient affordability, and fails to protect existing rent controlled units and neighborhood serving retail businesses. Instead, I support a community-focused approach to planning, as the Affordable Divis coalition has created with our Community Plan.

Stacy Thompson  
120 Webster Street  
San Francisco, 94117  
stacyt.thompson@gmail.com

**Somera, Alisa (BOS)**

---

**From:** Board of Supervisors, (BOS)  
**Sent:** Thursday, February 25, 2016 9:32 AM  
**To:** BOS-Supervisors; Somera, Alisa (BOS); Ausberry, Andrea  
**Subject:** File 150969 FW: RE:opposition to AHBP

**From:** sfcookin@aol.com [mailto:sfcookin@aol.com]  
**Sent:** Thursday, February 25, 2016 7:22 AM  
**To:** Board of Supervisors, (BOS) <board.of.supervisors@sfgov.org>  
**Subject:** RE:opposition to AHBP

As a part of the Affordable Divis coalition, I am **opposed** to the Affordable Housing Bonus Program (AHBP). It threatens neighborhood character, fails to require sufficient affordability, and fails to protect existing rent controlled units and neighborhood serving retail businesses. **Instead, I support a community-focused approach to planning, as the Affordable Divis coalition has created with our Community Plan.**

**The Divisadero corridor is already becoming San Francisco's version of a food and bar court. This plan will only accelerate the elimination of neighborhood-sized, and neighborhood-serving businesses.**

**Judith Kaminsky**

## Somera, Alisa (BOS)

---

**From:** Board of Supervisors, (BOS)  
**Sent:** Thursday, February 25, 2016 9:35 AM  
**To:** BOS-Supervisors; Somera, Alisa (BOS); Ausberry, Andrea  
**Subject:** File 150969 FW: Comment for 2/25 AHBP hearing from DNA  
**Attachments:** DNA AHBP letter 0225 2016.pdf

**From:** wumoffly@aol.com [mailto:wumoffly@aol.com]  
**Sent:** Thursday, February 25, 2016 9:33 AM  
**To:** Secretary, Commissions (CPC) <commissions.secretary@sfgov.org>; Board of Supervisors, (BOS) <board.of.supervisors@sfgov.org>; planning@rodneyfong.com; cwu.planning@gmail.com; wordweaver21@aol.com; richhillissf@yahoo.com; Johnson, Christine (CPC) <christine.d.johnson@sfgov.org>; mooreurban@aol.com; Richards, Dennis (CPC) <dennis.richards@sfgov.org>; Wiener, Scott <scott.wiener@sfgov.org>  
**Cc:** deannamooney@sbcglobal.net; diane@dmccarney.com; Dischinger, Kearstin (CPC) <kearstin.dischinger@sfgov.org>  
**Subject:** Comment for 2/25 AHBP hearing from DNA

Attn: J.P. Ionin

Attached please find the comments respectfully submitted from the Duncan Newburg Association regarding the Executive Summary hearing materials on AHBP for discussion by the Planning Commission on Feb 25.

Thank you for your consideration.

Sincerely,  
Deanna Mooney, President  
Diane McCarney, co-President  
Lily Wu  
Duncan Newburg Association

To: San Francisco Planning Commission

cc: Scott Wiener

cc: Board of Supervisors Secretary

cc: Planning Dept. AHBP

This is written on behalf of the Duncan Newburg Association (DNA) which represents approximately 70 home owners in the area surrounding the Duncan Castro Open Space Park.

We read the distributed Executive Summary of Planning Code Amendment for the AHBP which was distributed on February 22, and would respectfully like to forward the following feedback:

1. We strongly support the Planning Department's recommended amendment as stated on page 6 of the Executive Summary to "Add Limiting Criterion: Projects that propose to demolish any residential units shall not be eligible for AHBP." Demolishing existing units to build new units, even if more, is disruptive and wasteful. We hope the Planning Commission will accept this recommended amendment, and that the Board of Supervisors will similarly move to adopt it.
2. We also agree with and approve of the Planning Department's analysis that AHBP projects should generally be parcels which are "currently developed to less than five percent of existing zoning, and do not have residential uses, and are not schools, churches, hospitals, or historic resources." If anything, we hope the Planning Commission and the Board of Supervisors will adopt this exact language in the final AHBP code so that this intention and analysis is codified, and will not be forgotten or disregarded in future years. We believe this is an important protection against AHBP being used to disadvantage or dislocate existing stakeholders in San Francisco such as existing tenants, home owners and small business owners. We hope for more affordable housing, but in addition to, and not at the expense of existing San Francisco stakeholders.
3. We were disappointed to discover that the Local AHBP code (Sec. 206.3) is not entirely consistent with the State AHBP code (Sec. 206.5), and that the State code may override the Local code if conflicts or legal challenges were to arise. Specifically, the draft code for the Local AHBP (Sec. 206.3) has a clear applicability clause Sec. 206.3b(6) that AHBP projects "consists only of new construction, and excluding any project that includes an addition to an existing structure." We strongly agree with and support this applicability clause. However, this clause does not appear in the State AHBP code in the comparable section (Sec. 206.5b). The more tailored and better defined Local AHBP should prevail in San Francisco. We urge the Planning Commission and Board of Supervisors to close any loopholes whereby the more permissive State AHBP may be used to challenge or override the Local AHBP code.

Sincerely,

Duncan Newburg Association

23 February 2016

## Somera, Alisa (BOS)

---

**From:** Board of Supervisors, (BOS)  
**Sent:** Thursday, February 25, 2016 3:58 PM  
**To:** BOS-Supervisors; Somera, Alisa (BOS); Ausberry, Andrea  
**Subject:** file 150969 FW: No on AHBP: Yes on smart density planning

**From:** Ellisa F. [mailto:ellisafeinstein@gmail.com]  
**Sent:** Thursday, February 25, 2016 1:47 PM  
**To:** Board of Supervisors, (BOS) <board.of.supervisors@sfgov.org>; Secretary, Commissions (CPC) <commissions.secretary@sfgov.org>  
**Subject:** No on AHBP: Yes on smart density planning

Dear Supervisors and Planning Commissioners,

As a part of the Affordable Divis coalition and a 16 year resident of San Francisco, I am opposed to the Affordable Housing Bonus Program (AHBP). It threatens neighborhood character, fails to require sufficient affordability and new transit infrastructure, and fails to protect existing rent controlled units and neighborhood serving retail businesses.

While density housing is needed, it should not come to the expense of the beauty that defines San Francisco nor at the expense of residents' quality of life. What we have been currently seeing is an influx of new buildings without concern for the ascetics of the city - buildings that are, quite frankly, very ugly. We're also seeing proposed large buildings (i.e. along the Divisadero Corridor) that do not plan for transit improvements; for instance, right now, one can barely walk down the sidewalks on Divisadero when there is a crowd, bicycling is becoming even more precarious with additional cars on the road, and traffic is more horrendous than it was in the early 2000s.

Instead, I support a community-focused approach to planning, as the Affordable Divis coalition has created with our Community Plan. Please consider the Community Plan as an alternative.

Thank you for your time.

Sincerely,  
Ellisa Feinstein

400 Baker Street  
San Francisco, CA 94117



150969

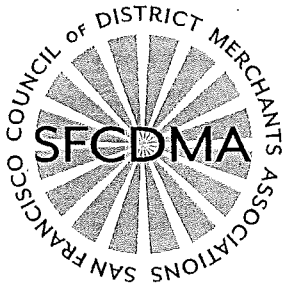

## SAN FRANCISCO COUNCIL OF DISTRICT MERCHANTS ASSOCIATIONS

Henry Karnilowicz  
President

Maryo Mogannam  
Vice President

Dani Sheehan-Meyer  
Secretary

Keith Goldstein  
Treasurer

February 21, 2016

San Francisco Board Of Supervisors  
Land Use & Transportation  
1 Dr. Carlton B. Goodlett Place  
City Hall, Room 244  
San Francisco, CA 94102-4689

Dear Supervisors Cohen, Peskin and Wiener,

I am writing to you on behalf of the San Francisco Council of District Merchants Associations to inform you that at our last meeting on Tuesday, February 16, 2016, Sheila Nickolopoulos and AnMarie Rodgers from City Planning did a presentation supporting and Denis Mosfogian from San Francisco for Community Planning opposing the proposed Affordable Housing Bonus Program.

We strongly support the building of affordable housing but not at the expense of possibly losing businesses by developers demolishing buildings to build new buildings. We have many concerns including the impact on utilities, transportation and parking.

We voted to not support the legislation as proposed and urge you to do likewise, and to recommend further study and input from the small business community.

Sincerely,

Henry Karnilowicz  
SFCDMA President

Cc:

Supervisor Malia Cohen  
Supervisor Aaron Peskin  
Supervisor Scott Wiener

Date: Feb 5, 2016

To: SF Planning Commissioners (Fong, Wu, Antonini, Moore, Richards, Hillis, and Johnson)

CC: Gil Kelley, Mayor Lee, SF Supervisors

From: Malcolm (Jim) Perkins

Re: Next steps for AHBP

I watched the entire AHBP segment of the Jan 28, 2016 meeting with interest. I will articulate some **additional points** not made by Planning Dept. Staff, the public, and the Commissioners.

My background

I moved to SF 29 years ago and live in a rent controlled apartment (not in the AHBP program area). I retired from SFUSD in 2015 and since September I have spent about 15 hours/week informing SF residents about AHBP, its context, and its ramifications. Prior to teaching, I had a decade of experience as a Senior Industrial Engineer and as a small business consultant. I have managed personal investments for 40 years.

Additional points:

- 1) **From listening** as I brought the public's attention to AHBP, housing and growth, I offer several **majority conclusions**:
  - a. In a quick reaction, most people do not want a taller building next to them.
  - b. After some time and thought, most people would accept 4 stories (if there is some public benefit). Very few people would accept 6 stories even if there is a public benefit.
  - c. The public desires a broader housing discussion and clear proposals.
  - d. Gentrification has a disparate impact on minorities and AHBP does address that.
  - e. AHBP appears to have random effects rather than predictable, planned/desired effects.
  - f. Many people who spent their careers in SF will be forced out as retirees.
  - g. People prefer rent control to the strictures of lower cost housing.
  - h. Many residents are unaware of how much heights and neighborhoods can change under existing regulations. Thanks to Commissioner Richards for his examples (please expand and repeat).
  - i. Trying to build housing to effect prices is a losing bet and political "b.s."
  - j. A primary public objection to city growth is transportation issues.
  - k. Most people want the issue of changing/streamlining planning dept. procedures addressed as a separate issue. Thanks to Gil Kelley for already starting work to clarify communications on this topic.

RECEIVED  
 BOARD OF SUPERVISORS  
 SAN FRANCISCO  
 2016 FEB -5 PM 1:00  
 BY AK

COB  
 Luoker  
 Log Dep

- 2) Though AHBP may have initially been considered a narrow, easily approved concept, as revised it affects 8,000+ lots over the long term. The number of soft site lots with developer appeal depends on other policies; specifically, the measures on the June ballot. If the measure by Supervisors Kim and Peskin is approved by voters, AHBP will become preferred by developers (dramatically increasing its scale and impact). How can the commission say adopting AHBP is desirable if its context and scale may change between April and July? Prudence requires either delay or approval with conditions and explanations for the rush.
- 3) The State option under AHBP exceeds requirements of state law and the judge's decision in the Napa case. Existing legal advice seeks to avoid all court action at the expense of good policy. To accept random increased height against the wishes of the public instead of developing legal alternatives not public service.
- 4) SF is still awakening to housing proposals. Supervisors are discussing additional proposals for projects under 25 units. The public will need one consolidated, well communicated AHBP proposal (not a jumble of amendments) and a full 90 days after Planning Commission action if there is to be any change in the current negative opinion.
- 5) Much of the public does not understand **the economics driving real estate prices in SF**.
  - a) SF has established a **"gig" labor force** with the skills and breadth necessary for **startups** in Information Technology, Biotechnology, websites, and "apps". Many large innovative technology companies have sizeable operations nearby. Several local universities have specialists in these sectors. Many **venture capitalists** in these sectors are bay area based. Bay area startups have a history of success. This economic sector in SF is already **self-sustaining** and its **growth has begun to slow in SF and spread across the bay area and U.S.** due to relative costs and inducements.
  - b) College students, individuals in their 20s, and young families have an **increased preference for living in cities**. No one knows how long this will last.
  - c) The People's Republic of China has **softened controls on capital**, their citizens include thousands of millionaires, and their citizens are diversifying worldwide rapidly. At these levels, the PRC can't afford this for more than 3 years.
  - d) American and SF real estate is stable and desirable relative to stocks and bonds and real estate elsewhere. Investors often prefer to keep their **investments close together** and in a limited number of geographic areas.
  - e) United States/world **populations are "greying"**. This **increases capital** faster than investment opportunities. This will continue for a minimum of 10 more years and drives down investment returns. **Lower returns will still attract residential real estate investors.**

Thank you for your service to San Francisco

## Somera, Alisa (BOS)

---

**From:** Board of Supervisors, (BOS)  
**Sent:** Tuesday, February 09, 2016 9:32 AM  
**To:** BOS-Supervisors; Somera, Alisa (BOS)  
**Subject:** File 150969 FW: An SF voter who opposes the Affordable Housing Bonus Program

**From:** Brett Miller [mailto:fritterboy2003@yahoo.com]  
**Sent:** Monday, February 08, 2016 11:22 PM  
**To:** Board of Supervisors, (BOS) <board.of.supervisors@sfgov.org>; Commissions.Secretary@sfgov.org  
**Subject:** An SF voter who opposes the Affordable Housing Bonus Program

Dear Supervisors and Planning Commissioners,

As part of the Affordable Divis coalition, I am opposed to the Affordable Housing Bonus Program (AHBP) as currently proposed because it threatens neighborhood character, fails to require sufficient affordability, and fails to protect existing rent controlled units and neighborhood serving businesses. Instead, I support a community-focused approach to planning, as the Affordable Divis has created with our community plan (<http://www.pdf-archive.com/2016/01/15/2016-divis-comm-plan-final/2016-divis-comm-plan-final.pdf>).

I am a resident voter who has serious concerns about the directions that our leadership personnel have taken our city and the negative impacts that are being seen in all our neighborhoods and to many of our most dedicated and long term citizens. The AHBP proposal is not a solution that will help ease the disparities that have had or threaten to have such debilitating consequences for the majority of our citizenry.

Please dismiss this plan and begin work on one that will legitimately have a positive impact for those of us who remain steadfastly devoted San Franciscans.

Thank you for your time and consideration,

Brett Miller  
District 5

**Somera, Alisa (BOS)**

---

**From:** Board of Supervisors, (BOS)  
**Sent:** Thursday, January 28, 2016 4:25 PM  
**To:** BOS-Supervisors; Somera, Alisa (BOS)  
**Subject:** File 150969 FW: AHBP

**From:** Claire Bevan [mailto:clairehbevan@gmail.com]  
**Sent:** Thursday, January 28, 2016 1:52 PM  
**To:** Board of Supervisors, (BOS) <board.of.supervisors@sfgov.org>; Secretary, Commissions (CPC) <commissions.secretary@sfgov.org>  
**Subject:** AHBP

Dear Supervisors and Planning Commissioners,

As a part of the Affordable Divis coalition, I am opposed to the Affordable Housing Bonus Program (AHBP) as currently proposed because it threatens neighborhood character, fails to require sufficient affordability, and fails to protect existing rent controlled units and neighborhood serving retail businesses.

Instead, I support a community-focused approach to planning, as the Affordable Divis coalition has created with our Community Plan.

Thanks for your service,  
Claire

--  
Claire Bevan  
[hiciairebevan.com](http://hiciairebevan.com)  
[@hiciairebevan](mailto:@hiciairebevan)

## Somera, Alisa (BOS)

---

**From:** Board of Supervisors, (BOS)  
**Sent:** Thursday, January 28, 2016 9:38 AM  
**To:** BOS-Supervisors; Somera, Alisa (BOS)  
**Subject:** File 150969 FW: Affordable Housing Bonus Program

**From:** Eihway Su [mailto:esinsf@yahoo.com]  
**Sent:** Thursday, January 28, 2016 8:34 AM  
**To:** Board of Supervisors, (BOS) <board.of.supervisors@sfgov.org>; Secretary, Commissions (CPC) <commissions.secretary@sfgov.org>  
**Subject:** Affordable Housing Bonus Program

I am opposed to the Affordable Housing Bonus Program (AHBP) as currently proposed because it threatens neighborhood character, fails to require sufficient affordability, and fails to protect existing rent controlled units and neighborhood serving retail businesses. Instead, I support a community-focused approach to planning as the Affordable Divis coalition has created with their Community Plan.

Eihway Su  
170 Parnassus Ave., #2  
SF CA 94117

**Somera, Alisa (BOS)**

---

**From:** Board of Supervisors, (BOS)  
**Sent:** Wednesday, January 27, 2016 4:16 PM  
**To:** BOS-Supervisors; Somera, Alisa (BOS)  
**Subject:** File 150969 FW: Affordable Housing Bonus Program

**From:** Denise Zietlow [mailto:dmzietlow@gmail.com]  
**Sent:** Wednesday, January 27, 2016 4:10 PM  
**To:** Board of Supervisors, (BOS) <board.of.supervisors@sfgov.org>  
**Subject:** Affordable Housing Bonus Program

Dear Supervisors,

As a part of the Affordable Divis coalition, I am opposed to the Affordable Housing Bonus Program (AHBP) as currently proposed. It does not require sufficient affordability in this very expensive city. It does nothing to protect existing rent controlled units and retail businesses that serve the neighborhood. Lastly, the allowable bulk and height threatens the character of a neighborhood and could lead to loss of green space and sunshine, both important health and quality of life factors in a congested city. Instead, I support a community-focused approach to planning, as the Affordable Divis coalition has created with our Community Plan.

Sincerely,

Denise Zietlow  
1968 Hayes Street  
San Francisco, CA

**Somera, Alisa (BOS)**

---

**From:** Board of Supervisors, (BOS)  
**Sent:** Wednesday, January 27, 2016 3:28 PM  
**To:** BOS-Supervisors; Somera, Alisa (BOS)  
**Subject:** File 150969 FW: AHBP

**From:** mario donoso [mailto:mndonoso1@gmail.com]  
**Sent:** Wednesday, January 27, 2016 3:25 PM  
**To:** Board of Supervisors, (BOS) <board.of.supervisors@sfgov.org>; Secretary, Commissions (CPC) <commissions.secretary@sfgov.org>  
**Subject:** AHBP

Dear Supervisors and Planning Commissioners:

As a part of the Affordable Divis Coalition, I am opposed to the Affordable Housing Bonus Program ( AHBP ) as currently proposed because it threatens neighborhood character, fails to require sufficient affordability, and fails to protect existing rent controlled units and neighborhood serving retail businesses. Instead, I support a community-focused approach to planning, as the Affordable Divis coalition has created with our Community Plan.

Sincerely,

--  
MARIO DONOSO ACOSTA  
1270 Grove St. Apt. #104  
San Francisco, Ca. 94117



## Somera, Alisa (BOS)

---

**From:** Board of Supervisors, (BOS)  
**Sent:** Wednesday, January 27, 2016 2:31 PM  
**To:** BOS-Supervisors; Somera, Alisa (BOS)  
**Subject:** File 150969 FW: proposed Affordable Housing Bonus Program  
**Attachments:** 2016-divis-comm-plan-final.pdf

**From:** Scott Bravmann [mailto:het.pakhuis@yahoo.com]  
**Sent:** Wednesday, January 27, 2016 1:37 PM  
**To:** Board of Supervisors, (BOS) <board.of.supervisors@sfgov.org>; Secretary, Commissions (CPC) <commissions.secretary@sfgov.org>  
**Subject:** proposed Affordable Housing Bonus Program

As a part of the Affordable Divis coalition, I am opposed to the Affordable Housing Bonus Program (AHBP) as currently proposed because it threatens neighborhood character, fails to require sufficient affordability, and fails to protect existing rent controlled units and neighborhood serving retail businesses. Instead, I support a community-focused approach to planning, as the Affordable Divis coalition has created with our Community Plan. I have attached a copy of the plan we developed over the course of several months with input from hundreds of residents.

Scott Bravmann, PhD  
1305 Buchanan St

## Somera, Alisa (BOS)

---

**From:** Board of Supervisors, (BOS)  
**Sent:** Wednesday, January 27, 2016 1:38 PM  
**To:** BOS-Supervisors; Somera, Alisa (BOS)  
**Subject:** File 150969 FW: Affordable Housing Bonus Program

**From:** Susan Mallon [mailto:sfmallon@gmail.com]  
**Sent:** Wednesday, January 27, 2016 11:33 AM  
**To:** Board of Supervisors, (BOS) <board.of.supervisors@sfgov.org>; Secretary, Commissions (CPC) <commissions.secretary@sfgov.org>  
**Subject:** Affordable Housing Bonus Program

Dear Supervisors and Planning Commissioners,

As a part of the Affordable Divis coalition, I am opposed to the Affordable Housing Bonus Program (AHBP) as currently proposed because it threatens neighborhood character, fails to require sufficient affordability, and fails to protect existing rent controlled units and neighborhood serving retail businesses. Instead, I support a community-focused approach to planning, as the Affordable Divis coalition has created with our Community Plan.

Sincerely,

Susan Mallon, District 5 resident  
909 Page Street #2  
San Francisco, CA 94117

**Somera, Alisa (BOS)**

---

**From:** Board of Supervisors, (BOS)  
**Sent:** Wednesday, January 27, 2016 1:26 PM  
**To:** BOS-Supervisors; Somera, Alisa (BOS)  
**Subject:** File 150969 FW: Opposing AHBP

**From:** Tracey Holland [mailto:theogwt@gmail.com]  
**Sent:** Wednesday, January 27, 2016 11:11 AM  
**To:** Board of Supervisors, (BOS) <board.of.supervisors@sfgov.org>  
**Cc:** Secretary, Commissions (CPC) <commissions.secretary@sfgov.org>  
**Subject:** Opposing AHBP

Dear Supervisors and Planning Commissioners,

As a part of the Affordable Divis coalition, I am opposed to the Affordable Housing Bonus Program (AHBP) as currently proposed because it threatens neighborhood character, fails to require sufficient affordability, and fails to protect existing rent controlled units and neighborhood serving retail businesses. Instead, I support a community-focused approach to planning, as the Affordable Divis coalition has created with our Community Plan.

## Somera, Alisa (BOS)

---

**From:** Board of Supervisors, (BOS)  
**Sent:** Wednesday, January 27, 2016 1:26 PM  
**To:** BOS-Supervisors; Somera, Alisa (BOS)  
**Subject:** file 150969 FW: No to the current Affordable Housing Bonus Program

-----Original Message-----

From: karoline [mailto:karoline@khatch.com]  
Sent: Wednesday, January 27, 2016 10:58 AM  
To: Board of Supervisors, (BOS) <board.of.supervisors@sfgov.org>; Secretary, Commissions (CPC) <commissions.secretary@sfgov.org>; BreedStaff, (BOS) <breedstaff@sfgov.org>  
Subject: No to the current Affordable Housing Bonus Program

Dear Supervisors and Planning Commissioners,

I am opposed to the Affordable Housing Bonus Program (AHBP) as currently proposed because it threatens neighborhood character, fails to require sufficient affordability, and fails to protect existing rent controlled units and neighborhood serving retail businesses. Instead, I support a community-focused approach to planning, as the Affordable Divis coalition has created with our Community Plan.

All the best,  
Caroline Hatch  
94117

**Somera, Alisa (BOS)**

---

**From:** Board of Supervisors, (BOS)  
**Sent:** Wednesday, January 27, 2016 1:25 PM  
**To:** BOS-Supervisors; Somera, Alisa (BOS)  
**Subject:** File 150969 FW: I do not support the Affordable Housing Bonus Program

**From:** leslie s. [mailto:lsullivan.email@gmail.com]  
**Sent:** Wednesday, January 27, 2016 10:54 AM  
**To:** Board of Supervisors, (BOS) <board.of.supervisors@sfgov.org>  
**Subject:** I do not support the Affordable Housing Bonus Program

I've lived off of Divisadero since 2003, I oppose the new heights as a bonus for the developers.

## Somera, Alisa (BOS)

---

**From:** Board of Supervisors, (BOS)  
**Sent:** Wednesday, January 27, 2016 1:24 PM  
**To:** BOS-Supervisors; Somera, Alisa (BOS)  
**Subject:** File 150969 FW: bonus program

**From:** aida jones [mailto:joneswest@mac.com]  
**Sent:** Wednesday, January 27, 2016 10:41 AM  
**To:** Board of Supervisors, (BOS) <board.of.supervisors@sfgov.org>; Secretary, Commissions (CPC) <commissions.secretary@sfgov.org>; Breed, London (BOS) <london.breed@sfgov.org>  
**Subject:** bonus program

dear supervisors & planning commissioners:

as a long-term resident of san francisco and a member of the affordable divisadero coalition,  
i am deeply opposed to the affordable housing bonus program (ahbp) in its current form.

i believe in community-focused planning and this ahbp does not require any transit or infrastructure improvements, does not create real affordable housing and has a number of other glaring omissions.

without consulting your constituency prior to drafting the ahbp we are left with asking that you do the right thing now and require it to be revised.

i support the community-focused plan as created by the affordable divis coalition.

thank you.

regards,  
aida jones

File 150969

**From:** Steven Thompson <styvwerx.thompson@gmail.com>  
**Sent:** Saturday, January 23, 2016 1:24 PM  
**To:** Tang, Katy (BOS)  
**Cc:** Mar, Eric (BOS); Farrell, Mark (BOS); Peskin, Aaron (BOS); BreedStaff, (BOS); Kim, Jane (BOS); Secretary, Commissions (CPC); Yee, Norman (BOS); scott.weiner@sfgov.org; Campos, David (BOS); Cohen, Malia (BOS); Avalos, John (BOS); Board of Supervisors, (BOS); Ojeda, Teresa (CPC)  
**Subject:** Affordable Housing Bonus Plan

Katy, I am writing you to express my views, and give direction, regarding this issue. I, and my wife, Helen, wish you to vote this ill conceived measure down. If a measure similar to this one is needed, it most certainly should be voted on by those who will be affected by **district** however, **it is not even remotely clear that such a need, as expressed in the current proposal, exists.** The current measure smacks of Dick Cheney energy policies, in its lack of transparency, and the fact that it is being presented to the voters with so little community input.

The proposed options for multi-story residences with no on site parking is, in my opinion, sheer idiocy. We live in a residential neighborhood, where rentals of existing units, often with two to four cars per unit, make parking on the streets difficult if not impossible, at present. Adding the parking requirements of such high density units does much to further the general impression, among our friends and neighbors in this area, that the profit motive among the developers of this plan were given so much more consideration than that of the City's residents, and that the whole plan should be thrown out.

We are citizens and voters, and we have long memories, having lived at our current address, which we own and occupy, for thirty-five years. Please act accordingly. Steve & Helen Thompson

## Somera, Alisa (BOS)

---

**From:** Board of Supervisors, (BOS)  
**Sent:** Friday, January 22, 2016 8:52 AM  
**To:** Somera, Alisa (BOS)  
**Subject:** File 150969 FW: DO NOT Approve the Affordable Housing Bonus Program

**From:** Beth Lewis [mailto:balewis100@gmail.com]  
**Sent:** Thursday, January 21, 2016 10:13 PM  
**To:** Mar, Eric (BOS) <eric.mar@sfgov.org>; Farrell, Mark (BOS) <mark.farrell@sfgov.org>; Peskin, Aaron (BOS) <aaron.peskin@sfgov.org>; Tang, Katy (BOS) <katy.tang@sfgov.org>; BreedStaff, (BOS) <breedstaff@sfgov.org>; Kim, Jane (BOS) <jane.kim@sfgov.org>; Yee, Norman (BOS) <norman.yee@sfgov.org>; Wiener, Scott <scott.wiener@sfgov.org>; Campos, David (BOS) <david.campos@sfgov.org>; Cohen, Malia (BOS) <malia.cohen@sfgov.org>; Avalos, John (BOS) <john.avalos@sfgov.org>; Board of Supervisors, (BOS) <board.of.supervisors@sfgov.org>; Secretary, Commissions (CPC) <commissions.secretary@sfgov.org>  
**Subject:** DO NOT Approve the Affordable Housing Bonus Program

### Supervisors:

Please do not approve the Affordable Housing Bonus Program (AHBP). The negative impacts outweigh the benefits that would be gained.

The character of many neighborhoods is threatened: The AHBP essentially throws out the zoning laws that have been carefully crafted over decades to protect and guide development in our city. It will disrupt neighborhood stability and character because it is an incentive for property owners to demolish low-rise buildings and cash out. It especially threatens renters and rent-controlled units as existing buildings are encouraged to be torn down.

As presented, the AHBP:

- Automatically allows building height increases by a minimum of 2 to 3 stories, reducing privacy and sunlight, and casting more shadows on nearby open space. THIS IS NOT GOOD URBAN DESIGN! Many blocks of the targeted streets are not commercial and are presently 1 to 3 storey residential buildings. Introduction and encouragement of random buildings twice the existing height is inappropriate in many places and is in violation of the spirit of the Housing Plan.
- Weakens existing environmental review requirements
- Approves increased density while ignoring our already overcrowded transit infrastructure
- Applies AHBP Design Guidelines throughout SF in areas where they are inappropriate.
- Authorizes increased density by allowing more units per building.
- Cuts property line setbacks with greater building bulk and more units (and people!) but less open space for those same building occupants;



- Restricts current advance notification rights for adjacent neighbors and limits public review: Will The Affordable Housing Bonus Program no longer require a zoning variance or conditional use permit for a developer who simply purports to offer housing to a certain demographic?
- The income requirements to live in an AHBP unit are much too high and will not help the majority of San Francisco residents who need housing.

While I do support the concept of encouraging and providing housing for middle and low income people, I strongly support the preservation of neighborhood density, livability and character which the proposed increased height limits will threaten. The mere fact that some of the targeted streets bear the burden of extra automobile traffic and bus routes or have a certain zoning classification should not make them vulnerable to the increase of existing heights—heights which have been developed and protected by zoning and building codes for decades.

Many blocks of the targeted streets are not commercial and are currently 1 to 3 storey residential buildings. Introduction and encouragement of random buildings twice the existing height is inappropriate in many places and is in violation of the spirit of the Housing Plan. Will The Affordable Housing Bonus Program no longer require a zoning variance or conditional use permit for a developer who simply purports to offer housing to a certain demographic? Will San Francisco residents suddenly face a five to six storey building next door with no recourse?

Please, DO NOT approve the Affordable Housing Bonus Program. It was essentially drafted without community input. It needs to go back to the drawing board.

Thank you in advance!

Beth Lewis  
571 25th Avenue  
SF, CA 94121

## Somera, Alisa (BOS)

---

**From:** Board of Supervisors, (BOS)  
**Sent:** Thursday, January 21, 2016 1:30 PM  
**To:** BOS-Supervisors; Somera, Alisa (BOS)  
**Subject:** File 150969 FW: I do not support the A H B P

**From:** R [mailto:rkinsf@gmail.com]  
**Sent:** Thursday, January 21, 2016 12:03 PM  
**To:** Board of Supervisors, (BOS) <board.of.supervisors@sfgov.org>  
**Subject:** I do not support the A H B P

Dear Supervisors:

I do not support the AHBP as it allows developers to gain increases in height and density without a true increase in the existing affordable housing requirement.

I am a long time resident who sees the AHBP as a way to benefit developers and the wealthy without addressing the needs of the local community.

Please vote against this measure - I believe that it would not be in the best interest of all San Franciscans.

Thank you.

Richard Kay  
415-341-3019

25 year resident of the lower haight.

BOARD of SUPERVISORS



City Hall  
1 Dr. Carlton B. Goodlett Place, Room 244  
San Francisco 94102-4689  
Tel. No. 554-5184  
Fax No. 554-5163  
TDD/TTY No. 554-5227

January 19, 2016

File No. 150969-2

Sarah Jones  
Environmental Review Officer  
Planning Department  
1650 Mission Street, 4<sup>th</sup> Floor  
San Francisco, CA 94103

Dear Ms. Jones:

On January 12, 2016, Mayor Lee introduced the following **substitute** legislation, which has been referred to the Land Use and Transportation Committee:

**File No. 150969-2**

Ordinance amending the Planning Code to create the Affordable Housing Bonus Programs, consisting of the Local Affordable Housing Bonus Program, the 100 Percent Affordable Housing Bonus Program, the Analyzed State Density Bonus Program, and the Individually Requested State Density Bonus Program, to provide for development bonuses and zoning modifications for affordable housing, in compliance with, and above those required by the State Density Bonus Law, Government Code, Sections 65915, et seq.; to establish the procedures in which the Local Affordable Housing Bonus Program and the 100 Percent Affordable Housing Bonus Program shall be reviewed and approved; adding a fee for applications under the Program; amending the Planning Code to exempt projects from the height limits specified in the Planning Code and the Zoning Maps; affirming the Planning Department's determination under the California Environmental Quality Act; and making findings of consistency with the General Plan, and the eight priority policies of Planning Code, Section 101.1.

This legislation is being transmitted to you for environmental review.

Angela Calvillo, Clerk of the Board

A handwritten signature in cursive script that reads "Alisa Somera".

By: Alisa Somera, Assistant Clerk  
Land Use and Transportation Committee

Attachment

cc: Joy Navarrete, Environmental Planning  
Jeanie Poling, Environmental Planning

BOARD of SUPERVISORS

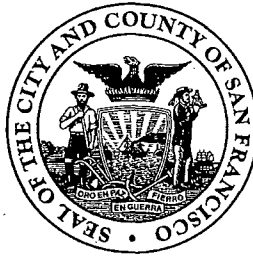

City Hall  
1 Dr. Carlton B. Goodlett Place, Room 244  
San Francisco 94102-4689  
Tel. No. 554-5184  
Fax No. 554-5163  
TDD/TTY No. 554-5227

January 19, 2016

Planning Commission  
Attn: Jonas Ionin  
1650 Mission Street, Ste. 400  
San Francisco, CA 94103

Dear Commissioners:

On January 12, 2016, Mayor Lee introduced the following **substitute** legislation, which has been referred to the Land Use and Transportation Committee:

**File No. 150969-2**

Ordinance amending the Planning Code to create the Affordable Housing Bonus Programs, consisting of the Local Affordable Housing Bonus Program, the 100 Percent Affordable Housing Bonus Program, the Analyzed State Density Bonus Program, and the Individually Requested State Density Bonus Program, to provide for development bonuses and zoning modifications for affordable housing, in compliance with, and above those required by the State Density Bonus Law, Government Code, Sections 65915, et seq.; to establish the procedures in which the Local Affordable Housing Bonus Program and the 100 Percent Affordable Housing Bonus Program shall be reviewed and approved; adding a fee for applications under the Program; amending the Planning Code to exempt projects from the height limits specified in the Planning Code and the Zoning Maps; affirming the Planning Department's determination under the California Environmental Quality Act; and making findings of consistency with the General Plan, and the eight priority policies of Planning Code, Section 101.1.

The proposed ordinance is being transmitted pursuant to Planning Code Section 302(b) for public hearing and recommendation. The ordinance is pending before the Land Use and Transportation Committee and will be scheduled for hearing upon receipt of your response.

Angela Calvillo, Clerk of the Board

A handwritten signature in cursive script that reads "Alisa Somera".

By: Alisa Somera, Assistant Clerk  
Land Use and Transportation Committee

cc: John Rahaim, Director of Planning  
Aaron Starr, Acting Manager of Legislative Affairs  
AnMarie Rodgers, Senior Policy Manager  
Scott Sanchez, Zoning Administrator  
Sarah Jones, Chief, Major Environmental Analysis  
Jeanie Poling, Environmental Planning  
Joy Navarrete, Environmental Planning

BOARD of SUPERVISORS



City Hall  
1 Dr. Carlton B. Goodlett Place, Room 244  
San Francisco 94102-4689  
Tel. No. 554-5184  
Fax No. 554-5163  
TDD/TTY No. 554-5227

## MEMORANDUM

TO: Olson Lee, Director, Mayor's Office of Housing & Community Development  
Robert Collins, Acting Executive Director, Rent Board

FROM:  Alisa Somera, Assistant Clerk, Land Use and Transportation Committee  
Board of Supervisors

DATE: January 19, 2016

SUBJECT: LEGISLATION INTRODUCED

---

The Board of Supervisors' Land Use and Transportation Committee has received the following **substitute** legislation, introduced by Mayor Lee on January 12, 2016:

**File No. 150969-2**

Ordinance amending the Planning Code to create the Affordable Housing Bonus Programs, consisting of the Local Affordable Housing Bonus Program, the 100 Percent Affordable Housing Bonus Program, the Analyzed State Density Bonus Program, and the Individually Requested State Density Bonus Program, to provide for development bonuses and zoning modifications for affordable housing, in compliance with, and above those required by the State Density Bonus Law, Government Code, Sections 65915, et seq.; to establish the procedures in which the Local Affordable Housing Bonus Program and the 100 Percent Affordable Housing Bonus Program shall be reviewed and approved; adding a fee for applications under the Program; amending the Planning Code to exempt projects from the height limits specified in the Planning Code and the Zoning Maps; affirming the Planning Department's determination under the California Environmental Quality Act; and making findings of consistency with the General Plan, and the eight priority policies of Planning Code, Section 101.1.

If you have any additional comments or reports to be included with the file, please forward them to the Board of Supervisors, City Hall, Room 244, 1 Dr. Carlton B. Goodlett Place, San Francisco, CA 94102.

cc: Eugene Flannery, Mayor's Office of Housing  
Sophie Hayward, Mayor's Office of Housing

BOARD of SUPERVISORS



City Hall  
1 Dr. Carlton B. Goodlett Place, Room 244  
San Francisco 94102-4689  
Tel. No. 554-5184  
Fax No. 554-5163  
TDD/TTY No. 554-5227

## MEMORANDUM

TO: Olson Lee, Director, Mayor's Office of Housing & Community Development  
Delene Wolf, Executive Director, Rent Board

FROM: Derek Evans, Assistant Clerk, Board of Supervisors

DATE: October 6, 2015

SUBJECT: LEGISLATION INTRODUCED

---

The Board of Supervisors' Land Use and Transportation Committee has received the following legislation, introduced by Mayor Lee and Supervisor Tang on September 29, 2015:

**File No. 150969**

**Ordinance amending the Planning Code to create the Affordable Housing Bonus Programs, consisting of the Local Affordable Housing Bonus Program, the 100 Percent Affordable Housing Bonus Program, the Analyzed State Density Bonus Program, and the Individually Requested State Density Bonus Program, to provide for development bonuses and zoning modifications for affordable housing, in compliance with, and above those required by the State Density Bonus Law, Government Code, Section 65915, et seq.; to establish the procedures in which the Local Affordable Housing Bonus Program and the 100 Percent Affordable Housing Bonus Program shall be reviewed and approved; amending the Planning Code to exempt projects from the height limits specified in the Planning Code and the Zoning Maps; affirming the Planning Department's determination under the California Environmental Quality Act; and making findings of consistency with the General Plan, and the eight priority policies of Planning Code, Section 101.1.**

If you have any additional comments or reports to be included with the file, please forward them to the Board of Supervisors, City Hall, Room 244, 1 Dr. Carlton B. Goodlett Place, San Francisco, CA 94102.

cc: Eugene Flannery, Mayor's Office of Housing  
Sophie Hayward, Mayor's Office of Housing

BOARD of SUPERVISORS



City Hall  
1 Dr. Carlton B. Goodlett Place, Room 244  
San Francisco 94102-4689  
Tel. No. 554-5184  
Fax No. 554-5163  
TDD/TTY No. 554-5227

October 6, 2015

File No. 150969

Sarah Jones  
Environmental Review Officer  
Planning Department  
1650 Mission Street, 4<sup>th</sup> Floor  
San Francisco, CA 94103

Dear Ms. Jones:

On September 29, 2015, Mayor Lee and Supervisor Tang introduced the following legislation, which has been referred to the Land Use and Transportation Committee:

**File No. 150969**

**Ordinance amending the Planning Code to create the Affordable Housing Bonus Programs, consisting of the Local Affordable Housing Bonus Program, the 100 Percent Affordable Housing Bonus Program, the Analyzed State Density Bonus Program, and the Individually Requested State Density Bonus Program, to provide for development bonuses and zoning modifications for affordable housing, in compliance with, and above those required by the State Density Bonus Law, Government Code, Section 65915, et seq.; to establish the procedures in which the Local Affordable Housing Bonus Program and the 100 Percent Affordable Housing Bonus Program shall be reviewed and approved; amending the Planning Code to exempt projects from the height limits specified in the Planning Code and the Zoning Maps; affirming the Planning Department's determination under the California Environmental Quality Act; and making findings of consistency with the General Plan, and the eight priority policies of Planning Code, Section 101.1.**

This legislation is being transmitted to you for environmental review.

Angela Calvillo, Clerk of the Board

A handwritten signature in black ink, appearing to read "Derek Evans".

By: Derek Evans, Assistant Clerk

Attachment

cc: Joy Navarrete, Environmental Planning  
Jeanie Poling, Environmental Planning

BOARD of SUPERVISORS

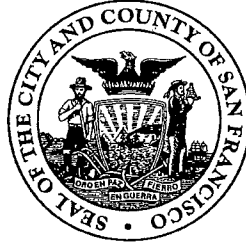

City Hall  
1 Dr. Carlton B. Goodlett Place, Room 244  
San Francisco 94102-4689  
Tel. No. 554-5184  
Fax No. 554-5163  
TDD/TTY No. 554-5227

October 6, 2015

Planning Commission  
Attn: Jonas Ionin  
1650 Mission Street, Ste. 400  
San Francisco, CA 94103

Dear Commissioners:

On September 29, 2015, Mayor Lee and Supervisor Tang introduced the following legislation:

**File No. 150969**

**Ordinance amending the Planning Code to create the Affordable Housing Bonus Programs, consisting of the Local Affordable Housing Bonus Program, the 100 Percent Affordable Housing Bonus Program, the Analyzed State Density Bonus Program, and the Individually Requested State Density Bonus Program, to provide for development bonuses and zoning modifications for affordable housing, in compliance with, and above those required by the State Density Bonus Law, Government Code, Section 65915, et seq.; to establish the procedures in which the Local Affordable Housing Bonus Program and the 100 Percent Affordable Housing Bonus Program shall be reviewed and approved; amending the Planning Code to exempt projects from the height limits specified in the Planning Code and the Zoning Maps; affirming the Planning Department's determination under the California Environmental Quality Act; and making findings of consistency with the General Plan, and the eight priority policies of Planning Code, Section 101.1.**

The proposed ordinance is being transmitted pursuant to Planning Code Section 302(b) for public hearing and recommendation. The ordinance is pending before the Land Use and Transportation Committee and will be scheduled for hearing upon receipt of your response.

Angela Calvillo, Clerk of the Board

A handwritten signature in black ink, appearing to read "Derek Evans".

By: Derek Evans, Assistant Clerk

cc: John Rahaim, Director of Planning  
Aaron Starr, Acting Manager of Legislative Affairs  
AnMarie Rodgers, Senior Policy Manager  
Scott Sanchez, Zoning Administrator  
Sarah Jones, Chief, Major Environmental Analysis  
Jeanie Poling, Environmental Planning  
Joy Navarrete, Environmental Planning



BOARD of SUPERVISORS



City Hall  
1 Dr. Carlton B. Goodlett Place, Room 244  
San Francisco 94102-4689  
Tel. No. 554-5184  
Fax No. 554-5163  
TDD/TTY No. 554-5227

## NOTICE OF PUBLIC HEARING

### BOARD OF SUPERVISORS OF THE CITY AND COUNTY OF SAN FRANCISCO LAND USE AND TRANSPORTATION COMMITTEE

NOTICE IS HEREBY GIVEN THAT the Land Use and Transportation Committee will hold a public hearing to consider the following proposal and said public hearing will be held as follows, at which time all interested parties may attend and be heard:

**Date:** Monday, May 8, 2017

**Time:** 1:30 p.m.

**Location:** Legislative Chamber, Room 250, located at City Hall  
1 Dr. Carlton B. Goodlett Place, San Francisco, CA

**Subject:** **File No. 150969.** Ordinance amending Planning Code, Section 206, to amend the 100 Percent Affordable Housing Bonus Program to add the HOME-SF Program, the Analyzed State Density Bonus Program, and the Individually Requested State Density Bonus Program, to provide for development bonuses and zoning modifications for increased affordable housing, in compliance with, and above those required by the State Density Bonus Law, Government Code, Sections 65915 et seq.; to establish the procedures in which the HOME-SF Program shall be reviewed and approved; adding a fee for applications under the Programs; affirming the Planning Department's determination under the California Environmental Quality Act; and making findings of consistency with the General Plan, and the eight priority policies of Planning Code, Section 101.1.

If the legislation passes, new initial fees shall be established based on the estimated construction cost for residential projects that are subject to the 100% Affordable Housing Bonus Program, including the HOME-SF Program, the Analyzed State Density Bonus Program, and the Individually Requested State Density Bonus Program, as follows:

- No construction costs, excluding extension of hours: \$1,012
- No construction costs, extension of hours: \$724
- Wireless Telecommunications Services (WTS): \$5,061
- \$1 to \$9,999: \$724

- \$10,000 to \$999,999: \$724 plus 0.328% of cost over \$10,000
- \$1,000,000 to \$4,999,999: \$4,033 plus 0.391% of cost over \$1,000,000
- \$5,000,000 to \$9,999,999: \$19,986 plus 0.328% of cost over \$5,000,000
- \$10,000,000 to \$19,999,999: \$36,701 plus 0.171% of cost over \$10,000,000
- \$20,000,000 or more: \$54,120

The initial fee shall not exceed 50% of the construction cost. A \$120 surcharge shall also be added to projects that have a conditional use or planning unit development, in order to compensate the City for the cost of appeals to the Board of Supervisors.

In accordance with Administrative Code, Section 67.7-1, persons who are unable to attend the hearing on this matter may submit written comments to the City prior to the time the hearing begins. These comments will be made as part of the official public record in this matter, and shall be brought to the attention of the members of the Committee. Written comments should be addressed to Angela Calvillo, Clerk of the Board, City Hall, 1 Dr. Carlton B. Goodlett Place, Room 244, San Francisco, CA 94102. Information relating to this matter is available in the Office of the Clerk of the Board. Agenda information relating to this matter will be available for public review on Friday, May 5, 2017.

  
Angela Calvillo  
Clerk of the Board

DATED: April 26, 2017  
PUBLISHED: April 28 and May 4, 2017

CALIFORNIA NEWSPAPER SERVICE BUREAU

DAILY JOURNAL CORPORATION

Mailing Address : 915 E FIRST ST, LOS ANGELES, CA 90012
Telephone (800) 788-7840 / Fax (800) 464-2839
Visit us @ www.LegalAdstore.com

Alisa Somera
CCSF BD OF SUPERVISORS (OFFICIAL NOTICES)
1 DR CARLTON B GOODLETT PL #244
SAN FRANCISCO, CA 94102

COPY OF NOTICE

Notice Type: GPN GOVT PUBLIC NOTICE
Ad Description AS - 05.08.17 Land Use - 150969 Fee Ad

To the right is a copy of the notice you sent to us for publication in the SAN FRANCISCO EXAMINER. Thank you for using our newspaper. Please read this notice carefully and call us with ny corrections. The Proof of Publication will be filed with the County Clerk, if required, and mailed to you after the last date below. Publication date(s) for this notice is (are):

04/28/2017 , 05/04/2017

The charge(s) for this order is as follows. An invoice will be sent after the last date of publication. If you prepaid this order in full, you will not receive an

EXM# 3004852
NOTICE OF PUBLIC HEARING
BOARD OF SUPERVISORS OF THE CITY AND COUNTY OF SAN FRANCISCO
LAND USE AND TRANSPORTATION COMMITTEE
MONDAY, MAY 8, 2017 - 1:30 PM
CITY HALL, LEGISLATIVE CHAMBER, ROOM 250
1 DR. CARLTON B. GOODLETT PLACE, SAN FRANCISCO, CA

NOTICE IS HEREBY GIVEN THAT the Land Use and Transportation Committee will hold a public hearing to consider the following proposal and said public hearing will be held as follows, at which time all interested parties may attend and be heard: File No. 150969. Ordinance amending Planning Code, Section 206, to amend the 100 Percent Affordable Housing Bonus Program to add the HOME-SF Program, the Analyzed State Density Bonus Program, and the Individually Requested State Density Bonus Program, to provide for development bonuses and zoning modifications for increased affordable housing, in compliance with, and above those required by the State Density Bonus Law, Government Code, Sections 65915 et seq.; to establish the procedures in which the HOME-SF Program shall be reviewed and approved; adding a fee for applications under the Programs; affirming the Planning Department's determination under the California Environmental Quality Act; and making findings of consistency with the General Plan, and the eight priority policies of Planning Code, Section 101.1. If the legislation passes, new initial fees shall be established based on the estimated construction cost for residential projects that are subject to the 100% Affordable Housing Bonus Program, including the HOME-SF Program, the Analyzed State Density Bonus Program, and the Individually Requested State Density Bonus Program, as follows: No construction costs, excluding extension of hours: \$1,012; No construction costs, extension of hours: \$724; Wireless Telecommunications Services (WTS): \$5,061; \$1 to \$9,999: \$724; \$10,000 to \$999,999: \$724 plus 0.328% of cost over \$10,000;

\$1,000,000 to \$4,999,999: \$4,033 plus 0.391% of cost over \$1,000,000; \$5,000,000 to \$9,999,999: \$19,986 plus 0.328% of cost over \$5,000,000; \$10,000,000 to \$19,999,999: \$36,701 plus 0.171% of cost over \$10,000,000; \$20,000,000 or more: \$54,120. The initial fee shall not exceed 50% of the construction cost. A \$120 surcharge shall also be added to projects that have a conditional use or planning unit development, in order to compensate the City for the cost of appeals to the Board of Supervisors. In accordance with Administrative Code, Section 67.7-1, persons who are unable to attend the hearing on this matter may submit written comments to the City prior to the time the hearing begins. These comments will be made as part of the official public record in this matter, and shall be brought to the attention of the members of the Committee. Written comments should be addressed to Angela Calvillo, Clerk of the Board, City Hall, 1 Dr. Carlton B. Goodlett Place, Room 244, San Francisco, CA 94102. Information relating to this matter is available in the Office of the Clerk of the Board. Agenda information relating to this matter will be available for public review on Friday, May 5, 2017. - Angela Calvillo, Clerk of the Board



\* A 0 0 0 0 0 4 4 2 9 2 1 7 \*

BOARD of SUPERVISORS



City Hall  
1 Dr. Carlton B. Goodlett Place, Room 244  
San Francisco 94102-4689  
Tel. No. 554-5184  
Fax No. 554-5163  
TDD/TTY No. 554-5227

## NOTICE OF PUBLIC HEARING

### BOARD OF SUPERVISORS OF THE CITY AND COUNTY OF SAN FRANCISCO LAND USE AND TRANSPORTATION COMMITTEE

NOTICE IS HEREBY GIVEN THAT the Land Use and Transportation Committee will hold a public hearing to consider the following proposal and said public hearing will be held as follows, at which time all interested parties may attend and be heard:

**Date:** Monday, March 13, 2017

**Time:** 1:30 p.m.

**Location:** Legislative Chamber, Room 250, located at City Hall  
1 Dr. Carlton B. Goodlett Place, San Francisco, CA

**Subject:** File No. 150969. Ordinance amending the Planning Code to create the Affordable Housing Bonus Programs, consisting of the Local Affordable Housing Bonus Program, the 100 Percent Affordable Housing Bonus Program, the Analyzed State Density Bonus Program, and the Individually Requested State Density Bonus Program, to provide for development bonuses and zoning modifications for affordable housing, in compliance with, and above those required by the State Density Bonus Law, Government Code, Sections 65915, et seq.; to establish the procedures in which the Local Affordable Housing Bonus Program and the 100 Percent Affordable Housing Bonus Program shall be reviewed and approved; adding a fee for applications under the Program; amending the Planning Code to exempt projects from the height limits specified in the Planning Code and the Zoning Maps; affirming the Planning Department's determination under the California Environmental Quality Act; and making findings of consistency with the General Plan, and the eight priority policies of Planning Code, Section 101.1.

If the legislation passes, Planning Code, Section 206.6(d), shall require a review of the required financial information submitted by a project sponsor applying under the State Density Bonus Program, when a Concession, Incentive, Waiver or Modification is submitted at the time of first application for a Housing Project. The cost of reviewing the required information, including the cost to the City for hiring a consultant to review the financial and architectural information, shall be borne by the applicant.

Planning Code, Section 352, shall establish a new Affordable Housing Bonus Program (AHBP) initial fee that will be charged to project sponsors participating in the AHBP, as follows:

- Projects with no construction cost, excluding extension hours the initial fee shall be \$1,012.00.
- Projects with no construction cost, extension of hours the initial fee shall be \$724.00.
- Projects with wireless telecommunications services (WTS) shall be \$5,061.00.
- Projects with an estimated construction cost from \$1.00 to \$9,999.00 the initial fee shall be \$724.00.
- Projects with an estimated construction cost from \$10,000.00 to \$999,999.00 the initial fee shall be \$724.00 plus 0.328% of cost over \$10,000.00.
- Projects with an estimated construction cost from \$1,000,000.00 to \$4,999,999.00 the initial fee shall be \$4,033.00 plus 0.391% of cost over \$1,000,000.00.
- Projects with an estimated construction cost from \$5,000,000.00 to \$9,999,999.00 the initial fee shall be \$19,986.00 plus 0.328% of cost over \$5,000,000.00.
- Projects with an estimated construction cost from \$10,000,000.00 to \$19,999,999.00 the initial fee shall be \$36,701.00 plus 0.171% of cost over \$10,000,000.00.
- Projects with an estimated construction cost from \$20,000,000.00 or more the initial fee shall be \$54,120.00.

The initial fee amount shall not exceed 50% of the construction cost. A \$120 surcharge shall be added to the fees for a conditional use or planned unit development to compensate the City for the costs of appeals to the Board of Supervisors.

In accordance with Administrative Code, Section 67.7-1, persons who are unable to attend the hearing on this matter may submit written comments to the City prior to the time the hearing begins. These comments will be made as part of the official public record in this matter, and shall be brought to the attention of the members of the Committee. Written comments should be addressed to Angela Calvillo, Clerk of the Board, City Hall, 1 Dr. Carlton B. Goodlett Place, Room 244, San Francisco, CA 94102. Information relating to this matter is available in the Office of the Clerk of the Board. Agenda information relating to this matter will be available for public review on Friday, March 10, 2017.

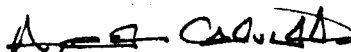
  
Angela Calvillo  
Clerk of the Board

CALIFORNIA NEWSPAPER SERVICE BUREAU

DAILY JOURNAL CORPORATION

Mailing Address : 915 E FIRST ST, LOS ANGELES, CA 90012
Telephone (800) 788-7840 / Fax (800) 464-2839
Visit us @ www.LegalAdstore.com

Alisa Somera
CCSF BD OF SUPERVISORS (OFFICIAL NOTICES)
1 DR CARLTON B GOODLETT PL #244
SAN FRANCISCO, CA 94102

COPY OF NOTICE

Notice Type: GPN GOVT PUBLIC NOTICE
Ad Description 03.13.17 Land Use - 150969 Fee Ad

To the right is a copy of the notice you sent to us for publication in the SAN FRANCISCO EXAMINER. Thank you for using our newspaper. Please read this notice carefully and call us with ny corrections. The Proof of Publication will be filed with the County Clerk, if required, and mailed to you after the last date below. Publication date(s) for this notice is (are):

03/03/2017 , 03/09/2017

The charge(s) for this order is as follows. An invoice will be sent after the last date of publication. If you prepaid this order in full, you will not receive an invoice.

EXM# 2983015

NOTICE OF PUBLIC HEARING
BOARD OF SUPERVISORS OF THE CITY AND COUNTY OF SAN FRANCISCO
LAND USE AND TRANSPORTATION COMMITTEE
MONDAY, MARCH 13, 2017 - 1:30 PM
CITY HALL, LEGISLATIVE CHAMBER, ROOM 250
1 DR. CARLTON B. GOODLETT PLACE, SAN FRANCISCO, CA

NOTICE IS HEREBY GIVEN THAT the Land Use and Transportation Committee will hold a public hearing to consider the following proposal and said public hearing will be held as follows, at which time all interested parties may attend and be heard: File No. 150969. Ordinance amending the Planning Code to create the Affordable Housing Bonus Programs, consisting of the Local Affordable Housing Bonus Program, the 100 Percent Affordable Housing Bonus Program, the Analyzed State Density Bonus Program, and the Individually Requested State Density Bonus Program, to provide for development bonuses and zoning modifications for affordable housing, in compliance with, and above those required by the State Density Bonus Law, Government Code, Sections 65915, et seq.; to establish the procedures in which the Local Affordable Housing Bonus Program and the 100 Percent Affordable Housing Bonus Program shall be reviewed and approved; adding a fee for applications under the Program; amending the Planning Code to exempt projects from the height limits specified in the Planning Code and the Zoning Maps; affirming the Planning Department's determination under the California Environmental Quality Act; and making findings of consistency with the General Plan, and the eight priority policies of Planning Code, Section 101.1. If the legislation passes, Planning Code, Section 206.6(d), shall require a review of the required financial information submitted by a project sponsor applying under the State Density Bonus Program, when a Concession, Incentive, Waiver or Modification is submitted at the time of first application for a Housing Project. The cost of reviewing the

required information, including the cost to the City for hiring a consultant to review the financial and architectural information, shall be borne by the applicant. Planning Code, Section 352, shall establish a new Affordable Housing Bonus Program (AHBP) initial fee that will be charged to project sponsors participating in the AHBP, as follows: Projects with no construction cost, excluding extension hours the initial fee shall be \$1,012.00; Projects with no construction cost, extension of hours the initial fee shall be \$724.00; Projects with wireless telecommunications services (WTS) shall be \$5,061.00; Projects with an estimated construction cost from \$1.00 to \$9,999.00 the initial fee shall be \$724.00; Projects with an estimated construction cost from \$10,000.00 to \$999,999.00 the initial fee shall be \$724.00 plus 0.328% of cost over \$10,000.00; Projects with an estimated construction cost from \$1,000,000.00 to \$4,999,999.00 the initial fee shall be \$4,033.00 plus 0.391% of cost over \$1,000,000.00; Projects with an estimated construction cost from \$5,000,000.00 to \$9,999,999.00 the initial fee shall be \$19,986.00 plus 0.328% of cost over \$5,000,000.00; Projects with an estimated construction cost from \$10,000,000.00 to \$19,999,999.00 the initial fee shall be \$36,701.00 plus 0.171% of cost over \$10,000,000.00; Projects with an estimated construction cost from \$20,000,000.00 or more the initial fee shall be \$54,120.00. The initial fee amount shall not exceed 50% of the construction cost. A \$120 surcharge shall be added to the fees for a conditional use or planned unit development to compensate the City for the costs of appeals to the Board of Supervisors. In accordance with Administrative Code, Section 67.7-1, persons who are unable to attend the hearing on this matter may submit written comments to the City prior to the time the hearing begins. These comments will be made as part of the official public record in this matter, and shall be brought to the attention of the members of the Committee. Written comments should be addressed to Angela Calvillo, Clerk of the Board, City Hall,



1 Dr. Carlton B. Goodlett  
Place, Room 244, San  
Francisco, CA 94102.  
Information relating to this  
matter is available in the  
Office of the Clerk of the  
Board. Agenda information  
relating to this matter will be  
available for public review on  
Friday, March 10, 2017. -  
Angela Calvillo, Clerk of the  
Board

SAN FRANCISCO EXAMINER

This space for filing stamp only

835 MARKET ST, SAN FRANCISCO, CA 94103  
Telephone (415) 314-1835 / Fax (510) 743-4178

Alisa Somera  
CCSF BD OF SUPERVISORS (OFFICIAL NOTICES)  
1 DR CARLTON B GOODLETT PL #244  
SAN FRANCISCO, CA - 94102

EXM#: 2983015

PROOF OF PUBLICATION

(2015.5 C.C.P.)

State of California )  
County of SAN FRANCISCO ) ss

Notice Type: GPN - GOVT PUBLIC NOTICE

Ad Description:

03.13.17 Land Use - 150969 Fee Ad

I am a citizen of the United States and a resident of the State of California; I am over the age of eighteen years, and not a party to or interested in the above entitled matter. I am the principal clerk of the printer and publisher of the SAN FRANCISCO EXAMINER, a newspaper published in the English language in the city of SAN FRANCISCO, county of SAN FRANCISCO, and adjudged a newspaper of general circulation as defined by the laws of the State of California by the Superior Court of the County of SAN FRANCISCO, State of California, under date 10/18/1951, Case No. 410667. That the notice, of which the annexed is a printed copy, has been published in each regular and entire issue of said newspaper and not in any supplement thereof on the following dates, to-wit:

03/03/2017, 03/09/2017

Executed on: 03/09/2017  
At Los Angeles, California

I certify (or declare) under penalty of perjury that the foregoing is true and correct.

Signature

NOTICE OF PUBLIC HEARING  
BOARD OF SUPERVISORS OF THE CITY AND COUNTY OF SAN FRANCISCO  
LAND USE AND TRANSPORTATION COMMITTEE  
MONDAY, MARCH 13, 2017 - 1:30 PM  
CITY HALL, LEGISLATIVE CHAMBER, ROOM 250  
1 DR. CARLTON B. GOODLETT PLACE, SAN FRANCISCO, CA

NOTICE IS HEREBY GIVEN THAT the Land Use and Transportation Committee will hold a public hearing to consider the following proposal and said public hearing will be held as follows, at which time all interested parties may attend and be heard: File No. 150969. Ordinance amending the Planning Code to create the Affordable Housing Bonus Programs, consisting of the Local Affordable Housing Bonus Program, the 100 Percent Affordable Housing Bonus Program, the Analyzed State Density Bonus Program, and the Individually Requested State Density Bonus Program, to provide for development bonuses and zoning modifications for affordable housing, in compliance with, and above those required by the State Density Bonus Law, Government Code, Sections 65915, et seq.; to establish the procedures in which the Local Affordable Housing Bonus Program and the 100 Percent Affordable Housing Bonus Program shall be reviewed and approved; adding a fee for applications under the Program; amending the Planning Code to exempt projects from the height limits specified in the Planning Code and the Zoning Maps; affirming the Planning Department's determination under the California Environmental Quality Act; and making findings of consistency with the General Plan, and the eight priority policies of Planning Code, Section 101.1. If the legislation passes, Planning Code, Section 206.6(d), shall require a review of the required financial information submitted by a project sponsor applying under the State Density Bonus Program, when a Concession, Incentive, Waiver or Modification is submitted at the time of first application for a Housing Project. The cost of reviewing the

required information, including the cost to the City for hiring a consultant to review the financial and architectural information, shall be borne by the applicant. Planning Code, Section 352, shall establish a new Affordable Housing Bonus Program (AHBP) initial fee that will be charged to project sponsors participating in the AHBP, as follows: Projects with no construction cost, excluding extension hours the initial fee shall be \$1,012.00; Projects with no construction cost, extension of hours the initial fee shall be \$724.00; Projects with wireless telecommunications services (WTS) shall be \$5,061.00; Projects with an estimated construction cost from \$1.00 to \$9,999.00 the initial fee shall be \$724.00; Projects with an estimated construction cost from \$10,000.00 to \$999,999.00 the initial fee shall be \$724.00 plus 0.328% of cost over \$10,000.00; Projects with an estimated construction cost from \$1,000,000.00 to \$4,999,999.00 the initial fee shall be \$4,033.00 plus 0.391% of cost over \$1,000,000.00; Projects with an estimated construction cost from \$5,000,000.00 to \$9,999,999.00 the initial fee shall be \$19,986.00 plus 0.328% of cost over \$5,000,000.00; Projects with an estimated construction cost from \$10,000,000.00 to \$19,999,999.00 the initial fee shall be \$36,701.00 plus 0.171% of cost over \$10,000,000.00; Projects with an estimated construction cost from \$20,000,000.00 or more the initial fee shall be \$54,120.00. The initial fee amount shall not exceed 50% of the construction cost. A \$120 surcharge shall be added to the fees for a conditional use or planned unit development to compensate the City for the costs of appeals to the Board of Supervisors. In accordance with Administrative Code, Section 67.7-1, persons who are unable to attend the hearing on this matter may submit written comments to the City prior to the time the hearing begins. These comments will be made as part of the official public record in this matter, and shall be brought to the attention of the members of the Committee. Written comments should be addressed to Angela Calvillo, Clerk of the Board, City Hall,



Email

\* A 0 0 0 0 0 4 4 0 4 0 0 2 \*



1 Dr. Carlton B. Goodlett  
Place, Room 244, San  
Francisco, CA 94102.  
Information relating to this  
matter is available in the  
Office of the Clerk of the  
Board. Agenda information  
relating to this matter will be  
available for public review on  
Friday, March 10, 2017. -  
Angela Calvillo, Clerk of the  
Board

BOARD of SUPERVISORS

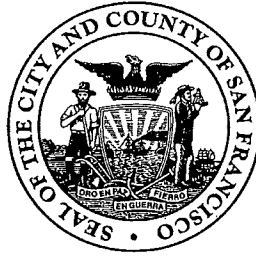

City Hall  
1 Dr. Carlton B. Goodlett Place, Room 244  
San Francisco 94102-4689  
Tel. No. 554-5184  
Fax No. 554-5163  
TDD/TTY No. 554-5227

## NOTICE OF PUBLIC HEARING

### BOARD OF SUPERVISORS OF THE CITY AND COUNTY OF SAN FRANCISCO LAND USE AND TRANSPORTATION COMMITTEE

NOTICE IS HEREBY GIVEN THAT the Land Use and Transportation Committee will hold a public hearing to consider the following proposal and said public hearing will be held as follows, at which time all interested parties may attend and be heard:

**Date:** Monday, June 13, 2016

**Time:** 1:30 p.m.

**Location:** Committee Room 263, located at City Hall  
1 Dr. Carlton B. Goodlett Place, San Francisco, CA

**Subject:** **File No. 150969.** Ordinance amending the Planning Code to create the Affordable Housing Bonus Programs, consisting of the Local Affordable Housing Bonus Program, the 100 Percent Affordable Housing Bonus Program, the Analyzed State Density Bonus Program, and the Individually Requested State Density Bonus Program, to provide for development bonuses and zoning modifications for affordable housing, in compliance with, and above those required by the State Density Bonus Law, Government Code, Sections 65915, et seq.; to establish the procedures in which the Local Affordable Housing Bonus Program and the 100 Percent Affordable Housing Bonus Program shall be reviewed and approved; adding a fee for applications under the Program; amending the Planning Code to exempt projects from the height limits specified in the Planning Code and the Zoning Maps; affirming the Planning Department's determination under the California Environmental Quality Act; and making findings of consistency with the General Plan, and the eight priority policies of Planning Code, Section 101.1.

If the legislation passes, an Affordable Housing Bonus Program Fee would be charged for applications under the Program. Planning Code, Section 352, shall establish the following initial fees for projects:

1. No construction cost, excluding extension hours; \$1,012.

2. No construction cost, extension of hours; \$724.
3. Wireless telecommunications services (WTS); \$5,061.
4. Estimated construction cost from \$1 to \$9,999; \$724.
5. Estimated construction cost from \$10,000 to \$999,999; \$724 plus 0.328% of cost over \$10,000.
6. Estimated construction cost from \$1,000,000 to \$4,999,999; \$4,033 plus 0.391% of cost over \$1,000,000.
7. Estimated construction cost from \$5,000,000 to \$9,999,999; \$19,986 plus 0.328% of cost over \$5,000,000.
8. Estimated construction cost from \$10,000,000 to \$19,999,999; \$36,701 plus 0.171% of cost over \$10,000,000.
9. Estimated construction cost from \$20,000,000 or more; \$54,120.

The initial fee amount shall not exceed 50% of the construction cost. A \$120 surcharge shall be added to the fees for a conditional use or planned unit development to compensate the City for the costs of appeals to the Board of Supervisors.

Planning Code, Section 206.6, regarding an application for a Density Bonus, Incentive, Concession, or waiver shall establish the following costs:

1. The cost of reviewing any required financial information supporting the request for concession or incentive not included within the menu set forth in Subsection 206.5(c), including, but not limited to, the cost to the City of hiring a consultant to review the financial data, shall be borne by the applicant.
2. The cost of reviewing any required information supporting the request for a waiver or modification, including, but not limited to, the cost to the City of hiring a consultant to review the architectural information, shall be borne by the applicant.

In accordance with Administrative Code, Section 67.7-1, persons who are unable to attend the hearing on this matter may submit written comments to the City prior to the time the hearing begins. These comments will be made as part of the official public record in this matter, and shall be brought to the attention of the members of the Committee. Written comments should be addressed to Angela Calvillo, Clerk of the Board, City Hall, 1 Dr. Carlton Goodlett Place, Room 244, San Francisco, CA 94102. Information relating to this matter is available in the Office of the Clerk of the Board. Agenda information relating to this matter will be available for public review on Friday, June 10, 2016.

*Peggy Nevin*  
for Angela Calvillo  
Clerk of the Board

DATED: June 1, 2016

PUBLISHED/POSTED: June 3 and 9, 2016

BOARD of SUPERVISORS



City Hall  
1 Dr. Carlton B. Goodlett Place, Room 244  
San Francisco 94102-4689  
Tel. No 554-5184  
Fax No. 554-5163  
TTD/TTY No. 5545227

## NOTIFICACIÓN DE AUDIENCIA PÚBLICA

### JUNTA DE SUPERVISORES DE LA CIUDAD Y CONDADO DE SAN FRANCISCO COMITÉ DE USO DE TERRENOS Y TRANSPORTE

SE NOTIFICA POR LA PRESENTE que el Comité de Uso de Terrenos y Transporte celebrará una audiencia pública para considerar la siguiente propuesta y dicha audiencia pública se celebrará de la siguiente manera, en tal momento que todos los interesados podrán asistir y ser escuchados:

**Fecha:** Lunes, 13 de junio de 2016

**Hora:** 1:30 p.m.

**Lugar:** Cámara Legislativa, Sala 263 del Ayuntamiento  
1 Dr. Carlton B. Goodlett Place, San Francisco, CA

**Asunto:** Expediente Núm. 150969. Ordenanza que enmienda el Código de Planificación para crear los Programas de Bonificación para Viviendas Asequibles, que consiste del Programa Local de Bonificación para Viviendas Asequibles, el Programa de Bonificación para el 100 por Ciento de Viviendas Asequibles, el Programa de Bonificación por Densidad Analizada del Estado, y el Programa de Bonificación por Densidad Solicitado Individualmente, para permitir las bonificaciones del desarrollo y las modificaciones de zonificación para la vivienda asequible, en cumplimiento con, y se extiende más allá de lo que exige la Ley de Bonificación por Densidad del Estado, Sección 65915 del Código de Gobierno, y siguientes; para establecer los procedimientos en que el Programa Local de Bonificación para Viviendas Asequibles y el Programa de Bonificación para el 100 por Ciento de Viviendas Asequibles se van a analizar y aprobar; agrega una cuota para las solicitudes del Programa; enmienda el Código de Planificación para eximir a los proyectos de los límites de altura especificados en el Código de Planificación y los Mapas de Zonificación; afirma la determinación del Departamento de Planificación según la Ley de Calidad Medioambiental de California; y realiza conclusiones coherentes con el Plan General, y las ocho políticas prioritarias de la Sección 101.1 del Código de Planificación.

*for* *Peggy Neuman*  
Angela Calvillo,  
Secretaria de la Junta

BOARD of SUPERVISORS



City Hall  
1 Dr. Carlton B. Goodlett Place, Room 244  
San Francisco 94102-4689  
Tel. No 554-5184  
Fax No. 554-5163  
TTD/TTY No. 5545227

公聽會通知

三藩市市及縣市參事委員會  
土地使用與交通運輸委員會

日期: 2016年6月13日星期一

時間: 下午1時30分

地點: 市政廳，立法會議廳 263 室，1 Dr. Carlton B. Goodlett Place, San Francisco, CA 94102

議題: 檔案號碼 150969。 該項條例修訂規劃法規旨在創建「可負擔房屋獎勵計劃」(Affordable Housing Bonus Programs)，此計劃包括了本地可負擔房屋獎勵計劃、百分百可負擔房屋獎勵計劃、分析州密度獎勵計劃，以及應個人所要求的州密度獎勵計劃，旨在為可負擔房屋發展獎勵及區劃修改訂定條文，須按照，及往後那些由州密度獎勵法、政府法規第65915條，及其後續條文所要求的規定；確立本地可負擔房屋獎勵計劃與百分百可負擔房屋獎勵計劃的審核與批准的程序；根據計劃增加申請費；修訂規劃法規使計劃豁免於規劃法規及區劃圖所規定的高度限制；依據「加州環境質量法」(California Environmental Quality Act) 明確規劃局的決定；並作出與總體計劃及規劃法規第101.1條款的八項優先政策相一致的裁斷。

*Reggy Nevin*  
for  
Angela Calvillo  
市參事委員會書記

公佈/張貼: 2016年6月3日和9日

# CALIFORNIA NEWSPAPER SERVICE BUREAU

## DAILY JOURNAL CORPORATION

Mailing Address : 915 E FIRST ST, LOS ANGELES, CA 90012  
Telephone (213) 229-5300 / Fax (213) 229-5481  
Visit us @ WWW.LEGALADSTORE.COM

AA

CCSF BD OF SUPERVISORS (OFFICIAL NOTICES)  
1 DR CARLTON B GOODLETT PL #244  
SAN FRANCISCO, CA 94102

CNS 2888681

### COPY OF NOTICE

Notice Type: GPN GOVT PUBLIC NOTICE  
Ad Description: LUT 150969 Fee Ad

To the right is a copy of the notice you sent to us for publication in the SAN FRANCISCO CHRONICLE. Please read this notice carefully and call us with any corrections. The Proof of Publication will be filed with the Clerk of the Board. Publication date(s) for this notice is (are):

06/03/2016 , 06/09/2016

The charge(s) for this order is as follows. An invoice will be sent after the last date of publication. If you prepaid this order in full, you will not receive an invoice.

The charge(s) for this order is as follows. An invoice will be sent after the last date of publication. If you prepaid this order in full, you will not receive an invoice.

Publication	\$1407.18
NetTotal	\$1266.46

#### Daily Journal Corporation

Serving your legal advertising needs throughout California. Call your local

BUSINESS JOURNAL, RIVERSIDE	(951) 784-0111
DAILY COMMERCE, LOS ANGELES	(213) 229-5300
LOS ANGELES DAILY JOURNAL, LOS ANGELES	(213) 229-5300
ORANGE COUNTY REPORTER, SANTA ANA	(714) 543-2027
SAN FRANCISCO DAILY JOURNAL, SAN FRANCISCO	(800) 640-4829
SAN JOSE POST-RECORD, SAN JOSE	(408) 287-4866
THE DAILY RECORDER, SACRAMENTO	(916) 444-2355
THE DAILY TRANSCRIPT, SAN DIEGO	(619) 232-3486
THE INTER-CITY EXPRESS, OAKLAND	(510) 272-4747

NOTICE OF PUBLIC HEARING BOARD OF SUPERVISORS OF THE CITY AND COUNTY OF SAN FRANCISCO LAND USE AND TRANSPORTATION COMMITTEE JUNE 13, 2016 - 1:30 PM COMMITTEE ROOM 263, LOCATED AT CITY HALL 1 DR. CARLTON B. GOODLETT PLACE, SAN FRANCISCO, CA NOTICE IS HEREBY GIVEN THAT THE Land Use and Transportation Committee will hold a public hearing to consider the following proposal and said public hearing will be held as follows, at which time all interested parties may attend and be heard: File No. 150969, Ordinance amending the Planning Code to create the Affordable Housing Bonus Programs, consisting of the Local Affordable Housing Bonus Program, the 100 Percent Affordable Housing Bonus Program, the Analyzed State Density Bonus Program, and the Individually Requested State Density Bonus Program, to provide for development bonuses and zoning modifications for affordable housing, in compliance with, and above those required by the State Density Bonus Law, Government Code, Sections 65915, et seq.; to establish the procedures in which the Local Affordable Housing Bonus Program and the 100 Percent Affordable Housing Bonus Program shall be reviewed and approved; adding a fee for applications under the Program; amending the Planning Code to exempt projects from the height limits specified in the Planning Code and the Zoning Maps; affirming the Planning Department's determination under the California Environmental Quality Act; and making findings of consistency with the General Plan, and the eight priority policies of Planning Code, Section 101.1. If the legislation passes, an Affordable Housing Bonus Program Fee would be charged for applications under the Program. Planning Code, Section 352, shall establish the following initial fees for projects:

1. No construction cost, excluding extension hours; \$1,012.
  2. No construction cost, extension of hours; \$724.
  3. Wireless telecommunications services (WTS); \$5,061.
  4. Estimated construction cost from \$1 to \$9,999; \$724.
  5. Estimated construction cost from \$10,000 to \$999,999; \$724 plus 0.328% of cost over \$10,000.
  6. Estimated construction cost from \$1,000,000 to \$4,999,999; \$4,033 plus 0.391% of cost over \$1,000,000.
  7. Estimated construction cost from \$5,000,000 to \$9,999,999; \$19,986 plus 0.328% of cost over \$5,000,000.
  8. Estimated construction cost from \$10,000,000 to \$19,999,999; \$36,701 plus 0.171% of cost over \$10,000,000.
  9. Estimated construction cost from \$20,000,000 or more; \$54,120.
- The initial fee amount shall not exceed 50% of the construction cost. A \$120 surcharge shall be added to the fees for a conditional use or planned unit development to compensate the City for the costs of appeals to the Board of Supervisors. Planning Code, Section 206.6, regarding an application for a Density

Bonus, Incentive, Concession, or waiver shall establish the following costs:

1. The cost of reviewing any required financial information supporting the request for concession or incentive not included within the menu set forth in Subsection 206.5(c), including, but not limited to, the cost to the City of hiring a consultant to review the financial data, shall be borne by the applicant.
2. The cost of reviewing any required information supporting the request for a waiver or modification, including, but not limited to, the cost to the City of hiring a consultant to review the architectural information, shall be borne by the applicant. In accordance with Administrative Code, Section 67.7-1, persons who are unable to attend the hearing on this matter may submit written comments to the City prior to the time the hearing begins. These comments will be made as part of the official public record in this matter, and shall be brought to the attention of the members of the Committee. Written comments should be addressed to Angela Calvillo, Clerk of the Board, City Hall, 1 Dr. Carlton Goodlett Place, Room 244, San Francisco, CA 94102. Information relating to this matter is available in the Office of the Clerk of the Board. Agenda information relating to this matter will be available for public review on Friday, June 10, 2016. Angela Calvillo, Clerk of the Board



\* A 0 0 0 0 0 4 1 1 9 2 0 8 \*

1 [Approval of a 90-Day Extension for Planning Commission Review of an Ordinance Creating  
2 the Affordable Housing Bonus Programs (File No. 150969)]

3 **Resolution extending by 90 days the prescribed time within which the Planning**  
4 **Commission may render its decision on a Ordinance (File No. 150969) amending the**  
5 **San Francisco Planning Code to create the Affordable Housing Bonus Programs,**  
6 **consisting of the Local Affordable Housing Bonus Program, the 100 Percent Affordable**  
7 **Housing Bonus Program, the Analyzed State Density Bonus Program and the**  
8 **Individually Requested State Density Bonus Program, to provide for development**  
9 **bonuses and zoning modifications for affordable housing, in compliance with, and**  
10 **above those required by the State Density Bonus Law, Government Code, Section**  
11 **65915, et seq.; to establish the procedures in which the Local Affordable Housing**  
12 **Bonus Program and the 100 Percent Affordable Housing Bonus Program shall be**  
13 **reviewed and approved; and amending the Planning Code to exempt projects from the**  
14 **height limits specified in the Planning Code and the Zoning Maps; and affirming the**  
15 **Planning Department's determination under the California Environmental Quality Act;**  
16 **and making findings of consistency with the General Plan, and the eight priority**  
17 **policies of Planning Code, Section 101.1.**

18  
19 WHEREAS, On September 29, 2015, Mayor Lee and Supervisor Tang introduced  
20 legislation amending the Planning Code to create the Affordable Housing Bonus Programs,  
21 consisting of the Local Affordable Housing Bonus Program, the 100 Percent Affordable  
22 Housing Bonus Program, the Analyzed State Density Bonus Program and the Individually  
23 Requested State Density Bonus Program, to provide for development bonuses and zoning  
24 modifications for affordable housing, in compliance with, and above those required by the  
25 State Density Bonus Law, Government Code, Section 65915, et seq.; to establish the



1 procedures in which the Local Affordable Housing Bonus Program and the 100 Percent  
2 Affordable Housing Bonus Program shall be reviewed and approved; and amending the  
3 Planning Code to exempt projects from the height limits specified in the Planning Code and  
4 the Zoning Maps; and affirming the Planning Department's determination under the California  
5 Environmental Quality Act; and making findings of consistency with the General Plan, and the  
6 eight priority policies of Planning Code, Section 101.1; and

7 WHEREAS, On or about October 6, 2015, the Clerk of the Board of Supervisors  
8 referred the proposed ordinance to the Planning Commission; and

9 WHEREAS, The Planning Commission shall, in accordance with Planning Code,  
10 Section 306.4(d), render a decision on the proposed Ordinance within 90 days from the date  
11 of referral of the proposed amendment or modification by the Board to the Commission; and

12 WHEREAS, Failure of the Commission to act within 90 days shall be deemed to  
13 constitute disapproval; and

14 WHEREAS, The Board, in accordance with Planning Code, Section 306.4(d), may, by  
15 Resolution, extend the prescribed time within which the Planning Commission is to render its  
16 decision on proposed amendments to the Planning Code that the Board of Supervisors  
17 initiates; and

18 WHEREAS, Mayor Lee and Supervisor Tang has requested additional time for the  
19 Planning Commission to review the proposed Ordinance; and

20 WHEREAS, The Board deems it appropriate in this instance to grant to the Planning  
21 Commission additional time to review the proposed Ordinance and render its decision; now,  
22 therefore, be it

23 RESOLVED, That by this Resolution, the Board hereby extends the prescribed time  
24 within which the Planning Commission may render its decision on the proposed Ordinance for  
25 approximately 90 additional days, until April 3, 2016.



City and County of San Francisco

Tails  
Resolution

City Hall  
1 Dr. Carlton B. Goodlett Place  
San Francisco, CA 94102-4689

File Number: 151238

Date Passed: December 08, 2015

Resolution extending by 90 days the prescribed time within which the Planning Commission may render its decision on a Ordinance (File No. 150969) amending the Planning Code to create the Affordable Housing Bonus Programs, consisting of the Local Affordable Housing Bonus Program, the 100 Percent Affordable Housing Bonus Program, the Analyzed State Density Bonus Program, and the Individually Requested State Density Bonus Program, to provide for development bonuses and zoning modifications for affordable housing, in compliance with, and above those required by the State Density Bonus Law, Government Code, Section 65915, et seq.; to establish the procedures in which the Local Affordable Housing Bonus Program and the 100 Percent Affordable Housing Bonus Program shall be reviewed and approved; amending the Planning Code to exempt projects from the height limits specified in the Planning Code and the Zoning Maps; affirming the Planning Department's determination under the California Environmental Quality Act; and making findings of consistency with the General Plan, and the eight priority policies of Planning Code, Section 101.1.

December 08, 2015 Board of Supervisors - AMENDED

Ayes: 11 - Avalos, Breed, Campos, Cohen, Farrell, Kim, Mar, Tang, Wiener, Yee and Peskin

December 08, 2015 Board of Supervisors - ADOPTED AS AMENDED

Ayes: 11 - Avalos, Breed, Campos, Cohen, Farrell, Kim, Mar, Tang, Wiener, Yee and Peskin

File No. 151238

I hereby certify that the foregoing  
Resolution was ADOPTED AS AMENDED  
on 12/8/2015 by the Board of Supervisors  
of the City and County of San Francisco.

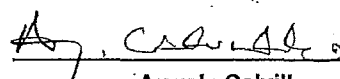
  
\_\_\_\_\_  
Angela Calvillo  
Clerk of the Board

  
\_\_\_\_\_  
Mayor

12/16/15  
\_\_\_\_\_  
Date Approved

OFFICE OF THE MAYOR  
SAN FRANCISCO



EDWIN M. LEE

TO: Angela Calvillo, Clerk of the Board of Supervisors  
FROM: *fo* Mayor Edwin M. Lee *NE*  
RE: Substitute Ordinance – File # 150969 -Planning Code – Affordable Housing  
Bonus Programs  
DATE: January 12, 2016

---

Attached for introduction to the Board of Supervisors is an ordinance amending the Planning Code to create the Affordable Housing Bonus Programs, consisting of the Local Affordable Housing Bonus Program, the 100 Percent Affordable Housing Bonus Program, the Analyzed State Density Bonus Program and the Individually Requested State Density Bonus Program, to provide for development bonuses and zoning modifications for affordable housing, in compliance with, and above those required by the State Density Bonus Law, Government Code Section 65915 et seq.; to establish the procedures in which the Local Affordable Housing Bonus Program and the 100 Percent Affordable Housing Bonus Program shall be reviewed and approved; adding a fee for applications under the Program; and amending the Planning Code to exempt projects from the height limits specified in the Planning Code and the Zoning Maps; and affirming the Planning Department's determination under the California Environmental Quality Act; and making findings of consistency with the General Plan and the eight priority policies of Planning Code Section 101.1.

Please note that this item is co-sponsored by Supervisor Tang.

Should you have any questions, please contact Nicole Elliott (415) 554-7940.

*ALL*  
JAN 12 PM 4:27  
OFFICE OF THE MAYOR  
SAN FRANCISCO

OFFICE OF THE MAYOR  
SAN FRANCISCO



EDWIN M. LEE  
MAYOR

TO: Angela Calvillo, Clerk of the Board of Supervisors  
FROM: *for* Mayor Edwin M. Lee *NE*  
RE: Planning Code – Affordable Housing Bonus Programs  
DATE: September 29, 2015

---

Attached for introduction to the Board of Supervisors is an ordinance amending the Planning Code to create the Affordable Housing Bonus Programs, consisting of the Local Affordable Housing Bonus Program, the 100 Percent Affordable Housing Bonus Program, the Analyzed State Density Bonus Program and the Individually Requested State Density Bonus Program, to provide for development bonuses and zoning modifications for affordable housing, in compliance with, and above those required by the State Density Bonus Law, Government Code Section 65915 et seq.; to establish the procedures in which the Local Affordable Housing Bonus Program and the 100 Percent Affordable Housing Bonus Program shall be reviewed and approved; and amending the Planning Code to exempt projects from the height limits specified in the Planning Code and the Zoning Maps; and affirming the Planning Department's determination under the California Environmental Quality Act; and making findings of consistency with the General Plan and the eight priority policies of Planning Code Section 101.1.

Please note that this item is co-sponsored by Supervisor Katy Tang.

I respectfully request that this item be calendared in Land Use Committee.

Should you have any questions, please contact Nicole Elliott (415) 554-7940.

RECEIVED  
BOARD OF SUPERVISORS  
SAN FRANCISCO  
SEP 29 PM 4:15  
*dl*