

File No. 140920

Committee Item No. 1

Board Item No. 16

COMMITTEE/BOARD OF SUPERVISORS

AGENDA PACKET CONTENTS LIST

Committee: Budget & Finance Committee

Date October 8, 2014

Board of Supervisors Meeting

Date October 21, 2014

Cmte Board

- | | | |
|-------------------------------------|-------------------------------------|--|
| <input type="checkbox"/> | <input type="checkbox"/> | Motion |
| <input checked="" type="checkbox"/> | <input checked="" type="checkbox"/> | Resolution |
| <input type="checkbox"/> | <input type="checkbox"/> | Ordinance |
| <input type="checkbox"/> | <input type="checkbox"/> | Legislative Digest |
| <input type="checkbox"/> | <input type="checkbox"/> | Budget and Legislative Analyst Report |
| <input type="checkbox"/> | <input type="checkbox"/> | Youth Commission Report |
| <input checked="" type="checkbox"/> | <input checked="" type="checkbox"/> | Introduction Form |
| <input checked="" type="checkbox"/> | <input checked="" type="checkbox"/> | Department/Agency Cover Letter and/or Report |
| <input type="checkbox"/> | <input type="checkbox"/> | MOU |
| <input type="checkbox"/> | <input type="checkbox"/> | Grant Information Form |
| <input type="checkbox"/> | <input type="checkbox"/> | Grant Budget |
| <input type="checkbox"/> | <input type="checkbox"/> | Subcontract Budget |
| <input checked="" type="checkbox"/> | <input checked="" type="checkbox"/> | Contract/Agreement |
| <input checked="" type="checkbox"/> | <input checked="" type="checkbox"/> | Form 126 – Ethics Commission |
| <input type="checkbox"/> | <input type="checkbox"/> | Award Letter |
| <input type="checkbox"/> | <input type="checkbox"/> | Application |
| <input type="checkbox"/> | <input type="checkbox"/> | Public Correspondence |

OTHER

(Use back side if additional space is needed)

- | | | |
|-------------------------------------|-------------------------------------|------------------------------------|
| <input checked="" type="checkbox"/> | <input checked="" type="checkbox"/> | <u>SEMTA Resolution No. 04-014</u> |
| <input type="checkbox"/> | <input type="checkbox"/> | _____ |
| <input type="checkbox"/> | <input type="checkbox"/> | _____ |
| <input type="checkbox"/> | <input type="checkbox"/> | _____ |
| <input type="checkbox"/> | <input type="checkbox"/> | _____ |
| <input type="checkbox"/> | <input type="checkbox"/> | _____ |
| <input type="checkbox"/> | <input type="checkbox"/> | _____ |
| <input type="checkbox"/> | <input type="checkbox"/> | _____ |
| <input type="checkbox"/> | <input type="checkbox"/> | _____ |
| <input type="checkbox"/> | <input type="checkbox"/> | _____ |
| <input type="checkbox"/> | <input type="checkbox"/> | _____ |

Completed by: Linda Wong

Date October 3, 2014

Completed by: L.W.

Date October 7, 2014

1 [Lease Disposition and Development Agreement and Lease and Access License - Geneva
2 Office Building and Powerhouse Rehabilitation - Cameron Beach Rail Yard]

3 **Resolution approving and authorizing a Lease Disposition and Development**
4 **Agreement and 55-year Lease and Access License to the Friends of the Geneva Office**
5 **Building and Powerhouse for the rehabilitation and use of the Geneva Office Building**
6 **and Powerhouse for Cameron Beach Rail Yard; affirming a community plan exemption**
7 **determination by the Planning Department and adopting findings pursuant to the**
8 **California Environmental Quality Act; authorizing the San Francisco Municipal**
9 **Transportation Agency Director of Transportation, or designee, to execute and make**
10 **certain modifications to the Access License; and authorizing the General Manager of**
11 **the Recreation and Park Department, or designee, to execute certain documents, make**
12 **certain modifications, and take certain actions in furtherance of this Resolution.**

13
14 WHEREAS, The City and County of San Francisco (City) owns the Geneva Office
15 Building and Powerhouse (the "Car Barn"), located at 2301 San Jose Avenue, at the corner of
16 Geneva Avenue and San Jose Avenue in San Francisco's District 11 and the adjacent
17 Cameron Beach Rail Yard; and

18 WHEREAS, The Car Barn consists of two adjoining structures, an approximately
19 13,000 square foot two-story office building, and an approximately 3,000 square foot single-
20 story car shed, known as the Powerhouse; and

21 WHEREAS, The Car Barn was designed and built in 1901 by the Reid brothers,
22 originally served as a depot for both private railroads as well as the San Francisco Municipal
23 Railway, and is the last physical vestige of San Francisco's first electric railway; and

24 WHEREAS, The Board of Supervisors of the City and County of San Francisco
25

1 designated the Car Barn as City Landmark No. 180 in 1985, and the Car Barn was included
2 on the National Register of Historic Places in 2010; and

3 WHEREAS, The City's Municipal Transportation Agency (SFMTA) used portions of the
4 Car Barn as office space until 1989, when the Car Barn was heavily damaged in the Loma
5 Prieta earthquake, and the Car Barn has been vacant ever since; and

6 WHEREAS, In 1998, the Car Barn was saved from a planned demolition through the
7 efforts of the Friends of the Geneva Car Barn and Powerhouse (Friends), a neighborhood
8 citizens group; and

9 WHEREAS, Between 1999 and 2000, a Stabilization Project for the Car Barn was
10 completed which included seismic bracing and re-enforcement to protect against additional
11 earthquake damage, the construction of a new roof and the repair of a sub-roof structural
12 system; the stabilization work did not include the work required to make the building
13 seismically safe for occupancy, or necessary electrical, mechanical or plumbing upgrades or
14 other refurbishment or renovations; and

15 WHEREAS, In 2004, jurisdiction over the Car Barn was transferred from SFMTA to the
16 Recreation and Park Department (RPD), to be used for recreational purposes and related
17 uses consistent with the RPD's mission (Board of Supervisors Resolution 193-04; File No.
18 040320), with SFMTA retaining jurisdiction over the adjacent Cameron Beach Rail Yard; and

19 WHEREAS, The Friends desire to support RPD's use and operation of the Car Barn,
20 and to work cooperatively with RPD to develop and manage the Car Barn as a dedicated
21 space where artists, youth, and community members convene, exchange, learn, create and
22 exhibit artistic and cultural works, and RPD welcomes and encourages such cooperation; and

23 WHEREAS, The proposed rehabilitation and use of the Car Barn by Friends will have
24 numerous public benefits to the City, including (i) the historic and seismic rehabilitation of the
25 Car Barn, a landmark structure that is currently in significant disrepair; (ii) the creation of a

1 substantially improved use for the Car Barn, which is currently unused; (iii) educational and
2 recreational opportunities in the Excelsior and Ocean View-Merced Heights-Ingleside
3 neighborhoods, which neighborhoods have a low median family income relative to the
4 remainder of the City of San Francisco and are underserved by community, cultural and
5 youth-serving facilities and programs; and (iv) support for other efforts underway and in the
6 planning process to revitalize the area surrounding the Balboa Park Station; and

7 WHEREAS, Between 2007 and 2013, the Friends received \$1,704,000 in seed funding
8 from the City, RPD, SFMTA, and the Department of Children Youth and Families to support
9 the capital campaign for the rehabilitation of the Car Barn as well as youth arts programming;
10 and

11 WHEREAS, Between 2009 and 2014, the Car Barn received \$489,500 of pro-bono
12 support for architectural services (including conceptual and schematic design), legal services,
13 graphic design and branding services, infrastructure and office support, and pre-construction
14 services; and

15 WHEREAS, As part of the Federal Historic Preservation Tax Credit Process, the
16 schematic design has been reviewed and approved by the State Office of Historic
17 Preservation (SHPO) and the National Park Service (NPS); and

18 WHEREAS, RPD allocated \$838,000 of the 2000 General Obligation Bond toward the
19 project and, in April 2014, the Board of Supervisors approved Ordinance No 52-14 (File No.
20 140034) authorizing the General Manager of RPD (the "General Manager") to enter into a
21 professional services agreement with Aidlin Darling Design in the amount of \$837,863 for the
22 purpose of completing the design development documents and partial completion of
23 construction documents for the Geneva Car Barn and Powerhouse project (the "Project") and
24 to amend the agreement as necessary to complete final (100 percent) construction
25 documents with funds provided by the Friends as long as the amendment would not require

1 expenditure of any other City funds; and provided that any gift of funds from the Friends to
2 RPD to fund the completion of the construction documents is subject to acceptance and
3 approval by the Board of Supervisors as required; and

4 WHEREAS, In furtherance of the Friends' goal of raising funds to support the design
5 and construction costs of the Car Barn rehabilitation, City staff and the Friends have
6 negotiated terms of a proposed Lease Disposition and Development Agreement (LDDA),
7 which governs the rehabilitation of the Car Barn and establishes the conditions that the
8 Friends and City must satisfy before the premises are delivered to and accepted by the
9 Friends, and a proposed ground lease (Lease), which governs the operations of the Car Barn,
10 a copy of which proposed LDDA and Lease are on file with the Clerk of the Board of
11 Supervisors in File No. 140920 which is hereby declared to be a part of this resolution as if set
12 forth fully herein; and

13 WHEREAS, The Friends require a license to access portions of SFMTA's Cameron
14 Beach Rail Yard for their rehabilitation and future operation of the Car Barn during the term of
15 the Lease (Access License), a copy of which proposed Access License is on file with the
16 Clerk of the Board of Supervisors in File No. 140920 which is hereby declared to be a part of
17 this resolution as if set forth fully herein, which would provide such access while protecting
18 SFMTA's continued operations at the Cameron Beach Rail Yard; and

19 WHEREAS, Due to the unique nature of the Friends as an organization founded to
20 save the Car Barn from demolition, and solely dedicated to supporting, promoting,
21 rehabilitating and providing programming for the Car Barn, competitively bidding the LDDA,
22 Lease, and Access License is impractical or infeasible; and

23 WHEREAS, Under the LDDA, the Friends' proposed project (Project) will include,
24 among other things (1) rehabilitating the exterior and interior of the Car Barn; (2) bringing the
25 Car Barn into compliance with current regulatory requirements, including the Secretary of the

1 Interior's Standards for the Rehabilitation and Guidelines for Rehabilitating Historic Buildings,
2 the San Francisco Building Code, and the Americans with Disabilities Act; (3) seismically
3 strengthening the Car Barn; (4) developing the Car Barn for use as a community center,
4 including, among other things, classrooms, a community meeting room, a theater, a café,
5 exhibition and event spaces, and a limited amount of visitor-serving retail space; and

6 WHEREAS, Pursuant to the LDDA, the Friends and the City must each satisfy certain
7 requirements as a condition to the other party entering into the Lease (Closing Conditions),
8 including, among other matters, (i) City's completion of and the Friends' approval of final
9 construction drawings, (ii) Friends, as part of the Historic Preservation Tax Credit process,
10 has received approval from the SHPO and the NPS, and from SHPO stating that the various
11 phases of construction drawings comply with the Secretary's Standards, (iii) City's approval of
12 an estimated budget of total development costs for the Project, (iv) evidence from the Friends
13 of a guaranteed maximum price contract or a stipulated sum contract for construction of the
14 improvements with a contractor reasonably acceptable to City, consistent with the approved
15 budget and the financing for the Project in form reasonably acceptable to City, (v) evidence
16 from the Friends of adequate financing for the Project, (vi) SFMTA's agreement to grant the
17 Access License to the Friends if the City and the Friends execute the Lease, and (vii) the
18 Friends shall have obtained all required regulatory approvals for construction of the
19 improvements; and

20 WHEREAS, The LDDA requires RPD and the Friends to work together to identify and
21 pursue private and public sources of funds for construction of the improvements; and

22 WHEREAS, The LDDA includes a schedule of performance with deadlines for
23 satisfying various Closing Conditions and for performing the Project, if the Closing Conditions
24 are satisfied, in each case subject to extension due to delay resulting from events of force
25 majeure described in the LDDA and subject to adjustments to the schedule as may be

1 approved administratively by the General Manager. The schedule of performance provides for
2 satisfaction of the Closing Conditions and delivery of the Lease not later than June 2017 and
3 completion of the Project not later than December 2018. If the Closing Conditions are not
4 satisfied by the date specified in the schedule of performance and the parties are unable to
5 reach agreement with regard to an amended schedule of performance following a period of
6 specified in the LDDA, then either party may terminate the LDDA upon one hundred eighty
7 (180) days prior written notice to the other and the Lease would not be executed by the
8 parties; and

9 WHEREAS, If the Closing Conditions are satisfied, City and the Friends would enter
10 into the Lease with the following material terms: (i) the term is fifty-five (55) years,
11 commencing after the Closing Conditions have been met; (ii) the premises will be delivered
12 "as-is", without representation or warranty by City; (iii) the Friends is not required to pay a
13 fixed rent to the City; instead, one hundred percent (100%) of the revenues generated by the
14 Friends from the Car Barn must be spent according to a budget approved by the City
15 annually; (iv) the Car Barn will be used for the purpose of providing recreational, educational
16 and cultural programming for youth and adults in the surrounding neighborhood, the City of
17 San Francisco, and the region (the "Primary Use"), including opportunities for job training and
18 apprenticeships in areas including, but not limited to, the culinary, media, literary, visual,
19 dance, musical, performing, film/cinema/television production, digital, design and technical
20 arts, and certain secondary uses reasonably related to the Primary Use, and the Friends, or
21 others on behalf of the Friends, shall actively program the Car Barn with youth-focused arts
22 programming by offering daily, weekday classes throughout the academic year, and more
23 robust programming during the summer months, subject to certain excused disruptions; (v)
24 the Friends must maintain a capital repair budget; (vi) the Friends shall provide utilities for
25 sub-leased and permitted spaces such as the cafe, retail space, Powerhouse, and theater and

1 the City shall provide utilities for Friends' nonprofit programming-specific uses such as
2 community meeting room, student lounge, and arts studios; (vii) if the General Manager
3 determines that the programming by the Friends is not the best use of the building and the
4 Friends proposes a change of use, the Lease gives the Recreation and Park Commission
5 (Commission) the authority to approve the proposed changed use and associated lease
6 amendment; and

7 WHEREAS, If City and the Friends enter into the Lease, at the Commission's request,
8 the SFMTA and the Friends would enter into the Access License, which would expire on the
9 expiration of the Lease unless earlier terminated on the terms specified in the Access License;
10 and

11 WHEREAS, RPD staff have reported that the annual value of the services and support
12 to RPD to be provided by Friends under the LDDA and Lease, such as raising a significant
13 portion of the funds for the rehabilitation of the Car Barn, employing a professional staff to
14 deliver programming at the Car Barn, including robust youth education programming,
15 managing the Car Barn facility and operations and funding non-structural interior repairs,
16 exceeds the fair market rental value for the leased premises during the Lease term; and

17 WHEREAS, The LDDA and the Lease contain commercially standard arbitration
18 provisions for the prompt resolution of certain limited disputes specifically enumerated in the
19 respective agreement; and

20 WHEREAS, In November 2013, the San Francisco Planning Department (Planning)
21 issued a Certificate of Determination that under the California Environmental Quality Act
22 (CEQA), Section 21083.3, and CEQA Guidelines Section 15183 that the Project is exempt
23 from environmental review under a Community Plan Exemption (the "CEQA Exemption"),
24 because the Project is consistent with the Balboa Station Area Plan, which the Board of
25 Supervisors approved by Ordinance No. 60-09, and for which the Board of Supervisors

1 adopted CEQA Findings, including a mitigation monitoring and reporting program and a
2 statement of overriding considerations, in reliance on the Balboa Park Station Area Plan Final
3 Environmental Impact Report (FEIR) (State Clearinghouse No. 2006072114); and

4 WHEREAS, In the CEQA Exemption, on file with the Clerk of the Board in File No.
5 140920, which is hereby declared to be a part of this resolution as if set forth fully herein, the
6 Planning Department determined that previously adopted feasible mitigation measures were
7 applicable to the Project; further, that there were no additional or peculiar significant adverse
8 effects not examined in the FEIR nor any new or additional information that would alter the
9 conclusions of the FEIR; and

10 WHEREAS, On May 15, 2014, following notice of its intent to take an approval action in
11 reliance on the CEQA Exemption as provided for in Administrative Code Chapter 31, the
12 Commission recommended that the Board of Supervisors approve the LDDA and Lease
13 between RPD and the Friends, and approved the Schematic Design for the Car Barn and a
14 Memorandum of Understanding between RPD and MTA; now, therefore, be it

15 RESOLVED, That the Board of Supervisors hereby affirms the CEQA Exemption
16 determination of the Planning Department; and, be it

17 FURTHER RESOLVED, That the Board of Supervisors finds that feasible mitigation
18 measures that the Board previously adopted and included in the CEQA Exemption are
19 adopted as conditions of approval and will be implemented by Friends and monitored by City
20 staff; and, be it

21 FURTHER RESOLVED, That the Board finds that the Project would not have new
22 significant or peculiar effects on the environment not previously identified in the FEIR; and no
23 environmental impacts would be substantially greater than described in the FEIR, no
24 mitigation measures previously found infeasible would be feasible, and no new mitigation
25

1 measures or alternatives have been identified that would reduce impacts found to be
2 significant in the FEIR; and, be it

3 FURTHER RESOLVED, That any and all documents referenced herein have been
4 made available to and reviewed by the Board of Supervisors and can be found in the files of
5 the Planning Department, as the custodian of records, at 1660 Mission Street in San
6 Francisco; and, be it

7 FURTHER RESOLVED, That RPD will report back to the Board of Supervisors in April
8 2015 and again by June 30, 2016, regarding the amount of funds secured to date and the
9 Friends' plans to secure the necessary funds or financing to complete the Project; and, be it

10 FURTHER RESOLVED, That in accordance with the recommendation of the
11 Recreation and Park Commission, the Board of Supervisors hereby approves the LDDA, the
12 Lease and the transactions contemplated thereby, and authorizes the General Manager to
13 execute the LDDA in substantially the form presented to this Board, and upon satisfaction of
14 the Closing Conditions, to execute the Lease in substantially the form presented to this Board;
15 and, be it

16 FURTHER RESOLVED, That in accordance with the recommendation of the
17 Recreation and Park Commission, the Board of Supervisors hereby approves the Access
18 License and the transactions contemplated thereby and authorizes the SFMTA Director of
19 Transportation to execute the Access License in substantially the form presented to this Board
20 and to enter into any additions, amendments or other modifications to the Access License
21 (including, without limitation, the attached exhibits) that the SFMTA Director of Transportation
22 determines is in the best interest of the City, do not materially increase the obligations or
23 liabilities of the City, and are necessary or advisable to complete the transaction contemplated
24 in the Lease and to effectuate the purpose and intent of this Resolution; and, be it

1 FURTHER RESOLVED, That the Board of Supervisors authorizes the General
2 Manager to enter into any additions, amendments or other modifications to the LDDA and the
3 Lease (including, without limitation, the attached exhibits) that the Recreation and Park
4 Commission determines is in the best interest of the City, do not materially decrease the
5 revenue to the City in connection with the Car Barn or otherwise materially increase the
6 obligations or liabilities of the City, and are necessary or advisable to complete the transaction
7 contemplated in the LDDA and the Lease and to effectuate the purpose and intent of this
8 resolution.

1
2
3
4
5
6
7
8
9
10
11
12
13
14
15
16
17
18
19
20
21
22
23
24
25

Item 1
File 14-0920

Department:
Recreation and Park Department

EXECUTIVE SUMMARY

Legislative Objectives

Regarding the proposed Geneva Car Barn Project, the proposed resolution would 1) authorize a Lease Disposition and Development Agreement (LDDA) between the City and the Friends of the Geneva Car Barn and Powerhouse (Friends); 2) authorize a 55-year lease between the City and the Friends upon satisfaction of the conditions in the LDDA; 3) authorize an Access License between the City and the Friends; 4) affirm a community plan exemption determination by the San Francisco Planning Department; 5) adopt findings pursuant to the California Environmental Quality Act (CEQA); and 6) authorize the San Francisco Municipal Transportation Agency (SFMTA) Director of Transportation, or designee, and the General Manager of the Recreation and Park Department, or designee, to execute documents and modifications.

Key Points

- The Geneva Car Barn Project includes 1) façade restoration; 2) seismic upgrades; and 3) interior renovations to provide a 300 person event space, a 99 seat black box theater, three youth training classrooms, and associated spaces for the new uses, including a restaurant and retail space.
- Since 2004, RPD and the Friends expended \$2,693,580 on the Car Barn from local, state, federal, and nonprofit organization funding sources. The estimated cost for the completion of the Project is \$24,285,660, including \$16,955,794 in construction costs. The source of funds for the \$24,285,660 in Project costs includes a mixture of City bond funds, City grants, tax credits and fundraising.
- There are a number of conditions in the LDDA which the parties must satisfy to enter into the Lease, including approval of construction documents, evidence of a guaranteed maximum price contract or a stipulated sum contract for construction of the improvements consistent with the approved budget and the financing for the Project, and evidence that Friends has the financing to complete the Project.

Fiscal Impact

- To date, of the total \$24,285,660 Project costs, \$857,572 has been secured, including \$837,813 of RPD funds and \$19,709 of Friends monies. For the Project to be completed, the Friends will need to secure the remaining \$23,428,088. In addition, under the proposed LDDA and Lease Agreement, the Friends would be responsible for operating and maintaining the completed Project, at the Friends expense.

Policy Consideration

- There is no guarantee that Friends will be able to secure sufficient funding to complete the Geneva Car Barn Project. The Friends must secure \$456,242 by April 2015 in order to pay for the final design and construction documents to apply for funding through the Community Opportunity Fund and Federal and potential State tax credits in 2015.
- As noted above, Ms. Wood advises that the subject LDDA only provides the framework for the RPD and the Friends to work together to try to secure the necessary funds to complete this Project. Therefore, there is not significant risk to the City to approve the proposed resolution

Recommendations

- Amend the proposed resolution to require RPD and the Friends to report back to the Board of Supervisors in April 2015 and again by June 30, 2016, to be heard at a public hearing regarding the amount of funds raised to date and the Friends plans to secure the necessary funds to complete this Project.
- Approve the proposed resolution, as amended.

MANDATE STATEMENT

San Francisco Charter Section 9.118 (b) states that any contracts or agreements entered into by a department, board or commission having a term in excess of ten years, or requiring anticipated expenditures by the City and County of \$10,000,000, or the modification or amendments to such contract or agreement having a cost of more than \$500,000 shall be subject to approval by the Board of Supervisors by resolution.

BACKGROUND

The Geneva Car Barn and Powerhouse (Car Barn) is located at the corner of Geneva Avenue and San Jose Avenue across from the Balboa Park BART Station. The Car Barn is located adjacent to a maintenance yard and vehicle storage facility owned by the San Francisco Municipal Transportation Agency (SFMTA). In 1998, the Car Barn was saved from demolition through the efforts of a neighborhood citizens group, the Friends of the Geneva Car Barn and Powerhouse (Friends), a nonprofit organization. In 2004, the Municipal Railway (now the San Francisco Municipal Transportation Agency (SFMTA) transferred jurisdiction of the Car Barn to the Recreation and Park Department (RPD) (File No. 04-0320) at no cost, with the intent for the RPD to form a partnership with the Friends to renovate the Car Barn. This transfer was subject to the condition that if the RPD Commission determines the property is no longer necessary for a recreational purpose, jurisdiction will revert to the SFMTA.

Since 2004, RPD and the Friends spent \$2,693,580 on the Car Barn from local, state, federal, and nonprofit organization funding sources, for various purposes including roof and building stabilization, project planning, and historic preservation as summarized below in Table 1.

Table 1: Car Barn Expenditures from 2004 to the Present

Source of Funds	Purpose	Year(s)	Funds
City General Fund	Project Planning, Fundraising, Program Administration	2006 – Present	\$860,000
Recreation and Park Department (Open Space & General Fund)	Roof and building stabilization, Planning	2004, 2012-13	423,580
San Francisco Municipal Transportation Agency (SFMTA)	Roof and building stabilization	2004	500,000
Caltrans	Roof and building stabilization	2004	500,000
California Cultural Historic Endowment	Historic preservation architect	2008-10	200,000
Environmental Protection Agency	Environmental Testing	2008-10	110,000
Department of Children, Youth, and Families	Program fees and student stipends	2010	50,000
Irvine Foundation	Program Fees	2010-11	50,000
Total			\$2,693,580

DETAILS OF PROPOSED LEGISLATION

Under the proposed resolution, for purposes of renovating the Car Barn, the Board of Supervisors would 1) authorize a Lease Disposition and Development Agreement (LDDA) between the City and the Friends; 2) authorize a 55-year lease between the City and the Friends once the conditions of the LDDA have been satisfied; 3) authorize an Access License between the City and the Friends; 4) affirm a community plan exemption determination by the San Francisco Planning Department; 5) adopt findings pursuant to the California Environmental Quality Act (CEQA); and 6) authorize the San Francisco Municipal Transportation Agency (SFMTA) Director of Transportation, or designee, and the General Manager of the Recreation and Park Department, or designee, to execute documents and modifications, and take certain actions in furtherance of these contracts.

According to Ms. Nicole Avril, Project Director at RPD, RPD and the Friends chose to initiate the LDDA and Lease Agreement at this time in order to provide stability for the ongoing fundraising process to renovate the Car Barn. Ms. Avril states that potential funders to the Project sought greater assurances of City involvement in the Project prior to making funding commitments. According to Ms. Avril, approval of the LDDA and Lease Agreement will formalize the relationship between the City and the Friends to provide such assurances to the funding community.

Lease Disposition and Development Agreement

The Lease Disposition and Development Agreement (LDDA) sets the terms for the renovation of the Car Barn and establishes the conditions that the Friends and the City must satisfy before the Lease Agreement becomes effective and the premises are delivered to the Friends. In addition, the LDDA states that following the completion of the Project, the Friends proposes to maintain and operate the building as a community center providing programming for youth and adults in the surrounding neighborhood, City and region, at the Friends cost.

The scope of the Project will include: 1) façade restoration; 2) seismic upgrades; and 3) interior renovations to provide a 300 person event space, a 99 seat black box theater, three youth training classrooms, and associated spaces for the new uses. The design will incorporate the shell and infrastructure for a 2000 square foot restaurant and a 730 square foot retail space.

The LDDA specifies a Schedule of Performance, which commences approximately February 2015 and has an estimated completion date of December 2018. A timeline of key Project milestones is included as Table 2 below.

Table 2: Key Car Barn Project Milestones and Estimated Completion Dates

Milestone	Estimated Date of Completion
Submission of preliminary construction documents	Q1 2015
Submission of updated budget and Financing Plan	Q1 2015
Submission of final construction documents	Q3 2015
Submission of final budget	Q3 2015
Submission of final Financing Plan	Q4 2015
Submission of final operating budget	Q4 2015
Submission of application for building permit	Q1 2016
Close of escrow and delivery of the executed lease All funding must be secured by this date	Q3 2016 – Q3 2017
Commencement of construction	Q3 2016-Q3 2017
Completion of construction	Q4 2018

Source: LDDA

The LDDA specifies that the Friends must demonstrate the financial capacity to execute the Project by submitting a financing plan for approval by the RPD. As shown in Table 2 above, the renovation Project is estimated to be completed by the fourth quarter of 2015. This Financing Plan must include: 1) final project budget; 2) sources and expected uses of funds; 3) operating budget; 4) bona fide commitments for debt financing and grant financing; 5) documentation of pledges of funds raised; and 6) guarantee of the maximum price for project construction. The Friends must provide updates to the Financial Plan to the City through written reports every six months after the effective date of the LDDA until close of escrow. In addition, the LDDA states that the City, in its sole discretion, may obtain a third-party cost estimator's report at the Friends sole cost, to evaluate the Friends' proposed construction budget.

The estimated cost for the completion of the Project is \$24,285,660 with \$16,955,794 in construction costs, \$6,143,078 in soft costs, plus \$339,000 for art enrichment and \$847,788 for a construction contingency, as shown in Table 3 below.

Table 3: Car Barn Project Budget

Project Element	Cost
Construction Cost	\$16,955,794
Soft Costs	
Design Team	\$1,313,814
Bids, Permitting and Contract Management	681,186
Regulatory Approvals	200,000
Data/Surveys	65,000
Project Manager	300,000
Furniture, Fixtures & Equipment	500,000
Hazardous Abatement	102,000
Fire Security Modification	75,000
Transaction Costs to Realize Tax Credits ¹	2,906,078
Soft Costs Subtotal	6,143,078
Art Enrichment (2% of construction costs)	339,000
Construction Contingency (5% of construction cost)	847,788
Total Project Cost	\$24,285,660

Source: LDDA

The Recreation and Park Department anticipates that the source of funds for the \$24,285,660 in total Project costs will include a mixture of City bond funds, City grants, tax credits and fundraising. The details for the funding sources are included in Table 4 below.

¹ Transaction costs include legal fees, economic studies, consulting services, and other costs to secure the tax credit financing.

Table 4: Car Barn Project Financing Plan

Source of Funds	Description	Status/Timing	Amount
2000 Neighborhood Park General Obligation Bonds	To complete design & 50% of construction documents	Appropriated in April 2014	\$837,863
Community Opportunity Fund	RPD competitive grant funding	Application to be submitted Q2 2015	3,000,000
Federal Historic Preservation Tax Credits	Federal program providing 20% of rehabilitation hard costs on certified historic structures	Q2 2016	3,964,000
State Historic Preservation Tax Credits	California potential program to provide 25-30% rehabilitation costs on certified historic structures	To be determined	3,964,000
New Market Tax Credits	20% of hard and soft costs for qualified projects	Awards announced Q2 2016 and final funds Q4 2016	5,689,000
Additional fundraising	To be secured from private and public sources	Q3 2016	6,830,797
Total Funding			\$24,285,660

Source: LDDA

Section 7.4 of the LDDA specifies that the Friends shall pay for the cost of construction of the Project. However, Section 7.4 also states that the City and the Friends agree to work together to jointly secure private and public sources of funding for construction of the improvements.

Ms. Anita Wood of the City Attorney's Office advises that while it is the goal of the RPD and the Friends to share the cost of the Project with funds secured from public and private sources, the City does not have any contractual obligation to provide funds for the Project. The LDDA only specifies that RPD staff will spend reasonable time and resources to assist the Friends' fundraising efforts and will present the Project to prospective funders as appropriate, and RPD will provide preliminary construction documents. Ms. Wood further advises that the LDDA only provides the framework for the RPD and the Friends to work together to try to secure the necessary funds to complete this Project. If the required funds are not secured by December 31, 2017, when the Lease Agreement would be delivered and construction would commence, the LDDA could be terminated.

Lease Agreement

The proposed Lease Agreement stipulates provisions, uses, and obligations in which the Friends will occupy the Geneva Car Barn. The term of the lease shall begin prior to the commencement

of construction activities at the Car Barn and extend 55 years. According to Ms. Avril, the 55 year lease term was established because it is a requirement for tax credit financing applications.

The Friends have the right to terminate the Lease Agreement by providing written notice to the City not less than 180 days prior to vacating and surrendering the premises. As stated in the Lease Agreement, no base rent will be payable by the Friends to RPD because the Project will have numerous public benefits and will lessen the burden on the City to operate and maintain the property. Under the Lease Agreement, the Friends would be responsible for operation and maintenance of the Car Barn. The key provisions of the Lease Agreement are summarized in Table 5 below.

Table 5: Key Lease Agreement Provisions for Car Barn

Term	55 years upon commencement of construction activities
Rent	\$0; Not required to pay rent, 100% of revenues will be spent according to a budget approved by City annually
Condition of premises	Delivered as-is
Allowed uses	<ul style="list-style-type: none"> • Recreational, educational and cultural programming for youth and adults • Public and private special events and exhibitions • Operation of a café and culinary training • Operation of a retail establishment
Utilities	<ul style="list-style-type: none"> • Friends shall provide utilities for restaurant and kitchen, retail space, powerhouse, theater and related spaces • City shall provide utilities for office building entry area, reception area, staff offices, first floor hallway, community meeting room, student lounge and the design, audio/visual and literary arts studios and related spaces.
Subleasing	<ul style="list-style-type: none"> • Friends has right to sublet portion of premises consistent with primary uses • Friends shall provide written notice to City of proposed sublease of one year or more. City shall have the right to reasonably object to such sublease. • Rent charged shall be determined by Friends
Facilities Maintenance	<ul style="list-style-type: none"> • Friends must maintain a capital repair budget • Friends shall conduct a physical needs assessment at least every 7 years
Ownership of Improvements	<ul style="list-style-type: none"> • Friends shall own any improvements during the term of the Lease. Ownership will return to City upon expiration or termination of the lease without compensation to Friends.

Access License

The Car Barn is located adjacent to a property owned by the SFMTA, which is the Cameron Beach Rail Yard maintenance and vehicle storage facility. The proposed resolution would

approve an Access License, which permits the Friends to have ingress and egress during construction and operation of the Car Barn facility to the freight elevator and loading dock located along the eastern wall of the Car Barn. The term for this Access License is 55 years, to coincide with the proposed Lease Agreement for the Project. Through use of this Access License, the Friends agree to not interfere with activities of the SFMTA. The Friends shall pay a one-time non-refundable permit fee of \$5,000 to the City for this Access License.

Exempt Community Plan and Adopt California Environmental Quality Act (CEQA) Findings

Under the proposed resolution, the Board of Supervisors will affirm a community plan exemption and adopt findings pursuant to CEQA for the Project. The San Francisco Planning Department issued a Certificate of Determination, which found that the Project would not result in significant impacts beyond those analyzed and disclosed in the Balboa Park Station Area Plan Final Environmental Impact Report. The Certificate of Determination further states that the Project is exempt from environmental review under CEQA and the California Public Resources Code.

FISCAL IMPACT

Only \$857,572 of the \$24,285,660 in Car Barn Project funds have been secured to date

As shown in Table 6 below, to date a total of \$857,572 has been secured, such that the Friends with assistance from RPD will need to secure the remaining \$23,428,088 to fund the Project prior to commencement of construction in Q3 2016.

Table 6: Funds to be Secured for Car Barn Project

Total Project Costs	\$24,285,660
<u>Previously Secured funds</u>	
2000 Neighborhood Park Bonds	\$837,863
Private Fundraising	<u>19,709</u>
Funds Previously Secured	\$857,572
<u>Not yet secured</u>	
Community Opportunity Fund	\$3,000,000
Federal Historic Preservation Tax Credits	3,964,000
State Historic Preservation Tax Credits	3,964,000
Federal New Market Tax Credits	5,689,000
Public and Private Fundraising	<u>6,811,088</u>
Remaining Funds to be Secured	23,428,088

Community Opportunity Fund

The Friends plans to apply for \$3,000,000 from RPD’s Community Opportunity Fund, which is a City-wide program funded with 2012 General Obligation Clean and Safe Neighborhood Parks

Bonds. Proposed projects are competitively selected; to be eligible for funding, projects must be located on land owned by the RPD, must be a capital project, and meet the following three evaluation criteria:

- 1) Enhance park aesthetic or reduce maintenance;
- 2) Have broad community support; and
- 3) Have a complete design, budget and schedule.

The Friends anticipate submitting an application to RPD for funding from the Community Opportunity Fund in Fall 2015 upon completion of the final project design. Section 7.1(d) of the LDDA states that while RPD staff will support the Friends' efforts to apply for the grant, the City cannot make a commitment of an award from the Community Opportunity Fund for the Project. In addition, the LDDA states that if the Friends do not receive a \$3,000,000 Community Opportunity Fund grant, the Friends may, at its sole discretion, raise other funds, or terminate the LDDA.

Federal and State Historic Preservation Tax Credits

Historic Preservation Tax Credits are a financing mechanism which offers funds for the rehabilitation of buildings determined to be certified historic structures. Typically, these tax credits are used by private entities that have a tax liability, however, governments and nonprofits that do not have a tax liability may also apply for these tax credits which can be transferred to private partners in exchange for funds to fulfill construction needs. In the case of the Project, RPD, as the owner of the building, has applied for Federal tax credits and will work with the Friends, the Friends' legal counsel and a firm with tax credit expertise to seek a private investor who will provide the upfront financing costs for construction.

The Federal Historic Preservation Tax Credit program offers a 20% tax credit, which the Friends estimates to be \$3,964,000 in value to the Project. The program is administered by the National Park Service and the Internal Revenue Service, in partnership with the State Historic Preservation offices. Projects must meet the following eligibility criteria to receive tax credit funding:

- 1) Be listed in the National Register of Historic Places;
- 2) Meet a "substantial rehabilitation test" which shows that the cost of rehabilitation is greater than the pre-rehabilitation value;
- 3) Rehabilitation will be conducted according to the Secretary of the Interior's published Standards for Rehabilitation; and
- 4) After the rehabilitation, the building must be used for income producing purposes for five years.

The application for funding of Federal Historic Preservation Tax Credits is conducted through the California State Historic Preservation office that initially reviews the project. RPD submitted its application for these funds in 2009. The application is conducted in three phases. Phase 1 was approved in 2009 and Phase 2 was approved in 2013. The third, and final, phase is submitted after the rehabilitation is completed to ensure that the actual rehabilitation has

adhered to what was originally applied for during the previous phases. Funding will be awarded upon successful completion of the third phase. No funds have been secured to date.

In April 2014, California State Historic Preservation Tax Credits were authorized by both the California State Senate and State Assembly, and are awaiting the Governor's signature to enact the law. This legislation includes up to a 25 percent credit for qualified rehabilitation expenditures or up to a 30 percent credit for qualified rehabilitation expenditures if the structure meets more stringent criteria. The application process and specific requirements for the California State Historic Preservation Tax Credits are currently unknown as it has not yet been signed into law. The Car Barn Project financing plan includes \$3,964,000 of State Historic Preservation Tax Credits.

New Markets Tax Credits

The Federal New Markets Tax Credits (NMTC) program was established by Congress in 2000 to spur new or increased investments into operating businesses or real estate projects in low-income communities. Administrated by the US Treasury, the Federal New Markets Tax Credits are available to community development entities that apply for the tax credits and then, in a process similar to the Historic Preservation Tax Credits, work with investors that provide bridge financing to pay for construction costs for the project.

The Northern California Community Loan Fund (NCCLF), a nonprofit organization, provides lending and consulting services to nonprofits and plans to include the Car Barn Project in its application for NMTC funding. Based on its analysis of the project, NCCLF estimates that the potential amount of NMTC funding would be \$5,689,000. No funds have been secured to date.

Public and Private Fundraising

Based on the Financing Plan provided in the LDDA, and shown above in Table 6, the Friends and RPD need to raise a total of \$6,811,088 in additional public and private funds. In May of 2014 the Board of Supervisors authorized \$837,863 to pay for 100 percent of the design and 50 percent of the construction documents with the Friends agreeing to raise an additional \$475,951 to complete the construction documents, for a total design budget of \$1,313,814, as shown in Table 3 above. According to Ms. Avril, the construction documents need to be finished by the Fall of 2015 in order to apply for the Community Opportunity funds and tax credit financing in 2015. Therefore, the \$475,951 funds need to be raised by April of 2015, to allow sufficient time for the construction documents to be completed by the Fall 2015.

However, in the five months since May of 2014, the Friends have only raised \$19,709 of the \$475,951, leaving a balance of \$456,242 to be raised over the next five months, or by April 2015 to pay for these final construction documents. The Budget and Legislative Analyst recommends that the RPD and the Friends report back to the Board of Supervisors in April 2015, to be heard at a public hearing regarding the amount of funds secured to date and the Friends plans to secure the necessary funds to complete this Project.

According to Mr. Tim Wirth, Executive Director of the Friends, funding proposals totaling \$338,000 have been submitted to potential funders. Additionally, Mr. Wirth advises that the

Friends have been invited to apply for two additional grants totaling \$100,000, although being invited to apply for funding does not guarantee that funding will be awarded. Mr. Wirth states that decisions from these funders are made on a quarterly basis. Mr. Wirth further states that a formal capital campaign and a comprehensive fundraising plan have not yet been developed.

Mr. Wirth acknowledges that the total \$6,811,088 fundraising goal is predicated on the ability to successfully raise funds from Federal and State tax credits and the Community Opportunity Fund and all of the grants currently being requested.

Ongoing Operation and Maintenance of Car Barn

In 2011, the Friends retained Ventura Partners, a development consulting and property management firm, to perform an analysis of potential operating revenues and expenses for the Project. This analysis found a range of market rate rents to be \$.90 - \$1.85 per sq. ft. per month for similar non-profit oriented space. The analysis estimated event rental rates to be \$800-\$1,000 for theater events, \$1,200 per day for parties/receptions and \$25-\$75 per hour for classes.

As stated in the proposed Lease, the Friends will operate and manage the Geneva Car Barn for the purpose of providing recreational, educational and cultural programming for youth and adults, at the Friend's expense. According to Mr. Wirth, the Friends will hire a part-time events manager and a facilities manager to perform ongoing operations, maintenance and subleasing functions for the Project.

Using expected rental rates, staffing costs, and required reserves², the Ventura Partners analysis provided two scenarios for estimated Project cash flow. Scenario 1 estimated a positive cash flow of \$110,893 in the first year of operations. Scenario 2 used more conservative assumptions and estimated positive cash flow of \$15,896 in the first year of operations, as summarized in Table 7 below.

Table 7: Car Barn Cash Flow Analysis

Scenario	Estimated Annual Cash Flow
Scenario 1 ³	\$110,893
Scenario 2, Conservative ⁴	\$15,896

² Annual operating reserve and capital replacement reserve are required after all operating expenses have been met.

³ For Scenario 1, rent for permanent space was calculated at \$15 per sq. ft. and other tenant space was calculated at \$9 per sq. ft. Rent for hourly use was calculated at \$35 per hour for the theater and \$75 per hour for the Power House space, with an average use of 26 hours per month for each. Rent for event use is calculated at \$1,000 per event for the theater and \$1,200 per event for the Power House with an average of four events per month in the theater and eight events per month in the Power House. The vacancy rate for the Project was calculated at 10 percent.

⁴ For Scenario 2, Conservative, rent for permanent space was calculated at \$12 per sq. ft. and other tenant space was calculated at \$6 per sq. ft. Rent for hourly use was calculated at \$35 per hour for the theater and \$75 per hour for the Power House space, with an average use of 26 hours per month for each. Rent for event use is calculated at \$1,000 per event for the theater and \$1,200 per event for the Power House with an average of four events per month in the theater and eight events per month in the Power House. The vacancy rate for the Project was calculated at 25 percent.

According to Mr. Wirth, NCCLF reviewed these two scenarios and found them to be reasonable for the Project. The Budget and Legislative Analyst notes that this cash flow analysis was completed in 2011, and over the past three years, lease costs per square foot in the City have increased significantly. In addition, while event rental rates for event space are stipulated in the San Francisco Park Code, Ms. Avril advises that RPD would seek an amendment to the Code to codify event space rental rates specifically for the Geneva Car Barn.

POLICY CONSIDERATION

Scenarios In Case of Fundraising Shortfall

There is no guarantee that Friends will be able to secure sufficient funding to complete the Geneva Car Barn Project. As noted above, the Friends must secure \$456,242 by April 2015 in order to pay for the final design and construction documents to apply for funding through the Community Opportunity Fund and Federal and potential State tax credits in 2015. To date, the Friends have secured \$19,709. If \$456,242 is not secured by the April 2015 deadline, the Project would need to be delayed until this funding would be secured. The Budget and Legislative Analyst therefore recommends that RPD and the Friends report back to the Board of Supervisors in April 2015, to be heard at a public hearing regarding the amount of funds secured to date and the Friends plans to secure the necessary funds to complete this Project.

If the Friends are able to secure \$456,242 necessary to complete the final design and construction documents by April 2015, the Project would have a remaining fundraising goal of \$22,971,846 to be secured from sources such as the Community Opportunity Fund, tax credit financing and public and private fundraising by December 31, 2017, as specified in the LDDA. If the Friends cannot secure these funds by this deadline, the LDDA will expire, and all related documents, including the Lease Agreement and Access License, would not come into effect. However, as shown in Table 4 above, by the second quarter of 2016, RPD and the Friends should know whether they have secured Federal Historic Preservation Tax Credits and New Market Tax Credits. Therefore, the Budget and Legislative Analyst recommends that RPD and the Friends again report back to the Board of Supervisors by June 30, 2016, to be heard at a public hearing regarding the amount of funds raised to date and the Friends plans to secure the necessary funds to complete this Project.

According to Ms. Avril, should this scenario occur, the City may elect to complete the Project to be funded through a General Obligation parks bond in 2018, currently estimated to be a minimum of \$150,000,000, to address various RPD projects throughout the City. The Car Barn could potentially be included as a designated project in this future bond measure. However, these bonds would need approval from the Board of Supervisors to be placed on the ballot and subsequently receive City voter approval. Should this future General Obligation bond measure pass, ongoing debt service payments would be made from increased property taxes assessed on all property owners in the City to pay down the incurred debt.

Alternatively, the City could elect to scale back the Project design to make the renovation less expensive and thus reduce the amount of City funding needed to complete the Project. Should the City elect to scale back the Project design, new design specifications would need to be developed and tax credit financing would need to be re-applied for based on the new design.

In a third scenario, the City could elect to not add any additional funding to the Project. In this scenario, the City would not incur any new costs to complete the Project beyond the \$2,693,580, shown in Table 1, which has already been expended on the Project.

Scenarios in Case of Operating Shortfall of Geneva Car Barn

If, over the 55 year term of the proposed lease, the Geneva Car Barn Project is unable to earn sufficient revenue to cover operating expenses, or if the Friends are unable to provide sufficient programming for the Project, Friends will be in default under the Lease Agreement. According to Ms. Avril, RPD has expertise in operating arts centers, given its current operation of the Harvey Milk Arts Center and the Mission Arts Center, and could potentially take over management of this Project, or issue a Request for Proposals (RFP) for a third party operator to take over management of the Project.

As noted above, Ms. Wood advises that the subject LDDA only provides the framework for the RPD and the Friends to work together to try to secure the necessary funds to complete this Project. Therefore, there is not significant risk to the City to approve the proposed resolution.

RECOMMENDATIONS

1. Amend the proposed resolution to require RPD and the Friends to report back to the Board of Supervisors in April 2015 and again by June 30, 2016, to be heard at a public hearing regarding the amount of funds secured to date and the Friends plans to secure the necessary funds to complete this Project.
2. Approve the proposed resolution, as amended.

CITY AND COUNTY OF SAN FRANCISCO
EDWIN M. LEE, MAYOR

LEASE

GENEVA OFFICE BUILDING AND POWER HOUSE

between the

CITY AND COUNTY OF SAN FRANCISCO,
a municipal corporation, acting by and through its

RECREATION AND PARKS COMMISSION

and

FRIENDS OF GENEVA OFFICE BUILDING AND POWER HOUSE,
a California nonprofit corporation

for the lease of real property located at
2301 San Jose Avenue, San Francisco, California

Dated as of _____, 20__

TABLE OF CONTENTS

	Page
Section 1 BASIC LEASE INFORMATION; DEFINITIONS	2
1.1 Basic Lease Information.....	2
1.2 Defined Terms.....	4
Section 2 PREMISES; CONDITION OF PREMISES	8
2.1 Premises.....	8
2.2 Condition of Premises.....	8
2.3 SFMTA License.....	9
2.4 Relationship of Lease to LDDA.....	10
Section 3 TERM; EARLY TERMINATION RIGHT.....	10
3.1 Term.....	10
3.2 Tenant's Early Termination Option.....	10
Section 4 RENT	10
4.1 Tenant's Covenant to Pay Rent.....	10
4.2 Additional Rent.....	10
4.3 Manner of Payment of Rent.....	11
4.4 Limitations on Abatement or Setoff.....	11
4.5 Interest on Delinquent Rent.....	11
4.6 Late Charges; Collection Costs.....	11
4.7 Net Lease.....	11
Section 5 USES.....	12
5.1 Permitted Uses.....	12
5.2 Tenant Proposal to Change Use.....	12
5.3 Advertising and Signs; Approved Signage Program.....	13
5.4 Limitations on Uses by Tenant.....	13
5.5 Building Rules and Regulations.....	13
5.6 Security Matters.....	14
5.7 Name of Building and Areas within Premises.....	14
5.8 Americans with Disabilities Act.....	14
5.9 Rates and Charges.....	14
5.10 Operating Covenants.....	14
Section 6 TAXES AND ASSESSMENTS	16
6.1 Payment of Possessory Interest Taxes and Other Impositions.....	16
6.2 City's Right to Pay.....	17
Section 7 CONTESTS.....	17
7.1 Right of Tenant to Contest Impositions and Liens and Laws.....	17
Section 8 COMPLIANCE WITH LAWS	17
8.1 Compliance with Laws and Other Requirements.....	17

8.2	Regulatory Approvals.....	18
Section 9	TENANT'S MANAGEMENT AND OPERATING COVENANTS	18
9.1	Operating Standards and Requirements; Management.....	18
9.2	Books and Records; Annual Report; Audit Right.....	19
Section 10 REPAIR AND MAINTENANCE	19
10.1	Covenants to Repair and Maintain the Premises.....	19
Section 11 INITIAL IMPROVEMENTS PURSUANT TO LDDA	22
11.1	Tenant's Obligation under LDDA to Construct Improvements.....	22
11.2	Title to Improvements.....	22
Section 12 SUBSEQUENT CONSTRUCTION	22
12.1	City's Approval Required for Subsequent Construction.....	22
12.2	Construction Documents in Connection with Subsequent Construction.....	23
12.3	Construction.....	23
12.4	Construction Standards.....	24
12.5	General Conditions.....	24
12.6	Construction Contracts.....	24
12.7	Tenant's Duty to Notify City.....	25
12.8	Prevailing Wages.....	25
12.9	Tropical Hardwood and Virgin Redwood Ban.....	25
12.10	Approvals.....	25
12.11	Safety Matters.....	25
12.12	First Source Hiring Ordinance.....	25
12.13	Construction Improvements that Disturb or Remove Exterior Paint.....	26
12.14	Preservative-Treated Wood Containing Arsenic.....	26
12.15	Resource Efficient City Buildings and Pilot Projects.....	26
12.16	As-Built Plans and Specifications.....	26
12.17	Title to Improvements.....	27
12.18	Tenant's Personal Property.....	27
12.19	City Cooperation.....	27
12.20	Annual Report of Subsequent Construction.....	27
Section 13 UTILITY AND OTHER SERVICES	27
13.1	Utilities and Services.....	27
13.2	Excess Use.....	28
13.3	Interruption of Services.....	28
13.4	Water and Energy Conservation; Mandatory or Voluntary Restrictions.....	28
13.5	Floor Load.....	29
13.6	Antennae and Telecommunications Dishes.....	29
Section 14 DAMAGE OR DESTRUCTION	29
14.1	General; Notice; Waiver.....	29
14.2	Certain Defined Terms.....	30
14.3	Tenant's Restoration Obligations.....	30

14.4	Major Damage and Destruction or Uninsured Casualty.....	31
14.5	Effect of Termination.....	31
14.6	Distribution Upon Lease Termination.....	31
14.7	Permitted Programming Disruption.....	31
Section 15	CONDEMNATION	32
15.1	Definitions.....	32
15.2	General.....	32
15.3	Total Taking; Automatic Termination.....	32
15.4	Partial Taking; Election to Terminate.....	32
15.5	Rent; Award.....	32
15.6	Partial Taking; Continuation of Lease.....	33
15.7	Temporary Takings.....	33
Section 16	LIENS AND LEASEHOLD MORTGAGES	33
16.1	Liens.....	33
16.2	Leasehold Encumbrances.....	33
16.3	Notices to Mortgagee and Tax Credit Investor.....	35
16.4	Mortgagee's and Tax Credit Investor's Right to Cure.....	35
16.5	Assignment by Mortgagee.....	37
16.6	Transfer of Mortgage.....	37
16.7	Memorandum of Lease.....	38
Section 17	ASSIGNMENT OF RENTS	38
17.1	Assignment of Rents.....	38
Section 18	ASSIGNMENT AND SUBLETTING	38
18.1	Assignments and Subleases.....	38
18.2	Conditions to Assignment or Sublet.....	39
18.3	Pre-Execution Deliveries to City.....	40
18.4	Effect of Sublease or Assignment.....	40
18.5	Assumption by Assignee.....	41
18.6	Indemnity for Relocation Benefits.....	41
18.7	Reasonable Grounds for Withholding Consent.....	41
18.8	Nondisturbance.....	41
18.9	Assignment to Accommodate Sale of Historic Tax Credits and New Market Tax Credit Tax Credit Financing.....	42
Section 19	INDEMNIFICATION OF CITY	42
19.1	Indemnification of City.....	42
19.2	Immediate Obligation to Defend.....	42
19.3	Not Limited by Insurance.....	43
19.4	Survival.....	43
19.5	Defense.....	43
19.6	Release of Claims and Losses Against City.....	43
Section 20	INSURANCE	43

20.1	Premises and Liability Coverage.....	43
20.2	Certificates of Insurance; Right of City to Maintain Insurance.	46
20.3	Insurance of Others.	47
20.4	City Entitled to Participate.	47
20.5	City's Self Insurance.	47
20.6	Release and Waiver.	47
Section 21	HAZARDOUS MATERIALS	47
21.1	Hazardous Materials Compliance.....	47
21.2	Hazardous Materials Indemnity.	48
21.3	Hazardous Substance Disclosure.....	49
Section 22	EVENTS OF DEFAULT; TERMINATION	49
22.1	Events of Default.....	49
Section 23	REMEDIES	50
23.1	City's Remedies Generally.....	50
23.2	Right to Keep Lease in Effect.	50
23.3	Right to Perform Tenant's Covenants.	51
23.4	Right to Terminate Lease.	51
23.5	Equitable Relief.....	51
23.6	Continuation of Subleases and Agreements.	52
Section 24	NO WAIVER	52
24.1	No Waiver.	52
24.2	No Accord or Satisfaction.	52
Section 25	ESTOPPEL CERTIFICATES.	52
25.1	Tenant Certificate.....	52
25.2	City Certificate.	53
Section 26	APPROVALS BY CITY	53
26.1	Approvals by City.	53
Section 27	SURRENDER OF PREMISES	53
27.1	Condition of Premises.	53
27.2	Termination of Subleases.	53
Section 28	HOLD OVER	53
28.1	Holdover Without Consent.....	53
28.2	Holdover With Consent.....	54
Section 29	NOTICES	54
29.1	Notices.....	54
Section 30	CITY ENTRY	54
30.1	City Entry.	54
30.2	City Reservations.	55

Section 31	EMPLOYMENT	55
31.1	First Source Hiring Ordinance.	55
31.2	Wages and Working Conditions; Theatrical Services.	55
31.3	Supervision of Minors.	56
31.4	Employee Signature Authorization Ordinance.	56
31.5	Tenant Control; No Joint Venture.	56
Section 32	REPRESENTATIONS AND WARRANTIES OF TENANT	57
32.1	Tenant Representations.	57
Section 33	SPECIAL PROVISIONS	57
33.1	Non-Discrimination in City Contracts and Benefits Ordinance.	57
33.2	MacBride Principles - Northern Ireland.	58
33.3	Tobacco Product Advertising Prohibition.	58
33.4	Conflict of Interest.	59
33.5	Drug-Free Workplace.	59
33.6	Waiver of Relocation Assistance Rights.	59
33.7	Public Records; Sunshine Ordinance.	59
33.8	Requiring Health Benefits for Covered Employees.	59
33.9	Intellectual Property; Music Broadcasting Rights.	60
33.10	Notification of Limitations on Contributions.	60
33.11	Food Service Waste Reduction.	61
Section 34	GENERAL	61
34.1	Time of Performance.	61
34.2	Interpretation of Agreement.	61
34.3	Successors and Assigns.	62
34.4	Interpretation of Lease; Approvals.	62
34.5	No Third Party Beneficiaries.	62
34.6	Real Estate Commissions.	62
34.7	Counterparts.	62
34.8	Entire Agreement.	62
34.9	Amendment.	63
34.10	Governing Law; Selection of Forum.	63
34.11	Extensions by City.	63
34.12	Attorneys' Fees and Costs.	63
34.13	Effective Date.	64
34.14	Severability.	64
34.15	Limitation on Liability.	64

EXHIBITS TO LEASE

- EXHIBIT A - Description of the Premises
- EXHIBIT B - Utility Responsibility Areas
- EXHIBIT C - Sublease Conditions; Form of Indemnity

LEASE

THIS LEASE ("Lease"), dated for reference purposes as of _____, 20__, is by and between the CITY AND COUNTY OF SAN FRANCISCO, a municipal corporation ("City" or "Landlord"), acting by and through its Recreation and Park Commission (the "Commission"), and the FRIENDS OF GENEVA OFFICE BUILDING AND POWER HOUSE, a California non-profit public benefit corporation ("Tenant"), and is made with reference to the facts and circumstances described in the Recitals set forth below.

RECITALS

A. City owns the Geneva Avenue Office Building and Power House (the "**Building**") located at 2301 San Jose Avenue in San Francisco, California, as more particularly described on *Exhibit A* attached hereto (the "**Property**"). The Building is comprised of two adjoining structures: a two-story office building containing approximately 13,000 square feet of space and a single-story car shed, known as the Powerhouse, containing approximately 3,000 square feet of space. The Building was designated as City Landmark No. 180 by the San Francisco Board of Supervisors on January 26, 1986. The Building was severely damaged in the 1989 Loma Prieta Earthquake, and fell into general disrepair.

B. The Commission has jurisdiction over the Property and is responsible, through City's Recreation and Park Department (the "**Department**"), for its operation and management. The Department identified the Building as a possible site for youth and teen arts, community center, and related uses consistent with the Department's mission. In 2004, the Department, City's Municipal Transportation Agency ("**SFMTA**"), and Caltrans cooperated on a project to stabilize the Building in a manner designed to make the Building less likely to collapse in an earthquake. The stabilization work did not include the work required to make the Building seismically safe for occupancy, or necessary electrical, mechanical or plumbing upgrades or other refurbishment or renovations. The Department did not have funding to permit the Department to perform seismic retrofitting of the Building or to construct improvements necessary for the use of the Building for recreational purposes.

C. Tenant is a non-profit 501(c)(3) corporation devoted to revitalizing and managing the Building as a dedicated space where artists, youth, and community members can convene, exchange, learn, create and exhibit artistic and cultural works. Tenant proposed to preserve the Building for the public benefit by (1) rehabilitating the exterior and interior of the Building; (2) bringing the Building into compliance with current regulatory requirements, including the San Francisco Building Code and the Americans with Disabilities Act; (3) seismically strengthening the Building; and (4) developing the Building for use as a community center, including, among other things, classrooms, meeting rooms, a theater, a café, exhibition and event spaces and a limited amount of retail space (collectively, the "**Project**"), and following completion of the Project, to operate the Building as a community center providing programming for youth and adults in the surrounding neighborhood, the city of San Francisco, and the region.

D. In furtherance of Tenant's goals of raising gifts in support of the design and construction costs of the Project and of completing the Project, City and Tenant entered into a Lease Disposition and Development Agreement, dated as of _____, 2013 (the "**LDDA**"), pursuant to which City agreed to lease the Property to Tenant, and Tenant agreed to lease the Property from Landlord, on the terms and conditions set forth herein, upon satisfaction of certain conditions precedent set forth in the LDDA. By their execution and delivery of this Lease, the Parties acknowledge that such conditions precedent have been satisfied or waived.

E. During the term of the LDDA, Tenant investigated the Building and Property and performed such due diligence regarding the Building and Property and their suitability for the purposes contemplated by this Lease as determined necessary by Tenant, and Tenant completed improvements to the Building.

F. Prior to the execution of this Lease, Tenant and/or the City obtained a number of Regulatory Approvals related to this Lease and the Project contemplated under the LDDA. On December 4, 2008, the San Francisco Planning Commission certified the Balboa Park Station Area Plan Final Environmental Impact Report, Planning Department Case No. 2004.1059E (the "FEIR"), and after several years of analysis, community outreach, and public review, the Balboa Park Station Area Plan was adopted on April 7, 2009. The Building is located in the Transit Station Area Subarea of the Balboa Park Station Area Plan. The San Francisco Planning Department determined that the Project was consistent with the development density established by the Balboa Park Station Area Plan and that there were no project-specific effects that are peculiar to the project or its site that were not analyzed in the FEIR, and concluded that the Project qualified for an exemption from further environmental review under California Environmental Quality Act ("CEQA") Guidelines Section 15183 and issued a Certificate of Determination of Exemption from Environmental Review on November 14, 2013. Certain Project Mitigation Measures set forth in FEIR will apply to the Project. By letter dated _____, 2014 (the "Determination Letter"), the City's Planning Department determined that this Lease is consistent with the requirements of City's Planning Code Section 101.1 and is in conformity with the City's General Plan *[add if required: subject to certain conditions specified in the Determination Letter]*. In a Certificate of Determination dated _____, 2014, the City's Planning Department determined that the Project is categorically exempt from environmental review under CEQA State Guidelines, Section 153019A0 or Class 1. *[Edit as required.]* On _____, 2014, the Recreation and Park Commission, by Resolution No. _____, among other things, authorized and directed the General Manager to (i) enter into the LDDA, and (ii) seek approval from the Board of Supervisors to execute this Lease.

G. This Lease will have numerous public benefits, and will lessen the burden on the Department in operating and maintaining the Property and in providing public programming, and the monetary value of the services and functions that Tenant will provide hereunder exceeds the fair market value of Premises. Accordingly, no base rent will be payable under this Lease.

H. City and Tenant now desire to enter into this Lease, upon all of the terms and conditions hereof.

ACCORDINGLY, for good and valuable consideration, the receipt and adequacy of which are hereby acknowledged, City and Tenant agree as follows:

Section 1 BASIC LEASE INFORMATION; DEFINITIONS

1.1 Basic Lease Information.

The following is a summary of basic lease information (the "Basic Lease Information"). Each item below shall be deemed to incorporate all of the terms in this Lease pertaining to such item. In the event of any conflict between the information in this Section and any more specific provision of this Lease, the more specific provision shall control.

Lease Reference Date:	_____, 20____
City:	CITY AND COUNTY OF SAN FRANCISCO, a municipal corporation
Tenant:	FRIENDS OF GENEVA OFFICE BUILDING AND POWER HOUSE, a California non-profit public benefit corporation
Premises (Section 2.1):	The building known as the "Geneva Avenue Office Building and Power House" located at 2301 San Jose Avenue in San Francisco, California (the "Building"), and certain real property surrounding the Building generally delineated on the attached <i>Exhibit A</i> .

Term (Section 2.3):

Approximately 55 years, commencing on the Commencement Date and ending on the Expiration Date, subject to Tenant's early termination rights described below.

Commencement Date: _____, 20____, which is the date of the Close of Escrow (as such term is defined in the LDDA)

Expiration Date: _____, 20_____

Tenant's Early Termination Right (Section 3.2):

Tenant shall have the option to terminate this Lease early by providing 180 days prior written notice to City. See Section 3.2.

Rent (Section 4):

No base rent is payable hereunder.

Use (Section 5):

Providing recreational, educational and cultural programming, including opportunities for job training and apprenticeships in areas including, but not limited to, the culinary, media, literary, visual, dance, musical, performing, film/cinema/television production, digital, design and technical arts, as described in Section 5 (the "Primary Mission"), and in connection therewith the Premises may be used for: (i) administrative/office use, (ii) arts rehearsals and performances, (iii) visual and design arts studios, (iv) classrooms, (v) theater, (vi) public and private special events and exhibitions, (vii) operation of a café and culinary training, and (viii) the operation of a visitor-serving retail as permitted on park property. See Section 5.

Initial Improvements/Deferred Items (Section 11.1):

Tenant has the obligation under the LDDA to perform certain improvements and alterations to the Premises prior to the Commencement Date of this Lease. To the extent the Certificate of Completion issued in connection with the LDDA was conditioned upon Tenant's completion of Deferred Items (as defined in the LDDA), Tenant's completion of such Deferred Items at the time(s) and in the manner provided is an obligation under this Lease. See Section 11.1.

Utilities and Services (Section 13.1):

City shall provide, at its sole cost and expense, electricity, water and gas services to those portions of the Premises generally depicted with the designation "Landlord Utility Area" on the attached *Exhibit B* (the "Landlord Utility Area"), which Landlord Utility Area includes the office building entry area and reception area, staff offices, first floor hallway, community meeting room, student lounge, and the design, audio/visual and literary arts studios and related spaces..

Tenant shall be responsible, at its sole cost and expense, for electricity, water, sewer and gas services to those portions of the Premises generally depicted with the designation "Tenant Utility Area" on the attached *Exhibit B* (the "Tenant Utility Area"), which Tenant Utility Area includes the proposed restaurant and kitchen, retail space, Powerhouse, theater and related spaces, including storage areas, stairwells and restrooms.

Tenant shall ensure that separate meters are installed to measure electricity, water and gas service to the Landlord Utility Area (for

which City is responsible) and the Tenant Utility Area (for which Tenant is responsible).

Tenant shall pay for garbage and recycling disposal and all telephone, fax and internet connection charges, including the cost of bringing any such service(s) to locations in the Premises.

Security Deposit: Not required.

Notice Address of City
(Section 29.1): Recreation and Park Department
McLaren Lodge Annex
San Francisco, California 94117
Attention: []
Facsimile: []

with a copy to: Office of the City Attorney
City Hall, Room 234
1 Dr. Carlton B. Goodlett Place
San Francisco, California 94102-4682
Attn: Real Estate/Finance Team
Fax No.: (415) 554-4755

Address for Tenant
(Section 29.1): Friends of Geneva Office Building and Power House
755 Ocean Avenue
San Francisco, CA 94112
Attention: Daniel Weaver
Facsimile: (415) 586-8357

with a copy to: Gibson, Dunn & Crutcher LLP
555 Mission Street
San Francisco, CA 94105
Attention: Mary G. Murphy
Facsimile: (415) 374-8480

Definitions: For purposes of this Lease, initially capitalized terms not otherwise defined in this Lease shall have the meanings ascribed to them in Section 1.2. In the event of any conflict between a definition given in Section 1.2 and any more specific provision of this Lease, the more specific provision shall control.

Other Noteworthy Provisions:

1.2 Defined Terms.

If not defined elsewhere in this Lease, initially capitalized terms shall have the meanings ascribed to them in this Section:

Additional Rent means any and all sums that may become due or be payable by Tenant under this Lease.

Agents means, when used with reference to either party to this Lease or any other person or party so designated, the members, officers, directors, commissioners, employees, agents, contractors and vendors of such party or other person, and their respective heirs, legal representatives, successors and assigns.

Approved Signage Program means, if and to the extent previously approved in writing by the General Manager in his or her reasonable discretion, the exterior signage program with respect to the Property, as provided in Section 5.3.

Assignments mean any assignment, encumbrance, pledge or otherwise transfer of any part of Tenant's interest in or rights with respect to the Premises or its leasehold estate hereunder.

Attorneys' Fees and Costs means reasonable attorneys' fees, costs, expenses and disbursements, including, but not limited to, expert witness fees and costs, travel time and associated costs, transcript preparation fees and costs, document copying, exhibit preparation, courier, postage, facsimile, long-distance and communications expenses, court costs and other reasonable costs and fees associated with any other legal, administrative or alternative dispute resolution proceeding, including such fees and costs associated with execution upon any judgment or order, and costs on appeal.

Bona Fide Institutional Lender means any one or more of the following, whether acting in its own interest and capacity or in a fiduciary capacity for another person: a savings bank, a savings and loan association, a commercial bank or trust company or branch thereof, an insurance company, a governmental agency, a real estate investment trust, an employees' welfare, benefit, pension or retirement fund or system, an investment banking, merchant banking or brokerage firm, or any other person or persons which, at the time of a Mortgage is recorded, has (or is controlled by a person having) assets of at least \$500 million in the aggregate (or the equivalent in foreign currency), and is regularly engaged in the financial services business.

Commencement Date is defined in the Basic Lease Information.

Construction Documents is defined in Section 12.2.

Default Rate is defined in Section 4.5.

Department means City's Recreation and Park Department.

Department's Mission means the mission to serve City residents by providing appropriate recreational, cultural and educational programs.

Disabled Access Laws means the Americans With Disabilities Act of 1990 and Title 24 of the California Code of Regulations and all other applicable federal, state, local and administrative laws, rules, regulations, orders and requirements intended to provide equal accessibility for persons with disabilities.

Effective Date is defined in Section 33.13.

Encumber means create any Mortgage.

Event of Default is defined in Section 22.1.

Expiration Date is defined in the Basic Lease Information as the same may be extended.

General Manager means the General Manager of the San Francisco Recreation and Park Department.

Hazardous Material means any material that, because of its quantity, concentration or physical or chemical characteristics, is deemed by any federal, state or local governmental authority to pose a present or potential hazard to human health or safety or to the environment. Hazardous Material includes, without limitation, any material or substance defined as a "hazardous substance," or "pollutant" or "contaminant" under the Comprehensive Environmental Response, Compensation and Liability Act of 1980 ("CERCLA", also commonly known as the "Superfund" law), as amended, (42 U.S.C. Sections 9601 *et seq.*) or under Sections 25281 or 25316 of the California Health & Safety Code; any "hazardous waste" as defined in Section 25117 or listed under Section 25140 of the California Health & Safety Code; any asbestos and asbestos containing materials whether or not such materials are part of the structure of any existing Improvements on the Premises, any Improvements to be constructed on the Premises by or

on behalf of Tenant, or are naturally occurring substances on, in or about the Premises, and petroleum, including crude oil or any fraction, and natural gas or natural gas liquids, and lead containing materials.

Hazardous Material Claims means any and all enforcement, Investigation, Remediation or other governmental or regulatory actions, agreements or orders threatened, instituted or completed under any Hazardous Materials Laws, together with any and all Losses made or threatened by any third party against City, relating to damage, contribution, cost recovery compensation, loss or injury resulting from the presence, release or discharge of any Hazardous Materials, including, without limitation, Losses based in common law. Hazardous Material Claims include, without limitation, Investigation and Remediation costs, fines, natural resource damages, damages for decrease in the value of the Premises or any Improvements, the loss or restriction of the use or any amenity of the Premises or any Improvements, and Attorneys' Fees and Costs.

Hazardous Material Laws means any present or future federal, state or local Laws relating to Hazardous Material (including, without limitation, its Handling, transportation or Release) or to human health and safety, industrial hygiene or environmental conditions in, on, under or about the Premises (including the Improvements), including, without limitation, soil, air, air quality, water, water quality and groundwater conditions. Hazardous Materials Laws include, but are not limited to, City's Pesticide Ordinance (Chapter 39 of the San Francisco Administrative Code).

Impositions means all taxes, assessments, liens, levies, charges or expenses of every description, levied, assessed, confirmed or imposed on the Premises, any of the improvements or personal property located on the Premises, Tenant's leasehold estate, any subleasehold estate, or any use or occupancy of the Premises hereunder.

Improvements means all buildings, structures, fixtures and other improvements erected, built, placed, installed or constructed upon or within the Premises, including, but not limited to, the Initial Improvements.

Indemnified Parties means City, including, but not limited to, all of its boards, commissions, departments, agencies, employees and member and other subdivisions, including, without limitation, all of the Agents of City and all of their respective heirs, legal representatives, successors and assigns, and each of them.

Indemnify means indemnify, protect, reimburse, defend and hold harmless.

Index means the Consumer Price Index for All Urban Consumers (base years 1982-1984 = 100) for the San Francisco-Oakland-San Jose area, published by the United States Department of Labor, Bureau of Labor Statistics. If the Index is changed so that the base year differs from that used as of the date most immediately preceding the Commencement Date, the Index shall be converted in accordance with the conversion factor published by the United States Department of Labor, Bureau of Labor Statistics. If the Index is discontinued or revised during the Term, such other government index or computation with which it is replaced shall be used in order to obtain substantially the same result as would be obtained if the Index had not been discontinued or revised.

Indexed means the product of the number to be Indexed multiplied by the percentage increase, if any, in the Index from the first day of the month in which the Commencement Date occurred to the first day of the most recent month for which the Index is available at any given time.

Initial Improvements has the meaning set forth in Section 11.1.

Initial Term means the period from the Commencement Date until the Expiration Date set forth in the Basic Lease Information, unless earlier terminated in accordance with the terms of this Lease.

Investigate or Investigation when used with reference to Hazardous Material means any activity undertaken to determine the nature and extent of Hazardous Material that may be located in, on, under or about the Premises, any Improvements or any portion of the site or the Improvements or which have been, are being, or threaten to be Released into the environment. Investigation shall include, without limitation,

preparation of site history reports and sampling and analysis of environmental conditions in, on, under or about the Premises or any Improvements.

Invitees when used with respect to Tenant means the customers, patrons, invitees, guests, members, licensees, assignees and subtenants of Tenant and the customers, patrons, invitees, guests, members, licensees, assignees and sub-tenants of subtenants.

Law or Laws means any one or more present and future laws, ordinances, rules, regulations, permits, authorizations, orders and requirements, to the extent applicable to the parties or to the Premises or any portion thereof, or to Tenant's use of the Premises, whether or not in the present contemplation of the parties.

Loss or Losses when used with reference to any Indemnity means any and all claims, demands, losses, liabilities, costs, damages (including foreseeable and unforeseeable consequential damages), liens, obligations, interest, injuries, penalties, fines, lawsuits, and other proceedings, judgments and awards and costs and expenses (including, without limitation, reasonable Attorneys' Fees and Costs, and consultants' fees and costs) of whatever kind or nature, known or unknown, contingent or otherwise.

Minor Alterations has the meaning set forth in Section 12.1(b).

Mortgage means any mortgage, deed of trust, assignment of rents, fixture filing, security agreement, or similar security instrument, or other lien or encumbrance.

Mortgagee means the holder or holders of a Mortgage and, if the Mortgage is held by or for the benefit of a trustee, agent or representative of one or more financial institutions, the financial institutions on whose behalf the Mortgage is being held. Multiple financial institutions participating in a single financing secured by a single Mortgage shall be deemed a single Mortgagee for purposes of this Lease.

Permitted Uses has the meaning set forth in Section 5.1

Personal Property means all fixtures, furniture, furnishings, equipment, machinery, supplies, software and other tangible personal property, whether now or hereafter located in, upon or about the Premises, belonging to Tenant and/or in which Tenant has or may hereafter acquire an ownership interest, together with all present and future attachments, accessions, replacements, substitutions and additions thereto or therefore.

Pre-Existing Hazardous Material as defined in Section 21.2.

Premises has the meaning set forth in Section 2.1(a).

Primary Mission has the meaning set forth in Section 1

Primary Use has the meaning set forth in Section 5.1

Property has the meaning set forth in Recital A.

Release when used with respect to Hazardous Material means any spilling, leaking, pumping, pouring, emitting, emptying, discharging, injecting, escaping, leaching, dumping, or disposing into or inside any existing improvements or any Improvements constructed under this Lease by or on behalf of Tenant, or in, on, under or about the Premises or any portion thereof.

Remediate or Remediation when used with reference to Hazardous Materials means any activities undertaken to clean up, remove, transport, dispose, contain, treat, stabilize, monitor or otherwise control Hazardous Materials located in, on, under or about the Premises or which have been, are being, or threaten to be Released into the environment. Remediation includes, without limitation, those actions included within the definition of "remedy" or "remedial action" in California Health and Safety Code Section 25322 and "remove" or "removal" in California Health and Safety Code Section 25323.

Rent means the sum of base rent, if any, payable hereunder, and Additional Rent.

Restore and Restoration mean the restoration, replacement, or rebuilding of the Improvements (or the relevant portion thereof) in accordance with all Laws then applicable (including code upgrades) to substantially the same condition they were in immediately before an event of damage or destruction, or in the case of a Taking, the restoration, replacement, or rebuilding of the Improvements to an architectural whole.

Sublease means any lease, sublease, license, concession or other agreement by which Tenant leases, subleases, demises, licenses or otherwise grants to any person in conformity with the provisions of this Lease, the right to occupy or use any portion of the Premises (whether in common with or to the exclusion of other persons).

Subsequent Construction as defined in Section 12.1(a).

Subtenant means any person or entity leasing, occupying or having the right to occupy any portion of the Premises under and by virtue of a Sublease.

Tax Credit Investor means any investor investing equity into the Initial Improvements in consideration of being allocated historic rehabilitation tax credits or new market tax credits.

Tenant's Personal Property means all furniture, trade fixtures, office equipment and articles of movable personal property installed in the Premises by or for the account of Tenant, without expense to City, and that can be removed without structural or other damage to the Premises.

Term shall have the meaning set forth in Section 3.1.

Unmatured Event of Default means any event, action or inaction that, with the giving of notice or the passage of time, or both, would constitute an Event of Default under this Lease.

Section 2 PREMISES; CONDITION OF PREMISES

2.1 Premises.

(a) Lease of Premises; Description. Subject to the terms and conditions of this Lease, City hereby leases the Property to Tenant, and Tenant hereby leases the Property from City. The Property and all other Improvements now and hereafter located on the Property are referred to in this Lease as the "Premises." The Parties reserve the right, upon mutual agreement of the General Manager and Tenant, to enter into memoranda setting forth the legal description of the Property or technical corrections thereto to reflect any non-material changes occurring during or after the development of the Project, and upon full execution thereof, such memoranda shall be deemed to become a part of this Lease.

(b) Permitted Title Exceptions. The interests granted by City to Tenant hereunder are subject to any and all existing title exceptions of record, together with any exceptions that Tenant either knew of or reasonably should have known as a result of its due diligence prior to entering into this Lease.

(c) No Subsurface Rights. Nothing in this Lease gives Tenant any right to any subsurface rights, including but not limited to any mineral, oil, gas, water, or other rights relative to the land.

2.2 Condition of Premises.

(a) Accessibility Inspection Disclosure. California law requires commercial landlords to disclose to tenants whether the property being leased has undergone inspection by a Certified Access Specialist ("CASp") to determine whether the property meets all applicable construction-related accessibility requirements. The law does not require landlords to have the inspections performed. Tenant is hereby advised that the Premises have not been inspected by a CASp.

(b) Energy Consumption. Tenant acknowledges and agrees that City has delivered a Disclosure Summary Sheet, Statement of Energy Performance, Data Checklist, and Facility Summary (all as defined in the California Code of Regulations, Title 20, Division 2, Chapter 4, Article 9, Section 1680)

for the Premises no less than 24 hours prior to Tenant's execution of this Lease. *[NOTE TO RECPARK: Since this lease is for the entire building that is more 10,000 square feet or more, RecPark will need to create an account, or update an existing account, for the building on the EPA's Energy Star program Portfolio Manager website at least 31 days before executing the lease, and provide certain energy efficiency disclosures to the tenant at least 24 hours before executing the lease. This note should be removed prior to the execution of the Lease.]*

(c) "As-Is With All Faults". Except with respect to those portions of the Initial Improvements, if any, that City elects or is required to perform following Close of Escrow (as defined in the LDDA) pursuant to the terms of the LDDA (including, if applicable, Remediation of Hazardous Materials), By taking possession of the Premises, Tenant agrees that the Premises have been delivered by City and accepted by Tenant in its "as is with all faults" condition. Tenant specifically acknowledges and agrees that neither City nor any of its officers or agents has made, and there is hereby disclaimed to the fullest extent, any representation or warranty, express or implied, of any kind, with respect to the condition of the Premises, the suitability or fitness of the Premises or appurtenances to the Premises for the development, use or operation of the Premises as contemplated by this Lease, any compliance with Laws or land use or zoning regulations, any matter affecting the use, value, occupancy or enjoyment of the Property, or any other matter whatsoever pertaining to the Premises. *[NOTE: Tenant should determine, based solely on its own investigation, that any work City is to perform pursuant to the LDDA has been completed. This Lease is As-Is.]*

(d) Release. As part of its agreement to accept the Premises in its "As Is With All Faults" condition set forth above, effective upon the Commencement Date, or, if later, the date Tenant takes possession of the Premises, Tenant, on behalf of itself and its successors and assigns, shall be deemed to waive any right to recover from, and forever release, acquit and discharge, City and its Agents of and from any and all Losses, whether direct or indirect, known or unknown, foreseen or unforeseen, that Tenant may now have or that may arise on account of or in any way be connected with (i) the physical, geotechnical or environmental condition of the Premises as of the Commencement Date, including, without limitation, any Hazardous Materials in, on, under, above or about the Premises, and (ii) the Premises' compliance as of the Commencement Date with any Laws applicable to the Premises, including without limitation, Hazardous Materials Laws. In connection with the foregoing release, Tenant acknowledges that it is familiar with Section 1542 of the California Civil Code, which provides as follows:

A GENERAL RELEASE DOES NOT EXTEND TO CLAIMS WHICH THE CREDITOR DOES NOT KNOW OR EXPECT TO EXIST IN HIS OR HER FAVOR AT THE TIME OF EXECUTING THE RELEASE, WHICH IF KNOWN TO HIM OR HER MUST HAVE MATERIALLY AFFECTED THE SETTLEMENT WITH THE DEBTOR.

Tenant agrees that the release contemplated by this Section includes unknown claims for Losses pertaining to the subject matter of this release. Accordingly, Tenant hereby waives the benefits of Civil Code Section 1542, or under any other statute or common law principle of similar effect, in connection with the releases contained in this Section. Notwithstanding anything to the contrary in this Lease, the foregoing release shall survive any termination of this Lease. Notwithstanding the foregoing, City shall not be released under this Section 2.2(d) with respect to its performance of its obligations specifically set forth in the Lease or its performance of obligations specifically set forth in the LDDA which City is obligated to perform following Close of Escrow.

Initials: _____

2.3 SFMTA License.

The Parties acknowledge and agree that during the Term of this Lease Tenant will require access to certain City owned property located immediately adjacent to the Property to the south and the east, which property is under the control and jurisdiction of the San Francisco Municipal Transportation Agency.

("SFMTA", and such property, the "SFMTA Property"), for purposes of ingress to and egress from the freight elevator and loading dock located on the eastern wall of the Building. Access to the SFMTA Property is presently governed by a memorandum of agreement between the Department and the SFMTA (the "SFMTA/RPD MOU"), dated for reference purposes only as of _____, 20____. Further, Tenant and the City and County of San Francisco, acting by and through the San Francisco Municipal Transportation Agency ("SFMTA"), are parties to that certain [*insert name of license/agreement*], dated _____, 20__ (the "SFMTA License"), pursuant to which Tenant has the right during the term of this Lease to access certain City-owned property under the jurisdiction of the SFMTA located immediately adjacent to the Property to the south and the east (the "SFMTA Property") for purposes of ingress and egress to the freight elevator and loading dock located on the eastern wall of the Building. Tenant shall not do or grant to others the right to do anything in, on, under or about the Premises or the SFMTA Property that would violate the SFMTA/RPD MOU or the SFMTA License. The General Manager shall reasonably cooperate with Tenant's efforts to enforce Tenant's rights under the SFMTA/RPD MOU and the SFMTA License during the Term of this Lease, but City, as Landlord under this Lease, shall have no direct obligations under the SFMTA/RPD MOU or the SFMTA License. At the time of any assignment of Tenant's interest in this Lease, Tenant shall assign Tenant's interest in the SFMTA License to such assignee.

2.4 Relationship of Lease to LDDA.

This Lease describes the rights and obligations of Tenant and City during the Term. This Lease also shall be subject to the provisions of the LDDA until the Certificate of Completion is recorded in accordance with the LDDA. Until the recording of the Certificate of Completion, the LDDA will govern the development of the Initial Improvements in the event of any inconsistency between this Lease and the LDDA. Other than the construction of the Initial Improvements, in the event of any conflict or inconsistency between this Lease and the LDDA with respect to the Premises or the lease, development, use or occupancy thereof, the provisions of this Lease shall control over any such inconsistent or conflicting provisions of the LDDA.

Section 3 TERM; EARLY TERMINATION RIGHT

3.1 Term.

The Term of this Lease shall commence on the Effective Date (the "Commencement Date"). The Lease shall expire on the Expiration Date as defined in the Basic Lease Information, unless sooner terminated in accordance with the terms of this Lease. City shall deliver the Premises to Tenant on the Commencement Date in their then existing as is condition as provided above, with no obligation of City to make any improvements, repairs or alterations in connection with such delivery.

3.2 Tenant's Early Termination Option.

Tenant shall have the right to terminate this Lease at any time by delivering to City not less than one hundred eighty (180) days prior written notice of termination, which termination notice shall specify the early termination date. Upon Tenant's valid exercise of this termination right, this Lease shall terminate without cost or liability to Tenant or City on the date specified in Tenant's termination notice, or such earlier or later date as may be agreed upon by the parties, and Tenant shall vacate and surrender the Premises in the condition required under this Lease by such date.

Section 4 RENT

4.1 Tenant's Covenant to Pay Rent.

During the Term of this Lease, Tenant shall pay Rent for the Premises to City at the times and in the manner provided in this Section 4.

4.2 Additional Rent.

Except as otherwise provided in this Lease, all costs, fees, interest, charges, expenses, reimbursements and obligations of every kind and nature relating to the Premises that may arise or

become due during the Term of, or in connection with, this Lease, whether foreseen or unforeseen, which are payable by Tenant to City pursuant to this Lease, shall be deemed Additional Rent. As used in this Lease "Rent" means Additional Rent.

4.3 Manner of Payment of Rent.

Tenant shall pay all Rent to City in lawful money of the United States of America at the address for notices to City specified in this Lease, or to such other person or at such other place as City may from time to time designate by notice to Tenant. Rent shall be due and payable at the times provided in this Lease, provided that if no date for payment is otherwise specified, or if payment is stated to be due "upon demand," "promptly following notice," "upon receipt of invoice," or the like, then such Rent shall be due twenty (20) days following the giving by City of such written demand, notice, invoice or the like to Tenant specifying that such sum is presently due and payable.

4.4 Limitations on Abatement or Setoff.

Tenant shall pay all Rent, including any Additional Rent, at the times and in the manner in this Lease provided without any abatement, setoff, deduction, or counterclaim whatsoever (except as specifically set forth in this Lease).

4.5 Interest on Delinquent Rent.

If any Rent is not paid within twenty (20) days following written demand for payment of such Rent, such unpaid amount shall bear interest from the date due until paid at an annual interest rate (the "Default Rate") equal to the greater of (i) ten percent (10%) or (ii) five percent (5%) in excess of the rate the Federal Reserve Bank of San Francisco charges, as of the date payment is due, on advances to member banks and depository institutions under Sections 13 and 13a of the Federal Reserve Act; provided, in no event shall the Default Rate exceed any applicable usury or similar Law. Payment of interest shall not excuse or cure any default by Tenant.

4.6 Late Charges; Collection Costs.

Tenant acknowledges and agrees that late payment by Tenant to City of Rent will cause City increased costs not contemplated by this Lease. The exact amount of such costs is extremely difficult to ascertain. Such costs include, but are not limited to, processing and accounting charges. Accordingly, without limiting any of City's rights or remedies hereunder, if any Rent is not paid within twenty (20) days following the due date, then Tenant shall immediately pay to City a late charge equal to five percent (5%) of such delinquent rent amount (the "Late Charge"). Tenant shall also pay reasonable attorney's fees incurred by City by reason of Tenant's failure to pay Rent by the due date. Late Charge shall accrue interest at the rate of ten percent (10%) per annum, compounded monthly, from the due date to the date of payment. Except as provided above, such late charge may be assessed without notice and, except as provided above, without cure periods, and regardless of whether such late payment results in an Event of Default. The Parties agree that the Late Charge and reimbursement for attorney's fees represents a fair and reasonable estimate of the cost which City will incur by reason of a late payment by Tenant. Amounts due under this Section 4.6 are in addition to, not in lieu of, amounts due under Section 4.5. Payment of Late Charge shall not excuse or cure any default by Tenant.

4.7 Net Lease.

It is the purpose of this Lease and intent of City and Tenant that, except as expressly stated to the contrary in this Lease, all Rent shall be absolutely net to City, so that this Lease shall yield to City the full amount of the Rent at all times during the Term, without deduction, abatement or offset. Except as otherwise expressly set forth in this Lease, under no circumstances, whether now existing or hereafter arising, and whether or not beyond the present contemplation of the Parties shall City be expected or required to incur any expense or make any payment of any kind with respect to this Lease or Tenant's use or occupancy of the Premises, including any improvements, except as specifically set forth in the LDDA. By taking possession of the Premises for operations pursuant to this Lease following receipt of the Certificate of Completion in accordance with the provisions of the LDDA, Tenant acknowledges that City

has satisfied its obligations under the LDDA (subject to completion of any punch list items or other deferred matters that are City's responsibility as specifically indicated in the Certificate of Completion).

Section 5 USES

5.1 Permitted Uses.

Tenant shall use the Premises for the purpose of providing recreational, educational and cultural programming for youth and adults in the surrounding neighborhood, the city of San Francisco, and the region (the "**Primary Use**"), including opportunities for job training and apprenticeships in areas including, but not limited to, the culinary, media, literary, visual, dance, musical, performing, film/cinema/television production, digital, design and technical arts. In connection with such Primary Use, Tenant may perform all acts reasonable and necessary in connection with the use, operation, development and maintenance of the Premises for the Primary Use, including, but not limited to: (i) administrative/office use, (ii) arts rehearsals and performances, (iii) visual and design arts studios, (iv) classrooms, (v) theater, (vi) special events and public and private exhibitions, (vii) operation of a café and culinary training, and (viii) the operation of visitor-serving retail as permitted for park property, all as reasonably related to the Primary Use and the Primary Mission. The foregoing permitted uses are collectively defined in this Lease as the "**Permitted Uses.**" Tenant shall obtain all permits as may be required under applicable Law in accordance with Tenant's use of the Premises. Tenant's use and operations on the Premises shall be commensurate in quality with other programming offered by the Department. Some or all of the Permitted Uses may be performed by subtenants or licensees, in compliance with the provisions of Section 18 below.

5.2 Tenant Proposal to Change Use.

If Tenant reasonably determines during the Term of this Lease that the programming to be conducted by Tenant or others in the Premises as required under this Lease is no longer the best use of the Building with respect to the Department's Mission, Tenant may submit in writing proposed new Primary Uses and Permitted Uses that are consistent with the Department's Mission for City's consideration, together with a management plan for the operation of the Premises for the proposed new Primary Uses and Permitted Uses, supporting studies and analysis, and such other materials as Tenant would like City to consider regarding the proposed change of use ("Tenant's Change in Use Proposal").

The General Manager shall consider Tenant's Change in Use Proposal and confer with Tenant regarding such proposal, and will reasonably cooperate in exploring the feasibility of Tenant's Change in Use Proposal, subject to budgetary and fiscal restraints, provided that if the General Manager, in his or her sole discretion, determines that the Department does not have sufficient funds available for fully exploring and, if applicable, acting on such proposal at the time of Tenant's Change in Use Proposal, the General Manager shall notify Tenant in writing of the General Manager's estimate of shortfall in available funds (the "Estimated Shortfall Notice"). Costs of considering Tenant's Change in Use Proposal and, if applicable, in pursuing any consents therefor, may include such costs as costs (if any) incurred by the Department and other City agencies related to conducting studies and public outreach and information, the costs of City's Planning Department and other City agencies and departments in performing the tasks and activities associated with any environmental review, and the cost to the Department and other City agencies and departments in negotiating, preparing, or adopting any amendment to this Lease or other document providing for the change in use, including any ancillary documents or legislation. If the General Manager delivers an Estimated Shortfall Notice, Tenant may, at its election, agree to pay a portion of the cost required for exploring the feasibility of Tenant's Change in Use Proposal and, if applicable, in pursuing any consents therefor.

If the General Manager, in his or her sole discretion, determines that the programming in the Premises by Tenant or others under this Lease is not the best use of the Building, and that this Lease should be amended to allow Tenant to use the Premises in the manner described in Tenant's Change in Use Proposal, based on Tenant's Change in Use Proposal and, if applicable, on other studies and public outreach performed by the Department, then General Manager shall present such proposed change in use

and negotiated lease amendment, if applicable, to the Commission for its review and consideration. The Board of Supervisors has delegated to the Commission the authority to approve amendments to this Lease documenting approved changes in use provided the uses so allowed are consistent with the Department's Mission.

5.3 Advertising and Signs; Approved Signage Program.

Tenant shall have the right to install signs and advertising inside the Premises that are not visible from the exterior of the Building. The Building is included on the National Register of Historic Places. At any time and from time to time during the Term, Friends shall have the right to submit for the General Manager's written approval (which may be granted or withheld in the General Manager's reasonable discretion) a proposed signage program (or a proposed replacement signage program) for the Property, and following approval by the General Manager and such signage program (or replacement signage program) shall be deemed to be the "Approved Signage Program" from and after the date of such approval. Each Approved Signage Program shall (i) establish limitations on the number of signs permitted to be erected on the exterior of the Property, (ii) establish limitations on the size of any sign erected on the exterior of the Property, (iii) address construction, design standards, maintenance and removal obligations, and (iii) be compliant with the requirements of the United States Secretary of the Interior's Standards for Rehabilitation and Guidelines for Rehabilitating Historic Buildings (36 Code of Federal Regulations § 67.7; the "Secretary's Standards"). Tenant may not place any advertisements or signs, including but not limited to awnings, canopies and banners, on the exterior of the Building, or any signs or advertising on the interior of the Building that are visible from the outside, except (i) in compliance with the requirements of California State Historic Preservation Office and the National Park Service and (ii) either (A) in compliance with the Approved Signage Program or (B) following written approval by the General Manager, which approval can be given or withheld in the reasonable discretion of the General Manager. Prior to any such installation Tenant shall obtain at Tenant's expense any required permits for such signage and installation. Nothing in this Section 5.3 shall prohibit installation or maintenance of the signage included in the Initial Improvements.

5.4 Limitations on Uses by Tenant.

Tenant shall not use, occupy or permit the use or occupancy of any of the Premises in any unlawful manner or for any illegal purpose, or permit any waste on or about the Premises. Tenant shall not do anything, or permit anything to be done, in or about the Premises which would be prohibited by a standard form fire insurance policy or subject City to potential premises liability, and Tenant shall take commercially reasonable precautions to eliminate any nuisances or hazards relating to its activities on or about the Premises. Tenant shall not conduct any business, place any sales display, or advertise in any manner in on the exterior portions of the Premises, except as set forth in Section 5.3 or as approved by City in its regulatory capacity in accordance with City's standard permitting process for the use of streets and sidewalks. Without limiting the foregoing, Tenant shall not conduct or permit on or about the Premises any of the following activities ("**Prohibited Activities**"): (i) any activity that creates a public nuisance; (ii) any activity that is not within the Permitted Uses or otherwise approved by General Manager in writing; (iii) any activity or object that will overload or cause damage to the Premises or include more persons than is permitted by the City's Fire Marshall; (iv) use of the Premises for sleeping or personal living quarters; or (v) any use by a group or organization that violates the nondiscrimination provisions set forth in this Lease.

5.5 Building Rules and Regulations.

Tenant shall establish and maintain reasonable rules and regulations for the Building consistent with industry standards. Furthermore, City may make reasonable additions or modifications to the rules and regulations, which shall be binding upon Tenant's users or licensees, provided that such additions or modifications shall not reduce City's obligations hereunder nor materially adversely interfere with Tenant's business in the Premises, and such additions or modifications are not in conflict with the provisions of this Lease and do not materially increase the burdens or obligations upon Tenant.

5.6 Security Matters.

Tenant at all times shall be responsible for on-site security in and about the Premises. Tenant shall have an affirmative obligation to use and operate the Premises in a safe and secure manner for all patrons and staff.

5.7 Name of Building and Areas within Premises.

Tenant acknowledges that any proposed change in the name of the Building shall be subject to the Commission's naming policy and the process and procedures established by the Commission in connection with such policy, and shall be subject to the approval of the Commission. In addition, Tenant acknowledges that if Tenant desires to name rooms or areas within the Premises to recognize major donors to the Project or to Tenant's programs conducted within the Premises, or to recognize other honorees approved by City, such naming shall be subject to the Commission's naming policy, gift policy, and donor recognition guidelines in effect at the time, and shall be subject to approval of the Commission. Any signage designating names of rooms, areas, or components of the Premises, and any plaques commemorating donations to Tenant, shall be removed by Tenant at Tenant's sole cost and expense at the expiration or termination of this Lease, except as otherwise specifically approved by the Commission in writing.

5.8 Americans with Disabilities Act.

Tenant acknowledges that the Americans with Disabilities Act (the "ADA") requires that programs, services and other activities provided by a public entity to the public, whether directly or through a contractor, must be accessible to the disabled public. Tenant further acknowledges its obligation to comply with the ADA and any other federal, state or local disability rights legislation. Without limiting Tenant's obligations under this Lease to comply with applicable Laws, Tenant warrants that it will fulfill that obligation, and that it will not discriminate against disabled persons in the provision of services, benefits or activities pursuant to this Lease.

5.9 Rates and Charges.

The rates and charges for classes and services offered and goods sold by Tenant or others at the Premises shall not unreasonably exceed the prices charged by similar businesses in San Francisco. Notwithstanding the foregoing, classes and programs offered by Tenant for job training or career development shall be subsidized and shall be offered to low income individuals for free or at reduced prices, generally consistent with the policy adopted by the Department or the Commission from time to time for eligibility for the Department's scholarship program for recreation programs offered by the Department.

5.10 Operating Covenants.

(a) Continuous Use; Full Program. Commencing not later than the date that is six (6) months after delivery of the Certificate of Completion under the LDDA, and subject to Permitted Programming Disruptions, as defined below, Tenant shall continuously use, maintain and operate the entire Premises, or cause the entire Premises to be continuously used, maintained and operated, for the Permitted Uses, and shall not allow the Premises or major areas within the Premises to remain unoccupied or unused without City's prior written consent, which City may give or withhold in its reasonable discretion. Tenant shall use the Premises, and cause each Subtenant and licensee to use and operate its business in the Premises, in a professional manner, commensurate with the standard of use and operation of other Department facilities, and, subject to Permitted Programming Disruptions, shall use diligent and good faith steps to provide a full program of classes and other programs and services that serve youth and other members of the public and promote strong attendance at the Premises. Tenant (or others on behalf of Tenant) shall actively program the Building with youth-focused arts programming by offering daily, weekday classes throughout the during the academic year, and more robust programming during the summer months (the "Minimum Programming"). As used herein, "Permitted Programming Disruptions" means: (A) reasonable and periodic gaps, not to exceed six (6) months each, in continuous use of portions

of the Premises or in providing full programming that result from (i) changes in or modifications to programming or staffing, or (ii) customary vacancies in sublease space that may arise from time to time in connection with retenanting; or (B) vacancies or programming disruptions resulting from required repairs or construction of alterations or improvements, provided that Tenant shall use reasonable efforts to minimize the period during which Tenant or any subtenant is required to vacate portions of the Premises and to minimize any disturbance to programming during the performance of such work, and if such vacancy or disruption exceeds six (6) months, Tenant shall provide City with a written explanation of the reasons such required repairs or construction could not be performed in a manner that would result in a shorter disruption; or (C) vacancies or programming disruptions resulting from a casualty or condemnation event, in which case the provisions of Article 14 or Article 15, as applicable, shall control. Tenant shall use reasonable diligence to minimize disruptions in programming or resulting from Permitted Programming Disruptions, including, as applicable, shifting the location of classes to portions of the Premises not impacted by the alterations, improvements or casualty where feasible and providing interim staff to temporarily replace outside staff for scheduled classes where practicable. Tenant shall provide City with prompt written notice of Permitted Programming Disruptions exceeding ten (10) business days.

(b) Management, Staffing and Funding. Tenant shall provide appropriate management and development staff for the operation of the Premises, shall adequately fund the use, maintenance and operation of the Premises consistent with Tenant's obligations under this Lease, including maintaining a reasonable annual repair and capital plan and budget and sufficient reserves to fund such plan in accordance with the budget.

(c) Supplemental Funding. Tenant shall use its reasonable efforts to raise private funds for the purposes of funding educational programs and scholarships and supplementing other operating and capital costs for Tenant's operations at the Premises, to the extent of any projected shortfall between Tenant's operating income and such costs.

(d) Management and Operational Plans. Prior to the Commencement Date Tenant submitted to City a management and operation plan describing Tenant's goals for staffing, operations, programs, and capital improvements at the Premises. Not less frequently once every five (5) years Tenant shall provide to City an updated management and operation plan. If the General Manager has reasonable concerns that the updated management and operation plan is not consistent with the Department's Mission or will not realistically allow Tenant to comply with the maintenance and operational requirements of this Lease, City shall provide Tenant with written notice of such concerns, and Tenant will consult with and carefully consider the views of the General Manager or his her designee regarding such concerns. In addition, on or before _____ of each year of the Term, Tenant shall submit to City a report detailing its management and operations during the prior year. Within sixty (60) days of such submittal (or such longer period of time as mutually agreed by the Parties), Tenant and the General Manager or his or her designee shall meet to discuss such report.

(e) Subject to Permitted Programming Disruptions, if Tenant fails to provide the Minimum Programming, City may provide Tenant with written notice of such failure. Tenant shall attempt in good faith to correct such deficiency in programming within sixty (60) calendar days of such notice. If the deficiency cannot be corrected within the 60-day period, Tenant may at Tenant's election submit a written proposal for the correction along with a specific timeline for such cure (a "Programming Cure Proposal") no later than thirty (30) days after the date of the original notice from City. Tenant's Programming Cure Proposal shall be subject to approval by the General Manager. If Tenant does not timely submit a Programming Cure Proposal and the deficiency is not corrected by the end of the 60-day period, Tenant shall be in default of this Lease. If Tenant timely submits a Programming Cure Proposal and the General Manager disapproves of Tenant's Programming Cure Proposal, the General Manager shall provide Tenant with written notice of such disapproval, together with the reasons for such disapproval. Within thirty (30) days of receipt by Tenant of such written disapproval notice, Department staff and Tenant shall meet in good faith to consider methods and timing for curing the programming deficiency, and Tenant may at Tenant's election submit a revised proposal for the correction along with a specific

timeline for such cure (a "Revised Programming Cure Proposal") no later than thirty (30) days after the date of such meeting. If Tenant timely submits a Revised Programming Cure Proposal and the General Manager disapproves of Tenant's Revised Programming Cure Proposal, the General Manager shall provide Tenant with written notice of such disapproval, together with the reasons for such disapproval. If the General Manager disapproves the original Programming Cure Proposal and Tenant does not thereafter timely submit a Revised Programming Cure Proposal and the deficiency is not corrected by the end of the original 60-day period, Tenant shall be in default of this Lease. If Tenant timely submits a Programming Cure Proposal or a Revised Programming Cure Proposal which is not disapproved by the General Manager, and thereafter fails to cure the deficiency within the period provided in such proposal, Tenant shall be in default under this Lease. The foregoing opportunity to correct deficiencies in Minimum Programming shall not apply to failure to comply with any other specific obligation under this Lease.

Section 6 TAXES AND ASSESSMENTS

6.1 Payment of Possessory Interest Taxes and Other Impositions.

(a) Payment of Possessory Interest Taxes; Reporting Requirements. Subject to Tenant's rights under Section 7.1, Tenant shall pay or cause to be paid, prior to delinquency, all possessory interest and property taxes legally assessed, levied or imposed by applicable Laws on the Premises or any of the improvements or personal property located on the Premises or arising out of Tenant's leasehold estate created by this Lease, to the full extent of installments or amounts payable or arising during the Term. All such taxes shall be paid directly to City's Tax Collector or other charging authority prior to delinquency, provided that if applicable Law permits Tenant to pay such taxes in installments, Tenant may elect to do so in which event only those installments that are due and payable prior to the expiration or earlier termination of the Lease shall be payable by Tenant. In addition, Tenant shall pay any fine, penalty, interest or cost as may be charged or assessed for nonpayment or delinquent payment of such taxes. Tenant specifically recognizes and agrees that this Lease creates a possessory interest which is subject to taxation, and that this Lease requires Tenant to pay any and all possessory interest taxes levied upon Tenant's interest pursuant to an assessment lawfully made by City's Assessor; provided, that Tenant shall have the right to contest the validity, applicability or amount of any such taxes in accordance with Section 7. San Francisco Administrative Code Sections 23.38 and 23.39 require that the City, as landlord under this Lease, report certain information relating to this Lease, and any renewals thereof, to the County Assessor within sixty (60) days after any such transaction, and that Tenant report certain information relating to any assignment of or sublease under this Lease to the County Assessor within thirty (30) days after such assignment or sublease transaction. Tenant agrees to comply with these requirements.

(b) Other Impositions. Subject to Tenant's rights under Section 7.1, Tenant shall pay or cause to be paid all Impositions to the full extent of installments or amounts payable or arising during the Term (subject to the provisions of Section 6.1(c)), which may be legally assessed, levied, confirmed or imposed on or in respect of or be a lien upon the Premises, any of the improvements or personal property now or hereafter located thereon, the leasehold estate created hereby, or any subleasehold estate permitted hereunder, including any taxable possessory interest which Tenant, or any subtenant or any other person may have acquired pursuant to this Lease. Tenant shall pay all Impositions directly to the taxing authority, prior to delinquency, provided that if any applicable Law permits Tenant to pay any such Imposition in installments, Tenant may elect to do so in which event only those installments that are due and payable prior to the expiration or earlier termination of the Lease shall be payable by Tenant. In addition, Tenant shall pay any fine, penalty, interest or cost as may be assessed for nonpayment or delinquent payment of any such Imposition. Impositions shall include all such taxes, assessments, fees and other charges whether general or special, ordinary or extraordinary, foreseen or unforeseen, or hereinafter levied or assessed in lieu of or in substitution of any of the foregoing of every character. The foregoing or subsequent provisions notwithstanding, Tenant shall not be responsible for any Impositions arising from or related to, City's interest as landlord under this Lease.

(c) Prorations. All Impositions imposed for the tax years in which the Commencement Date occurs or during the tax year in which this Lease terminates shall be apportioned and prorated between Tenant and City on a daily basis.

(d) Proof of Compliance. Within a reasonable time (but in any event, not more than fifteen (15) days) following City's written request which City may give at any time and give from time to time, Tenant shall deliver to City copies of official receipts of the appropriate taxing authorities, or other proof reasonably satisfactory to City, evidencing the timely payment of such Impositions.

6.2 City's Right to Pay.

Unless Tenant is exercising its right to contest under and in accordance with the provisions of Section 7, if Tenant fails to pay and discharge any Impositions (including without limitation, fines, penalties and interest) prior to delinquency and fails to pay same thereafter for more than ten (10) days after written demand from City that Tenant pay same, City, at its sole and absolute option, may (but is not obligated to) pay or discharge the same, and the amount so paid by City (including any interest and penalties thereon paid by City), together with interest at the Default Rate computed from the date City makes such payment, shall be deemed to be and shall be payable by Tenant as Additional Rent, and Tenant shall reimburse such sums to City within thirty (30) days following demand.

Section 7 CONTESTS

7.1 Right of Tenant to Contest Impositions and Liens and Laws.

Tenant shall have the right to contest the amount, validity or applicability, in whole or in part, of any possessory interest tax, property tax, or other Imposition or other lien, charge or encumbrance, against or attaching to the Premises or any portion of, or interest in, the Premises, including any lien, charge or encumbrance arising from work performed or materials provided to Tenant or other person to improve the Premises or any portion of the Premises, or the application of any Law to Tenant or the Premises, by appropriate proceedings conducted in good faith and with due diligence. Tenant shall give notice to City within a reasonable period of time of the commencement of any such contest and of the final determination of such contest. Nothing in this Lease shall require Tenant to pay any Imposition as long as it contests the validity, applicability or amount of such Imposition or Law in good faith, and so long as it does not allow the portion of the Premises affected by such Imposition or Law to be forfeited to the entity levying such Imposition as a result of its nonpayment. If any Law requires, as a condition to such contest, that the disputed amount be paid under protest, or that a bond or similar security be provided, Tenant shall be responsible for complying with such condition as a condition to its right to contest. Tenant shall be responsible for the payment of any interest, penalties or other charges which may accrue as a result of any contest, and Tenant shall provide a statutory lien release bond or other security reasonably satisfactory to City in connection with any such contest. Without limiting Section 19, Tenant shall indemnify City for any such fines, penalties, costs, expenses or fees, including Attorneys' Fees and Costs, resulting from Tenant's failure to pay any Imposition or Tenant's contest of an Imposition or Law.

Section 8 COMPLIANCE WITH LAWS

8.1 Compliance with Laws and Other Requirements.

Tenant shall promptly comply, at no cost to City, with all present or future Laws relating to the Premises or the use or occupancy thereof and with any and all recorded covenants, conditions and restrictions affecting the Property or any portion thereof. Tenant acknowledges that the Permitted Uses under Section 5.1 do not limit Tenant's responsibility to obtain Regulatory Approvals for such uses, including but not limited to, building permits. Tenant further understands and agrees that it is Tenant's obligation, at no cost to City, to cause the Premises and Tenant's uses thereof to be conducted in compliance with all Disabled Access Laws. The parties acknowledge and agree that Tenant's obligation to comply with all Laws provided herein is a material part of the bargained for consideration under this Lease. Tenant's obligation under this Section shall include, without limitation, the responsibility of Tenant to make repairs and alterations to the Premises other than the making of structural repairs or

alterations to the Building except to the extent such structural repairs or alterations are required due to Tenant's alterations to or Tenant's particular use of the Premises. Tenant waives any rights now or hereafter conferred upon it by any existing or future Law to terminate this Lease, to receive any abatement, diminution, reduction or suspension of payment of Rent, or to compel City to make any repairs to comply with any such Laws, on account of any such occurrence or situation.

8.2 Regulatory Approvals.

(a) Responsible Party. Tenant understands and agrees that Tenant's use of the Premises hereunder may require authorizations, approvals or permits from governmental regulatory agencies with jurisdiction over the Premises. Tenant shall be solely responsible for obtaining any and all such regulatory approvals. Tenant shall bear all costs associated with applying for and obtaining any necessary or appropriate regulatory approval and shall be solely responsible for satisfying any and all conditions imposed by regulatory agencies as part of a regulatory approval. Any fines or penalties levied as a result of Tenant's failure to comply with the terms and conditions of any regulatory approval shall be immediately paid and discharged by Tenant (subject to Tenant's right to contest pursuant to Section 7), and City shall have no liability, monetary or otherwise, for any such fines or penalties. Without limiting the other indemnification provisions of this Lease, Tenant shall Indemnify City and any Indemnified Party from and against any and all such fines and penalties, together with Attorneys' Fees and Costs, for which City may be liable in connection with Tenant's failure to obtain or comply with any Regulatory Approval or in connection with the litigation against or appeal or contest of, any Regulatory Approval or any conditions thereof.

(b) City Acting as Owner of Real Property. Tenant understands and agrees that City is entering into this Lease in its proprietary capacity, as the holder of fee title to the Premises, and not in its capacity as a regulatory agency of City. Tenant understands that City's entering into this Lease shall not be deemed to imply that Tenant will be able to obtain any required approvals from City departments, boards or commissions which have jurisdiction over the Premises, including City itself in its regulatory capacity. By entering into this Lease, City is in no way modifying Tenant's obligations to cause the Premises to be used and occupied in accordance with all Laws, as provided herein.

Section 9 TENANT'S MANAGEMENT AND OPERATING COVENANTS

9.1 Operating Standards and Requirements; Management.

(a) Following completion of the Initial Improvements Tenant shall operate Premises in a commercially reasonable manner consistent with achieving the Primary Use and the Project goals. Tenant shall be exclusively responsible, at no cost to City, for the management and operation of the Premises. In connection with managing and operating the Premises, Tenant shall provide (or require others, including, without limitation, Subtenants, to provide) such services as may be necessary or appropriate to achieve and maintain operating standards commensurate with that of facilities managed by the Department, including, but not limited to, (a) repair and maintenance of the Improvements, (b) those utility services that are Tenant's obligations hereunder, (c) cleaning, janitorial, extermination, and trash removal, (d) landscaping and groundskeeping, (e) security services, (f) marketing the Premises, selection of Subtenants and negotiation of Subleases and Event Permits (subject to the requirements of Section 18 below), (g) enforcement of reasonable rules and regulations for the conduct of Subtenants and others present on the Premises, (h) collection of rents and other receivables and preparation of statements, (i) use reasonable efforts to enforce, as fully as practicable, the compliance by Subtenants and permittees with the terms, covenants and conditions of their Subleases or permits, (i) placement of insurance and payment of premiums and securing certificates of insurance from Subtenants, permittees and persons working on the Premises, if applicable, (j) preparing a budget that permits Tenant to pay operating expenses and meet debt service obligations, and (k) establishing and maintaining books and records and systems of account covering operations of the Premises in accordance with sound accounting practices.

(b) Tenant, at its election, shall either manage the Premises and negotiate and enter into Subleases and Event Permits by its staff or shall engage one or more third-party entities to manage

and market the Premises. Tenant shall manage the Premises, whether directly or indirectly, in a commercially reasonable manner consistent with sound facility management practices. If City determines in its reasonable judgment that the Premises are not being operated, managed or subleased in accordance with the requirements and standards of this Lease, City may provide Tenant with written notice of such defect in operation, management or subleasing. Within thirty (30) days of receipt by Tenant of such written notice, City staff and Tenant shall meet in good faith to consider methods for improving the operating, management or subleasing of the Premises, and Tenant shall cure the defects in performance, which cure must begin as soon as practicable and in all events within forty five (45) days after City's notice and must be completed within seventy-five (75) days after the date of City's notice, provided that if the deficiency cannot be corrected within the 75-day period, Tenant shall submit a written proposal for the correction along with a specific timeline for such cure no later than thirty (30) days after the date of the meeting between Tenant and City. Tenant's proposal shall be subject to approval by the Department at Department's reasonable discretion. If the deficiency is not corrected by the end of the 75-day period, or if the Department has not accepted Tenant's plan for cure by such date, Tenant shall be in default of this Lease. No contract for the operation or management or leasing of the Premises entered into by Tenant shall be binding on City and no act or omission of a manager pursuant to any management agreement, or otherwise, shall in any manner excuse Tenant's failure to perform any of its obligations under this Lease.

9.2 Books and Records; Annual Report; Audit Right.

Tenant shall keep accurate books and records according to generally accepted accounting principles. On or before the date which is ninety (90) days following the close of each year during the Term and ninety (90) days following the end of the Term, Tenant shall deliver to City an itemized statement of income and expenditures by Tenant for such year, which statement shall set forth income and expenditures by department for the year just concluded broken down by category (such as subtenant rental, event rental, income from classes, and donations received) and a cash flow table that itemizes expenditures on staff and consultant salaries, utilities and maintenance, capital improvements, and the like (the "**Annual Statement**"), certified as correct by an officer of Tenant and in form delivered to Tenant's board of directors, or if no such form which such detail was delivered to Tenant's board of directors, in a form satisfactory to City. Tenant agrees to make its books and records available to City, or to any City auditor, or to any auditor or representative designated by City, for the purpose of examining such books and records to determine the accuracy of Tenant's earnings and expenses. Such books and records shall be kept for four (4) years and shall be maintained and/or made available in San Francisco to City's representative for the purpose of auditing or re-auditing. In addition, Tenant shall promptly provide to City its annual report and Form 990 tax form.

Section 10 REPAIR AND MAINTENANCE

10.1 Covenants to Repair and Maintain the Premises.

(a) Tenant's Duty to Maintain and Repair. Throughout the Term of this Lease, Tenant shall maintain and repair, at no expense to City, the non-structural, interior components of the Premises in good repair and working order and in a clean, secure, safe and sanitary condition. Subject to Section 10.1(b), and Section 15 of this Lease, Tenant shall promptly make (or cause others to make) all necessary or appropriate non-structural, interior repairs, including repair of wear and tear. Tenant shall make such repairs with materials, apparatus and facilities with materials, apparatus and facilities at least equal in quality, appearance and durability to the materials, apparatus and facilities repaired or replaced. Without limiting the foregoing, Tenant shall promptly make all such repairs and replacements: (a) at no cost to City, (b) by licensed contractors or qualified mechanics, and (c) in accordance with any applicable Laws. In addition to the foregoing, subject to the provisions of Section 10.1(b), Tenant shall be responsible for regularly scheduled maintenance to the structural and exterior components of the Building, including the roof (collectively, the "**Structural Components**") as more particularly described in the Maintenance Budget, as defined below.

(b) Capital Repair Budget; Replacement Reserve Account. Tenant shall engage a qualified professional to develop a 35-year asset reserve analysis for the Premises (the "**Reserve Study**"), which Reserve Study shall include a schedule for repair, replacement, major maintenance, and improvement of Structural Components, Building systems, and other capital improvements, fixtures or equipment located on or used in connection with the operation of the Premises which are subject to wearing out during the useful life of the Buildings on the Premises ("**Capital Repairs and Replacements**"). Tenant, in consultation with the Department, shall develop a schedule for periodic deposits into a separate depository account (the "**Replacement Reserve Account**") in the amount reasonably adequate for the payment of all reasonably anticipated costs of Capital Repairs and Replacements, which schedule shall be subject to the reasonable approval or disapproval of the General Manager (as so approved, the "**Capital Repair Budget**"). The schedule for deposits into the Replacement Reserve Account shall be informed by the Reserve Study and shall take into account Tenant's desire to fund major Capital Repairs and Replacements with donations from periodic capital campaigns tied to specific scheduled or anticipated Capital Repairs and Replacements, whenever possible, rather than by ongoing monthly deposits. Tenant shall make deposits of \$10,000 into the Replacement Reserve Account in each of the five (5) years commencing on the Close Date under the LDDA on a schedule determined by Tenant. Thereafter, Tenant shall keep a working fund of \$50,000, as Indexed, in the Replacement Reserve Account (subject to withdrawal and replenishment as described below), and shall make additional deposits from time to time as required to fund the Replacement Reserve Account, at a minimum, to the levels proposed in the Capital Repair Budget or recommended by City's Controller, as provided below, if applicable. If Tenant withdraws funds from the Replacement Reserve Account such that the resulting balance is \$25,000 or less, as Indexed, Tenant shall replenish the Replacement Reserve Account to a minimum balance of \$50,000, as Indexed, within twenty-four (24) months of the withdrawal. If Tenant withdraws funds from the Replacement Reserve Account such that the resulting balance is less than \$50,000 as Indexed, but greater than \$25,000, as Indexed, Tenant shall replenish the Replacement Reserve Account to a minimum balance of \$50,000, as Indexed, within twelve (12) months of the withdrawal. The funds in the Replacement Reserve Account shall be used by Tenant only for Capital Repairs and Replacements, and shall not be used to fund program costs or for any other purpose unless Tenant obtains the prior written consent of City, which consent may be withheld in City's sole discretion. City's Controller may review the adequacy of deposits to the Replacement Reserve Account periodically and if the Controller determines from time to time in his or her reasonable discretion that the amount in the Replacement Reserve Account is insufficient to fund the cost of the likely expenditures which will be required to be made from such account, City may require an increase in the amount of deposits into the Replacement Reserve Account upon one hundred eighty (180) days prior written notice to Tenant, and Tenant shall thereupon make such adjustments, either by monthly payments or by capital campaign funds or otherwise, as reasonably agreed by City and Tenant. City's Controller shall include in its written notice to Tenant a written explanation of the reasons for requiring an increase in the monthly deposits into the Replacement Reserve Account. Tenant shall deliver to City annually a statement from the depository institutions in which the Replacement Reserve Account is held, showing the then current balance in such account and any activity on such account which occurred during the immediately prior year. In the event that Tenant has withdrawn funds from the Replacement Reserve Account within the immediately prior year, Tenant shall include with the delivery of such statement, an explanation of such withdrawal. In connection with any such expenditure, Tenant shall provide City with any other documentation related thereto, reasonably requested by City. The insufficiency of any balance in the Replacement Reserve Account shall not abrogate Tenant's obligation to fulfill all preservation and maintenance covenants in this Lease. Notwithstanding the foregoing, if Capital Repairs and Replacements are required during the final five (5) years of the Term, Tenant may propose that City and Tenant share the cost of such Capital Repairs and Replacements in a manner that takes into account the useful life of the repair or replacement and the remaining Lease Term, such that Tenant is responsible only for that portion of the cost attributable to the time period prior to the expiration of the Term, and if City does not agree to fund the balance of the cost of the required Capital Repairs and Replacements City shall so notify

Tenant and Tenant may either terminate this Lease by providing written notice of termination to City, or Tenant may elect to make such Capital Repairs and Replacements at Tenant's cost.

(c) Inspection Reports. Not less frequently than once every seven (7) years, Tenant shall conduct an inspection and physical needs assessment for the Premises to identify replacements and repairs required to maintain the Premises in good order and repair and to keep the Improvements from deteriorating, and shall cause to be prepared a written report (the "**Inspection Report**") detailing the results of such inspection and assessment. The Inspection Report shall identify capital repairs and improvements which are reasonably required to preserve, repair or replace capital improvements, fixtures or equipment located on or used in connection with the operation of the Premises as well as routine maintenance and repairs. At City's request, Tenant shall cooperate with City to ensure maintenance and repair data is provided promptly to City's Capital Planning Committee staff for inclusion in the master City property database currently known as Facility Renewal and Replacement Model (FRRM).

(d) No City Duty to Maintain. City shall not, as a result of this Lease, have any obligation to make repairs or replacements of any kind or maintain the Premises or any portion of any of them, including the Structural Components.

(e) Cooperation in Identifying Funding Sources. City and Tenant shall use reasonable efforts to identify funding for any unexpected repairs not identified in the Maintenance Budget and not otherwise the obligation of Tenant under this Lease, and if such funding is identified, to perform such repairs.

(f) Right to Terminate; Tenant Right to Perform Repairs. If Structural Components require repair, and City elects to not make the repair, then City shall so notify Tenant and either City or Tenant may either terminate this Lease by providing the other written notice of termination, or Tenant may elect to make such repair (in which case, City may not terminate this Lease), in which case such work shall be performed following an open and fair competitive bid process approved in writing by the General Manager in his or her reasonable discretion. Any and all licenses and agreements entered into by Tenant for use of the Premises must acknowledge Tenant's and City's repair and termination rights as set forth in this Lease, and waive any rights against City in the event of any such repair or termination as permitted by this Lease. Tenant waives any and all claims for damages, injury or inconvenience to or interference with Tenant's business, any loss of occupancy or quiet enjoyment of the Premises or any other loss, in the event of City exercises its right to repair the Premises or to terminate this Lease following damage or destruction or as otherwise permitted hereunder. In making any such repairs, City shall comply with the applicable requirements of the California State Historic Preservation Office and the National Park Service, and use commercially reasonable efforts to minimize disruption to Tenant's use of the Premises.

(g) Tenant Waivers. Except as expressly set forth above, (i) City shall have no obligation to make repairs or replacements of any kind or maintain the Premises or any portion thereof, and (ii) Tenant waives the benefit of any existing or future law that would permit Tenant to make repairs or replacements at City's expense, or abate or reduce any of Tenant's obligations under, or terminate, this Lease, on account of the need for any repairs or replacements. Without limiting the foregoing, Tenant hereby waives any right to make repairs at City's expense as may be provided by Sections 1932(1), 1941 and 1942 of the California Civil Code, as any such provisions may from time to time be amended, replaced, or restated.

(h) Notice. Tenant shall deliver to City, promptly after receipt, a copy of any notice which Tenant may receive from time to time: (i) from any governmental authority having responsibility for the enforcement of any applicable Laws, asserting that the Premises is in violation of such Laws; or (ii) from the insurance company issuing or responsible for administering one or more of the insurance policies required to be maintained by Tenant under this Lease, asserting that the requirements of such insurance policy or policies are not being met. City shall deliver to Tenant, promptly after receipt, a copy of any notice which City may receive from time to time from any governmental authority having

responsibility for the enforcement of any applicable Laws, asserting that the Premises is in violation of such Laws.

Section 11 INITIAL IMPROVEMENTS PURSUANT TO LDDA

11.1 Tenant's Obligation under LDDA to Construct Improvements.

Tenant has the obligation under the LDDA to perform certain improvements and alterations to the Premises (the "**Initial Improvements**"). To the extent the Certificate of Completion issued in connection with the LDDA was conditioned upon Tenant's completion of Deferred Items (as defined in the LDDA), Tenant's agreement to complete such Deferred Items at the time(s) and in the manner provided shall be an obligation under this Lease, and failure to do so shall be a default hereunder.

11.2 Title to Improvements.

As used in this Lease, "**Improvements**" means all buildings, structures, fixtures and other improvements erected, built, placed, installed or constructed upon or within the Premises, including, but not limited to, the Initial Improvements. During the Term of this Lease, Tenant shall own all of the Improvements, including all Subsequent Construction (as defined in Section 12 below) and all appurtenant fixtures, machinery and equipment installed therein (except for trade fixtures and other personal property of Subtenants). At the expiration or earlier termination of this Lease, title to the Improvements, including appurtenant fixtures (but, except as otherwise set forth in this Lease, excluding trade fixtures and, other Personal Property of Tenant and its Subtenants), will vest City without further action of any Party, and without compensation or payment to Tenant. Tenant and its Subtenants shall have the right at any time, or from time to time, including, without limitation, at the expiration or upon the earlier termination of the Term of this Lease to remove trade fixtures and other Personal Property from the Premises in the ordinary course of business; provided, however, that if the removal of Personal Property causes damage to the Premises, Tenant shall promptly cause the repair of such damage at no cost to City.

Section 12 SUBSEQUENT CONSTRUCTION

12.1 City's Approval Required for Subsequent Construction.

(a) Subsequent Construction. Following completion of the Initial Improvements, Tenant shall not make or permit any alterations to the Building or to the heating, ventilating, air conditioning, plumbing, electrical, fire protection, life safety, security and other mechanical, electrical, communications systems of the Building, and shall not make or permit any construction, alterations, installations, additions or improvements (collectively, "**Subsequent Construction**"), in, to or about the Premises, except for Minor Alterations, without City's prior written consent in each instance, which consent shall not be unreasonably withheld.

(b) Minor Alterations. Unless otherwise required under Section 12.1(a), City's approval hereunder shall not be required for (a) the installation, repair or replacement of furnishings, fixtures, equipment or decorative improvements which do not materially affect the structural integrity of the Improvements, (b) recarpeting, repainting the interior of the Premises, or similar alterations, (c) any other Subsequent Construction which does not require a building permit, approval from the Planning Department or other Departments of the City or SHPO, or (d) any other Subsequent Construction costing less than One Hundred Thousand Dollars (\$100,000), as Indexed (collectively, "**Minor Alterations**").

(c) Notice by Tenant; General Approval. At least thirty (30) days before commencing any Subsequent Construction which requires City's approval under Section 12.1(a) above, Tenant shall notify City of such planned Subsequent Construction. City shall have the right to object to any such Subsequent Construction, to the extent that such Subsequent Construction requires City's approval, by providing Tenant with written notice of such objection within thirty (30) days after receipt of such notice from Tenant. If City does not approve or object to the proposed Subsequent Construction within the thirty (30) day period described above, then Tenant may submit a second written notice to City

that such objection was not received within the period provided by this Section 18.1(b) and requesting City's response.

(d) All Subsequent Construction shall be done at Tenant's expense in accordance with plans and specifications approved by City (to the extent plans are reasonably required), only by duly licensed and bonded contractors or mechanics (which contractors or mechanics shall be subject to the prior approval of City if the proposed work exceeds One Hundred Thousand Dollars (\$100,000), as Indexed) and, if City's approval was required, subject to any conditions that City may reasonably impose at the time of approval. At least twenty (20) days before commencing any Subsequent Construction, excluding any Minor Alterations, Tenant shall notify City of such planned Subsequent Construction.

12.2 Construction Documents in Connection with Subsequent Construction.

With regard to any Subsequent Construction (excluding Minor Alterations), Tenant shall prepare and submit to City, for review and written approval hereunder, reasonably detailed schematic drawings. City may waive the submittal requirement of schematic drawings if it determines in its reasonable discretion that the scope of the Subsequent Construction does not warrant such initial review. Schematic drawings, if required, shall generally include perspective drawings sufficient to illustrate the Improvements to be constructed, a site plan at appropriate scale showing relationships of the Improvements with their respective uses, building plans, floor plans and elevations sufficient to describe the development proposal, and the general architectural character, and the location and size of uses, of the proposed work, and building sections showing height relationships of the areas noted above. Tenant shall prepare and submit to City, for review and written approval hereunder (following City's approval of schematic drawings, if required) preliminary and final construction documents (collectively "**Construction Documents**"), which are consistent with the approved schematic drawings, if applicable. Construction Documents means plans, specifications and working drawings for Improvements, setting forth in detail all aspects of the design, function and construction of the Improvements (including architectural, structural, mechanical, electrical, materials and such other elements as may be appropriate), in form sufficient for obtaining permits and bidding all elements of construction, and in otherwise in conformity with all of the requirements of this Lease. Construction Documents shall be prepared by a qualified architect or structural engineer duly licensed in California. City shall approve or disapprove schematic drawings and Construction Documents submitted to it for approval within thirty (30) days following receipt, and any disapproval shall state in writing the reasons for disapproval. If City deems the Construction Documents incomplete, City shall notify Tenant of such fact. If City disapproves Construction Documents, and Tenant revises or supplements, as the case may be, and resubmits such Construction Documents, City shall promptly review the revised or supplemented Construction Documents to determine whether the revisions satisfy the objections or deficiencies cited in City's previous notice of rejection. Upon receipt by Tenant of a disapproval of Construction Documents from City, Tenant (if it still desires to proceed) shall revise such disapproved portions of such Construction Documents in a manner that addresses City's written objections to the extent acceptable to Tenant. Tenant shall resubmit such revised portions to City as soon as possible after receipt of the notice of disapproval. City shall approve or disapprove such revised portions in the same manner as provided above for approval of Construction Documents (and any proposed changes therein) initially submitted to City.

12.3 Construction.

(a) Conditions. Tenant shall not commence any Subsequent Construction until the following conditions have been satisfied or waived by City: (i) except with respect to Minor Alterations, City shall have approved the final Construction Documents; (ii) Tenant shall have obtained all permits and other regulatory approvals necessary to commence such construction; and (iii) Tenant shall have submitted to City in writing its good faith estimate of the anticipated total construction costs of the Subsequent Construction if such estimated cost exceeds Twenty Five Thousand Dollars (\$25,000), as Indexed. If such good faith estimate exceeds One Hundred Thousand Dollars (\$100,000) , as Indexed,

Tenant shall also submit, at City's request, evidence reasonably satisfactory to City, of Tenant's ability to pay such costs as and when due.

(b) Reports. During periods of construction, Tenant shall submit to City upon City's reasonable request, but not more frequently than monthly, written progress reports, along with appropriate backup documentation.

12.4 Construction Standards.

All construction on the Premises shall be accomplished expeditiously, diligently and in accordance with good construction and engineering practices and applicable Laws. Tenant shall undertake commercially reasonable measures to minimize damage, disruption or inconvenience caused by such work and make adequate provision for the safety and convenience of all persons affected by such work. Dust, noise and other effects of such work shall be controlled using commercially-accepted methods customarily used to control deleterious effects associated with construction projects in populated or developed urban areas.

12.5 General Conditions.

All construction on the Premises shall be subject to the following terms and conditions:

(a) All construction work shall be performed in compliance with all Laws, including but not limited to Disabled Access Laws and any historic preservation requirements.

(b) City shall have no responsibility for costs of any Subsequent Construction; Tenant shall pay (or cause to be paid) all such costs.

(c) Tenant shall be responsible for all required insurance.

(d) Tenant shall resolve any and all disputes arising out of the construction in a manner which shall allow work to proceed expeditiously.

(e) City and its Agents shall have the right to enter areas in which construction is being performed to inspect the progress of the work provided such inspections do not unreasonably interfere with the construction. City shall use reasonable efforts to provide prior written or telephonic notice of such entry. Such access shall be subject to Tenant's reasonable security and safety measures. Nothing in this Lease, however, shall be interpreted to impose an obligation upon City to conduct such inspections or any liability in connection therewith.

12.6 Construction Contracts.

Except as otherwise agreed by City in writing, any construction contract for Subsequent Construction (a "**Construction Contract**") shall include terms and conditions: (A) requiring contractor to obtain performance and payment bonds guaranteeing in full the contractor's performance and payment of subcontractors under the Construction Contract; (B) naming City and its boards, commissions, directors, officers, agents, and employees as co-indemnitees with respect to Tenant's contractor's obligation to indemnify and hold harmless Tenant and its directors, officers, agents, and employees from all Losses directly or indirectly arising out of, connected with, or resulting from the contractor's performance or nonperformance under the Construction Contract; (C) requiring Tenant and contractor (as applicable) to obtain and maintain insurance coverages reasonably acceptable to City, including general liability and builder's risk insurance coverage that names City and its directors, officers, agents, and employees as additional insureds under the terms of the policies, (D) identifying City as an intended third party beneficiary of the Construction Contract, with the right to enforce the terms and conditions of the Construction Contract and pursue all claims thereunder as if it were an original party thereto; (E) consenting to the assignment of the Construction Contract to the City, in whole or in part, including but not limited to the assignment of (i) all express and implied warranties and guarantees from the contractor, all subcontractors and suppliers, (ii) all contractual rights related to the correction of nonconforming work, and (iii) the right to pursue claim(s) for patent and latent defects in the work and the completed project; and (F) providing for the contractor's(s') obligation, for a period of at least one (1)

year after the final completion of construction of the Improvements, to correct, repair, and replace any work that fails to conform to the Final Construction Documents (as the same may be revised during construction pursuant to properly approved change orders) and damage due to: (i) faulty materials or workmanship; or (ii) defective installation by such contractor(s) of materials or equipment manufactured by others.

12.7 Tenant's Duty to Notify City.

Tenant shall promptly notify City in writing of (i) any written communication that Tenant may receive from any governmental, judicial or legal authority, giving notice of any claim or assertion that the Property, Building or any completed improvements fail in any respect to comply with applicable laws, rules and regulations; (ii) any known material adverse change in the physical condition of the Property, including, without limitation, any damage suffered as a result of earthquakes; (iii) any known default by any contractor or subcontractor or material supplier; or (iv) any known material adverse change in the financial condition or business operations of any contractor or subcontractor or material supplier that is reasonably anticipated to interfere with the completion of the applicable construction.

12.8 Prevailing Wages.

Tenant agrees that any person performing labor in the construction on the Premises shall be paid not less than the highest prevailing rate of wages and that Tenant shall include, in any contract for construction a requirement that all persons performing labor under such contract shall be paid not less than the highest prevailing rate of wages for the labor so performed and shall use reasonable diligence to enforce such contract provisions. Tenant further agrees that, during the performance of any construction at the Premises during the Term, Tenant shall comply with all the provisions of Section 6.22(E) of the San Francisco Administrative Code, as if the construction contracts had been awarded by the City and County of San Francisco.

12.9 Tropical Hardwood and Virgin Redwood Ban.

Neither Tenant nor any of its contractors shall provide any items to City in the construction of improvements or otherwise in the performance of this Lease that are tropical hardwood, tropical hardwood wood products, virgin redwood, or virgin redwood wood products. The City and County of San Francisco urges companies not to import, purchase, obtain or use for any purpose, any tropical hardwood, tropical hardwood product, virgin redwood, or virgin redwood wood products. In the event Tenant fails to comply in good faith with any of the provisions of Chapter 8 of the San Francisco Environment Code, Tenant shall be liable for liquidated damages as set forth in Chapter 8.

12.10 Approvals.

Tenant understands and agrees that City is entering into this Lease in its proprietary capacity and not as a regulatory agency with certain police powers. Notwithstanding anything to the contrary herein, no approval by City of the plans for any construction (including the schematic design documents or Construction Documents) nor any other approvals by City hereunder shall be deemed to constitute approval of any governmental or regulatory authority with jurisdiction over the Premises. All approvals or other determinations of City as landlord hereunder may be made by the General Manager unless otherwise specified herein.

12.11 Safety Matters.

Tenant, while performing any construction or maintenance or repair of the Building, shall undertake commercially reasonable measures in accordance with good construction practices to minimize the risk of injury or damage to adjoining portions of the Premises and the surrounding property, or the risk of injury to members of the public, caused by or resulting from the performance of its work.

12.12 First Source Hiring Ordinance.

City has adopted a First Source Hiring Ordinance (Board of Supervisors Ordinance No. 264-98) which establishes specific requirements, procedures and monitoring for first source hiring of qualified

economically disadvantaged individuals for entry level positions. Tenant agrees to comply with the First Source Hiring Ordinance to the extent applicable and shall enter into a First Source Hiring Agreement meeting applicable requirements of Section 83.9 of the First Source Hiring Ordinance.

12.13 Construction Improvements that Disturb or Remove Exterior Paint.

Tenant, on behalf of itself and its Agents, employees, officers and contractors, shall comply with all requirements of the San Francisco Building Code Chapter 36 and all other applicable local, state, and Federal laws, including but not limited to the California and United States Occupational and Health Safety Acts and their implementing regulations, when the work of improvement or alteration disturbs or removes exterior or interior lead-based or "presumed" lead-based paint (as defined below). Tenant, its Agents, employees, officers and contractors shall give to City three (3) business days prior written notice of any disturbance or removal of exterior or interior lead-based or presumed lead-based paint. Tenant acknowledges that the required notification to the Department of Building Inspection regarding the disturbance or removal of exterior lead-based paint pursuant to Chapter 36 of the San Francisco Building Code does not constitute notification to City as Tenant under the Lease and similarly that notice under the Lease does not constitute notice under Chapter 36 of the San Francisco Building Code. Further, Tenant and its Agents, employees, officers and contractors, when disturbing or removing exterior or interior lead-based or presumed lead-based paint, shall not use or cause to be used any of the following methods: (a) acetylene or propane burning and torching; (b) scraping, sanding or grinding without containment barriers or a High Efficiency Particulate Air filter ("HEPA") local vacuum exhaust tool; (c) hydroblasting or high-pressure wash without containment barriers; (d) abrasive blasting or sandblasting without containment barriers or a HEPA vacuum exhaust tool; and (e) heat guns operating above 1,100 degrees Fahrenheit. Tenant covenants and agrees to comply with the requirements of Title 17 of the California Code of Regulations when taking measures that are designed to reduce or eliminate lead hazards. Paint on the exterior or interior of buildings built before January 1, 1979 is presumed to be lead-based paint unless a lead-based paint test, as defined by Chapter 36 of the San Francisco Building Code, demonstrates an absence of lead-based paint on the interior or exterior surfaces of such buildings. Lead-based paint is "disturbed or removed" if the work of improvement or alteration involves any action that creates friction, pressure, heat or a chemical reaction upon any lead-based or presumed lead-based paint on a surface so as to abrade, loosen, penetrate, cut through or eliminate paint from that surface.

12.14 Preservative-Treated Wood Containing Arsenic.

Tenant may not purchase preservative-treated wood products containing arsenic in the performance of this Lease unless an exemption from the requirements of Environment Code Chapter 13 is obtained from the Department of Environment under Section 1304 of the Environment Code. The term "preservative-treated wood containing arsenic" shall mean wood treated with a preservative that contains arsenic, elemental arsenic, or an arsenic copper combination, including, but not limited to, chromated copper arsenate preservative, ammoniac copper zinc arsenate preservative, or ammoniacal copper arsenate preservative. Tenant may purchase preservative-treated wood products on the list of environmentally preferable alternatives prepared and adopted by the Department of Environment. This provision does not preclude Tenant from purchasing preservative-treated wood containing arsenic for saltwater immersion. The term "saltwater immersion" shall mean a pressure-treated wood that is used for construction purposes or facilities that are partially or totally immersed in saltwater.

12.15 Resource Efficient City Buildings and Pilot Projects.

Tenant acknowledges that the City and County of San Francisco has enacted San Francisco Environment Code Sections 700 to 707 relating to resource-efficient City buildings and resource-efficient pilot projects. Tenant hereby agrees that it shall comply with all applicable provisions of such code sections.

12.16 As-Built Plans and Specifications.

Tenant shall furnish to City one copy of as-built plans and specifications for Subsequent Construction (reproducible transparencies and CAD files) within one hundred twenty (120) days

following completion; provided, however, Tenant shall continue to own the rights to such as built plans and specifications until the expiration or earlier termination of the Lease. If Tenant fails to provide such as-built plans and specifications to City within the time period specified herein, and such failure continues for an additional thirty (30) days following written request from City, City will thereafter have the right to cause an architect or surveyor selected by City to prepare as-built plans and specifications showing such Subsequent Construction, and the reasonable cost of preparing such plans and specifications shall be reimbursed by Tenant to City as Additional Rent. Nothing in this Section shall limit Tenant's obligations, if any, to provide plans and specifications in connection with Subsequent Construction under applicable regulations adopted by City in its regulatory capacity.

12.17 Title to Improvements.

Tenant shall have the right to remove and safely store City's personal property at any time during the Term, provided Tenant shall return the same to the Premises upon the expiration or earlier termination of the Lease. Notwithstanding anything to the contrary in the Lease, equipment, additions and other property attached or affixed to or installed in the Premises by Tenant which can be removed without structural damage to the Premises (e.g., sound systems, seating, lights, and similar improvements), but not including any such items if included as part of the Initial Improvements, shall remain Tenant's property and may be removed at any time so long as Tenant repairs any damage to the Premises caused by such removal. Tenant shall not have the right to remove the Initial Improvements (excluding any portion of the Initial Improvements that constitute Personal Property), all of which shall be delivered to City upon Lease termination or expiration.

12.18 Tenant's Personal Property.

All Tenant's Personal Property shall be and remain Tenant's property (not including the Initial Improvements to the extent the same do not constitute Personal Property, which are and shall remain City's property). Tenant may remove its Personal Property at any time during the Term.

12.19 City Cooperation.

Upon Tenant's request, City, acting in its proprietary capacity as a landlord but not in any regulatory capacity, shall reasonably cooperate with Tenant, in accordance with industry custom for landlords, in connection with Tenant's applications for permits and other governmental approvals in connection with the operation of the Premises or construction of any improvements under this Lease. Nothing in the foregoing shall limit or alter City's discretion as landlord for approvals or consents as described elsewhere in this Lease.

12.20 Annual Report of Subsequent Construction.

Tenant shall submit an annual report to City detailing any Subsequent Construction (including Minor Alterations) made to the Premises during the immediately preceding year.

Section 13 UTILITY AND OTHER SERVICES

13.1 Utilities and Services.

(a) City shall provide, at its sole cost and expense, electricity, water and gas services to those portions of the Premises generally depicted with the designation "Landlord Utility Area" on the attached *Exhibit B* (the "Landlord Utility Area"). City, in its proprietary capacity as fee owner of the real property comprising the Premises and landlord under this Lease, shall not be required to provide any utility services to those portions of the Premises generally depicted with the designation "Tenant Utility Area" on the attached *Exhibit B* (the "Tenant Utility Area"), which Tenant Utility Area includes the proposed restaurant and kitchen, retail space, Powerhouse, theater and related spaces, including storage areas, stairwells and restrooms. Tenant shall be responsible, at its sole cost and expense, for electricity, water, sewer and gas services to the Tenant Utility Area. Tenant will pay or cause to be paid as the same become due all deposits, charges, meter installation fees, connection fees and other costs for all public or

private utility services at any time rendered to the Tenant Utility Area or any part of the Tenant Utility Area, and will do all other things required for the maintenance and continuance of all such services.

(b) Tenant shall ensure that separate meters are installed to measure electricity, water and gas service to the Landlord Utility Area (for which City is responsible) and the Tenant Utility Area (for which Tenant is responsible). The Parties anticipate that such meters will be installed as part of the Initial Improvements (as defined in Section 11.1).

(c) Tenant shall pay for garbage and recycling disposal and all telephone, fax and internet connection charges for the entire Premises, including the cost of bringing any such service(s) to locations in the Premises.

13.2 Excess Use.

If Tenant requires any utilities or services not provided by City hereunder, Tenant shall pay any and all costs of such utilities and services. Without limiting the foregoing, Tenant shall not: (a) connect or use any apparatus, device or equipment that will impair the proper functioning or capacity of the Building Systems; or (b) connect any apparatus, device or equipment through electrical outlets or facilities except in the manner for which such outlets or facilities are designed; or (c) maintain at any time an electrical demand load in excess of the amount the Building's electrical systems were designed to support.

13.3 Interruption of Services.

City's obligation to provide utilities and services for the Landlord Utility Area is subject to applicable Laws and shutdowns for maintenance and repairs, for security purposes, or due to strikes, lockouts, labor disputes, fire or other casualty, acts of God, or other causes beyond the control of City. In the event of an interruption in, or failure or inability to provide any service or utility for the Landlord Utility Area for any reason, such interruption, failure or inability shall not constitute an eviction of Tenant, constructive or otherwise, or impose upon City any liability whatsoever, including, but not limited to, liability for consequential damages or loss of business by Tenant, however City shall use reasonable and diligent efforts to restore or to cause the restoration of the interrupted service, if the cause of the interruption or failure is within City's reasonable control in its capacity as owner of the Premises. Further, Tenant agrees, with respect to any public utility services provided to the Premises by City's utility company (if applicable), that no act or omission of City in its capacity as a provider of public utility services shall abrogate, diminish, or otherwise affect the respective rights, obligations and liabilities of Tenant and City under this Lease, or entitle Tenant to terminate this Lease or to claim any abatement or diminution of Rent, except as expressly set forth herein to the contrary. Further, Tenant covenants not to raise as a defense to its obligations under this Lease, or assert as a counterclaim or cross-claim in any litigation or arbitration between Tenant and City relating to this Lease, any losses arising from or in connection with City's provision (or failure to provide) public utility services. Tenant hereby waives the provisions of California Civil Code Section 1932(1) or any other applicable existing or future Legal Requirement permitting the termination of this Lease due to such interruption, failure or inability. The foregoing shall not constitute a waiver by Tenant of any claim it may or may not in the future have (or claim to have) against any such utility provider including City's utility company.

13.4 Water and Energy Conservation; Mandatory or Voluntary Restrictions.

In the event any law, ordinance, code or governmental or regulatory guideline imposes mandatory or voluntary controls on City or the Premises or any part thereof, relating to the use or conservation of energy, water, gas, light or electricity or the reduction of automobile or other emissions, or the provision of any other utility or service provided with respect to this Lease, or in the event City is required or elects to make alterations to any part of the Building in order to comply with such mandatory or voluntary controls or guidelines or to save power, water or other utility charges, such compliance and the making of such alterations shall in no event entitle Tenant to any damages, relieve Tenant of the obligation to pay the full Rent and Additional Charges hereunder or to perform each of its other covenants hereunder or constitute or be construed as a constructive or other eviction of Tenant, provided that City shall consult

with Tenant prior to the construction of any such alterations in order to minimize the effect of any such improvement on the operations of Tenant under this Lease. Without limiting the foregoing, Tenant acknowledges that City shall have the right to install, at City's cost, solar panels, wind turbines and other energy-generating equipment on the roof of the Building so long as: (i) the same shall not interfere with equipment installed by Tenant on the roof in accordance with the terms of this Lease; (ii) the same shall not adversely affect the stability of the roof or materially interfere with Tenant's operations at the Premises; (iii) the same shall be permitted by Law (including those relating to historic preservation); and (iv) the same shall not have an adverse effect on any historic tax credits that have been or will be issued with respect to the Premises.

13.5 Floor Load.

Without City's prior written consent, which City shall not unreasonably withhold, condition or delay, Tenant shall not place or install in the Premises any equipment that weighs in excess of the normal load-bearing capacity of the floors of the Building; provided that it shall not be unreasonable for City to withhold consent to any such placement or installation if City's engineers are not satisfied that the improvements suggested by Tenant are sufficient to support such placement or installation and not cause damage to the Building. If City consents to the placement or installation of any such machine or equipment in the Premises, Tenant, at no cost to City, shall reinforce the floor of the Premises, pursuant to plans and specifications approved by City and otherwise in compliance with the constructions provisions of this Lease, as necessary to assure that no damage to the Premises or the Building or weakening of any structural supports will be occasioned thereby.

13.6 Antennae and Telecommunications Dishes.

Except as set forth in approved plans as part of the Initial Improvements performed pursuant to the LDDA, no antennae or telecommunications dish or other similar facilities may be installed on the roof or exterior of the Premises without the prior written approval of the General Manager, which approval shall not be unreasonably withheld, conditioned or delayed. Any wireless telecommunications systems shall be subject to City's approval pursuant to City's policies on the siting and requirements for wireless telecommunications, as the same may be amended or modified from time to time. No such antennae shall interfere with City's plans for solar panels or wind turbines on the roof of the Building or City's emergency communications and transmission facilities (if any) and, to the extent existing at the time approval to the same was requested, City's non-emergency communications and transmission facilities of City (if any).

Section 14 DAMAGE OR DESTRUCTION

14.1 General; Notice; Waiver.

(a) General. If at any time during the Term any damage or destruction occurs to all or any portion of the Premises, including the Improvements thereon, and including, but not limited to, any Major Damage and Destruction, the rights and obligations of the Parties shall be as set forth in this Section.

(b) Notice. If there is any damage to or destruction of the Premises or of the Improvements thereon or any part thereof, which could materially impair use or operation of the Improvements for their intended purposes for a period of thirty (30) days or longer, Tenant shall promptly, but not more than ten (10) days after the occurrence of any such damage or destruction, give written notice thereof to City describing with as much specificity as is reasonable the nature and extent of such damage or destruction.

(c) Waiver. The Parties intend that this Lease fully govern all of their rights and obligations in the event of any damage or destruction of the Premises. Accordingly, City and Tenant each hereby waive the provisions of Sections 1932(2) and 1933(4) of the California Civil Code, as such sections may from time to time be amended, replaced, or restated.

14.2 Certain Defined Terms.

Major Damage or Destruction means damage to or destruction of all or any portion of the Improvements on the Premises (a) to the extent that the hard costs of Restoration will exceed One Million Dollars (\$1,000,000) or (b) which cannot reasonably be repaired within two hundred ten (210) days after the date of the damage or (c) during the last five (5) years of the Term.

Restore and Restoration have the meanings set forth in Section 1.

Tenant Force Majeure means events which result in delays in Tenant's performance of its obligations hereunder due to causes beyond Tenant's control and not caused by the acts or omissions of the Tenant, such as acts of nature or of the public enemy, fires, floods, earthquakes, strikes, freight embargoes, and unusually severe weather; delays of contractors or subcontractors due to any of these causes; the presence of Hazardous Materials or other concealed conditions on the Premises that would substantially delay or materially and adversely impair the Tenant's ability to construct on the Premises; substantial interruption of work because of other construction by third parties in the immediate vicinity of the Premises; archeological finds on the Premises; strikes, delay in the granting of permits and other governmental approvals beyond reasonable time periods and substantial interruption of work because of labor disputes; inability to obtain materials or reasonably acceptable substitute materials (provided that Tenant has ordered such materials on a timely basis and Tenant is not otherwise at fault for such inability to obtain materials). Force Majeure does not include failure to obtain financing or have adequate funds, or any event that could have been avoided by exercising that standard of foresight and due diligence that any ordinary, prudent and competent person would exercise under the circumstances. In the event of the occurrence of any such delay, the time or times for performance of the obligations will be extended for the period of the delay; provided, however, (i) within thirty (30) days after the beginning of any such delay, Tenant shall have first notified City in writing of the cause or causes of such delay and claimed an extension for the reasonably estimated period of the delay, and (ii) Tenant cannot, through commercially reasonable and diligent efforts (not including the incurring of overtime premiums or the like), make up for the delay. Under no circumstances shall an event of Tenant Force Majeure exceed twelve months without City's consent.

Uninsured Casualty means any of the following: (1) an event of damage or destruction occurring at any time during the Term for which the costs of Restoration (including the cost of any required code upgrades) are not insured under the policies of insurance that Tenant is required to carry under Section 20 hereof, or (2) an event of damage or destruction occurring at any time during the Term, which is covered under Tenant's policies of insurance that Tenant is required to carry under Section 20 hereof, but where the cost of Restoration (including the cost of any required code upgrades) will exceed the net proceeds of any insurance payable (or which would have been payable but for Tenant's default in its obligation to maintain insurance required to be maintained hereunder) plus the amount of any applicable policy deductible. Damage or destruction due to flood or earthquake shall be deemed an Uninsured Casualty notwithstanding that there may be insurance coverage.

14.3 Tenant's Restoration Obligations.

If all or any portion of the Improvements are damaged or destroyed by an event not constituting an Uninsured Casualty or Major Damage or Destruction for which Tenant elects to terminate this Lease under Section 14.4, then Tenant shall, subject to Section 14.4 hereof, within a reasonable period of time, commence and diligently, subject to Tenant Force Majeure, Restore the Premises to substantially the condition they were in immediately before such damage or destruction, to the extent possible in accordance with then applicable Laws. Except as set forth below, all insurance proceeds received by Tenant for the repair or rebuilding of the Premises shall be used by Tenant for the repair or rebuilding of the Premises. All restoration performed by Tenant shall be in accordance with the procedures set forth in Section 12 relating to Subsequent Construction and shall be at Tenant's sole expense. Such destruction, in and of itself, shall not terminate this Lease.

14.4 Major Damage and Destruction or Uninsured Casualty.

(a) Tenant's Election to Restore or Terminate. If an event of Major Damage or Destruction or Uninsured Casualty occurs at any time during the Term, then Tenant shall provide City with a written notice (the "**Casualty Notice**") either (1) electing to commence and complete Restoration of the Premises to substantially the condition they were in immediately before such Major Damage or Destruction or Uninsured Casualty to the extent possible in accordance with then applicable Law and in accordance with any restoration work to be performed by City in accordance with the terms of this Lease; or (2) electing to terminate this Lease (subject to Section 14.4(b)). Tenant shall provide City with the Casualty Notice no later than ninety (90) days following the occurrence of such Major Damage or Destruction or Uninsured Casualty. If Tenant elects to Restore the Improvements, all of the provisions of Section 12 that are applicable to Subsequent Construction of the Improvements shall apply to such Restoration of the Improvements to substantially the condition they were in prior to such Major Damage or Destruction as if such Restoration were Subsequent Construction. .

(b) Condition to Termination; Payment of Insurance Proceeds. As a condition precedent to Tenant's right to terminate the Lease upon the occurrence of either of the events set forth in Section 14.4(a) above, Tenant, in its election to terminate described in Section 14.4(a), shall state the estimated cost of Restoration of the Premises, and the amount by which the estimated cost of Restoration exceeds insurance proceeds payable. Upon receipt by Tenant of any insurance proceeds paid on account of such casualty for the repair or rebuilding of the Premises, Tenant shall promptly pay or cause to be paid to City such insurance proceeds recoverable by Tenant after first reimbursing any Mortgagee for the outstanding balance of any loan used to fund the cost of constructing the Initial Improvements or Subsequent Construction. Upon such event, Tenant shall provide to City a statement of such costs and the remaining debt, certified as true and correct, together with appropriate backup documentation.

14.5 Effect of Termination.

If Tenant elects to terminate the Lease under Section 14.4 above, then this Lease shall terminate on the date that Tenant shall have fully complied with all provisions of the first sentence of Section 14.4(b). Upon such termination, the Parties shall be released thereby without further obligations to the other party as of the effective date of such termination subject to payment to City of accrued and unpaid Rent, up to the effective date of such termination; provided, however, that the indemnification provisions hereof shall survive any such termination with respect to matters arising before the date of any such termination. City's right to receive insurance proceeds under this Lease shall survive the termination or expiration of the Lease.

14.6 Distribution Upon Lease Termination.

If Tenant is obligated to restore the Premises as provided herein and the Lease is terminated as a result of an Event of Default by Tenant, then at the time of termination Tenant shall transfer to City all remaining insurance proceeds for the repair or rebuilding of the Premises, or the right to such proceeds if not yet received, in order to allow City to complete the restoration of the Premises.

14.7 Permitted Programming Disruption.

If the fire or other casualty damages the Premises, and Tenant or any subtenant ceases to use any portion of the Premises as a result of such damage, then vacancies or programming disruptions resulting from such casualty shall be a "Permitted Programming Disruption," during the period the Premises or portion thereof are rendered unusable by such damage and repair, based upon the extent to which the damage and repair prevents Tenant or such subtenant from operating in the applicable portion of the Premises.

Section 15 CONDEMNATION

15.1 Definitions.

(a) "Taking" means a taking or damaging, including severance damage, by eminent domain, inverse condemnation or for any public or quasi-public use under law. A Taking may occur pursuant to the recording of a final order of condemnation, or by voluntary sale or conveyance in lieu of condemnation or in settlement of a condemnation action.

(b) "Date of Taking" means the earlier of (i) the date upon which title to the portion of the Premises taken passes to and vests in the condemnor, or (ii) the date on which Tenant is dispossessed.

(c) "Award" means all compensation, sums or anything of value paid, awarded or received for a Taking, whether pursuant to judgment, agreement, settlement or otherwise.

(d) "Improvements Pertaining to the Realty" means machinery or equipment installed for use on the Premises that cannot be removed without a substantial economic loss or without substantial damage to the property on which it is installed, regardless of the method of installation, but excluding all of Tenant's Personal Property. In determining whether particular property can be removed "without a substantial economic loss," the value of the property in place considered as part of the realty should be compared with its value if it were removed and sold.

15.2 General.

If during the Term or during the period between the execution of this Lease and the Commencement Date, there is any Taking of all or any part of the Premises or any interest in this Lease, the rights and obligations of the parties hereunder shall be determined pursuant to this Section. City and Tenant intend that the provisions hereof govern fully in the event of a Taking and accordingly, the parties each hereby waive any right to terminate this Lease in whole or in part under Sections 1265.110, 1265.120, 1265.130 and 1265.140 of the California Code of Civil Procedure or under any similar law now or hereafter in effect.

15.3 Total Taking; Automatic Termination.

If there is a total Taking of the Premises, then this Lease shall terminate as of the Date of Taking.

15.4 Partial Taking; Election to Terminate

(a) If there is a Taking of any portion (but less than all) of the Premises, then this Lease shall terminate in its entirety under either of the following circumstances: (i) if all of the following exist: (A) the partial Taking renders the remaining portion of the Premises untenable or unsuitable for continued use by Tenant, or the Taking is of areas that are necessary for Tenant to derive sufficient income to perform its obligations hereunder (i.e., part or all of the Tenant Utility Area), and (B) Tenant elects to terminate; or (ii) if there is a partial Taking of a substantial portion of the Premises, then City or Tenant shall have the right to terminate this Lease in its entirety; provided, however, that this Lease shall not terminate if Tenant agrees to, and does, fully perform all of its obligations hereunder.

(b) Either party electing to terminate under the provisions of this Section shall do so by giving the other party written notice to the other party before or within thirty (30) days after the Date of Taking, and thereafter this Lease shall terminate upon the later of the thirtieth (30th) day after such written notice is given or the Date of Taking.

15.5 Rent; Award.

Upon termination of this Lease pursuant to an election under Section 15.4 above, City shall be entitled to the entire Award in connection therewith (including, but not limited to, any portion of the Award made for the value of the leasehold estate created by this Lease and any Improvements Pertaining to the Realty), and Tenant shall have no claim against City for the value of any unexpired term of this

Lease, provided that Tenant shall receive any Award made specifically to Tenant for Tenant's relocation expenses or the interruption of or damage to Tenant's business or damage to Tenant's Personal Property.

15.6 Partial Taking; Continuation of Lease.

If there is a partial Taking of the Premises under circumstances where this Lease is not terminated in its entirety under Section 15.4 above, then this Lease shall terminate as to the portion of the Premises so taken, but shall remain in full force and effect as to the portion not taken, and the rights and obligations of the parties shall be as follows: (a) any Award shall be payable first to City to be applied to the restoration or repair of the balance of the Premises not taken, to the extent required to render such portion of the Premises tenantable, (b) Tenant shall be entitled to that portion of the balance of the Award attributable to the Tenant Utility Area, and (c) City shall be entitled to that portion of the balance of the Award attributable to portions of the Premises other than the Tenant Utility Area (including, but not limited to, any portion of the Award made for the value of the leasehold estate created by this Lease), and Tenant shall have no claim against City for the value of any unexpired term of this Lease, provided that Tenant may make a separate claim for compensation, and Tenant shall receive any Award made specifically to Tenant, for Tenant's relocation expenses or the interruption of or damage to Tenant's business or damage to Tenant's Personal Property.

15.7 Temporary Takings.

Notwithstanding anything to contrary in this Section, if a Taking occurs with respect to all or any part of the Premises for a limited period of time not in excess of one hundred eighty (180) consecutive days, this Lease shall remain unaffected thereby, and Tenant shall continue to perform all of the terms, conditions and covenants of this Lease; provided that Tenant shall be relieved from all obligations under this Lease requiring possession of that portion of the Premises so condemned for the period of such temporary Taking. In the event of such temporary Taking, Tenant shall be entitled to receive that portion of any Award representing compensation for the Tenant's use or occupancy of the Premises during the applicable Taking and City shall be entitled to receive that portion of the Award representing compensation for City's use or occupancy of the Premises (if any) during the applicable Taking.

Section 16 LIENS AND LEASEHOLD MORTGAGES

16.1 Liens.

Tenant shall keep the Premises free from any liens arising out of any work performed, material furnished or obligations incurred by or for Tenant. In the event Tenant does not, within thirty (30) days following the imposition of any such lien, cause the lien to be released of record by payment or posting of a proper bond, City shall have, in addition to all other remedies, the right, but not the obligation, to cause the lien to be released by such means as it shall deem proper, including, but not limited to, payment of the claim giving rise to such lien. All such sums paid by City and all expenses incurred by it in connection therewith (including, without limitation, Attorneys' Fees and Costs) shall be payable to City by Tenant upon written demand, accompanied by supporting invoices. City shall have the right to post on the Premises any notices that City may deem proper for the protection of City, the Premises, and the Building, from mechanics' and materialmen's liens. Tenant agrees to indemnify, defend and hold City and its Agents harmless from and against any claims for mechanic's, materialmen's or other liens in connection with any repairs or construction on the Premises, or materials furnished or obligations incurred by or for Tenant.

16.2 Leasehold Encumbrances.

(a) Tenant's Right to Mortgage Leasehold. Except as expressly permitted in this Section 16.3, Tenant shall not Encumber Tenant's leasehold interest in the Premises, the Building, the Improvements or the Lease. Any Mortgage that is not permitted hereunder shall be deemed to be a violation of this Lease on the date of its execution or filing of record regardless of whether or when it is foreclosed or otherwise enforced. Pursuant to the terms and to the extent permitted by this Section 16.2, Tenant shall have the right to Encumber Tenant's leasehold estate created by this Lease by way of a

leasehold Mortgage; provided that, notwithstanding any foreclosure thereof, Tenant shall remain liable for the payment of Rent and for the performance of all other obligations under this Lease. Tenant shall promptly notify City of any lien or encumbrance of which Tenant has knowledge and which has been recorded against or attached to the Improvements or Tenant's leasehold estate hereunder whether by act of Tenant or otherwise.

(b) Leasehold Mortgage Subject to this Lease. With the exception of the rights expressly granted to Mortgagees in this Lease, the execution and delivery of a Mortgage shall not give or be deemed to give a Mortgagee any greater rights than those granted to Tenant hereunder. Notwithstanding anything to the contrary set forth herein, any rights given hereunder to Mortgagees shall not apply to more than one Mortgagee at any one time. If at any time there is more than one Mortgage constituting a lien on any portion of the Premises, the lien of the Mortgage prior in time to all others shall be vested with the rights under this Section 16 to the exclusion of the holder of any junior Mortgage.

(i) No Invalidation of Mortgage by Tenant Default. No failure by Tenant or any other party to comply with the terms of any Mortgage, including, without limitation, the use of any proceeds of any debt, the repayment of which is secured by the Mortgage, shall be deemed to invalidate, defeat or subordinate the lien of the Mortgage. Notwithstanding anything to the contrary in this Lease, neither the occurrence of any default under a Mortgage, nor any foreclosure action or conveyance in-lieu-of foreclosure, nor any action taken by a Mortgagee as permitted under the terms of the Mortgage or to cure any default of Tenant under this Lease, shall, by itself, constitute an Event of Default under this Lease, however such matters may be evidence of Tenant's failure to operate the Premises in accordance with the operating standards set forth herein.

(ii) Purpose of Mortgage; Protections Limited to Permitted Mortgagees. A Mortgage may be given only to a Bona Fide Institutional Lender, or to any other lender approved by City in its sole discretion (it being agreed that such other lender may include a philanthropic organization that engages in philanthropic lending, if such organization is otherwise acceptable to City). A Mortgage shall be made only to finance any Subsequent Construction, or for the purpose of refinancing a permitted Mortgage, and shall not be cross-collateralized or cross defaulted with any other debt of Tenant or any other party. Tenant shall not be permitted to refinance a permitted Mortgage in order to take out cash for application to property other than the Premises or for application to the obligations of Tenant other than those created under this Lease.

(iii) Rights Subject to Lease; Restoration Obligations. All rights acquired by the Mortgagee under a Mortgage shall be subject to each and all of the covenants, conditions and restrictions set forth in this Lease, and to all rights of the City hereunder. None of such covenants, conditions and restrictions is or shall be waived by City by reason of the giving of the Mortgage, except as expressly provided in this Lease or otherwise specifically waived by City in writing. Except as set forth below, no Mortgagee shall be obligated to restore any damage to the Premises; provided, however, (i) that nothing in this Section shall be deemed or construed to permit or authorize any such holder to devote the Premises or any part thereof to any uses, or to construct any improvements thereon, other than those uses or improvements permitted under this Lease, and (ii) in the event that the Mortgagee obtains title to the leasehold and chooses not to complete or restore the improvements where Tenant otherwise has the obligation to so restore, it shall so notify City in writing of its election within forty-five (45) days following its acquisition of the tenancy interest in this Lease and shall sell its tenancy interest with reasonable diligence to a purchaser that shall be obligated to restore the improvements as required under this Lease, but in any event the Mortgagee shall cause such sale to occur within six (6) months following the Mortgagee's written notice to City of its election not to restore. If Mortgagee fails to sell its tenancy interest using good faith efforts within such six (6) month period, it shall not constitute a default hereunder, but the Mortgagee shall be obligated by the provisions of this Lease to restore the improvements to the extent Tenant is required under this Lease to so restore, and all such work shall be performed in accordance with all the requirements set forth in this Lease.

(iv) Required Notice Provision in Mortgage. Tenant agrees to have any Mortgage provide: (a) that the Mortgagee shall by registered or certified mail give written notice to City of the occurrence of any event of default under the Mortgage; (b) that City shall be given notice at the time any Mortgagee initiates any foreclosure action; and (c) that the disposition and application of insurance and condemnation awards shall be in accordance with the provisions of this Lease.

16.3 Notices to Mortgagee and Tax Credit Investor.

(a) Copies of Notices. Subject to subsection (b) below, City shall give a copy of each default notice City gives to Tenant from time to time of the occurrence of a default or an Event of Default, to a Mortgagee or Tax Credit Investor that has given to City written notice substantially in the form provided in subsection (b). Copies of such notices shall be given to the Mortgagee and Tax Credit Investor at the same time as notices are given to Tenant by City, addressed to the Mortgagee and Tax Credit Investor at the address last furnished to City. City's delay or failure to give such notice to the Mortgagee or Tax Credit Investor shall not be deemed to constitute a default by City under this Lease, but such delay or failure shall extend for the number of days until such notice is given, the time allowed to the Mortgagee to cure any default by Tenant. Any such notices to Mortgagee shall be given in the same manner as provided in Section 29 below.

(b) Notice From Mortgagee or Tax Credit Investor to City. The Mortgagee and Tax Credit Investor shall be entitled to receive notices from time to time given to Tenant by City under this Lease in accordance with subsection (a) above, provided such Mortgagee or Tax Credit Investor shall have delivered a notice to City in substantially the following form:

"The undersigned does hereby certify that it is the [Mortgagee][Tax Credit Investor], as such term is defined in that certain Lease entered into by and between the City and County of San Francisco, as landlord, and _____, as tenant (the "Lease"), of Tenant's interest in the Lease of the premises known as the Geneva Avenue Office Building and Power House, a legal description of which is attached hereto as Exhibit A. The undersigned hereby requests that copies of any and all default notices from time to time given under the Lease by City to Tenant be sent to the undersigned at the following address: _____."

16.4 Mortgagee's and Tax Credit Investor's Right to Cure.

If Tenant shall enter into a Mortgage in compliance with the provisions of this Lease, then, so long as any such Mortgage shall remain unsatisfied of record, and with respect to the Tax Credit Investor, the following provisions shall apply:

(a) Cure Periods. In the case of any notice of default given by City to Tenant, the Mortgagee and Tax Credit Investor shall each have the same concurrent cure periods as are given Tenant under this Lease for remedying a default or causing it to be remedied plus an additional fifteen (15) days thereafter for a monetary default or an additional thirty (30) days thereafter for a nonmonetary default, and City shall accept such performance by or at the instance of the Mortgagee or Tax Credit Investor as if the same had been made by Tenant within the applicable cure periods under the Lease.

(b) Foreclosure. Notwithstanding anything contained in this Lease to the contrary, upon the occurrence of an Event of Default, other than an Event of Default due to a default in the payment of money or other default reasonably susceptible of being cured prior to Mortgagee obtaining possession, City shall take no action to effect a termination of this Lease if, within thirty (30) days after notice of such Event of Default is given to Mortgagee, a Mortgagee shall have (x) obtained possession of the Premises (including possession by a receiver), or (y) notified City of its intention to institute foreclosure proceedings or otherwise acquire Tenant's interest under the Lease, and thereafter promptly commences and prosecutes such proceedings with diligence and dispatch and completes such proceedings no later than six (6) months thereafter. A Mortgagee, upon acquiring Tenant's interest under this Lease, shall be required promptly to cure all monetary defaults and all other defaults then reasonably susceptible of being cured by such Mortgagee. The foregoing provisions of this subsection (b) are subject to the following: (i) no Mortgagee shall be obligated to continue possession or to continue foreclosure

proceedings after the defaults or Events of Default hereunder referred to shall have been cured; (ii) nothing herein contained shall preclude City, subject to the provisions of this Section, from exercising any rights or remedies under this Lease (other than a termination of this Lease to the extent otherwise permitted hereunder) with respect to any other Event of Default by Tenant during the pendency of such foreclosure proceedings; and (iii) the Mortgagee shall agree with City in writing to comply during the period City forebears from terminating this Lease with the terms, conditions and covenants of this Lease that are reasonably susceptible of being complied with by the Mortgagee. Notwithstanding anything to the contrary, the Mortgagee shall have the right at any time to notify City that it has relinquished possession of the Premises to Tenant, or that it will not institute foreclosure proceedings or, if such foreclosure proceedings have commenced, that it has discontinued them, and, in such event, the Mortgagee shall have no further liability from and after the date it delivers such notice to City, and, thereupon, City shall be entitled to seek the termination of this Lease and/or any other available remedy as provided in this Lease. If Mortgagee is prohibited by any process or injunction issued by any court having jurisdiction of any bankruptcy or insolvency proceedings involving Tenant from commencing or prosecuting foreclosure or other appropriate proceedings in the nature thereof, the times specified above for commencing or prosecuting such foreclosure or other proceedings shall be extended for the period of such prohibition, provided that Mortgagee shall (i) have fully cured any Event of Default due to a default in the payment of money, (ii) continue to pay currently such monetary obligations as and when the same become due, and (iii) perform all other obligations of Tenant under this Lease to the extent that they are reasonably susceptible of being performed by the Mortgagee. Notwithstanding anything herein to the contrary, to the extent the Mortgagee is not reasonable capable of performing an obligation under this Lease, such obligations shall apply to and remain effective on a prospective basis to any assignee or transferee of the Mortgagee notwithstanding Mortgagee's inability to perform. Notwithstanding anything to the contrary above, if the Premises are not used by Tenant or Mortgagee or a designee of Mortgagee as required in Section 5 above and such non-use continues for a period of twelve (12) months, then City shall have the right to terminate this Lease by providing thirty (30) days notice of termination, subject to Tenant's and/or Mortgagee's right to cure by commencing operations during the thirty (30) day period and continuing thereafter in accordance with Section 5.

(c) Construction. Subject to subsection (b) above, if an Event of Default occurs following any damage but prior to restoration of the improvements, the Mortgagee, either before or after foreclosure or action in lieu thereof, shall not be obligated to restore the improvements beyond the extent necessary to preserve or protect the improvements or construction already made, unless the Mortgagee expressly assumes Tenant's obligations to City by written agreement reasonably satisfactory to City, to restore, in the manner provided in this Lease, the improvements. Upon assuming Tenant's obligations to restore, the Mortgagee or any transferee of Mortgagee shall not be required to adhere to the existing construction schedule, but instead all dates set forth in this Lease for such restoration or otherwise agreed to shall be extended for the period of delay from the date that Tenant stopped work on the restoration to the date of such assumption.

(d) New Lease. In the event of the termination of this Lease before the expiration of the Term, except as a result of damage or destruction to the Premises as in Section 14 or a Taking as set forth in Section 15, City shall serve upon the Mortgagee written notice that this Lease has been terminated, together with a statement of any and all sums which would at that time be due under this Lease but for such termination, and of all other defaults, if any, under this Lease then known to City. The Mortgagee shall thereupon have the option to obtain a New Lease (a "New Lease") in accordance with and upon the following terms and conditions:

(i) Upon the written request of the Mortgagee, within thirty (30) days after service of such notice that this Lease has been terminated, City shall enter into a New Lease of the Premises with the Mortgagee within such period or its designee, subject to the provisions set forth in this Section and provided that the Mortgagee assumes all of Tenant's obligations under any subleases or contracts affecting the Premises then in effect; and

(ii) Such New Lease shall be entered into at the sole cost of the Mortgagee, shall be effective as of the date of termination of this Lease, and shall be for the remainder of the Term of this Lease and at the Rent and upon all the agreements, terms, covenants and conditions hereof, in substantially the same form as this Lease (provided however, that Mortgagee shall not be required to comply with any Laws or ordinances adopted by the City after the Commencement Date hereof to the extent that such Laws or ordinances would not have been applicable to Tenant under this Lease). Such New Lease shall require the Mortgagee to perform any unfulfilled obligation of Tenant under this Lease. Upon the execution of such New Lease, the Mortgagee shall pay any and all sums which would at the time of the execution thereof be due under this Lease but for such termination, and shall pay all expenses, including Attorneys' Fees and Costs incurred by City in connection with such defaults and termination, the recovery of possession of the Premises, and the preparation, execution and delivery of the New Lease. Effective upon the commencement of the term of any New Lease, any sublease or contract then in effect shall be assigned and transferred to Mortgagee.

(e) Nominee. Any rights of a Mortgagee under this Section 16 may be exercised by or through its nominee or designee (other than Tenant) which is an affiliate of the Mortgagee; provided, however, no Mortgagee shall acquire title to the Lease through a nominee or designee which is not a person otherwise permitted to become Tenant hereunder; provided, further that the Mortgagee may acquire title to the Lease through a wholly owned (directly or indirectly) subsidiary of the Mortgagee.

(f) Limited to Permitted Mortgagees. Notwithstanding anything herein to the contrary, the provisions of this Section 16 shall inure only to the benefit of the holder of a Mortgage which is permitted hereunder.

(g) Consent of Mortgagee. No material modification, termination or cancellation of this Lease (herein, a "change") shall be effective as against a permitted Mortgagee unless a copy of the proposed change shall have been delivered to the Mortgagee and such Mortgagee shall have approved the change in writing, which approval shall not be unreasonably withheld, conditioned or delayed. Any Mortgagee shall either approve or disapprove the proposed modification, termination, cancellation or surrender, as applicable, with specified reasons for any disapproval together with reasonable requirements that if satisfied would obtain Mortgagee's approval, in writing within thirty (30) days after delivery of a copy thereof. Mortgagee's failure to deliver an approval or disapproval notice within such thirty (30) day period shall be deemed approval.

(h) Limitation on Liability of Mortgagee. Notwithstanding anything herein to the contrary, no Mortgagee shall be liable to perform Tenant's obligations under this Lease unless and until the Mortgagee acquires Tenant's rights under this Lease.

16.5 Assignment by Mortgagee.

The foreclosure of any Mortgage, or any sale thereunder, whether by judicial proceedings or by virtue of any power contained in the Mortgage, or any conveyance of the leasehold estate hereunder from Tenant to any Mortgagee or its designee through, or in lieu of, foreclosure or other appropriate proceedings in the nature thereof, shall not require the consent of City or constitute a breach of any provision of or a default under this Lease, and upon such foreclosure, sale or conveyance City shall recognize the Mortgagee or other transferee in connection therewith as the tenant under this Lease. Such Mortgagee's or transferee's right thereafter to transfer, assign or sublet this Lease or a New Lease shall be subject to the restrictions of Section 18.

16.6 Transfer of Mortgage.

City hereby consents to the transfer of a Mortgage, provided such transfer is to a Bona Fide Institutional Lender and otherwise satisfies the requirements of this Lease, and in the event of any such transfer, the new holder of the Mortgage shall have all the rights of its predecessor Mortgagee hereunder until such time as the Mortgage is further transferred or released from the leasehold estate.

16.7 Memorandum of Lease.

In the event the recordation of a memorandum of this Lease (a "Memorandum of Lease") is necessary in connection with a Mortgage permitted under this Lease, Tenant shall have the right to at its sole cost to record a Memorandum of Lease confirming the existence of this Lease, and commencement and expiration dates and option dates, and referencing the actual Lease for all other provisions. In such event, the City agrees to prepare, execute and acknowledge such Memorandum of Lease in recordable form, and deliver the Memorandum of Lease to Tenant for Tenant's execution and recordation at Tenant's cost. If such a Memorandum of Lease is recorded, then upon expiration or earlier termination of this Lease, Tenant agrees promptly to execute, acknowledge and deliver to City, upon written request by City, a termination of such Memorandum of Lease in such form as City may reasonably request, for the purpose of terminating any continuing effect of the previously recorded Memorandum of Lease as a cloud upon title to the Premises, and Tenant shall indemnify, defend and hold harmless City from and against any and all claims, demands, liabilities, actions, losses, costs and expenses, including (but not limited to) reasonable attorneys' fees, arising out of or in connection with Tenant's failure to so promptly execute such termination of Memorandum of Lease.

Section 17 ASSIGNMENT OF RENTS

17.1 Assignment of Rents.

Tenant hereby assigns to City, as security for Tenant's performance of its obligations under this Lease, all of Tenant's right, title and interest in and to all rents and fees due or to become due from any present or future subtenant, licensee, concessionaire, or other person occupying or providing services or goods on or to the Premises (collectively, "Assigned Rents"), but such assignment shall be subject to the right of Tenant to collect such rents until the date of any default hereunder. City shall apply amount collected hereunder to the Rent due under this Lease. The foregoing assignment shall be subject and subordinate to any assignment made to a Mortgagee under Section 16.2 of which City has been made aware in writing until such time as City has terminated this Lease, at which time the rights of City in all rents and other payments assigned pursuant to this Section 17.1 shall become prior and superior in right. Such subordination shall be self-operative. However, in confirmation thereof, City shall, upon the request of a Mortgagee, execute a subordination agreement reflecting the subordination described in this Section in form and substance reasonably satisfactory to such Mortgagee and to City. Notwithstanding the foregoing, if this Lease terminates by reason of an Event of Default, any Mortgagee which actually collected any rents from any Subtenants pursuant to any assignment of rents or subleases made in its favor shall promptly remit to City the rents so collected (less the actual and reasonable cost of collection) to the extent necessary to pay City any Rent, through the date of termination of this Lease.

Section 18 ASSIGNMENT AND SUBLETTING

18.1 Assignments and Subleases.

(a) Generally; Consent of City. Except as otherwise specifically permitted hereunder, Tenant shall not directly or indirectly (including, without limitation, by merger, acquisition, sale or other transfer of any controlling interest in Tenant), voluntarily or by operation of Law, sell, assign, encumber, pledge or otherwise transfer any part of its interest in or rights with respect to the Premises, any Improvements or its leasehold estate hereunder ("Assign" or an "Assignment"), or permit any portion of the Premises or any Improvements to be occupied by anyone other than itself, or sublet any portion of the Premises or any permitted Improvements thereon ("Sublet" or a "Sublease"), without the General Manager's or the Commission's prior written consent in each instance.

(b) Assignment. Tenant may not Assign all or any portion of its rights under the Lease without the prior written consent of the Commission, which it may withhold in its sole and absolute discretion. If City rejects a proposed assignment, City shall provide Tenant with written notice of its reasons for doing so. If City fails to respond to a request for consent to a proposed Assignment within sixty (60) days, City shall be deemed to have refused to give its consent.

(c) Sublease. The Parties agree that an important component of Tenant's annual operating budget will derive from Tenant subletting facilities within the Premises. Tenant shall have the right to sublet all or a portion of the Premises at any time, provided, however, (i) Tenant shall have provided prior written notice to City of a proposed Sublease of one year or more, and City shall have the right to reasonably object to such Sublease within forty-five (45) days of receipt of notice, and (ii) the proposed use of the sublet space shall be consistent with the Primary Uses. The rent charged to each subtenant shall be determined by Tenant, in its sole and absolute discretion, and shall accrue solely to Tenant, except as otherwise specifically provided herein. If City fails or declines to respond to Tenant within the applicable forty-five (45) day period described above, then Tenant may at Tenant's election provide written notice to City that no disapproval was received, and provided that such notice displays prominently on the envelope enclosing such notice and the first page of such notice, substantially the following words: "SUBLEASE APPROVAL REQUEST FOR GENEVA CAR BARN. IMMEDIATE ATTENTION REQUIRED; FAILURE TO RESPOND COULD RESULT IN THE REQUEST BEING DEEMED APPROVED," the Sublease shall be deemed approved if City does not disapprove the Sublease within ten (10) days of such notice.

(d) Event Permits. The Parties agree that an important component of Tenant's annual operating budget will derive from Tenant renting facilities within the Premises for short term one time uses ("**Events**"). Tenant shall have the right to rent any facility within the Premises for a short term one-time use or consecutive short term one-time uses without obtaining City's consent, provided such Event complies with City's then-current event permitting requirements, which include obtaining the approvals from the San Francisco Fire, Police, and Alcoholic Beverage Control Departments as well as any specialized licenses. Tenant shall also obtain a Dance Hall Keeper Permit from the San Francisco Police Department. Tenant shall develop a template for the written agreement to be used by Tenant for such Events (the "**Event Permit**"), and shall submit such template to the City for the approval or reasonable disapproval of the General Manager or his or her designee prior to entering into any Event Permits. The provisions of Section 18.2 below shall apply to such rentals as if they were subleases.

18.2 Conditions to Assignment or Sublet.

Any Assignment of this Lease or Sublease or Event Permit is further subject to the satisfaction of the following conditions precedent (or written waiver thereof by the General Manager, which waiver may be withheld in the sole discretion of the General Manager), each of which is hereby agreed to be reasonable as of the date hereof:

(a) any assignee, by instrument in writing reasonably approved by the General Manager (in consultation with the City Attorney), for itself and its successors and assigns, and expressly for the benefit of City, must agree to be subject to all of the conditions and restrictions to which Tenant is subject and must expressly assume all of the obligations of Tenant under this Lease, and any subtenant, by instrument in writing reasonably approved by the General Manager (in consultation with the City Attorney) must agree to be subject to all of the applicable conditions and restrictions of this Lease as they relate to the subtenancy. It is the intent of this Lease, to the fullest extent permitted by Law and excepting only in the manner and to the extent specifically provided otherwise in this Lease, that no transfer of this Lease, or any interest therein, however consummated or occurring, and whether voluntary or involuntary, may operate, legally or practically, to deprive or limit City of or with respect to any rights or remedies or controls provided in or resulting from this Lease with respect to the Premises and the construction of the Improvements that City would have had, had there been no such transfer or change;

(b) other than with respect to a Minor Event Permit, all instruments and other legal documents involved in effecting the transfer shall have been submitted to City for review, including the agreement of sale, transfer, Sublease, Event Permit or equivalent, and City shall have approved such documents, and with respect to an Event Permit for use of part of the Premises for a period of two (2) weeks or less (a "**Minor Event Permit**"), the form of the permit and other legal document shall have been approved by City and Tenant shall have the right to make commercially reasonable modifications to

such form in the course of negotiations with the applicable assignee so long as such modification does not materially adversely affect City's rights;

(c) there shall be no Event of Default or Unmatured Event of Default on the part of Tenant under this Lease;

(d) in the event of an Assignment, the proposed transferee has the qualifications and has demonstrated to City's reasonable satisfaction that it is capable, financially and otherwise, of performing each of Tenant's obligations under this Lease and any other documents to be assigned;

(e) any assignee, subtenant or permittee is subject to the jurisdiction of the courts of the State of California;

(f) the proposed Assignment is not in connection with any transaction for the purposes of syndicating the Lease, such as a security, bond or certificates of participation financing as determined by City in its sole discretion;

(g) the permitted uses are consistent with this Lease, including without limitation, the Permitted Uses;

(h) the Subtenant and the Sublease or the permittee and the Event Permit (including a Minor Event Permit), as applicable, are expressly subject to all applicable terms and provisions of this Lease;

(i) the term of any Sublease not requiring City's approval hereunder, including any extension options, shall not exceed one (1) year and does not extend beyond the term of this Lease;

(j) the Subtenant or permittee under an Event Permit (including a Minor Event Permit) indemnifies City for any loss or damage arising in connection with the Sublease in form set forth in *Exhibit C*;

(k) the Subtenant or permittee under an Event Permit (including a Minor Event Permit) provides liability and other insurance reasonably requested by City, naming City as an additional insured, in form and amounts reasonably approved by City; and

(l) the Sublease includes the provisions set forth in *Exhibit C*.

18.3 Pre-Execution Deliveries to City.

Prior to executing a Sublease that requires City's consent, Tenant shall submit a summary of the key terms of the proposed Sublease (i.e., location, proposed use, square footage of the demised premises, length of term, rental rate, tenant improvement allowances and leasing concessions) to City for review by the City for conformance with Permitted Uses and the sublease requirements attached hereto as *Exhibit C*.

18.4 Effect of Sublease or Assignment.

No Sublease or Assignment by Tenant nor any consent by City thereto shall relieve Tenant of any obligation to be performed by Tenant under this Lease, unless City expressly agrees to a release in writing in connection with a City consent to an Assignment and then only to the extent set forth in such release. Any Sublease or Assignment not in compliance with this Section shall be void and, at City's option, shall constitute a material default by Tenant under this Lease. The acceptance of any Rent or other payments by City from a proposed transferee shall not constitute consent to such Sublease or Assignment by City or a recognition of any transferee, or a waiver by City of any failure of Tenant or other transferor to comply with this Section. If there is an Assignment or Sublet, whether in violation of or in compliance with this Section, upon the occurrence and during the continuance of an Event of Default in the event of default by any transferee or successor of Tenant in the performance or observance of any of the terms of this Lease, City may proceed directly against Tenant without the necessity of exhausting remedies against such transferee or successor except to the extent City has released Tenant in writing at the time of City's consent to such transferee or successor.

18.5 Assumption by Assignee.

Each Assignee shall assume all obligations of Tenant under this Lease and, except as provided in Section 18.4, shall be liable jointly and severally with Tenant for the payment of the Rent, and for the performance of all the terms, covenants and conditions to be performed on Tenant's part hereunder. No Assignment shall be binding on City unless Tenant or Transferee has delivered to City a counterpart of the Assignment and an instrument that contains a covenant of assumption by such Assignee reasonably satisfactory in form and substance to City. However, the failure or refusal of such Assignee to execute such instrument of assumption shall not release such Transferee from its liability as set forth above.

18.6 Indemnity for Relocation Benefits.

Without limiting Section 18.5 above, Tenant shall cause every Assignee and Subtenant to expressly waive entitlement to any and all relocation assistance and benefits in connection with this Lease. Tenant shall Indemnify City and the Indemnified Parties for any and all Losses arising out of any relocation assistance or benefits payable to any Assignee or Subtenant.

18.7 Reasonable Grounds for Withholding Consent.

Where an Assignment or Sublease requires City's reasonable consent, it shall be reasonable (1) for City to withhold its consent if Tenant has not supplied sufficient information (including supplemental materials reasonably requested by City) to enable City to make a reasonable determination whether any applicable condition has been satisfied, and (2) if Tenant is then in default of any of its obligations under this Lease, for City to condition its consent on the cure of such defaults as City may specify in its notice conditionally approving such Assignment or Sublease.

18.8 Nondisturbance.

From time to time upon the request of Tenant, City shall enter into agreements with Subtenants providing generally, with regard to a given Sublease, that in the event of any termination of this Lease, City will not terminate or otherwise disturb the rights of the Subtenant under such Sublease, but will instead honor such Sublease as if such agreement had been entered into directly between City and such Subtenant ("**Non-Disturbance Agreements**"). City shall provide a Non-Disturbance Agreement to a Subtenant only if all of the following conditions are satisfied: (i) the performance by Tenant of its obligations under such Sublease will not cause an Event of Default to occur under this Lease; (ii) the term of the Sublease, including options, does not extend beyond the scheduled Term; (iii) the Sublease contains provisions whereby the Subtenant agrees to comply with applicable provisions of this Lease; (iv) if Tenant is then in default of any of its obligations under this Lease, City may condition its agreement to provide a Non-Disturbance Agreement on the cure of such defaults as City may specify either in a notice of default given under this Lease or in a notice conditionally approving Tenant's request for such Non Disturbance Agreement (and if an Event of Default on the part of Tenant then exists, then City may withhold or condition the giving of a Non-Disturbance Agreement); and (v) the Subtenant shall have delivered to City an executed estoppel certificate certifying such matters as may be reasonably required by City. In addition, City may condition its agreement to provide a Non-Disturbance Agreement on its reasonable approval of the form and material business terms of the Sublease in light of market conditions existing at the time such Sublease is entered into. Each Non-Disturbance Agreement shall be substantially in form and substance agreed upon by Tenant and City, not to be unreasonably withheld by either Party, provided that form shall, at a minimum, provide that (i) the Subtenant agrees that in the event this Lease expires, terminates or is canceled during the term of the Sublease, the Subtenant shall attorn to City (provided City agrees not to disturb the occupancy or other rights of the Subtenant and to be bound by the terms of the Sublease), and (ii) the Sublease shall be deemed a direct lease agreement between the Subtenant and City, provided, however that (a) at the time of the termination of this Lease no uncured default shall exist under the Sublease which at such time would then permit the termination of the Sublease or the exercise of any dispossession remedy provided for therein, and (b) City shall not be liable to the Subtenant for any security deposit or prepaid rent previously paid by such Subtenant to Tenant unless such deposits are transferred to City and except for rent for the current month, if previously paid,

shall not be responsible for any prior act or omission of Tenant, and shall not be subject to any offsets or defenses that the Subtenant may have against Tenant.

18.9 Assignment to Accommodate Sale of Historic Tax Credits and New Market Tax Credit Tax Credit Financing.

City acknowledges that Tenant may desire to convey its interest in this Lease, in the form of a sublease or assignment ("**Tax Credit Assignment**") to a Tax Credit Investor for the purpose of taking advantage of historic preservation tax credits or new market tax credits financing. In such event, Tenant may further desire to sublease back the interest in this Lease assigned to the Tax Credit Investor pursuant to the Tax Credit Assignment. If such arrangement does not involve Tenant's sublease back of all of the interest in the Lease that the Tax Credit Investor assumed pursuant to the Tax Credit Assignment, then, pursuant to the Tax Credit Assignment, the Tax Credit Investor shall assume all rights, duties, obligations and interest of Tenant under the Lease. City's consent shall not be required in the event of an Assignment to and Sublet from (and, following the expiration of the tax credit hold period, an Assignment from) an entity solely for the purpose of taking advantage of historic preservation tax credits or new market tax credits, subject to all of the following conditions: (a) at least thirty (30) days prior to such Assignment, Tenant shall furnish City with the name of the proposed assignee, together with evidence reasonably satisfactory to City that the proposed Assignment is solely for the purpose of taking advantage of historic preservation tax credits or new market tax credits, as applicable (or, following the expiration of the tax credit hold period, for the purpose of terminating the relationship with the Tax Credit Investor); and (b) the conditions set forth in Section 18.2(a), (c), (d), (e), and (f) and Section 18.5 have been satisfied.

Section 19 INDEMNIFICATION OF CITY

19.1 Indemnification of City.

Tenant agrees to and shall Indemnify the Indemnified Parties from and against any and all Losses imposed upon or incurred by or asserted against any such Indemnified Party, the Premises or City's interest therein in connection with the occurrence or existence of any of the following: (i) any accident, injury to or death of persons or loss of or damage to property occurring in or on the Premises or any part thereof, except to the extent caused by City or its Agents; (ii) any accident, injury to or death of persons or loss or damage to property occurring in or on the Premises which is caused directly or indirectly by Tenant or any of its Assignees, Subtenants, Agents or Invitees; (iii) any use, possession, occupation, operation, maintenance, or management of the Premises or any part thereof or the SFMTA Property by Tenant or any of its Assignees, Subtenants, Agents or Invitees, (iv) any matter relating to the condition of the Premises caused by Tenant or any of its Assignees, Subtenants, Agents or Invitees; (v) any failure on the part of Tenant or its Agents, Assignees or Subtenants, as applicable, to perform or comply with any of the terms of this Lease or with applicable Laws, rules or regulations, or permits as required under this Lease (subject to any express written release by City in connection with an Assignment, as set forth above); (vi) performance of any labor or services or the furnishing of any materials or other property in respect of the Premises or any part thereof by Tenant or any of its Assignees, Subtenants, Agents or Invitees; and (vii) any legal actions or suits initiated by any user or occupant of the Premises to the extent it relates to such use and occupancy of the Premises or Tenant's operations at the Premises; except in each case to the extent caused by the negligence or willful misconduct of City, City or any of its Agents or a breach of City's obligations under this Lease and except to the extent City is required to Indemnify Tenant for the same under this Lease.

19.2 Immediate Obligation to Defend.

Tenant specifically acknowledges that it has an immediate and independent obligation to defend the Indemnified Parties from any claim which is actually or potentially within the scope of the indemnity provision of Section 19.1 or any other indemnity provision under this Lease, even if such allegation is or may be groundless, fraudulent or false, and such obligation arises at the time such claim is tendered to Tenant by an Indemnified Party and continues at all times thereafter. If any action, suit or proceeding is brought against any Indemnified Party by reason of any occurrence for which Tenant is obliged to

Indemnify such Indemnified Party, such Indemnified Party will notify Tenant of such action, suit or proceeding within a reasonable time of such Indemnified Party obtaining notice of such claim, or obtaining facts sufficient to constitute inquiry notice for a reasonable person, and thereafter shall cooperate in good faith with Tenant in the defense of such claim at no cost to City or such Indemnified Party. Tenant may, and upon the request of such Indemnified Party will, at Tenant's sole expense, resist and defend such action, suit or proceeding, or cause the same to be resisted and defended by counsel designated by Tenant and reasonably approved by such Indemnified Party in writing.

19.3 Not Limited by Insurance.

The insurance requirements and other provisions of this Lease shall not limit Tenant's indemnification obligations under this Lease.

19.4 Survival.

Tenant's obligations under this Section and any other Indemnification in this Lease shall survive the expiration or sooner termination of this Lease for a period of four (4) years. All such Indemnifications are in addition to, and in no way shall be construed to limit or replace, any other obligations or liabilities which Tenant may have to City in this Lease, at common law or otherwise.

19.5 Defense.

Tenant shall, at its option but subject to the reasonable consent and approval of City, be entitled to control the defense, compromise, or settlement of any indemnified matter through counsel of the Tenant's own choice (so long as such counsel is reasonably satisfactory to City); provided, however, in all cases City shall be entitled to participate in such defense, compromise, or settlement at its own expense. If the Tenant shall fail, however, in City's reasonable judgment, within a reasonable time following notice from City alleging and describing in reasonable detail the nature of such failure, to take reasonable and appropriate action to defend such suit or claim, City shall have the right promptly to use City Attorney or to hire outside counsel to carry out such defense, at Tenant's sole expense, which expense shall be due and payable to City within thirty (30) days after receipt by the Tenant of an invoice therefore.

19.6 Release of Claims and Losses Against City.

Tenant, as a material part of the consideration of this Lease, hereby waives and releases any and all claims against City and the other Indemnified Parties from any Losses including damages to or loss of goods, wares, goodwill, merchandise, business opportunities, and equipment and by persons in, upon or about the Premises for any cause arising at any time including, without limitation, all claims arising from any joint or concurrent negligence of City or the other Indemnified Parties, but excluding any gross negligence or willful misconduct of City or other Indemnified Parties or breach of the City's obligations under the Lease or claims for which City has otherwise agreed to indemnify Tenant hereunder, and further excluding any claims, demands, or causes of action Tenant may now or hereafter have against City for rights of contribution or equitable indemnity under applicable Laws.

Section 20 INSURANCE

20.1 Premises and Liability Coverage.

(a) Required Types and Amounts of Insurance. Tenant shall, at no cost to City, obtain, maintain and cause to be in effect at all times (except as provided below) from the Commencement Date to the later of (i) the last day of the Term, or (ii) the last day Tenant (A) is in possession of the Premises, or (B) has the right of possession of the Premises, the following types and amounts of insurance:

(i) Builders Risk Insurance. At all times during construction and prior to completion of the Initial Improvements, and during any period of Subsequent Construction, Tenant shall maintain, on a form reasonably approved by City, builders' risk insurance in the amount of 100% of the completed value of all new construction, insuring all new construction, including all materials and equipment incorporated in, on or about the Premises, and in transit or storage off-site, that are or will be

part of the Improvements, against "all risk" or "special form" hazards, including an additional insured City with any deductible (other than earthquake and flood) not to exceed Ten Thousand Dollars (\$10,000).

(ii) Premises Insurance; Earthquake and Flood Insurance. Tenant shall maintain property insurance policies with coverage at least as broad as Insurance Services Office ("ISO") form CP 10 30 06 07 ("Causes of Loss -Special Form", or its replacement), including or excluding earthquake and flood, in an amount not less than 100% of the then-current full replacement cost of the Building and other Improvements and other property being insured pursuant thereto (including building code upgrade coverage), with any deductible (other than earthquake or flood) not to exceed Ten Thousand Dollars (\$10,000.00); provided, however, that as to both earthquake insurance and flood insurance separate sublimits of the insurance required under this Section may be required.

(iii) Commercial General Liability Insurance. Tenant shall maintain "Commercial General Liability" insurance policies with coverage at least as broad as ISO form CG 00 01 12 07, insuring against claims for bodily injury (including death), property damage, personal injury, advertising liability, contractual liability and products and completed operations, occurring upon the Premises (including the Improvements), and operations incidental or necessary thereto, such insurance to afford protection in the following amounts: (A) during construction in an amount not less than Five Million Dollars (\$5,000,000) each occurrence covering bodily injury and broad form property damage including contractual liability (which includes coverage of the indemnity in Section 23.1 and any other indemnity of City by Tenant) independent contractors, explosion, collapse, underground (XCU), and products and completed operations coverage, with an umbrella policy of Ten Million Dollars (\$10,000,000); (B) from and after completion of construction in an amount not less than One Million Dollars (\$1,000,000) each occurrence and Two Million Dollars (\$2,000,000) in the aggregate, with an umbrella policy of Two Million Dollars (\$2,000,000) (the "Umbrella Policy"); (C) if Tenant has (or is required under Laws to have) a liquor license and is selling or distributing alcoholic beverages on the Premises, or is selling or distributing food products on the Premises, then liquor liability coverage with limits not less than One Million Dollars (\$1,000,000) each occurrence, with excess coverage provided by the Umbrella Policy, and food products liability insurance with limits not less than One Million Dollars (\$1,000,000) each occurrence, with excess coverage provided by the Umbrella Policy, as applicable, and (D) Tenant shall require any Subtenant who has (or is required under Laws to have) a liquor license and who is selling or distributing alcoholic beverages and food products on the Premises, to maintain coverage in amounts at least comparable to Tenant's base policies.

(iv) Workers' Compensation Insurance. During any period in which Tenant has employees as defined in the California Labor Code, Tenant shall maintain policies of workers' compensation insurance, including employer's liability coverage with limits not less than the greater of those limits required under applicable Law, and One Million Dollars (\$1,000,000) each accident (except that such insurance in excess of One Million Dollars (\$1,000,000) each accident may be covered by a so-called "umbrella" or "excess coverage" policy, covering all persons employed by Tenant in connection with the use, operation and maintenance of the Premises and the Improvements.

(v) Boiler and Machinery Insurance. Tenant shall maintain boiler and machinery insurance covering damage to or loss or destruction of machinery and equipment located on the Premises or in the Improvements that is used by Tenant for heating, ventilating, air-conditioning, power generation and similar purposes, in an amount not less than one hundred percent (100%) of the actual replacement value of such machinery and equipment.

(vi) Business Automobile Insurance. Tenant shall maintain policies of business automobile liability insurance covering all owned, non-owned or hired motor vehicles to be used in connection with Tenant's use and occupancy of the Premises, affording protection for bodily injury (including death) and property damage in the form of Combined Single Limit Bodily Injury and Property Damage policy with limits of not less than One Million Dollars (\$1,000,000) per occurrence.

(vii) Professional Liability. Tenant shall require all architectural, design, engineering, geotechnical, and environmental professionals under contract with Tenant for the Initial Improvements or any Subsequent Construction to maintain professional liability (errors and omissions) insurance, with limits not less than One Million And No/100 Dollars (\$1,000,000.00) each claim and aggregate, with respect to all professional services provided to Tenant therefore and a deductible of not more than Ten Thousand Dollars (\$10,000) per claim, during any period for which such professional services are engaged and for five (5) years following the completion of any such professional services.

(viii) Environmental Liability Insurance. During the course of any Hazardous Materials Remediation activities, Tenant shall maintain, or cause its contractor or consultant to maintain, environmental pollution or contamination liability insurance, on an occurrence form, with limits of not less than Two Million Dollars (\$2,000,000) each occurrence combined single liability for Bodily Injury, Property Damage and clean-up costs, with the prior written approval of City (such approval not to be unreasonably withheld, conditioned or delayed).

(ix) Other Insurance. Tenant shall obtain such other insurance as is reasonably requested by City's Risk Manager and is reasonably customary for similar premises and uses in the San Francisco Bay Area.

(b) General Requirements. All insurance provided for pursuant to this Section:

(i) Shall be carried under a valid and enforceable policy or policies issued by insurers of recognized responsibility that are rated Best A-VI or better (or a comparable successor rating) and legally authorized to sell such insurance within the State of California;

(ii) As property and boiler and machinery insurance, shall name City as loss payee as its interest may appear, and as to both property and liability insurance shall name as additional insureds the following: "THE CITY AND COUNTY OF SAN FRANCISCO AND ITS OFFICERS, DIRECTORS AND EMPLOYEES." Tenant shall cause such additional insured endorsements to be issued on Form CG2010(1185).

(iii) As to earthquake insurance only:

(1) during the Term of this Lease; unless City reasonably agrees with Tenant that earthquake insurance is not generally commercially available at commercially reasonable rates, such insurance shall be in an amount at least equal to the lesser of (i) the maximum amount as is available at commercially reasonable rates from recognized carriers (with a deductible of up to but not to exceed five percent (5%) of the then-current, full replacement cost of the Building or other property being insured pursuant thereto (including building code upgrade coverage and the cost of any foundations, excavations and footings and without any deduction being made for depreciation), except that a greater deductible will be permitted to the extent that such coverage is not available from recognized insurance carriers or at commercially reasonable rates), and (ii) one hundred percent (100%) of the maximum probable loss that would be sustained by the Premises (based on the full value of the Improvements) as a result of the occurrence of an earthquake measuring 8.3 on the Richter scale (which maximum probable loss shall be determined not less frequently than every five (5) years by a consultant chosen and paid for by Tenant who is reasonably satisfactory to City), with a deductible of up to but not to exceed five percent (5%) of the then-current, full replacement cost of the Improvements or other property being insured pursuant thereto (including building code upgrade coverage and the cost of any foundations, excavations and footings and without any deduction being made for depreciation);

(2) rates for all earthquake insurance required under this Lease shall be deemed to be commercially reasonable in the event that they are less than or equal to one third of one percent (.33%) of the then-current full replacement cost of the improvements;

(iv) As to flood insurance only, unless City reasonably agrees with Tenant in writing that flood insurance is not generally available at commercially reasonable rates:

(1) during construction of the Initial Improvements or any Subsequent Improvement, such insurance shall be in an amount at least equal to the maximum amount as is available at commercially reasonable rates from recognized insurance carriers (with a deductible up to, but not to exceed fifteen percent (15%) of the then-current, full replacement cost of the Improvements or other property being insured pursuant thereto (including building code upgrade coverage and the cost of any foundations, excavations and footings and without any deduction being made for depreciation) except that a greater deductible will be permitted to the extent that such coverage is not available from recognized insurance carriers or at commercially reasonable rates);

(2) from and after completion of the Improvements, such insurance shall be in an amount at least equal to the amount available at commercially reasonable rates from recognized insurance carriers, with a deductible of up to but not to exceed an amount that is necessary to make such flood insurance available at commercially reasonable rates.

(3) rates for all flood insurance required under this Lease shall be deemed to be commercially reasonable in the event that they are less than or equal to one tenth of one percent (.1%) of the then-current full replacement cost of the Improvements;

(v) Shall be evaluated by City for adequacy not less frequently than every five (5) years from the anniversary date of Completion of the Initial Improvements. City may, upon not less than ninety (90) days prior written notice, require Tenant to increase the insurance limits for all or any of its general liability policies if, in the reasonable judgment of the City's Risk Manager, it is the prevailing commercial practice in the San Francisco Bay Area to carry insurance for facilities similar to the Premises in amounts greater than the amounts carried by Tenant with respect to risks comparable to those associated with use of the Premises.

(vi) Shall provide that the insurer shall endeavor to provide thirty (30) days' prior written notice (ten (10) days' prior written notice for nonpayment of premiums) to City of any cancellation, reduction or material modification, or termination of such insurance for any reason;

(vii) As to Commercial General Liability only, shall provide that it constitutes primary insurance to any other insurance available to any additional insured, with respect to claims insured by such policy, and that insurance applies separately to each insured against whom claim is made or suit is brought;

(viii) Each policy of property insurance required hereunder shall provide for waivers of any right of subrogation that the insurer of such party may acquire against each party hereto with respect to any losses and damages that are of the type covered under the policies required by Sections 20.1(a)(i), (ii), or (v);

(ix) Shall be subject to the reasonable approval of City;

(x) Except for professional liability insurance which shall be maintained as provided above, if any of the liability insurance required to be carried by Tenant hereunder is provided under a claims-made form of policy, Tenant shall maintain such coverage continuously throughout the Term, and following the expiration or termination of the Term, Tenant shall maintain, without lapse for a period of two (2) years beyond the expiration or termination of this Lease, coverage with respect to occurrences during the Term that give rise to claims made after expiration or termination of this Lease; and

(xi) Shall for property insurance only, provide that all losses payable under all such policies that are payable to City shall be payable notwithstanding any act or negligence of Tenant.

20.2 Certificates of Insurance; Right of City to Maintain Insurance.

Tenant shall furnish City certificates with respect to the policies required under this Section, together with copies of each such policy (if City so requests) and evidence of payment of premiums, within thirty (30) days after the Commencement Date and, with respect to renewal policies, at least ten

(10) business days after the expiration date of each such policy. If at any time Tenant fails to maintain the insurance required pursuant to Section 20.1, or fails to deliver certificates or policies as required pursuant to this Section, then, upon five (5) days' written notice to Tenant, City may obtain and cause to be maintained in effect such insurance by taking out policies with companies satisfactory to City. Within ten (10) days following demand, Tenant shall reimburse City for all amounts so paid by City, together with all costs and expenses in connection therewith and interest thereon at the Default Rate.

20.3 Insurance of Others.

If Tenant requires liability insurance policies to be maintained by Subtenants, contractors, subcontractors or others in connection with their use or occupancy of, or their activities on, the Premises, Tenant shall require that such policies name Tenant and City as additional insureds. Notwithstanding the foregoing, Tenant shall require all contractors and sub-contractors performing work in, on, under, around, or about the Premises and all operators and Subtenants of any portion of the Premises to carry the insurance coverages required by the respective construction contract, sublease, or other agreement governing such party's activities that was approved by City, if applicable.

20.4 City Entitled to Participate.

City shall be entitled to participate in and consent to any settlement, compromise or agreement with respect to any claim for any loss in excess of Fifty Thousand and No/100 Dollars (\$50,000.00) covered by the insurance required to be carried hereunder, but only to the extent that its interest may appear; provided, however, that City's consent shall not be unreasonably withheld.

20.5 City's Self Insurance.

Tenant acknowledges that City self-insures against casualty, property damage and public liability risks and agrees that City may at its sole election, but shall not be required to, carry any third party insurance with respect to the Building, the Premises or otherwise.

20.6 Release and Waiver.

Each party hereby waives all rights of recovery and causes of action, and releases each other party from any Losses occasioned to the property of each such party, which Losses are of the type that are covered under the property policies required by Sections 20.1(a)(i), (ii), to the extent that such loss is reimbursed by an insurer.

Section 21 HAZARDOUS MATERIALS

21.1 Hazardous Materials Compliance.

(a) Compliance with Hazards Materials Laws. Tenant shall comply and use commercially reasonable efforts to cause (i) its Agents, (ii) its Subtenants or operators, and (iii) all of Tenant's Invitees entering upon the Premises (other than City and its Agents), to comply with all Hazardous Materials Laws and prudent business practices. Without limiting the generality of the foregoing, Tenant covenants and agrees that it will not Handle, nor will it permit the Handling of Hazardous Materials on, under or about the Premises, except for (A) standard building materials and equipment that do not contain asbestos or asbestos-containing materials, lead or polychlorinated biphenyl (PCBs), (B) gasoline and other fuel products used to transport and operate vehicles and equipment, (C) any Hazardous Materials which do not require a permit or license from, or that need not be reported to, a governmental agency, which Hazardous Materials are used in the construction and operation of the Initial Improvements, or any Subsequent Construction, and which are reported to, and approved by City prior to any such Handling and, in any case, are used in strict compliance with all applicable laws, (D) janitorial supplies or materials in such limited amounts as are customarily used for such purposes so long as such Handling is at all times in full compliance with all Hazardous Material Laws; (E) all food and food products and cleaning and other supplies which are customarily used in similar venues, so long as in each case such Handling is at all times in full compliance with all Hazardous Material Laws; and (F) in connection with the construction of the Initial Improvements.

(b) Notice. Except for Hazardous Materials permitted by Section 20.1(a) above, Tenant shall advise City in writing promptly (but in any event within five (5) days) upon learning or receiving notice of (i) the presence of any Hazardous Materials on, under or about the Premises, (ii) any action taken by Tenant in response to any (A) Hazardous Materials on, under or about the Premises or (B) Hazardous Materials Claims, and (iii) Tenant's discovery of the presence of Hazardous Materials on, under or about any real property adjoining the Premises. Tenant shall inform City orally as soon as possible of any emergency or non-emergency regarding a Release or discovery of Hazardous Materials. In addition, Tenant shall provide City with copies of all communications with federal, state and local governments or agencies relating to Hazardous Materials Laws (other than privileged communications, so long as any non-disclosure of such privileged communication does not otherwise result in any non-compliance by Tenant with the terms and provisions of this Article 21) and all communication with any person relating to Hazardous Materials Claims (other than privileged communications; provided, however, such non-disclosure of such privileged communication shall not limit or impair Tenant's obligation to otherwise comply with each of the terms and provisions of this Lease, including, without limitation, this Article 21).

(c) City's Approval of Remediation. Except as required by law or to respond to an emergency, Tenant shall not take any Remediation in response to the presence, Handling, transportation or Release of any Hazardous Materials on, under or about the Premises unless Tenant shall have first submitted to City for City's approval, which approval shall not be unreasonably withheld or delayed, a written remediation plan and the name of the proposed contractor which will perform the work. If City disapproves of any such remediation plan, City shall specify in writing the reasons for its disapproval. Any such Remediation undertaken by Tenant shall be done in a manner so as to minimize any impairment to the Premises and the operations and use thereof. In the event Tenant undertakes any Remediation with respect to any Hazardous Materials on, under or about the Premises, Tenant shall conduct and complete such Remediation (i) in compliance with all applicable Hazardous Materials Laws and the directives of applicable governmental authorities, and (ii) to the reasonable satisfaction of City. If and to the extent required, City shall sign a manifest indicating City ownership of any existing Hazardous Material removed from the Property by Tenant in connection with the construction of the Initial Improvements or any Subsequent Construction; provided, Tenant and its Agents shall be responsible for the proper Handling, transportation and disposal of the Hazardous Material and any failure to properly Handle, transport or dispose of such material shall be covered by the Hazardous Materials Indemnity set forth in Section 20.2 below.

(i) Pesticide Prohibition. Tenant shall comply with the provisions of Section 308 of Chapter 3 of the San Francisco Environment Code (the "**Pesticide Ordinance**") that (i) prohibit the use of certain pesticides on City property, (ii) require the posting of certain notices and the maintenance of certain records regarding pesticide usage, and (iii) require Tenant to submit to the General Manager an integrated pest management ("**IPM**") plan that (a) lists, to the extent reasonably possible, the types and estimated quantities of pesticides that Tenant may need to apply to the Premises during the terms of this Lease, (b) describes the steps Tenant will take to meet City's IPM Policy described in Section 300 of the Pesticide Ordinance, and (c) identifies, by name, title, address and telephone number, an individual to act as the Tenant's primary IPM contact person with City. In addition, Tenant shall comply with the requirements of Sections 303(a) and 303(b) of the Pesticide Ordinance.

21.2 Hazardous Materials Indemnity.

Without limiting the indemnity in Section 18.1 (except to the extent the same relates to Hazardous Materials), Tenant shall Indemnify the Indemnified Parties from and against any and all Losses which arise out of or relate in any way to any use, Handling, production, transportation, disposal, storage or Release of any Hazardous Materials in or on the Premises at any time during the Term of the Lease and before the surrender of the Premises by Tenant, any Subtenant, Agent or Invitee of Tenant (but excluding City, its Agents or Invitees) directly or indirectly arising out of (a) the Handling, transportation or Release of Hazardous Materials by Tenant, or its Subtenants, Agents or Invitees, (b) any failure by Tenant or its Subtenants, Agents or Invitees to comply with Hazardous Materials Laws in connection with

their use, Handling, production, transportation, disposal, storage or Release of any Hazardous Materials in, on or about the Premises at any time during the Term of the Lease and before their surrender of the Premises; or (c) any failure by Tenant to comply with the obligations contained in Section 20.1. All such Losses within the scope of this Section shall constitute Additional Rent owing from Tenant to City hereunder and shall be due and payable from time to time immediately upon City's request, as incurred. Tenant understands and agrees that its liability to the Indemnified Parties shall arise upon the earlier to occur of (i) discovery of any such Hazardous Materials on, under or about the Premises or the discovery of the disturbance or exacerbation of the pre-existing condition, or (ii) the institution of any Hazardous Materials Claim with respect to such Hazardous Materials, and not upon the realization of loss or damage.

Notwithstanding anything to the contrary in the Lease, Tenant shall not be liable under the Lease with respect to any Hazardous Materials located in, on or under the Premises as of the Effective Date of this Lease ("**Pre-Existing Hazardous Material**") except for liability resulting from the disturbance or exacerbation of Pre-Existing Hazardous Material by Tenant, its Subtenants, or Agents, including but not limited to any disturbance or exacerbation by Tenant in connection with the Initial Improvements or any Subsequent Construction. City shall comply with all Hazardous Material Laws with respect to all Pre-Existing Hazardous Material except for any compliance that is required or triggered as a result of any act of Tenant, its Subtenants, or Agents, including but not limited to the construction of the Initial Improvements or any Subsequent Construction, or any disturbance or exacerbation of the Pre-Existing Hazardous Material.

21.3 Hazardous Substance Disclosure.

California law requires landlords to disclose to tenants the presence or potential presence of certain Hazardous Materials. Accordingly, Tenant is hereby advised that occupation of the Premises may lead to exposure to Hazardous Materials such as, but not limited to, gasoline, diesel and other vehicle fluids, vehicle exhaust, office maintenance fluids, tobacco smoke, methane and building materials containing chemicals, such as formaldehyde. Further, there are Hazardous Materials located on the Premises, which are described in due diligence materials which have been delivered to or made available to Tenant. By execution of this Lease, Tenant acknowledges that the notices and warnings set forth above satisfy the requirements of California Health and Safety Code Section 25359.7 and related statutes.

Section 22 EVENTS OF DEFAULT; TERMINATION

22.1 Events of Default.

The occurrence of any one or more of the following events shall constitute an "**Event of Default**" under the terms of this Lease:

- (a) Tenant fails to pay any Rent to City when due, which failure continues for ten (10) days following written notice from City; provided, however, City shall not be required to give such notice on more than three (3) times during any Lease Year, and failure to pay any Rent thereafter when due shall be an immediate Event of Default without need for further notice;
- (b) Tenant files a petition for relief, or an order for relief is entered against Tenant, in any case under applicable bankruptcy or insolvency Law, or any comparable law that is now or hereafter may be in effect, whether for liquidation or reorganization, which proceedings if filed against Tenant are not dismissed or stayed within sixty (60) days;
- (c) A writ of execution is levied on the leasehold estate which is not released within sixty (60) days, or a receiver, trustee or custodian is appointed to take custody of all or any material part of the property of Tenant, which appointment is not dismissed within one hundred sixty (60) days;
- (d) Tenant makes a general assignment for the benefit of its creditors;
- (e) Tenant abandons the Premises within the meaning of California Civil Code Section 1951.3 (or its successor), which abandonment is not cured within fifteen (15) days after notice of belief of abandonment or vacation from City;

(f) Tenant fails to maintain any insurance required to be maintained by Tenant under this Lease, which failure continues without cure for ten (10) days after written notice from City of such failure;

(g) Tenant violates any other covenant, or fails to perform any other obligation to be performed by Tenant under this Lease at the time such performance is due, and such violation or failure continues without cure for more than thirty (30) days after written notice from City specifying the nature of such violation or failure, or, if such cure cannot reasonably be completed within such thirty (30)-day period, if Tenant does not within such thirty (30)-day period commence such cure, or having so commenced, does not diligently prosecute such cure to completion within a reasonable time thereafter;

(i) Tenant suffers or permits an Assignment, Sublease or other transfer of this Lease or any interest therein to occur in violation of this Lease, which event is not cured by Tenant within thirty (30) days after written demand by City by an effective rescission of the Assignment, Sublease or transfer or through City's consent; or

(ii) Tenant engages in or allows any use not permitted hereunder which event is not cured by Tenant within ten (10) days after written demand by City, or, if such cure cannot reasonably be completed within such ten (10)-day period, if Tenant does not within such ten (10)-day period commence such cure, and having so commenced, does not diligently prosecute such cure to completion within a reasonable time thereafter and in all events within sixty (60) days.

Section 23 REMEDIES

23.1 City's Remedies Generally.

Upon the occurrence and during the continuance of an Event of Default under this Lease, City shall have all rights and remedies provided in this Lease or available at law or equity that are not otherwise specifically waived or limited pursuant to the terms of this Lease. All of City's rights and remedies granted pursuant to this Lease shall be cumulative, and except as may be otherwise provided by applicable Law or specifically limited pursuant to this Lease, the exercise of any one or more rights shall not preclude the exercise of any others.

23.2 Right to Keep Lease in Effect.

(a) Continuation of Lease. Upon the occurrence of an Event of Default hereunder, City may continue this Lease in full force and effect pursuant to Civil Code Section 1951.4.

(b) No Termination. No act by City allowed by this Section 23.2, nor any appointment of a receiver upon City's initiative to protect its interest under this Lease, nor any withholding of consent to a subletting or assignment or termination of a subletting or assignment in accordance herewith, shall terminate this Lease, unless and until City notifies Tenant in writing that City elects to terminate this Lease.

(c) Application of Proceeds of Reletting. In the event of any such subletting, rents received by City from such subletting shall be applied (i) first, to the payment of the costs of maintaining, preserving, altering and preparing the Premises for subletting, the other costs of subletting, including but not limited to brokers' commissions, Attorneys' Fees and Costs, and expenses of removal of Tenant's Personal Property, trade fixtures and alterations; (ii) second, to the payment of Rent then due and payable hereunder; (iii) third, to the payment of future Rent as the same may become due and payable hereunder; and (iv) fourth, the balance, if any, shall be paid to Tenant upon (but not before) expiration of the term of this Lease. If the rents received by City from such subletting, after application as provided above, are insufficient in any month to pay the rent due and payable hereunder for such month, Tenant shall pay such deficiency to City monthly upon demand. Notwithstanding any such subletting for Tenant's account without termination, City may at any time thereafter, by written notice to Tenant, elect to terminate this Lease by virtue of a previous Event of Default.

23.3 Right to Perform Tenant's Covenants.

City may cure the Event of Default at Tenant's expense, it being understood that such performance shall not waive or cure the subject Event of Default. If City pays any sum or incurs any expense in curing the Event of Default, Tenant shall reimburse City upon demand for the amount of such payment or expense with interest at the Interest Rate from the date the sum is paid or the expense is incurred until City is reimbursed by Tenant. Any amount due City under this subsection shall constitute additional rent hereunder. Without limiting any other provision of this Lease, and in addition to any other rights or remedies available to City under this Lease, if at any time Tenant fails to pay any sums required to be paid by Tenant pursuant to this Lease to any person other than City, or if Tenant fails to perform any obligation on Tenant's part to be performed under this Lease, which failure continues without cure following any applicable cure period specified above, then City may, at its sole option, but shall not be obligated to, pay such sum or perform such obligation for and on behalf of Tenant.

23.4 Right to Terminate Lease.

(a) Damages. City may terminate this Lease at any time after the occurrence (and during the continuation) of an Event of a Default by giving written notice of such termination. Termination of this Lease shall thereafter occur on the date set forth in such notice. Acts of maintenance or preservation, and any appointment of a receiver upon City's initiative to protect its interest hereunder shall not in any such instance constitute a termination of Tenant's right to possession. No act by City other than giving notice of termination to Tenant in writing shall terminate this Lease. On termination of this Lease, City shall have the right to recover from Tenant all sums allowed under California Civil Code Section 1951.2, including, without limitation, the following: (i) the worth at the time of the award of the unpaid Rent which had been earned at the time of termination of this Lease; (ii) the worth at the time of the award of the amount by which the unpaid Rent which would have been earned after the date of termination of this Lease until the time of the award exceeds the amount of the loss of Rent that Tenant proves could have been reasonably avoided; (iii) the worth at the time of the award of the amount by which the unpaid Rent for the balance of the Term after the time of award exceeds the amount of the loss of Rent that Tenant proves could have been reasonably avoided; and (iv) any other amount necessary to compensate City for all detriment proximately caused by the default of Tenant, or which in the ordinary course of things would be likely to result therefrom. "The worth at the time of the award" shall be computed by allowing interest at a rate per annum equal to the Default Rate; provided, however, for purposes of subclause (iii) above only, "the worth at the time of the award" shall be computed by discounting such amount at the discount rate of the Federal Reserve Bank of San Francisco at the time of the award, plus one percent (1%).

(b) Interest. Rent not paid within twenty (20) days following written demand for payment of such Rent shall bear interest from the date due until paid at the Default Rate.

(c) Waiver of Rights to Recover Possession. In the event City terminates Tenant's right to possession of the Premises, and if such termination is contested by Tenant and City successfully prevails, and in any appeal thereof, Tenant hereby waives any rights to recover or regain possession of the Premises under any rights of redemption to which it may be entitled by or under any present or future Law, including, without limitation, California Code of Civil Procedure Sections 1174 and 1179 or any successor provisions.

(d) No Rights to Transfer or Sublet. Upon the occurrence and continuation of an Event of Default, notwithstanding Section 18, Tenant shall have no right to Assign or Sublease the Premises in whole or in part or to enter into any Event Permits without City's written consent, which may be given or withheld in City's sole and absolute discretion.

23.5 Equitable Relief.

In addition to the other remedies provided in this Lease, City shall be entitled at any time after a default or threatened default by Tenant to seek injunctive relief, an order for specific performance (but not specific performance in connection with Tenant's obligation to continue to occupy and operate the

Premises; provided that the foregoing shall not limit the City's rights under Section 22.2 above), or any other equitable relief, where appropriate to the circumstances of such default.

In addition to the other remedies provided in this Lease, Tenant shall be entitled at any time after a default or threatened default by City to seek injunctive relief, an order for specific performance, or any other equitable relief, where appropriate to the circumstances of such default.

23.6 Continuation of Subleases and Agreements.

If this Lease is terminated prior to the expiration thereof, and subject to any non disturbance agreements entered into by City pursuant to the terms of this Agreement, City shall have the right, at its sole option, to assume any and all agreements by Tenant for the maintenance or operation of the Premises, to the extent assignable by Tenant. Tenant hereby further covenants that, upon request of City following an Event of Default and termination of Tenant's interest in this Lease, Tenant shall execute, acknowledge and deliver to City such further instruments as may be necessary or desirable to vest or confirm or ratify vesting in City the then existing agreements then in force, as above specified, but only to the extent assignable by Tenant.

Section 24 NO WAIVER

24.1 No Waiver.

Neither this Lease nor any terms or provisions hereof may be changed, waived, discharged or terminated, except by a written instrument signed by the party against which the enforcement of the change, waiver, discharge or termination is sought. No failure by City to insist upon the strict performance of any term of this Lease or to exercise any right, power or remedy consequent upon a breach of any such term, shall be deemed to imply any waiver of any such breach or of any such term unless clearly expressed in writing. No waiver of any breach shall affect or alter this Lease, but each and every term, covenant and condition of this Lease shall continue in full force and effect with respect to any other then-existing or subsequent breach thereof.

24.2 No Accord or Satisfaction.

No submission by Tenant or acceptance by City of full or partial Rent or other sums during the continuance of any failure by Tenant to perform its obligations hereunder shall waive any of City's rights or remedies hereunder or constitute an accord or satisfaction, whether or not City had knowledge of any such failure. No endorsement or statement on any check or remittance by or for Tenant or in any communication accompanying or relating to such payment shall operate as a compromise or accord or satisfaction unless the same is approved as such in writing by City. City may accept such check, remittance or payment and retain the proceeds thereof, without prejudice to its rights to recover the balance of any Rent, including any and all Additional Rent, due from Tenant and to pursue any right or remedy provided for or permitted under this Lease or in law or at equity. No payment by Tenant of any amount claimed by City to be due as Rent hereunder (including any amount claimed to be due as Additional Rent) shall be deemed to waive any claim which Tenant may be entitled to assert with regard to the making of such payment or the amount thereof, and all such payments shall be without prejudice to any rights Tenant may have with respect thereto, whether or not such payment is identified as having been made "under protest" (or words of similar import).

Section 25 ESTOPPEL CERTIFICATES.

25.1 Tenant Certificate.

Tenant shall execute, acknowledge and deliver to City, within fifteen (15) days after a request, a certificate stating to Tenant's knowledge (a) that this Lease is unmodified and in full force and effect (or, if there have been modifications, that this Lease is in full force and effect, as modified, and stating the modifications or, if this Lease is not in full force and effect, so stating), (b) the dates, if any, to which any Rent and other sums payable hereunder have been paid, (c) that no notice has been received by Tenant of any default hereunder which has not been cured, except as to defaults specified in such certificate, (d)

Tenant is not aware of any defaults by City, except any defaults specified in such certificate, and (e) attached to the certificate is a true, correct and complete copy of the Lease and any amendments thereto (and Tenant shall attach such copy to the certificate). Any such certificate may be relied upon by City or any successor agency, and any prospective purchaser or mortgagee of City's interest in the Premises or any part thereof. Tenant will also use commercially reasonable efforts (including inserting a provision similar to this Section into every Sublease) to cause Subtenants under Subleases to execute, acknowledge and deliver to City, within twenty (20) business days after request, an estoppel certificate covering the matters described above with respect to such Sublease.

25.2 City Certificate.

City shall execute, acknowledge and deliver to Tenant, within fifteen (15) days after a request, a certificate stating to City's knowledge (a) that this Lease is unmodified and in full force and effect (or, if there have been modifications, that this Lease is in full force and effect as modified, and stating the modifications or if this Lease is not in full force and effect, so stating), (b) the dates, if any, to which Rent and other sums payable hereunder have been paid, (c) whether or not, to the knowledge of City, there are then existing any defaults under this Lease (and if so, specifying the same), and (d) attached to the certificate is a true, correct and complete copy of the Lease and any amendments thereto (and City shall attach such copy to the certificate). Any such certificate may be relied upon by Tenant, any Mortgagee, any Tax Credit Investor or an approved transferee of Tenant's interest under this Lease.

Section 26 APPROVALS BY CITY

26.1 Approvals by City.

Wherever this Lease requires or permits the giving by City of its consent or approval, or whenever an amendment, waiver, notice, or other instrument or document is to be executed by or on behalf of City, the General Manager, or his or her designee, shall be authorized to execute such instrument on behalf of City, except as otherwise provided by applicable law, including City's Charter.

Section 27 SURRENDER OF PREMISES

27.1 Condition of Premises.

Upon the expiration or other termination of the Term of this Lease as may be permitted or may occur pursuant to any other provision of this Lease, Tenant shall quit and surrender to City the Premises, and all Improvements, repairs, alterations, additions, substitutions and replacements thereto, in good order and condition, but with reasonable wear and tear (consistent with Tenant's maintenance obligations under this Lease), casualty and condemnation, if applicable, excepted. Tenant hereby agrees to execute all documents as City may deem necessary to evidence or confirm any such other termination. Upon expiration or termination of this Lease, Tenant and its Agents shall have the right to remove their respective Personal Property and trade fixtures consistent with Section 12.17, but any damage to the Improvements which is caused by their removal of same shall be repaired at Tenant's expense. At City's request, Tenant shall remove, at no cost to City, any Personal Property belonging to Tenant which then remains on the Premises (excluding any personal property owned by other persons).

27.2 Termination of Subleases.

Upon any termination of this Lease, any and all Subleases or other rights of parties acting by and through Tenant shall terminate without further action.

Section 28 HOLD OVER

28.1 Holdover Without Consent.

If Tenant retains possession of any portion of the Premises after the expiration or the earlier termination of this Lease, then unless City expressly agrees to the holdover in writing, Tenant shall pay City, on a month-to-month basis base rent equal to one hundred twenty percent (120%) of the fair market rental (as reasonably determined by City's Director of Real Estate, acting in good faith) for the Premises,

together with the Additional Rent payable under this Lease, and shall otherwise be on the terms and conditions herein specified so far as applicable (except for those pertaining to the Term). Any failure by Tenant to surrender, discontinue using, or, if required by City, any failure to remove any property or equipment following written demand for the same by City, shall constitute continuing possession for purposes hereof. Tenant acknowledges that the foregoing provisions shall not serve as permission for the Tenant to hold over, nor serve to extend the term of this Lease beyond the end on the term hereof. Any holding over without City's consent shall constitute a default by Tenant and entitle City to exercise any or all of its remedies as provided herein, notwithstanding that City may elect to accept one or more payments of Rent, and whether or not such amounts are at the holdover rate specified above or the rate in effect at the end of the Term of this Lease.

28.2 Holdover With Consent.

Any holding over after the expiration of the Term with the express written consent of City shall be construed to automatically extend the Term of this Lease on a month-to-month basis at a base rent equal to the base rent, if any, specified by City in such written consent, together with Additional Rent payable under this Lease, and shall otherwise be on the terms and conditions herein specified so far as applicable (except for those pertaining to the Term). Tenant's obligations under this Section shall survive the expiration or termination of this Lease.

Section 29 NOTICES

29.1 Notices.

Any notice given under this Lease shall be effective only if in writing and given by delivering the notice in person or by sending it first-class mail or certified mail with a return receipt requested or by overnight courier, return receipt requested, with postage prepaid, to: (a) Tenant, at Tenant's address set forth in the Basic Lease Information; or (b) City, at City's address set forth in the Basic Lease Information; or (c) to such other address as either City or Tenant may designate as its new address for such purpose by notice given to the other in accordance with the provisions of this Section at least ten (10) days prior to the effective date of such change. Any notice hereunder shall be deemed to have been given three (3) business days after the date when it is mailed if sent by first class or certified mail, one (1) business day after the date it is made if sent by overnight courier, or upon the date personal delivery is made. For convenience of the parties, copies of notices may also be given by telefacsimile to the telephone number set forth in the Basic Lease Information or such other number as may be provided from time to time; however, neither party may give official or binding notice by facsimile. Tenant shall promptly provide City with copies of any and all notices received regarding any alleged violation of laws or insurance requirements or any alleged unsafe condition or practice.

Section 30 CITY ENTRY

30.1 City Entry.

Tenant shall permit City and its Agents to enter the Premises during regular business hours (and at any time in the event of an emergency) upon one (1) business days' prior notice (except in the event of an emergency) for the purpose of (i) inspecting the same for compliance with any of the provisions of this Lease, (ii) performing any work therein that City may have a right to perform under this Lease, (iii) inspecting, sampling, testing and monitoring the Premises or the Improvements or any portion thereof, including buildings, grounds and subsurface areas, as City reasonably deems necessary or appropriate, and (iv) showing the Premises to prospective tenants or other interested parties during the last one hundred eighty (180) days of the Term, and to post notices of non-responsibility; provided, however, City agrees in performing or undertaking any of the foregoing activities to use reasonable efforts to minimize interference with the activities of Tenant. Such access shall be subject to Tenant's reasonable security and safety measures. Tenant shall provide City with a set of keys to all doors in the Premises, and shall provide replacement keys if and when any locks are changed. City shall have the right to use any means that it deems proper to open doors in an emergency in order to obtain access to any part of the Premises,

and any such entry shall not be construed or deemed to be a forcible or unlawful entry into or a detainer of, the Premises, or an eviction, actual or constructive, of Tenant from the Premises or any portion thereof. All locks installed in the Premises (excluding Tenant's vaults, safes or special security areas, if any) shall be keyed to the Building master key system, and City shall at all times have a key with which to unlock all such doors.

30.2 City Reservations.

Notwithstanding anything to the contrary in this Lease, City reserves and retains the right to grant future easements, permits and rights of way over, across, under, in and upon the Premises as City shall determine to be in the public interest, including for the installation, operation, maintenance, and repair of equipment for cellular telephone, radio or other telecommunications services, provided that any such easement, permit or right-of-way shall be conditioned upon the grantee's assumption of liability to Tenant for damage to its property that Tenant may sustain hereunder as a result of the grantee's use of such easement, permit or right-of-way, and provided further that any such easement, permit or right-of-way shall not materially interfere with Tenant's use of the Premises hereunder.

Section 31 EMPLOYMENT

31.1 First Source Hiring Ordinance.

City has adopted a First Source Hiring Ordinance (Board of Supervisors Ordinance No. 264 98) which establishes specific requirements, procedures and monitoring for first source hiring of qualified economically disadvantaged individuals for entry-level positions. Tenant agrees to comply with all applicable provisions of the First Source Hiring Ordinance and shall, if applicable and upon City's request, enter into a First Source Hiring Agreement that meets the applicable requirements of Section 83.9 of the First Source Hiring Ordinance.

31.2 Wages and Working Conditions; Theatrical Services.

Pursuant to San Francisco Administrative Code Sections 21.C-4 and 21.C-7, unless excepted, Contracts, Leases, Franchises, Permits, and Agreements awarded, let, issued or granted by the City and County of San Francisco for the use of property owned by the City and County of San Francisco shall require any Individual engaged in theatrical or technical services related to the presentation of a Show to be paid not less than the Prevailing Rate of Wages. Individuals engaged in theatrical and technical services include, without limitation, those engaged in rigging, sound, projection, theatrical lighting, videos, computers, draping, carpentry, special effects, and motion picture services. Capitalized terms in this Section that are not defined in this Lease shall have the meanings provided in Administrative Code Sections 21.C-4 and 21.C-7.

Tenant agrees to comply with and be fully bound by, and to require its Subcontractors to comply with and be fully bound by, the provisions of Administrative Code Sections 21.C-4 and 21.C-7, including, without limitation, the payment of any penalties for noncompliance and other remedies available to the City. The provisions of Administrative Code Sections 21.C-4 and 21.C-7 are hereby incorporated by reference and made a part of this Lease. Tenant shall cooperate fully with the Labor Standards Enforcement Officer and any other City official or employee, or any of their respective agents, in the administration and enforcement of the requirements of Administrative Code Sections 21.C-4 and 21.C-7, including, without limitation, any investigation of noncompliance by Tenant or its Subcontractors. Tenant agrees that the City may inspect and/or audit any workplace or job site involved in or related to the performance of this Lease, including, without limitation, interviewing Tenant's and any Subcontractor's employees and having immediate access to employee time sheets, payroll records, and paychecks for inspection.

Tenant may obtain a copy of the current Prevailing Rate of Wages from City by contacting its Office of Labor Standards Enforcement. Tenant acknowledges that the City's Board of Supervisors may amend such Prevailing Rate of Wages and agrees that Tenant and any Subcontractors shall be bound by and shall fully comply with any such amendments by the Board of Supervisors.

31.3 Supervision of Minors.

(a) Records Request. If any person applies for employment or for a volunteer position with Tenant, or any subtenant or subcontractor, in which such applicant would have supervisory or disciplinary power over a minor or any person under such applicant's care, then Tenant, and any subtenant or subcontractors providing services at the Premises, shall request from the California Department of Justice records of all convictions or any arrest pending adjudication of such applicant involving the offenses listed in Welfare and Institution Code Section 15660(a), in accordance with the procedures established in California Penal Code Section 11105.3.

(b) Restriction on Hires for Recreational Sites. If Tenant, or any subtenant or subcontractor, is providing services under this Lease at a City park, playground, recreational center or beach (separately and collectively, "**Recreational Site**"), Tenant shall not hire, and shall prevent its subcontractors from hiring, any person for employment or a volunteer position to provide supervisory or disciplinary power over a minor or any person under his or her care if that person has been convicted of any offense listed in Welfare and Institution Code Section 15660(a).

(c) Notice Required for Sites Other Than Recreational Sites. If Tenant, or any of its subtenants or subcontractors, hires an employee or volunteer to provide services to minors at any location other than a Recreational Site, and that employee or volunteer has been convicted of an offense specified in Penal Code Section 11105.3(c), then Tenant shall comply, and cause its subtenants and subcontractors to comply, with Penal Code Section 11105.3(c) and provide written notice to the parents or guardians of any minor who will be supervised or disciplined by the employee or volunteer not less than ten (10) days prior to the day the employee or volunteer begins his or her duties or tasks. Tenant shall provide, or cause its subtenants or subcontractors to provide, City with a copy of any such notice at the same time that it provides notice to any parent or guardian, to the extent permitted by law.

(d) General Requirements. Tenant shall expressly require any of its subcontractors with supervisory or disciplinary power over a minor to comply with this Section of the Lease as a condition of its contract with the subcontractor. Tenant acknowledges and agrees that failure by Tenant or any of its subcontractors to comply with any provision of this Section of this Lease shall constitute an Event of Default. Tenant further acknowledges and agrees that such Event of Default shall be grounds for the City to terminate the Lease, partially or in its entirety, to recover from Tenant any amounts paid under this Lease, and to withhold any future payments to Tenant. The remedies provided in this Section shall not limit any other remedy available to the City hereunder, or in equity or law for an Event of Default, and each remedy may be exercised individually or in combination with any other available remedy. The exercise of any remedy shall not preclude or in any way be deemed to waive any other remedy.

31.4 Employee Signature Authorization Ordinance.

City has adopted an Ordinance (San Francisco Administrative Code Sections 23.50-23.56) that requires employers of employees in hotel or restaurant projects on City property with more than fifty (50) employees to enter into a "card check" agreement with a labor union regarding the preference of employees to be represented by a labor union to act as their exclusive bargaining representative, if the City has a proprietary interest in the hotel or restaurant project. Tenant acknowledges and agrees that Tenant shall comply, and it shall cause Tenant's subtenants to comply, with the requirements of such Ordinance to the extent applicable to operations within the Premises.

31.5 Tenant Control; No Joint Venture.

Tenant shall have complete control over its employees in the method of performing their work under this Lease. Subject to the provisions of this Lease, Tenant retains the right to exercise full control and supervision of the services and full control of the employment, direction, compensation and discharge of all its employees and Tenant agrees to be solely responsible for all matters relating to its employees. All personnel employed by Tenant shall be employees of Tenant and not of City. Nothing contained in this Lease shall be deemed or construed as creating a partnership or joint venture between City and Tenant or between City and any other person, or cause City to be responsible in any way for the debts or

obligations of Tenant. The subject of this Lease is a lease with neither party acting as the Agent of the other party in any respect.

Section 32 REPRESENTATIONS AND WARRANTIES OF TENANT

32.1 Tenant Representations.

Tenant represents, warrants and covenants to City as follows, as of the date hereof and as of the Commencement Date:

(a) Valid Existence, Good Standing. Tenant is a nonprofit corporation duly organized and validly existing under the laws of the State of California. Tenant has the requisite power and authority to own its property and conduct its business as presently conducted. Tenant is in good standing in the State of California.

(b) Authority. Tenant has the requisite power and authority to execute and deliver this Lease and the agreements contemplated hereby and to carry out and perform all of the terms and covenants of this Lease and the agreements contemplated hereby to be performed by Tenant.

(c) No Limitation on Ability to Perform. Neither Tenant's articles of organization or operating agreement, nor any applicable Law, prohibits Tenant's entry into this Lease or its performance hereunder. No consent, authorization or approval of, and no notice to or filing with, any governmental authority, regulatory body or other person is required for the due execution and delivery of this Lease by Tenant and Tenant's performance hereunder, except for consents, authorizations and approvals which have already been obtained, notices which have already been given and filings which have already been made. There are no undischarged judgments pending against Tenant, and Tenant and its members have not received notice of the filing of any pending suit or proceedings which might materially adversely affect Tenant's ability to perform under this Lease.

(d) Valid Execution. The execution and delivery of this Lease and the performance by Tenant hereunder have been duly and validly authorized. When executed and delivered by City and Tenant, this Lease will be a legal, valid and binding obligation of Tenant.

(e) Defaults. The execution, delivery and performance of this Lease (i) do not and will not violate or result in a violation of, contravene or conflict with, or constitute a default by Tenant under (A) any agreement, document or instrument to which Tenant is a party or by which Tenant is bound, (B) any law, statute, ordinance, or regulation applicable to Tenant or its businesses, or (C) the articles of incorporation or bylaws of Tenant, and (ii) do not result in the creation or imposition of any lien or other encumbrance upon the assets of Tenant, except as contemplated hereby.

(f) Financial Matters. Except to the extent disclosed to City in writing, neither Tenant nor any of its members (i) have knowledge of a material default under, or received notice asserting that it is in default under, any lease or management agreement or the like, (ii) have filed a petition for relief under any chapter of the U.S. Bankruptcy Code, and (iii) have suffered any material adverse change to its financial condition that could reasonably effect its ability to perform its obligations under this Lease.

The representations and warranties herein shall survive any termination of this Lease to the extent specified in this Lease.

Section 33 SPECIAL PROVISIONS

33.1 Non-Discrimination in City Contracts and Benefits Ordinance.

(a) Covenant Not to Discriminate. In the performance of this Lease, Tenant covenants and agrees not to discriminate on the basis of the fact or perception of a person's race, color, creed, religion, national origin, ancestry, age, sex, sexual orientation, gender identity, domestic partner status, marital status, disability, weight, height or Acquired Immune Deficiency Syndrome or HIV status (AIDS/HIV status) against any employee of, any City employee working with, or applicant for employment with Tenant, in any of Tenant's operations within the United States, or against any person

seeking accommodations, advantages, facilities, privileges, services, or membership in all business, social, or other establishments or organizations operated by Tenant.

(b) Subleases and Other Subcontracts. Tenant shall include in all Subleases and other subcontracts relating to the Premises a non-discrimination clause applicable to such Subtenant or other subcontractor in substantially the form of subsection (a) above. In addition, Tenant shall incorporate by reference in all subleases and other subcontracts the provisions of Sections 12B.2(a), 12B.2(c)-(k), and 12C.3 of the San Francisco Administrative Code and shall require all subtenants and other subcontractors to comply with such provisions. Tenant's failure to comply with the obligations in this subsection shall constitute a material breach of this Lease subject to the applicable notice and cure periods under this Lease.

(c) Non-Discrimination in Benefits. Tenant does not as of the date of this Lease and will not during the Term, in any of its operations in San Francisco or with respect to its operations under this Lease elsewhere within the United States, discriminate in the provision of bereavement leave, family medical leave, health benefits, membership or membership discounts, moving expenses, pension and retirement benefits or travel benefits, as well as any benefits other than the benefits specified above, between employees with domestic partners and employees with spouses, and/or between the domestic partners and spouses of such employees, where the domestic partnership has been registered with a governmental entity pursuant to state or local law authorizing such registration, subject to the conditions set forth in Section 12B.2(b) of the San Francisco Administrative Code.

(i) HRC Form. As a condition to this Lease, Tenant shall execute the "Chapter 12B Declaration: Nondiscrimination in Contracts and Benefits" form (Form HRC-12B-101) with supporting documentation and secure the approval of the form by the San Francisco Human Rights Commission. Tenant hereby represents that prior to execution of this Lease, (i) Tenant executed and submitted to the HRC Form HRC-12B-101 with supporting documentation, and (ii) the HRC approved such form.

(ii) Incorporation of Administrative Code Provisions by Reference. The provisions of Chapters 12B and 12C of the San Francisco Administrative Code relating to non-discrimination by parties contracting for the lease of City property are incorporated in this Section by reference and made a part of this Agreement as though fully set forth herein. Tenant shall comply fully with and be bound by all of the provisions that apply to this Lease under such Chapters of the Administrative Code, including but not limited to the remedies provided in such Chapters. Without limiting the foregoing, Tenant understands that pursuant to Section 12B.2(h) of the San Francisco Administrative Code, a penalty of Fifty Dollars (\$50) for each person for each calendar day during which such person was discriminated against in violation of the provisions of this Lease may be assessed against Tenant and/or deducted from any payments due Tenant.

33.2 MacBride Principles - Northern Ireland.

The City and County of San Francisco urges companies doing business in Northern Ireland to move toward resolving employment inequities and encourages them to abide by the MacBride Principles as expressed in San Francisco Administrative Code Section 12F.1 et seq. The City and County of San Francisco also urges San Francisco companies to do business with corporations that abide by the MacBride Principles. Tenant acknowledges that it has read and understands the above statement of the City and County of San Francisco concerning doing business in Northern Ireland.

33.3 Tobacco Product Advertising Prohibition.

Tenant acknowledges and agrees that no sales or advertising of cigarettes or tobacco products is allowed on any real property owned by or under the control of City, including the Premises and the Property. This advertising prohibition includes the placement of the name of a company producing, selling or distributing cigarettes or tobacco products or the name of any cigarette or tobacco product in any promotion of any event or product. This advertising prohibition does not apply to any advertisement

sponsored by a state, local or nonprofit entity designed to communicate the health hazards of cigarettes and tobacco products or to encourage people not to smoke or to stop smoking.

33.4 Conflict of Interest.

Through its execution of this Lease, Tenant acknowledges that it is familiar with the provisions of Section 15.103 of the San Francisco Charter, Article III, Chapter 2 of City's Campaign and Governmental Conduct Code, and Section 87100 et seq. and Section 1090 et seq. of the Government Code of the State of California, and certifies that it does not know of any facts which would constitute a violation of said provisions, and agrees that if Tenant becomes aware of any such fact during the term of this Lease Tenant shall immediately notify City.

33.5 Drug-Free Workplace.

Tenant acknowledges that pursuant to the Federal Drug-Free Workplace Act of 1989, the unlawful manufacture, distribution, possession or use of a controlled substance is prohibited on City premises. Tenant agrees that any violation of this prohibition by Tenant, its Agents or assigns shall, subject to applicable notice and cure periods under this Lease, be deemed a material breach of this Lease.

33.6 Waiver of Relocation Assistance Rights.

Tenant acknowledges that it will not be a displaced person at the time this Lease is terminated or expires by its own terms, and Tenant fully RELEASES, WAIVES AND DISCHARGES forever any and all Claims against, and covenants not to sue, City, its departments, commissions, officers, directors and employees, and all persons acting by, through or under each of them, under any laws, including, without limitation, any and all claims for relocation benefits or assistance from City under federal and state relocation assistance laws (including, but not limited to, California Government Code Section 7260 et seq.).

33.7 Public Records; Sunshine Ordinance.

Tenant understands and agrees that City's Sunshine Ordinance (San Francisco Administrative Code Chapter 67) and the State Public Records Law (Government Code Section 6250 et seq.) (together with any amendments, supplements and successor statutes and ordinances, are hereinafter referred to as the "Public Records Laws") apply to this Lease, and any and all records, information, and materials submitted to City. Accordingly, any and all such records, information and materials may be subject to public disclosure in accordance with Public Records Laws, subject to any exceptions or exemptions set forth in the Public Records Laws.

33.8 Requiring Health Benefits for Covered Employees.

Unless exempt, (i) Tenant agrees to comply fully with and be bound by all of the provisions of the Health Care Accountability Ordinance (HCAO), as set forth in San Francisco Administrative Code Chapter 12Q, including the remedies provided, and implementing regulations, as the same may be amended from time to time and (ii), the provisions of this Section 33.8 shall apply. The provisions of Chapter 12Q are incorporated herein by reference and made a part of this Lease as though fully set forth. The text of the HCAO is available on the web at <http://www.sfgov.org/olse/hcao>. Capitalized terms used in this Section and not defined in this Lease shall have the meanings assigned to such terms in Chapter 12Q.

(a) For each Covered Employee, Tenant shall provide the appropriate health benefit set forth in Section 12Q.3 of the HCAO. If Tenant chooses to offer the health plan option, such health plan shall meet the minimum standards set forth by the San Francisco Health Commission.

(b) Notwithstanding the above, if the Tenant is a small business as defined in Section 12Q.3(d) of the HCAO, it shall have no obligation to comply with subsection (a) above.

(c) Tenant's failure to comply with the HCAO shall, subject to applicable notice and cure periods under this Lease, constitute a material breach of this Lease. City shall notify Tenant if such a

breach has occurred. If, within thirty (30) days after receiving City's written notice of a breach of this Lease for violating the HCAO, Tenant fails to cure such breach or, if such breach cannot reasonably be cured within such period of thirty (30) days, Tenant fails to commence efforts to cure within such period, or thereafter fails diligently to pursue such cure to completion, City shall have the right to pursue the remedies set forth in Section 12Q.5(f)(1-5). Each of these remedies shall be exercisable individually or in combination with any other rights or remedies available to City.

(d) Any Subcontract entered into by Tenant shall require the Subcontractor to comply with the requirements of the HCAO and shall contain contractual obligations substantially the same as those set forth in this Section. Tenant shall notify City's Purchasing Department when it enters into such a Subcontract and shall certify to the Purchasing Department that it has notified the Subcontractor of the obligations under the HCAO and has imposed the requirements of the HCAO on Subcontractor through the Subcontract. Each Tenant shall be responsible for its Subcontractors' compliance with this Chapter. If a Subcontractor fails to comply, City may pursue the remedies set forth in this Section against Tenant based on the Subcontractor's failure to comply, provided that City has first provided Tenant with notice and an opportunity to obtain a cure of the violation.

(e) Tenant shall not discharge, reduce in compensation, or otherwise discriminate against any employee for notifying City with regard to Tenant's compliance or anticipated compliance with the requirements of the HCAO, for opposing any practice proscribed by the HCAO, for participating in proceedings related to the HCAO, or for seeking to assert or enforce any rights under the HCAO by any lawful means.

(f) Tenant represents and warrants that it is not an entity that was set up, or is being used, for the purpose of evading the intent of the HCAO.

(i) Tenant shall keep itself informed of the current requirements of the HCAO.

(ii) Tenant shall provide reports to City in accordance with any reporting standards promulgated by City under the HCAO, including reports on Subcontractors and Subtenants, as applicable.

(iii) Tenant shall provide City with access to records pertaining to compliance with HCAO after receiving a written request from City to do so and being provided at least five (5) business days to respond.

(iv) City may conduct random audits of Tenant to ascertain its compliance with HCAO. Tenant agrees to cooperate with City when it conducts such audits.

33.9 Intellectual Property; Music Broadcasting Rights.

Tenant shall be solely responsible for obtaining any necessary clearances or permissions for the use of intellectual property on the Premises, including, but not limited to musical or other performance rights. (Note to Tenant: To obtain the appropriate music performance license, you may contact the BMI Licensing Executive toll free at 1-877-264-2137 Monday – Friday, 9-5 p.m. (Central Time) and the American Society of Composers, Authors and Publishers (“ASCAP”) at 1-800-505-4052 Monday – Friday, 9-5 p.m. (Eastern Time).)

33.10 Notification of Limitations on Contributions.

Through its execution of this Lease, Tenant acknowledges that it is familiar with Section 1.126 of the San Francisco Campaign and Governmental Conduct Code, which prohibits any person who contracts with City for the selling or leasing of any land or building to or from City whenever such transaction would require approval by a City elective officer or the board on which that City elective officer serves, from making any campaign contribution to (1) an individual holding a City elective office if the contract must be approved by the individual, a board on which that individual serves, or a board on which an appointee of that individual serves, (2) a candidate for the office held by such individual, or (3) a

committee controlled by such individual, at any time from the commencement of negotiations for the contract until the later of either the termination of negotiations for such contract or six months after the date the contract is approved. Tenant acknowledges that the foregoing restriction applies only if the contract or a combination or series of contracts approved by the same individual or board in a fiscal year have a total anticipated or actual value of \$50,000 or more. Tenant further acknowledges that the prohibition on contributions applies to each prospective party to the contract; each member of Tenant's board of directors, chairperson, chief executive officer, chief financial officer and chief operating officer (or, if not a corporation, then the equivalent person that directs or participates in directing the affairs or actions of the entity); any person with an ownership interest of more than 20 percent in Tenant; any subcontractor listed in the contract; and any committee that is sponsored or controlled by Tenant. Additionally, Tenant acknowledges that Tenant must inform each of the persons described in the preceding sentence of the prohibitions contained in Section 1.126.

33.11 Food Service Waste Reduction.

Tenant agrees to comply fully with and be bound by all of the provisions of the Food Service Waste Reduction Ordinance, as set forth in the San Francisco Environment Code, Chapter 16, including the remedies provided therein, and implementing guidelines and rules. The provisions of Chapter 16 are incorporated herein by reference and made a part of this Lease as though fully set forth herein. This provision is a material term of this Lease. By entering into this Lease, Tenant agrees that if it breaches this provision, City will suffer actual damages that will be impractical or extremely difficult to determine. Without limiting City's other rights and remedies, Tenant agrees that the sum of One Hundred Dollars (\$100.00) liquidated damages for the first breach, Two Hundred Dollars (\$200.00) liquidated damages for the second breach in the same year, and Five Hundred Dollars (\$500.00) liquidated damages for subsequent breaches in the same year is a reasonable estimate of the damage that City will incur based on the violation, established in light of the circumstances existing at the time this Lease was made. Such amounts shall not be considered a penalty, but rather agreed monetary damages sustained by City because of Tenant's failure to comply with this provision.

Section 34 GENERAL

34.1 Time of Performance.

(a) Expiration. All performance dates (including cure dates) expire at 5:00 p.m., San Francisco, California time, on the performance or cure date.

(b) Weekend; Holiday; Business Day. A performance date which falls on a Saturday, Sunday or City holiday is deemed extended to 5:00 pm on the next business day. For purposes of this Lease, a business day means any day except Saturday, Sunday, or a day on which City and County of San Francisco is closed for business.

(c) Days for Performance. All periods for performance or notices specified herein in terms of days shall be calendar days, and not business days, unless otherwise provided herein.

(d) Time of the Essence. Time is of the essence with respect to each provision of this Lease, including, but not limited, the provisions for the exercise of any option on the part of Tenant hereunder and the provisions for the payment of Rent and any other sums due hereunder.

34.2 Interpretation of Agreement.

Whenever an "Exhibit" is referenced, it means an attachment to this Lease unless otherwise specifically identified. All such Exhibits are incorporated herein by reference. The captions preceding the articles and sections of this Lease and in the table of contents have been inserted for convenience of reference only and such captions shall in no way define or limit the scope or intent of any provision of this Lease. This Lease has been negotiated at arm's length and between persons sophisticated and knowledgeable in the matters dealt with herein and shall be interpreted to achieve the intents and purposes of the parties, without any presumption against the party responsible for drafting any part of this Lease. Provisions in this Lease relating to number of days shall be calendar days, unless otherwise specified,

provided that if the last day of any period to give notice, reply to a notice or to undertake any other action occurs on a Saturday, Sunday or a bank or City holiday, then the last day for undertaking the action or giving or replying to the notice shall be the next succeeding business day. Use of the word "including" or similar words shall not be construed to limit any general term, statement or other matter in this Lease, whether or not language of non-limitation, such as "without limitation" or similar words, are used.

34.3 Successors and Assigns.

Subject to the provisions of this Lease relating to Assignment and Subletting, the terms, covenants and conditions contained in this Lease shall bind and inure to the benefit of City and Tenant and, except as otherwise provided herein, their personal representatives and successors and assigns; provided, however, that upon any sale, assignment or transfer by City named herein (or by any subsequent landlord) of its interest in the Building as owner or lessee, including any transfer by operation of law, City (or any subsequent landlord) shall be relieved from all subsequent obligations and liabilities arising under this Lease subsequent to such sale, assignment or transfer.

34.4 Interpretation of Lease; Approvals.

Whenever the context so requires, the use of the singular shall be deemed to include the plural and vice versa, and each gender reference shall be deemed to include the other and the neuter. If there is more than one Tenant, the obligations and liabilities under this Lease imposed on Tenant shall be joint and several. The captions preceding the articles and sections of this Lease and in the table of contents have been inserted for convenience of reference and such captions in no way define or limit the scope or intent of any provision of this Lease. All approvals, consents or other determinations permitted or required by City hereunder shall be made by or through the General Manager unless otherwise provided in this Lease, subject to applicable Law. Except as otherwise specifically provided in the Lease, whenever the Lease requires an approval or consent by either City (acting in its proprietary capacity) or Tenant, such approval or consent shall not be unreasonably withheld, and each party shall at all times act in good faith.

34.5 No Third Party Beneficiaries.

This Lease is for the exclusive benefit of the parties hereto and not for the benefit of any other person and shall not be deemed to have conferred any rights, express or implied, upon any other person.

34.6 Real Estate Commissions.

City is not liable for any real estate commissions, brokerage fees or finder's fees which may arise from this Lease. Tenant and City each represents that it engaged no broker, real estate agent or finder in connection with this transaction. In the event any broker, real estate agent or finder makes a claim, the party through whom such claim is made agrees to indemnify the other party from any Losses arising out of such claim.

34.7 Counterparts.

This Lease may be executed in counterparts, each of which is deemed to be an original, and all such counterparts constitute one and the same instrument.

34.8 Entire Agreement.

This instrument, including the exhibits hereto, which are made a part of this Lease, contains the entire agreement between the parties and all prior written or oral negotiations, understandings and agreements are merged herein. The parties further intend that this Lease shall constitute the complete and exclusive statement of its terms and that no extrinsic evidence whatsoever (including prior drafts hereof and changes therefrom) may be introduced in any judicial, administrative or other legal proceeding involving this Lease. Tenant hereby acknowledges that neither City nor City's Agents have made any representations or warranties with respect to the Premises, the Building or this Lease except as expressly set forth herein, and no rights, easements or licenses are or shall be acquired by Tenant by implication or otherwise unless expressly set forth herein.

34.9 Amendment.

Neither this Lease nor any of the terms hereof may be terminated, amended or modified except by a written instrument executed by the Parties.

34.10 Governing Law; Selection of Forum.

This Lease shall be governed by, and interpreted in accordance with, the laws of the State of California. As part of the consideration for City's entering into this Lease, Tenant agrees that all actions or proceedings arising directly or indirectly under this Lease may, at the sole option of City, be litigated in courts having situs within the State of California, and Tenant consents to the jurisdiction of any such local, state or federal court, and consents that any service of process in such action or proceeding may be made by personal service upon Tenant wherever Tenant may then be located, or by certified or registered mail directed to Tenant at the address set forth herein for the delivery of notices.

34.11 Extensions by City.

Upon the request of Tenant, City may, by written instrument, extend the time for Tenant's performance of any term, covenant or condition of this Lease or permit the curing of any default upon such terms and conditions as it determines appropriate, including but not limited to, the time within which Tenant must agree to such terms and/or conditions, provided, however, that any such extension or permissive curing of any particular default will not operate to release any of Tenant's obligations nor constitute a waiver of City's rights with respect to any other term, covenant or condition of this Lease or any other default in, or breach of, this Lease or otherwise effect the time of the essence provisions with respect to the extended date or other dates for performance hereunder.

34.12 Attorneys' Fees and Costs.

If either party hereto fails to perform any of its respective obligations under this Lease or if any dispute arises between the parties hereto concerning the meaning or interpretation of any provision of this Lease, then the defaulting party or the party not prevailing in such dispute, as the case may be, shall pay any and all costs and expenses incurred by the other party on account of such default and/or in enforcing or establishing its rights hereunder, including, without limitation, reasonable Attorneys' Fees and Costs. Any such Attorneys' Fees and Costs incurred by either party in enforcing a judgment in its favor under this Lease shall be recoverable separately from and in addition to any other amount included in such judgment, and such Attorneys' Fees and Costs obligation is intended to be severable from the other provisions of this Lease and to survive and not be merged into any such judgment. For purposes of this Lease, the reasonable fees of attorneys of City's Office of City Attorney shall be based on the fees regularly charged by private attorneys with the equivalent number of years of experience in the subject matter area of the law for which the City Attorney's services were rendered who practice in the City of San Francisco in law firms with approximately the same number of attorneys as employed by the City Attorney's Office. The "prevailing party" shall be determined based upon an assessment of which party's major arguments or positions taken in the action or proceeding could fairly be said to have prevailed (whether by compromise, settlement, abandonment by the other party of its claim or defense, final decision, after any appeals, or otherwise) over the other party's major arguments or positions on major disputed issues. Any Attorneys' Fees incurred in enforcing a judgment shall be recoverable separately from any other amount included in the judgment and shall survive and not be merged in the judgment. The Attorneys' Fees shall be deemed an "actual pecuniary loss" within the meaning of Bankruptcy Code Section 365(b)(1)(B), and notwithstanding the foregoing, all Fees incurred by either party in any bankruptcy case filed by or against the other party, from and after the order for relief until this Lease is rejected or assumed in such bankruptcy case, will be "obligations of the debtor" as that phrase is used in Bankruptcy Code Section 365(d)(3).

34.13 Effective Date.

This Lease shall become effective on the date (the "Effective Date") which is the later of: (i) the date on which the Parties have executed and delivered this Lease, and (ii) the effective date of a resolution by the City's Board of Supervisors approving this Lease and authorizing the City's execution.

34.14 Severability.

If any provision of this Lease, or its application to any person or circumstance, is held invalid by any court, the invalidity or inapplicability of such provision shall not affect any other provision of this Lease or the application of such provision to any other person or circumstance, and the remaining portions of this Lease shall continue in full force and effect, unless enforcement of this Lease as so modified by and in response to such invalidation would be grossly inequitable under all of the circumstances, or would frustrate the fundamental purposes of this Lease, in which case, the parties will negotiate in good faith a replacement provision which is not invalid to accomplish substantially the same intention as the provision held invalid.

34.15 Limitation on Liability.

No elective or appointive board, commission, member, officer, director, employee or other Agent of City shall be personally liable to Tenant, its successors and assigns, in the event of any default or breach by City or for any amount which may become due to Tenant, its successors and assigns, or for any obligation of City under this Agreement. No member, officer, director, employee or other Agent of Tenant shall be personally liable to City, its successors and assigns, in the event of any default or breach by Tenant or for any amount which may become due to City, its successors and assigns, or for any obligation of Tenant under this Agreement.

[No further text this page.]

IN WITNESS WHEREOF, the Parties have executed this Lease as of the day and year first above written.

TENANT

FRIENDS OF GENEVA OFFICE BUILDING AND POWER HOUSE,
a California nonprofit corporation

By: _____
Its: _____

By: _____
Its: _____

CITY:

CITY AND COUNTY OF SAN FRANCISCO,
a municipal corporation

By: _____
PHILIP GINSBURG, General Manager
Recreation and Park Department

APPROVED BY
RECREATION AND PARK COMMISSION
PURSUANT TO RESOLUTION NO. _____ DATED: _____

Margaret McArthur, Commission Liaison

Board of Supervisors Resolution No. _____ Adopted on _____

APPROVED AS TO FORM:

DENNIS J. HERRERA, City Attorney

By _____
Anita L. Wood, Deputy City Attorney

EXHIBIT A
Description of Premises

EXHIBIT B
Utility Responsibility Areas

EXHIBIT C

Sublease Conditions; Form of Indemnity

CITY AND COUNTY OF SAN FRANCISCO
ED LEE, MAYOR

**GENEVA OFFICE BUILDING AND POWER HOUSE
LEASE DISPOSITION AND DEVELOPMENT AGREEMENT**

between the
CITY AND COUNTY OF SAN FRANCISCO,

acting by and through its
RECREATION AND PARKS COMMISSION

and

FRIENDS OF GENEVA OFFICE BUILDING AND POWER HOUSE,
a California nonprofit corporation

for the delivery of a leasehold estate in real property located at
2301 San Jose Avenue, in San Francisco, California
for the rehabilitation and development of a community center project

Dated as of _____

TABLE OF CONTENTS

	<u>Page</u>
RECITALS	1
1. THE SITE, TERM, DEFINITIONS, RELATIONSHIP TO LEASE, FEES	3
1.1 Site	3
1.2 Term of this Agreement	3
1.3 Definitions	4
1.4 Relationship of this Agreement to Lease	4
2. DISPOSITION OF LEASEHOLD ESTATE THROUGH ESCROW	4
2.1 Agreement to Lease	4
2.2 Escrow	4
2.3 Conditions to City's Obligation to Close of Escrow	5
2.4 Conditions to Friends' Obligation to Close Escrow	7
2.5 Delivery of the Property	9
2.6 Condition of Title to the Property	10
2.7 Title Insurance	11
2.8 Taxes and Assessments	12
2.9 Compliance with Laws	12
2.10 Period to Cure Defaults Prior to the Close of Escrow	14
3. AS IS CONDITION OF THE SITE; CITY IMPROVEMENT OBLIGATIONS; INDEMNIFICATION	14
3.1 Site As Is; Risk of Loss	14
3.2 Release	15
3.3 Environmental Matters	16
3.4 SFMTA Facilities Matters	17
3.5 Indemnification	18
3.6 No Representation Regarding Adjacent Property	19
4. ACCESS BY FRIENDS	19
4.1 Access and Entry by Friends to the Property	19
4.2 Access and Entry by Friends on SFMTA Property	20
5. DEVELOPMENT OF THE SITE	21
5.1 Friends' Construction Obligations	21
5.2 Utilities	24
5.3 Construction Documents	24
5.4 Project Requirements	25
5.5 Preparation of Construction Documents; Role of Architect and Structural Engineer	26
5.6 Submission of Construction Documents	26
5.7 Scope of Friends' Review of Construction Documents	27
5.8 Construction Document Review Procedures	27
5.9 Changes in Final Construction Documents	28
5.10 Conflict Between Project Requirements and Other Governmental Requirements	29
5.11 Selection of Contractor and Subcontractors	29
5.12 Progress Meetings/Consultation	30

**Table of Contents
(Continued)**

		<u>Page</u>
	5.13 Construction Schedule	30
	5.14 Submittals After Completion	30
	5.15 Insurance Requirements	31
	5.16 City and Other Governmental Permits	31
	5.17 City Rights of Access	33
	5.18 Wages and Working Conditions	34
	5.19 Construction Signs and Barriers	34
	5.20 Damage and Destruction	34
6.	CERTIFICATE OF COMPLETION	34
	6.1 Certificate of Completion	34
	6.2 Form and Effect of Certificate	35
	6.3 Failure to Issue	36
	6.4 Permission for Phased Occupancy	36
7.	CITY APPROVAL OF FINANCING; FUNDING OBLIGATIONS	36
	7.1 Required Submittals	36
	7.2 Approval Process	39
	7.3 Financing Plan	39
	7.4 Funding Obligations of the Parties	39
	7.5 Disbursement of Community Opportunity Fund Grant Funds and Other City Funds	40
8.	ENCUMBRANCES AND LIENS	41
	8.1 No Mortgage of Fee	41
	8.2 Leasehold Liens	41
	8.3 Mechanics' Liens	41
	8.4 Contests	41
9.	ASSIGNMENT AND TRANSFER	41
	9.1 Prohibition Against Transfer of the Agreement or Significant Change	41
	9.2 No Release of Obligations	42
10.	DEFAULTS, REMEDIES AND TERMINATION	42
	10.1 Events of Default — Friends	42
	10.2 Remedies of City	44
	10.3 Events of Default – City	44
	10.4 Remedies of Friends	45
	10.5 General	45
	10.6 Plans and Data	46
	10.7 Return of Site	47
11.	SPECIAL PROVISIONS	47
	11.1 Non-Discrimination in City Contracts and Benefits Ordinance.	47
	11.2 Mitigation Measures	48
	11.3 MacBride Principles — Northern Ireland	48
	11.4 Tropical Hardwood Ban/Virgin Redwood Ban	49
	11.5 Tobacco Product Advertising Prohibition	49
	11.6 Drug-Free Workplace	49

**Table of Contents
(Continued)**

	<u>Page</u>
11.7 Pesticide Ordinance	49
11.8 First Source Hiring Ordinance	49
11.9 Card Check Ordinance	50
11.10 Workforce Hiring Program	50
11.11 Friends Conflicts of Interest	50
11.12 Prohibition of Political Activity with City Funds	50
11.13 Resource-Efficient Building Ordinance	51
11.14 Sunshine Ordinance	51
11.15 Public Access to Meetings and Records	51
11.16 Preservative Treated Wood Containing Arsenic	52
11.17 Compliance with Disabled Access Laws	52
11.18 Nondisclosure of Private Information	52
11.19 Graffiti Removal	53
11.20 Incorporation	54
11.21 Budgetary and Fiscal Requirements of City Charter	54
12. GENERAL PROVISIONS	54
12.1 Force Majeure – Extension of Time of Performance	54
12.2 Notices	56
12.3 Conflict of Interest	57
12.4 Inspection of Books and Records	57
12.5 Time of Performance	58
12.6 Interpretation of Agreement	58
12.7 Successors and Assigns	59
12.8 No Third Party Beneficiaries	59
12.9 Real Estate Commissions	59
12.10 Counterparts	59
12.11 Entire Agreement	59
12.12 Amendment	60
12.13 Governing Law	60
12.14 Recordation	60
12.15 Extensions by City	60
12.16 Further Assurances; Technical Corrections	60
12.17 Attorneys' Fees	61
12.18 Relationship of Parties	61
12.19 Severability	61
12.20 Representations and Warranties of Friends	61
12.21 Effective Date	62
13. COOPERATION AND GOOD FAITH	63
14. DEFINITIONS	63

**Table of Contents
(Continued)**

Page

LIST OF EXHIBITS

<u>Exhibits</u>	<u>Description</u>
A	Legal Description of Site and SFMTA Property
B	Site Plan
C	Recommendations Regarding Environmental Conditions
D	Form of Certificate of Completion
E	Form of the Lease
F	Schedule of Performance
G	Form of Memorandum of Lease
H	Permitted Title Exceptions
I	Scope of Development
J	Form of Architect's Certificate
K	Prevailing Wage Agreement
L	Budget
M	Financing Plan
N	Form of First Source Hiring Agreement
O	Workforce Hiring Program
P	Form of Memorandum of Agreement
Q	Form of LDDA Permit to Enter

GENEVA OFFICE BUILDING AND POWER HOUSE

LEASE DISPOSITION AND DEVELOPMENT AGREEMENT

THIS GENEVA OFFICE BUILDING AND POWER HOUSE LEASE DISPOSITION AND DEVELOPMENT AGREEMENT (this "Agreement"), dated for reference purposes as of _____, is by and between the CITY AND COUNTY OF SAN FRANCISCO, a municipal corporation ("**City**"), acting by and through its RECREATION AND PARK COMMISSION, and the FRIENDS OF GENEVA OFFICE BUILDING AND POWER HOUSE, a California non-profit public benefit corporation ("**Friends**").

RECITALS

THIS AGREEMENT is made with reference to the following facts and circumstances:

A. City owns the Geneva Avenue Office Building and Power House (the "**Building**") located at 2301 San Jose Avenue in San Francisco, California (the "**Property**"). The Property is adjacent to the Geneva Rail Yard and Carhouse, which is under the jurisdiction of City's Municipal Transportation Agency ("**SFMTA**"). The north, east and south faces of the Building adjoin streetcar tracks, and the west face of the Building fronts San Jose Avenue. The Building is comprised of two adjoining structures: a two-story office building containing approximately 13,000 square feet of space and a single-story car shed, known as the Powerhouse, containing approximately 3,000 square feet of space. The Building was designated as City Landmark No. 180 by the San Francisco Board of Supervisors on January 26, 1986.

B. The Building was severely damaged in the 1989 Loma Prieta Earthquake, and fell into general disrepair. In 1998, it was proposed that the Property, then under the jurisdiction of City's Municipal Transportation Agency ("**SFMTA**"), be demolished. The Friends of the Geneva Office Building and Power House, a nonprofit 501(c)3 organization, was formed as a neighborhood citizens group to halt the demolition plans. In response to these efforts, SFMTA halted plans for demolition, and in 1999 SFMTA designed and together with Caltrans and City's Recreation and Park Department (the "**Department**") partially funded a project to stabilize the Building in a manner designed to make the Building less likely to collapse in an earthquake. The stabilization project was completed in 2004. The stabilization work did not include the work required to make the Building seismically safe for occupancy, or necessary electrical, mechanical or plumbing upgrades or other refurbishment or renovations.

C. In 2004 jurisdiction of the Property was transferred from SFMTA to the Recreation and Park Commission (the "**Commission**"), subject to the condition subsequent that if the Commission determines that the Property is no longer necessary for a recreational purpose, jurisdiction will revert to the SFMTA. Because of the limited footprint of the Property, its adjacency to an active SFMTA rail yard operation, and presence of certain SFMTA facilities in the Building and on the Property, SFMTA and the Department entered into an interdepartmental agreement (the "**2004 MOU**") governing SFMTA's access to and management of the remaining SFMTA facilities in the Building and the Department's ability to access the Property through the adjacent SFMTA property for contractors working on the renovation and improvement of the Building and for ongoing Building maintenance, operations and repairs.

E. The Department has identified the Building as a possible site for youth and teen arts and related uses consistent with the Department's mission. The Friends desire to support the Department's use and operation of the Building, and to work cooperatively with the Department to develop and manage the Building as a dedicated space where artists, youth, and community members convene, exchange, learn, create and exhibit artistic and cultural works, and the Department welcomes and encourages such cooperation.

F. Friends has proposed to preserve the Building for the public benefit by (1) rehabilitating the exterior and interior of the Building; (2) bringing the Building into compliance with current regulatory requirements, including the San Francisco Building Code and the Americans with Disabilities Act; (3) seismically strengthening the Building; and (4) developing the Building for use as a community center, including, among other things, classrooms, meeting rooms, a theater, a café, exhibition and event spaces and a limited amount of retail space (collectively, the "Project"). It is Friends' intention to rehabilitate the Building in a manner consistent with the United States Secretary of the Interior's Standards for Rehabilitation and Guidelines for Rehabilitating Historic Buildings (36 Code of Federal Regulations § 67.7; the "Secretary's Standards"). It is the Parties' goal that the Friends and the City share the cost of the Project in the manner described in this Agreement, with Project funds to be raised by the Parties from a variety of public and private sources including, without limitation, the Federal Historic Preservation Tax Credit Incentive program and philanthropic sources. Following completion of the Project, Friends proposes to operate the Building as a community center providing programming for youth and adults in the surrounding neighborhood, the City of San Francisco, and the region.

G. The proposed Project will have numerous public benefits. First, the Project will include the historic and seismic rehabilitation of the Building, a landmark structure that is currently in significant disrepair. Second, the Project will create a substantially improved use for the Building, which is currently unused. Third, the Project will provide educational and recreational opportunities in the Excelsior and Ocean View-Merced Heights-Ingleside neighborhoods, which neighborhoods have a low median family income relative to the remainder of the City of San Francisco and are underserved by community, cultural and youth-serving facilities and programs. Finally, the Project will support other efforts underway and in the planning process to revitalize the area surrounding the Balboa Park BART Station.

H. Between 2007 and 2013, the Friends received seed funding from the City of San Francisco and the Department to support the capital campaign for the rehabilitation of the Building as well as youth arts programming. In 2008, the California Cultural Historical Endowment provided funding for pre-design and schematic design activities. In 2009 the Friends hired its first staff members. Since 2009, substantial additional conceptual and schematic design services, legal services, and pre-construction services have been provided pro-bono. In 2010, the Building was listed on the National Register of Historic Places.

I. On December 4, 2008, the San Francisco Planning Commission certified the Balboa Park Station Area Plan Final Environmental Impact Report, Planning Department Case No. 2004.1059E (the "FEIR"), and after several years of analysis, community outreach, and public review, the Balboa Park Station Area Plan was adopted on April 7, 2009. The Building is located in the Transit Station Area Subarea of the Balboa Park Station Area Plan. The San

Francisco Planning Department determined that the Geneva Car Barn and Powerhouse project, which includes the work described herein to the Building, was consistent with the development density established by the Balboa Park Station Area Plan and that there were no project-specific effects that are peculiar to the project or its site that were not analyzed in the FEIR. Thus the San Francisco Planning Department concluded that the Geneva Car Barn and Powerhouse project, including all the work described herein, qualified for an exemption from further environmental review under California Environmental Quality Act ("CEQA") Guidelines Section 15183 and issued a Certificate of Determination of Exemption from Environmental Review on November 14, 2013. Certain Project Mitigation Measures set forth in FEIR will apply to the Project.

J. On _____, 20____, the Recreation and Park Commission, by Resolution No. ____-____, among other things, authorized and directed the General Manager to (i) enter into this Agreement, and (ii) seek approval from the Board of Supervisors to execute the Lease with Friends. *[Include BOS approval if received.]*

K. In light of the substantial public benefits afforded by the Project, the parties wish to enter into this Agreement to set forth the terms and conditions upon which City will lease the Property to Friends and Friends will develop the Property, subject to all of the terms and conditions set forth below.

AGREEMENT

ACCORDINGLY, for good and valuable consideration, the receipt and adequacy of which are hereby acknowledged, the Parties agree as follows:

1. THE SITE, TERM, DEFINITIONS, RELATIONSHIP TO LEASE, FEES

1.1 Site

(a) **Generally.** The Property occupies a portion of a City block (Block 6972, Lot 036), consisting of an approximately [] square foot parcel of land located at 2301 San Jose Avenue, San Francisco, California. The Property is shown generally on the diagram attached hereto as Exhibit B (the "Site"), and, together with the adjacent property under the jurisdiction of the SFMTA, is within the real property described on Exhibit A attached hereto.

(b) **Building.** The Building is a two (2)-story structure with approximately 15,853 square feet of gross area, including approximately 12,754 square feet within the office building component and approximately 3,099 square feet of area within the power house component.

1.2 Term of this Agreement

The term of this Agreement shall be from the Effective Date until City records a Certificate of Completion for the Improvements pursuant to Section 6 below, substantially in the form of Exhibit D attached hereto, unless this Agreement is earlier terminated in accordance with its provisions (the "LDDA Term").

1.3 Definitions

Initially capitalized terms used in this Agreement are defined in Section 13 below, or have the meanings given them when first defined. Any initially capitalized words or acronyms used but not defined in this Agreement shall have the meanings given them in the Lease.

1.4 Relationship of this Agreement to Lease

This Agreement (i) provides for an agreement to lease the Property subject to certain conditions precedent, and (ii) controls development of the Property during the LDDA Term. Specifically, it addresses, among other matters, the conditions to the Close of Escrow and the Delivery of the Property under the Lease, the scope of Friends' obligations to construct the Improvements, the Schedule of Performance for those obligations, certain Workforce Hiring Program and Prevailing Wage Provisions, and the financing for construction of the Improvements. If the conditions for the Close of Escrow set forth in Section 2 of this Agreement are satisfied, City will lease the Property to Friends, and Friends will lease the Property from City, pursuant to the terms and conditions of a lease in substantially the form and substance of the lease attached hereto as Exhibit E (the "Lease"). No leasehold interest in the Property shall be granted to Friends until the Close of Escrow. Before Completion of the Improvements (but after the Close of Escrow), both this Agreement and the Lease will apply, but this Agreement shall control in the event of any inconsistency between this Agreement and the Lease. Upon Completion of the Improvements, and subject to the other terms and conditions of this Agreement, this Agreement will terminate. From and after Completion of the Improvements, the Lease will govern the rights and obligations of the Parties with respect to use and occupancy of the Property. Completion of the Improvements will be conclusively evidenced by recordation of a Certificate of Completion as set forth in Section 6 below.

2. DISPOSITION OF LEASEHOLD ESTATE THROUGH ESCROW

2.1 Agreement to Lease

Subject to satisfaction of all applicable conditions to the Close of Escrow, City agrees to lease the Property to Friends, and Friends agrees to lease the Property from City, under the Lease for the development and operation of the Project, all in accordance with and subject to the terms, covenants and conditions of this Agreement.

2.2 Escrow

(a) **Opening of Escrow.** Friends shall open an escrow for the Delivery of the Property through the Lease (the "Escrow") with Chicago Title Company in San Francisco, or the local office of such other title company as Friends may select and City may find reasonably satisfactory ("Title Company"). Friends shall open the Escrow not later than the date specified in the schedule of performance attached hereto as Exhibit F (as extended from time to time in accordance with the terms hereof, the "Schedule of Performance").

(b) **Close Date.** Subject to Force Majeure or Litigation Force Majeure, the "Close Date" shall be the date set forth on the Schedule of Performance. Notwithstanding the foregoing, the Close of Escrow may not occur earlier than the date by which all of the

conditions precedent described in Sections 2.3 and 2.4 are either satisfied or waived by the Party which is benefited by such conditions. In the event that all of the conditions precedent described in Sections 2.3 and 2.4 are not satisfied or waived by the Close Date, City may extend the Close of Escrow by giving Friends prior written notice, but in no event shall such extension extend the Construction Completion Date set forth in the Schedule of Performance without City's prior written approval, which may be granted, withheld, or conditioned in City's sole discretion.

~~(c)~~ **Joint Escrow Instructions.** Not later than thirty (30) days before the Close Date, Friends shall prepare and submit to City for review and approval joint escrow instructions as are necessary and consistent with this Agreement. If the joint escrow instructions are acceptable to City, City shall execute and transmit the instructions to the Title Company not later than five (5) days prior to the Close Date.

(d) Recordation of Memorandum of Lease. The joint escrow instructions referred to in Section 2.2(c) above shall, among other things, provide that the Title Company will record the Memorandum of Lease in the Official Records, in the form attached hereto as Exhibit G (the "**Memorandum of Lease**"), as well as any other documents provided for in this Agreement which are to be recorded upon Close of Escrow, as further provided in Section 2.5 below.

(e) Costs of Escrow. City shall not be required to pay any costs or expenses for or related to the Escrow. Friends shall pay all fees, charges, costs and other amounts necessary for the Close of Escrow, including, but not limited to, any escrow fees, the costs of any title reports, surveys, inspections or premiums for any title insurance policies and endorsements obtained by Friends, recording fees, if any, and transfer taxes, if any (together, "**Closing Costs**"). Friends shall pay any Closing Costs within the times necessary for the Close of Escrow, as set forth in a closing statement prepared by the Title Company.

2.3 Conditions to City's Obligation to Close of Escrow

(a) City's Conditions Precedent. The following are conditions precedent to City's obligation to approve of the Close of Escrow and thereby Deliver the Property to Friends under the Lease:

(i) No uncured Event of Default (or Unmatured Event of Default) exists on Friends' part under this Agreement, and all of Friends' representations and warranties made in Section 12.20 of this Agreement shall have been true and correct when made and shall be true and correct as of the Close Date. At the Closing, Friends shall deliver to City a certificate to confirm the accuracy of such representations and warranties.

(ii) City shall have approved those aspects of the Construction Documents that are required under Section 5 below to be approved by City prior to the Close of Escrow, in accordance with the Schedule of Performance.

(iii) City shall have approved, under the standard set forth in Section 7 below, those aspects of the evidence of adequate financing for the Project (based on the Budget for Completion of the Improvements in accordance with the Construction Documents) that are

required under Section 7 below, including evidence of the Construction Contract described in Section 7.1(h) below, in accordance with the Schedule of Performance. In evaluating Friends' proposed Budget, City may obtain a third-party cost estimator's report at Friends' sole cost and expense if City, in its sole discretion, elects to do so.

(iv) Friends shall have submitted into Escrow the Lease, in the form attached hereto as Exhibit E, duly executed by Friends.

(v) Friends shall have submitted to City evidence that Friends has submitted an Historic Preservation Certification Application, Part 2 — Description of Rehabilitation (the "**Part 2 Application**") to the National Park Service ("NPS") and NPS shall have approved such application with conditions as is customary.

(vi) If applicable, Friends shall have submitted to City an executed operating agreement or limited partnership agreement with all related authority and governing documents or such other evidence that is reasonably satisfactory to City, indicating that Friends has entered or has a binding commitment to enter into an agreement with an investor to utilize in such partnership or limited liability company the Historic Preservation Tax Credit for eligible Project costs.

(vii) SHPO has approved all plans for which SHPO approval is required except documents necessary for Phase 3 Historic Preservation Tax Credit Approval.

(viii) Friends shall have obtained all Regulatory Approvals for construction of the Improvements and such Regulatory Approvals shall be Finally Granted. Building Permits, or, in the case of the Site Permit Process, the Site Permit and any addendum or addenda to the Site Permit, which are required for the commencement of Construction of the Improvements shall have been Finally Granted.

(ix) Title Company shall be irrevocably committed to issue to City the title insurance policy required by Section 2.7(a)(ii) to be delivered to City, if any.

(x) City shall have approved the submissions Friends is required to make regarding the Special City Requirements, in accordance with Section 11 below, and Friends shall have executed and delivered to City a certification of compliance with San Francisco Administrative Code Chapters 12B and 12C on the "Chapter 12B Declaration: Nondiscrimination in Contracts and Benefits" form (Form HRC-12B-101), together with supporting documentation, and shall have secured approval of the form by City's Human Rights Commission.

(xi) City shall have approved such evidence of Friends' authority to enter into the Lease, and this agreement and the transactions which the Lease and this Agreement contemplate, as City and the Title Company may reasonably require, including, without limitation, legal opinions regarding due authorization and execution.

(xii) Friends shall have in place all insurance required under this Agreement and the Lease and shall have deposited evidence thereof into Escrow.

(xiii) Friends shall have deposited into Escrow a duly executed and authorized Performance Bond.

(xiv) City shall have provided the Construction Documents required to be approved by Friends by the Close of Escrow in accordance with the Schedule of Performance.

(xv) City shall have approved the Construction Contract for Consistency.

(xvi) City's Board of Supervisors authorization and approval required for this Agreement, the Lease, and, any other agreements contemplated by this Agreement to be executed by City which require such approval, shall have been completed and shall have become and remain effective, and such approvals shall be Finally Granted.

(xvii) City and Friends shall have agreed upon the legal description for the Site.

(xviii) Friends shall have prepared and delivered to City and City shall have reasonably approved an updated Workforce Hiring Program that covers the workforce in connection with the construction of the Project.

(b) Satisfaction of City's Conditions. The conditions precedent set forth above are intended solely for the benefit of City. If any such condition precedent is not satisfied on or before the Close Date, subject to the provisions of Section 12.1, City, acting through the General Manager, shall have the right in its sole discretion to (i) waive in writing the condition precedent in question and proceed with the Close of Escrow, (ii) unless any such condition precedent is not satisfied due to City's breach of Section 5.8(b) hereunder, terminate this Agreement, and exercise all of its rights and remedies hereunder, or (iii) unless any such condition precedent is not satisfied due to City's breach of Section 5.8(b) hereunder, extend the Close Date for a reasonable period of time specified in writing by City not to exceed sixty (60) days, to allow such conditions precedent to be satisfied, subject to City's right to terminate this Agreement upon the expiration of the period of any such extension if all such conditions precedent have not been satisfied, and to exercise all of its rights and remedies hereunder.

2.4 Conditions to Friends' Obligation to Close Escrow

(a) Friends' Conditions Precedent. The following are conditions precedent to Friends' obligation to approve the Close of Escrow and thereby accept Delivery of the Property under the Lease:

(i) No uncured Event of Default (or Unmatured Event of Default) exists on City's part under this Agreement.

(ii) Title Company shall be irrevocably committed to issue to Friends, upon payment by Friends of the premium thereunder, the title insurance policy required by Section 2.7(a)(i) to be delivered to Friends.

(iii) There shall have been no Adverse Change.

(iv) Friends shall have approved the Construction Documents required to be approved by the Close of Escrow in accordance with the Schedule of Performance.

(v) All Regulatory Approvals required to commence construction of the Project shall have been issued without conditions reasonably unacceptable to Friends, and such Regulatory Approvals shall be Finally Granted.

(vi) Building Permits, or, in the case of the Site Permit Process, the Site Permit and any addendum or addenda to the Site Permit, which are required for the commencement of construction of the Improvements shall have been Finally Granted, and City shall have executed any such permits which City is required to execute as co-permittee.

(vii) City's Board of Supervisors authorizations and approvals required for this Agreement, the Lease, and, any other agreements contemplated by this Agreement to be executed by City which require such approval, shall have been completed and shall have become and remain effective, and such approvals shall be Finally Granted.

(viii) Friends shall have obtained commitments for, and City shall have approved the evidence of, the financing required to be approved by City under Section 7 of this Agreement by the Close of Escrow in accordance with the Schedule of Performance, and the Construction Contract.

(ix) City shall be irrevocably committed to contributing, and Friends shall have approved evidence of, the financing to be provided by City under Section 7 of this Agreement by the Close of Escrow in accordance with the Schedule of Performance.

(x) SFMTA shall have granted the Temporary Construction License and the Long-Term License in accordance with Section 4.2 of this Agreement.

(xi) NPS shall have conditionally determined that the Part 2 Application is consistent with the Secretary's Standards, and SHPO and the NPS shall have conditionally agreed on a treatment of the Project that will permit Friends to effectively utilize the Historic Preservation Tax Credit.

(xii) City shall have approved Friends' submissions in accordance with the Special City Requirements, as set forth in Section 11 below.

(xiv) City shall have relocated the high-tension electrical wire and alarm system in accordance with Section 3.4 to Friends' satisfaction, as determined by Friends in its sole and absolute discretion.

(xv) No Unknown Pre-Existing Environmental Conditions shall have been discovered that are unacceptable to Friends, in its sole and absolute discretion, that City has not Remediated to Friends' satisfaction by the date agreed to by City and Friends (if applicable) in accordance with the provisions of Section 3.3(g) below.

(b) **Satisfaction of Friends' Conditions Precedent.** The conditions precedent set forth above are intended solely for the benefit of Friends. If any such condition

precedent is not satisfied on or before the Close Date, subject to Force Majeure and Litigation Force Majeure, Friends shall have the right in its sole discretion to (i) waive in writing the condition precedent in question and proceed with the Close of Escrow, (ii) terminate this Agreement, and exercise all of its rights and remedies hereunder, subject to the other provisions of this Agreement which expressly survive a termination hereof, or (iii) extend the Close Date for a reasonable period of time specified in writing by Friends not to exceed sixty (60) days, to allow such conditions precedent to be satisfied, subject to Friends' right to terminate this Agreement upon the expiration of the period of any such extension if all such conditions precedent have not been satisfied, and to exercise all of its rights and remedies hereunder, subject to the other provisions of this Agreement which expressly survive a termination hereof.

2.5 Delivery of the Property

(a) **Obligation to Close Escrow.** Provided that the conditions to City's obligations with respect to the Close of Escrow and Delivery of the Property as set forth in Section 2.3 and the conditions to Friends' obligations with respect to Close of Escrow and acceptance of the Delivery of the Property as set forth in Section 2.4 have been satisfied or expressly waived on or before the Close Date, City and Friends shall instruct the Title Company to complete the Close of Escrow, as set forth below. Upon the Close of Escrow, City shall Deliver the Property to Friends, and Friends shall accept the Delivery of the Property, under the Lease.

(b) **Steps to Close Escrow.** The Close of Escrow shall be completed as follows:

(i) On or before the Close of Escrow, City shall execute and acknowledge, or cause to be executed and acknowledged, as necessary, and deposit into Escrow with the Title Company the following: (1) the Lease, (2) the Memorandum of Lease, (3) the Temporary Construction License, (4) the Long-Term License, and (5) copies of the resolutions of the Board of Supervisors authorizing and approving the Lease and this Agreement.

(ii) On or before the Close of Escrow, Friends shall (A) pay into Escrow with the Title Company all Closing Costs, and (B) execute and acknowledge (or cause to be executed and acknowledged), as necessary, and deposit into Escrow with the Title Company the following: (1) the Lease, (2) the Memorandum of Lease, and (3) the certificate as to the accuracy of the representations and warranties under this Agreement required by Section 2.3(a)(i).

(iii) City and Friends shall instruct the Title Company to consummate the Escrow according to the joint escrow instructions described in Section 2.2(c). Upon the Close of Escrow, the Title Company shall record in the Official Records the Memorandum of Lease, the Temporary Construction License, the Long-Term License, and any other documents reasonably required to be recorded under the terms of any Regulatory Approvals or under the terms hereof and shall deliver to the respective Parties executed counterparts of the applicable documents. In addition, on or before the Close of Escrow, a Memorandum of this Agreement in the form of Exhibit P attached hereto (a "**Memorandum of Agreement**") shall have been recorded in the Official Records.

(iv) Upon the Close of Escrow, the Title Company shall disburse any funds deposited into Escrow pursuant to this Agreement in accordance with the terms hereof.

(v) The Title Company shall issue a title policy to Friends and City as required under Section 2.7.

(c) **Waiver of Conditions to Close of Escrow.** Unless the Parties otherwise expressly agree at the time of Close of Escrow, all conditions to the Close of Escrow of the Parties shall, upon the Close of Escrow, be deemed waived by the Party benefited by such condition.

2.6 Condition of Title to the Property

(a) **Permitted Title Exceptions.** Except for those permitted title exceptions shown on Exhibit H attached hereto (collectively, the “**Permitted Title Exceptions**”), and such other matters as Friends shall cause to arise, which arise in connection with Friends’ use or operation of the Property, and which Friends agrees to hereunder, City shall Deliver to Friends the Property under and subject to the provisions of the Lease for the term specified in the Lease, free and clear of (i) possession and rights of possession of the Property by others, and (ii) liens, encumbrances, covenants, assessments, easements, leases and taxes.

(b) **Survey Review.** On or prior to the date set forth in the Schedule of Performance, Friends may, at Friends’ sole cost and expense, obtain a survey of the Property and deliver to City a notice identifying any matters that are not acceptable to Friends (a “**Survey Defect**”). If City elects to remove or cure the Survey Defect, City shall have up to thirty (30) days from receipt of such notice (the “**Survey Defect Cure Period**”) to remove or cure the Survey Defect. If by expiration of the Survey Defect Cure Period, subject to Force Majeure, unless the Parties mutually agree to extend such date, a Survey Defect still exists, Friends may by written notice to City terminate this Agreement within such seven (7) days after the expiration of the Survey Defect Cure Period. In the event that Friends does not accept terminate this Agreement within such seven (7) days after the expiration of the Survey Defect Cure Period, or any extension thereof as provided above, this Agreement shall continue in full force and effect and any Survey Defect will be deemed waived.

(c) **Title Defect.** If at the time scheduled for the Close of Escrow under Section 2.2, there remains (i) any possession and rights of possession of the Property by others, or (ii) any lien, encumbrance, covenant, assessment, easement, lease, tax, judgment, or other right, title or interest in the Property, which in either case, is not a Permitted Title Exception, that encumbers the Property and would materially and adversely affect the development or operation of the Project (a “**Title Defect**”), City will have up to thirty (30) days from the time scheduled for the Close of Escrow under Section 2.2 to remove the Title Defect (the “**Title Defect Cure Period**”). In such event, the time scheduled for the Close of Escrow under Section 2.2 will be extended to the earlier of seven (7) business days after the Title Defect is removed or the expiration of the Title Defect Cure Period. If the Title Defect can be removed by bonding and City has not so bonded within the Title Defect Cure Period, Friends may in its sole discretion cause a bond to be issued. If Friends causes a bond to be issued in accordance with this Section 2.6(c), City, at its option, shall reimburse Friends for the cost of such bond

within thirty (30) days of demand therefor or offset such amounts against any rent due under the Lease.

(d) **Friends' Remedies for an Uncured Title Defect.** If by expiration of the Title Defect Cure Period, subject to Force Majeure, unless the Parties mutually agree to extend such date, a Title Defect still exists and all other of City's Conditions Precedent have been satisfied, Friends may by written notice to City either (i) terminate this Agreement or (ii) accept Delivery of the Property under the Lease. If Friends elects to accept Delivery, the Title Defect will be deemed waived but solely with respect to any action by Friends against City. If Friends does not accept Delivery and fails to terminate this Agreement within seven (7) days after the expiration of the Title Defect Cure Period, or any extension thereof as provided above, City may terminate this Agreement upon three (3) days written notice to Friends. If the Agreement is terminated under this Section, Friends shall have no further remedies against City with respect to such termination. In the event that Friends does not accept Delivery and fails to terminate this Agreement within such seven (7) days after the expiration of the Title Defect Cure Period, or any extension thereof as provided above, and City elects not to terminate this Agreement as set forth in this Section, this Agreement shall continue in full force and effect and any Title Defect will be deemed waived and City shall have all of its rights and remedies under this Agreement, at law and in equity.

(e) **Covenants of City Regarding the Site Before the Close of Escrow.** In addition to its obligations under Section 2.6(a) above, and not in limitation of Friends' rights under Section 2.4, City will not intentionally take any actions that materially alters the condition of title to the Property existing as of the date of this Agreement except as specifically contemplated hereunder or under the Lease. Between the Effective Date of this Agreement and the Close of Escrow or earlier termination of this Agreement as permitted hereunder, City shall not (i) make any material physical alterations to the Property except as expressly contemplated by this Agreement or (ii) enter into any lease, license or other agreement for the use or occupancy of the Property, in each case without Friends' prior written consent.

2.7 Title Insurance

(a) **Title Insurance to be Issued at the Close of Escrow.** The joint escrow instructions described in Section 2.2(c) will provide that concurrently with the Close of Escrow, the Title Company will issue and deliver:

(i) to Friends, an A.L.T.A. extended coverage title insurance policy (or, at Friends' election, a C.L.T.A. title insurance policy) issued by the Title Company, with such coinsurance or reinsurance and direct access agreements as Friends may request reasonably, in an amount reasonably designated by Friends which is satisfactory to the Title Company, insuring that the leasehold estate in the Property is vested in Friends subject only to the Permitted Title Exceptions, and with such C.L.T.A. form endorsements and such other endorsements as may be requested reasonably by Friends, all at the sole cost and expense of Friends; and

(ii) to City an A.L.T.A. extended coverage title insurance policy (or, if Friends elects to obtain the same, a C.L.T.A. title insurance policy) issued by Title Company in a reasonable amount specified by City and satisfactory to the Title Company, insuring City's fee

interest in the Property subject to the Lease and those Permitted Title Exceptions which are applicable to the fee, and with such C.L.T.A. endorsements as City may reasonably request, provided that subject to Section 2.7(c) below, City pays any incremental cost for such policy (including endorsements) in excess of the C.L.T.A. standard coverage portion of City's title insurance policy.

(b) **Surveys.** Friends is responsible for securing any and all surveys and engineering studies at its sole cost and expense, as needed for the title insurance required under this Agreement or as otherwise required to consummate the transactions contemplated by this Agreement. Friends shall provide City with complete and accurate copies of all such final surveys (which shall be certified to City in a form reasonably satisfactory to City) and engineering studies.

(c) **Construction Endorsement.** In the event that the title insurance policy described in Section 2.7(a)(ii) above is issued to City, and in the event that Friends obtains an endorsement to its title insurance policy with respect to the Property insuring Friends that the Improvements have been completed free and clear of all mechanics' and materialmen's liens, Friends shall also obtain such an endorsement for City with respect to City's title insurance policy, all at the sole cost and expense of Friends.

2.8 Taxes and Assessments

(a) **Ad Valorem Taxes and Assessments Before and After Delivery.** For any period before the Close of Escrow, Friends is responsible for any ad valorem taxes (including, but not limited to, possessory interest taxes) assessed by reason of this Agreement, its entry upon the Property under a Permit to Enter, or otherwise. Ad valorem taxes and assessments levied, assessed, or imposed for any period on or after the Close of Escrow, including but not limited to, possessory interest taxes, are the sole responsibility of Friends, as further provided in the Lease.

(b) **Possessory Interest Taxes.** Friends recognizes and understands that this Agreement may create a possessory interest subject to property taxation and that Friends may be subject to the payment of property taxes levied on such interest. San Francisco Administrative Code Sections 23.38 and 23.39 require that City and County of San Francisco report certain information relating to this Agreement, and any renewals of this Agreement, to the County Assessor within sixty (60) days after any such transaction, and that Friends report certain information relating to any assignment, sublease or transfer under this Agreement to the County Assessor within sixty (60) days after such assignment transaction. Friends agrees to provide such information as may be requested by City to enable City to comply with this requirement.

2.9 Compliance with Laws

(a) **Compliance with Laws and Other Requirements.** Friends shall comply (taking into account any variances or the terms of other Regulatory Approvals properly obtained) at all times throughout the LDDA Term, with: (i) all Laws; (ii) all of the Mitigation Measures described in Section 11.2 below; (iii) all requirements of all policies of insurance required under Section 5.14 hereof, and under Section 18 of the Lease and such other insurance

policies of Friends which may be applicable to the Site, the Improvements or Friends' personal property; (iv) the Lease (to the extent that it is then in effect); (v) all applicable requirements for qualification of the Project for the Historic Preservation Tax Credit; and (vi) all other applicable Project Requirements. It is expressly understood and agreed that the performance required of Friends by the preceding sentence shall include the obligation to make all additions to, modifications of, and installations on the Property that may be required by any Laws regulating the Site or any insurance policies covering the Site, the Improvements or Friends' personal property; provided, however, that if City elects to perform the Remediation of Unknown Pre-Existing Hazardous Materials pursuant to the provisions of Section 3.3(g) below, Friends shall have no obligation to cause the Property to comply with Hazardous Materials Laws to the extent that any failure to comply is a result of Unknown Pre-Existing Hazardous Materials. Friends shall, promptly upon request, provide City with evidence of compliance with Friends' obligations under this Section.

(b) Regulatory Approvals.

(i) Friends understands and agrees that City is entering into this Agreement in its capacity as a landowner with a proprietary interest in the Property and not as a regulatory agency with certain police powers. Friends understands and agrees that neither entry by City into this Agreement nor any approvals given by City under this Agreement shall be deemed to imply that Friends will obtain any required approvals from City departments, boards or commissions which have jurisdiction over the Property. By entering into this Agreement, City is in no way modifying or limiting the obligations of Friends to develop the Project in accordance with all Laws, as provided in this Agreement.

(ii) Friends understands that its Construction of the Improvements on the Site and development of the Project will require approvals, authorizations and permits from governmental agencies with jurisdiction, which may include, without limitation, City's Planning Commission and/or Zoning Administrator, the Recreation and Park Commission, the Department of Building Inspection, the Art Commission, the Department of Public Health and SHPO. Friends shall use good faith efforts to obtain and shall be solely responsible for obtaining any Regulatory Approvals required for the Project in the manner set forth in this Section. Friends shall not seek any Regulatory Approval without first notifying City. Throughout the permit process for any Regulatory Approval, Friends shall consult and coordinate with City in Friends' efforts to obtain such permits. City shall cooperate reasonably with Friends in its efforts to obtain such permits, including executing any letters of authorization as owner of the Property. However, Friends shall not agree to the imposition of conditions or restrictions in connection with its efforts to obtain a permit from any other regulatory agency if City is required to be a permittee under such permit and the conditions or restrictions could create any obligations on the part of City whether on or off of the Site, or the conditions or restrictions could otherwise encumber, restrict or change the use of the Site, unless in each instance City has previously approved such conditions in writing and in City's sole and absolute discretion. No such approval by City shall limit Friends' obligation to pay its share of the costs of complying with such conditions under this Section. Subject to the conditions of this Section, City shall join any application by Friends for any required Regulatory Approval and in executing such permit where required, provided that City shall have no obligation to join in any such application or sign any such permit if City does not approve the conditions imposed by the regulatory agency under such

permit as set forth above. Friends shall bear all costs associated with applying for and obtaining any necessary Regulatory Approval. Friends shall comply with any and all conditions or restrictions imposed by regulatory agencies as part of a Regulatory Approval, whether such conditions are on-site or require off-site improvements as a result of the Project. Friends shall have the right to reasonably appeal or contest any adverse decision and/or imposition of any condition in any manner permitted by Law imposed upon any such Regulatory Approval. Friends shall pay or discharge any fines, penalties or corrective actions imposed as a result of the failure of Friends to comply with the terms and conditions of any Regulatory Approval. Without limiting any other indemnification provisions of this Agreement, Friends shall Indemnify City and the other City Indemnified Parties from and against any and all Losses which may arise in connection with Friends' failure to seek to obtain in good faith, or to comply with, the terms and conditions of any Regulatory Approval or to pursue in good faith the appeal or contest of any conditions of any Regulatory Approval initiated in connection with the Project, except to the extent such Losses are caused by the gross negligence or willful misconduct of City acting in its proprietary capacity. The provisions of this Section shall survive any termination of this Agreement.

2.10 Period to Cure Defaults Prior to the Close of Escrow

If Escrow is not in condition to close at the Close Date due to an Event of Default, either Party who has performed fully the acts to be performed by it before Close of Escrow, or whose performance has been excused, may terminate this Agreement by written notice, demand the return of its money, papers or documents deposited in Escrow and exercise all of its rights and remedies hereunder; *provided, however*, the other Party will have sixty (60) days after such notice to perform any acts required of it to permit Close of Escrow or such other additional time as reasonably agreed to by the Parties in writing. If neither City nor Friends has performed fully with respect to the Close of Escrow before the time established therefor, the Title Company will have been instructed in the joint instructions described in Section 2.2(c), to return all documents and funds deposited with it to the respective Parties thirty (30) days after such time, unless within such thirty (30)-day period both Parties shall have performed fully all their obligations with respect to Close of Escrow, in which case the Title Company will be instructed to carry out its instructions without regard to such thirty (30)-day delay.

3. AS IS CONDITION OF THE SITE; CITY IMPROVEMENT OBLIGATIONS; INDEMNIFICATION

3.1 Site As Is; Risk of Loss

(a) **Acceptance of Site in "AS IS WITH ALL FAULTS" Condition; Risk of Loss.** Except as set forth in Sections 3.3 and 3.4, City shall not prepare the Property for any purpose whatsoever related to Friends' obligations to Construct the Improvements. Except as set forth in Sections 2.6(a), 3.3 and 3.4, Friends agrees to accept the Site in its "AS IS WITH ALL FAULTS" condition on the date of the Close of Escrow as further described in Section 3.1(c); provided, however, that, between the Effective Date and the Close of Escrow, there is no discovery of a physical condition of the Property not created by the acts or omission of Friends or its Agents that was not known to Friends prior to the Effective Date that would materially, adversely interfere with Construction of the Project for its intended uses or the operation of the

Site for its intended uses (an "Adverse Change"). It shall be a condition precedent to Friends' obligation to Close of Escrow and to accept Delivery of the Property, that there be no such Adverse Change. Notwithstanding the foregoing, City will not under any circumstances be liable to Friends for any monetary damages caused by an Adverse Change.

(b) **Independent Investigation by Friends.** Within fifteen (15) days of the Effective Date, City will provide Friends a full opportunity to inspect all of the public records of City in the possession of City's project manager for the Building and the General Manager that relate to the physical condition of the Property. City makes no representation or warranty as to the accuracy or completeness of any matters contained in such records. If such records disclose any information that is unacceptable to Friends, as determined by Friends in its sole discretion, Friends shall have the right to terminate this Agreement upon thirty (30) days prior written notice to City given within ninety (90) days of receipt of such materials.

(c) **DISCLAIMER OF REPRESENTATIONS AND WARRANTIES.** FRIENDS AGREES THAT, EXCEPT AS SET FORTH IN SECTIONS 3.3 AND 3.4, THE PROPERTY IS BEING DELIVERED BY CITY AND ACCEPTED BY FRIENDS IN ITS "AS IS WITH ALL FAULTS" CONDITION. FRIENDS SPECIFICALLY ACKNOWLEDGES AND AGREES THAT, EXCEPT AS SET FORTH IN SECTIONS 3.3 AND 3.4, NEITHER CITY, NOR ANY OF THE OTHER CITY INDEMNIFIED PARTIES, NOR ANY EMPLOYEE, OFFICER, COMMISSIONER, REPRESENTATIVE OR OTHER AGENT OF ANY OF THEM, HAS MADE, AND THERE IS HEREBY DISCLAIMED, ANY REPRESENTATION OR WARRANTY, EXPRESS OR IMPLIED, OF ANY KIND, WITH RESPECT TO THE CONDITION OF THE PROPERTY, THE SUITABILITY OR FITNESS OF THE PROPERTY OR APPURTENANCES TO THE PROPERTY FOR THE DEVELOPMENT, USE OR OPERATION OF THE PROJECT, ANY COMPLIANCE WITH LAWS OR APPLICABLE LAND USE OR ZONING REGULATIONS ANY MATTER AFFECTING THE USE, VALUE, OCCUPANCY OR ENJOYMENT OF THE PROPERTY, OR ANY OTHER MATTER WHATSOEVER PERTAINING TO THE PROPERTY OR THE PROJECT.

3.2 Release

As part of its agreement to accept the Property in accordance with the terms of Section 3.1(a), effective upon the Close of Escrow, Friends, on behalf of itself and its successors and assigns, shall be deemed to waive any right to recover from, and forever release, acquit and discharge, City, and its Agents of and from any and all Losses, whether direct or indirect, known or unknown, foreseen or unforeseen, that Friends may now have or that may arise on account of or in any way be connected with (i) the physical, geotechnical or environmental condition of the Property, including, without limitation, any Hazardous Materials in, on, under, above or about the Property (including, but not limited to, soils and groundwater conditions), and (ii) any Laws applicable thereto.

In connection with the foregoing release, Friends acknowledges that it is familiar with Section 1542 of the California Civil Code, which provides as follows:

A GENERAL RELEASE DOES NOT EXTEND TO CLAIMS WHICH THE CREDITOR DOES NOT KNOW OR EXPECT TO EXIST IN HIS OR HER FAVOR AT THE TIME OF EXECUTING THE RELEASE, WHICH IF KNOWN BY HIM OR HER MUST HAVE MATERIALLY AFFECTED HIS OR HER SETTLEMENT WITH THE DEBTOR.

Friends agrees that the release contemplated by this Section includes unknown claims. Accordingly, Friends hereby waives the benefits of Civil Code Section 1542, or under any other statute or common law principle of similar effect, in connection with the releases contained in this Section. Notwithstanding anything to the contrary in this Agreement, the foregoing release shall survive any termination of this Agreement.

3.3 Environmental Matters

(a) **Environmental Assessment.** Ecology and Environment, Inc. (“E&E”), prepared a Phase I Environmental Site Assessment for Geneva Car Barn and Powerhouse, dated February 2012 (the “**Phase I ESA**”). The Phase I ESA identified environmental conditions which were the basis of a Field Sampling Plan for Targeted Brownfields Assessment, Geneva Car Barn and Powerhouse, San Francisco, California, dated April 2012 (the “**FSB**”), and a Field Sampling Plan Addendum, Geneva Car Barn and Powerhouse, dated November 15, 2012 (the “**FSP Addendum**”). The FSP and FSP Addendum describe proposed soil sampling; indoor air mercury vapor monitoring; indoor air sampling for volatile organic compounds, and assessment of suspected asbestos-containing building materials and lead-based paint. Following the monitoring and sampling recommended in the FSP and FSP Addendum, E&E prepared a Targeted Brownfields Assessment Report for Geneva Car Barn and Powerhouse, 2301 San Jose Avenue, San Francisco, California, dated June 2013 (the “**Phase II ESA**,” and together with the FSB the “**Environmental Assessment**”), a copy of which has been made available to City and Friends. Friends received a Targeted Brownfields Assessment award to fund the monitoring and assessment effort. Based on the conclusions reached in the Environmental Assessment, E&E made a number of recommendations regarding the handling of certain material during the Project, which recommendations are set forth in the Phase II ESA and in the attached Exhibit C (the “**Recommendations Regarding Environmental Conditions**”). The Hazardous Materials present (or likely present) on the Property as identified by the Environmental Assessment are referred to herein collectively as the “**Disclosed Pre-Existing Hazardous Materials**”).

(b) **Implementation of Recommendations Regarding Environmental Conditions.** Friends shall Remediate the Disclosed Pre-Existing Hazardous Materials following Close of Escrow as a Project cost. Friends shall cause such Remediation to be performed in accordance with the Recommendations Regarding Environmental Conditions and applicable Laws, regulations and agency requirements and standards, in each case, taking into account the construction and operational activities anticipated at the Property. In order to ensure that the scope of Remediation is sufficient for the development of the Project, Friends shall consult with City prior to entering into a contract for and prior to commencing the Remediation.

(c) **Post Remediation Environmental Assessment.** Following Remediation of the Disclosed Pre-Existing Hazardous Materials, Friends shall deliver to City an

environmental assessment evidencing that the Property is clear of Disclosed Pre-Existing Hazardous Materials, which environmental assessment shall be satisfactory to City in its reasonable discretion.

(d) **Compliance with Hazardous Materials Laws.** From and after the Close of Escrow, Friends shall comply with the provisions of all Hazardous Materials Laws and all conditions for Regulatory Approval of Hazardous Materials Remediation applicable to the Property, including the Improvements, and the activities conducted on the Site, and all uses, improvements and appurtenances of and to the Property, as further provided in the Lease.

(e) **Remedies Against Other Persons.** Nothing in this Agreement is intended in any way to preclude or limit Friends from pursuing any remedies Friends may have with regard to the existence of Hazardous Materials in, on, under or about the Property against any Person other than City Indemnified Parties; provided, however, Friends may pursue such remedies only with the advance written consent of City, which consent shall not be unreasonably withheld, conditioned or delayed.

(f) **Condition of Property.** Between the Effective Date and the Close of Escrow, City shall not introduce new Hazardous Materials to the Property other than such types typically associated with any maintenance or protection of the Property by or on behalf of City.

(g) **Unknown Pre-Existing Hazardous Materials.** If prior to or during the course of construction of the Improvements, the Parties discover environmental conditions other than the Disclosed Pre-Existing Environmental Conditions that are unacceptable to Friends (“**Unknown Pre-Existing Environmental Conditions**”), the Department and Friends shall use best efforts to develop a plan for Remediation of the Unknown Pre-Existing Environmental Conditions and to identify a funding source for such Remediation, taking into consideration that certain funds available to the Department are or will be dedicated to other projects or programs as well as City budget limitations, and subject in all events to the budgetary and fiscal provisions of City’s Charter. If after using best efforts to identify a funding source for the Remediation (i) the Parties do not identify grant funding or other funding sufficient to cover the entire cost of the required work, or (ii) City, at its sole election, elects to perform the Remediation of the Unknown Pre-Existing Hazardous Materials (“**City’s Remediation Election**”) and City fails to Remediate the Unknown Pre-Existing Hazardous Materials to Friends’ satisfaction (which may, to the extent reasonably required by Friends, include the requirement that City deliver to Friends an environmental assessment evidencing that the Property is clear of such Unknown Pre-Existing Hazardous Materials) by the date agreed to by City and Friends for the performance thereof (as extended by delays resulting from Force Majeure), then Friends shall have the right to terminate this Agreement upon thirty (30) days’ prior written notice to City given not later than one hundred twenty (120) days after the date the condition triggering such termination right occurs, provided that if construction of the Improvements commenced prior to discovery of the Unknown Pre-Existing Environmental Conditions, then prior to the effective date of such termination Friends shall remove any construction debris from the Property.

3.4 SFMTA Facilities Matters

The parties acknowledge and agree that a high-tension electrical wire benefitting the SFMTA Property has been mounted to eastern wall of the Building and an alarm system serving the SFMTA Property is located, in part, within the Building. Friends acknowledges that the 2004 MOU provides that certain SFMTA facilities may remain on the Property and that SFMTA will have continuing access to such facilities. The General Manager shall use good faith efforts to reach an agreement with the Director of SFMTA requiring the relocation of the SFMTA facilities on terms and conditions reasonably acceptable to Friends and acceptable to the General Manager and the Director of SFMTA in their respective sole discretion (the "Updated MOU"). On or prior to the respective dates set forth in the Schedule of Performance, City shall (i) deliver to Friends evidence that City and/or SFMTA has entered into a contract for removal of the high-tension electrical wire and alarm system from the Building or notify Friends that City and/or SFMTA shall perform such relocation itself, and (ii) cause the removal of such high-tension electrical wire and alarm system from the Building. In no event shall such high-tension electrical wire or alarm system be relocated to any other portion of the Property or in a manner that would interfere with the Project. Friends acknowledges that the Updated MOU may provide that part or all of the cost of such relocation shall be borne by the Recreation and Park Department, and in such event City may elect to terminate this Agreement unless a source of funds for such relocation costs is found that is acceptable to City. City shall have no obligation hereunder to pay for any such relocation.

3.5 Indemnification

(a) **Indemnification by Friends Before Close of Escrow.** Without limiting any indemnity contained in any Permit to Enter, Friends shall Indemnify City and the other City Indemnified Parties from and against any and all Losses incurred in connection with or arising prior to the Close of Escrow out of the conduct of Friends or its Agents on the Property or related to the Project, including, without limitation, (i) the death of any person or any accident, injury, loss or damage whatsoever caused to any person or to the property of any person which may occur on or adjacent to the Property and which may be caused directly or indirectly by any acts done on the Property, or any acts or omissions of Friends or its Agents; (ii) any default by Friends in the observation or performance of any of the terms, covenants or conditions of this Agreement to be observed or performed on Friends' part; and (iii) the entry by Friends, its Agents or Invitees or any Person claiming through or under any of them, upon the Property. Notwithstanding the foregoing, Friends shall not be required to Indemnify City or other City Indemnified Parties against Losses if such Losses (A) are caused by the gross negligence or willful misconduct of any of City or any of the other City Indemnified Parties, including in the exercise of police powers; (B) arise from the satisfaction by Friends of the obligations of Friends under Section 11.1 below; or (C) are caused by third party claims arising from the condition or use of the Property prior to the date hereof, to the extent not arising from the negligence or willful misconduct of Friends or its Agents.

(b) **Indemnification On and After Delivery.** Friends shall Indemnify City and the other City Indemnified Parties for Losses arising after the Close of Escrow in accordance with the provisions of the Lease.

(c) **General Provisions Regarding Indemnities.**

(i) **Costs.** The foregoing Indemnities shall include, without limitation, Attorneys' Fees and Costs and the fees and costs of consultants and experts, laboratory costs, and other related costs, as well as the Indemnified Party's reasonable costs of investigating any Loss.

(ii) **Immediate Obligation to Defend.** Friends agrees to defend the City Indemnified Parties against any claims which are actually or potentially within the scope of the indemnity provisions of this Agreement even if such claims may be groundless, fraudulent or false. The City or City Indemnified Party against whom any claim is made which may be within the scope of the indemnity provisions of this Agreement shall provide notice to Friends of such claim within a reasonable time after learning of such claim, and thereafter shall cooperate with Friends in the defense of such claim; provided that any failure to provide such notice shall not affect Friends' obligations under any such indemnity provisions except to the extent Friends is prejudiced by such failure.

(iii) **Not Limited by Insurance.** The insurance requirements and other provisions of this Agreement shall not limit Friends' indemnification obligations under this Agreement, any Permit to Enter or the Lease.

(iv) **Survival.** The indemnification obligations of Friends set forth in this Agreement shall survive any termination of this Agreement as to any acts or omissions occurring prior to such date.

(v) **Additional Obligations.** The agreements to Indemnify set forth in this Agreement are in addition to, and in no way shall be construed to limit or replace, any other obligations or liabilities which Friends may have to City in this Agreement, any Permit to Enter or applicable Law.

(vi) **Defense.** Friends shall, at its option but subject to the reasonable consent and approval of City, be entitled to control the defense, compromise, or settlement of any indemnified matter through counsel of Friends' own choice; provided, however, in all cases City shall be entitled to participate in such defense, compromise, or settlement at its own expense. If Friends shall fail, however, within a reasonable time following notice from City alleging such failure, to take reasonable and appropriate action to defend such suit or claim, City shall have the right promptly to use City or to hire outside counsel (reasonably satisfactory to Friends) to carry out such defense, which expense shall be due and payable to the City within ten (10) days after receipt of an invoice therefor.

3.6 No Representation Regarding Adjacent Property

The Parties acknowledge and agree that certain SFMTA-controlled parcels adjacent to and in the immediate vicinity of the Property may be sold or otherwise made available for private development, and that such development may adversely affect the Project.

4. ACCESS BY FRIENDS

4.1 Access and Entry by Friends to the Property

(a) **Permit to Enter Before Close of Escrow.** This Section will govern the right of access to and entry upon the Property by Friends and its Agents before the Close of Escrow.

(i) City hereby grants to Friends and its Agents the right of access to and entry upon and around the Property for purposes associated with the Project from and after the Effective Date, including showing the Property to potential donors and investors and developing construction documents, provided Friends first obtains a Permit to Enter from City in substantially the form as the Permit to Enter attached hereto as Exhibit Q (the “**LDDA Permit to Enter**”), but excluding the work described in clauses (ii) through (iii) below.

(ii) Provided Friends first obtains an LDDA Permit to Enter from City for such purpose, Friends and its Agents shall have the right of access to and entry upon and around the Property for the purposes of performing testing necessary to carry out this Agreement, including invasive testing.

(iii) Friends may not perform any demolition, excavation or construction work before the Close of Escrow without the express written approval of City, which City may give or withhold in its sole and absolute discretion. If City grants such approval, City may include in a separate permit to enter such additional insurance, bond, guaranty and indemnification requirements as City reasonably determines are appropriate to protect its interests.

(iv) In making any entry upon the Property authorized in accordance with the foregoing, Friends shall not materially interfere with or obstruct the permitted, lawful use of the Property by City, or its invitees.

(v) City may require any contractor performing the work under a Permit to Enter to be a co-permittee.

(b) **Property Maintenance.** At all times prior to the Close of Escrow, and at City’s sole cost and expense, City shall maintain the Property in the same or better condition than exists as of the date hereof, provided that City shall have no obligation to maintain any portion of the Property upon which Friends has commenced Construction, and provided further that Friends, at Friends’ expense, shall maintain in the same or better condition than exists as of the date immediately preceding commencement of Construction those portions of the Property on which Construction has commenced.

4.2 **Access and Entry by Friends on SFMTA Property**

(a) **Temporary Construction License.** The Parties acknowledge and agree that access to City-owned property located immediately adjacent to the Site to the south and the east (the “**SFMTA Property**”), which property is under the control and jurisdiction of the San Francisco Municipal Transportation Agency (“**SFMTA**”), will be necessary during Construction of the Improvements for ingress, egress and staging. Access to the SFMTA Property is presently governed by the 2004 MOU. City and Friends shall use good faith efforts to obtain from SFMTA a more comprehensive temporary construction license or other right of access, in form and substance acceptable to the General Manager and Friends in their respective

reasonable discretion, for purposes of ingress, egress, and staging during Construction of the Improvements (the "Temporary Construction License").

(b) **Long-Term License.** The Parties acknowledge and agree that access to the SFMTA Property will be necessary during the term of the Lease for purposes of ingress and egress to the freight elevator and loading dock to be located on the eastern wall of the Building. Access to the SFMTA Property is presently governed by the 2004 MOU. City and Friends shall use good faith efforts to obtain from SFMTA a more comprehensive license or other right of access, in form and substance acceptable to the General Manager and Friends in their respective reasonable discretion, for purposes of ingress and egress during the term of the Lease (the "Long-Term License"), and to obtain the right to record the Long-Term License or a memorandum thereof against title to the SFMTA Property upon the Close of Escrow.

5. DEVELOPMENT OF THE SITE

5.1 Friends' Construction Obligations

(a) **Scope of Development; Schedule of Performance.** Friends shall Construct or cause to be Constructed the Improvements on the Site within the times and in the manner set forth in this Section 5 and as more particularly set forth in the Schedule of Performance, the Scope of Development attached hereto as Exhibit I, the Schematic Drawings, and the approved Construction Documents.

(b) **Timing and Extensions.** The satisfaction of the matters set forth in the Schedule of Performance by the required completion dates is an essential part of this Agreement, time being of the essence. Friends shall use its best efforts to complete the milestone tasks, including, without limitation, commencing and completing construction of each phase of the Project, by the respective dates specified in the Schedule of Performance or within such extension of time, if any, as the City may grant in writing or as otherwise permitted by this Agreement.

(i) Force Majeure.

(A) The Schedule of Performance shall be extended for delay caused by Force Majeure.

(B) If Friends determines that Force Majeure will or may prevent Friends from commencing Construction of any phase in accordance with the Schedule of Performance or performing any other act in accordance with the Schedule of Performance, then Friends shall notify City in writing of the event or condition constituting Force Majeure and shall propose equitable adjustments to the Schedule of Performance, together with a written explanation of how the proposed adjustments were calculated.

(C) Within thirty (30) days after receipt of Friends' written notice, City shall provide a written response to Friends either (1) requesting additional information as reasonably required to analyze Friends' request, or (2) agreeing with or disputing Friends' determination of the occurrence of Force Majeure, and, in the event City agrees with Friends' determination of Force Majeure, either approving Friends' requested adjustments to the Schedule

of Performance or proposing alternative adjustments to the Schedule of Performance. Provided that Friends is not in default of its obligations under this Agreement and City agrees with Friends' determination of the occurrence of Force Majeure, then City shall approve a reasonable, equitable adjustment to the Schedule of Performance. If City fails or declines to respond to Friends within thirty (30) day period described above, then Friends may at Friends' election provide written notice to City that no notice was received, and provided that such notice displays prominently on the envelope enclosing such notice and the first page of such notice, substantially the following words: "REQUEST TO EXTEND SCHEDULE OF PERFORMANCE FOR GENEVA CAR BARN. IMMEDIATE ATTENTION REQUIRED; FAILURE TO RESPOND COULD RESULT IN THE REQUEST BEING DEEMED APPROVED," the requested adjustment to the Schedule of Performance shall be deemed approved if City does not respond in writing within ten (10) days after such notice.

(D) If City requests additional information, Friends shall promptly provide such information, together with a renewed request for an adjustment to the Schedule of Performance, and the provisions of the foregoing subsection shall apply to such renewed request. If Friends and City disagree on the occurrence, duration or impact of Force Majeure or on the proposed adjustments to the Schedule of Performance, then Friends and City shall attempt in good faith to meet no less than two (2) times during the thirty (30) day period following City's written response to Friends, at a mutually agreed upon time and place, to attempt to resolve any such disagreement. During any such period, each Party shall promptly provide the other with additional information on request.

(ii) **Other Extensions.**

(A) If and at such time as Friends determines it will be unable, for reasons other than Force Majeure, to commence a phase in accordance with the Schedule of Performance or perform any other act in accordance with the Schedule of Performance, then, as soon as reasonably practicable, Friends shall prepare and submit to City in writing (1) the reasons Friends will be unable to commence such Construction or perform such other act in accordance with the Schedule of Performance; and (2) Friends' proposed adjustments to the Schedule of Performance (the "**Proposed Update**").

(B) Within sixty (60) days after receipt of Friends' Proposed Update, City shall provide a written response to Friends either (1) requesting additional information as reasonably required to analyze Friends' request, or (2) approving Friends' requested adjustments to the Schedule of Performance or (3) proposing alternative adjustments to the Schedule of Performance. If City proposes alternative adjustments to the Schedule of Performance, then City's notice to Friends shall include a written explanation of the reason(s) therefor. If City fails or declines to respond to Friends within the sixty (60) day period described above, then Friends may at Friends' election provide written notice to City that no notice was received, and provided that such notice displays prominently on the envelope enclosing such notice and the first page of such notice, substantially the following words: "REQUEST TO EXTEND SCHEDULE OF PERFORMANCE FOR GENEVA CAR BARN. IMMEDIATE ATTENTION REQUIRED; FAILURE TO RESPOND COULD RESULT IN THE REQUEST BEING DEEMED APPROVED," the requested adjustment to the Schedule of Performance shall be deemed approved if City does not respond in writing within ten (10) days after such notice.

(C) If City requests additional information, Friends shall promptly provide such information, together with a renewed request for an adjustment to the Schedule of Performance. If Friends and City disagree on the proposed adjustments to the Schedule of Performance, then Friends and City shall attempt in good faith to meet no less than two (2) times during the thirty (30) day period following City's written response to Friends, at a mutually agreed upon time and place, to attempt to resolve any such disagreement. During any such period, each Party shall promptly provide the other with additional information on request.

~~(iii)~~ **Dispute Resolution.** If Friends and City are unable to resolve any disagreement over the occurrence or duration of Force Majeure or the reasonable adjustments to the Schedule of Performance required in connection therewith, then Friends and City, by mutual agreement, may submit such dispute to non-binding arbitration, mediation or other alternate dispute resolution mechanism ("ADR") of non-judicial dispute resolution. The Party requesting ADR shall give written notice of its request, specifying the requested ADR procedure, to the other Party, who shall notify the requesting Party of its agreement or refusal to proceed within a reasonable time after receipt of the requesting notice. If the parties agree to proceed, they shall select a mutually acceptable individual, with qualifications appropriate to the subject matter of the dispute, to conduct the designated ADR, or, if the parties cannot agree on such individual, they shall submit the dispute for the applicable ADR to a commercial ADR service. In all events, the proceedings shall be conducted only in a manner acceptable to both parties. The parties may enter into operating memoranda from time to time to establish procedures for the initiation and conduct of such ADR mechanisms. Within thirty (30) days after selection of the individual conducting the ADR, such individual shall determine the resolution of the matter. In making this determination, such individual's review shall be confined to (i) the applicable terms and conditions of this Agreement; (ii) the parties' written notices to each other, as required by this Section, and (iii) any additional written information and correspondence exchanged between the parties during consultation period following City's decision to propose alternative adjustments to the Schedule of Performance.

(iv) Administrative Approval of Adjustment to Schedule of Performance. Amendment to the Schedule of Performance contemplated under this Section may be processed and approved administratively by the General Manager, and shall not require the approval of the Recreation and Park Commission or other legislative body, provided that the General Manager shall not have the right to extend the Close Date or the Completion Date by more than _____ months without approval of the Recreation and Park Commission. The granting of an extension of any date therein shall not be deemed to be a waiver of any other rights under this Agreement or imply the extension of any other dates. In the event the Schedule of Performance is amended prior to the Close of Escrow, the parties may agree to extend the Close Date by designating a new Close Date on such amended Schedule of Performance. In the event the Parties are unable to reach agreement with regard to an amended Schedule of Performance following a period of negotiation of not less than nine (9) months, then either party may terminate this Agreement upon one hundred eighty (180) days prior written notice to the other.

(c) Construction Standards. All Construction with respect to the Project shall be accomplished expeditiously, diligently within the time frames set forth in the Schedule of Performance and in accordance with good construction and engineering practices and

applicable Laws. Friends shall undertake commercially reasonable measures to minimize damage, disruption or inconvenience caused by such work and make adequate provision for the safety and convenience of all persons affected by such work. Dust, noise and other effects of such work shall be controlled using commercially reasonable methods customarily used to control deleterious effects associated with construction projects in populated or developed urban areas. Friends, while performing any Construction with respect to the Project, shall undertake commercially reasonable measures in accordance with good construction practices to minimize the risk of injury or damage to the Site and Improvements and the surrounding property, or the risk of injury to members of the public, caused by or resulting from the performance of such Construction.

(d) **Costs.** Friends shall bear any and all costs of the Project and Construction of the Improvements, including any and all cost overruns in relation to the Budget. Without limiting the foregoing, the Friends shall be responsible for performing all Property preparation work necessary for the rehabilitation and development of the Improvements. Such preparation of the Property shall include, among other things, Investigation and Remediation of Hazardous Materials required for development or operation of the Improvements, except to the extent City elects to perform such work, and all structure and substructure work.

(e) **Character Defining Features.** At all times during Construction of the Improvements and during the term of the Lease, Friends shall be solely responsible for the safekeeping and protection of the character defining features of the Building as designated by the Historic Structure Report. Friends shall take all commercially reasonable measures during such time to protect the character defining features from damage or injury. Friends shall make no changes to the character defining features of the Building except in strict accordance with the terms of this Agreement, the Construction Documents and the Regulatory Approvals.

(f) **Phased Construction.** City may at its sole discretion approve modifications to the Schedule of Performance and the review process and timeframes set forth in Section 5.8 herein to accommodate a request by Friends for phased construction of the Improvements.

5.2 Utilities

(a) **Friends Responsibility.** Friends, at its sole expense, shall arrange for the provision and construction of all on-site and off-site utilities necessary to Construct the Improvements on the Property, if any, as shown on the Construction Documents, and the cost thereof shall be included in the Budget.

5.3 Construction Documents

(a) **Definition of Construction Documents.** The Construction Documents shall consist of the following:

(i) Schematic Drawings prepared by Aiden Darling Design, comprised of those certain Schematic Drawings for the Project, dated July 12, 2010; as more particularly described on the attached Exhibit I, which generally include, without limitation (a) perspective drawings sufficient to illustrate the Project, (b) a site plan at appropriate scale

showing relationships of the Improvements with their respective uses, and designating public access areas, open space areas, walkways, loading areas and adjacent uses, (c) building plans, floor plans and elevations sufficient to describe the development proposal for the Project, and the general architectural character, and the location and size of uses, of the Project, and (d) building sections showing height relationships of the areas noted above. City has approved the Schematic Drawings.

(ii) Preliminary Construction Documents in sufficient detail and completeness to show the Improvements and the construction thereof in compliance with the Project Requirements (as defined in Section 5.4 below), and which shall generally include, without limitation, (a) site plans at appropriate scale showing the building, streets, walks, and other open spaces, with all land uses designated and all site development details and bounding streets, and points of vehicular and pedestrian access shown, (b) all building plans and elevations at appropriate scale, (c) building sections showing all typical cross sections at appropriate scale, floor plans, (e) preliminary tenant improvement plans, if applicable, (f) plans for public access areas, (g) outline specifications for materials, finishes and methods of construction, (h) exterior signage and exterior lighting plans, (i) material and color samples, and (j) roof plans showing all mechanical and other equipment. The Preliminary Construction Documents shall be in conformance with the Schematic Drawings and the Scope of Development, and shall incorporate conditions, modifications and changes specified by City or required as a condition of Regulatory Approvals. At City's election, secondary structural systems, including curtain wall members, elevators, non load-bearing walls, skylights and exterior façade will be design/build by the contractor's specialty engineer and secondary stair required for means of egress will be design/build, and will not be included in the Preliminary Construction Documents.

(iii) Final Construction Documents, which shall include all plans and specifications required under applicable Laws to be submitted with an application for a Building Permit as provided in Section 5.15 below. The Final Construction Documents shall be a final development of, and be based upon and conform to, the approved Preliminary Construction Documents for the Improvements. The Final Construction Documents shall incorporate conditions, modifications and changes required by City for the approval of the Preliminary Construction Documents for the Improvements. The Final Construction Documents shall include all drawings, specifications and documents necessary for the Improvements to be constructed and completed in accordance with this Agreement.

(b) **Exclusion.** As used in this Agreement, "Construction Documents" does not mean any contracts between Friends and any contractor, subcontractor, architect, engineer or consultant.

5.4 Project Requirements

Friends shall construct all of the Improvements in compliance with the Construction Documents and in compliance with all applicable Laws, including, without limitation, Hazardous Materials Laws and Disabled Access Laws, and as further provided in Section 2.9. The Construction Documents shall conform to and be in compliance with applicable requirements of (i) this Agreement, including the Scope of Development, the Schematic Drawings and the Special City Requirements set forth in Section 11 below, (ii) the Mitigation Measures, (iii) City's

Building Code, (iv) any required Regulatory Approvals, and (v) the Preliminary Construction Documents, and shall be consistent with the project described and preliminarily approved by the NPS in the Part 2 Application. All of the requirements set forth in this Section 5.4 are referred to collectively as the “**Project Requirements.**” Notwithstanding any other provision of this Agreement or the Lease to the contrary, City’s approval of the Schematic Drawings and the Site Plan in the respective forms attached hereto is in no manner intended to, and shall not, evidence or be deemed to evidence City’s approval of any aspect of the Project with respect to the scope of review described in this Section 5.4 or in Section 5.7 below.

5.5 Preparation of Construction Documents; Role of Architect and Structural Engineer

(a) **Preparation by Licensed Architect.** The Construction Documents shall be prepared by or signed by an architect (or architects) duly licensed to practice architecture in and by the State of California, in consultation with a licensed historic preservation architect for purposes of complying with applicable historic preservation standards required by SHPO and NPS. A California licensed architect shall coordinate the work of any associated design professionals, including engineers and landscape architects.

(b) **Inspection.** A California licensed architect shall inspect all Construction of the Improvements and shall provide certificates in the form of the Architect’s Certificate attached hereto as Exhibit J when required by City.

(c) **Certification by Structural Engineer.** A California licensed structural engineer shall review and certify all final structural plans and the sufficiency of structural support elements to support the Improvements under applicable Laws.

5.6 Submission of Construction Documents

(a) **Construction Documents.** Construction Documents shall be prepared as provided in Section 5.7 below in accordance with the Scope of Development and at the time or times established in the Schedule of Performance. As to all stages of the Construction Documents, each of the Construction Document stages is intended to constitute a further development and refinement from the previous stage. Thus, the Preliminary Construction Documents shall be in substantial conformance with the Schematic Drawings and the Scope of Development, and shall incorporate conditions, modifications and changes specified by City or required as a condition of Regulatory Approvals as approved by City. The Design Development Drawings and the Preliminary Construction Documents shall be in sufficient detail and completeness to show that the Improvements and the Construction of Improvements will be in compliance with the Project Requirements and matters previously approved. The Final Construction Documents shall be a final development of, and be based upon and conform to, the approved Preliminary Construction Documents. The Final Construction Documents shall incorporate conditions, modifications and changes required by City or Friends for the approval of the Preliminary Construction Documents. The Final Construction Documents shall include all drawings, specifications and documents necessary for the Improvements to be constructed and completed in accordance with this Agreement.

(b) **Updated Budgets and Financing Plans.** Within thirty (30) days of Friends' receipt of the Preliminary Construction Documents and of the Final Construction Documents, Friends' shall submit to City for City's review and approval an updated estimated Budget of total development costs for the Project, prepared at a level of detail commensurate with the stage of design expressed in the drawings then under review, and to the extent the Budget differs from the Budget previously submitted, shall also submit to City, for City's information, an updated Financing Plan setting forth anticipated sources and uses of funds within of the updated Budget.

5.7 Scope of Friends' Review of Construction Documents

(a) **Preparation of Preliminary Construction Documents and Final Construction Documents.** City shall cause the Preliminary Construction Documents to be prepared in accordance with the provisions of this Article 5. *[Note – edit this Section 5.7(a) if the Department has not entered into an agreement with Aidlin Darling Design for the Preliminary Construction Documents by the date this LDDA is approved by the Commission and the Board of Supervisors.]* By the date set forth in the Schedule of Performance, Friends shall proffer to City a gift of funds in an amount sufficient for City to amend City's agreement with Aidlin Darling Design as necessary for Aidlin Darling Design to complete Final Construction Documents with funds provided by Friends, provided that such amendment shall not require expenditure of any other City funds and shall be on such terms and conditions as City shall reasonably require. Any gift of funds from the Friends to the City to fund the completion of the Final Construction Documents shall be subject to acceptance and approval by the Commission and/or the City's Board of Supervisors as required under the City's Charter and Administrative Code.

(b) **Scope of Review.** Friends' review and approval of the Construction Documents under this Agreement shall address, among other matters of concern to Friends (i) conformity with the Project Requirements, and (ii) architectural appearance and aesthetics.

(c) **Effect of Review.** Except by mutual agreement with City, Friends will not disapprove or require changes subsequently in, or in a manner which is inconsistent with, matters which it has approved previously.

5.8 Construction Document Review Procedures

(a) **Role of City Staff.** City's review and approval of Construction Documents means and requires review and approval of required Construction Documents by City staff or consultants designated to review the Construction Documents by the General Manager ("Staff"). Notwithstanding any other provision of this Agreement or the Lease to the contrary, approval of the Schematic Drawings and the site plan by City in the respective forms attached hereto is in no manner intended to, and shall not, evidence or be deemed to evidence approval of the Preliminary Construction Documents or the Final Construction Documents by City. Approval of Construction Documents by City shall not be construed as approval of such documents by SHPO.

(b) Method of Friends Action/Prior Approvals for Construction Documents. Friends shall reasonably and in good faith approve, disapprove or approve conditionally the Construction Documents in writing, within thirty (30) days after submittal, so long as the applicable documents are properly submitted in accordance herewith and with the Schedule of Performance and/or the other terms of this Agreement. Failure by Friends to either approve or disapprove within such times will entitle City to an extension of time equal to the period of such delay.

(c) Timing of Friends Disapproval/Conditional Approval and City Resubmission for Construction Documents. If Friends disapproves of any of the Construction Documents in whole or in part, Friends in the written disapproval shall state the reason or reasons and may recommend changes and make other recommendations. If Friends conditionally approves the Construction Documents in whole or in part, the conditions shall be stated in writing and a reasonable time shall be stated for satisfying the conditions. City shall make a resubmittal as expeditiously as possible. City may continue making resubmissions until the approval of the submissions or the later of (i) the time specified in any conditional approval or (ii) the date specified in the Schedule of Performance, as either may be extended under the terms hereof. Failure to have a submission approved by such last date will permit termination of this Agreement by Friends on thirty (30) days' written notice to City, unless City cures such failure within such thirty (30)-day period.

(d) Method of City Action/Prior Approvals for Other Submissions. City shall reasonably and in good faith approve, disapprove or approve conditionally unless otherwise set forth herein, any submissions required under the terms of this Agreement, in writing, within forty-five (45) days after submittal, so long as the applicable documents are properly submitted in accordance herewith and with the Schedule of Performance and/or the other terms of this Agreement. Failure by City to either approve or disapprove within such times will entitle Friends to an extension of time equal to the period of such delay. Notwithstanding the foregoing, if Friends submits a full building permit application in accordance with Section 5.15(a), City's time for review shall be sixty (60) days. The Parties hereby acknowledge and agree that City and has approved the Schematic Drawings described Exhibit I.

5.9 Changes in Final Construction Documents

(a) Approval of Changes in Construction Documents. City shall not make or cause to be made any material changes in any approved Construction Documents without the express written approval in its reasonable discretion of the other Party as provided in Section 5.9(b) below. Prior to making any changes that City considers to be nonmaterial to any Friends-approved Construction Documents, City shall notify Friends in writing or verbally at the progress meetings pursuant to Section 5.11 hereof of such proposed changes. If Friends in its reasonable discretion determines that such noticed changes are material, then such changes shall be subject to Friends' approval under Section 5.9(b).

(b) Response in Connection with Construction Documents. City shall request in writing Friends' approval in connection with all material changes to previously approved Construction Documents. Friends shall respond to City in writing within thirty (30)

days after receipt of City's request. If Friends fails to respond to such request on or after twenty-five (25) days after City's written request, City may submit a second notice to Friends requesting Friends' approval or disapproval within five (5) days after City's second notice. If Friends fails to respond within such five (5)-day period, such changes will be deemed approved. Friends acknowledges that the submission, review, approval and dispute resolution process used in connection with the initial approval of the Construction Documents shall apply in connection with the approval of any changes to the Construction Documents.

5.10 Conflict Between Project Requirements and Other Governmental Requirements

(a) **Approval by City or Friends.** Neither Friends nor City shall withhold its approval, where otherwise required under this Agreement, of elements of the Construction Documents or changes in Construction Documents required by any governmental body with jurisdiction over the Project if all of the following have occurred: (i) such Party receives written notice of the required change; (ii) such Party is afforded at least thirty (30) days to discuss such element or change with the governmental body having jurisdiction over the Project and requiring such element or change and with City's architect; (iii) City's architect cooperates fully with such Party and with the governmental body having jurisdiction in seeking reasonable modifications of such requirement, or reasonable design modifications of the Improvements, or some combination of such modifications, all to the end that a design solution reasonably satisfactory to such Party may be achieved despite the imposition of such requirement; and (iv) any conditions imposed in connection with such requirements comply with Section 2.9(b).

(b) **Best Efforts to Attempt to Resolve Disputes.** Friends and City recognize that the foregoing kind of conflict may arise at any stage in the preparation or the Construction Documents, but that it is more likely to arise at or after the time of the preparation of the Final Construction Documents and may arise in connection with the issuance of building permits. Accordingly, time may be of the essence when such a conflict arises. Both Parties agree to use their best efforts to reach a solution expeditiously that is mutually satisfactory to Friends and City.

5.11 Selection of Contractor and Subcontractors

Friends' general contractor for the Project shall (1) have substantial recent experience in the construction of similar improvements in the San Francisco Bay Area, (2) be licensed by the State of California (as evidenced by Friends' submission to City of Friends' contractor's state license number), and (3) have the capacity to be bonded by a recognized surety company to assure full performance of the construction contract for the work shown on the Final Construction Documents (as evidenced by Friends' submission to City of a commitment or other writing satisfactory to City issued by a recognized surety company confirming that Friends' contractor is bondable for construction projects having a contract price not less than the contract price under the construction contract for the Improvements). Friends' architectural, surveying, engineering, legal, project management, construction, contracting, and other consulting services for the Project shall be subject to the requirements of Chapter 6 of City's Administrative Code, except for work performed by Aidlin Darling Design.

5.12 Progress Meetings/Consultation

During the preparation of Construction Documents and during the Construction of the Improvements, Staff and Friends shall hold periodic progress meetings to consider Friends' progress, and to coordinate the preparation of, submission to, and review of Construction Documents by Friends and of the Construction process by City. Staff and Friends will communicate and consult informally as frequently as is reasonably necessary to assure that the formal submittal of any Construction Documents to Friends and any matters regarding Construction can receive prompt and speedy consideration (subject to the terms of this Agreement). Friends shall keep City reasonably informed of all meetings taking place in connection with Construction and shall give City the opportunity to attend and participate in such meetings. City may at its own cost, but is not obligated to, have one or more individuals present on the Property at any time and from time to time during Construction, to observe the progress of Construction and to monitor Friends' compliance with this Agreement and any other approved submittals.

5.13 Construction Schedule

Friends shall use its best efforts to commence, prosecute and complete all Construction within the times specified in the Schedule of Performance or within such extension of time as City may reasonably grant in writing or as otherwise permitted by the Agreement, subject to Force Majeure and Litigation Force Majeure. During periods of Construction Friends shall submit written progress reports to City, and if requested by City, related or supporting information, in form and detail as may be required reasonably by City, but at least on a monthly basis.

5.14 Submittals After Completion

(a) **As Built Documents.** Friends shall furnish City as-built plans, specifications and surveys with respect to the Property within ninety (90) days after Completion of the Improvements. As used in this Section "as-built plans and specifications" means as-built field plans prepared during the course of construction. If Friends fails to provide such surveys and as-built plans and specifications to City within such period of time, City after giving notice to Friends shall have the right, but not the obligation, to cause the preparation by an architect of City's choice of final surveys and as-built plans and specifications, at Friends' sole cost, to be paid by Friends to City within thirty (30) days after City's request therefor.

(b) **Certified Construction Costs.** Within ninety (90) days after Completion of the Improvements, Friends shall furnish City with an itemized statement of all Construction Costs (which costs shall include all Friends improvement work, if any) incurred by Friends in connection with the construction of the Improvements in accordance with the final construction drawings, certified as true and accurate by a certified public accountant (the "**Certified Construction Costs**"). Friends shall keep accurate books and records of all Construction Costs incurred in accordance with accounting principles generally accepted in the construction industry. Within sixty (60) days after receipt of the statement of Certified Construction Costs, City shall have the right to inspect Friends' records regarding the construction of the Improvements and the costs incurred in connection therewith. If City disagrees with the

statement of Certified Construction Costs, City may request that such records may be audited by an independent certified public accounting firm mutually acceptable to City and Friends, or if the Parties are unable to agree, either party may apply to the Superior Court of the State of California in and for the County of San Francisco for appointment of an auditor meeting the foregoing qualifications. If the court denies or otherwise refuses to act upon such application, either party may apply to the American Arbitration Association, or any similar provider of professional commercial arbitration services, for appointment in accordance with the rules and procedures of such organization of an independent auditor. Such audit shall be binding on the Parties, except in the case of fraud, corruption or undue influence. The entire cost of the audit shall be paid by City unless the audit discovers that Friends has overstated the Construction Costs by more than three percent (3%), in which case Friends shall pay the entire cost of the audit.

5.15 Insurance Requirements

(a) **Before Close of Escrow.** Before Close of Escrow, Friends shall procure and maintain insurance coverage as required by any Permit to Enter given to Friends by City.

(b) **After Close of Escrow.** From and after Close of Escrow, Friends' obligation to maintain insurance with respect to the Site and the Project will be as set forth in the Lease, provided that Friends' shall require Friends' contractor to comply with the insurance requirements of the approved construction contract for the Project.

(c) **City Self-Help Right to Obtain Insurance.** After five (5) days' written notice to Friends, City has the right, but not the obligation, to obtain, and thereafter continuously to maintain, any insurance required by this Agreement that Friends fails to obtain or maintain, and to charge the cost of obtaining and maintaining that insurance to Friends; provided, however, if Friends reimburses City for any premiums and subsequently provides such insurance satisfactory to City, then City agrees to cancel the insurance it obtained and to credit Friends with any premium refund.

5.16 City and Other Governmental Permits

(a) **Regular Track.** As further provided in Section 2.9(b), Friends has the sole responsibility for obtaining all necessary permits for the Improvements and shall make application for such permits directly to the applicable regulatory agency (except with respect to work to be performed by City pursuant to Sections 3.3 and 3.4). Unless Friends elects to use the Site Permit method described in Section 5.15(b) below, Friends shall submit to City a complete application for a full building permit within a time adequate to obtain the same before the date set forth in the Schedule of Performance, taking into account normal processing time by City and notwithstanding the dates set forth in the Schedule of Performance for submission of Construction Documents. Upon any such submission, Friends shall use its best efforts to prosecute the application diligently to issuance.

(b) **Site Permit.** The so-called "Site Permit" method of permit approval for construction of improvements allows construction to begin with an approved site permit and addenda. Construction may continue to completion through the issuance of addenda covering

the remaining aspects and phases of construction not provided for under the initial approved portion of the building permit. City is willing to allow the Site Permit method for Construction of Improvements at the election of Friends, provided that Friends proceeds diligently and strictly in accordance with this Section and that the use of Site Permit will not delay the dates set forth in the Schedule of Performance for commencement or Completion of Construction.

(i) Under the Site Permit process, only the Site Permit and addenda required for commencement of Construction are required to satisfy the building permit condition to the Close of Escrow.

(ii) If Friends elects to use the Site Permit for any portion of the Improvements, the following provisions shall apply:

(A) Friends shall notify City in writing of its election to do so at any time after City's approval of Friends' Schematic Drawings, including submittal of a proposed sequence, scope and schedule of Site Permit addenda.

(B) City will review the schedule and sequence promptly, and within ten (10) days of receipt, will advise Friends in writing whether or not City believes that such schedule and sequence (i) comply with applicable building code requirements and provide City with adequate processing time, and (ii) would delay the construction commencement date or the Completion of the Improvements beyond the dates in the Schedule of Performance for commencement and Completion in accordance with a full building permit process. If City reasonably believes the schedule and sequence do not so comply or that such a delay would result, it will specify the basis for such belief. Failure of City to respond will be deemed to be approval of the schedule and sequence.

(C) If City disapproves of the schedule or sequence in accordance with this Section, City will meet and consult with Friends to revise the schedule or sequence to make them acceptable to City.

(D) If the schedule and sequence are approved, City will notify Friends in writing of City's required Final Construction Document submission schedule. Such schedule shall be consistent with the schedule for permit addenda submissions, advising which documents shall be approved by City as a condition of approving each permit addendum, commencing with the Site Permit. Friends acknowledges that City's approval of such submissions is a condition precedent to issuance of any permit addenda.

(iii) If Friends objects to City's schedule for Final Construction Documents submittal and review, Friends shall make its objections known to City in writing within seven (7) days of receipt of City schedule.

(iv) If the requirements above have been satisfied and if City and Friends have agreed to a Final Construction Documents submission schedule, Friends will be relieved of the requirement to submit a full set of Final Construction Documents at the time specified in the Schedule of Performance as a condition to the Close of Escrow. In lieu of such requirement, the Final Construction Documents shall be submitted sequentially in accordance

with the agreed-upon schedule established above. The Schedule of Performance will be deemed to be amended accordingly.

(v) Friends may request that City modify the Preliminary Construction Document submittal or approval process to accommodate the Site Permit schedule. If City agrees to such modifications, City will make its submission schedule consistent with the schedule for permit addenda submissions.

~~(vi) If the Site Permit or any addenda are not issued or will not be issued in accordance with City-approved schedule, Friends will advise City in writing within three (3) days of such fact and state what it believes to be the reason for the delay. City may then conduct its own investigation with Friends as to the reason for the delay. If City determines that the delay is due to acts or omissions of Friends or was contributed to by Friends, City will advise Friends. Friends shall then take all steps and prepare all documents required for the issuance of the permit addenda within forty-five (45) days of the original permit addenda issuance date.~~

(vii) If Friends so decides, it may change from the Site Permit to regular building permit at any time before commencement of construction by electing to do so in written notice to City. However, such a change may be made only if City determines that the change will not delay the commencement and completion of construction dates specified in the Schedule of Performance for the regular building permit process and that Construction Document review by City can be accommodated reasonably and in sufficient time for issuance of a full building permit and timely commencement of construction. City's determination will be final.

(viii) City's review of Final Construction Documents shall be limited to a determination of consistency with the Preliminary Construction Documents with respect to matters within the scope of City's review and approval as set forth in Section 5.7, including satisfaction of any conditions to City's approval of the Preliminary Construction Documents. Nothing herein shall limit City's review in its regulatory capacity as issuer of the Site Permit and addenda thereto under City's Building Code.

5.17 City Rights of Access

City and its Agents will have the right of access to the Property to the extent necessary to carry out the purposes of this Agreement, including, but not limited to, the inspection of Friends' maintenance of the Property (to the extent such obligation exists) and inspection of the work being performed by Friends in constructing the Improvements. To the extent reasonably practicable, City shall take reasonable action to minimize any interference with Friends' construction activities. City will not be estopped from taking any action (including, but not limited to, later claiming that the construction of the Improvements is defective, unauthorized or incomplete) nor be required to take any action as a result of any such inspection.

5.18 Wages and Working Conditions

Friends agrees that any person performing labor in the Construction of the Improvements shall be paid not less than the highest prevailing rate of wages as would be required by Section 6.22(E) of the San Francisco Administrative Code, shall be subject to the same hours and working conditions, and shall receive the same benefits as in each case are provided for similar work performed in San Francisco, California. Friends shall include in any contract for Construction a requirement that all persons performing labor under such contract shall be paid not less than the highest prevailing rate of wages for the labor so performed. Friends shall require any contractor to provide, and shall deliver to City upon request, certified payroll reports with respect to all persons performing labor in connection with the Construction.

5.19 Construction Signs and Barriers

Friends shall provide appropriate construction barriers and construction signs and post the signs on the Site during the period of construction. The size, design and location of such signs and the composition and appearance of any non-moveable construction barriers must be submitted to City for approval before installation, which approval may not be withheld, conditioned or delayed unreasonably.

5.20 Damage and Destruction

(a) **After Close of Escrow.** If at any time between the Close of Escrow and the end of the LDDA Term, a fire, flood, earthquake or other casualty damages or destroys the Site or the Improvements, or any portion of the Site or the Improvements, the obligations of the Parties shall be governed by Section 14 of the Lease.

(b) **Before Close of Escrow.** If any such casualty occurs during the LDDA Term but before the Close of Escrow, the obligations of the Parties shall be governed by Section 3.1(a) of this Agreement and this Section 5.20(b). If Friends elects not to accept the Delivery of the Property due to a fire, flood, earthquake or other casualty that damages or destroys the Site or the Improvements, or any portion of the Site or the Improvements, or due to an Adverse Change, this Agreement shall terminate and Friends shall have no further obligations hereunder.

6. CERTIFICATE OF COMPLETION

6.1 Certificate of Completion

(a) Issuance Process

(i) Before issuance by City of a Certificate of Completion, Friends may not occupy the Improvements on the Site, or any portion of the Improvements, except for construction purposes under this Agreement or the Lease, or in accordance with Section 6.4 below.

(ii) After Friends has Completed the Construction of the Improvements in accordance with all the provisions of this Agreement, including, but not limited

to, the Scope of Development and the Schedule of Performance, Friends may request a Certificate of Completion in writing. City shall act on Friends' request within thirty (30) days of receipt.

(iii) City's issuance of any Certificate of Completion does not relieve Friends or any other Person from any obligations to secure or comply with any Regulatory Approval of any agency (including City) that may be required for the occupancy or operation of the Improvements of the Project. Friends shall comply with all such requirements or conditions separately.

(b) **Condition to Approval.** If there remain uncompleted (i) customary punch list items, (ii) landscaping (to the extent (i) and (ii) are subject to City's approval), (iii) exterior finishes (to the extent Friends can demonstrate to City's reasonable satisfaction that such exterior finishes would be damaged during the course of later construction of interior improvements), or (iv) any other item that City approves in writing in its sole and absolute discretion (collectively "**Deferred Items**"), City may reasonably condition approval of a Certificate of Completion upon provision of security or other assurances in form, substance and amount satisfactory to City that all the Deferred Items will be completed in a timely fashion. Such security may include a letter of credit (in a form and issued by an institution acceptable to City) or funds in an escrow account acceptable to City (with joint escrow instructions acceptable to both Parties) in the amount of one hundred ten percent (110%) of the cost of completion of the Deferred Items as reasonably determined by City. The obligations set forth in this subsection shall survive a termination of this Agreement in the manner set forth in Section 6.1(c) below.

(c) **Definition of Completed and Completion.** For purposes of City's issuance of a Certificate of Completion in accordance with the provisions of Section 6.1(a), "**Completed**" and "**Completion**" mean completion of Construction by Friends of all aspects of the Improvements for which City's approval is required in accordance with the approved Construction Documents, and in compliance with all Regulatory Approvals needed for the occupancy and development of the Improvements, or provision of security satisfactory to City for Deferred Items under Section 6.1(b), and issuance of applicable certificates of occupancy for the portions of the Improvements that will not be leased to Friends of the Project pursuant to the Scope of Work attached to the Lease, together with completion of all such portions of the Improvements that are required for such occupancy of the Improvements.

6.2 Form and Effect of Certificate

(a) **Form of Certificates.** The Certificate of Completion will be in the form of Exhibit D attached hereto, and which permits it to be recorded in the Official Records. For purposes of this Agreement, the Certificate of Completion will be a conclusive determination of Completion of the Improvements (except for completion of Deferred Items) and of the right of Friends to occupy all of the Improvements in accordance with the terms of the Lease.

(b) **Effect.** The Certificate of Completion is not a notice of completion as referred to in Section 3093 of the California Civil Code, and is not in lieu of a certificate of

occupancy to be issued by City in its regulatory capacity, which is separately required for occupancy and is a condition precedent to issuance of a Certificate of Completion.

(c) **Termination of Agreement Upon Recordation.** Recording of the Certificate of Completion by City (or by Friends at the written request and authorization of City) will terminate this Agreement, and shall have the force and effect of a quitclaim deed by City of its interest in this Agreement; *provided, however*, that such termination shall not relieve Friends of its obligations to complete the Deferred Items as set forth in Section 6.1(b) above, nor shall such termination relieve Friends of its obligations pursuant to any of the other provisions of this Agreement which expressly survive such a termination. At the request of Friends, following recordation of a Certificate of Completion, City will execute and acknowledge a quitclaim, estoppel or other documentation, in form reasonably satisfactory to City, as may be required by any title company, Lender or Friends to confirm the complete termination of this Agreement.

6.3 Failure to Issue

If City refuses or fails to furnish a Certificate of Completion, City shall, within the thirty (30)-day period specified in Section 6.1(a)(ii) above, provide Friends with a written statement specifying the reasons City refused or failed to furnish the Certificate of Completion and identifying the items Friends shall complete or requirements it shall satisfy to obtain a Certificate of Completion.

6.4 Permission for Phased Occupancy

Friends may request in writing permission to occupy portions of the Property before issuance of a Certificate of Completion; provided that City has issued a certificate of occupancy for such space, which may be issued or withheld in City's sole and absolute discretion. Each such request shall specify the portions of the Site which Friends wishes to occupy and the intended date of occupancy. City will approve such occupancy and issue a written confirmation thereof in a form and substance reasonably satisfactory to the Parties within five (5) days of such request if Friends has obtained valid temporary certificates of occupancy for such portions of the Property, which may be issued or withheld in City's sole and absolute discretion, and no uncured Friends Event of Default exists.

7. CITY APPROVAL OF FINANCING; FUNDING OBLIGATIONS

7.1 Required Submittals

No later than the date specified in the Schedule of Performance for submission of evidence of financing, Friends shall have submitted the items listed below. Except with respect to Section 7.1(c) below, the sole purpose of City's review shall be to determine whether Friends has satisfied the criteria in Section 7.1(b)(i) and Section 7.1(b)(ii) below.

(a) A final budget of total development costs for the Site and the Improvements (the "**Budget**") in accordance with (i) the Final Construction Documents or the Preliminary Construction Documents if Friends is using the Site Permit process and (ii) the Scope of Development. The Budget shall be substantially in the form attached hereto as

Exhibit L and shall include, but not be limited to, line items for all pre-development costs, permits and fees, architectural and engineering costs, marketing costs, financing costs, hard construction costs, furniture, fixtures and equipment costs, and costs of Friends improvements to be constructed by Friends allocated between space to be occupied by Friends and by other subtenants.

(b) A statement and appropriate supporting documents certified by Friends to be true and correct and in form reasonably satisfactory to City showing sources and expected uses of funds and sufficient to demonstrate that (i) Friends has or will have adequate funds (including the funds to be contributed by City in accordance with this Agreement) to complete the Improvements in accordance with the Budget and (ii) such funds have been spent for uses described in the Budget or are committed and available for that purpose.

(c) An operating budget, including all anticipated gross revenues, all anticipated expenses, including required deposits into the Capital Maintenance Account, as required by the Lease, and including an estimate of net revenues anticipated to be realized for the period covered by such operating budget (the "**Operating Budget**"). The Operating Budget must also project expenses, gross revenues and net revenues for the four (4) year period after the initial budget year and must be approved by City as a condition to close Escrow. The scope of City's review for such approval shall include whatever City reasonably determines is necessary to conclude that the Project is financially feasible, including, without limitation, City's analysis of the assumptions underlying the Operating Budget and City's determination regarding whether the anticipated debt service will negatively impact Friends' positive cash flow and ability to operate the Project in accordance with the requirements of the Lease.

(d) With regard to all debt financing, a copy of a bona fide commitment or commitments, with no conditions other than standard and customary conditions (or as otherwise approved by City in its reasonable discretion) and no provisions requiring acts of Friends prohibited in this Agreement or the Lease or prohibiting acts of Friends required in this Agreement or the Lease, for the financing of that portion of the Budget intended to be borrowed by Friends, which must not reduce the anticipated cash flow of the Project below the level necessary to adequately fund operating expenses necessary to comply with the Approved Operating Standards, certified by Friends to be a true and correct copy or copies thereof. In evaluating the proposed Budget, City may consider whether the proposed Budget reflects a reasonable maximum loan to value ratio. The commitment or commitments shall be obtained from a Bona Fide Institutional Lender (or Lenders), and, if required by any construction lenders(s), shall include commitments for permanent financing. Friends covenants and agrees to perform any and all conditions to funding in accordance with such commitments.

(e) With regard to all grant financing, a copy of a bona fide commitment or commitments, with no conditions other than standard and customary conditions (or as otherwise approved by City in its reasonable discretion) and no provisions requiring acts of Friends prohibited in this Agreement or the Lease or prohibiting acts of Friends required in this Agreement or the Lease, for the funding of that portion of the Budget intended to be granted to Friends, certified by Friends to be a true and correct copy or copies thereof. The commitment or commitments shall be obtained from grant providers with reputations for fulfilling grant

commitments and reasonably approved by City. Friends covenants and agrees to perform any and all conditions to funding in accordance with such commitments.

(f) With regard to all unpaid capital campaign contributions or other unpaid contributions from individual donors designated as sources of funds for development of the Project, for each pledgee, a written pledge which meets the provisions for recording pledges under the Guide, executed by such pledgee, showing the name of the pledgee, the amount of the pledge and the date by which the pledge will be paid.

(g) With regard to all paid capital contributions or other paid contributions from the individual donors, a written statement with appropriate supporting documents certified by Friends to be true and correct and in a form reasonably satisfactory to City showing actual receipt of pledged contributions and describing in detail any expenditure thereof previously made.

(h) Evidence of a guaranteed maximum price contract or a stipulated sum contract for Construction of the Improvements consistent with the approved Budget and the financing for the Project as described in Section 7.1(c) through 7.1(g) above in form reasonably acceptable to City with a contractor reasonably acceptable to City (a "**Construction Contract**"). Except as otherwise specifically agreed by the General Manager in writing, the Construction Contract shall be a contract on commercially reasonable terms for construction of the Improvements described in the Final Construction Documents: (A) with a contract sum or guaranteed maximum price consistent with the approved Budget and financing, (B) requiring contractor to obtain performance and payment bonds guaranteeing in full the contractor's performance and payment of subcontractors under the Construction Contract; (C) naming City and its boards, commissions, directors, officers, agents, and employees as co-indemnitees with respect to Tenant's contractor's obligation to indemnify and hold harmless Friends and its directors, officers, agents, and employees from all Losses directly or indirectly arising out of, connected with, or resulting from the contractor's performance or nonperformance under the Construction Contract; (D) requiring Friends and Contractor (as applicable) to obtain and maintain insurance coverages reasonably acceptable to City, including general liability and builder's risk insurance coverage that names City and its directors, officers, agents, and employees as additional insureds under the terms of the policies, (E) identifying City as an intended third party beneficiary of the Construction Contract, with the right to enforce the terms and conditions of the Construction Contract and pursue all claims thereunder as if it were an original party thereto; (F) consenting to the assignment of the Construction Contract to the City, in whole or in part, including but not limited to the assignment of (i) all express and implied warranties and guarantees from the contractor, all subcontractors and suppliers, (ii) all contractual rights related to the correction of nonconforming work, and (iii) the right to pursue claim(s) for patent and latent defects in the work and the completed project; and (G) providing for the contractor's(s) obligation, for a period of at least one (1) year after the final completion of construction of the Improvements, to correct, repair, and replace any work that fails to conform to the Final Construction Documents (as the same may be revised during construction pursuant to properly approved change orders) and damage due to: (i) faulty materials or workmanship; or (ii) defective installation by such contractor(s) of materials or equipment manufactured by others.

(i) Evidence of a performance bond approved by City, issued by a responsible surety company licensed to do business in California and acceptable to City, that guarantees in full (i) the Construction of the Improvements in accordance with this Agreement in an amount not less than the value of the completed Improvements and (ii) if the Project is not completed as required by this Agreement, the restoration of the Property to the condition required by SHPO, including, without limitation, the removal of any new construction or installation required to satisfy the Secretary's Standards (the "Performance Bond").

The foregoing submissions required under this Section 7.1 may be in substantially final form (including the pricing under the Construction Contract) at the time of initial submission by Friends, but must be noted as such at the time of such submission and all material changes to such submission thereafter must be resubmitted to City for approval with all additions and deletions clearly noted by Friends. All such submissions must be in final form by no later than ten (10) days prior to the Close of Escrow.

7.2 Approval Process

Within thirty (30) days after Friends' submission of all of the documents described in Section 7.1 above, City will notify Friends in writing of its approval or disapproval (including the reasons for disapproval) of the evidence of financing as described in Sections 7.1(b) and Section 7.1(c) above, provided that at least forty-five (45) days before the date of such request for approval, City shall have received Preliminary Construction Documents in accordance with Section 5 above in sufficient detail to allow City to obtain a cost estimator's report if City, in its sole discretion and at its sole cost and expense, determines to obtain such a report.

7.3 Financing Plan

The Financing Plan approved by City is attached hereto as Exhibit M. Friends must keep City informed of Friends' implementation of the Financing Plan in a written report submitted to City beginning six (6) months after the Effective Date and each six (6) months thereafter until the Close of Escrow. In connection with its submission of the financing submittals described in Section 7.1 above, Friends shall provide a detailed written explanation of all material differences between the components of the attached Financing Plan and the financing submittals described in Section 7.1 above.

7.4 Funding Obligations of the Parties

(a) **Friends' Obligation.** Friends shall pay the cost of Construction of the Improvements, except to the extent specifically provided herein.

(b) **Cooperation.** It is the Parties' goal that the Friends and the City share the cost of the Project in the manner described in this Agreement, with Project funds to be raised by the Parties from a variety of public and private sources. Accordingly, Department and Friends agree to work together to jointly raise funding for the Project. The Parties agree to identify and pursue private and public sources of funds for Construction of the Improvements. Specifically, the Parties will pursue (i) public sources of funding such as Historic Preservation Tax Credits and, to the extent available, New Markets Tax Credits ("Tax Credits") and (ii) private sources of

funding including without limitation donations and/or pledges made to Friends, in the form of foundation and corporate grants, and individual gifts.

(c) **Department Support.** Department staff will spend reasonable time and resources to properly assist Friends' efforts in pursuing funds for the Construction of the Improvements. The Department will also present the Project to prospective funders as appropriate.

(d) **Department Grant Funds and Other Grants.** Friends will apply for a matching grant of up to \$3,000,000 from the Department's 2012 bond-funded Community Opportunity Fund to be applied towards the cost of Construction of the Improvements. Department staff shall keep Friends informed about the requirements of the Community Opportunity Fund application process. Notwithstanding the amount (if any) of Community Opportunity Fund grant funds shown on the proposed budget, Friends acknowledges that the selection process for the Community Opportunity Fund is the responsibility of an independent body and that, while Department staff will support the Friends' efforts to apply for the grant, City cannot make a commitment of an award from the Community Opportunity Fund for the Project.

(e) **Failure to Receive Grant Funds.** If Friends fails to secure a Community Opportunity Fund grant in the amount specified in Section 7.4(d) by the date specified in the Schedule of Performance, Friends may, at its sole discretion, elect to raise such funds from other sources or terminate this Agreement.

(f) **Other City Funds.** Separate and apart from the Community Opportunity Fund's matching grant program and Tax Credits programs, the Department and Friends will jointly pursue additional City funding to match latter and final stage private funds raised for the Project. Friends acknowledges that, while Department staff will pursue such additional matching funding, City cannot make a commitment of additional funding and any such funding shall be subject to the budgetary and fiscal provisions of the City's Charter.

7.5 Disbursement of Community Opportunity Fund Grant Funds and Other City Funds.

Community Opportunity Fund grant funds and any other funds provided by or through City will be held and disbursed in accordance with requirements of the applicable program. Without limiting the foregoing, Friends acknowledges that if Friends is awarded a grant from Community Opportunity Fund and the remaining necessary Project funds have not been raised by December 31, 2017, the Community Opportunity Fund grant funds will be released back into the Community Opportunity Fund for re-distribution. If the applicable program requires the City, the Department, or the Friends to enter into one or more additional agreements regarding use of the funds, construction management or coordination, or the like, Friends and Department staff shall reasonably cooperate to negotiate in good faith regarding the terms of such agreement. Friends acknowledges that any future agreement to which the City or the Department is a party would be subject to the prior approval of the then-Commission, or its designee, in its sole and absolute discretion.

8. ENCUMBRANCES AND LIENS

8.1 No Mortgage of Fee

Friends may not under any circumstance engage in any financing or other transaction creating any mortgage, lien or other encumbrance on City's fee interest in the Property. City's fee interest in the Property shall not be subordinated under any circumstance whatsoever to any Mortgage allowed under the Lease.

8.2 Leasehold Liens

Following the Close of Escrow, Friends shall, pursuant to the terms and conditions of the Lease, have the right to assign, mortgage or encumber any or all of its right, title and interest in the Property by way of leasehold mortgages, deeds of trust or other security instruments to any Mortgagee under a Mortgage permitted under the Lease. Friends may assign, mortgage or encumber its interest under this Agreement to any Mortgagee permitted under the Lease under a Mortgage permitted under the Lease, and in such event all of the provisions set forth in the Lease relating to the rights of Mortgagees shall also apply to the rights and obligations of Friends and City under this Agreement.

8.3 Mechanics' Liens

Friends shall keep the Site, this Agreement, and any Improvements thereon free from any liens arising out of any work performed, materials furnished or obligations incurred by Friends or its Agents. If Friends does not, within twenty (20) days following the imposition of any such lien, cause the same to be released of record or sufficiently bonded over in City's reasonable determination, it shall be a material default under this Agreement, and City shall have, in addition to all other remedies provided by this Agreement or by Law, the right but not the obligation to cause the same to be released by such means as it shall deem proper, including without limitation, payment of the claim giving rise to such lien. All sums paid by City for such purpose and all reasonable expenses incurred by City in connection therewith shall be payable to City by Friends within thirty (30) days following written demand by City. City shall keep the Site and any Improvements thereon free from any liens arising out of any work performed, materials furnished or obligations incurred by Agents of City.

8.4 Contests

Friends may contest the validity or amount of any tax, assessment, encumbrance or lien related to the Property and to pursue any remedies associated with such contest; *provided, however*, such contest and pursuit of remedies does not subject the Property or any portion of it to forfeiture or sale and such contest shall be subject to all of the terms and conditions of the Lease, including, but not limited to, the provision of security.

9. ASSIGNMENT AND TRANSFER

9.1 Prohibition Against Transfer of the Agreement or Significant Change

Except as otherwise permitted under Section 8.2 or as required in connection with the utilization of Historic Preservation Tax Credits, Friends may not sell, convey, assign, transfer, alienate or otherwise dispose of all or any of its interest or rights in this Agreement, including, but not limited to, any right or obligation to acquire a leasehold estate in the Site, develop the Site or otherwise do any of the above or make any contract or agreement to do any of the same (collectively, a “**Transfer**”), or permit a Significant Change to occur, without in each instance obtaining the prior written approval of City, except that a Transfer or Significant Change shall be permitted on and after the Close of Escrow in conjunction with a Transfer or Significant Change permitted by the Lease or approved by City in accordance with the Lease. City’s consent to a Transfer or Significant Change prior to the Close of Escrow may be given, withheld, or conditioned in the City’s sole and absolute discretion, except that if such Transfer or Significant Change is requested solely in connection with obtaining Historic Tax Credits or New Markets Tax Credits, the City’s consent shall not be unreasonably withheld or conditioned. Consent to any one Transfer or Significant Change will not be a waiver of City’s right to require such consent for each and every Transfer or Significant Change. Friends shall reimburse City for its reasonable costs of reviewing a proposed Transfer or Significant Change, as provided in the Lease, even if such cost is incurred prior to Close of Escrow.

9.2 No Release of Obligations

Except as expressly provided in the Lease or by the specific written approval of City, which City may give or withhold in its sole discretion, no Transfer or Significant Change will relieve Friends or any other party from any obligations under this Agreement or the Lease.

10. DEFAULTS, REMEDIES AND TERMINATION

10.1 Events of Default — Friends

Except to the extent caused directly or indirectly by a failure of City to comply with the terms of this Agreement, any one or more of the following constitute an Event of Default by Friends:

(a) Friends fails to use its good faith efforts to obtain all Regulatory Approvals or all the elements of the financing described in Section 7 above within the time frames set forth in the Schedule of Performance;

(b) Friends fails to commence in accordance with the Schedule of Performance, or after commencement fails to prosecute diligently to Completion, the Construction of the Improvements to be constructed on the Site under the Scope of Development on or before the required completion dates set forth in the Schedule of Performance, or abandons or substantially suspends Construction for more than thirty (30) consecutive days, and such failure to commence or prosecute diligently to completion, abandonment or suspension continues for a period of sixty (60) days (or such later date as agreed to by City in its sole discretion) from the date of written notice from City, except for Deferred Items, if any;

(c) Friends fails to pay any amount required to be paid under this Agreement when due and such failure continues for thirty (30) days following written notice from City to Friends;

(d) Friends does not accept Delivery of the Property in accordance with this Agreement within the times set forth in this Agreement, provided that all conditions to Friends' obligation to the Close of Escrow as set forth in Section 2.4 above have been satisfied or waived, and such failure continues for a period of fifteen (15) business days after written notice from City;

(e) Friends fails to perform its obligations under the Card Check Ordinance, Workforce Hiring Program, Prevailing Wage Provision or First Source Hiring Program set forth in this Agreement (together, the "**Special City Requirements**"); provided, however, that any rights to cure and City's remedies for any default under the Special City Requirements will be only as set forth in such Special City Requirements;

(f) Friends does not submit such of the Construction Documents as are required to be submitted within the times provided in this Agreement and the Schedule of Performance or by any permitted Site Permit, and Friends does not cure such default within sixty (60) days after the date of written demand by City to Friends;

(g) After Close of Escrow, Friends commits an Event of Default under the Lease, as Event of Default is defined in the Lease, but such Event of Default under this Agreement shall be deemed cured if the Event of Default as defined in the Lease is cured pursuant thereto;

(h) Friends files a petition for relief, or an order for relief is entered against Friends, in any case under applicable bankruptcy or insolvency Law, or any comparable Law that is now or hereafter may be in effect, whether for liquidation or reorganization, which proceedings if filed against Friends are not dismissed or stayed within sixty (60) days;

(i) A writ of execution is levied on this Agreement which is not released within sixty (60) days, or a receiver, trustee or custodian is appointed to take custody of all or any material part of the property of Friends, which appointment is not dismissed within sixty (60) days;

(j) Friends makes a general assignment for the benefit of its creditors;

(k) Friends fails to maintain the insurance required pursuant to Section 5.14, or fails to deliver certificates or policies as required pursuant to that Section, and such failure continues for fifteen (15) days following written notice from City to Friends;

(l) Without limiting any other provisions of this Section, Friends violates any other covenant, or fails to perform any other obligation to be performed by Friends under this Agreement or the Lease at the time such performance is due (including the expiration of any specified grace period), and such violation or failures continues without cure for more than thirty (30) days after written notice from City specifying the nature of such violation or failure, or, if such cure cannot reasonably be completed within such thirty (30)-day period, if Friends

does not within such thirty (30)-day period commence such cure, or having so commenced, does not prosecute such cure with diligence and dispatch to completion within a reasonable time thereafter;

(m) Friends executes any mortgage, encumbrance or lien not permitted by this Agreement, or such mortgage, encumbrance or lien is placed of record (regardless of whether or when it is foreclosed or otherwise enforced); and

(n) Any Transfer or Significant Change made in violation of Section 9.1 above.

10.2 Remedies of City

Upon the occurrence of an Event of Default by Friends, City has the remedies set forth below:

(a) **Termination.** City may terminate this Agreement upon thirty (30) days' written notice to Friends; *provided, however*, in the case of an Event of Default under Sections 10.1(g) or (l), City may exercise such remedy only if such Event of Default involves a material or willful breach by Friends of Friends' covenants and obligations under this Agreement or the Lease, as applicable.

(b) **Specific Performance.** City may institute an action for specific performance.

(c) **Other Remedies.** City is entitled to all other remedies permitted by law or at equity or under this Agreement, including without limitation damages (but excluding punitive, incidental or consequential damages). Without limiting Section 10.5(c) below, the remedies provided for in this Agreement are in addition to and not in limitation of other remedies including, but not limited to, the remedies provided in the Lease or under the Special City Requirements.

(d) **Nonliability of Friends' Member, Partners, Shareholders, Directors Officers and Employees.** No member, officer, partner, agent, shareholder, director or employee of Friends will be personally liable to City in the event of an Event of Default by Friends or for any amount which may become due to City or with respect to any obligations under the terms of this Agreement or the Lease including, without limitation, the indemnity obligations set forth in Section 3.5.

10.3 Events of Default – City

Any one or more of the following constitute an Event of Default by City:

(a) City fails to make Delivery of the Property in violation of this Agreement within the times set forth in this Agreement, provided that all conditions to City's obligation to the Close of Escrow as set forth in Section 2.3 above have been satisfied or waived by City, and such failure continues for thirty (30) days after written notice from Friends;

(b) Without limiting subsection (a) above, City violates any other covenant, or fails to perform any other obligation to be performed by City under this Agreement or the Lease at the time such performance is due (including the expiration of any specified grace period) and such violation or failure continues without cure for more than thirty (30) days after the written notice by Friends, specifying the nature of such violation or failure, or, if such cure cannot reasonably be completed within such thirty (30)-day period, if City does not within such thirty (30)-day period commence such cure, or having so commenced does not prosecute such cure with diligence and dispatch to completion within a reasonable time thereafter; and

(c) City fails to pay any amount required to be paid under this Agreement when due and such failure continues for thirty (30) days following written notice from Friends to City.

10.4 Remedies of Friends

Upon the occurrence of an Event of Default by City, Friends has the remedies set forth below:

(a) **Termination.** Friends may terminate this Agreement upon thirty (30) days' written notice to City only if the Event of Default would make impossible Completion of Improvements in accordance with the Schedule of Performance or the Budget and the provisions of this Agreement.

(b) **Specific Performance.** Friends may institute an action for specific performance. City acknowledges that an Event of Default by City hereunder will be conclusively deemed to be a breach of an agreement to transfer real property that cannot be adequately relieved by pecuniary compensation as set forth in California Civil Code Section 3387.

(c) **Damages.** If an Event of Default occurs under Section 10.3(a) above, City will be liable for Friends' actual out-of-pocket damages, but shall not be liable for any consequential or incidental damages (including, but not limited to, lost profits). If an Event of Default occurs under Section 10.3(b) above, City will not be liable to Friends for any damages caused by such Event of Default.

(d) **Other Remedies.** Subject to the limitations in Section 10.4(c), Friends is entitled to all other remedies permitted by law or at equity.

(e) **Nonliability of City Members, Officials and Employees.** No member, official, commissioner or employee of City will be personally liable to Friends, or any successor in interest, in the event of an Event of Default by City or for any amount which may become due to Friends or successor or on any obligations under the terms of this Agreement.

10.5 General

(a) **Institution of Legal Actions.** Subject to the limitations contained in this Agreement, either Party may institute legal action to cure correct or remedy any Event of Default, to recover damages for any default or to obtain any other remedy consistent with the

terms of this Agreement. Such legal actions shall be instituted in the Superior Court of City and County of San Francisco, State of California, in any other appropriate court in that City and County or, if appropriate, in the Federal District Court in San Francisco, California.

(b) **Acceptance of Service of Process.** In the event that any legal action is commenced by Friends against City, service of process on City shall be made by personal service upon City in such manner as may be provided by Law. In the event that any legal action is commenced by City against Friends, service of process on Friends shall be made by personal service upon Friends at the address provided for notices or such other address as shall have been given to City by Friends under Section 12.2, or in such other manner as may be provided by Law, and will be valid whether made within or outside of the State of California.

(c) **Rights and Remedies Are Cumulative.** Except with respect to any rights and remedies expressly declared to be exclusive in this Agreement, the rights and remedies of the Parties to this Agreement, whether provided by law, in equity or by this Agreement, are cumulative, and not in derogation of other rights and remedies found in this Agreement and, after Delivery, in the Lease. The exercise by either Party of any one or more of such remedies will not preclude the exercise by it, at the same or a different time, of any other such remedies for the same default or breach or of any of its remedies for any other default or breach by the other Party. No waiver made by either Party with respect to the performance, or manner or time of performance, or any obligation of the other party or any condition to its own obligation under this Agreement will be considered a waiver with respect to the particular obligation of the other party or condition to its own obligation beyond those expressly waived to the extent of such waiver, or a waiver in any respect in regard to any other rights of the Party making the waiver or any other obligations of the other Party.

10.6 Plans and Data

If either Party terminates this Agreement before Completion of the Improvements, Friends shall assign and deliver to City any and all copies of reports and studies in its possession of Friends or Friends' agents, employees, contractors, architects, engineers or consultants or reasonably obtainable by Friends or reports and studies prepared by or for Friends regarding the Property and all Construction Documents in the possession of Friends or Friends' agents, employees, contractors, architects, engineers or consultants or reasonably obtainable by Friends, or prepared for Friends, for the development of the Property within thirty (30) days after written demand from City, in each case if and to the extent assignable. City may use said reports, studies and Construction Documents for any purpose whatsoever relating to the Site, without cost or liability therefor to Friends or any other Person; provided, however, City shall release Friends and Friends' contractor, architect, engineer, agents, employees and other consultants from any Losses arising out of City's use of such reports and Construction Documents except to the extent such contractor, architect, engineer, agent, employee or other consultant is retained by City to complete construction. The Friends shall include in all contracts and authorizations for services pertaining to the planning and design of the Improvements an express agreement by the Person performing such services that the City may use such reports, studies or Construction Documents as provided in this Section 10.6 without compensation or payment from the City in the event such reports, studies or Construction Documents are delivered to the City under the provisions of this Section 10.6, provided that the City agrees (i) not to remove the name of the

preparer of such reports of Construction Documents without the preparer's written permission or (ii) to remove it at their written request.

10.7 Return of Site

If this Agreement terminates due to an Event of Default by Friends, Friends shall, at its sole expense and as promptly as practicable, return the Property to City in a condition not less safe than the condition of the Property on the Effective Date, and unless otherwise requested by City, shall remove all loose building materials and debris present at the Property resulting from Friends' Construction activities. In the event that Friends is required to return the Property as provided above in this Section 10.7, Friends shall obtain those permits customary and necessary to enter upon the Property in order to complete such work and shall otherwise comply with applicable Law. In such event, City shall cooperate with Friends in Friends' efforts to obtain such permits, provided that City will not be required to expend any money or undertake any obligations in connection therewith. Notwithstanding any such termination, Friends shall remain responsible for any obligations with respect to the Investigation and Remediation of Hazardous Materials arising after the Close of Escrow to the extent provided in this Agreement and the Lease; provided, however, that Friends shall have no responsibility for any obligations with respect to the Investigation and Remediation of Unknown Pre-Existing Hazardous Materials to the extent City made City's Remediation Election with respect thereto. The provisions of this Section shall survive any termination of this Agreement.

11. SPECIAL PROVISIONS

Friends agrees to comply with the following, based on the requirements in effect as of the Effective Date, and as they may be amended between the Effective Date and the Lease Commencement Date.

11.1 Non-Discrimination in City Contracts and Benefits Ordinance.

(a) **Covenant Not to Discriminate.** In the performance of this Agreement, Friends covenants and agrees not to discriminate on the basis of the fact or perception of a person's race, color, creed, religion, national origin, ancestry, age, sex, sexual orientation, gender identity, domestic partner status, marital status, disability, weight, height or Acquired Immune Deficiency Syndrome or HIV status (AIDS/HIV status) against any employee of, any City employee working with, or applicant for employment with Friends, in any of Friends' operations within the United States, or against any person seeking accommodations, advantages, facilities, privileges, services, or membership in all business, social, or other establishments or organizations operated by Friends.

(b) **Subleases and Other Subcontracts.** Friends shall include in all subleases and other subcontracts relating to the Property a non-discrimination clause applicable to such subtenant or other subcontractor in substantially the form of Section 11.1(a) above. In addition, Friends shall incorporate by reference in all subleases and other subcontracts the provisions of Sections 12B.2(a), 12B.2(c)-(k) and 12C.3 of the San Francisco Administrative Code and shall require all subtenants and other subcontractors to comply with such provisions.

Friends' failure to comply the obligations in this subsection shall constitute a material breach of this Agreement.

(c) **Non-Discrimination in Benefits.** Friends does not as of the date of this Agreement and will not during the LDDA Term or Lease Term, in any of its operations in San Francisco or where the work is being performed for City or elsewhere within the United States, discriminate in the provision of bereavement leave, family medical leave, health benefits, membership or membership discounts, moving expenses, pension and retirement benefits or travel benefits (collectively "**Core Benefits**") as well as any benefits other than the Core Benefits between employees with domestic partners and employees with spouses, and/or between the domestic partners and spouses of such employees, where the domestic partnership has been registered with a governmental entity pursuant to state or local law authorizing such registration, subject to the conditions set forth in Section 12B.2(b) of the San Francisco Administrative Code.

(d) **HRC Form.** On or prior to the Effective Date, Friends shall execute and deliver to City the "Nondiscrimination in Contracts and Benefits" form approved by the San Francisco Human Rights Commission.

(e) **Incorporation of Administrative Code Provisions by Reference.** The provisions of Chapters 12B and 12C of the San Francisco Administrative Code relating to non-discrimination by parties contracting for the lease of City property are incorporated in this Section by reference and made a part of this Agreement as though fully set forth herein. Friends shall comply fully with and be bound by all of the provisions that apply to this Agreement and the Lease under such Chapters of the Administrative Code, including but not limited to the remedies provided in such Chapters. Without limiting the foregoing, Friends understands that pursuant to Section 12B.2(h) of the San Francisco Administrative Code, a penalty of Fifty Dollars (\$50) for each person for each calendar day during which such person was discriminated against in violation of the provisions of this Agreement may be assessed against Friends and/or deducted from any payments due Friends.

11.2 Mitigation Measures

In order to mitigate any significant environmental impacts of development of the Property, Friends agrees that the rehabilitation and construction of the Improvements will be in accordance with any mitigation measures imposed through a final environmental impact report certified by City.

11.3 MacBride Principles — Northern Ireland

City and County of San Francisco urges companies doing business in Northern Ireland to move toward resolving employment inequities and encourages them to abide by the MacBride Principles as expressed in San Francisco Administrative Code Section 12F.1, et seq. City and County of San Francisco also urges San Francisco companies to do business with corporations that abide by the MacBride Principles. Friends acknowledges that it has read and understands the above statement of City and County of San Francisco concerning doing business in Northern Ireland.

11.4 Tropical Hardwood Ban/Virgin Redwood Ban

Pursuant to § 804(b) of the San Francisco Environment Code, City urges Friends not to import, purchase, obtain, or use for any purpose, any tropical hardwood, tropical hardwood wood product, virgin redwood or virgin redwood wood product. Except as expressly permitted by the application of Sections 802(b) and 803(b) of the San Francisco Environment Code, Friends shall not provide any items to the rehabilitation or development of the Property, or otherwise in the performance of this Agreement or the Lease which are tropical hardwoods, tropical hardwood wood products, virgin redwood, or virgin redwood products. In the event Friends fails to comply in good faith with any of the provisions of Chapter 8 of the San Francisco Environment Code, Friends shall be liable for liquidated damages for each violation in any amount equal to the contractor's net profit on the contract, or five percent (5%) of the total amount of the contract dollars, whichever is greater.

11.5 Tobacco Product Advertising Prohibition

Friends acknowledges and agrees that no advertising of cigarettes or tobacco products shall be allowed on the Property. The foregoing prohibition shall include the placement of the name of a company producing, selling or distributing cigarettes or tobacco products or the name of any cigarette or tobacco product in any promotion of any event or product, or on any sign. The foregoing prohibition shall not apply to any advertisement sponsored by a state, local or nonprofit entity designed to communicate the health hazards of cigarettes and tobacco products or to encourage people not to smoke or to stop smoking.

11.6 Drug-Free Workplace

Friends acknowledges that pursuant to the Federal Drug-Free Workplace Act of 1989, the unlawful manufacture, distribution, dispensation, possession, or use of a controlled substance is prohibited on City premises. Friends and its employees, agents or assigns shall comply with all terms and provisions of such Act and the rules and regulations promulgated thereunder.

11.7 Pesticide Ordinance

Friends shall comply with the provisions of Section 308 of Chapter 3 of the San Francisco Environment Code (the "Pesticide Ordinance") which (i) prohibit the use of certain pesticides on City property, (ii) require the posting of certain notices and the maintenance of certain records regarding pesticide usage and (iii) require Friends to submit to City an integrated pest management ("IPM") plan that (a) lists, to the extent reasonably possible, the types and estimated quantities of pesticides that Friends may need to apply to the Property during the terms of this Agreement or the Lease, (b) describes the steps Friends will take to meet City's IPM Policy described in Section 300 of the Pesticide Ordinance, and (c) identifies by name, title, address and telephone number, an individual to act as Friends' primary IPM contact person with City. In addition, Friends shall comply with the requirements of Sections 303(a) and 303(b) of the Pesticide Ordinance. Nothing herein shall prevent Friends, through City, from seeking a determination from the Agency on the Environment that it is exempt from complying with certain portions of the Pesticide Ordinance as provided in Section 307 thereof.

11.8 First Source Hiring Ordinance

City has adopted a First Source Hiring Ordinance (San Francisco Administrative Code Chapter 83), which established specific requirements, procedures and monitoring for first source hiring of qualified economically disadvantaged individuals for entry level positions (“**First Source Hiring Program**”), and Friends agrees to duly execute and deliver to City simultaneously with the execution of this Agreement, and be bound by, the terms and conditions of the First Source Hiring Agreement attached hereto as Exhibit N, which includes the requirements of the First Source Hiring Ordinance.

11.9 Card Check Ordinance

City has adopted a Card Check Ordinance (San Francisco Administrative Code Sections 23.50-23.56). That ordinance requires employers of employees in hotel or restaurant projects on City property with more than fifty (50) employees to enter into a “Card Check” agreement with a labor union regarding the preference of employees to be represented by a labor union to act as their exclusive bargaining representative. Friends acknowledges and agrees that the Lease will require Friends and Friends’ subtenants to comply with the requirements of such Ordinance to the extent applicable.

11.10 Workforce Hiring Program

In furtherance of its covenant not to discriminate in Section 11.1 above, Friends is committed to affording opportunities for minority-owned enterprises, women-owned enterprises, and economically disadvantaged local businesses to participate in the architecture, design, engineering, and construction of the Improvements, and agrees as of the date of this Agreement to implement the Workforce Hiring Plan approved by City and attached hereto as Exhibit O as to the Site and Improvements.

11.11 Friends Conflicts of Interest

Friends states that it is familiar with the provisions of Section 15.103 of the San Francisco Charter, Article III, Chapter 2 of City’s Campaign and Governmental Conduct Code, and Section 87100 et seq. and Section 1090 et seq. of the Government Code of the State of California, certifies that it knows of no facts which would constitute a violation of such provisions and agrees that if Friends becomes aware of any such fact during the term of this Agreement Friends shall immediately notify City. Friends further certifies that it has made a complete disclosure to City of all facts bearing on any possible interests, direct or indirect, which Friends believes any officer or employee of City presently has or will have in this Agreement or in the performance thereof or in any portion of the profits thereof. Willful failure by Friends to make such disclosure, if any, shall constitute grounds for City’s termination and cancellation of this Agreement.

11.12 Prohibition of Political Activity with City Funds

In accordance with S.F. Administrative Code Chapter 12.0, no funds appropriated by City for this Agreement may be expended for organizing, creating, funding, participating in, supporting, or attempting to influence any political campaign for a candidate or for a ballot measure (collectively, “**Political Activity**”). The terms of San Francisco Administrative Code Chapter 12.0 are incorporated herein by this reference. Accordingly, an employee working in

any position funded under this Agreement shall not engage in any Political Activity during the work hours funded hereunder, nor shall any equipment or resource funded by this Agreement be used for any Political Activity. In the event Friends, or any staff member in association with Friends, engages in any Political Activity, then (i) Friends shall keep and maintain appropriate records to evidence compliance with this section, and (ii) Friends shall have the burden to prove that no funding from this Agreement has been used for such Political Activity. Friends agrees to cooperate with any audit by City or its designee in order to ensure compliance with this Section. In the event Friends violates the provisions of this Section, City may, in addition to any other rights or remedies available hereunder, (i) terminate this Agreement and any other agreements between Friends and City, and (ii) prohibit Friends from bidding on or receiving any new City contract for a period of two (2) years.

11.13 Resource-Efficient Building Ordinance

Friends acknowledges that City and County of San Francisco has enacted San Francisco Environment Code Chapter 7 relating to resource-efficient City buildings and resource-efficient pilot projects. Friends hereby agrees it shall comply with the applicable provisions of such code sections as such sections may apply to the Property. Upon the request of Friends, if the General Manager determines that compliance with certain provisions of the code section would prevent Friends from complying with the Secretary's Standards or otherwise warrants a waiver as set forth in such code, the General Manager will request a waiver of such code sections.

11.14 Sunshine Ordinance

In accordance with Section 67.24(e) of the San Francisco Administrative Code, contracts, contractors' bids, leases, agreements, responses to Requests for Proposals, and all other records of communications between City and persons or firms seeking contracts will be open to inspection immediately after a contract has been awarded. Nothing in this provision requires the disclosure of a private person's or organization's net worth or other proprietary financial data submitted for qualification for a contract, lease, agreement or other benefit until and unless that person or organization is awarded the contract, lease, agreement or benefit. Information provided which is covered by this Section will be made available to the public upon request.

11.15 Public Access to Meetings and Records

If Friends receives a cumulative total per year of at least \$250,000 in City funds or City-administered funds and is a non-profit organization as defined in Chapter 12L of the San Francisco Administrative Code, Friends shall comply with and be bound by all the applicable provisions of that Chapter. By executing this Agreement, Friends agrees to open its meetings and records to the public in the manner set forth in Sections 12L.4 and 12L.5 of the Administrative Code. Friends further agrees to make good-faith efforts to promote community membership on its Board of Directors in the manner set forth in Section 12L.6 of the Administrative Code. Friends acknowledges that its material failure to comply with any of the provisions of this paragraph shall constitute a material breach of this Agreement. Friends further acknowledges that such material breach of the Agreement shall be grounds for City to terminate and/or not renew this Agreement, partially or in its entirety.

11.16 Preservative Treated Wood Containing Arsenic

Friends may not purchase preservative-treated wood products containing arsenic in the performance of this Agreement unless an exemption from the requirements of Chapter 13 of the San Francisco Environment Code is obtained from the Department of the Environment under Section 1304 of the Code. The term "preservative-treated wood containing arsenic" shall mean wood treated with a preservative that contains arsenic, elemental arsenic, or an arsenic copper combination, including, but not limited to, chromated copper arsenate preservative, ammoniacal copper zinc arsenate preservative, or ammoniacal copper arsenate preservative. Friends may purchase preservative-treated wood products on the list of environmentally preferable alternatives prepared and adopted by the Department of the Environment. This provision does not preclude Friends from purchasing preservative-treated wood containing arsenic for saltwater immersion. The term "saltwater immersion" shall mean a pressure-treated wood that is used for construction purposes or facilities that are partially or totally immersed in saltwater.

11.17 Compliance with Disabled Access Laws

Friends acknowledges that, pursuant to the Disabled Access Laws, programs, services and other activities provided by a public entity to the public, whether directly or through Friends or contractor, must be accessible to the disabled public. Friends shall not discriminate against any person protected under the Disabled Access Laws in connection with the use of all or any portion of the Property and shall comply at all times with the provisions of the Disabled Access Laws.

11.18 Nondisclosure of Private Information

Friends agrees to comply fully with and be bound by all of the provisions of Chapter 12M of the San Francisco Administrative Code (the "**Nondisclosure of Private Information Ordinance**"), including the remedies provided. The provisions of the Nondisclosure of Private Information Ordinance are incorporated herein by reference and made a part of this Agreement as though fully set forth. Initially capitalized terms used in this Section and not defined in this Agreement shall have the meanings assigned to such terms in the Nondisclosure of Private Information Ordinance. Consistent with the requirements of the Nondisclosure of Private Information Ordinance, Contractor agrees to all of the following:

(a) Neither Friends nor any of its Subcontractors shall disclose Private Information to a Subcontractor, person, or other entity, unless one of the following is true:

- (i) The disclosure is authorized by this Agreement;
- (ii) Friends received advance written approval from the Contracting Department to disclose the information; or
- (iii) The disclosure is required by law or judicial order.

(b) Any disclosure or use of Private Information authorized by this Agreement shall be in accordance with any conditions or restrictions stated in this Agreement. Any

disclosure or use of Private Information authorized by a Contracting Department shall be in accordance with any conditions or restrictions stated in the approval.

(c) "Private Information" shall mean any information that: (1) could be used to identify an individual, including without limitation, name, address, social security number, medical information, financial information, date and location of birth, and names of relatives; or (2) the law forbids any person from disclosing.

(d) Any failure of Friends to comply with the Nondisclosure of Private Information Ordinance shall be a material breach of this Agreement. In such an event, in addition to any other remedies available to it under equity or law, City may terminate this Agreement, debar Friends, or bring a false claim action against Friends.

11.19 Graffiti Removal

Graffiti is detrimental to the health, safety and welfare of the community in that it promotes a perception in the community that the laws protecting public and private property can be disregarded with impunity. This perception fosters a sense of disrespect of the law that results in an increase in crime; degrades the community and leads to urban blight; is detrimental to property values, business opportunities and the enjoyment of life; is inconsistent with City's property maintenance goals and aesthetic standards; and results in additional graffiti and in other properties becoming the target of graffiti unless it is quickly removed from public and private property. Graffiti results in visual pollution and is a public nuisance. Graffiti must be abated as quickly as possible to avoid detrimental impacts on City and County and its residents, and to prevent the further spread of graffiti.

From and after the Close of Escrow, Friends shall remove all graffiti from the Property and any real property owned or leased by Friends in City and County of San Francisco within forty-eight (48) hours of the earlier of Friends' (a) discovery or notification of the graffiti or (b) receipt of notification of the graffiti from the Department of Public Works. This Section is not intended to require Friends to breach any lease or other agreement that it may have concerning its use of the real property. The term "graffiti" means any inscription, word, figure, marking or design that is affixed, marked, etched, scratched, drawn or painted on any building, structure, fixture or other improvement, whether permanent or temporary, including by way of example only and without limitation, signs, banners, billboards and fencing surrounding construction sites, whether public or private, without the consent of the owner of the property or the owner's authorized agent, and which is visible from the public right-of-way. "Graffiti" shall not include: (1) any sign or banner that is authorized by, and in compliance with, the applicable requirements of the San Francisco Public Works Code, the San Francisco Planning Code or the San Francisco Building Code; or (2) any mural or other painting or marking on the property that is protected as a work of fine art under the California Art Preservation Act (California Civil Code Sections 987 et seq.) or as a work of visual art under the Federal Visual Artists Rights Act of 1990 (17 U.S.C. §§ 101 et seq.).

Any failure of Friends to comply with this section of this Agreement shall constitute an Event of Default of this Agreement.

11.20 Incorporation

Each and every provision of the San Francisco Administrative Code or any other San Francisco Code specifically described or referenced in this Agreement is hereby incorporated by reference, as it exists on the Effective Date, and as may be amended between the Effective Date and the Lease Commencement Date as though fully set forth herein. Failure of Friends to comply with any provision of this Agreement relating to any such code provision shall be governed by Section 10 of this Agreement, unless (i) such failure is otherwise specifically addressed in this Agreement or (ii) such failure is specifically addressed by the applicable code section.

11.21 Budgetary and Fiscal Requirements of City Charter

The terms of this Agreement shall be governed by and subject to the budgetary and fiscal provisions of the City's Charter. Notwithstanding anything to the contrary contained in this Agreement, there shall be no obligation for the payment or expenditure of money by City under this Agreement unless the Controller of the City and County of San Francisco first certifies, pursuant to Section 3.105 of the City's Charter, that there is a valid appropriation from which the expenditure may be made and that unencumbered funds are available from the appropriation to pay the expenditure.

12. GENERAL PROVISIONS

12.1 Force Majeure – Extension of Time of Performance

(a) **Effect of Force Majeure.** For the purpose of any of the provisions of this Agreement, including, without limitation, the Schedule of Performance, neither Friends, City, nor any successor in interest (the “**Delayed Party**,” as applicable) will be considered in breach of or default in any obligation or satisfaction of a condition to an obligation of the other Party in event of Force Majeure or Litigation Force Majeure.

(b) **Definition of Force Majeure.** “**Force Majeure**” means events other than Litigation Force Majeure that cause delays in the Delayed Party’s performance of its obligations under this Agreement, or in the satisfaction of a condition to the other Party’s performance under this Agreement, due primarily to causes beyond the Delayed Party’s control and not caused by the acts or omissions of the Delayed Party (excluding, in any case, a Delayed Party’s performance of the payment of money required under the terms of this Agreement), including, but not restricted to: acts of God or of the public enemy; war; explosion; invasion; insurrection; rebellion; riots; acts of the government (including any general moratorium in the issuance of permits applicable to the Site or the Improvements, provided, however, in the absence of such a moratorium, acts of the government relating to issuance of building permits or other Regulatory Approvals are governed by Section 12.1(d) below); fires; floods; tidal waves; epidemics; quarantine restrictions; freight embargoes; earthquakes; unusually severe weather; delays of contractors or subcontractors due to any of these causes; the unanticipated presence of Hazardous Materials or other concealed conditions on the Site or Improvements that would not have reasonably been discovered through due diligence and that would delay or materially adversely impair Friends’ ability to construct the Project; substantial interruption of work

because of other construction by third parties in the immediate vicinity of the Site; archeological finds on the Site; strikes, and substantial interruption of work because of labor disputes; inability to obtain materials or reasonably acceptable substitute materials (provided that Friends has ordered such materials on a timely basis and Friends is not otherwise at fault for such inability to obtain materials); changes in state or federal law that would delay or materially adversely impair Friends' ability to construct the Project; or any Litigation Force Majeure or other administrative appeals, litigation and arbitration relating to the construction of the Project (provided that the Delayed Party proceeds with due diligence to defend such action or proceeding or take other appropriate measures to resolve any dispute that is the subject of such action or proceeding). In the event of the occurrence of any such delay, the time or times for performance of the obligations of Friends or City will be extended for the period of the delay; provided, however, within thirty (30) days after the beginning of any such delay, the Delayed Party shall have first notified the other Party in writing of the cause or causes of such delay and claimed an extension for the reasonably estimated period of the delay. Notwithstanding anything to the contrary in this Section, the lack of credit or financing (unless such lack is itself a result of some other event of Force Majeure) shall not be considered to be a matter beyond Friends' control and therefore no event caused by a lack of such financing in and of itself shall be considered to be an event of Force Majeure for purposes of this Agreement.

(c) **Definition of Litigation Force Majeure.** "Litigation Force Majeure" means any action or proceeding before any court, tribunal, or other judicial, adjudicative or legislative decision-making body, including any administrative appeal, brought by a third party, (a) which seeks to challenge the validity of any action taken by City in connection with the Project, including City's approval, execution, and delivery of this Agreement or the Lease and its performance hereunder, or other action by City or any of its commissions approving City's execution and delivery of this Agreement, the performance of any action required or permitted to be performed by City hereunder, or any findings upon which any of the foregoing are predicated, or (b) which seeks to challenge the validity of any other Regulatory Approval. With respect to an event of Litigation Force Majeure occurring after the Close of Escrow, such event will not be considered Litigation Force Majeure unless such event would (1) create a default under the loan documents or grant documents for any Mortgage approved under the Lease such that the lender will imminently discontinue funding the loan, as evidenced by a written notice from such lender's counsel (or other official representative of lender reasonably satisfactory to City), or a written legal opinion from experienced counsel reasonably satisfactory to City, and/or (2) result in the issuance of an injunction, temporary restraining order or writ of mandate (collectively, a "*writ*") and such writ is in effect or, if no writ has yet been issued as a result of the filing of such action, Friends obtains a written legal opinion from experienced counsel reasonably satisfactory to City that it is likely that writ will issue (except that if the challenge is procedural and City furnishes to Friends a written opinion of experienced counsel reasonably satisfactory to Friends that such defect is curable and City seeks to cure such defect, such event shall not constitute Litigation Force Majeure until such attempt to cure fails). Notwithstanding the foregoing, Litigation Force Majeure shall exclude any action or proceeding brought by an Affiliate of Friends, any of Friends' members or their Affiliates, any consultant of Friends, or any other third party assisted by Friends, directly or indirectly, in such action or proceeding. Performance by a party hereunder shall be deemed delayed or made impossible by virtue of Litigation Force Majeure during the pendency thereof, and until a judgment, order, or other decision resolving such matter in favor of the party whose performance is delayed has become

final and unappealable. Under no circumstances shall the delay attributable to an event of Litigation Force Majeure extend beyond twenty-four (24) months unless such limitation is expressly waived by both Parties in each of their respective sole and absolute discretion. The Parties shall each proceed with due diligence and, shall cooperate with one another to defend the action or proceeding or take other measures to resolve the dispute that is the subject of such action or proceeding.

(d) **Permits.** If Friends is diligently proceeding to obtain necessary building permits or addenda as required by Sections 5.15(a) or 5.15(b) or other Regulatory Approvals for the Improvements, Force Majeure includes Friends' inability to obtain building permits or other Regulatory Approvals.

(e) **Limitations Before Close of Escrow.** Before the Close of Escrow, Force Majeure delays (other than Litigation Force Majeure or delays described in Section 12.1(d) above) will be limited to an aggregate of sixty (60) months. At any time after the expiration of such sixty (60)-month period, the other Party may terminate the Agreement by giving thirty (30) days' notice to the Delayed Party. Notwithstanding the foregoing, necessary Project funds must be raised by December 31, 2017.

12.2 Notices

(a) **Manner of Delivery.** Except as otherwise expressly provided in this Agreement, all notices, demands, approvals, consents and other formal communications between City and Friends required or permitted under this Agreement shall be in writing and shall be deemed given and effective (i) on the date of receipt if given by personal delivery on a business day (or the next business day if delivered personally on a day that is not a business day), or (ii) if mailed, three (3) business days after deposit with the U.S. Postal Service for delivery by United States registered or certified mail, first class postage prepaid, or (iii) on the first business day after deposit with a reputable overnight delivery service, all fees for such delivery prepaid, in each case to City or Friends at their respective addresses for notice designated below. For convenience of the Parties, copies of notices may also be given by telefacsimile to the facsimile number set forth below or such other number as may be provided from time to time by notice given in the manner required under this Agreement; however, neither Party may give official or binding notice by telefacsimile or email.

(b) **Request for Approval.** In order for a request for any approval required under the terms of this Agreement to be effective, it shall be clearly marked "Request for Approval" and state (or be accompanied by a cover letter stating) substantially the following:

(i) the section of this Agreement under which the request is made and the action or response required;

(ii) if applicable, the period of time as stated in this Agreement within which the recipient of the notice shall respond; and

(iii) if specifically stated in the Agreement that the failure to object to the notice within the stated time period will be deemed to be the equivalent of the recipient's approval of or consent to the request for approval which is the subject matter of the notice.

In the event that a request for approval states a period of time for approval which is less than the time period provided for in this Agreement for such approval, the time period stated in this Agreement shall be the controlling time period. In no event shall a recipient's approval of or consent to the subject matter of notice be deemed to have been given by its failure to object to such notice if such notice (or the accompanying cover letter) does not comply with the requirements of this Section.

(c) Addresses for Notices. All notices shall be properly addressed and delivered to the Parties at the addresses set forth below or at such other addresses as either Party may designate by written notice given in the manner provided in this Section:

To Friends: Friends of Geneva Office Building and Power House
755 Ocean Avenue
San Francisco, CA 94112
Attention: Daniel Weaver
Facsimile: (415) 586-8357

With a copy to: Gibson, Dunn & Crutcher LLP
555 Mission Street
San Francisco, CA 94105
Attention: Mary G. Murphy
Facsimile: (415) 374-8480

To City: Recreation and Park Department
McLaren Lodge Annex
San Francisco, California 94117
Attention: []
Facsimile: []

Office of City Attorney
City Hall, Room 234
1 Dr. Carlton B. Goodlett Place
San Francisco, California 94102-4682
Attention: Real Estate/Finance Team
Facsimile: (415) 554-4755

12.3 Conflict of Interest

No member, official or employee of City may have any personal interest, direct or indirect, in this Agreement nor shall any such member, official or employee participate in any decision relating to this Agreement which affects her or his personal interest or the interests of any corporation, partnership or association in which she or he is interested directly or indirectly.

12.4 Inspection of Books and Records

City, including its Agents, has the right at all reasonable times and from time to time, to inspect the books and records of Friends pertaining to Friends' compliance with its obligations under this Agreement, provided that City shall, to the maximum extent allowed by applicable

Law, keep strictly confidential any such information which Friends reasonably and in good faith determines is proprietary and clearly and conspicuously so designates.

12.5 Time of Performance

(a) **Expiration.** All performance dates (including cure dates) expire at 5:00 p.m., San Francisco, California time, on the performance or cure date.

(b) **Weekends and Holidays.** A performance date which falls on a Saturday, Sunday or City holiday is deemed extended to the next working day.

(c) **Days for Performance.** All periods for performance specified in this Agreement in terms of days shall be calendar days, and not business days, unless otherwise expressly provided in this Agreement.

(d) **Time of the Essence.** Time is of the essence with respect to each required completion date in the Schedule of Performance, subject to the provisions of Section 12.1 relating to Force Majeure and subject to the cure provisions of Section 10.1(b).

12.6 Interpretation of Agreement

(a) **Exhibits.** Whenever an "Exhibit" is referenced, it means an exhibit or attachment to this Agreement unless otherwise specifically identified. All such exhibits are incorporated in this Agreement by reference.

(b) **Captions.** Whenever a section or paragraph is referenced, it refers to this Agreement unless otherwise specifically identified. The captions preceding the sections of this Agreement and in the table of contents have been inserted for convenience of reference only. Such captions shall not define or limit the scope or intent of any provision of this Agreement.

(c) **Words of Inclusion.** The use of the term "including," "such as" or words of similar import when following any general term, statement or matter shall not be construed to limit such item, statement or matter to the specific items or matters, whether or not language of non-limitation is used with reference thereto. Rather, such terms shall be deemed to refer to all other items or matters that could reasonably fall within the broadest possible scope of such statement, term or matter.

(d) **No Presumption Against Drafter.** This Agreement has been negotiated at arm's length and between Persons sophisticated and knowledgeable in the matters dealt with herein. In addition, each Party has been represented by experienced and knowledgeable legal counsel. Accordingly, this Agreement shall be interpreted to achieve the intents and purposes of the Parties, without any presumption against the Party responsible for drafting any part of this Agreement (including, but not limited to California Civil Code Section 1654).

(e) **Costs and Expenses.** The Party on which any obligation is imposed in this Agreement shall be solely responsible for paying all costs and expenses incurred in the performance of such obligation, unless the provision imposing such obligation specifically provides to the contrary.

(f) **Agreement References.** Wherever reference is made to any provision, term or matter "in this Agreement," "herein" or "hereof" or words of similar import, the reference shall be deemed to refer to any and all provisions of this Agreement reasonably related thereto in the context of such reference, unless such reference refers solely to a specific numbered or lettered section or paragraph of this Agreement or any specific subdivision of this Agreement.

(g) **Approvals.** Unless this Agreement otherwise expressly provides or unless City's Charter otherwise requires, all approvals, consents or determinations to be made by or on behalf of City or City under this Agreement shall be made by the General Manager or his designee, and the General Manager is hereby authorized to make such approvals, consents and determinations.

12.7 Successors and Assigns

This Agreement is binding upon and will inure to the benefit of the successors and assigns of City and Friends, subject to the limitations set forth in Section 9. Where the term "Friends" or "City" is used in this Agreement, it means and includes their respective successors and assigns.

12.8 No Third Party Beneficiaries

This Agreement is made and entered into for the sole protection and benefit of City and Friends and their successors and assigns. No other Person shall have or acquire any right or action based upon any provisions of this Agreement.

12.9 Real Estate Commissions

Friends and City each represents that it engaged no broker, agent or finder in connection with this transaction. In the event any broker, agent or finder makes a claim, the Party through whom such claim is made agrees to Indemnify the other Party from any Losses arising out of such claim.

12.10 Counterparts

This Agreement may be executed in counterparts, each of which is deemed to be an original, and all such counterparts constitute one and the same instrument.

12.11 Entire Agreement

This Agreement (including the Exhibits attached hereto) constitutes the entire agreement between the Parties with respect to the subject matter of this Agreement and supersedes all negotiations or previous agreements between the Parties with respect to all or any part of the terms and conditions mentioned in or incidental to this Agreement. No parole evidence of any prior or other agreement shall be permitted to contradict or vary the terms of this Agreement.

12.12 Amendment

Neither this Agreement nor any of its terms may be terminated, amended or modified except by a written instrument executed by the Parties.

12.13 Governing Law

The Laws of the State of California shall govern the interpretation and enforcement of this Agreement. As part of the consideration for City's entering into this Agreement, Friends agrees that all actions or proceedings arising directly or indirectly under this Agreement may, at the sole option of City, be litigated in courts having sites within the State of California, and Friends expressly consents to the jurisdiction of any such local, state or federal court, and consents that any service of process in such action or proceeding may be made by personal service upon Friends wherever Friends may then be located, or by certified or registered mail directed to Friends at the address set forth in Section 12.2 for the delivery of notices.

12.14 Recordation

A Memorandum of Agreement will be recorded by Friends in the Official Records on or after the Effective Date. Either Party shall, promptly upon request of the other Party, deliver to such requesting Party a duly executed and acknowledged quitclaim deed, suitable for recordation in the Official Records and in form and content reasonably satisfactory to the requesting Party (and City Attorney in the event that City is the requesting Party), for the purpose of effecting the termination of the non-requesting Party's interest under this Agreement upon the termination of this Agreement. Either Party may record such quitclaim deed at any time on or after the termination of this Agreement, without the need for any approval or further act of the non-requesting Party.

12.15 Extensions by City

Upon the request of Friends, City, acting through the General Manager, may, by written instrument, extend the time for Friends' performance of any term, covenant or condition of this Agreement or permit the curing of any default upon such terms and conditions as it determines appropriate, including but not limited to, the time within which Friends shall agree to such terms or conditions, provided, however, any such extension or grant of permission to cure any particular default will not operate to release Friends from, nor constitute a waiver of City's rights with respect to any of Friends' obligations or any other term, covenant or condition of this Agreement or any other default in, or breach of, this Agreement or otherwise effect the time of the essence provisions with respect to the extended date or the other dates for performance under this Agreement.

12.16 Further Assurances; Technical Corrections

The Parties hereto agree to execute and acknowledge such other and further documents and take such other reasonable actions as may be necessary or reasonably required to effectuate the terms of this Agreement. The General Manager is authorized to execute on behalf of City any closing or similar documents and any contracts, agreements, memoranda or similar documents with State, regional or local entities or other Persons that are necessary or proper to

achieve the purposes and objectives of this Agreement and do not materially increase the obligations of City under this Agreement, if the General Manager determines, in consultation with City Attorney, that the document is necessary or proper and in City's best interests. The General Manager's signature of any such document shall conclusively evidence such a determination by him or her. Further, the parties reserve the right, upon mutual agreement of the General Manager and Friends, to enter into memoranda of technical corrections hereto to reflect any non-material changes in the actual legal description and square footages of the Site and the Improvements, and upon full execution thereof, such memoranda shall be deemed to become a part of this Agreement.

12.17 Attorneys' Fees

If either Party fails to perform any of its respective obligations under this Agreement or if any material dispute arises between the Parties hereto concerning the meaning or interpretation of any provision of this Agreement, then the defaulting Party or the Party not prevailing in such dispute, as the case may be, shall pay any and all costs and expenses incurred by the other Party on account of such default or in enforcing or establishing its rights under this Agreement, including, without limitation, Attorneys' Fees and Costs. Any such Attorneys' Fees and Costs incurred by either Party in enforcing a judgment in its favor under this Agreement shall be recoverable separately from and in addition to any other amount included in such judgment, and such Attorneys' Fees and Costs obligation is intended to be several from the other provisions of this Agreement and to survive and not be merged into any such judgment.

12.18 Relationship of Parties

The subject of this Agreement is a private development with neither Party acting as the agent of the other Party in any respect. None of the provisions in this Agreement shall be deemed to render City a partner in Friends' business, or joint venturer or member in any joint enterprise with Friends.

12.19 Severability

If any provision of this Agreement, or its application to any Person or circumstance, is held invalid by any court, the invalidity or inapplicability of such provision shall not affect any other provision of this Agreement or the application of such provision to any other Person or circumstance, and the remaining portions of this Agreement shall continue in full force and effect, unless enforcement of this Agreement as so modified by and in response to such invalidation would be grossly inequitable under all of the circumstances, or would frustrate the fundamental purposes of this Agreement.

12.20 Representations and Warranties of Friends

Friends represents and warrants as follows, as of the Effective Date:

(a) **Valid Existence; Good Standing.** Friends is a nonprofit corporation duly organized and validly existing under the laws of the State of California. Friends has all requisite power and authority to own its property and conduct its business as presently conducted. Friends has made all filings and is in good standing in the State of California.

(b) **Authority.** Friends has all requisite power and authority to execute and deliver this Agreement and the agreements contemplated by this Agreement and to carry out and perform all of the terms and covenants of this Agreement and the agreements contemplated by this Agreement.

(c) **No Limitation on Ability to Perform.** Neither Friends' articles of incorporation or bylaws, nor any other agreement or Law in any way prohibits, limits or otherwise affects the right or power of Friends to enter into and perform all of the terms and covenants of this Agreement. Friends is not party to or bound by any contract, agreement, indenture, trust agreement, note, obligation or other instrument which could prohibit, limit or otherwise affect the same. No consent, authorization or approval of, or other action by, and no notice to or filing with, any governmental authority, regulatory body or any other Person is required for the due execution, delivery and performance by Friends of this Agreement or any of the terms and covenants contained in this Agreement. There are no pending or threatened suits or proceedings or undischarged judgments affecting Friends before any court, governmental agency, or arbitrator which might materially adversely affect the enforceability of this Agreement or the business, operations, assets or condition of Friends.

(d) **Valid Execution.** The execution and delivery of this Agreement and the agreements contemplated hereby by Friends has been duly and validly authorized by all necessary action. This Agreement will be a legal, valid and binding obligation of Friends, enforceable against Friends in accordance with its terms. Friends has provided to City a written resolution of Friends authorizing the execution of this Agreement and the agreements contemplated by this Agreement.

(e) **Defaults.** The execution, delivery and performance of this Agreement (i) do not and will not violate or result in a violation of, contravene or conflict with, or constitute a default under (A) any agreement, document or instrument to which Friends is a party or by which Friends' assets may be bound or affected, or (B) the articles of incorporation or the bylaws of Friends, and (ii) do not and will not result in the creation or imposition of any lien or other encumbrance upon the assets of Friends.

(f) **Meeting Financial Obligations.** To Friends' knowledge, all financial information regarding Friends previously submitted to City is true and correct, and Friends is meeting its current liabilities as they mature; no federal or state tax liens have been filed against it; and Friends is not in default or claimed default under any agreement for borrowed money.

The representations and warranties in this Section shall survive any termination of this Agreement.

12.21 Effective Date

This Agreement shall become effective on the date the Parties duly execute and deliver this Agreement following approval by City's Board of Supervisors and the Mayor, in their respective sole and absolute discretion. The Effective Date of this Agreement will be inserted by City on the cover page and on Page 1 of this Agreement; provided, however, no failure by City to do so shall in any way invalidate this Agreement. Where used in this Agreement or in any of

its exhibits, references to "the date of this Agreement," the "reference date of this Agreement," "Agreement date" or "Effective Date" will mean the Effective Date determined as set forth above and shown on Page 1 of this Agreement.

13. COOPERATION AND GOOD FAITH

In connection with this Agreement, Friends and City shall reasonably cooperate with one another to achieve the objectives and purposes of this Agreement. In so doing, Friends and City shall each refrain from doing anything that would render its performance under this Agreement impossible and each shall do everything that this Agreement contemplates that the Party shall do to accomplish the objectives and purposes of this Agreement. In furtherance, and not in limitation of Friends' obligations under the terms of this Agreement, Friends covenants that Friends shall pursue all actions, obligations, undertakings and agreements for which it is responsible under this Agreement with diligence and in good faith, including without limitation, in connection with all submissions required under Section 5.6 and any revisions required thereunder, all obligations to seek Regulatory Approvals and Building Permit or Site Permit and any addenda thereto as set forth in Section 2.9(b) and Section 5.15, all obligations to seek financing commitments and to obtain the other documents and make the submissions required by Section 7.1, and all obligations to reach the agreements and make submissions as set forth in Section 11.

14. DEFINITIONS

For purposes of this Agreement, the following initially capitalized terms shall have the meanings ascribed to them in this Section:

Adverse Change as defined in Section 3.1(a).

Affiliate as defined in the Lease.

Agents means, when used with reference to either Party to this Agreement or any other Person, the members, officers, directors, commissioners, boards, employees, agents and contractors of such Party or other Person, and their respective heirs, legal representatives, successors and assigns.

Agreement means this Geneva Office Building and Power House Lease Disposition and Development Agreement, as it may be amended from time to time in accordance with its terms.

Approved Operating Standards as defined in the Lease.

Arbiter as defined in Section 5.7(c)(i).

Attorneys' Fees and Costs means any and all attorneys' fees, costs, expenses and disbursements (including such fees, costs, expenses and disbursements of attorneys of City's Office of City Attorney), including, but not limited to, expert witness fees and costs, travel time and associated costs, transcript preparation fees and costs, document copying, exhibit preparation, courier, postage, facsimile, long-distance and communications expenses, court costs and other costs and fees associated with any other legal, administrative or alternative dispute

resolution proceeding, including such fees and costs associated with execution upon any judgment or order, and costs on appeal. For purposes of this Agreement, the reasonable fees of attorneys of the Office of City Attorney shall be based on the fees regularly charged by private attorneys with the equivalent number of years of experience in the subject matter area of the law for which City Attorney's services were rendered who practice in the City of San Francisco in law firms with approximately the same number of attorneys as employed by the City Attorney's Office.

Bona Fide Institutional Lender as defined in the Lease.

Budget as defined in Section 7.1(a) and a form of which is attached hereto as Exhibit L.

Building as defined in Recital A.

Building Permit(s) means a permit or permits issued by City which will allow Friends to commence Construction of the Improvements (see Section 5.15).

Card Check Ordinance as described in Section 11.9.

Certificate of Completion as described in Section 6 and a form of which is attached as Exhibit D.

Certified Construction Costs as defined in Section 5.13(b).

CEQA means the California Environmental Quality Act (California Public Resources Code, Section 21000 *et seq.*).

City as defined in the introductory paragraph of this Agreement.

City Indemnified Parties means City, including, but not limited to, all of its boards, commissions, departments, agencies and other subdivisions, including, without limitation, all of the Agents of City.

City's Remediation Election as defined in Section 3.3(g).

Close Date as defined in Section 2.2(b).

Close of Escrow means the Delivery of the Property by City to Friends through the Escrow.

Closing Costs as defined in Section 2.2(e).

Consistency means consistent in all material respects with this Agreement, the assumptions set forth in the Budget, the Operating Budget, the Regulatory Approvals and Project Requirements.

Completion or Completed as defined in Section 6.1(c).

Construction means all new construction, replacement, rehabilitation, and demolition occurring on the Site pursuant to this Agreement and the Lease.

Construction Contract as defined in Section 7.1(h).

Construction Documents as defined in Section 5.3(b).

Core Benefits as defined in Section 11.1(c).

Deferred Items as defined in Section 6.1(b).

Delayed Party as defined in Section 12.1(a).

Delivery means execution and delivery of the Lease and the delivery through Escrow by City of leasehold estate in the Property under the Lease.

Friends as defined in the introductory paragraph of this Agreement and includes Friends' permitted successors and assigns.

Friends Indemnified Parties means Friends and its directors, employees and agents.

Disabled Access Laws means all Laws related to access for persons with disabilities including, without limitation, the Americans with Disabilities Act, 42 U.S.C.S. Sections 12101 et seq. and disabled access laws under City's building code.

Disclosed Pre-Existing Hazardous Materials as defined in Section 3.3(a).

E&E means Ecology and Environment, Inc.

Effective Date as defined in Section 12.21.

Environmental Assessment as defined in Section 3.3(a).

Escrow as defined in Section 2.2(a).

Event of Default as defined in Section 10.

Final Construction Documents as defined in Section 5.3(a)(iii).

Finally Granted means that the action is final, binding and non-appealable and all applicable statutes of limitation relating to such action, including without limitation with respect to CEQA, shall have expired without the filing or commencement of any judicial or administrative action or proceeding in a court of competent jurisdiction with regard to such action.

Financing Plan means the financing plan attached hereto as Exhibit M, which includes (i) a detailed description of all sources and uses of funds for the construction of the Project, the timing for receipt of such funds and a description of conditions that Friends must meet to receive such funds, including, without limitation, a detailed description of the capital fundraising process

that Friends expects to utilize showing the amount of funds required to be raised and a timeline for raising such funds; (ii) a summary of the key loan terms for anticipated construction and take out financing, if any; and (iii) a proforma operating budget assumptions covering a period of one year from the commencement of operation of the Project.

First Source Hiring Program as defined in Section 11.8.

Force Majeure means the Force Majeure provisions described in Section 12.1(b).

FSB as defined in Section 3.3(a).

FSB Addendum as defined in Section 3.3(a).

General Manager means the General Manager of the San Francisco Recreation and Park Department, or his or her designee, or successor that succeeds to the rights and obligations of the General Manager under applicable Law.

Graffiti as defined in Section 11.19.

Guide means the AICPA Audit Guide for Not-for-Profit Organizations and its related standards.

Handle when used with reference to Hazardous Materials means to use, generate, manufacture, process, produce, package, treat, store, emit, discharge, or dispose of any Hazardous Material. "Handling" will have a correlative meaning.

Hazardous Material means any material that, because of its quantity, concentration or physical or chemical characteristics, is deemed by any federal, state or local governmental authority to pose a present or potential hazard to human health or safety or to the environment. Hazardous Material includes, without limitation, any material or substance defined as a "hazardous substance," or "pollutant" or "contaminant" under the Comprehensive Environmental Response, Compensation and Liability Act of 1980 ("CERCLA," also commonly known as the "Superfund" law), as amended, (42 U.S.C. Sections 9601 et seq.) or under Section 25281 or 25316 of the California Health & Safety Code; any "hazardous waste" as defined in Section 25117 or listed under Section 25140 of the California Health & Safety Code; any asbestos and asbestos containing materials whether or not such materials are part of the structure of any existing Improvements on the Site, any Improvements to be constructed on the Site by or on behalf of Friends, or are naturally occurring substances on, in or about the Site; and petroleum, including crude oil or any fraction, and natural gas or natural gas liquids.

Hazardous Material Claims means any and all enforcement, Investigation, Remediation or other governmental or regulatory actions, agreements or orders threatened, instituted or completed under any Hazardous Materials Laws, together with any and all Losses made or threatened by any third party against City, or any of the other City Indemnified Parties and any of their Agents, or the Site or any Improvements, relating to damage, contribution, cost recovery compensation, loss or injury resulting from the presence, release or discharge of any Hazardous Materials, including, without limitation, Losses based in common law. Hazardous Material Claims include, without limitation, Investigation and Remediation costs, fines, natural resource

damages, damages for decrease in value of the Site or any Improvements, the loss or restriction of the use or any amenity of the Site or any Improvements, and attorneys' fees and consultants' fees and experts' fees and costs.

Hazardous Material Laws means any present or future federal, state or local Laws or policies relating to Hazardous Material (including, without limitation, its Handling, transportation or Release) or to human health and safety, industrial hygiene or environmental conditions in, on, under or about the Site (including the Improvements) and any other property, including, without limitation, soil, air, air quality, water, water quality and groundwater conditions. Hazardous Materials Laws include, but shall not be limited to, City's Pesticide Ordinance (Chapter 39 of the San Francisco Administrative Code), to the extent the same is as of the date of this Agreement applicable to developers of City property, and Section 20 of the San Francisco Public Works Code ("Analyzing Soils for Hazardous Waste").

Historic Preservation Tax Credit means the 20% federal income tax credits for historic rehabilitation, pursuant to Internal Revenue Code §§38 and 47, and 16 U.S.C.A. §470 et seq. and applicable regulations.

Historic Structure Report means [_____].

Improvements means all physical construction on the Site and all buildings, structures, fixtures and other improvements, rehabilitated, erected, built, placed, installed or constructed upon or within the Site on or after the Effective Date, including, but not limited to all renovation and rehabilitation work on the existing Building other than Friends improvement work not required to occur for the Improvements to be Completed pursuant to Section 6.1 hereto, all as described in the Scope of Development and approved by City as provided for in Section 6 and elsewhere in this Agreement, but excluding the Investigation and Remediation of Unknown Pre-Existing Hazardous Materials to the extent City made City's Remediation Election with respect thereto.

Indemnified Parties means, individually or collectively, City Indemnified Parties and Friends Indemnified Parties.

Indemnify means indemnify, protect, defend and hold harmless.

Investigate or Investigation when used with reference to Hazardous Material means any activity undertaken to determine the nature and extent of Hazardous Material that may be located in, on, under or about the Site, any Improvements or any portion of this Agreement or which have been, are being, or threaten to be Released into the environment. Investigation shall include, without limitation, preparation of site history reports and sampling and analysis of environmental conditions in, on, under or about the Site or any Improvements.

Invitees as defined in the Lease.

Law or Laws shall mean all present and future laws, ordinances, rules, regulations, permits, authorizations, orders and requirements, to the extent applicable to the Parties, the Site, the Improvements, or any portion of any of them (including, without limitation, any subsurface area, the use thereof and of the Site, or any portion thereof, and the buildings and Improvements

thereon) whether or not in the contemplation of the Parties, including, without limitation, all consents or approvals (including Regulatory Approvals) required to be obtained from, and all rules and regulations of, and all building and zoning laws of, all federal, state, county and municipal governments, the departments, bureaus, agencies or commissions thereof, authorities, board of officers, any national or local board of fire underwriters, or any other body or bodies exercising similar functions, having or acquiring jurisdiction of the Site, the Improvements or any portion of any of them.

LDDA Permit to Enter as defined in Section 4.1(a)(ii).

LDDA Term as defined in Section 1.2.

Lease as defined in Section 1.4.

Litigation Force Majeure as defined in Section 12.1(c).

Long-Term License as defined in Section 4.2(b).

Loss or Losses when used with reference to any Indemnity means any and all claims, demands, losses, liabilities, damages (including foreseeable and unforeseeable consequential damages), liens, obligations, interest, injuries, penalties, fines, lawsuits and other proceedings, judgments and awards and costs and expenses (including, without limitation, Attorneys' Fees and Costs, and consultants' fees and costs) of whatever kind or nature, known or unknown, contingent or otherwise.

Memorandum of Agreement as defined in Section 2.5(b)(iii).

Memorandum of Lease as defined in Section 2.2(d).

Mitigation Measures as described in Section 11.2.

Mortgage as defined in the Lease.

Mortgagee as defined in the Lease.

Net Revenue as defined in the Lease.

New Markets Tax Credit means those tax credits received for investing in certain low income census tracts as governed by Section 45D of the Internal Revenue Code of the United States.

Nondisclosure of Private Information Ordinance as defined in Section 11.18.

NPS as defined in Section 2.3(a)(vii).

Official Records mean, with reference to the recordation of documents, the Official Records of City and County of San Francisco.

Operating Budget as defined in Section 7.1(c).

Part 2 Application as defined in Section 2.3(a)(vii).

Party means City or Friends, as a party to this Agreement. "Parties" means both City and Friends, as parties to this Agreement.

Performance Bond as defined in Section 7.1(i).

Permit to Enter as referred to in Section 4.1(a).

Permitted Title Exceptions as defined in Section 2.6(a).

Person means any individual, partnership, corporation (including, but not limited to, any business trust), limited liability company, joint stock company, trust, unincorporated association, joint venture or any other entity or association, the United States, or a federal, state or political subdivision thereof.

Pesticide Ordinance as defined in Section 11.7.

Political Activity as defined in Section 11.12.

Phase I ESA as defined in Section 3.3(a).

Phase II ESA as defined in Section 3.3(a).

Preliminary Construction Documents as referred to in Section 5.3(a)(ii).

Prevailing Wage mean the provisions described in Section 5.17.

Prevailing Wage Agreement in the form of Exhibit K.

Private Information as defined in Section 11.18(c).

Project means the Construction of the Improvements described in the Scope of Development, operated as a community center, together with complementary uses as described in the Scope of Development all at the Approved Operating Standards.

Project Requirements as defined in Section 5.4.

Property as defined in Recital A.

Recommendations Regarding Environmental Conditions as defined in Section 3.3(a).

Regulatory Approval means any rezoning, authorization, approval or permit required by any governmental agency having jurisdiction over the Site or the Project, including, but not limited to, City's Planning Commission and/or Zoning Administrator, City's Historic Preservation Commission, City's Recreation and Park Commission, City's Department of Building Inspection and the Board of Supervisors. "Regulatory Approval" shall not include any such authorization, approval or permit required to Investigate or Remediate the Unknown Pre-Existing Hazardous Materials if City has made City's Remediation Election.

Release when used with respect to Hazardous Material means any actual or imminent spilling, leaking, pumping, pouring, emitting, emptying, discharging, injecting, escaping, leaching, dumping, or disposing into or inside any existing improvements or any improvements constructed under this Agreement by or on behalf of Friends, or in, on, under or about the Site or any portion of the Site.

Remediate or Remediation when used with reference to Hazardous Materials means any activities undertaken to clean up, remove, contain, treat, stabilize, monitor or otherwise control Hazardous Materials located in, on, under or about the Site or which have been, are being, or threaten to be Released into the environment. Remediation includes, without limitation, those actions included within the definition of "remedy" or "remedial action" in California Health and Safety Code Section 25322 and "remove" or "removal" in California Health and Safety Code Section 25323.

Schedule of Performance as defined in Section 2.2(a).

Schematic Drawings means the drawings prepared by Aidlin Darling Design described on Exhibit I.

Scope of Development means the narrative document attached hereto as Exhibit I and the Schematic Drawings.

Secretary's Standards as defined in Recital C.

SFMTA as defined in Section 4.2(a).

SFMTA Property as defined in Section 4.2(a).

SHPO means the California State Historic Preservation Office.

Significant Change as defined in the Lease.

Site as defined in Section 1.1(a).

Site Permit means the permit for construction of improvements as described in Section 5.15(b).

Special City Requirements as defined in Section 10.1(e).

Staff as defined in Section 5.8(a).

Temporary Construction License as defined in Section 4.2(a).

Title Company as defined in Section 2.2(a).

Title Defect as defined in Section 2.6(c).

Title Defect Cure Period as defined in Section 2.6(c).

TM as defined in Section 11.7.

Transfer as defined in Section 9.1.

Unknown Pre-Existing Environmental Conditions as defined in Section 3.3(g).

Unmatured Event of Default means any event, act, failure to act, or other occurrence that, with the giving of notice or the passage of time, or both, would constitute an Event of Default under this Agreement.

Workforce Hiring Program means the program for diversity concerning design, construction and operation of the Improvements which Friends has agreed to implement as described in Section 11.10 and attached hereto as Exhibit O.

Writ as defined in Section 12.1(c).

[Remainder of Page Intentionally Blank]

IN WITNESS WHEREOF City and Friends have caused this Lease Disposition and Development Agreement to be executed by their duly appointed representatives as of the date first above written.

FRIENDS

FRIENDS OF GENEVA OFFICE BUILDING AND POWER HOUSE, a California nonprofit corporation

By: _____
Name: _____
Title: _____

CITY

CITY & COUNTY OF SAN FRANCISCO, a municipal corporation

By: _____
PHILIP A. GINSBURG
General Manager
Recreation and Park Department

**APPROVED BY
RECREATION AND PARK COMMISSION
PURSUANT TO RESOLUTION NO. _____ DATED: _____**

Margaret McArthur, Commission Liaison

APPROVED AS TO FORM:

DENNIS J. HERRERA, City Attorney

By: _____
Anita L. Wood, Deputy City Attorney

EXHIBIT A

LEGAL DESCRIPTION OF SITE AND SFMTA PROPERTY

THE LAND REFERRED TO HEREIN BELOW IS SITUATED IN THE CITY OF SAN FRANCISCO, COUNTY OF SAN FRANCISCO, STATE OF CALIFORNIA, AND IS DESCRIBED AS FOLLOWS:

BEGINNING at the point of intersection of the Southeasterly line of San Jose Avenue with the Southwesterly line of Geneva Avenue; thence Southeasterly along said line of Geneva Avenue 422.24 feet to the Northwesterly line of Delano (formerly Delaware) Avenue; thence at a right angle Southwesterly along said line of Delano Avenue 331.38 feet, more or less, to a point distant thereon 120 feet Northeasterly from the Northeasterly line of Niagara (formerly Unadilla) Avenue; thence at a right angle Northwesterly parallel with said line of Niagara Avenue 454 feet to the Southeasterly line of San Jose Avenue; thence Northeasterly along said line of San Jose Avenue 333.4 feet to the point of beginning.

BEING a portion of Block 29 "West End Map No. 1". Excepting therefrom that portion lying within Parcel 25 as shown on the Map filed March 3, 1965 in Book U of Maps, Page 69.

Also excepting therefrom that portion described in the Deed Zanello/Gaehwiler, a California partnership recorded February 2, 1987 in Reel E270 Page 598, Document No. D938354.

EXHIBIT B

SITE PLAN

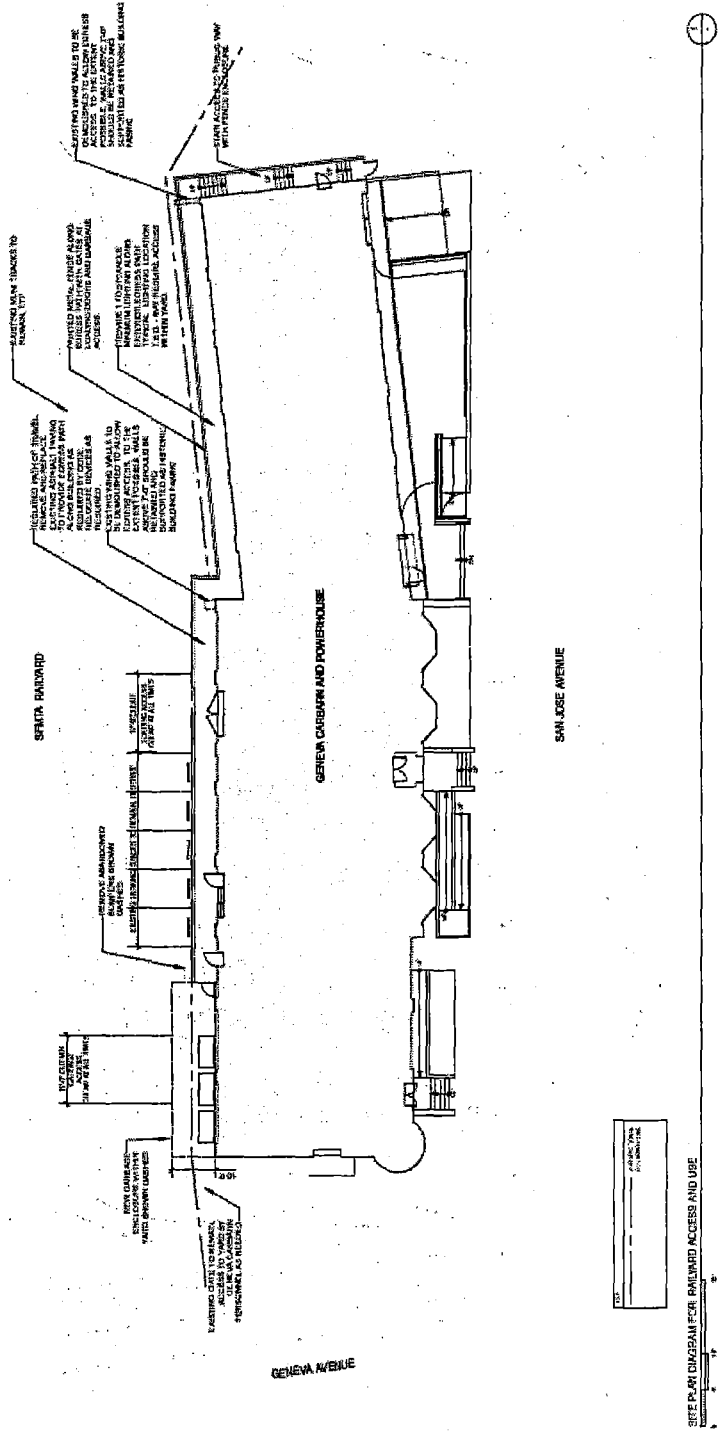

EXHIBIT C

RECOMMENDATIONS REGARDING ENVIRONMENTAL CONDITIONS

- Before renovation begins, the fluorescent light ballasts and electrical components throughout the office building and powerhouse should be collected and recycled or disposed, based on whether or not they contain PCBs.
- Before renovation begins, the mercury-containing switches should be collected from wall thermo stats in the office building and properly disposed by a contractor who is licensed and trained to handle and dispose of hazardous wastes.
- During renovation, ACM, LBP, and lead-based material should be abated and waste materials disposed of in accordance with all applicable regulations as described in the ACM and LBP survey report (Vista 2013).
- Before renovation, stained areas of concrete in the powerhouse should be cleaned and waste materials disposed in accordance with 40 CFR Part 761. The initial step in the cleanup process will be to prepare and submit a notification describing planned cleanup activities as described in 40 CFR Part 761.61. The notification process will notify federal, State, and local agencies who may act as the lead oversight agency for the cleanup and identify the lead agency that will direct the work. The lead oversight agency may have site-specific requirements for further assessment or cleanup.

EXHIBIT D

FORM OF CERTIFICATE OF COMPLETION

Recorded at the request of, and
When recorded, mail to:

[Real Estate Division
City and County of San Francisco
25 Van Ness Avenue, Suite 400
San Francisco, CA 94102
Attn: Director of Property]

CERTIFICATE OF COMPLETION OF IMPROVEMENTS

WHEREAS, City and County of San Francisco, acting by and through its Recreation and Park Commission ("*City*"), and the Friends of the Geneva Office Building and Power House, a California nonprofit corporation ("*Friends*"), entered into a Lease Disposition and Development Agreement dated as of _____, 201__ (the "*Agreement*"), a memorandum of which was recorded on _____, 201__, in the Office of the Recorder of City and County of San Francisco, in Reel _____, of the Official Records, at Image _____, setting forth the terms and conditions under which City and Friends would enter into a Ground Lease of certain real property situated in City and County of San Francisco, State of California, which property is more particularly described in Exhibit A attached hereto and made a part hereof (the "*Property*"), and setting forth certain obligations of Friends to rehabilitate and construct certain Improvements (as defined in the Agreement) on the Property;

WHEREAS, pursuant to that certain Lease dated _____, 201__ (the "*Lease*"), a memorandum of which was recorded on _____, 201__, in the Office of the Recorder of City and County of San Francisco, in Reel _____, of the Official Records, at Image _____, City did convey to Friends (as Friends thereunder) a leasehold interest in the Property;

WHEREAS, City has conclusively determined that the rehabilitation and construction obligations of Friends as specified in the Agreement have been fully performed and the Improvements, as defined in the Agreement, have been completed in accordance therewith; and

WHEREAS, as stated in the Agreement, City's determination regarding such rehabilitation and construction obligations is not directed to, and thus City assumes no responsibility by virtue of this Certificate for, engineering or structural matters or compliance with building codes, regulations, Regulatory Approvals or applicable Laws (each as defined in the Agreement) relating to construction standards.

NOW THEREFORE, as provided in the Agreement, with respect to the Property, and subject to the foregoing provisions hereof, City does hereby certify that Friends' rehabilitation and construction obligations under the Agreement related to Completion of the Improvements

have been fully performed and completed as described above and that the Agreement shall be deemed terminated and of no further force or effect, except as specifically set forth therein. Nothing contained in this instrument shall modify in any way any provisions of the Lease.

IN WITNESS WHEREOF, City has duly executed this instrument this _____ day of _____, 20__.

CITY AND COUNTY OF _____
SAN FRANCISCO, a municipal corporation

By: _____
Name: _____
Title: _____

APPROVED AS TO FORM:

DENNIS J. HERRERA, City Attorney

By: _____
Deputy City Attorney

EXHIBIT E

FORM OF THE LEASE

[Attached]

EXHIBIT F

SCHEDULE OF PERFORMANCE

INTRODUCTION

Several principles apply to an effective understanding of this Schedule of Performance: (i) all terms used herein have the same meanings as provided in the Lease Disposition and Development Agreement between the City and County of San Francisco through the San Francisco Recreation and Parks Department (“City”), and Friends of Geneva Office Building and Power House, a California non profit corporation (“Developer”) to which this Schedule of Performance is attached (the “Agreement”); (ii) parenthetical numbers are references to sections of the Agreement, as the dates described herein are not exhaustive of all dates described in the Agreement; (iii) all Required Completion Dates provided for in this Schedule of Performance may be extended by applicable Force Majeure provisions or as otherwise provided for in the Agreement; (iv) the Projected Dates provided herein are for informational purposes only and are not binding in any way on the City or the Developer, except as otherwise specifically provided in the Agreement; and (v) in the event of an inconsistency between this Schedule of Performance and the Agreement, the Agreement shall prevail.

<u>Action</u>	<u>Required Completion Date</u>
<u>Approval – LDDA.</u> Recreation and Park Commission shall approve, disapprove, or conditionally approve LDDA.	Expected May 2014
<u>Submission – Preliminary Construction Documents.</u> City shall prepare and submit the Preliminary Construction Documents to the Friends for review and approval (Sec. 5.6).	February 1, 2015
<u>Approval – Preliminary Construction Documents.</u> Friends must approve, disapprove or approve conditionally the Preliminary Construction Documents in writing (Sec. 5.8(b)).	30 days after receipt of Preliminary Construction Documents from City.
<u>Submission – Updated Budget and Financing Plan.</u> Friends shall submit for City’s review and approval an updated estimated Budget of total development costs for the Project, prepared at a level of detail commensurate with the stage of design expressed in the drawings then under review, and to the extent the Budget differs from the Budget previously submitted, shall also submit, for City’s information, an updated Financing Plan setting forth anticipated sources and uses of funds. (Sec. 5.6 (b))	30 days after receipt of Preliminary Construction Documents from City.
<u>Approval – Preliminary Construction Documents.</u>	No later than 45 days after receipt of

City must approve, disapprove or approve conditionally the any submissions required under the terms of this Agreement other than full building permit application (Sec. 5.8(d)).	full submission
<u>Submission – Final Construction Document Funding.</u> Friends will gift total funds to the City for completion of Final Construction Documents (for acceptance by the Board of Supervisors).	February 1, 2015 (expected) – November 1, 2015
<u>Submission – Final Construction Documents.</u> City shall prepare and submit the Final Construction Drawings to the Friends for review and approval (Sec 5.6).	June 1, 2015 (expected) - March 1, 2016
<u>Approval – Final Construction Documents.</u> Friends must approve, disapprove or approve conditionally the Final Construction Documents in writing (Sec. 5.8(b)).	30 days after receipt of Final Construction Documents from City.
<u>Submission – Final Budget.</u> Friends shall submit for City’s review and approval a final Budget of total development costs for the Site and the Improvements (Sec. 7.1 (a)).	30 days after receipt of Final Construction Documents from City.
<u>Approval – Final Construction Documents.</u> City must approve, disapprove or approve conditionally the Preliminary Construction Documents in writing (Sec. 5.8(d)).	No later than 45 days after approval of final construction documents by Friends.
<u>Submission - Evidence of Regulatory Approvals.</u> Friends shall submit to City evidence of all required Regulatory Approvals. (Sec. 2.3 (vii)).	No later than 10 days before Close of Escrow.
<u>Submission- Historic Certification Application, Part 2.</u> Friends shall submit to City evidence of submission of Historic Certification Application, Part 2 to the NPS and their approval thereof. (Sec. 2.3 (v)).	No later than 10 days before Close of Escrow.
<u>Submission – HPTC Partnership Agreement (if applicable).</u> Friends shall submit to City operating agreement or limited partnership agreement with an investor to utilize the HTPC. (Sec. 2.3 (vi)).	No later than 10 days before Close of Escrow.

<u>Submission – Final Financing Plan.</u> Friends shall submit to City for review and approval a final Financing Plan setting forth confirmed sources and uses of funds (Sec 7.1 (b))	At least 45 days after submission of Preliminary Construction Documents in accordance with Section 5 and no later than December 2016.
<u>Submission – Operating Budget.</u> Friends shall submit to City an Operating Budget for review and approval. (Sec. 7.1(c)).	On or before submission of final Financing Plan.
<u>Submission – Evidence of City Financing.</u> City shall provide to Developer evidence of all financing to be provided by the City. (Sec. 2.4 (a)(ix)).	On or before submission of final Financing Plan.
<u>Submission – Application for Building Permit.</u> Friends shall complete and submit application for either a Site Permit or a full building permit for planned Improvements (Sec. 5.16).	January 2016 (expected) – January 2017
<u>Submission - SFMTA Short Term License.</u> Friends shall submit to SFMTA Short Term License Permit Area and Construction Work Plan for review and approval.	January 2016 (expected) – January 2017
<u>Submission – Survey of Property.</u> Friends shall prepare and submit a Survey to City for review and approval (Sec.2.7 (b)).	January 2016 (expected) – January 2017
<u>Approval – Survey of Property.</u> City will review and approve Survey (Sec.2.7 (b)).	Within 30 days after submission.
<u>Completion – SFMTA Facilities Matters.</u> SFMTA high tension wire/alarm removed (Section 3.4).	No later than 45 days prior to the start of Construction.
<u>Prepare and Execute Joint Escrow Instructions – Friends.</u> Friends must prepare and execute joint escrow instructions (Sec. 2.2(c)).	No later than 30 days before the Close Date Developer shall prepare and submit to the City for review joint escrow instructions.
<u>Opening of Escrow.</u> Developer shall open Escrow (Sec. 2.2).	No later than 15 days prior to Close Date.
<u>Close of Escrow.</u> (Sec. 2.2(b))	June 2016 [expected] – June 2017.
<u>Commencement of Construction Improvements.</u> Friends shall use its reasonable efforts to commence all construction and development within the times specified in the Schedule of Performance or within such extension of time as the City may grant in writing, in its reasonable discretion or as otherwise permitted by the Agreement, subject to Force	July 2016 [expected] – July 2017.

Majeure. (Sec. 5.13).	
<u>Completion of Construction Improvements.</u> Friends shall use its reasonable efforts to complete all construction and development within the times specified in the Schedule of Performance or within such extension of time as the City may grant in writing, in its reasonable discretion or as otherwise permitted by the Agreement, subject to Force Majeure. (Sec. 5.13).	December 2017 [expected] – December 2018
<u>Submission – Request for Certificate of Completion.</u> Developer may request in writing from the City a Certificate of Completion (Sec. 6.1(a)(ii)).	After Construction of Improvements (except for Deferred Items) on the Property has been completed by the Developer in accordance with all provisions of the LDDA.
<u>Approval – Certificate of Approval.</u> The City shall act on Developer's request for a Certificate of Completion (Sec. 6.1(a)(ii)).	Within 30 days of receipt of the request.
<u>Submission – As Built Documents.</u> Developer must furnish City as-built plans, specifications and surveys with respect to the Site (Sec. 5.14(a)).	Within 90 days after Completion of the Improvements.
<u>Submission - Certified Construction Costs.</u> The Developer shall furnish to the City Certified Construction Costs (Sec. 5.14(b)).	Within 90 days after Completion of the Improvements.
<u>Inspection – Certified Construction Costs.</u> The City shall have the right to inspect the Developer's records regarding the construction of the Improvements (Sec. 5.14(b)).	Within 60 days after receipt by the City of Certified Construction.

EXHIBIT G

FORM OF MEMORANDUM OF LEASE

RECORDING REQUESTED BY, AND
WHEN RECORDED, MAIL TO:

Friends of Geneva Office Building and Power
House
755 Ocean Avenue
San Francisco, CA 94112
Attention: Daniel Weaver

No Documentary Transfer Tax due
No fee for recording pursuant to
Government Code § 27383

FOR RECORDER'S USE ONLY

APN: Block 6972 Lot 36

MEMORANDUM OF LEASE

This Memorandum of Lease ("Memorandum"), dated for reference purposes as of _____, 20____, is by and between the CITY AND COUNTY OF SAN FRANCISCO, a municipal corporation, acting by and through its Recreation and Park Commission ("City") and FRIENDS OF GENEVA OFFICE BUILDING AND POWER HOUSE, a California non-profit corporation ("Tenant").

Recitals

A. City owns certain real property in the City and County of San Francisco, State of California, located at the corner of Geneva Avenue and San Jose Avenue as more particularly described on Exhibit A attached hereto (the "City Property"). That portion of the City Property depicted as the Geneva Office Building and Powerhouse property on the Property Boundary Survey attached hereto as Exhibit B (the "Leased Property") is in the jurisdiction of City's Recreation and Parks Commission, and is improved with a building comprised of two adjoining structures: a two-story office building and a single-story car shed, known as the Powerhouse. City and Tenant have entered into that certain Lease, dated _____, 20____ (the "Lease"), pursuant to which City leased to Tenant and Tenant leased from City the Leased Property.

B. City and Tenant desire to execute this Memorandum to provide constructive notice of the Lease to all third parties, and all of the terms and conditions of the Lease are incorporated herein by reference as if they were fully set forth herein and reference is made to the Lease itself for a complete and definitive statement of the rights and obligations of City and Tenant thereunder.

For good and valuable consideration, the receipt and adequacy of which are hereby acknowledged, the parties agree as follows:

1. Term. Pursuant to the terms of the Lease, City leased the Leased Property to Tenant for a term commencing on _____, 20__ and ending on _____, 20__, unless earlier terminated in accordance with the terms of the Lease, subject to Tenant's early termination rights described below. Tenant has the option to terminate the Lease early by providing 180 days prior written notice to City, as provided in Section 3.2 of the Lease.

2. Lease Terms. The lease of the Leased Property to Tenant is made pursuant to the Lease, which is incorporated in this Memorandum by reference. This Memorandum shall not be deemed to modify, alter or amend in any way the provisions of the Lease. In the event any conflict exists between the terms of the Lease and this Memorandum, the terms of the Lease shall govern. Except as otherwise defined in this Memorandum, capitalized terms shall have the meanings given them in the Lease.

3. Successors and Assigns. This Memorandum and the Lease shall bind and inure to the benefit of the parties and their respective heirs, successors, and assigns, subject, however, to the provisions of the Lease.

IN WITNESS WHEREOF, City and Tenant have executed this Memorandum of Lease as of the day and year first above written.

TENANT

FRIENDS OF GENEVA OFFICE BUILDING AND
POWER HOUSE, a California non-profit
corporation

By: _____
Its: _____

By: _____
Its: _____

CITY:

CITY AND COUNTY OF SAN FRANCISCO,
a municipal corporation

By: _____
PHILIP A. GINSBURG
General Manager
Recreation and Park Department

APPROVED AS TO FORM:

DENNIS J. HERRERA
City Attorney

By: _____
Deputy City Attorney

State of California)

County of _____)

On _____ before me, _____, personally appeared _____, who proved to me on the basis of satisfactory evidence to be the person(s) whose name(s) is/are subscribed to the within instrument and acknowledged to me that he/she/they executed the same in his/her/their authorized capacity(ies), and that by his/her/their signature(s) on the instrument the person(s), or the entity upon behalf of which the person(s) acted, executed the instrument.

I certify under PENALTY OF PERJURY under the laws of the State of California that the foregoing paragraph is true and correct.

WITNESS my hand and official seal.

Signature _____ (Seal)

State of California)

County of _____)

On _____ before me, _____, personally appeared _____, who proved to me on the basis of satisfactory evidence to be the person(s) whose name(s) is/are subscribed to the within instrument and acknowledged to me that he/she/they executed the same in his/her/their authorized capacity(ies), and that by his/her/their signature(s) on the instrument the person(s), or the entity upon behalf of which the person(s) acted, executed the instrument.

I certify under PENALTY OF PERJURY under the laws of the State of California that the foregoing paragraph is true and correct.

WITNESS my hand and official seal.

Signature _____ (Seal)

State of California)
County of _____)

On _____ before me, _____, personally appeared _____, who proved to me on the basis of satisfactory evidence to be the person(s) whose name(s) is/are subscribed to the within instrument and acknowledged to me that he/she/they executed the same in his/her/their authorized capacity(ies), and that by his/her/their signature(s) on the instrument the person(s), or the entity upon behalf of which the person(s) acted, executed the instrument.

I certify under PENALTY OF PERJURY under the laws of the State of California that the foregoing paragraph is true and correct.

WITNESS my hand and official seal.

Signature _____ (Seal)

EXHIBIT A

to

Memorandum of Lease

Legal Description of City Property

THAT CERTAIN REAL PROPERTY SITUATED IN THE CITY AND COUNTY OF SAN FRANCISCO, STATE OF CALIFORNIA, DESCRIBED AS FOLLOWS:

BEGINNING at the point of intersection of the Southeasterly line of San Jose Avenue with the Southwesterly line of Geneva Avenue; thence Southeasterly along said line of Geneva Avenue 422.24 feet to the Northwesterly line of Delano (formerly Delaware) Avenue; thence at a right angle Southwesterly along said line of Delano Avenue 331.38 feet, more or less, to a point distant thereon 120 feet Northeasterly from the Northeasterly line of Niagara (formerly Unadilla) Avenue; thence at a right angle Northwesterly parallel with said line of Niagara Avenue 454 feet to the Southeasterly line of San Jose Avenue; thence Northeasterly along said line of San Jose Avenue 333.4 feet to the point of beginning.

BEING a portion of Block 29 "West End Map No. 1". Excepting therefrom that portion lying within Parcel 25 as shown on the Map filed March 3, 1965 in Book U of Maps, Page 69.

Also excepting therefrom that portion described in the Deed Zanello/Gaehwiler, a California partnership recorded February 2, 1987 in Reel E270 Page 598, Document No. D938354.

APN:

Commonly known as 2301 San Jose Avenue

EXHIBIT B
to
Memorandum of Lease

Depiction of Leased Property

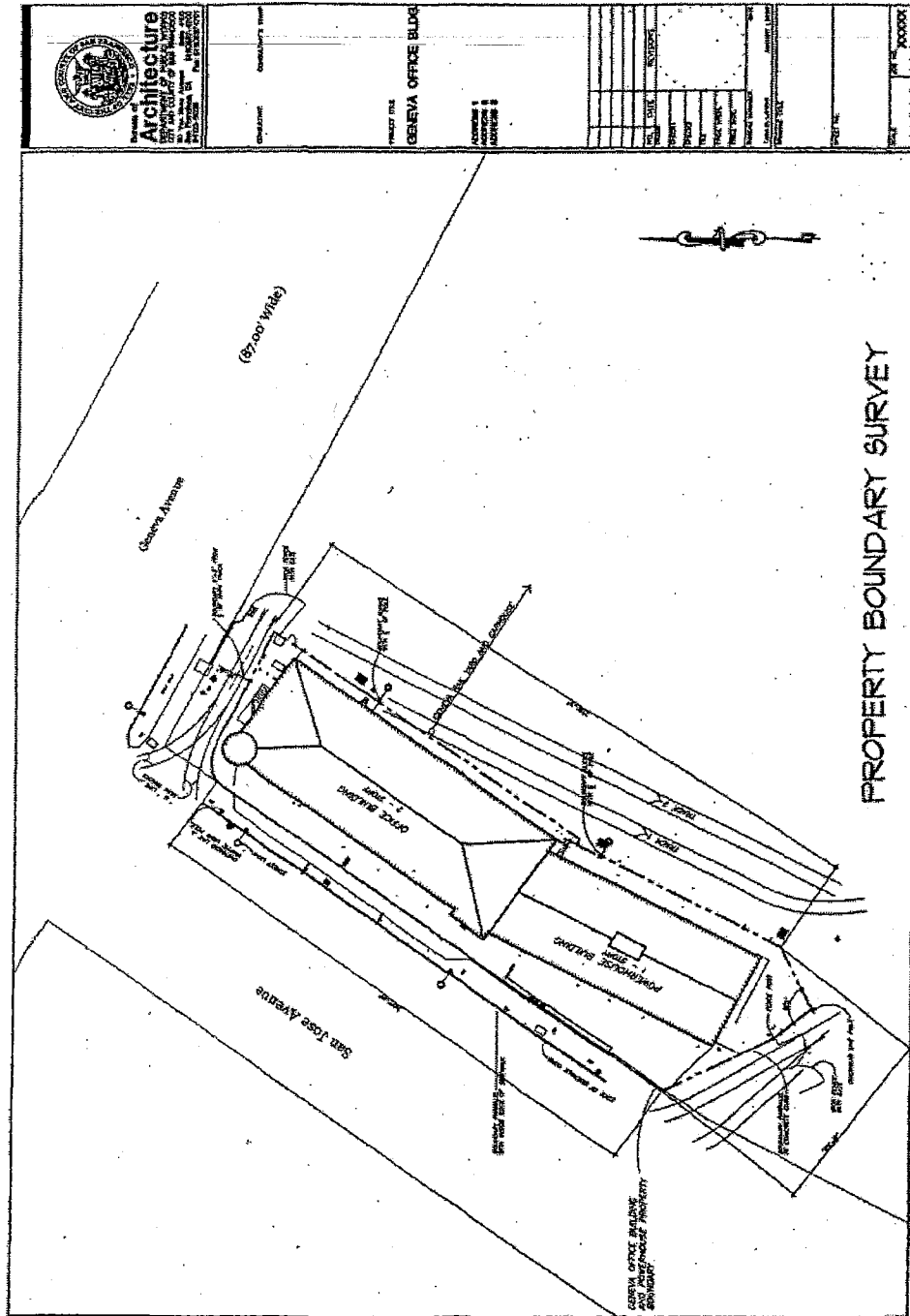

EXHIBIT H

PERMITTED TITLE EXCEPTIONS

1. The lien of supplemental taxes, if any, assessed pursuant to the provisions of Chapter 3.5 (Commencing with Section 75) of the Revenue and Taxation Code of the State of California.

2. The herein described property lies within the boundaries of a Mello Roos Community Facilities District ("CFD"), as follows:

CFD No: 90 1

For: School Facility Repair and Maintenance

This property, along with all other parcels in the CFD, is liable for an annual special tax. This special tax is included with and payable with the general property taxes of the City and County of San Francisco. The tax may not be prepaid.

Further information may be obtained by contacting:

Chief Financial Officer

San Francisco Unified School District

135 Van Ness Ave. - Room 300

San Francisco, CA 94102

Phone (415) 241-6542

3. Terms and provisions of the Emergency Order No. 7838, Location 2301 San Jose Avenue, Block 6972, Lot 020, recorded November 27, 2001, Instrument No. 2001-H060302-00, Reel I021, Image 0469, of Official Records.

EXHIBIT I

SCOPE OF DEVELOPMENT / SCHEMATIC DRAWINGS

A. Schematic Drawings. Drawings prepared by Aidlin Darling Design, dated July 8, 2010, comprised of the following sheets:

- A0.1 Project Information
- A0.2 Site Plan
- A1.1 Basement Level Demolition Plan
- A1.2 Level 1 Demolition Plan
- A1.3 Level 2 Demolition Plan
- A1.4 Level 3 Demolition Plan
- A1.5 Roof Demolition Plan
- A2.1 Basement Level Plan
- A2.2 Level 1 Plan
- A2.3 Level 2 Plan
- A2.4 Level 3 Plan
- A2.5 Roof Plan
- A5.1 Exterior Elevations
- A5.2 Exterior Elevations
- A5.3 Exterior Elevations
- A5.4 Building Sections
- A5.5 Building Sections
- A5.6 Building Sections

B. Scope of Development. The project entails the renovation and restoration of the Geneva Car Barn and Powerhouse, a historic structure located at 2301 San Jose Avenue in San Francisco. Design and documentation work is based on the completed schematic design architectural and structural drawings prepared by Aidlin Darling Design, dated July 12, 2010. Project scope includes facade restoration, seismic upgrade and interior renovation to provide a 300 person event space, a 99 seat black box Theater, three youth training classrooms and associated spaces for the new uses. The design will incorporate the shell and infrastructure for a 2000 square foot restaurant and a 730 square foot retail space.

EXHIBIT J

FORM OF ARCHITECT'S CERTIFICATE

TO: City and County of San Francisco
Recreation and Park Department
McLaren Lodge Annex
San Francisco, California 94117

Date: _____

FROM: [Architect]

RE: Geneva Avenue Office Building and Power House

Note: This certificate is being provided pursuant to Section 5.5(b) of that certain Lease Disposition and Development Agreement between the City and County of San Francisco and the Friends of Geneva Avenue Office Building and Power House, a California non-profit public benefit corporation ("Friends"), dated as of _____, 20__, hereinafter referred to as the "Agreement". All terms used below which are defined terms in the Agreement have the same meaning herein as therein.

I visited the construction site for the Project at intervals appropriate to the stage of construction, or as otherwise agreed by me and the Friends, to become generally familiar with the progress and quality of the construction completed and to determine in general if the construction was being performed in a manner indicating that the construction of the Improvements when completed would be in accordance with the Construction Documents.

My opinions and statements provided in this certificate are limited to my on-site observations. I am not required to make nor have I made exhaustive or continuous on-site inspections to check the quality or quantity of the construction.

I neither retained nor exercised control over or charge of, nor am I responsible for construction means, methods, techniques, sequences or procedures, or for safety precautions and programs in connection with the construction of the Improvements.

Subject to the limitations set forth above, I hereby certify to the best of my knowledge, information and belief as follows:

Construction of the Improvements has been performed in a good and workmanlike manner and in accordance with those elements of the Final Construction Documents which have been approved by the City pursuant to the Agreement, except as may be noted on Schedule A attached hereto.

The Project, as constructed, complies with all applicable statues, codes, zoning ordinance and regulations, including, but not limited to, handicapped accessibility ordinances and

regulations, including, but not limited to the "ADA Accessibility Guidelines for Buildings and Facilities", 28 CFR part 36, Appendix A (the "ADA Guidelines").

The Project is complete (except for minor punch list items specifically described in Schedule A, with estimated costs).

The required certificates, approvals and permits of all governmental authorities having jurisdiction covering the work to date on Improvements have been issued and are in force, and there is not an undischarged violation of applicable laws, regulations or orders of any governmental authority having jurisdiction of which I have notice as of the date hereof, except as may be noted on Schedule A attached hereto.

All statements and opinions made in this certificate are limited to the extent that I have not made exhaustive or continuous on-site inspections to check the quality or quantity of the construction nor have I reviewed the construction means, methods, techniques, sequences or procedures.

Architect

SCHEDULE A

to

Form of Architect's Certificate

EXHIBIT K

PREVAILING WAGE AGREEMENT

[Attached]

EXHIBIT L

FORM OF BUDGET

Construction Cost	\$16,955,794
Soft Costs	
Design Team	\$1,995,000
Regulatory Approvals	\$200,000
Data/Surveys	\$65,000
Project Manager	\$300,000
FF&E	\$500,000
Art Enrichment (2% of construction cost)	\$339,000
Hazardous Abatement	\$102,000
Fire Security Modification	\$75,000
Construction Contingency (5%)	\$847,788
Subtotal	\$4,423,903
Total Project Cost	\$21,379,657

EXHIBIT M

FINANCING PLAN

Source of Funds	Status/Timing	Description	Amount
2000 Neighborhood Park General Obligation Bond Funds	Appropriated	For Design Development and Preliminary Construction Drawings	\$838,000
Community Opportunity Funding*	Spring 2015 (anticipated)	Capital program allowing residents, neighborhood groups, and advocates to initiate capital improvements to RPD properties by matching public funding with other gifts and grants; must have a complete design, budget, and schedule	≤ \$3,000,000
Historic Preservation Tax Credits	Accepted on a rolling basis	20% of rehabilitation hard costs for substantial projects on certified historic structures; must meet SHPO and NPS standards for rehabilitation	≤ \$3,400,000
New Market Tax Credits	Winter 2015 (anticipated)	20% of rehabilitation hard and soft costs for qualified projects in economically distressed areas; must demonstrate Project Readiness	≤ \$4,200,000
Additional fundraising	2014-2016	To be raised from private and public sources	≤ \$9,941,657
Total Funding			\$21,379,657

**City has not made a commitment of an award from the Community Opportunity Fund for the Project.*

EXHIBIT N

FORM OF FIRST SOURCE HIRING AGREEMENT

[Attached]

EXHIBIT O

WORKFORCE HIRING PROGRAM



CITY AND COUNTY OF SAN FRANCISCO
OFFICE OF ECONOMIC AND WORKFORCE DEVELOPMENT
CITYBUILD PROGRAM



LOCAL HIRING PROGRAM
OEWD FORM 2
CONSTRUCTION CONTRACTS

FORM 2: LOCAL HIRING PLAN

Department: _____ Project Name: _____ Contract #: _____

If the Engineer's Estimate for this Project exceeds \$1 million, then Contractor must submit a Local Hiring Plan using this Form 2 through the City's Project Reporting System. NTP will not be issued until Contractor submits a completed Form 2. Contractor shall be responsible for any delays to NTP and resulting damages incurred by the City caused by the Contractor's failure to submit a completed Form 2 in a timely manner. The Local Hiring Plan must be approved in writing by OEWD before any Application for Payment can be approved and progress payment paid to Contractor. The OEWD-approved Local Hiring Plan will be a Contract Document and will be the basis for determining Contractor's and its Subcontractors' compliance with the local hiring requirements. Any OEWD-approved Conditional Waivers (Form 4) will be incorporated into the OEWD-approved Local Hiring Plan.

COMPLETE AND SUBMIT A SEPARATE FORM 2 FOR EACH TRADE THAT WILL BE UTILIZED ON THIS PROJECT.

INSTRUCTIONS:

1. Please complete tables below for Contractor and all Subcontractors that will be contributing Project Work Hours to meet the Local Hiring Requirement.
2. Please note that a Form 2 will need to be developed and approved separately for each trade craft that will be utilized on this project.
3. If you anticipate utilizing apprentices on this project, please note the requirement that 50% of apprentice hours must be performed by San Francisco residents.
4. The Contractor and each Subcontractor identified in the Local Hiring Plan must sign this form before it will be considered for approval by OEWD.
5. If applicable, please attach all OEWD-approved Form 4 Conditional Waivers.
6. Additional blank forms are available at our Website: www.workforcedevelopmentsf.org. For assistance or questions in completing this form, contact CityBuild (415) 701-4848 or Email Local.hire.ordinance@sfgov.org.

List Trade Craft. Add numerical values from Form 1: Local Hiring Workforce Projection and input in the table below.

Trade Craft	Total Work Hours	Total Local Work Hours	Local Work Hours%	Total Apprentice Work Hours	Total Local Apprentice Work Hours	Local Apprentice Work Hours %
<i>Example: Laborer</i>	1500	300	30%	200	100	50%

STATEMENT OF COMPLIANCE:

This project will follow the City's Mandatory Local Hiring Policy for Construction and include all requirements stipulated under Legislative Code Chapter 6.22(q). Public Projects advertised between March 25, 2013 and March 24, 2014 will have a mandatory local hiring requirement of 30% by trade.

Signature: _____ Name: _____ Contract #: _____

Title: _____ Email: _____

EXHIBIT P

FORM OF MEMORANDUM OF AGREEMENT

RECORDING REQUESTED BY, AND
WHEN RECORDED, MAIL TO:

Friends of Geneva Office Building and Power
House
755 Ocean Avenue
San Francisco, CA 94112
Attention: Daniel Weaver

No Documentary Transfer Tax due
No fee for recording pursuant to
Government Code § 27383

FOR RECORDER'S USE ONLY

APN: Block 6972 Lot 36

**MEMORANDUM OF LEASE DISPOSITION
AND DEVELOPMENT AGREEMENT**

This Memorandum of Lease Disposition and Development Agreement ("Memorandum of LDDA"), dated for reference purposes as of _____, 20____, is by and between the CITY AND COUNTY OF SAN FRANCISCO, a municipal corporation, acting by and through its Recreation and Park Commission ("City") and FRIENDS OF GENEVA OFFICE BUILDING AND POWER HOUSE, a California non-profit corporation ("Friends").

Recitals

C. City owns certain real property in the City and County of San Francisco, State of California, located at the corner of Geneva Avenue and San Jose Avenue as more particularly described on Exhibit A attached hereto (the "City Property"). That portion of the City Property depicted as the Geneva Office Building and Powerhouse property on the Property Boundary Survey attached hereto as Exhibit B (the "Leased Property") is in the jurisdiction of City's Recreation and Parks Commission, and is improved with a building comprised of two adjoining structures: a two-story office building and a single-story car shed, known as the Powerhouse.

D. City and Friends have entered into that certain Geneva Office Building and Power House Lease Disposition and Development Agreement with respect to the Leased Property (the "LDDA"). The Effective Date of the LDDA, as that term is defined in the LDDA, is _____, 20____. *[Title Company to insert Effective Date pursuant to LDDA Section 12.21; Delete note in execution copy.]*

E. City and Friends desire to execute this Memorandum of LDDA to provide constructive notice of the LDDA to all third parties, and all of the terms and conditions of the LDDA are incorporated herein by reference as if they were fully set forth herein and reference is made to the LDDA itself for a complete and definitive statement of the rights and obligations of City and Friends thereunder.

F. Capitalized terms not otherwise defined herein shall have the same meaning as set forth in the LDDA.

For good and valuable consideration, the receipt and adequacy of which are hereby acknowledged, the parties agree as follows:

4. Term: The term of the LDDA shall commence upon the Effective Date and continue until City records a Certificate of Completion for the Improvements pursuant to Section 6 of the LDDA, unless earlier terminated by written agreement of the parties or otherwise in accordance with its provisions.

5. Lease of Leased Property. The City hereby agrees to lease to the Friends and the Friends hereby agrees to lease from the City, the Leased Property, each pursuant and subject to the terms and conditions of the LDDA.

6. No Amendment of LDDA. This Memorandum of LDDA is solely for recording purposes and shall not be construed to alter, modify, amend or supplement the LDDA. In the event of any conflict between any provision of the LDDA and any provision of this Memorandum of LDDA, the LDDA shall control.

7. Successors and Assigns. This Memorandum of LDDA shall bind and inure to the benefit of the parties and their respective heirs, successors, and assigns, subject, however, to the provisions of the LDDA.

IN WITNESS WHEREOF, City and the Friends have executed this Memorandum of LDDA as of the day and year first above written.

FRIENDS:

FRIENDS OF GENEVA OFFICE BUILDING AND
POWER HOUSE, a California non-profit
corporation

By: _____
Its: _____

By: _____
Its: _____

CITY:

CITY AND COUNTY OF SAN FRANCISCO,
a municipal corporation

By: _____
PHILIP A. GINSBURG
General Manager
Recreation and Park Department

APPROVED AS TO FORM:

DENNIS J. HERRERA
City Attorney

By: _____
Deputy City Attorney

State of California)

County of _____)

On _____ before me, _____, personally appeared _____, who proved to me on the basis of satisfactory evidence to be the person(s) whose name(s) is/are subscribed to the within instrument and acknowledged to me that he/she/they executed the same in his/her/their authorized capacity(ies), and that by his/her/their signature(s) on the instrument the person(s), or the entity upon behalf of which the person(s) acted, executed the instrument.

I certify under PENALTY OF PERJURY under the laws of the State of California that the foregoing paragraph is true and correct.

WITNESS my hand and official seal.

Signature _____ (Seal):

State of California)

County of _____)

On _____ before me, _____, personally appeared _____, who proved to me on the basis of satisfactory evidence to be the person(s) whose name(s) is/are subscribed to the within instrument and acknowledged to me that he/she/they executed the same in his/her/their authorized capacity(ies), and that by his/her/their signature(s) on the instrument the person(s), or the entity upon behalf of which the person(s) acted, executed the instrument.

I certify under PENALTY OF PERJURY under the laws of the State of California that the foregoing paragraph is true and correct.

WITNESS my hand and official seal.

Signature _____ (Seal)

State of California)
)
County of _____)

On _____ before me, _____, personally appeared _____, who proved to me on the basis of satisfactory evidence to be the person(s) whose name(s) is/are subscribed to the within instrument and acknowledged to me that he/she/they executed the same in his/her/their authorized capacity(ies), and that by his/her/their signature(s) on the instrument the person(s), or the entity upon behalf of which the person(s) acted, executed the instrument.

I certify under PENALTY OF PERJURY under the laws of the State of California that the foregoing paragraph is true and correct.

WITNESS my hand and official seal.

Signature _____ (Seal)

EXHIBIT A

to

Memorandum of Lease Disposition and Development Agreement

Legal Description of City Property

THAT CERTAIN REAL PROPERTY SITUATED IN THE CITY AND COUNTY OF SAN FRANCISCO, STATE OF CALIFORNIA, DESCRIBED AS FOLLOWS:

BEGINNING at the point of intersection of the Southeasterly line of San Jose Avenue with the Southwesterly line of Geneva Avenue; thence Southeasterly along said line of Geneva Avenue 422.24 feet to the Northwesterly line of Delano (formerly Delaware) Avenue; thence at a right angle Southwesterly along said line of Delano Avenue 331.38 feet, more or less, to a point distant thereon 120 feet Northeasterly from the Northeasterly line of Niagara (formerly Unadilla) Avenue; thence at a right angle Northwesterly parallel with said line of Niagara Avenue 454 feet to the Southeasterly line of San Jose Avenue; thence Northeasterly along said line of San Jose Avenue 333.4 feet to the point of beginning.

BEING a portion of Block 29 "West End Map No. 1". Excepting therefrom that portion lying within Parcel 25 as shown on the Map filed March 3, 1965 in Book U of Maps, Page 69.

Also excepting therefrom that portion described in the Deed Zanello/Gaehwiler, a California partnership recorded February 2, 1987 in Reel E270 Page 598, Document No. D938354.

APN: Block 6972 Lot 36

Commonly known as 2301 San Jose Avenue

EXHIBIT B

to

Memorandum of Lease Disposition and Development Agreement

Depiction of Leased Property

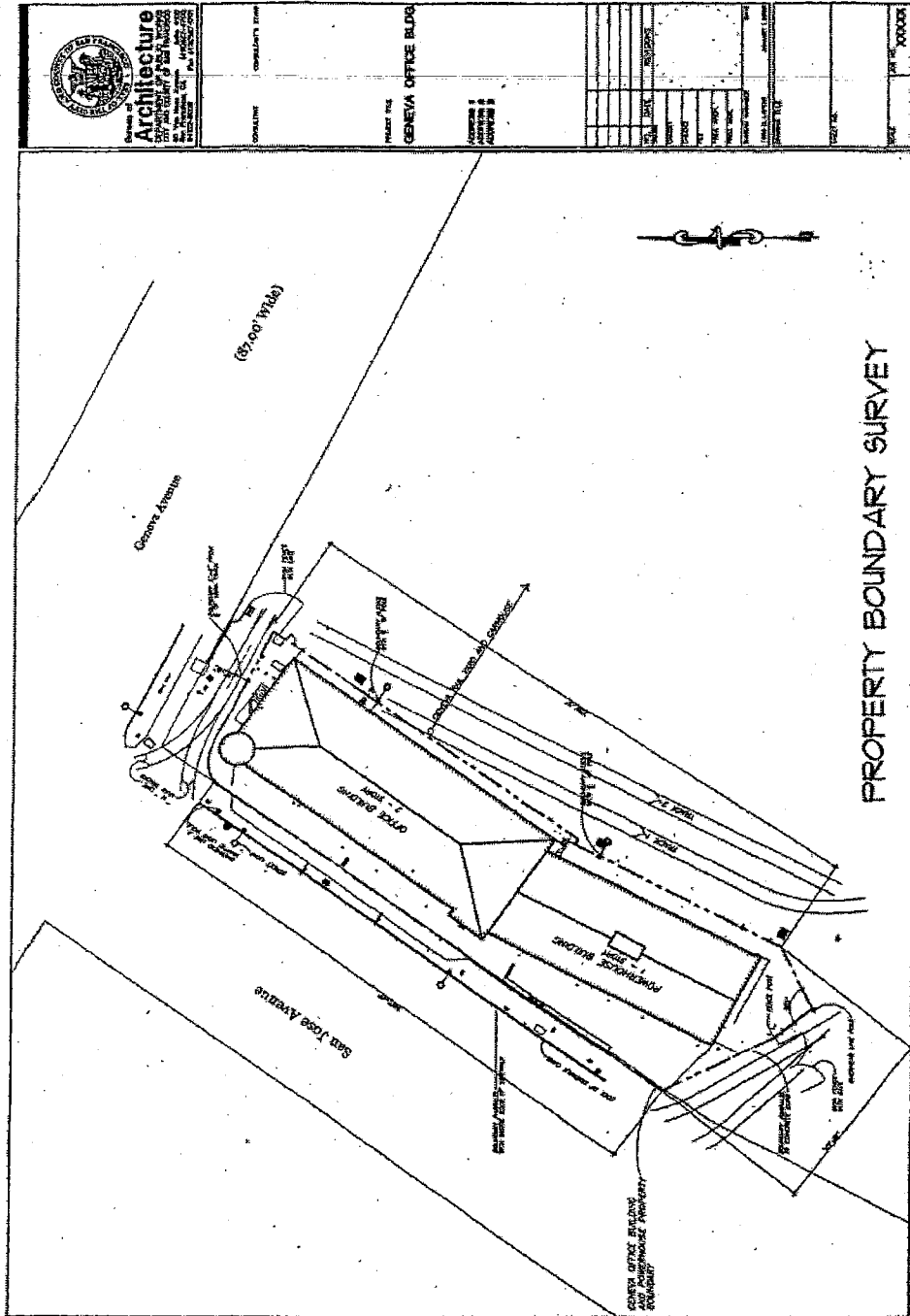

EXHIBIT Q

FORM OF LDDA PERMIT TO ENTER

REVOCABLE PERMIT TO ENTER AND USE PROPERTY

THIS REVOCABLE PERMIT TO ENTER AND USE PROPERTY (this "**Entry Permit**"), dated for reference purposes only as of _____, 20__, is made by and between the CITY AND COUNTY OF SAN FRANCISCO, a municipal corporation ("**City**"), acting by and through Recreation and Park Commission, and FRIENDS OF THE GENEVA OFFICE BUILDING AND POWERHOUSE, a California non-profit corporation ("**Permittee**").

RECITALS

A. City owns certain real property located at the intersection of San Jose Avenue and Geneva Avenue in the City and County of San Francisco, as further described in the attached Exhibit A (the "**City Property**"), with the buildings on the City Property known as the "Geneva Car Barn" and the "Geneva Powerhouse" (together, the "**Buildings**") under the jurisdiction of City's Recreation and Park Commission and the remainder of the City Property under the jurisdiction of the San Francisco Municipal Transportation Agency ("**SFMTA**").

B. City, acting by and through its Recreation and Park Department, has entered into a Lease Disposition and Development Agreement with Permittee, dated as of _____, 2014 ("**LDDA**"), which provides for Permittee's rehabilitation and improvement of the Buildings (the "**Project**") pursuant to the LDDA and a lease that will be between City and Permittee (the "**Ground Lease**").

City and Permittee agree as follows:

AGREEMENT

1. License; Permit Area. The "**Effective Date**" shall be the date that the following requirements are met: (a) this Entry Permit shall have been fully executed, and (b) Permittee shall have delivered to City the insurance certificates described in Section 10. As of the Effective Date, City confers to Permittee a revocable, personal, unassignable, non-exclusive and non-possessory privilege for Permittee and its affiliates and their respective officers, agents, employees, contractors, subcontractors and invitees (collectively, the "**Permittee Agents**") to enter upon and use that portion of the City Property depicted on the attached Exhibit A (the "**Permit Area**") for the Permitted Activities (as defined in Section 3).

This Entry Permit gives Permittee a license only and, notwithstanding anything to the contrary herein, this Entry Permit does not constitute a grant by City of any ownership, leasehold, easement or other property interest or estate whatsoever in the Permit Area, or any portion thereof. The privilege given to Permittee under this Entry Permit is effective only insofar as the rights of City in the Permit Area are concerned, and Permittee shall obtain any further permission necessary because of any other existing rights affecting the Permit Area.

2. Term of Permit. The privilege given to Permittee pursuant to this Entry Permit is temporary only and shall commence on the Effective Date. Unless sooner terminated pursuant to the terms hereof, the term of this Entry Permit ("**Term**") shall commence on the Effective Date and expire on _____, 20__ (the "**Termination Date**").

Without limiting any of its rights hereunder, City may at its sole option, exercised in good faith, freely revoke this Entry Permit at any time prior to the Termination Date, without cause and without any obligation to pay any consideration to Permittee, by delivering no less than five (5) days' prior written notice of such termination to Permittee.

3. Uses; Permitted Activities. Permittee and the Permittee Agents may use the Permit Area to perform the following activities (collectively, the "**Permitted Activities**"): (a) to perform Permittee's obligations under this Entry Permit, and (b) to use the Permit Area for

4. Performance of Work. [To be modified as appropriate to the Permitted Activities] Permittee shall conduct, and shall cause the Permittee Agents, to conduct the Permitted Activities in compliance with the terms of this Entry Permit, including the following conditions, which are for the sole benefit of City:

4.1 Work Plans. Prior to commencing the Permitted Activities, Permittee shall have prepared a work plan and schedule for the Permitted Activities to be performed that is approved in writing by City (each, a "**Work Plan**"), which approval shall not be unreasonably withheld, conditioned or delayed. Permittee acknowledges and agrees that it shall be reasonable for City to withhold such approval if a submitted work plan materially conflicts with this Entry Permit, the LDDA, the Ground Lease or any regulatory agreements or permit needed for the Permitted Activities or the Project (collectively, the "**Specification Documents**"), would materially affect City's use of the remainder of the City Property, including its railcar operations, or would raise material health or safety concerns. A Work Plan shall not be amended, modified or supplemented without City's prior written consent pursuant to this Entry Permit.

4.2 Permits and Approvals; Compliance with Specification Documents. Before beginning any of the Permitted Activities, Permittee shall obtain all permits, licenses and approvals (collectively, "**Approvals**") required of any regulatory agencies to commence and complete Permitted Activities, including, but not limited to, any permits from the San Francisco Department of Public Works and the San Francisco Department of Building Inspection. Permittee shall deliver copies of all Approvals to City prior to the Effective Date. Permittee recognizes and agrees that no approval by City of any of the Permitted Activities pursuant to this Entry Permit shall be deemed to constitute the Approval required of any federal, state or local regulatory authority with jurisdiction, including any required of City acting in its regulatory capacity, and nothing herein shall limit Permittee's obligation to obtain all such Approvals at Permittee's sole cost. Permittee shall conduct, and shall cause the Permittee Agents, to conduct the Permitted Activities in compliance with the terms of the Specification Documents.

4.3 Licensed Contractors; Exercise of Due Care. The Permitted Activities shall only be performed by contractors that are licensed by the State of California and duly qualified to perform such work, to the extent required by the State of California, and any of the Permitted Activities that is not required to be performed under applicable laws by a contractor licensed by the State of California for such work shall be performed by persons duly qualified to perform such work. Permittee shall use and cause the Permittee Agents to use due care at all times to avoid any damage or harm to City's property and to native vegetation and natural attributes of the Permit Area (other than as reasonably necessary to perform any of the Permitted Activities). City shall have the right to have a representative present during any of the Permitted Activities. Permittee shall do everything reasonably within its power, both independently and upon request by City, to prevent and suppress fires and the release of Hazardous Materials (as defined in Section 9.1) on and adjacent to the Permit Area attributable to the use of the Permit Area by Permittee or the Permittee Agents pursuant to this Entry Permit.

4.4 Cooperation with City Personnel. Permittee and the Permittee Agents shall work closely with City personnel to avoid disruption of City property in, under, on or about the Permit Area, City's use of the remainder of the City Property, and the maintenance, operation, repair,

replacement of City's utilities and improvements on the City Property. Permittee shall provide City's designated representative with advance written notice of (a) the commencement of the Permitted Activities, and (b) the completion of the Permitted Activities. City shall have the right, at its sole cost, to have a designated representative observe, photograph and/or otherwise record all of Permittee's activities on the Permit Area.

4.5 Work and Use Schedule. Permittee and the Permittee Agents may only perform the Permitted Activities during the hours specified in the applicable Work Plan (or between any shorter hours required under any applicable laws). Permittee will notify City if it terminates any phase of the Permitted Activities prior to the last day of such phase specified in the Work Plan for such phase. Permittee will notify City if it terminates the Permitted Activities prior to the Termination Date.

4.6 Pre-Entry Baseline. At City's request, Permittee shall document the condition of the Permit Area prior to the commencement of any Permitted Activities through the use of photographs, maps and any other appropriate documentation to provide a pre-construction baseline to monitor impacts. Appropriate documentation shall be determined in consultation with a staff member from the Recreation and Park Department's Capital Management Division. Permittee shall provide City with a copy of such documentation prior to the commencement of any Permitted Activities.

4.7 Maintenance of Permit Area; Repair of Damage. Permittee shall remove all debris in the Permit Area caused by any of the Permitted Activities or the use of the Permit Area by Permittee or any of the Permittee Agents. If any portion of the Permit Area or any City property located on or about the City Property is damaged at any time by any of the activities conducted by Permittee or any of the Permittee Agents hereunder, Permittee shall immediately, at its sole cost, repair any and all such damage and restore the Permit Area or property to its previous condition. Permittee shall, at all times and at its sole cost, maintain the Permit Area in a good, clean, safe, secure, sanitary and slightly condition (giving due consideration to the nature of the Permitted Activities) so far as the Permit Area may be affected by the Permitted Activities or any other actions in the Permit Area by Permittee or the Permittee Agents.

4.8 Excavation Activities. Permittee shall prevent all materials (including soil) displaced by or resulting from the Permitted Activities or the use of the Permit Area by Permittee or any of the Permittee Agents from entering storm drains, sewers, or water ways and shall immediately notify the City, and all appropriate regulatory agencies required under applicable laws, if there is any accidental release of such materials.

4.9 Agent Acknowledgement of Agreement. Permittee shall deliver a complete copy of this Entry Permit to all Permittee Agents performing any of the Permitted Activities or otherwise entering the Permit Area pursuant to this Entry Permit. Prior to the entry on the Permit Area by any such party, Permittee shall deliver a notice to City signed by such party acknowledging its receipt of a copy of this Entry Permit and its agreement to comply with and be bound by all of the provisions of this Entry Permit pertaining to its entry on the Permit Area.

4.10 Wages and Working Conditions. With respect to the installation of any facilities or improvements or the performance of any work that is a "public work" under the State of California Labor Code, any employee performing services for Permittee or any Permittee Agent shall be paid not less than the highest prevailing rate of wages and that Permittee shall include, in any contract for construction of such improvement work or any alterations on the Permit Area, a requirement that all persons performing labor under such contract shall be paid not less than the highest prevailing rate of wages for the labor so performed. Permittee further agrees that, as to the construction of such improvement work or any alterations on the Permit Area under this Entry Permit, Permittee shall comply, and cause all Permittee Agents to comply, with the provisions of Section 6.22(E) of the San Francisco Administrative Code (as the same may be amended, supplemented or replaced) that relate to payment of prevailing wages. Permittee shall

require all Permittee Agents to provide, and shall deliver to City upon request, certified payroll reports with respect to all persons performing labor in the construction of the improvement work or any alterations on the Permit Area for Permittee or any Permittee Agent.

5. Restrictions on Use; City's Uses. Permittee agrees that, by way of example only and without limitation, the following uses of the Permit Area by Permittee or any other party claiming by or through Permittee are inconsistent with the limited purpose of this Entry Permit and are strictly prohibited as provided below:

5.1 Improvements. Except for any temporary structures or improvements described in a Work Plan and the personal property reasonably needed to perform the Permitted Activities described in the applicable Work Plan, Permittee shall not construct or place any temporary or permanent structures or improvements or personal property on the Permit Area, nor shall Permittee alter any existing structures or improvements on the Permit Area. Permittee understands and agrees that City is entering into this Entry Permit in its capacity as a landowner with a proprietary interest in City's Property and not as a regulatory agency with certain police powers. Permittee understands and agrees that neither the City's execution of this Entry Permit nor any approvals by City of any work plan or otherwise given by City under this Entry Permit shall grant, or be deemed to imply, that Permittee will be able obtain, any required Approvals from departments, boards or commissions of the City and County of San Francisco that have jurisdiction over any of the Permitted Activities.

5.2 Dumping; Storing; Signs. Permittee shall not dump or dispose of refuse or other unsightly materials or store any materials on, in, under or about the Permit Area. Permittee shall not place, erect or maintain any sign, advertisement, banner or similar object on or about the Permit Area, except for any temporary sign that is necessary for any of the Permitted Uses and is approved by City in writing, which approval may be given or withheld in City's sole discretion.

5.3 Nuisances; No Interference with City's Uses. Permittee shall not conduct any activities on or about the Permit Area that constitute waste, nuisance or unreasonable annoyance (including, without limitation, emission of objectionable odors, noises or lights) to City, to the owners or occupants of neighboring property or to the public; provided, however, that City shall not, in its proprietary capacity as landowner under this Entry Permit, deem Permittee's performance of any of the Permitted Activities in compliance with the terms and conditions of this Entry Permit to be a nuisance or unreasonable annoyance. Except for any activities described in a Work Plan, Permittee shall not materially interfere with or obstruct City's use of the Permit Area or the rights of SFMTA or any other party with rights to occupy or use the other portions of the Property.

5.5 Utilities. City has no responsibility or liability of any kind or character with respect to any utilities that may be on, in or under the Permit Area. Permittee has the sole responsibility to locate such utilities and protect them from damage, and Permittee has sole responsibility for any damage to utilities or damages resulting from Permittee's activities at the Permit Area. Permittee shall arrange and pay for any necessary temporary relocation of City and public utility company facilities reasonably necessary to facilitate any of the Permitted Activities, subject to the prior written approval by City and any such utility companies of any such relocation. Permittee shall be solely responsible for arranging and paying directly for any utilities or services necessary for its activities hereunder.

5.6 Damage. Permittee shall not do anything about the Permit Area that will cause damage to any of City's property. City's approval of any work plan pursuant to this Entry Permit or of the proposed Permitted Activities shall not be deemed to constitute the waiver of any rights City may have under Applicable Laws for any damage to the City's real or personal property or the City Property resulting from the Permitted Activities.

6. Fees. [Intentionally omitted.]

7. Surrender; As-Built Plans; Remaining Improvements. Upon the expiration of this Entry Permit or within five (5) days after any sooner revocation or other termination of this Entry Permit, Permittee shall surrender the Permit Area in a broom clean, free from hazards, clear of all debris and restore the Permit Area substantially to its condition immediately prior to the Effective Date, to the reasonable satisfaction of City; provided, however, that Permittee shall have no obligation to repair or restore any deficient condition at the Permit Area that was disclosed, but not caused, by any of the Permitted Activities. At such time, Permittee shall remove all of its property from the Permit Area and any signs permitted hereunder, and shall repair, at its cost, any damage to the Permit Area caused by such removal. Permittee's obligations under this Section shall survive any termination of this Entry Permit.

Any equipment or any other property of Permittee or Permittee Agents remaining in the Permit Area after completion of activities may be deemed abandoned by City in its sole discretion and City may store, remove, and dispose of such equipment or property at Permittee's sole cost and expense unless City has otherwise granted written permission to Permittee for such remaining equipment or property. Permittee waives all claims for any costs or damages resulting from City's retention, removal, and disposition of such property.

8. Compliance with Laws. Permittee shall, at its expense, conduct and cause to be conducted all Permitted Activities in a safe and prudent manner and in compliance with all laws, regulations, codes, ordinances and orders of any governmental or other regulatory entity (including, without limitation, the Americans with Disabilities Act and any other disability access laws), whether presently in effect or subsequently adopted and whether or not in the contemplation of the parties. Permittee shall, at its sole expense, maintain all Approvals in force at all times during its use of the Permit Area. Permittee understands and agrees that City is entering into this Entry Permit in its capacity as a property owner with a proprietary interest in the Permit Area and not as a regulatory agency with police powers. Nothing herein shall limit in any way Permittee's obligation to obtain any required Approvals from City departments, boards or commissions or other governmental regulatory authorities or limit in any way City's exercise of its police powers.

9. Hazardous Materials.

9.1 Definitions. For purposes of this Entry Permit, the following terms have the following meanings:

(a) **"Environmental Laws"** means any federal, state or local laws, ordinances, regulations or policies judicial and administrative directives, orders and decrees dealing with or relating to Hazardous Materials (including, without limitation, their use, handling, transportation, production, disposal, discharge, storage or reporting requirements) or to health and safety, industrial hygiene or environmental conditions in, on, under or about the Permit Area or property, including, without limitation, soil, air, bay water and groundwater conditions or community right-to-know requirements, related to the work being performed under this Entry Permit.

(b) **"Handle"** or **"handling"** means to use, generate, process, produce, package, treat, store, emit, discharge or dispose.

(c) **"Hazardous Material"** means any substance or material which has been determined by any state, federal, or local government authority to be a hazardous or toxic substance or material, including without limitation, any hazardous substance as defined in Section 101(14) of CERCLA (42 USC Section 9601(14)) or Sections 25281(f) or 25316 of the California Health and Safety Code, any hazardous material as defined in Section 25501(k) of the California Health and Safety Code, and any additional substances or materials which at such

time are classified or considered to be hazardous or toxic under any federal, state or local law, regulation or other exercise of governmental authority.

(d) **"Investigation"** means activities undertaken to determine the nature and extent of Hazardous Materials which may be located on or under real property, or which have been, are being, or threaten to be released to the environment.

(e) **"Remediation"** shall mean activities undertaken to cleanup, remove, contain, treat, stabilize, monitor or otherwise control Hazardous Materials located on or under real property or which have been, are being or threaten to be released to the environment.

(f) **"Regulatory Agency"** means any federal, state or local governmental agency or political subdivision having jurisdiction over the Permit Area and any of the Permitted Activities. The City shall be a "Regulatory Agency" to the extent that City is acting in its capacity as a regulatory authority, rather than in its proprietary capacity as a landowner.

(g) **"Release"** means any spilling, leaking, pumping, pouring, emitting, emptying, discharging, injecting, escaping, leaching, dumping, or disposing into the environment of any Hazardous Material (including the abandonment or discarding of barrels, containers, and other closed receptacles containing any Hazardous Material or pollutant or contaminant).

9.2 Environmental Laws. Permittee shall handle all Hazardous Materials introduced or disturbed on the Permit Area during the Term in compliance with all Environmental Laws. Permittee shall not be responsible for the safe handling of Hazardous Materials to the extent released on the Permit Area by City or any City employee, agent, contractor, subcontractor, or invitee, or existing on the Permit Area prior to the Effective Date, except to the extent any of the Permitted Activities exacerbates such Hazardous Materials. Permittee shall protect its employees and the general public in accordance with all Environmental Laws. City may from time to time request, and Permittee shall be obligated to provide, information reasonably adequate for City to determine that any and all Hazardous Materials are being handled in a manner which complies with all Environmental Laws.

9.3 Removal of Hazardous Materials. Prior to termination of this Entry Permit, Permittee, at its sole cost and expense, shall remove any and all Hazardous Materials to the extent introduced or released in, on, under or about the Permit Area by Permittee or the Permittee Agents during the Term and shall Remediate or dispose of any Hazardous Materials produced as a result of the Permitted Activities. All costs of storage, shipping and disposal of extracted soils and groundwater shall be the sole responsibility of Permittee including, without limitation, the costs of preparation and execution of shipping papers, including but not limited to hazardous waste manifests. With respect to shipping papers and hazardous waste manifests, Permittee shall be the "generator" and in no case shall the City be named as the generator.

9.4 Notification. Permittee shall provide City with a copy of any permits issued for any Permitted Activity that involves the potential release or discharge of any Hazardous Materials in or from the Permit Area, and the receipt of a hazardous waste generator identification number issued by the U.S. Environmental Protection Agency or the California Environmental Protection Agency to itself or any of the Permittee Agents. Permittee shall promptly notify City in writing of, and shall contemporaneously provide City with a copy of:

(a) Any release or discharge of any Hazardous Materials, whether or not the release is in quantities that would be required under applicable laws to be reported to a Regulatory Agency;

(b) Any written notice of release of Hazardous Materials in or on the Permit Area that is provided by Permittee or any of the Permittee Agents to a Regulatory Agency including any City agency;

(c) Any notice of a violation, or a potential or alleged violation, of any Environmental Law that is received by Permittee or any of the Permittee Agents from any Regulatory Agency;

(d) Any inquiry, investigation, enforcement, cleanup, removal, or other action that is instituted or threatened by a Regulatory Agency against Permittee or any of the Permittee Agents and that relates to the release or discharge of Hazardous Material on or from the Permit Area;

(e) Any claim that is instituted or threatened by any third party against Permittee or any of the Permittee Agents and that relates to any release or discharge of Hazardous Materials on or from the Permit Area; and

(f) Any notice of the termination, expiration or substantial amendment of any environmental operating permit needed by Permittee or any of the Permittee Agents.

9.5 Hazardous Material Disclosures. California law requires landlords to disclose to tenants the presence or potential presence of certain Hazardous Materials. Although this Entry Permit grants Permittee a license only, Permittee is hereby advised that Hazardous Materials may be present on the Permit Area, including, but not limited to vehicle fluids, janitorial products, tobacco smoke, and building materials containing chemicals, such as formaldehyde. By execution of this Entry Permit, Permittee acknowledges that the notice set forth in this Section satisfies the requirements of California Health and Safety Code Section 25359.7 and related statutes. Permittee also acknowledges its own obligations pursuant to California Health and Safety Code Section 25359.7 as well as the penalties that apply for failure to meet such obligations.

10. Insurance. [To be updated/reviewed by City's Risk Manager once RPD knows Permittee's proposed Permitted Activities]

10.1 Insurance Policies. Permittee shall procure and keep in effect at all times during the Term, at Permittee's expense, and cause its contractors and subcontractors to maintain at all times insurance as follows during the Term:

(a) General Liability Insurance with limits not less than Two Million Dollars (\$2,000,000) each occurrence Combined Single Limit for Bodily Injury and Property Damage, including coverages for Contractual Liability, Personal Injury, Independent Contractors, Explosion, Collapse and Underground (XCU), Broadform Property Damage, Sudden and Accidental Pollution, Products Liability and Completed Operations;

(b) Automobile Liability Insurance with limits not less than One Million Dollars (\$1,000,000) each occurrence Combined Single Limit for Bodily Injury and Property Damage, including coverages for owned, non-owned and hired automobiles, as applicable, and sudden and accidental pollution (unless such coverage requirement is waived by City's Risk Manager);

(c) Workers' Compensation Insurance with Employer's Liability Coverage with limits of not less than One Million Dollars (\$1,000,000) each accident; and

(d) Contractor's Pollution Legal Liability Insurance with combined single limit of Two Million Dollars (\$2,000,000) each claim, and with coverage to include legal

liability arising from the sudden and accidental release of pollutants, and no less than a one-year extended reporting period, endorsed to include Non-Owned Disposal Site coverage.

10.2 Policy Requirements; Delivery of Certificates.

(a) All liability policies required hereunder shall provide for the following: (i) name as additional insureds the City and County of San Francisco, its officers, agents and employees; and (ii) specify that such policies are primary insurance to any other insurance available to the additional insureds, with respect to any claims arising out of this Entry Permit and that insurance applies separately to each insured against whom claim is made or suit is brought. Such policies shall also provide for severability of interests and that an act or omission of one of the named insureds which would void or otherwise reduce coverage shall not reduce or void the coverage as to any insured, and shall afford coverage for all claims based on acts, omissions, injury or damage which occurred or arose (or the onset of which occurred or arose) in whole or in part during the policy period. Sudden and accidental pollution coverage in the liability policies required hereunder shall be limited to losses resulting from Permittee's activities (and the activities of any Permittee Agents) under this Entry Permit (excluding non-negligent aggravation of existing conditions with respect to Hazardous Materials).

(b) All policies shall be endorsed to provide thirty (30) days' prior written notice of cancellation, non-renewal or reduction in coverage to City.

(c) Permittee shall deliver to City certificates of insurance and additional insured policy endorsements from insurers prior to the Effective Date and in a form satisfactory to City, evidencing the coverages required hereunder, together with complete copies of the policies at City's request. In the event Permittee shall fail to procure such insurance, or to deliver such certificates, City may procure, at its option, the same for the account of Permittee, and the cost thereof shall be paid to City within ten (10) days after delivery to Permittee of bills therefor.

(d) All policies shall include a waiver of subrogation endorsement or provision wherein the insurer acknowledges acceptance of Permittee's waiver of claims against City, provide for severability of interests and that an act or omission of one of the named insureds which would void or otherwise reduce coverage shall not reduce or void the coverage as to any other insured, and shall afford coverage for all claims based on acts, omissions, injury or damage which occurred or arose in whole or in part during the policy period.

(e) Should any of the required insurance be provided under a form of coverage that includes a general annual aggregate limit or provides that claims investigation or legal defense costs be included in such general annual aggregate limit, such general aggregate limit shall double the occurrence or claims limits specified above.

(f) Should any of the required insurance be provided under a claims made form, Permittee shall maintain such coverage continuously throughout the Term and, without lapse, for a period of three (3) years beyond the Termination Date, to the effect that, should any occurrences during the Term Permit give rise to claims made after Termination Date, such claims shall be covered by such claims-made policies.

(f) Upon City's request, Permittee and City shall periodically review the limits and types of insurance carried pursuant to this Section. If the general commercial practice in the City and County of San Francisco is to carry liability insurance in an amount or coverage materially greater than the amount or coverage then being carried by Permittee for risks comparable to those associated with the Permit Area, then City in its sole discretion may require Permittee to increase the amounts or coverage carried by Permittee hereunder to conform to such general commercial practice.

10.3 Waiver of Subrogation. Notwithstanding anything to the contrary contained herein, Permittee hereby waives any right of recovery against City for any loss or damage sustained by Permittee with respect to the Permit Area or any portion thereof or the contents of the same or any operation therein, whether or not such loss is caused by the fault or negligence of City, to the extent such loss or damage is covered by insurance which is required to be purchased by Permittee under this Entry Permit or is actually covered by insurance obtained by Permittee. Permittee agrees to cause its insurers to issue appropriate waiver of subrogation rights endorsements to all policies relating to the Permit Area; provided, the failure to obtain any such endorsement shall not affect the above waiver.

10.4 No Limitation on Permittee Obligations. Permittee's compliance with the provisions of this Section shall in no way relieve or decrease Permittee's indemnification obligations under this Entry Permit or any of Permittee's other obligations hereunder. Notwithstanding anything to the contrary in this Entry Permit, this Entry Permit shall terminate immediately, without notice to Permittee, upon the lapse of any required insurance coverage. Permittee shall be responsible, at its expense, for separately insuring Permittee's personal property.

11. Waiver of Claims; Waiver of Consequential and Incidental Damages.

(a) Neither City nor any of its commissions, departments, boards, officers, agents or employees shall be liable for any damage to the property of Permittee, the Permittee Agents, or their respective officers, agents, employees, contractors or subcontractors, or employees, or for any bodily injury or death to such persons, resulting or arising from the condition of the Permit Area or its use by Permittee or the Permittee Agents, except to the extent that any such damage, injury or death is caused by the gross negligence or willful misconduct of City or any of its commissions, departments, boards, officers, agents, employees, or contractors (each, a "City Agent").

(b) Permittee acknowledges that the Permit Area and the Permitted Activities can be modified by City pursuant to Section 3 and revoked by City pursuant to Section 2 and in view of such fact, Permittee expressly assumes the risk of making any expenditures in connection with this Entry Permit, even if such expenditures are substantial. Without limiting any indemnification obligations of Permittee or other waivers contained in this Entry Permit and as a material part of the consideration for this Entry Permit, Permittee fully RELEASES, WAIVES AND DISCHARGES forever any and all claims, demands, rights, and causes of action against, and covenants not to sue, City, its departments, commissions, officers, directors and employees, and all persons acting by, through or under each of them, under any present or future laws, statutes, or regulations (including, but not limited to, any claim for inverse condemnation or the payment of just compensation under the law of eminent domain or otherwise at equity), in the event that City exercises its right to modify the Permit Area or the Permitted Activities pursuant to Section 3 or to revoke this Entry Permit pursuant to Section 2.

(c) Permittee acknowledges that it will not be a displaced person at the time this Entry Permit is terminated or revoked or expires by its own terms, and Permittee fully RELEASES, WAIVES AND DISCHARGES forever any and all claims, demands, rights, and causes of action against, and covenants not to sue, City, its departments, commissions, officers, directors and employees, and all persons acting by, through or under each of them, under any present or future laws, statutes, or regulations for displaced persons, including, without limitation, any and all claims for relocation benefits or assistance from City under federal and state relocation assistance laws.

(d) Permittee expressly acknowledges and agrees that the fees payable hereunder do not take into account any potential liability of City for any consequential or incidental damages including, but not limited to, lost profits, arising out of disruption to Permittee's uses hereunder. City would not be willing to give this Entry Permit in the absence of a complete waiver of

liability for consequential or incidental damages due to the acts or omissions of City or its Agents, and Permittee expressly assumes the risk with respect thereto. Accordingly, without limiting any indemnification obligations of Permittee or other waivers contained in this Entry Permit and as a material part of the consideration for this Entry Permit, Permittee fully RELEASES, WAIVES AND DISCHARGES forever any and all claims, demands, rights, and causes of action against for consequential and incidental damages (including without limitation, lost profits) and covenants not to sue for such damages, City, its departments, commissions, officers, directors and employees, and all persons acting by, through or under each of them, arising out of this Entry Permit or the uses authorized hereunder, including, without limitation, any interference with uses conducted by Permittee pursuant to this Entry Permit, regardless of the cause, and whether or not due to the negligence of City or its Agents, except for the gross negligence or willful misconduct of City or its Agents.

(e) In connection with the foregoing releases, Permittee acknowledges that it is familiar with Section 1542 of the California Civil Code, which reads:

“A general release does not extend to claims which the creditor does not know or suspect to exist in his or her favor at the time of executing the release, which if known by him or her must have materially affected his or her settlement with the debtor.”

Permittee acknowledges that the releases contained herein includes all known and unknown, disclosed and undisclosed, and anticipated and unanticipated claims. Permittee realizes and acknowledges that it has agreed upon this Entry Permit in light of this realization and, being fully aware of this situation, it nevertheless intends to waive the benefit of Civil Code Section 1542, or any statute or other similar law now or later in effect. The releases contained herein shall survive any termination of this Entry Permit.

12. Defaults by Permittee. If Permittee fails to perform any of its monetary obligations under this Entry Permit and fails to cure such monetary failure within five (5) business days following City's written notice of such monetary failure to Permittee, then City may, at its sole option, immediately terminate this Entry Permit by providing Permittee with written notice of such termination. If Permittee fails to perform any of its non-monetary obligations under this Entry Permit, then City may, at its sole option, remedy such failure for Permittee's account and at Permittee's expense or terminate this Entry Permit by providing Permittee with thirty (30) days' prior written notice of City's intention to cure such default (except that no such prior notice shall be required in the event of an emergency as determined by City) or to terminate this Entry Permit. Such action by City shall not be construed as a waiver of any rights or remedies of City under this Entry Permit, and nothing herein shall imply any duty of City to do any act that Permittee is obligated to perform. Permittee shall pay to City upon demand, all costs, damages, expenses or liabilities reasonably incurred by City, including, without limitation, reasonable attorneys' fees, in remedying or attempting to remedy such default. Permittee's obligations under this Section shall survive the termination of this Entry Permit.

13. No Costs to City; No Liens. Permittee shall bear all costs or expenses of any kind or nature in connection with its use of the Permit Area and in complying with the conditions of this Entry Permit, and shall keep the Permit Area free and clear of any liens or claims of lien arising out of or in any way connected with its use of the Permit Area.

14. Indemnity. Except solely to the extent of Losses resulting directly from the willful misconduct or gross negligence of City or of any City Agent or from any material breach of this Entry Permit by City or any City Agent, Permittee shall indemnify, defend and hold harmless each of City and the City Agents each from and against any and all demands, claims, legal or administrative proceedings, losses, costs, penalties, fines, liens, judgments, damages and liabilities of any kind (collectively, "Losses"), arising in any manner out of (a) any injury to or death of any person or damage to or destruction of any property occurring in, on or about the

Permit Area, or any part thereof, whether the person or property of Permittee, any Permittee Agent, and any of their respective officers, agents, employees, contractors, subcontractors, or third persons, relating in any manner to any of the Permitted Activities, (b) any failure by Permittee to faithfully observe or perform any of the terms, covenants or conditions of this Entry Permit, including all applicable laws, or to cause the Permittee Agents, to comply with such terms, covenants or conditions, (c) the use of the Permit Area or any activities conducted thereon by Permittee or any Permittee Agent, (d) any handling, release or threatened release, or discharge, or threatened discharge, of any Hazardous Material caused or allowed by Permittee or any Permittee Agent on, in, under or about the Permit Area, any improvements permitted thereon, or into the environment; (e) any requirement of a Regulatory Agency for investigation or remediation of any release of Hazardous Materials at the Permit Area in connection with use of the Permit Area by Permittee or any Permittee Agent; and (f) any requirement of a Regulatory Agency for investigation or remediation of any Hazardous Materials arising out of or in connection with the activities of Permittee or any Permittee Agent at the Permit Area, including, without limitation, requirements which would not have been imposed except for such party's use of the Permit Area for an of the Permitted Activities. The foregoing indemnity shall not include any Losses incurred by City with respect to any Hazardous Materials at the Permit Area discovered, but not released, by Permittee or any Permittee Agent. The indemnity in this Section shall include, without limitation, reasonable attorneys' and consultants' fees, investigation and remediation costs and all other reasonable costs and expenses incurred by the indemnified parties, including, without limitation, damages for decrease in the value of the Permit Area and claims for damages or decreases in the value of adjoining property. Permittee specifically acknowledges and agrees that it has an immediate and independent obligation to defend City from any claim which actually or potentially falls within this indemnity provision even if such allegation is or may be groundless, fraudulent or false, which obligation arises at the time such claim is tendered to Permittee by City and continues at all times thereafter. Permittee's obligations under this Section shall survive the expiration or other termination of this Entry Permit.

15. "As Is" Condition of Permit Area; Disclaimer of Representations. Permittee accepts the Permit Area in its "AS IS" condition, without representation or warranty of any kind by City, its officers, agents or employees, including, without limitation, the suitability, safety, or duration of availability of the Permit Area or any facilities on the Permit Area for Permittee's use. Without limiting the foregoing, this Entry Permit is made subject to all applicable laws, rules and ordinances governing the use of the Permit Area, and to any and all covenants, conditions, restrictions, easements, encumbrances, claims of title and other title matters affecting the Permit Area, whether foreseen or unforeseen, and whether such matters are of record or would be disclosed by an accurate inspection or survey. It is Permittee's sole obligation to conduct an independent investigation of the Permit Area and all matters relating to its use of the Permit Area hereunder, including, without limitation, the suitability of the Permit Area for such uses. Permittee, at its own expense, shall obtain such permission or other approvals from any third parties with existing rights as may be necessary for Permittee to make use of the Permit Area in the manner contemplated hereby. Under California Civil Code Section 1938, to the extent applicable to this Entry Permit, Permittee is hereby advised that the Permit Area has not undergone inspection by a Certified Access Specialist ("CAsp") to determine whether it meets all applicable construction-related accessibility requirements.

16. Notices. Except as otherwise expressly provided herein, any notices given under this Entry Permit shall be effective only if in writing and given by delivering the notice in person, by sending it first class mail or certified mail, with a return receipt requested, or overnight courier, return receipt requested, with postage prepaid, addressed as follows:

If to City: City and County of San Francisco
 Recreation and Park Department
 Property Management
 McLaren Lodge Annex

San Francisco, California 94117

If to Permittee: Friends of the Geneva Car Barn and Powerhouse
755 Ocean Ave.
San Francisco, California 94112

Notices herein shall be deemed given two (2) days after the date when it shall have been mailed if sent by first class, certified or overnight courier, or upon the date personal delivery is made.

17. No Joint Ventures or Partnership; No Authorization. This Entry Permit does not create a partnership or joint venture between City and Permittee as to any activity conducted by Permittee on, in or relating to the Permit Area. Permittee is not a State actor with respect to any activity conducted by Permittee on, in, or under the Permit Area. The giving of this Entry Permit by City does not constitute authorization or approval by City of any activity conducted by Permittee on, in or relating to the Permit Area.

18. MacBride Principles – Northern Ireland. The City and County of San Francisco urges companies doing business in Northern Ireland to move toward resolving employment inequities and encourages them to abide by the MacBride Principles as expressed in San Francisco Administrative Code Section 12F.1 *et seq.* The City and County of San Francisco also urges San Francisco companies to do business with corporations that abide by the MacBride Principles. Permittee acknowledges that it has read and understands the above statement of the City and County of San Francisco concerning doing business in Northern Ireland.

19. Non-Discrimination.

19.1 Covenant Not to Discriminate. In the performance of this Entry Permit, Permittee agrees not to discriminate against any employee of, any City employee working with Permittee, or applicant for employment with Permittee, or against any person seeking accommodations, advantages, facilities, privileges, services, or membership in all business, social, or other establishments or organizations, on the basis of the fact or perception of a person's race, color, creed, religion, national origin, ancestry, age, height, weight, sex, sexual orientation, gender identity, domestic partner status, marital status, disability or Acquired Immune Deficiency Syndrome or HIV status (AIDS/HIV status), or association with members of such protected classes, or in retaliation for opposition to discrimination against such classes.

19.2 Subcontracts. Permittee shall include in all subcontracts relating to the Permit Area a non-discrimination clause applicable to such subcontractor in substantially the form of Section 19.1. In addition, Permittee shall incorporate by reference in all subcontracts the provisions of Sections 12B.2(a), 12B.2(c)-(k), and 12C.3 of the San Francisco Administrative Code and shall require all subcontractors to comply with such provisions. Permittee's failure to comply with the obligations in this Subsection shall constitute a material breach of this Entry Permit.

19.3 Non-Discrimination in Benefits. Permittee does not as of the date of this Entry Permit and will not during the Term, in any of its operations in San Francisco, on real property owned by City, or where the work is being performed for the City or elsewhere within the United States, discriminate in the provision of bereavement leave, family medical leave, health benefits, membership or membership discounts, moving expenses, pension and retirement benefits or travel benefits, as well as any benefits other than the benefits specified above, between employees with domestic partners and employees with spouses, and/or between the domestic partners and spouses of such employees, where the domestic partnership has been registered with a governmental entity pursuant to state or local law authorizing such registration, subject to the conditions set forth in Section 12B.2(b) of the San Francisco Administrative Code.

19.4 Condition to Permit. As a condition to this Entry Permit, Permittee shall execute the "Chapter 12B Declaration: Nondiscrimination in Contracts and Benefits" form (Form HRC-12B-101) with supporting documentation and secure the approval of the form by the San Francisco Human Rights Commission (the "HRC"). Permittee hereby represents that prior to execution of this Entry Permit, (i) Permittee executed and submitted to the HRC Form HRC-12B-101 with supporting documentation, and (ii) the HRC approved such form.

19.5 Incorporation of Administrative Code Provisions by Reference. The provisions of Chapters 12B and 12C of the San Francisco Administrative Code relating to non-discrimination by parties contracting for the use of City property are incorporated in this Section by reference and made a part of this Agreement as though fully set forth herein. Permittee shall comply fully with and be bound by all of the provisions that apply to this Entry Permit under such Chapters of the Administrative Code, including but not limited to the remedies provided in such Chapters. Without limiting the foregoing, Permittee understands that pursuant to Section 12B.2(h) of the San Francisco Administrative Code, a penalty of Fifty Dollars (\$50) for each person for each calendar day during which such person was discriminated against in violation of the provisions of this Entry Permit may be assessed against Permittee and/or deducted from any payments due Permittee.

20. Notification of Limitations on Contributions. Through its execution of this Entry Permit, Permittee acknowledges that it is familiar with Section 1.126 of the San Francisco Campaign and Governmental Conduct Code, which prohibits any person who contracts with the City for the selling or leasing of any land or building to or from the City whenever such transaction would require the approval by a City elective officer, the board on which that City elective officer serves, or a board on which an appointee of that individual serves, from making any campaign contribution to (1) the City elective officer, (2) a candidate for the office held by such individual, or (3) a committee controlled by such individual or candidate, at any time from the commencement of negotiations for the contract until the later of either the termination of negotiations for such contract or six months after the date the contract is approved. Permittee acknowledges that the foregoing restriction applies only if the contract or a combination or series of contracts approved by the same individual or board in a fiscal year have a total anticipated or actual value of \$50,000 or more. Permittee further acknowledges that the prohibition on contributions applies to each Permittee; each member of Permittee's board of directors, and Permittee's chief executive officer, chief financial officer and chief operating officer; any person with an ownership interest of more than twenty percent (20%) in Permittee; any subcontractor listed in the contract; and any committee that is sponsored or controlled by Permittee. Additionally, Permittee acknowledges that Permittee must inform each of the persons described in the preceding sentence of the prohibitions contained in Section 1.126. Permittee further agrees to provide to City the names of each person, entity or committee described above.

21. Pesticide Prohibition. Permittee shall comply with the provisions of Section 308 of Chapter 3 of the San Francisco Environment Code (the "**Pesticide Ordinance**") which (i) prohibit the use of certain pesticides on City property, (ii) require the posting of certain notices and the maintenance of certain records regarding pesticide usage and (iii) require Permittee to submit to the Recreation and Park Department an integrated pest management ("**IPM**") plan that (a) lists, to the extent reasonably possible, the types and estimated quantities of pesticides that Permittee may need to apply to the Permit Area during the Term, (b) describes the steps Permittee will take to meet the City's IPM Policy described in Section 300 of the Pesticide Ordinance and (c) identifies, by name, title, address and telephone number, an individual to act as the Permittee's primary IPM contact person with the City. In addition, Permittee shall comply with the requirements of Sections 303(a) and 303(b) of the Pesticide Ordinance.

22. Conflicts of Interest. Through its execution of this Entry Permit, Permittee acknowledges that it is familiar with the provisions of Section 15.103 of the San Francisco Charter, Article III, Chapter 2 of City's Campaign and Governmental Conduct Code, and Sections 87100 *et seq.* and Sections 1090 *et seq.* of the Government Code of the State of California, and certifies that it does

not know of any facts which would constitute a violation of said provision, and agrees that if Permittee becomes aware of any such fact during the Term, Permittee shall immediately notify the City.

23. No Assignment. This Entry Permit is personal to Permittee and shall not be assigned, conveyed or otherwise transferred by Permittee under any circumstances except by operation of law. Any attempt to assign, convey or otherwise transfer this Entry Permit shall be null and void and cause the immediate termination and revocation of this Entry Permit.

24. Sunshine Ordinance. Permittee understands and agrees that under the City's Sunshine Ordinance (San Francisco Administrative Code Chapter 67) and the State Public Records Law (California Government Code Section 6250 *et seq.*), apply to this Entry Permit and any and all records, information, and materials submitted to the City in connection with this Entry Permit. Accordingly, any and all such records, information and materials may be subject to public disclosure in accordance with the City's Sunshine Ordinance and the State Public Records Law. Permittee hereby authorizes the City to disclose any records, information and materials submitted to the City in connection with this Entry Permit.

25. Food Service Waste Reduction. Permittee agrees to comply fully with and be bound by all of the applicable provisions of the Food Service Waste Reduction Ordinance, as set forth in the San Francisco Environment Code, Chapter 16, including the remedies provided therein, and implementing guidelines and rules. The provisions of Chapter 16 are incorporated herein by reference and made a part of this Entry Permit as though fully set forth herein. Accordingly, Permittee acknowledges that City contractors and lessees may not use Disposable Food Service Ware that contains Polystyrene Foam in City Facilities and while performing under a City contract or lease, and shall instead use suitable Biodegradable/Compostable or Recyclable Disposable Food Service Ware. This provision is a material term of this Entry Permit.

26. Prohibition of Tobacco Sales and Advertising. Permittee acknowledges and agrees that no advertising of cigarettes or tobacco products is allowed on the Permit Area. This advertising prohibition includes the placement of the name of a company producing, selling or distributing cigarettes or tobacco products or the name of any cigarette or tobacco product in any promotion of any event or product. This advertising prohibition does not apply to any advertisement sponsored by a state, local, nonprofit or other entity designed to (i) communicate the health hazards of cigarettes and tobacco products, or (ii) encourage people not to smoke or to stop smoking.

27. Prohibition of Alcoholic Beverage Advertising. Permittee acknowledges and agrees that no advertising of alcoholic beverages is allowed on the Permit Area. For purposes of this Section, "alcoholic beverage" shall be defined as set forth in California Business and Professions Code Section 23004, and shall not include cleaning solutions, medical supplies and other products and substances not intended for drinking. This advertising prohibition includes the placement of the name of a company producing, selling or distributing alcoholic beverages or the name of any alcoholic beverage in any promotion of any event or product. This advertising prohibition does not apply to any advertisement sponsored by a state, local, nonprofit or other entity designed to (i) communicate the health hazards of alcoholic beverages, (ii) encourage people not to drink alcohol or to stop drinking alcohol, or (iii) provide or publicize drug or alcohol treatment or rehabilitation services.

28. Tropical Hardwoods and Virgin Redwood Ban. The City and County of San Francisco urges companies not to import, purchase, obtain or use for any purpose, any tropical hardwood, tropical hardwood wood product, virgin redwood or virgin redwood wood product, except as expressly permitted by the application of Sections 802(b) and 803(b) of the San Francisco Environment Code. Permittee agrees that, except as permitted by the application of Sections 802(b) and 803(b), Permittee shall not use or incorporate any tropical hardwood, tropical

hardwood wood product, virgin redwood or virgin redwood wood product in the performance of this Entry Permit.

29. Possessory Interest Taxes. Permittee recognizes and understands that this Entry Permit may create a possessory interest subject to property taxation and that Permittee may be subject to the payment of property taxes levied on such interest under applicable law. Permittee agrees to pay taxes of any kind, including possessory interest taxes, if any, that may be lawfully assessed on Permittee's interest under this Entry Permit or use of the Permit Area pursuant hereto and to pay any other taxes, excises, licenses, permit charges or assessments based on Permittee's usage of the Permit Area that may be imposed upon Permittee by applicable law. Permittee shall pay all of such charges when they become due and payable and before delinquency.

30. Consideration of Criminal History in Hiring and Employment Decisions. Permittee agrees to comply fully with and be bound by all of the provisions of Chapter 12T of the San Francisco Administrative Code (City Contractor/Subcontractor Consideration of Criminal History in Hiring and Employment Decisions) ("**Chapter 12T**"), including the remedies and implementing regulations of Chapter 12T, as may be amended from time to time, in the hiring or employment any person with respect to the Permitted Activities. The provisions of Chapter 12T are incorporated by reference and made a part of this Entry Permit as though fully set forth herein. Such provisions include, but are not limited to, the requirements for solicitations or advertisements for employees made by Permittee if such employees would perform any of the Permitted Activities and the prohibition of certain inquiries when initially interviewing job candidates for such employment positions. The text of the Chapter 12T is available on the web at <http://sfgov.org>.

Permittee shall incorporate by reference in all subcontracts the provisions of Chapter 12T, and shall require all its contractors to comply with such provisions. Permittee's failure to comply with the obligations in this Section shall constitute a material breach of this Entry Permit. Permittee understands and agrees that if it fails to comply with the requirements of Chapter 12T, City shall have the right to pursue any rights or remedies available under Chapter 12T, including but not limited to, a penalty of \$50 for a second violation and \$100 for a subsequent violation for each employee, applicant or other person as to whom a violation occurred or continued, termination or suspension in whole or in part of this Entry Permit.

31. Cooperative Drafting. This Entry Permit has been drafted through a cooperative effort of both parties, and both parties have had an opportunity to have the License reviewed and revised by legal counsel. No party shall be considered the drafter of this Entry Permit, and no presumption or rule that an ambiguity shall be construed against the party drafting the clause shall apply to the interpretation or enforcement of this Entry Permit.

32. Severability. If any provision of this Entry Permit or the application thereof to any person, entity or circumstance shall be invalid or unenforceable, the remainder of this Entry Permit, or the application of such provision to persons, entities or circumstances other than those as to which it is invalid or unenforceable, shall not be affected thereby, and each other provision of this Entry Permit shall be valid and be enforceable to the fullest extent permitted by law, except to the extent that enforcement of this Entry Permit without the invalidated provision would be unreasonable or inequitable under all the circumstances or would frustrate a fundamental purpose of this Entry Permit.

33. Counterparts. This Entry Permit may be executed in two or more counterparts, each of which shall be deemed an original, but all of which taken together shall constitute one and the same instrument.

34. General Provisions. (a) This Entry Permit may be amended or modified only by a writing signed by City and Permittee. (b) No waiver by any party of any of the provisions of this Entry Permit shall be effective unless in writing and signed by an officer or other authorized

representative, and only to the extent expressly provided in such written waiver. (c) Except as otherwise expressly set forth herein, all approvals and determinations of City requested, required or permitted pursuant to this Entry Permit may be made in the sole and absolute discretion of the General Manager of City's Recreation and Park Department or other authorized City official. (d) This Entry Permit (including the exhibit(s) hereto) contains the entire agreement between the parties and all prior written or oral negotiations, discussions, understandings and agreements are merged herein. (e) The section and other headings of this Entry Permit are for convenience of reference only and shall be disregarded in the interpretation of this Entry Permit. (f) Time is of the essence. (g) This Entry Permit shall be governed by California law and the City's Charter. (h) If either party commences an action against the other or a dispute arises under this Entry Permit, the prevailing party shall be entitled to recover from the other reasonable attorneys' fees and costs. For purposes hereof, reasonable attorneys' fees of City shall be based on the fees regularly charged by private attorneys in San Francisco with comparable experience. (i) Permittee may not record this Entry Permit or any memorandum hereof. (j) Subject to the prohibition against assignments or other transfers by Permittee hereunder, this Entry Permit shall be binding upon and inure to the benefit of the parties and their respective heirs, representatives, successors and assigns. (i) If City sells or otherwise conveys any portion of the Permit Area, the owner of such conveyed portion of the Permit Area shall accept such portion subject to this Entry Permit and shall assume City's rights and obligations under this Entry Permit to the extent such rights and obligations affect such transferred portion.

[REMAINDER OF PAGE INTENTIONALLY LEFT BLANK]

Permittee represents and warrants to City that it has read and understands the contents of this Entry Permit and agrees to comply with and be bound by all of its provisions.

PERMITTEE:

FRIENDS OF THE GENEVA OFFICE
BUILDING AND POWERHOUSE, a California
non-profit corporation

By: _____
Its: _____

Date: _____

By: _____
Its: _____

Date: _____

CITY:

CITY AND COUNTY OF SAN FRANCISCO,
a municipal corporation, acting by and through its
Recreation and Park Commission

By: _____
PHILIP A. GINSBURG, General Manager
Recreation and Park Department

Date: _____

APPROVED AS TO FORM:

DENNIS J. HERRERA, City Attorney

By: _____
Deputy City Attorney

EXHIBIT A
to

LDDA Permit to Enter

Depiction of City Property, Buildings, and Permit Area

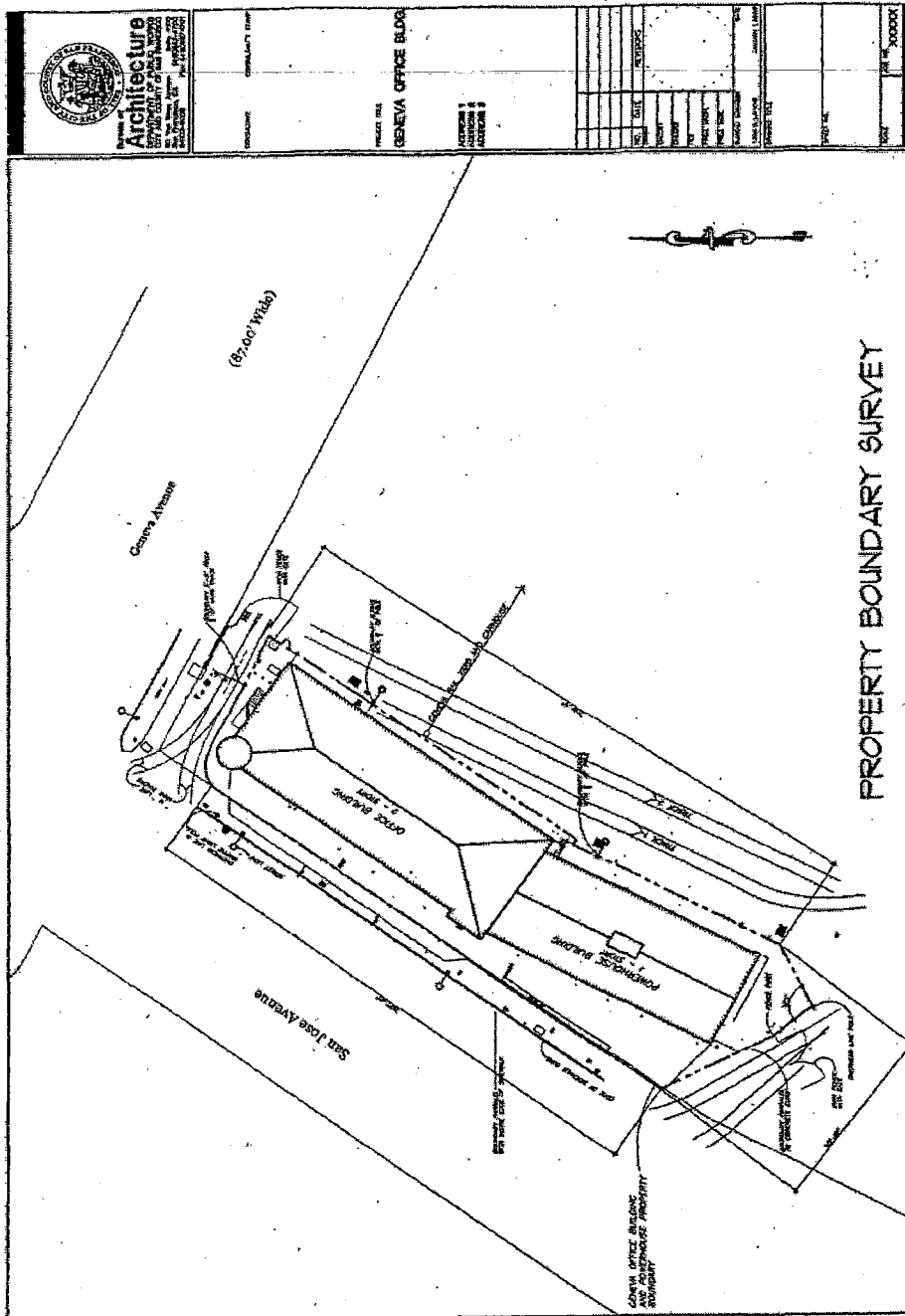

ACCESS LICENSE AGREEMENT

THIS ACCESS LICENSE AGREEMENT (this "**Agreement**"), dated for reference purposes only as of _____, 201__, is made by and between the CITY AND COUNTY OF SAN FRANCISCO, a municipal corporation ("**City**"), acting by and through the San Francisco Municipal Transportation Agency ("**SFMTA**"), and FRIENDS OF THE GENEVA OFFICE BUILDING AND POWERHOUSE, a California non-profit corporation ("**Licensee**").

RECITALS

A. City owns certain real property located at the intersection of San Jose Avenue and Geneva Avenue in the City and County of San Francisco, as further described in the attached Exhibit A (the "**City Property**"), with the buildings on the City Property known as the "Geneva Car Barn" and the "Geneva Powerhouse" (together, the "**Buildings**") under the jurisdiction of City's Recreation and Park Commission and the remainder of the City Property (the "**Yard**") under the jurisdiction of SFMTA.

B. Licensee and City, acting by and through its Recreation and Park Department ("**RPD**"), are parties to a Lease Disposition and Development Agreement dated as of _____, 2014 ("**LDDA**"), which provided for Licensee's rehabilitation and improvement of the Buildings (the "**Project**"), and are parties to a lease for the Buildings dated as of _____, 2014 ("**Ground Lease**").

C. Licensee has completed the rehabilitation and improvement work described in Section ___ of the LDDA and wishes to acquire a long term license to use the portion of the Yard depicted as the "Access Area" on the attached Exhibit A (the "**Access Area**") for the Access Activities (as defined in Section 3.1) during the term of the Ground Lease.

D. City, acting by and through SFMTA, consents to such access on the terms and conditions of this Agreement.

City and Licensee agree as follows:

AGREEMENT

1. License: Access Area. The "**Effective Date**" shall be the date that the following requirements are met: (a) this Agreement, the LDDA, and the Ground Lease have been fully executed, (b) the Project has been substantially completed and a temporary certificate of occupancy has been issued for the Buildings by City acting in its regulatory capacity, and (c) Licensee shall have delivered to City the insurance certificates described in Section 10. As of the Effective Date, City confers to Licensee a revocable, personal, unassignable, non-exclusive and non-possessory privilege for Licensee and its affiliates and their respective officers, agents, employees, contractors, subcontractors (collectively, the "**Licensee Agents**") to enter upon and use the Access Area for the Permitted Activities (as defined in Section 3.1).

This Agreement gives Licensee a license only and, notwithstanding anything to the contrary herein, this Agreement does not constitute a grant by City of any ownership, leasehold, easement or other property interest or estate whatsoever in the Access Area, or any portion thereof. The privilege given to Licensee under this Agreement is effective only insofar as the rights of City in the Access Area are concerned, and Licensee shall obtain any further permission necessary because of any other existing rights affecting the Access Area.

2. Term. The privilege given to Licensee pursuant to this Agreement is temporary only and shall be in effect during the period of time ("**Term**") that commences on the Effective

Date and expires on the earlier date (the "**Termination Date**") to occur of the expiration of the Ground Lease and any earlier termination of this Agreement pursuant to the terms hereof.

3. Uses.

3.1 Permitted Activities. Licensee and the Licensee Agents may use the Access Area to perform the following activities (collectively, the "**Permitted Activities**"): (a) to perform Licensee's obligations under this Agreement (the "**Performance Activities**"), and (b) for purposes of ingress and egress to the freight elevator and loading dock located on, and the trash receptacles located along, the eastern wall of the Building and the loading dock located adjacent to the Powerhouse portion of the Building, as well as reasonably necessary for repairs and maintenance of such freight elevator and loading docks.

3.2 Restrictions on Permitted Activities. Without limiting any of its rights hereunder, if City determines that any of the Permitted Activities poses a material risk to public health or safety or that City needs to use any portion of the Access Area for emergency purposes, and such emergency use requires changes to the Permitted Activities, City shall deliver written notice of such determination to Licensee (the "**Revision Notice**"). This Agreement shall be automatically amended to incorporate the changed Permitted Activities or changed Access Area described in the Revision Notice within five (5) business days of Licensee's receipt of the Revision Notice.

Notwithstanding anything to the contrary in the foregoing paragraph, if City determines that any of the Permitted Activities poses an immediate risk to public health or safety or that City needs to immediately use all or any portion of the Access Area for emergency purposes (an "**Emergency Situation**"), City shall have the right to temporarily restrict such Permitted Activities or use the Access Area without first delivering a Revision Notice to Licensee. If reasonably possible, City shall give Licensee verbal notification of an Emergency Situation before restricting any of the Permitted Activities or commencing its use of the Access Area. City shall deliver written notice of such action to Licensee as soon as reasonably possible. If City needs to continue its restriction on any of the Permitted Activities or its use of the Access Area in response to an Emergency Situation for more than five (5) consecutive business days and City determines it will need to continue such activities, City shall deliver a Revision Notice describing the restriction for Permitted Activities or the City's use of the Access Area, as applicable, prior to the end of such fifth (5th) business day.

City shall have no obligation to pay any consideration to Licensee if City needs to restrict, in accordance with this Section, any of the Permitted Activities or to use the Access Area for emergency purposes or to protect public health or safety (including any Emergency Situation). Licensee acknowledges and agrees that neither Licensee's efforts to comply with the conditions of this Agreement (including any related costs incurred by Licensee) nor the commencement of the Permitted Activities shall in any way whatsoever limit City's right to restrict the Permitted Activities pursuant to this Section or as expressly set forth in this Agreement.

4. Performance of Work. Licensee shall conduct, and shall cause the Licensee Agents, to conduct the Permitted Activities in compliance with the terms of this Agreement, including the following conditions, which are for the sole benefit of City:

4.1 Permits and Approvals. Licensee shall obtain all permits, licenses and approvals (collectively, "**Approvals**") required of any regulatory agencies to perform the Permitted Activities. Licensee shall deliver copies of all Approvals to City on request. Licensee recognizes and agrees that no approval by City of any of the Permitted Activities pursuant to this Agreement shall be deemed to constitute the Approval required of any

federal, state or local regulatory authority with jurisdiction, including any required of City acting in its regulatory capacity, and nothing herein shall limit Licensee's obligation to obtain all such Approvals at Licensee's sole cost.

4.2 Exercise of Due Care. Licensee shall use and cause the Licensee Agents to use due care at all times to avoid any damage or harm to City's property and to native vegetation and natural attributes of the Access Area (other than as reasonably necessary to perform any of the Permitted Activities). Licensee shall do everything reasonably within its power, both independently and upon request by City, to prevent and suppress fires and the release of Hazardous Materials (as defined in Section 9.1) on and adjacent to the Access Area attributable to the use of the Access Area by Licensee or the Licensee Agents pursuant to this Agreement.

4.3 Cooperation with City Personnel. Licensee and the Licensee Agents shall work closely with City personnel to avoid any disruption of City property in, under, on or about the Access Area, vehicular and pedestrian ingress and egress over the Access Area by City or any City employees, contractors, subcontractors, representatives, agents, or invitees, City's use of the remainder of the Yard, and the maintenance, operation, repair, replacement of City's utilities and improvements on the Yard.

4.4 Maintenance of Access Area; Repair of Damage. Licensee shall remove all debris and any excess dirt or debris in the Access Area caused by any of the Permitted Activities or the use of the Access Area by Licensee or any of the Licensee Agents. If any portion of the Access Area or any City property located on or about Yard is damaged at any time by any of the activities conducted by Licensee or any of the Licensee Agents hereunder, Licensee shall immediately, at its sole cost, repair any and all such damage and restore the Access Area or property to its previous condition. Licensee shall, at all times and at its sole cost, maintain the Access Area in a good, clean, safe, secure, sanitary and slightly condition so far as the Access Area may be affected by the Permitted Activities or any other actions in the Access Area by Licensee or the Licensee Agents.

4.5 Excavation Activities. Licensee shall prevent all materials (including soil) displaced by or resulting from the Performance Activities or the use of the Access Area by Licensee or any of the Licensee Agents from entering storm drains, sewers, or water ways and shall immediately notify the City, and all appropriate regulatory agencies required under applicable laws, if there is any accidental release of such materials.

4.6 Contractor Acknowledgement of Agreement. Licensee shall deliver a complete copy of this Agreement to all Licensee Agents performing any of the Performance Activities or otherwise entering the Access Area pursuant to this Agreement for any of the Performance Activities. Prior to the entry on the Access Area by any such party, Licensee shall deliver a notice to City signed by such party acknowledging its receipt of a copy of this Agreement and its agreement to be comply with and be bound by all of the provisions of this Agreement pertaining to its entry on the Access Area.

4.7 Wages and Working Conditions. With respect to the installation of any facilities or improvements or the performance of any work that is a "public work" under the State of California Labor Code, any employee performing services for Licensee or any Licensee Agent shall be paid not less than the highest prevailing rate of wages and that Licensee shall include, in any contract for construction of such improvement work or any alterations on the Access Area, a requirement that all persons performing labor under such contract shall be paid not less than the highest prevailing rate of wages for the labor so performed. Licensee further agrees that, as to the construction of such improvement work or any alterations on the Access Area under this Agreement, Licensee shall comply, and cause all Licensee Agents to comply, with the provisions of Section 6.22(E) of the San Francisco Administrative Code (as the same may be amended, supplemented or replaced)

that relate to payment of prevailing wages. Licensee shall require all Licensee Agents to provide, and shall deliver to City upon request, certified payroll reports with respect to all persons performing labor in the construction of the improvement work or any alterations on the Access Area for Licensee or any Licensee Agent.

5. Restrictions on Use: City's Uses. Licensee agrees that, by way of example only and without limitation, the following uses of the Access Area by Licensee or any other party claiming by or through Licensee are inconsistent with the limited purpose of this Agreement and are strictly prohibited as provided below:

5.1 Improvements. Licensee shall not construct or place any temporary or permanent structures or improvements or personal property on the Access Area, nor shall Licensee alter any existing structures or improvements on the Access Area, without the prior written consent of City. Licensee understands and agrees that City is entering into this Agreement in its capacity as a landowner with a proprietary interest in City's Property and not as a regulatory agency with certain police powers. Licensee understands and agrees that neither the City's execution of this Agreement nor any approvals by City of any work plan or otherwise given by City under this Agreement shall grant, or be deemed to imply, that Licensee will be able to obtain, any required Approvals from departments, boards or commissions of the City and County of San Francisco that have jurisdiction over any of the Permitted Activities.

5.2 Dumping; Storing; Signs. Licensee shall not dump or dispose of refuse or other unsightly materials or store any materials on, in, under or about the Access Area.

5.3 Transit Operations. Licensee acknowledges that the Yard is used for railcar operations, the maintenance and storage of railcars and other transit vehicles, and employee parking, all of which includes temporary, but continuous, ingress and egress activities over the Access Area to and from San Jose Avenue (the "**SFMTA Access Activities**"). Licensee shall not use, nor permit any of the Licensee Agents to use, the Access Area in a manner that materially interferes with, or causes a safety risk for, the SFMTA Access Activities or other City activities on the remainder of the Yard without written prior approval for each proposed activity that would pose such an interference or safety risk or unless such activity is expressly permitted pursuant to, and performed in compliance with the terms of, this Agreement.

5.4 Nuisances; No Interference with City's Uses. Licensee shall not conduct any activities on or about the Access Area that constitute waste, nuisance or unreasonable annoyance (including, without limitation, emission of objectionable odors, noises or lights) to City, to the owners or occupants of neighboring property or to the public; provided, however, that City shall not, in its proprietary capacity as landowner under this Agreement, deem Licensee's performance of any of the Permitted Activities in compliance with the terms and conditions of this Agreement to be a nuisance or unreasonable annoyance. Licensee shall not materially interfere with or obstruct the SFMTA Access Activities, City's use of the Access Area, its conduct of normal business operations thereon, or the rights of any party with rights to occupy or use the Access Area.

5.5 Utilities. City has no responsibility or liability of any kind or character with respect to any utilities that may be on, in or under the Access Area. Licensee has the sole responsibility to locate such utilities and protect them from damage, and Licensee has sole responsibility for any damage to utilities or damages resulting from Licensee's activities at the Access Area. Licensee shall arrange and pay for any necessary temporary relocation of City and public utility company facilities reasonably necessary to facilitate any of the Permitted Activities, subject to the prior written approval by City and any such utility companies of any such relocation. Licensee shall be solely responsible for arranging and paying directly for any utilities or services necessary for its activities hereunder.

5.6 Damage. Licensee shall not do anything about the Access Area that will cause damage to any of City's property (including, but not limited to, the existing rail lines, railcars, transit and support vehicles and facilities, utilities, and light poles, employee parking areas, or any other improvements) or the property of any other party with rights to occupy or use the Access Area. City's approval of any work plan pursuant to this Agreement or of the proposed Permitted Activities shall not be deemed to constitute the waiver of any rights City may have under Applicable Laws for any damage to the City's real or personal property or the Yard resulting from the Permitted Activities.

6. Fees. Licensee shall pay to City a one-time non-refundable \$5,000 permit fee to cover City's processing, inspection and other administrative costs for this Agreement. Such fee is payable at such time as Licensee signs and delivers this Agreement to City, and shall be paid in cash or by good check payable to the City and County of San Francisco.

7. Surrender: Remaining Improvements. Upon the expiration of this Agreement or within five (5) days after any sooner revocation or other termination of this Agreement, Licensee shall surrender the Access Area in a broom clean, free from hazards, clear of all debris and restore the Access Area substantially to its condition immediately prior to the Effective Date, to the reasonable satisfaction of City; provided, however, that Licensee shall have no obligation to repair or restore any deficient condition at the Access Area that was disclosed, but not caused, by any of the Permitted Activities. At such time, Licensee shall remove all of its property from the Access Area and any signs permitted hereunder, and shall repair, at its cost, any damage to the Access Area caused by such removal. Licensee's obligations under this Section shall survive any termination of this Agreement.

Any equipment or any other property of Licensee remaining in the Access Area after completion of activities may be deemed abandoned by City in its sole discretion and City may store, remove, and dispose of such equipment or property at Licensee's sole cost and expense unless City has otherwise granted written permission to Licensee for such remaining equipment or property. Licensee waives all claims for any costs or damages resulting from City's retention, removal, and disposition of such property.

8. Compliance with Laws. Licensee shall, at its expense, conduct and cause to be conducted all Permitted Activities in a safe and prudent manner and in compliance with all laws, regulations, codes, ordinances and orders of any governmental or other regulatory entity (including, without limitation, the Americans with Disabilities Act and any other disability access laws), whether presently in effect or subsequently adopted and whether or not in the contemplation of the parties. Licensee shall, at its sole expense, maintain all Approvals in force at all times during its use of the Access Area. Licensee understands and agrees that City is entering into this Agreement in its capacity as a property owner with a proprietary interest in the Access Area and not as a regulatory agency with police powers. Nothing herein shall limit in any way Licensee's obligation to obtain any required Approvals from City departments, boards or commissions or other governmental regulatory authorities or limit in any way City's exercise of its police powers.

9. Hazardous Materials.

9.1 Definitions. For purposes of this Agreement, the following terms have the following meanings:

(a) **"Environmental Laws"** means any federal, state or local laws, ordinances, regulations or policies judicial and administrative directives, orders and decrees dealing with or relating to Hazardous Materials (including, without limitation, their use, handling, transportation, production, disposal, discharge, storage or reporting requirements) or to health and safety, industrial hygiene or environmental conditions in,

on, under or about the Access Area or property, including, without limitation, soil, air, bay water and groundwater conditions or community right-to-know requirements, related to the work being performed under this Agreement.

(b) **"Handle" or "handling"** means to use, generate, process, produce, package, treat, store, emit, discharge or dispose.

(c) **"Hazardous Material"** means any substance or material which has been determined by any state, federal, or local government authority to be a hazardous or toxic substance or material, including without limitation, any hazardous substance as defined in Section 101(14) of CERCLA (42 USC Section 9601(14)) or Sections 25281(f) or 25316 of the California Health and Safety Code, any hazardous material as defined in Section 25501(k) of the California Health and Safety Code, and any additional substances or materials which at such time are classified or considered to be hazardous or toxic under any federal, state or local law, regulation or other exercise of governmental authority.

(d) **"Investigation"** means activities undertaken to determine the nature and extent of Hazardous Materials which may be located on or under real property, or which have been, are being, or threaten to be released to the environment.

(e) **"Remediation"** shall mean activities undertaken to cleanup, remove, contain, treat, stabilize, monitor or otherwise control Hazardous Materials located on or under real property or which have been, are being or threaten to be released to the environment.

(f) **"Regulatory Agency"** means any federal, state or local governmental agency or political subdivision having jurisdiction over the Access Area and any of the Permitted Activities. The City shall be a "Regulatory Agency" to the extent that City is acting in its capacity as a regulatory authority, rather than in its proprietary capacity as a landowner.

(g) **"Release"** means any spilling, leaking, pumping, pouring, emitting, emptying, discharging, injecting, escaping, leaching, dumping, or disposing into the environment of any Hazardous Material (including the abandonment or discarding of barrels, containers, and other closed receptacles containing any Hazardous Material or pollutant or contaminant).

9.2 **Environmental Laws.** Licensee shall handle all Hazardous Materials introduced or disturbed on the Access Area during the Term in compliance with all Environmental Laws. Licensee shall not be responsible for the safe handling of Hazardous Materials to the extent released on the Access Area by City or any City employee, agent, contractor, subcontractor, or invitee, or existing on the Access Area prior to the Effective Date, except to the extent any of the Permitted Activities exacerbates such Hazardous Materials. Licensee shall protect its employees and the general public in accordance with all Environmental Laws. City may from time to time request, and Licensee shall be obligated to provide, information reasonably adequate for City to determine that any and all Hazardous Materials are being handled in a manner which complies with all Environmental Laws.

9.3 **Removal of Hazardous Materials.** Prior to termination of this Agreement, Licensee, at its sole cost and expense, shall remove any and all Hazardous Materials to the extent introduced or released in, on, under or about the Access Area by Licensee or the Licensee Agents during the Term and shall Remediate or dispose of any Hazardous Materials produced as a result of the Permitted Activities. All costs of storage, shipping and disposal of extracted soils and groundwater shall be the sole responsibility of Licensee including, without limitation, the costs of preparation and execution of shipping papers,

including but not limited to hazardous waste manifests. With respect to shipping papers and hazardous waste manifests, Licensee shall be the "generator" and in no case shall the City be named as the generator.

9.4 Notification. Licensee shall provide City with a copy of any permits issued for any Permitted Activity that involves the potential release or discharge of any Hazardous Materials in or from the Access Area, and the receipt of a hazardous waste generator identification number issued by the U.S. Environmental Protection Agency or the California Environmental Protection Agency to itself or any of the Licensee Agents. Licensee shall promptly notify City in writing of, and shall contemporaneously provide City with a copy of:

(a) Any release or discharge of any Hazardous Materials, whether or not the release is in quantities that would be required under applicable laws to be reported to a Regulatory Agency;

(b) Any written notice of release of Hazardous Materials in or on the Access Area that is provided by Licensee or any of the Licensee Agents to a Regulatory Agency including any City agency;

(c) Any notice of a violation, or a potential or alleged violation, of any Environmental Law that is received by Licensee or any of the Licensee Agents from any Regulatory Agency;

(d) Any inquiry, investigation, enforcement, cleanup, removal, or other action that is instituted or threatened by a Regulatory Agency against Licensee or any of the Licensee Agents and that relates to the release or discharge of Hazardous Material on or from the Access Area;

(e) Any claim that is instituted or threatened by any third party against Licensee or any of the Licensee Agents and that relates to any release or discharge of Hazardous Materials on or from the Access Area; and

(f) Any notice of the termination, expiration or substantial amendment of any environmental operating permit needed by Licensee or any of the Licensee Agents.

9.5 Hazardous Material Disclosures. California law requires landlords to disclose to tenants the presence or potential presence of certain Hazardous Materials. Although this Agreement grants Licensee a license only, Licensee is hereby advised that Hazardous Materials may be present on the Access Area, including, but not limited to vehicle fluids, janitorial products, tobacco smoke, and building materials containing chemicals, such as formaldehyde. By execution of this Agreement, Licensee acknowledges that the notice set forth in this Section satisfies the requirements of California Health and Safety Code Section 25359.7 and related statutes. Licensee also acknowledges its own obligations pursuant to California Health and Safety Code Section 25359.7 as well as the penalties that apply for failure to meet such obligations.

10. Insurance.

10.1 Insurance Policies. Licensee shall procure and keep in effect at all times during the Term, at Licensee's expense, and cause its contractors and subcontractors to maintain at all times insurance as follows during the Term:

(a) General Liability Insurance with limits not less than Two Million Dollars (\$2,000,000) each occurrence Combined Single Limit for Bodily Injury and Property Damage, including coverages for Contractual Liability, Personal Injury, Independent Contractors, Explosion, Collapse and Underground (XCU), Broadform

Property Damage, Sudden and Accidental Pollution, Products Liability and Completed Operations;

(b) Automobile Liability Insurance with limits not less than One Million Dollars (\$1,000,000) each occurrence Combined Single Limit for Bodily Injury and Property Damage, including coverages for owned, non-owned and hired automobiles, as applicable, and sudden and accidental pollution; and

(c) Workers' Compensation Insurance with Employer's Liability Coverage with limits of not less than One Million Dollars (\$1,000,000) each accident.

10.2 Policy Requirements; Delivery of Certificates.

(a) All liability policies required hereunder shall provide for the following: (i) name as additional insureds the City and County of San Francisco, its officers, agents and employees; and (ii) specify that such policies are primary insurance to any other insurance available to the additional insureds, with respect to any claims arising out of this Agreement and that insurance applies separately to each insured against whom claim is made or suit is brought. Such policies shall also provide for severability of interests and that an act or omission of one of the named insureds which would void or otherwise reduce coverage shall not reduce or void the coverage as to any insured, and shall afford coverage for all claims based on acts, omissions, injury or damage which occurred or arose (or the onset of which occurred or arose) in whole or in part during the policy period. Sudden and accidental pollution coverage in the liability policies required hereunder shall be limited to losses resulting from Licensee's activities (and the activities of any Licensee Agents) under this Agreement (excluding non-negligent aggravation of existing conditions with respect to Hazardous Materials).

(b) All policies shall be endorsed to provide thirty (30) days' prior written notice of cancellation, non-renewal or reduction in coverage to City.

(c) Licensee shall deliver to City certificates of insurance and additional insured policy endorsements from insurers prior to the Effective Date and in a form satisfactory to City, evidencing the coverages required hereunder, together with complete copies of the policies at City's request. In the event Licensee shall fail to procure such insurance, or to deliver such certificates, City may procure, at its option, the same for the account of Licensee, and the cost thereof shall be paid to City within ten (10) days after delivery to Licensee of bills therefor.

(d) All policies shall include a waiver of subrogation endorsement or provision wherein the insurer acknowledges acceptance of Licensee's waiver of claims against City, provide for severability of interests and that an act or omission of one of the named insureds which would void or otherwise reduce coverage shall not reduce or void the coverage as to any other insured, and shall afford coverage for all claims based on acts, omissions, injury or damage which occurred or arose in whole or in part during the policy period.

(e) Should any of the required insurance be provided under a form of coverage that includes a general annual aggregate limit or provides that claims investigation or legal defense costs be included in such general annual aggregate limit, such general aggregate limit shall double the occurrence or claims limits specified above.

(f) Should any of the required insurance be provided under a claims made form, Licensee shall maintain such coverage continuously throughout the Term and, without lapse, for a period of three (3) years beyond the Termination Date, to the effect

that, should any occurrences during the Term give rise to claims made after Termination Date, such claims shall be covered by such claims-made policies.

(f) Upon City's request, Licensee and City shall periodically review the limits and types of insurance carried pursuant to this Section. If the general commercial practice in the City and County of San Francisco is to carry liability insurance in an amount or coverage materially greater than the amount or coverage then being carried by Licensee for risks comparable to those associated with the Access Area, then City in its sole discretion may require Licensee to increase the amounts or coverage carried by Licensee hereunder to conform to such general commercial practice.

10.3 Waiver of Subrogation. Notwithstanding anything to the contrary contained herein, Licensee hereby waives any right of recovery against City for any loss or damage sustained by Licensee with respect to the Access Area or any portion thereof or the contents of the same or any operation therein, whether or not such loss is caused by the fault or negligence of City, to the extent such loss or damage is covered by insurance which is required to be purchased by Licensee under this Agreement or the Ground Lease or is actually covered by insurance obtained by Licensee. Licensee agrees to cause its insurers to issue appropriate waiver of subrogation rights endorsements to all policies relating to the Access Area; provided, the failure to obtain any such endorsement shall not affect the above waiver.

10.4 No Limitation on Licensee Obligations. Licensee's compliance with the provisions of this Section shall in no way relieve or decrease Licensee's indemnification obligations under this Agreement or any of Licensee's other obligations hereunder. Notwithstanding anything to the contrary in this Agreement, this Agreement shall terminate immediately, without notice to Licensee, upon the lapse of any required insurance coverage. Licensee shall be responsible, at its expense, for separately insuring Licensee's personal property.

11. Waiver of Claims; Waiver of Consequential and Incidental Damages.

(a) Neither City nor any of its commissions, departments, boards, officers, agents or employees shall be liable for any damage to the property of Licensee, the Licensee Agents, or their respective officers, agents, employees, contractors or subcontractors, or employees, or for any bodily injury or death to such persons, resulting or arising from the condition of the Access Area or its use by Licensee or the Licensee Agents, except to the extent that any such damage, injury or death is caused by the gross negligence or willful misconduct of City or any of its commissions, departments, boards, officers, agents, employees, or contractors (each, a "City Agent").

(b) Licensee acknowledges that the Access Area and the Permitted Activities can be modified by City pursuant to Section 3 and revoked by City pursuant to Section 2 and in view of such fact, Licensee expressly assumes the risk of making any expenditures in connection with this Agreement, even if such expenditures are substantial. Without limiting any indemnification obligations of Licensee or other waivers contained in this Agreement and as a material part of the consideration for this Agreement, Licensee fully RELEASES, WAIVES AND DISCHARGES forever any and all claims, demands, rights, and causes of action against, and covenants not to sue, City, its departments, commissions, officers, directors and employees, and all persons acting by, through or under each of them, under any present or future laws, statutes, or regulations (including, but not limited to, any claim for inverse condemnation or the payment of just compensation under the law of eminent domain or otherwise at equity), in the event that City exercises its right to modify the Access Area or the Permitted Activities pursuant to Section 3.

(c) Licensee acknowledges that it will not be a displaced person at the time this Agreement is terminated or revoked or expires by its own terms, and Licensee fully RELEASES, WAIVES AND DISCHARGES forever any and all claims, demands, rights, and causes of action against, and covenants not to sue, City, its departments, commissions, officers, directors and employees, and all persons acting by, through or under each of them, under any present or future laws, statutes, or regulations for displaced persons, including, without limitation, any and all claims for relocation benefits or assistance from City under federal and state relocation assistance laws.

(d) Licensee expressly acknowledges and agrees that the fees payable hereunder do not take in to account any potential liability of City for any consequential or incidental damages including, but not limited to, lost profits, arising out of disruption to Licensee's uses hereunder. City would not be willing to give this Agreement in the absence of a complete waiver of liability for consequential or incidental damages due to the acts or omissions of City or its Agents, and Licensee expressly assumes the risk with respect thereto. Accordingly, without limiting any indemnification obligations of Licensee or other waivers contained in this Agreement and as a material part of the consideration for this Agreement, Licensee fully RELEASES, WAIVES AND DISCHARGES forever any and all claims, demands, rights, and causes of action against for consequential and incidental damages (including without limitation, lost profits) and covenants not to sue for such damages, City, its departments, commissions, officers, directors and employees, and all persons acting by, through or under each of them, arising out of this Agreement or the uses authorized hereunder, including, without limitation, any interference with uses conducted by Licensee pursuant to this Agreement, regardless of the cause, and whether or not due to the negligence of City or its Agents, except for the gross negligence or willful misconduct of City or its Agents.

(e) In connection with the foregoing releases, Licensee acknowledges that it is familiar with Section 1542 of the California Civil Code, which reads:

"A general release does not extend to claims which the creditor does not know or suspect to exist in his or her favor at the time of executing the release, which if known by him or her must have materially affected his or her settlement with the debtor."

Licensee acknowledges that the releases contained herein includes all known and unknown, disclosed and undisclosed, and anticipated and unanticipated claims. Licensee realizes and acknowledges that it has agreed upon this Agreement in light of this realization and, being fully aware of this situation, it nevertheless intends to waive the benefit of Civil Code Section 1542, or any statute or other similar law now or later in effect. The releases contained herein shall survive any termination of this Agreement.

12. Defaults by Licensee. If Licensee fails to perform any of its monetary obligations under this Agreement and fails to cure such monetary failure within five (5) business days following City's written notice of such monetary failure to Licensee, then City may, at its sole option, immediately terminate this Agreement by providing Licensee with written notice of such termination. If Licensee fails to perform any of its non-monetary obligations under this Agreement, then City may, at its sole option, remedy such failure for Licensee's account and at Licensee's expense or terminate this Agreement by providing Licensee with thirty (30) days' prior written notice of City's intention to cure such default (except that no such prior notice shall be required in the event of an emergency as determined by City) or to terminate this Agreement. Such action by City shall not be construed as a waiver of any rights or remedies of City under this Agreement, and nothing herein shall imply any duty of City to do any act that Licensee is obligated to perform. Licensee shall pay to City upon demand, all costs, damages, expenses or liabilities reasonably incurred by City, including, without limitation, reasonable attorneys' fees, in remedying or attempting to remedy such

default. Licensee's obligations under this Section shall survive the termination of this Agreement.

13. No Costs to City; No Liens. Licensee shall bear all costs or expenses of any kind or nature in connection with its use of the Access Area and in complying with the conditions of this Agreement, and shall keep the Access Area free and clear of any liens or claims of lien arising out of or in any way connected with its use of the Access Area.

14. Indemnity. Except solely to the extent of Losses resulting directly from the willful misconduct or gross negligence of City or of any City Agent or from any material breach of this Agreement by City or any City Agent, Licensee shall indemnify, defend and hold harmless each of City and the City Agents each from and against any and all demands, claims, legal or administrative proceedings, losses, costs, penalties, fines, liens, judgments, damages and liabilities of any kind (collectively, "**Losses**"), arising in any manner out of (a) any injury to or death of any person or damage to or destruction of any property occurring in, on or about the Access Area, or any part thereof, whether the person or property of Licensee, any Licensee Agent, and any of their respective officers, agents, employees, contractors, subcontractors, or third persons, relating in any manner to any of the Permitted Activities, (b) any failure by Licensee to faithfully observe or perform any of the terms, covenants or conditions of this Agreement, including all applicable laws, or to cause the Licensee Agents, to comply with such terms, covenants or conditions, (c) the use of the Access Area or any activities conducted thereon by Licensee or any Licensee Agent, (d) any handling, release or threatened release, or discharge, or threatened discharge, of any Hazardous Material caused or allowed by Licensee or any Licensee Agent on, in, under or about the Access Area, any improvements permitted thereon, or into the environment; (e) any requirement of a Regulatory Agency for investigation or remediation of any release of Hazardous Materials at the Access Area in connection with use of the Access Area by Licensee or any Licensee Agent; and (f) any requirement of a Regulatory Agency for investigation or remediation of any Hazardous Materials arising out of or in connection with the activities of Licensee or any Licensee Agent at the Access Area, including, without limitation, requirements which would not have been imposed except for such party's use of the Access Area for an of the Permitted Activities. The foregoing indemnity shall not include any Losses incurred by City with respect to any Hazardous Materials at the Access Area discovered, but not released, by Licensee or any Licensee Agent. The indemnity in this Section shall include, without limitation, reasonable attorneys' and consultants' fees, investigation and remediation costs and all other reasonable costs and expenses incurred by the indemnified parties, including, without limitation, damages for decrease in the value of the Access Area and claims for damages or decreases in the value of adjoining property. Licensee specifically acknowledges and agrees that it has an immediate and independent obligation to defend City from any claim which actually or potentially falls within this indemnity provision even if such allegation is or may be groundless, fraudulent or false, which obligation arises at the time such claim is tendered to Licensee by City and continues at all times thereafter. Licensee's obligations under this Section shall survive the expiration or other termination of this Agreement.

15. "As Is" Condition of Access Area; Disclaimer of Representations. Licensee accepts the Access Area in its "AS IS" condition, without representation or warranty of any kind by City, its officers, agents or employees, including, without limitation, the suitability, safety, or duration of availability of the Access Area or any facilities on the Access Area for Licensee's use. Without limiting the foregoing, this Agreement is made subject to all applicable laws, rules and ordinances governing the use of the Access Area, and to any and all covenants, conditions, restrictions, easements, encumbrances, claims of title and other title matters affecting the Access Area, whether foreseen or unforeseen, and whether such matters are of record or would be disclosed by an accurate inspection or survey. It is Licensee's sole obligation to conduct an independent investigation of the Access Area and all matters relating to its use of the Access Area hereunder, including, without limitation,

the suitability of the Access Area for such uses. Licensee, at its own expense, shall obtain such permission or other approvals from any third parties with existing rights as may be necessary for Licensee to make use of the Access Area in the manner contemplated hereby. Under California Civil Code Section 1938, to the extent applicable to this Agreement, Licensee is hereby advised that the Access Area has not undergone inspection by a Certified Access Specialist ("CASp") to determine whether it meets all applicable construction-related accessibility requirements.

16. Notices. Except as otherwise expressly provided herein, any notices given under this Agreement shall be effective only if in writing and given by delivering the notice in person, by sending it first class mail or certified mail, with a return receipt requested, or overnight courier, return receipt requested, with postage prepaid, addressed as follows:

If to City: SFMTA
City and County of San Francisco
1 South Van Ness Avenue, 8th Floor
San Francisco, CA 94103
Attn: Senior Manager, Real Estate

If to Licensee:

Notices herein shall be deemed given two (2) days after the date when it shall have been mailed if sent by first class, certified or overnight courier, or upon the date personal delivery is made.

17. No Joint Ventures or Partnership; No Authorization. This Agreement does not create a partnership or joint venture between City and Licensee as to any activity conducted by Licensee on, in or relating to the Access Area. Licensee is not a State actor with respect to any activity conducted by Licensee on, in, or under the Access Area. The giving of this Agreement by City does not constitute authorization or approval by City of any activity conducted by Licensee on, in or relating to the Access Area.

18. MacBride Principles - Northern Ireland. The City and County of San Francisco urges companies doing business in Northern Ireland to move toward resolving employment inequities and encourages them to abide by the MacBride Principles as expressed in San Francisco Administrative Code Section 12F.1 *et seq.* The City and County of San Francisco also urges San Francisco companies to do business with corporations that abide by the MacBride Principles. Licensee acknowledges that it has read and understands the above statement of the City and County of San Francisco concerning doing business in Northern Ireland.

19. Non-Discrimination.

19.1 Covenant Not to Discriminate. In the performance of this Agreement, Licensee agrees not to discriminate against any employee of, any City employee working with Licensee, or applicant for employment with Licensee, or against any person seeking accommodations, advantages, facilities, privileges, services, or membership in all business, social, or other establishments or organizations, on the basis of the fact or perception of a person's race, color, creed, religion, national origin, ancestry, age, height, weight, sex, sexual orientation, gender identity, domestic partner status, marital status, disability or Acquired Immune Deficiency Syndrome or HIV status (AIDS/HIV status), or association with members of such protected classes, or in retaliation for opposition to discrimination against such classes.

19.2 Subcontracts. Licensee shall include in all subcontracts relating to the Access Area a non-discrimination clause applicable to such subcontractor in substantially the form of Section 19.1. In addition, Licensee shall incorporate by reference in all subcontracts the provisions of Sections 12B.2(a), 12B.2(c)-(k), and 12C.3 of the San Francisco Administrative Code and shall require all subcontractors to comply with such provisions. Licensee's failure to comply with the obligations in this Subsection shall constitute a material breach of this Agreement.

19.3 Non-Discrimination in Benefits. Licensee does not as of the date of this Agreement and will not during the Term, in any of its operations in San Francisco, on real property owned by City, or where the work is being performed for the City or elsewhere within the United States, discriminate in the provision of bereavement leave, family medical leave, health benefits, membership or membership discounts, moving expenses, pension and retirement benefits or travel benefits, as well as any benefits other than the benefits specified above, between employees with domestic partners and employees with spouses, and/or between the domestic partners and spouses of such employees, where the domestic partnership has been registered with a governmental entity pursuant to state or local law authorizing such registration, subject to the conditions set forth in Section 12B.2(b) of the San Francisco Administrative Code.

19.4 Condition to Agreement. As a condition to this Agreement, Licensee shall execute the "Chapter 12B Declaration: Nondiscrimination in Contracts and Benefits" form (Form HRC-12B-101) with supporting documentation and secure the approval of the form by the San Francisco Human Rights Commission (the "HRC"). Licensee hereby represents that prior to execution of this Agreement, (i) Licensee executed and submitted to the HRC Form HRC-12B-101 with supporting documentation, and (ii) the HRC approved such form.

19.5 Incorporation of Administrative Code Provisions by Reference. The provisions of Chapters 12B and 12C of the San Francisco Administrative Code relating to non-discrimination by parties contracting for the use of City property are incorporated in this Section by reference and made a part of this Agreement as though fully set forth herein. Licensee shall comply fully with and be bound by all of the provisions that apply to this Agreement under such Chapters of the Administrative Code, including but not limited to the remedies provided in such Chapters. Without limiting the foregoing, Licensee understands that pursuant to Section 12B.2(h) of the San Francisco Administrative Code, a penalty of Fifty Dollars (\$50) for each person for each calendar day during which such person was discriminated against in violation of the provisions of this Agreement may be assessed against Licensee and/or deducted from any payments due Licensee.

20. Notification of Limitations on Contributions. Through its execution of this Agreement, Licensee acknowledges that it is familiar with Section 1.126 of the San Francisco Campaign and Governmental Conduct Code, which prohibits any person who contracts with the City for the selling or leasing of any land or building to or from the City whenever such transaction would require the approval by a City elective officer, the board on which that City elective officer serves, or a board on which an appointee of that individual serves, from making any campaign contribution to (1) the City elective officer, (2) a candidate for the office held by such individual, or (3) a committee controlled by such individual or candidate, at any time from the commencement of negotiations for the contract until the later of either the termination of negotiations for such contract or six months after the date the contract is approved. Licensee acknowledges that the foregoing restriction applies only if the contract or a combination or series of contracts approved by the same individual or board in a fiscal year have a total anticipated or actual value of \$50,000 or more. Licensee further acknowledges that the prohibition on contributions applies to each Licensee; each member of Licensee's board of directors, and Licensee's chief executive officer, chief financial officer and chief operating officer; any person with an

ownership in interest of more than twenty percent (20%) in Licensee; any subcontractor listed in the contract; and any committee that is sponsored or controlled by Licensee. Additionally, Licensee acknowledges that Licensee must inform each of the persons described in the preceding sentence of the prohibitions contained in Section 1.126. Licensee further agrees to provide to City the names of each person, entity or committee described above.

21. Pesticide Prohibition. Licensee shall comply with the provisions of Section 308 of Chapter 3 of the San Francisco Environment Code (the "**Pesticide Ordinance**") which (i) prohibit the use of certain pesticides on City property, (ii) require the posting of certain notices and the maintenance of certain records regarding pesticide usage and (iii) require Licensee to submit to SFMTA an integrated pest management ("**IPM**") plan that (a) lists, to the extent reasonably possible, the types and estimated quantities of pesticides that Licensee may need to apply to the Access Area during the Term, (b) describes the steps Licensee will take to meet the City's IPM Policy described in Section 300 of the Pesticide Ordinance and (c) identifies, by name, title, address and telephone number, an individual to act as the Licensee's primary IPM contact person with the City. In addition, Licensee shall comply with the requirements of Sections 303(a) and 303(b) of the Pesticide Ordinance.

22. Conflicts of Interest. Through its execution of this Agreement, Licensee acknowledges that it is familiar with the provisions of Section 15.103 of the San Francisco Charter, Article III, Chapter 2 of City's Campaign and Governmental Conduct Code, and Sections 87100 *et seq.* and Sections 1090 *et seq.* of the Government Code of the State of California, and certifies that it does not know of any facts which would constitute a violation of said provision, and agrees that if Licensee becomes aware of any such fact during the Term, Licensee shall immediately notify the City.

23. No Assignment. This Agreement is personal to Licensee and shall not be assigned, conveyed or otherwise transferred by Licensee under any circumstances except by operation of law. Any attempt to assign, convey or otherwise transfer this Agreement shall be null and void and cause the immediate termination and revocation of this Agreement.

24. Sunshine Ordinance. Licensee understands and agrees that under the City's Sunshine Ordinance (San Francisco Administrative Code Chapter 67) and the State Public Records Law (California Government Code Section 6250 *et seq.*), apply to this Agreement and any and all records, information, and materials submitted to the City in connection with this Agreement. Accordingly, any and all such records, information and materials may be subject to public disclosure in accordance with the City's Sunshine Ordinance and the State Public Records Law. Licensee hereby authorizes the City to disclose any records, information and materials submitted to the City in connection with this Agreement.

25. Food Service Waste Reduction. Licensee agrees to comply fully with and be bound by all of the applicable provisions of the Food Service Waste Reduction Ordinance, as set forth in the San Francisco Environment Code, Chapter 16, including the remedies provided therein, and implementing guidelines and rules. The provisions of Chapter 16 are incorporated herein by reference and made a part of this Agreement as though fully set forth herein. Accordingly, Licensee acknowledges that City contractors and lessees may not use Disposable Food Service Ware that contains Polystyrene Foam in City Facilities and while performing under a City contract or lease, and shall instead use suitable Biodegradable/Compostable or Recyclable Disposable Food Service Ware. This provision is a material term of this Agreement.

26. Prohibition of Tobacco Sales and Advertising. Licensee acknowledges and agrees that no advertising of cigarettes or tobacco products is allowed on the Access Area. This advertising prohibition includes the placement of the name of a company producing, selling or distributing cigarettes or tobacco products or the name of any cigarette or tobacco

product in any promotion of any event or product. This advertising prohibition does not apply to any advertisement sponsored by a state, local, nonprofit or other entity designed to (i) communicate the health hazards of cigarettes and tobacco products, or (ii) encourage people not to smoke or to stop smoking.

27. Prohibition of Alcoholic Beverage Advertising. Licensee acknowledges and agrees that no advertising of alcoholic beverages is allowed on the Access Area. For purposes of this Section, "alcoholic beverage" shall be defined as set forth in California Business and Professions Code Section 23004, and shall not include cleaning solutions, medical supplies and other products and substances not intended for drinking. This advertising prohibition includes the placement of the name of a company producing, selling or distributing alcoholic beverages or the name of any alcoholic beverage in any promotion of any event or product. This advertising prohibition does not apply to any advertisement sponsored by a state, local, nonprofit or other entity designed to (i) communicate the health hazards of alcoholic beverages, (ii) encourage people not to drink alcohol or to stop drinking alcohol, or (iii) provide or publicize drug or alcohol treatment or rehabilitation services.

28. Tropical Hardwoods and Virgin Redwood Ban. The City and County of San Francisco urges companies not to import, purchase, obtain or use for any purpose, any tropical hardwood, tropical hardwood wood product, virgin redwood or virgin redwood wood product, except as expressly permitted by the application of Sections 802(b) and 803(b) of the San Francisco Environment Code. Licensee agrees that, except as permitted by the application of Sections 802(b) and 803(b), Licensee shall not use or incorporate any tropical hardwood, tropical hardwood wood product, virgin redwood or virgin redwood wood product in the performance of this Agreement.

29. Possessory Interest Taxes. Licensee recognizes and understands that this Agreement may create a possessory interest subject to property taxation and that Licensee may be subject to the payment of property taxes levied on such interest under applicable law. Licensee agrees to pay taxes of any kind, including possessory interest taxes, if any, that may be lawfully assessed on Licensee's interest under this Agreement or use of the Access Area pursuant hereto and to pay any other taxes, excises, licenses, permit charges or assessments based on Licensee's usage of the Access Area that may be imposed upon Licensee by applicable law. Licensee shall pay all of such charges when they become due and payable and before delinquency.

30. Consideration of Criminal History in Hiring and Employment Decisions. Licensee agrees to comply fully with and be bound by all of the provisions of Chapter 12T of the San Francisco Administrative Code (City Contractor/Subcontractor Consideration of Criminal History in Hiring and Employment Decisions) ("**Chapter 12T**"), including the remedies and implementing regulations of Chapter 12T, as may be amended from time to time, in the hiring or employment any person with respect to the Permitted Activities. The provisions of Chapter 12T are incorporated by reference and made a part of this Agreement as though fully set forth herein. Such provisions include, but are not limited to, the requirements for solicitations or advertisements for employees made by Licensee if such employees would perform any of the Permitted Activities and the prohibition of certain inquiries when initially interviewing job candidates for such employment positions. The text of the Chapter 12T is available on the web at <http://sfgov.org>.

Licensee shall incorporate by reference in all subcontracts the provisions of Chapter 12T, and shall require all its contractors to comply with such provisions. Licensee's failure to comply with the obligations in this Section shall constitute a material breach of this Agreement. Licensee understands and agrees that if it fails to comply with the requirements of Chapter 12T, City shall have the right to pursue any rights or remedies available under Chapter 12T, including but not limited to, a penalty of \$50 for a second violation and \$100 for a subsequent violation for each employee, applicant or other person

as to whom a violation occurred or continued, termination or suspension in whole or in part of this Agreement.

31. Cooperative Drafting. This Agreement has been drafted through a cooperative effort of both parties, and both parties have had an opportunity to have the License reviewed and revised by legal counsel. No party shall be considered the drafter of this Agreement, and no presumption or rule that an ambiguity shall be construed against the party drafting the clause shall apply to the interpretation or enforcement of this Agreement.

32. Severability. If any provision of this Agreement or the application thereof to any person, entity or circumstance shall be invalid or unenforceable, the remainder of this Agreement, or the application of such provision to persons, entities or circumstances other than those as to which it is invalid or unenforceable, shall not be affected thereby, and each other provision of this Agreement shall be valid and be enforceable to the fullest extent permitted by law, except to the extent that enforcement of this Agreement without the invalidated provision would be unreasonable or inequitable under all the circumstances or would frustrate a fundamental purpose of this Agreement.

33. Counterparts. This Agreement may be executed in two or more counterparts, each of which shall be deemed an original, but all of which taken together shall constitute one and the same instrument.

34. General Provisions. (a) This Agreement may be amended or modified only by a writing signed by City and Licensee. (b) No waiver by any party of any of the provisions of this Agreement shall be effective unless in writing and signed by an officer or other authorized representative, and only to the extent expressly provided in such written waiver. (c) Except as otherwise expressly set forth herein, all approvals and determinations of City requested, required or permitted pursuant to this Agreement may be made in the sole and absolute discretion of the SFMTA's Director of Transportation or other authorized City official. (d) This Agreement (including the exhibit(s) hereto) contains the entire agreement between the parties and all prior written or oral negotiations, discussions, understandings and agreements are merged herein. (e) The section and other headings of this Agreement are for convenience of reference only and shall be disregarded in the interpretation of this Agreement. (f) Time is of the essence. (g) This Agreement shall be governed by California law and the City's Charter. (h) If either party commences an action against the other or a dispute arises under this Agreement, the prevailing party shall be entitled to recover from the other reasonable attorneys' fees and costs. For purposes hereof, reasonable attorneys' fees of City shall be based on the fees regularly charged by private attorneys in San Francisco with comparable experience. (i) Licensee may not record this Agreement or any memorandum hereof. (j) Subject to the prohibition against assignments or other transfers by Licensee hereunder, this Agreement shall be binding upon and inure to the benefit of the parties and their respective heirs, representatives, successors and assigns. (k) If City sells or otherwise conveys any portion of the Access Area, the owner of such conveyed portion of the Access Area shall accept such portion subject to this Agreement and shall assume City's rights and obligations under this Agreement to the extent such rights and obligations affect such transferred portion.

[REMAINDER OF PAGE INTENTIONALLY LEFT BLANK]

Licensee represents and warrants to City that it has read and understands the contents of this Agreement and agrees to comply with and be bound by all of its provisions.

LICENSEE:

FRIENDS OF THE GENEVA OFFICE BUILDING
AND POWERHOUSE, a California non-profit
corporation

By: _____
Its: _____

Date: _____

By: _____
Its: _____

Date: _____

CITY:

CITY AND COUNTY OF SAN FRANCISCO,
a municipal corporation, acting by and through
the San Francisco Municipal Transportation
Agency

By: _____
Edward D. Reiskin
Director of Transportation

Date: _____

APPROVED AS TO FORM:

DENNIS J. HERRERA, City Attorney

By: _____
Carol Wong, Deputy City Attorney

EXHIBIT A

Depiction of City Property, Buildings, and Access Area

[see attached]

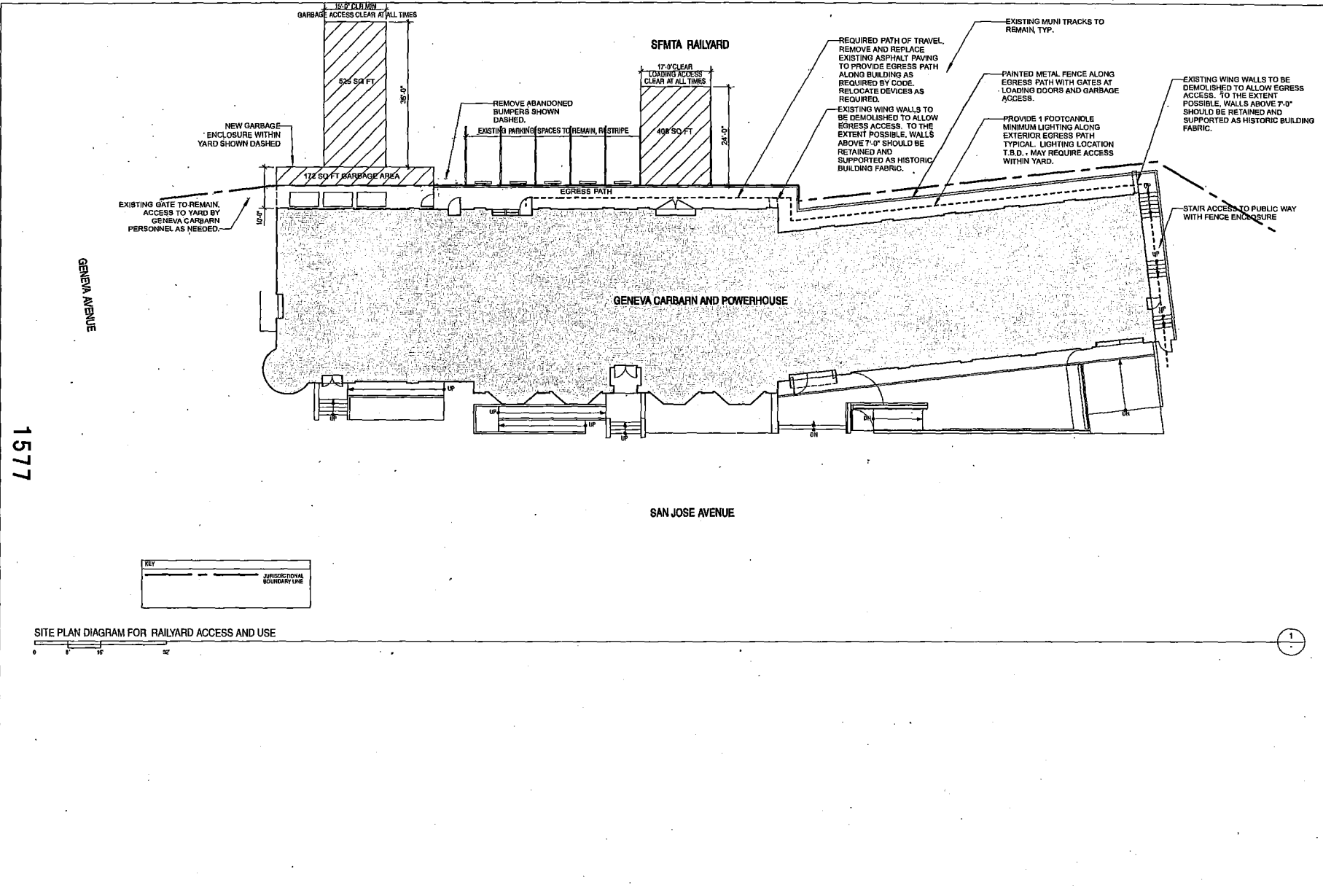

AD

adlin darling design
200 mind street
suite 410
345 francisco, ca 94107
415 974 8661 fax
415 974 8661 phone

**GENEVA CAR BARN
AND POWERHOUSE**

2311 SAN JOSE AVENUE
SAN FRANCISCO, CA

DATE:	05.01.14
JOB:	0908
DRAWN:	RC
SCALE:	AS NOTED
ISSUE	DATE

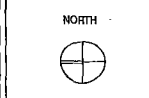

**SITE PLAN
DIAGRAM FOR
RAILYARD ACCESS
AND USE**

MEMORANDUM OF UNDERSTANDING

THIS MEMORANDUM OF UNDERSTANDING (herein "MOU") dated hereof for reference purposes only as of _____, 2014, is entered into by and between the San Francisco Municipal Transportation Agency (the "SFMTA"), an agency of the City and County of San Francisco (the "City") and the City's Recreation and Park Commission (the "Commission"). SFMTA and the Commission shall each be referred to from time to time in this MOU as a "Party" and together as the "Parties".

RECITALS

A. In 2004, SFMTA and the City's Recreation and Park Department (the "Department") reached an agreement for SFMTA to transfer jurisdiction over the Geneva Avenue Office Building and Powerhouse (the "Building"), along with the property surrounding the Building as delineated in Exhibit A (collectively, the Building and surrounding property are hereinafter referred to as the "Property"), to the Commission for recreational use as a new space for youth and teen arts and related uses consistent with the Department's mission. By Resolution 193-04, City's Board of Supervisors transferred jurisdiction of the Property from SFMTA to the Commission, subject to the condition subsequent that if the Commission finds that the Property no longer serves a recreational purpose jurisdiction it will revert to SFMTA.

B. The Property is located adjacent to the SFMTA's Geneva Rail Yard and Carhouse (collectively, the "Yard"), sometimes referred to by SFMTA as the Cameron Beach Yard. A high-tension electrical wire benefitting the Yard is presently mounted to eastern wall of the Building and an alarm system serving the Yard is located, in part, within the Building.

C. The Building, which is comprised of two adjoining structures, a two-story office building and a single-story car shed, known as the Powerhouse, had been severely damaged in the 1989 Loma Prieta Earthquake and had fallen into general disrepair.

D. Around the time of the jurisdictional transfer in 2004, the Department, SFMTA, and Caltrans collectively funded and cooperated on a project to stabilize the Building in a manner designed to make the Building less likely to collapse in an earthquake. The stabilization work did not include the work required to make the Building seismically safe for occupancy, or the necessary electrical, mechanical or plumbing upgrades or other refurbishment or renovations required for the use and occupancy of the Building for recreational purposes, and the electrical wire and the components of the alarm system serving the Yard were not removed from the Building at the time of the work.

E. In connection with the jurisdictional transfer and the stabilization work, SFMTA and the Department entered into a Memorandum of Understanding (the "2004 MOU") providing for the funding and performance of the stabilization work, and granting SFMTA limited access to the Property and the Department limited access to the Yard, on terms and conditions specified in the 2004 MOU.

F. The Department has entered into, or anticipates entering into, a Lease Disposition and Development Agreement ("LDDA") with Friends of the Geneva Office Building and Powerhouse (the "Friends"), an independent nonprofit organization. The LDDA provides for the

rehabilitation and improvement of the Building, including a complete seismic upgrade of both building structures, new electrical, mechanical and plumbing systems, new interior finishes and refurbishing of historically significant building elements (the "Project"), and the eventual lease ("Lease") of the Property to Friends, on terms and conditions specified in the LDDA. Among the LDDA conditions to the lease of the Property to Friends are (i) the removal of the high-tension electrical wire and alarm system serving the Yard, and (ii) a more comprehensive license or other right of access in favor of the Department and Friends for purposes of ingress and egress to the freight elevator and loading dock to be located on the eastern wall of the Building during the term of the Lease (the "Long-Term License"), including the right to record the Long-Term License or a memorandum thereof against title to the Yard upon the close of escrow under the LDDA. The LDDA also anticipates that the Department will cooperate in the Friends' efforts to obtain from SFMTA a more comprehensive temporary construction license or other right of access in favor of the Department and Friends for purposes of ingress, egress, and staging during construction of the improvements contemplated under the LDDA and the proposed Lease (the "Temporary Construction License"), once Friends is able to identify the areas required for construction access and staging and to propose a construction staging plan.

G. SFMTA desires to ensure the integrity of the systems serving the Yard, and accordingly has agreed to remove the high-tension electrical wire from the Building and to deactivate the alarm system in the Building. Further, if the Department and Friends enter into the LDDA, SFMTA is agreeable to entering into a Long-Term License and to consider in the future a Temporary Construction License, both of which are consistent with the access rights granted to the Department by SFMTA under the 2004 MOU.

NOW, THEREFORE, IT IS AGREED AS FOLLOWS:

AGREEMENT

1. **Recitals.** The foregoing recitals are true and correct and are incorporated herein by this reference.
2. **Term.** This MOU shall become effective upon the later of the date that is the later of approval by the Board of SFMTA or approval by the Commission (such date, the "Effective Date"). This MOU shall continue from the Effective Date until terminated in writing by both Parties.
3. **Termination of 2004 MOU.** Effective as of the Effective Date, the terms and conditions of the 2004 MOU shall be of no further force and effect.
4. **SFMTA Work; Right of Entry.**
 - a. **SFMTA Equipment Removal and Alarm Deactivation.** If the Department and Friends enter into the LDDA, SFMTA, at SFMTA's sole cost and expense, shall remove the high-tension electrical wire benefitting the Yard that is presently mounted to eastern wall of the Building, together with all associated installations and equipment thereto on the Property (collectively, the "SFMTA Electrical Equipment"), and shall deactivate those portions of SFMTA's alarm system located on the Property (the "SFMTA Alarm System"). SFMTA agrees

that in order to avoid interference with the work to be performed by the Department or Friends under the LDDA, SFMTA shall use good faith efforts to complete the removal and deactivation work (collectively, the "Removal and Deactivation Work") before December 31, 2014. SFMTA shall have no obligation to remove any components of the SFMTA Alarm System. If SFMTA elects to abandon such components in place, such abandoned components shall be automatically be deemed the property of the Department on SFMTA's completion of the Removal and Deactivation Work. SFMTA warrants that no third party has any lien on or interest in or to the SFMTA Alarm System.

b. Access; Performance of Work; Repairs. The Department hereby grants to SFMTA and its employees, agents, consultants, contractors and authorized representatives (collectively, "Agents") the right to enter upon and use the Property as reasonably necessary for the Removal and Deactivation Work. SFMTA shall cause the Removal and Deactivation Work to be performed (i) by City staff or duly licensed and bonded contractors or mechanics approved by the Department, (ii) in a good and professional manner that avoids excessive and unnecessary damage or harm to the Building or the Property, and (iii) in strict compliance with all laws, regulations and requirements of Federal, state, county and municipal authorities, now in force or which may hereafter be in force, and all laws relating to hazardous materials, which impose any duty upon SFMTA with respect to the Removal and Deactivation Work. SFMTA shall be responsible, at its sole cost and expense, for obtaining all applicable approvals ("Approvals") of any regulatory agencies required for the performance of the Removal and Deactivation Work by or for SFMTA. The Department shall cooperate in good faith with SFMTA to submit any necessary consents or other documents reasonably required to enable SFMTA or SFMTA's Agents to apply for and obtain such Approvals; provided, however, that SFMTA shall obtain the Department's written consent, which shall not be unreasonably withheld, delayed or conditioned, to any Approvals that would place any restriction or obligations that encumber the Property and survive the completion of the Removal and Deactivation Work. If any portion of the Building or the Property is damaged by the performance of the Removal and Deactivation Work, SFMTA shall repair such damage (except to the extent Department staff reasonably determines that such repair is not required due to the nature and scope of the work on the Project to be performed pursuant to the LDDA).

c. Third Party Insurance and Indemnity. SFMTA shall require each contractor and subcontractor performing any Removal and Deactivation Work on the Property to obtain and maintain insurance as is recommended by the City Risk Manager and reasonably approved by the Department. If necessary to protect the interests of the Department, the Department shall be included as an additional insured in any such insurance. SFMTA shall include the Department as an indemnified party in any indemnification provision between SFMTA and any Agent it hires in connection with the Removal and Deactivation Work, to the extent the indemnification in such contract is not broad enough to cover the Department as a department of the City and County of San Francisco.

d. Schedule; Cooperation. At least thirty (30) days prior to the date SFMTA proposes for the commencement of any Removal and Deactivation Work on the Property, SFMTA shall notify the day-to-day contact person for the Department identified below of the date SFMTA proposes such work shall commence and the intended schedule. SFMTA shall obtain the Department's prior written approval of such schedule, which approval shall not be

unreasonably withheld or delayed. If the Removal and Deactivation Work is not complete before the Department or Friends commences work on the Project, SFMTA and the Department will each cause their respective Agents to coordinate with the Agents of the other Party to accommodate, to the extent reasonably practicable, the other Party's work, and each Party shall take reasonable precautionary measures to protect the other's work from damage due to such own Party's work.

5. **Long-Term License.** That portion of the Yard shown outlined on the attached Exhibit B is referred to herein as the "Yard License Area." SFMTA acknowledges and agrees that the Department and its tenants, subtenants, and Agents will require access to the Yard License Area from time to time during the life of the Building for purposes of ingress and egress to the freight elevator, loading dock and trash receptacles to be located on the Geneva Avenue side of the Building and the loading dock to be located adjacent to the Powerhouse portion of the Building, as well as reasonably necessary for Building repairs, maintenance and operations and any future construction projects. The use of the Yard License Area for such purposes shall be governed by the provisions of the Long-Term License, which shall be substantially the form attached hereto as Exhibit C and will be executed by SFMTA if Friends and the Department enter into the LDDA and SFMTA receives a written request for its execution of the Long-Term License from the Department. The Commission acknowledges and agrees that the Yard is a working rail yard that the SFMTA, its Agents, and its invitees will need to use the Yard License Area at all times for ingress and egress to the remainder of the Yard. Among other restrictions set forth in the Long-Term License, the use of the Yard License Area by the Department and its Agents pursuant to this MOU must not interfere with such access to the Yard, including, but not limited to, the access of SFMTA's railcars or other transportation vehicles. The Commission further acknowledges that the Yard and associated maintenance and operating facilities are in the SFMTA's Real Estate and Facilities Vision for the 21st Century Report, which will require significant capital improvements to upgrade the Yard and facilities to accommodate an expanding fleet. The proposed Long-Term License shall not affect any future SFMTA capital projects requiring the demolition, relocation, rebuilding and or redevelopment of the Yard, including the eventual expansion and reconfiguration of storage tracks to accommodate future growth.

6. **Temporary Construction License.**

a. **Use of Yard Construction Area During Construction of Project; Future Construction Access and Staging License.** The Department anticipates that the Department or its Agents (which term shall include Friends and the contractors, subcontractors and agents of Friends) will require a right to enter upon and use portions of the Yard as reasonably necessary for access to the Building during the performance of the Project contemplated by the LDDA and for construction staging in connection with the Project. SFMTA acknowledges that it is anticipated that construction of the Project will take approximately two (2) years, and that access to the Building through the Yard and use of portions of the Yard for construction staging will be required from time to time throughout the construction period. If construction of the Project takes longer than two (2) years, SFMTA agrees to reasonably extend the term of the Temporary Construction License until the earlier to occur of the substantial completion of construction of the Project and the three (3) year anniversary of the date this MOU is fully executed. If Friends and the Department enter into the LDDA, SFMTA agrees that SFMTA will enter into the

Temporary Construction License with Friends or other Agents of Friends or the Department, which shall be in substantially the form attached as Exhibit D, at the time that Friends is ready to commence construction of the Project, provided that SFMTA approves the proposed uses, location, construction staging plan, and construction schedule proposed for the execution version of the Temporary Construction License, which approval shall not be unreasonably withheld. The Department and Friends acknowledge and agree that the location of such construction access and staging area shall remain within the portion of the Yard depicted as the "Outer Construction Staging Area" on the attached Exhibit B. The final dimensions of the construction access and staging area within the Outer Construction Staging Area (the "Yard Construction Area") shall be attached as Exhibit ___ to the Temporary Construction License. The Department and Friends further acknowledge and agree that it shall be reasonable for SFMTA to withhold its approval to any proposed use, location, plan, or schedule that would, in SFMTA's sole determination, interfere with access over, or the use of, the Yard (other than the Outer Construction Staging Area) by SFMTA or its employees, contractors, or agents or poses a health or safety risk.

b. Request for License and Required Information. At least thirty (30) days prior to the date the Department proposes for the commencement of use of the Yard for construction access and staging pursuant to the Temporary Construction License, the Department shall provide the day-to-day contact person for SFMTA identified below with the intended work plan and schedule for use of the Yard for the Project, including access, parking and staging, and shall request that SFMTA enter into a license with Friends or its Agents for the requested use. The Department shall obtain SFMTA's prior written approval of such schedule, which approval shall not be unreasonably withheld or delayed. The request for the construction access and staging license and day-to-day communications to SFMTA regarding use of the Yard under this Paragraph 6 should be directed to the SFMTA person designated in Section ___ of the Temporary Construction License, or to such other person as SFMTA may designate from time to time by written notice to the Department. The Department acknowledges that it shall be reasonable for SFMTA to withhold its approval to any proposed schedule that would, in SFMTA's sole determination, interfere with access over, or the use of, the Yard (other than the Outer Construction Staging Area) by SFMTA or its employees, contractors, or agents or pose a health or safety risk.

c. Contract Requirements. The Commission agrees that the Department shall require each of its Agents using the Yard Construction Area to obtain and maintain insurance as is recommended by the City Risk Manager and approved by SFMTA. If necessary to protect the interests of SFMTA, SFMTA shall be included as an additional insured in any such insurance. Further, the Commission agrees that the Department shall include SFMTA as an indemnified party in any indemnification provision between the Department and Friends regarding the Project, and between the Department or Friends and any agent, contractor or subcontractor either of them hires in connection with its use of the Yard Construction Area and the Yard License Area, to the extent the indemnification in such contract is not broad enough to cover SFMTA as a department of the City and County of San Francisco. The Department shall require its Agents to use due care at all times to avoid any damage or harm to the Yard and SFMTA's property. The Department shall cause the construction contractors on the Project to coordinate with SFMTA staff prior to commencement of construction and installation activities and to provide SFMTA

staff the ongoing opportunity to monitor construction activities within the Yard Construction Area.

7. **Limitations on Use.** SFMTA shall not use, or permit its Agents to use, the Property, or any part thereof, for any purposes or in any manner other than the purposes and manner set forth in Paragraph 4 of this MOU. The Friends or Department shall not use or permit the Yard, or any part thereof, to be used for any purposes or in any manner other than the purposes and manner set forth in Paragraphs 5 and 6 of this MOU.

8. **Indemnification.** It is the understanding of the Parties that each Party is responsible for all costs associated with all claims, damages, liabilities or losses which arise as a result of such Party's uses permitted hereunder.

9. **Notices.** All notices, demand, consents or approvals which are or may be required to be given by either Party to the other under this MOU shall be in writing and shall be deemed to have been fully given when delivered in person to such representatives of the Department and the SFMTA as shall from time to time be designated by the Parties for the receipt of notices, or when deposited in the United States mail, postage prepaid, and addressed,

if to SFMTA to:

Municipal Transportation Agency
1 South Van Ness Avenue, 8th Floor
San Francisco, CA 94103
Attn: Senior Manager, Real Estate

and if to the Department to:

Recreation and Park Department
Philip Ginsburg, General Manager
McLaren Lodge
San Francisco, CA 94117

or such other address with respect to either Party as that Party may from time to time designate by notice to the other given pursuant to the provisions of this Paragraph.

10. **Cooperation.** Subject to the terms and conditions of this MOU, the Parties agree to use reasonable efforts to do, or cause to be done, all things reasonably necessary or advisable to carry out the purposes of this MOU as expeditiously as practicable, including, without limitation, performance of further acts and the execution and delivery of any additional documents in form and content reasonably satisfactory to both Parties.

IN WITNESS WHEREOF, the Parties have caused this MOU to be executed as of the date first written above.

<p>SAN FRANCISCO RECREATION AND PARK COMMISSION</p> <p>By: _____ PHILIP GINSBURG General Manager</p> <p>Date: _____</p>	<p>SAN FRANCISCO MUNICIPAL TRANSPORTATION AGENCY</p> <p>By: _____ Edward D. Reiskin Director of Transportation</p> <p>Date: _____</p>
<p>APPROVED BY:</p> <p>RECREATION AND PARK COMMISSION PURSUANT TO RESOLUTION NO. _____ DATED: _____</p> <p>_____ Margaret McArthur, Commission Liaison</p>	<p>APPROVED BY:</p> <p>San Francisco Municipal Transportation Agency Board of Directors Resolution No: _____ Adopted: _____ Attest: _____</p> <p>_____ Secretary, SFMTA Board of Directors</p>

EXHIBIT A
 Depiction of the Property

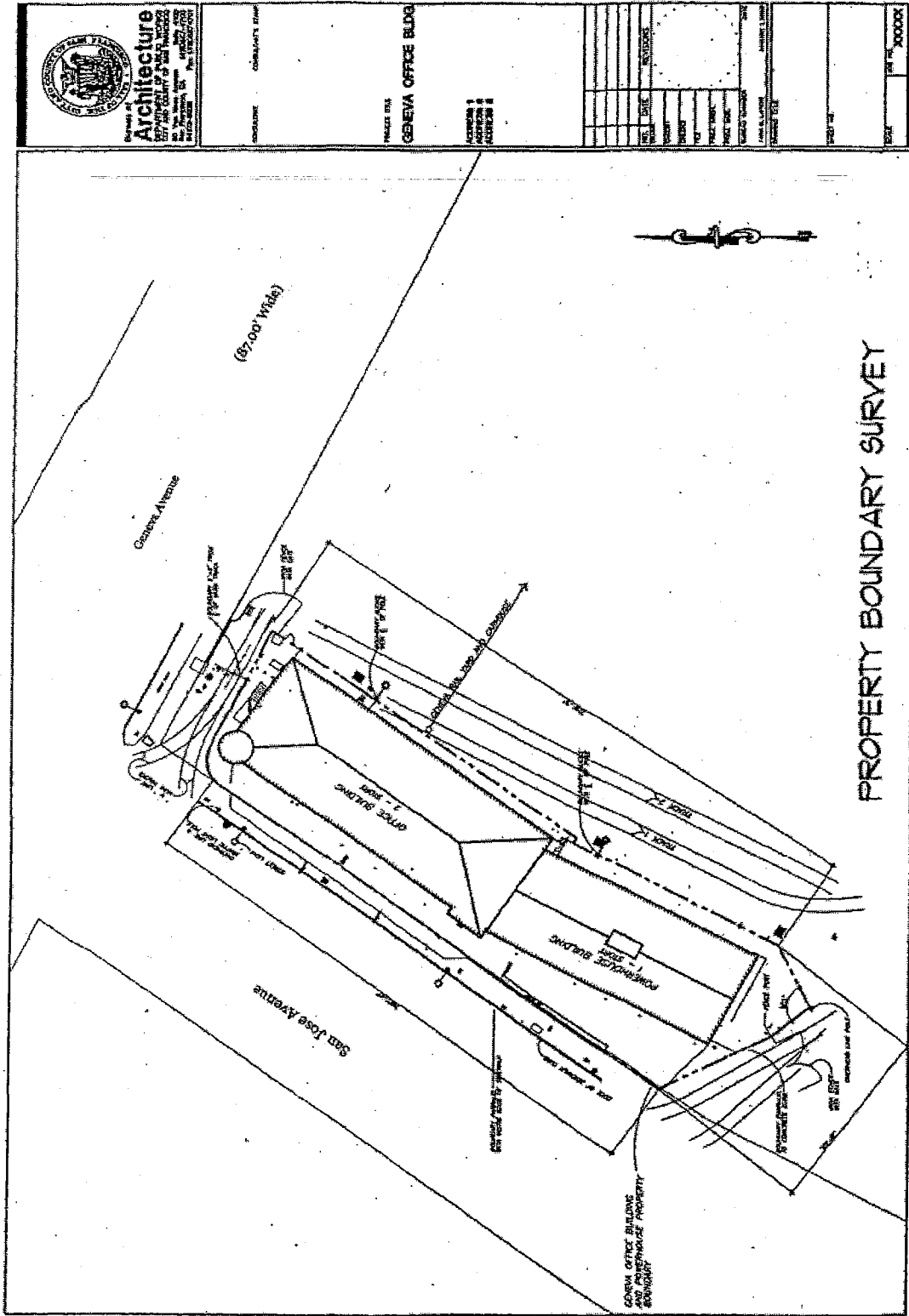
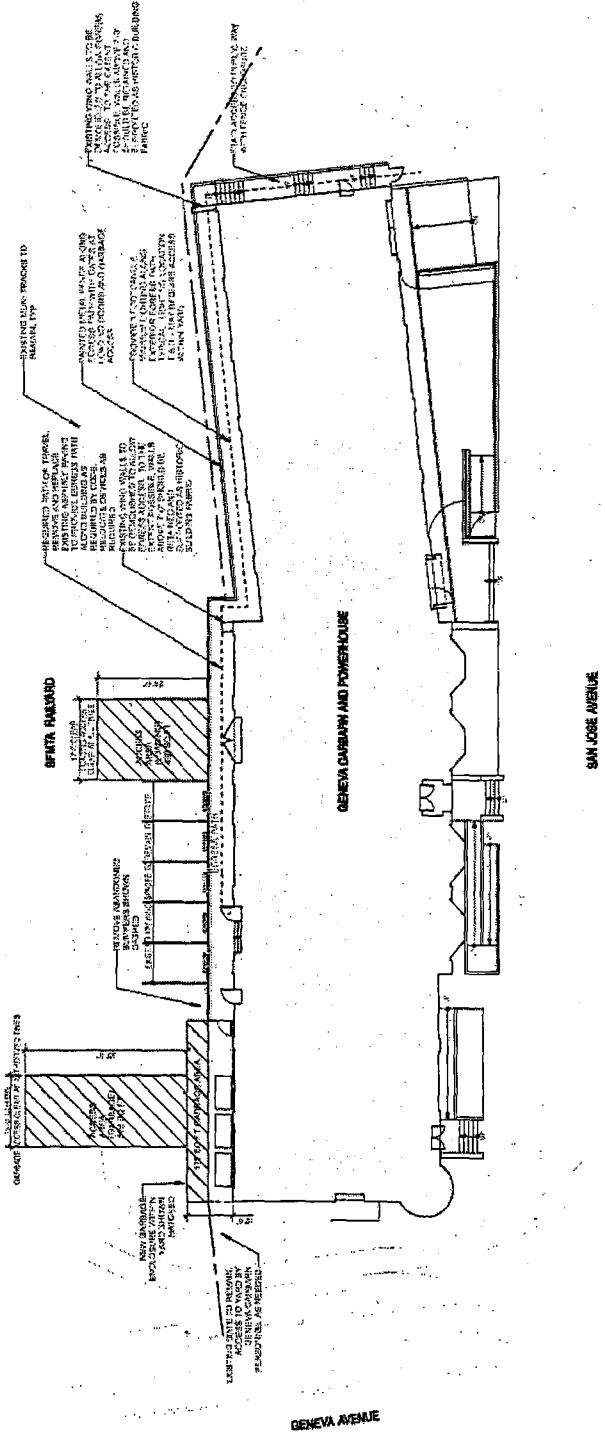

EXHIBIT B
 Depiction of Yard License Area



1

SITE PLAN DRAWING FOR RAILROAD ACCESS AND USE

EXHIBIT C
Form of Long-Term License

ACCESS LICENSE AGREEMENT

THIS ACCESS LICENSE AGREEMENT (this "**Agreement**"), dated for reference purposes only as of _____, 201__, is made by and between the CITY AND COUNTY OF SAN FRANCISCO, a municipal corporation ("**City**"), acting by and through the San Francisco Municipal Transportation Agency ("**SFMTA**"), and FRIENDS OF THE GENEVA OFFICE BUILDING AND POWERHOUSE, a California non-profit corporation ("**Licensee**").

RECITALS

A. City owns certain real property located at the intersection of San Jose Avenue and Geneva Avenue in the City and County of San Francisco, as further described in the attached Exhibit A (the "**City Property**"), with the buildings on the City Property known as the "Geneva Car Barn" and the "Geneva Powerhouse" (together, the "**Buildings**") under the jurisdiction of City's Recreation and Park Commission and the remainder of the City Property (the "**Yard**") under the jurisdiction of SFMTA.

B. Licensee and City, acting by and through its Recreation and Park Department ("**RPD**"), are parties to a Lease Disposition and Development Agreement dated as of _____, 2014 ("**LDDA**"), which provided for Licensee's rehabilitation and improvement of the Buildings (the "**Project**"), and are parties to a lease for the Buildings dated as of _____, 2014 ("**Ground Lease**").

C. Licensee has completed the rehabilitation and improvement work described in Section ___ of the LDDA and wishes to acquire a long term license to use the portion of the Yard depicted as the "Access Area" on the attached Exhibit A (the "**Access Area**") for the Access Activities (as defined in Section 3.1) during the term of the Ground Lease.

D. City, acting by and through SFMTA, consents to such access on the terms and conditions of this Agreement.

City and Licensee agree as follows:

AGREEMENT

1. License; Access Area. The "**Effective Date**" shall be the date that the following requirements are met: (a) this Agreement, the LDDA, and the Ground Lease have been fully executed, (b) the Project has been substantially completed and a temporary certificate of occupancy has been issued for the Buildings by City acting in its regulatory capacity, and (c) Licensee shall have delivered to City the insurance certificates described in Section 10. As of the Effective Date, City confers to Licensee a revocable, personal, unassignable, non-exclusive and non-possessionary privilege for Licensee and its affiliates and their respective officers, agents, employees, contractors, subcontractors (collectively, the "**Licensee Agents**") to enter upon and use the Access Area for the Permitted Activities (as defined in Section 3.1).

This Agreement gives Licensee a license only and, notwithstanding anything to the contrary herein, this Agreement does not constitute a grant by City of any ownership, leasehold, easement or other property interest or estate whatsoever in the Access Area, or any portion thereof. The privilege given to Licensee under this Agreement is effective only

insofar as the rights of City in the Access Area are concerned, and Licensee shall obtain any further permission necessary because of any other existing rights affecting the Access Area.

2. Term. The privilege given to Licensee pursuant to this Agreement is temporary only and shall be in effect during the period of time ("**Term**") that commences on the Effective Date and expires on the earlier date (the "**Termination Date**") to occur of the expiration of the Ground Lease and any earlier termination of this Agreement pursuant to the terms hereof.

3. Uses.

3.1 Permitted Activities. Licensee and the Licensee Agents may use the Access Area to perform the following activities (collectively, the "**Permitted Activities**"): (a) to perform Licensee's obligations under this Agreement (the "**Performance Activities**"), and (b) for purposes of ingress and egress to the freight elevator and loading dock located on, and the trash receptacles located along, the eastern wall of the Building and the loading dock located adjacent to the Powerhouse portion of the Building, as well as reasonably necessary for repairs and maintenance of such freight elevator and loading docks.

3.2 Restrictions on Permitted Activities. Without limiting any of its rights hereunder, if City determines that any of the Permitted Activities poses a material risk to public health or safety or that City needs to use any portion of the Access Area for emergency purposes, and such emergency use requires changes to the Permitted Activities, City shall deliver written notice of such determination to Licensee (the "**Revision Notice**"). This Agreement shall be automatically amended to incorporate the changed Permitted Activities or changed Access Area described in the Revision Notice within five (5) business days of Licensee's receipt of the Revision Notice.

Notwithstanding anything to the contrary in the foregoing paragraph, if City determines that any of the Permitted Activities poses an immediate risk to public health or safety or that City needs to immediately use all or any portion of the Access Area for emergency purposes (an "**Emergency Situation**"), City shall have the right to temporarily restrict such Permitted Activities or use the Access Area without first delivering a Revision Notice to Licensee. If reasonably possible, City shall give Licensee verbal notification of an Emergency Situation before restricting any of the Permitted Activities or commencing its use of the Access Area. City shall deliver written notice of such action to Licensee as soon as reasonably possible. If City needs to continue its restriction on any of the Permitted Activities or its use of the Access Area in response to an Emergency Situation for more than five (5) consecutive business days and City determines it will need to continue such activities, City shall deliver a Revision Notice describing the restriction for Permitted Activities or the City's use of the Access Area, as applicable, prior to the end of such fifth (5th) business day.

City shall have no obligation to pay any consideration to Licensee if City needs to restrict, in accordance with this Section, any of the Permitted Activities or to use the Access Area for emergency purposes or to protect public health or safety (including any Emergency Situation). Licensee acknowledges and agrees that neither Licensee's efforts to comply with the conditions of this Agreement (including any related costs incurred by Licensee) nor the commencement of the Permitted Activities shall in any way whatsoever limit City's right to restrict the Permitted Activities pursuant to this Section or as expressly set forth in this Agreement.

4. Performance of Work. Licensee shall conduct, and shall cause the Licensee Agents, to conduct the Permitted Activities in compliance with the terms of this Agreement, including the following conditions, which are for the sole benefit of City:

4.1 Permits and Approvals. Licensee shall obtain all permits, licenses and approvals (collectively, "**Approvals**") required of any regulatory agencies to perform the Permitted Activities. Licensee shall deliver copies of all Approvals to City on request. Licensee recognizes and agrees that no approval by City of any of the Permitted Activities pursuant to this Agreement shall be deemed to constitute the Approval required of any federal, state or local regulatory authority with jurisdiction, including any required of City acting in its regulatory capacity, and nothing herein shall limit Licensee's obligation to obtain all such Approvals at Licensee's sole cost.

4.2 Exercise of Due Care. Licensee shall use and cause the Licensee Agents to use due care at all times to avoid any damage or harm to City's property and to native vegetation and natural attributes of the Access Area (other than as reasonably necessary to perform any of the Permitted Activities). Licensee shall do everything reasonably within its power, both independently and upon request by City, to prevent and suppress fires and the release of Hazardous Materials (as defined in Section 9.1) on and adjacent to the Access Area attributable to the use of the Access Area by Licensee or the Licensee Agents pursuant to this Agreement.

4.3 Cooperation with City Personnel. Licensee and the Licensee Agents shall work closely with City personnel to avoid any disruption of City property in, under, on or about the Access Area, vehicular and pedestrian ingress and egress over the Access Area by City or any City employees, contractors, subcontractors, representatives, agents, or invitees, City's use of the remainder of the Yard, and the maintenance, operation, repair, replacement of City's utilities and improvements on the Yard.

4.4 Maintenance of Access Area; Repair of Damage. Licensee shall remove all debris and any excess dirt or debris in the Access Area caused by any of the Permitted Activities or the use of the Access Area by Licensee or any of the Licensee Agents. If any portion of the Access Area or any City property located on or about Yard is damaged at any time by any of the activities conducted by Licensee or any of the Licensee Agents hereunder, Licensee shall immediately, at its sole cost, repair any and all such damage and restore the Access Area or property to its previous condition. Licensee shall, at all times and at its sole cost, maintain the Access Area in a good, clean, safe, secure, sanitary and sightly condition so far as the Access Area may be affected by the Permitted Activities or any other actions in the Access Area by Licensee or the Licensee Agents.

4.5 Excavation Activities. Licensee shall prevent all materials (including soil) displaced by or resulting from the Performance Activities or the use of the Access Area by Licensee or any of the Licensee Agents from entering storm drains, sewers, or water ways and shall immediately notify the City, and all appropriate regulatory agencies required under applicable laws, if there is any accidental release of such materials.

4.6 Contractor Acknowledgement of Agreement. Licensee shall deliver a complete copy of this Agreement to all Licensee Agents performing any of the Performance Activities or otherwise entering the Access Area pursuant to this Agreement for any of the Performance Activities. Prior to the entry on the Access Area by any such party, Licensee shall deliver a notice to City signed by such party acknowledging its receipt of a copy of this Agreement and its agreement to be comply with and be bound by all of the provisions of this Agreement pertaining to its entry on the Access Area.

4.7 Wages and Working Conditions. With respect to the installation of any facilities or improvements or the performance of any work that is a "public work" under the State of California Labor Code, any employee performing services for Licensee or any Licensee Agent shall be paid not less than the highest prevailing rate of wages and that Licensee shall include, in any contract for construction of such improvement work or any alterations on the Access Area, a requirement that all persons performing labor under such

contract shall be paid not less than the highest prevailing rate of wages for the labor so performed. Licensee further agrees that, as to the construction of such improvement work or any alterations on the Access Area under this Agreement, Licensee shall comply, and cause all Licensee Agents to comply, with the provisions of Section 6.22(E) of the San Francisco Administrative Code (as the same may be amended, supplemented or replaced) that relate to payment of prevailing wages. Licensee shall require all Licensee Agents to provide, and shall deliver to City upon request, certified payroll reports with respect to all persons performing labor in the construction of the improvement work or any alterations on the Access Area for Licensee or any Licensee Agent.

5. Restrictions on Use; City's Uses. Licensee agrees that, by way of example only and without limitation, the following uses of the Access Area by Licensee or any other party claiming by or through Licensee are inconsistent with the limited purpose of this Agreement and are strictly prohibited as provided below:

5.1 Improvements. Licensee shall not construct or place any temporary or permanent structures or improvements or personal property on the Access Area, nor shall Licensee alter any existing structures or improvements on the Access Area, without the prior written consent of City. Licensee understands and agrees that City is entering into this Agreement in its capacity as a landowner with a proprietary interest in City's Property and not as a regulatory agency with certain police powers. Licensee understands and agrees that neither the City's execution of this Agreement nor any approvals by City of any work plan or otherwise given by City under this Agreement shall grant, or be deemed to imply, that Licensee will be able obtain, any required Approvals from departments, boards or commissions of the City and County of San Francisco that have jurisdiction over any of the Permitted Activities.

5.2 Dumping; Storing; Signs. Licensee shall not dump or dispose of refuse or other unsightly materials or store any materials on, in, under or about the Access Area.

5.3 Transit Operations. Licensee acknowledges that the Yard is used for railcar operations, the maintenance and storage of railcars and other transit vehicles, and employee parking, all of which includes temporary, but continuous, ingress and egress activities over the Access Area to and from San Jose Avenue (the "**SFMTA Access Activities**"). Licensee shall not use, nor permit any of the Licensee Agents to use, the Access Area in a manner that materially interferes with, or causes a safety risk for, the SFMTA Access Activities or other City activities on the remainder of the Yard without written prior approval for each proposed activity that would pose such an interference or safety risk or unless such activity is expressly permitted pursuant to, and performed in compliance with the terms of, this Agreement.

5.4 Nuisances; No Interference with City's Uses. Licensee shall not conduct any activities on or about the Access Area that constitute waste, nuisance or unreasonable annoyance (including, without limitation, emission of objectionable odors, noises or lights) to City, to the owners or occupants of neighboring property or to the public; provided, however, that City shall not, in its proprietary capacity as landowner under this Agreement, deem Licensee's performance of any of the Permitted Activities in compliance with the terms and conditions of this Agreement to be a nuisance or unreasonable annoyance. Licensee shall not materially interfere with or obstruct the SFMTA Access Activities, City's use of the Access Area, its conduct of normal business operations thereon, or the rights of any party with rights to occupy or use the Access Area.

5.5 Utilities. City has no responsibility or liability of any kind or character with respect to any utilities that may be on, in or under the Access Area. Licensee has the sole responsibility to locate such utilities and protect them from damage, and Licensee has sole responsibility for any damage to utilities or damages resulting from Licensee's activities at

the Access Area. Licensee shall arrange and pay for any necessary temporary relocation of City and public utility company facilities reasonably necessary to facilitate any of the Permitted Activities, subject to the prior written approval by City and any such utility companies of any such relocation. Licensee shall be solely responsible for arranging and paying directly for any utilities or services necessary for its activities hereunder.

5.6 Damage. Licensee shall not do anything about the Access Area that will cause damage to any of City's property (including, but not limited to, the existing rail lines, railcars, transit and support vehicles and facilities, utilities, and light poles, employee parking areas, or any other improvements) or the property of any other party with rights to occupy or use the Access Area. City's approval of any work plan pursuant to this Agreement or of the proposed Permitted Activities shall not be deemed to constitute the waiver of any rights City may have under Applicable Laws for any damage to the City's real or personal property or the Yard resulting from the Permitted Activities.

6. Fees. Licensee shall pay to City a one-time non-refundable \$5,000 permit fee to cover City's processing, inspection and other administrative costs for this Agreement. Such fee is payable at such time as Licensee signs and delivers this Agreement to City, and shall be paid in cash or by good check payable to the City and County of San Francisco.

7. Surrender; Remaining Improvements. Upon the expiration of this Agreement or within five (5) days after any sooner revocation or other termination of this Agreement, Licensee shall surrender the Access Area in a broom clean, free from hazards, clear of all debris and restore the Access Area substantially to its condition immediately prior to the Effective Date, to the reasonable satisfaction of City; provided, however, that Licensee shall have no obligation to repair or restore any deficient condition at the Access Area that was disclosed, but not caused, by any of the Permitted Activities. At such time, Licensee shall remove all of its property from the Access Area and any signs permitted hereunder, and shall repair, at its cost, any damage to the Access Area caused by such removal. Licensee's obligations under this Section shall survive any termination of this Agreement.

Any equipment or any other property of Licensee remaining in the Access Area after completion of activities may be deemed abandoned by City in its sole discretion and City may store, remove, and dispose of such equipment or property at Licensee's sole cost and expense unless City has otherwise granted written permission to Licensee for such remaining equipment or property. Licensee waives all claims for any costs or damages resulting from City's retention, removal, and disposition of such property.

8. Compliance with Laws. Licensee shall, at its expense, conduct and cause to be conducted all Permitted Activities in a safe and prudent manner and in compliance with all laws, regulations, codes, ordinances and orders of any governmental or other regulatory entity (including, without limitation, the Americans with Disabilities Act and any other disability access laws), whether presently in effect or subsequently adopted and whether or not in the contemplation of the parties. Licensee shall, at its sole expense, maintain all Approvals in force at all times during its use of the Access Area. Licensee understands and agrees that City is entering into this Agreement in its capacity as a property owner with a proprietary interest in the Access Area and not as a regulatory agency with police powers. Nothing herein shall limit in any way Licensee's obligation to obtain any required Approvals from City departments, boards or commissions or other governmental regulatory authorities or limit in any way City's exercise of its police powers.

9. Hazardous Materials.

9.1 Definitions. For purposes of this Agreement, the following terms have the following meanings:

(a) **"Environmental Laws"** means any federal, state or local laws, ordinances, regulations or policies judicial and administrative directives, orders and decrees dealing with or relating to Hazardous Materials (including, without limitation, their use, handling, transportation, production, disposal, discharge, storage or reporting requirements) or to health and safety, industrial hygiene or environmental conditions in, on, under or about the Access Area or property, including, without limitation, soil, air, bay water and groundwater conditions or community right-to-know requirements, related to the work being performed under this Agreement.

(b) **"Handle"** or **"handling"** means to use, generate, process, produce, package, treat, store, emit, discharge or dispose.

(c) **"Hazardous Material"** means any substance or material which has been determined by any state, federal, or local government authority to be a hazardous or toxic substance or material, including without limitation, any hazardous substance as defined in Section 101(14) of CERCLA (42 USC Section 9601(14)) or Sections 25281(f) or 25316 of the California Health and Safety Code, any hazardous material as defined in Section 25501(k) of the California Health and Safety Code, and any additional substances or materials which at such time are classified or considered to be hazardous or toxic under any federal, state or local law, regulation or other exercise of governmental authority.

(d) **"Investigation"** means activities undertaken to determine the nature and extent of Hazardous Materials which may be located on or under real property, or which have been, are being, or threaten to be released to the environment.

(e) **"Remediation"** shall mean activities undertaken to cleanup, remove, contain, treat, stabilize, monitor or otherwise control Hazardous Materials located on or under real property or which have been, are being or threaten to be released to the environment.

(f) **"Regulatory Agency"** means any federal, state or local governmental agency or political subdivision having jurisdiction over the Access Area and any of the Permitted Activities. The City shall be a "Regulatory Agency" to the extent that City is acting in its capacity as a regulatory authority, rather than in its proprietary capacity as a landowner.

(g) **"Release"** means any spilling, leaking, pumping, pouring, emitting, emptying, discharging, injecting, escaping, leaching, dumping, or disposing into the environment of any Hazardous Material (including the abandonment or discarding of barrels, containers, and other closed receptacles containing any Hazardous Material or pollutant or contaminant).

9.2 **Environmental Laws.** Licensee shall handle all Hazardous Materials introduced or disturbed on the Access Area during the Term in compliance with all Environmental Laws. Licensee shall not be responsible for the safe handling of Hazardous Materials to the extent released on the Access Area by City or any City employee, agent, contractor, subcontractor, or invitee, or existing on the Access Area prior to the Effective Date, except to the extent any of the Permitted Activities exacerbates such Hazardous Materials. Licensee shall protect its employees and the general public in accordance with all Environmental Laws. City may from time to time request, and Licensee shall be obligated to provide, information reasonably adequate for City to determine that any and all Hazardous Materials are being handled in a manner which complies with all Environmental Laws.

9.3 **Removal of Hazardous Materials.** Prior to termination of this Agreement, Licensee, at its sole cost and expense, shall remove any and all Hazardous Materials to the

extent introduced or released in, on, under or about the Access Area by Licensee or the Licensee Agents during the Term and shall Remediate or dispose of any Hazardous Materials produced as a result of the Permitted Activities. All costs of storage, shipping and disposal of extracted soils and groundwater shall be the sole responsibility of Licensee including, without limitation, the costs of preparation and execution of shipping papers, including but not limited to hazardous waste manifests. With respect to shipping papers and hazardous waste manifests, Licensee shall be the "generator" and in no case shall the City be named as the generator.

9.4 Notification. Licensee shall provide City with a copy of any permits issued for any Permitted Activity that involves the potential release or discharge of any Hazardous Materials in or from the Access Area, and the receipt of a hazardous waste generator identification number issued by the U.S. Environmental Protection Agency or the California Environmental Protection Agency to itself or any of the Licensee Agents. Licensee shall promptly notify City in writing of, and shall contemporaneously provide City with a copy of:

(a) Any release or discharge of any Hazardous Materials, whether or not the release is in quantities that would be required under applicable laws to be reported to a Regulatory Agency;

(b) Any written notice of release of Hazardous Materials in or on the Access Area that is provided by Licensee or any of the Licensee Agents to a Regulatory Agency including any City agency;

(c) Any notice of a violation, or a potential or alleged violation, of any Environmental Law that is received by Licensee or any of the Licensee Agents from any Regulatory Agency;

(d) Any inquiry, investigation, enforcement, cleanup, removal, or other action that is instituted or threatened by a Regulatory Agency against Licensee or any of the Licensee Agents and that relates to the release or discharge of Hazardous Material on or from the Access Area;

(e) Any claim that is instituted or threatened by any third party against Licensee or any of the Licensee Agents and that relates to any release or discharge of Hazardous Materials on or from the Access Area; and

(f) Any notice of the termination, expiration or substantial amendment of any environmental operating permit needed by Licensee or any of the Licensee Agents.

9.5 Hazardous Material Disclosures. California law requires landlords to disclose to tenants the presence or potential presence of certain Hazardous Materials. Although this Agreement grants Licensee a license only, Licensee is hereby advised that Hazardous Materials may be present on the Access Area, including, but not limited to vehicle fluids, janitorial products, tobacco smoke, and building materials containing chemicals, such as formaldehyde. By execution of this Agreement, Licensee acknowledges that the notice set forth in this Section satisfies the requirements of California Health and Safety Code Section 25359.7 and related statutes. Licensee also acknowledges its own obligations pursuant to California Health and Safety Code Section 25359.7 as well as the penalties that apply for failure to meet such obligations.

10. Insurance.

10.1 Insurance Policies. Licensee shall procure and keep in effect at all times during the Term, at Licensee's expense, and cause its contractors and subcontractors to maintain at all times insurance as follows during the Term:

(a) General Liability Insurance with limits not less than Two Million Dollars (\$2,000,000) each occurrence Combined Single Limit for Bodily Injury and Property Damage, including coverages for Contractual Liability, Personal Injury, Independent Contractors, Explosion, Collapse and Underground (XCU), Broadform Property Damage, Sudden and Accidental Pollution, Products Liability and Completed Operations;

(b) Automobile Liability Insurance with limits not less than One Million Dollars (\$1,000,000) each occurrence Combined Single Limit for Bodily Injury and Property Damage, including coverages for owned, non-owned and hired automobiles, as applicable, and sudden and accidental pollution; and

(c) Workers' Compensation Insurance with Employer's Liability Coverage with limits of not less than One Million Dollars (\$1,000,000) each accident.

10.2 Policy Requirements; Delivery of Certificates.

(a) All liability policies required hereunder shall provide for the following: (i) name as additional insureds the City and County of San Francisco, its officers, agents and employees; and (ii) specify that such policies are primary insurance to any other insurance available to the additional insureds, with respect to any claims arising out of this Agreement and that insurance applies separately to each insured against whom claim is made or suit is brought. Such policies shall also provide for severability of interests and that an act or omission of one of the named insureds which would void or otherwise reduce coverage shall not reduce or void the coverage as to any insured, and shall afford coverage for all claims based on acts, omissions, injury or damage which occurred or arose (or the onset of which occurred or arose) in whole or in part during the policy period. Sudden and accidental pollution coverage in the liability policies required hereunder shall be limited to losses resulting from Licensee's activities (and the activities of any Licensee Agents) under this Agreement (excluding non-negligent aggravation of existing conditions with respect to Hazardous Materials).

(b) All policies shall be endorsed to provide thirty (30) days' prior written notice of cancellation, non-renewal or reduction in coverage to City.

(c) Licensee shall deliver to City certificates of insurance and additional insured policy endorsements from insurers prior to the Effective Date and in a form satisfactory to City, evidencing the coverages required hereunder, together with complete copies of the policies at City's request. In the event Licensee shall fail to procure such insurance, or to deliver such certificates, City may procure, at its option, the same for the account of Licensee, and the cost thereof shall be paid to City within ten (10) days after delivery to Licensee of bills therefor.

(d) All policies shall include a waiver of subrogation endorsement or provision wherein the insurer acknowledges acceptance of Licensee's waiver of claims against City, provide for severability of interests and that an act or omission of one of the named insureds which would void or otherwise reduce coverage shall not reduce or void the coverage as to any other insured, and shall afford coverage for all claims based on acts, omissions, injury or damage which occurred or arose in whole or in part during the policy period.

(e) Should any of the required insurance be provided under a form of coverage that includes a general annual aggregate limit or provides that claims investigation or legal defense costs be included in such general annual aggregate limit, such general aggregate limit shall double the occurrence or claims limits specified above.

(f) Should any of the required insurance be provided under a claims made form, Licensee shall maintain such coverage continuously throughout the Term and, without lapse, for a period of three (3) years beyond the Termination Date, to the effect that, should any occurrences during the Term give rise to claims made after Termination Date, such claims shall be covered by such claims-made policies.

(f) Upon City's request, Licensee and City shall periodically review the limits and types of insurance carried pursuant to this Section. If the general commercial practice in the City and County of San Francisco is to carry liability insurance in an amount or coverage materially greater than the amount or coverage then being carried by Licensee for risks comparable to those associated with the Access Area, then City in its sole discretion may require Licensee to increase the amounts or coverage carried by Licensee hereunder to conform to such general commercial practice.

10.3 Waiver of Subrogation. Notwithstanding anything to the contrary contained herein, Licensee hereby waives any right of recovery against City for any loss or damage sustained by Licensee with respect to the Access Area or any portion thereof or the contents of the same or any operation therein, whether or not such loss is caused by the fault or negligence of City, to the extent such loss or damage is covered by insurance which is required to be purchased by Licensee under this Agreement or the Ground Lease or is actually covered by insurance obtained by Licensee. Licensee agrees to cause its insurers to issue appropriate waiver of subrogation rights endorsements to all policies relating to the Access Area; provided, the failure to obtain any such endorsement shall not affect the above waiver.

10.4 No Limitation on Licensee Obligations. Licensee's compliance with the provisions of this Section shall in no way relieve or decrease Licensee's indemnification obligations under this Agreement or any of Licensee's other obligations hereunder. Notwithstanding anything to the contrary in this Agreement, this Agreement shall terminate immediately, without notice to Licensee, upon the lapse of any required insurance coverage. Licensee shall be responsible, at its expense, for separately insuring Licensee's personal property.

11. Waiver of Claims; Waiver of Consequential and Incidental Damages.

(a) Neither City nor any of its commissions, departments, boards, officers, agents or employees shall be liable for any damage to the property of Licensee, the Licensee Agents, or their respective officers, agents, employees, contractors or subcontractors, or employees, or for any bodily injury or death to such persons, resulting or arising from the condition of the Access Area or its use by Licensee or the Licensee Agents, except to the extent that any such damage, injury or death is caused by the gross negligence or willful misconduct of City or any of its commissions, departments, boards, officers, agents, employees, or contractors (each, a "City Agent").

(b) Licensee acknowledges that the Access Area and the Permitted Activities can be modified by City pursuant to Section 3 and revoked by City pursuant to Section 2 and in view of such fact, Licensee expressly assumes the risk of making any expenditures in connection with this Agreement, even if such expenditures are substantial. Without limiting any indemnification obligations of Licensee or other waivers contained in this Agreement and as a material part of the consideration for this Agreement, Licensee fully RELEASES, WAIVES AND DISCHARGES forever any and all claims, demands, rights, and causes of action against, and covenants not to sue, City, its departments, commissions, officers, directors and employees, and all persons acting by, through or under each of them, under any present or future laws, statutes, or regulations (including, but not limited to, any claim for inverse condemnation or the payment of just compensation under the law of

eminent domain or otherwise at equity), in the event that City exercises its right to modify the Access Area or the Permitted Activities pursuant to Section 3.

(c) Licensee acknowledges that it will not be a displaced person at the time this Agreement is terminated or revoked or expires by its own terms, and Licensee fully RELEASES, WAIVES AND DISCHARGES forever any and all claims, demands, rights, and causes of action against, and covenants not to sue, City, its departments, commissions, officers, directors and employees, and all persons acting by, through or under each of them, under any present or future laws, statutes, or regulations for displaced persons, including, without limitation, any and all claims for relocation benefits or assistance from City under federal and state relocation assistance laws.

(d) Licensee expressly acknowledges and agrees that the fees payable hereunder do not take into account any potential liability of City for any consequential or incidental damages including, but not limited to, lost profits, arising out of disruption to Licensee's uses hereunder. City would not be willing to give this Agreement in the absence of a complete waiver of liability for consequential or incidental damages due to the acts or omissions of City or its Agents, and Licensee expressly assumes the risk with respect thereto. Accordingly, without limiting any indemnification obligations of Licensee or other waivers contained in this Agreement and as a material part of the consideration for this Agreement, Licensee fully RELEASES, WAIVES AND DISCHARGES forever any and all claims, demands, rights, and causes of action against for consequential and incidental damages (including without limitation, lost profits) and covenants not to sue for such damages, City, its departments, commissions, officers, directors and employees, and all persons acting by, through or under each of them, arising out of this Agreement or the uses authorized hereunder, including, without limitation, any interference with uses conducted by Licensee pursuant to this Agreement, regardless of the cause, and whether or not due to the negligence of City or its Agents, except for the gross negligence or willful misconduct of City or its Agents.

(e) In connection with the foregoing releases, Licensee acknowledges that it is familiar with Section 1542 of the California Civil Code, which reads:

"A general release does not extend to claims which the creditor does not know or suspect to exist in his or her favor at the time of executing the release, which if known by him or her must have materially affected his or her settlement with the debtor."

Licensee acknowledges that the releases contained herein includes all known and unknown, disclosed and undisclosed, and anticipated and unanticipated claims. Licensee realizes and acknowledges that it has agreed upon this Agreement in light of this realization and, being fully aware of this situation, it nevertheless intends to waive the benefit of Civil Code Section 1542, or any statute or other similar law now or later in effect. The releases contained herein shall survive any termination of this Agreement.

12. Defaults by Licensee. If Licensee fails to perform any of its monetary obligations under this Agreement and fails to cure such monetary failure within five (5) business days following City's written notice of such monetary failure to Licensee, then City may, at its sole option, immediately terminate this Agreement by providing Licensee with written notice of such termination. If Licensee fails to perform any of its non-monetary obligations under this Agreement, then City may, at its sole option, remedy such failure for Licensee's account and at Licensee's expense or terminate this Agreement by providing Licensee with thirty (30) days' prior written notice of City's intention to cure such default (except that no such prior notice shall be required in the event of an emergency as determined by City) or to terminate this Agreement. Such action by City shall not be construed as a waiver of any rights or remedies of City under this Agreement, and nothing herein shall imply any duty of

City to do any act that Licensee is obligated to perform. Licensee shall pay to City upon demand, all costs, damages, expenses or liabilities reasonably incurred by City, including, without limitation, reasonable attorneys' fees, in remedying or attempting to remedy such default. Licensee's obligations under this Section shall survive the termination of this Agreement.

13. No Costs to City; No Liens. Licensee shall bear all costs or expenses of any kind or nature in connection with its use of the Access Area and in complying with the conditions of this Agreement, and shall keep the Access Area free and clear of any liens or claims of lien arising out of or in any way connected with its use of the Access Area.

14. Indemnity. Except solely to the extent of Losses resulting directly from the willful misconduct or gross negligence of City or of any City Agent or from any material breach of this Agreement by City or any City Agent, Licensee shall indemnify, defend and hold harmless each of City and the City Agents each from and against any and all demands, claims, legal or administrative proceedings, losses, costs, penalties, fines, liens, judgments, damages and liabilities of any kind (collectively, "Losses"), arising in any manner out of (a) any injury to or death of any person or damage to or destruction of any property occurring in, on or about the Access Area, or any part thereof, whether the person or property of Licensee, any Licensee Agent, and any of their respective officers, agents, employees, contractors, subcontractors, or third persons, relating in any manner to any of the Permitted Activities, (b) any failure by Licensee to faithfully observe or perform any of the terms, covenants or conditions of this Agreement, including all applicable laws, or to cause the Licensee Agents, to comply with such terms, covenants or conditions, (c) the use of the Access Area or any activities conducted thereon by Licensee or any Licensee Agent, (d) any handling, release or threatened release, or discharge, or threatened discharge, of any Hazardous Material caused or allowed by Licensee or any Licensee Agent on, in, under or about the Access Area, any improvements permitted thereon, or into the environment; (e) any requirement of a Regulatory Agency for investigation or remediation of any release of Hazardous Materials at the Access Area in connection with use of the Access Area by Licensee or any Licensee Agent; and (f) any requirement of a Regulatory Agency for investigation or remediation of any Hazardous Materials arising out of or in connection with the activities of Licensee or any Licensee Agent at the Access Area, including, without limitation, requirements which would not have been imposed except for such party's use of the Access Area for an of the Permitted Activities. The foregoing indemnity shall not include any Losses incurred by City with respect to any Hazardous Materials at the Access Area discovered, but not released, by Licensee or any Licensee Agent. The indemnity in this Section shall include, without limitation, reasonable attorneys' and consultants' fees, investigation and remediation costs and all other reasonable costs and expenses incurred by the indemnified parties, including, without limitation, damages for decrease in the value of the Access Area and claims for damages or decreases in the value of adjoining property. Licensee specifically acknowledges and agrees that it has an immediate and independent obligation to defend City from any claim which actually or potentially falls within this indemnity provision even if such allegation is or may be groundless, fraudulent or false, which obligation arises at the time such claim is tendered to Licensee by City and continues at all times thereafter. Licensee's obligations under this Section shall survive the expiration or other termination of this Agreement.

15. "As Is" Condition of Access Area; Disclaimer of Representations. Licensee accepts the Access Area in its "AS IS" condition, without representation or warranty of any kind by City, its officers, agents or employees, including, without limitation, the suitability, safety, or duration of availability of the Access Area or any facilities on the Access Area for Licensee's use. Without limiting the foregoing, this Agreement is made subject to all applicable laws, rules and ordinances governing the use of the Access Area, and to any and all covenants, conditions, restrictions, easements, encumbrances, claims of title and other title matters affecting the Access Area, whether foreseen or unforeseen, and whether such

matters are of record or would be disclosed by an accurate inspection or survey. It is Licensee's sole obligation to conduct an independent investigation of the Access Area and all matters relating to its use of the Access Area hereunder, including, without limitation, the suitability of the Access Area for such uses. Licensee, at its own expense, shall obtain such permission or other approvals from any third parties with existing rights as may be necessary for Licensee to make use of the Access Area in the manner contemplated hereby. Under California Civil Code Section 1938, to the extent applicable to this Agreement, Licensee is hereby advised that the Access Area has not undergone inspection by a Certified Access Specialist ("CAsp") to determine whether it meets all applicable construction-related accessibility requirements.

16. Notices. Except as otherwise expressly provided herein, any notices given under this Agreement shall be effective only if in writing and given by delivering the notice in person, by sending it first class mail or certified mail, with a return receipt requested, or overnight courier, return receipt requested, with postage prepaid, addressed as follows:

If to City: SFMTA
City and County of San Francisco
1 South Van Ness Avenue, 8th Floor
San Francisco, CA 94103
Attn: Senior Manager, Real Estate

If to Licensee:

Notices herein shall be deemed given two (2) days after the date when it shall have been mailed if sent by first class, certified or overnight courier, or upon the date personal delivery is made.

17. No Joint Ventures or Partnership; No Authorization. This Agreement does not create a partnership or joint venture between City and Licensee as to any activity conducted by Licensee on, in or relating to the Access Area. Licensee is not a State actor with respect to any activity conducted by Licensee on, in, or under the Access Area. The giving of this Agreement by City does not constitute authorization or approval by City of any activity conducted by Licensee on, in or relating to the Access Area.

18. MacBride Principles - Northern Ireland. The City and County of San Francisco urges companies doing business in Northern Ireland to move toward resolving employment inequities and encourages them to abide by the MacBride Principles as expressed in San Francisco Administrative Code Section 12F.1 *et seq.* The City and County of San Francisco also urges San Francisco companies to do business with corporations that abide by the MacBride Principles. Licensee acknowledges that it has read and understands the above statement of the City and County of San Francisco concerning doing business in Northern Ireland.

19. Non-Discrimination.

19.1 Covenant Not to Discriminate. In the performance of this Agreement, Licensee agrees not to discriminate against any employee of, any City employee working with Licensee, or applicant for employment with Licensee, or against any person seeking accommodations, advantages, facilities, privileges, services, or membership in all business, social, or other establishments or organizations, on the basis of the fact or perception of a person's race, color, creed, religion, national origin, ancestry, age, height, weight, sex, sexual orientation, gender identity, domestic partner status, marital status, disability or Acquired

Immune Deficiency Syndrome or HIV status (AIDS/HIV status), or association with members of such protected classes, or in retaliation for opposition to discrimination against such classes.

19.2 Subcontracts. Licensee shall include in all subcontracts relating to the Access Area a non-discrimination clause applicable to such subcontractor in substantially the form of Section 19.1. In addition, Licensee shall incorporate by reference in all subcontracts the provisions of Sections 12B.2(a), 12B.2(c)-(k), and 12C.3 of the San Francisco Administrative Code and shall require all subcontractors to comply with such provisions. Licensee's failure to comply with the obligations in this Subsection shall constitute a material breach of this Agreement.

19.3 Non-Discrimination in Benefits. Licensee does not as of the date of this Agreement and will not during the Term, in any of its operations in San Francisco, on real property owned by City, or where the work is being performed for the City or elsewhere within the United States, discriminate in the provision of bereavement leave, family medical leave, health benefits, membership or membership discounts, moving expenses, pension and retirement benefits or travel benefits, as well as any benefits other than the benefits specified above, between employees with domestic partners and employees with spouses, and/or between the domestic partners and spouses of such employees, where the domestic partnership has been registered with a governmental entity pursuant to state or local law authorizing such registration, subject to the conditions set forth in Section 12B.2(b) of the San Francisco Administrative Code.

19.4 Condition to Agreement. As a condition to this Agreement, Licensee shall execute the "Chapter 12B Declaration: Nondiscrimination in Contracts and Benefits" form (Form HRC-12B-101) with supporting documentation and secure the approval of the form by the San Francisco Human Rights Commission (the "HRC"). Licensee hereby represents that prior to execution of this Agreement, (i) Licensee executed and submitted to the HRC Form HRC-12B-101 with supporting documentation, and (ii) the HRC approved such form.

19.5 Incorporation of Administrative Code Provisions by Reference. The provisions of Chapters 12B and 12C of the San Francisco Administrative Code relating to non-discrimination by parties contracting for the use of City property are incorporated in this Section by reference and made a part of this Agreement as though fully set forth herein. Licensee shall comply fully with and be bound by all of the provisions that apply to this Agreement under such Chapters of the Administrative Code, including but not limited to the remedies provided in such Chapters. Without limiting the foregoing, Licensee understands that pursuant to Section 12B.2(h) of the San Francisco Administrative Code, a penalty of Fifty Dollars (\$50) for each person for each calendar day during which such person was discriminated against in violation of the provisions of this Agreement may be assessed against Licensee and/or deducted from any payments due Licensee.

20. Notification of Limitations on Contributions. Through its execution of this Agreement, Licensee acknowledges that it is familiar with Section 1.126 of the San Francisco Campaign and Governmental Conduct Code, which prohibits any person who contracts with the City for the selling or leasing of any land or building to or from the City whenever such transaction would require the approval by a City elective officer, the board on which that City elective officer serves, or a board on which an appointee of that individual serves, from making any campaign contribution to (1) the City elective officer, (2) a candidate for the office held by such individual, or (3) a committee controlled by such individual or candidate, at any time from the commencement of negotiations for the contract until the later of either the termination of negotiations for such contract or six months after the date the contract is approved. Licensee acknowledges that the foregoing restriction applies only if the contract or a combination or series of contracts approved by the same individual or board in a fiscal year have a total anticipated or actual value of

\$50,000 or more. Licensee further acknowledges that the prohibition on contributions applies to each Licensee; each member of Licensee's board of directors, and Licensee's chief executive officer, chief financial officer and chief operating officer; any person with an ownership interest of more than twenty percent (20%) in Licensee; any subcontractor listed in the contract; and any committee that is sponsored or controlled by Licensee. Additionally, Licensee acknowledges that Licensee must inform each of the persons described in the preceding sentence of the prohibitions contained in Section 1.126. Licensee further agrees to provide to City the names of each person, entity or committee described above.

21. Pesticide Prohibition. Licensee shall comply with the provisions of Section 308 of Chapter 3 of the San Francisco Environment Code (the "**Pesticide Ordinance**") which (i) prohibit the use of certain pesticides on City property, (ii) require the posting of certain notices and the maintenance of certain records regarding pesticide usage and (iii) require Licensee to submit to SFMTA an integrated pest management ("**IPM**") plan that (a) lists, to the extent reasonably possible, the types and estimated quantities of pesticides that Licensee may need to apply to the Access Area during the Term, (b) describes the steps Licensee will take to meet the City's IPM Policy described in Section 300 of the Pesticide Ordinance and (c) identifies, by name, title, address and telephone number, an individual to act as the Licensee's primary IPM contact person with the City. In addition, Licensee shall comply with the requirements of Sections 303(a) and 303(b) of the Pesticide Ordinance.

22. Conflicts of Interest. Through its execution of this Agreement, Licensee acknowledges that it is familiar with the provisions of Section 15.103 of the San Francisco Charter, Article III, Chapter 2 of City's Campaign and Governmental Conduct Code, and Sections 87100 *et seq.* and Sections 1090 *et seq.* of the Government Code of the State of California, and certifies that it does not know of any facts which would constitute a violation of said provision, and agrees that if Licensee becomes aware of any such fact during the Term, Licensee shall immediately notify the City.

23. No Assignment. This Agreement is personal to Licensee and shall not be assigned, conveyed or otherwise transferred by Licensee under any circumstances except by operation of law. Any attempt to assign, convey or otherwise transfer this Agreement shall be null and void and cause the immediate termination and revocation of this Agreement.

24. Sunshine Ordinance. Licensee understands and agrees that under the City's Sunshine Ordinance (San Francisco Administrative Code Chapter 67) and the State Public Records Law (California Government Code Section 6250 *et seq.*), apply to this Agreement and any and all records, information, and materials submitted to the City in connection with this Agreement. Accordingly, any and all such records, information and materials may be subject to public disclosure in accordance with the City's Sunshine Ordinance and the State Public Records Law. Licensee hereby authorizes the City to disclose any records, information and materials submitted to the City in connection with this Agreement.

25. Food Service Waste Reduction. Licensee agrees to comply fully with and be bound by all of the applicable provisions of the Food Service Waste Reduction Ordinance, as set forth in the San Francisco Environment Code, Chapter 16, including the remedies provided therein, and implementing guidelines and rules. The provisions of Chapter 16 are incorporated herein by reference and made a part of this Agreement as though fully set forth herein. Accordingly, Licensee acknowledges that City contractors and lessees may not use Disposable Food Service Ware that contains Polystyrene Foam in City Facilities and while performing under a City contract or lease, and shall instead use suitable Biodegradable/Compostable or Recyclable Disposable Food Service Ware. This provision is a material term of this Agreement.

26. Prohibition of Tobacco Sales and Advertising. Licensee acknowledges and agrees that no advertising of cigarettes or tobacco products is allowed on the Access Area. This advertising prohibition includes the placement of the name of a company producing, selling or distributing cigarettes or tobacco products or the name of any cigarette or tobacco product in any promotion of any event or product. This advertising prohibition does not apply to any advertisement sponsored by a state, local, nonprofit or other entity designed to (i) communicate the health hazards of cigarettes and tobacco products, or (ii) encourage people not to smoke or to stop smoking.

27. Prohibition of Alcoholic Beverage Advertising. Licensee acknowledges and agrees that no advertising of alcoholic beverages is allowed on the Access Area. For purposes of this Section, "alcoholic beverage" shall be defined as set forth in California Business and Professions Code Section 23004, and shall not include cleaning solutions, medical supplies and other products and substances not intended for drinking. This advertising prohibition includes the placement of the name of a company producing, selling or distributing alcoholic beverages or the name of any alcoholic beverage in any promotion of any event or product. This advertising prohibition does not apply to any advertisement sponsored by a state, local, nonprofit or other entity designed to (i) communicate the health hazards of alcoholic beverages, (ii) encourage people not to drink alcohol or to stop drinking alcohol, or (iii) provide or publicize drug or alcohol treatment or rehabilitation services.

28. Tropical Hardwoods and Virgin Redwood Ban. The City and County of San Francisco urges companies not to import, purchase, obtain or use for any purpose, any tropical hardwood, tropical hardwood wood product, virgin redwood or virgin redwood wood product, except as expressly permitted by the application of Sections 802(b) and 803(b) of the San Francisco Environment Code. Licensee agrees that, except as permitted by the application of Sections 802(b) and 803(b), Licensee shall not use or incorporate any tropical hardwood, tropical hardwood wood product, virgin redwood or virgin redwood wood product in the performance of this Agreement.

29. Possessory Interest Taxes. Licensee recognizes and understands that this Agreement may create a possessory interest subject to property taxation and that Licensee may be subject to the payment of property taxes levied on such interest under applicable law. Licensee agrees to pay taxes of any kind, including possessory interest taxes, if any, that may be lawfully assessed on Licensee's interest under this Agreement or use of the Access Area pursuant hereto and to pay any other taxes, excises, licenses, permit charges or assessments based on Licensee's usage of the Access Area that may be imposed upon Licensee by applicable law. Licensee shall pay all of such charges when they become due and payable and before delinquency.

30. Consideration of Criminal History in Hiring and Employment Decisions. Licensee agrees to comply fully with and be bound by all of the provisions of Chapter 12T of the San Francisco Administrative Code (City Contractor/Subcontractor Consideration of Criminal History in Hiring and Employment Decisions) ("**Chapter 12T**"), including the remedies and implementing regulations of Chapter 12T, as may be amended from time to time, in the hiring or employment any person with respect to the Permitted Activities. The provisions of Chapter 12T are incorporated by reference and made a part of this Agreement as though fully set forth herein. Such provisions include, but are not limited to, the requirements for solicitations or advertisements for employees made by Licensee if such employees would perform any of the Permitted Activities and the prohibition of certain inquiries when initially interviewing job candidates for such employment positions. The text of the Chapter 12T is available on the web at <http://sfgov.org>.

Licensee shall incorporate by reference in all subcontracts the provisions of Chapter 12T, and shall require all its contractors to comply with such provisions. Licensee's failure to comply with the obligations in this Section shall constitute a material breach of this

Agreement. Licensee understands and agrees that if it fails to comply with the requirements of Chapter 12T, City shall have the right to pursue any rights or remedies available under Chapter 12T, including but not limited to, a penalty of \$50 for a second violation and \$100 for a subsequent violation for each employee, applicant or other person as to whom a violation occurred or continued, termination or suspension in whole or in part of this Agreement.

31. Cooperative Drafting. This Agreement has been drafted through a cooperative effort of both parties, and both parties have had an opportunity to have the License reviewed and revised by legal counsel. No party shall be considered the drafter of this Agreement, and no presumption or rule that an ambiguity shall be construed against the party drafting the clause shall apply to the interpretation or enforcement of this Agreement.

32. Severability. If any provision of this Agreement or the application thereof to any person, entity or circumstance shall be invalid or unenforceable, the remainder of this Agreement, or the application of such provision to persons, entities or circumstances other than those as to which it is invalid or unenforceable, shall not be affected thereby, and each other provision of this Agreement shall be valid and be enforceable to the fullest extent permitted by law, except to the extent that enforcement of this Agreement without the invalidated provision would be unreasonable or inequitable under all the circumstances or would frustrate a fundamental purpose of this Agreement.

33. Counterparts. This Agreement may be executed in two or more counterparts, each of which shall be deemed an original, but all of which taken together shall constitute one and the same instrument.

34. General Provisions. (a) This Agreement may be amended or modified only by a writing signed by City and Licensee. (b) No waiver by any party of any of the provisions of this Agreement shall be effective unless in writing and signed by an officer or other authorized representative, and only to the extent expressly provided in such written waiver. (c) Except as otherwise expressly set forth herein, all approvals and determinations of City requested, required or permitted pursuant to this Agreement may be made in the sole and absolute discretion of the SFMTA's Director of Transportation or other authorized City official. (d) This Agreement (including the exhibit(s) hereto) contains the entire agreement between the parties and all prior written or oral negotiations, discussions, understandings and agreements are merged herein. (e) The section and other headings of this Agreement are for convenience of reference only and shall be disregarded in the interpretation of this Agreement. (f) Time is of the essence. (g) This Agreement shall be governed by California law and the City's Charter. (h) If either party commences an action against the other or a dispute arises under this Agreement, the prevailing party shall be entitled to recover from the other reasonable attorneys' fees and costs. For purposes hereof, reasonable attorneys' fees of City shall be based on the fees regularly charged by private attorneys in San Francisco with comparable experience. (i) Licensee may not record this Agreement or any memorandum hereof. (j) Subject to the prohibition against assignments or other transfers by Licensee hereunder, this Agreement shall be binding upon and inure to the benefit of the parties and their respective heirs, representatives, successors and assigns. (i) If City sells or otherwise conveys any portion of the Access Area, the owner of such conveyed portion of the Access Area shall accept such portion subject to this Agreement and shall assume City's rights and obligations under this Agreement to the extent such rights and obligations affect such transferred portion.

[REMAINDER OF PAGE INTENTIONALLY LEFT BLANK]

Licensee represents and warrants to City that it has read and understands the contents of this Agreement and agrees to comply with and be bound by all of its provisions.

LICENSEE:

FRIENDS OF THE GENEVA OFFICE BUILDING AND POWERHOUSE, a California non-profit corporation

By: _____
Its: _____

Date: _____

By: _____
Its: _____

Date: _____

CITY:

CITY AND COUNTY OF SAN FRANCISCO, a municipal corporation, acting by and through the San Francisco Municipal Transportation Agency

By: _____
Edward D. Reiskin
Director of Transportation

Date: _____

APPROVED AS TO FORM:

DENNIS J. HERRERA, City Attorney

By: _____
Carol Wong, Deputy City Attorney

EXHIBIT A

Depiction of City Property, Buildings, and Access Area

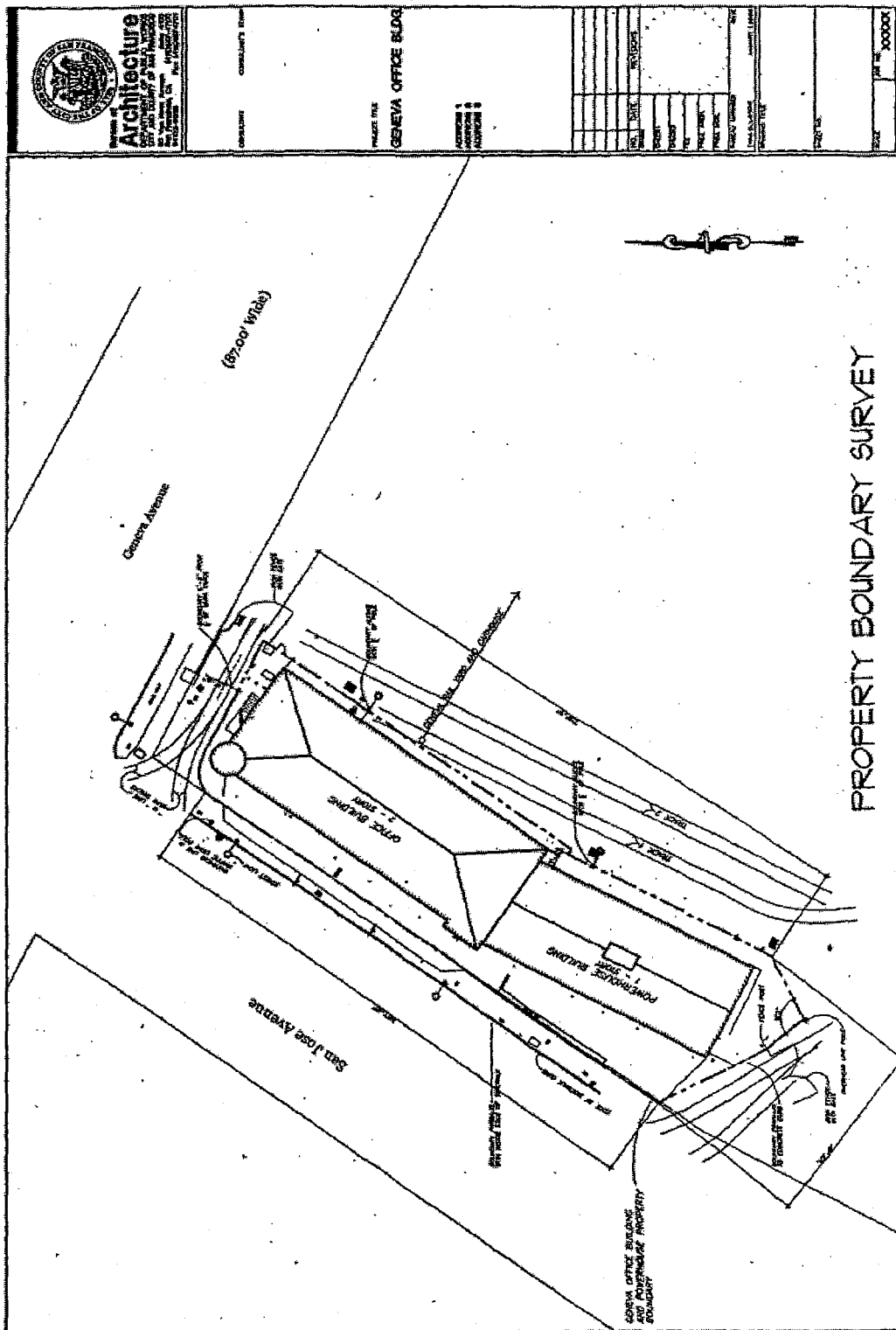

EXHIBIT D
Form of Temporary Construction License

PERMIT TO ENTER AND USE PROPERTY

THIS PERMIT TO ENTER AND USE PROPERTY (this "**Entry Permit**"), dated for reference purposes only as of _____, 201__, is made by and between the CITY AND COUNTY OF SAN FRANCISCO, a municipal corporation ("**City**"), acting by and through the San Francisco Municipal Transportation Agency ("**SFMTA**"), and FRIENDS OF THE GENEVA OFFICE BUILDING AND POWERHOUSE, a California non-profit corporation ("**Permittee**").

RECITALS

A. City owns certain real property located at the intersection of San Jose Avenue and Geneva Avenue in the City and County of San Francisco, as further described in the attached Exhibit A (the "**City Property**"), with the buildings on the City Property known as the "Geneva Car Barn" and the "Geneva Powerhouse" (together, the "**Buildings**") under the jurisdiction of City's Recreation and Park Commission and the remainder of the City Property under the jurisdiction of SFMTA.

B. City, acting by and through its Recreation and Park Department ("**RPD**"), has entered into a Lease Disposition and Development Agreement with Permittee, dated as of _____, 2014 ("**LDDA**"), which provides for Permittee's rehabilitation and improvement of the Buildings (the "**Project**") pursuant to a lease that will be between City and LDDA and substantially in the form attached as Exhibit E to the LDDA (the ("**Ground Lease**").

C. If Permittee and City enter into the Ground Lease, Permittee wishes to acquire a temporary construction staging permit over the portion of the City Property depicted as the "Construction Area", as depicted on the attached Exhibit A (the "**Permit Area**"), for access and construction staging as necessary to complete the Project.

D. City, acting by and through SFMTA, consents to such access and construction staging on the terms and conditions of this Entry Permit.

City and Permittee agree as follows:

AGREEMENT

1. License; Permit Area. The "**Effective Date**" shall be the date that the following requirements are met: (a) this Entry Permit and the Ground Lease shall have been fully executed, (b) Permittee shall have met all conditions in the Ground Lease for the commencement of construction of the Project, and (c) Permittee shall have delivered to City the insurance certificates described in Section 10, evidence of the Approvals (as defined in Section 4.2), and the permit fee and first monthly staging fee payment described in Section 6. As of the Effective Date, City confers to Permittee a revocable, personal, unassignable, non-exclusive and non-possessory privilege for Permittee and its affiliates (including Project Developer) and their respective officers, agents, employees, contractors, subcontractors (collectively, the "**Permittee Agents**") to enter upon and use the Permit Area for the Permitted Activities (as defined in Section 3.5).

This Entry Permit gives Permittee a license only and, notwithstanding anything to the contrary herein, this Entry Permit does not constitute a grant by City of any ownership, leasehold, easement or other property interest or estate whatsoever in the Permit Area, or

any portion thereof. The privilege given to Permittee under this Entry Permit is effective only insofar as the rights of City in the Permit Area are concerned, and Permittee shall obtain any further permission necessary because of any other existing rights affecting the Permit Area.

2. Term of Permit. The privilege given to Permittee pursuant to this Entry Permit is temporary only and shall commence on the Effective Date. Unless sooner terminated pursuant to the terms hereof, the term of this Entry Permit ("**Term**") shall commence on the Effective Date and expire on the earlier date (the "**Termination Date**") to occur of (i) the issuance of a temporary certificate of occupancy for the Buildings by City acting in its regulatory capacity (the "**Completion Date**"), and (ii) the second (2nd) anniversary of the Effective Date (the "**Outside Date**"). [If construction staging activities will be during separate phases that are spaced more than two months apart, this form will be modified so we have one entry permit for each phase.]

Without limiting any of its rights hereunder, City may at its sole option freely revoke this Entry Permit at any time prior to the Termination Date, without cause and without any obligation to pay any consideration to Permittee, by delivering no less than five (5) days' prior written notice of such termination to Permittee.

3. Uses.

3.1 Permitted Activities. Permittee and the Permittee Agents may use the Permit Area to perform the following activities (collectively, the "**Permitted Activities**"): (a) to perform Permittee's obligations under this Entry Permit, (b) to use the portion of the Permit Area depicted as the "Staging Area" on the attached Exhibit A (the "**Staging Area**") for construction staging related to the Project (the "**Staging Activities**"), which shall consist of _____, and (c) to use the portion of the Permit Area depicted as the "Access Area" on the attached Exhibit A (the "**Access Area**") for vehicular and pedestrian access between San Jose Avenue and the rear of the Buildings.

3.2 Subject to Public Right-of-Way. Permittee is aware that the License Area is adjacent to a public street and therefore any use of the curb or street area is subject to the existing public easement for travel, transportation and right-of-way purposes. Accordingly, Permittee recognizes and agrees that notwithstanding anything to the contrary in this Entry Permit, any and all of Permittee's rights to use the Permit Area hereunder shall be subject and subordinate at all times to such public easement and the uses related thereto, including, but not limited to, public use as a street, utility uses, and City's uses for other purposes.

3.3 Restrictions on Permitted Activities. Without limiting any of its rights hereunder, if City determines that any of the Permitted Activities poses a material risk to public health or safety or that City needs to use any portion of the Permit Area for emergency purposes, and such emergency use requires changes to the Permitted Activities, City shall deliver written notice of such determination to Permittee (the "**Revision Notice**"). This Entry Permit shall be automatically amended to incorporate the changed Permitted Activities or changed Permit Area described in the Revision Notice within five (5) business days of Permittee's receipt of the Revision Notice.

Notwithstanding anything to the contrary in the foregoing paragraph, if City determines that any of the Permitted Activities poses an immediate risk to public health or safety or that City needs to immediately use all or any portion of the Permit Area for emergency purposes (an "**Emergency Situation**"), City shall have the right to temporarily restrict such Permitted Activities or use the Permit Area without first delivering a Revision Notice to Permittee. If reasonably possible, City shall give Permittee verbal notification of an Emergency Situation before restricting any of the Permitted Activities or commencing

its use the Permit Area. City shall deliver written notice of such action to Permittee as soon as reasonably possible. If City needs to continue its restriction on any of the Permitted Activities or its use of the Permit Area in response to an Emergency Situation for more than five (5) consecutive business days and City determines it will need to continue such activities, City shall deliver a Revision Notice describing the restriction for Permitted Activities or the City's use of the Permit Area, as applicable, prior to the end of such fifth (5th) business day.

City shall have no obligation to pay any consideration to Permittee if City needs to restrict, in accordance with this Section, any of the Permitted Activities or to use the Permit Area for emergency purposes or to protect public health or safety (including any Emergency Situation). Permittee acknowledges and agrees that neither Permittee's efforts to comply with the conditions of this Entry Permit (including any related costs incurred by Permittee) nor the commencement of the Permitted Activities shall in any way whatsoever limit City's right to restrict the Permitted Activities pursuant to this Section or as expressly set forth in this Entry Permit.

4. Performance of Work. Permittee shall conduct, and shall cause the Permittee Agents, to conduct the Permitted Activities in compliance with the terms of this Entry Permit, including the following conditions, which are for the sole benefit of City:

4.1 Construction Work Plans. Permittee shall perform the Project in the _____ phases described on the attached Exhibit B. Prior to commencing the Permitted Activities to be performed in connection with each such phase, Permittee shall have prepared a work plan and schedule for the Permitted Activities to be performed for such phase that is approved in writing by City (each, a "**Construction Work Plan**"), which approval shall not be unreasonably withheld, conditioned or delayed. Permittee acknowledges and agrees that it shall be reasonable for City to withhold such approval if a submitted work plan materially conflicts with this Entry Permit, the Ground Lease or any regulatory agreements or permitted needed for the Permitted Activities or the Project (collectively, the "**Specification Documents**"), would materially affect City's use of the remainder of the City Property, including its railcar operations, or raise material health or safety concerns.

Each work plan submitted for City's approval shall include a schedule for such phase and plans and specifications for each temporary improvement to be installed or constructed in the Permit Area during such phase, together with the proposed schedule and hours of each activity during such phase and any requested modification to City's railcar operations at the City Property. SFMTA shall provide Permittee with written notice of its approval or disapproval of a draft work plan within ten (10) business days of receiving such draft. If City does not approve of a draft work plan, such notice shall further set forth City's reasons for such disapproval. A Construction Work Plan shall not be amended, modified or supplemented without City's prior written consent pursuant to this Entry Permit. [If construction staging activities will be during separate phases that are spaced more than two months apart, modify to have one entry permit for each phase, and one construction work plan and schedule per permit.]

4.2 Permits and Approvals; Compliance with Specification Documents. Before beginning any of the Permitted Activities, Permittee shall obtain all permits, licenses and approvals (collectively, "**Approvals**") required of any regulatory agencies to commence and complete the Project and the Permitted Activities, including, but not limited to, any permits from the San Francisco Department of Public Works and the San Francisco Department of Building Inspection. Permittee shall deliver copies of all Approvals to City prior to the Effective Date. Permittee recognizes and agrees that no approval by City of any of the Permitted Activities pursuant to this Entry Permit shall be deemed to constitute the Approval required of any federal, state or local regulatory authority with jurisdiction, including any required of City acting in its regulatory capacity, and nothing herein shall

limit Permittee's obligation to obtain all such Approvals at Permittee's sole cost. Permittee shall conduct, and shall cause the Permittee Agents, to conduct the Permitted Activities in compliance with the terms of the Specification Documents.

4.3 Licensed Contractors; Exercise of Due Care. The Permitted Activities shall only be performed by contractors that are licensed by the State of California and duly qualified to perform such work, to the extent required by the State of California, and any of the Permitted Activities that is not required to be performed under applicable laws by a contractor licensed by the State of California for such work shall be performed by persons duly qualified to perform such work. Permittee shall use and cause the Permittee Agents to use due care at all times to avoid any damage or harm to City's property and to native vegetation and natural attributes of the Permit Area (other than as reasonably necessary to perform any of the Permitted Activities). City shall have the right to have a representative present during any of the Permitted Activities. Permittee shall do everything reasonably within its power, both independently and upon request by City, to prevent and suppress fires and the release of Hazardous Materials (as defined in Section 9.1) on and adjacent to the Permit Area attributable to the use of the Permit Area by Permittee or the Permittee Agents pursuant to this Entry Permit.

4.4 Cooperation with City Personnel. Permittee and the Permittee Agents shall work closely with City personnel to avoid disruption of City property in, under, on or about the Permit Area, City's vehicular and pedestrian access through the Permit Area, City's use of the remainder of the City Property, and the maintenance, operation, repair, replacement of City's utilities and improvements on the City Property. Permittee shall provide City's designated representative with advance written notice of (a) the commencement of each phase of the Permitted Activities, (b) the substantial completion of each phase of the Permitted Activities, and (c) the substantial completion of all of the Permitted Activities. City shall have the right, at its sole cost, to have a designated representative observe, photograph and/or otherwise record all of Permittee's activities on the Permit Area.

4.5 Work and Use Schedule. Permittee and the Permittee Agents may only perform the Permitted Activities during the hours specified in the applicable Construction Work Plan (or between any shorter hours required under any applicable laws). Permittee will notify City if it terminates any phase of the Permitted Activities prior to the last day of such phase specified in the Construction Work Plan for such phase. Permittee will notify City if it terminates the Permitted Activities prior to the Termination Date.

4.6 Pre-Construction Baseline. Permittee shall document the condition of the Permit Area prior to the commencement of any Permitted Activities through the use of photographs, maps and any other appropriate documentation to provide a pre-construction baseline to monitor impacts. Appropriate documentation shall be determined in consultation with City. Permittee shall provide City with a copy of such documentation prior to the commencement of any Permitted Activities.

4.7 Maintenance of Permit Area; Repair of Damage. Permittee shall remove all debris and any excess dirt or debris in the Permit Area caused by any of the Permitted Activities or the use of the Permit Area by Permittee or any of the Permittee Agents. If any portion of the Permit Area or any City property located on or about the City Property is damaged at any time by any of the activities conducted by Permittee or any of the Permittee Agents hereunder, Permittee shall immediately, at its sole cost, repair any and all such damage and restore the Permit Area or property to its previous condition. Permittee shall, at all times and at its sole cost, maintain the Permit Area in a good, clean, safe, secure, sanitary and slightly condition so far as the Permit Area may be affected by the Permitted Activities or any other actions in the Permit Area by Permittee or the Permittee Agents.

4.8 Excavation Activities. Permittee shall prevent all materials (including soil) displaced by or resulting from the Permitted Activities or the use of the Permit Area by Permittee or any of the Permittee Agents from entering storm drains, sewers, or water ways and shall immediately notify the City, and all appropriate regulatory agencies required under applicable laws, if there is any accidental release of such materials.

4.9 Contractor Acknowledgement of Agreement. Permittee shall deliver a complete copy of this Entry Permit to all Permittee Agents performing any of the Permitted Activities or otherwise entering the Permit Area pursuant to this Entry Permit. Prior to the entry on the Permit Area by any such party, Permittee shall deliver a notice to City signed by such party acknowledging its receipt of a copy of this Entry Permit and its agreement to be comply with and be bound by all of the provisions of this Entry Permit pertaining to its entry on the Permit Area.

4.10 Wages and Working Conditions. With respect to the installation of any facilities or improvements or the performance of any work that is a "public work" under the State of California Labor Code, any employee performing services for Permittee or any Permittee Agent shall be paid not less than the highest prevailing rate of wages and that Permittee shall include, in any contract for construction of such improvement work or any alterations on the Permit Area, a requirement that all persons performing labor under such contract shall be paid not less than the highest prevailing rate of wages for the labor so performed. Permittee further agrees that, as to the construction of such improvement work or any alterations on the Permit Area under this Entry Permit, Permittee shall comply, and cause all Permittee Agents to comply, with the provisions of Section 6.22(E) of the San Francisco Administrative Code (as the same may be amended, supplemented or replaced) that relate to payment of prevailing wages. Permittee shall require all Permittee Agents to provide, and shall deliver to City upon request, certified payroll reports with respect to all persons performing labor in the construction of the improvement work or any alterations on the Permit Area for Permittee or any Permittee Agent.

5. Restrictions on Use; City's Uses. Permittee agrees that, by way of example only and without limitation, the following uses of the Permit Area by Permittee or any other party claiming by or through Permittee are inconsistent with the limited purpose of this Entry Permit and are strictly prohibited as provided below:

5.1 Improvements. Except for any temporary structures or improvements described in a Construction Work Plan and the personal property reasonably needed to perform the Permitted Activities described in the applicable Construction Work Plan, Permittee shall not construct or place any temporary or permanent structures or improvements or personal property on the Permit Area, nor shall Permittee alter any existing structures or improvements on the Permit Area. Permittee understands and agrees that City is entering into this Entry Permit in its capacity as a landowner with a proprietary interest in City's Property and not as a regulatory agency with certain police powers. Permittee understands and agrees that neither the City's execution of this Entry Permit nor any approvals by City of any work plan or otherwise given by City under this Entry Permit shall grant, or be deemed to imply, that Permittee will be able obtain, any required Approvals from departments, boards or commissions of the City and County of San Francisco that have jurisdiction over any of the Permitted Activities.

5.2 Dumping; Storing; Signs. Permittee shall not dump or dispose of refuse or other unsightly materials or store any materials on, in, under or about the Permit Area; provided, however, that Permittee may conduct normal construction staging activities in the Staging Area. Permittee shall not place, erect or maintain any sign, advertisement, banner or similar object on or about the Permit Area, except for any temporary sign that is necessary for any of the Permitted Uses and is approved by City in writing, which approval may be given or withheld in City's sole discretion.

5.3 Transit Operations. Permittee acknowledges that the City Property is used for railcar operations, the maintenance and storage of railcars and other transit vehicles, and employee parking, all of which includes temporary, but continuous, ingress and egress activities over the Permit Area to and from San Jose Avenue (the "**Access Activities**"). Permittee shall not use, nor permit any of the Permittee Agents to use, the Permit Area in a manner that materially interferes with, or causes a safety risk for, the Access Activities or other City activities on the remainder of the City Property without written prior approval for each proposed activity that would pose such an interference or safety risk or unless such activity is conducted pursuant to a Work Plan or is expressly permitted pursuant to, and performed in compliance with the terms of, this Entry Permit.

5.4 Nuisances; No Interference with City's Uses. Permittee shall not conduct any activities on or about the Permit Area that constitute waste, nuisance or unreasonable annoyance (including, without limitation, emission of objectionable odors, noises or lights) to City, to the owners or occupants of neighboring property or to the public; provided, however, that City shall not, in its proprietary capacity as landowner under this Entry Permit, deem Permittee's performance of any of the Permitted Activities in compliance with the terms and conditions of this Entry Permit to be a nuisance or unreasonable annoyance. Except for any activities described in a Construction Work Plan, Permittee shall not materially interfere with or obstruct the Access Activities, City's use of the Permit Area, its conduct of normal business operations thereon, or the rights of any party with rights to occupy or use the Permit Area.

5.5 Utilities. City has no responsibility or liability of any kind or character with respect to any utilities that may be on, in or under the Permit Area. Permittee has the sole responsibility to locate such utilities and protect them from damage, and Permittee has sole responsibility for any damage to utilities or damages resulting from Permittee's activities at the Permit Area. Permittee shall arrange and pay for any necessary temporary relocation of City and public utility company facilities reasonably necessary to facilitate any of the Permitted Activities, subject to the prior written approval by City and any such utility companies of any such relocation. Permittee shall be solely responsible for arranging and paying directly for any utilities or services necessary for its activities hereunder.

5.6 Damage. Permittee shall not do anything about the Permit Area that will cause damage to any of City's property (including, but not limited to, the existing rail lines, railcars, transit and support vehicles and facilities, utilities, and light poles, employee parking areas, or any other improvements) or the property of any other party with rights to occupy or use the Permit Area. City's approval of any work plan pursuant to this Entry Permit or of the proposed Permitted Activities shall not be deemed to constitute the waiver of any rights City may have under Applicable Laws for any damage to the City's real or personal property or the City Property resulting from the Permitted Activities.

6. Fees. (a) Permit Fee. Permittee shall pay to City a one-time non-refundable \$5,000 permit fee to cover City's processing, inspection and other administrative costs for this Entry Permit. Such fee is payable at such time as Permittee signs and delivers this Entry Permit to City, and shall be paid in cash or by good check payable to the City and County of San Francisco.

(b) Staging Fee. Permittee shall pay to City a staging fee (the "**Staging Fee**") in the amount of \$_____ for each month of the Term, which is based on a \$.75/sq.ft. basis using the square footage of the Staging Area. The Staging Fee payment for the first month of the Term shall be payable at such time as Permittee signs and delivers this Entry Permit to City and Permittee shall deliver a monthly Staging Fee payment to City on or before each monthly anniversary of the Effective Date. All payments of the monthly Staging Fee shall be paid in cash or by good check payable to the City and County of San Francisco.

7. Surrender; As-Built Plans; Remaining Improvements. Upon the expiration of this Entry Permit or within five (5) days after any sooner revocation or other termination of this Entry Permit, Permittee shall surrender the Permit Area in a broom clean, free from hazards, clear of all debris and restore the Permit Area substantially to its condition immediately prior to the Effective Date, to the reasonable satisfaction of City; provided, however, that Permittee shall have no obligation to repair or restore any deficient condition at the Permit Area that was disclosed, but not caused, by any of the Permitted Activities. At such time, Permittee shall remove all of its property from the Permit Area and any signs permitted hereunder, and shall repair, at its cost, any damage to the Permit Area caused by such removal. Permittee's obligations under this Section shall survive any termination of this Entry Permit.

Any equipment or any other property of Permittee remaining in the Permit Area after completion of activities may be deemed abandoned by City in its sole discretion and City may store, remove, and dispose of such equipment or property at Permittee's sole cost and expense unless City has otherwise granted written permission to Permittee for such remaining equipment or property. Permittee waives all claims for any costs or damages resulting from City's retention, removal, and disposition of such property.

8. Compliance with Laws. Permittee shall, at its expense, conduct and cause to be conducted all Permitted Activities in a safe and prudent manner and in compliance with all laws, regulations, codes, ordinances and orders of any governmental or other regulatory entity (including, without limitation, the Americans with Disabilities Act and any other disability access laws), whether presently in effect or subsequently adopted and whether or not in the contemplation of the parties. Permittee shall, at its sole expense, maintain all Approvals in force at all times during its use of the Permit Area. Permittee understands and agrees that City is entering into this Entry Permit in its capacity as a property owner with a proprietary interest in the Permit Area and not as a regulatory agency with police powers. Nothing herein shall limit in any way Permittee's obligation to obtain any required Approvals from City departments, boards or commissions or other governmental regulatory authorities or limit in any way City's exercise of its police powers.

9. Hazardous Materials.

9.1 Definitions. For purposes of this Entry Permit, the following terms have the following meanings:

(a) **"Environmental Laws"** means any federal, state or local laws, ordinances, regulations or policies judicial and administrative directives, orders and decrees dealing with or relating to Hazardous Materials (including, without limitation, their use, handling, transportation, production, disposal, discharge, storage or reporting requirements) or to health and safety, industrial hygiene or environmental conditions in, on, under or about the Permit Area or property, including, without limitation, soil, air, bay water and groundwater conditions or community right-to-know requirements, related to the work being performed under this Entry Permit.

(b) **"Handle"** or **"handling"** means to use, generate, process, produce, package, treat, store, emit, discharge or dispose.

(c) **"Hazardous Material"** means any substance or material which has been determined by any state, federal, or local government authority to be a hazardous or toxic substance or material, including without limitation, any hazardous substance as defined in Section 101(14) of CERCLA (42 USC Section 9601(14)) or Sections 25281(f) or 25316 of the California Health and Safety Code, any hazardous material as defined in Section 25501(k) of the California Health and Safety Code, and any additional substances or

materials which at such time are classified or considered to be hazardous or toxic under any federal, state or local law, regulation or other exercise of governmental authority.

(d) **"Investigation"** means activities undertaken to determine the nature and extent of Hazardous Materials which may be located on or under real property, or which have been, are being, or threaten to be released to the environment.

(e) **"Remediation"** shall mean activities undertaken to cleanup, remove, contain, treat, stabilize, monitor or otherwise control Hazardous Materials located on or under real property or which have been, are being or threaten to be released to the environment.

(f) **"Regulatory Agency"** means any federal, state or local governmental agency or political subdivision having jurisdiction over the Permit Area and any of the Permitted Activities. The City shall be a "Regulatory Agency" to the extent that City is acting in its capacity as a regulatory authority, rather than in its proprietary capacity as a landowner.

(g) **"Release"** means any spilling, leaking, pumping, pouring, emitting, emptying, discharging, injecting, escaping, leaching, dumping, or disposing into the environment of any Hazardous Material (including the abandonment or discarding of barrels, containers, and other closed receptacles containing any Hazardous Material or pollutant or contaminant).

9.2 Environmental Laws. Permittee shall handle all Hazardous Materials introduced or disturbed on the Permit Area during the Term in compliance with all Environmental Laws. Permittee shall not be responsible for the safe handling of Hazardous Materials to the extent released on the Permit Area by City or any City employee, agent, contractor, subcontractor, or invitee, or existing on the Permit Area prior to the Effective Date, except to the extent any of the Permitted Activities exacerbates such Hazardous Materials. Permittee shall protect its employees and the general public in accordance with all Environmental Laws. City may from time to time request, and Permittee shall be obligated to provide, information reasonably adequate for City to determine that any and all Hazardous Materials are being handled in a manner which complies with all Environmental Laws.

9.3 Removal of Hazardous Materials. Prior to termination of this Entry Permit, Permittee, at its sole cost and expense, shall remove any and all Hazardous Materials to the extent introduced or released in, on, under or about the Permit Area by Permittee or the Permittee Agents during the Term and shall Remediate or dispose of any Hazardous Materials produced as a result of the Permitted Activities. All costs of storage, shipping and disposal of extracted soils and groundwater shall be the sole responsibility of Permittee including, without limitation, the costs of preparation and execution of shipping papers, including but not limited to hazardous waste manifests. With respect to shipping papers and hazardous waste manifests, Permittee shall be the "generator" and in no case shall the City be named as the generator.

9.4 Notification. Permittee shall provide City with a copy of any permits issued for any Permitted Activity that involves the potential release or discharge of any Hazardous Materials in or from the Permit Area, and the receipt of a hazardous waste generator identification number issued by the U.S. Environmental Protection Agency or the California Environmental Protection Agency to itself or any of the Permittee Agents. Permittee shall promptly notify City in writing of, and shall contemporaneously provide City with a copy of:

(a) Any release or discharge of any Hazardous Materials, whether or not the release is in quantities that would be required under applicable laws to be reported to a Regulatory Agency;

(b) Any written notice of release of Hazardous Materials in or on the Permit Area that is provided by Permittee or any of the Permittee Agents to a Regulatory Agency including any City agency;

(c) Any notice of a violation, or a potential or alleged violation, of any Environmental Law that is received by Permittee or any of the Permittee Agents from any Regulatory Agency;

(d) Any inquiry, investigation, enforcement, cleanup, removal, or other action that is instituted or threatened by a Regulatory Agency against Permittee or any of the Permittee Agents and that relates to the release or discharge of Hazardous Material on or from the Permit Area;

(e) Any claim that is instituted or threatened by any third party against Permittee or any of the Permittee Agents and that relates to any release or discharge of Hazardous Materials on or from the Permit Area; and

(f) Any notice of the termination, expiration or substantial amendment of any environmental operating permit needed by Permittee or any of the Permittee Agents.

9.5 Hazardous Material Disclosures. California law requires landlords to disclose to tenants the presence or potential presence of certain Hazardous Materials. Although this Entry Permit grants Permittee a license only, Permittee is hereby advised that Hazardous Materials may be present on the Permit Area, including, but not limited to vehicle fluids, janitorial products, tobacco smoke, and building materials containing chemicals, such as formaldehyde. By execution of this Entry Permit, Permittee acknowledges that the notice set forth in this Section satisfies the requirements of California Health and Safety Code Section 25359.7 and related statutes. Permittee also acknowledges its own obligations pursuant to California Health and Safety Code Section 25359.7 as well as the penalties that apply for failure to meet such obligations.

10. Insurance. [To be updated/reviewed by City's risk manager once SFMTA knows Permittee's proposed Permitted Activities]

10.1 Insurance Policies. Permittee shall procure and keep in effect at all times during the Term, at Permittee's expense, and cause its contractors and subcontractors to maintain at all times insurance as follows during the Term:

(a) General Liability Insurance with limits not less than Two Million Dollars (\$2,000,000) each occurrence Combined Single Limit for Bodily Injury and Property Damage, including coverages for Contractual Liability, Personal Injury, Independent Contractors, Explosion, Collapse and Underground (XCU), Broadform Property Damage, Sudden and Accidental Pollution, Products Liability and Completed Operations;

(b) Automobile Liability Insurance with limits not less than One Million Dollars (\$1,000,000) each occurrence Combined Single Limit for Bodily Injury and Property Damage, including coverages for owned, non-owned and hired automobiles, as applicable, and sudden and accidental pollution;

(c) Workers' Compensation Insurance with Employer's Liability Coverage with limits of not less than One Million Dollars (\$1,000,000) each accident; and

(d) Contractor's Pollution Legal Liability Insurance with combined single limit of Two Million Dollars (\$2,000,000) each claim, and with coverage to include legal liability arising from the sudden and accidental release of pollutants, and no less than a one-year extended reporting period, endorsed to include Non-Owned Disposal Site coverage.

10.2 Policy Requirements; Delivery of Certificates.

(a) All liability policies required hereunder shall provide for the following: (i) name as additional insureds the City and County of San Francisco, its officers, agents and employees; and (ii) specify that such policies are primary insurance to any other insurance available to the additional insureds, with respect to any claims arising out of this Entry Permit and that insurance applies separately to each insured against whom claim is made or suit is brought. Such policies shall also provide for severability of interests and that an act or omission of one of the named insureds which would void or otherwise reduce coverage shall not reduce or void the coverage as to any insured, and shall afford coverage for all claims based on acts, omissions, injury or damage which occurred or arose (or the onset of which occurred or arose) in whole or in part during the policy period. Sudden and accidental pollution coverage in the liability policies required hereunder shall be limited to losses resulting from Permittee's activities (and the activities of any Permittee Agents) under this Entry Permit (excluding non-negligent aggravation of existing conditions with respect to Hazardous Materials).

(b) All policies shall be endorsed to provide thirty (30) days' prior written notice of cancellation, non-renewal or reduction in coverage to City.

(c) Permittee shall deliver to City certificates of insurance and additional insured policy endorsements from insurers prior to the Effective Date and in a form satisfactory to City, evidencing the coverages required hereunder, together with complete copies of the policies at City's request. In the event Permittee shall fail to procure such insurance, or to deliver such certificates, City may procure, at its option, the same for the account of Permittee, and the cost thereof shall be paid to City within ten (10) days after delivery to Permittee of bills therefor.

(d) All policies shall include a waiver of subrogation endorsement or provision wherein the insurer acknowledges acceptance of Permittee's waiver of claims against City, provide for severability of interests and that an act or omission of one of the named insureds which would void or otherwise reduce coverage shall not reduce or void the coverage as to any other insured, and shall afford coverage for all claims based on acts, omissions, injury or damage which occurred or arose in whole or in part during the policy period.

(e) Should any of the required insurance be provided under a form of coverage that includes a general annual aggregate limit or provides that claims investigation or legal defense costs be included in such general annual aggregate limit, such general aggregate limit shall double the occurrence or claims limits specified above.

(f) Should any of the required insurance be provided under a claims made form, Permittee shall maintain such coverage continuously throughout the Term and, without lapse, for a period of three (3) years beyond the Termination Date, to the effect that, should any occurrences during the Term Permit give rise to claims made after Termination Date, such claims shall be covered by such claims-made policies.

(f) Upon City's request, Permittee and City shall periodically review the limits and types of insurance carried pursuant to this Section. If the general commercial

practice in the City and County of San Francisco is to carry liability insurance in an amount or coverage materially greater than the amount or coverage then being carried by Permittee for risks comparable to those associated with the Permit Area, then City in its sole discretion may require Permittee to increase the amounts or coverage carried by Permittee hereunder to conform to such general commercial practice.

10.3 Waiver of Subrogation. Notwithstanding anything to the contrary contained herein, Permittee hereby waives any right of recovery against City for any loss or damage sustained by Permittee with respect to the Permit Area or any portion thereof or the contents of the same or any operation therein, whether or not such loss is caused by the fault or negligence of City, to the extent such loss or damage is covered by insurance which is required to be purchased by Permittee under this Entry Permit or the Ground Lease or is actually covered by insurance obtained by Permittee. Permittee agrees to cause its insurers to issue appropriate waiver of subrogation rights endorsements to all policies relating to the Permit Area; provided, the failure to obtain any such endorsement shall not affect the above waiver.

10.4 No Limitation on Permittee Obligations. Permittee's compliance with the provisions of this Section shall in no way relieve or decrease Permittee's indemnification obligations under this Entry Permit or any of Permittee's other obligations hereunder. Notwithstanding anything to the contrary in this Entry Permit, this Entry Permit shall terminate immediately, without notice to Permittee, upon the lapse of any required insurance coverage. Permittee shall be responsible, at its expense, for separately insuring Permittee's personal property.

11. Waiver of Claims; Waiver of Consequential and Incidental Damages.

(a) Neither City nor any of its commissions, departments, boards, officers, agents or employees shall be liable for any damage to the property of Permittee, the Permittee Agents, or their respective officers, agents, employees, contractors or subcontractors, or employees, or for any bodily injury or death to such persons, resulting or arising from the condition of the Permit Area or its use by Permittee or the Permittee Agents, except to the extent that any such damage, injury or death is caused by the gross negligence or willful misconduct of City or any of its commissions, departments, boards, officers, agents, employees, or contractors (each, a "City Agent").

(b) Permittee acknowledges that the Permit Area and the Permitted Activities can be modified by City pursuant to Section 3 and revoked by City pursuant to Section 2 and in view of such fact, Permittee expressly assumes the risk of making any expenditures in connection with this Entry Permit, even if such expenditures are substantial. Without limiting any indemnification obligations of Permittee or other waivers contained in this Entry Permit and as a material part of the consideration for this Entry Permit, Permittee fully RELEASES, WAIVES AND DISCHARGES forever any and all claims, demands, rights, and causes of action against, and covenants not to sue, City, its departments, commissions, officers, directors and employees, and all persons acting by, through or under each of them, under any present or future laws, statutes, or regulations (including, but not limited to, any claim for inverse condemnation or the payment of just compensation under the law of eminent domain or otherwise at equity), in the event that City exercises its right to modify the Permit Area or the Permitted Activities pursuant to Section 3 or to revoke this Entry Permit pursuant to Section 2.

(c) Permittee acknowledges that it will not be a displaced person at the time this Entry Permit is terminated or revoked or expires by its own terms, and Permittee fully RELEASES, WAIVES AND DISCHARGES forever any and all claims, demands, rights, and causes of action against, and covenants not to sue, City, its departments, commissions, officers, directors and employees, and all persons acting by, through or under each of them,

under any present or future laws, statutes, or regulations for displaced persons, including, without limitation, any and all claims for relocation benefits or assistance from City under federal and state relocation assistance laws.

(d) Permittee expressly acknowledges and agrees that the fees payable hereunder do not take into account any potential liability of City for any consequential or incidental damages including, but not limited to, lost profits, arising out of disruption to Permittee's uses hereunder. City would not be willing to give this Entry Permit in the absence of a complete waiver of liability for consequential or incidental damages due to the acts or omissions of City or its Agents, and Permittee expressly assumes the risk with respect thereto. Accordingly, without limiting any indemnification obligations of Permittee or other waivers contained in this Entry Permit and as a material part of the consideration for this Entry Permit, Permittee fully RELEASES, WAIVES AND DISCHARGES forever any and all claims, demands, rights, and causes of action against for consequential and incidental damages (including without limitation, lost profits) and covenants not to sue for such damages, City, its departments, commissions, officers, directors and employees, and all persons acting by, through or under each of them, arising out of this Entry Permit or the uses authorized hereunder, including, without limitation, any interference with uses conducted by Permittee pursuant to this Entry Permit, regardless of the cause, and whether or not due to the negligence of City or its Agents, except for the gross negligence or willful misconduct of City or its Agents.

(e) In connection with the foregoing releases, Permittee acknowledges that it is familiar with Section 1542 of the California Civil Code, which reads:

"A general release does not extend to claims which the creditor does not know or suspect to exist in his or her favor at the time of executing the release, which if known by him or her must have materially affected his or her settlement with the debtor."

Permittee acknowledges that the releases contained herein includes all known and unknown, disclosed and undisclosed, and anticipated and unanticipated claims. Permittee realizes and acknowledges that it has agreed upon this Entry Permit in light of this realization and, being fully aware of this situation, it nevertheless intends to waive the benefit of Civil Code Section 1542, or any statute or other similar law now or later in effect. The releases contained herein shall survive any termination of this Entry Permit.

12. Defaults by Permittee. If Permittee fails to perform any of its monetary obligations under this Entry Permit and fails to cure such monetary failure within five (5) business days following City's written notice of such monetary failure to Permittee, then City may, at its sole option, immediately terminate this Entry Permit by providing Permittee with written notice of such termination. If Permittee fails to perform any of its non-monetary obligations under this Entry Permit, then City may, at its sole option, remedy such failure for Permittee's account and at Permittee's expense or terminate this Entry Permit by providing Permittee with thirty (30) days' prior written notice of City's intention to cure such default (except that no such prior notice shall be required in the event of an emergency as determined by City) or to terminate this Entry Permit. Such action by City shall not be construed as a waiver of any rights or remedies of City under this Entry Permit, and nothing herein shall imply any duty of City to do any act that Permittee is obligated to perform. Permittee shall pay to City upon demand, all costs, damages, expenses or liabilities reasonably incurred by City, including, without limitation, reasonable attorneys' fees, in remedying or attempting to remedy such default. Permittee's obligations under this Section shall survive the termination of this Entry Permit.

13. No Costs to City; No Liens. Permittee shall bear all costs or expenses of any kind or nature in connection with its use of the Permit Area and in complying with the conditions

of this Entry Permit, and shall keep the Permit Area free and clear of any liens or claims of lien arising out of or in any way connected with its use of the Permit Area.

14. Indemnity. Except solely to the extent of Losses resulting directly from the willful misconduct or gross negligence of City or of any City Agent or from any material breach of this Entry Permit by City or any City Agent, Permittee shall indemnify, defend and hold harmless each of City and the City Agents each from and against any and all demands, claims, legal or administrative proceedings, losses, costs, penalties, fines, liens, judgments, damages and liabilities of any kind (collectively, "**Losses**"), arising in any manner out of (a) any injury to or death of any person or damage to or destruction of any property occurring in, on or about the Permit Area, or any part thereof, whether the person or property of Permittee, any Permittee Agent, and any of their respective officers, agents, employees, contractors, subcontractors, or third persons, relating in any manner to any of the Permitted Activities, (b) any failure by Permittee to faithfully observe or perform any of the terms, covenants or conditions of this Entry Permit, including all applicable laws, or to cause the Permittee Agents, to comply with such terms, covenants or conditions, (c) the use of the Permit Area or any activities conducted thereon by Permittee or any Permittee Agent, (d) any handling, release or threatened release, or discharge, or threatened discharge, of any Hazardous Material caused or allowed by Permittee or any Permittee Agent on, in, under or about the Permit Area, any improvements permitted thereon, or into the environment; (e) any requirement of a Regulatory Agency for investigation or remediation of any release of Hazardous Materials at the Permit Area in connection with use of the Permit Area by Permittee or any Permittee Agent; and (f) any requirement of a Regulatory Agency for investigation or remediation of any Hazardous Materials arising out of or in connection with the activities of Permittee or any Permittee Agent at the Permit Area, including, without limitation, requirements which would not have been imposed except for such party's use of the Permit Area for an of the Permitted Activities. The foregoing indemnity shall not include any Losses incurred by City with respect to any Hazardous Materials at the Permit Area discovered, but not released, by Permittee or any Permittee Agent. The indemnity in this Section shall include, without limitation, reasonable attorneys' and consultants' fees, investigation and remediation costs and all other reasonable costs and expenses incurred by the indemnified parties, including, without limitation, damages for decrease in the value of the Permit Area and claims for damages or decreases in the value of adjoining property. Permittee specifically acknowledges and agrees that it has an immediate and independent obligation to defend City from any claim which actually or potentially falls within this indemnity provision even if such allegation is or may be groundless, fraudulent or false, which obligation arises at the time such claim is tendered to Permittee by City and continues at all times thereafter. Permittee's obligations under this Section shall survive the expiration or other termination of this Entry Permit.

15. "As Is" Condition of Permit Area; Disclaimer of Representations. Permittee accepts the Permit Area in its "AS IS" condition, without representation or warranty of any kind by City, its officers, agents or employees, including, without limitation, the suitability, safety, or duration of availability of the Permit Area or any facilities on the Permit Area for Permittee's use. Without limiting the foregoing, this Entry Permit is made subject to all applicable laws, rules and ordinances governing the use of the Permit Area, and to any and all covenants, conditions, restrictions, easements, encumbrances, claims of title and other title matters affecting the Permit Area, whether foreseen or unforeseen, and whether such matters are of record or would be disclosed by an accurate inspection or survey. It is Permittee's sole obligation to conduct an independent investigation of the Permit Area and all matters relating to its use of the Permit Area hereunder, including, without limitation, the suitability of the Permit Area for such uses. Permittee, at its own expense, shall obtain such permission or other approvals from any third parties with existing rights as may be necessary for Permittee to make use of the Permit Area in the manner contemplated hereby. Under California Civil Code Section 1938, to the extent applicable to this Entry Permit, Permittee is hereby advised that the Permit Area has not undergone inspection by

a Certified Access Specialist ("CASp") to determine whether it meets all applicable construction-related accessibility requirements.

16. Notices. Except as otherwise expressly provided herein, any notices given under this Entry Permit shall be effective only if in writing and given by delivering the notice in person, by sending it first class mail or certified mail, with a return receipt requested, or overnight courier, return receipt requested, with postage prepaid, addressed as follows:

If to City: SFMTA
City and County of San Francisco
1 South Van Ness Avenue, 8th Floor
San Francisco, CA 94103
Attn: Senior Manager, Real Estate

If to Permittee:

Notices herein shall be deemed given two (2) days after the date when it shall have been mailed if sent by first class, certified or overnight courier, or upon the date personal delivery is made.

17. No Joint Ventures or Partnership; No Authorization. This Entry Permit does not create a partnership or joint venture between City and Permittee as to any activity conducted by Permittee on, in or relating to the Permit Area. Permittee is not a State actor with respect to any activity conducted by Permittee on, in, or under the Permit Area. The giving of this Entry Permit by City does not constitute authorization or approval by City of any activity conducted by Permittee on, in or relating to the Permit Area.

18. MacBride Principles – Northern Ireland. The City and County of San Francisco urges companies doing business in Northern Ireland to move toward resolving employment inequities and encourages them to abide by the MacBride Principles as expressed in San Francisco Administrative Code Section 12F.1 *et seq.* The City and County of San Francisco also urges San Francisco companies to do business with corporations that abide by the MacBride Principles. Permittee acknowledges that it has read and understands the above statement of the City and County of San Francisco concerning doing business in Northern Ireland.

19. Non-Discrimination.

19.1 Covenant Not to Discriminate. In the performance of this Entry Permit, Permittee agrees not to discriminate against any employee of, any City employee working with Permittee, or applicant for employment with Permittee, or against any person seeking accommodations, advantages, facilities, privileges, services, or membership in all business, social, or other establishments or organizations, on the basis of the fact or perception of a person's race, color, creed, religion, national origin, ancestry, age, height, weight, sex, sexual orientation, gender identity, domestic partner status, marital status, disability or Acquired Immune Deficiency Syndrome or HIV status (AIDS/HIV status), or association with members of such protected classes, or in retaliation for opposition to discrimination against such classes.

19.2 Subcontracts. Permittee shall include in all subcontracts relating to the Permit Area a non-discrimination clause applicable to such subcontractor in substantially the form of Section 19.1. In addition, Permittee shall incorporate by reference in all subcontracts the provisions of Sections 12B.2(a), 12B.2(c)-(k), and 12C.3 of the San

Francisco Administrative Code and shall require all subcontractors to comply with such provisions. Permittee's failure to comply with the obligations in this Subsection shall constitute a material breach of this Entry Permit.

19.3 Non-Discrimination in Benefits. Permittee does not as of the date of this Entry Permit and will not during the Term, in any of its operations in San Francisco, on real property owned by City, or where the work is being performed for the City or elsewhere within the United States, discriminate in the provision of bereavement leave, family medical leave, health benefits, membership or membership discounts, moving expenses, pension and retirement benefits or travel benefits, as well as any benefits other than the benefits specified above, between employees with domestic partners and employees with spouses, and/or between the domestic partners and spouses of such employees, where the domestic partnership has been registered with a governmental entity pursuant to state or local law authorizing such registration, subject to the conditions set forth in Section 12B.2(b) of the San Francisco Administrative Code.

19.4 Condition to Permit. As a condition to this Entry Permit, Permittee shall execute the "Chapter 12B Declaration: Nondiscrimination in Contracts and Benefits" form (Form HRC-12B-101) with supporting documentation and secure the approval of the form by the San Francisco Human Rights Commission (the "HRC"). Permittee hereby represents that prior to execution of this Entry Permit, (i) Permittee executed and submitted to the HRC Form HRC-12B-101 with supporting documentation, and (ii) the HRC approved such form.

19.5 Incorporation of Administrative Code Provisions by Reference. The provisions of Chapters 12B and 12C of the San Francisco Administrative Code relating to non-discrimination by parties contracting for the use of City property are incorporated in this Section by reference and made a part of this Agreement as though fully set forth herein. Permittee shall comply fully with and be bound by all of the provisions that apply to this Entry Permit under such Chapters of the Administrative Code, including but not limited to the remedies provided in such Chapters. Without limiting the foregoing, Permittee understands that pursuant to Section 12B.2(h) of the San Francisco Administrative Code, a penalty of Fifty Dollars (\$50) for each person for each calendar day during which such person was discriminated against in violation of the provisions of this Entry Permit may be assessed against Permittee and/or deducted from any payments due Permittee.

20. Notification of Limitations on Contributions. Through its execution of this Entry Permit, Permittee acknowledges that it is familiar with Section 1.126 of the San Francisco Campaign and Governmental Conduct Code, which prohibits any person who contracts with the City for the selling or leasing of any land or building to or from the City whenever such transaction would require the approval by a City elective officer, the board on which that City elective officer serves, or a board on which an appointee of that individual serves, from making any campaign contribution to (1) the City elective officer, (2) a candidate for the office held by such individual, or (3) a committee controlled by such individual or candidate, at any time from the commencement of negotiations for the contract until the later of either the termination of negotiations for such contract or six months after the date the contract is approved. Permittee acknowledges that the foregoing restriction applies only if the contract or a combination or series of contracts approved by the same individual or board in a fiscal year have a total anticipated or actual value of \$50,000 or more. Permittee further acknowledges that the prohibition on contributions applies to each Permittee; each member of Permittee's board of directors, and Permittee's chief executive officer, chief financial officer and chief operating officer; any person with an ownership interest of more than twenty percent (20%) in Permittee; any subcontractor listed in the contract; and any committee that is sponsored or controlled by Permittee. Additionally, Permittee acknowledges that Permittee must inform each of the persons described in the

preceding sentence of the prohibitions contained in Section 1.126. Permittee further agrees to provide to City the names of each person, entity or committee described above.

21. Pesticide Prohibition. Permittee shall comply with the provisions of Section 308 of Chapter 3 of the San Francisco Environment Code (the "**Pesticide Ordinance**") which (i) prohibit the use of certain pesticides on City property, (ii) require the posting of certain notices and the maintenance of certain records regarding pesticide usage and (iii) require Permittee to submit to SFMTA an integrated pest management ("**IPM**") plan that (a) lists, to the extent reasonably possible, the types and estimated quantities of pesticides that Permittee may need to apply to the Permit Area during the Term, (b) describes the steps Permittee will take to meet the City's IPM Policy described in Section 300 of the Pesticide Ordinance and (c) identifies, by name, title, address and telephone number, an individual to act as the Permittee's primary IPM contact person with the City. In addition, Permittee shall comply with the requirements of Sections 303(a) and 303(b) of the Pesticide Ordinance.

22. Conflicts of Interest. Through its execution of this Entry Permit, Permittee acknowledges that it is familiar with the provisions of Section 15.103 of the San Francisco Charter, Article III, Chapter 2 of City's Campaign and Governmental Conduct Code, and Sections 87100 *et seq.* and Sections 1090 *et seq.* of the Government Code of the State of California, and certifies that it does not know of any facts which would constitute a violation of said provision, and agrees that if Permittee becomes aware of any such fact during the Term, Permittee shall immediately notify the City.

23. No Assignment. This Entry Permit is personal to Permittee and shall not be assigned, conveyed or otherwise transferred by Permittee under any circumstances except by operation of law. Any attempt to assign, convey or otherwise transfer this Entry Permit shall be null and void and cause the immediate termination and revocation of this Entry Permit.

24. Sunshine Ordinance. Permittee understands and agrees that under the City's Sunshine Ordinance (San Francisco Administrative Code Chapter 67) and the State Public Records Law (California Government Code Section 6250 *et seq.*), apply to this Entry Permit and any and all records, information, and materials submitted to the City in connection with this Entry Permit. Accordingly, any and all such records, information and materials may be subject to public disclosure in accordance with the City's Sunshine Ordinance and the State Public Records Law. Permittee hereby authorizes the City to disclose any records, information and materials submitted to the City in connection with this Entry Permit.

25. Food Service Waste Reduction. Permittee agrees to comply fully with and be bound by all of the applicable provisions of the Food Service Waste Reduction Ordinance, as set forth in the San Francisco Environment Code, Chapter 16, including the remedies provided therein, and implementing guidelines and rules. The provisions of Chapter 16 are incorporated herein by reference and made a part of this Entry Permit as though fully set forth herein. Accordingly, Permittee acknowledges that City contractors and lessees may not use Disposable Food Service Ware that contains Polystyrene Foam in City Facilities and while performing under a City contract or lease, and shall instead use suitable Biodegradable/Compostable or Recyclable Disposable Food Service Ware. This provision is a material term of this Entry Permit.

26. Prohibition of Tobacco Sales and Advertising. Permittee acknowledges and agrees that no advertising of cigarettes or tobacco products is allowed on the Permit Area. This advertising prohibition includes the placement of the name of a company producing, selling or distributing cigarettes or tobacco products or the name of any cigarette or tobacco product in any promotion of any event or product. This advertising prohibition does not apply to any advertisement sponsored by a state, local, nonprofit or other entity designed

to (i) communicate the health hazards of cigarettes and tobacco products, or (ii) encourage people not to smoke or to stop smoking.

27. Prohibition of Alcoholic Beverage Advertising. Permittee acknowledges and agrees that no advertising of alcoholic beverages is allowed on the Permit Area. For purposes of this Section, "alcoholic beverage" shall be defined as set forth in California Business and Professions Code Section 23004, and shall not include cleaning solutions, medical supplies and other products and substances not intended for drinking. This advertising prohibition includes the placement of the name of a company producing, selling or distributing alcoholic beverages or the name of any alcoholic beverage in any promotion of any event or product. This advertising prohibition does not apply to any advertisement sponsored by a state, local, nonprofit or other entity designed to (i) communicate the health hazards of alcoholic beverages, (ii) encourage people not to drink alcohol or to stop drinking alcohol, or (iii) provide or publicize drug or alcohol treatment or rehabilitation services.

28. Tropical Hardwoods and Virgin Redwood Ban. The City and County of San Francisco urges companies not to import, purchase, obtain or use for any purpose, any tropical hardwood, tropical hardwood wood product, virgin redwood or virgin redwood wood product, except as expressly permitted by the application of Sections 802(b) and 803(b) of the San Francisco Environment Code. Permittee agrees that, except as permitted by the application of Sections 802(b) and 803(b), Permittee shall not use or incorporate any tropical hardwood, tropical hardwood wood product, virgin redwood or virgin redwood wood product in the performance of this Entry Permit.

29. Possessory Interest Taxes. Permittee recognizes and understands that this Entry Permit may create a possessory interest subject to property taxation and that Permittee may be subject to the payment of property taxes levied on such interest under applicable law. Permittee agrees to pay taxes of any kind, including possessory interest taxes, if any, that may be lawfully assessed on Permittee's interest under this Entry Permit or use of the Permit Area pursuant hereto and to pay any other taxes, excises, licenses, permit charges or assessments based on Permittee's usage of the Permit Area that may be imposed upon Permittee by applicable law. Permittee shall pay all of such charges when they become due and payable and before delinquency.

30. Consideration of Criminal History in Hiring and Employment Decisions. Permittee agrees to comply fully with and be bound by all of the provisions of Chapter 12T of the San Francisco Administrative Code (City Contractor/Subcontractor Consideration of Criminal History in Hiring and Employment Decisions) ("**Chapter 12T**"), including the remedies and implementing regulations of Chapter 12T, as may be amended from time to time, in the hiring or employment any person with respect to the Permitted Activities. The provisions of Chapter 12T are incorporated by reference and made a part of this Entry Permit as though fully set forth herein. Such provisions include, but are not limited to, the requirements for solicitations or advertisements for employees made by Permittee if such employees would perform any of the Permitted Activities and the prohibition of certain inquiries when initially interviewing job candidates for such employment positions. The text of the Chapter 12T is available on the web at <http://sfgov.org>.

Permittee shall incorporate by reference in all subcontracts the provisions of Chapter 12T, and shall require all its contractors to comply with such provisions. Permittee's failure to comply with the obligations in this Section shall constitute a material breach of this Entry Permit. Permittee understands and agrees that if it fails to comply with the requirements of Chapter 12T, City shall have the right to pursue any rights or remedies available under Chapter 12T, including but not limited to, a penalty of \$50 for a second violation and \$100 for a subsequent violation for each employee, applicant or other person as to whom a violation occurred or continued, termination or suspension in whole or in part of this Entry Permit.

31. Cooperative Drafting. This Entry Permit has been drafted through a cooperative effort of both parties, and both parties have had an opportunity to have the License reviewed and revised by legal counsel. No party shall be considered the drafter of this Entry Permit, and no presumption or rule that an ambiguity shall be construed against the party drafting the clause shall apply to the interpretation or enforcement of this Entry Permit.

32. Severability. If any provision of this Entry Permit or the application thereof to any person, entity or circumstance shall be invalid or unenforceable, the remainder of this Entry Permit, or the application of such provision to persons, entities or circumstances other than those as to which it is invalid or unenforceable, shall not be affected thereby, and each other provision of this Entry Permit shall be valid and be enforceable to the fullest extent permitted by law, except to the extent that enforcement of this Entry Permit without the invalidated provision would be unreasonable or inequitable under all the circumstances or would frustrate a fundamental purpose of this Entry Permit.

33. Counterparts. This Entry Permit may be executed in two or more counterparts, each of which shall be deemed an original, but all of which taken together shall constitute one and the same instrument.

34. General Provisions. (a) This Entry Permit may be amended or modified only by a writing signed by City and Permittee. (b) No waiver by any party of any of the provisions of this Entry Permit shall be effective unless in writing and signed by an officer or other authorized representative, and only to the extent expressly provided in such written waiver. (c) Except as otherwise expressly set forth herein, all approvals and determinations of City requested, required or permitted pursuant to this Entry Permit may be made in the sole and absolute discretion of the SFMTA's Director of Transportation or other authorized City official. (d) This Entry Permit (including the exhibit(s) hereto) contains the entire agreement between the parties and all prior written or oral negotiations, discussions, understandings and agreements are merged herein. (e) The section and other headings of this Entry Permit are for convenience of reference only and shall be disregarded in the interpretation of this Entry Permit. (f) Time is of the essence. (g) This Entry Permit shall be governed by California law and the City's Charter. (h) If either party commences an action against the other or a dispute arises under this Entry Permit, the prevailing party shall be entitled to recover from the other reasonable attorneys' fees and costs. For purposes hereof, reasonable attorneys' fees of City shall be based on the fees regularly charged by private attorneys in San Francisco with comparable experience. (i) Permittee may not record this Entry Permit or any memorandum hereof. (j) Subject to the prohibition against assignments or other transfers by Permittee hereunder, this Entry Permit shall be binding upon and inure to the benefit of the parties and their respective heirs, representatives, successors and assigns. (i) If City sells or otherwise conveys any portion of the Permit Area, the owner of such conveyed portion of the Permit Area shall accept such portion subject to this Entry Permit and shall assume City's rights and obligations under this Entry Permit to the extent such rights and obligations affect such transferred portion.

[REMAINDER OF PAGE INTENTIONALLY LEFT BLANK]

Permittee represents and warrants to City that it has read and understands the contents of this Entry Permit and agrees to comply with and be bound by all of its provisions.

PERMITTEE:

FRIENDS OF THE GENEVA OFFICE BUILDING AND POWERHOUSE, a California non-profit corporation

By: _____
Its: _____

Date: _____

By: _____
Its: _____

Date: _____

CITY:

CITY AND COUNTY OF SAN FRANCISCO, a municipal corporation, acting by and through the San Francisco Municipal Transportation Agency

By: _____
Edward D. Reiskin
Director of Transportation

Date: _____

APPROVED AS TO FORM:

DENNIS J. HERRERA, City Attorney

By: _____
Carol Wong, Deputy City Attorney

EXHIBIT A

Depiction of City Property, Buildings, and Permit Area

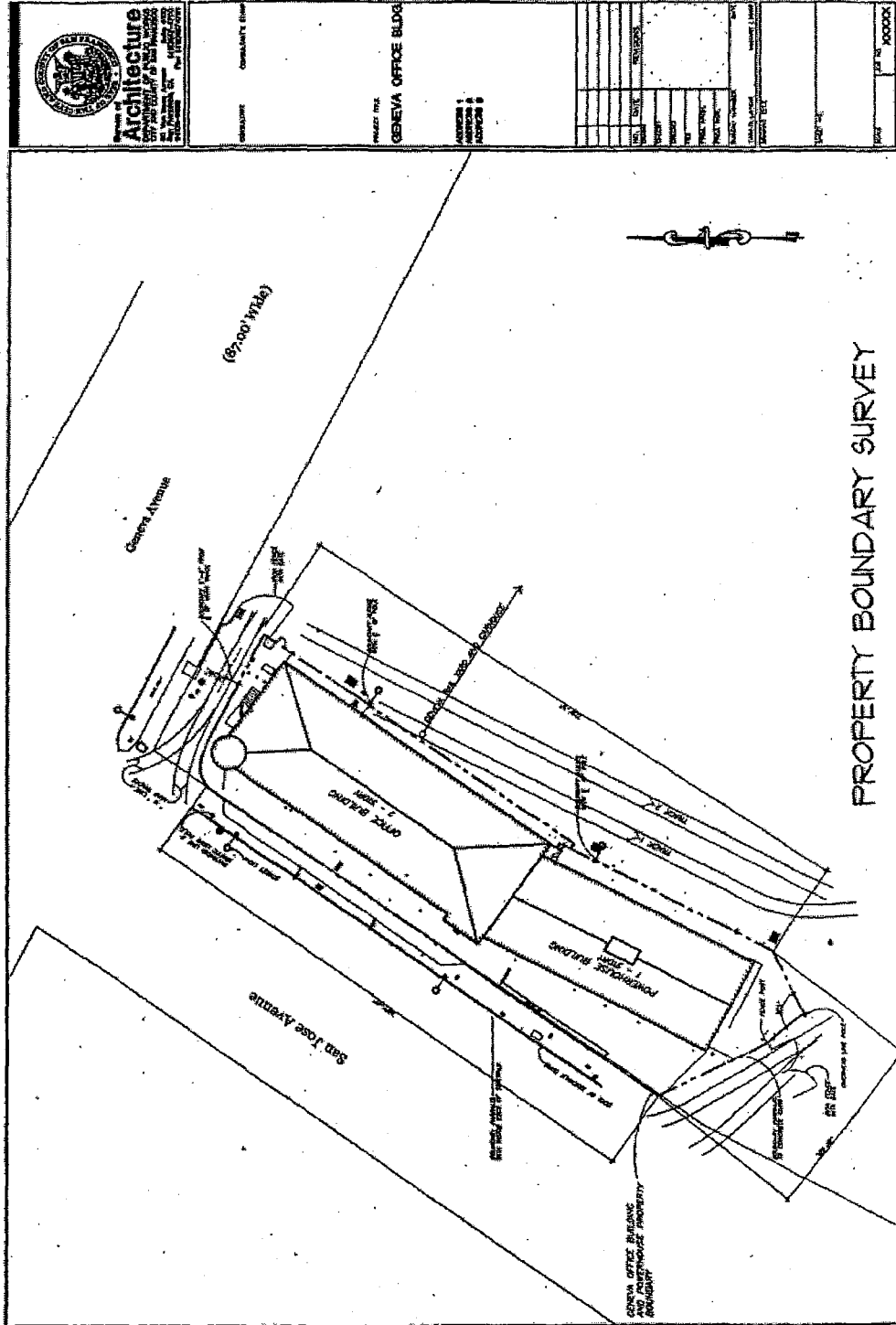

Architecture	CONSULTANT'S SEAL
PROJECT TITLE: GENEVA OFFICE BLDG.	
ARCHITECT: [Name]	
DATE: [Date]	
SCALE: [Scale]	
SHEET NO. 10000	

EXHIBIT B

Project Phases

[to be modified as applicable]



SAN FRANCISCO PLANNING DEPARTMENT

Certificate of Determination EXEMPTION FROM ENVIRONMENTAL REVIEW

Case No.: 2012.0262E
 Project Title: Geneva Car Barn and Powerhouse - 2301 San Jose Avenue
 Zoning/Plan Area: Public (P) District
 40-X Height and Bulk District
 Balboa Park Station Plan Area
 Block/Lot: 6972/036
 Lot Size: 117,804 square feet
 Project Sponsor: Nicole Avril, San Francisco Recreation and Park Department
 (415) 305-8468
 Staff Contact: Craig Jung - (415) 575-9126
 craig.jung@sfgov.org

1650 Mission St.
 Suite 400
 San Francisco,
 CA 94103-2479

Reception:
 415.558.6378

Fax:
 415.558.6409

Planning
 Information:
 415.558.6377

PROJECT DESCRIPTION:

The proposed project involves adaptive reuse of two contiguous structures on the site: the Geneva Office Building (12,916 square feet) and Power House (3,735 square feet), collectively referred to as the "Geneva Complex." The project sponsor would construct a 40-foot-tall, 19,892 square-foot (sf) youth arts education center, theater and community assembly space. The Geneva Office Building is a two-story-plus-basement, utilitarian building, and the Geneva Power House is a one-story (with mezzanine), industrial building.

[continued on the next page]

EXEMPT STATUS:

Exempt per Section 15183 of the California Environmental Quality Act (CEQA) Guidelines California Public Resources Code Section 21083.3

DETERMINATION:

I do hereby certify that the above determination has been made pursuant to State and Local requirements.

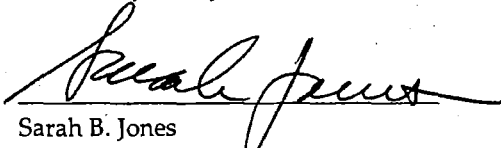
 Sarah B. Jones
 Environmental Review Officer

November 14, 2013
 Date

cc: Nicole Avril, Project Sponsor
 Michael Smith, Current Planning Division
 Dan Weaver, Friends of the Geneva Car Barn

Supervisor John Avalos, District 11
 Virna Byrd, M.D.F.
 Historic Preservation Distribution List

PROJECT DESCRIPTION (CONTINUED):**Project Location and Existing Conditions**

The project site (Assessor Block 6972, Lot 036) is located at 2301 San Jose Avenue on a 117,804 sf lot at the southeast corner of San Jose Avenue and Geneva Avenue on the block bounded by Geneva Avenue to the north, Delano Avenue to the east, Niagara Avenue to the south and San Jose Avenue to the west (Figure 1). Historically, the Geneva Complex served as both the administrative center of the San Francisco rail system (Office Building) and as the power source for all the rail cars (Powerhouse). The project site is also known or referred to as "The Geneva Car Barn and Powerhouse" and will be referred to as such here after.

The project site is on a lot that is 329 feet wide by 373 feet long and has two, contiguous, two-story buildings on the project site: a 40-foot-tall, 50-foot-wide, 12,916-square-foot office building that extends 129 feet along San Jose Avenue and a 30-foot-tall, 37-foot-wide, 3,735 -square-foot powerhouse (historical use) building that extends 92 feet along San Jose Avenue. The Geneva Office Building was constructed in 1901 and the Powerhouse was constructed between 1901 and 1903. At the north and south ends of the two buildings are two sets of train tracks that are used by Muni street cars to access the site. There are no curb cuts but automobile access to the site is provided through the train tracks on the south side of the two buildings. An eight-foot-tall metal fence exists along the perimeter of the project site. Trees are adjacent to the project site along Geneva Avenue in the public right of way. The project site is vacant and is owned by the San Francisco Recreation and Park Department. Based on United States Geological Survey data, the project site elevation is between 215 feet above mean sea level, with a gentle slope to the east. The project site is within a Public (P) Use District and 40-X Height and Bulk District.

Zoning districts in the project vicinity vary (Figure 2). Zoning near and around the project site consists of RH-1, NCT-1, NCT-2 and Public Use Districts. To the west, approximately 338 feet from the project site, is Interstate-280 (I-280) and the land adjacent to I-280 is zoned for Small-Scale Neighborhood Commercial Transit (NCT-2). Abutting the project site to the south and east are Residential-House One Family (RH-1) Use Districts. To the north and across San Jose Avenue from the site is a block consisting of Public (P), Neighborhood Commercial Transit Cluster (NCT-1) and Residential-House One Family (RH-1) Use Districts.

The Balboa Park BART Station, situated in a P Use District, is located at the northwest corner of San Jose and Geneva Avenues across the street from the project site. Other P Use Districts are located north of the project site, and include James Denman Middle School, and the Geneva Avenue Strip public open space. The RH-1 Use District (east, southeast and northeast of the project site) is made up of primarily single-family, one-story over garage houses. The NCT-1 Use District (north of the project site) is made up of primarily single-family, one-story over garage houses except for the corner of Geneva Avenue and San Jose Avenue where a three-story residential over commercial building is situated next to a single-story commercial building. Across the street, west of the project site, is a NCT-2 Use District that is currently a parking lot but would be developed to include residential/commercial uses in the future.

Figure 1

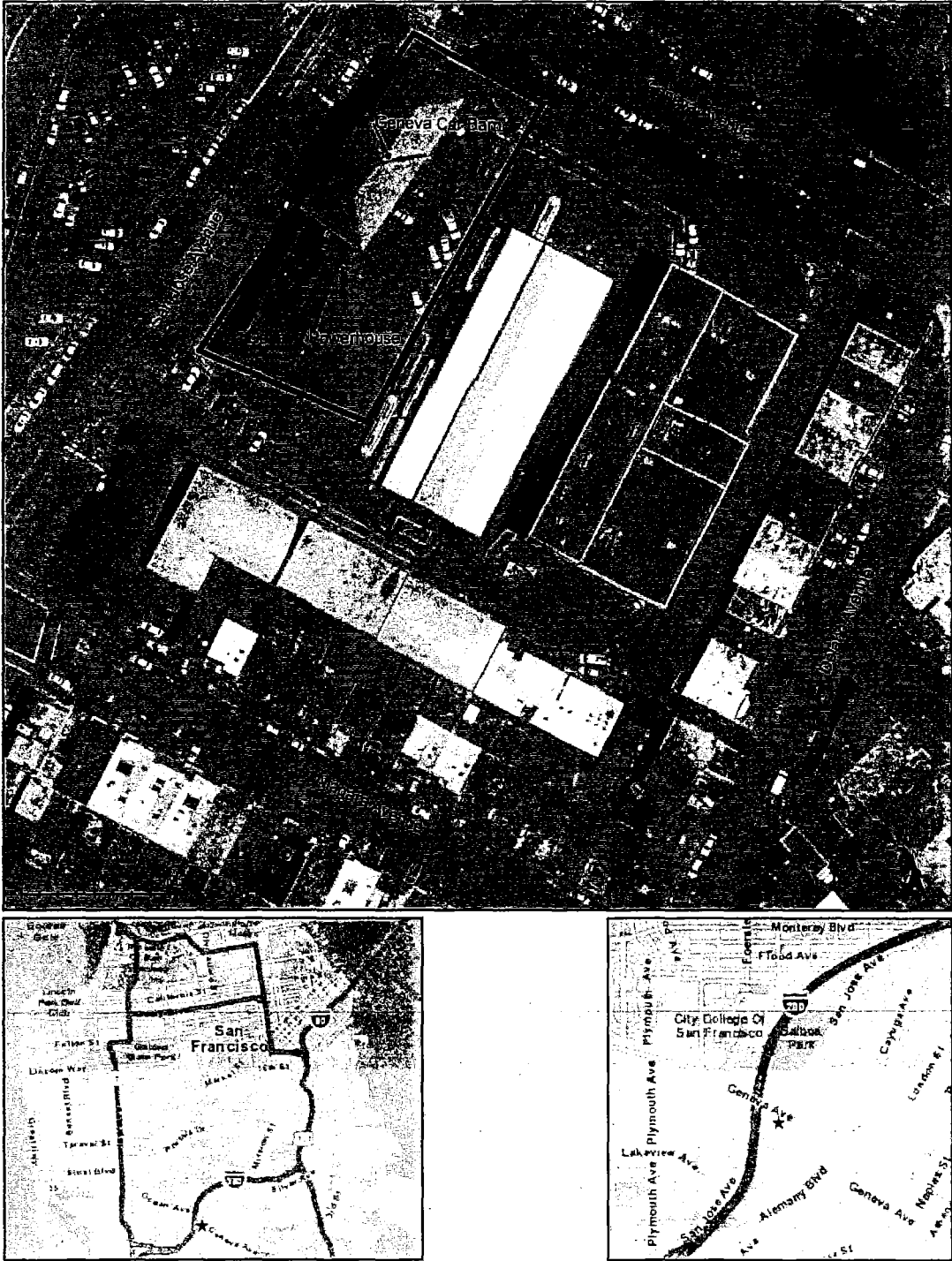





SAN FRANCISCO
PLANNING DEPARTMENT

Created by: San Francisco Planning Department
August 07, 2013

Figure 2



- Zoning Districts**
- Public**
 -  P Public
 - Residential, House**
 -  RH-1 One Family
 - Neighborhood Commercial Transit**
 -  NCT-1 Neighborhood Commercial Transit Cluster District
 -  NCT-2 Small-scale Neighborhood Commercial Transit District

 **SAN FRANCISCO
 PLANNING DEPARTMENT**
 27 August, 2013

Project Characteristics

The Geneva Office Building would contain the youth arts-related training facilities, a movie theater, administrative offices, training kitchen, restaurant and retail space on the ground floor. The Powerhouse would contain a community space and performing arts theater. Within the Office Building a third floor including two mezzanines would be constructed and add 2,400 sf. Within the Powerhouse a 550 sf would be added to serve the movie theater lobby. The basement would add 250sf for ancillary uses, i.e. bathrooms. These additional structures would add 3,200 sf and increase the overall square footage from 16,650 sf to 19,900 sf (Figures 3 and 4).

Significant historic features and finishes of the Geneva Office Building would be restored, an elevator and staircase would be added and all building systems would be brought up to code. This facility would be restored and the exterior massing and envelope will remain. All exterior work will be in accordance with the Secretary of the Interior's Standards.

Construction would last approximately 14-15 months with an anticipated date of occupancy in winter, 2015. Construction phases would occur simultaneously and include soil remediation, excavation, below-grade construction, exterior renovations and glazing, and interior renovations, construction and finishes. The estimated construction cost is \$21,000,000.

Project Approvals

The proposed project would require the following approvals, with the Recreation and Park Commission approval of the conceptual design as the Approval Action for the proposed project:

Recreation and Park Commission

- The project would require approval of the conceptual and schematic design.
- The project would require the approval of the Lease Disposition and Development Agreement between the Rec and Park Department and the Friends of the Geneva Car Barn.
- The project would require the approval of the lease.
- The Memorandum of Understanding (MOU) between the Rec and Park Department and San Francisco Municipal Transportation Authority would require approval.

Planning Commission

- The project would require a Conditional Use authorization for the proposed restaurant pursuant to Section 234.2 of the Planning Code.
- A parking variance would be required to eliminate the parking requirement pursuant to Section 151 of the Planning Code.

Historic Preservation Commission

- Certificate of Appropriateness pursuant to Section 1006 of the Planning Code.

Figure 3. The proposed floor plans for the basement and first floor.

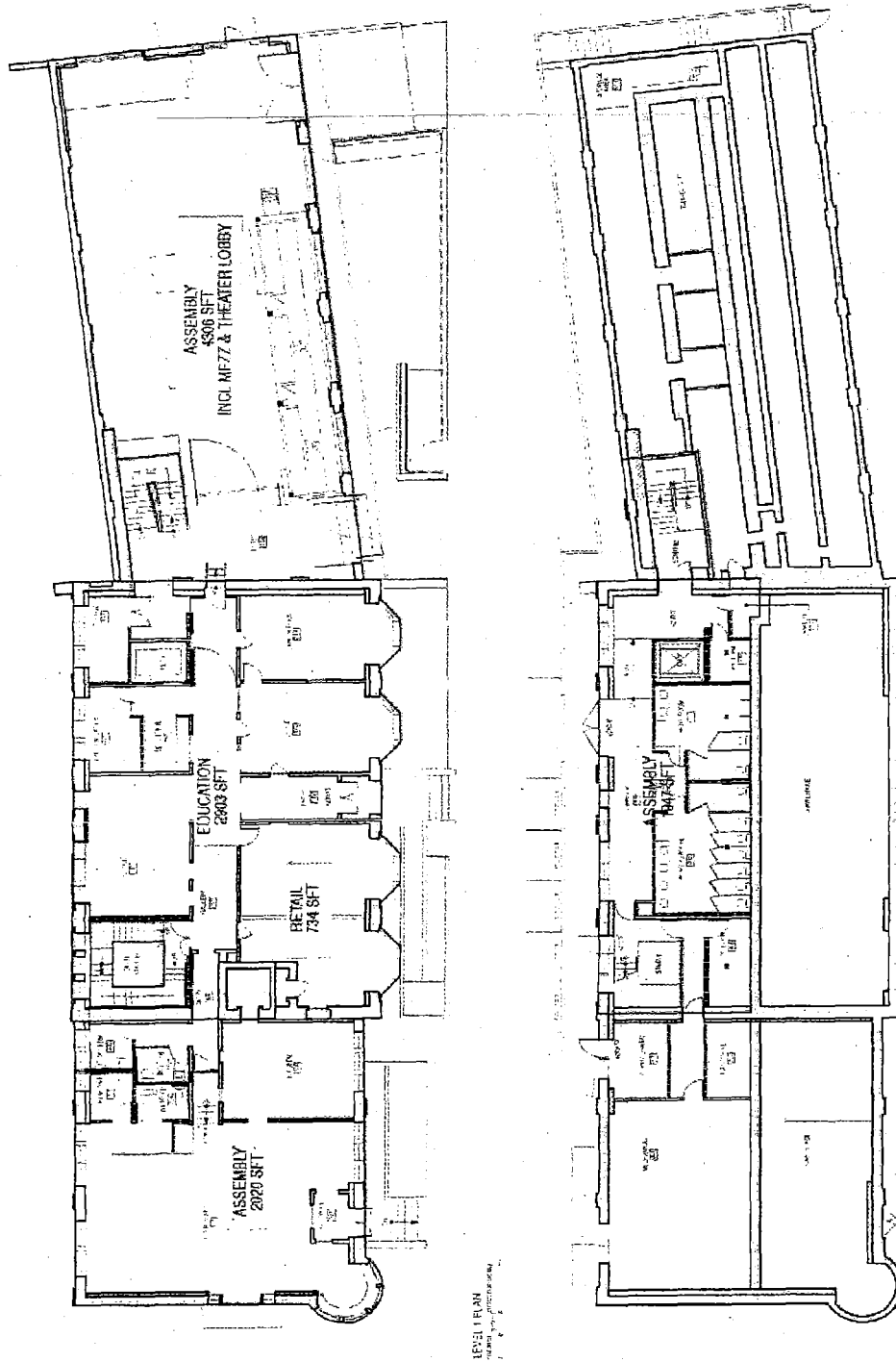

Created by: Aidlin Darling Design
10/30/13

BASEMENT PLAN
10/30/13

Figure 4. The proposed floor plans for the second floor and attic (3rd level).

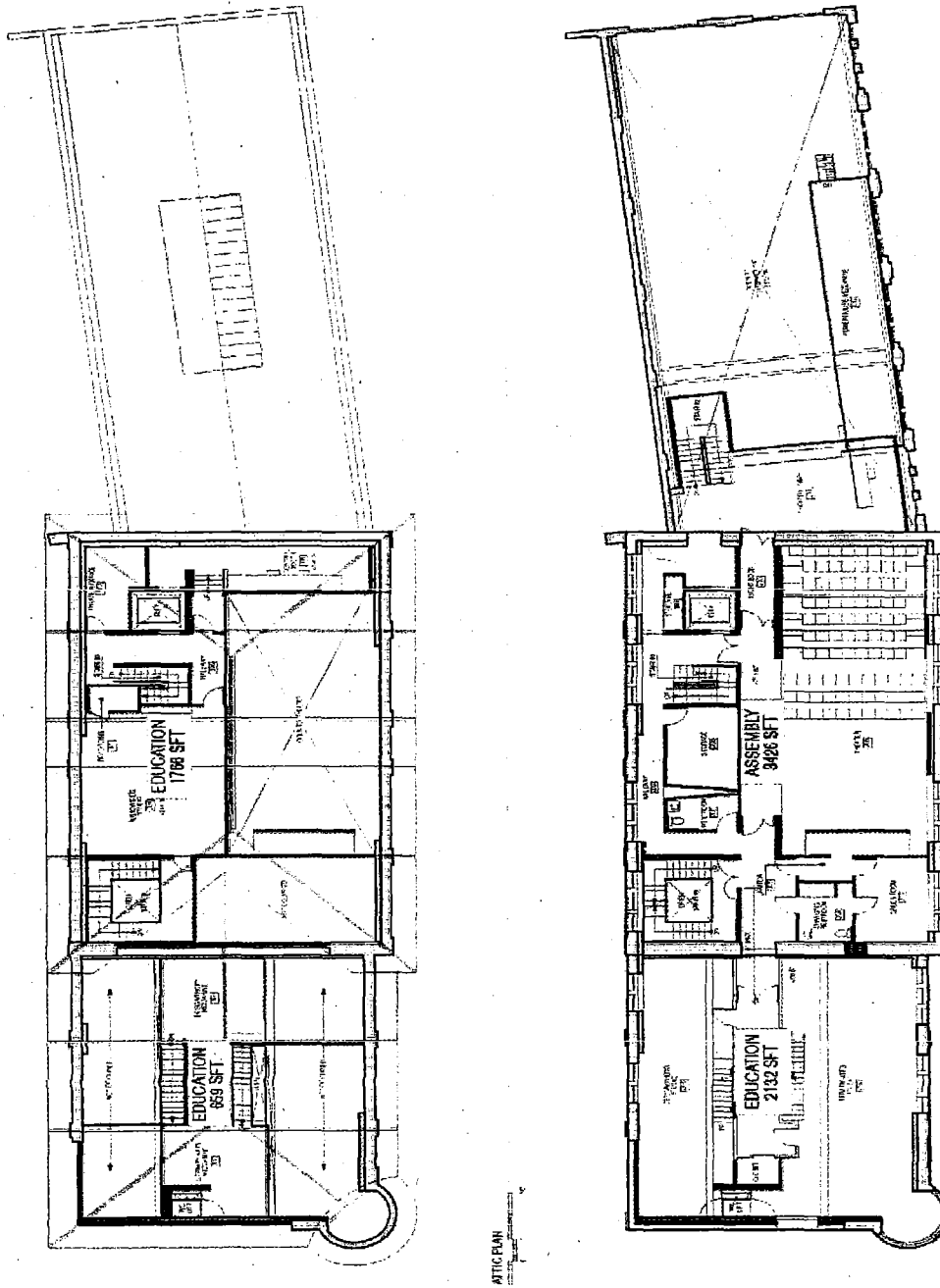

Created by: Aidlin Darling Design
10/30/13

LEVEL 2 PLAN
Aidlin Darling Design

REMARKS:

The California Environmental Quality Act (CEQA) State Guidelines Section 15183 provides an exemption from environmental review for projects that are consistent with the development density established by existing zoning, community plan or general plan policies for which an Environmental Impact Report (EIR) was certified, except as might be necessary to examine whether there are project-specific effects which are peculiar to the project or its site. Section 15183 specifies that examination of environmental effects shall be limited to those effects that: a) are peculiar to the project or parcel on which the project would be located; (b) were not analyzed as significant effects in a prior EIR on the zoning action, general plan or community plan with which the project is consistent; c) are potentially significant off-site and cumulative impacts which were not discussed in the underlying EIR; and d) are previously identified in the EIR, but are determined to have a more severe adverse impact than that discussed in the underlying EIR. Section 15183(c) specifies that if an impact is not peculiar to the parcel or to the proposed project, then an EIR need not be prepared for that project solely on the basis of that impact.

This Certificate of Determination (determination) evaluates the topics for which a significant impact is identified in the final programmatic EIR, the *Balboa Park Station Area Plan Final EIR*¹ (FEIR), and evaluates whether the proposed project would result in impacts that would contribute to the impact identified in the FEIR. Mitigation measures identified in the FEIR applicable to the proposed project are identified in the text of the determination under each topic area. The Community Plan Exemption Checklist (Attachment A) identifies the potential environmental impacts of the proposed project and indicates whether such impacts are addressed in the *Balboa Park Station FEIR*.

This determination assesses the proposed project's potential to cause environmental impacts and concludes that the proposed project would not result in new, peculiar environmental effects, or effects of greater severity than were already analyzed and disclosed in the *Balboa Park Station Area Plan FEIR*. This determination does not identify new or additional information that would alter the conclusions of the *Balboa Park Station Area Plan FEIR*. This determination also identifies mitigation measures contained in the *Balboa Park Station Area Plan FEIR* that would be applicable to the proposed Geneva Car Barn and Powerhouse project. Relevant information pertaining to prior environmental review conducted for the *Balboa Park Station Area Plan* (Area Plan) is included below, along with an evaluation of potential environmental effects.

Background

After several years of analysis, community outreach, and public review, the *Balboa Park Station Area Plan* was adopted in April 7, 2009. The *Balboa Park Station Area Plan* was adopted in part to encourage and intensify mixed-use housing and neighborhood-serving retail development near transit. The *Balboa Park Station Area Plan* also included changes to existing height and bulk districts in some areas, including the project site.

During the *Balboa Park Station Area Plan* adoption phase, the Planning Commission held public hearings to consider the various aspects of the proposed area plans, and Planning Code and Zoning Map amendments. On December 4, 2008, the Planning Commission certified the *Balboa Park Station Area Plan FEIR* by Motion 17774 and adopted the Preferred Project for final recommendation to the Board of Supervisors.

¹ *Balboa Park Station Area Plan Final Environmental Impact Report*, Planning Department Case No. 2004.1059E, certified December 4, 2008. The FEIR is on file for public review at the Planning Department, 1650 Mission Street Suite 400 as part of Case No. 2004.1059E, or at http://www.sf-planning.org/ftp/files/MEA/2004.1059E_Balboa_FEIR_Pt1.pdf.

On April 7, 2009 the Board of Supervisors approved the *Balboa Park Station Area Plan*, and the Mayor signed the legislation for the *Balboa Park Station Area Plan*. It was enacted on May 18, 2009. New zoning districts would encourage residential infill, maintain existing commercial uses, encourage new commercial uses and increase public transportation use.

The *Balboa Park Station Area Plan* FEIR is a comprehensive programmatic document that presents an analysis of the environmental effects of implementing the Balboa Park Station Rezoning and Area Plans, as well as the potential impacts of the proposed alternative scenarios. The *Balboa Park Station Area Plan* Draft EIR evaluated three alternatives, the Area Plan with Transportation Improvements, the Area Plan with No Transportation Improvements, and No Project. The Planning Commission adopted the Area Plan with Transportation Improvements as the Preferred Project after fully considering the environmental effects of the Preferred Project and the various scenarios discussed in the FEIR.

The *Balboa Park Station Area Plan* FEIR identified a significant and unavoidable impact to cultural architectural resources and transportation and circulation. The *Balboa Park Station Area Plan* FEIR included analyses of environmental issues including: land use; population, housing and employment (growth inducement); transportation and circulation; noise; air quality; shadow; archeological resources; historic architectural resources; greenhouse gas emissions; and water quality and hydrology. The Initial Study included analyses of visual resources; utilities and public resources; biological resources; geology; energy and natural resources and hazardous materials.

The Geneva Car Barn and Powerhouse are located in the Transit Station Area Subarea of the *Balboa Park Station Area Plan*, which retains the project site's P (Public) Use District zoning but changed the height district of the site from 105 feet to 40 feet. The Area Plan rezoned other areas of the Transit Station Area Subarea from a RH-1 (One-Family) and NC-2 (Small-Scale Neighborhood Commercial) Use District to a NCT (Neighborhood Commercial Transit) Use District.

Individual projects that could occur in the future under the *Balboa Park Station Area Plan* will undergo project-level environmental evaluation to determine if they would result in further impacts specific to the development proposal, the site, and the time of development and to assess whether additional environmental review would be required. This determination concludes that the proposed project is consistent with and was partially analyzed in the *Balboa Park Station Area Plan* FEIR. Further, this determination finds that the *Balboa Park Station Area Plan* FEIR adequately anticipated and described the impacts of the proposed project, and identified the applicable mitigation measures. Planning Department staff has determined that the proposed project is consistent with the *Balboa Park Station Area Plan* FEIR Plan and satisfies the requirements of the General Plan and the Planning Code.^{2,3} Therefore, no further CEQA evaluation for the Geneva Car Barn and Powerhouse project is necessary.

Potential Environmental Effects

The following discussion demonstrates that the Geneva Car Barn and Powerhouse project would not result in significant impacts beyond those analyzed and disclosed in the *Balboa Park Station Area Plan* FEIR, including project-specific impacts related to cultural resources, transportation and circulation, noise, air quality, and hazardous materials.

² Adam Varat, San Francisco Planning Department, Community Plan Exemption Eligibility Determination, Citywide Planning and Policy Analysis, 2301 San Jose Avenue - Geneva Car Barn. This document is on file and available for review as part of Case File No. 2012.0262E at the San Francisco Planning Department, 1650 Mission Street, Suite 400

³ Jeff Joslin, San Francisco Planning Department, Community Plan Exemption Eligibility Determination, Neighborhood Analysis, 2301 San Jose Avenue - Geneva Car Barn. This document is on file and available for review as part of Case File No. 2012.0262E at the San Francisco Planning Department, 1650 Mission Street, Suite 400

Cultural Resources

Archeological Resources

The *Balboa Park Station FEIR* identified potential archeological impacts due to the lack of survey and data collection required to identify the location of specific pre-historic and historic archaeological resources within the entire project area. Two archeological mitigation measures were proposed that would reduce impacts to archeological resources to a less-than-significant level. *Balboa Park Station Area Plan FEIR Mitigation Measure AM-1 - Accidental Discovery*: applies to projects involving activities including excavation, construction of foundations, soils improvement/densification, and installation of utilities or soils remediation resulting in soils disturbance/modification to a depth of 4 feet or greater below ground surface. Mitigation Measure AM-2 - Accidental Discovery: applies to any project involving any soils-disturbing activities greater than 10 feet in depth, including excavation, installation of foundations or utilities or soils remediation, and to any soils-disturbing project of any depth within the Phelan Loop and Kragen Auto Parts Sites, the east side of San Jose between Ocean and Geneva Avenues, and the Upper Yard Parcel.

The proposed project would require approximately four feet to ten feet of excavation and soil remediation. Therefore, Mitigation Measure AM-1 would apply to the proposed project.

The project would not require ten feet or more of excavation. Therefore, the project would not be subject to Mitigation Measure AM-2.

Finally, review by the San Francisco Planning Department Staff Archaeologist determined the proposed project would have "no effect to archaeological resources".

With Project Mitigation Measures 1, the proposed project would not result in significant impacts that were not identified in the *Balboa Park Station Area Plan FEIR* related to archeological resources.

Project Mitigation Measure 1 – Accidental Discovery (Mitigation Measure AM-1 of the Balboa Park Station Area Plan FEIR). The following mitigation measure is required to avoid any potential adverse effect from the proposed project on accidentally discovered buried historical resources as defined in CEQA Guidelines Section 15064.5(a)(c). The project sponsor shall distribute the Planning Department archeological resource "ALERT" sheet to the project prime contractor; to any project subcontractor (including demolition, excavation, grading, foundation, pile driving, etc. firms); or utilities contractor involved in soils disturbing activities within the project site. Prior to any soils disturbing activities being undertaken each contractor is responsible for ensuring that the "ALERT" sheet is circulated to all field personnel, including machine operators, field crew, pile drivers, supervisory personnel, etc. The project sponsor shall provide the Environmental Review Officer (ERO) with a signed affidavit from the responsible parties (prime contractor, subcontractor(s), and utilities firm) to the ERO confirming that all field personnel have received copies of the Alert Sheet.

Should any indication of an archeological resource be encountered during any soils disturbing activity of the project, the project Head Foreman and/or project sponsor shall immediately notify the ERO and shall immediately suspend any soils disturbing activities in the vicinity of the discovery until the ERO has determined what additional measures should be undertaken.

If the ERO determines that an archeological resource may be present within the project site, the project sponsor shall retain the services of a qualified archeological consultant. The archeological consultant shall advise the ERO as to whether the discovery is an archeological resource, retains

sufficient integrity, and is of potential scientific/historical/cultural significance. If an archeological resource is present, the archeological consultant shall identify and evaluate the archeological resource. The archeological consultant shall make a recommendation as to what action, if any, is warranted. Based on this information, the ERO may require, if warranted, specific additional measures to be implemented by the project sponsor.

Measures might include: preservation in situ of the archeological resource; an archaeological monitoring program; or an archeological testing program. If an archeological monitoring program or archeological testing program is required, it shall be consistent with the Major Environmental Analysis (MEA) division guidelines for such programs. The ERO may also require that the project sponsor immediately implement a site security program if the archeological resource is at risk from vandalism, looting, or other damaging actions.

The project archeological consultant shall submit a Final Archeological Resources Report (FARR) to the ERO that evaluates the historical significance of any discovered archeological resource and describing the archeological and historical research methods employed in the archeological monitoring/data recovery program(s) undertaken. Information that may put at risk any archeological resource shall be provided in a separate removable insert within the final report.

Copies of the Draft FARR shall be sent to the ERO for review and approval. Once approved by the ERO, copies of the FARR shall be distributed as follows: California Archaeological Site Survey Northwest Information Center (NWIC) shall receive one (1) copy and the ERO shall receive a copy of the transmittal of the FARR to the NWIC. The Major Environmental Analysis division of the Planning Department shall receive three copies of the FARR along with copies of any formal site recordation forms (CA DPR 523 series) and/or documentation for nomination to the National Register of Historic Places/California Register of Historical Resources. In instances of high public interest or interpretive value, the ERO may require a different final report content, format, and distribution than that presented above.

Historical Architecture

The *Balboa Park Station Area Plan FEIR* anticipated that implementation of the Area Plan may result in the demolition of buildings identified as contributors to a historic district. The FEIR determined that a cumulative significant impact to historic resources would occur due to the loss of contributing buildings and the construction of considerably taller infill buildings in their place and on other sites within the potential district. The loss of specific buildings could eliminate the integrity of the potential district (i.e., its ability to convey its historic significance through survival of original features) such that potential the Ocean Avenue Neighborhood Commercial District could no longer be justified. The FEIR did not recommend any mitigation measures to address this impact. This unavoidable impact was addressed in a Statement of Overriding Considerations with Findings and adopted as part of the *Balboa Park Station Area Plan* approval on December 4, 2008.

The *Balboa Park Station Area Plan FEIR* identified the Geneva Office Building as a historic resource due to its inclusion in Article 10 of the San Francisco Planning Code, the City's landmarks preservation ordinance. The Geneva Office Building is San Francisco Designated Landmark no. 180.⁴ Accordingly, as part of the environmental review for the proposed Geneva Car Barn and Powerhouse project, San

⁴ The Geneva Office Building and not the Geneva Powerhouse is presumed to be a historical resource under CEQA as a locally designated resource under Article 10 of the Planning Code (City Landmark #180). The San Francisco Board of Supervisors made this designation with Ordinance Number 555-85.

San Francisco Planning Department historical preservation staff evaluated the project's impact on historical resources. The following is a summary of the staff's analysis.⁵

The Geneva Car Barn and Powerhouse are not located within the potential Ocean Avenue Neighborhood Commercial Historic District or the potential Balboa Park Historic District. As such, the proposed project would not have a significant impact on the potential historic districts.

The FEIR analyzed the impact of the Area Plan on the Geneva Office Building. The FEIR indicated that the Area Plan does not include any specific development proposal for the project site. However, the Area Plan envisions rehabilitation and reuse of the landmark Geneva Office Building as a "primary activity generator for the station area." The Area Plan reduced the existing 105-foot height limit to 40 feet, which maintains the existing height of the Geneva Office Building and further ensures the building is preserved. This downzoning would reduce development pressures on the site by reducing the likelihood that the site would be redeveloped with a new building or addition that would be out of scale and character with the existing building. Any proposal for exterior alteration or demolition of the resource would require review under Article 10 of the Planning Code, and project-level analysis under CEQA to evaluate the significance of impacts on the historical resource.

The project site contains several structures including a metal building for train maintenance, constructed in 2009, a parking lot and a Muni car storage yard. The Geneva Office Building and Power House historically served as both the administrative center of the San Francisco rail system and as the power source for all the rail cars, respectively.

The first structure, the Geneva Office Building, is a two-story (plus basement), 12,916-sf utilitarian building, designed by the Reid Brothers Architects, and constructed in 1901. The building is reinforced concrete and brick, with a brick and wood trim exterior, built in the Roman-Renaissance Revival style. This building was also historically known as the S.F. & San Mateo Railroad Company Office Building. The S.F. & San Mateo Railroad Co., the first tenant of the building, is historically significant as a component of the electrical railway system in San Francisco at the turn of the century.

The second structure is the Geneva Power House, a two-story, 3,735-sf industrial building which was constructed sometime between 1901 and 1903. It is thought that the Reid Brothers Architects may have executed the design for this building; however, this is unconfirmed. The Geneva Power House contained the electrical transformers that powered San Francisco's electric rail cars. The Power House was significantly damaged in the earthquake of 1906, including collapse of the entire second story. The repairs to the Power House resulted in significant alterations to the building's original appearance. For this reason, the Geneva Office Building was designated by the Board of Supervisors as San Francisco Landmark No. 180, and the Power House was not included.

San Francisco Planning Department Historical Preservation staff determined that the proposed project would not have a significant adverse impact upon the Geneva Office Building such that the significance of the building would be materially impaired, nor would the proposed project cause a significant adverse impact to a California Register-eligible historic district. The proposed project would adaptively reuse the Geneva Office Building and the Geneva Power House. The exterior massing and building envelope would remain. The significant historic exterior features and finishes would be restored. Any additions to the historic building would not impair nor encroach upon the structural significance of the building.

⁵ Michael Smith, San Francisco Planning Department, Historic Resource Evaluation Response, January 11, 2013. This evaluation is available for review as part of Case file No. 2012.0262E at the San Francisco Planning Department, 1650 Mission Street, Suite 400.

Rehabilitation rather than replacement would be incorporated when possible. All rehabilitation and cleaning techniques would not damage the historical characteristics of the building. The project sponsor would conduct all work in accordance with the Secretary of the Interior's Standards.

In light of the above, the proposed project would not significantly impact San Francisco Designated Landmark no. 180.

Transportation and Circulation

The *Balboa Station Area Plan FEIR* anticipated that growth resulting from the zoning changes and transportation improvements could result in significant transportation and circulation impacts and identified mitigation measures. These impacts were found to be significant and unavoidable because cumulative traffic impacts at certain local intersections and the cumulative impacts on Muni K-Ingleside transit line could not be fully mitigated to less-than-significant levels. These impacts were addressed in a Statement of Overriding Considerations with Findings and adopted as part of the *Balboa Park Station Area Plan* approval on December 4, 2008.

The Balboa Park Station Area Plan FEIR proposed a mitigation measure to alter traffic signal timing for the Ocean Avenue/San Jose Avenue and Ocean Avenue/I-280 NB on-ramp intersections. In order to improve operating conditions to acceptable levels at the Ocean Avenue/I-280 NB on-ramp intersection, on-street parking would need to be removed from the westbound approach to the intersection in order to stripe an exclusive right-turn lane. Five seconds of green time would also need to be shifted from the westbound movement to the eastbound left-turn movement in order to accommodate the increased eastbound left-turn volume. Operating conditions at Ocean/San Jose Avenue intersection could improve by adding eight seconds of green time, which would need to be shifted from the north-south permitted phase to the east-west permitted phase to accommodate the increased east-west volume. Since implementing the proposed mitigation measures would involve the San Francisco Municipal Transportation Agency (SFMTA) assessment and approval it is uncertain that the measure is feasible to mitigate significant impacts to a less-than-significant level.

Trip Generation

Trip generation of the proposed project was calculated using information in the 2002 Transportation Impacts Analysis Guidelines for Environmental Review (SF Guidelines) developed by the San Francisco Planning Department.⁶ The proposed project would generate approximately 184 person trips (inbound and outbound) on a weekday daily basis during the PM peak hours of 5:00 to 6:00, consisting of 119 person trips by auto, 22 transit trips, and 43 trips by other modes. During the p.m. peak hour, the proposed project would generate an estimated 64 vehicle trips (accounting for vehicle occupancy data for this Census Tract). Due to the project's location near major transit routes, this is likely a conservative estimate of vehicle trips.

Traffic

Intersection operating conditions are characterized by the concept of Level of Service (LOS), which ranges from A to F and provides a description of an intersection's performance based on traffic volumes, intersection capacity, and vehicle delays. LOS A represents free flow conditions, with little or no delay, while LOS F represents congested conditions, with extremely long delays; LOS D (moderately high delays) is considered the lowest acceptable level in San Francisco. Implementing the Area Plan would

⁶ CHS Consulting Group, *Transportation Memo for Geneva Car Barn and Powerhouse Trip Generation Study*, August 13, 2013. This document is available for review as part of Case file No. 2012.0262E at the San Francisco Planning Department, 1650 Mission Street, Suite 400.

impact the intersections discussed below because they would experience significant loss of service (LOS) levels, E-F.

The proposed project is located in the Transit Station Area Subarea, which the *Balboa Park Station Area Plan FEIR* included in the traffic analysis (existing and 2025 operating conditions) based on proposed development plan options. During weekday p.m. peak hour conditions under the 2025 Area Plan the LOS at the following intersections would deteriorate: Ocean Avenue/I-280 northbound (NB) on-ramp is anticipated to change from LOS C to LOS F; Ocean Avenue/San Jose Avenue intersection⁷ is anticipated to change from LOS C to LOS F; Geneva Avenue/I-280 northbound and southbound (SB) ramps intersection is anticipated to change from LOS C to LOS F; and Ocean Avenue/Geneva Avenue/Phelan Avenue intersection is anticipated to change from LOS B to LOS F. The intersection of Ocean Avenue and Junipero Serra Boulevard is anticipated to change from LOS D to F under the 2025 Area Plan. The proposed project would not contribute to the traffic-related impacts at this intersection because the two locations are 1.7 miles apart.

The signalized intersection at Ocean Avenue/I-280 NB on-ramp intersection (approximately one block to the north of the project site) during p.m. peak hour operates a LOS C under existing (baseline) conditions and implementing the Area Plan would deteriorate to LOS F. Additional vehicle trips from the proposed project are estimated to be an average of one vehicle per alternate signal cycle. This is a minimal contribution to the increased number of vehicles anticipated at this intersection. Therefore, the proposed project would not make a substantial contribution at this intersection and no mitigation measures would apply.

The signalized intersection at Ocean Avenue/San Jose Avenue (approximately one block to the north of the project site) during p.m. peak hour operates at LOS C under existing (baseline) conditions and implementing the Area Plan would deteriorate to LOS F under 2025 weekday p.m. peak hour operating conditions. Additional project-related trips are estimated to be an average of one vehicle per alternate signal cycle, but would not add substantial demand at the intersection. Therefore, the proposed project would not make a substantial contribution to the significant impact at this intersection and no mitigation measures would apply.

The signalized intersection at Geneva Avenue/I-280 northbound and southbound ramp intersection (one block away to the west of the project site) operates at LOS C under existing (baseline) conditions and implementing the Area Plan would cause the intersection to deteriorate to LOS F. The proposed project would contribute an average of one vehicle per alternate signal cycle. This would be a minimal contribution to the increased number of vehicles expected at this intersection. Therefore, the proposed project would not make a substantial contribution to the significant impact at this intersection and no mitigation measures would apply.

The signalized intersection at Ocean Avenue/Geneva Avenue/Phelan Avenue (four blocks northwest of the project site) currently operates at LOS B under existing (baseline) conditions and implementing the Area Plan would cause the intersection to deteriorate to LOS F. Changes to the intersection due to adding corner sidewalk bulbs, removing a channelized right-turn pocket and the elimination of a westbound vehicle travel lane from constructing a new segment of bicycle lane would contribute to the traffic congestion. The proposed project would contribute an average of one vehicle per alternate signal cycle. This is a minimal contribution to the increased number of vehicles anticipated at this intersection. Therefore, the proposed project would not make a substantial contribution to the significant impact of the Area Plan at this intersection and no mitigation measures would apply.

⁷ Ocean Avenue/San Jose Avenue would operate at LOS F with or without implementation of the Area Plan.

Given that the proposed project would add approximately 64 p.m. peak hour vehicle trips to surrounding intersections, it is not anticipated to substantially increase traffic volumes at these or other nearby intersections, nor substantially contribute to the average delay that would cause these intersections to deteriorate to unacceptable levels of service. The proposed project's contribution of 64 p.m. peak hour vehicle trips would not be a substantial proportion of the overall traffic volume or the new vehicle trips generated by the *Balboa Park Station Area Plan* projects, should they be approved. Therefore, the proposed project would not result in a project-specific traffic impact.

Freeway Ramp Operating Conditions

The Area Plan proposed changing to a single-point interchange, where there would be only one on- and off-ramp for each freeway mainline direction. The Geneva Avenue/I-280 NB on-ramp would be eliminated and the I-280 SB off-ramps to Geneva Avenue and Ocean Avenue would be combined into one off-ramp at Geneva Avenue. Overall, the revised freeway on-ramps are expected to operate at LOS D, with conditions similar to the current configuration. At the study off-ramps, with the proposed lane configurations, queues can be expected to spill back onto I-280, which would cause operations to deteriorate to LOS F, a significant impact on freeway mainline conditions. At the program level of analysis, feasible mitigation measures cannot be identified or developed to address the effects to mainline conditions as a result of the proposed consolidation of the off-ramps. Therefore, a Statement of Overriding Considerations related to the significant and unavoidable cumulative (2025) traffic impact was adopted as part of the EIR certification and project approval on December 4, 2008.

The proposed project would provide minimal contributions to the mainline traffic queues related to the Geneva Avenue/I-280 off-ramp. Therefore, the proposed project would not make a substantial contribution to the significant impact regarding the I-280 mainline operating conditions.

Transit

The *Balboa Park Station Area Plan FEIR* identified a significant and unavoidable cumulative impact relating to increases in transit ridership due to the Area Plan rezoning, population increase, and infill development. Implementation of the Area Plan would contribute about 6 percent to the future ridership on the K-Ingleside line at the maximum load point, increasing the already exceeded capacity utilization from 100 percent to 106 percent during the p.m. peak period. There is no mitigation measure proposed to address the impact related to increased ridership, and therefore, was found to be significant and unavoidable.

The proposed project is estimated to add 22 p.m. peak hour transit person trips occurring in the p.m. peak hour. The project site is served by other local and regional transit lines including BART, Muni Metro lines (J-Church and M-Oceanside) and Muni bus lines (8x-Bayshore Express, 8BX-Bayshore B Express, 26-Valencia, 29-Sunset, 43-Masonic, 49-Van Ness-Mission, 54-Felton, 88 BART Shuttle and 91-Owl) and therefore, the additional project-related P.M. peak hour transit trips would likely be accommodated on existing routes, and would result in a less-than-significant impact to transit services. For the above reasons, the proposed project would not result in transit-related peculiar impacts that were not identified and analyzed in the *Balboa Park Station Area Plan FEIR*.

In conclusion, the proposed project would not have peculiar transportation circulation impacts that were not evaluated and identified in the *Balboa Park Station Area Plan FEIR*.

Noise

The *Balboa Park Station Area Plan Initial Study* (IS) identified potential significant noise impacts from short-term and long-term construction-related activities. The *Balboa Park Station Area Plan FEIR* identified potential significant noise and vibration impacts related to exposing occupants of new residential development in close proximity to high traffic roadways such as I-280, Ocean, Geneva, San Jose and Phelan Avenue. The IS determined that compliance with San Francisco Noise Ordinance (Article 29 of the Police Code) would mitigate potential construction noise impacts to a less-than-significant level. Two mitigation measures, N-1 and N-2, were proposed in the *Balboa Park Station Area Plan FEIR*. Both mitigation measures are specific to new residential development related to implementation of the Area Plan.

Since the proposed project would not construct new dwelling units that could be exposed to excessive ambient noise levels or create new noise-generating uses the project would result in less-than-significant noise impacts and would not have peculiar impacts.

Air Quality

The *Balboa Park Station Area Plan IS* identified a significant construction-related air quality impact and determined that Mitigation Measure AQ-1, which specified construction dust control measures, would reduce the effects to a less-than-significant level. Subsequent to publication of the IS, the San Francisco Board of Supervisors approved a series of amendments to the San Francisco Building and Health Codes, generally referred to as the Construction Dust Control Ordinance (Ordinance 176-08, effective July 30, 2008). The intent of the Construction Dust Control Ordinance is to reduce the quantity of dust generated during site preparation, demolition, and construction work in order to protect the health of the general public and of on-site workers, minimize public nuisance complaints, and to avoid orders to stop work by the Department of Building Inspection. Construction activities from the proposed project would result in dust, primarily from ground-disturbing activities.

The project sponsor would be required to comply with the Construction Dust Control Ordinance, which would avoid any significant potential construction-related air quality impacts. As a result, the proposed project would not have significant impacts related to the generation of construction dust.

The *Balboa Station Area Plan FEIR* identified potentially significant air quality impacts related to exposing future new residential uses near roadways with elevated pollutant levels, diesel particulate matter and PM₁₀. These significant impacts would conflict with the applicable air quality plan at the time, the *Bay Area 2005 Ozone Strategy*. The *Balboa Station Area Plan FEIR* identified one mitigation measure that would reduce air quality impacts to less-than-significant levels.

The *Balboa Park Station Area Plan FEIR* determined that Mitigation Measure AQ-2 would reduce effects to a less-than-significant level. Mitigation Measure AQ-2 would not apply because the proposed project does not include residential units.

For the above reasons, significant air quality impacts would not result from the proposed project.

Hazardous Materials

The *Balboa Park Station Area Plan Initial Study* determined that during excavation, grading, and dewatering activities, hazardous materials could be encountered in the soil or groundwater, resulting in the potential exposure of workers, the public, and the environment to hazardous materials, which would be a significant impact.

Potential impacts from the proposed project would be the result of the exterior/interior renovations, excavation and change of use from industrial to institutional. The exterior/interior renovations would likely result in potential exposure of workers or the community to hazardous building materials during renovation and construction. The previous industrial use would require further investigation, soil remediation, and is subject to the Maher Ordinance due to the past industrial use and the change of use from industrial to institutional.

There are four mitigation measures from the IS but only two of the measures would apply because one measure addresses naturally occurring asbestos and the other is specific to the Kragen Auto Parts Site development project. The project site is not located on top of serpentine rock formations, which are the primary source of naturally occurring asbestos in San Francisco. In accordance with the *Balboa Park Station Area Plan FEIR* requirements, the project sponsor has agreed to implement Project Mitigation Measures 3 and 4, below.

Implementation of Project Mitigation Measure 3 would minimize worker, public, and environmental exposure to hazardous materials in the soil or groundwater during construction and would be less than significant.

Project Mitigation Measure 3 – Phase I, Environmental Site Assessment (Mitigation Measure HM-1 of the Balboa Park Station Area Plan FEIR). Development projects in the *Balboa Park Station Area Plan* Project Area that include excavation, shall prepare a site-specific Phase I Environmental Site Assessment for sites not subject to regulatory closure prior to development. The site assessment shall include visual inspection of the property; review of historical documents; and review of environmental databases to assess the potential for contamination from sources such as underground storage tanks, current and historical site operations, and migration from off-site sources. If the Phase I Environmental Site Assessment indicates that a release of hazardous materials could have affected soil or groundwater quality at the site, follow up investigations and possibly remediation shall be conducted in conformance with state and local laws, regulations, and guidelines.

Project Mitigation Measure 3 has been met due to the project site being located within the Maher zone, the historic industrial use at the site and the change of use from industrial to institutional. As such, the project is subject to Article 22A of the Health Code, also known as the Maher Ordinance, which is administered and overseen by the Department of Public Health (DPH). The Maher Ordinance requires the project sponsor to retain the services of a qualified professional to prepare a Phase I Environmental Site Assessment (ESA) that meets the requirements of Health Code Section 22.A.6.

The Geneva Car Barn and Powerhouse property is listed on various hazardous materials databases. The databases included the emissions inventory data (EMI), Resource Conservation and Recovery Act small quantity generator (RCRA SQG), facility and manifest data (HAZNET), historical hazardous waste and substance site (HIST CORTESE), leaking underground storage tank (LUST), facility index system (FINDS) and historical underground storage tank (HIST UST). An underground storage tanks (UST) existed on the project site.

The Phase I ESA prepared for the project⁸ identified several potentially recognized environmental conditions (REC's) in connection with the prior uses of the site and adjacent properties required

⁸ Ecology and Environment, Inc., Phase I Environmental Site Assessment for Geneva Car Barn and Powerhouse, 2301 San Jose Avenue, City and County of San Francisco, California, February 2012. A copy of this document is available for review at the Planning Department, 1650 Mission Street, Suite 400, in File No. 2012.0262E.

assessment to determine potential presence at the site. Historically the office building was used by SFMTA for offices and boarding of transit agency workers. The powerhouse structure housed fuel oil powered electric generators that provided power for electric street cars. The southwest end of the powerhouse contained a former oil storage area that may be contaminated with petroleum oil, which could allow for vapor intrusion from aromatic volatile organic compounds into the powerhouse structure. Chlorinated volatile organic compounds (VOCs) in the breathing air of the office building and powerhouse used off-site may be present. In the powerhouse, the oil stains on the concrete floor suggest the possible presence of poly chlorinated biphenyls (PCB), which may also be found in fluorescent light ballasts and various electric components throughout both buildings. Mercury from old thermostats may be present in the office building. Lead based paint (LBP) and asbestos containing building materials (ACBM) may be present in both buildings.

The Phase I report concluded that a Phase II would be required. The Phase II required the development of a field sampling plan to conduct subsurface investigation of the project site.⁹

The Phase II determined the following information. Total petroleum hydrocarbons such as motor oil (TPH-mo) were detected at concentrations exceeding the project screening level in two samples collected from the ½ foot sampling taken from the asphalt pavement. No associated indications of contamination such as staining and odor were noted in the samples suggesting that due to the shallow samples obtained the TPH-mo is most likely associated with the asphalt pavement and not contamination. No further soil testing for TPH-mo is required.

Benzene, a VOC, was the only constituent of potential concern (COPC) from all the indoor air samples obtained that was above the screening levels. It was detected in all the indoor air samples. The source of the VOCs was found to be from an off-site source. No further assessment of VOCs in indoor air at the site is required.

Testing for mercury vapor concentrations determined that it was below the 3,000 ng/m³ screening level. This level is considered acceptable for occupancy of a structure in an occupational or commercial setting after a spill where mercury is not usually handled. The Agency for Toxic Substances and Disease Registry considers this concentration of mercury vapor to be safe and acceptable for indoor air where shorter exposure time typical of most work places provided no visible mercury is present after a spill has been cleaned up.

Lead and asbestos in paint and construction materials are present at concentrations that require special handling and/or disposal and specialized worker training disturbed during the renovation.

Concrete chip samples showed that concentrations of PCBs are below the project screening level of 50 mg/kg. This level is considered to be adequate when determining whether PCB-contaminated concrete will require handling and disposal. Since the land use will change from the original power plant, remediation is required in accordance with 40 CFR Part 761.

The potential presence of PCBs in fluorescent light ballasts and in various electrical components in the office building and in the basement of the powerhouse is a REC that would be addressed by a qualified contractor before renovation of the site.

Recommendations, in terms of pre-renovation requirements, based on review of current and historical laboratory analytical results presented in the Phase I and II reports were provided. Fluorescent light

⁹ Ecology and Environment, Inc., Field Sampling Plan for Targeted Brownfields Assessment of Geneva Car Barn and Powerhouse, 2301 San Jose Avenue, City and County of San Francisco, California, April 2012. A copy of this document is available for review at the Planning Department, 1650 Mission Street, Suite 400, in File No. 2012.0262E.

ballasts and electrical components throughout the office building and powerhouse would be collected and recycled or disposed of, based on whether or not they contain PCBs. Mercury-containing switches would be collected from wall thermostats in the office building by a contractor licensed and trained to handle and dispose of hazardous waste. LBP, ACM and lead-based material would be abated and waste material disposed of in accordance with all applicable regulations. Stained areas of concrete in the powerhouse would be cleaned and waste materials disposed of in accordance with 40 CFR Part 761.

A site mitigation plan (SMP) was prepared and presented mitigation measures recommending how to handle risks to the environment, to workers' and project site users' health and safety from the presence of metal and petroleum related contamination in the soil.

As of August 24, 2013, remediation of any subsurface contamination is required by ordinance under the authority provided in Health Code Article 22A (the Maher Ordinance), which is administered by the Department of Public Health (DPH). Similarly to Mitigation Measure HM-1 (Project Mitigation Measure 3) from the FEIR, the Maher Ordinance requires the project sponsor to retain the services of a qualified professional to prepare a Phase I ESA that meets the requirements of Health Code Section 22.A.6. These steps are required to be completed prior to the issuance of any building permit. Therefore, Mitigation Measure HM-1 is now required by law, and would ensure that remediation of any subsurface soil contamination occurs, resulting in a less-than-significant impact with respect to hazardous materials. Since the project sponsor already complied with the Maher Ordinance, the proposed project would result in less-than-significant hazardous materials impacts from exposing construction workers, the public, and the environment to contaminated soil and groundwater.

Building renovation may lead to the exposure of workers and the public to PCBs and DEHP. Project Mitigation Measure 4 would minimize worker, public and environmental exposure to hazardous materials during construction. Implementation of Project Mitigation Measure 4 would reduce potential exposure to PCBs and DEHP to a less-than-significant level.

Project Mitigation Measure 4 - Hazardous Building Materials (Mitigation Measure HM-2 of the Balboa Station FEIR. The project sponsors of future development in the Project Area that include demolition shall ensure that any equipment containing PCBs or DEHP, such as fluorescent light ballasts, are removed and properly disposed of according to applicable federal, state, and local laws prior to the start of renovation or demolition, and that any fluorescent light tubes, which could contain mercury, are similarly removed and properly disposed of. Any other hazardous materials identified, such as asbestos-containing building materials, either before or during work, shall be abated according to applicable federal, state, and local laws.

Public Notice and Comment

A "Notification of Project Receiving Environmental Review" was mailed on July 27, 2013 to adjacent occupants and owners of properties within 300 feet of the project site.

The Planning Department received comments in response to the notice. Concerns raised include the absence of off-street parking for the project, potential light pollution effects from the type and amount of lighting for the new buildings, loitering in the surrounding neighborhoods, the type of uses and occupants using the new community space, changes to Muni train storage, access changes to Muni train yard due to the project, estimated construction time, hours of operation for construction, hours of operation for the new facility, and whether there will be a public hearing for the proposed project.

Concerns and issues raised in the public comments on the environmental review are discussed in the corresponding topical sections of this CPE. No significant, adverse environmental impacts from issues of

concern have been identified. Comments that do not pertain to physical environmental issues and comments on the merits of the proposed project will be considered in the context of project approval or disapproval, independent of the environmental review process. While local concerns or other planning considerations may be grounds for modifying or denying the proposal, in the independent judgment of the Planning Department, there is no substantial evidence that the proposed project could have a significant effect on the environment.

Conclusion

The *Balboa Park Station Area Plan* FEIR incorporated and adequately addressed all potential impacts of the proposed Geneva Car Barn and Powerhouse project. As described above, the Geneva Car Barn and Powerhouse project would not have any additional or peculiar significant adverse effects not examined in the *Balboa Park Station Area Plan* FEIR, nor has any new or additional information come to light that would alter the conclusions of the *Balboa Station Park Area Plan* FEIR. Thus, the proposed Geneva Car Barn and Powerhouse project would not have new significant or peculiar effects on the environment not previously identified in the *Balboa Station Area Plan* FEIR, nor would any environmental impacts be substantially greater than described in the *Balboa Park Station Area Plan* FEIR. No mitigation measures previously found infeasible have been determined to be feasible, nor have any new mitigation measures or alternatives been identified but rejected by the project sponsor. Therefore, in addition to being exempt from environmental review under Section 15183 of the CEQA Guidelines, the proposed project is also exempt under Section 21083.3 of the California Public Resources Code.

SITE LOCATION MAP (not to scale)

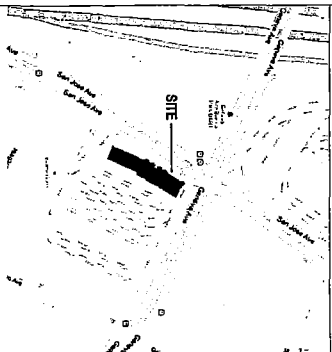

ABBREVIATIONS

Table with 2 columns: Abbreviation and Full Name. Includes entries like 'AA' for Architectural, 'AC' for Architectural Consultant, 'AD' for Architectural Director, etc.

GENERAL NOTES

- 1. ALL DOCUMENTS MUST BE SUBMITTED TO THE ARCHITECT FOR REVIEW AND APPROVAL PRIOR TO CONSTRUCTION.
2. THE CONTRACTOR SHALL BE RESPONSIBLE FOR OBTAINING ALL NECESSARY PERMITS AND APPROVALS FROM THE LOCAL AND STATE AUTHORITIES.
3. THE CONTRACTOR SHALL MAINTAIN ALL UTILITIES AND SERVICES AT ALL TIMES DURING CONSTRUCTION.

SYMBOLS

Table mapping symbols to their corresponding components. Includes symbols for Window Detail, Door Detail, Fan, and various lighting fixtures like Wall Mounted and Recessed Downlight.

SHEET INDEX

Table listing sheet numbers and their corresponding titles. Includes sheets like 'SHEET 001 - GENERAL NOTES' and 'SHEET 002 - LIGHTING PLAN'.

PROJECT DATA

Project Name: [Name]
Address: [Address]
City: [City]
State: [State]
Zip: [Zip]

DIRECTORY

Architect: [Name]
Contractor: [Name]
Electrical: [Name]
Mechanical: [Name]

GENERAL CONTRACTOR AND POWERHOUSE
300 SAN JOSE AVENUE
SAN FRANCISCO, CA
94102

Table with columns: NO., DATE, and NAME. Lists project milestones and dates.

North arrow symbol and project information: A0.1 PROJECT INFORMATION

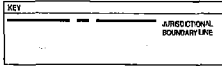
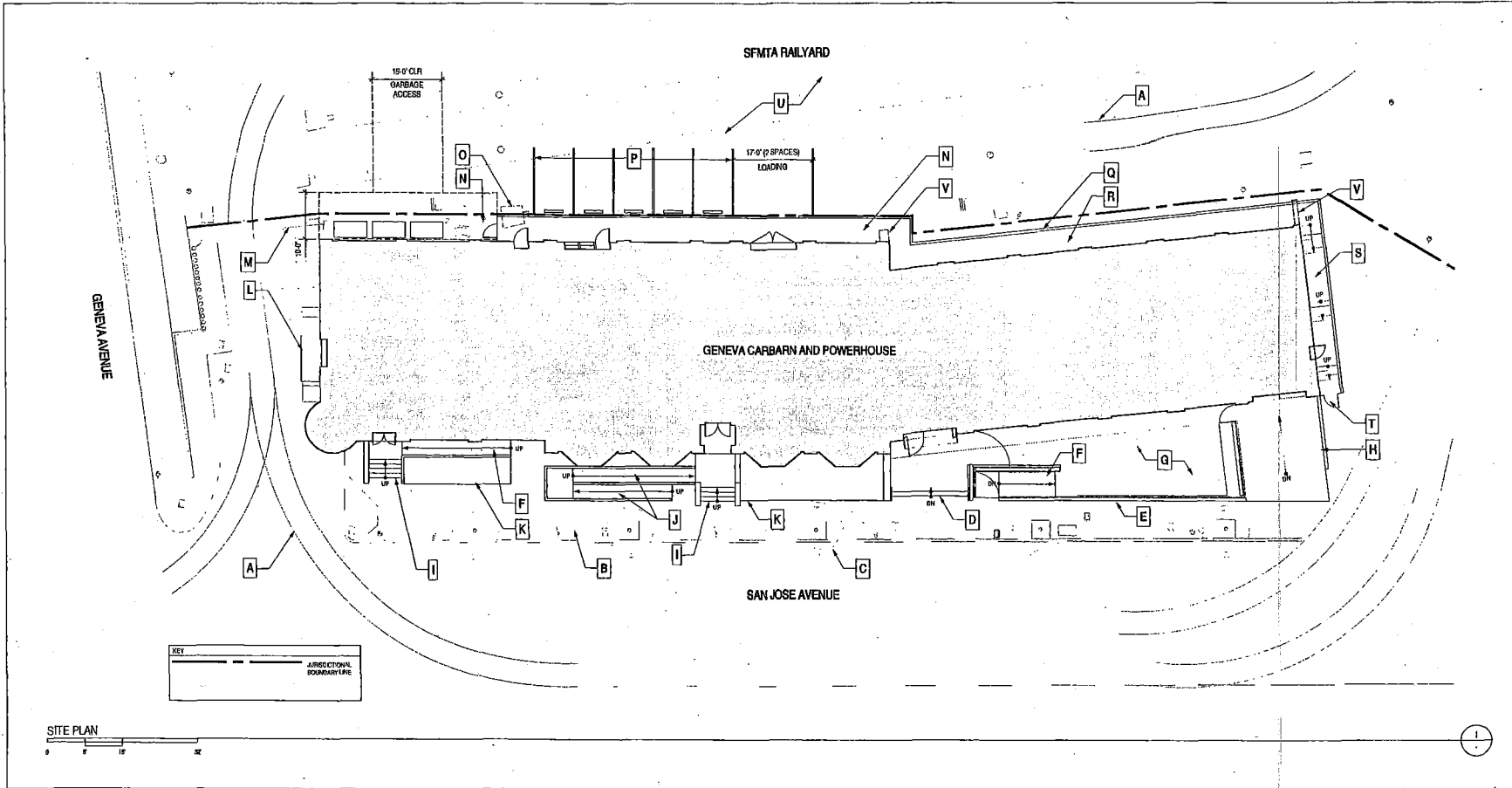

KEY NOTES X

- A. EXISTING MAIN TRACKS TO REMAIN, TYPICAL.
- B. REPLACE EXISTING ASPHALT SIDEWALK WITH CONCRETE. EXISTING CURB TO REMAIN IN PLACE.
- C. STREET TREES WITH METAL GRATES WHERE SHOWN.
- D. CONCRETE STEPS WITH PAINTED METAL HANDRAILS. PROVIDE INTEGRAL STRIPING AT EACH STEP, TYPICAL.
- E. CONCRETE RETAINING WALLS WITH QUADRAL OF PAINTED STEEL VERTICAL PICKETS. SEE RENDERING VIEW IN OUTLINE SPECIFICATIONS FOR DESIGN INTENT.
- F. ACCESSIBLE 1:12 CONCRETE RAMP WITH CODE COMPLIANT PAINTED METAL HANDRAILS.
- G. PERMEABLE PAVING SURFACE AT GARDEN. ASSUME 95% OF AREA TO HAVE PLANTING.
- H. CONCRETE CURB/RETAINING WALL AT LOADING AREA.
- I. REMOVE AND REPLACE EXISTING STAIRS. PROVIDE CONCRETE CURBS AT STAIRS TO MATCH EXISTING. PROVIDE PAINTED STEEL HANDRAILS AND INTEGRAL STRIPING AT EACH STEP, TYPICAL.
- J. ACCESSIBLE 1:20 CONCRETE RAMP WITH CURB AS WHEEL STOP. NO HANDRAILS.
- K. LOW PLANTING BED.
- L. EXISTING WOOD PLATFORM TO BE RETAINED.
- M. EXISTING GATE TO REMAIN.
- N. REMOVE AND REPLACE EXISTING ASPHALT PAVING TO PROVIDE EGRESS PATH ALONG BUILDING.
- O. REMOVE ABANDONED BUMPERS SHOWN DASHED.
- P. RESTRIPE PARKING SPACES ALONG BUILDING.
- Q. PAINTED METAL FENCE AT APPROXIMATELY 4'6" HIGH ALONG EGRESS PATH. ASSUME DESIGN SIMILAR TO THAT AT GARAGE. PROVIDE GATES AT LOADING DOCKS AND AT GARAGE ACCESS.
- R. PROVIDE 1 FOOT CANDLE MINIMUM LIGHTING ALONG EXTERIOR EGRESS PATH, TYPICAL.
- S. CONCRETE STAIR AND RETAINING WALL WITH PAINTED METAL HANDRAIL.
- T. PROVIDE GATE IN EXISTING METAL FENCE WITH EGRESS PANIC HARDWARE.
- U. ALL SITE WORK AND SITE ACCESS WITHIN SFMTA RAILYARD TO BE COORDINATED WITH SFMTA.
- V. EXISTING IRON WALLS TO BE DEMOLISHED TO ALLOW EGRESS ACCESS. TO THE EXTENT POSSIBLE, WALLS ABOVE 7'-0" SHOULD BE RETAINED AND SUPPORTED AS HISTORIC BUILDING FABRIC USING A.E.S.S. FRAME.

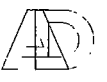

aida lin design
 500 Third Street
 Suite 410
 San Francisco, CA 94107
 415 894 9885 fax
 415 894 9882 phone

GENEVA CAR BARN AND POWERHOUSE

201 SAN JOSE AVENUE
 SAN FRANCISCO, CA

DATE:	07.10.10
JOB:	1001
OWNER:	CW
SCALE:	AS SHOWN
ISSUE:	DATE
SCHUBA/C/P/CAV	07.10.10

NORTH



A0.2

SITE PLAN

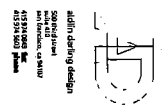

adrian | sterling | design
 2001 16th Street
 San Francisco, CA 94103
 415.774.8888

GENERAL DEMOLITION AND RENOVATION

200 JAWAISE AVENUE
 SAN FRANCISCO, CA
 DATE: 04/10
 SHEET: 101
 DRAWING: 101
 PROJECT: 101

NO.	DATE	DESCRIPTION

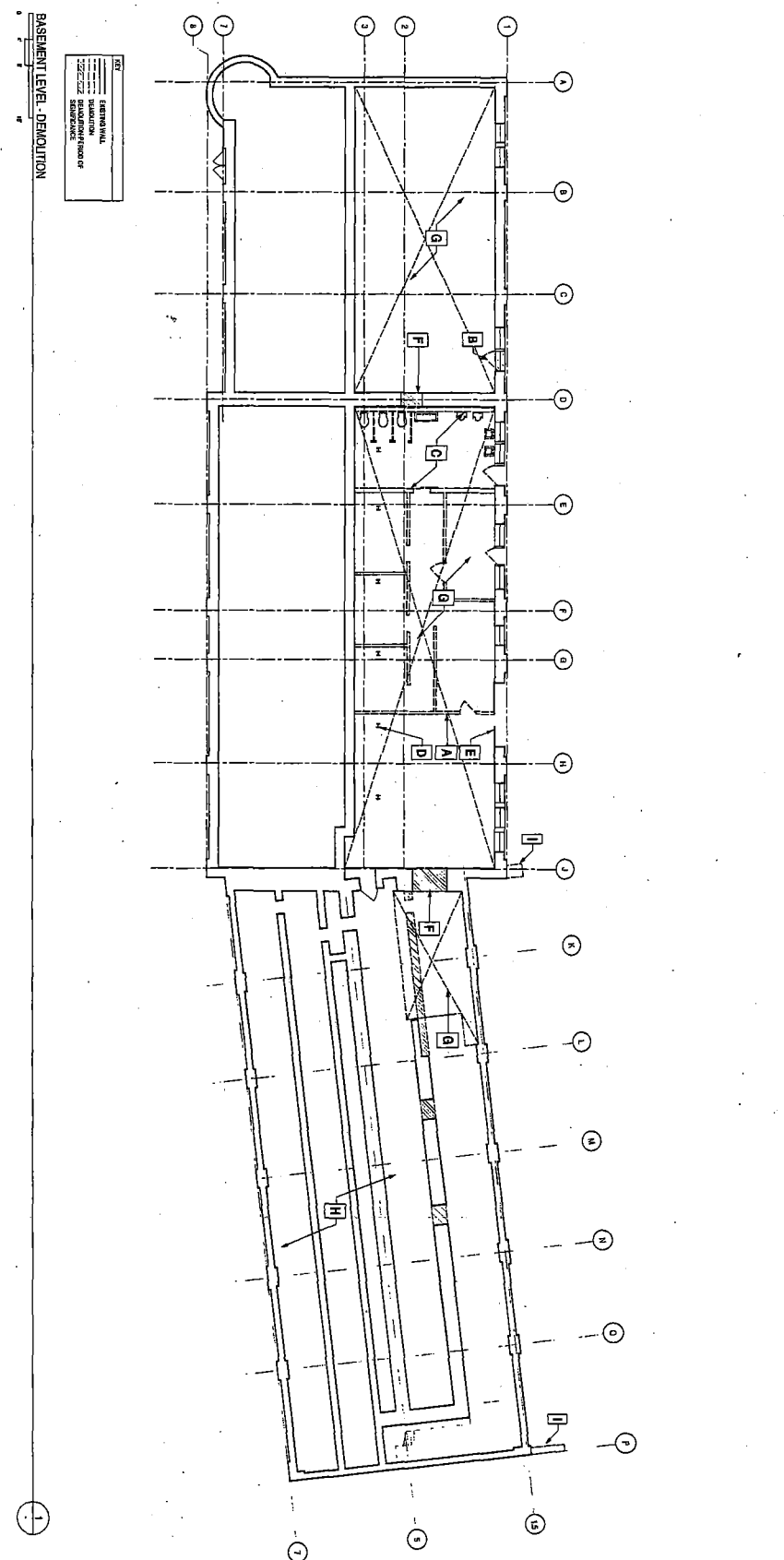

BASEMENT LEVEL - DEMOLITION

SYMBOL	DESCRIPTION
(Solid line)	EXISTING WALL
(Dashed line)	DEMOLITION
(Dotted line)	RENOVATION

GENERAL DEMOLITION NOTES

- PROTECT ALL EXISTING HISTORIC MATERIAL TO REMAIN IN PLACE DURING CONSTRUCTION.
- PROTECT FALLOUT DEMOLITION MATERIALS AS REQUIRED FOR REMEDIATION.
- DEMOLISH ALL UNWANTED DOORS, WINDOWS AND DOOR CASINGS.
- REMOVE ALL UNWANTED BRICK AND CONCRETE.
- REMOVE ALL UNWANTED INTERIORS SUCH AS PLASTER, SHEETROCK, GYP BOARD, AND OTHER FINISHES.
- REMOVE ALL UNWANTED PARTS OF THE BUILDING INCLUDING ROOFING, FLOORING, AND CEILING.
- REMOVE ALL WINDOW FRAMES FROM FINISHES FOR RESTORATION AND REPLACEMENT OF GLASS.

KEYNOTES

- A. DEMO WALLS AND DOORS FROM DRAWING TYPICAL.
- B. DEMO EXISTING DOORS, TRIM, ETC.
- C. REMOVE EXISTING TRIM, PARTS AND ACCESSORIES. REMOVE EXISTING FINISHES FROM WORK.
- D. REMOVE EXISTING STEEL COLUMNS, TYPICAL.
- E. REMOVE EXISTING STEEL BEAMS, TYPICAL.
- F. REMOVE EXISTING STEEL JOISTS FROM THE EXHAUST ROOMS INCLUDING SANGUINO COMPARTMENT.
- G. DEMO EXISTING ROOFING.
- H. REMOVE SOIL FROM UNDER AREA TYPICAL.
- I. SEE SITE PLAN FOR WINDOW LOC.

A1.1

BASEMENT LEVEL
 DEMOLITION PLAN

1650

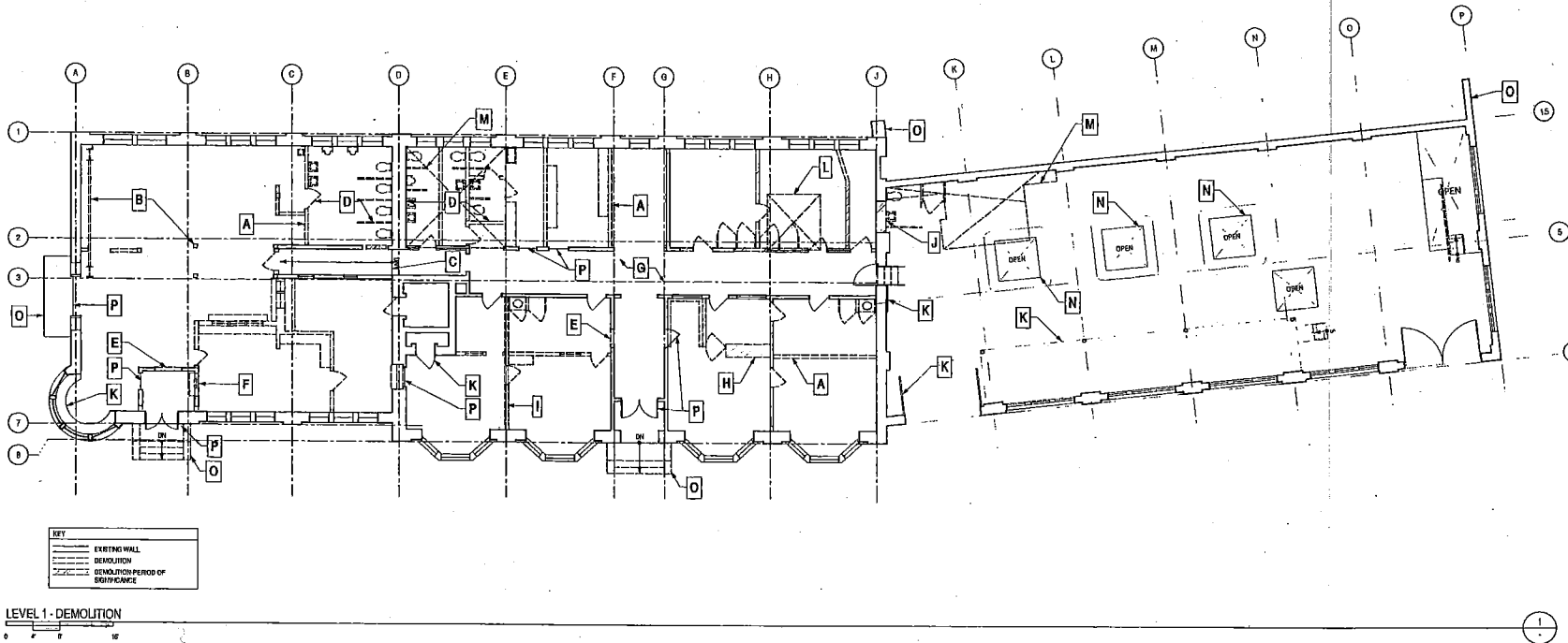

KEY	
	EXISTING WALL
	DEMOLITION
	DEMOLITION PERIOD OF SIGNIFICANCE

LEVEL 1 - DEMOLITION
0 2 4 8 16



adlin clarke design
500 Broadway
Suite 400
San Francisco, CA 94107
415.974.0810 fax
415.974.5653 phone

GENEVA CAR BARN AND POWERHOUSE

3001 BAY JOSE AVENUE
SAN FRANCISCO, CA

DATE:	07.06.10
JOB:	0008
DRAWN:	CW
SCALE:	AS NOTED
ISSUE:	DATE
SCHEMATIC PHASE:	07.12.10

GENERAL DEMOLITION NOTES

PROTECT ALL EXISTING HISTORIC MATERIAL TO REMAIN IN PLACE DURING CONSTRUCTION.

PROTECT SALVAGED DEMOLITION MATERIALS AS REQUIRED FOR REINSTALLATION.

DEMOLISH ALL PLYWOOD WINDOW AND DOOR COVERINGS.

DEMOLISH ALL WATER DAMAGED, BROKEN AND LOOSE PLASTER.

COORDINATE REMOVAL OF HAZARDOUS MATERIALS FROM SITE. ASSUME EXISTING PAINT IS LEAD BASED AND WILL REQUIRE REMOVAL. AT POWERHOUSE, ASSUME PLASTER PAINT TO BE REMOVED WITH REMAINING PART TO BE RETAINED AND ENCAPSULATED.

REMOVE ALL WINDOW SASHES FROM FRAMES FOR RESTORATION AND REPLACEMENT OF GLASS

KEY NOTES X →

A. DEMO WALLS, DOORS AND CASEWORK SHOWN DASHED, TYPICAL.

B. DEMO EXISTING STRUCTURE SHOWN DASHED. SEE STRUCTURAL DRAWINGS.

C. DEMO EXISTING RAMP.

D. REMOVE EXISTING TOILET FIXTURES AND ACCESSORIES. REMOVE EXISTING FINISHES FOR NEW WORK.

E. DEMO OPENING FOR NEW WINDOW.

F. DEMO OPENING FOR NEW DOOR.

G. REMOVE AND RETAIN WOOD FLOORING THROUGHOUT FOR REUSE.

H. REMOVE AND RETAIN CASEWORK FOR RELOCATION.

I. REMOVE WALL BELOW COVERED CEILING MOLDING. RETAIN SURFACE ABOVE.

J. CUT OPENING IN EXISTING BRICK WALL.

K. RETAIN AND PROTECT EXISTING HISTORIC ELEMENT, TYPICAL.

L. REMOVE STRUCTURE AS REQUIRED FOR ELEVATOR. SEE STRUCTURAL DRAWINGS.

M. REMOVE STRUCTURE AS REQUIRED FOR STAIR OPENING. SEE STRUCTURAL DRAWINGS.

N. REMOVE SOIL AND PLANT MATERIAL, TYPICAL.

O. SEE SITE PLAN FOR INFORMATION.

P. EXISTING DOOR TO REMAIN



A1.2
LEVEL 1
DEMOLITION PLAN

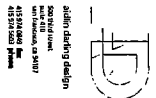

GENERAL CAR BARN AND PORCHES

300 BAY STREET AVENUE
EMERYVILLE, CA

DATE: 02/10/10
JOB: 000

SCALE: AS SHOWN
SHEET: 01

DATE: 02/10/10
SCALE: AS SHOWN

DATE: 02/10/10
SCALE: AS SHOWN

DATE: 02/10/10
SCALE: AS SHOWN

DATE: 02/10/10
SCALE: AS SHOWN

DATE: 02/10/10
SCALE: AS SHOWN

DATE: 02/10/10
SCALE: AS SHOWN

DATE: 02/10/10
SCALE: AS SHOWN

DATE: 02/10/10
SCALE: AS SHOWN

DATE: 02/10/10
SCALE: AS SHOWN

DATE: 02/10/10
SCALE: AS SHOWN

DATE: 02/10/10
SCALE: AS SHOWN

DATE: 02/10/10
SCALE: AS SHOWN

DATE: 02/10/10
SCALE: AS SHOWN

DATE: 02/10/10
SCALE: AS SHOWN

DATE: 02/10/10
SCALE: AS SHOWN

DATE: 02/10/10
SCALE: AS SHOWN

DATE: 02/10/10
SCALE: AS SHOWN

DATE: 02/10/10
SCALE: AS SHOWN

DATE: 02/10/10
SCALE: AS SHOWN

DATE: 02/10/10
SCALE: AS SHOWN

DATE: 02/10/10
SCALE: AS SHOWN

DATE: 02/10/10
SCALE: AS SHOWN

DATE: 02/10/10
SCALE: AS SHOWN

DATE: 02/10/10
SCALE: AS SHOWN

DATE: 02/10/10
SCALE: AS SHOWN

DATE: 02/10/10
SCALE: AS SHOWN

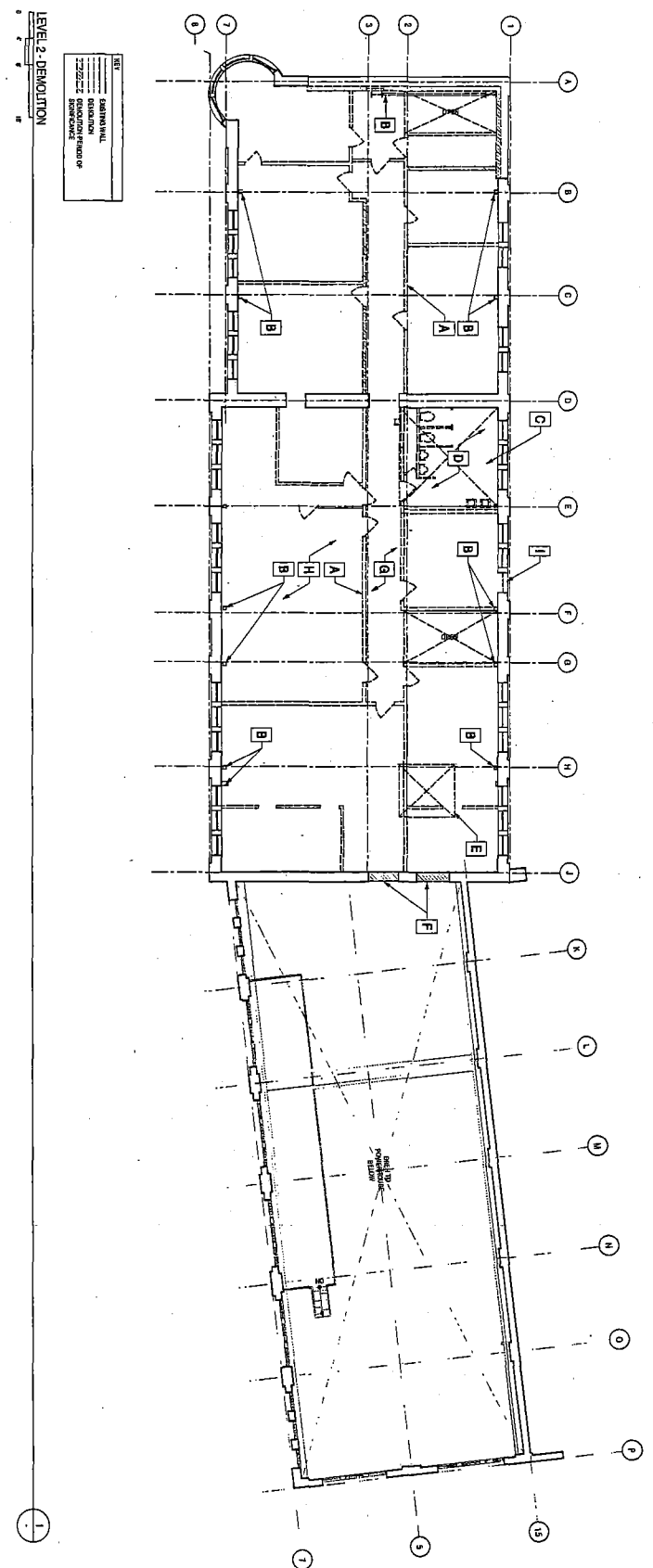

GENERAL DEMOLITION NOTES

PROTECT ALL EXISTING HISTORIC MATERIAL TO REMAIN IN PLACE DURING CONSTRUCTION.
PROTECT SALVAGED DEMOLITION MATERIALS AS REQUIRED FOR REUSE/MATERIAL.
DEMOLISH ALL WINDOW WINDOW AND DOOR CASINGS.
DEMOLISH ALL WINDOW WINDOW AND DOOR CASINGS.
CONCRETE SLOPE OF REVISIONS THROUGHOUT FOR REUSE. REPAIR EXISTING PAINT TO LEAD BASED AND MILL REPAIR. AT REVISIONS, REPAIR EXISTING PAINT TO BE REPAIRED WITH REPAIRING PAINT TO BE REPAIRED AND REPAIRED.
REMOVE ALL WINDOW SIZES FROM FRAMES FOR REVISIONS AND REPAIRMENT OF GLASS.

KEYNOTES

- A. DEMO WALL, DOORS AND CASINGS SHOWN DASHED, TYPICAL.
- B. DEMO EXISTING STRUCTURE SHOWN DASHED. SEE STRUCTURAL DRAWINGS.
- C. REMOVE STRUCTURE AS SHOWN ON SPIN OVERALL. SEE STRUCTURAL DRAWINGS.
- D. REMOVE EXISTING TOILET FIXTURES AND ACCESSORIES. REMOVE EXISTING FINISHES FOR NETWORK.
- E. REMOVE STRUCTURE AS SHOWN ON ELEVATOR. SEE STRUCTURAL DRAWINGS.
- F. CONCRETE SLOPE REPAIR WALL.
- G. REMOVE AND RETAIN WOOD FLOORING THROUGHOUT FOR REUSE. REPAIR EXISTING PAINT TO LEAD BASED AND MILL REPAIR. AT REVISIONS, REPAIR EXISTING PAINT TO BE REPAIRED WITH REPAIRING PAINT TO BE REPAIRED AND REPAIRED.
- H. REMOVE AND SALVAGE EXISTING WOOD WALL AND CEILING FINISH FOR REUSE/CASING WITHIN THEATRE.
- I. REMOVE WOOD PROTECTION AT CHAIRS STAIRS, RETAIN AND PROTECT REMAINING SURROUNDING HISTORIC ELEMENTS, TYPICAL.
- J. REMOVE WOOD PROTECTION AT CHAIRS STAIRS, RETAIN AND PROTECT REMAINING SURROUNDING HISTORIC ELEMENTS, TYPICAL.
- K. REMOVE WOOD PROTECTION AT CHAIRS STAIRS, RETAIN AND PROTECT REMAINING SURROUNDING HISTORIC ELEMENTS, TYPICAL.

NORTH
A1.3
LEVEL 2
DEMOLITION PLAN



adelle d'arling design
 501 15th Street
 San Francisco, CA 94103
 415 398 0800 fax
 415 398 5200 phone

**GEREMO OR BURN
 AUTOPEWHOUSE**

220 SANGAZO AVENUE
 SAN FRANCISCO, CA

DATE	07/10
JOB	899
DRAWN BY	
CHECKED BY	
SCALE	AS SHOWN
DATE	
REVISIONS	
NO.	DESCRIPTION
1	
2	
3	
4	
5	
6	
7	
8	
9	
10	
11	
12	
13	
14	
15	
16	
17	
18	
19	
20	
21	
22	
23	
24	
25	
26	
27	
28	
29	
30	
31	
32	
33	
34	
35	
36	
37	
38	
39	
40	
41	
42	
43	
44	
45	
46	
47	
48	
49	
50	



A1.4
 LEVEL 3
 DEMOLITION PLAN

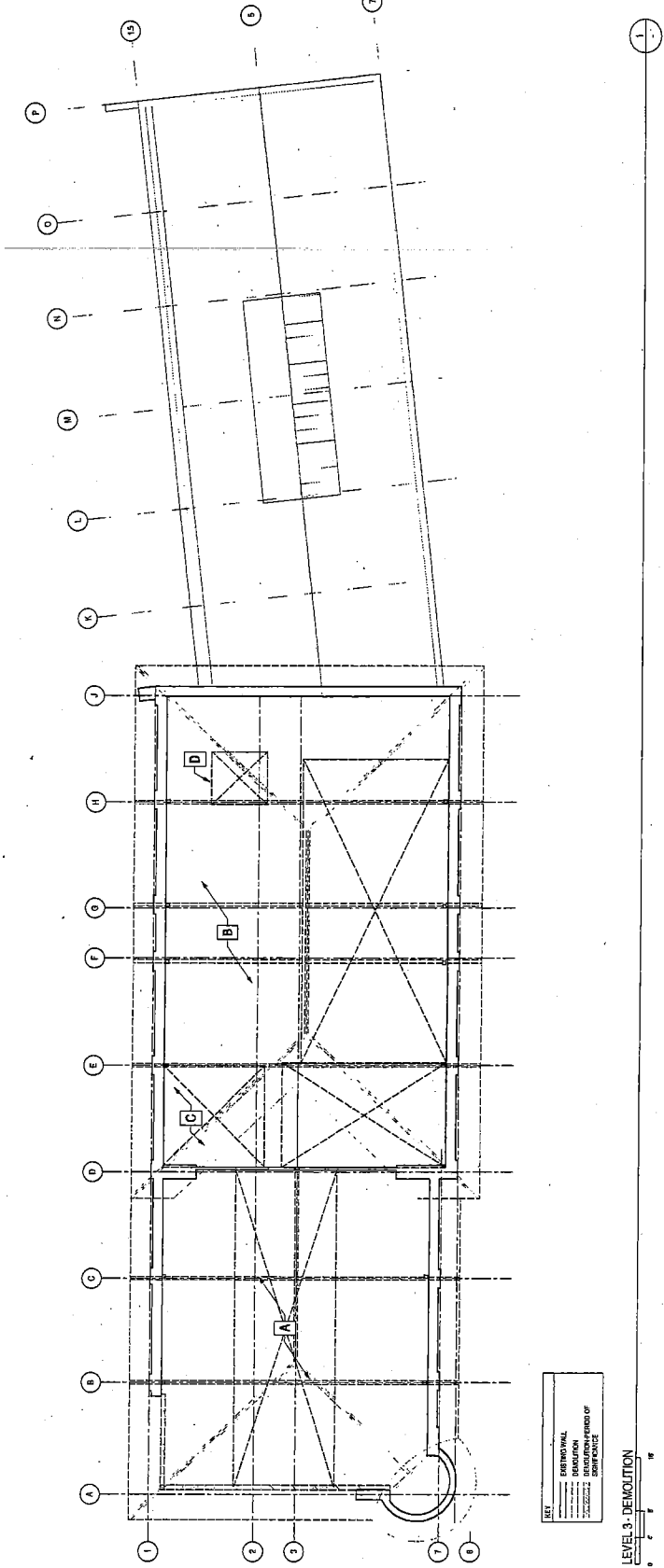

KEY

---	EXISTING WALL
---	DEMOLITION
---	REMOVE FROM PERIOD OF SIGNIFICANCE

LEVEL 3 - DEMOLITION
 0 5 10

GENERAL DEMOLITION NOTES

PROTECT ALL EXISTING HISTORIC MATERIAL TO REMAIN IN PLACE DURING CONSTRUCTION.
 PROTECT SALVAGED DEMOLITION MATERIALS AS REQUIRED FOR REINSTALLATION.
 DEMOLISH ALL PLASTER, WINDOW AND DOOR COVERS.
 DEMOLISH ALL WATER DAMAGED BRICK AND LOOSE PLASTER.
 DISCONNECT ALL ELECTRICAL AND MECHANICAL SYSTEMS. EXISTING PIPES SHALL
 BE REMOVED AND ALL REMOVE MATERIAL AT POWERHOUSE. ASSURE ALL PIPING IS
 WITH REMAINING PAINT TO BE REMOVED AND RECYCLED.
 REMOVE ALL WINDOW SASHES FROM FRAMES FOR RESTORATION AND REPLACEMENT OF GLASS.

KEY NOTES

- A. REMOVE FLOOR-CEILING ASSEMBLY FOR LEVEL 2 MEZZANINES.
- B. REMOVE FLOOR-CEILING ASSEMBLY FOR LEVEL 1.
- C. REMOVE STRUCTURE AS REQUIRED FOR STAIR OPENING. SEE STRUCTURAL DRAWINGS.
- D. REMOVE STRUCTURE AS REQUIRED FOR ELEVATOR. SEE STRUCTURAL DRAWINGS.

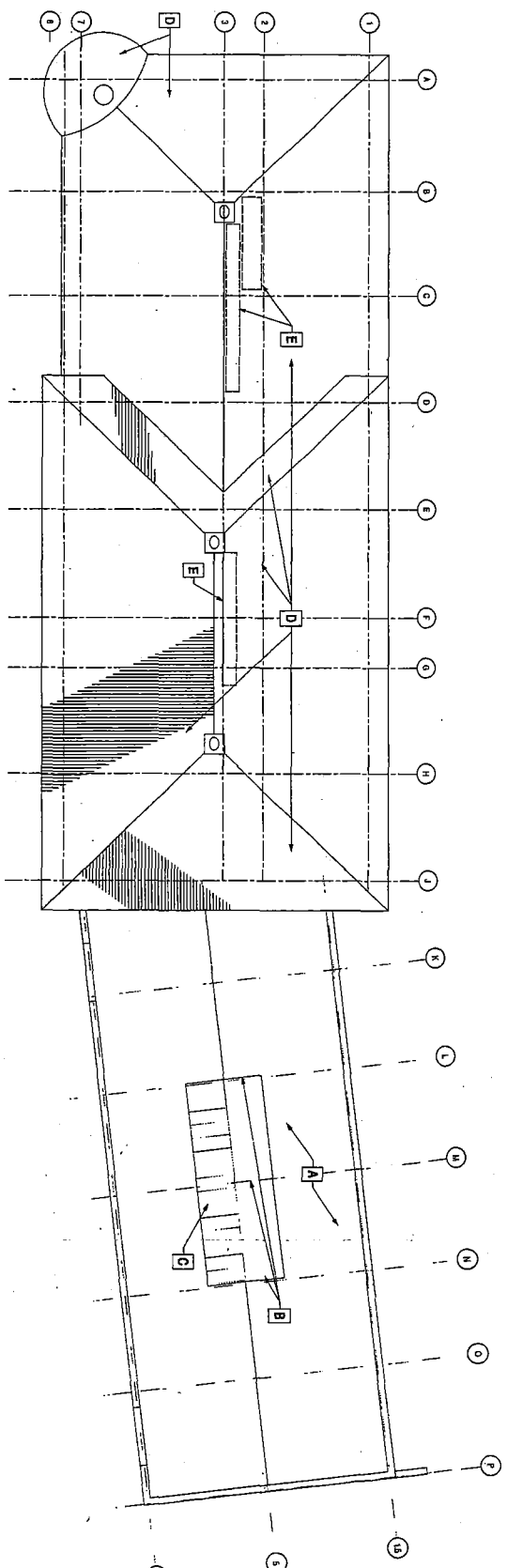

ROOF PLAN - DEMOLITION

GENERAL DEMOLITION NOTES

PROJECT ALL EXISTING STRUCTURE MATERIAL TO REMAIN IN PLACE UNLESS OTHERWISE NOTED.

REMOVE ALL EXISTING ROOFING MATERIALS AS INDICATED BY HATCHED PATTERNS.

REMOVE ALL EXISTING WINDOW AND DOOR CASINGS.

REMOVE ALL INTERIOR WALLS, BRICKS AND LOOSE PLASTER.

COORDINATE REMOVAL OF HANGING MATERIALS FROM SITE. ASSUME EXISTING PARTS SHOWN AS REMAINING UNLESS OTHERWISE NOTED.

REMOVE ALL WINDOW CASINGS FROM PROJECT FOR RESTORATION AND REPAIRMENT OF GLASS.

KEY NOTES

A. REMOVE EXISTING ROOFING ASSEMBLY AT THIS LOCATION. SEE STRUCTURAL DRAWINGS.

B. REMOVE EXISTING CORRUGATED METAL CLADDING FOR RE-CLADDING RESTORATION.

C. REMOVE ALL EXISTING GUTTERS, DOWNSPUTTERS AND DRAINAGE FOR RESTORATION.

D. EXISTING ROOFING TO REMAIN. REMOVE OPENINGS AS INDICATED ALONG WITH EXISTING ROOFING.

E. REMOVE ROOF STRUCTURE.

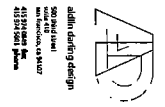

GENERAL CORNER AND POWERHOUSE

200 SALADIE AVENUE SAN FRANCISCO, CA
DATE: 07/18/00
SCALE: 1/8" = 1'-0"
DRAWN: CV
CHECKED: CV
DATE: 07/18/00
PROJECT: GENERAL CORNER AND POWERHOUSE
DATE: 07/18/00
SCALE: 1/8" = 1'-0"
DRAWN: CV
CHECKED: CV
DATE: 07/18/00
PROJECT: GENERAL CORNER AND POWERHOUSE



A1.5

ROOF DEMOLITION PLAN

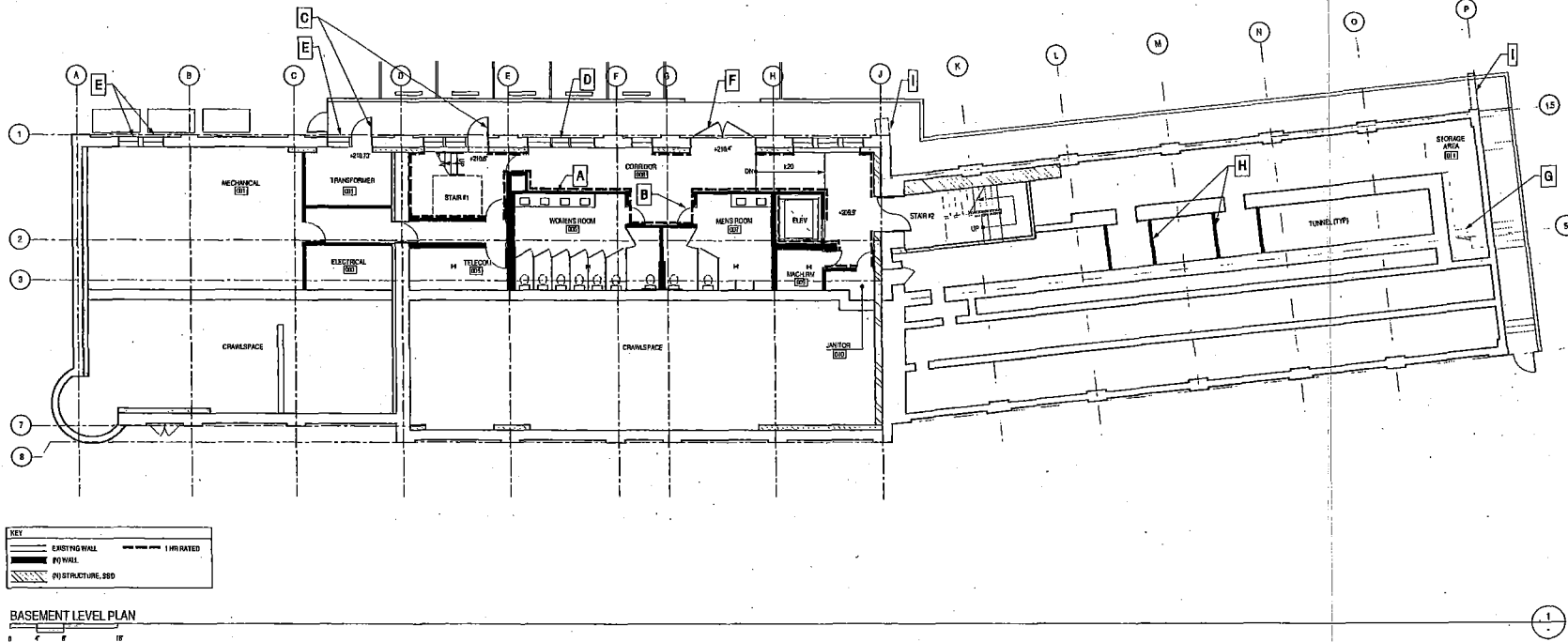

	EXISTING WALL
	NEW WALL
	NO STRUCTURE, SDD
	1" IR RATED

BASEMENT LEVEL PLAN

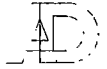

stidin darling design
 5001 15th Street
 San Francisco, CA 94117
 415.224.0468 fax
 415.974.5663 phone

GENEVA CAR BARN AND POWERHOUSE

220 SAN JOSE AVENUE
 SAN FRANCISCO, CA

DATE:	07.08.10
JOB:	0006
DRAWING:	017
SCALE:	AS NOTED
DATE:	07.12.10

GENERAL NOTES

PROTECT ALL EXISTING HISTORIC MATERIALS TO REMAIN IN PLACE DURING CONSTRUCTION.
 ALL WINDOWS TO BE RESTORED FOR REPLACEMENT IN EXISTING LOCATIONS. PROVIDE NEW GLASS IN EXISTING FRAMES COMPRISED OF 2 LAYERS OF 1/4" GLASS UNLEADED.
 SEE STRUCTURAL REPORT AND DRAWINGS PREPARED BY W&E FOR BUILDING ENVELOPE EVALUATION AND REPAIR RECOMMENDATIONS.
 SEE HISTORIC STRUCTURES REPORT PREPARED BY ARCHITECTURAL RESOURCES GROUP FOR CONDITIONS ASSESSMENT AND TREATMENT. CONDITIONS ASSESSMENT AND TREATMENT INFORMATION INCLUDES THE FOLLOWING: BRICK, CONCRETE, EXTERIOR WOOD, WINDOWS AND DOORS, ROOF AND DRAINAGE, INTERIOR PLASTER, INTERIOR WOOD, AND BUILDING SYSTEMS.
 SEE SCHEMATIC DESIGN REPORT FOR ROOM FINISHES AND SYSTEM DESCRIPTION.
 SEE RENDERING MEETS IN SCHEMATIC DESIGN REPORT FOR DESIGN INTENT OF POWERHOUSE, THEATER AND STUDIO MEZZANINES.
 SEE STRUCTURAL DRAWINGS FOR COMPLETE STRUCTURAL SCOPE.

KEY NOTES

- A. PROVIDE WALLS WHERE SHOWN, TYPICAL WALLS TO BE COMPRISED OF METAL STUDS WITH ONE LAYER OF PLYWOOD BOARD EACH SIDE AND INSULATION UNLESS OTHERWISE NOTED. WALLS TO BE ONE HOUR RATED WHERE IDENTIFIED.
- B. PROVIDE SOLID CORE WOOD DOOR WHERE SHOWN.
- C. PROVIDE EXTERIOR WOOD DOOR IN EXISTING LOCATION.
- D. REPLACE EXISTING DOOR WITH FIXED GLAZING.
- E. PROVIDE METAL LOUVER WITH WINDOW FRAME. SEE MECHANICAL SCHEMATIC DRAWING IN SCHEMATIC DESIGN REPORT.
- F. REFURBISHED EXISTING METAL DOORS AND HANG AS OUT-SWINGING.
- G. EXISTING STAIR TO REMAIN.
- H. DISPLAY VITRINES, PROVIDE CONCRETE SLAB AND WALLS.
- I. EXISTING WIND WALLS TO BE DEMOLISHED TO ALLOW ADDRESS ACCESS. TO THE EXTENT POSSIBLE, WALLS ABOVE 7" SHOULD BE RETAINED AND SUPPORTED AS HISTORIC BUILDING FABRIC USING A.E.S. FRAME.

NORTH



A2.1

BASEMENT LEVEL PLAN

ability ceiling design
 505 8th Street
 San Francisco, CA 94103
 415 398 0800
 415 398 0801
 www.ability.com



GENERAL CARBON
 AND POWERHOUSE

300 10th Street, Suite 200
 San Francisco, CA 94103

DATE	DRAWN
08/14/09	CH
REVISION	BY
01	CH
02	AS/NT/B
03	CH
DATE	BY
02/28/10	CH

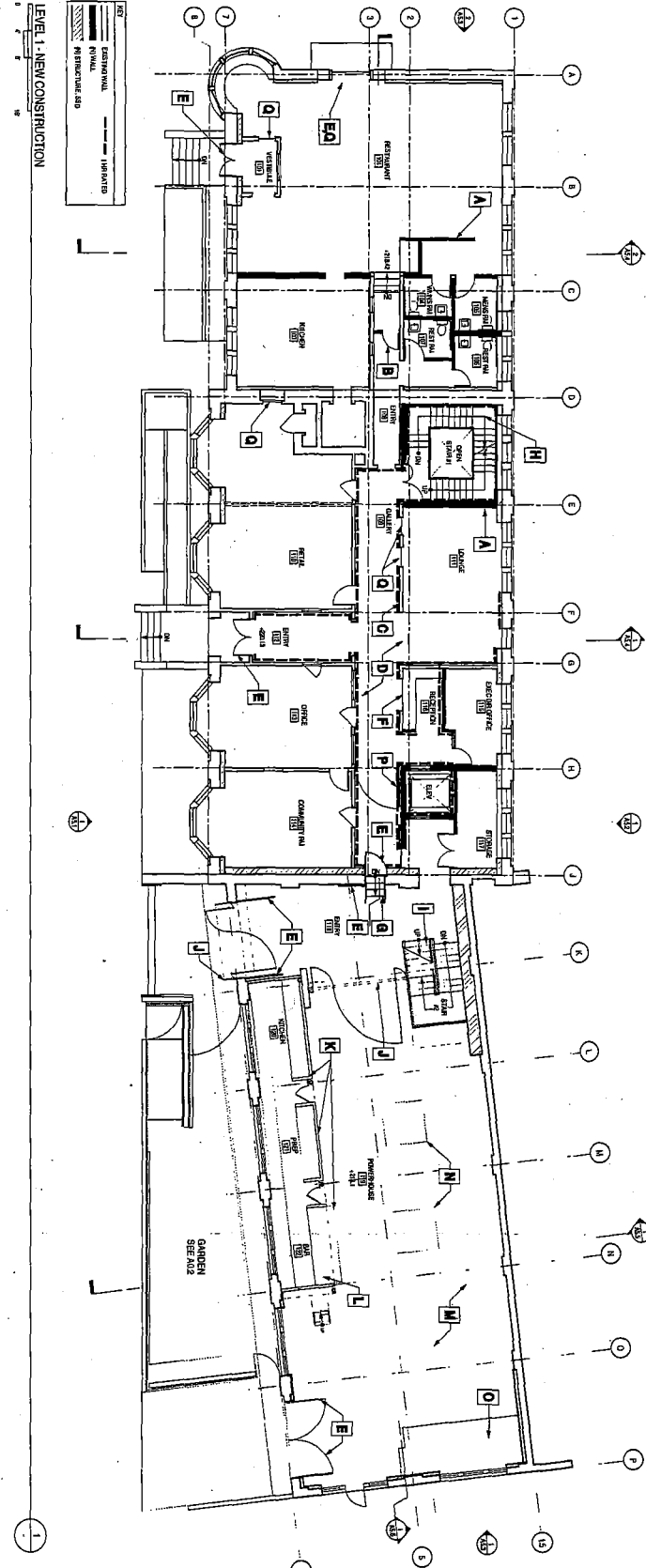

LEVEL 1 - NEW CONSTRUCTION

GENERAL NOTES

PROTECT ALL EXISTING HISTORIC MATERIALS TO REMAIN IN PLACE DURING CONSTRUCTION. ALL WORKING TO BE RESTORED TO ORIGINAL CONDITION OR BETTER. PROVIDE ALL GLASS IN EXISTING FRAMEWORKS WITH 1/2" LAMINATED GLASS. PROVIDE ALL GLASS IN NEW FRAMEWORKS WITH 1/2" LAMINATED GLASS. PROVIDE ALL GLASS IN NEW FRAMEWORKS WITH 1/2" LAMINATED GLASS. PROVIDE ALL GLASS IN NEW FRAMEWORKS WITH 1/2" LAMINATED GLASS.

KEYNOTES

A. REMOVE WALLS WHERE SHOWN. TYPICAL WALLS TO BE COMPOSED OF METAL STUDS WITH ONE HOUR RATED Gypsum BOARD FINISHES ON BOTH SIDES.

B. PROVIDE EXPOSED CONCRETE WHERE SHOWN.

C. EXISTING HISTORIC WOODWORK AND TRIM TO REMAIN AND BE REFINISHED. TYPICAL AT EXISTING WALL AND CEILING.

D. REMOVE EXISTING WOOD FLOOR TO THE SUBFLOOR EXCEPT WHERE SHOWN. PROVIDE NEW 3/4" OSB SUBFLOOR OVER EXISTING WOOD SUBFLOOR. PROVIDE 1/2" WOOD STRIKE AS REQUIRED. SEE SCHEDULE FOR MORE DETAILS.

E. RECONSTRUCT EXISTING RESTROOMS TO BE IDENTICAL TO EXISTING.

F. RECONSTRUCT EXISTING RESTROOMS TO BE IDENTICAL TO EXISTING.

G. NEW GLASS EXISTING FRAMEWORKS TO BE IDENTICAL TO EXISTING. PROVIDE ALL FOUR SIDES METALLIC FINISHING FOR ALL GLASS SYSTEMS. TYPICAL.

H. WOOD TRIM WITH METAL FINISHING TO BE IDENTICAL TO EXISTING. PROVIDE ALL FOUR SIDES METALLIC FINISHING FOR ALL GLASS SYSTEMS. TYPICAL.

I. PAINTED METAL AND GLASS SYSTEMS. SEE REVISIONS FOR MORE DETAILS. PROVIDE ALL FOUR SIDES METALLIC FINISHING FOR ALL GLASS SYSTEMS. TYPICAL.

J. PROVIDE CONCRETE SLAB OVER EXISTING. PROVIDE ALL FOUR SIDES METALLIC FINISHING FOR ALL GLASS SYSTEMS. TYPICAL.

K. PROVIDE STAINLESS STEEL COMPARTMENTS OVER EXISTING. PROVIDE ALL FOUR SIDES METALLIC FINISHING FOR ALL GLASS SYSTEMS. TYPICAL.

L. PROVIDE STAINLESS STEEL COMPARTMENTS OVER EXISTING. PROVIDE ALL FOUR SIDES METALLIC FINISHING FOR ALL GLASS SYSTEMS. TYPICAL.

M. PROVIDE STAINLESS STEEL COMPARTMENTS OVER EXISTING. PROVIDE ALL FOUR SIDES METALLIC FINISHING FOR ALL GLASS SYSTEMS. TYPICAL.

N. PROVIDE STAINLESS STEEL COMPARTMENTS OVER EXISTING. PROVIDE ALL FOUR SIDES METALLIC FINISHING FOR ALL GLASS SYSTEMS. TYPICAL.

O. PROVIDE STAINLESS STEEL COMPARTMENTS OVER EXISTING. PROVIDE ALL FOUR SIDES METALLIC FINISHING FOR ALL GLASS SYSTEMS. TYPICAL.

AP22
 LEVEL 1/100



**GENIUM CARBARI
AND POWERHOUSE**

220 SAN JOSE AVENUE
SAN FRANCISCO, CA

DATE:	07.11.11
JOB:	CON
PROJECT:	CON
SCALE:	AS SHOWN
DATE:	
SCHEMATIC PHASE:	07.11.11



A2.3
LEVEL PLAN

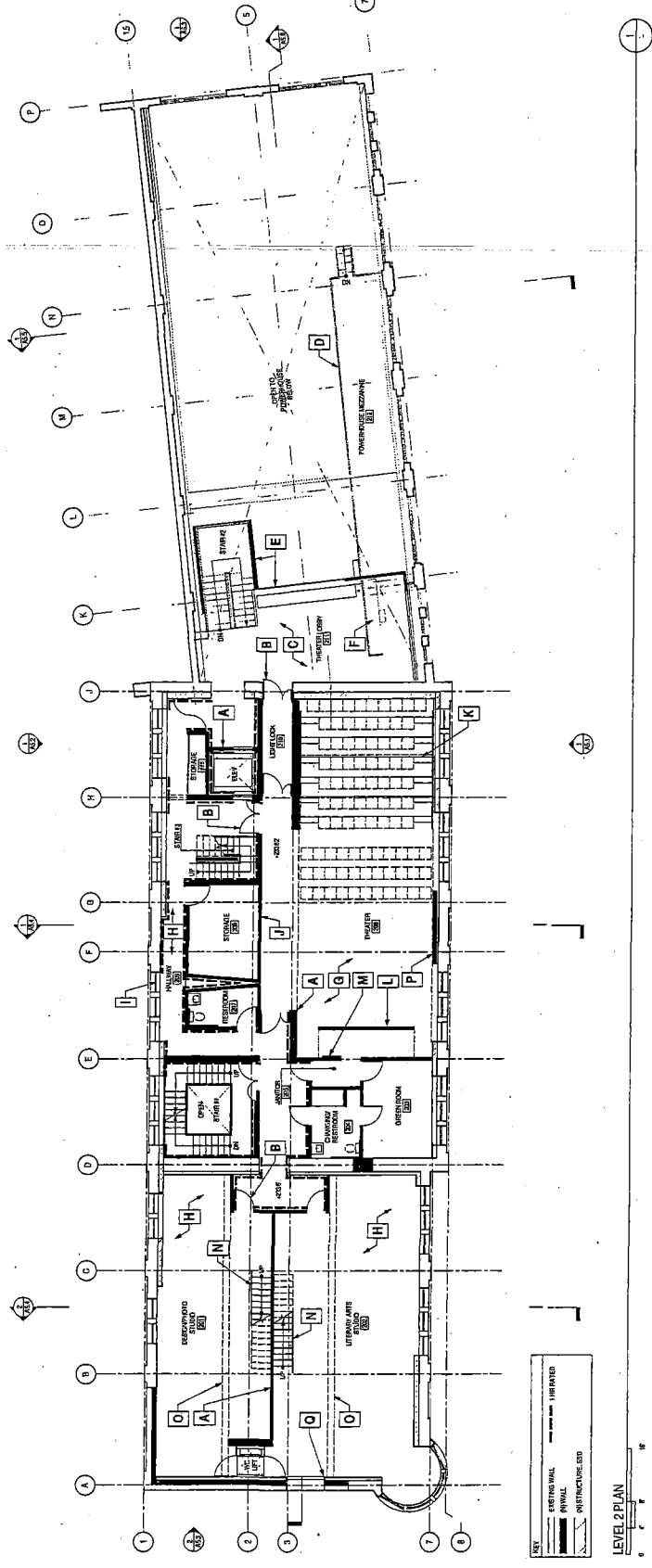

- KEY NOTES**
- A. FINISH WALLS TO BE RECONSTRUCTED TO MATCH EXISTING WALLS. FINISH WALLS TO BE RECONSTRUCTED TO MATCH EXISTING WALLS. FINISH WALLS TO BE RECONSTRUCTED TO MATCH EXISTING WALLS.
 - B. PROVIDE SOLID CORE WOOD DOOR WHERE SHOWN.
 - C. INTERIOR COLORED CONCRETE FLOOR.
 - D. EXISTING REZAMINE STRUCTURE TO BE RESTORED. PROVIDE CONCRETE FLOOR W/ PER STRUCTURAL DRAWINGS.
 - E. PAINTED METAL COPPER AND GLASS SYSTEM. SEE HENNINGSEN SCHEMATIC DESIGN REPORT FOR DESIGN INTENT.
 - F. TRICE AND CONDENSED SINK.
 - G. FLOOR SYSTEM AT THEATER TO BE UNBAY OVER. MAKE SURE OVER TWO LAYERS. FINISH WOOD ON INTERIOR SIDE OF UNBAY OVER. MAKE SURE OVER TWO LAYERS. FINISH WOOD ON INTERIOR SIDE OF UNBAY OVER. MAKE SURE OVER TWO LAYERS. FINISH WOOD ON INTERIOR SIDE OF UNBAY OVER.
 - H. FLOOR SYSTEM AT STUDIOS AND UNBAY TO BE SALVAGED WOOD OVER EXISTING WOOD UNBAY OVER. MAKE SURE OVER TWO LAYERS. FINISH WOOD ON INTERIOR SIDE OF UNBAY OVER. MAKE SURE OVER TWO LAYERS. FINISH WOOD ON INTERIOR SIDE OF UNBAY OVER.
 - I. FINISH WALLS AT CARBARI THEATER DOOR LOCATION.
 - J. CARBARI OBSERVE SLOT.
 - K. LINE OF CONTROL BROOM HEADLINE.
 - L. STAIRS WALL.
 - M. STAIRS DOOR.
 - N. STEEL STAIRS WITH METAL GLASS RAIL.
 - O. OPEN GLOT TO ATTIC ABOVE.
 - P. STACKEO MOVABLE PARTITIONS ON METAL TRUCK TO COVER WINDOWS.
 - Q. FINISH METAL FRAME ASSEMBLY W/ FINISH GLAZING.

GENERAL NOTES

PROTECT ALL EXISTING HISTORIC MATERIALS TO REMAIN IN PLACE DURING CONSTRUCTION. ALL WINDOWS TO BE RESTORED OR REPLACED IN EXISTING LOCATIONS. PROVIDE NEW GLASS UNITS WITH FINISH GLAZING. PROVIDE NEW GLASS UNITS WITH FINISH GLAZING. PROVIDE NEW GLASS UNITS WITH FINISH GLAZING.

SEE HISTORIC STRUCTURES REPORT PREPARED BY ARCHITECTURAL RESOURCES GROUP FOR CONDITIONS ASSESSMENT AND TREATMENT. CONDITIONS ASSESSMENT AND TREATMENT REPORT PREPARED BY ARCHITECTURAL RESOURCES GROUP FOR CONDITIONS ASSESSMENT AND TREATMENT. CONDITIONS ASSESSMENT AND TREATMENT REPORT PREPARED BY ARCHITECTURAL RESOURCES GROUP FOR CONDITIONS ASSESSMENT AND TREATMENT.

SEE SCHEMATIC DESIGN REPORT FOR ROOM FINISHES AND SYSTEM DESCRIPTION.

SEE HENNINGSEN SCHEMATIC DESIGN REPORT FOR DESIGN INTENT OF POWERHOUSE, THEATER AND STUDIO REZAMINES.

SEE STRUCTURAL DRAWINGS FOR COMPLETE STRUCTURAL SCOPE.

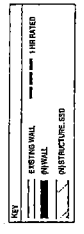

LEVEL 2 PLAN

1658

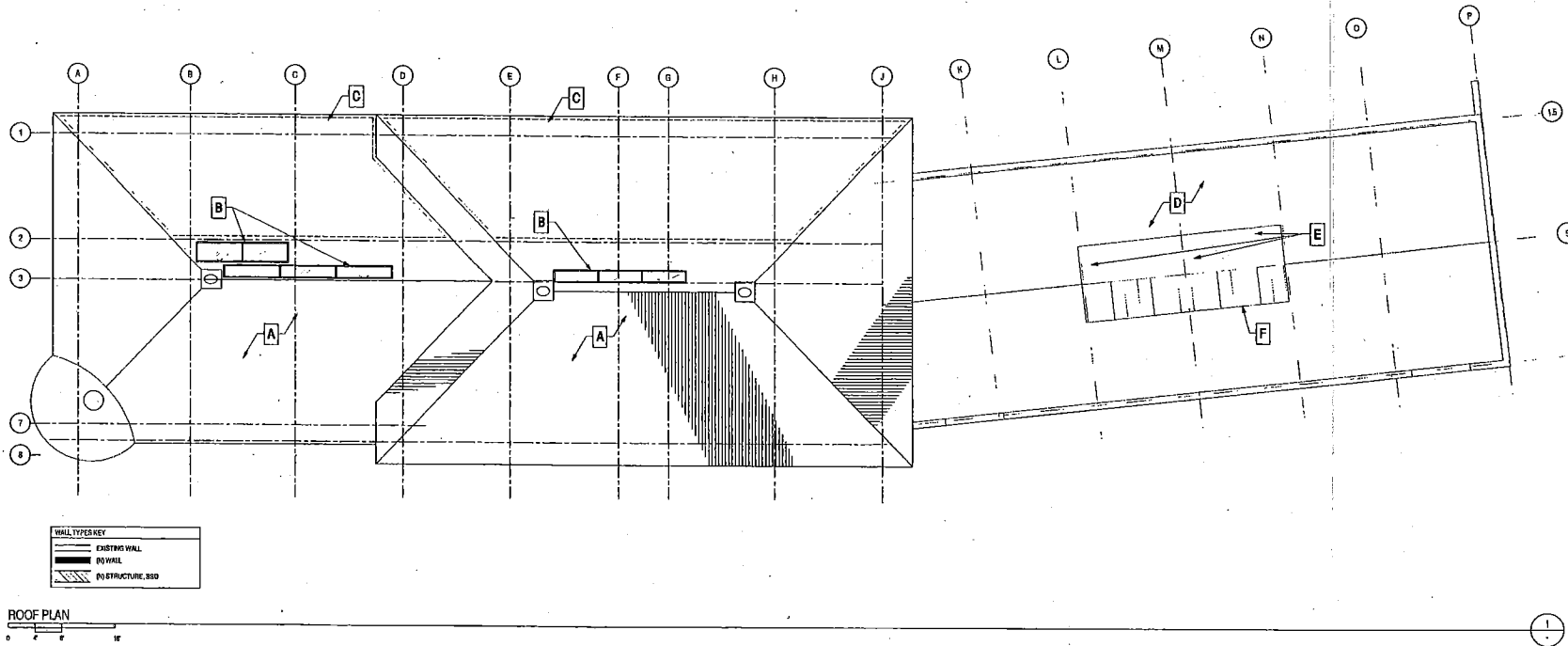

WALL TYPE KEY	
	EXISTING WALL
	NEW WALL
	NEW STRUCTURE, 200

ROOF PLAN
0 2 4 8



a/c/d/r design
500 Grand Street
Suite 410
San Francisco, CA 94107
415 974 0849 fax
415 944 5660 phone

GENEVA CAR BARN AND POWERHOUSE

2201 SAN JOSE AVENUE
SAN FRANCISCO, CA

DATE:	07.06.10
JOB:	8800
DRAWN BY:	CH
SCALE:	AS NOTED
ISSUE:	DATE:
SCHEMATIC P/CHNG	07.12.10

GENERAL NOTES

PROTECT ALL EXISTING HISTORIC MATERIALS TO REMAIN IN PLACE DURING CONSTRUCTION.

ALL WINDOWS TO BE RESTORED FOR REPLACEMENT IN EXISTING LOCATIONS. PROVIDE NEW GLASS IN EXISTING FRAMES COMPRISED OF (2) LAYERS OF 1/8" GLASS, LAMINATED.

SEE STRUCTURAL REPORT AND DRAWINGS PREPARED BY WJE FOR BUILDING ENVELOPE EVALUATION AND REPAIR RECOMMENDATIONS.

SEE HISTORIC STRUCTURES REPORT PREPARED BY ARCHITECTURAL RESOURCES GROUP FOR CONDITIONS ASSESSMENT AND TREATMENT, CONDITIONS ASSESSMENT AND TREATMENT INFORMATION INCLUDES THE FOLLOWING: BRICK, CONCRETE, EXTERIOR WOOD, WINDOWS AND DOORS, ROOF AND DRAINAGE, INTERIOR PLASTER, INTERIOR WOOD, AND BUILDING SYSTEMS.

SEE SCHEMATIC DESIGN REPORT FOR ROOM FINISHES AND SYSTEM DESCRIPTION.

SEE RENDERING VIEWS IN SCHEMATIC DESIGN REPORT FOR DESIGN INTENT OF POWERHOUSE, THEATER AND STUDIO MEZZANINES.

SEE STRUCTURAL DRAWINGS FOR COMPLETE STRUCTURAL SCOPE.

KEY NOTES X

A: EXISTING ROOF TO REMAIN. SEAL REQUIRED PENETRATIONS FOR MECHANICAL SYSTEM. PROVIDE ROOF INSULATION AND PLYWOOD STAINED TO MATCH EXISTING BEAMS AT UNDERSIDE FOR FINISHED CEILING SYSTEM.

B: PROVIDE MOTORIZED OPERABLE SKYLIGHTS WHERE SHOWN.

C: PROVIDE AMORPHOUS SILICONE PHOTOVOLTAIC SYSTEM AT EAST SIDE OF ROOF - ASSUME 2,000 SQUARE FEET OF AVAILABLE ROOF AREA. SEE MEP SCHEMATIC NARRATIVE.

D: CONCRETE ROOF STRUCTURE WITH RIGID INSULATION AND SLATE TILE ROOFING. PROVIDE SYNTHETIC SLATE AS ROOFING ALTERNATE. SEE STRUCTURAL DRAWINGS.

E: CORRUGATED GALVANIZED CLADDING OVER EXISTING SKYLIGHT STRUCTURE.

F: REPLACE GLAZING WITHIN EXISTING SKYLIGHT SYSTEM. REPAIR AND REPAINT GLAZING STRUCTURE.

NORTH



A2.5

ROOF PLAN

aditya arching design
 3000 E. 15th Ave.
 Suite 400
 Denver, CO 80202
 303.733.8200
 455.733.8200



GENERAL NOTES

DATE	VERSION
10/20/11	01
11/01/11	02
01/01/12	03
02/01/12	04
03/01/12	05
04/01/12	06
05/01/12	07
06/01/12	08
07/01/12	09
08/01/12	10
09/01/12	11
10/01/12	12
11/01/12	13
12/01/12	14
01/01/13	15
02/01/13	16
03/01/13	17
04/01/13	18
05/01/13	19
06/01/13	20
07/01/13	21
08/01/13	22
09/01/13	23
10/01/13	24
11/01/13	25
12/01/13	26
01/01/14	27
02/01/14	28
03/01/14	29
04/01/14	30
05/01/14	31
06/01/14	32
07/01/14	33
08/01/14	34
09/01/14	35
10/01/14	36
11/01/14	37
12/01/14	38
01/01/15	39
02/01/15	40
03/01/15	41
04/01/15	42
05/01/15	43
06/01/15	44
07/01/15	45
08/01/15	46
09/01/15	47
10/01/15	48
11/01/15	49
12/01/15	50
01/01/16	51
02/01/16	52
03/01/16	53
04/01/16	54
05/01/16	55
06/01/16	56
07/01/16	57
08/01/16	58
09/01/16	59
10/01/16	60
11/01/16	61
12/01/16	62
01/01/17	63
02/01/17	64
03/01/17	65
04/01/17	66
05/01/17	67
06/01/17	68
07/01/17	69
08/01/17	70
09/01/17	71
10/01/17	72
11/01/17	73
12/01/17	74
01/01/18	75
02/01/18	76
03/01/18	77
04/01/18	78
05/01/18	79
06/01/18	80
07/01/18	81
08/01/18	82
09/01/18	83
10/01/18	84
11/01/18	85
12/01/18	86
01/01/19	87
02/01/19	88
03/01/19	89
04/01/19	90
05/01/19	91
06/01/19	92
07/01/19	93
08/01/19	94
09/01/19	95
10/01/19	96
11/01/19	97
12/01/19	98
01/01/20	99
02/01/20	100

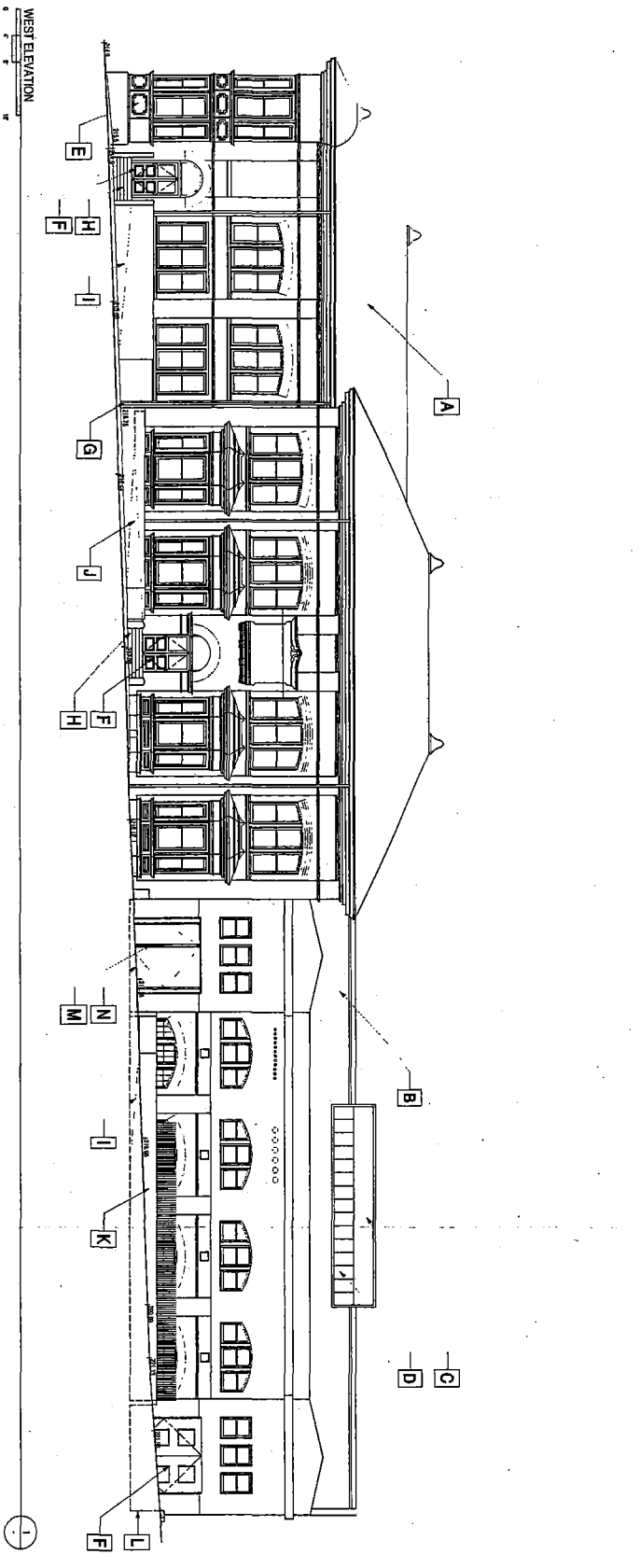

GENERAL NOTES

PROJECT ALL EXISTING HISTORIC MATERIALS TO REMAIN IN PLACE DURING CONSTRUCTION. ALL WORKS TO BE RESTORED FOR ORIGINAL APPEARANCE. PROVIDE NEW WORK TO MATCH EXISTING WORK. ALL NEW WORK TO BE DONE IN ACCORDANCE WITH THE FOLLOWING: SEE HISTORIC PRESERVATION REPORT PREPARED BY ARCHITECTURAL RESOURCES GROUP FOR CONDITIONS ASSESSMENT AND REPAIRS. CONDITIONS ASSESSMENT AND REPAIRS REPORT FOR BOOMS ROOM AND DAMAGED INTERIOR FLOORING, INTERIOR WOOD AND BUILDING SYSTEMS. SEE SCRAMANT DESIGN REPORT FOR BOOMS ROOMS AND STEEL DESCRIPTION. SEE RESTORATION AND REPAIR DESIGN REPORT FOR RESTORATION OF FLOORING, INTERIOR WOOD AND BUILDING SYSTEMS. SEE STRUCTURAL DRAWINGS FOR COMPLETE STRUCTURAL SCOPE.

KEY NOTES

- A. EXISTING ROOF TO REMAIN. SEPARATE FROM EXISTING ROOF MECHANICAL SYSTEM.
- B. CONCRETE ROOF FLOORING WITH SATELITE ANTENNA PROVIDE FINISHED SATELITE AS CONCRETE FLOORING. SEE STRUCTURAL DRAWINGS FOR FINISHES.
- C. COMPARISON TO DEVELOPED DRAWING OVER EXISTING EXTERIOR FINISHES.
- D. REPAIR EXISTING EXTERIOR FINISHES. REPAIR AND REFINISH EXISTING EXTERIOR FINISHES. REPAIR AND REFINISH EXISTING EXTERIOR FINISHES. REPAIR AND REFINISH EXISTING EXTERIOR FINISHES.
- E. PATCH AND REPAIR WOODEN PANEL, REPAIR, TYPICAL.
- F. REPAIR EXISTING ROOFING WITH COPPER, TYPICAL.
- G. REMOVE AND REPLACE EXISTING STAIRS. PROVIDE CONCRETE CURBS AT STAIRS TO MATCH EXISTING. PROVIDE FINISH TO STEEL TYPICAL AND INTERIOR STAIRS AT EACH LEVEL AS SHOWN.
- H. ACCESSIBLE TO CONCRETE FLOOR WITH CURB CONFORM TO ADA TYPICAL. PROVIDE AS SHOWN.
- I. ACCESSIBLE TO CONCRETE FLOOR WITH CURB AS SHOWN. PROVIDE AS SHOWN.
- J. ACCESSIBLE TO CONCRETE FLOOR WITH CURB AS SHOWN. PROVIDE AS SHOWN.
- K. CONCRETE EXTERIOR WALLS WITH FINISHES OF PAINTED STEEL VERTICAL PORTALS. SEE STRUCTURAL DRAWINGS FOR FINISHES.
- L. CONCRETE EXTERIOR WALLS WITH FINISHES OF PAINTED STEEL VERTICAL PORTALS. SEE STRUCTURAL DRAWINGS FOR FINISHES.
- M. CONCRETE EXTERIOR WALLS WITH FINISHES OF PAINTED STEEL VERTICAL PORTALS. SEE STRUCTURAL DRAWINGS FOR FINISHES.

NORTH

A5.1
 EXTERIOR ELEVATIONS

1660

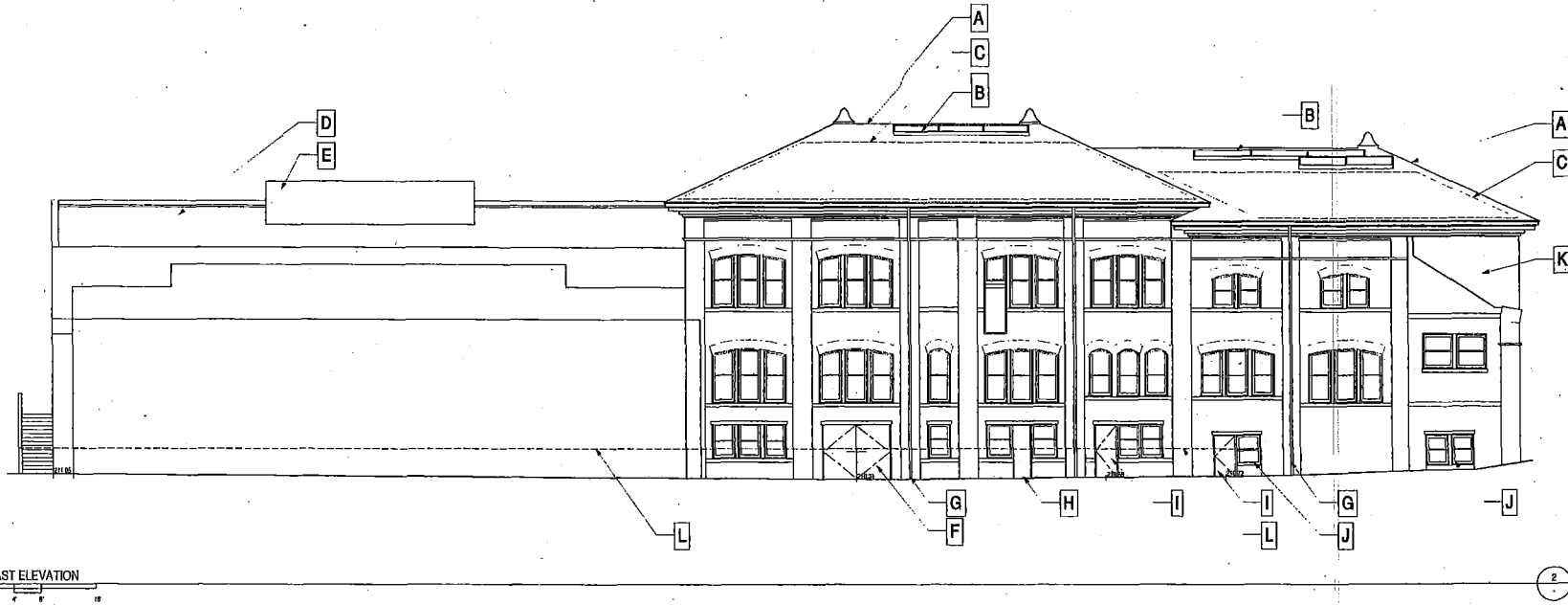

EAST ELEVATION
0 4 8 16



aida/ra design
500 Mission
San Francisco, CA 94107
415.594.0845 Fax
415.594.5652 www.aidara.com

GENEVA CAR BARN

2211 SAN JOSE AVENUE
SAN FRANCISCO, CA

DATE: 12/09

JOB: 030

DRAWN: CV

SCALE: AS NOTED

ISSUE: DATE:

SCHEMATIC PRINCIPAL 07.12.10

GENERAL NOTES

PROTECT ALL EXISTING HISTORIC MATERIALS TO REMAIN IN PLACE DURING CONSTRUCTION. ALL WINDOWS TO BE RESTORED FOR REPLACEMENT IN EXISTING LOCATIONS. PROVIDE NEW GLASS IN EXISTING FRAMES COMPRISED OF (2) LAYERS OF 1/8" GLASS, LAMINATED.

SEE STRUCTURAL REPORT AND DRAWINGS PREPARED BY WUE FOR BUILDING ENVELOPE EVALUATION AND REPAIR RECOMMENDATIONS.

SEE HISTORIC STRUCTURES REPORT PREPARED BY ARCHITECTURAL RESOURCES GROUP FOR CONDITIONS ASSESSMENT AND TREATMENT, CONDITIONS ASSESSMENT AND TREATMENT INFORMATION INCLUDES THE FOLLOWING: BRICK, CONCRETE, EXTERIOR WOOD, WINDOWS AND DOORS, ROOF AND DRAINAGE, INTERIOR PLASTER, INTERIOR WOOD, AND BUILDING SYSTEMS.

SEE SCHEMATIC DESIGN REPORT FOR ROOM FINISHES AND SYSTEM DESCRIPTION.

SEE RENDERING VIEWS IN SCHEMATIC DESIGN REPORT FOR DESIGN INTENT OF POWERHOUSE, THEATER AND STUDIO MEZZANINES.

SEE STRUCTURAL DRAWINGS FOR COMPLETE STRUCTURAL SCOPE.

KEY NOTES X →

A. EXISTING ROOF TO REMAIN. SEAL REQUIRED PENETRATIONS FOR MECHANICAL SYSTEM.

B. PROVIDE SKYLIGHTS WHERE SHOWN.

C. PROVIDE AMORPHOUS SILICONE PHOTOVOLTAIC SYSTEM AT EAST SIDE OF ROOF - ASSUME 2000 SQUARE FEET OF AVAILABLE ROOF AREA. SEE MEP SCHEMATIC NARRATIVE.

D. CONCRETE ROOF STRUCTURE WITH RIGID INSULATION AND SLATE TILE ROOFING. PROVIDE SYNTHETIC SLATE AS ROOFING ALTERNATE. SEE STRUCTURAL DRAWINGS.

E. CORRUGATED GALVANIZED CLADDING OVER EXISTING SKYLIGHT STRUCTURE.

F. REFURBISHED EXISTING METAL DOORS AND HANG AS OUT-SWINGING.

G. REPLACE EXISTING DOWNSPOUTS WITH COPPER, TYPICAL.

H. REPLACE EXISTING DOOR WITH FIXED GLAZING.

I. REPLACE EXTERIOR WOOD DOOR IN EXISTING LOCATION.

J. PROVIDE METAL LOUVER WITH IN WINDOW FRAME. SEE MECHANICAL SCHEMATIC NARRATIVE IN SCHEMATIC DESIGN REPORT.

K. POWDER COATED BLACK ALUM. PANELS

L. FENCING IN FRONT NOT SHOWN, SEE PLAN

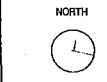

A5.2
EXTERIOR ELEVATIONS

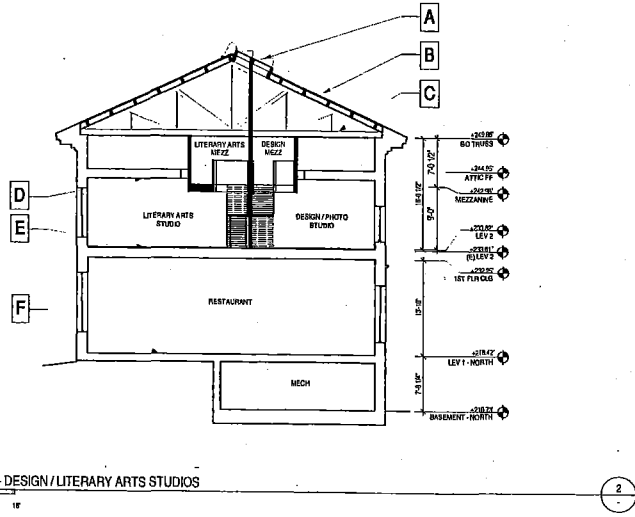

CROSS SECTION - DESIGN/LITERARY ARTS STUDIOS

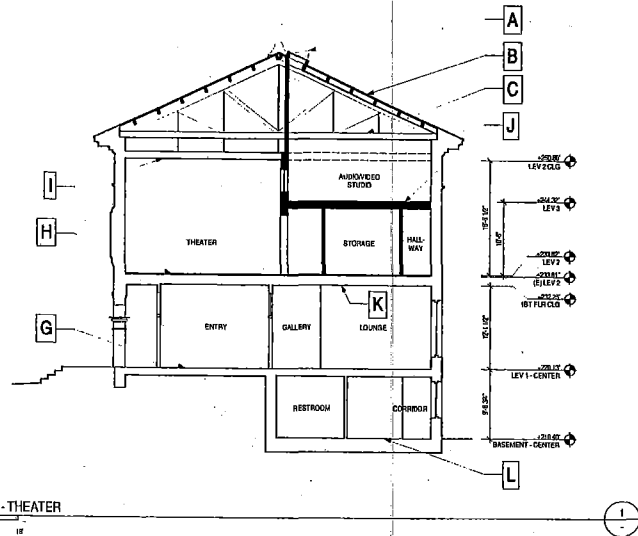

CROSS SECTION - THEATER

GENERAL NOTES

- PROTECT ALL EXISTING HISTORIC MATERIALS TO REMAIN IN PLACE DURING CONSTRUCTION.
- ALL WINDOWS TO BE RESTORED FOR REPLACEMENT IN EXISTING LOCATIONS. PROVIDE NEW GLASS IN EXISTING FRAMES COMPRISED OF (2) LAYERS OF 1/4" GLASS, LAMINATED.
- SEE STRUCTURAL REPORT AND DRAWINGS PREPARED BY WJE FOR BUILDING ENVELOPE EVALUATION AND REPAIR RECOMMENDATIONS.
- SEE HISTORIC STRUCTURES REPORT PREPARED BY ARCHITECTURAL RESOURCES GROUP FOR CONDITIONS ASSESSMENT AND TREATMENT. CONDITIONS ASSESSMENT AND TREATMENT INFORMATION INCLUDES THE FOLLOWING: BRICK; CONCRETE; EXTERIOR WOOD; WINDOWS AND DOORS; ROOF AND DRAINAGE; INTERIOR PLASTER; INTERIOR WOOD; AND BUILDING SYSTEMS.
- SEE SCHEMATIC DESIGN REPORT FOR ROOM FINISHES AND SYSTEM DESCRIPTION.
- SEE REPAIRING VIEWS IN SCHEMATIC DESIGN REPORT FOR DESIGN INTENT OF POWERHOUSE, THEATER AND STUDIO MEZZANINES.
- SEE STRUCTURAL DRAWINGS FOR COMPLETE STRUCTURAL SCOPE.

KEY NOTES X →

- A. OPERABLE SKYLIGHTS.
- B. EXISTING ROOF TO REMAIN. PROVIDE RIGID INSULATION BETWEEN EXISTING JOISTS WITH STAINED PLYWOOD AS FINISHED CEILING SURFACE, EXCEPT AT THEATER, HALLWAY, GREEN IN. REST DIA. PROVIDE INSULATION ONLY AT OTHER AREAS.
- C. EXISTING TRUSSES TO REMAIN. SEE STRUCTURAL DRAWINGS FOR CROSS BRACING AT UNDERSIDE OF TRUSSES.
- D. EXISTING PLASTER CEILING TO BE PATCHED AND PAINTED.
- E. FLOOR SYSTEM AT STUDIOS AND HALLWAY TO BE SALVAGED WOOD OVER ACOUSTIC UNDERLAY OVER 1" GYPCRETE OVER TWO LAYERS - STRUCTURAL PLYWOOD REUSE EXISTING WOOD FLOOR TO THE GREATEST EXTENT POSSIBLE; FOR FINISH PURPOSES, ASSUME GCR CAN BE SALVAGED AND REUSED.
- F. AT RESTAURANT PROVIDE PLYWOOD FLOOR SUBSTRATE FOR FUTURE TENANT BUILD OUT. RETAIN SALVAGED WOOD FLOOR FOR POTENTIAL USE IN THESE SPACES.
- G. REUSE EXISTING WOOD FLOOR TO THE GREATEST EXTENT POSSIBLE. FOR FINISH PURPOSES, ASSUME 50% CAN BE SALVAGED AND REUSED. REPLACE PLYWOOD SUBSTRATE AS REQUIRED. SEE STRUCTURAL DRAWINGS.
- H. FLOOR SYSTEM AT THEATER TO BE MARLEY OVER 1/2" MASONITE OVER TWO LAYERS - PLYWOOD ON 1X SLEEPERS ON 1" SUPER W PAD OVER TWO LAYERS - STRUCTURAL PLYWOOD. PROVIDE INSULATION WITHIN SLEEPER SYSTEM.
- I. SALVAGED REDWOOD CEILING AT THEATER. SEE ARCHITECTURAL NARRATIVE FOR RESTORATION FINISH WORK.
- J. FLOORS TO BE STAINED PLYWOOD.
- K. EXISTING PLASTER TO BE PATCHED AND PAINTED.
- L. CONCRETE SLAB ON GRADE.



aida/dw design

500 Mission Street
 Suite #100
 San Francisco, CA 94107
 415.541.9849 fax
 415.541.5503 phone

GENEVA CAR BARN

2201 SAN JOSE AVENUE
 SAN FRANCISCO, CA

DATE: 12.08.09

JOB: 0909

DRAWN: CW

SCALE: AS NOTED

ISSUE DATE

SCHEMATIC FINISH 07.12.10

NORTH



A5.4

BUILDING SECTIONS

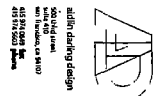

GENERAL CONTRACTOR
 2815 SAN JOSE AVENUE
 DENVER, COLORADO, CO
 DATE: 10/20/09
 DRAWN: CBY
 SCALE: AS SHOWN
 SHEET: 05.01A
 PROJECT: POKERHOUSE

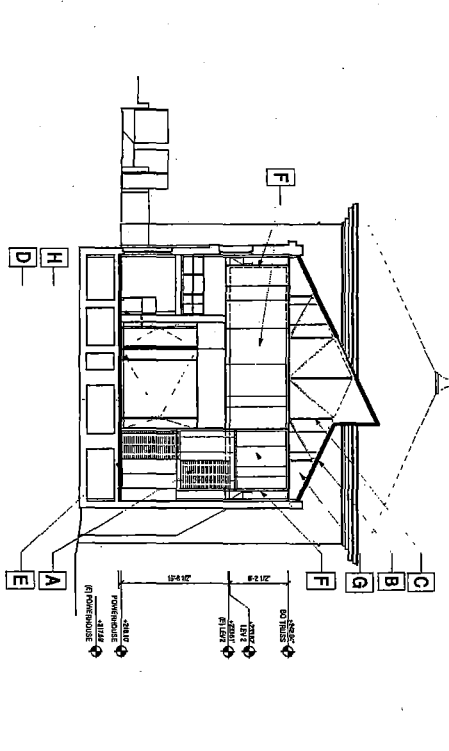

GENERAL NOTES

PROJECT: ALL EXISTING STRUCTURE AND REPAIRS TO EXISTING IN PLACE EXTERIOR CONSTRUCTION. ALL EXISTING TO BE RECONSTRUCTED FOR REPAIRS TO EXISTING IN PLACE EXTERIOR CONSTRUCTION. SEE STRUCTURAL REPORT AND PARAGRAPHS REFERENCED BY THE FOLLOWING FOR MORE DETAILED INFORMATION AND REPAIR RECOMMENDATIONS. SEE STRUCTURAL REPORT FOR REPAIRS TO EXISTING IN PLACE EXTERIOR CONSTRUCTION. SEE STRUCTURAL REPORT FOR REPAIRS TO EXISTING IN PLACE EXTERIOR CONSTRUCTION. SEE STRUCTURAL REPORT FOR REPAIRS TO EXISTING IN PLACE EXTERIOR CONSTRUCTION. SEE STRUCTURAL REPORT FOR REPAIRS TO EXISTING IN PLACE EXTERIOR CONSTRUCTION.

KEY NOTES

- A. CONCRETE FLOOR FINISHES, REPAIRS, ASSEMBLY AND GENERAL WORKING. SEE REPAIRS TO EXISTING IN PLACE EXTERIOR CONSTRUCTION REPORT FOR ADDITIONAL INFORMATION.
- B. REPAIRS TO EXISTING IN PLACE EXTERIOR CONSTRUCTION.
- C. EXISTING WALLS TO REMAIN.
- D. EXISTING ROOF STRUCTURE.
- E. EXISTING ROOF FINISHES, REPAIRS, ASSEMBLY AND GENERAL WORKING. SEE REPAIRS TO EXISTING IN PLACE EXTERIOR CONSTRUCTION REPORT FOR ADDITIONAL INFORMATION.
- F. EXISTING ROOF FINISHES, REPAIRS, ASSEMBLY AND GENERAL WORKING. SEE REPAIRS TO EXISTING IN PLACE EXTERIOR CONSTRUCTION REPORT FOR ADDITIONAL INFORMATION.
- G. EXISTING ROOF FINISHES, REPAIRS, ASSEMBLY AND GENERAL WORKING. SEE REPAIRS TO EXISTING IN PLACE EXTERIOR CONSTRUCTION REPORT FOR ADDITIONAL INFORMATION.
- H. EXISTING ROOF FINISHES, REPAIRS, ASSEMBLY AND GENERAL WORKING. SEE REPAIRS TO EXISTING IN PLACE EXTERIOR CONSTRUCTION REPORT FOR ADDITIONAL INFORMATION.

A5.5
 BUILDING SECTIONS

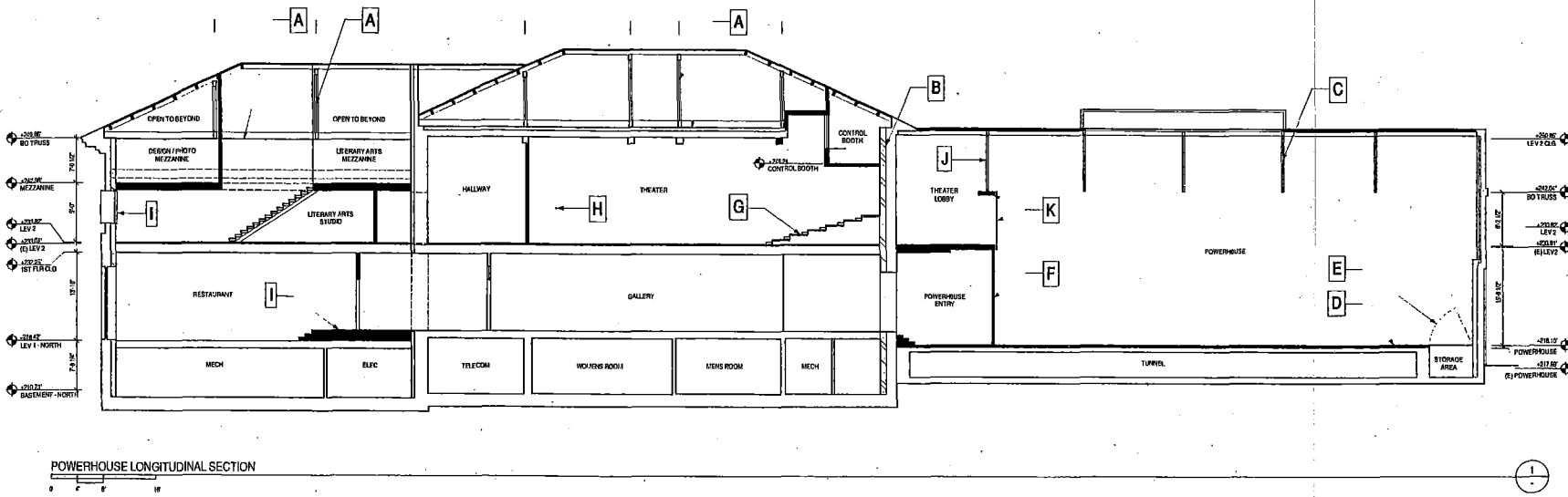

POWERHOUSE LONGITUDINAL SECTION



aifin darling design
 500 Third Street
 Suite 410
 San Francisco, CA 94107
 415.314.0213 fax
 415.314.0212 phone

GENEVA CAR BARN

2301 DANLUSSE AVENUE
 SAN FRANCISCO, CA

DATE: 12.01.10

JOB: 0910

DRAWN: CV

SCALE: AS NOTED

ISSUE: DATE

SCHEMATIC PRICING: 07.10.10

GENERAL NOTES

PROTECT ALL EXISTING HISTORIC MATERIALS TO REMAIN IN PLACE DURING CONSTRUCTION.
 ALL WINDOWS TO BE RESET ORED FOR REPLACEMENT IN EXISTING LOCATIONS. PROVIDE NEW GLASS IN EXISTING FRAMES COMPRISED OF (2) LAYERS OF 1/4" GLASS, UNHATCHED.
 SEE STRUCTURAL REPORT AND DRAWINGS PREPARED BY WUE FOR BUILDING ENVELOPE EVALUATION AND REPAIR RECOMMENDATIONS.
 SEE HISTORIC STRUCTURES REPORT PREPARED BY ARCHITECTURAL RESOURCES GROUP FOR CONDITIONS ASSESSMENT AND TREATMENT. CONDITIONS ASSESSMENT AND TREATMENT INFORMATION INCLUDES THE FOLLOWING: BRICK, CONCRETE, EXTERIOR WOOD, WINDOWS AND DOORS, ROOF AND DRAINAGE, INTERIOR PLASTER, EXTERIOR WOOD, AND BUILDING SYSTEMS.
 SEE SCHEMATIC DESIGN REPORT FOR ROOM FINISHES AND SYSTEM DESCRIPTION.
 SEE RENOVATION VIEWS IN SCHEMATIC DESIGN REPORT FOR DESIGN INTENT OF POWERHOUSE, THEATER AND STUDIO MEZZANINES.
 SEE STRUCTURAL DRAWINGS FOR COMPLETE STRUCTURAL SCOPE.

KEY NOTES

- A. EXISTING TRUSSES TO REMAIN. SEE STRUCTURAL DRAWINGS FOR CROSS BRACING AT UNDERSIDE OF TRUSSES.
- B. STRUCTURAL CONCRETE WALLS SHOWN HATCHED. SEE STRUCTURAL DRAWINGS.
- C. EXISTING STEEL TRUSSES TO REMAIN.
- D. OPERABLE SLIP RESISTANT METAL COVER OVER STORAGE AREA.
- E. 6" SMOOTH TROWEL INTEGRAL COLORED CONCRETE FLOOR OVER EXISTING.
- F. STEEL AND GLASS WINDOW WALL ASSEMBLY.
- G. RETRACTABLE RISER SYSTEM.
- H. CAMERA OBSCURA PEEP HOLE.
- I. RAISED FLOOR AND STAIR SYSTEM AT EXISTING RAMP LOCATION.
- J. BUTT GLAZING ASSEMBLY BEHIND TRUSS.
- K. PATIATED COPPER SHEET METAL CLADDED PLYWOOD PANEL ASSEMBLY OVER STEEL FRAMING W/ BUTT GLAZING INFILL.
- L. PAINTED METAL FRAME ASSEMBLY W/ FIXED GLAZING.

NORTH



A5.6

BUILDING SECTIONS



City and County of San Francisco

Master Report

City Hall
1 Dr. Carlton B. Goodlett Place
San Francisco, CA 94102-4689

File Number: 040320	File Type: Resolution	Status: Passed
Enacted: 193-04		Effective:
Version: 1	Reference:	In Control: Mayor
File Name: Interdepartmental jurisdictional transfer of the Geneva Office Building and Powerhouse		Introduced: 3/16/2004
Requester:	Cost:	Date Passed: 4/1/2004
Comment: No fiscal impact.	Title: Resolution transferring jurisdiction over the Geneva Office Building and Powerhouse, located at the corner of Geneva Avenue and San Jose Avenue, from the Municipal Transportation Agency to the Recreation and Park Commission for recreational uses; adopting findings pursuant to the California Environmental Quality Act; and adopting findings that the transfer of jurisdiction is consistent with the City's General Plan and the Eight Priority Policies of Planning Code Section 101.1.	
Indexes:	Sponsors: Sandoval, Hall	

History of Legislative File		040320				
Ver	Acting Body	Date	Action	Sent To	Due Date	Pass/Fail
1	President	3/16/2004	REFERRED FOR ADOPTION WITHOUT COMMITTEE REFERENCE AGENDA AT THE NEXT BOARD MEETING			
1	Board of Supervisors	3/23/2004	AMENDED			Passed
	<i>Amended on page 3, line 15, by replacing "February 28, 2004" with "February 26, 2004."</i>					
2	Board of Supervisors	3/23/2004	ADOPTED AS AMENDED			Passed
	<i>Supervisor Hall requested to be added as a co-sponsor.</i>					
1	Mayor	4/1/2004	APPROVED			

1 [Interdepartmental jurisdictional transfer of the Geneva Office Building and Powerhouse.]

2
3 **Resolution Transferring Jurisdiction over the Geneva Office Building and Powerhouse,**
4 **Located at the Corner of Geneva Avenue and San Jose Avenue, from the Municipal**
5 **Transportation Agency to the Recreation and Park Commission for Recreational Uses;**
6 **Adopting Findings pursuant to the California Environmental Quality Act; and Adopting**
7 **Findings that the Transfer of Jurisdiction Is Consistent with the City's General Plan and**
8 **the Eight Priority Policies of Planning Code Section 101.1.**

9
10 WHEREAS, The Geneva Avenue Office Building and Powerhouse (the "Building") is
11 located on certain real property at the corner of Geneva Avenue and San Jose Avenue owned
12 by the City and County of San Francisco (the "City") under the jurisdiction of the City's
13 Municipal Transportation Agency ("MTA") and adjacent to the MTA's Geneva Rail Yard and
14 Carhouse (collectively, the "Yard"); and,

15 WHEREAS, The Building, which was built in 1901 and declared a City Landmark in
16 1985, consists of two adjoining structures: a two-story office building containing approximately
17 12,000 square feet with a Romanesque design, slanted wooden bays, a rounded Queen Anne
18 turret; and a single-story car shed, known as the Powerhouse, containing approximately 4,000
19 square feet with windows extending 28 feet from the floor to the ceiling; and,

20 WHEREAS, The MTA's Municipal Railway ("Muni") previously used the Building for
21 office functions, but the Building has sat vacant since being severely damaged in the 1989
22 Loma Prieta Earthquake; and,

23 WHEREAS, The MTA and the City's Recreation and Park Department (the
24 "Department") have reached a conceptual agreement to transfer jurisdiction over the Building
25 and the property surrounding the Building as shown on a survey plan, a copy of which is on

Supervisors Sandoval, Hall
Recreation and Park Department
BOARD OF SUPERVISORS

1 file with the Clerk of the Board of Supervisors in File No. 040320 and which is
2 hereby declared to be a part of this resolution as if set forth fully herein, (collectively, the
3 Building and surrounding property are hereinafter referred to as the "Property") to the
4 Recreation and Park Commission (the "Commission") for recreational use as a new space for
5 youth and teen arts and related uses consistent with the Department's mission; and,

6 WHEREAS, The MTA has used Federal and San Francisco County Transportation
7 Authority funds to design a project to stabilize the Building and also can contribute toward the
8 rehabilitation of the Building approximately \$865,000, including \$540,000 in funds obtained
9 from the State Transportation Congestion Relief Program for the Building, of which up to
10 \$490,000 can be used for the stabilization project and the remainder for future design work;
11 and,

12 WHEREAS, The Department will be responsible for securing the remaining funds for
13 the rehabilitation of the Building after the transfer; and,

14 WHEREAS, The MTA and the Department shall enter into a mutually acceptable
15 memorandum of understanding regarding funding for the rehabilitation of the Building,
16 coordination of construction staging and other issues during the rehabilitation project for the
17 Building, access to the Property and the surrounding Yard by both parties, and coordination of
18 operational issues; and

19 WHEREAS, The MTA and the Department have agreed that the transfer of jurisdiction
20 over the Property is subject to a condition subsequent whereby if the Commission determines
21 that the Property is no longer necessary for a recreational purpose, jurisdiction will revert to
22 the MTA; and,

23 WHEREAS, On January 20, 2004, the Municipal Transportation Agency Board of
24 Directors adopted Resolution No. 04-014, a copy of which is on file with the Clerk of the Board
25 of Supervisors in File No. 040320, which is hereby declared to be a part of this

1 resolution as if set forth fully herein, finding the Property surplus for the MTA's needs and
2 requesting that the Property be transferred to the Recreation and Park Commission at no cost
3 to be used for recreational purposes and related uses consistent with the Department's
4 mission; and,

5 WHEREAS, On January 15, 2004, the Recreation and Park Commission adopted
6 Resolution No. 0401-008, a copy of which is on file with the Clerk of the Board of Supervisors
7 in File No. 040320, which is hereby declared to be a part of this resolution as if set
8 forth fully herein, requesting that the Board of Supervisors approve the jurisdictional transfer
9 of the Property to the Commission; and,

10 WHEREAS, In accordance with the provisions of Section 23.13 of the San Francisco
11 Administrative Code, the Director of Property has reported to the Mayor his opinion that the
12 subject property can be most advantageously used by the Recreation and Park Commission
13 and has therefore recommended that the transfer be made; and,

14 WHEREAS, The Mayor recommends the proposed transfer of the Property; and,

15 WHEREAS, In a letter dated February 26, 2004, a copy of which is on file with the
16 Clerk of the Board of Supervisors in File No. 040320, which is hereby declared to be a
17 part of this resolution as if set forth fully herein, the Director of Planning found that the
18 jurisdictional transfer of the Property is consistent with the City's General Plan and with the
19 Eight Priority Policies of City Planning Code Section 101.1, and pursuant to the California
20 Environmental Quality Act ("CEQA"), State CEQA Guidelines and Chapter 31 of the San
21 Francisco Administrative Code, the Director of Planning also found that the transfer is
22 categorically exempt from CEQA; now, therefore be it

23 RESOLVED, That pursuant to San Francisco Administrative Code Section 23.13, this
24 Board hereby determines that the subject property is surplus to the Municipal Transportation
25

1 Agency and that it can be used most advantageously by the Recreation and Park
2 Commission; and, be it
3 FURTHER RESOLVED, That, accordingly and in accordance with the
4 recommendations of the Director of Property, the Mayor, the Director of Transportation and
5 the General Manager of the Recreation and Park Department, and with the approvals of the
6 Municipal Transportation Agency's Board of Directors and the Recreation and Park
7 Commission, jurisdiction of the subject Property is hereby transferred to the Recreation and
8 Park Commission, subject to the condition subsequent that if the Commission determines that
9 the Property is no longer necessary for a recreational purpose, jurisdiction will revert to the
10 MTA; and, be it

11 FURTHER RESOLVED, That the Board of Supervisors finds, based on the record
12 before it and in its independent judgment, that the actions proposed in this legislation are
13 categorically exempt from CEQA for the reasons set forth in the CEQA findings of the Director
14 of Planning set forth above and adopts as its own and incorporates by reference herein as
15 though fully set forth said findings; and, be it

16 FURTHER RESOLVED, That the Board of Supervisors adopts as its own and
17 incorporates by reference herein as though fully set forth the findings in the Director of
18 Planning's letter referred to above, that the jurisdictional transfer is in conformity with the
19 General Plan and is consistent with the Eight Priority Policies of Planning Code Section 101.1.

20 RECOMMENDED:
21 
22 _____
23 General Manager,
24 Recreation & Park Department

Michael J. Sun

Director of Transportation

Steve Legritto

Director of Property

- 1
- 2
- 3
- 4
- 5
- 6
- 7
- 8
- 9
- 10
- 11
- 12
- 13
- 14
- 15
- 16
- 17
- 18
- 19
- 20
- 21
- 22
- 23
- 24
- 25

RECEIVED
BOARD OF SUPERVISORS
SAN FRANCISCO
2004 MAR 19 PH 3:08

RECREATION AND PARK COMMISSION
City and County of San Francisco
Resolution No. 0401-008

BY BR

GENEVA OFFICE BUILDING AND POWERHOUSE TRANSFER

RESOLVED, That this Commission does approve a resolution urging approval by the Municipal Transportation Agency and the Board of Supervisors of the transfer of jurisdiction over the Geneva Avenue Office Building and Powerhouse, along with portions of the property surrounding the building, to the Recreation and Park Commission; adopting findings pursuant to the California Environmental Quality Act; authorizing a memorandum of understanding between RPD and MTA; and to allocate funds for temporary structural stabilization of the Geneva Avenue Office Building and Powerhouse in the amount of \$540,000.

Adopted by the following vote:

Ayes	6
Noes	0
Absent	1

I hereby certify that the foregoing resolution was adopted at the Regular Meeting of the Recreation and Park Commission held on January 15, 2004.

Margaret A. McArthur, Commission Liaison



March 15, 2004

Honorable Mayor Gavin Newsom
City Hall, Room 200
1 Dr. Carlton B. Goodlett Place
San Francisco, CA 94102

**Re: Request to Transfer Land
Geneva Office Building and Powerhouse**

Honorable Mayor Newsom:

In accordance with Section 23.13 of the San Francisco Administrative Code, the Recreation and Park Department (Rec Park) requests that the Geneva Avenue Office Building and Powerhouse (G.O.B.) be transferred from the San Francisco Municipal Transportation Agency (MTA) to the Recreation and Park Commission's jurisdiction in order to improve and reuse this building for recreational purposes.

The MTA and Rec Park have reached a conceptual agreement to transfer the G.O.B. to Rec Park. The structures are located on Geneva Avenue at San Jose Avenue in Supervisorial District 11 and include approximately 12,000 sq. ft. of floor area. Rec Park has been working with the community to find adequate space for youth and teen arts and wishes to proceed with plans to create a new recreational space at this MTA site for the purpose of housing this function.

G.O.B. was built in 1899, and declared a City Landmark in 1983. Most of its office functions were replaced when MTA's Green Annex, across San Jose Ave., became operational in 1986. A few MTA office functions remained there until October 1989, when the building was severely damaged in the Loma Prieta earthquake; the building has been declared uninhabitable.

Using Federal Emergency Management Agency (FEMA) funds and San Francisco County Transportation Authority (SFCTA) grant funds, MTA has undertaken the design of a project to stabilize the building. Stabilization will make it less likely to collapse in an earthquake, but will not make the building structurally safe for occupancy. When funds are available, Rec Park intends to structurally upgrade the G.O.B. and bring it into conformance with Building Code standards.

MTA has also obtained \$540,000 in State Transportation Congestion Relief Program (TCRP) funds for the G.O.B. Up to \$490,000 of these funds can be used for

I:\USERS\JACOBSON\2301 San Jose Ave\Ltr to Mayor_Req Trnsfer.doc

the stabilization project, and the remainder for future design work. Including this \$490,000, MTA is prepared to contribute a total of approximately \$824,000 toward the remainder of the work needed to complete the stabilization project. The \$490,000 in TCRP funds must be expended by June 30, 2004, their current expiration date. MTA has no other funds besides the approximately \$824,000 noted above. All project costs above this amount will be the responsibility of Rec Park.

All of MTA's available funding must be used for structural stabilization, to make the building safer for Muni employees who work nearby and for the general public who pass by on the San Jose Ave. side of the building.

The MTA has agreed to transfer its project management responsibilities for stabilizing the building, as well as all available funding for this work, to Rec Park. The Department of Public Works including Bureau of Architecture will work with Rec Park to oversee the on-going project management for stabilizing the building and developing designs for future use of the building. The Real Estate Division will continue to work with MTA, Rec Park and the City Attorney's office on the transfer of this property.

I would be happy to discuss this proposal in greater detail with you or your staff. Please feel free to call me at 554-9871 or Larry Jacobson at 554-9861.

Sincerely,



Steve Legnitto
Acting Director of Property

cc: Supervisor Gerardo Sandoval – District 11
Michael Burns, Exec. Director, MTA
Jim Nelson, Muni
Elizabeth Goldstein, Gen. Manager, Rec Park
Yomi Agunbiade, Rec Park
Darryl Burton, Director, Admin. Services

Photographed
12.1.55
LJ

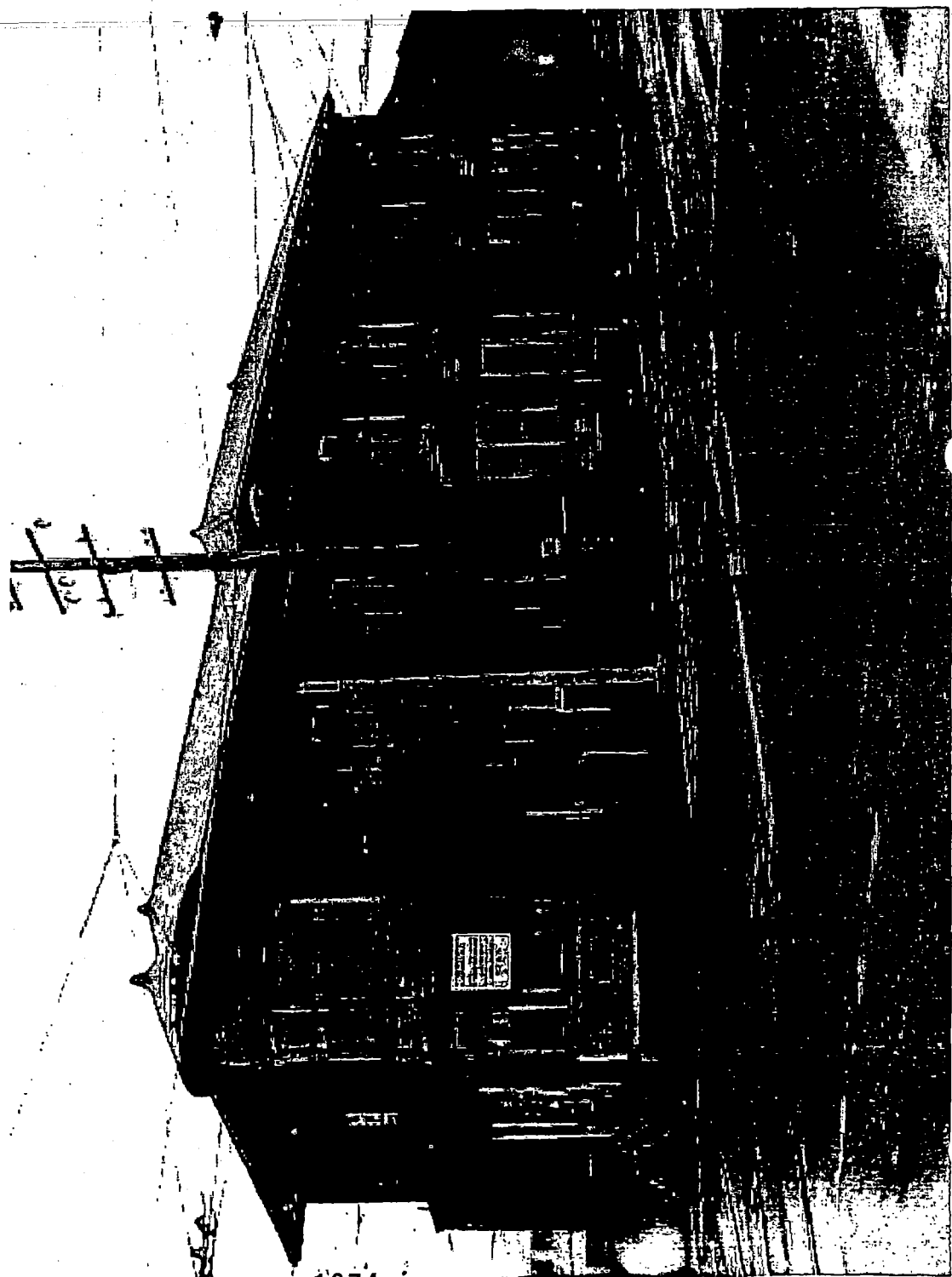

1674



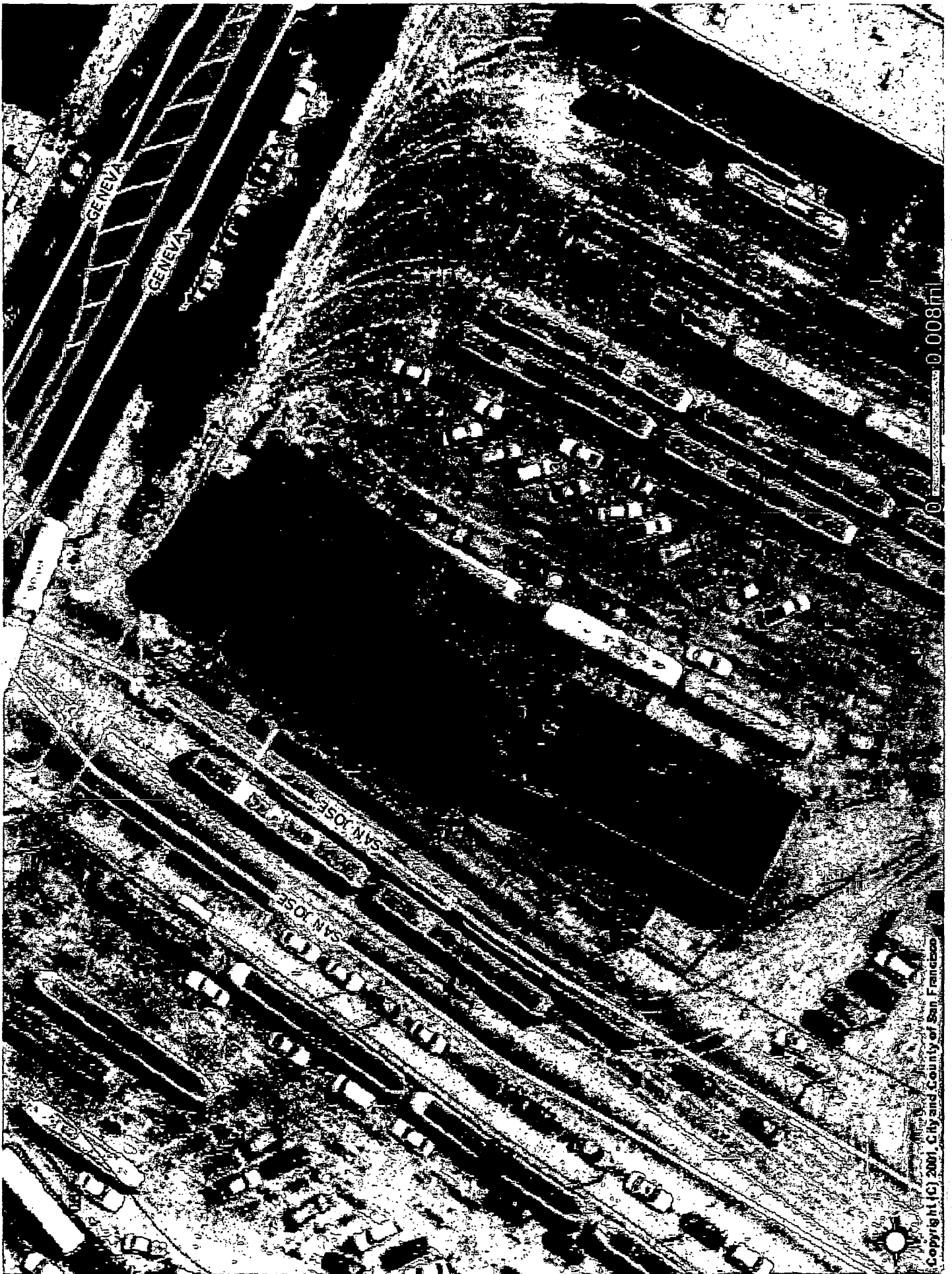

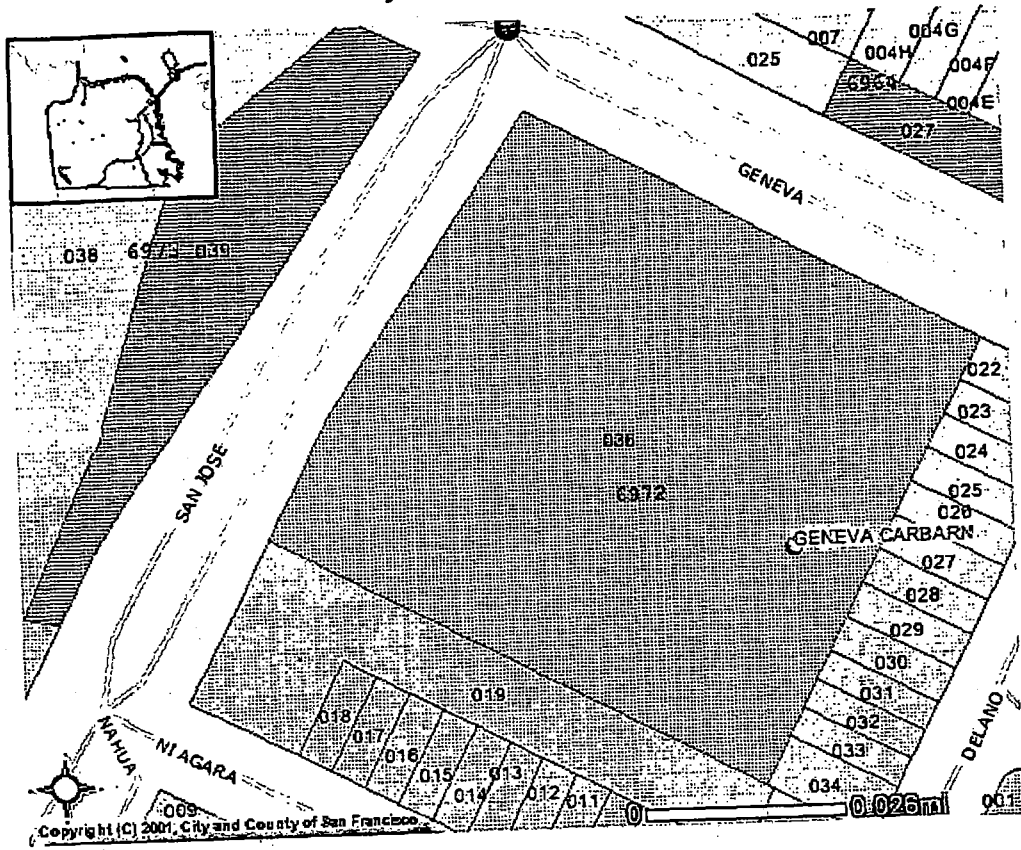
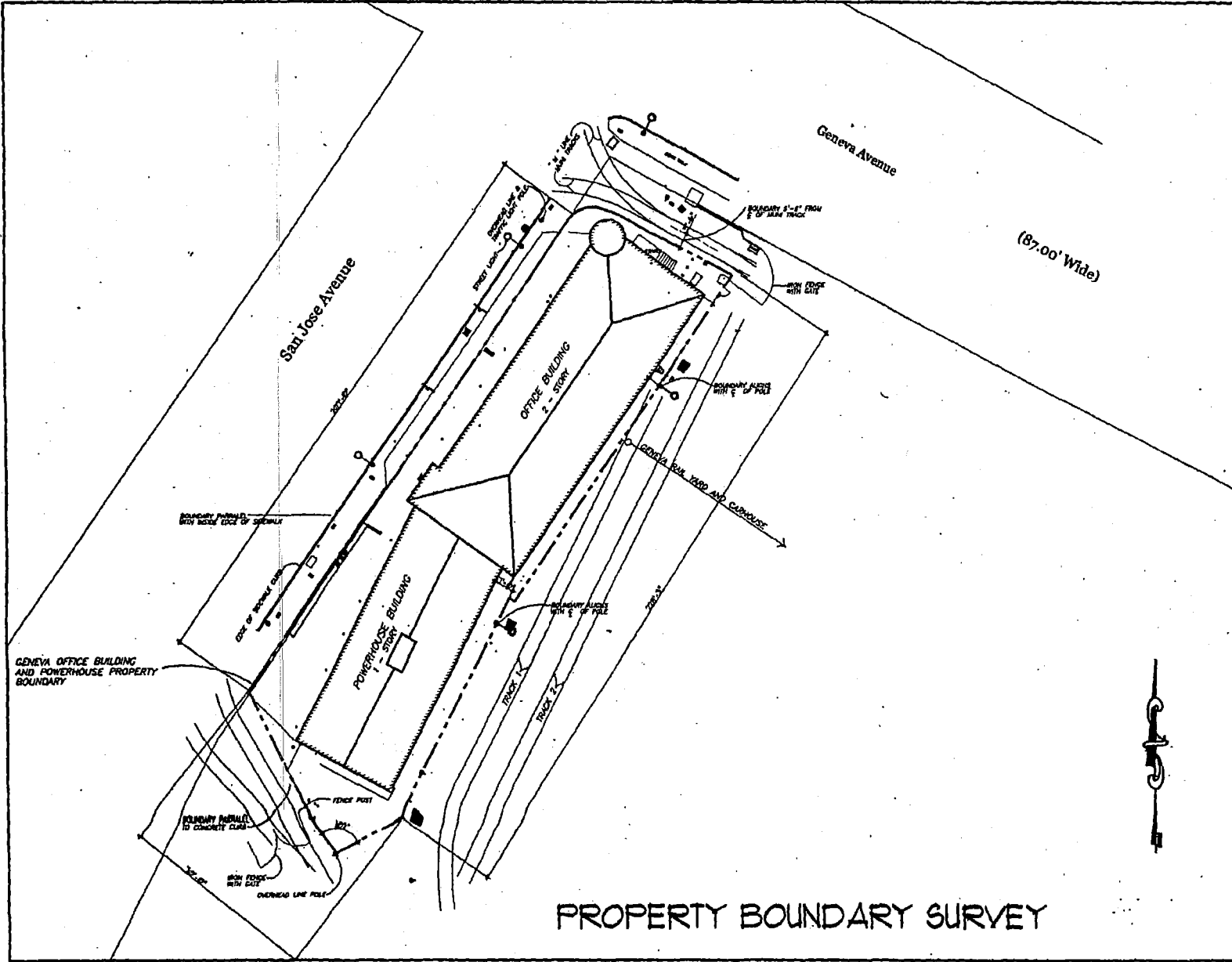

Exhibit A



PROPERTY BOUNDARY SURVEY



Bureau of
Architecture
 DEPARTMENT OF PUBLIC WORKS
 CITY AND COUNTY OF SAN FRANCISCO
 80 Van Ness Avenue Suite 4100
 San Francisco, CA 415247-4700
 415222-6006 Fax 415247-4701

CONSULTANT CONSULTANT'S STAFF

PROJECT TITLE
GENEVA OFFICE BLDG.

ADDRESS 1
 ADDRESS 2
 ADDRESS 3

NO.	DATE	REVISIONS

DRAWING TITLE

SHEET NO.

SCALE

30000X

MEMORANDUM OF UNDERSTANDING

DRAFT

THIS MEMORANDUM OF UNDERSTANDING (herein "MOU") dated hereof for reference purposes only as of _____, 2004, is entered into by and between the Municipal Transportation Agency (the "MTA"), an agency of the City and County of San Francisco (the "City") and the City's Recreation and Park Commission (the "Commission").

RECITALS

A. The MTA and the City's Recreation and Park Department (the "Department") have reached a conceptual agreement to transfer jurisdiction over the Geneva Avenue Office Building and Powerhouse (the "Building"), along with the property surrounding the Building as delineated in Exhibit A (collectively, the Building and surrounding property are hereinafter referred to as the "Property") to the Recreation and Park Commission (the "Commission") for recreational use as a new space for youth and teen arts and related uses consistent with the Department's mission. This recreational use is consistent with the recommendations contained in the Draft Balboa Park Station Area Plan produced by the City Planning Department as part of their Better Neighborhoods 2002 Program. The Property is more particularly shown on Exhibit A attached hereto.

B. The Recreation and Park Department (the "Department"), working with the Department of Public Works ("DPW"), will oversee a construction project to rehabilitate and restore the Building in order to ready it for use as a recreation center (the "Project").

C. The MTA can contribute approximately \$865,000 toward the rehabilitation of the Building, including \$540,000 in funds obtained from the State Transportation Congestion Relief Program (TCRP) for the Building, of which up to \$490,000 can be used for the stabilization project and the remainder for future design work. However, the entire MTA contribution to this project consists of grant funds from outside agencies, and if such funds should at some point become unavailable to the MTA, this contribution will be reduced accordingly. The Department will be responsible for remainder of funds required for the Project.

D. The Property is located adjacent to the MTA's Geneva Rail Yard and Carhouse (collectively, the "Yard"). The fire alarm control panel for the adjacent Carhouse, as well as the switch for the Carhouse telephone system, are located within the Building, so MTA's Municipal Railway ("Muni") will need continued access to the first floor and basement of the Building both during and after the Project. In addition, the Department may need access to the Yard from time to time in connection with the Project and with ongoing Building maintenance, operations and repairs. Both Parties will reasonably cooperate to provide the other Party necessary access, as further described in this MOU.

NOW, THEREFORE, IT IS AGREED AS FOLLOWS:

AGREEMENT

1. **Recitals.** The foregoing recitals are true and correct and are incorporated herein by this reference.

2. **Term.** This MOU shall become effective upon approval by the Board of Supervisors and the Mayor of the transfer of jurisdiction over the Property to the Department. The day upon which the transfer is finally approved and this MOU becomes effective shall be the "Effective Date." The MOU shall continue from the Effective Date until terminated in writing by both Parties.

3. **Grant of Mutual Rights of Entry.**

(a) **The MTA's Permitted Uses of the Property.** The Department hereby grants to Muni and its employees, agents, consultants, contractors and authorized representatives (collectively, "Agents") the right to enter upon and use the Property as reasonably necessary for the operation of the Yard to access the electrical control panel located on the first floor of the Building. During the Project, such access will be provided to the extent it is safe to enter the Building. In the event the Project does not permit continued access, Muni and the Department will work together to relocate the fire alarm control panel and the telephone switch. Muni will coordinate access during the Project, or any subsequent construction project, with the Department's construction contractor and/or DPW. Muni will designate in advance its Agents with 24-hour access to the Building and provide contact information for such Agents to the Department. Muni shall be responsible for securing the Building after Muni's entry permitted hereunder. In the event Muni needs access to the Property for any project in connection with the Yard, Muni shall provide 30 days advance notice to the Department, except in the case of an emergency requiring such access, in which case Muni shall provide notice to the Department of its entry of the Property as soon as reasonably possible. Muni shall provide any construction plans that could reasonably affect the Property, including, without limitation, such plans requiring access thereto, for the Department's advance review and approval, which shall not be unreasonably withheld.

(b) **The Department's Permitted Uses of the Yard.** The MTA hereby grants to the Department and its Agents the right to enter upon and use that part of the Yard directly adjacent to the Building as necessary for work on the Building, including, without limitation, such Project construction work, ongoing Building repairs, maintenance and operations, and future construction projects. The Department shall protect and not interrupt power and telephone services routed through the building (as noted in Recital "D"), and shall give MTA at least 24 hours advance notice of any temporary interruptions that may be necessary. The Department shall provide 30 days advance notice to Muni of its need to enter the Yard, except in the case of an emergency requiring such entry, in which case the Department shall provide notice to Muni of its entry of the Yard as soon as reasonably possible. The Department shall provide any construction plans that could reasonably affect the Yard, including, without limitation, such plans requiring access thereto, for Muni's advance review and approval, which shall not be unreasonably withheld. The Department shall reimburse Muni for staff costs and for contractor costs that Muni may have to incur in connection with making the Yard available for the Department's construction project on the Building. The Parties acknowledge and agree that the Yard is a working rail yard. No automobile parking in connection with the Department's use and operation of the Building will be permitted in the Yard, and the access to the Yard by Muni's railcars must not be constrained. Public access to the Building upon conclusion of the Project shall be via San Jose Avenue only.

4. **Construction Project and Funding.** The seismic upgrade and rehabilitation of the Geneva Office Building and Power House will be carried out in two phases.

(a) Phase I, Structural Stabilization:

Abatement and construction work are estimated at \$ 857,000 and soft cost and contingencies at \$540,000, for a total project cost of \$1.4 million. Construction is expected to start in Feb 2004 and be completed by August 2004. The scope of work includes structural bracing and essential repairs designed to make the building less likely to collapse in an earthquake, but will not make the building structurally safe for occupancy. The Project will also pay for any and all Muni operating expenses that result from adapting Muni service to accommodate the Project work.

Using FEMA funds and SFCTA grant funds, MTA has undertaken the design of a Phase I to stabilize the building. MTA has obtained \$540,000 in State TCRP (Transportation Congestion Relief Program) funds for the G.O.B., of which up to \$490,000 can be used for the stabilization project, and the remainder for future design work. Including this \$490,000, MTA can contribute a total of approximately \$865,000. However, the entire MTA contribution to this project consists of grant funds from outside agencies, and if such funds should at some point become unavailable to the MTA, this contribution will be reduced accordingly. The Department will invoice the MTA as the Project proceeds, and the MTA will pay the invoices until none of the available funds remain. Recreation and Park Dept. has committed \$50,000 in Open Space Funds to begin the Phase I stabilization project work. The Department of Public Works (DPW) on behalf of Recreation and Parks will use one of their as-need construction contracts to carry out the work. DPW will bid the project in December and have a firm bid to do the work in January, prior to the RPD Finance committee meeting. In January 2004, the Recreation and Park Commission committed \$540,000 to the project.

(b) Phase II, Seismic Upgrade & Rehabilitation of Office Building & Powerhouse:

Construction is estimated between \$14 and \$16 million. Planning, design and bidding for this work is expected to take two years followed by two years of construction. The scope of work for this phase includes a complete seismic upgrade of both building structures, new electrical, mechanical and plumbing systems, new interior finishes and refurbishing of historically significant building elements, as well as Muni operational changes necessitated by the construction of Phase II. No specific funding sources have been identified for the project, but it is believed that due to the nature of the future use of the building, funding could be leveraged from multiple sources, including private donations, State and Federal Grants, and matching local funds.

5. **Limitations on Use.** Muni shall not use or permit the Property, or any part thereof, to be used for any purposes or in any manner other than the purposes and manner set forth in Paragraph 3 of this MOU. The Department shall not use or permit the Yard, or any part thereof, to be used for any purposes or in any manner other than the purposes and manner set forth in Paragraph 3 of this MOU.

6. **Indemnification.** It is the understanding of the Parties that each Party is responsible for all costs associated with all claims, damages, liabilities or losses which arise as a result of such Party's uses permitted hereunder.

7. **Notices.** All notices, demand, consents or approvals which are or may be required to be given by either party to the other under this MOU shall be in writing and shall be deemed to have been

fully given when delivered in person to such representatives of the Department and the MTA as shall from time to time be designated by the parties for the receipt of notices, or when deposited in the United States mail, postage prepaid, and addressed, if to Muni to:

Municipal Transportation Agency
Kerstin Magary, Manager of Real Estate
1145 Market Street, 3rd Floor
San Francisco, CA 94103-1545

and if to the Department to:

Recreation and Park Department
Elizabeth Goldstein, General Manager
McLaren Lodge
San Francisco, CA 94117

or such other address with respect to either party as that party may from time to time designate by notice to the other given pursuant to the provisions of this Paragraph.

8. **Cooperation.** Subject to the terms and conditions of this MOU, the Parties agree to use reasonable efforts to do, or cause to be done, all things reasonably necessary or advisable to carry out the purposes of this MOU as expeditiously as practicable, including, without limitation, performance of further acts and the execution and delivery of any additional documents in form and content reasonably satisfactory to both Parties.

IN WITNESS WHEREOF, the parties have caused this agreement to be executed as of the date first written above.

AGREED TO AS WRITTEN ABOVE:

AGREED TO AS WRITTEN ABOVE:

CITY AND COUNTY OF
SAN FRANCISCO, a municipal
Corporation operating by and through
THE RECREATION AND PARK
COMMISSION

CITY AND COUNTY OF
SAN FRANCISCO, a municipal
corporation operating by and through
THE MUNICIPAL
TRANSPORTATION AGENCY

By: _____
ELIZABETH GOLDSTEIN
General Manager

By: _____
MICHAEL T. BURNS
Director of Transportation

Date: _____

Date: _____

Exhibit

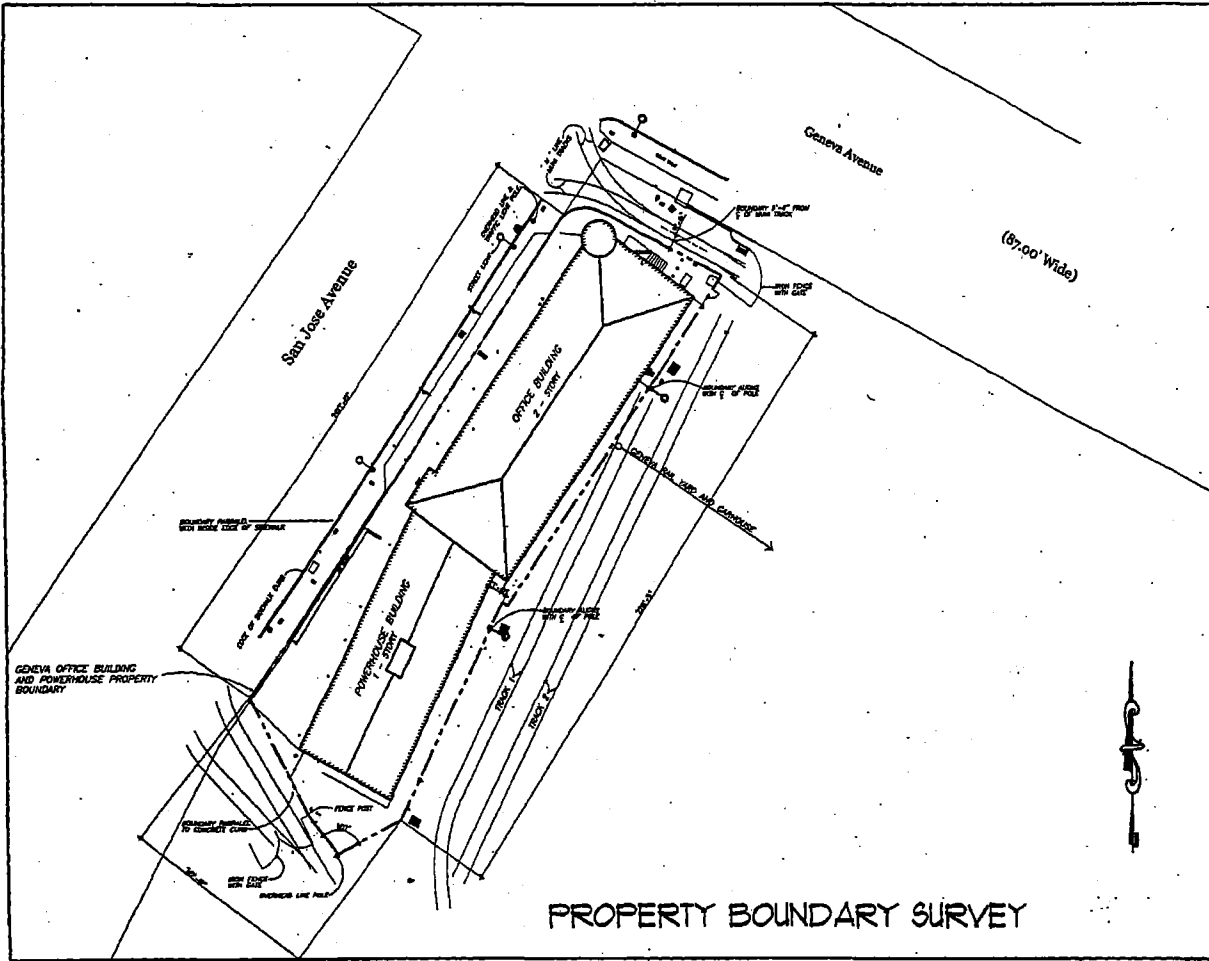

PROPERTY BOUNDARY SURVEY



Bureau of Architecture
 DEPARTMENT OF PUBLIC WORKS
 CITY AND COUNTY OF SAN FRANCISCO
 20 Van Ness Avenue, Suite 400
 San Francisco, CA 94102-4000
 (415) 398-3300 Fax (415) 398-3301

CONSULTANT CONSULTANT'S REPORT

PROJECT TITLE
GENEVA OFFICE BLDG

ADDRESS 1
 ADDRESS 2
 ADDRESS 3

NO.	DATE	REVISIONS

PREP BY: _____
 CHECK BY: _____
 DATE: _____
 SCALE: _____

MUNICIPAL TRANSPORTATION AGENCY BOARD
CITY AND COUNTY OF SAN FRANCISCO

RESOLUTION No. 04-014

WHEREAS, The Municipal Transportation Agency (MTA) currently has jurisdiction over the Geneva Office Building and Powerhouse (the "Building"), located at Geneva and San José Avenues, adjacent to the Municipal Railway's (Muni's) Geneva Rail Yard; and

WHEREAS, The Building, built in 1901, contains approximately 14,800 square feet of office and storage space, and was declared a City Landmark in 1985; and

WHEREAS, The Building has been unoccupied and unused since being severely damaged in the 1989 Loma Prieta Earthquake, and Muni has no future uses planned for the Building; and

WHEREAS, A conceptual agreement has been developed to transfer jurisdiction of the Building and portions of property surrounding the Building as shown on a survey plan, a copy of which is on file with the Board Secretary and is hereby declared to be a part of this resolution as if set forth fully herein (collectively, the Building and surrounding property are hereinafter referred to as the "Property"), from the MTA to the Recreation and Park Commission (the "Commission") for recreational purposes as space for youth and teen arts and related uses; and

WHEREAS, The MTA has expended approximately \$345,000 to date on design of a project to increase the seismic stability of the Building and add a new roof (the "Project"); and

WHEREAS, The MTA will contribute an additional \$815,000, approximately, in site-specific funding to the construction phase of the Project, and \$50,000 to the ultimate rehabilitation of the Building; and

WHEREAS, The Commission will contribute all of the additional funding needed to complete the Project, and to design and complete the ultimate rehabilitation; and

WHEREAS, Staff for the MTA and the Commission have developed a memorandum of understanding (MOU) regarding funding for the stabilization and rehabilitation of the Building, coordination of construction staging and other issues during the Project and future construction projects, access to the Property and the surrounding Yard by both parties, and coordination of operational issues; and

WHEREAS, The transfer of jurisdiction over the Property is subject to a condition subsequent whereby if the Commission determines that the Property is no longer necessary for a recreational purpose, jurisdiction will revert to the MTA; and

WHEREAS, In a statement dated December 18, 2003, a copy of which is on file with the Board Secretary and is hereby declared to be a part of this resolution as if set forth fully herein, the Director of Planning found that the jurisdictional transfer of the Property is categorically exempt from CEQA; now, therefore, be it

RESOLVED, That the MTA Board of Directors consents to the jurisdictional transfer of the Geneva Office Building and Powerhouse, along with portions of property surrounding the Building, to the Recreation and Park Commission for purposes of recreational uses, subject to the condition subsequent that if the Commission determines that the Property is no longer necessary for a recreational purpose, jurisdiction will revert to the MTA; and, be it

FURTHER RESOLVED, That the MTA Board authorizes the Director of Transportation to enter into an MOU with the Commission regarding project funding and uses of the Property and the surrounding yard in substantially the form presented to this Board; and, be it

FURTHER RESOLVED, That the MTA Board requests that the Board of Supervisors approve legislation authorizing the transfer of jurisdiction over the Property to the Commission; and, be it

FURTHER RESOLVED, That the MTA Board finds, based on the record before it and in its independent judgment, that the actions proposed in this legislation are categorically exempt from CEQA for the reasons set forth in the CEQA findings of the Director of Planning set forth above and adopts as its own and incorporates by reference herein as though fully set forth said findings.

I hereby certify that the foregoing resolution was adopted by the Municipal Transportation Agency Board of Directors at its meeting of JAN 20 2004

R. Boomer

Secretary, Municipal Transportation Agency Board



PLANNING DEPARTMENT

City and County of San Francisco • 1660 Mission Street, Suite 500 • San Francisco, California • 94103-2414

MAIN NUMBER
(415) 558-6378

DIRECTOR'S OFFICE
PHONE: 558-6411

4TH FLOOR
FAX: 558-6426

ZONING ADMINISTRATOR
PHONE: 558-6350

5TH FLOOR
FAX: 558-6400

PLANNING INFORMATION
PHONE: 558-6377

MAJOR ENVIRONMENTAL
FAX: 558-5991

COMMISSION CALENDAR
INFO: 558-6422

INTERNET WEB SITE
WWW.SFGOV.ORG/PLANNING

February 26, 2004

Larry Jacobson
Real Estate Division
City and County of San Francisco
25 Van Ness Avenue, Suite 400
San Francisco, CA 94102

Re: 2003.1280R
Geneva Office Building and Powerhouse
2301 San Jose Avenue
Jurisdictional Transfer from Municipal Railway to Recreation and Parks Department

Dear Mr. Jacobson:

On December 2, 2003, the Planning Department received your request to determine whether the above-referenced jurisdictional transfer is in conformity with the General Plan. The Recreation and Parks Department proposes to take over this facility from the Municipal Railway for the purpose of restoring the building and using it for recreational uses. *Please note that this General Plan Referral covers only the jurisdictional transfer and not the ultimate re-use of this facility.* The Recreation and Parks Department must apply in the future to the Planning Department for another General Plan referral on the proposed specific design and re-use of the facility.

The jurisdictional transfer is, on balance, **in-conformity** with the General Plan.

Please note that the transfer and re-use of this facility is taking place within the context of the Balboa Park Station Area Plan, currently in draft form. Recreation and Parks staff should consult closely with Planning Department staff in planning the re-use of the building to ensure that it is in conformity with this plan, as well as the General Plan.

Environmental Review

On December 18, 2003, the Major Environmental Analysis Division of the Planning Department determined that the proposal is Categorically Exempt from Environmental Review, under Class 16 of State Environmental Review Guidelines.

Planning Code Section 101.1 Policies

The project has been reviewed for consistency with the Eight Priority Policies of Planning Code Section 101.1 and the findings are attached.

Sincerely,

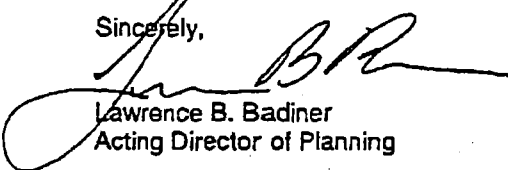
Lawrence B. Badiner
Acting Director of Planning

cc: Planning File 2003.1280R
Elizabeth Goldstein, Recreation and Parks Department

Attachments

1. Staff Report *General Plan* Policies
2. Planning Code Section 101.1 Policies

W:\GEN_PLANREFERRAL\2003.1280R

STAFF REPORT - GENERAL PLAN POLICIES

Note: General Plan Objectives and Policies in **Bold font**; General Plan text is in regular font. Staff comments are in *italic font*.

RECREATION AND OPEN SPACE ELEMENT

Objective 4:

PROVIDE OPPORTUNITIES FOR RECREATION AND THE ENJOYMENT OF OPEN SPACE IN EVERY SAN FRANCISCO NEIGHBORHOOD

Policy 4.1: Make better use of existing facilities

Policy 4.2: Maximize joint use of other properties and facilities

Policy 4.3: Renovate and renew the City's parks and recreation facilities.

COMMUNITY FACILITIES ELEMENT

Objective 3:

ASSURE THAT NEIGHBORHOOD RESIDENTS HAVE ACCESS TO NEEDED SERVICES AND A FOCUS FOR NEIGHBORHOOD ACTIVITIES.

Policy 3.1: Provide neighborhood centers in areas lacking adequate community facilities.

Policy 3.2: Assure that neighborhood centers complement and do not duplicate existing public and private facilities.

Policy 3.4: Locate neighborhood centers so they are easily accessible and near the natural center of activity.

Policy 3.5: Develop neighborhood centers that are multipurpose in character, attractive in design, secure and comfortable, and inherently flexible in meeting the current and changing needs of the neighborhood served.

Policy 3.7: Program the centers to fill gaps in needed services, and provide adequate facilities for ill-housed existing services.

Objective 4:

PROVIDE NEIGHBORHOOD CENTERS THAT ARE RESPONSIVE TO THE COMMUNITY SERVED.

Policy 4.1: Assure effective neighborhood participation in the initial planning, ongoing programming, and activities of multi-purpose neighborhood centers.

Planning Code Section 101.1 Eight Priority Policies

The Subject project, defined as a jurisdictional transfer of the Geneva Office Building and Powerhouse, is consistent with the Eight Priority Policies of Planning Code Section 101, as described below:

1. The transfer would have no adverse effect on neighborhood serving retail uses or opportunities for employment in or ownership of such businesses.
2. The transfer would have no adverse effect on the City's housing stock or on neighborhood character.
3. The transfer would have no adverse effect on the City's supply of affordable housing.
4. The transfer would not result in commuter traffic impeding Muni transit service or overburdening the streets or neighborhood parking.
5. The transfer would not adversely affect the industrial or service sectors or future opportunities for resident employment or ownership in these sectors.
6. The transfer would not adversely affect achieving the greatest possible preparedness against injury and loss of life in an earthquake. After its transfer is effected, the Recreation and Parks Department intends to seek the funds to move ahead with a full seismic upgrade of the facility.
7. The transfer would have no negative effect on landmarks or historic buildings. The facility is a city landmarked building and the Recreation and Parks Department intends to restore the building in accordance with historical preservation standards.
8. The transfer would have no adverse effect on parks and open space or their access to sunlight and vistas.



MEMORANDUM

DATE: December 3, 2003

TO: Sally Ramon
Planning Department

FROM: Larry Jacobson *[Signature]*
Real Estate Division

SUBJECT: Jurisdictional Transfer from Muni to RecPark
2301 San Jose Avenue - General Plan Referral

The Recreation and Park Department has work order funds at City Planning. Please ask the Planning finance officer to call Julie Lee at RecPark (831-2743) for authorization to charge the \$228.00 application fee to the existing work order.

This project has a March deadline to begin construction work; it is one of the conditions of the grant funds that are being used for building rehabilitation. The matter is going to the Board of Supervisors in January. Legislation is currently being prepared for both the Recreation and Park Commission and the Municipal Transportation Agency.

Your prompt attention to this matter is very much appreciated.

SAN FRANCISCO DEPARTMENT OF CITY PLANNING
CATEGORICALLY EXEMPT FROM ENVIRONMENTAL REVIEW

*CLASS 16 Transfer of land
to create parks.
Nannie L. Farrell
December 18, 2003
(any subsequent development
proposal will be subject to
additional environmental
review.)*

I:\USERS\LJACOBS\2301 San Jose Ave\juris transf RamonS planning.doc

INTRODUCTION FORM

By a member of the Board of Supervisors or the Mayor

RECEIVED
BOARD OF SUPERVISORS
SAN FRANCISCO
2004 MAR 16 PM 12:39
Time Stamp or Meeting Date

I hereby submit the following item for introduction:

BY [Signature]

- 1. For reference to Committee:
An ordinance, resolution, motion, or charter amendment.
- 2. Request for next printed agenda without reference to Committee
- 3. Request for Committee hearing on a subject matter.
- 4. Request for letter beginning "Supervisor _____ inquires..."
- 5. City Attorney request.
- 6. Call file from Committee.
- 7. Budget Analyst request (attach written motion).

[Note: For the Imperative Agenda (a resolution not on the printed agenda), use a different form.]

Sponsor(s): Supervisor Gerardo C. Sandoval

SUBJECT: Resolution transferring the Geneva Office Building and Powerhouse from the jurisdiction of the San Francisco Municipal Transportation Agency (MTA) to the jurisdiction of the Recreation and Park Commission in order to improve and reuse this building for recreational purposes.

The text is listed below or attached:

See attached.

Signature of Sponsoring Supervisor: Gerardo Sandoval

For Clerk's Use Only:

AMENDED IN COMMITTEE
4/2/14

FILE NO. 140034

ORDINANCE NO. 52-14

1 [Waiving Competitive Solicitation Requirement to Procure Partial Design Documents -
2 Professional Services Agreement - Geneva Car Barn and Powerhouse Project - Aidlin Darling
3 Design - \$838,000 \$837,863]

4 Ordinance waiving the competitive solicitation requirement under Administrative Code,
5 Section 6.40, and authorizing the General Manager of the Recreation and Park
6 Department to enter into a professional services agreement with Aidlin Darling Design
7 in the amount of ~~\$838,000~~\$837,863, for the purpose of completing the design
8 development documents and partial completion of construction documents for the
9 Geneva Car Barn and Powerhouse project, and to amend the agreement as necessary
10 to complete final (100 percent) construction documents, to commence following Board
11 approval.

12 NOTE: Unchanged Code text and uncodified text are in plain Arial font.
13 Additions to Codes are in *single-underline italics Times New Roman font*.
14 Deletions to Codes are in *strikethrough italics Times New Roman font*.
15 Board amendment additions are in double-underlined Arial font.
16 Board amendment deletions are in ~~Arial font~~.
17 Asterisks (* * * *) indicate the omission of unchanged Code
18 subsections or parts of tables.

17 Be it ordained by the People of the City and County of San Francisco:

18 Section 1. Background. The Geneva Car Barn and Powerhouse ("Car Barn"),
19 designed and built in 1901 by the Reid brothers, originally served as a depot for both private
20 railroads as well as the San Francisco Municipal Railway (Muni). It is the last physical vestige
21 of San Francisco's first electric railway and was designated a City Landmark in 1985 and
22 placed on the National Register of Historic Places in 2010. The Car Barn, located at the
23 corner of Geneva Avenue and San Jose Avenue, consists of two adjoining structures, an
24 approximately 12,000 square foot two-story office building, and an approximately 4,000
25 square foot single-story car shed, known as the Powerhouse. Muni used the building as office

1 space until 1989, when it was heavily damaged in the Loma Prieta earthquake. The Car Barn
2 has been vacant ever since.

3 In 1998, the Car Barn was saved from a planned demolition through the efforts of a
4 neighborhood citizens group, the Friends of the Geneva Car Barn and Powerhouse
5 ("Friends"), formed to oppose the demolition of the Car Barn. After the Municipal
6 Transportation Agency ("MTA") stabilized the Car Barn in 1999, the MTA transferred
7 jurisdiction over the Car Barn to the Recreation and Park Department ("RPD") to be used for
8 recreational purposes and related uses consistent with the RPD's mission (Resolution
9 193-04).

10 On March 13, 2007, the Board of Supervisors appropriated \$1,044,490 for the repair
11 and renovation of the Car Barn (Ordinance No. 61-07). RPD, in partnership with the Friends,
12 developed a plan for the renovation and adaptive reuse of the Car Barn. The plan included a
13 seismic upgrade, installation of modern utility systems, restoration of historic features,
14 accessibility improvements, artist studios, event/exhibition space, a cafe, theater, community
15 meeting room, student lounge, and retail spaces. RPD allocated \$838,000 of the 2000
16 General Obligation Bond toward the project.

17 In 2009, as a result of the City's budget deficit, the \$1,044,490 allocated to the Car
18 Barn in Ordinance No. 61-07 was rescinded.

19 In response to this loss of funds, the Friends initiated a design competition for pro bono
20 architectural services for the renovation of the Car Barn. Aidlin Darling Design ("Aidlin") won
21 the competition, and to date has donated services valued at \$205,500. These services
22 include the completion of concept and schematic designs, renderings of the proposed project,
23 as well as assistance in the City's attainment of State and federal historic preservation
24 approvals.

1 RPD used Aidlin's schematic design to seek California Environmental Quality Act
2 ("CEQA") approval as well as approvals from the State Office of Historic Preservation
3 ("SHPO") and the National Park Service ("NPS").

4 Section 2. Rationale for Waiver of Competitive Solicitation Requirement. RPD wishes
5 to leverage the \$838,000 in 2000 GO Bond funds available for the project to seek additional
6 funds from the 2015 Historic Preservation and New Market Tax Credit program as well as the
7 City's Community Opportunity Fund program. To be eligible for these programs, the project
8 must have final design and construction documents completed by the end of 2014.

9 Section 6.40 of the Administrative Code requires Departments to procure outside
10 temporary professional design or consultant services for public work projects greater than
11 \$100,000 through a competitive process.

12 RPD desires to award a professional services contract to Aidlin for two reasons. First,
13 because a typical competitive procurement for architectural services for public works projects
14 can take many months, a competitive solicitation process under Section 6.40 of the
15 Administrative Code would likely impair the City's ability to seek 2015 Historic Preservation
16 and New Market Tax Credits and Community Opportunity Fund money for the Car Barn
17 project. Second, RPD is concerned that if another architect is brought onto the project, not
18 only would it be unusual for that new firm to complete design and construction documents
19 based on Aidlin's schematic design, but inconsistencies or changes with the design of the Car
20 Barn could jeopardize the approvals received from SHPO and the NPS.

21 Accordingly, RPD seeks to enter into an agreement with Aidlin in an amount of
22 \$837,853 to complete 100 percent design development documents and 50 percent
23 construction documents. Final construction documents (100% completion) will require an
24 additional \$475,951 based on current cost proposals. RPD and the Friends have agreed that
25 the Friends will attempt to make up the \$475,951 shortfall through fundraising.

1 Section 3. Waiver of Competitive Solicitation Requirement. The Board of Supervisors
2 hereby waives the competitive solicitation process requirement under Section 6.40 of the
3 Administrative Code and authorizes the General Manager of the Recreation and Park
4 Department to enter into a professional services agreement with Aidlin Darling Design in the
5 amount of ~~\$838,000~~837,863 for the limited purpose of completing the 100 percent design
6 development documents and 50 percent and construction documents for the Geneva Car
7 Barn and Powerhouse, and to amend the agreement as necessary to complete final (100
8 percent) construction documents with funds provided by the Friends as long as the
9 amendment would not require expenditure of any other City funds. Any gift of funds from the
10 Friends to RPD to fund the completion of the construction documents, are subject to
11 acceptance and approval by the Board as required.

12 Section 4. Effective Date. This ordinance shall become effective 30 days after
13 enactment. Enactment occurs when the Mayor signs the ordinance, the Mayor returns the
14 ordinance unsigned or does not sign the ordinance within ten days of receiving it, or the Board
15 of Supervisors overrides the Mayor's veto of the ordinance.

16 Section 5. That within thirty (30) days of the agreement being fully executed by all
17 parties the Recreation and Park Department shall provide the final agreement to the Clerk of
18 the Board for inclusion into the official file.

19
20 APPROVED AS TO FORM:
21 DENNIS J. HERRERA, City Attorney

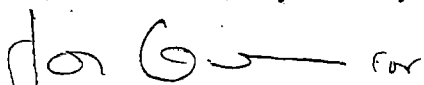
22 By:  For
23 Yadira Taylor
Deputy City Attorney

24 n:\vegana\as2014\1400329\00915219.doc

25
Supervisor Avalos
BOARD OF SUPERVISORS

Page 4.



City and County of San Francisco

Tails
Ordinance

City Hall
1 Dr. Carlton B. Goodlett Place
San Francisco, CA 94102-4689

File Number: 140034

Date Passed: April 15, 2014

Ordinance waiving the competitive solicitation requirement under Administrative Code, Section 6.40, and authorizing the General Manager of the Recreation and Park Department to enter into a professional services agreement with Aidlin Darling Design in the amount of \$837,863, for the purpose of completing design development documents and partial completion of construction documents for the Geneva Car Barn and Powerhouse project, and to amend the agreement as necessary to complete final (100 percent) construction documents, to commence following Board approval.

April 02, 2014 Budget and Finance Committee - AMENDED, AN AMENDMENT OF THE WHOLE BEARING NEW TITLE

April 02, 2014 Budget and Finance Committee - RECOMMENDED AS AMENDED

April 08, 2014 Board of Supervisors - PASSED, ON FIRST READING

Ayes: 11 - Avalos, Breed, Campos, Chiu, Cohen, Farrell, Kim, Mar, Tang, Wiener and Yee

April 15, 2014 Board of Supervisors - FINALLY PASSED

Ayes: 11 - Avalos, Breed, Campos, Chiu, Cohen, Farrell, Kim, Mar, Tang, Wiener and Yee

File No. 140034

I hereby certify that the foregoing Ordinance was FINALLY PASSED on 4/15/2014 by the Board of Supervisors of the City and County of San Francisco.

Angela Calvillo
Clerk of the Board

Mayor

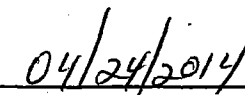
Date Approved

Print Form

Introduction Form

By a Member of the Board of Supervisors or the Mayor

Time stamp
or meeting date

I hereby submit the following item for introduction (select only one):

- 1. For reference to Committee.
An ordinance, resolution, motion, or charter amendment.
- 2. Request for next printed agenda without reference to Committee.
- 3. Request for hearing on a subject matter at Committee.
- 4. Request for letter beginning "Supervisor [] inquires"
- 5. City Attorney request.
- 6. Call File No. [] from Committee.
- 7. Budget Analyst request (attach written motion).
- 8. Substitute Legislation File No. []
- 9. Request for Closed Session (attach written motion).
- 10. Board to Sit as A Committee of the Whole.
- 11. Question(s) submitted for Mayoral Appearance before the BOS on []

Please check the appropriate boxes. The proposed legislation should be forwarded to the following:

- Small Business Commission Youth Commission Ethics Commission
- Planning Commission Building Inspection Commission

Note: For the Imperative Agenda (a resolution not on the printed agenda), use a Imperative

Sponsor(s):

Avalos

Subject:

Lease Disposition and Development Agreement and Lease for the Geneva Office Building and Powerhouse and Access License for Cameron Beach Rail Yard

The text is listed below or attached:

Resolution approving and authorizing a Lease Disposition and Development Agreement and 55-year Lease and Access License to the Friends of the Geneva Office Building and Powerhouse for the rehabilitation and use of the Geneva Office Building and Powerhouse; affirming a community plan exemption determination by the Planning Department and adopting findings pursuant to the California Environmental Quality Act; authorizing the San Francisco Municipal Transportation Authority Director of Transportation, or designee, to execute and make certain modifications to the Access License; and authorizing the General Manager of the Recreation and Park Department, or designee, to execute certain documents, make certain modifications and take certain actions in furtherance of this resolution.

140920

Signature of Sponsoring Supervisor:

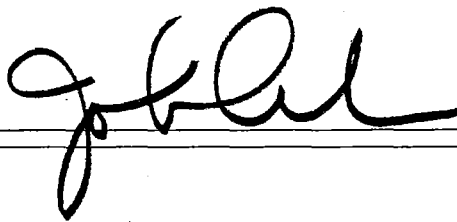
A handwritten signature in black ink, appearing to be 'J. B. Al', written over a horizontal line.

For Clerk's Use Only:

**FORM SFEC-126:
NOTIFICATION OF CONTRACT APPROVAL**
(S.F. Campaign and Governmental Conduct Code § 1.126)

City Elective Officer Information <i>(Please print clearly.)</i>	
Name of City elective officer(s):	City elective office(s) held:
Members, Board of Supervisors	Members, Board of Supervisors

Contractor Information <i>(Please print clearly.)</i>
Friends of the Geneva Office Building and Powerhouse ("Friends")

Please list the names of:

(1) *Members of the contractor's board of directors;*
 Daniel Weaver, Board Chair and Founder
 Christian Ard,
 Bruce Bonacker,
 Grace D'Anca
 Sharon Eberhardt
 Elizabeth Goldstein
 Al Harris
 Alexander Mullaney
 Tom Radulovich

(2) *Chief executive officer, Chief financial officer, Chief operating officer:*
 No one identified with these specific titles.

(3) *any person who has an ownership of 20 percent or more in the contractor;*
 Not applicable.

(4) *any subcontractor listed in the bid or contract;*
 None.

(5) *any political committee sponsored or controlled by the contractor.*
 None.

500 Third Street, Suite 410, San Francisco CA 94107

Date that contract was approved:	Amount of contract: \$0
----------------------------------	-------------------------

Under the LDDA the Friends' proposed project will include, among other things (1) rehabilitating the exterior and interior of the Car Barn; (2) bringing the Car Barn into compliance with current regulatory requirements, including the Secretary of the Interior's Standards for the Rehabilitation and Guidelines for Rehabilitating Historic Buildings, the San Francisco Building Code, and the Americans with Disabilities Act; (3) seismically strengthening the Car Barn; (4) developing the Car Barn for use as a community center, including, among other things, classrooms, a community meeting room, a theater, a café, exhibition and event spaces and a limited amount of visitor-serving retail space.

If Closing Conditions to the LDDA are satisfied, City and the Friends will enter into the Lease with the following material terms: (i) the term is fifty-five (55) years; (ii) the premises will be delivered "as-is"; (iii) the Friends is not required to pay a fixed rent to the City; instead, one hundred percent (100%) of the revenues generated by the Friends from the Car Barn must be spent according to a budget approved by the City annually; (iv) the Car Barn will be used for the purpose of providing recreational, educational and cultural programming for youth and adults in

the surrounding neighborhood, the city of San Francisco, and the region, including opportunities for job training and apprenticeships in areas including, but not limited to, the culinary, media, literary, visual, dance, musical, performing, film/cinema/television production, digital, design and technical arts, and the shall actively program the Car Barn with arts programming by offering daily, weekday classes throughout the during the academic year, and more robust programming during the summer months; and (v) the Friends must maintain a capital repair budget.

Comments:

This contract was approved by (check applicable):

the City elective officer(s) identified on this form

a board on which the City elective officer(s) serves San Francisco Board of Supervisors

Print Name of Board

the board of a state agency (Health Authority, Housing Authority Commission, Industrial Development Authority Board, Parking Authority, Redevelopment Agency Commission, Relocation Appeals Board, Treasure Island Development Authority) on which an appointee of the City elective officer(s) identified on this form sits

Print Name of Board

Filer Information (Please print clearly.)	
Name of filer: Angela Calvillo, Clerk of the Board	Contact telephone number: (415) 554-5184
Address: City Hall, Room 244, 1 Dr. Carlton B. Goodlett Pl., San Francisco, CA 94102	E-mail: Board.of.Supervisor@sfgov.org

Signature of City Elective Officer (if submitted by City elective officer)

Date Signed

Signature of Board Secretary or Clerk (if submitted by Board Secretary or Clerk)

Date Signed