

April 2013

DRAFT
Environmental Impact Report

Volume 1 of 3

For the
San Francisco Public Utilities Commission's
**Regional Groundwater Storage and Recovery
Project**

Important Dates:

Draft EIR Publication Date:

April 10, 2013

Draft EIR Hearing Dates:

May 14, 2013 in San Mateo County

May 16, 2013 in San Francisco

Draft EIR Public Comment Period:

April 10, 2013 through May 28, 2013



San Francisco Planning Department
Case No. 2008.1396E
State Clearinghouse No. 2005092026



SAN FRANCISCO PLANNING DEPARTMENT

DATE: April 10, 2013

TO: Distribution List for the Regional Groundwater Storage and Recovery Project Draft EIR

FROM: Sarah B. Jones, Acting Environmental Review Officer

SUBJECT: Request for the Final Environmental Impact Report for the Regional Groundwater Storage and Recovery Project (Planning Department File No. 2008.1396E)

1650 Mission St.
Suite 400
San Francisco,
CA 94103-2479

Reception:
415.558.6378

Fax:
415.558.6409

Planning
Information:
415.558.6377

This is the Draft of the Environmental Impact Report (EIR) for Groundwater Storage and Recovery Project. A public hearing will be held on the adequacy and accuracy of this document. After the public hearing, our office will prepare and publish a document titled "Comments and Responses," which will contain a summary of all relevant comments on this Draft EIR and our responses to those comments. It may also specify changes to this Draft EIR. Those who testify at the hearing on the Draft EIR will automatically receive a copy of the Comments and Responses document, along with notice of the date reserved for certification; others may receive a copy of the Comments and Responses and notice by request or by visiting our office. This Draft EIR together with the Comments and Responses document will be considered by the Planning Commission in an advertised public meeting and will be certified as a Final EIR if deemed adequate.

After certification, we will modify the Draft EIR as specified by the Comments and Responses document and print both documents in a single publication called the Final EIR. The Final EIR will add no new information to the combination of the two documents except to reproduce the certification resolution. It will simply provide the information in one document, rather than two. Therefore, if you receive a copy of the Comments and Responses document in addition to this copy of the Draft EIR, you will technically have a copy of the Final EIR.

We are aware that many people who receive the Draft EIR and Comments and Responses have no interest in receiving virtually the same information after the EIR has been certified. To avoid expending money and paper needlessly, we would like to send copies of the Final EIR in Adobe Acrobat format on a CD to private individuals only if they request them. Therefore, if you would like a copy of the Final EIR, please fill out and mail the postcard provided inside the back cover to the Major Environmental Analysis division of the Planning Department within two weeks after certification of the EIR. Any private party not requesting a Final EIR by that time will not be mailed a copy. Public agencies on the distribution list will automatically receive a copy of the Final EIR.

Thank you for your interest in this project.

www.sfplanning.org

Regional Groundwater Storage and Recovery Project

Draft Environmental Impact Report
Volume 1 of 3

San Francisco Planning Department Case No. 2008.1396E
State Clearinghouse No. 2005092026

Important Dates:

Draft EIR Publication Date:	April 10, 2013
Draft EIR Hearing Dates:	May 14, 2013, San Mateo County May 16, 2013, San Francisco
Draft EIR Public Comment Period:	April 10, 2013 through May 28, 2013

Written comments should be sent to:

Sarah Jones, Acting Environmental Review Officer
Regional Groundwater Storage and Recovery Project
San Francisco Planning Department
1650 Mission Street, Suite 400
San Francisco, CA 94103

TABLE OF CONTENTS

Regional Groundwater Storage and Recovery Project Draft Environmental Impact Report

Volume 1

	Page
Glossary	x
Acronyms and Abbreviations.....	xxiv
1 Executive Summary.....	1-1
1.1 Introduction and Purpose of the Project.....	1-1
1.2 Overview of Regional Water System	1-2
1.3 Project Background and Objectives.....	1-7
1.4 Project Description	1-8
1.5 Summary of Project Impacts and Mitigation Measures	1-11
1.6 Alternatives to the Proposed Project.....	1-31
1.7 Areas of Controversy	1-33
1.8 References	1-34
2 Introduction and Background.....	2-1
2.1 Introduction.....	2-1
2.2 Project Background	2-4
2.3 Purpose of this EIR.....	2-12
2.4 Public Review.....	2-13
2.5 Organization of the Draft EIR	2-16
2.6 References	2-18
3 Project Description.....	3-1
3.1 Project Location.....	3-1
3.2 Project Goals and Objectives.....	3-2
3.3 Existing Groundwater Use in the Westside Groundwater Basin.....	3-3
3.4 Proposed Project	3-4
3.5 Project Construction.....	3-123
3.6 SFPUC Standard Construction Measures.....	3-136
3.7 Greenhouse Gas Reduction Actions.....	3-136
3.8 Operations and Maintenance	3-136
3.9 Required Permits and Approvals.....	3-141
3.10 Property Rights Acquisition.....	3-144
3.11 References	3-149
4 Plans and Policies.....	4-1
4.1 Overview.....	4-1
4.2 Plans and Policies Relevant to the Groundwater Storage and Recovery Project.....	4-2
4.3 Inconsistency Evaluation.....	4-16
4.4 References	4-23

Volume 1 (continued)

5 Environmental Setting, Impacts, and Mitigation Measures.....5-1
 5.1 Overview.....5.1-1
 5.2 Land Use5.2-1
 5.3 Aesthetics.....5.3-1
 5.4 Population and Housing.....5.4-1
 5.5 Cultural and Paleontological Resources.....5.5-1

Volume 2

5.6 Transportation and Circulation5.6-1
 5.7 Noise and Vibration5.7-1
 5.8 Air Quality.....5.8-1
 5.9 Greenhouse Gas Emissions5.9-1
 5.10 Wind and Shadow5.10-1
 5.11 Recreation5.11-1
 5.12 Utilities and Service Systems5.12-1
 5.13 Public Services.....5.13-1
 5.14 Biological Resources.....5.14-1
 5.15 Geology and Soils.....5.15-1
 5.16 Hydrology and Water Quality.....5.16-1
 5.17 Hazards and Hazardous Materials5.17-1
 5.18 Mineral and Energy Resources5.18-1
 5.19 Agriculture and Forest Resources5.19-1

6 Other CEQA Issues6-1
 6.1 Growth Inducement6-1
 6.2 Summary of Cumulative Impacts6-7
 6.3 Significant Environmental Effects that Cannot Be
 Avoided if the Proposed Project is Implemented6-9
 6.4 Significant Irreversible Environmental Changes.....6-10
 6.5 References6-11

7 Alternatives7-1
 7.1 Introduction.....7-1
 7.2 WSIP Alternatives.....7-2
 7.3 GSR Alternatives Analysis7-4
 7.4 Comparison of Alternatives7-34
 7.5 Environmentally Superior Alternative7-56
 7.6 Alternatives Considered but Rejected from Further Analysis7-60
 7.7 References7-64

8 EIR Authors and Consultants8-1

Volume 3**Appendices**

Appendix A – Notice of Preparation	A-1
Appendix B – Scoping Summary Memorandum	B-1
Appendix C – Summary of Impacts Table	C-1
Appendix D – WSIP PEIR Water Supply Impact and Mitigation and Consistency Analysis.....	D-1
Appendix E – GSR Final Air Quality Technical Report.....	E-1
Appendix F – Special-status Species Tables	F-1
Appendix G – Geotechnical Reports.....	G-1
Appendix H – Groundwater Technical Reports (CD Included on Back Cover).....	H-1
Appendix I – Calculations for GSR Energy Use Impacts	I-1
Appendix J – Lake Merced Vegetation Change Analysis Methodology.....	J-1
Appendix K – Lake Merced Water Quality Data and Graphs.....	K-1

List of Figures

Figure 2-1	Project Vicinity Map	2-3
Figure 2-2	Overview of SFPUC Regional Water System & Water Supply Watersheds	2-5
Figure 2-3	SFPUC Water Service Area, San Francisco, and SFPUC Wholesale Customers	2-7
Figure 3-1	Groundwater Storage and Recovery Schematic Diagram	3-7
Figure 3-2	Source of Proposed Water Supply for Partner Agencies	3-9
Figure 3-3	Project Location Map – North	3-11
Figure 3-4	Project Location Map – Central	3-13
Figure 3-5	Project Location Map – South	3-15
Figure 3-6	Well Building and Fenced Enclosure Conceptual Layout	3-23
Figure 3-7	Well Plus Chemical Treatment Building Conceptual Layouts	3-25
Figure 3-8	Well Plus Chemical Treatment and Filtration Building Conceptual Layouts	3-27
Figure 3-9	Typical Well Profile for Above Ground Motor Driven Pump	3-33
Figure 3-10	Typical Well Profile for Submersible Motor Driven Pump	3-35
Figure 3-11	Site 1 Lake Merced Golf Club	3-41
Figure 3-12	Site 2 Park Plaza Meter, Site 3 Ben Franklin Intermediate School, Site 4 Garden Village Elementary School	3-43
Figure 3-13	Westlake Pump Station Upgrades	3-45
Figure 3-14	Sites 5, 6, & 7 Consolidated Treatment at Site 6	3-51
Figure 3-15	Site 5 (Consolidated Treatment at Site 6) Right-of-Way at Serra Bowl	3-53
Figure 3-16	Site 6 (Consolidated Treatment at Site 6) Right-of-Way at Colma BART	3-57
Figure 3-17	Site 7 (Consolidated Treatment at Site 6) Right-of-Way at Colma Blvd.	3-59
Figure 3-18	Sites 5, 6, & 7 (On-site Treatment)	3-63
Figure 3-19	Site 5 (On-site Treatment) Right-of-Way at Serra Bowl	3-65
Figure 3-20	Site 6 (On-site Treatment) Right-of-Way at Colma BART	3-69
Figure 3-21	Site 7 (On-site Treatment) Right-of-Way at Colma Blvd.	3-71
Figure 3-22	Site 8, Right-of-Way at Serramonte Blvd.	3-75
Figure 3-23	Site 9, Access Road Treasure Island Trailer Court	3-77
Figure 3-24	Site 9, Treasure Island Trailer Court	3-79
Figure 3-25	Site 10, Right-of-Way at Hickey Blvd.	3-83
Figure 3-26	Site 10, Right-of-Way at Hickey Blvd. Landscape Plan	3-85
Figure 3-27	Site 11, Pipeline and Access Road South San Francisco Main Area	3-87
Figure 3-28	Site 11, South San Francisco Main Area	3-89
Figure 3-29	Site 12 with Pipelines	3-93
Figure 3-30	Site 12, Garden Chapel Funeral Home	3-95
Figure 3-31	Site 13 with Pipelines	3-97
Figure 3-32	Site 13, South San Francisco Linear Park	3-99
Figure 3-33	Site 13, South San Francisco Linear Park Landscape Plan	3-101
Figure 3-34	Sites 14 & 15 with Pipelines	3-103
Figure 3-35	Site 14, Golden Gate National Cemetery	3-105
Figure 3-36	Site 15, Golden Gate National Cemetery	3-109
Figure 3-37	Site 16, Millbrae Corporation Yard	3-111
Figure 3-38	Site 17 (Alternate), Standard Plumbing Supply	3-115
Figure 3-39	Site 18 (Alternate), Alta Loma Drive	3-117
Figure 3-40	Site 19 (Alternate), Garden Chapel Funeral Home	3-121
Figure 5.1-1	North South Geologic Cross Section, Westside Groundwater Basin	5.1-13

Figure 5.1-2	Effects of Project and Cumulative Conditions relative to Modeled Existing Conditions on Groundwater Storage Volumes in the Westside Groundwater Basin.....	5.1-15
Figure 5.1-3	Location of Projects Considered in the Cumulative Analysis.....	5.1-24
Figure 5.3-1	Views of Sites 1 and 2	5.3-13
Figure 5.3-2	Views of Westlake Pump Station and Site 5.....	5.3-17
Figure 5.3-3	Views of Sites 6 and 7	5.3-19
Figure 5.3-4	Views of Sites 3 and 4	5.3-21
Figure 5.3-5	Views of Sites 8 and 9	5.3-25
Figure 5.3-6	Views of Sites 10 and 11	5.3-29
Figure 5.3-7	Views of Sites 12 and 13	5.3-33
Figure 5.3-8	Views of Sites 18 (Alternate) and 19 (Alternate).....	5.3-37
Figure 5.3-9	Views of Sites 14 and 15	5.3-41
Figure 5.3-10	Views of Sites 16 and 17 (Alternate)	5.3-45
Figure 5.3-11	Visual Simulation of Site 13	5.3-89
Figure 5.3-12	Visual Simulation of Site 14.....	5.3-95
Figure 5.3-13	Visual Simulation of Site 15.....	5.3-99
Figure 5.11-1	Recreational Resources (North).....	5.11-5
Figure 5.11-2	Recreational Resources (South).....	5.11-7
Figure 5.14-1	Lake Merced 2012 Vegetation Types.....	5.14-15
Figure 5.14-2	Lake Merced Sensitive Habitats and Species	5.14-17
Figure 5.14-3	Site 6, Right-of-Way at Colma BART Central Coast Riparian Scrub	5.14-61
Figure 5.14-4	Site 11, Pipeline and Access Road, South San Francisco Main Area, Central Coast Riparian Scrub and Jurisdictional Waters.....	5.14-63
Figure 5.14-5	Site 17 (Alternate), Standard Plumbing Supply, Central Coast Riparian Scrub	5.14-65
Figure 5.14-6	Site 1, Lake Merced Golf Club Central Coast Riparian Scrub.....	5.14-67
Figure 5.14-7	Site 9, Treasure Island Trailer Court, Jurisdictional Waters.....	5.14-71
Figure 5.15-1	Project Geology Map	5.15-3
Figure 5.15-2	Regional Fault Map.....	5.15-9
Figure 5.16-1	Surface Water Hydrology Map	5.16-3
Figure 5.16-2	North-South Geologic Cross Section, Westside Groundwater Basin.....	5.16-9
Figure 5.16-3	Groundwater Quality Monitoring Network	5.16-15
Figure 5.16-4	Groundwater Elevation Monitoring Network.....	5.16-17
Figure 5.16-5	Historic Lake Merced Water Levels	5.16-33
Figure 5.16-6	Existing Irrigation Wells in the South Westside Groundwater Basin.....	5.16-75
Figure 5.16-7	Well Interference Schematic	5.16-77
Figure 5.16-8	Subsidence Schematic.....	5.16-101
Figure 5.16-9	Seawater Intrusion Schematic	5.16-107
Figure 5.16-10	Interaction of Groundwater and Lakes.....	5.16-115
Figure 5.16-11	Simulated Lake Merced Level Changes.....	5.16-121
Figure 5.16-12	Simulated Lake Merced Levels Relative to Modeled Existing Conditions	5.16-123

List of Tables

Table 1-1	Summary of Impacts and Mitigation Measures.....	1-13
Table 2-1	WSIP Goals and Objectives.....	2-9
Table 2-2	Summary of Scoping Comments	2-14
Table 3-1	Estimated Existing Groundwater Use in the Westside Groundwater Basin	3-4

Table 3-2	Facility Site Names and Locations	3-16
Table 3-3	Site-Specific Facility Characteristics	3-18
Table 3-4	Maximum Volume of Chemical Storage.....	3-30
Table 3-5	Pipeline Lengths by Facility Site	3-36
Table 3-6	Electrical Energy Demand for Facility Sites during Dry Years.....	3-38
Table 3-7	Facility Construction Clusters and Construction Sequencing	3-124
Table 3-8	Estimated Daily Worker and Construction Equipment Trips for Wells and Well Facilities Construction.....	3-127
Table 3-9	Construction Area Size and Characteristics	3-132
Table 3-10	Construction Soil Material Haul Amounts and Anticipated Haul Truck Trips	3-134
Table 3-11	Regulatory/Permitting Agencies/Utility	3-142
Table 3-12	Property Rights Proposed for Acquisition.....	3-144
Table 3-13	Anticipated Property Rights Requirements	3-145
Table 5.1-1	Location of Treatment for Well Facilities without Treatment Systems	5.1-6
Table 5.1-2	Model Input – Pumping Assumptions for Modeling Scenarios.....	5.1-9
Table 5.1-3	Projects Considered for Cumulative Impacts.....	5.1-25
Table 5.2-1	Land Uses in the Vicinity of Facility Sites.....	5.2-2
Table 5.2-2	Summary of Impacts – Land Use	5.2-18
Table 5.3-1	Summary of Visual Sensitivity Findings.....	5.3-6
Table 5.3-2	Designated State, County, and Local Scenic Roads in the Vicinity of Facility Sites	5.3-48
Table 5.3-3	Visual Impact Scale.....	5.3-52
Table 5.3-4	Summary of Impacts – Aesthetics.....	5.3-55
Table 5.4-1	Estimated Population and Housing Units in 2011	5.4-1
Table 5.5-1	Architectural C-APEs	5.5-3
Table 5.5-2	Criteria for Determining Paleontological Potential.....	5.5-8
Table 5.5-3	Recorded Archaeological Sites Near the Proposed Project	5.5-20
Table 5.5-4	Archaeological Sensitivity of Well Facility Sites and Pump Station	5.5-22
Table 5.5-5	Historical Architectural Resources in the Record Search Area, but Outside the Architectural C-APE.....	5.5-29
Table 5.5-6	Additional Architectural Resources Identified During Field Surveys.....	5.5-31
Table 5.5-7	Summary of Impacts – Cultural and Paleontological Resources.....	5.5-46
Table 5.6-1	Daily Traffic Volumes on Regional Roadways	5.6-2
Table 5.6-2	Characteristics of Local Access Roadways for Facility Sites	5.6-4
Table 5.6-3	Local Roadway Existing Level of Service Conditions.....	5.6-9
Table 5.6-4	Location and Duration of Partial Roadway Closures	5.6-15
Table 5.6-5	Summary of Impacts – Transportation and Circulation.....	5.6-18
Table 5.6-6	Maximum Daily Construction Vehicle Round Trip Generation during the Highest Volume Construction Phase.....	5.6-21
Table 5.6-7	Peak Hour Construction Trips	5.6-24
Table 5.6-8	Local Roadway Project Level of Service	5.6-26
Table 5.6-9	Cumulative Traffic Peak Hour Construction Trips.....	5.6-63
Table 5.6-10	Local Roadway Project plus Cumulative Projects Level of Service	5.6-65
Table 5.7-1	Definitions of Acoustical Terms.....	5.7-3
Table 5.7-2	Typical A-Weighted Sound Levels	5.7-4
Table 5.7-3	Decibel Addition	5.7-4
Table 5.7-4	Vibration Levels for Construction Equipment.....	5.7-5
Table 5.7-5	Human Response to Construction Vibration	5.7-6

Table 5.7-6	Potential Vibration-induced Damage Thresholds for Buildings	5.7-6
Table 5.7-7	Summary of Nearby Sensitive Receptors.....	5.7-8
Table 5.7-8	Summary of Measured Noise Levels at Representative Sites -- April and October 2009	5.7-12
Table 5.7-9	South San Francisco Noise Level Standards.....	5.7-15
Table 5.7-10	Summary of Local Noise Regulations Pertaining to Construction	5.7-16
Table 5.7-11	San Mateo County General Noise Level Limits.....	5.7-18
Table 5.7-12	Summary of Local Noise Regulations and General Plan Policies Pertaining to Operation.....	5.7-20
Table 5.7-13	Summary of Impacts – Noise and Vibration	5.7-29
Table 5.7-14	Noise Levels and Assumed Operational Parameters for Construction Equipment.....	5.7-32
Table 5.7-15	Construction Activities, Equipment, Duration, and Maximum Estimated Noise Levels at 50 feet from Noise Source.....	5.7-33
Table 5.7-16	Conflicts with Local Noise Ordinances during Construction	5.7-37
Table 5.7-17	Conflicts with Local Noise Ordinances during Nighttime Construction – Noise Levels with Mitigation Measures M-NO-1 (Noise Control Plan).....	5.7-47
Table 5.7-18	Conflicts with Local Noise Ordinances during Daytime Construction – Noise Levels with Mitigation Measures M-NO-1 (Noise Control Plan).....	5.7-48
Table 5.7-19	Exceedance of Noise Thresholds – Daytime Construction.....	5.7-51
Table 5.7-20	Exceedance of Noise Thresholds – Nighttime Construction.....	5.7-55
Table 5.7-21	Exceedance of Noise Thresholds during Construction – Mitigation Noise Level.....	5.7-80
Table 5.7-22	Summary of Noise Effects from Construction Truck Traffic	5.7-83
Table 5.7-23	Conflicts with Local Noise Ordinances – Operation.....	5.7-85
Table 5.7-24	Exceedance of Noise Thresholds – Operation.....	5.7-88
Table 5.8-1	Relevant California and National Ambient Air Quality Standards.....	5.8-3
Table 5.8-2	Highest Measured Air Pollutant Concentrations	5.8-7
Table 5.8-3	Air Quality Significance Thresholds.....	5.8-13
Table 5.8-4	Summary of Impacts – Air Quality.....	5.8-20
Table 5.8-5	Estimated Total Criteria Air Pollutant Construction Emissions (in pounds)	5.8-24
Table 5.8-6	Project Cancer Risks, Non-cancer Hazard Indices, and PM _{2.5} Concentrations.....	5.8-28
Table 5.8-7	Cumulative Cancer Risks, Non-cancer Hazard Indices, and PM _{2.5} Concentrations Calculated at the Project MEI	5.8-32
Table 5.9-1	Summary of Impacts – Greenhouse Gas Emissions	5.9-8
Table 5.9-2	Project Construction GHG Emissions (Sites 1-19 [Alternate] and Westlake Pump Station)	5.9-9
Table 5.11-1	Recreational Resources near GSR Facility Sites	5.11-1
Table 5.11-2	Summary of Impacts on Recreational Resources.....	5.11-13
Table 5.11-3	Summary of Impacts on Recreational Resources at Lake Merced.....	5.11-15
Table 5.11-4	Lake Merced Acreage and Depth under Modeled Existing Conditions and Project Conditions.....	5.11-32
Table 5.11-5	Recreational Resources Near Proposed GSR Facility Sites and Other Cumulative Projects.....	5.11-35
Table 5.11-6	Lake Merced Acreage and Depth under Modeled Existing Conditions and Cumulative Conditions.....	5.11-39
Table 5.12-1	Utilities and Major Service Providers in the Project Area	5.12-2
Table 5.12-2	Summary of Impacts – Utilities and Service Systems	5.12-10
Table 5.12-3	Preliminary List of Known Utilities Within Construction Area at Facility Sites.....	5.12-11

Table 5.13-1	Law Enforcement and Fire Protection Services within the Project Area.....	5.13-2
Table 5.14-1	Plant Communities Present within or near Facility Sites and near Lake Merced	5.14-4
Table 5.14-2	Special-status Animal Species Potentially Occurring within or near Facility Sites or at Lake Merced.....	5.14-19
Table 5.14-3	San Mateo County Heritage Trees	5.14-33
Table 5.14-4	Lake Merced Vegetation Acreage: 2002, 2010, and 2012.....	5.14-46
Table 5.14-5	Summary of Impacts – Biological Resources.....	5.14-51
Table 5.14-6	Summary of Impacts on Biological Resources at Lake Merced	5.14-53
Table 5.14-7	San Mateo County Protected Trees.....	5.14-74
Table 5.14-8	Town of Colma Protected Trees.....	5.14-75
Table 5.14-9	South San Francisco Protected Trees.....	5.14-76
Table 5.14-10	San Bruno Protected Trees.....	5.14-77
Table 5.14-11	Summary of Predicted Annual Range in Lake Levels	5.14-85
Table 5.14-12	Predicted Loss of Sensitive Communities with Rising Water Levels	5.14-86
Table 5.14-13	Comparison of Predicted Sensitive Community Acreages under Modeled Existing Conditions and the Project	5.14-87
Table 5.14-14	Predicted Change in Vegetation Acreages and Percent Change Relative to a 6-foot Water Surface Elevation: Rising Water Levels.....	5.14-91
Table 5.14-15	Predicted Change in Vegetation Acreages and Percent Change Relative to a 6-foot Water Surface Elevation: Receding Water Levels	5.14-92
Table 5.14-16	Lake Merced Water Surface Elevation Range with a Predicted No-Net-Loss of Wetlands	5.14-95
Table 5.14-17	Predicted Loss of Eucalyptus Forest with Rising Water Levels	5.14-98
Table 5.14-18	Comparison of Eucalyptus Forest Acreages with Predicted Acreages under Modeled Existing Conditions and the Project.....	5.14-99
Table 5.15-1	Geologic Units, Landslide, Liquefaction Susceptibility and Shaking Severity Levels at Facility Sites	5.15-4
Table 5.15-2	Soil Properties in the Project Area	5.15-7
Table 5.15-3	Summary of Impacts – Geology and Soils.....	5.15-17
Table 5.16-1	Impaired Surface Water Bodies.....	5.16-5
Table 5.16-2	Modeled Annual Average Groundwater Budget for the Westside Groundwater Basin under Modeled Existing Conditions.....	5.16-26
Table 5.16-3	Range of Existing Ambient Groundwater Quality for Selected Constituents in the Westside Groundwater Basin (mg/L).....	5.16-28
Table 5.16-4	Lake Merced Water Quality Data and Basin Plan Water Quality Objectives	5.16-35
Table 5.16-5	Designated Beneficial Uses of Surface Water Bodies in Project Area	5.16-47
Table 5.16-6	Summary of Surface Water Hydrology and Water Quality Construction and Operational Impacts	5.16-59
Table 5.16-7	Summary of Hydrology and Water Quality Operational and Cumulative Impacts relative to Proposed Project Pumping and In-lieu Recharge.	5.16-61
Table 5.16-8	Existing Irrigators’ Wells Identified as a Primary, Active, or Secondary Well that May Be Affected by the Project	5.16-80
Table 5.16-9	Existing Irrigated Acreage and Estimated Peak Demand at Potentially Affected Land Uses	5.16-81
Table 5.16-10	Existing Average Annual Recycled Water and Groundwater Use and Estimated Peak Demand at Potentially Affected Land Uses that Use Recycled Water	5.16-82

Table 5.16-11	Estimated Static and Pumping Depth to Water Levels at the End of the Design Drought	5.16-85
Table 5.16-12	Estimated Pump Discharge Rate at the End of the Design Drought	5.16-87
Table 5.16-13	Estimated Peak Demand and 12-Hour Production Capacities	5.16-88
Table 5.16-14	Estimated Static and Pumping Depth to Water Levels at the End of the Design Drought	5.16-89
Table M-HY-6	Existing or Planned Peak Irrigation Demand at Sites with Significant Impacts Due to Project Operation	5.16-99
Table 5.16-15	Estimated Subsidence due to Project Operation (in inches)	5.16-105
Table 5.16-16	Predicted Groundwater Levels relative to Depth of Known Contamination	5.16-138
Table 5.16-17	Estimated Static and Pumping Depth to Water at the End of the Design Drought with Cumulative Projects	5.16-149
Table 5.16-18	Estimated Pump Discharge Rate at the End of the Design Drought with Cumulative Projects	5.16-150
Table 5.16-19	Estimated Peak Demands and 12-Hour Production Capacities	5.16-150
Table 5.16-20	Estimated Subsidence Due to Cumulative Projects and the GSR Project (in inches)	5.16-152
Table 5.17-1	Hazardous Materials Release Sites Identified Within 0.25 Mile of a Facility Site Construction Area	5.17-5
Table 5.17-2	Summary of Impacts – Hazards and Hazardous Materials	5.17-24
Table 5.17.3	Schools within 0.25 Mile of a Proposed Facility Site Construction Area	5.17-33
Table 5.18-1	Summary of Impacts – Mineral and Energy Resources	5.18-7
Table 6-1	Summary of Significant Cumulative Impacts	6-8
Table 7-1	Selected CEQA Alternatives	7-10
Table 7-2	Environmental Impacts of the CEQA Alternatives as Compared to the Proposed Project	7-35

GLOSSARY

100-year flood – A flood that has a one percent chance of being equaled or exceeded each year.

A-weighted decibel (dBA) – Since the human ear is not equally sensitive to all sound frequencies within the entire spectrum, human response is factored into sound descriptions in a process called “A-weighting,” expressed as “dBA.” The dBA, or A-weighted decibel, refers to a scale of noise measurement that approximates the range of sensitivity of the human ear to sounds of different frequencies.

Acoustical louver – Horizontal slats on a building that are used as sound-attenuating features; that is, to keep noise from escaping.

Active fault – A fault that shows geologic evidence of movement within Holocene time (approximately the last 11,000 years).

Alluvium – Consists of unconsolidated mixtures of gravel, sand, clay, and silt typically deposited by streams.

Alquist-Priolo Earthquake Fault Zone – The Alquist-Priolo Earthquake Fault Zoning Act was passed in 1972 to mitigate the hazard of surface faulting to structures for human occupancy. In accordance with this act, the state geologist established regulatory zones called “earthquake fault zones” around the surface traces of active faults and published maps showing these zones. Within these zones, buildings for human occupancy cannot be constructed across the surface trace of active faults. Each earthquake fault zone extends approximately 200 to 500 feet on either side of the mapped fault trace.

Aquifer – Permeable subsurface materials (soil, sediments, and rock) that contain groundwater. Aquifers may be large or small, local or regional, shallow or deep, and confined or unconfined, depending on the subsurface geologic conditions. The permeable materials that surround an unconfined aquifer allow the water table to fluctuate in response to recharge (precipitation in the wet season) and discharge (evapotranspiration in the dry season). A confined aquifer is contained within impermeable materials and, as a result, the water table does not fluctuate.

There are three aquifer systems that are commonly referred to within the Westside Groundwater Basin, defined below:

Shallow Aquifer: this aquifer is present in the northern part of the Basin, in the vicinity of Lake Merced and the southern portion of the Sunset district of San Francisco. The base of the Shallow Aquifer is defined as the top of the “-100 foot clay.”

Primary Production Aquifer: this aquifer is present throughout the Basin, overlying the “W-clay” where present. Where the W-clay is not present in locations to the south (in the South San Francisco area), the Primary Production Aquifer is divided into shallow and deep units separated by a clay unit at an elevation of approximately -300 feet mean sea level (msl).

Deep Aquifer: this aquifer underlies the W-clay, and thus its extent is limited to the generally-known extent of that clay unit.

Asbestos – A common name for a group of naturally occurring fibrous silicate minerals that are made up of thin but strong, durable fibers. Asbestos is a known carcinogen and presents a public health hazard if it is present in the friable (easily crumbled) form. Naturally occurring asbestos would most likely be encountered in Franciscan ultramafic rock (primarily serpentinite) or Franciscan mélange.

Base flows – Flows in a river or stream that occur in the absence of any recent rainfall.

Beneficial uses – Uses of water defined in the State of California Water Code (Chapter 10 of Part 2 of Division 2), including but not limited to agricultural, domestic, municipal, industrial, power generation, fish and wildlife habitat, recreation, and mining.

Biological Opinion – Document issued under the authority of the federal Endangered Species Act stating the findings of the U.S. Fish and Wildlife Service and/or the National Marine Fisheries Service as to whether a federal action is likely to jeopardize the continued existence of a threatened or endangered species or result in the destruction or adverse modification of critical habitat.

Brackish water – A mixture of freshwater and saltwater.

California Environmental Quality Act (CEQA) – Regulations set forth in California Public Resources Code Sections 21000-21178 that requires State and local agencies to identify and minimize significant environmental effects of a project.

Channel – A natural or artificial watercourse, with a defined bed and banks to confine and convey continuously or periodically flowing water.

Chloramine/chloraminated – Chloramine is a chemical disinfecting agent comprised of a combination of chlorine and ammonia. Water that has been disinfected with chloramines is “chloraminated.”

Chlorination/dechlorination – A disinfection process that involves the addition of free chlorine, whether as chlorine gas or liquid sodium hypochlorite. Dechlorination is the process of removing chlorine from a substance such as water.

City Datum – City Datum is a measurement system that has been used at Lake Merced since at least 1926 and is used throughout this document for Lake Merced water levels. The City Datum does not represent the depth of the lake. An elevation of 0 feet City Datum is equal to 11.37 feet above mean sea level (NAVD 88). Thus, a lake level of -11.37 City Datum is equal to mean sea level, and negative lake elevations above this level are not below mean sea level.

Class I, II, and III Bicycle Facilities – A Class I bicycle facility (bike path) is an exclusive right-of-way that is physically separated from motor vehicles. A Class II bicycle facility (bike lane) provides preferential use of a paved area of roadway for bicyclists by establishing specific lines of demarcation between areas reserved for bicycles and motor vehicles. A Class III bicycle facility (bike route) is a roadway recommended for use by bicycles and shared with motor vehicles (with no marked lanes), designated by signs.

Colluvium – A loose deposit of rock debris accumulated through the action of gravity at the base of a cliff or slope.

Community Noise Equivalent Level (CNEL) – Because community receptors are more sensitive to unwanted noise intrusion during the evening and at night, State law requires that, for planning purposes, an artificial dBA increment be added to “quiet time” noise levels to form a 24-hour noise descriptor called the Community Noise Equivalent Level (CNEL). CNEL adds a 5-dBA “penalty” during the evening hours (7:00 p.m. to 10:00 p.m.) and a 10-dBA penalty during the night hours (10:00 p.m. to 7:00 a.m.).

Cone of depression – The area of groundwater level decline around a well caused by pumping.

Conjunctive Use – The coordinated and planned management of both surface and groundwater resources to maximize the efficient use of the resource; that is, the planned and managed operation of a groundwater basin and a surface water storage system combined through a coordinated conveyance infrastructure.

Connate water – Older, high salinity water that is trapped in sediments when they are deposited. Flow of connate waters into the South Westside Groundwater Basin would have an impact identical to seawater intrusion.

Cultural resource – A fragile and nonrenewable remain of human activity that is valued by or significantly representative of a culture or that contains significant information about a culture. Cultural resources encompass archaeological, traditional, and built environment resources, including landscapes or districts, sites, buildings, structures, objects, or cultural practices that are usually greater than 50 years of age and possess architectural, historic, scientific, or other technical value.

Cumulatively considerable – A CEQA term used to indicate whether or not a cumulative impact is significant.

Day-night noise level (L_{dn}) – Another 24-hour noise descriptor, called the day-night noise level (L_{dn}), is similar to CNEL. While both add a 10-dBA penalty to all nighttime noise events between 10:00 p.m. and 7:00 a.m., L_{dn} does not add the evening 5-dBA penalty. In practice, L_{dn} and CNEL usually differ by less than 1 dBA at any given location for transportation noise sources.

Deciduous trees – Trees that shed their leaves each year, typically in winter.

Design drought – A planning and operational tool that water supply agencies use to define a reasonable worse-case drought scenario based on local hydrology in order to establish design and operating parameters for the water system. Droughts more severe than the design drought would cause failure of supply within the water system.

Designed historic landscape – The National Register Bulletin 18 defines a designed historic landscape as “a landscape that has significance as a design or work of art; was consciously designed and laid out by a master gardener, landscape architect, architect, or horticulturalist to a design principle, or an owner or other amateur using a recognized style or tradition in response or reaction to a recognized style or tradition; has a historical association with a significant person, trend, event, etc., in landscape gardening or landscape architecture; or a significant relationship to the theory or practice of landscape architecture.”

Discharge – The flow of surface water in a stream or canal or the outflow of groundwater from a flowing artesian well, ditch, or spring. Also refers to the discharge of liquid effluent from a facility or to chemical emissions into the air through designated venting mechanisms.

Disinfection and Disinfection Byproducts – Disinfection is the treatment process used to inactivate and destroy disease-causing bacteria, viruses, and other waterborne microorganisms. Chlorine, a commonly and historically used disinfectant in drinking water, provides a high degree of public health protection from bacteria and viruses. However, in 1974 it was discovered that chlorine reacts with natural organic and inorganic matter in water to form disinfection byproducts. The major groups of disinfection byproducts produced by chlorination are trihalomethanes and haloacetic acids, and these byproducts have been shown to cause health effects in laboratory animals. Thus, based on numerous toxicological studies, the U.S. Environmental Protection Agency adopted the Stage 1 and Stage 2 Disinfectants and Disinfection Byproducts Rules to lower the public health risk associated with potential exposure to disinfection byproducts.

Dissolved oxygen (DO) – The oxygen freely available in water, which is vital to fish and other aquatic life and for the prevention of odors. DO levels are considered an important indicator of a water body's ability to support desirable aquatic life. Secondary and advanced wastewater treatments are generally designed to ensure adequate DO in waste-receiving waters.

Disturbance – Any event or series of events that disrupt ecosystem, community, or population structure and alter the physical environment.

Diversions – The use of part of a stream flow as water supply; a channel for diverting water to sites where it can be used and disposed of. In terms of waste management, potentially recyclable material that has been diverted out of the waste disposal stream, and therefore not disposed of in landfills.

Dual Phase Extraction – A remedial technology that uses pumps to remove various combinations of contaminated groundwater, separate-phase petroleum product, and hydrocarbon vapor from the subsurface.

Earthquake faults – A discrete surface or zone separating two rock masses (or blocks of crust) across which one mass has slid past the other. These include:

Reverse faults involve predominantly vertical movement in which the upper block moves upward in relation to the lower block.

Thrust faults are low-angle reverse faults.

Blind-thrust faults are low-angled subterranean faults that have no surface expression.

Range-front faults are faults along the front of mountain ranges responsible for the uplift of the mountains.

Strike-slip faults are vertical (or nearly vertical) fractures where the blocks have mostly moved horizontally.

Ecosystem – A geographically identifiable area that encompasses unique physical and biological characteristics. It is the sum of the plant community, animal community, and environment in a particular region or habitat.

Endangered species – Any species or subspecies of bird, mammal, fish, amphibian, reptile, or plant that is in serious danger of becoming extinct throughout all or a significant portion of its range. Federally-

listed endangered species are officially designated by the U.S. Fish and Wildlife Service or the National Marine Fisheries Service and published in the Federal Register. Species may also be listed under the California Endangered Species Act by the Department of Fish and Wildlife.

Endemic – The ecological state of being unique to a defined geographic location, such as an island, nation, or other defined zone, or habitat type; organisms that are indigenous to a place are not endemic to it if they are also found elsewhere.

Enhancement – Measures that develop or improve the quality or quantity of existing conditions or resources beyond a condition or level that would have occurred without an action (i.e., beyond compensation).

Environmental cases (hazardous materials) – Sites suspected of releasing hazardous substances or have had cause for hazardous materials investigations and are identified on regulatory agency lists. These are sites where soil and/or groundwater contamination is known or suspected to have occurred.

Ethnohistoric context – Combined historical and anthropological context.

Exclusion head – The theoretical groundwater level that must be maintained at a well location to prevent seawater intrusion from reaching the well location.

Expansive soils – These types of soils are characterized by their ability to undergo significant volume change (shrink and swell) due to variations in soil moisture content.

Fault creep – Movement along a fault that does not entail noticeable earthquake activity.

Floodplain – Land adjacent to a watercourse over which water flows in times of flood. The limits of the flood plain are defined by the peak level of a 1-in-100 year return period flood.

Flow – The volume of water passing a given point per unit of time.

Fossiliferous deposits – Fossil-containing deposits.

Franciscan mélange – Mélange is a mixture of rock materials of differing sizes and types typically contained within a sheared matrix.

Fugitive dust – “Fugitive” dust generally refers to the emission of fine soil particles that are released to the atmosphere from a construction site or agricultural field.

Groundwater flux – The rate at which water discharges from the aquifer.

Groundwater recharge – Inflow to aquifers from precipitation, infiltration, through-flow, and/or other means that replaces groundwater lost through pumping or other forms of discharge. The process of water being added to the saturated zone *or* the volume of water added by this process.

Habitat – The specific area or environment in which a particular type of animal or plant lives.

Hazardous materials – As defined in Section 25501(h) of the California Health and Safety Code, hazardous materials are materials that, because of their quantity, concentration, or physical or chemical

characteristics, pose a substantial present or potential hazard to human health and safety or to the environment if released to the workplace or environment. Hazardous materials have been and are commonly used in commercial, agricultural, and industrial applications as well as in residential areas to a more limited extent.

Hazardous materials business plans – Businesses that handle specified quantities of chemicals are required to submit a hazardous materials business plan (HMBP) in accordance with community right-to-know laws. This plan allows local agencies to plan appropriately for a chemical release, fire, or other incident.

Hazardous waste – Any material that is relinquished, recycled, or inherently waste-like. Title 22 of the California Code of Regulations, Division 4.5, Chapter 11, contains regulations for the classification of hazardous wastes. A waste is considered a hazardous waste if it is toxic (causes human health effects), ignitable (has the ability to burn), corrosive (causes severe burns or damage to materials), or reactive (causes explosions or generates toxic gases) in accordance with the criteria established in Article 3. Article 4 lists specific hazardous wastes, and Article 5 identifies specific waste categories, including Resource Conservation and Recovery Act (RCRA) hazardous wastes, non-RCRA hazardous wastes, extremely hazardous wastes, and special wastes.

Heritage trees – Large, old, or historically important trees that receive local-jurisdiction protection.

Hetch Hetchy Aqueduct – The part of the regional water system consisting of the transmission facilities that convey water from Hetch Hetchy Reservoir, including pipelines and tunnels from the beginning of the Foothill Tunnel to the Alameda East Portal.

High-priority utility lines – As defined by Caltrans (1999), pipelines carrying: petroleum products; oxygen; chlorine; toxic or flammable gases; natural gas in pipelines greater than six inches diameter with normal operating pressures greater than 60 pounds per square inch gauge; and underground electricity supply lines, conductors, or cables with potential to ground more than 300 volts that do not have effectively grounded sheaths.

Hold Periods – Refers to the period when the SFPUC has neither directed “take” nor “put” of in-lieu groundwater. This would occur when the SFPUC Storage Account is full, but there is no shortage requiring the SFPUC to pump groundwater from Regional Groundwater Storage and Recovery Project wells. During Hold Periods, Project wells would remain inactive apart from well exercising and emergencies.

Hydrograph – A graph showing water levels with respect to time. A well hydrograph commonly shows water level.

Hydrology – The science that deals with the waters above and below land surfaces; their occurrence, circulation, and distribution, both in time and space; their biological, chemical, and physical properties; and their reaction with their environment, including their relation to living beings.

Impaired Water Bodies – Segments of a water body where it is known that water quality does not meet applicable water quality standards, and/or is not expected to meet applicable water quality standards, even after application of technology-based effluent limitations.

Impervious surfaces – A surface composed of any material that impedes or prevents the natural infiltration of water into the soil, such as paved streets, driveways, rooftops, and parking lots.

In-lieu Groundwater Recharge – The practice of providing surplus surface water to groundwater users, thereby leaving groundwater in storage for later use.

Inert solid waste material – Includes asphalt, concrete, rock, stone, brick, sand, soil, and fines.

Juvenile – A young or sexually immature animal.

Lateral spreading – A phenomenon where large blocks of intact, non-liquefied soil move downslope on a liquefied substrate of large aerial extent.

L_{eq} – Time variations in noise exposure are typically expressed in terms of a steady-state energy level (called L_{eq}) that represents the acoustical energy of a given measurement. L_{eq(24)} is the steady-state energy level measured over a 24-hour period.

Level of Service (traffic) – A qualitative description of a transportation facility's performance based on average delay per vehicle, vehicle density, or volume-to-capacity ratios. Levels of service range from LOS A, which indicates free-flow or excellent conditions with short delays, to LOS F, which indicates congested or overloaded conditions with extremely long delays.

Liquefaction – A phenomenon in which saturated granular sediments temporarily lose their shear strength during periods of earthquake-induced, strong groundshaking. The susceptibility of a site to liquefaction is a function of the depth, density, and water content of the granular sediments and the magnitude of earthquakes likely to affect the site.

Mafic rocks – Igneous rocks containing a group of dark-colored minerals, composed chiefly of magnesium and iron.

Mineral Resource Zones – Areas mapped using the California Mineral Land Classification System to define areas where economically significant mineral deposits are either present or likely to occur based on the best available scientific data.

Mitigation – One or all of the following: (1) Avoiding an impact altogether by not taking a certain action or parts of an action; (2) minimizing impacts by limiting the degree or magnitude of an action and its implementation; (3) rectifying an impact by repairing, rehabilitating, or restoring the affected environment; (4) reducing or eliminating an impact over time by preservation and maintenance operations during the life of an action; and (5) compensating for an impact by replacing or providing substitute resources or environments.

Moieties – In reference to Costanoan (Ohlone) ethnohistory, either of two kinship groups based on unilateral descent that together make up a tribe or society.

Non-inert waste materials – Cardboard and paper, wood, metals, green waste, new gypsum wallboard, tile, porcelain fixtures, and other easily recycled materials.

Open-trench construction – A construction method for installing pipelines; open-trench construction involves the following steps: vegetation removal and grading or pavement cutting depending on the

location; trench excavation and shoring to stabilize the sides of the trench if necessary; pipeline installation; trench backfilling and compacting; and surface restoration.

Overexcavation – A technique for the expedited corrective action of a limited release from an underground storage tank. Specifically, if a release is identified during the removal of a tank, the soil surrounding the tank pit area is often excavated to remove the contaminated materials.

Paleontological resource – The fossilized remains of plants and animals, including vertebrates (animals with backbones), invertebrates (e.g., starfish, clams, ammonites, and marine coral), and the fossils of microscopic plants and animals (microfossils).

Particulate Matter – Particulate matter is a class of air pollutants that consists of solid and liquid airborne particles in an extremely small size range. Particulate matter is typically measured in two size ranges: PM₁₀ for particles less than 10 microns in diameter, and PM_{2.5} for particles less than 2.5 microns in diameter.

Partner Agencies – Refers to the cities of Daly City and San Bruno and the California Water Service Company (CalWater) in its South San Francisco service area that would receive the new dry-year water supply from the Regional Groundwater Storage and Recovery Project.

Peak particle velocity (PPV) – To assess the potential for structural damage associated with vibration, the vibratory ground motion in the vicinity of the affected structure is measured in terms of peak particle velocity (PPV) in the vertical and horizontal directions (vector sum), typically in units of inches per second (in/sec).

Perched Water Bearing Zone – Water-bearing zone is an unconfined groundwater body supported or underlain by impermeable or slowly permeable materials.

Permitted hazardous materials uses – Facilities that use hazardous materials or handle hazardous wastes but comply with current hazardous materials and hazardous waste regulations.

Polychlorinated biphenyls (PCBs) – Known carcinogens that are mixtures of synthetic organic chemicals with physical properties ranging from oily liquids to waxy solids. Under the Toxic Substances Control Act, the U.S. Environmental Protection Agency began to impose bans on PCB manufacturing and sales on most PCB uses in 1978.

Potentially active fault – A fault that shows geologic evidence of movement during the Quaternary period (approximately the last 1.6 million years).

Predation – The act of preying on another animal or animals.

Prehistoric – Of, relating to or belonging to the era before recorded history, or 5,000 years before present. Paleontological resources are prehistoric resources.

Program Environmental Impact Report – One type of environmental review document identified under the California Environmental Quality Act that may be used to evaluate a plan or program that has multiple components (projects and actions) or to address a series of actions that are related.

Project – For purposes of this EIR, the Groundwater Storage and Recovery Project.

Propagation – To move or transmit something forward in space, especially as a light or sound wave.

Pump discharge rate – Flow rate of water delivered by pump from aquifer to surface.

Pumping lift – The distance water has to travel vertically from the pump to the surface.

Put Periods – Refers to the period of sufficient surface water supplies when the SFPUC directs the Partner Agencies to store water through the mechanism of in-lieu recharge. During “put” periods, Regional Groundwater Storage and Recovery Project wells would be normally turned off (except for emergencies), but regular exercising of wells would be conducted. Also referred to as “normal and wet (i.e., above average) rainfall years.”

Rated capacity – Theoretical pump discharge rate established by the manufacturer for specified conditions.

Rearing habitat – An area where juvenile fish find food and shelter, e.g., in nursery areas of rivers, lakes, streams, and estuaries before migration.

Reference dose – The amount at which a daily exposure would likely not have deleterious non-cancer effects over a lifetime.

Regional water system – The entire SFPUC water system starting at Hetch Hetchy Reservoir and ending in San Francisco; the regional system includes all facilities serving the SFPUC wholesale and retail customers, except for the facilities that serve only retail customers in San Francisco. The SFPUC regional water system consists of a complex network of facilities covering a geographic range of about 160 miles, from the Sierra Nevada on the east to San Francisco on the west. The regional water system crosses seven counties—Tuolumne, Stanislaus, San Joaquin, Alameda, Santa Clara, San Mateo, and San Francisco. The regional water system includes over 280 miles of pipelines, over 60 miles of tunnels, 11 reservoirs, five pump stations, and two water treatment plants.

Riparian – The land adjacent to a natural watercourse such as a river or stream. Riparian areas support vegetation that provides important wildlife habitat, as well as important fish habitat when sufficient to overhang the bank.

Saltwater wedge – A wedge-shaped intrusion of saltwater into freshwater.

Scarp – A cliff formed by faulting, erosion, or landslides.

Scenic Highway Program – The State Scenic Highway Program lists highways that are either eligible for nomination as scenic highways or have been officially designated. Local governing bodies must nominate and apply to Caltrans in order for an eligible highway to be officially designated a Scenic Highway. Part of the application includes defining and identifying the scenic corridor of the highway, and adopting ordinances, zoning, and/or planning policies to preserve the scenic quality of the corridor or documenting that such regulations already exist. These ordinances and policies constitute the Corridor Protection Plan.

Scenic resource – Includes, but is not limited to, trees, rock outcroppings, and historic buildings that contribute to a scenic public setting.

Scenic roadways (local) – Local scenic routes are considered notable roadways with scenic values that offer views of creeks, hillsides, open space features, water bodies, and unique visual resources.

Secondary Maximum Contaminant Level (MCL) – The U.S. Environmental Protection Agency and Title 22 of the California Code of Regulations establish secondary MCLs to prevent drinking water that may appear colored or taste or smell bad, causing people to stop using water from their public water system. These contaminants are not considered to present a risk to human health at the Secondary MCL, but are enforceable by the State nonetheless.

Sedimentation – The deposition of material suspended in a stream system, whether in suspension (suspended load) or on the bottom (bedload).

Seiche – Earthquake-induced oscillating waves in an enclosed water body.

Sensitive receptors – Persons that are sensitive or more vulnerable to effects of (i.e., that “receive”) excessive noise and/or poor air quality than the general population, usually analyzed in terms of land use types where such persons are typically located.

Serpentine – A naturally occurring group of minerals that can be formed when ultramafic rocks are metamorphosed during uplift to the earth’s surface. Serpentinite is a rock consisting of one or more serpentine minerals. This rock type is commonly associated with ultramafic rock along earthquake faults. Small amounts of chrysotile asbestos, a fibrous form of serpentine minerals, are common in serpentinite.

Siltation – Sediment influx from either erosion or from sediment carried into a water body by inflowing rivers and tributaries.

Sliplining – Installing a new, smaller diameter pipe into an existing pipe to provide structural integrity.

Soil Vapor Extraction – A remedial technology that reduces concentrations of volatile constituents in petroleum products adsorbed to soils in the unsaturated (vadose) zone.

Spawning – Laying (and fertilizing) eggs in the process of reproduction.

Special-status biological resources – Includes special-status plants, animals, and natural communities, plus wetlands and other waters of the United States and State as defined by the U.S. Army Corps of Engineers, California Department of Fish and Wildlife, and the State Water Resources Control Board.

Special-status natural community – A natural habitat community that receives regulatory recognition from municipal, county, state, and/or federal entities such as the California Natural Diversity Database (CNDDB) because it is unique in its constituent components, restricted in distribution, supported by distinctive soil conditions, and/or considered locally rare.

Special-status species – Several species known to occur within the general region of the program area are accorded “special status” because of their recognized rarity or vulnerability to habitat loss or population decline. Some of these species receive specific protection in federal and/or state endangered species legislation. Others have been designated as “sensitive species” or “species of special concern” on the basis of adopted policies of federal, state, or local resource agencies. These species are referred to collectively as “special-status species.”

Spill sites – Locations where a spill of hazardous materials has been reported to the State or federal regulatory agencies.

Stratigraphy – Geological and archaeological layers that make up an archaeological deposit.

Submersible pump – A submersible pump is a device that has a hermetically sealed motor and is designed to operate while submerged in a liquid (e.g., water) that is being pumped.

Subsidence – The gradual sinking of land surface (due to groundwater pumping, seismic activity, subsurface excavation, etc.).

Substrate – The materials found in streambeds or riverbeds (i.e., large and small boulders, stone, rubble, cobble, pebble, coarse and fine gravel, sand, silt, and clay). The surface upon which an organism grows or is attached.

Supervisory Control and Data Acquisition (SCADA) – A system using radio frequencies that allows the gathering of data and sending of commands to equipment at remote facilities.

Surface water – All water that is naturally open to the atmosphere (i.e., rivers, lakes, reservoirs, ponds, streams, impoundments, seas, estuaries, etc.).

Swales – Drainage areas where rain collects but does not stand as long, as in vernal pools.

Take Periods – Refers to the second year of a multi-year drought, following implementation of the Shortage Allocation Plan, when the SFPUC pumps groundwater from new Project wells connected to the SFPUC Regional Water System transmission lines, and directs the Partner Agencies to utilize stored groundwater by pumping new Project wells that connect to their individual water distribution systems. Also referred to as “dry (i.e., below average) rainfall years.”

Terrestrial species – Types of species of animals and plants that live on or grow from the land.

Threatened species – Legal status afforded to plant or animal species that are likely to become endangered within the foreseeable future throughout all or a significant portion of their range, as determined by the U.S. Fish and Wildlife Service, the National Marine Fisheries Service., or the California Department of Fish and Wildlife.

Threshold vibration damage – The lowest vibration amplitude at which cosmetic or minor damage occurs to buildings. This includes “threshold cracks” or “hair-sized” cracks in room walls.

Tiering (CEQA) – The coverage of general matters in broader EIRs with subsequent narrower EIRs or ultimately site-specific EIRs incorporating by reference the general discussions and concentrating solely on the issues specific to the EIR subsequently prepared.

Total maximum daily load – A Total Maximum Daily Load (TMDL) is a water quality attainment strategy required by the Clean Water Act for pollutants and water bodies where water quality standards are not currently met. The TMDL is a calculation of the maximum amount of a pollutant that a water body can receive and still meet water quality standards, and an allocation of that load among the various sources of that pollutant.

Transverse ridges – Toe-like features found within a landslide mass that consist of thrusts of soil/debris that appear as linear to concave upslope features.

Tributary – A stream that contributes its water to another stream or body of water.

Ultramafic rocks – These rock units are formed in high-temperature environments well below the surface of the earth.

Vadose Zone – The unsaturated portion of the subsurface above the water table.

Vernal pools – Seasonal wetlands formed in gently undulating or rolling topography where the soil is underlain by a slowly permeable claypan or hardpan.

Viewshed – An area of land, water, or other urban or environmental element that is visible to the human eye from a fixed vantage point.

Visual character – The visual attributes of a particular land use setting. For urban areas, visual character is typically described on the neighborhood level or in terms of areas with common land use; intensity of development; socioeconomic conditions; and/or landscaping and urban design features. For natural and open space settings, visual character is most commonly described in terms of areas with common landscape attributes (such as landform, vegetation, water features, etc.).

Visual sensitivity – The overall measure of a site's susceptibility to adverse visual changes. Visual sensitivity is rated as high, moderate, or low and is determined based on the combined factors of visual quality, viewer types and volumes, and visual exposure to the proposed Project as described above.

Visual quality – The overall visual impression or attractiveness of a site or locale as determined by its aesthetic qualities (such as color, variety, vividness, coherence, uniqueness, harmony, and pattern).

Waste Discharge Requirements – A type of State discharge permit prepared and enforced by the local Regional Water Quality Control Board to control point source discharges to surface waters.

Water quality objectives – Numeric and narrative limits or bans on substances, water characteristics, and activities which impact water quality including discharges of waste materials, sediment, and pesticides; procedures which alter concentrations of dissolved oxygen, temperature, and turbidity; and any actions which generally increase in-stream toxicity and pollution.

Water quality standards – Water quality standards are legally binding norms that describe the desired ambient condition (i.e., level of protection) for a water body and consist of the following three principle elements: designated beneficial uses of the State's waters, water quality objectives, and anti-degradation policies.

Water rights – The legal right to the use of water. In the groundwater context, water rights are either "overlying," meaning used on the land overlying the well such as for irrigation at a golf course, or "appropriative," meaning that water from the well is exported for use elsewhere. Municipal water wells typically operate based on an appropriative water right.

Water Shortage Allocation Plan – The water shortage allocation plan for the Regional Water System for system wide shortages of up to 20 percent that was agreed to by the SFPUC and its wholesale customers

as part of the 2009 Water Supply Agreement. The Water Shortage Allocation Plan allocates the available water supply based on the total amount of water in storage as of April 15 of each year. Depending on the level of the shortage, the available water supply is first allocated between SFPUC retail customers and the wholesale customer. The wholesale customers then allocate the wholesale share of the available water among themselves.

Waters of the State of California – Waters of the State of California are defined as “any surface water or groundwater, including saline waters, within the boundaries of the State” California Water Code Section 13050(e). These include nearly every surface or groundwater in California, or tributaries thereto, and include drainage features outside U.S. Army Corps of Engineers jurisdiction (e.g., dry and ephemeral/seasonal stream beds and channels, etc.), isolated wetlands (e.g., vernal pools, seeps, springs, and other groundwater-supplied wetlands, etc.), and storm drains, and flood control channels.

Waters of the United States – A broad federal definition that describes U.S. Army Corps of Engineers jurisdiction over deep-water habitats and special aquatic sites, including wetlands, as follows:

- The territorial seas with respect to the discharge of fill material.
- Coastal and inland waters, lakes, rivers, and streams that are navigable waters of the United States, including their adjacent wetlands.
- Tributaries to navigable waters of the United States, including wetlands.
- Interstate waters and their tributaries, including adjacent wetlands.

All other waters of the United States not identified above, such as isolated wetlands and lakes, intermittent streams, prairie potholes, and other waters that are not a part of a tributary system to interstate waters or navigable waters of the United States, the degradation or destruction of which could affect interstate commerce.

Watershed – A region or area bounded peripherally by a water parting and draining ultimately to a particular watercourse or body of water.

Well screen – A perforated section of the well casing which allows groundwater from the aquifer to be pumped into the well casing and then to the ground surface.

Wetland – A zone periodically or continuously submerged or having high soil moisture, which has aquatic and/or riparian vegetation components, and is maintained by water supplies significantly in excess of those otherwise available through local precipitation.

ACRONYMS AND ABBREVIATIONS

°C	degrees Celsius
°F	degrees Fahrenheit
µg/m ³	microgram per cubic meter
µm	micrometer
AAR	Alternatives Analysis Report
AB	California Assembly Bill
AASHTO	American Association of State Highway and Transportation Officials
ABAG	Association of Bay Area Governments
ACM	asbestos-containing materials
ADRR	Archaeological Data Recovery Report
af	acre-feet
Afm	acre-feet per month
afy	acre-feet per year
ALUC	Airport Land Use Commission
AMR	American Medical Response
APE	Area of Potential Effects
APN	Assessor's Parcel Number
ASCA	American Society of Consulting Arborists
ASCE	American Society of Civil Engineers
AT&T	American Telephone and Telegraph
ATCM	Airborne Toxic Control Measure
BA	Biological Assessment
BAAQMD	Bay Area Air Quality Management District
BACT	Best Available Control Technology
BART	Bay Area Rapid Transit
Basin Plan	Water Quality Control Plan for a particular watershed
BAWSCA	Bay Area Water Supply and Conservation Agency
BCDC	Bay Conservation and Development Commission

bgs	below ground surface
BLM	Bureau of Land Management
BMP	best management practice
BO	Biological Opinion
B.P.	before present
BSE	Basic Safety Earthquake
BSSC	Building and Seismic Safety Council
C-APE	CEQA Area of Potential Effects
C/CAG	City and County Association of Governments of San Mateo County
CAA	federal Clean Air Act
CAAQS	California ambient air quality standards
CAB	construction area boundary
Cal	calibrated
Cal EMA	California Emergency Management Agency
CAL FIRE	California Department of Forestry and Fire Protection
Cal Water	California Water Service Company
Cal/EPA	California Environmental Protection Agency
Cal/OSHA	California Division of Occupational Safety and Health
CalARP	California Accidental Release Program
CalRecycle	California Department of Resources, Recycling, and Recovery
Caltrans	California Department of Transportation
CAP	Bay Area Clean Air Plan
CARB	California Air Resources Board
CBC	California Building Code
CCAA	California Clean Air Act
CCAR	California Climate Action Registry
CCC	California Coastal Commission
CCR	California Code of Regulations
CCSF	City and County of San Francisco
CCTS	Central California Taxonomic System
CDC	California Department of Conservation

CDFW	California Department of Fish and Wildlife
CDP	census designated place
CDPH	California Department of Public Health
CEC	California Energy Commission
CEQA	California Environmental Quality Act
CER	Conceptual Engineering Report
CERCLA	Comprehensive Environmental Response, Compensation and Liability Act
CERCLIS	Comprehensive Environmental Response, Compensation, and Liability Information System
CESA	California Endangered Species Act
CFC	California Fire Code
CFCW	California Fish and Wildlife Code
CFR	Code of Federal Regulations
cfs	cubic feet per second
CGS	California Geological Survey
CH ₄	methane
CHP	California Highway Patrol
CHRIS	California Historical Resources Information System
CHSC	California Health and Safety Code
CIWMA	California Integrated Waste Management Act
CIWMB	California Integrated Waste Management Board
cm	centimeter
CMA	Congestion Management Agency
CMP	Congestion Management Program
CNDDDB	California Natural Diversity Database
CNEL	community noise equivalent level
CNPS	California Native Plant Society
CO	carbon monoxide
CO ₂	carbon dioxide
CO _{2e}	carbon dioxide equivalent
CPUC	California Public Utilities Commission

CRHR	California Register of Historical Resources
CRLF	California red-legged frog
CRSMP	construction risk and soils management plan
CUPA	Certified Unified Program Agency
CWA	1972 federal Clean Water Act
cy	cubic yard(s)
CZMA	Coastal Zone Management Act
dB	decibel
dBA	A-weighted decibel
DBH	diameter at breast height
DDT	dichlorodiphenyltrichloroethane
DEHP	di(2-ethylhexyl)phthalate
DOD	Department of Defense
DOE	Department of Energy
DOF	Department of Finance
DPM	diesel particulate matter
DSOD	California Division of Safety of Dams
DTSC	Department of Toxic Substances Control
DWR	California Department of Water Resources
DWSAP	Drinking Water Source Assessment and Protection Program
E/C RMP	Excavation/Construction Risk Management Plan
EAS	extended archaeological surveys
ECPs	Erosion Control Plans
EFZ	Earthquake Fault Zone
EIR	Environmental Impact Report
EMFAC	EMission FACtor model
EMSA	California Emergency Medical Services Authority
EP	Environmental Planning Division of the San Francisco Planning Department
EPCRA	Emergency Preparedness and Community Right-to-Know Act
ERO	Environmental Review Officer of the San Francisco Planning Department

ERT	Emergency Response Team
ESL	Environmental screening levels
ESZ	Ecological Sensitivity Zone
FAA	Federal Aviation Administration
FAR	Federal Aviation Regulation
Fed/OSHA	Federal Occupational Safety and Health Administration
FEMA	Federal Emergency Management Agency
FERC	Federal Energy Regulatory Commission
FESA	Federal Endangered Species Act
FIRM	Flood Insurance Rate Map
FIS	Flood Insurance Study
FPPA	Farmland Protection and Policy Act
FR	Federal Register
FTA	Federal Transit Administration
g	acceleration of gravity
GAMA	Groundwater Ambient Monitoring and Assessment Program
GGNC	Golden Gate National Cemetery
GGNRA	Golden Gate National Recreation Area
GHG	greenhouse gas
GIS	Geographic Information System
gpm	gallons per minute
GPR	ground-penetrating radar
GPS	global positioning system
GSR	Regional Groundwater Storage and Recovery Project
GWh	gigawatt hours
GWMP	South Westside Basin Groundwater Management Plan
GWPC	Great Western Power Company
H ₂ O	water vapor
HASP	Health and Safety Plan
HCP	Habitat Conservation Plan
HEPA	high-efficiency particulate air

HFA	hydrofluorosilicic acid
HHWP	Hetch Hetchy Water & Power
HI	Hazard Index
HMBP	Hazardous Materials Business Plan
hp	horsepower
HVAC	heating/ventilation/air conditioning
Hz	hertz
I-280	Interstate 280
I-380	Interstate 380
IBC	International Building Code
INA	information not available
ITP	incidental take permit
kW	kilowatt
kWh	kilowatt-hours
L _{dn}	day-night sound level
LEED	Leadership in Energy and Environmental Design
L _{eq}	equivalent sound level
LIDAR	Light Detection and Ranging
L _{max}	maximum sound level
L _{min}	minimum sound level
LOS	level of service
LOX	liquid oxygen
LS	Less than Significant
LSM	Less than Significant with Mitigation
LUST	Leaking Underground Storage Tank
L _{xx}	percentile-exceeded sound levels
m	meter
MBTA	Migratory Bird Treaty Act
MCL	maximum contaminant level
MEI	maximally exposed individual
MG	million gallon

mg/kg	milligrams per kilogram
mg/L	milligrams per liter
mgd	million gallons per day
MLD	most likely descendant
MLT	Middle/Late Transition
MMT	million metric tons
mph	miles per hour
MPS	multiple property submission
MRZ	Mineral Resource Zone
MSE	mechanically stabilized earth
msl	mean sea level
MT	metric tons
MTBE	methyl tert-butyl ether
MTC	Metropolitan Transportation Commission
MUNI	San Francisco Municipal Railway
MVEB	motor vehicle emissions budget
MW	megawatt
N ₂ O	nitrus oxide
NA	not applicable
NAAQS	national ambient air quality standards
NAHC	Native American Heritage Commission
NAVD	North American Vertical Datum
NCA	National Cemetery Administration
NCRS	Natural Resources Conservation Service
NEPA	National Environmental Policy Act
NHPA	National Historic Preservation Act
NI	No Impact
NMFS	National Marine Fisheries Service
NO ₂	nitrogen dioxide
NOA	naturally occurring asbestos
NOAA	National Oceanic and Atmospheric Administration

NOP	Notice of Preparation of an Environmental Impact Report
NO _x	oxides of nitrogen
NPDES	National Pollutant Discharge Elimination System
NPPA	Native Plant Protection Act
NPS	National Park Service
NRA	National Recovery Act
NRCS	National Resources Conservation Service
NRHP	National Register of Historic Places
NSMCSD	North San Mateo County Sanitation District
NSR	New Source Review
NTU	nephelometric turbidity unit
NWIC	Northwest Information Center
NWP	nationwide permit
O ₃	ozone
OAP	Ozone Attainment Plan
OEHHA	California Office of Environmental Health Hazard Assessment
OEM	Office of Emergency Management
OES	State Office of Emergency Services
OHP	California Office of Historic Preservation
OPR	Office of Planning and Research
PCA	Possible Contaminating Activity
PCB	polychlorinated biphenyl
PEIR	Program EIR
PG	professional geologist
PG&E	Pacific Gas and Electric Company
Phase I ESA	Phase I Environmental Site Assessment
PM _{2.5}	particulate matter 2.5 microns or less in diameter
PM ₁₀	particulate matter 10 microns or less in diameter
ppb	parts per billion
ppm	parts per million
PPV	peak particle velocity

PRC	California Public Resources Code
PSD	Prevention of Significant Deterioration
psig	pounds per square inch
PSM	Potentially Significant, Mitigable
PV	photovoltaic
PVC	polyvinyl chloride
PWMP	Peninsula Watershed Management Plan
RACM	reasonably available control measures
RCN	Regional Cable Network
RCRA	Resource Conservation and Recovery Act
REB	Resource Efficient Building
REL	reference exposure level
RMP	risk management plan
ROG	reactive organic gas
ROW	right of way
RPG	registered professional geologist
RPS	California's Renewable Portfolio Standard
RWQCB	Regional Water Quality Control Board
SAAQS	state ambient air quality standards
SamTrans	San Mateo County Transit District
SARA	Superfund Amendments and Reauthorization Act
SB	Senate Bill
SCADA	Supervisory Control and Data Acquisition
SDC	Seismic Design Category
sf	square feet
SFBAAB	San Francisco Bay Area Air Basin
SFBRWQCB	San Francisco Bay Area Regional Water Quality Control Board
SFCC	San Francisco City Charter
SFDE	San Francisco Department of the Environment
SFGW Project	San Francisco Groundwater Project
SFO	San Francisco International Airport

SFPUC	San Francisco Public Utilities Commission
SFWD	San Francisco Water Department
SHPO	State Historic Preservation Officer
SIL	significant impact level
SIP	state implementation plan
SLIC	Spills, Leaks, Investigations, and Cleanup
SMARA	Surface Mining and Reclamation Act of 1975
SMCFCD	San Mateo County Flood Control District
SMCWPPP	San Mateo Countywide Water Pollution Prevention Program
SO ₂	sulfur dioxide
SPCC	Spill Prevention, Control, and Countermeasure
SR	State Route
SR 82	State Route 82
SSF/SB WQCP	South San Francisco-San Bruno Water Quality Control Plant
SU	Significant and Unavoidable
SUM	Significant and Unavoidable with Mitigation
SVP	Society of Vertebrate Paleontology
SWIS	Solid Waste Information System
SWPPP	stormwater pollution prevention plan
SWRCB	State Water Resources Control Board
TAC	toxic air contaminants
TCM	transportation control measure
TDS	total dissolved solids
TIN	Triangular Irregular Network
TMDL	total maximum daily load
TOCs	total organic compounds
TPH _d	total petroleum hydrocarbons as diesel
TPH _g	total petroleum hydrocarbons as gasoline
TPZ	tree protection zone
TSCA	Toxic Substances Control Act
TTLC	total threshold limit concentration

U.S. 101	U.S. Highway 101
U.S. EPA	U.S. Environmental Protection Agency
UCMP	University of California, Berkeley, Museum of Paleontology
UPS	uninterruptible power supply
USA North	Underground Service Alert North
USACE	U.S. Army Corps of Engineers
USFS	U.S. Forest Service
USFWS	U.S. Fish and Wildlife Service
USGS	U.S. Geological Survey
UST	underground storage tank
UWMP	Urban Water Management Plan
V/C	volume-to-capacity ratio
VA	U.S. Department of Veterans Affairs
VFD	variable frequency drive
VOC	volatile organic compound
WDR	Waste Discharge Requirement
WMP	Watershed Management Plan
WSE	Water surface elevation
WSIP	Water System Improvement Program
WTP	water treatment plant
WWTP	wastewater treatment plant

This page left intentionally blank

1 EXECUTIVE SUMMARY

Sections	Tables
1.1 Introduction and Purpose of the Project	1-1 Summary of Impacts and Mitigation Measures
1.2 Overview of the Regional Water System	
1.3 Project Background and Objectives	
1.4 Project Description	
1.5 Summary of Project Impacts and Mitigation Measures	
1.6 Alternatives to the Proposed Project	
1.7 Areas of Controversy	
1.8 References	

1.1 INTRODUCTION AND PURPOSE OF THE PROJECT

The San Francisco Public Utilities Commission (SFPUC) proposes the Regional Groundwater Storage and Recovery (GSR) Project (proposed Project or Project) to increase water supply reliability during dry years or in emergencies by increasing water storage in the Westside Groundwater Basin during wet and normal years for subsequent recapture during dry years. The proposed Project is located in San Mateo County and is sponsored by the SFPUC in coordination with its partner agencies, the cities of Daly City and San Bruno and the California Water Service Company (Cal Water) in its South San Francisco service area (collectively referred to as Partner Agencies). This new dry-year water supply would be blended with water from the regional water system and made available to the Partner Agencies, other wholesale customers overlying the southern portion of the Westside Groundwater Basin (defined in Section 1.4.1 [Project Location]) and SFPUC retail water customers. The proposed Project is part of the SFPUC's Water System Improvement Program (WSIP).

Under the San Francisco Administrative Code, Chapter 31, the San Francisco Planning Department's Environmental Planning Division is responsible for conducting the environmental review of all City and County of San Francisco (CCSF) projects pursuant to the requirements of the California Environmental Quality Act (CEQA). Thus, the San Francisco Planning Department, through its Environmental Planning Division, is the lead agency responsible for preparing this Environmental Impact Report (EIR) in compliance with CEQA; the SFPUC is the project sponsor. This EIR is being prepared for the public and decision-makers to disclose the potential physical impacts of the Project so that an informed judgment can be made about the Project's environmental consequences.

1.2 OVERVIEW OF REGIONAL WATER SYSTEM

This overview of the regional water system provides background information and context for the proposed Project. The discussion includes a description of the existing water system and the SFPUC's WSIP.

1.2.1 Existing Regional Water System

The CCSF, through the SFPUC, owns and operates a regional water system that extends from the Sierra Nevada to San Francisco and serves retail and wholesale customers in San Francisco, San Mateo, Santa Clara, Alameda, and Tuolumne Counties. The regional water system consists of water conveyance, treatment and distribution facilities. The regional system includes over 280 miles of pipelines, over 60 miles of tunnels, 11 reservoirs, five pump stations and two water treatment plants. The source of the water supply is a combination of local supplies from streamflow and runoff in the Alameda Creek watershed and in the San Mateo Creek and Pilarcitos Creek watersheds (referred to together as the Peninsula watersheds), along with imported supplies from the Tuolumne River watershed. Local watersheds provide about 15 percent of total supplies, with the Tuolumne River providing the remaining 85 percent.

The SFPUC serves about one-third of its water supplies directly to retail customers, primarily in San Francisco, and about two-thirds of its water supplies to wholesale customers by contractual agreement. The wholesale customers are largely represented by the Bay Area Water Supply and Conservation Agency (BAWSCA), which consists of 26 member agencies in Alameda, San Mateo, and Santa Clara Counties¹. Some of these wholesale customers have other sources of water in addition to what they receive from the SFPUC, while others rely completely on the SFPUC for supply.

1.2.2 SFPUC Water System Improvement Program

On October 30, 2008, the SFPUC adopted a systemwide program, the WSIP (also known as the "Phased WSIP Variant") (SFPUC Resolution No. 08-200). The WSIP is a comprehensive program designed to improve the regional system with respect to water quality, seismic response and water delivery based on a planning horizon through the year 2030. The WSIP also aims to improve the regional system with respect to water supply to meet water delivery needs in the service area through the year 2018. The proposed program area spans seven counties – Tuolumne, Stanislaus, San Joaquin, Alameda, Santa Clara, San Mateo, and San Francisco. The GSR Project is one of the WSIP groundwater projects.

The overall goals of the WSIP are to: maintain high-quality water; reduce vulnerability to earthquakes; increase delivery reliability and improve the ability to maintain the system; meet customer water supply needs; enhance sustainability in all system activities; and achieve a cost effective, fully operational

¹ The Cordilleras Mutual Water Association is an additional wholesale customer that receives water from the SFPUC, but is not a BAWSCA member. It is a small water association serving 18 single-family homes in San Mateo County.

system. To further these program goals, the WSIP also includes objectives that address system performance in the areas of water quality, seismic reliability, delivery reliability and water supply (San Francisco Planning Department 2008a).

To address the potential environmental impacts of the WSIP in compliance with CEQA, the San Francisco Planning Department prepared a Program EIR (PEIR) on the WSIP, which the San Francisco Planning Commission certified in October 2008 (San Francisco Planning Department 2008a; San Francisco Planning Department 2008b). The PEIR evaluated the environmental impacts of the WSIP water supply strategy and system operations at a project level of detail, and evaluated the environmental impacts of the WSIP facility improvement projects at a program level of detail. When the SFPUC approved the WSIP in 2008, it made CEQA Findings on the program and adopted a statement of overriding considerations and a mitigation monitoring and reporting program (SFPUC Resolution No. 08-200) on the program and projects.

This project-level EIR on the GSR Project tiers from the WSIP PEIR and also incorporates by reference the relevant analyses presented in the PEIR with respect to the WSIP's impacts and mitigation measures that apply to the GSR Project. The PEIR (State Clearinghouse No. 2005092026) is available for public review at the San Francisco Planning Department, 1650 Mission Street, San Francisco, CA 94103, and is on the Planning Department's website at <http://www.sfplanning.org/index.aspx?page=1829>. The PEIR is also available at the San Mateo Main Library, 55 West 3rd Avenue, San Mateo, CA 94402. CEQA permits tiering from a program-level EIR in order to allow agencies to broadly consider the environmental effects of a series of actions and/or policies, and then to provide a more detailed examination of a project's impacts in a subsequent project-level EIR. The GSR Project was defined as part of the WSIP and was analyzed in the PEIR as a WSIP groundwater project. This project-level EIR provides more detailed information about the GSR Project, its impacts and project-specific mitigation measures, as well as alternatives to the Project. This EIR summarizes and incorporates by reference the PEIR evaluation of the impacts associated with the WSIP water supply strategy and system operations, including the PEIR analysis and conclusions regarding impacts on the SFPUC's watersheds and the WSIP's growth inducement impacts. The PEIR analysis of WSIP water supply and growth-inducement impacts accounted for the proposed Project in sufficient detail; therefore no further evaluation of these aspects of the proposed Project is required.

1.2.2.1 Description of the WSIP

The WSIP involves improvements to the regional water system with respect to water quality, seismic response and water delivery based on a planning horizon through the year 2030. The WSIP also includes phased implementation of a water supply strategy to meet projected water demand through the year 2018. The WSIP includes full implementation of the proposed WSIP facility improvement projects to ensure that the public health, seismic safety and delivery reliability goals are achieved as soon as

possible.² Under the WSIP, the SFPUC established the year 2018 as an interim mid-term planning horizon for its water supply strategy. Thus, the SFPUC made a decision about a water supply strategy to serve its customers through 2018, and is deferring a decision regarding long-term water supply after 2018 and through 2030 until it undertakes further water supply planning and demand analysis.

The WSIP includes the following key program elements:

- Full implementation of all of the 17 proposed WSIP facility improvement projects described in the PEIR.
- Water supply delivery of 265 million gallons per day (mgd) (average annual target delivery) to regional water system customers through 2018, with water supplies originating from the Tuolumne, Alameda, and Peninsula watersheds. This includes 184 mgd for the wholesale customers (including nine mgd for the cities of San Jose and Santa Clara) and 81 mgd for the retail customers.
- Development of 20 mgd of conservation, recycled water and groundwater within the SFPUC service area (10 mgd in the retail service area and 10 mgd in the wholesale service area).
- Dry-year transfer from the Modesto and/or Turlock Irrigation Districts of about two mgd coupled with the GSR Project (previously listed as the Westside Groundwater Basin conjunctive-use project) to meet the drought year goal of limiting rationing to no more than 20 percent on a systemwide basis.
- Reevaluation of 2030 demand projections, potential regional water system purchase requests and water supply options by 2018, as well as a separate SFPUC decision in 2018 regarding regional water system water deliveries after 2018.
- Financial incentives to limit water sales to an annual average of 265 mgd from the watersheds.

Under the WSIP, the SFPUC will deliver to customers up to 265 mgd from the SFPUC watersheds on an average annual basis. While average annual deliveries from the SFPUC watersheds would be limited to 265 mgd, such that there would be no increase in diversions from the Tuolumne River to serve additional demand, there would be a small increase in average annual Tuolumne River diversions of about two mgd over existing conditions in order to meet delivery and drought reliability goals through 2018.

The SFPUC must maintain water deliveries to all its customers for the protection of public health and safety. Therefore, under the WSIP, the SFPUC will work with its customers to develop financial incentives to limit water sales to an average annual amount of 265 mgd from the watersheds through 2018. With the projected 20 mgd of conservation, recycled water, and groundwater projects, the WSIP water supply strategy would meet average daily demand of 285 mgd in 2018.

² The size and design of the WSIP facility improvement projects are driven by the SFPUC's system performance objectives and would not change as a result of the water supply decision included as part of the WSIP (see SFPUC Resolution No. 08-0200).

As part of adoption of the WSIP, the SFPUC has committed to implementing the mitigation measures identified for the WSIP in the PEIR, including measures addressing impacts that may result from increases in deliveries from the SFPUC watersheds over the total annual average of 265 mgd in the event that conservation, recycled water and groundwater projects are not completed prior to the increase in customer demand (SFPUC Resolution No. 08-200).

1.2.2.2 WSIP Systemwide Operation Strategy

The WSIP also provides a future operating strategy for the regional water system, which addresses the condition of the physical facilities and infrastructure while accounting for factors that affect the system including fluctuating customer demand, meteorological and hydrological conditions, facility and infrastructure capacity and maintenance requirements, and institutional parameters. The operating strategy addresses four components of system operation: water supply and storage, water quality, water delivery, and asset management.

Day-to-day operation of the regional water system under the WSIP would be similar to existing operations, but would provide for additional facility maintenance activities and improved emergency preparedness. This would allow the SFPUC to meet its WSIP objectives and provide for increased system reliability and additional flexibility for scheduling repairs and maintenance. The proposed operations strategy would also include a multistage drought response program. Under the WSIP, regional water system operations would continue to comply with all applicable institutional and planning requirements including complying with all water quality, environmental and public safety regulations; maximizing the use of water from local watersheds; assigning a higher priority to water delivery over hydropower generation; and meeting all downstream flow requirements.

1.2.2.3 Summary of Impacts and Mitigation Measures Associated with the WSIP Water Supply and System Operations Strategy

The WSIP would result in changes in reservoir levels and associated changes in downstream flows in rivers and creeks in the three affected watersheds, potentially affecting groundwater, water quality, fisheries, and terrestrial biological resources. In the event that deliveries to customers exceed 265 mgd (average annual), streamflow changes in the Tuolumne River watershed could affect fisheries and terrestrial biological resources. In the Alameda Creek and Peninsula watersheds, the WSIP, which includes restoring the historical storage capacities of Calaveras and Lower Crystal Springs Reservoirs, could affect reservoir levels, downstream flows, fisheries, and terrestrial biological resources. In addition, the WSIP proposes to develop groundwater supplies in the northern portion of the Westside Groundwater Basin as well as a conjunctive-use program in the southern portion of the Westside Groundwater Basin (the GSR Project).

The WSIP impacts identified in the PEIR that are potentially significant but mitigable, potentially significant and unavoidable, and significant and unavoidable are listed below. As set forth in the PEIR, the San Francisco Planning Department determined the environmental impacts on all resources not listed below would be less than significant and no mitigation measures for these impacts would be required (see WSIP PEIR Chapter 5, Environmental Setting and Impacts, for further discussion of the impact

analysis on the WSIP's water supply strategy; see PEIR Chapter 6, Mitigation Measures, for a list of the mitigation measures associated with these impacts).

Potentially Significant but Mitigable WSIP Water Supply and System Operations Impacts

- **Fisheries Resources:** Tuolumne River (only when average annual deliveries from the watersheds exceed 265 mgd); Alameda Creek.
- **Terrestrial Biological Resources:** Tuolumne River (below La Grange Dam - only when average annual deliveries exceed 265 mgd; and impacts on alluvial features that support meadow and riparian habitat from O'Shaughnessy Dam to Don Pedro Reservoir); Calaveras Reservoir; Alameda Creek; Calaveras Creek; Upper and Lower Crystal Springs Reservoir.
- **Groundwater:** Pumping overdraft; change in water levels in Lake Merced and other surface water features; seawater intrusion due to decreased groundwater levels; contamination of drinking water.

Potentially Significant and Unavoidable WSIP Water Supply and System Operations Impacts

- **Fisheries:** Upper and Lower Crystal Springs Reservoir. Based on the best available information at that time, the PEIR made the conservative determination that the WSIP would result in potentially significant and unavoidable impact on fishery resources in Crystal Springs Reservoir related to inundation of spawning habitat upstream of the reservoir (see PEIR Chapter 5, Section 5.5.5, Impact 5.5.5-1). The project-level fisheries analysis in the EIR on the Lower Crystal Springs Dam Improvements project modified certain PEIR impact determinations based upon more detailed site-specific data and analysis (San Francisco Planning Department 2010). Project-level conclusions supersede the contrary impact conclusions in the PEIR and the project-level analysis determined that impacts on fishery resources due to inundation effects would be less than significant.
- **Growth Inducement:** SFPUC service area.

Significant and Unavoidable WSIP Water Supply and System Operations Impacts

- **Streamflow:** Alameda Creek below Alameda Creek Diversion Dam. Based on the best available information at that time, the PEIR made the conservative determination that the WSIP would result in a significant and unavoidable impact related to flow along Alameda Creek below the Alameda Creek Diversion Dam ("Alameda Creek Hydrologic Impact") (see PEIR Chapter 5, Section 5.4.1, Impact 5.4.1-2). The project-level analysis in the Calaveras Dam Replacement Project EIR modifies this PEIR impact determination to be less than significant based upon more detailed site-specific data and analysis (San Francisco Planning Department 2011). Project-level conclusions supersede the contrary impact conclusions in the PEIR.

1.2.2.4 *Alternatives to the WSIP*

The PEIR evaluated seven alternatives to the WSIP because of their ability to meet most of the WSIP's goals, their ability to reduce one or more of the significant impacts associated with program implementation, their potential feasibility, and their collective ability to provide a reasonable range of alternatives to foster informed decision-making and public participation. Analysis of the No Program Alternative was included as required by CEQA. The seven WSIP alternatives are summarized in Chapter 7, Alternatives, of this EIR; PEIR Chapters 9, CEQA Alternatives, and 14, Master Responses, respectively, present a more detailed summary of these alternatives and are incorporated into this EIR by reference.

1.3 PROJECT BACKGROUND AND OBJECTIVES

1.3.1 Project Background

The proposed GSR Project, as one of the WSIP projects, would support the WSIP goals and system performance objectives. The proposed Project would help achieve the WSIP goals because it would provide dry-year supply to increase water delivery reliability and meet customer water supply needs. In addition, the proposed Project would provide increased regional operational flexibility to restore water service during unplanned outages and/or a loss of water source. Without the Project, the SFPUC has determined that it could not meet its goals for dry-year delivery reliability (San Francisco Planning 2008a).

1.3.2 Project Goals and Objectives

The proposed Project would increase the volume of groundwater in storage by allowing the southern portion of the Westside Groundwater Basin to recharge naturally during normal and wet years. The increased volume of groundwater in storage would occur through a reduction in groundwater pumping by the Partner Agencies; this reduction in groundwater pumping would be made possible by increased surface water deliveries to the Partner Agencies from the regional water system in those years. This "conjunctive" or cooperative use of the basin would allow recapture of the naturally stored water during dry years.

The primary goal for the Project is to provide an additional dry-year water supply. Specific objectives of the Project are to:

- Conjunctively manage the southern portion of the Westside Groundwater Basin through the coordinated use of SFPUC surface water and groundwater pumped by the Partner Agencies;
- Provide supplemental SFPUC surface water to the Partner Agencies in normal and wet years, with a corresponding reduction of groundwater pumping by these agencies to allow for in-lieu recharge of the southern portion of the Westside Groundwater Basin;
- Increase the dry-year and emergency pumping capacity of the southern portion of the Westside Groundwater Basin by 7.2 million gallons per day (mgd); and

- Provide a new dry-year groundwater supply for SFPUC customers and increase water supply reliability during the 8.5-year design drought cycle³.

1.4 PROJECT DESCRIPTION

1.4.1 Project Location

The proposed Project would be located in northern San Mateo County, overlying the southern portion of the Westside Groundwater Basin. The Westside Groundwater Basin extends from western San Francisco south into San Mateo County. The Basin has an area of approximately 40 square miles and underlies San Francisco, Daly City, Colma, South San Francisco, San Bruno, Millbrae, and Burlingame. For purposes of discussion in this EIR, the Westside Groundwater Basin has been administratively divided at the San Francisco-San Mateo County line. Although this is not a physical boundary, there are differences in conditions between the northern and southern portions of the Westside Groundwater Basin. The chief distinction is that in the northern portion of the Basin, groundwater levels remain above sea level and groundwater currently discharges to the ocean, whereas decades of pumping by the Partner Agencies and irrigators in the southern portion of the Basin have lowered groundwater levels to between 15 and 195 feet below sea level, effectively freeing up vacated aquifer storage space for the proposed conjunctive use of the Basin (LSCE 2010). The northern portion of the Basin that lies within San Francisco County is referred to in this EIR as the North Westside Groundwater Basin. Likewise, the southern portion of the Basin that lies within San Mateo County is referred to herein as the South Westside Groundwater Basin.

The Project would be located within the water service areas for the cities of Daly City, San Bruno, and Millbrae, as well as Cal Water, which includes portions of South San Francisco, Colma, and unincorporated San Mateo County. Groundwater production well facilities would be constructed and owned by the SFPUC in the cities of Daly City, Colma, South San Francisco, San Bruno, Millbrae, and unincorporated San Mateo County. Well facilities would be connected to existing water distribution pipelines owned by the Partner Agencies and the SFPUC.

1.4.2 Groundwater Storage and Recovery

The Regional Groundwater Storage and Recovery (GSR) Project (proposed Project or Project) proposes to increase water supply reliability during dry years or in emergencies, by increasing water storage in the South Westside Groundwater Basin during wet and normal years for subsequent recapture during dry years. The proposed Project consists of this groundwater storage and recovery, with construction and operation of groundwater production wells and associated distribution and treatment facilities to recover

³ The SFPUC measures water supply reliability using an 8.5-year design drought. The proposed Operating Agreement between the SFPUC and Partner Agencies contemplates use of the dry-year supplies made available by the Project starting in the second year of the design drought. Therefore, the estimated 60,500 acre feet (af) of new groundwater storage is assumed to be used over 7.5 years of the design drought, operating at a maximum capacity of 7.2 mgd.

the stored groundwater. An Operating Agreement would guide overall groundwater management and surface water deliveries associated with the proposed Project.

The SFPUC supplies surface water to the Partner Agencies from its regional water system. The Partner Agencies currently supply potable water to their retail customers through a combination of groundwater from the South Westside Groundwater Basin and purchase of SFPUC surface water. The proposed Project would provide supplemental SFPUC surface water to the Partner Agencies during normal and wet years. During normal and wet years, the Partner Agencies would reduce their groundwater pumping by a comparable amount to increase the amount of groundwater in storage through natural, or in-lieu, recharge during these periods. During normal and wet years, the volume of groundwater in the South Westside Groundwater Basin would increase due to natural recharge and reduced groundwater pumping by the Partner Agencies. During dry years, the Partner Agencies and the SFPUC would pump the stored groundwater using 16 new well facilities. This new dry-year water supply would be blended with water from the regional water system, and would thereby increase the available water supply to all regional water system customers.

1.4.3 Project Construction

The proposed Project consists of the construction and operation of up to 16 new well facilities within the South Westside Groundwater Basin and an upgrade to the existing Daly City Westlake Pump Station. This EIR also includes the evaluation of three additional well facilities (19 in total), which the SFPUC also proposes as alternates in case one of the 16 preferred well facilities cannot be constructed because either: (1) the SFPUC is unable to secure access or necessary easements; (2) the well facility cannot be successfully operated because groundwater quality or groundwater yield does not meet Project requirements; or (3) the well facility is otherwise determined by the SFPUC to be infeasible. Under any of these circumstances, the SFPUC would eliminate that well site from the Project (and properly decommission the well if it had already been constructed) and construct and operate one of the three other proposed alternate well facilities. Therefore, this EIR evaluates construction of 19 well facilities (16 preferred and three alternate sites) and operation of only 16 well facilities. The preferred well facilities would be at Sites 1-16; the three alternate well facilities would be at Sites 17 (Alternate), 18 (Alternate), and 19 (Alternate). Therefore, the 16 well facilities to be operated could be at any of the 19 well facility locations.

For Sites 5, 6, and 7, two treatment scenarios are analyzed in this EIR. One scenario, referred to herein as “on-site treatment”, involves the installation of treatment equipment at each of these well facility sites (as described below). Water drawn from each well would be treated at that site and delivered to the distribution system. The second scenario – preferred by the SFPUC – would involve wells at each of the three sites, but a single consolidated treatment facility at Site 6. Referred to as “consolidated treatment at Site 6,” in this preferred scenario water drawn from Sites 5 and 7 would be conveyed via pipeline to Site 6 for treatment there and delivery into the distribution system.

Each well facility would contain a well pump station, distribution piping, and utility connections. Most well facilities would also provide disinfection designed to inactivate harmful pathogens using chlorine and ammonia. At certain sites, additional treatment (i.e., pH adjustment, fluoridation and/or

iron/manganese removal) has been incorporated into the design of the facility to meet both regulatory and water quality targets in the finished water for all agencies.

The proposed well facilities have been designed and sited so that wells are in proximity to treatment systems and existing distribution systems (the regional water system and the local distribution systems of the Partner Agencies) to minimize energy use and the overall facility footprint. This EIR also analyzes the environmental impacts associated with the installation of water pipelines, sanitary sewers, storm drains, and electrical service from each well facility site to existing systems. In some cases, alternate pipeline routes connecting a well facility to the existing water distribution system are also analyzed.

Of the 16 preferred well facility sites evaluated in this EIR, four well facilities would connect to Daly City's distribution system; three to San Bruno's distribution system; two to Cal Water's distribution system; and seven to the regional water system. If, however, any of the 16 preferred wells cannot be feasibly constructed or operated, then the alternate well facilities may need to be connected to alternate distribution systems, so that the SFPUC and the Partner Agencies can receive the water allotted to each under the proposed Operating Agreement. The alternate well facilities would connect to either to Cal Water's distribution system or the regional water system.

1.4.4 Project Operations

Under the Project, the SFPUC and Partner Agencies would operate the 16 new well facilities with an annual average pumping capacity of 7.2 million gallons per day (equivalent to 8,100 acre-feet [af] per year) to provide a supplemental dry-year water supply. During dry-year conditions, Partner Agencies would also pump from their own existing wells up to annual average rates consistent with the pumping limitations expressed in the proposed Operating Agreement between the SFPUC and the Partner Agencies, as explained later in this section.

The SFPUC would supply the Partner Agencies with water from the regional water system during normal and wet years to reduce their need to pump groundwater. This reduction in pumping would allow the aquifer to recharge naturally. During dry years, the Partner Agencies would pump groundwater from proposed Project wells in addition to their existing wells to meet demands. This water would be distributed to San Francisco and other wholesale customers in northern San Mateo County through existing SFPUC transmission lines and the three Partner Agency water distribution systems. These existing distribution systems are located and sized appropriately to accommodate the additional groundwater that would be produced as part of the proposed Project (MWH et al. 2008).

The SFPUC would maintain an accounting of the storage volumes in the SFPUC Storage Account. The SFPUC would track the amount of water that has been stored during normal and wet years (Put Periods), and the amount of water pumped from the SFPUC Storage Account (Take Periods). When the SFPUC Storage Account is full, but there is no shortage of water that requires the SFPUC to pump groundwater from Project wells, then neither storage nor recovery would take place (Hold Periods). Accruals in the SFPUC Storage Account would be recorded based on metered, in-lieu surface water deliveries and corresponding metered decreases in groundwater pumping. The Project would be operated so that the SFPUC Storage Account would be increased up to 60,500 af (about 20 billion gallons).

Operation of the Project by the SFPUC and the Partner Agencies would be governed by an Operating Agreement. The proposed Operating Agreement describes the operation of Project wells; Put, Hold and Take Periods; and the role of the Operating Committee established by the Operating Agreement for purposes of groundwater basin management. The proposed Operating Agreement provides that the Project wells may be operated under the following circumstances:

- Beginning in the second dry year of a multiple year drought;
- During emergencies;
- During system rehabilitation, scheduled maintenance or malfunctioning of the water system; and
- Upon recommendation of the Operating Committee established by the Operating Agreement for purposes of Basin management⁴.

1.5 SUMMARY OF PROJECT IMPACTS AND MITIGATION MEASURES

Chapter 5, Environmental Setting, Impacts, and Mitigation Measures, of this EIR presents the environmental impact analyses for all CEQA topic areas and provides mitigation measures that would reduce significant impacts to a less-than-significant level, where feasible. A summary of all impacts and mitigation measures is provided in Table 1-1 (Summary of Impacts and Mitigation Measures). Text for the more extensive and longer mitigation measures is not included in this table; however the table refers the reader to the appropriate EIR analysis section for the full mitigation text and explanation. The categories used to designate impact significance in Table 1-1 are:

- **No Impact (NI).** An impact is considered not applicable (no impact) if there is no potential for impacts or if the environmental resource does not occur within the Project area or the area of potential effect. For example, there would be no impact related to tree removal if no trees would be removed at a facility site.
- **Less than Significant Impact (LS).** This determination applies if the potential exists for some limited impact, but not for a substantial adverse effect that qualifies under the significance criteria as a significant impact.
- **Less than Significant Impact with Mitigation (LSM).** This determination applies if the Project would result in an adverse effect that meets the significance criteria, but feasible mitigation is available that would reduce the impact to a less-than-significant level.
- **Significant Impact (S).** A “significant effect” is defined by Section 15382 of the CEQA Guidelines as “a substantial, or potentially substantial, adverse change in any of the physical

⁴ Over time, the Operating Committee may need to respond to issues to ensure appropriate management of the groundwater basin. Depending on what actions, if any, are proposed in the future, additional CEQA review may be required.

conditions within the project area affected by the project including land, air, water, minerals, flora, fauna, ambient noise, and objects of aesthetic significance. An economic or social change by itself shall not be considered a significant effect on the environment ... [but] may be considered in determining whether the physical change is significant.”

- **Significant and Unavoidable Impact with implementation of feasible Mitigation (SUM).**
This determination applies if the Project would result in an adverse effect that meets the significance criteria and mitigation is available to lessen the impact, but the residual effect after implementation of the measure would remain significant. The impact would, therefore, be significant and unavoidable with mitigation.
- **Significant and Unavoidable Impact for which feasible mitigation is not available (SU).**
This determination applies if the Project would result in an adverse effect that meets the significance criteria, but for which there appears to be no feasible mitigation available to reduce the impact to a less-than-significant level. The impact would, therefore, be significant and unavoidable.

The impact level of significance shown in Table 1-1 (Summary of Impacts and Mitigation Measures) represents the highest level of significance for that impact (i.e., out of all 19 sites). Sites numbers for all significant and unavoidable impacts are listed in the table. Appendix C (Summary of Impacts Table) provides significance levels for each impact, at each individual site. Mitigation measures listed in the table include the site number for which the measure would be required to reduce significant impacts.

As discussed in Chapter 6, Other CEQA Issues, Section 6.1 (Growth Inducement), the proposed Project is one of several capital improvement projects that make up the SFPUC’s WSIP. Implementation of the WSIP would support growth in the SFPUC service area, thereby contributing indirectly to environmental impacts caused by that growth. Because the proposed Project is part of the WSIP and would contribute to the WSIP’s growth-inducement impact, the GSR Project would therefore contribute to the significant and unavoidable program-level impacts associated with growth inducement.

TABLE 1-1
Summary of Impacts and Mitigation Measures

Impact	Level of Significance Prior to Mitigation	Mitigation Measure(s)	Level of Significance After Mitigation
Section 5.2 Land Use			
<p>Impact LU-1. Project construction would have a substantial impact on the existing character of the vicinity and could substantially disrupt or displace existing land uses or land use activities.</p>	S	<p>M-LU-1: Maintain Internal Cemetery Access (Site 7 [Consolidated Treatment at Site 6] and Site 14). Prior to commencing construction at either Site 7 (where treatment for Site 7 is consolidated at Site 6) or at Site 14, the SFPUC or its construction contractor shall develop an access plan to be implemented during construction to ensure that access is available for visitors to all portions of the Woodlawn Memorial Park and Golden Gate National Cemetery within a reasonable period of time upon their arrival at the cemetery. The access plan shall include, for example, trench plating and alternative routing for visitors. The plan shall also address measures to maintain access for cemetery operations and maintenance. A copy of the access plan shall be submitted to the owner or operator of the Woodlawn Memorial Park and the Golden Gate National Cemetery prior to commencing construction, and they also shall be provided with the name of, and contact information for, a person identified to act as a liaison during construction at these sites.</p> <p>M-TR-1: Traffic Control Plan (Sites 2, 4, 5, 6, 7, 10, 12, 13, 14, 15, 17 [Alternate], 18 [Alternate], and 19 [Alternate]). Refer to the discussion of Impact TR-1 in Section 5.6, Transportation and Circulation.</p> <p>M-NO-1: Noise Control Plan (1, 3, 4, 5, 8, 9, 10, 11, 12, 13, 14, 15, 16, 17 [Alternate], 18 [Alternate], and 19 [Alternate]). Refer to the discussion of Impact NO-1 in Section 5.7, Noise and Vibration⁵.</p> <p>M-NO-3: Expanded Noise Control Plan (1, 3, 4, 5, 9, 10, 11, 12, 13, 14, 15, 16, 17 [Alternate], 18 [Alternate], and 19 [Alternate]). Refer to the discussion of Impact NO-3 in Section 5.7, Noise and Vibration.</p> <p>M-AQ-2a: BAAQMD Basic Construction Measures (All Sites). Refer to the discussion of Impact AQ-2 in Section 5.8, Air Quality.</p> <p>M-AQ-3: Construction Health Risk Mitigation (Site 5 On-site Treatment). Refer to the discussion of Impact AQ-3 in Section 5.8, Air Quality.</p>	<p>SUM Sites 1, 3, 4, 5 (On-site Treatment) 9, 12, 14, 16, 18 (Alternate) and 19 (Alternate)</p>
<p>Impact LU-2. Project operations would result in substantial long-term or permanent impacts on the existing character or disrupt or displace land uses.</p>	S	<p>M-NO-5: Operational Noise Control Measures (Sites 1, 5 [On-site Treatment], 7 [On-site Treatment], 9, 12, 18 [Alternate], and the Westlake Pump Station). Refer to the discussion of Impact NO-5 in Section 5.7, Noise and Vibration.</p>	LSM
<p>Impact C-LU-1. Construction and operation of the proposed Project could result in a cumulatively considerable contribution to cumulative impacts related to land use.</p>	S	<p>M-NO-1: Noise Control Plan (1, 3, 4, 5, 8, 9, 10, 11, 12, 13, 14, 15, 16, 17 [Alternate], 18 [Alternate], and 19 [Alternate]). Refer to the discussion of Impact NO-1 in Section 5.7, Noise and Vibration.</p> <p>M-NO-3: Expanded Noise Control Plan (1, 3, 4, 5, 9, 10, 11, 12, 13, 14, 15, 16, 17 [Alternate], 18 [Alternate], and 19 [Alternate]). Refer to the discussion of Impact NO-3 in Section 5.7, Noise and Vibration.</p> <p>M-NO-5: Operational Noise Control Measures (Sites 1, 5 [On-site Treatment], 7 [On-site Treatment], 9, 12, 18 [Alternate], and the Westlake Pump Station). Refer to the discussion of Impact NO-5 in Section 5.7, Noise and Vibration.</p>	<p>SUM Sites 9, 12, and 19</p>
Section 5.3 Aesthetics			
<p>Impact AE-1. Project construction would have a substantial adverse impact on a scenic vista, resource, or on the visual character of a site or its surroundings.</p>	S	<p>M-AE-1a: Site Maintenance (Sites 4, 7, 12, 13, 14, 15, and 18 [Alternate]). The SFPUC shall require the contractor to ensure that construction-related activity is as clean and inconspicuous as practical by storing construction materials and equipment at areas of the construction site that are generally away from public view, and by removing construction debris promptly at regular intervals.</p>	<p>SUM Site 7 Consolidated Treatment at Site 6 and On-site Treatment options</p>

⁵ Impact NO-1 is not significant for Sites 5 and 15, but they are included in the title of the mitigation measure because Mitigation Measure M-NO-1 is required under Impact NO-3.

TABLE 1-1
Summary of Impacts and Mitigation Measures

Impact	Level of Significance Prior to Mitigation	Mitigation Measure(s)	Level of Significance After Mitigation
		<p>M-AE-1b⁶: Tree Protection Measures (Sites 3, 4, 7, 10, 11, 12, 13, 14, 15, and 17 [Alternate]) The SFPUC shall identify trees to be protected and retained during construction and minimize potential impact to these trees by implementing the following measures:</p> <ul style="list-style-type: none"> • Construction activities within the dripline of trees to be retained adjacent to construction area boundaries or adjacent to pipeline routes shall be avoided. • A qualified arborist shall identify the location of exclusion fencing to be installed around trees to be retained. • Prior to the start of construction, the SFPUC or its contractor shall install exclusion fencing around the dripline of trees to be retained and within 50 feet of any grading or construction activity. • Prior to construction, the SFPUC shall verify that the temporary construction fencing is installed and approved by a qualified arborist. Any encroachment within these areas must first be approved by a qualified arborist and the SFPUC. Temporary fencing shall be continuously maintained by the contractor until all construction activities near the trees are completed. No construction activities shall occur within the exclusion fencing. • For trees on slopes, exclusion fencing shall consist of a silt fence that will be installed at the upslope base of the tree to prevent soil from moving into the root zone (defined as the extent of the tree dripline) if work is performed upslope of any protected trees. • Pruning of trees to be retained shall be completed by either a certified arborist or by the contractor under supervision of either an International Society of Arboriculture qualified arborist, American Society of Consulting Arborists consulting arborist, or a qualified horticulturalist. <p>M-AE-1c: Develop and Implement a Tree Replanting Plan (Site 12).The SFPUC shall develop and implement a tree replanting plan to address the removal of trees along El Camino Real at Site 12. The tree replanting plan shall include planting locations (which may include non-SFPUC properties), native tree and shrub species (consistent with those near the well facility site), planting ratios, and irrigation requirements. Tree replanting activities occurring on SFPUC properties or right-of-way shall be consistent with the requirements of the SFPUC’s Integrated Vegetation Management Policy (SFPUC 2007). The planting ratio for replacement trees shall be a minimum of 1:1, or in substantial compliance with the City of South San Francisco’s tree preservation ordinance (Chapter 13.30.080, Replacement of Protected Trees).. Replanting shall occur the first year after completion of construction. The SFPUC shall monitor the replacement trees annually for five years after project completion to ensure that the trees survive; if necessary, the SFPUC shall implement additional measures, such as replanting for trees that did not survive.</p> <p>M-AE-1d: Construction Area Screening (Site 15).The SFPUC and its contractors shall screen the construction area at the facility site at Site 15. Screening shall be designed to minimize view of construction equipment and construction activities from views from Sneath Lane and the surrounding areas. Vehicles and other construction equipment shall be parked in the screened construction area at night and when equipment is not actively being used for pipeline construction along Sneath Lane.</p> <p>M-AE-1e: Tree Removal and Replacement (Site 7).Prior to the removal of any trees within the construction area boundary at Site 7, the SFPUC shall determine if any trees within the Town-designated tree mass can be retained without causing conflicts with construction equipment and/or safety risks during construction at this site. A qualified arborist shall conduct the tree retention survey. Any trees found not to conflict with construction activities or create a safety risks shall be protected during construction.</p> <p>For each tree to be removed, the SFPUC shall plant replacement trees on-site to the extent allowable by its Integrated Vegetation Management Policy (Section 13.006) (SFPUC 2007). Each replacement tree shall be in a minimum 15-gallon container and shall be of species listed in the vegetation management policy. The on-site plantings shall be located such that the visual continuity of the existing tree mass is restored to the extent feasible. To the extent tree replacement on-site is not feasible, replacement trees shall be planted off-site in substantial compliance with the Town of Colma’s Tree Cutting and Removal ordinance.</p> <p>In all cases, the planting ratio shall be a minimum of 1:1 (i.e., one tree planted for each tree removed). Replanting shall occur within the first year after completion of construction. The SFPUC shall monitor plantings annually for five years after project completion to ensure that the replacement planting(s) has developed and that the</p>	

⁶ Impact AE-1 is not significant for Sites 3, 4, 7, 10, 11, 13, 14, and 17 (Alternate), however the sites are listed here because tree protection measures are required to reduce impacts to trees protected by local tree preservation ordinances as described under Impact BR-4 as discussed in the Biological Resources section.

TABLE 1-1
Summary of Impacts and Mitigation Measures

Impact	Level of Significance Prior to Mitigation	Mitigation Measure(s)	Level of Significance After Mitigation
		trees survive. If necessary, the SFPUC shall implement additional measures (e.g., replanting, installation of irrigation) to address continued survival of the plantings, and shall re-plant additional trees should a significant amount of the original plantings not survive during the monitoring period. M-CR-1a: Minimize Construction-related Impacts on Elements of the Historical Resource at Site 14. Refer to the discussion of Impact CR-1 in Section 5.5, Cultural and Paleontological Resources.	
Impact AE-2. Project construction would not create a new source of substantial light that would adversely affect day or nighttime views in the area.	LS	No mitigation required.	LS
Impact AE-3. Project operation would have a substantial adverse impact on a scenic vista, resource, or on the visual character of a site or its surroundings.	S	M-AE-3a: Implement Landscape Screening (Sites 4, 7, and 18 [Alternate]). The SFPUC shall develop and implement a landscape-screening plan to screen views of the well facility. The landscape plan shall include native trees and shrubs common to the surrounding areas. The landscape plan shall include plant species, planting specifications, and irrigation requirements necessary to screen the well facility. The SFPUC shall monitor landscape plantings annually for five years after project completion to ensure that sufficient ground coverage has developed and that the shrubs survive. If necessary, the SFPUC shall implement additional measures (e.g., replanting, temporary irrigation) to address continued survival of the plantings, and shall replant additional shrubs should a significant amount of the plantings not survive during the monitoring period. M-CR-5a: Minimize Facilities Siting Impacts on Elements of the Historical Resource at Site 14. Refer to the discussion of Impact CR-5 in Section 5.5, Cultural and Paleontological Resources. M-CR-5b: Minimize Facilities Siting Impacts on Elements of the Historical Resource at Site 15. Refer to the discussion of Impact CR-5 in Section 5.5, Cultural and Paleontological Resources.	LSM
Impact AE-4. Project operation would not create a new source of substantial light that would adversely affect day or nighttime views in the area.	LS	No mitigation required.	LS
Impact C-AE-1. Construction and operation of the proposed Project could result in a cumulatively considerable contribution to cumulative impacts related to scenic resources and visual character.	S	M-AE-1a: Site Maintenance (Sites 4, 7, 12, 13, 14, 15, and 18 [Alternate]). Refer to the discussion of Impact AE-1 in Section 5.3, Aesthetics. M-AE-1b: Tree Protection Measures (Sites 3, 4, 7, 10, 11, 12, 13, 14, 15, and 17 [Alternate]). Refer to the discussion of Impact AE-1 in Section 5.3, Aesthetics. M-AE-1c: Develop and Implement a Tree Replanting Plan (Site 12). Refer to the discussion of Impact AE-1 in Section 5.3, Aesthetics.	LSM
Section 5.4 Population and Housing - None. No impacts would occur.			

TABLE 1-1
Summary of Impacts and Mitigation Measures

Impact	Level of Significance Prior to Mitigation	Mitigation Measure(s)	Level of Significance After Mitigation
Section 5.5 Cultural and Paleontological Resources			
Impact CR-1. Project construction could cause an adverse change in the significance of a historical resource.	S	<p>M-CR-1a: Minimize Construction-related Impacts to Elements of the Historical Resource at Site 14. Refer to the discussion of Impact CR-1 in Section 5.5, Cultural and Paleontological Resources.</p> <p>M-NO-2: Reduce Vibration Levels during Construction of Pipelines (Sites 3, 4, 12, 15, and 18 [Alternate]). Refer to the discussion of Impact NO-2 in Section 5.7, Noise and Vibration.</p> <p>M-CR-1b: Minimize Construction-related Impacts on Elements of the Historical Resource at Site 15. Refer to the discussion of Impact CR-1 in Section 5.5, Cultural and Paleontological Resources.</p>	LSM
Impact CR-2. Project construction could cause an adverse change in the significance of an archaeological resource.	S	M-CR-2: Discovery of Archaeological Resources (All Sites except West Lake Pump Station). Refer to the discussion of Impact CR-2 in Section 5.5, Cultural and Paleontological Resources.	LSM
Impact CR-3. Project construction could result in a substantial adverse effect by destroying a unique paleontological resource or site.	S	M-CR-3: Suspend Construction Work If a Paleontological Resource Is Identified (All Sites except Site 9 and Westlake Pump Station). If a paleontological resource (fossilized invertebrate, vertebrate, plant or micro-fossil) is discovered during construction at any of the proposed well facility sites, all ground disturbing activities within 50 feet of the find shall be temporarily halted but may be diverted to areas beyond 50 feet from the discovery to continue working. An appointed representative of the SFPUC shall notify a qualified paleontologist, who will document the discovery as needed, evaluate the potential resource, and assess the nature and significance of the find. Based on the scientific value or uniqueness of the find, the paleontologist may record the find and allow work to continue, or recommend salvage and recovery of the material, if the SFPUC determines that the find cannot be avoided. The paleontologist shall make recommendations for any necessary treatment that is consistent with the SVP Guidelines (SVP 2012) and currently accepted scientific practices. If required, treatment for fossil remains may include preparation and recovery of fossil materials so that they can be housed in an appropriate museum or university collection and may also include preparation and publication of a report describing the find. The paleontologist's recommendations shall be subject to review and approval by the ERO or designee. The SFPUC shall be responsible for ensuring that treatment is implemented and reported to the San Francisco Planning Department. If no report is required, the SFPUC shall nonetheless ensure that information on the nature, location and depth of all finds is readily available to the scientific community through university curation or other appropriate means.	LSM
Impact CR-4. Project construction could result in a substantial adverse effect related to the disturbance of human remains.	S	M-CR-4: Accidental Discovery of Human Remains (All Sites except Westlake Pump Station). The treatment of any human remains and associated or unassociated funerary objects discovered during soil-disturbing activities shall comply with applicable State laws. Such treatment would include immediate notification of the San Mateo County Coroner and, in the event of the coroner's determination that the human remains are Native American, notification of the NAHC, which would appoint a Most Likely Descendant (MLD) (PRC Section 5097.98). A qualified archaeologist, the SFPUC and MLD shall make all reasonable efforts to develop an agreement for the treatment, with appropriate dignity, of any human remains and associated or unassociated funerary objects (CEQA Guidelines Section 15064.5[d]). The agreement would take into consideration the appropriate excavation, removal, recordation, analysis, custodianship, and final disposition of the human remains and associated or unassociated funerary objects. The PRC allows 48 hours to reach agreement on these matters. If the MLD and the other parties could not agree on the reburial method, the SFPUC shall follow Section 5097.98(b) of the PRC, which states that "the landowner or his or her authorized representative shall reinter the human remains and items associated with Native American burials with appropriate dignity on the property in a location not subject to further subsurface disturbance." All archaeological work performed under this mitigation measure shall be subject to review by the ERO or designee.	LSM
Impact CR-5. Project facilities could cause an adverse change in the significance of a historical resource.	S	<p>M-CR-5a: Minimize Facilities Siting Impacts on Elements of the Historical Resource at Site 14. Refer to the discussion of Impact CR-5 in Section 5.5, Cultural and Paleontological Resources.</p> <p>M-CR-5b: Minimize Facilities Siting Impacts on Elements of the Historical Resource at Site 15. Refer to the discussion of Impact CR-5 in Section 5.5, Cultural and Paleontological Resources.</p>	LSM

TABLE 1-1
Summary of Impacts and Mitigation Measures

Impact	Level of Significance Prior to Mitigation	Mitigation Measure(s)	Level of Significance After Mitigation
<p>Impact C-CR-1. Construction of the proposed Project could result in a cumulatively considerable contribution to cumulative impacts on historical, archaeological, or paleontological resources, or human remains.</p>	S	<p>M-CR-2: Discovery of Archaeological Resources (All Sites except Westlake Pump Station). Refer to the discussion of Impact CR-2 in Section 5.5, Cultural and Paleontological Resources.</p> <p>M-CR-3: Suspend Construction Work If a Paleontological Resource Is Identified (All Sites except Site 9 and Westlake Pump Station). Refer to the discussion of Impact CR-3 in Section 5.5, Cultural and Paleontological Resources.</p> <p>M-CR-4: Accidental Discovery of Human Remains (All Sites except Westlake Pump Station). Refer to the discussion of Impact CR-4 in Section 5.5, Cultural and Paleontological Resources.</p>	LSM
<p>Section 5.6 Transportation and Circulation</p>			
<p>Impact TR-1. The Project would conflict with an applicable plan, ordinance or policy establishing measures of effectiveness for the performance of the circulation system.</p>	S	<p>M-TR-1: Traffic Control Plan (Sites 2, 4, 5, 6, 7, 10, 12, 13, 14, 15, 17 [Alternate], 18 [Alternate], and 19 [Alternate]). Refer to the discussion of Impact TR-1 in Section 5.6, Transportation and Circulation.</p>	LSM
<p>Impact TR-2. The Project would temporarily impair emergency access to adjacent roadways and land uses during construction.</p>	S	<p>M-TR-1: Traffic Control Plan (Sites 2, 4, 5, 6, 7, 10, 12, 13, 14, 15, 17 [Alternate], 18 [Alternate], and 19 [Alternate]). Refer to the discussion of Impact TR-1 in Section 5.6, Transportation and Circulation.</p>	LSM
<p>Impact TR-3. The Project would temporarily decrease the performance and safety of public transit, bicycle, and pedestrian facilities during construction.</p>	S	<p>M-TR-1: Traffic Control Plan (Sites 2, 4, 5, 6, 7, 10, 12, 13, 14, 15, 17 [Alternate], 18 [Alternate], and 19 [Alternate]). Refer to the discussion of Impact TR-1 in Section 5.6, Transportation and Circulation.</p>	LSM
<p>Impact TR-4. Project operations and maintenance activities would not conflict with an applicable plan or policies regarding performance of the transportation system or alternative modes of transportation.</p>	LS	No mitigation required.	LS
<p>Impact C-TR-1. Construction and operation of the proposed Project could result in a cumulatively considerable contribution to cumulative impacts related to transportation and circulation.</p>	S	<p>M-TR-1: Traffic Control Plan (Sites 2, 4, 5, 6, 7, 10, 12, 13, 14, 15, 17 [Alternate], 18 [Alternate], and 19 [Alternate]). Refer to the discussion of Impact TR-1 in Section 5.6, Transportation and Circulation.</p> <p>M-C-TR-1: Coordinate Traffic Control Plan with other SFPUC Construction Projects (Sites 2, 4, 5, 6, 7, 10, 12, 13, 14, 15, 17 [Alternate], 18 [Alternate], and 19 [Alternate]). Prior to construction, the SFPUC and its contractors shall coordinate with other SFPUC construction projects in the region and update traffic control plans to avoid overlapping construction schedules or, if not practical, to minimize impacts to congestion, emergency access, and alternative modes of transportation.</p>	LSM

⁷ Impact TR-1 is not significant for Site 2, but it is included here because a Traffic Control Plan is required under Impact TR-2.

TABLE 1-1
Summary of Impacts and Mitigation Measures

Impact	Level of Significance Prior to Mitigation	Mitigation Measure(s)	Level of Significance After Mitigation
Section 5.7 Noise and Vibration			
Impact NO-1. Project construction would result in noise levels in excess of local standards.	S	M-NO-1: Noise Control Plan (1, 3, 4, 5, 8, 9, 10, 11, 12, 13, 14, 15, 16, 17 [Alternate], 18 [Alternate], and 19 [Alternate]). ⁸ Refer to the discussion of Impact NO-1 in Section 5.7, Noise and Vibration.	SUM Sites 1, 4, 9, 12, 16, 18 (Alternate), and 19 (Alternate)
Impact NO-2. Project construction would result in excessive groundborne vibration.	S	M-NO-2: Reduce Vibration Levels during Construction of Pipelines (Sites 3, 4, 12, 15, and 18 [Alternate]). The SFPUC shall require that the construction contractor not use vibratory compaction equipment within 25 feet of structures adjacent to Sites 3, 4, 12, 15, and 18 (Alternate).Non-vibratory compaction or controlled low strength materials (CLSM) backfill may be used in lieu of vibratory compaction equipment at these locations.	LSM
Impact NO-3. Project construction would result in a substantial temporary increase in ambient noise levels.	S	M-NO-1: Noise Control Plan (1, 3, 4, 5, 8, 9, 10, 11, 12, 13, 14, 15, 16, 17 [Alternate], 18 [Alternate], and 19 [Alternate]). Refer to the discussion of Impact NO-1 in Section 5.7, Noise and Vibration. M-NO-3: Expanded Noise Control Plan (1, 3, 4, 5, 9, 10, 11, 12, 13, 14, 15, 16, 17 [Alternate], 18 [Alternate], and 19 [Alternate]). Refer to the discussion of Impact NO-3 in Section 5.7, Noise and Vibration.	SUM Sites 1, 3, 4, 5 (On-site Treatment), 9, 12, 14, 16, 18 (Alternate), and 19 (Alternate)
Impact NO-4. Project construction would not result in a substantial temporary increase in ambient noise levels along construction haul routes.	LS	No mitigation required.	LS
Impact NO-5. Operation of the Project would result in exposure of people to noise levels in excess of local noise standards or result in a substantial permanent increase in ambient noise levels in the Project vicinity.	S	M-NO-5: Operational Noise Control Measures (Sites 1, 5 [On-site Treatment], 7 [On-site Treatment], 9, 12, 18 [Alternate], and the Westlake Pump Station). Refer to the discussion of Impact NO-5 in Section 5.7, Noise and Vibration.	LSM
Impact C-NO-1. Construction and operation of the proposed Project could result in a cumulatively considerable contribution to cumulative impacts related to noise.	S	M-NO-1: Noise Control Plan (1, 3, 4, 5, 8, 9, 10, 11, 12, 13, 14, 15, 16, 17 [Alternate], 18 [Alternate], and 19 [Alternate]). Refer to the discussion of Impact NO-1 in Section 5.7, Noise and Vibration. M-NO-3: Expanded Noise Control Plan (1, 3, 4, 5, 9, 10, 11, 12, 13, 14, 15, 16, 17 [Alternate], 18 [Alternate], and 19 [Alternate]). Refer to the discussion of Impact NO-3 in Section 5.7, Noise and Vibration. M-NO-5: Operational Noise Control Measures (Sites 1, 5 [On-site Treatment], 7 [On-site Treatment], 9, 12, 18 [Alternate], and the Westlake Pump Station). Refer to the discussion of Impact NO-5 in Section 5.7, Noise and Vibration.	SUM Sites 12 and 19 (Alternate)

⁸ Impact NO-1 is not significant for Sites 5 and 15, but they are included here because a Noise Control Plan is required under Impact NO-3.

TABLE 1-1
Summary of Impacts and Mitigation Measures

Impact	Level of Significance Prior to Mitigation	Mitigation Measure(s)	Level of Significance After Mitigation
Section 5.8 Air Quality			
Impact AQ-1. Construction of the Project would not conflict with or obstruct implementation of applicable air quality plans.	LS	No mitigation required.	LS
Impact AQ-2. Emissions generated during construction activities would violate air quality standards and would contribute substantially to an existing air quality violation.	S	M-AQ-2a: BAAQMD Basic Construction Measures (All Sites). Refer to the discussion of Impact AQ-2 in Section 5.8, Air Quality. M-AQ-2b: NO_x Reduction during Construction of Alternate Sites. If one to three wells at Sites 1 through 16 are drilled but found to be unusable for any reason, and one to three well facilities are therefore constructed at alternate sites, the SFPUC shall reduce NO _x emissions by 20 percent during construction at the alternate site or sites. To meet this performance standard, the SFPUC shall develop and implement a plan demonstrating that the off-road equipment (i.e., equipment rated at more than 50 horsepower that is owned or leased by the contractor or subcontractors) to be used in constructing the wells and facilities at the alternate sites would achieve a fleet-wide average 20-percent NO _x reduction compared to the most recent CARB fleet average. Acceptable options for reducing emissions include the use of late model engines (i.e., meeting U.S. EPA Tier 3 standards or later), low-emission diesel products, alternative fuels that have lower NO _x emissions, engine retrofit technology, after-treatment products, add-on devices, and/or other options as such become available.	LSM
Impact AQ-3. Project construction would expose sensitive receptors to substantial pollutant concentrations.	S	M-AQ-3: Construction Health Risk Mitigation (Site 5 On-site Treatment). The SFPUC shall require the construction contractor to utilize, during the construction of Site 5 (On-site Treatment), off-road equipment (more than 50 horsepower) with late model engines meeting U.S. EPA Tier 4 (Interim), or utilize a combination of Tier 2 or Tier 3 engines with add-on devices that consist of level 3 diesel particulate filters.	LSM
Impact AQ-4. Project construction activities would not create objectionable odors affecting a substantial number of people.	LS	No mitigation required.	LS
Impact AQ-5. Project operations would not violate air quality standards or contribute substantially to an existing air quality violation.	LS	No mitigation required.	LS
Impact AQ-6. Project operations would not expose sensitive receptors to substantial pollutant concentrations.	LS	No mitigation required.	LS
Impact AQ-7. Project operations would not create objectionable odors affecting a substantial number of people.	LS	No mitigation required.	LS
Impact C-AQ-1. Construction and operation of the proposed Project could result in a cumulatively considerable contribution to cumulative impacts related to air quality.	S	M-AQ-2a: BAAQMD Basic Construction Measures (All Sites). Refer to the discussion of Impact AQ-2 in Section 5.8, Air Quality. M-AQ-2b: NO_x Reduction during Construction of Alternate Sites. Refer to the discussion of Impact AQ-2 in Section 5.8, Air Quality.	LSM

TABLE 1-1
Summary of Impacts and Mitigation Measures

Impact	Level of Significance Prior to Mitigation	Mitigation Measure(s)	Level of Significance After Mitigation
Section 5.9 Greenhouse Gas Emissions			
Impact GG-1. Project construction would generate GHG emissions, but not at levels that would have a significant impact on the environment.	LS	No mitigation required.	LS
Impact GG-2. Project operations would generate GHG emissions, but not at levels that would result in a significant impact on the environment.	LS	No mitigation required.	LS
Impact C-GG. The proposed Project would not result in a cumulatively considerable contribution to GHG emissions.	LS	No mitigation required.	LS
Section 5.10 Wind and Shadow - None. No impacts would occur.			
Section 5.11 Recreation			
Impact RE-1. The Project would not remove or damage existing recreational resources during construction	LS	No mitigation required.	LS
Impact RE-2. The Project would deteriorate the quality of the recreational experience during construction.	S	M-AQ-2a: BAAQMD Basic Construction Measures (All Sites). Refer to the discussion of Impact AQ-2 in Section 5.8, Air Quality.	LSM
Impact RE-3. The Project would not impair access to recreational resources during construction.	LS	No mitigation required.	LS
Impact RE-4. The Project would not damage recreational resources during operation.	LS	No mitigation required.	LS
Impact RE-5. The Project would not deteriorate the quality of the recreational experience during operation.	LS	No mitigation required.	LS
Impact RE-6. Operation of the Project would not remove or damage recreational resources, impair access to, or deteriorate the quality of the recreational experience at Lake Merced.	LS	No mitigation required.	LS

TABLE 1-1
Summary of Impacts and Mitigation Measures

Impact	Level of Significance Prior to Mitigation	Mitigation Measure(s)	Level of Significance After Mitigation
<p>Impact C-RE-1. Construction and operation of the proposed Project would not result in significant cumulative impacts on recreational resources.</p>	<p>LS</p>	<p>No mitigation required.</p>	<p>LS</p>
<p>Impact C-RE-2. Operation of the Project would not result in significant cumulative impacts on recreational resources at Lake Merced.</p>	<p>LS</p>	<p>No mitigation required.</p>	<p>LS</p>
<p>Section 5.12 Utilities and Service Systems</p>			
<p>Impact UT-1. Project construction could result in potential damage to or temporary disruption of existing utilities during construction.</p>	<p>S</p>	<p>M-UT-1a: Confirm Utility Line Information (All Sites). Prior to excavation and/or other ground-disturbing construction activities, the SFPUC or its contractor(s) shall locate overhead and underground utility lines, such as natural gas, electricity, sewer, telephone and waterlines, that may be encountered during excavation work. Pursuant to State law, the SFPUC or its contractor(s) shall notify USA North. Information regarding the size and location of existing utilities shall be confirmed before excavation and other ground-disturbing activities commence. These utilities shall be highlighted on all construction drawings. Utilities may be located by customary techniques such as geophysical methods and hand excavation.</p> <p>M-UT-1b: Safeguard Employees from Potential Accidents Related to Underground Utilities (All Sites). While any excavation is open, the SFPUC or its contractor(s) shall protect, support, or remove underground utilities as necessary to safeguard employees. As part of contractor specifications, the contractor(s) shall be required to provide updates on planned excavations for the upcoming week and to specify when construction will occur near any high-priority utility lines that are identified. At the beginning of each week when this work will take place, the SFPUC construction managers shall conduct meetings with contractor staff, as required by the California Occupational Safety and Health Administration (CalOSHA), to record all protective and avoidance measures regarding such excavations.</p> <p>M-UT-1c: Notify Local Fire Departments (All Sites). In the event that construction activities result in damage to high-priority utility lines, including leaks or suspected leaks, the SFPUC or its contractor(s) shall immediately notify local fire departments to protect worker and public safety.</p> <p>M-UT-1d: Emergency Response Plan (All Sites). Prior to commencing construction activities, the SFPUC shall develop an emergency response plan that outlines procedures to follow in the event of a leak or explosion resulting from a utility rupture. The emergency response plan shall identify the names and phone numbers of PG&E staff who would be available 24 hours per day in the event of damage or rupture of the high-pressure PG&E natural gas pipelines. The plan shall also detail emergency response protocols including notification, inspection and evacuation procedures; any equipment and vendors necessary to respond to an emergency, such as an alarm system; and routine inspection guidelines.</p> <p>M-UT-1e: Advance Notification (All Sites). The SFPUC or its contractor(s) shall notify all affected utility service providers in advance of Project excavation and/or other ground-disturbing activities. The SFPUC or its contractor(s) shall make arrangements with these entities regarding the protection, relocation, or temporary disconnection of services prior to the start of excavation and other ground-disturbing activities. The SFPUC or its contractor(s) shall coordinate with the appropriate utility service providers to ensure advance notification to residents, owners and businesses in the Project area of a potential utility service disruption two to four days in advance of construction. The notification shall provide information about the timing and duration of the potential service disruption.</p> <p>M-UT-1f: Protection of Other Utilities during Construction (All Sites). Detailed specifications shall be prepared as part of the design plans to include procedures for the excavation, support and fill of areas around subsurface utilities, cables and pipes. If it is not feasible to avoid an overhead utility line during construction, the SFPUC or its contractor(s) shall coordinate with the affected utility owner to either temporarily or permanently support the line, to de-energize the line while temporarily supporting the overhead line, or to temporarily re-route the line.</p> <p>M-UT-1g: Ensure Prompt Reconnection of Utilities (All Sites). The SFPUC or its contractor(s) shall promptly notify utility providers to reconnect any disconnected utility lines as soon as it is safe to do so.</p>	<p>LSM</p>

**TABLE 1-1
Summary of Impacts and Mitigation Measures**

Impact	Level of Significance Prior to Mitigation	Mitigation Measure(s)	Level of Significance After Mitigation
		<p>M-UT-1h: Avoidance of Utilities Constructed or Modified by Other SFPUC Projects (All Sites). The final construction drawings for the Project shall reflect any changes in utility locations, as well as the locations of any new utilities installed during construction of other SFPUC projects in San Mateo County whose disturbance areas overlap with the Project area.</p> <p>M-UT-1i: Coordinate Final Construction Plans with Affected Utilities (All Sites). The SFPUC or its contractor(s) shall coordinate final construction plans and specifications with affected utility providers.</p>	
<p>Impact UT-2. Project construction would not exceed the capacity of wastewater treatment facilities, exceed wastewater treatment requirements, require or result in the construction of new or expansion of existing wastewater treatment facilities or stormwater drainage facilities, the construction of which could cause significant environmental effects.</p>	LS	No mitigation required.	LS
<p>Impact UT-3. Project construction would not result in adverse effects on solid waste landfill capacity.</p>	LS	No mitigation required.	LS
<p>Impact UT-4. Project construction could result in a substantial adverse effect related to compliance with federal, State, and local statutes and regulations pertaining to solid waste.</p>	S	M-UT-4: Waste Management Plan (All Sites). Refer to the discussion of Impact UT-4 in Section 5.12, Utilities and Service Systems.	LSM
<p>Impact UT-5. Project operation would not exceed the capacity of wastewater treatment facilities, exceed wastewater treatment requirements, or require or result in the construction of new, or expansion of existing, wastewater treatment facilities or stormwater drainage facilities, the construction of which could cause significant environmental effects.</p>	LS	No mitigation required.	LS
<p>Impact C-UT-1. Construction and operation of the proposed Project could result in a cumulatively considerable contribution to cumulative impacts related to utilities and service systems.</p>	S	<p>M-UT-1a: Confirm Utility Line Information (All Sites). Refer to the discussion of Impact UT-1 in Section 5.12, Utilities and Service Systems.</p> <p>M-UT-1b: Safeguard Employees from Potential Accidents Related to Underground Utilities (All Sites). Refer to the discussion of Impact UT-1 in Section 5.12, Utilities and Service Systems.</p> <p>M-UT-1c: Notify Local Fire Departments (All Sites). Refer to the discussion of Impact UT-1 in Section 5.12, Utilities and Service Systems.</p> <p>M-UT-1d: Emergency Response Plan (All Sites). Refer to the discussion of Impact UT-1 in Section 5.12, Utilities and Service Systems.</p> <p>M-UT-1e: Advance Notification (All Sites). Refer to the discussion of Impact UT-1 in Section 5.12, Utilities and Service Systems.</p> <p>M-UT-1f: Protection of Other Utilities during Construction (All Sites). Refer to the discussion of Impact UT-1 in Section 5.12, Utilities and Service Systems.</p> <p>M-UT-1g: Ensure Prompt Reconnection of Utilities (All Sites). Refer to the discussion of Impact UT-1 in Section 5.12, Utilities and Service Systems.</p> <p>M-UT-1h: Avoidance of Utilities Constructed or Modified by Other SFPUC Projects (All Sites). Refer to the discussion of Impact UT-1 in Section 5.12, Utilities and Service Systems.</p>	LSM

TABLE 1-1
Summary of Impacts and Mitigation Measures

Impact	Level of Significance Prior to Mitigation	Mitigation Measure(s)	Level of Significance After Mitigation
		<p>M-UT-1i: Coordinate Final Construction Plans with Affected Utilities (All Sites). Refer to the discussion of Impact UT-1 in Section 5.12, Utilities and Service Systems.</p> <p>M-UT-4: Waste Management Plan (All Sites). Refer to the discussion of Impact UT-4 in Section 5.12, Utilities and Service Systems.</p>	
<p>Section 5.13 Public Services - None. No impacts would occur.</p>			
<p>Section 5.14 Biological Resources</p>			
<p>Impact BR-1. Project construction would adversely affect candidate, sensitive, or special-status species.</p>	S	<p>M-BR-1a: Protection Measures during Construction for Special-status Birds and Migratory Passerines and Raptors (All Sites). Refer to the discussion of Impact BR-1 in Section 5.14, Biological Resources.</p> <p>M-BR-1b: Protection Measures for Special-status Bats during Tree Removal or Trimming (Sites 1, 3, 4, 7, 10, 11, 12, 15, and 16). Refer to the discussion of Impact BR-1 in Section 5.14, Biological Resources.</p> <p>M-BR-1c: Protection Measures during Structure Demolition for Special-status Bats (Site 1). Refer to the discussion of Impact BR-1 in Section 5.14, Biological Resources.</p> <p>M-BR-1d: Monarch Butterfly Protection Measures (Sites 1, 3, 7, 10, and 12). Refer to the discussion of Impact BR-1 in Section 5.14, Biological Resources.</p>	LSM
<p>Impact BR-2. Project construction could adversely affect riparian habitat or other sensitive natural communities.</p>	S	<p>M-HY-1: Develop and Implement a Storm Water Pollution Prevention Plan (SWPPP) or an Erosion and Sediment Control Plan (All Sites). Refer to the discussion of Impact HY-1 in Section 5.16, Hydrology and Water Quality.</p> <p>M-BR-2: Avoid Disturbance to Riparian Habitat (Site 1). Refer to the discussion of Impact BR-2 in Section 5.14, Biological Resources.</p>	LSM
<p>Impact BR-3. The Project would impact jurisdictional wetlands or waters of the United States.</p>	S	<p>M-HY-1: Develop and Implement a Storm Water Pollution Prevention Plan (SWPPP) or an Erosion and Sediment Control Plan (All Sites). Refer to the discussion of Impact HY-1 in Section 5.16, Hydrology and Water Quality.</p>	LSM
<p>Impact BR-4. Project construction would conflict with local tree preservation ordinances.</p>	S	<p>M-BR-4a: Identify Protected Trees (Sites 3, 4, 7, 10, 11, 12, 13, 14, 15, and 17 [Alternate]). Refer to the discussion of Impact BR-4 in Section 5.14, Biological Resources.</p> <p>M-AE-1b: Tree Protection Measures (Sites 3, 4, 7, 10, 11, 12, 13, 14, 15, and 17 [Alternate]). Refer to the discussion in Impact BR-4 in Section 5.14, Biological Resources and in Impact AE-1 in Section 5.2, Aesthetics.</p> <p>M-BR-4b: Protected Tree Replacement (Sites 4, 7, 9, 12, 15, and 18 [Alternate]). Refer to the discussion of Impact BR-4 in Section 5.14, Biological Resources.</p>	LSM
<p>Impact BR-5. Project operations could adversely affect candidate, sensitive, or special-status species.</p>	S	<p>M-NO-5: Operational Noise Control Measures (Sites 1, 5 [On-site Treatment], 7 [On-site Treatment], 9, 12, 18 [Alternate], and the Westlake Pump Station). Refer to the discussion of Impact NO-5 in Section 5.7, Noise and Vibration.</p>	LSM
<p>Impact BR-6. Operation of the Project would not adversely affect species identified as candidate, sensitive, or special-status wildlife species in local or regional plans, policies, or regulations, or by the CDFW or USFWS.</p>	LS	No mitigation required.	LS

TABLE 1-1
Summary of Impacts and Mitigation Measures

Impact	Level of Significance Prior to Mitigation	Mitigation Measure(s)	Level of Significance After Mitigation
<p>Impact BR-7. Operation of the Project could adversely affect sensitive habitat types associated with Lake Merced.</p>	S	<p>M-HY-9a: Lake Level Monitoring and Modeling for Lake Merced. Refer to the discussion of Impact HY-9 in Section 5.16, Hydrology and Water Quality.</p> <p>M-HY-9b: Lake Level Management for Lake Merced. Refer to the discussion of Impact HY-9 in Section 5.16, Hydrology and Water Quality.</p> <p>M-BR-7: Lake Level Management for Water Level Increases for Lake Merced. Refer to the discussion of Impact BR-7 in Section 5.14, Biological Resources.</p>	LSM
<p>Impact BR-8. Operation of the Project could adversely affect wetland habitats and other waters of the United States associated with Lake Merced.</p>	S	<p>M-BR-8: Lake Level Management for No-Net-Loss of Wetlands for Lake Merced. Refer to the discussion of Impact BR-8 in Section 5.14, Biological Resources.</p> <p>M-HY-9a: Lake Level Monitoring and Modeling for Lake Merced. Refer to the discussion of Impact HY-9 in Section 5.16, Hydrology and Water Quality.</p> <p>M-HY-9b: Lake Level Management for Lake Merced. Refer to the discussion of Impact HY-9 in Section 5.16, Hydrology and Water Quality.</p>	LSM
<p>Impact BR-9. Operation of the Project could adversely affect native wildlife nursery sites associated with Lake Merced.</p>	S	<p>M-HY-9a: Lake Level Monitoring and Modeling for Lake Merced. Refer to the discussion of Impact HY-9 in Section 5.16, Hydrology and Water Quality.</p> <p>M-BR-7: Lake Level Management for Water Level Increases for Lake Merced. Refer to the discussion of Impact HY-7 in Section 5.16, Hydrology and Water Quality.</p>	LSM
<p>Impact C-BR-1. Construction and operation of the proposed Project could result in significant cumulative impacts related to biological resources.</p>	S	<p>M-BR-1a: Protection Measures during Construction for Special-status Birds and Migratory Passerines and Raptors (All Sites). Refer to the discussion of Impact BR-1 in Section 5.14, Biological Resources.</p> <p>M-BR-1b: Protection Measures for Special-status Bats during Tree Removal or Trimming (Sites 1, 3, 4, 7, 10, 11, 12, 15, and 16). Refer to the discussion of Impact BR-1 in Section 5.14, Biological Resources.</p> <p>M-BR-1c: Protection Measures during Structure Demolition for Special-status Bats (Site 1). Refer to the discussion of Impact BR-1 in Section 5.14, Biological Resources.</p> <p>M-BR-1d: Monarch Butterfly Protection Measures (Sites 1, 3, 7, 10, and 12). Refer to the discussion of Impact BR-1 in Section 5.14, Biological Resources.</p> <p>M-BR-2: Avoid Disturbance to Riparian Habitat (Site 1). Refer to the discussion of Impact BR-2 in Section 5.14, Biological Resources.</p> <p>M-BR-4a: Identify Protected Trees (Sites 3, 4, 7, 10, 11, 12, 13, 14, 15, and 17 [Alternate]). Refer to the discussion of Impact BR-4 in Section 5.14, Biological Resources.</p> <p>M-AE-1b: Tree Protection Measures (Sites 3, 4, 7, 10, 11, 12, 13, 14,, 15, 17 [Alternate])</p> <p>M-BR-4b: Protected Tree Replacement (Sites 4, 7, 9, 12, 15, and 18 [Alternate]). Refer to the discussion of Impact BR-4 in Section 5.14, Biological Resources.</p> <p>M-HY-1: Develop and Implement a Storm Water Pollution Prevention Plan (SWPPP) or an Erosion and Sediment Control Plan (All Sites). Refer to the discussion of Impact HY-1 in Section 5.16, Hydrology and Water Quality.</p>	LSM
<p>Impact C-BR-2. The Project would result in cumulative construction or operational impacts related to special-status species, riparian habitat, sensitive communities, wetlands or waters of the United States, or compliance with local policies and ordinances protecting biological resources at Lake Merced.</p>	S	<p>M-BR-7: Lake Level Management for Water Level Increases for Lake Merced. Refer to the discussion of Impact HY-7 in Section 5.16, Hydrology and Water Quality.</p> <p>M-HY-9a: Lake Level Monitoring and Modeling for Lake Merced. Refer to the discussion of Impact HY-9 in Section 5.16, Hydrology and Water Quality.</p> <p>M-HY-9b: Lake Level Management for Lake Merced. Refer to the discussion of Impact HY-9 in Section 5.16, Hydrology and Water Quality.</p>	LSM

TABLE 1-1
Summary of Impacts and Mitigation Measures

Impact	Level of Significance Prior to Mitigation	Mitigation Measure(s)	Level of Significance After Mitigation
Section 5.15 Geology and Soils			
Impact GE-1. The Project would not be located on a geologic unit or soil that is unstable, or that would become unstable during construction.	LS	No mitigation required.	LS
Impact GE-2. The Project would not substantially change the topography or any unique geologic or physical features of the site(s).	LS	No mitigation required.	LS
Impact GE-3. The Project would expose people or structures to substantial adverse effects related to the risk of property loss, injury, or death due to fault rupture, seismic groundshaking, or landslides.	S	M-GE-3: Conduct Site-Specific Geotechnical Investigations and Implement Recommendations (All Sites). Refer to the discussion of Impact GE-3 in Section 5.15, Geology and Soils.	LSM
Impact GE-4. The Project would be located on a geologic unit or soil that is unstable, or that would become unstable.	S	M-GE-3: Conduct Site-Specific Geotechnical Investigations and Implement Recommendations (All Sites). Refer to the discussion of Impact GE-3 in Section 5.15, Geology and Soils.	LSM
Impact GE-5. The Project would not be located on corrosive or expansive soil, creating substantial risks to life or property.	LS	No mitigation required.	LS
Impact C-GE-1. Construction and operation of the proposed Project could result in significant impacts related to soils and geology.	LS	No mitigation required.	LS
Section 5.16 Hydrology and Water Quality			
Impact HY-1. Project construction activities would degrade water quality as a result of erosion or siltation caused by earthmoving activities or by the accidental release of hazardous construction chemicals during construction.	S	M-HY-1: Develop and Implement a Storm Water Pollution Prevention Plan (SWPPP) or an Erosion and Sediment Control Plan (All Sites). Refer to the discussion of Impact HY-1 in Section 5.16, Hydrology and Water Quality.	LSM
Impact HY-2. Discharge of groundwater could result in minor localized flooding, violate water quality standards and/or otherwise degrade water quality.	S	M-HY-2: Management of Well Development and Pump Testing Discharges (All Sites, Except Westlake Pump Station). Refer to the discussion of Impact HY-2 in Section 5.16, Hydrology and Water Quality.	LSM

TABLE 1-1
Summary of Impacts and Mitigation Measures

Impact	Level of Significance Prior to Mitigation	Mitigation Measure(s)	Level of Significance After Mitigation
Impact HY-3. Project operation would not alter drainage patterns in such a manner that could result in degraded water quality or cause on- or off-site flooding.	LS	No mitigation required.	LS
Impact HY-4. Project operation would not impede or redirect flood flows.	LS	No mitigation required.	LS
Impact HY-5. Project operation would not result in a violation of water quality standards or in the degradation of water quality from the discharge of groundwater during well maintenance.	LS	No mitigation required.	LS
Impact HY-6. Project operation would decrease the production rate of existing nearby irrigation wells due to localized groundwater drawdown within the Westside Groundwater Basin such that existing or planned land use(s) may not be fully supported.	S	M-HY-6: Ensure Existing Irrigators' Wells Are Not Prevented from Supporting Existing or Planned Land Use Due to Project Operation. Refer to the discussion of Impact HY-6 in Section 5.16, Hydrology and Water Quality.	SUM
Impact HY-7. Project operation would not result in substantial land subsidence due to decreased groundwater levels in the Westside Groundwater Basin where the historical low water levels are exceeded.	LS	No mitigation required.	LS
Impact HY-8. Project operation would not result in seawater intrusion due to decreased groundwater levels in the Westside Groundwater Basin.	LS	No mitigation required.	LS
Impact HY-9. Project operation could have a substantial, adverse effect on water quality that could affect the beneficial uses of Lake Merced.	S	M-HY-9a: Lake Level Monitoring and Modeling for Lake Merced. Refer to the discussion of Impact HY-9 in Section 5.16, Hydrology and Water Quality. M-HY-9b: Lake Level Management for Lake Merced. Refer to the discussion of Impact HY-9 in Section 5.16, Hydrology and Water Quality.	LSM
Impact HY-10. Project operation would not have a substantial adverse effect on water quality that could affect the beneficial uses of Pine Lake.	LS	No mitigation required.	LS
Impact HY-11. Project operation would not have a substantial adverse effect on water quality that could affect the beneficial uses of Colma Creek, San Bruno Creek, Lomita Channel, or Millbrae Creek.	LS	No mitigation required.	LS

TABLE 1-1
Summary of Impacts and Mitigation Measures

Impact	Level of Significance Prior to Mitigation	Mitigation Measure(s)	Level of Significance After Mitigation
Impact HY-12. Project operation would not cause a violation of water quality standards due to mobilization of contaminants in groundwater from changing groundwater levels in the Westside Groundwater Basin.	LS	No mitigation required.	LS
Impact HY-13. Project operation would not result in degradation of drinking water quality or groundwater quality relative to constituents for which standards do not exist.	LS	No mitigation required.	LS
Impact HY-14. Project operation may have a substantial adverse effect on groundwater depletion in the Westside Groundwater Basin over the very long term.	S	M-HY-14: Prevent Groundwater Depletion. Refer to the discussion of Impact HY-14 in Section 5.16, Hydrology and Water Quality.	LSM
Impact C-HY-1. Project construction could result in a cumulatively considerable contribution to cumulative impacts on surface water hydrology and water quality.	S	M-HY-1: Develop and Implement a Storm Water Pollution Prevention Plan (SWPPP) or an Erosion and Sediment Control Plan (All Sites). Refer to the discussion of Impact HY-1 in Section 5.16, Hydrology and Water Quality. M-HY-2: Management of Well Development and Pump Testing Discharges (All Sites except Westlake Pump Station). Refer to the discussion of Impact HY-2 in Section 5.16, Hydrology and Water Quality.	LSM
Impact C-HY-2. Operation of the proposed Project would result in a cumulatively considerable contribution to cumulative impacts related to well interference.	S	M-HY-6: Ensure Existing Irrigators' Wells Are Not Prevented from Supporting Existing or Planned Land Use Due to Project Operation. Refer to the discussion of Impact HY-7 in Section 5.16, Hydrology and Water Quality.	SUM
Impact C-HY-3. Operation of the proposed Project would not result in a cumulatively considerable contribution to cumulative impacts related to subsidence.	LS	No mitigation required.	LS
Impact C-HY-4. Operation of the proposed Project would not have a cumulatively considerable contribution to seawater intrusion.	LS	No mitigation required.	LS
Impact C-HY-5. Operation of the proposed Project could have a cumulatively considerable contribution to cumulative impacts on beneficial uses of surface waters.	S	M-HY-9a: Lake Level Monitoring and Modeling for Lake Merced. Refer to the discussion of Impact HY-9 in Section 5.16, Hydrology and Water Quality. M-HY-9b: Lake Level Management for Lake Merced. Refer to the discussion of Impact HY-9 in Section 5.16, Hydrology and Water Quality.	LSM

TABLE 1-1
Summary of Impacts and Mitigation Measures

Impact	Level of Significance Prior to Mitigation	Mitigation Measure(s)	Level of Significance After Mitigation
Impact C-HY-6. Operation of the proposed Project would not result in a cumulatively considerable contribution to cumulative impacts related to water quality standards	LS	No mitigation required.	LS
Impact C-HY-7. Operation of the proposed Project would not result in a cumulatively considerable contribution to cumulative impacts related to water quality degradation.	LS	No mitigation required.	LS
Impact C-HY-8. Operation of the proposed Project would have a cumulatively considerable contribution to a cumulative impact related to groundwater depletion effect.	S	M-HY-14: Prevent Groundwater Depletion. Refer to the discussion of Impact HY-14 in Section 5.16, Hydrology and Water Quality.	LSM
Section 5.17 Hazards and Hazardous Materials			
Impact HZ-1. The Project would not create a significant hazard to the public or the environment related to transport, use, or disposal of hazardous materials during construction.	LS	No mitigation required.	LS
Impact HZ-2. The Project would result in a substantial adverse effect related to reasonably foreseeable upset and accident conditions involving the release of hazardous materials into the environment during construction.	S	<p>M-HY-1: Develop and Implement a Storm Water Pollution Prevention Plan (SWPPP) or an Erosion and Sediment Control Plan (All Sites). Refer to the discussion of Impact HY-1 in Section 5.16, Hydrology and Water Quality.</p> <p>HZ-2a: Preconstruction Hazardous Materials Assessment (All Sites). Within three months prior to construction, the SFPUC shall retain a qualified environmental professional to conduct a regulatory agency database review to update and identify hazardous materials sites within 0.25 mile of a well facility site and to review appropriate standard information sources to determine the potential for soil or groundwater contamination at the project sites. Should this review indicate a high likelihood of encountering contamination at the proposed facility sites, follow-up sampling shall be conducted to characterize soil and groundwater quality prior to construction to provide necessary data for the site health and safety plan (Mitigation Measure M-HZ-2b) and hazardous materials management plan (Mitigation Measure M-HZ-2c). If needed, site investigations or remedial activities shall be performed at facility sites in accordance with applicable laws and regulations.</p> <p>M-HZ 2b: Health and Safety Plan (All Sites). The construction contractor shall, prior to construction, prepare a site-specific health and safety plan in accordance with federal OSHA regulations (29 CFR 1910.120) and Cal-OSHA regulations (8 CCR Title 8, Section 5192) to address worker health and safety issues during construction. The health and safety plan shall identify the potentially present chemicals, health and safety hazards associated with those chemicals, all required measures to protect construction workers and the general public from exposure to harmful levels of any chemicals identified at the site (including engineering controls, monitoring, and security measures to prevent unauthorized entry to the work area), appropriate personal protective equipment, and emergency response procedures. The health and safety plan shall designate qualified individuals responsible for implementing the plan and for directing subsequent procedures in the event that unanticipated contamination is encountered.</p> <p>M-HZ-2c: Hazardous Materials Management Plan (All Sites). Refer to the discussion of Impact HZ-2 in Section 5.17, Hazards and Hazardous Materials.</p>	LSM
Impact HZ-3. The Project would result in impacts from the emission or use of hazardous materials within 0.25 mile of a school during construction.	S	M-HY-1: Develop and Implement a Storm Water Pollution Prevention Plan (SWPPP) or an Erosion and Sediment Control Plan (All Sites). Refer to the discussion of Impact HY-1 in Section 5.16, Hydrology and Water Quality.	LSM

TABLE 1-1
Summary of Impacts and Mitigation Measures

Impact	Level of Significance Prior to Mitigation	Mitigation Measure(s)	Level of Significance After Mitigation
		M-HZ-2c: Hazardous Materials Management Plan (All Sites). Refer to the discussion of Impact HZ-2 in Section 5.17, Hazards and Hazardous Materials.	
Impact HZ-4. The Project would not create a hazard to the public or environment from the routine transport, use, or disposal of hazardous materials or accidental release of hazardous materials during operation.	LS	No mitigation required.	LS
Impact HZ-5. The Project would not result in impacts from the emission or use of hazardous materials within 0.25 mile of a school during operation.	LS	No mitigation required.	LS
Impact HZ-6. The Project would not result in a safety hazard for people residing or working in the vicinity of a public use airport.	LS	No mitigation required.	LS
Impact HZ-7. The Project would not expose people or structures to a significant risk of loss, injury, or death involving fires.	LS	No mitigation required.	LS
Impact C-HZ-1. Construction and operation of the proposed Project could result in a cumulatively considerable contribution to cumulative impacts related to hazards and hazardous materials.	S	M-HY-1: Develop and Implement a Storm Water Pollution Prevention Plan (SWPPP) or an Erosion and Sediment Control Plan (All Sites). Refer to discussion of Impact HY-1 in Section 5.16, Hydrology and Water Quality. M-HZ-2a: Preconstruction Hazardous Materials Assessment (All Sites). Refer to the discussion of Impact HZ-2 in Section 5.17, Hazards and Hazardous Materials M-HZ 2b: Health and Safety Plan (All Sites). Refer to the discussion of Impact HZ-2 in Section 5.17, Hazards and Hazardous Materials M-HZ-2c: Hazardous Materials Management Plan (All Sites). Refer to the discussion of Impact HZ-2 in Section 5.17, Hazards and Hazardous Materials	LSM
Section 5.18 Minerals and Energy Resources			
Impact ME-1. The Project would not encourage activities that result in the use of large amounts of fuel and energy in a wasteful manner during construction.	LS	No mitigation required.	LS
Impact ME-2. The Project would not encourage activities that result in the use of large amounts of fuel and energy in a wasteful manner during operation.	LS	No mitigation required.	LS
Impact C-ME-1. Construction and operation of the proposed Project would not result in a cumulatively considerable contribution to cumulative impacts related to mineral and energy resources.	LS	No mitigation required.	LS
Section 5.19 Agriculture and Forest Resources - None. No impacts would occur.			

This page left intentionally blank

1.6 ALTERNATIVES TO THE PROPOSED PROJECT

Chapter 7, Alternatives, of this EIR evaluates five alternatives to the proposed Project:

- Alternative 1: No Project Alternative.** The SFPUC would not construct well facilities and the conjunctive use of the South Westside Groundwater Basin would not occur. Under the No Project Alternative, a GSR dry-year water supply would not be available to the SFPUC, its wholesale customers, or the Partner Agencies, as planned for and approved in the Phased WSIP.
- Alternative 2A: Reduce Lake Merced Impacts and Maintain Project Yield.** Alternative 2A was selected for analysis because it would reduce significant biological, and water quality impacts associated with declining lake levels at Lake Merced due to Project pumping during dry years. Under this alternative, the SFPUC would construct only 14 wells and well facilities (instead of 16 wells under the proposed Project) to reduce impacts associated with declining lake levels at Lake Merced due to Project pumping during dry years by approximately 54 percent. This alternative would not construct wells or well facilities at Sites 1 and 4, and without wells as these sites, pumping near Lake Merced would be reduced. To maintain the overall Project yield at 7.2 mgd, pumping would be redistributed to 11 wells at Sites 5 through 15. Pumping at each of Sites 5 through 15 would increase by approximately 20 percent compared to the proposed Project.
- Alternative 2B: Reduce Lake Merced Impacts and Reduce Project Yield.** Alternative 2B was selected for analysis because it would reduce significant biological, and water quality impacts associated with declining lake levels at Lake Merced due to Project pumping during dry years, but would not include any redistribution of pumping as Alternative 2A does. Under this alternative, the SFPUC would construct only 14 wells and well facilities (instead of 16 wells under the proposed Project) to reduce impacts associated with declining lake levels at Lake Merced due to Project pumping during dry years. This alternative would not construct wells or well facilities at Sites 1 and 4, and without wells at Sites 1 and 4, Project pumping would be reduced by 1.0 mgd and the overall Project yield would be 6.2 mgd. This alternative would decrease pumping near Lake Merced by approximately 54 percent.
- Alternative 3A: Reduce Impacts on Colma-area Existing Irrigation Wells and Maintain Project Yield:** Alternative 3A was selected for analysis because it would reduce the significant well interference impacts of the Project during dry years at existing irrigation wells that are located at the Colma-area cemeteries. Under this alternative, the SFPUC would construct only 14 wells and well facilities (instead of 16 wells under the proposed Project). The 14 wells would be located at the same preferred sites as the Project; however, Alternative 3A would not include a well or well facility at Sites 7 or 8 in Colma. Without wells at Sites 7 and 8, Project pumping would be reduced by approximately 1.2 mgd. To maintain the overall Project yield at 7.2 mgd, pumping would be redistributed to the nine wells at Sites 1 through 4 and Sites 11 through 15. Project pumping at each of these sites would increase by approximately 31 percent compared to the proposed Project. Pumping at Sites 5, 6, 9, and 10 would be the same as the Project, because they are near Colma; pumping at Site 16 would be

the same as the Project, because groundwater availability is restricted there as compared to the other preferred sites. The alternative would decrease pumping in the Colma area by approximately 32 percent.

- **Alternative 3B: Reduce Impacts on Colma-area Existing Irrigation Wells and Reduce Project Yield:** Alternative 3B was selected for analysis because it would reduce the significant well interference impacts of the Project at existing irrigation wells for cemeteries in the Colma area due to Project pumping during dry years, but unlike Alternative 3A, it would not include any redistribution of pumping. Under Alternative 3B, the SFPUC would construct only 14 wells and well facilities (instead of 16 wells under the proposed Project). The 14 wells would be located at the same preferred sites as the Project; however, Alternative 3B would not include a well or well facility at Sites 7 or 8 in Colma. Without wells at Sites 7 and 8, pumping would be reduced by approximately 1.2 mgd, and the overall Project yield would be 6.0 mgd. The alternative would decrease pumping near Colma by approximately 32 percent.

Although the No Project Alternative would avoid construction-related impacts of the proposed Project, it would not achieve any of the Project objectives, and it would not fulfill the SFPUC's basic mission of providing a reliable water supply for its customers, because a new source of dry-year and/or emergency pumping capacity would be unavailable for SFPUC customers.

The alternatives analysis determined that Alternative 2A (Reduce Lake Merced Impacts and Maintain Project Yield) would eliminate construction impacts at two sites. Construction impacts at the other sites would be the same as those of the proposed Project. During operations, Alternative 2A would reduce the severity of well interference impacts on five existing irrigation wells near Lake Merced, but would increase well interference impacts at 12 existing irrigation wells compared to the Project, due to redistribution of pumping to GSR wells toward Colma-area existing irrigation wells. Impacts of Alternative 2A would be less severe than those of the proposed Project, with the exception of increased well interference impacts at some wells, and Alternative 2A would achieve the Project objectives and would support the SFPUC's goal of providing a reliable dry-year groundwater supply during the 8.5-year design drought cycle.

The alternatives analysis determined that Alternative 2B (Reduce Lake Merced Impacts and Reduce Project Yield) would also eliminate construction impacts at two sites. Construction impacts at the other sites would be the same as those of the proposed Project. Alternative 2B would meet most of the Project objectives, but it would not fully support the SFPUC's goal to supply water reliably to customers in the event of emergencies and drought because of the reduced yield associated with Alternative 2B.

The alternatives analysis determined that Alternative 3A (Reduce Impacts on Colma-area Existing Irrigation Wells and Maintain Project Yield) would eliminate construction impacts at two sites. Construction impacts at the other sites would be the same as those of the proposed Project. During operations, Alternative 3A would reduce the severity of well interference impacts on 10 existing irrigation wells at cemeteries in Colma, but would increase well interference impacts at seven existing irrigation wells compared to the Project and increase impacts to Lake Merced, due to redistribution of pumping to GSR wells away from the Colma area. The operational impacts of Alternative 3A would be

less severe than the Project or Alternatives 2A or 2B, with the exception of increased impacts on Lake Merced. Alternative 3A would fully achieve the Project objectives and support the SFPUC's basic goal of providing a reliable dry-year and emergency groundwater supply during the 8.5-year design drought cycle.

The alternatives analysis determined that Alternative 3B (Reduce Impacts on Colma-area Existing Irrigation Wells and Reduce Project Yield) would eliminate construction impacts at two sites. Construction impacts at the other sites would be the same as those of the proposed Project. During operations, Alternative 3B would reduce the severity of well interference impacts on five existing irrigation wells at cemeteries in Colma as compared to the Project. As a result, two existing irrigation wells in Colma would not experience significant impacts, as they would under the proposed Project. The alternative would meet most of the Project objectives, but would not provide the full 7.2-mgd dry-year and emergency pumping capacity needed during the 8.5-year design drought. The alternative would result in an approximately 1.2-mgd shortfall during each year of a severe drought.

None of the alternatives would reduce all the significant and unavoidable impacts of the proposed Project. Alternatives 2A, 2B, 3A, and 3B would cause significant and unavoidable impacts related to construction at one or two fewer sites than the Project; however, significant and unavoidable construction-period impacts would still occur at up to other facility sites, as they would under the proposed Project. In addition, such impacts, although significant and unavoidable, would be temporary and would only last through the 16-month construction period. Alternatives 3A and 3B would cause significant and potentially unavoidable well interference impacts during operation at one or two fewer existing irrigation wells than the Project; however, significant and unavoidable well interference impacts would still occur at 11 or 12 existing irrigation wells, as they would under the proposed Project. Alternative 3A would cause slightly greater impacts to Lake Merced. The No Project Alternative would not cause significant and unavoidable construction impacts (since no construction would occur), but water levels at Lake Merced would continue to fluctuate as they do now under varying hydrologic conditions, and during a drought as severe as the design drought, lake levels would decline to a level that could have adverse water quality effects at Lake Merced. Because permanent operational impacts are considered more severe than temporary construction-period impacts, Alternative 3B (Reduce Impacts on Colma-area Existing Irrigation Wells and Reduce Yield) is considered the environmentally superior alternative, in that it would have significant and unavoidable well interference impacts at fewer sites than the proposed Project or Alternatives 2A, 2B or 3A.

1.7 AREAS OF CONTROVERSY

Several areas of potential controversy were identified during the scoping period. Environmental concerns raised during scoping include construction-related impacts from traffic and access issues, potential impacts of climate change, and an array of groundwater issues, which included potential impacts to private wells and the long-term productivity of these wells, impacts to the water level at Lake Merced, impacts to groundwater quality, and sustainability of the groundwater basin. During the scoping meeting, held on July 9, 2009, attendees commented on the scope of the Draft EIR. Written comments were also received during the scoping period (between June 24 and July 28, 2009). A scoping report was prepared that summarizes the comments received on the project, including a transcript of oral testimony

at the July 2009 scoping session (see Appendix B [Scoping Summary Memorandum]). Refer to Table 2-2 (Summary of Scoping Comments) in Chapter 2, Introduction and Background, for an overview of the environmental concerns raised during the scoping period.

1.8 REFERENCES

- Luhdorff & Scalmanini Consulting Engineers (LSCE). 2010. *Technical Memorandum No. 1. Hydrologic setting of the Westside Basin*. May.
- MWH with AGS, M. Lee, and Talavera & Richardson. 2008. *Conceptual Engineering Report (CER), Groundwater Conjunctive Use Project*. Prepared for the San Francisco Public Utilities Commission. November.
- San Francisco Planning Department. 2008a. *Final Program Environmental Impact Report for the San Francisco Public Utility Commission's Water System Improvement Program*, File No. 2005.0159E, State Clearinghouse No. 2005092026. Certified October 30, 2008.
- San Francisco Planning Department. 2008b. *Motion No. 17734, Adopting Findings Related to the Certification of a Final Program Environmental Impact Report for a Proposed Water System Improvement Program for the San Francisco Public Utilities Commission*. Adopted October 30, 2008.
- San Francisco Planning Department. 2010. *Final Environmental Impact Report for the San Francisco Public Utility Commission's Lower Crystal Springs Dam Improvements Project*, File No. 2006.0536E, State Clearinghouse No. 2007012002. Certified October 7, 2010.
- San Francisco Planning Department. 2011. *Final Environmental Impact Report for the San Francisco Public Utilities Commission Calaveras Dam Replacement Project*, File No. 2005.0161E, State Clearinghouse No. 2005102102. Certified January 27, 2011.
- San Francisco Public Utilities Commission (SFPUC). 2007. *Right of Way Integrated Vegetation Management Policy*.
- SFPUC. 2008. *SFPUC Resolution 08-200, Water System Improvement Program California Environmental Quality Act Findings: Findings of Fact, Evaluation of Mitigation Measures and Alternatives, and Statement of Overriding Considerations*. October.
- Society of Vertebrate Paleontology (SVP). 2012. *Assessment and Mitigation of Adverse Impacts to Nonrenewable Paleontologic Resources: Standard Guidelines*. Website accessed April 1, 2013 at: <http://vertpaleo.org/The-Society/Statements-and-Guidelines/Conformable-Impact-Mitigation-Guidelines-Committee.aspx>.

2 INTRODUCTION AND BACKGROUND

Sections	Figures	Tables
2.1 Introduction	2-1 Project Vicinity Map	2-1 WSIP Goals and Objectives
2.2 Project Background	2-2 Overview of SFPUC Regional Water System & Water Supply Watersheds	2-2 Summary of Scoping Comments
2.3 Purpose of this EIR		
2.4 Public Review	2-3 SFPUC Water Service Area, San Francisco, and SFPUC Wholesale Customers	
2.5 Organization of the Draft EIR		
2.6 References		

2.1 INTRODUCTION







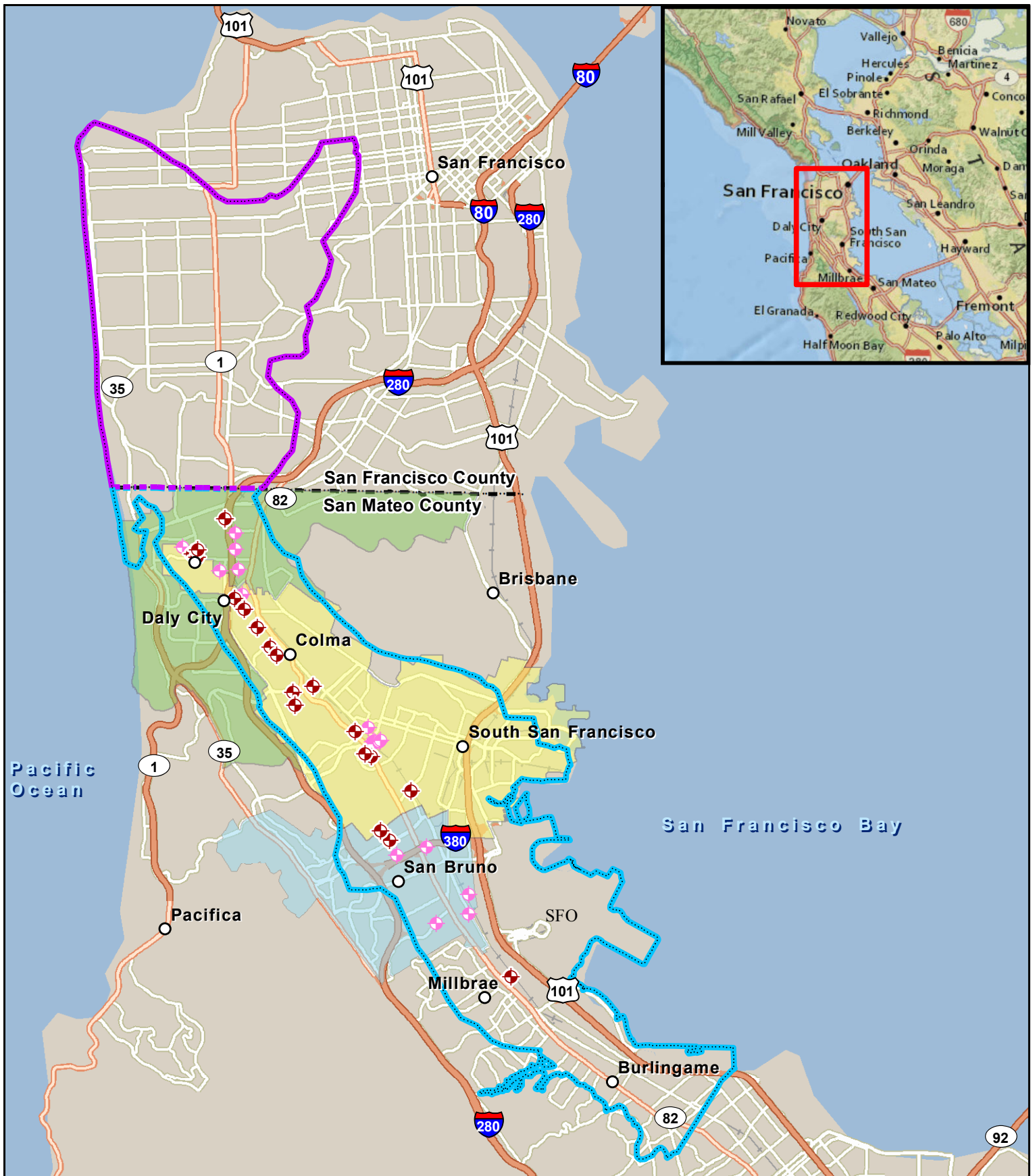

The Regional Groundwater Storage and Recovery (GSR) Project (proposed Project or Project) proposes to increase water supply reliability during dry years or in emergencies, by increasing water storage in the Westside Groundwater Basin during wet and normal years for subsequent recapture during dry years and emergencies. The proposed Project would be located in San Mateo County and is sponsored by the San Francisco Public Utilities Commission (SFPUC) in coordination with its partner agencies, which include the cities of Daly City and San Bruno, and the California Water Service Company (Cal Water) in its South San Francisco service area (collectively referred to as Partner Agencies).

The SFPUC currently supplies surface water to the Partner Agencies from its regional water system. The Partner Agencies supply potable water to their retail customers through a combination of groundwater from the South Westside Groundwater Basin and purchase of SFPUC surface water. The proposed Project would provide supplemental SFPUC surface water to the Partner Agencies during normal and above-average rainfall years (referred to throughout this Environmental Impact Report [EIR] as “wet” years). During these years, the Partner Agencies would reduce their groundwater pumping by a comparable amount to increase the amount of groundwater in storage through natural (in-lieu) recharge. During normal and wet years, the volume of groundwater in the South Westside Groundwater Basin would increase due to the combination of natural recharge and reduced groundwater pumping by the Partner Agencies. During dry years, the Partner Agencies and the SFPUC would pump the stored groundwater using 16 new well facilities in addition to the Partner Agencies’ existing wells. This new dry-year water supply would be blended with water from the regional water system and distributed to San Francisco and other wholesale customers in northern San Mateo County through existing SFPUC transmission lines or the three Partner Agency water distribution systems, thereby increasing the available water supply to all regional water system customers. The existing distribution systems are located and sized appropriately to accommodate the additional groundwater that would be produced as part of the proposed Project. Figure 2-1 (Project Vicinity Map), shows the proposed Project location in northern San Mateo County and the Westside Groundwater Basin.

This page left intentionally blank



Legend

-  Partner Agency Wells
-  Proposed Project Well Facility Sites
-  County Boundary
-  Cal Water Service Co. Service Area
-  Daly City Water Service Area
-  San Bruno Water Service Area
-  North Westside Groundwater Basin¹
-  South Westside Groundwater Basin¹

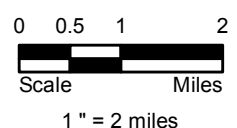

Project Vicinity Map

Regional Groundwater Storage and Recovery Project

Figure 2-1

Source: San Mateo County 2010, modified by GHD 2012.

¹The Westside Groundwater Basin has been administratively divided at the San Francisco-San Mateo County line.

The proposed Project is part of the SFPUC's Water System Improvement Program (WSIP). The purpose of the WSIP is to increase the reliability of the regional water system with respect to seismic response, water delivery, and water quality through the year 2030, as well as water supply to meet water delivery needs in the service area through the year 2018.

Under the San Francisco Administrative Code, Chapter 31, the San Francisco Planning Department's Environmental Planning (EP) Division is responsible for conducting environmental review of all City and County of San Francisco (CCSF) projects pursuant to the requirements of the California Environmental Quality Act (CEQA). The San Francisco Planning Department is, therefore, the lead agency responsible for preparing this EIR; the Project sponsor is the SFPUC. This document constitutes the Draft EIR for the proposed Project and was prepared to fulfill the requirements of CEQA.

2.2 PROJECT BACKGROUND

2.2.1 Regional Water System Overview

The CCSF, through the SFPUC, owns and operates the regional water system that extends from the Sierra Nevada to San Francisco and serves over 2.4 million people in San Francisco, San Mateo, Santa Clara, Alameda and Tuolumne counties. The regional water system consists of water conveyance, treatment, and distribution facilities, and delivers water to retail and wholesale customers. The existing regional water system includes over 280 miles of pipelines, over 60 miles of tunnels, 11 reservoirs, five pump stations, and two water treatment plants. The SFPUC delivers up to an annual average of about 265 million gallons per day (mgd) of water to its customers. The source of the water supply is a combination of local supplies from streamflow and runoff in the Alameda Creek watershed and in the San Mateo and Pilarcitos creeks watersheds (referred to together as the Peninsula watersheds), augmented with imported supplies from the Tuolumne River watershed. Local watersheds provide about 15 percent of total supplies and the Tuolumne River provides the remaining 85 percent. Figure 2-2 (Overview of the Regional Water System & Water Supply Watersheds), illustrates the general location of the regional water system and water supply watersheds.

The SFPUC serves about one-third of its water supplies directly to retail customers, primarily in San Francisco, and about two-thirds of its water supplies to wholesale customers by contractual agreement. The wholesale customers are largely represented by the Bay Area Water Supply and Conservation Agency (BAWSCA) shown in Figure 2-3 (SFPUC Water Service Area, San Francisco, and SFPUC Wholesale Customers)¹. Some of these wholesale customers have other sources of water in addition to what they receive from the regional water system, while others rely completely on the SFPUC for supply.

¹ The Cordilleras Mutual Water Association is also a wholesale customer receiving water from the SFPUC, but it is not a BAWSCA member and is not shown in Figure 2-3 (SFPUC Water Service Area, San Francisco, and SFPUC Wholesale Customers). It is a small water association serving 18 single-family homes located in San Mateo County.

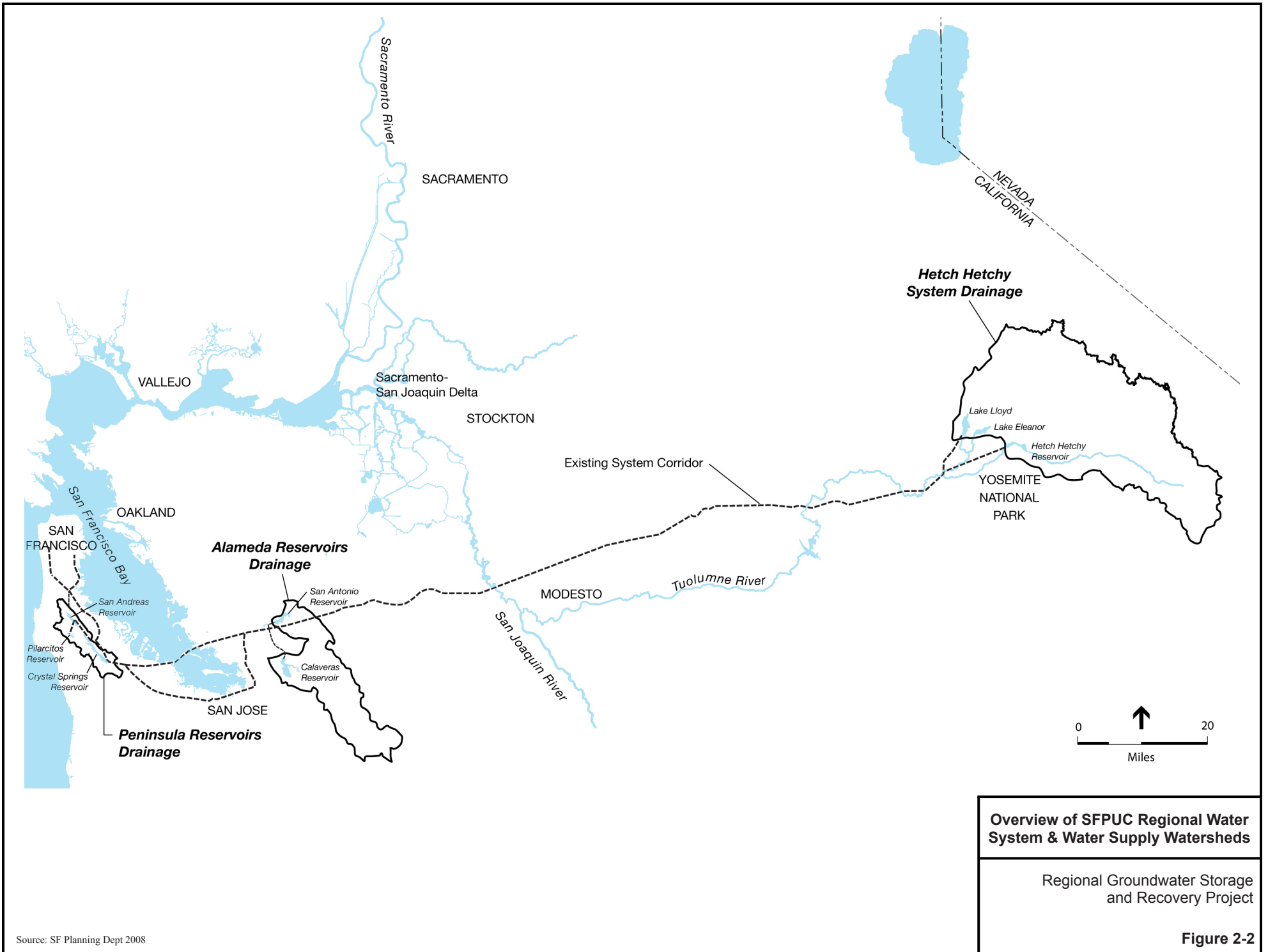

Source: SF Planning Dept 2008

Overview of SFPUC Regional Water System & Water Supply Watersheds

Regional Groundwater Storage and Recovery Project

Figure 2-2

This page left intentionally blank

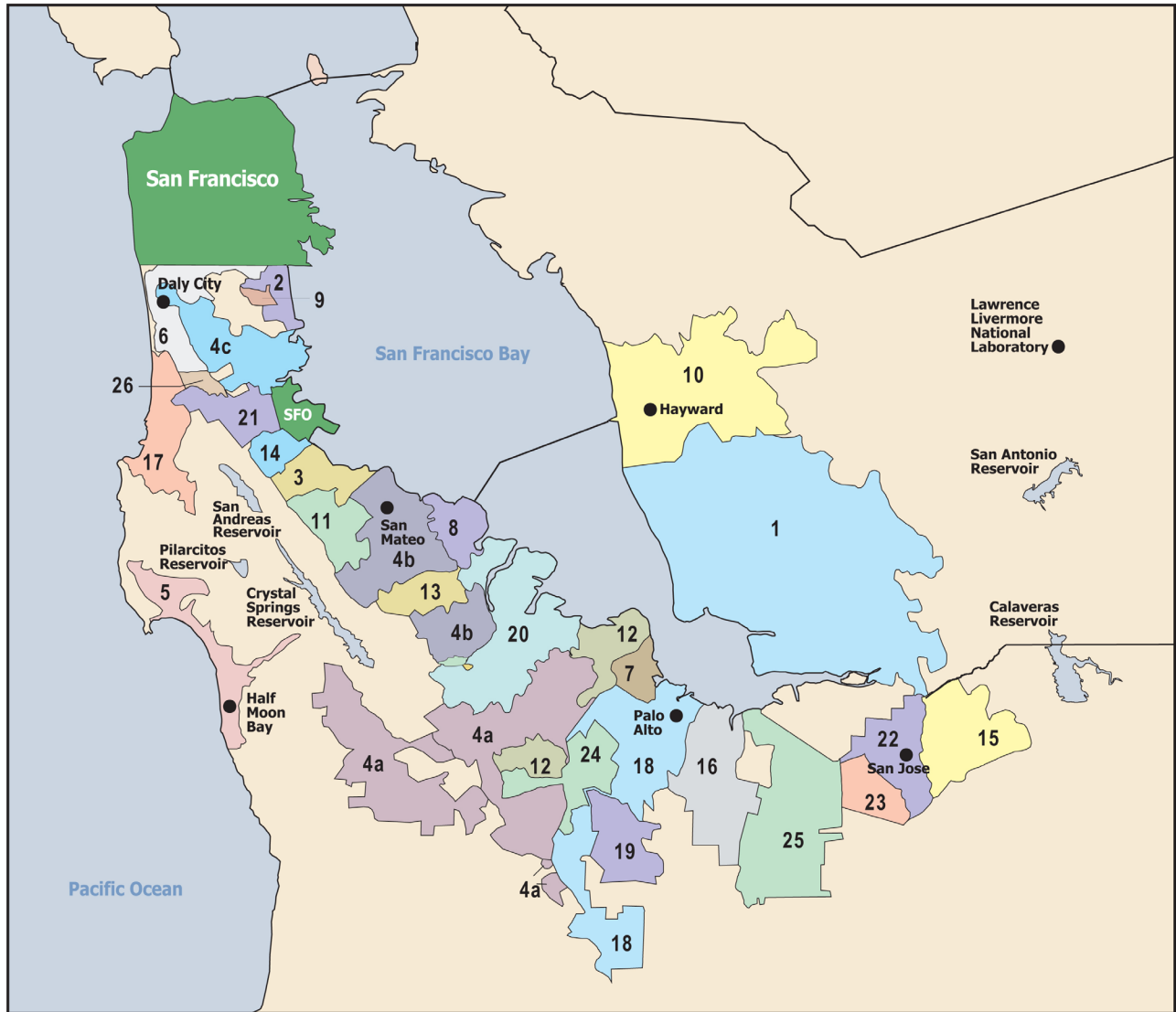

- | | |
|---|-----------------------------------|
| 1 Alameda County Water District | 14 City of Millbrae |
| 2 City of Brisbane | 15 City of Milpitas |
| 3 City of Burlingame | 16 City of Mountain View |
| 4a Cal Water Service Co. – Bear Gulch | 17 North Coast Water District |
| 4b Cal Water Service Co. – Mid-Peninsula | 18 City of Palo Alto |
| 4c Cal Water Service Co. – SSF | 19 Purissima Hills Water District |
| 5 Coastside County Water District | 20 City of Redwood City |
| 6 City of Daly City | 21 City of San Bruno |
| 7 East Palo Alto | 22 City of San Jose |
| 8 Estero Municipal Improvement District | 23 City of Santa Clara |
| 9 Guadalupe Valley Municipal Improvement District | 24 Stanford University |
| 10 City of Hayward | 25 City of Sunnyvale |
| 11 Town of Hillsborough | 26 Westborough Water District |
| 12 City of Menlo Park | |
| 13 Mid-Peninsula Water District | |

Note: CWS – California Water Service Company
 Portions of Coastside County Water District not served by the SFPUC
 Regional water system

**SFPUC Water Service Area
 San Francisco and SFPUC
 Wholesale Customers**

Regional Groundwater Storage
 and Recovery Project

2.2.2 SFPUC Water System Improvement Program

On October 30, 2008, the SFPUC adopted the WSIP (SFPUC 2008). The adopted WSIP aims to improve the regional water system with respect to water quality, seismic response, and water delivery based on a planning horizon through the year 2030. The WSIP also aims to improve the regional system with respect to water supply to meet water delivery needs in the service area through the year 2018. The proposed program area spans seven counties – Tuolumne, Stanislaus, San Joaquin, Alameda, Santa Clara, San Mateo, and San Francisco.

The WSIP includes a water supply strategy, modifications to system operations, and construction of a series of facility improvement projects. The proposed Project includes new groundwater facilities and would implement the WSIP water supply strategy during drought years. The overall goals of the WSIP are to maintain high-quality water; reduce vulnerability to earthquakes; increase delivery reliability and improve the ability to maintain the system; meet customer purchase requests in nondrought and drought periods; enhance sustainability in all system activities; and achieve a cost-effective, fully operational system (see Table 2-1 [WSIP Goals and Objectives]).

To further these program goals, the WSIP also includes objectives that address system performance in the areas of water quality, seismic reliability, delivery reliability, and water supply.

To address the potential environmental impacts of the WSIP, the San Francisco Planning Department prepared a Program EIR (PEIR), which was certified by the San Francisco Planning Commission on October 30, 2008 (San Francisco Planning Department 2008). The PEIR evaluated the environmental impacts of the WSIP's water supply component at a project-level of detail, as well as evaluating the environmental impacts of the WSIP's facility improvement projects at a program-level of detail. This EIR tiers from the PEIR; the analyses of the WSIP that are relevant to this Project are incorporated by reference into this EIR, as noted throughout the EIR. All WSIP-related impacts to which this Project contributes have been examined at a sufficient level of detail in the PEIR, enabling those effects to be mitigated or avoided through mitigation measures that are also imposed on this Project as part of the SFPUC's approval of the WSIP.

TABLE 2-1
WSIP Goals and Objectives

Program Goal	System Performance Objective
<i>Water Quality - maintain high quality water</i>	<ul style="list-style-type: none"> ● Design improvements to meet current and foreseeable future federal and State water quality requirements. ● Provide clean, unfiltered water originating from Hetch Hetchy Reservoir and filtered water from local watersheds. ● Continue to implement watershed protection measures.
<i>Seismic Reliability – reduce vulnerability to earthquakes</i>	<ul style="list-style-type: none"> ● Design improvements to meet current seismic standards. ● Deliver basic service to the three regions in the service area (East/South Bay, Peninsula, and San Francisco) within 24 hours after a major earthquake. Basic service is defined as average winter-month usage, and the performance objective for the regional system is 229 mgd. The performance objective is to provide delivery to at least 70 percent of the turnouts (i.e., water diversion connecting points from the regional system to customers) in each region, with 104, 44, and 81 mgd delivered to East/South Bay, Peninsula, and San Francisco regions, respectively. ● Restore facilities to meet average-day demand of up to 300 mgd within 30 days after a major earthquake.
<i>Delivery Reliability – increase delivery reliability and improve the ability to maintain the system</i>	<ul style="list-style-type: none"> ● Provide operational flexibility to allow planned maintenance shutdown of individual facilities without interrupting customer service. ● Provide operational flexibility to minimize the risk of service interruption due to unplanned facility upsets or outages. ● Provide operational flexibility and system capacity to replenish local reservoirs as needed. ● Meet estimated average annual demand of up to 300 mgd under the conditions of one planned shutdown of a major facility for maintenance concurrent with one unplanned facility outage due to a natural disaster, emergency, or facility failure/upset.
<i>Water Supply – meet customer water needs in non-drought and drought periods</i>	<ul style="list-style-type: none"> ● Meet average annual water demand of 265 mgd from the SFPUC watersheds for retail and wholesale customers during non-drought years for system demands through 2018. ● Meet dry-year delivery needs through 2018 while limiting rationing to a maximum 20 percent systemwide reduction in water service during extended droughts. ● Diversify water supply options during non-drought and drought periods. ● Improve use of new water sources and drought management, including groundwater, recycled water, conservation, and transfers.

TABLE 2-1
WSIP Goals and Objectives

Program Goal	System Performance Objective
Sustainability – <i>enhance sustainability in all system activities</i>	<ul style="list-style-type: none"> • Manage natural resources and physical systems to protect watershed ecosystems. • Meet, at a minimum, all current and anticipated legal requirements for protection of fish and wildlife habitat. • Manage natural resources and physical systems to protect public health and safety.
Cost-effectiveness – <i>achieve a cost-effective, fully operational system</i>	<ul style="list-style-type: none"> • Ensure cost-effective use of funds. • Maintain gravity-driven system. • Implement regular inspection and maintenance program for all facilities.

Source: SFPUC 2008

2.2.3 Relation of the Project to Regional Water System Facilities and Partner Agencies' Water Supply and Distribution Facilities

The proposed Project would be located in northern San Mateo County. Under the Project, the SFPUC would construct well facilities in the South Westside Groundwater Basin, together with water treatment systems and connections to existing water distribution systems. These new well facilities would be in addition to the existing well and water distribution facilities that are currently operated in northern San Mateo County by the Partner Agencies. The Partner Agencies currently pump groundwater from their facilities to meet a portion of their potable demand; the remainder of their potable supply comes through existing local connections to the regional water system.

Under the Project, the SFPUC would supply the Partner Agencies with supplemental water from the regional water system during normal and wet years to reduce the Partner Agencies' need to pump groundwater. This reduction in pumping would allow the aquifer to recharge naturally. During dry years, the Partner Agencies would return to pumping groundwater from their existing wells. The SFPUC and the Partner Agencies would operate and maintain Project facilities connected to their respective water distribution systems. These existing distribution systems are located and sized appropriately to accommodate the additional groundwater that would be produced as part of the proposed Project. This new dry-year water supply would be made available to both the Partner Agencies and to certain SFPUC retail customers and other wholesale customers, as well as to retail customers in San Francisco, thereby increasing the available surface water supply to all regional water system customers.

Refer to Chapter 3, Project Description Section 3.3 (Existing Groundwater Use in the Westside Groundwater Basin), for a summary of existing groundwater use by the Partner Agencies, cemeteries, and golf clubs overlying the groundwater basin.

2.2.4 Relation to Other WSIP Projects and Local Groundwater Management Plan

In addition to the GSR Project, there are other projects that are part of the larger WSIP proposed in the Westside Groundwater Basin: the San Francisco Groundwater Supply Project, the Harding Park Recycled Water Project, the San Francisco Westside Recycled Water Project, and the Lake Merced Water Levels Restoration Project.

The San Francisco Groundwater Supply Project would provide an average of 4 mgd of groundwater to San Francisco's municipal supply. The Draft EIR for the San Francisco Groundwater Supply Project was published for public review on March 13, 2013 (San Francisco Planning Department 2013). Groundwater for that project would be pumped from the North Westside Groundwater Basin, whereas the GSR Project wells would be located in the South Westside Groundwater Basin². Also, the purpose of the GSR Project is to provide a dry-year water supply, whereas the San Francisco Groundwater Supply Project would operate during normal and wet years, as well as dry years. More detail regarding the purpose of the proposed GSR Project is provided in Chapter 3, Project Description, Section 3.2 (Project Goals and Objectives).

The Harding Park Recycled Water Project currently provides 1.3 mgd of recycled water for irrigation purposes and the San Francisco Westside Recycled Water Project would provide 2.8 mgd of recycled water for irrigation purposes, thus reducing demand on potable water supplies. Some of the properties proposed for irrigation with recycled water are located on lands overlying the Westside Groundwater Basin. The Harding Park Recycled Water Project EIR was certified by the City of Daly City in 2009 (Daly City 2009); the project is operational. A Revised Notice of Preparation for the San Francisco Westside Recycled Water Project was released in 2010 (San Francisco Planning Department 2010).

The Lake Merced Water Levels Restoration Project is located within the Westside Groundwater Basin. The purpose of the project is to provide a supplemental source of water, such as treated stormwater, to address raising the level of Lake Merced in San Francisco. Since approval of the WSIP, the City of Daly City has studied the viability of a Vista Grande Drainage Basin Improvement Project, which is a separate project intended to reduce or eliminate flooding in the Vista Grande watershed, reduce erosion along Lake Merced, and provide other benefits such as habitat enhancement and lake level augmentation at Lake Merced. Daly City identified several potential alternatives to manage stormwater flows in the Vista Grande Stormwater Basin in order to reduce flooding from the Vista Grande Drainage Canal, as shown in their *Draft Vista Grande Drainage Basin Alternatives Analysis Report Executive Summary* (Daly City 2011). The Alternatives Analysis Report recommended the South Lake Merced Alternative, which proposes to divert stormwater flow from the Vista Grande Drainage Canal to Lake Merced. Daly City is proceeding with

² The Westside Groundwater Basin has been administratively divided at the San Francisco County-San Mateo County line. The portion of the basin that lies within San Francisco County is referred to as the North Westside Groundwater Basin. The portion of the basin that lies within San Mateo County is referred to as the South Westside Groundwater Basin. The terms are not intended to imply physical boundary.

CEQA environmental review of this alternative, along with the National Park Service as lead agency under the National Environmental Policy Act. The Notice of Preparation/Notice of Intent to Prepare a Joint EIR/EIS for the Vista Grande Drainage Basin Improvement Project was issued on February 28, 2013 (Daly City 2013). The Draft EIR/EIS is anticipated to be published in late 2013. The SFPUC is cooperating with Daly City on the Vista Grande Drainage Basin Improvement Project and is not pursuing the Lake Merced Water Levels Restoration Project independently at this time, because the Vista Grande Drainage Basin Improvement Project, if approved, would accomplish substantially similar goals for better managing Lake Merced water levels, thereby achieving the purpose of the Lake Merced Water Levels Restoration Project.

The City of San Bruno recently adopted the *South Westside Basin Groundwater Management Plan (GWMP)*, and the GWMP was accepted by Cal Water in July 2012 (San Bruno et al. 2012). The goal of the GWMP is to ensure a sustainable, high quality, reliable water supply at a fair price for beneficial uses achieved through local groundwater management. The GWMP defines the Basin management objectives, which are intended to maintain or enhance long-term groundwater levels and quality, and minimize land subsidence, along with actions to be taken to accomplish these management goals. The basic management objectives are defined through management areas and sub-areas, public input, monitoring, adaptive management and enforcement. The GSR Project seeks to support the GWMP by providing a conjunctive use project that would increase the volume of groundwater in storage through a reduction in groundwater pumping by the Partner Agencies made possible by increased surface water deliveries from the regional water system in normal and wet years. The GSR Project would help meet a goal of the GWMP to ensure a sustainable, high-quality, reliable water supply at a fair price for beneficial uses achieved through local groundwater management.

The Groundwater Storage element of the GWMP includes measures that could be considered to mitigate groundwater overdraft conditions, although the South Westside Groundwater Basin is not currently considered to be in a state of overdraft. The GWMP includes identification of actions to be implemented in the event that groundwater level monitoring indicates that the South Westside Groundwater Basin is in overdraft conditions, and it includes a local conjunctive use project in the South Westside Groundwater Basin as one of the management actions. Actions also include consideration of the development, implementation, and maintenance of programs and projects to recharge aquifers and the support of regional groundwater banking operations that would be beneficial to the South Westside Basin and the region. As noted in the GWMP, conjunctive use would likely take the form of an in-lieu recharge project where imported water or recycled water would replace groundwater use to offset future groundwater pumping during times of reduced imported water supplies.

2.3 PURPOSE OF THIS EIR

The San Francisco Planning Department is the lead agency for implementation of CEQA for all projects sponsored by the CCSF or conducted within San Francisco. The Environmental Planning Division (EP) of the San Francisco Planning Department has prepared this EIR for the SFPUC's proposed Project. The purpose of the EIR is to provide information about any potentially significant adverse environmental effects of the proposed Project, to identify reasonable and feasible methods to minimize any potentially

significant adverse effects, and to describe and analyze feasible alternatives to the proposed Project. The EIR has been prepared as a project EIR in compliance with CEQA Guidelines Section 15161. The EIR tiers from the PEIR for the WSIP, which was certified by the San Francisco Planning Commission on October 30, 2008 (San Francisco Planning Department 2008). The analyses of the WSIP that are relevant to this Project are incorporated by reference into this EIR.

2.3.1 Draft EIR

This Draft EIR is a public information document for use by governmental agencies and the public. This Draft EIR will be circulated for public review, with hearings held to solicit comments from the public and governmental agencies on the environmental analysis and completeness of information presented in this Draft EIR (refer to Section 2.4 [Public Review]).

2.3.2 Responses to Comments and Final EIR

Following the public review and comment period, EP will prepare responses to the written and verbal comments received from the public and governmental agencies. The Draft EIR will be revised, as appropriate and, together with the Response to Comments document, will constitute the Final EIR. The Response to Comments document will be distributed to all commenters and individuals requesting a copy. The San Francisco Planning Commission will then consider EIR certification (CEQA Guidelines Section 15090) during a public hearing. Once certified, the EIR will serve as a source of information to assist the SFPUC in determining whether to approve the proposed Project. CEQA also requires the adoption of findings prior to approval of a Project where a certified EIR identifies significant environmental effects that would be caused by the Project (CEQA Guidelines Sections 15091 and 15092).

2.4 PUBLIC REVIEW

2.4.1 Scoping Process

The process of determining the appropriate scope, focus, and content of an EIR is known as “scoping.” As the first step in the scoping process, the San Francisco Planning Department published a *Notice of Preparation of an Environmental Impact Report* (NOP) on June 24, 2009, announcing the anticipated preparation of a Draft EIR for the GSR Project. The scoping period began on June 24, 2009, with the issuance of the NOP and written comments on the NOP were accepted through July 28, 2009. The NOP summarized the goals, objectives, and elements of the Project. It also presented the San Francisco Planning Department’s determination that the Project may have significant effects on the environment and that an EIR must be prepared. The NOP also described the EIR scoping process and provided information on a public scoping meeting. The scoping process, notification procedures, and outcome of the scoping meeting are described below. The NOP is included in Appendix A of this EIR.

In accordance with CEQA Guidelines, Section 15083, the San Francisco Planning Department held a public scoping meeting on July 9, 2009, to solicit input from governmental agencies and the public to assist the Department in determining the appropriate scope and focus of the Project’s environmental

impact analysis and information to be contained in the EIR, including mitigation measures, and potential alternatives to the Project. The meeting was held at the South San Francisco Municipal Services Building in South San Francisco and was attended by approximately 33 individuals.

Notices of the public scoping meeting were placed in local newspapers to inform the general public of the meeting. Additionally, the San Francisco Planning Department sent the NOP, including the scoping meeting notice, to approximately 1,500 interested parties, including landowners and tenants within 300 feet of proposed Project facilities, and 32 public agencies. The meeting included a presentation on the scope of the Project and the environmental review process, followed by public comment.

A *Scoping Summary Memorandum* (included in Appendix B) was prepared to summarize the scoping process, notification procedures, outcome of the scoping meeting and comments received. A transcript of the scoping meeting is included in the *Scoping Summary Memorandum*.

2.4.2 Public and Agency Comments on the NOP

Verbal comments were received from six individuals at the scoping meeting. During the 35-day scoping period, comment letters were received from nine individuals and organizations and eight comment letters were received from State, regional, and local agencies. One letter was received after the close of the scoping period and also was considered in preparing this EIR. The *Scoping Summary Memorandum* contains a record of the comments received.

The environmental concerns raised during the scoping period are summarized in Table 2-2 (Summary of Scoping Comments), which also references the section in this Draft EIR where the concerns are addressed.

TABLE 2-2
Summary of Scoping Comments

Environmental Concerns Raised during Scoping	Section where Concern is Addressed in this EIR
Details of operation strategy	Chapter 3, Project Description, Section 3.8 (Operations and Maintenance)
Construction-related traffic and site access during construction	Section 5.6, Transportation and Circulation
Impacts of climate change	Section 5.9, Greenhouse Gas Emissions Section 5.16, Hydrology and Water Quality
Describe groundwater use by irrigators, including future needs	Section 5.16, Hydrology and Water Quality
Ground settlement or subsidence	Section 5.16, Hydrology and Water Quality
Aquifer recharge	Section 5.16, Hydrology and Water Quality
Damage to private wells and long-term productivity	Section 5.16, Hydrology and Water Quality
Mobilization of contaminants in the groundwater	Section 5.16, Hydrology and Water Quality
Impacts to the water level at Lake Merced	Section 5.16, Hydrology and Water Quality
Impacts to quality of potable water	Section 5.16, Hydrology and Water Quality

2.4.3 Draft EIR Public Review

2.4.3.1 *Public Review*

Publication of this Draft EIR marks the beginning of a 45-day public review period, from April 10, 2013 to May 28, 2013. Written comments may be directed to the following address until close of business (5:00 p.m.) on May 28, 2013.

San Francisco Planning Department
 Attn: Sarah Jones, AICP, Acting Environmental Review Officer
 GSR Project Draft EIR
 1650 Mission Street, Suite 400
 San Francisco, CA 94103

By facsimile to: (415) 558-6409

By email to: timothy.johnston@sfgov.org

This Draft EIR is available on the Planning Department website at <http://www.sf-planning.org/index.aspx?page=1829>.

Hard copies of the Draft EIR are also available for public review at the following locations:

San Francisco Planning Department
 1650 Mission Street, 1st Floor
 Planning Information Counter
 San Francisco, CA 94103

South San Francisco Library
 840 West Orange Street
 South San Francisco, CA 94080

San Francisco Public Library
 100 Larkin Street
 San Francisco, CA 94103

San Mateo Public Library
 55 West 3rd Street
 San Mateo, CA 94044

Daly City Public Library
 40 Wembley Drive
 Daly City, CA 94015

San Bruno Public Library
 701 Angus Avenue West
 San Bruno, CA 94066

Westlake Library
 275 Southgate Avenue
 Daly City, CA 94015

Millbrae Public Library
 1 Library Avenue
 Millbrae, CA 94030

Colma Town Hall
 1198 El Camino Real
 Colma, CA 94014

2.4.3.2 *Public Hearings*

Public hearings on the Draft EIR to accept written or verbal comments are scheduled as follows.

Tuesday, May 14, 2013 at 6:30 p.m.
 South San Francisco Municipal Services Building
 Community Room
 33 Arroyo Drive
 South San Francisco, California

Thursday, May 16, 2013 at 12:00 p.m. or later
 San Francisco Planning Commission
 City Hall, 1 Dr. Carleton B. Goodlett Place
 Commission Chambers, Room 400
 San Francisco, CA 94102
 (Call 415-558-6422 the week of the hearing for more specific hearing time.)

2.5 ORGANIZATION OF THE DRAFT EIR

The Draft EIR consists of three volumes. Volume 1 contains Chapters 1 through Chapter 5, Section 5.5. Volume 2 contains Chapter 5, Section 5.6 through Chapter 8, and Volume 3 contains the appendices. The organization of the Draft EIR is as follows:

- Chapter 1 provides an **Executive Summary** of the Draft EIR. The executive summary includes a brief description of the Project and summarizes construction and operational impacts that the Project would have on environmental resources, along with mitigation measures to reduce those impacts, where feasible. Significant unavoidable impacts of the Project are also identified. Alternatives that would reduce or avoid the significant environmental impacts of the Project are briefly described and the impacts they would have are compared to the significant impacts of the Project. Areas of controversy are identified.
- Chapter 2, **Introduction and Background**, provides project background information and describes the environmental review process and the organization of the EIR.
- Chapter 3 provides the **Project Description**, including all Project components (both construction and operational phases) and provides a list of permits and approvals that are anticipated for the Project.
- Chapter 4, **Plans and Policies**, describes the Project's consistency with relevant land use plans and policies.
- Chapter 5, **Environmental Setting, Impacts, and Mitigation Measures**, describes existing resources in the Project area, describes the environmental regulations and policies applicable to the Project, identifies impact significance criteria and identifies and analyzes potential impacts of the Project. Mitigation Measures for significant impacts are also identified. Chapter 5 is broken down into the following resource area sections:

- Land Use (Section 5.2)
 - Aesthetics (Section 5.3)
 - Population and Housing (Section 5.4)
 - Cultural and Paleontological Resources (Section 5.5)
 - Transportation and Circulation (Section 5.6)
 - Noise and Vibration (Section 5.7)
 - Air Quality (Section 5.8)
 - Greenhouse Gas Emissions (Section 5.9)
 - Wind and Shadow (Section 5.10)
 - Recreation (Section 5.11)
 - Utilities and Service Systems (Section 5.12)
 - Public Services (Section 5.13)
 - Biological Resources (Section 5.14)
 - Geology and Soils (Section 5.15)
 - Hydrology and Water Quality (Section 5.16)
 - Hazards and Hazardous Materials (Section 5.17)
 - Mineral and Energy Resources (Section 5.18)
 - Agriculture and Forest Resources (Section 5.19)
- Chapter 6, **Other CEQA Issues**, discusses areas of controversy, growth inducement, cumulative impacts, significant environmental effects that cannot be avoided if the Project is implemented, and describes the significant irreversible effects associated with the Project.
 - Chapter 7, **Alternatives**, describes the alternatives to the Project and compares their impacts to those of the proposed Project. This chapter also summarizes alternatives that were considered but screened from further analysis.
 - Chapter 8 lists the **EIR Authors and Consultants**.
 - Appendices provide information in support of the above chapters and have been bound separately in Volume 3. The appendices are:
 - A. Notice of Preparation
 - B. Scoping Summary Memorandum
 - C. Summary of Impacts Table
 - D. WSIP PEIR Water Supply Impact and Mitigation and Consistency
 - E. GSR Final Air Quality Technical Report
 - F. Special-status Species Tables
 - G. Geotechnical Reports
 - H. Groundwater Technical Reports
 - I. Calculations for GSR Energy Use Impacts
 - J. Lake Merced Vegetation Change Analysis Methodology
 - K. Lake Merced Water Quality Data and Graphs

2.6 REFERENCES

- Bay Area Water Supply & Conservation Agency (BAWSCA). 2012. *BAWSCA Members Map*. Website accessed on February 2, 2013 at: http://bawasca.org/docs/Member_Map.pdf.
- Daly City, City of. 2009. *Harding Park Recycled Water Project EIR*. July.
- Daly City, City of. 2011. *Vista Grande Drainage Basin Alternatives Analysis Report Project Executive Summary (Draft)*. Prepared by Jacobs Associates. February 7.
- Daly City, City of. 2013. *Notice of Preparation/Notice of Intent to Prepare a Joint EIR/EIS for the Vista Grande Drainage Basin Improvement Project*. February 28.
- San Bruno, California Water Service Company, City of Daly City, and San Francisco Public Utilities Commission. 2012. *South Westside Basin Groundwater Management Plan*. Prepared by WRIME. July.
- San Francisco Planning Department. 2008. *Final Program Environmental Impact Report on the San Francisco Public Utilities Commission's Water System Improvement Program*, San Francisco Planning Department File No. 2005.0159E; State Clearinghouse No. 2005092026. October.
- San Francisco Planning Department. 2010. *Revised Notice of Preparation of an Environmental Impact Report on the San Francisco Westside Recycled Water Project*.
- San Francisco Planning Department. 2013. *Draft Environmental Impact Report on the San Francisco Groundwater Supply Project*. March.
- San Francisco Public Utilities Commission (SFPUC). 2008. *Resolution 08-0200, Water System Improvement Program California Environmental Quality Act Findings: Findings of Fact, Evaluation of Mitigation Measures and Alternatives, and Statement of Overriding Considerations*. October.
- San Mateo County. 2010. *Water Supply GIS Data*. Received April 13, 2012.

3 PROJECT DESCRIPTION

Sections		Tables	
3.1	Project Location	3-1	Estimated Existing Groundwater Use in the Westside Groundwater Basin
3.2	Project Goals and Objectives		
3.3	Existing Groundwater Use in the Westside Groundwater Basin	3-2	Facility Site Names and Locations
		3-3	Site-specific Facility Characteristics
3.4	Proposed Project	3-4	Maximum Volume of Chemical Storage
3.5	Project Construction	3-5	Pipeline Lengths by Facility Site
3.6	SFPUC Standard Construction Measures	3-6	Electrical Energy Demand for Facility Sites during Dry Years
3.7	Greenhouse Gas Reduction Actions		
3.8	Operations and Maintenance	3-7	Facility Construction Clusters and Construction Sequencing
3.9	Required Permits and Approvals		
3.10	Property Rights Acquisition	3-8	Estimated Daily Worker and Construction Equipment Trips for Wells and Well Facilities Construction
3.11	References	3-9	Construction Area Size and Characteristics
		3-10	Construction Soil Material Haul Amounts and Anticipated Haul Truck Trips
		3-11	Regulatory/Permitting Agencies/Utility
		3-12	Property Rights Proposed for Acquisition
		3-13	Anticipated Property Rights Requirements

3.1 PROJECT LOCATION

The proposed Groundwater Storage and Recovery (GSR) Project (proposed Project or Project) would be located in northern San Mateo County, overlying the southern portion of the Westside Groundwater Basin, as shown in Figure 2-1 (Project Vicinity Map), in Chapter 2, Introduction and Background.

The Project would be located within the water service areas for the cities of Daly City and San Bruno, as well as the California Water Service Company (Cal Water), which includes portions of South San Francisco, Colma, and unincorporated San Mateo County. These water providers are referred to herein as “Partner Agencies” for this Project. Groundwater production well facilities would be constructed and owned by the San Francisco Public Utilities Commission (SFPUC) in the cities of Daly City, Colma, South San Francisco, San Bruno, Millbrae, and unincorporated San Mateo County. Well facilities would be connected to existing water distribution pipelines owned by the Partner Agencies and the SFPUC. The SFPUC and the Partner Agencies would operate and maintain proposed well facilities connected to their respective water systems. Existing Partner Agency wells all are located within San Mateo County.

3.2 PROJECT GOALS AND OBJECTIVES

As described in Chapter 2, Introduction and Background, the proposed Project is part of the SFPUC's Water System Improvement Program (WSIP). The overall WSIP goals (refer to Table 2-1 [WSIP Goals and Objectives]) for the regional water system include:

- Maintain high-quality water;
- Reduce vulnerability to earthquakes;
- Increase water delivery reliability;
- Meet customer water supply needs;
- Enhance sustainability; and
- Achieve a cost-effective, fully operational system.

The proposed Project would help achieve the WSIP goals because it would provide dry-year supply to increase water delivery reliability and meet customer water supply needs. In addition, the Project would provide increased regional operational flexibility to respond and restore water service during unplanned outages and/or a loss of a water source. Without the Project, the SFPUC could not meet its goals for dry-year delivery reliability (incorporated by reference from the WSIP Program Environmental Impact Report [PEIR]) (San Francisco Planning Department 2008; SFPUC 2008).

The proposed Project would increase the volume of groundwater in storage by allowing the South Westside Groundwater Basin to recharge naturally during normal and wet years. The increased volume of groundwater in storage would occur through a reduction in groundwater pumping by the Partner Agencies; this reduction in groundwater pumping would be made possible by increased surface water deliveries to the Partner Agencies from the regional water system in those years. This "conjunctive" or cooperative use of the basin would allow the SFPUC and Partner Agencies to pump the naturally accumulated and stored water during dry years.

The SFPUC measures water supply reliability using an 8.5-year "design drought." A design drought is a planning and operations tool used by water agencies to define a reasonable worst-case drought scenario in order to establish design and operating parameters for the water system. The WSIP uses a design drought based on the hydrology of the six years of the worst historical drought (1987-1992) on record, plus the 2.5 years of the 1976-1977 drought, for a combined total of an 8.5-year design drought sequence. The proposed Operating Agreement between the SFPUC and Partner Agencies (see Section 3.8.1 [Operating Agreement]) contemplates use of the dry-year supplies made available by the Project starting in the second year of the design drought. Therefore, the estimated 60,500 af of new groundwater storage is assumed to be used over 7.5 years of the design drought, operating at a maximum average annual capacity of 7.2 million gallons per day (mgd).

The primary goal for the Project is to provide an additional dry-year water supply. Specific objectives of the Project are to:

- Conjunctively manage the South Westside Groundwater Basin through the coordinated use of SFPUC surface water and groundwater pumped by the Partner Agencies;
- Provide supplemental SFPUC surface water to the Partner Agencies in normal and wet years, with a corresponding reduction of groundwater pumping by these agencies, which then allows for in-lieu recharge of the South Westside Groundwater Basin;
- Increase the dry-year and emergency pumping capacity of the South Westside Groundwater Basin by an average annual 7.2 mgd; and
- Provide a new dry-year groundwater supply for SFPUC customers and increase water supply reliability during the 8.5-year design drought cycle.

3.3 EXISTING GROUNDWATER USE IN THE WESTSIDE GROUNDWATER BASIN

The Westside Groundwater Basin extends from western San Francisco south into San Mateo County. The Basin has an area of approximately 40 square miles and underlies portions of San Francisco, Daly City, Colma, South San Francisco, San Bruno, Millbrae, and Burlingame. The Westside Groundwater Basin has been administratively divided at the San Francisco-San Mateo County line. Although this is not a physical boundary, there are differences in conditions between the northern and southern portions of the Westside Groundwater Basin. The chief distinction is related to groundwater levels. In the northern portion of the Basin, groundwater levels are generally above sea level and groundwater flow is primarily westerly to the ocean, except near Lake Merced, where the flow is to the south. However, decades of groundwater pumping in the southern portion of the Basin have lowered groundwater levels to between 15 and 195 feet below sea level, effectively freeing up vacated aquifer storage space that could be used for the proposed conjunctive use of the Basin (LSCE 2010). The northern portion of the Basin that lies within San Francisco County is referred to in this EIR as the North Westside Groundwater Basin. Likewise, the southern portion of the Basin that lies within San Mateo County is referred to herein as the South Westside Groundwater Basin.

In the North Westside Groundwater Basin, groundwater is extracted for the purpose of irrigation (e.g., in Golden Gate Park and the San Francisco Zoo) and for augmentation of lakes (e.g., Pine Lake in Stern Grove and Golden Gate Park lakes). In the South Westside Groundwater Basin, groundwater is extracted for the purpose of municipal use (by the Partner Agencies) and irrigation at cemeteries, golf clubs, and residences. Table 3-1 (Estimated Existing Groundwater Use in the Westside Groundwater Basin) indicates the estimated existing groundwater use in the Basin.

TABLE 3-1
Estimated Existing Groundwater Use in the Westside Groundwater Basin

Type of Groundwater Use	Estimated Use (mgd)		
	North Westside Groundwater Basin	South Westside Groundwater Basin	Total
Municipal use for potable water	0	6.84 ^(a)	6.84
Irrigation and other non-potable uses ^(b)	1.51	1.39	2.90
Total	1.51	8.23	9.74

Notes:

- (a) Existing municipal groundwater pumping is estimated as the median of Partner Agencies' pumping for the period from 1959 to 2009 (SFPUC 2011); municipal pumping varies from year to year.
- (b) Taken from s/Jenks 2012; irrigation and lake augmentation pumping varies from year to year.

3.4 PROPOSED PROJECT

The proposed Project consists of groundwater storage and recovery in the South Westside Groundwater Basin, including the operation of groundwater production wells and associated distribution and treatment facilities. As summarized below, an Operating Agreement between the SFPUC and the Partner Agencies (see Section 3.8.1 [Operating Agreement]) would guide overall groundwater and surface water deliveries associated with the proposed Project. This section includes a description of these proposed Project components¹.

3.4.1 Groundwater Storage and Recovery

The SFPUC supplies surface water to the Partner Agencies from its regional water system. The Partner Agencies currently supply potable water to their retail customers through a combination of groundwater from the South Westside Groundwater Basin and purchase of SFPUC surface water. The proposed Project would provide supplemental SFPUC surface water to the Partner Agencies during normal and wet years. During these years, the Partner Agencies would reduce their groundwater pumping by a comparable amount to increase the amount of groundwater in storage through natural, or in-lieu, recharge.

During normal and wet years, the volume of groundwater in the South Westside Groundwater Basin would increase due to natural recharge and reduced groundwater pumping by the Partner Agencies, eventually reaching an increased storage volume of up to 60,500 af (about 20 billion gallons). During dry

¹ Much of the information in this chapter regarding the location and design of the well facility sites and routine operating strategies is based on information contained in the Final Alternatives Analysis Report, Groundwater Conjunctive Use Project (MWH 2007) or the Groundwater Conjunctive Use Project Conceptual Engineering Report (MWH et al. 2008).

years, the Partner Agencies and the SFPUC would pump the stored groundwater as needed to supplement other supplies. This new dry-year water supply would thereby increase the available water supply to all regional water system customers.

As part of the Project, an Operating Agreement would be implemented by the SFPUC and the Partner Agencies to guide the conjunctive use of groundwater and surface water. Specifically, the agreement would address:

- Water accounting;
- Ownership principles;
- The operation, maintenance, and replacement of well facilities;
- Levels of groundwater pumping and provision of supplemental surface water; and
- The allocation of costs.

The Operating Agreement is further discussed later in this chapter in Section 3.8.1 (Operating Agreement).

The identification of a dry year for the purpose of initiating groundwater pumping under the Project would be based upon whether or not a water shortage has been identified for a given fiscal year during the SFPUC's annual determination of the supply of water available to the regional water system under its Water Shortage Allocation Plan (WSA)². This identification would be made as part of the SFPUC's annual April 15 estimate of water supply available to the regional water system, with shortage allocations taking effect on July 1st, the start of the fiscal year. As a result of this timing, Project pumping would not occur until the second year of a drought. Approximately 20 percent of years are projected to be dry years when the Project would be in groundwater recovery mode (SFPUC 2009b).

Figure 3-1 (Groundwater Storage and Recovery Schematic Diagram) provides a schematic diagram of how groundwater storage and recovery typically operates. The figure illustrates the increase in groundwater storage expected from a reduction in pumping when supplemental water is delivered, as well as the decrease in groundwater storage projected from an increase in pumping during dry years.

Figure 3-2 (Source of Proposed Water Supply for Partner Agencies) illustrates how the Project would change the source of water supply for the Partner Agencies. During normal and wet years, the portion of water supply coming from the SFPUC to the Partner Agencies would increase compared to the existing

² In the July 2009 Water Shortage Allocation Plan (WSA), the SFPUC and its wholesale customers adopted a plan to allocate water between retail and wholesale customers during system wide shortages of 20 percent or less. The specific amount of rationing required by each wholesale customer, including the Partner Agencies, is determined either by agreement of the wholesale customers themselves or, in the absence of such agreement, by the SFPUC after discussion with the wholesale customers.

condition because the Partner Agencies would limit their pumping during these years. During dry years, the portion of water supply coming from groundwater would increase.

The “Groundwater from the GSR Well Facilities” on Figure 3-2 would be piped to each Partner Agency’s distribution system and the SFPUC Regional Transmission System. The SFPUC Regional Distribution System downstream of the GSR Wells would thus have a blend of surface water and groundwater during dry years that would be delivered to the City of Brisbane, the Guadalupe Valley Municipal Improvement District, the City of San Francisco, San Francisco International Airport, and possibly the City of Millbrae.

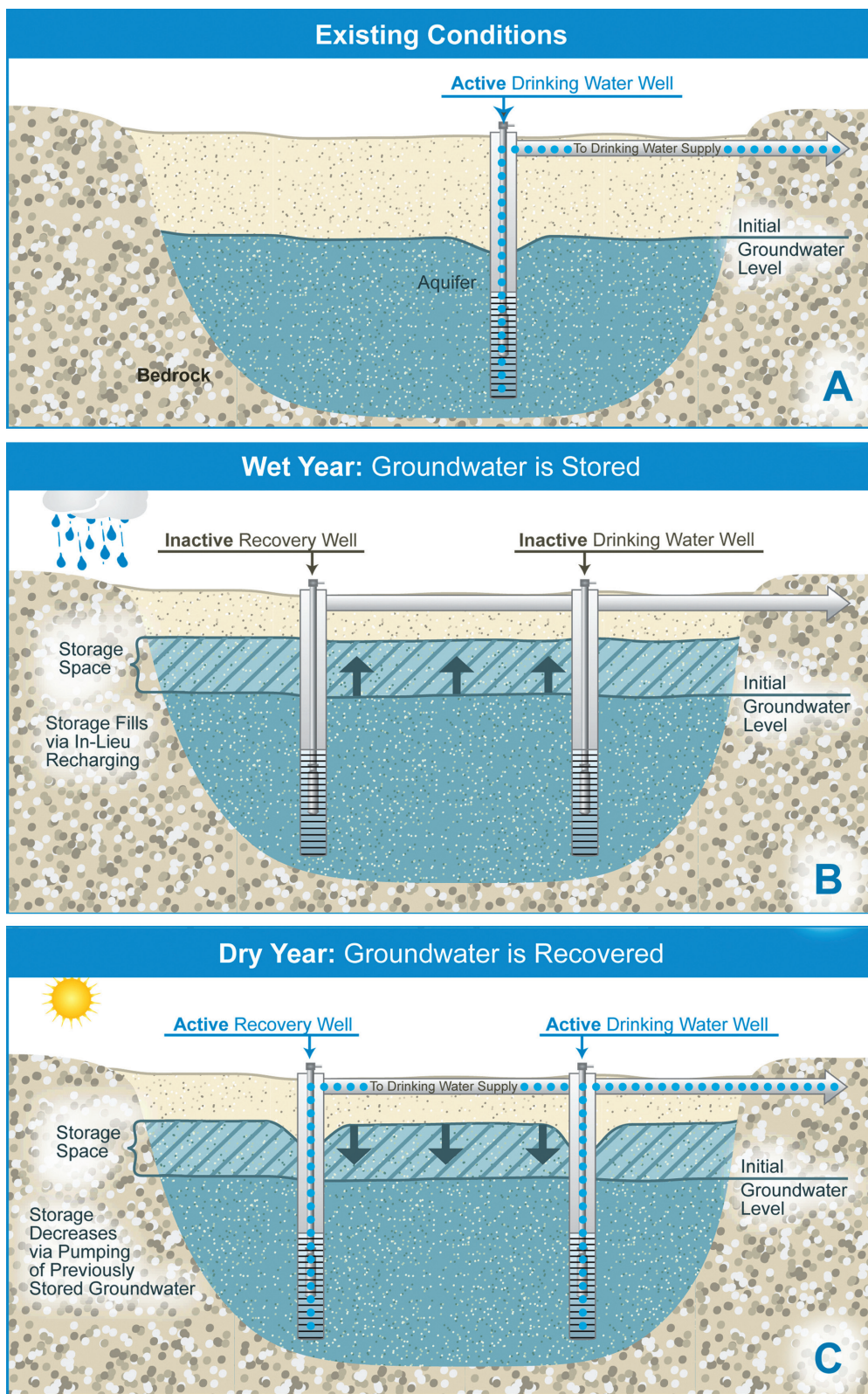
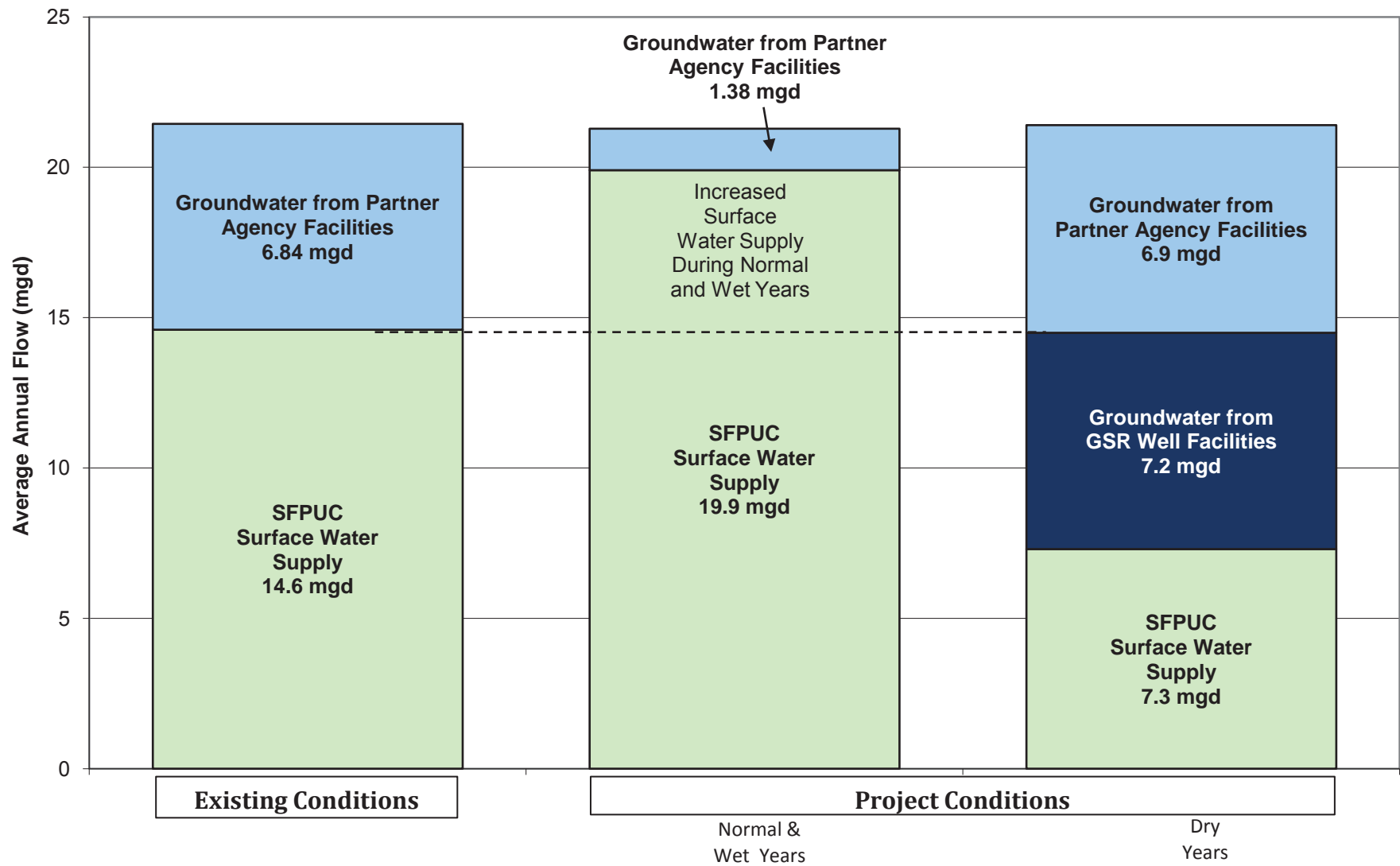

Figure (A) reflects the existing groundwater conditions, showing available storage space above the aquifer. In (B) the upward arrows represent the filling of the storage space with groundwater during wet years; in (C) the downward arrows represent the decline in stored water during dry years. The “Drinking Water Wells” represent the existing wells operated by the Cities of San Bruno and Daly City and California Water Service Company. The “Recovery Wells” represent the new wells that are proposed as part of the Project.

Groundwater Storage and Recovery Schematic Diagram
Regional Groundwater Storage and Recovery Project
Figure 3-1

This page left intentionally blank



- Groundwater from Partner Agency Facilities^{1,2,3}
- Groundwater GSR Well Facilities³
- SFPUC Surface Water Supply

¹ Groundwater from Partner Agency facilities during normal and wet years could vary from 1.38 mgd to 1.9 mgd.

² Partner Agency water supply facilities that are operated by the City of Daly City, City of San Bruno, and Cal Water.

³ The specific volumes shown are based on historic rainfall and hydrology records, but actual volumes in any given year would depend on several factors, including: 1) the final location and capacity of the project well facilities, the volume of water in the SFPUC Storage Account and 3) direction from the Operating Committee regarding which wells should be used (SFPUC 2011; MWH 2008).

Source of Proposed Water Supply for Partner Agencies

Regional Groundwater Storage and Recovery Project

Figure 3-2

3.4.2 Production Wells and Associated Facilities

The proposed Project consists of the construction and operation of up to 16 new well facilities within the South Westside Groundwater Basin and an upgrade to the existing Westlake Pump Station (see Figures 3-3, 3-4, and 3-5, location maps). This EIR, however, includes the evaluation of three additional well facilities (for a total of 19) that could be developed in the instance where one of the 16 preferred well facilities cannot be constructed or operated because either: (1) the SFPUC is unable to secure access or necessary easements; (2) the well facility cannot be successfully operated because groundwater quality or groundwater yield do not meet Project requirements; or (3) the well facility is otherwise determined by the SFPUC to be infeasible. Under any of these circumstances, the SFPUC would eliminate that well site from the Project (and properly decommission the well, if it had already been constructed) and construct and operate one of the three other well facilities on alternate sites. Therefore, this EIR evaluates construction of 19 well facilities, of which 16 are preferred sites at this time and three are alternate well facilities, and operation of only 16 well facilities. The decision to construct and operate alternate well facilities would occur when the SFPUC determines that the proposed well facilities are infeasible, as described above, which could be during initial implementation of the Project or later. The preferred well facilities would be at Sites 1 through 16; the three alternate well facilities would be at Sites 17 (Alternate), 18 (Alternate), and 19 (Alternate). Therefore, the 16 well facilities to be operated could be at any of the 19 well facility locations.

Together, the 16 proposed well facilities would have an annual average pumping capacity of 7.2 mgd (equivalent to 8,100 acre-feet per year [afy]), a peak pumping capacity of 8.3 mgd, and would be used as a supplemental dry-year supply. During dry years, Partner Agency water deliveries from the regional water system would be comprised of reduced surface water deliveries and groundwater pumped from Project wells, as identified in the Operating Agreement. The Partner Agencies' pumping from their existing wells would not exceed the annual average rates consistent with the pumping limits expressed in the Operating Agreement. SFPUC retail water deliveries from the regional water system would be comprised of surface water and groundwater from the proposed GSR Project wells.

Of the preferred 16 well facility sites evaluated in this EIR, four well facilities would connect to Daly City's distribution system; three to San Bruno's distribution system; two to Cal Water's distribution system; and seven to the regional water system. These are the preferred connections; if, however, not all of the preferred 16 new wells can be feasibly connected to the proposed distribution systems due to groundwater quality or yield issues, or if one or more of the alternate well facility sites are operated, or if the distribution system cannot successfully be connected to the new source because of system pressure or demand issues, then well facilities may need to be connected to alternate distribution systems. To account for this potential outcome, this EIR evaluates connections to alternate water distribution systems at 14 well facility sites; these connections are listed in the detailed descriptions under Sections 3.4.2.2 (Well Facility Types) and 3.4.3 (Facility Sites) of this Chapter. The decision to construct a connection to an alternate distribution system could occur at any time that the SFPUC determines that the preferred connections are infeasible, as described above, which could be during initial implementation of the Project or later. A list of the 19 well facility sites and the Westlake Pump Station site is provided in Table 3-2 (Facility Site Names and Locations) and shown on Figures 3-3, 3-4, and 3-5.



Legend Proposed Project Well Facility Sites County Boundary		Westlake Pump Station North Westside ¹ Groundwater Basin South Westside ¹ Groundwater Basin	0 1,000 2,000 Scale Feet 1" = 2,000' 	Project Location Map-North Regional Groundwater Storage and Recovery Project Figure 3-3
--	--	---	--	--

¹ North and south groundwater basin divide is an artificial construct.

This page left intentionally blank

This page left intentionally blank

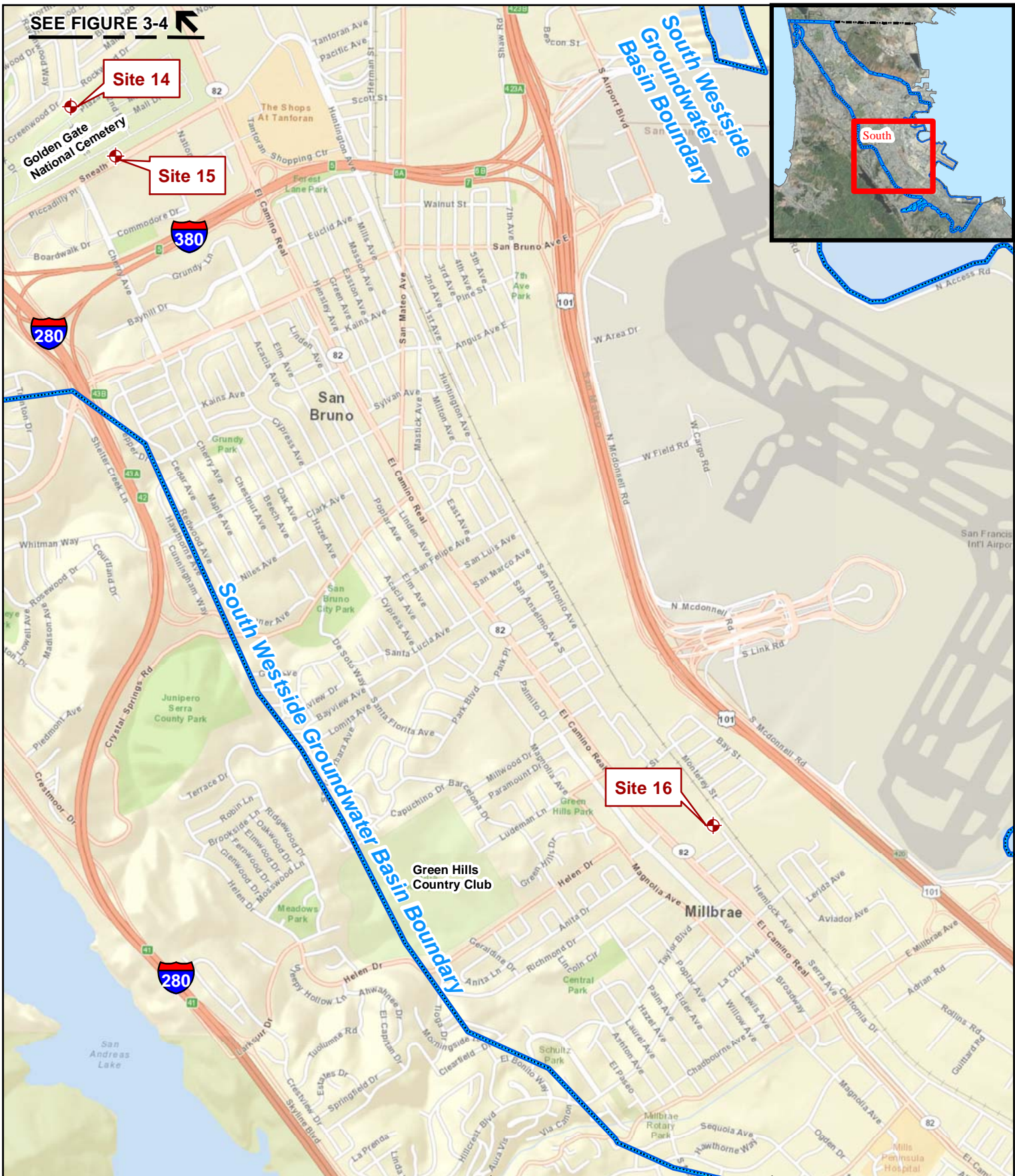

SEE FIGURE 3-4 ↖

Site 14

Site 15

Site 16

South

Legend

 Proposed Project Well Facility Sites

 South Westside Groundwater Basin

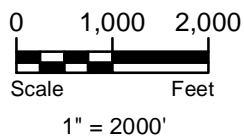

Project Location Map-South

Regional Groundwater Storage and Recovery Project

Figure 3-5

TABLE 3-2
Facility Site Names and Locations^(a)

Site	Site Name	Location
Site 1	Lake Merced Golf Club	Daly City
Site 2	Park Plaza Meter	Daly City
Site 3	Ben Franklin Intermediate School	Unincorporated San Mateo County (Broadmoor)
Site 4	Garden Village Elementary School	Unincorporated San Mateo County (Broadmoor)
Westlake Pump Station	Westlake Pump Station	Daly City and Unincorporated San Mateo County (Broadmoor)
Site 5	Right-of-Way at Serra Bowl	Daly City
Site 6	Right-of-Way at Colma BART ^(b)	Daly City
Site 7	Right-of-Way at Colma Boulevard	Colma
Site 8	Right-of-Way at Serramonte Boulevard	Colma
Site 9	Treasure Island Trailer Court	South San Francisco
Site 10	Right-of-Way at Hickey Boulevard	South San Francisco
Site 11	South San Francisco Main Area	South San Francisco
Site 12	Garden Chapel Funeral Home	South San Francisco
Site 13	South San Francisco Linear Park	South San Francisco
Site 14	Golden Gate National Cemetery	San Bruno
Site 15	Golden Gate National Cemetery	San Bruno
Site 16	Millbrae Corporation Yard	Millbrae
Site 17 (Alternate)	Standard Plumbing Supply	Colma
Site 18 (Alternate)	Alta Loma Drive	South San Francisco
Site 19 (Alternate)	Garden Chapel Funeral Home	South San Francisco

Notes:

- (a) This EIR evaluates 16 proposed and three alternate well facility sites, even though a maximum of 16 well facilities would ultimately be operated by the agency to which the water is distributed.
- (b) BART = Bay Area Rapid Transit

Each well facility would include a well pump station, underground distribution piping, and above or underground utility connections. Most well facilities would also have disinfection units designed for microbial inactivation, unless they are near an existing disinfection unit that can accommodate the additional volume of groundwater, in which case the well would connect to the existing unit. At certain sites, additional treatment (i.e., for pH adjustment, fluoridation, nitrate, Volatile Organic Compounds

[VOCs], and/or iron/manganese removal) would be incorporated into the design of the facility to meet both regulatory and water quality targets in the finished water for all agencies. The treatment facilities that would be included in the design of each well facility are listed in the detailed descriptions in Sections 3.4.2.2 (Well Facility Types) and 3.4.3 (Facility Sites) of this Chapter.

The proposed well facilities have been sited so that wells are close to treatment systems and close to existing distribution systems (the regional water system and the local distribution systems of the Partner Agencies), resulting in a more energy efficient system.

3.4.2.1 Well Facility Characteristics

Site-specific well facility characteristics for the 19 potential well facility sites are listed in Table 3-3 (Site-specific Facility Characteristics). These characteristics include the proposed well facility (i.e., building) type, pump type and pumping capacity, water distribution system connection point and alternate connection point (if any), groundwater disinfection location, and the method that would be used to achieve water quality goals specific to the SFPUC and each of the Partner Agencies (i.e., blending with surface water or other treatment).

3.4.2.2 Well Facility Types

Well facility design includes consideration of regulatory, operational, maintenance, and technical information. Four well facility types are included in the proposed Project:

- Well with fenced enclosure,
- Well with building,
- Well plus chemical treatment building, and
- Well plus chemical treatment and filtration building.

The type of well facility proposed for each of the sites is listed in Table 3-3 (Site-specific Facility Characteristics) and is described in detail below. Figures 3-6, 3-7, and 3-8 provide conceptual layouts for these facilities.

Where no well facility building is proposed, only the wellhead, electric panel, a fence, and possibly a screening wall, would be located aboveground. A conceptual site plan of this type of facility is illustrated on Figure 3-6 (Well Building and Fenced Enclosure Conceptual Layout).

Where buildings to enclose the well facility are proposed, the buildings would be about 15 feet above finished grade and constructed of board-formed concrete and metal panels, except at Sites 14 and 15, which would require special architectural features to integrate visually with the surrounding landscape. The exterior building colors would be gray or earth tone with anti-graffiti coating. A galvanized decorative gate would provide access into the building.

TABLE 3-3
Site-specific Facility Characteristics

Site	Site Name	Facility Type ^(a)	Pump Type/ Capacity (gpm) ^(b)	Proposed Connection Point	Alternate Connection Point	Proposed On-site Water Treatment	Disinfection Location	Method for Achieving Water Quality Goals for Iron/Manganese
Site 1	Lake Merced Golf Club	1,480-square-foot facility with well plus chemical treatment	Aboveground Vertical Turbine/ 300-600	SFPUC	Daly City	Disinfection, pH adjustment fluoridation	At site	Treatment for iron/manganese not required
Site 2	Park Plaza Meter	Well with fenced enclosure	Submersible Vertical Turbine/ 300-600	Daly City	None	No on-site treatment	Westlake Pump Station	Treatment for iron/manganese not required
Site 3	Ben Franklin Intermediate School	Well with fenced enclosure	Submersible Vertical Turbine/ 300-600	Daly City	None	No on-site treatment	Westlake Pump Station	Treatment for iron/manganese not required
Site 4	Garden Village Elementary School	Well with fenced enclosure	Submersible Vertical Turbine/ 300-600	Daly City	None	No on-site treatment	Westlake Pump Station	Treatment for iron/manganese not required
Westlake Pump Station	Westlake Pump Station	Pump station and treatment upgrade	Up to 3 new booster pumps	Daly City	None	Disinfection, fluoridation	At site	Treatment for iron/manganese not required
Site 5 (Consolidated Treatment at Site 6) ^(c)	Right-of-Way at Serra Bowl	Well with fenced enclosure	Submersible Vertical Turbine/ 300-600	SFPUC	None	No on-site treatment	At Site 6	Treatment at Site 6

TABLE 3-3
Site-specific Facility Characteristics

Site	Site Name	Facility Type ^(a)	Pump Type/ Capacity (gpm) ^(b)	Proposed Connection Point	Alternate Connection Point	Proposed On-site Water Treatment	Disinfection Location	Method for Achieving Water Quality Goals for Iron/Manganese
Site 6 (Consolidated Treatment at Site 6) ^(c)	Right-of-Way at Colma BART	2,990-square-foot facility with well plus chemical treatment and filtration	Aboveground Vertical Turbine/ 300-600	SFPUC	Cal Water	Disinfection, pH adjustment fluoridation, iron/manganese removal	At site	Treatment
Site 7 (Consolidated Treatment at Site 6) ^(c)	Right-of-Way at Colma Boulevard	Well with fenced enclosure	Submersible Vertical Turbine/ 300-600	SFPUC	None	No on-site treatment	At Site 6	Treatment at Site 6
Site 5 (On-site Treatment)	Right-of-Way at Serra Bowl	2,095-square-foot facility with well plus chemical treatment and filtration	Aboveground Vertical Turbine/ 300-600	SFPUC	Daly City	Disinfection, pH adjustment, fluoridation, iron/manganese removal	At site	Treatment
Site 6 (On-site Treatment)	Right-of-Way at Colma BART	2,090-square-foot facility with well plus chemical treatment and filtration	Aboveground Vertical Turbine/ 300-600	SFPUC	Cal Water	Disinfection, pH adjustment, fluoridation, iron/manganese removal	At site	Treatment for iron/manganese not required
Site 7 (On-site Treatment)	Right-of-Way at Colma Boulevard	2,090-square-foot facility with well plus chemical treatment and filtration	Aboveground Vertical Turbine/ 300-600	SFPUC	Cal Water	Disinfection, pH adjustment, fluoridation, iron/manganese removal	At site	Treatment for iron/manganese not required

TABLE 3-3
Site-specific Facility Characteristics

Site	Site Name	Facility Type ^(a)	Pump Type/ Capacity (gpm) ^(b)	Proposed Connection Point	Alternate Connection Point	Proposed On-site Water Treatment	Disinfection Location	Method for Achieving Water Quality Goals for Iron/Manganese
Site 8	Right-of-Way at Serramonte Boulevard	2,095-square-foot facility with well plus chemical treatment and filtration	Aboveground Vertical Turbine 300-600	Cal Water	SFPUC	Disinfection, pH adjustment (if needed) ^(d) , fluoridation, iron/manganese removal	At site	Treatment
Site 9	Treasure Island Trailer Court	2,095-square-foot facility with well plus chemical treatment and filtration	Aboveground Vertical Turbine/ 200-500	SFPUC	None	Disinfection, pH adjustment, fluoridation, iron/manganese removal	At site	Treatment
Site 10	Right-of-Way at Hickey Boulevard	2,095-square-foot facility with well plus chemical treatment and filtration	Aboveground Vertical Turbine/ 200-500	Daly City	SFPUC	Disinfection, pH adjustment (if needed) ^(d) , fluoridation, iron/manganese removal	At site	Treatment
Site 11	South San Francisco Main Area	2,095-square-foot facility with well plus chemical treatment and filtration	Aboveground Vertical Turbine/ 200-500	Cal Water	SFPUC	Disinfection, pH adjustment (if needed) ^(d) , fluoridation, iron/manganese removal	At site	Treatment

TABLE 3-3
Site-specific Facility Characteristics

Site	Site Name	Facility Type ^(a)	Pump Type/ Capacity (gpm) ^(b)	Proposed Connection Point	Alternate Connection Point	Proposed On-site Water Treatment	Disinfection Location	Method for Achieving Water Quality Goals for Iron/Manganese
Site 12	Garden Chapel Funeral Home	1,495-square-foot facility with well plus chemical treatment	Aboveground Vertical Turbine/ 200-500	SFPUC	Other SFPUC	Disinfection, pH adjustment	At site	Blending ^(e)
Site 13	South San Francisco Linear Park	2,095-square-foot facility with well plus chemical treatment and filtration	Aboveground Vertical Turbine/ 200-500	San Bruno	Cal Water	Disinfection, fluoridation, iron/manganese removal	At site	Treatment
Site 14	Golden Gate National Cemetery	700-square-foot building enclosure with well	Submersible Vertical Turbine/ 300-600	San Bruno	SFPUC	No on-site treatment	At Site 15	Treatment at Site 15
Site 15	Golden Gate National Cemetery	2,095-square-foot facility with well plus chemical treatment and filtration	Aboveground Vertical Turbine/ 300-600	San Bruno	SFPUC	Disinfection, pH adjustment (if needed) ^(d) , fluoridation, iron/manganese removal	At site	Treatment
Site 16	Millbrae Corporation Yard	1,480-square-foot facility with well plus chemical treatment	Aboveground Vertical Turbine/ 100-200	SFPUC	Other SFPUC	Disinfection, pH adjustment, fluoridation	At site	Treatment for iron/manganese not required

TABLE 3-3
Site-specific Facility Characteristics

Site	Site Name	Facility Type ^(a)	Pump Type/ Capacity (gpm) ^(b)	Proposed Connection Point	Alternate Connection Point	Proposed On-site Water Treatment	Disinfection Location	Method for Achieving Water Quality Goals for Iron/Manganese
Site 17 (Alternate)	Standard Plumbing Supply	1,495-square-foot facility with well plus chemical treatment	Aboveground Vertical Turbine/ 300-600	Cal Water	SFPUC	Disinfection, pH adjustment (if needed) ^(d) , fluoridation	At site	Treatment for iron/manganese not required
Site 18 (Alternate)	Alta Loma Drive	1,495-square-foot facility with well plus chemical treatment	Aboveground Vertical Turbine/ 200-500	SFPUC	Cal Water	Disinfection, pH adjustment (if needed) ^(d) , fluoridation	At site	Treatment for iron/manganese not required
Site 19 (Alternate)	Garden Chapel Funeral Home	Well with fenced enclosure	Submersible Vertical Turbine/ 200-500	SFPUC	Other SFPUC	No on-site treatment	At Site 12	Blending ^(e)

Notes:

- (a) Well station types are described in this section and shown on Figures 3-6, 3-7, and 3-8.
- (b) "gpm" is gallons per minute.
- (c) Consolidated Treatment at Site 6 means that groundwater water from Sites 5 and 7 would be conveyed to a single water treatment facility at Site 6. No treatment facilities would be constructed at Site 5 or at Site 7 under this scenario. Please refer to Section 3.4.3 (Facility Sites), for a detailed explanation of the consolidated treatment option.
- (d) pH adjustment only needed if alternate connection point is used.
- (e) Blending is mixing groundwater with other potable supply water. If nitrate concentrations in Project wells or Partner Agency wells increase above target levels due to the Project, this would be addressed through blending or other treatment to ensure that all drinking water standards for nitrate are met.

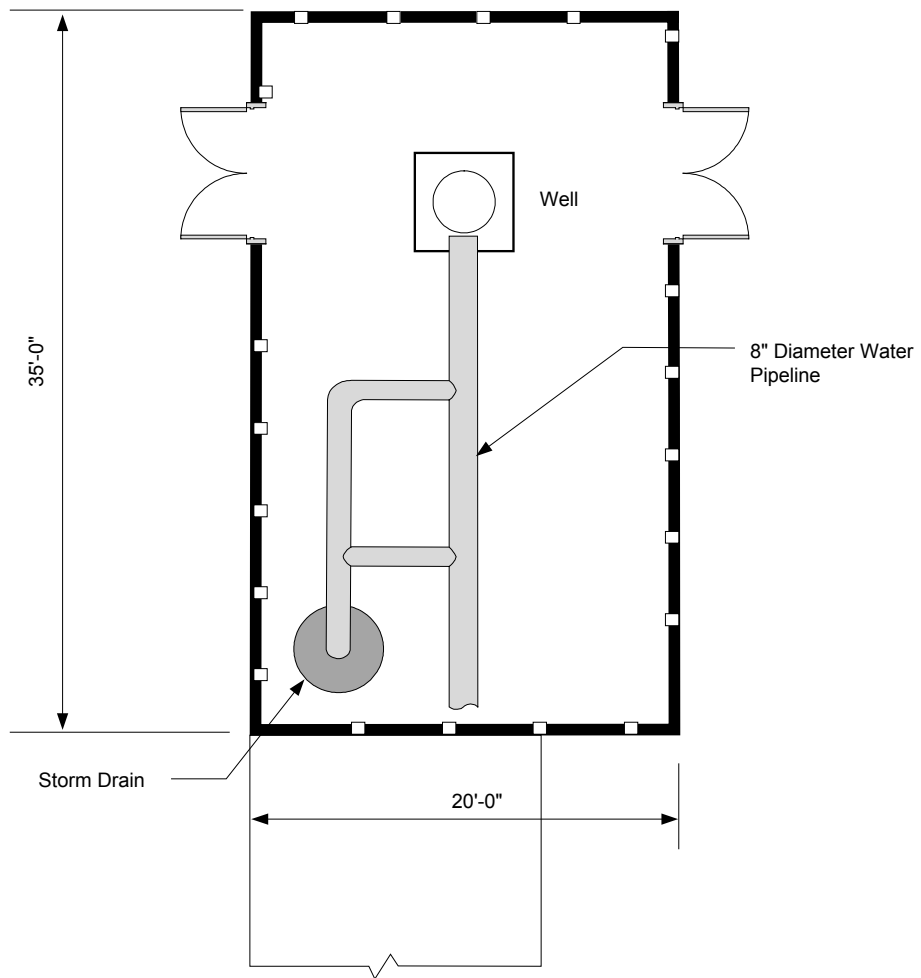

Typical Well with Building Enclosure
(Plan View)

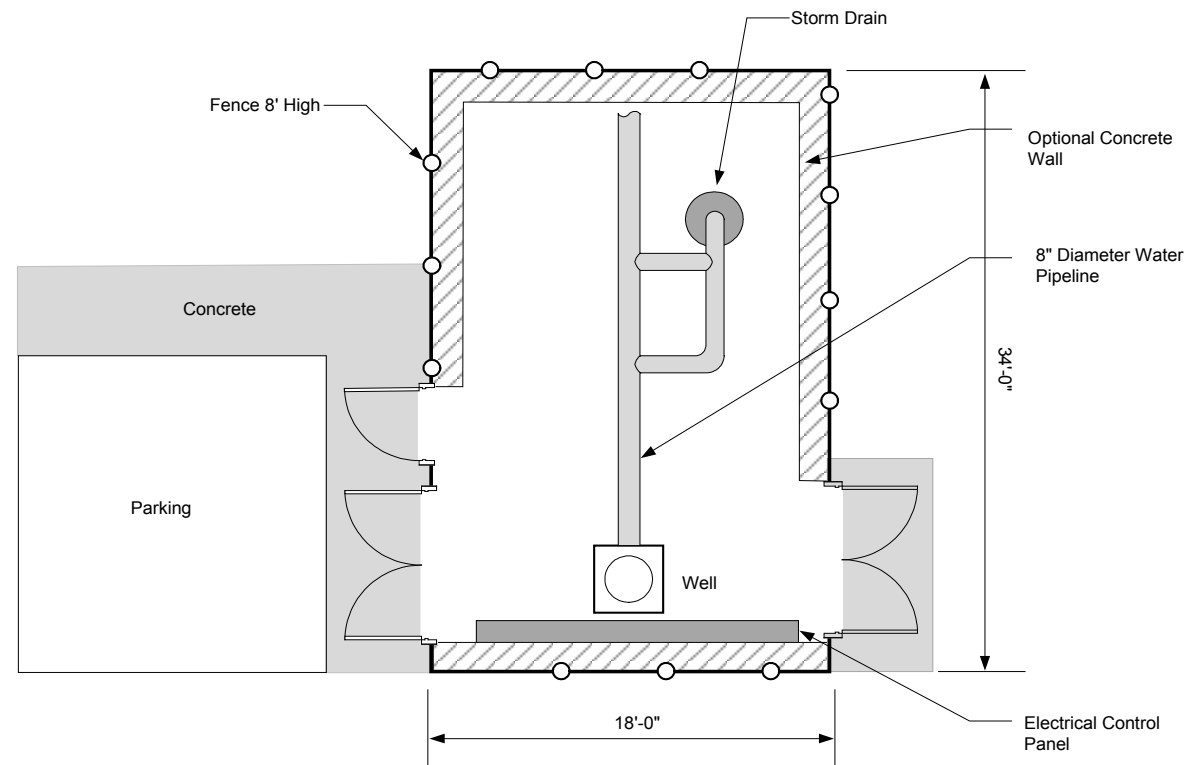

Typical Well with Fenced Enclosure
(Plan View)

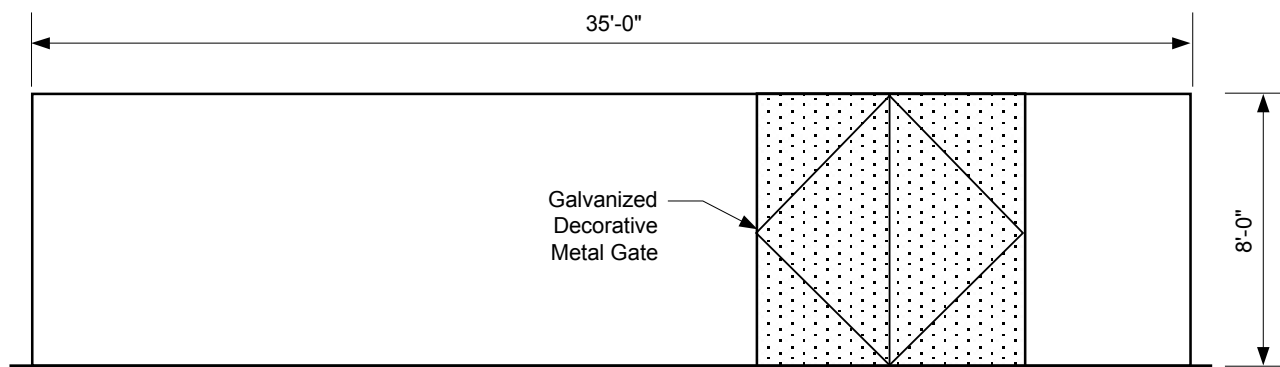

Typical Well with Building
(East Elevation)

Well Building and Fenced Enclosure
Conceptual Layout

Regional Groundwater Storage
and Recovery Project

Figure 3-6

This page left intentionally blank

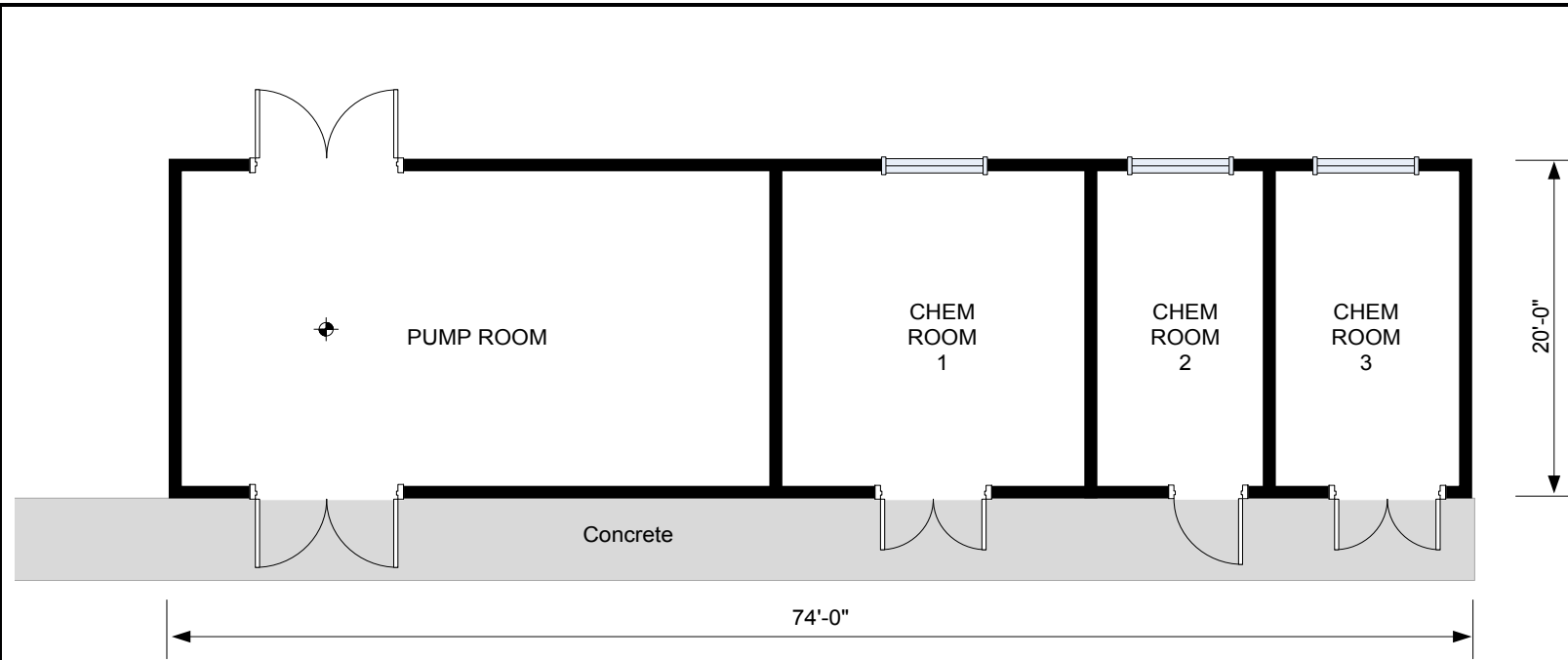

Typical Well Plus Chemical Treatment Four-Room Facility
(Plan View)

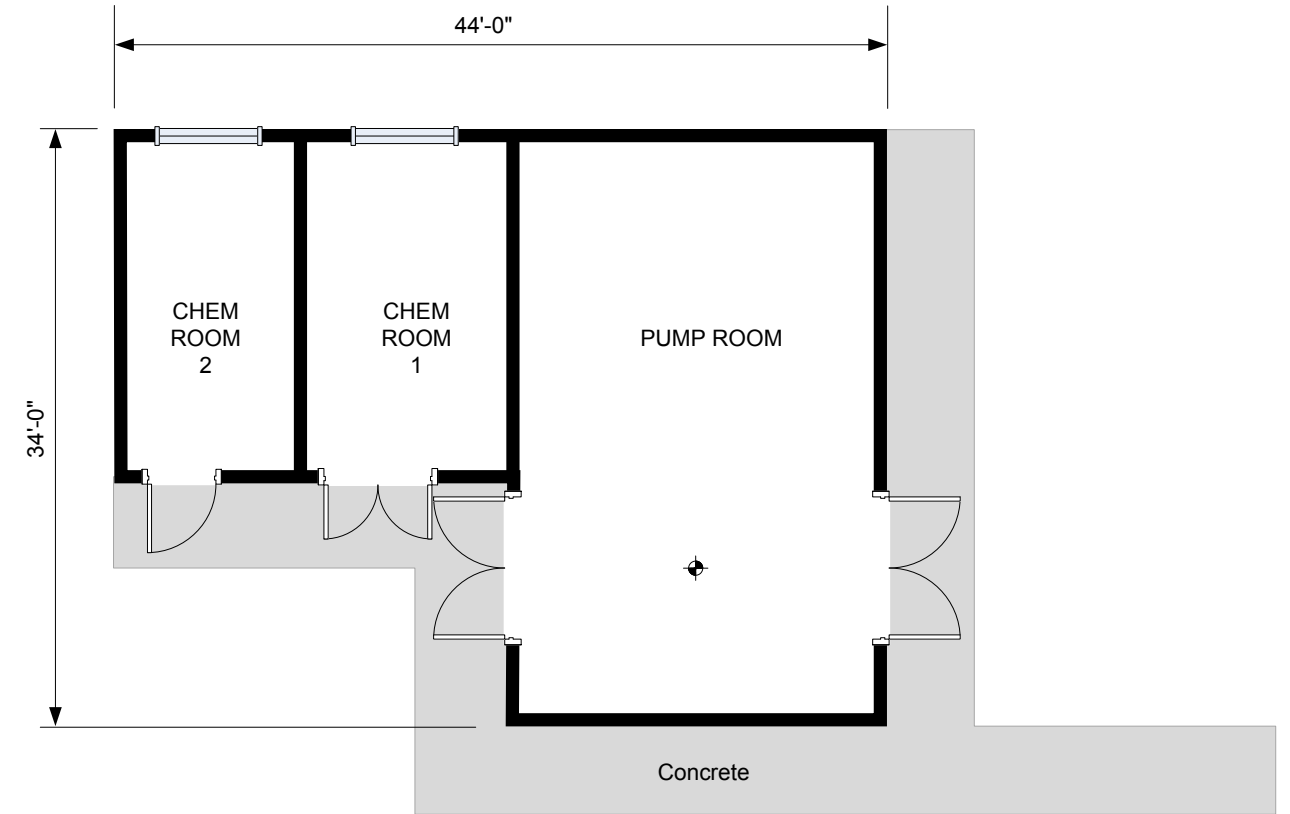

Typical Well Plus Chemical Treatment Three-Room Facility
(Plan View)

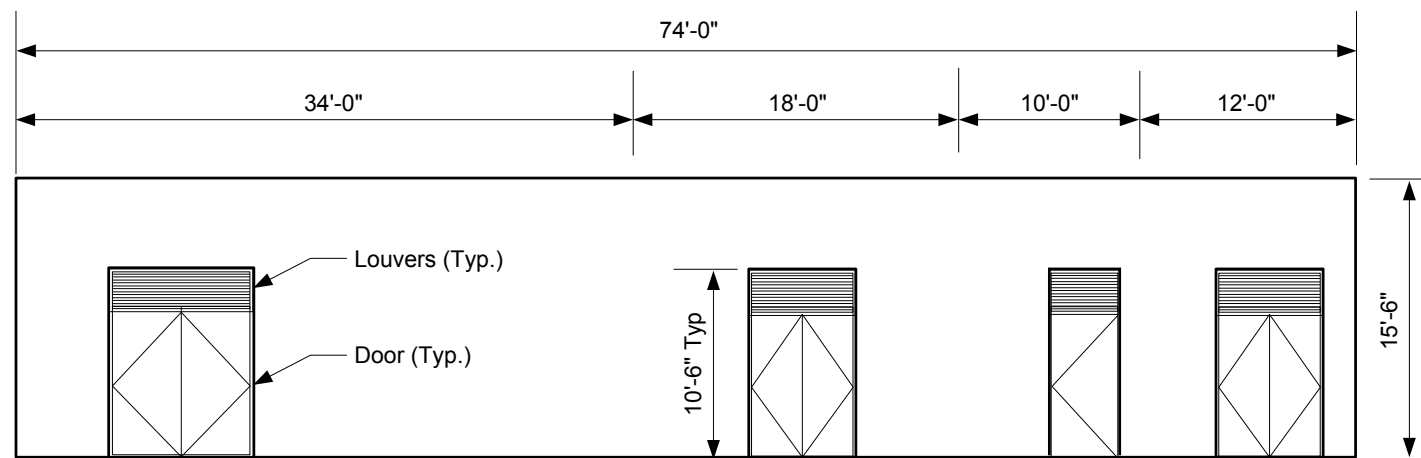

Typical Well Plus Chemical Treatment Four-Room Facility
(Elevation)

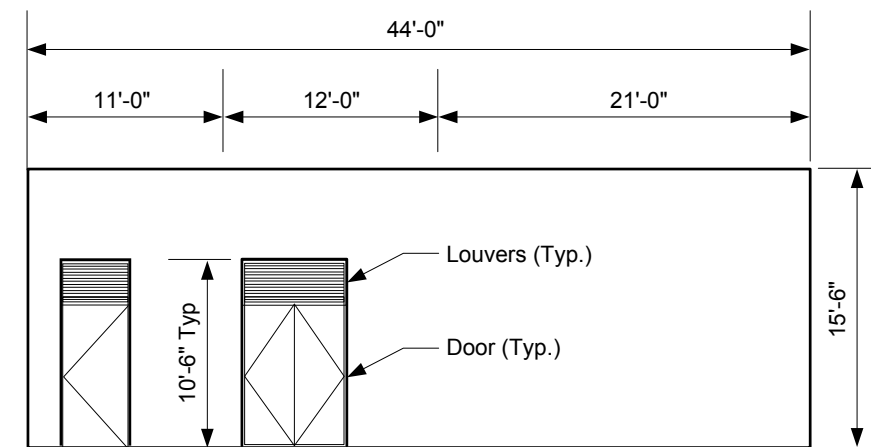

Typical Well Plus Chemical Treatment Three-Room Facility
(Elevation)

Note: Pump room would include the proposed well and pipelines similar to that shown on Figure 3-6.

Source: San Francisco Public Works 35% Design Sheets

Well Plus Chemical Treatment
Building Conceptual Layouts

Regional Groundwater Storage
and Recovery Project

Figure 3-7

This page left intentionally blank

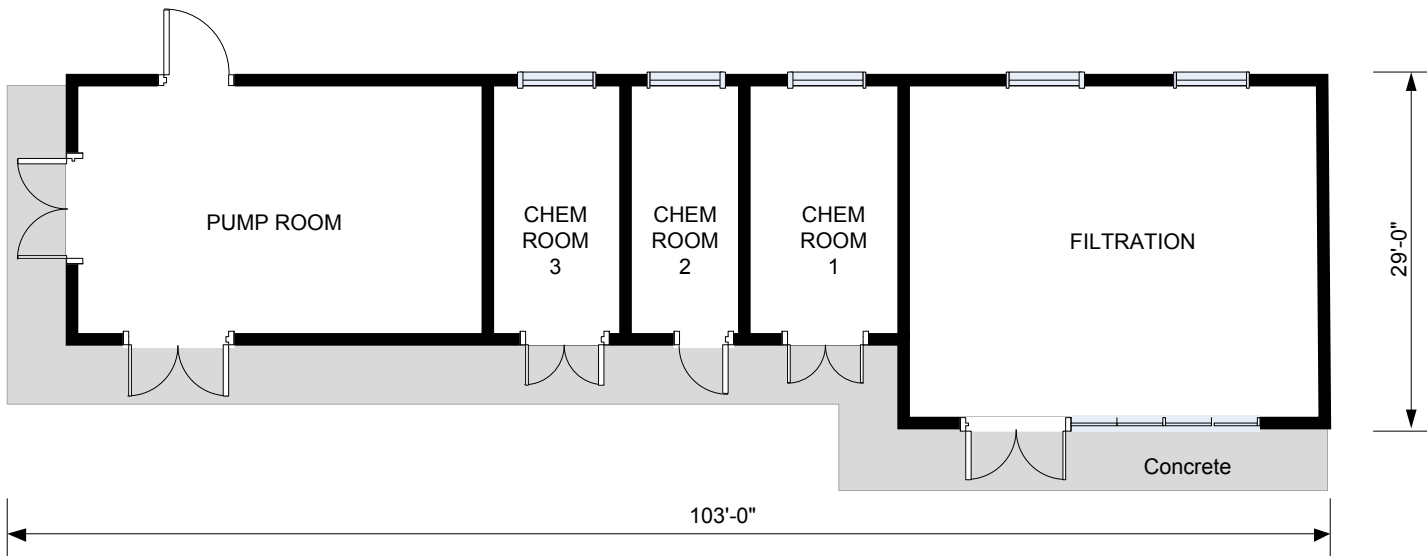

Typical Well Plus Chemical Treatment Five-Room Facility
(Plan View)

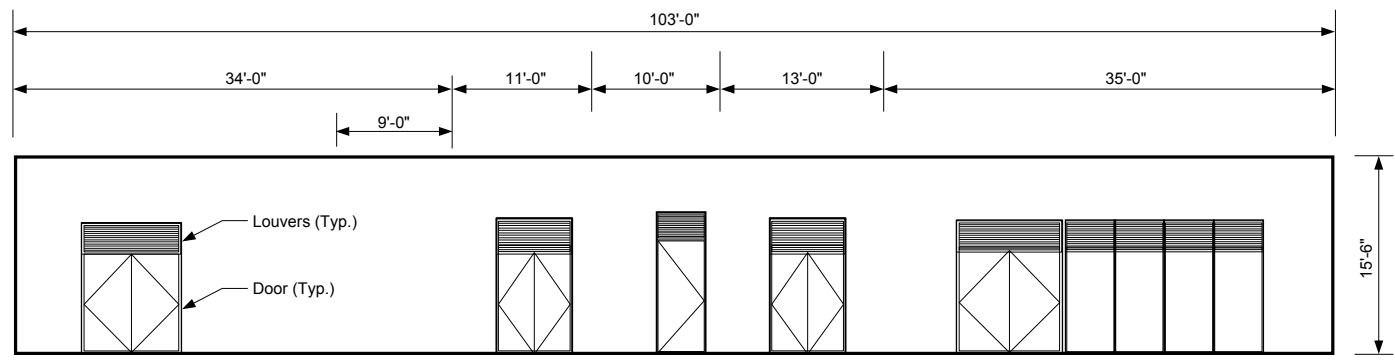

Typical Well Plus Chemical Treatment Five-Room Facility
(Elevation)

Well Plus Chemical Treatment and Filtration Building Conceptual Layouts
Regional Groundwater Storage and Recovery Project
Figure 3-8

Note: Pump room would include the proposed well and pipelines similar to that shown on Figure 3-6.

The building sizes would range from 700 to 2,990 square feet depending on the treatment needs for each well or if treatment would be consolidated at a single site for two or more wells.

Where the building's air system would be connected to the outside air for intake and exhaust, acoustical louvers would be installed to help reduce noise produced inside the building from reaching the exterior of the building. The building would also include noise-reducing features such as standard weatherproofed steel doors and roofing materials with sound-reducing qualities. A limited amount of sound absorbing material would be included inside the well buildings to minimize reverberant buildup of noise³.

All facilities would include permanent outdoor lighting. Lights would either be mounted on the building or pole-mounted within the well facility site. All lighting would meet Title 24 of the California Code of Regulations standards including shielding, manual switch operation with automatic shut-off, and energy requirements. Lighting would be added near the main entrance of the well facility for security purposes and adjacent to the parking and service area at the rear of the building, if needed. Lighting would be used only when nighttime access is required. All lights would be switch operated with automatic shut-off.

Well with Fenced Enclosure

The conceptual layout for the "well with fenced enclosure" well facility type would include either an eight-foot-high, black vinyl-coated fence with one-inch mesh or an eight-foot-high metal picket fence with ¾-inch black pickets to house the wellhead, pump, piping, and associated electrical controls that would be located in a weather-proof control panel (see Figure 3-6 [Well Building and Fenced Enclosure Conceptual Layout]). An optional concrete wall may be added as illustrated in Figure 3-6.

A waste line for overboard water would be connected from the well to the nearest storm drain for disposing of pumped water ("overboard water") that would be generated during each well start-up, testing cycle, well rehabilitation, or other maintenance.

Well with Building

The "well with building" well facility type includes a 35- by 20-foot (700 square feet) building to house the wellhead, pump, piping, and associated electrical controls, as illustrated on Figure 3-6. The building height would be about eight feet above finished grade. A waste line for overboard water would be connected to the nearest storm drain.

³ A reverberation, or "reverb," is created when a sound is produced in an enclosed space causing a large number of echoes to build up and then slowly decay as the sound is absorbed by the walls and air.

Well plus Chemical Treatment

There are two conceptual layouts for a well with a chemical treatment building, as illustrated on Figure 3-7 (Well Plus Chemical Treatment Building Conceptual Layouts). The building's horizontal dimensions would be approximately 44 by 34 feet (1,495 square feet), or 75 by 20 feet (1,500 square feet), depending on the number of chemical treatment rooms needed at the site. The building would house the wellhead, pump, piping, and associated electrical and control equipment. The building would also provide for disinfection and fluoridation. The chemical treatment rooms would store disinfection chemicals, as needed, for treatment to address the quality of the groundwater and the receiving water systems.

In addition to the pump room, which would house the well head and mechanical and electrical equipment, chemical treatment facilities would require two or three separate chemical rooms. One room would contain a storage tank for sodium hypochlorite (for disinfection) and sodium hydroxide (for pH adjustment), if needed. The second room would contain a storage tank for ammonia (for disinfection) and a third room would accommodate fluoridation. Sodium fluoride would be used for fluoridation as required to meet Title 22 of the California Code of Regulations. The volume of chemical storage is shown in Table 3-4 (Maximum Volume of Chemical Storage).

Each tank is intended to provide a chemical storage capacity of 14 to 21 days (with an additional 15 percent safety factor) and the total volume of chemicals in each room would be kept at or below 1,000 gallons. The proposed storage capacity allows for chemical delivery to occur every two to three weeks. Space for a chlorine contact tank has been designated in the site layouts, in case disinfection is required. The chemical storage tanks would be placed on top of a pedestal and above a grate-covered chemical containment pit. The depth of the pit would be sized to provide 110 percent of the total storage volume.

A waste line for overboard water would be connected to the sanitary sewer and/or storm drain. This waste line would not drain any chemical storage areas. The facility would include a sink which would be connected to the sanitary sewer system. Water for the sink would come from a small potable water supply line.

TABLE 3-4
Maximum Volume of Chemical Storage

Site	Aqueous ammonia (gal) (Disinfection)	Sodium hypochlorite (gal) (Disinfection)	Sodium hydroxide (gal) (pH Adjustment)	Sodium fluoride (gal) (Fluoridation)	Filter media (cubic feet) (Iron/ Manganese Removal)
Sites 2, 3, 4, 5 (Consolidated Treatment at Site 6), 7 (Consolidated Treatment at Site 6), 14, 19 (Alternate)	N/A	N/A	N/A	N/A	N/A
Site 9	120	550	300	50	360
Sites 16 and 18 (Alternate)	120	200	200	50	0
Sites 1 and 17 (Alternate)	120	550	100	50	0
Sites 5 (On-site Treatment), 6 (On-site Treatment), 7 (On-site Treatment)	120	300	100	50	360
Sites 8 and 10	120	300	100 ^(a)	50	360
Site 11	120	200	100 ^(a)	50	360
Site 13	120	200	0	50	360
Site 12	120	550	100	0	0
Site 15	120	550	100 ^(a)	50	360
Site 6 (Consolidated Treatment at Site 6)	300	1,000	1,000	100	960
Westlake Pump Station	120	600	0	200	0

Note:

(a) Sodium hydroxide storage only required if alternate connection is used.

Well plus Chemical Treatment and Filtration

There are two conceptual layouts for well stations with chemical treatment and filtration associated with iron/manganese removal, as shown in Figure 3-8 (Well Plus Chemical Treatment and Filtration Building Conceptual Layouts). The dimensions of the building would be approximately 91 by 23 feet (2,095 square feet), or 103 by 29 feet (2,990 square feet), depending upon the size of the filtration system needed and the number of rooms at the site. The chemical treatment rooms would be similar to those described above for the well plus chemical treatment type facility. An additional filtration room would be located only at well facilities that require iron and/or manganese removal. This well station type would be larger than the

other types to provide space for the filtration vessels. The filtration system would consist of a series of vertical pressure vessels that utilize a proprietary media, plus possibly potassium permanganate⁴ to remove silica. The volume of chemical storage is shown in Table 3-4 (Maximum Volume of Chemical Storage). The backwash water from the system would connect with a waste line to be connected to a nearby sanitary sewer. It is anticipated that filters would be backwashed, on average, once a day for five minutes at approximately 350 gallons per minute (gpm) per filter (MWH et al. 2008). Depending on the quantity of water being treated, the treatment facilities would have six to 16 filters, which would result in a discharge of approximately 0.01 to 0.03 mgd per well.

A waste line for overboard water would be connected to the sanitary sewer and/or storm drain. This waste line would not drain any chemical storage areas. The facility would include a wash sink which would be connected to the sanitary sewer system. Water for the sink would be conveyed through a small potable water supply pipeline.

Seismic Design Requirements

Well facility design would conform to the 2010 California Building Code and the SFPUC's *General Seismic Requirements for Design of New Facilities and Upgrade of Existing Facilities, Revision 2* (SFPUC 2009d). The SFPUC's General Seismic Requirements for Design of New Facilities and Upgrade of Existing Facilities set forth criteria for the seismic design of facilities and components of WSIP facility improvement projects. Under these design requirements, each facility is evaluated for its necessity in meeting the water service delivery goals and assigned a seismic performance class for the purpose of determining appropriate seismic design criteria. The SFPUC has classified the proposed facilities as "Important" (Class II), which is defined as facilities that may experience damage, but should be capable of restoration to service within 30 days (SFPUC 2009d).

3.4.2.3 Well Pumps

The pump type and pumping capacity for each well facility site are listed in Table 3-3 (Site-specific Facility Characteristics). The SFPUC proposes installing either submersible vertical turbine pumps or aboveground vertical turbine pumps in the wells. Wells enclosed in buildings would be equipped with aboveground vertical turbine pumps. Wells that are in fenced enclosures (i.e., without buildings) would be equipped with submersible pumps to minimize noise. Conceptual well profiles for the two well pump types are shown in Figures 3-9 (Typical Well Profile for Above Ground Motor Driven Pump) and 3-10 (Typical Well Profile for Submersible Motor Driven Pump).

⁴ If potassium permanganate is required in the filtration system to remove silica, the volumes needed would be minimal.

3.4.2.4 Water Connection, Sanitary Sewer, and Storm Drain Piping

Underground piping would be installed at each well site to connect the well to the local water distribution system or to the regional water system, or to connect the well to a neighboring facility for treatment. As explained in the introduction to Section 3.4.2 (Production Wells and Associated Facilities), connections to alternate distribution systems are also identified to provide the Project with design flexibility to accommodate access issues and utility conflicts.

Underground piping would connect well facilities to the local storm drain system and/or the sanitary sewer system to allow discharge of overboard well water, chloraminated water, or filter backwash. Chloraminated water would be dechlorinated and sent to the storm drain or, if not treated, sent to the local sanitary sewer system. The determination of where to send the chloraminated water would be based on operational constraints such as the duration and volume of the discharge and the distance to the closest sanitary sewer. Backwash from the iron/manganese removal facilities would also be sent to the local sanitary sewer system.

Ductile iron pipe would be installed to convey water from the well facility to the regional water system. The pipeline would be encased with polyethylene (plastic sheeting wrapped and taped around the pipe) as a corrosion control measure. Other similarly effective measures, such as other pipeline coating or passive cathodic protection, would be used as well.

The total pipe length required for all 19 well facility sites, including the proposed distribution system connections (whichever one is longer), would be approximately 19,000 feet of six-inch and eight-inch pipe. The location and type of piping is shown on each of the site plans (see Figures 3-11 through 3-40). Table 3-5 (Pipeline Lengths by Facility Site) presents the approximate pipeline lengths for each site.

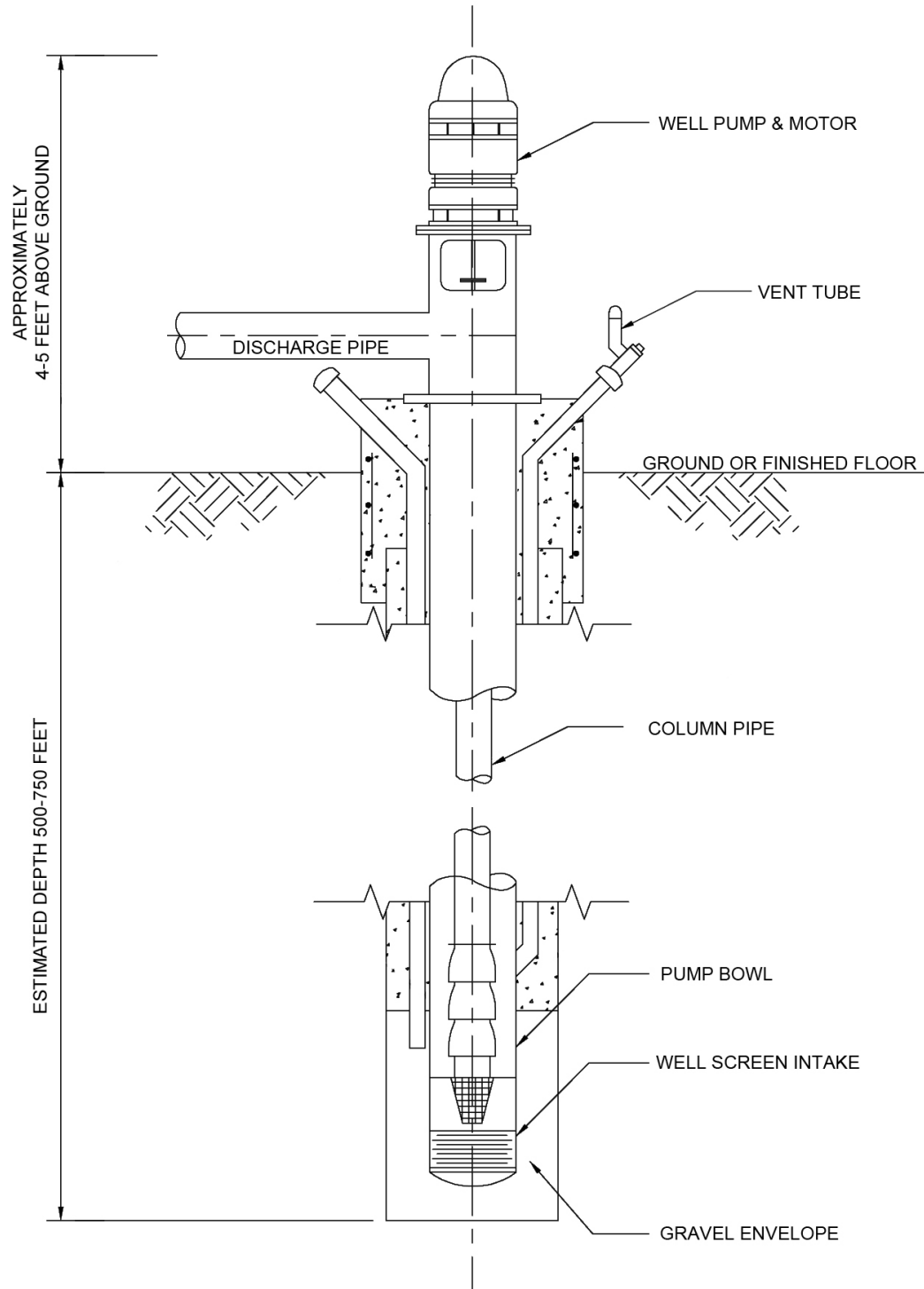

Not to Scale

Typical Well Profile for Above Ground Motor Driven Pump

Regional Groundwater Storage and Recovery Project

Figure 3-9

This page left intentionally blank

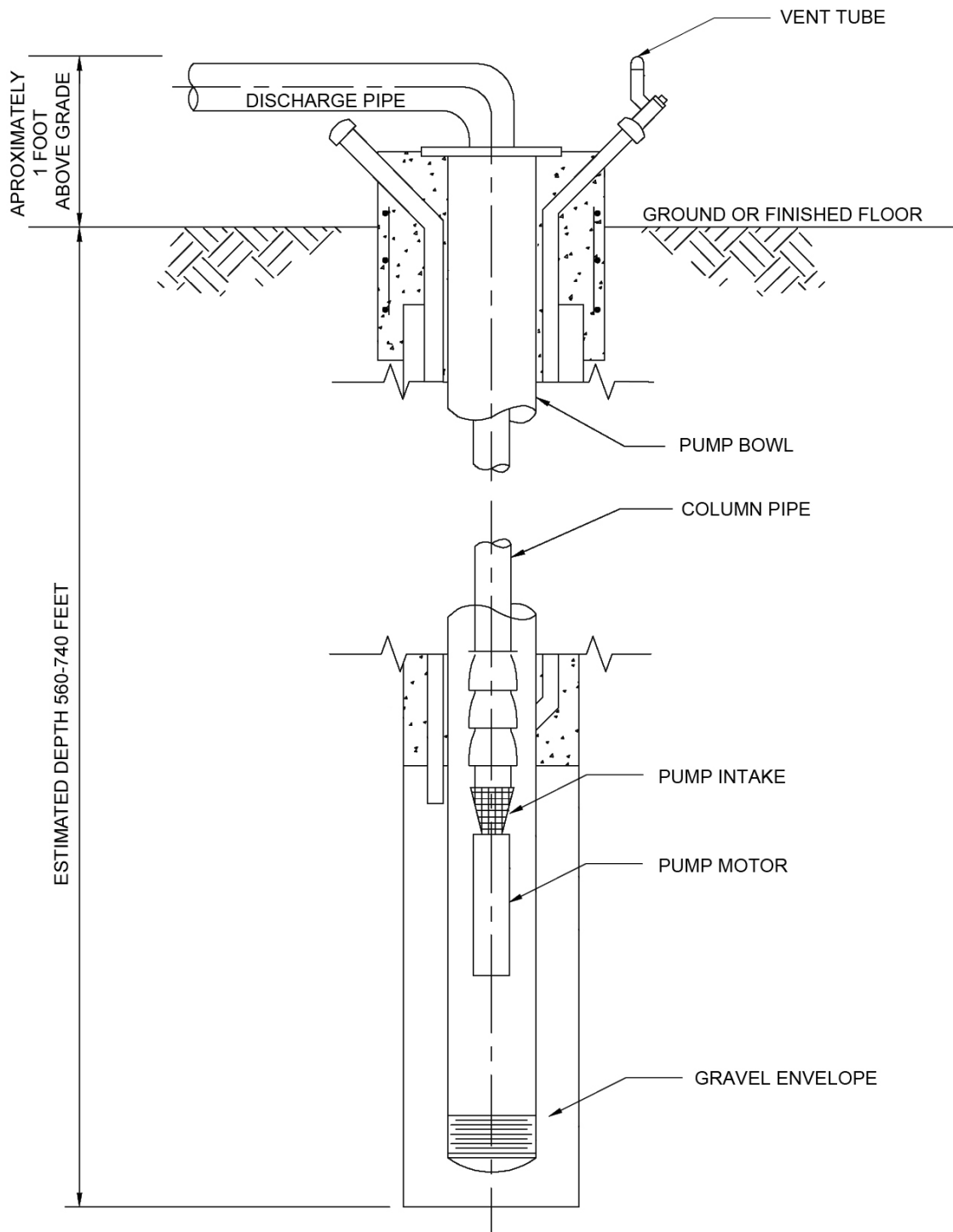

Not to Scale

Typical Well Profile for Submersible Motor Driven Pump

Regional Groundwater Storage and Recovery Project

Figure 3-10

TABLE 3-5
Pipeline Lengths by Facility Site^(a)

Site	Approximate Pipeline Lengths (feet)			
	Proposed Water Connection Pipeline	Alternate Water Connection Pipeline	Sanitary Sewer Pipeline	Storm Drain Pipeline
Site 1	125	175	55	65
Site 2 ^(b)	315	None	None	125
Site 3 ^(b)	375	None	None	470
Site 4 ^(b)	670	None	None	330
Westlake Pump Station	None	None	None	None
Site 5 (Consolidated Treatment at Site 6) ^(c)	1,120	None	None	370
Site 6 (Consolidated Treatment at Site 6) ^(c)	115	525	130	110
Site 7 (Consolidated Treatment at Site 6) ^(c)	1,780	None	None	170
Site 5 (On-site Treatment)	145	165	110	370
Site 6 (On-site Treatment)	115	525	130	110
Site 7 (On-site Treatment)	75	145	170	170
Site 8	145	125	85	220
Site 9	245	None	185	170
Site 10	200	100	145	110
Site 11	205	160	965	145
Site 12	925	90	355	355
Site 13	1,835	185	495	145
Site 14	1,785	None	None	1,110
Site 15	670	680	100	155
Site 16	40	700	290	105
Site 17 (Alternate)	105	20	70	75
Site 18 (Alternate)	130	120	140	155
Site 19 (Alternate) ^(d)	1,450	150	None	190

Notes:

- (a) Pipelines listed in the table are illustrated on site plans for each site – Figures 3-11 through Figure 3-40.
- (b) The water connection pipeline for Sites 2, 3, and 4 indicates the length of pipeline needed to connect to the existing Daly City pipeline for conveyance to the Westlake Pump Station.
- (c) Water connection pipelines for Site 5 (Consolidated Treatment at Site 6) and Site 7 (Consolidated Treatment at Site 6) indicate the pipeline length necessary to deliver water to Site 6 for treatment.
- (d) The water connection pipeline for Site 19 (Alternate) indicates the pipeline length needed to deliver water to the treatment facility at Site 12 and to then deliver water to the regional water system following treatment.

3.4.2.5 Site Access and Security

Permanent access to the well sites would be needed for servicing the well and pumping equipment and for normal daily operations. The permanent access would be provided via a new concrete driveway from a public street or other normally accessible roadway (except at Site 14 where the new driveway would use grass pavers). Where there is existing access, no new access would be constructed. Locations of proposed new access driveways and existing access driveways for each of the sites are shown on the proposed site plans (Figures 3-11 through 3-40). Parking would be accommodated in and around the well facilities and may include one designated parking space at each site.

Security fencing would be provided at all sites except Site 14. The proposed security fence would be either a black vinyl-coated eight-foot-high with one-inch mesh or an eight-foot-high black metal picket fence. The location of the fencing is shown on the site layouts. The fence would include a locked gate for access. No on-site fuel storage would be required at the well sites.

3.4.2.6 Site SCADA Systems

All well station and related facilities would be integrated into the SFPUC's and Partner Agencies' existing Supervisory Control and Data Acquisition (SCADA) systems. A new controller would be provided at each facility for local control. SCADA systems allow remote access to gather data and send commands to equipment at the facilities. The SCADA system would consist of a computer and communications software to allow for remote data gathering and operations of well facilities via telephone lines.

3.4.2.7 Power Supply Requirements

The power required at each well station was primarily determined by the size of the well pump motor. Power requirements for appurtenances such as SCADA equipment, flow meters, pressure transmitters, level transmitters, chemical metering pumps, eye wash equipment, lights, and receptacles are small in comparison and are identified under auxiliary equipment in Table 3-6 (Electrical Energy Demand for Facility Sites during Dry Years). Electric energy demands vary by well site, also shown in Table 3-6.

TABLE 3-6
Electrical Energy Demand for Facility Sites during Dry Years

Site	Energy Demand		
	Well Pumps (KVA) ^(a)	Auxiliary Equipment (KVA)	Total for One Year of Pumping (millions of kWh) ^(b)
Site 1	168	15	1.6
Site 2	84	15	0.8
Site 3	84	15	0.8
Site 4	84	15	0.8
Westlake Pump Station	84	15	0.8
Site 5 (Consolidated Treatment at Site 6)	126	15	1.2
Site 6 (Consolidated Treatment at Site 6)	168	15	1.6
Site 7 (Consolidated Treatment at Site 6)	126	15	1.2
Site 5 (On-site Treatment)	126	15	1.2
Site 6 (On-site Treatment)	168	15	1.6
Site 7 (On-site Treatment)	126	15	1.2
Site 8	126	15	1.2
Site 9	84	15	0.8
Site 10	105	15	1.0
Site 11	84	15	0.8
Site 12	84	15	0.8
Site 13	84	15	0.8
Site 14	168	15	1.6
Site 15	126	15	1.2
Site 16	126	15	1.2
Total^(c)			17.4
Site 17 (Alternate)	126	15	1.2
Site 18 (Alternate)	105	15	1.0
Site 19 (Alternate)	84	15	0.8

Notes:

- (a) KVA is kilovolt amperes.
- (b) kWh is kilowatt hours.
- (c) Total energy demand is for the 16 well facilities and does not include the alternate well facilities, because only 16 wells would ultimately be operated.

When the Project is pumping during a dry year, the wells may operate up to 24 hours a day, 365 days a year. At such a rate, the SFPUC estimates that energy demands would be approximately 17 million kilowatt-hours (kWh) for the year (see Appendix I, [Calculations for GSR Energy Use Impacts]). During normal and wet years, when the wells are not operating, energy requirements would be minimal. Permanent electrical power at the well stations would be hydroelectrically generated power supplied by the SFPUC Power Enterprise, distributed via the Pacific Gas & Electric Company (PG&E) system. Each well facility would contain a motor control center with a step-down transformer, a variable frequency drive for operational flexibility, and panel board to serve the well pumps, lighting, receptacle, controls, and instrumentation loads.

3.4.2.8 Stand-by Power Requirements

In the event of a regional or local emergency or a planned/unplanned shutdown of the regional water system or of any Partner Agency distribution facility, the Project well facilities may be operated until service is restored regardless of year type (i.e., wet/normal/dry).

All well stations would have provisions for a drive-up portable generator connection, so that in the event of a power failure the well pumps could continue to run in a dry year or be used as a temporary alternate water supply (in a normal or wet year). The portable emergency generator would operate when the SFPUC or Partner Agencies need to operate the pumps during power outages. The portable diesel generators would be trailer-mounted models with built-in sound reduction and spill containment features.

3.4.3 Facility Sites

This section describes the site layouts and system connections for each of the 16 preferred and three alternate well sites and for the Westlake Pump Station upgrade⁵. The summary tables under each heading describe the components proposed for each well facility. The text accompanying each summary table provides information about the geographic location of the well facility, the water treatment proposed for the site, the location of electrical power to the site, the location of temporary and permanent access to the site and any unique project elements for the site. The proposed site layouts are shown in Figures 3-11 through 3-40. The site layouts show the construction area boundary, site access, and the proposed pipelines, including the proposed and alternate water connections. The well locations, the well facility footprint, and the permanent paving and parking locations are also shown. Construction activities, including grading, tree trimming and removal, temporary access, and construction staging areas are described in Section 3.5 (Project Construction). For more specific information regarding individual site ownership and easement rights, refer to Section 3.10 (Property Rights Acquisition).

⁵ Estimated system connections are shown as accurately as possible given the limitations of the preliminary engineering design. Exact locations would be determined when each well site is surveyed during future design phases. The SFPUC's site plans are flexible; however, any changes in future design phases would be made within the identified construction area boundary for each site.

Site 1: Lake Merced Golf Club

Layout Type	Well plus chemical treatment facility
Pump Type	Aboveground vertical turbine
Proposed Water Connection	SFPUC
Pipeline length	125 feet
Alternate Water Connection	Daly City
Pipeline length	175 feet
Storm Drains & Sanitary Sewer pipelines	120 feet
Pavement Size	1,280 square feet
Building Size	1,480 square feet

Site 1 would be located in Daly City on the northeast corner of the Lake Merced Golf Club west of Interstate 280 (I-280) on land owned by the Golf Club. The site layout is shown in Figure 3-11. The proposed Project includes a new production well and continued operation of an existing water quality monitoring well. The existing restroom located on the well facility site would be demolished. The SFPUC would financially compensate the Lake Merced Golf Club for the loss of the restroom. The treatment processes at the site would include disinfection, fluoridation, and pH adjustment.

Electrical power would be provided to the site by connecting to existing PG&E overhead electric lines that traverse the site. Temporary construction access and permanent access to Site 1 would be from Poncetta Drive and an existing on-site access driveway. No new access improvements would be required.

Site 2: Park Plaza Meter

Layout Type	Well with fenced enclosure
Pump Type	Submersible vertical turbine
Proposed Water Connection	Daly City
Pipeline Length	315 feet
Alternate Water Connection	None
Storm Drains	125 feet
Pavement Size	612 square feet
Building Size	N/A

Site 2 would be located near the southwest portion of Lake Merced Golf Club, east of Park Plaza Drive, in Daly City on SFPUC property. The site layout is shown in Figure 3-12. The proposed Project at Site 2 includes conversion of an existing test well to a production well and continued operation of an existing water quality monitoring well. No on-site treatment processes are proposed, because extracted groundwater would be conveyed to the Westlake Pump Station for disinfection and fluoridation via existing pipelines. Figure 3-13

shows the location of Daly City's Westlake Pump Station relative to Site 2.



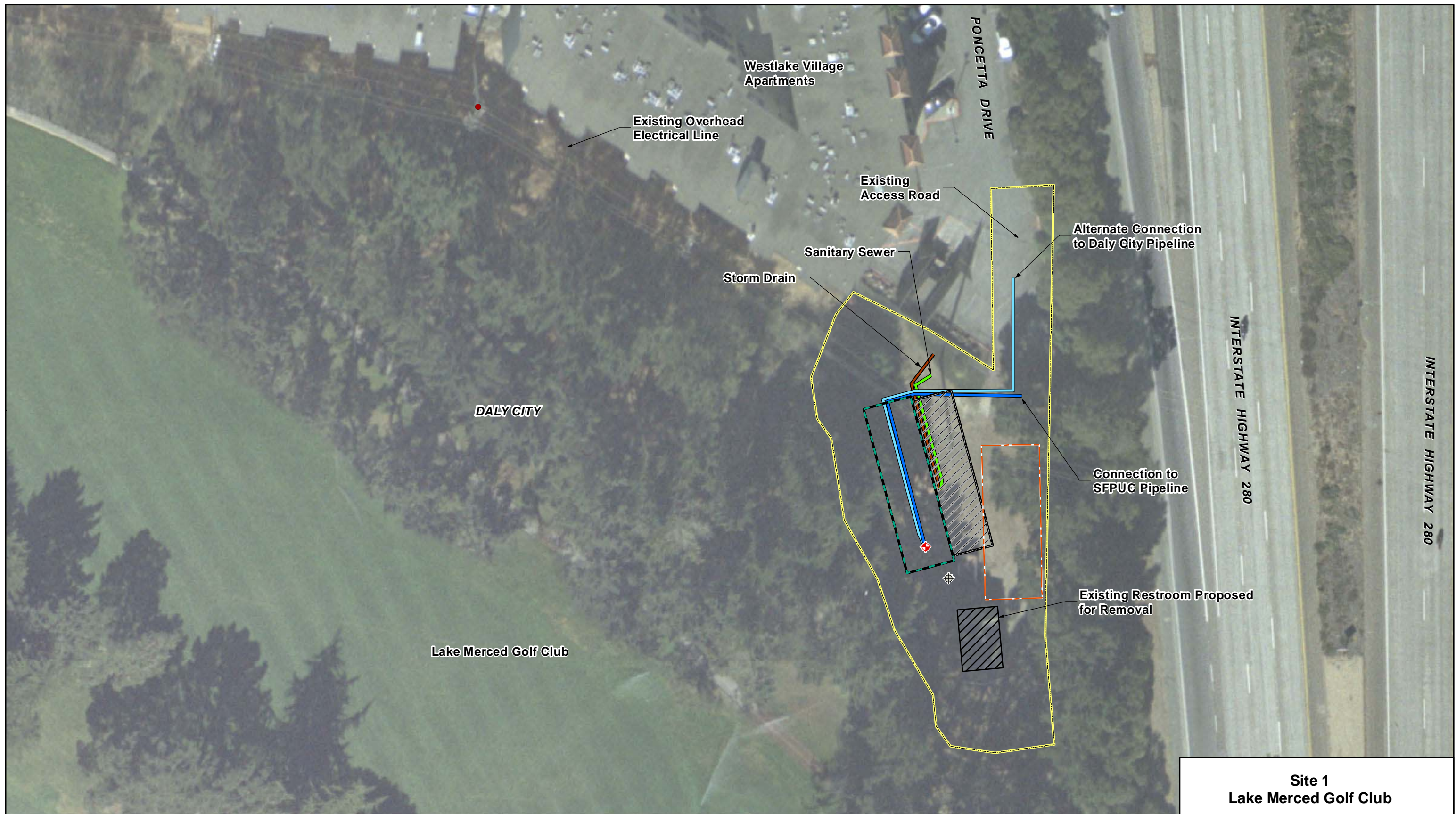









Electrical power would be provided to Site 2 through a new underground connection to an existing PG&E power pole located approximately 40 feet to the north. Temporary construction access and permanent site access would be from an existing golf club access road off of Park Plaza Drive. The on-site access driveway would be improved from the existing golf club road to the well facility.



**Site 1
Lake Merced Golf Club**

**Regional Groundwater Storage
and Recovery Project**

Legend

-  Proposed Well
-  Proposed Connection (Water)
-  Construction Area Boundary
-  Existing Restroom
-  Existing Monitoring Well
-  Proposed Alternate Connection (Water)
-  Staging Area Boundary
-  Existing PG&E Power Pole
-  Proposed Sanitary Sewer
-  Proposed Chemical Treatment Building
-  Proposed Storm Drain
-  Proposed Footprint of Other Permanent Areas (Concrete, Parking, etc.)

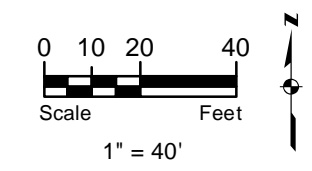
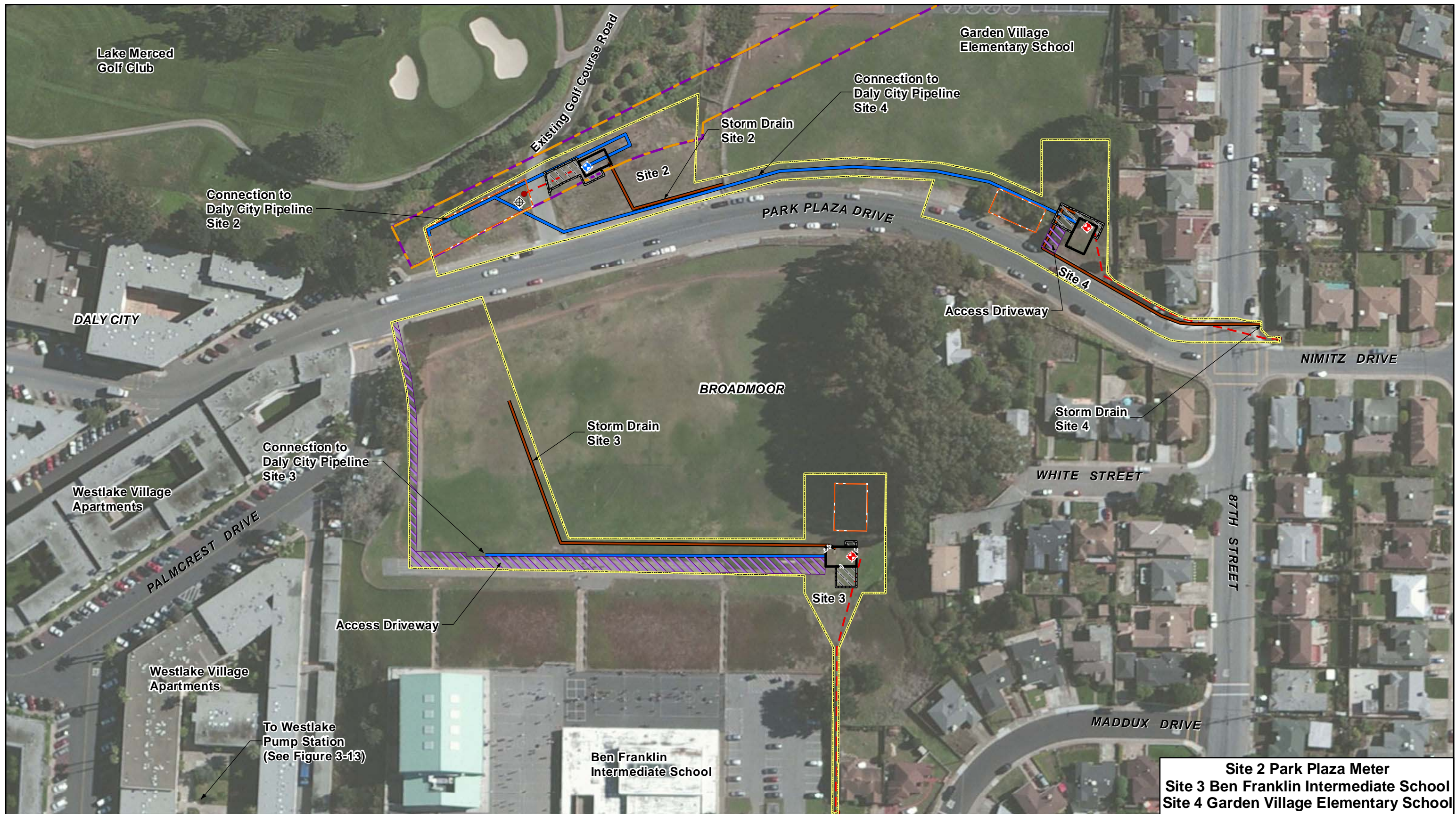

Figure 3-11

Source: SFPUC and Kennedy/Jenks

This page left intentionally blank



Site 2 Park Plaza Meter
 Site 3 Ben Franklin Intermediate School
 Site 4 Garden Village Elementary School

Legend

	Proposed Well		Proposed Underground Electrical		Construction Area Boundary		Proposed Fenced Enclosure
	Existing Test Well		Proposed Connection (Water)		Staging Area Boundary		Proposed Footprint of Other Permanent Areas (Concrete, Parking, etc.)
	Existing Monitoring Well		Proposed Storm Drain		SFPUC Property Boundary		Proposed Access Driveway
	Existing PG&E Power Pole						

Scale Feet
 1" = 100'

Source: SFPUC and Kennedy/Jenks

Figure 3-12

This page left intentionally blank



Westlake Pump Station Upgrades

Regional Groundwater Storage and Recovery Project

Figure 3-13

Legend

Proposed Well	Proposed Underground Electrical	Construction Area Boundary	Proposed Fenced Enclosure
Existing Test Well	Proposed Connection (Water)	Staging Area Boundary	Proposed Footprint of Other Permanent Areas (Concrete, Parking, etc.)
Existing Monitoring Well	Proposed Storm Drain	SFPUC Property Boundary	Proposed Temporary Access Driveway
Existing PG&E Power Pole			

Scale Feet

 1" = 200'

Source: SFPUC and Kennedy/Jenks

This page left intentionally blank

Site 3: Ben Franklin Intermediate School

Layout Type	Well with fenced enclosure
Pump Type	Submersible vertical turbine
Proposed Water Connection	Daly City
Pipeline Length	375 feet
Alternate Water Connection	None
Storm Drains	470 feet
Pavement Size	612 square feet
Building Size	N/A

Site 3 would be located in Broadmoor in unincorporated San Mateo County, west of Park Plaza Drive on property owned by the Jefferson Elementary School District. The site layout is shown in Figure 3-12. The site would be located on the southwest portion of an athletic field at Ben Franklin Intermediate School. The proposed Project at Site 3 includes a new production well. No on-site

treatment processes are proposed, because extracted groundwater would be conveyed via existing pipelines to the Westlake Pump Station for disinfection and fluoridation. Figure 3-13 shows the location of Daly City's Westlake Pump Station relative to Site 3.

Electrical power to Site 3 would be via a new underground connection to an existing PG&E power pole located approximately 150 feet to the west.

The well facility would be constructed over two summers, when the neighboring schools are not in session. Temporary construction access and permanent access to Site 3 would follow the route shown on Figure 3-12 from Park Plaza Drive along the path at the northern edge of the athletic field and along the running track at Ben Franklin School. No permanent access improvements are proposed, other than restoration of the path and running track to at least their general pre-existing conditions at the completion of each construction season. The existing baseball backstop would be repaired or replaced and the turf along the pipeline route would be replaced following construction. The SFPUC would notify the Jefferson Elementary School District of construction activities a minimum of nine months in advance of any construction on school grounds to allow the District to plan for school ground closures. Prior to the start of the school year, the SFPUC would restore the site for school use.

Site 4: Garden Village Elementary School

Layout Type	Well with Fenced Enclosure
Pump Type	Submersible Vertical Turbine
Proposed Water Connection	Daly City
Pipeline Length	670 feet
Alternate Water Connection	None
Storm Drains	330 feet
Pavement Size	612 square feet
Building Size	N/A

Site 4 would be located in Broadmoor in unincorporated San Mateo County, east of Park Plaza Drive, on property owned by San Mateo County. The site layout is shown in Figure 3-12. Site 4 is adjacent to the playing field of the Garden Village Elementary School and single-family residences. The proposed Project at Site 4 includes a new production well. No on-site

treatment processes are proposed, because the extracted groundwater would be conveyed via existing pipelines to the Westlake Pump Station for disinfection and fluoridation. Figure 3-13 shows the location of Daly City's Westlake Pump Station relative to Site 4.

Electrical power to Site 4 would be via a new underground connection to an existing PG&E power pole located approximately 270 feet to the southwest.

An existing baseball backstop would be temporarily relocated during construction; after construction is complete it would be returned to its original location. Turf along the pipeline route would be replaced following construction. The SFPUC would notify the Jefferson Elementary School District of construction activities a minimum of nine months in advance of any construction on school grounds to allow the District to plan for any partial school ground closures.

Temporary construction access and permanent access would be from Park Plaza Drive. The on-site driveway would be improved from Park Plaza Drive to the well facility.

Westlake Pump Station Upgrade

The existing Westlake Pump Station is owned and operated by the City of Daly City. It is located partially in Daly City and partially in unincorporated San Mateo County, south of Coronado Avenue, on property owned by the City of Daly City. The site is shown in Figure 3-13. The Westlake Pump Station is adjacent to the back (west) of the Ben Franklin Intermediate School and multi-family residences. The existing Westlake Pump Station site includes an existing well and treatment facilities (disinfection and fluoridation), and serves as a corporation yard for the Daly City Water and Wastewater Resources Department.

The proposed Project includes upgrades to the Westlake Pump Station to serve the well facilities at Sites 2, 3, and 4, including new fluoride, chlorine, and ammonia chemical storage tanks, replaced or upgraded chemical metering pumps, a resized transformer, and up to three new booster pumps to deliver the additional water into the Daly City distribution system. All Project facilities would be located within the existing pump station building.

Temporary construction access and permanent access would be from Coronado Avenue, from an existing driveway through the Westlake Apartments and from an existing on-site driveway within the Westlake Pump Station. No new access improvements would be required.

Sites 5, 6, and 7: Right-of-Way at Serra Bowl, Right-of-Way at Colma BART, and Right-of-Way at Colma Boulevard

Sites 5, 6, and 7 would be located in close proximity to one another in southern Daly City and northern Colma. The SFPUC proposes consolidated treatment at Site 6, meaning that groundwater from Sites 5 and 7 would be conveyed to a centralized treatment facility at Site 6, which is the SFPUC's preferred configuration for the Project. However, the SFPUC has also identified an option to construct on-site treatment facilities at each of Sites 5, 6, and 7 as a contingency in case consolidating treatment at Site 6 is found to be infeasible due to, for example, the difficulty of constructing the pipelines from Sites 5 or 7 to Site 6 due to the presence of existing underground infrastructure or other currently unforeseen underground constraints. If so, then on-site treatment at Sites 5 or 7 may be needed. The decision to construct on-site treatment facilities, rather than consolidated treatment at Site 6, would occur prior to construction at any of the three sites and would be based on site constraints.

The facilities necessary at each site for both the consolidated and on-site treatment options are discussed in detail below. The facilities necessary at each site for the consolidated treatment option are illustrated on Figures 3-14 through 3-17. Figure 3-14 illustrates Sites 5, 6, and 7 together with consolidated treatment at Site 6, and Figures 3-15 through 3-17 illustrate the individual sites. Figure 3-18 illustrates Sites 5, 6, and 7 with on-site treatment, and Figures 3-19 through 3-21 illustrate the individual sites. The figures are located following the discussion of each option.

Sites 5, 6, and 7 with Consolidated Treatment at Site 6

With consolidated treatment at Site 6, Sites 5 and 7 would have only a fenced enclosure and would convey groundwater via new pipelines to Site 6 for treatment. This is the SFPUC's preferred configuration for the Project. However, due to the potential for currently unforeseen underground constraints, this configuration may not be technically feasible.

Site 5 (Consolidated Treatment at Site 6): Right-of-Way at Serra Bowl

Layout Type	Well with fenced enclosure
Pump Type	Submersible vertical turbine
Proposed Water Connection	See Site 6
Alternate Water Connection	See Site 6
Pipeline to Site 6	1,120 feet
Storm Drains	370 feet
Pavement Size	1,955 square feet
Building Size	N/A

Site 5 (Consolidated Treatment at Site 6) would be located south of B Street between Junipero Serra Boulevard and Hill Street in Daly City on SFPUC property. The site would be adjacent to the Serra Bowl parking lot, commercial uses, and a single-family residence. The site layout is shown on Figure 3-15. The proposed Project at Site 5

(Consolidated Treatment at Site 6) includes conversion of an existing test well to a production well and continued use of an existing water quality monitoring well. Water from Site 5 (Consolidated Treatment at Site 6) would be conveyed to Site 6 for treatment before addition of the water to the SFPUC distribution system. Treatment facilities at Site 6 include disinfection, pH adjustment, fluoridation, and iron/manganese removal.

Electrical power would be provided to the site through a new underground connection to an existing PG&E power pole located approximately 200 feet to the north.

Temporary construction access and permanent access to Site 5 (Consolidated Treatment at Site 6) would be from B Street, via an existing driveway. The on-site access driveway would be improved from B Street to the well facility.

This page left intentionally blank

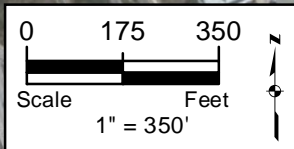
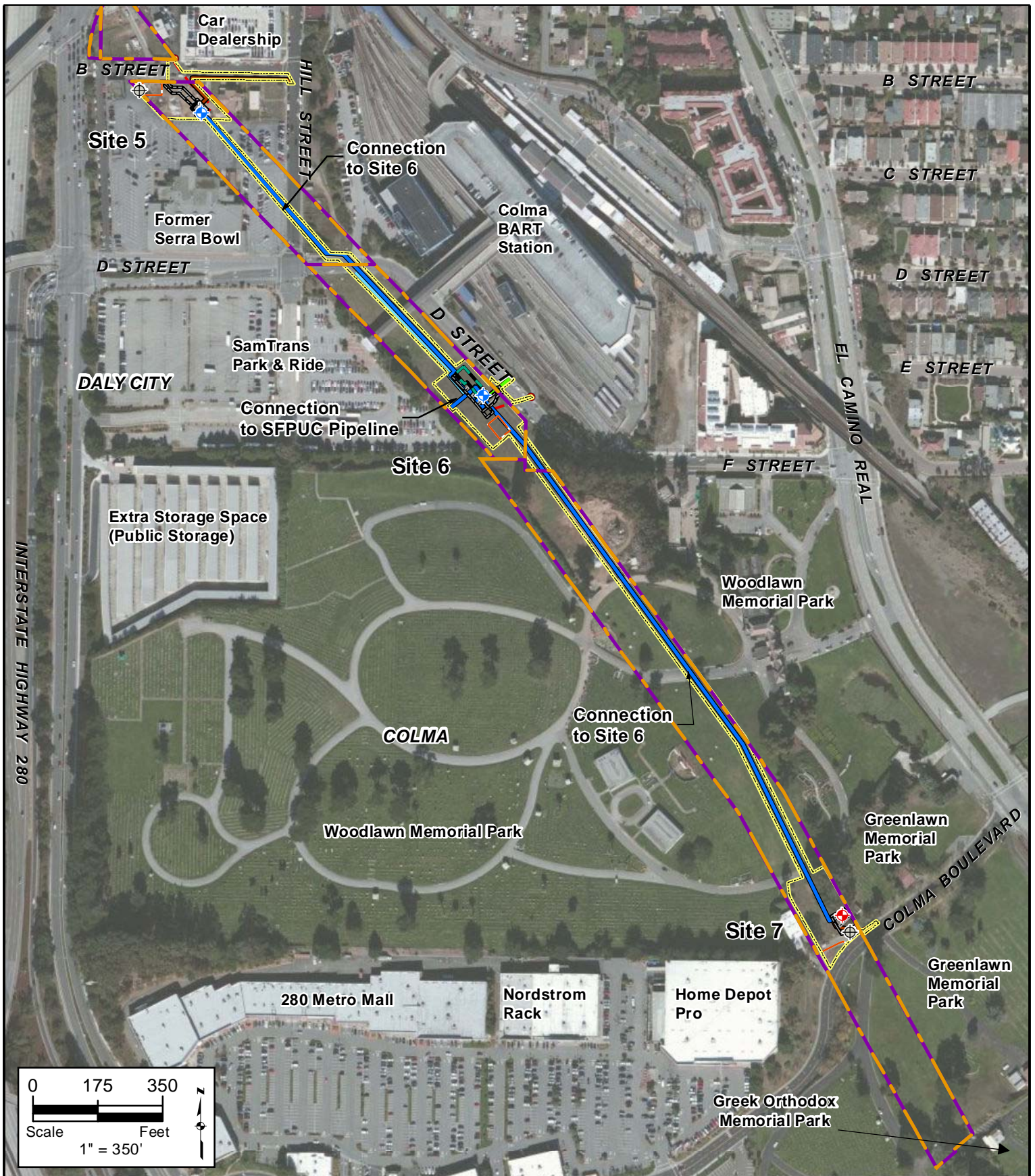

Legend	
	Proposed Well
	Existing Test Well
	Existing Monitoring Well
	Existing PG&E Power Pole
	Proposed Underground Electrical
	Proposed Connection (Water)
	Proposed Alternate Connection (Water)
	Proposed Sanitary Sewer
	Proposed Storm Drain
	Construction Area Boundary
	Staging Area Boundary
	SFPUC Property Boundary
	Proposed Fenced Enclosure (Sites 5 & 7)
	Proposed Chemical Treatment & Filtration Building (Site 6)
	Proposed Footprint of Other Permanent Areas (Concrete, Parking, etc.)

Sites 5, 6, & 7
Consolidated Treatment at Site 6

Regional Groundwater Storage and Recovery Project

Figure 3-14

This page left intentionally blank

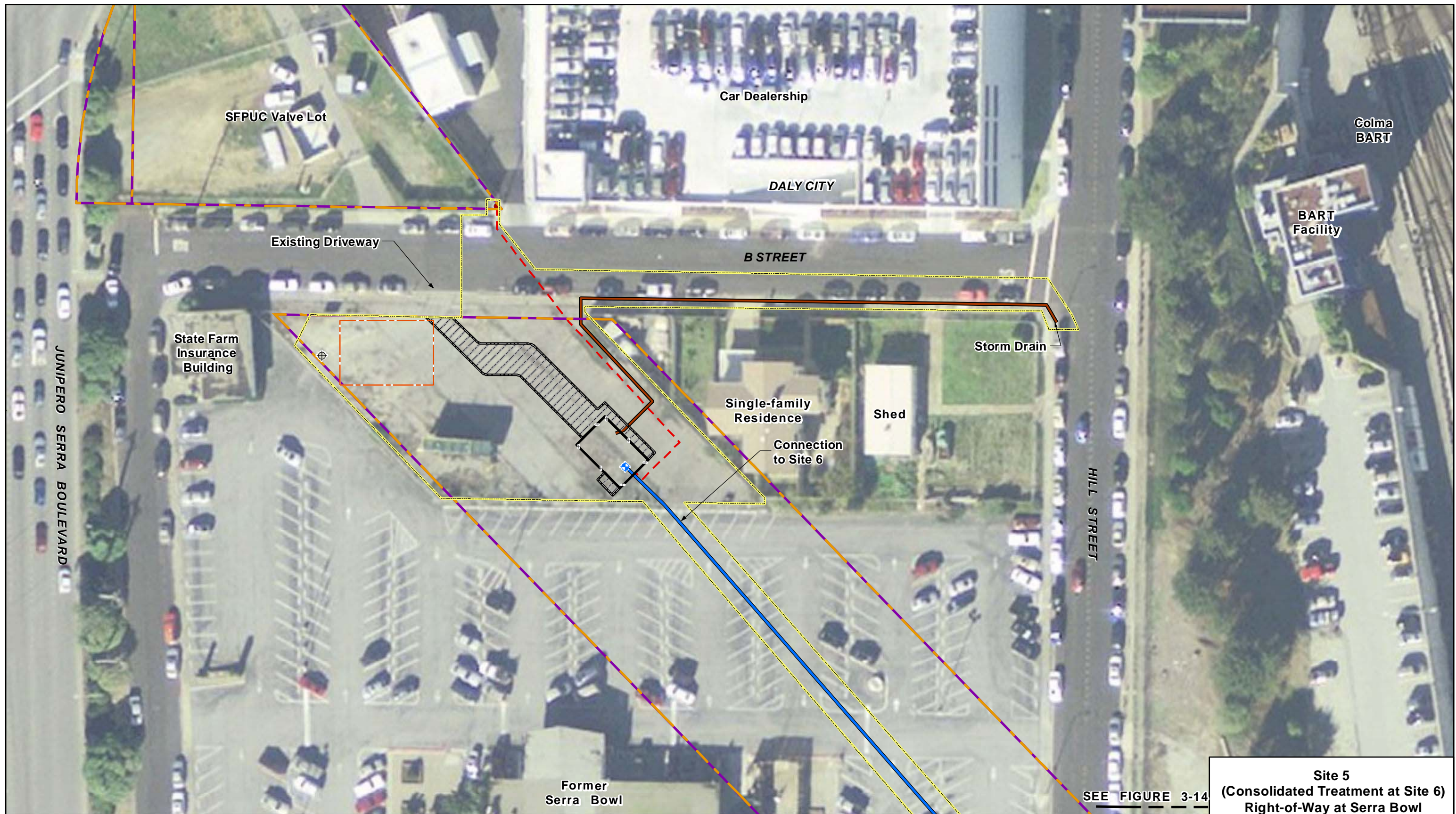

SEE FIGURE 3-14

**Site 5
(Consolidated Treatment at Site 6)
Right-of-Way at Serra Bowl**

Legend			
Existing Test Well	Proposed Underground Electrical	Construction Area Boundary	Proposed Fenced Enclosure
Existing Monitoring Well	Proposed Connection (Water)	Staging Area Boundary	Proposed Footprint of Other Permanent Areas (Concrete, Parking, etc.)
Existing PG&E Power Pole	Proposed Storm Drain	SFPUC Property Boundary	

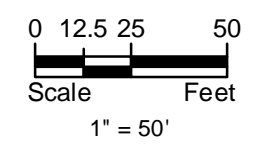

**Regional Groundwater Storage
and Recovery Project**

Figure 3-15

Source: SFPUC and Kennedy/Jenks

This page left intentionally blank

Site 6 (Consolidated Treatment at Site 6): Right-of Way at Colma BART

Layout Type	Well plus chemical treatment and filtration facility
Pump Type	Aboveground vertical turbine
Proposed Water Connection	SFPUC
Pipeline Length	115 feet
Alternate Water Connection	Cal Water
Pipeline Length	525 feet
Sanitary Sewer & Storm Drain Pipelines	240 feet
Pavement Size	3,535 square feet
Building Size	2,990 square feet

Site 6 (Consolidated Treatment at Site 6) would be located west of D Street across from the Colma Bay Area Rapid Transit (BART) Station in Daly City on SFPUC property. The site layout is illustrated in Figure 3-16. The proposed Project at Site 6 (Consolidated Treatment at Site 6) includes conversion of an existing test well to a production well. Treatment at Site 6 (Consolidated Treatment at Site 6) includes disinfection, pH adjustment, fluoridation, and iron and/or manganese removal.

Electrical power would be provided to the site through a new underground connection to an existing PG&E power pole located approximately 135 feet to the east.

Temporary construction access and permanent access would be from D Street. A new on-site driveway would be constructed from D Street to the well facility. There would be a permanent loss of two on-street parking spaces on D Street to accommodate the new driveway.

Site 7 (Consolidated Treatment at Site 6): Right-of Way at Colma Boulevard

Layout Type	Well with fenced enclosure
Pump Type	Submersible vertical turbine
Proposed Water Connection	See Site 6
Pipeline to Site 6	1,780 feet
Alternate Water Connection	See Site 6
Storm Drains	170 feet
Pavement Size	612 square feet
Building Size	N/A

Site 7 (Consolidated Treatment at Site 6) would be located north of Colma Boulevard in Colma on SFPUC property. The site layout is illustrated in Figure 3-17. The site would be adjacent to a maintenance building and an unoccupied mausoleum for the Greenlawn Memorial Park and behind the Woodlawn Memorial Park and a Home Depot Pro store.

The proposed Project at Site 7 (Consolidated Treatment at Site 6) includes a new production well and continued operation of an existing water quality monitoring well. Water from the site would be conveyed to Site 6 for treatment prior to addition to the SFPUC distribution system. Treatment at Site 6 includes disinfection, pH adjustment, fluoridation, and iron/manganese removal.

Electrical power would be provided to the site through a new underground connection to an existing PG&E power pole located approximately 200 feet to the southeast.

Temporary construction access and permanent access to the site would be from Colma Boulevard and an existing driveway that serves the Greenlawn Memorial Park maintenance building. A new on-site driveway would be improved from the maintenance building driveway to the well facility.

This page left intentionally blank

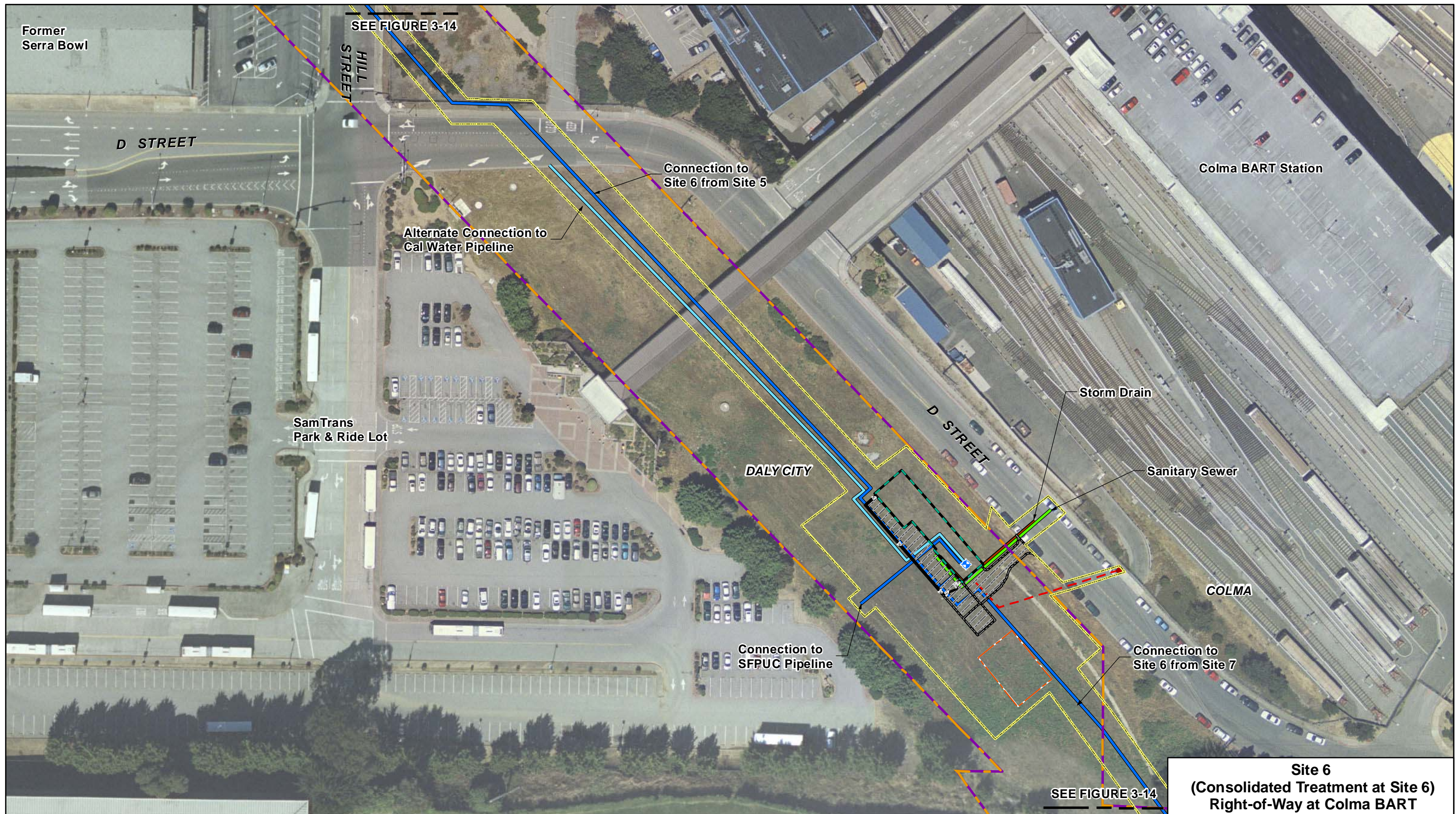

**Site 6
(Consolidated Treatment at Site 6)
Right-of-Way at Colma BART**

Legend

Existing Test Well	Proposed Connection (Water)	Construction Area Boundary	Proposed Chemical Treatment and Filtration Building
Existing PG&E Power Pole	Proposed Alternate Connection (Water)	Staging Area Boundary	Proposed Footprint of Other Permanent Areas (Concrete, Parking, etc.)
Proposed Underground Electrical	Proposed Sanitary Sewer	SFPUC Property Boundary	
Proposed Fence	Proposed Storm Drain		

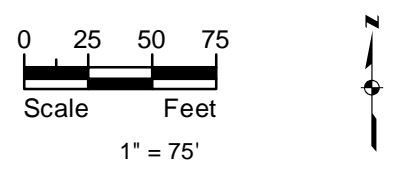

Source: SFPUC and Kennedy/Jenks

Figure 3-16

Regional Groundwater Storage and Recovery Project

This page left intentionally blank



**Site 7
(Consolidated Treatment at Site 6)
Right-of-Way at Colma Blvd.**

Legend				
Proposed Well	Proposed Underground Electrical	Construction Area Boundary	Proposed Fenced Enclosure	
Existing Monitoring Well	Proposed Connection (Water)	Staging Area Boundary	Proposed Footprint of Other Permanent Areas (Concrete, Parking, etc.)	
Existing PG&E Power Pole	Proposed Storm Drain	SFPUC Property Boundary		

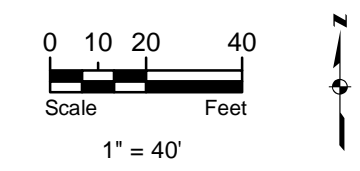

**Regional Groundwater Storage
and Recovery Project**

Figure 3-17

Source: SFPUC and Kennedy/Jenks

This page left intentionally blank

Sites 5, 6, and 7 with On-site Treatment

The Project includes an option for on-site treatment at Sites 5, 6, and 7. With on-site treatment, Sites 5 and 7 would not be connected to Site 6. If consolidated treatment at Site 6 (the SFPUC's preferred configuration for the Project) is found to be infeasible due to, for example, the difficulty of constructing the pipelines from Sites 5 or 7 to Site 6 due to the presence of existing underground infrastructure or other currently unforeseen constraints, then on-site treatment at Sites 5 or 7 may be needed. Figure 3-18 illustrates Sites 5, 6 and 7 with on-site treatment. Treatment at individual sites is illustrated on Figures 3-19 through 3-21.

Site 5 (On-site Treatment): Right-of-Way at Serra Bowl

Layout Type	Well plus chemical treatment and filtration facility
Pump Type	Aboveground vertical turbine
Proposed Water Connection	SFPUC
Pipeline Length	145 feet
Alternate Water Connection	Daly City
Pipeline Length	165 feet
Sanitary Sewer & Storm Drains	470 feet
Pavement Size	1,955 square feet
Building Size	2,095 square feet

Site 5 (On-site Treatment) would be located south of B Street between Junipero Serra Boulevard and Hill Street in Daly City on SFPUC property. The site would be adjacent to the Serra Bowl parking lot, a commercial office, and a single-family residence. The site layout is shown on Figure 3-19. The proposed Project at Site 5 (On-site Treatment) includes conversion of an existing test well to a production well and the continued use of an existing water quality monitoring well. Treatment facilities at Site 5 (On-site Treatment) would include disinfection, pH adjustment, fluoridation, and iron/manganese removal.

Electrical power would be provided to the site through a new underground connection to an existing PG&E power pole located approximately 200 feet to the north.

Temporary construction access and permanent access would be from B Street via an existing driveway. The on-site driveway would be improved from B Street to the well facility.

This page left intentionally blank

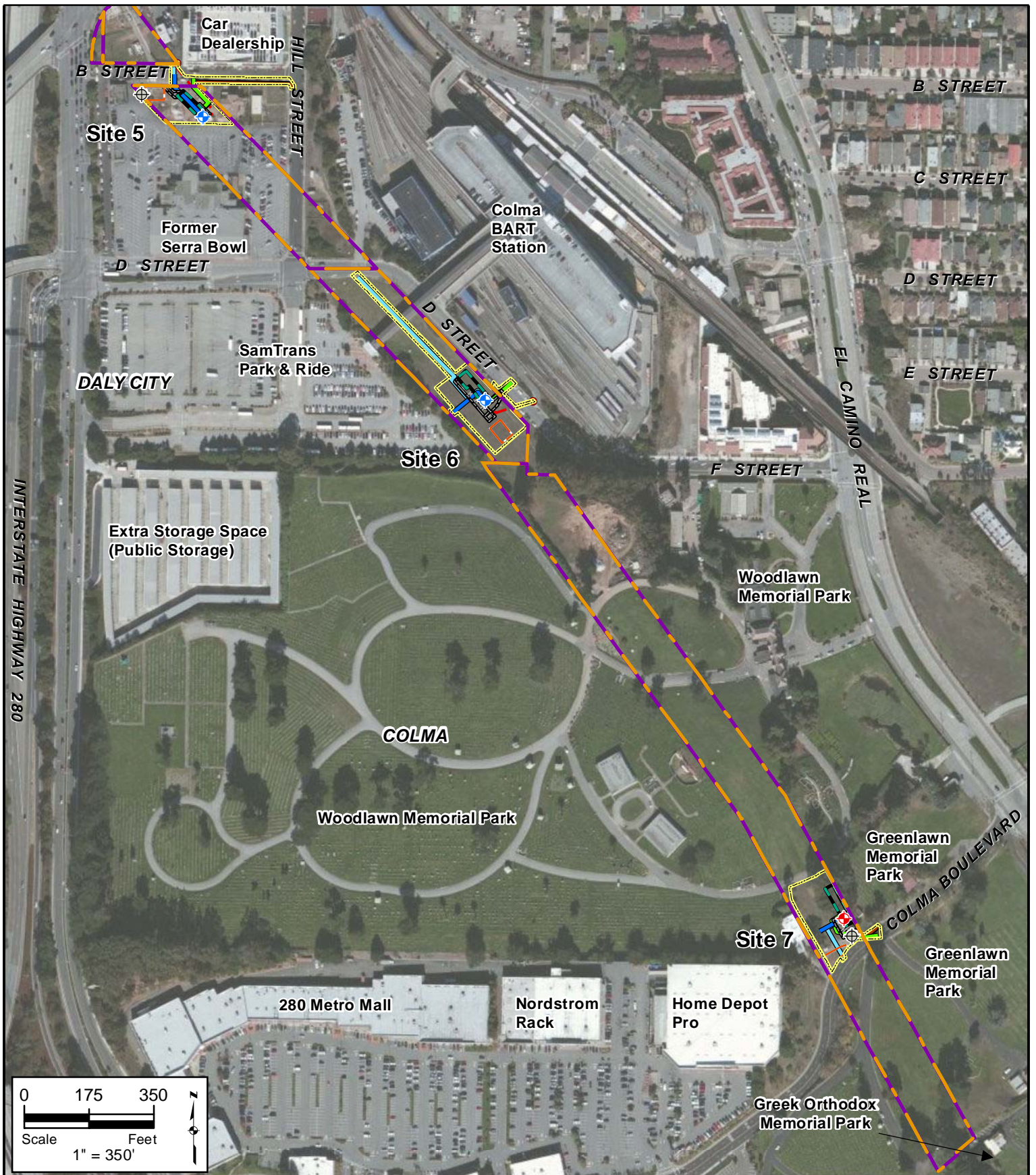

Legend	
	Proposed Well
	Existing Test Well
	Existing Monitoring Well
	Existing PG&E Power Pole
	Proposed Underground Electrical
	Proposed Connection (Water)
	Proposed Alternate Connection (Water)
	Proposed Sanitary Sewer
	Proposed Storm Drain
	Construction Area Boundary
	Staging Area Boundary
	SFPUC Property Boundary
	Proposed Chemical Treatment & Filtration Building
	Proposed Footprint of Other Permanent Areas (Concrete, Parking, etc.)

**Sites 5, 6, & 7
(On-site Treatment)**

**Regional Groundwater Storage
and Recovery Project**

Figure 3-18

Source: SFPUC and Kennedy/Jenks

This page left intentionally blank

This page left intentionally blank

Site 6 (On-site Treatment): Right-of Way at Colma BART

Layout Type	Well plus chemical treatment and filtration facility
Pump Type	Aboveground vertical turbine
Proposed Water Connection	SFPUC
Pipeline Length	115 feet
Alternate Water Connection	Cal Water
Pipeline Length	525 feet
Sanitary Sewer & Storm Drains	240 feet
Pavement Size	3,535 square feet
Building Size	2,095 square feet

Site 6 (On-site Treatment) would be located west of D Street across from the Colma BART Station in Daly City on SFPUC property. The site layout is illustrated in Figure 3-20. The proposed Project at Site 6 (On-site Treatment) includes conversion of an existing test well to a production well. Treatment at Site 6 (On-site Treatment) would include disinfection, pH adjustment, fluoridation, and iron/manganese removal.

Electrical power would be provided to the site through a new underground connection to an existing PG&E power pole located approximately 135 feet to the east.

Temporary construction access and permanent access would be from D Street. A new on-site driveway would be constructed from D Street to the well facility. There would be a permanent loss of two on-street parking spaces to accommodate the new driveway.

Site 7 (On-site Treatment): Right-of Way at Colma Boulevard

Layout Type	Well plus chemical treatment and filtration facility
Pump Type	Aboveground vertical turbine
Proposed Water Connection	SFPUC
Pipeline Length	75 feet
Alternate Water Connection	Cal Water
Pipeline Length	145 feet
Sanitary Sewer & Storm Drains	340 feet
Pavement Size	205 square feet
Building Size	2,095 square feet

Site 7 (On-site Treatment) would be located north of Colma Boulevard in Colma on SFPUC property. The site layout is illustrated in Figure 3-21. The site would be adjacent to a maintenance building and unoccupied mausoleum for the Greenlawn Memorial Park and behind the Woodlawn Memorial Park and a Home Depot Pro store. The proposed Project at Site 7 (On-site Treatment) includes a new production well

and continued operation of an existing water quality monitoring well. Treatment facilities at Site 7 (On-site Treatment) would include disinfection, pH adjustment, fluoridation, and iron/manganese removal.

Electrical power would be provided to the site through a new underground connection to an existing PG&E power pole located approximately 200 feet to the southeast.

Temporary construction access and permanent access to the site would be from Colma Boulevard and an existing driveway that serves the Greenlawn Memorial Park maintenance building. A new on-site driveway would be improved from the maintenance building driveway to the well facility.

This page left intentionally blank

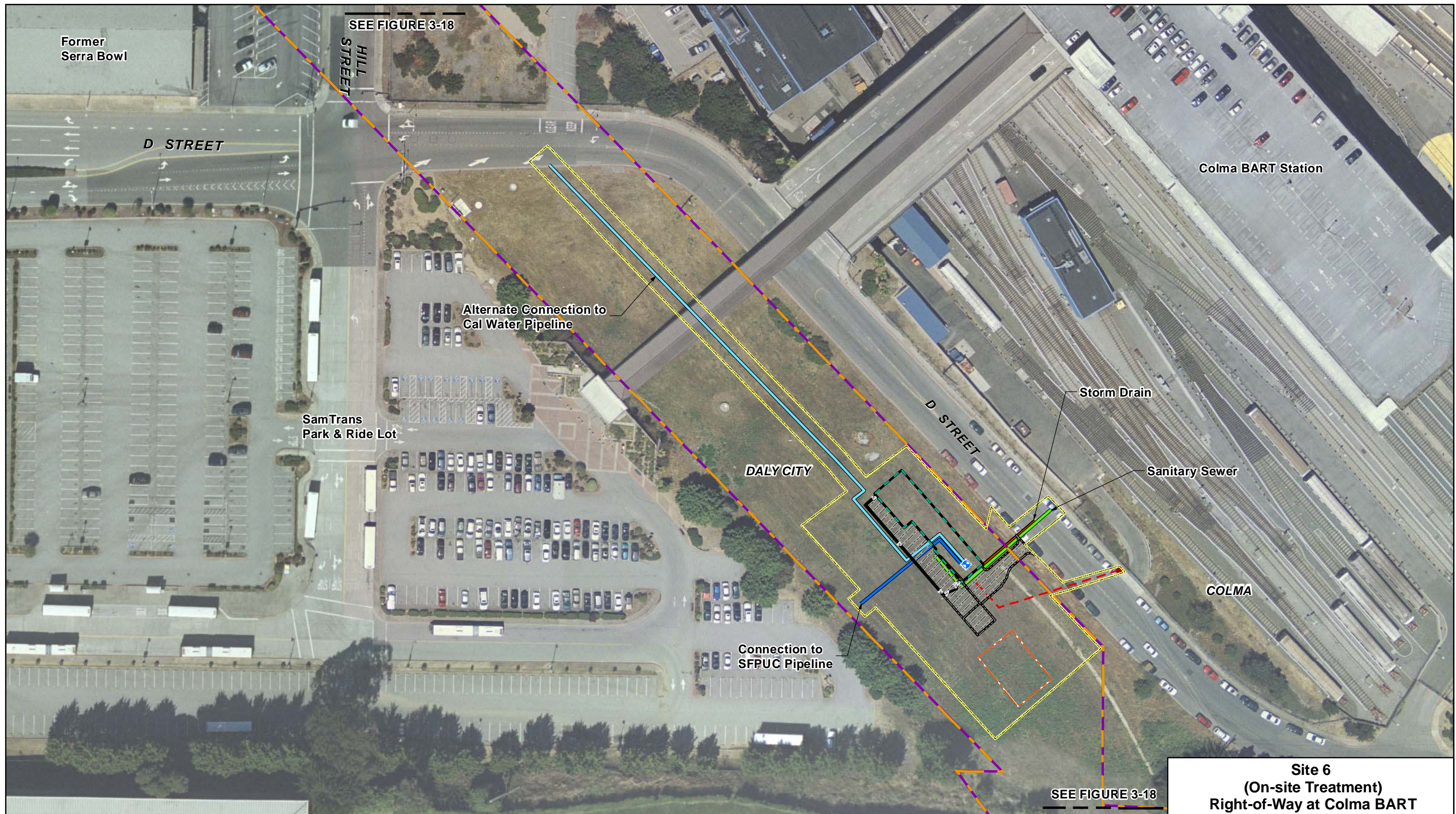

Legend	
Existing Test Well	Proposed Connection (Water)
Existing PG&E Power Pole	Proposed Alternate Connection (Water)
Proposed Underground Electrical	Proposed Sanitary Sewer
Proposed Fence	Proposed Storm Drain
Construction Area Boundary	Staging Area Boundary
SFPUC Property Boundary	Proposed Chemical Treatment and Filtration Building
	Proposed Footprint of Other Permanent Areas (Concrete, Parking, etc.)

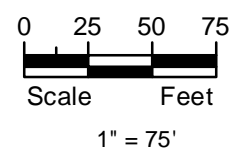

**Site 6
(On-site Treatment)
Right-of-Way at Colma BART**

Regional Groundwater Storage
and Recovery Project

Figure 3-20

Source: SFPUC and Kennedy/Jenks

This page left intentionally blank



**Site 7
(On-site Treatment)
Right-of-Way at Colma Blvd.**

**Regional Groundwater Storage
and Recovery Project**

Figure 3-21

Legend

- | | | | |
|--|---|---|--|
| <ul style="list-style-type: none"> Proposed Well Existing Monitoring Well Existing PG&E Power Pole Proposed Underground Electrical | <ul style="list-style-type: none"> Proposed Connection (Water) Proposed Alternate Connection (Water) Proposed Sanitary Sewer Proposed Storm Drain | <ul style="list-style-type: none"> Construction Area Boundary Staging Area Boundary SFPUC Property Boundary | <ul style="list-style-type: none"> Proposed Chemical Treatment and Filtration Building Proposed Footprint of Other Permanent Areas (Concrete, Parking, etc.) |
|--|---|---|--|

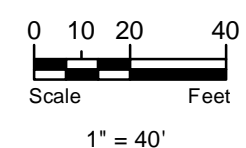

Source: SFPUC and Kennedy/Jenks

This page left intentionally blank

Site 8: Right-of-Way at Serramonte Boulevard

Layout Type	Well plus chemical treatment and filtration facility
Pump Type	Aboveground vertical turbine
Proposed Water Connection	Cal Water
Pipeline Length	145 feet
Alternate Water Connection	SFPUC
Pipeline Length	125 feet
Sanitary Sewer & Storm Drains	305 feet
Pavement Size	2,815 square feet
Building Size	2,095 square feet

Site 8 would be located south of Serramonte Boulevard in Colma on SFPUC property. The site layout is shown on Figure 3-22. The site would be located between Kohl's Department Store and a car dealership. The proposed Project at Site 8 includes conversion of a test well to a production well and continued operation of an existing water quality monitoring well. The treatment processes at the site would include disinfection, pH adjustment (if needed), fluoridation, and iron

and/or manganese removal.

Electrical power would be provided to the site through a new underground connection to an existing PG&E pad-mounted transformer located approximately 170 feet to the east, adjacent to the loading and supply docks for Kohl's Department Store.

Temporary construction access and permanent access would be through the existing Kohl's parking lot off Serramonte Boulevard. A new on-site driveway would be constructed from the edge of the Kohl's parking lot to the well facility.

Site 9: Treasure Island Trailer Court

Layout Type	Well plus chemical treatment and filtration facility
Pump Type	Aboveground vertical turbine
Proposed Water Connection	SFPUC
Pipeline Length	245 feet
Alternate Water Connection	None
Sanitary Sewer & Storm Drains	355 feet
Pavement Size	3,205 square feet
Building Size	2,095 square feet

Site 9 would be located east of the intersection of El Camino Real and Hickey Boulevard in South San Francisco on SFPUC property. The access route and site layout are shown on Figures 3-23 and 3-24. The site would be located adjacent to the Treasure Island trailer court and across the Colma Creek Diversion Channel from residential and commercial land uses. The facility would be elevated above the 100-year flood elevation

level. The proposed Project at Site 9 includes a new production well and continued use of an existing water quality monitoring well. The treatment processes at the site would include disinfection, pH adjustment, fluoridation, and iron and/or manganese removal.

Electrical power would be provided to the site through a new aboveground connection to an existing PG&E power pole located approximately 590 feet east of the site.

Temporary construction access and permanent access would be along an existing San Mateo County Flood Control District (SMCFCD) access road that starts at Mission Road and extends along the Colma Creek Diversion Channel as illustrated on Figure 3-23. The SMCFCD access road is gated and is not open to the public. An on-site driveway would be improved from the SMCFCD access road to the well facility.

This page left intentionally blank



**Site 8
Right-of-Way at Serramonte Blvd.**

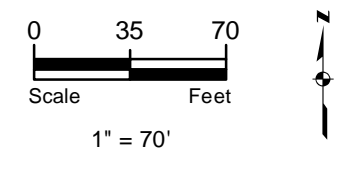
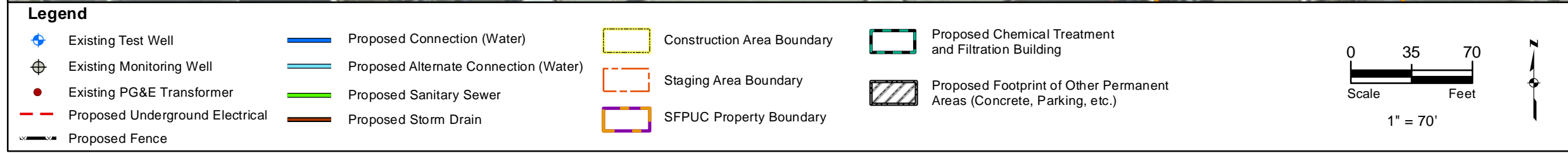

Regional Groundwater Storage and Recovery Project

Figure 3-22

Source: SFPUC and Kennedy/Jenks

This page left intentionally blank



**Site 9 Access Road
Treasure Island Trailer Court**

**Regional Groundwater Storage
and Recovery Project**

Legend

- ◆ Proposed Well
- Proposed Connection (Water)
- Construction Area Boundary
- Staging Area Boundary
- SFPUC Property Boundary
- Proposed Sanitary Sewer
- Proposed Chemical Treatment and Filtration Building
- Proposed Storm Drain
- Proposed Footprint of Other Permanent Areas (Concrete, Parking, etc.)
- ⊕ Existing Monitoring Well
- Proposed Overhead Electrical
- Proposed Fence

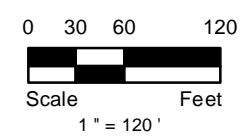
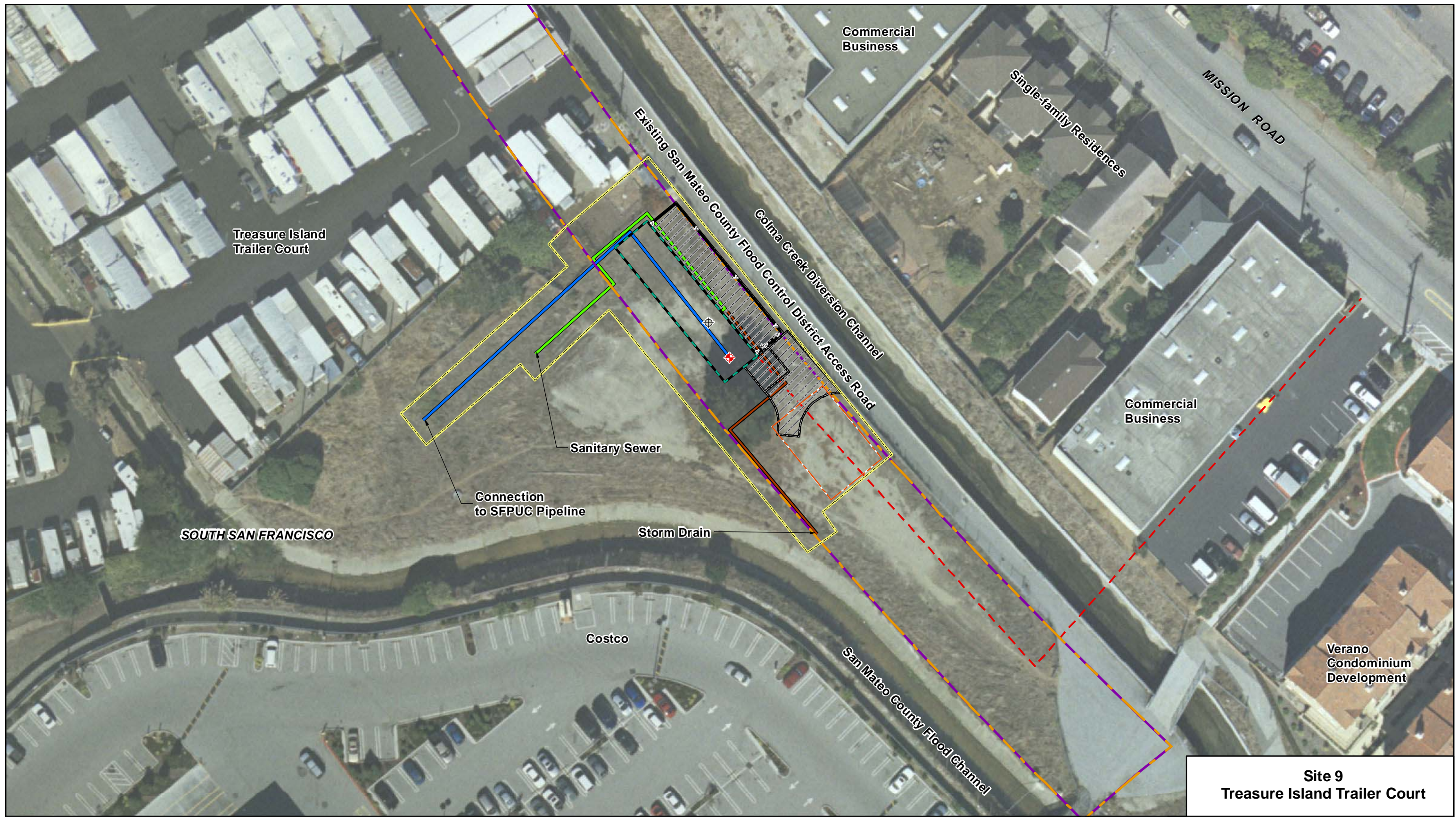

Figure 3-23

Source: SFPUC and Kennedy/Jenks

This page left intentionally blank



**Site 9
Treasure Island Trailer Court**

**Regional Groundwater Storage
and Recovery Project**

Legend

- | | | | | | | | |
|--|------------------------------|--|-----------------------------|--|----------------------------|--|---|
| | Proposed Well | | Proposed Connection (Water) | | Construction Area Boundary | | Proposed Chemical Treatment and Filtration Building |
| | Existing Monitoring Well | | Proposed Sanitary Sewer | | Staging Area Boundary | | Proposed Footprint of Other Permanent Areas (Concrete, Parking, etc.) |
| | Proposed Overhead Electrical | | Proposed Storm Drain | | SFPUC Property Boundary | | |
| | Proposed Fence | | | | | | |

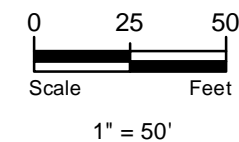

Figure 3-24

This page left intentionally blank

Site 10: Right-of-Way at Hickey Boulevard

Layout Type	Well plus chemical treatment and filtration facility
Pump Type	Aboveground vertical turbine
Proposed Water Connection	Daly City
Pipeline Length	200 feet
Alternate Water Connection	SFPUC
Pipeline Length	100 feet
Sanitary Sewer & Storm Drains	255 feet
Pavement Size	2,995 square feet
Building Size	2,095 square feet

Site 10 would be located south of Hickey Boulevard and west of Camaritas Avenue in South San Francisco on SFPUC property. The site layout is shown on Figure 3-25, and the proposed landscape plan is shown on Figure 3-26. The site would be located across Camaritas Avenue from the Winston Manor Shopping Center. The proposed Project at Site 10 includes conversion of an existing test well to a production well and continued use of an existing water quality monitoring well. Drought tolerant native and or

climate-adapted landscape trees, shrubs, and grasses would be planted around the perimeter of the building when construction is complete. The treatment processes at the site would include disinfection, pH adjustment (if needed), fluoridation, and iron and/or manganese removal.

Electrical power would be provided to the site through a new underground connection to an existing PG&E power pole located approximately 65 feet to the north. Temporary construction access and permanent access to the well facility would be from Camaritas Avenue. A new on-site driveway would be constructed from Camaritas Avenue to the well facility. There would be a permanent loss of two on-street parking spaces on the west side of Camaritas Avenue to accommodate the new driveway.

Site 11: South San Francisco Main Area

Layout Type	Well plus chemical treatment and filtration facility
Pump Type	Aboveground vertical turbine
Proposed Water Connection	Cal Water
Pipeline Length	205 feet
Alternate Water Connection	SFPUC
Pipeline Length	160 feet
Sanitary Sewer & Storm Drains	1,110 feet
Pavement Size	3,675 square feet
Building Size	2,095 square feet

Site 11 would be located east of El Camino Real, north of its intersection with Arroyo Drive, in South San Francisco on SFPUC property. The site layout is shown on Figures 3-27 and 3-28. The site would be adjacent to a BART ventilation structure and a Kaiser Medical Center garage and parking lot. The proposed Project at Site 11 includes a new production well and continued use of an existing water quality monitoring well. The treatment processes at the site would include disinfection,

pH adjustment (if needed), fluoridation, and iron and/or manganese removal.

Electrical power would be provided to the site through a new underground connection to an existing PG&E power pole located approximately 75 feet to the east.

Temporary construction access and permanent access would be from an existing BART access road from Antoinette Lane as illustrated on Figure 3-27. An on-site driveway would be improved from the BART access road to the well facility.

This page left intentionally blank

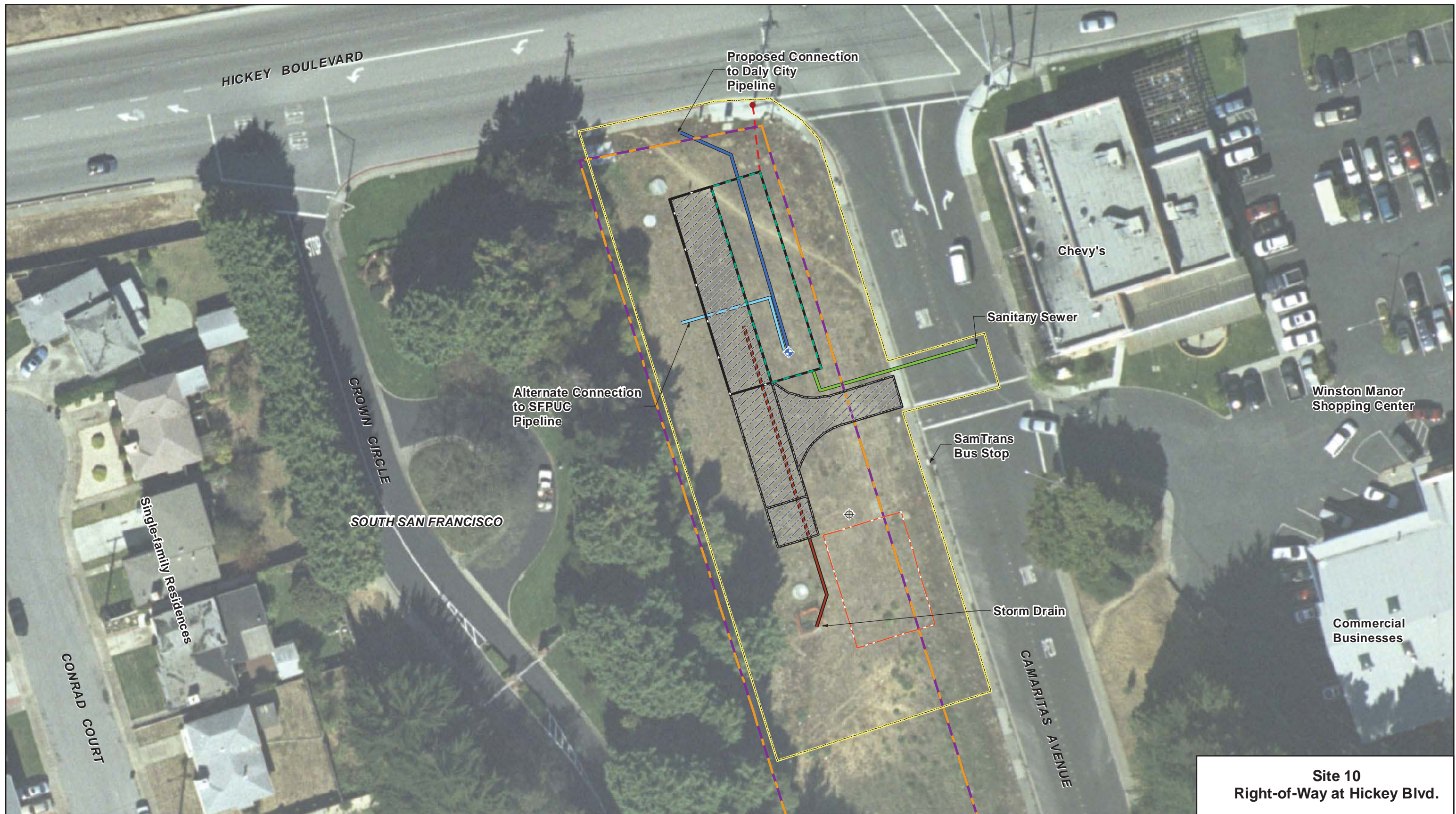

**Site 10
Right-of-Way at Hickey Blvd.**

**Regional Groundwater Storage
and Recovery Project**

Legend

- | | | | |
|---------------------------------|---------------------------------------|----------------------------|---|
| Existing Test Well | Proposed Connection (Water) | Construction Area Boundary | Proposed Chemical Treatment and Filtration Building |
| Existing Monitoring Well | Proposed Alternate Connection (Water) | Staging Area Boundary | Proposed Footprint of Other Permanent Areas (Concrete, Parking, etc.) |
| Existing PG&E Power Pole | Proposed Sanitary Sewer | SFPUC Property Boundary | |
| Proposed Underground Electrical | Proposed Storm Drain | | |
| Proposed Fence | | | |

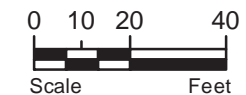

This page left intentionally blank

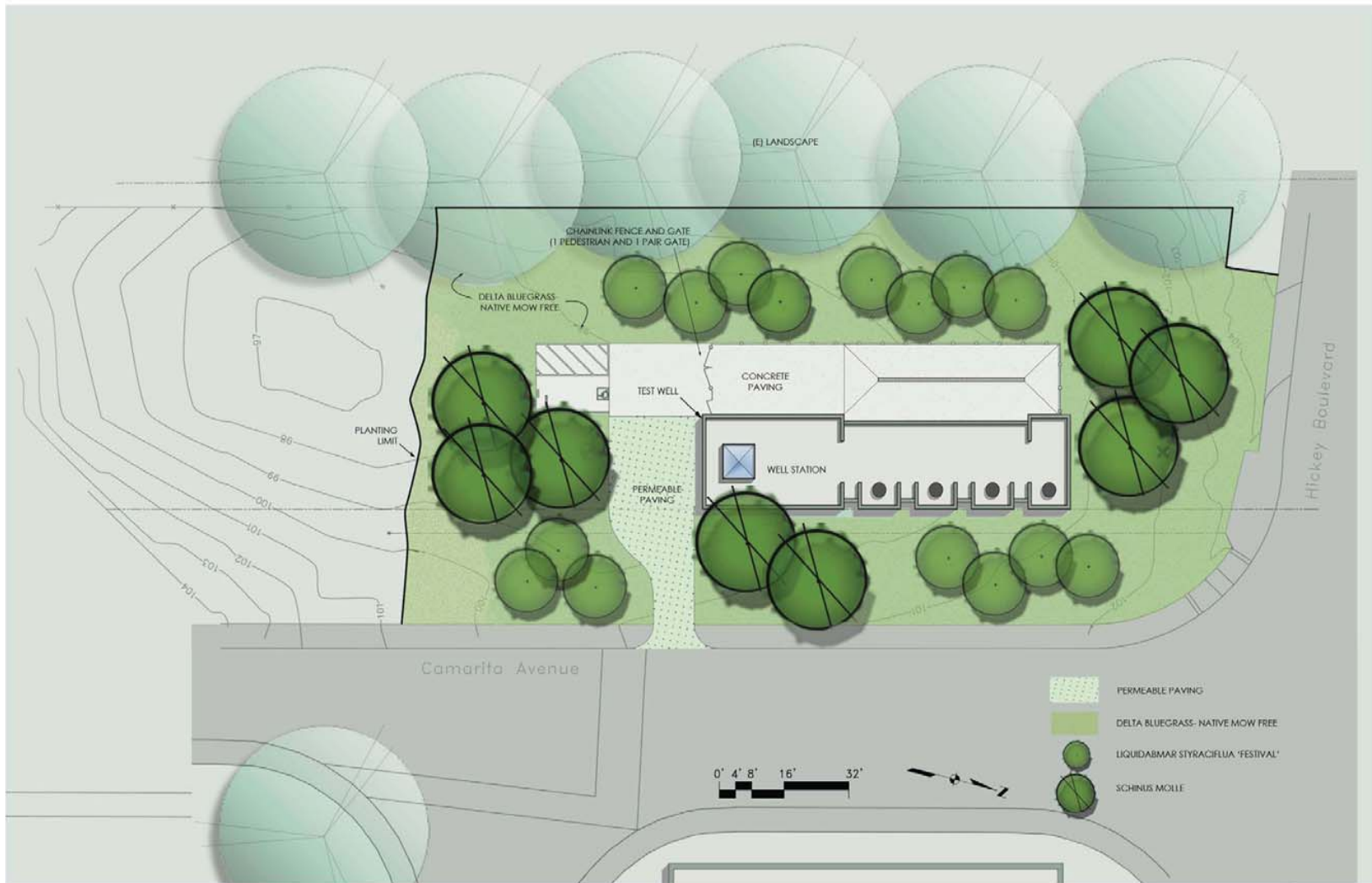

**Site 10
Right-of-way at Hickey Blvd.
Landscape Plan**

Regional Groundwater Storage
and Recovery Project

Figure 3-26

This page left intentionally blank

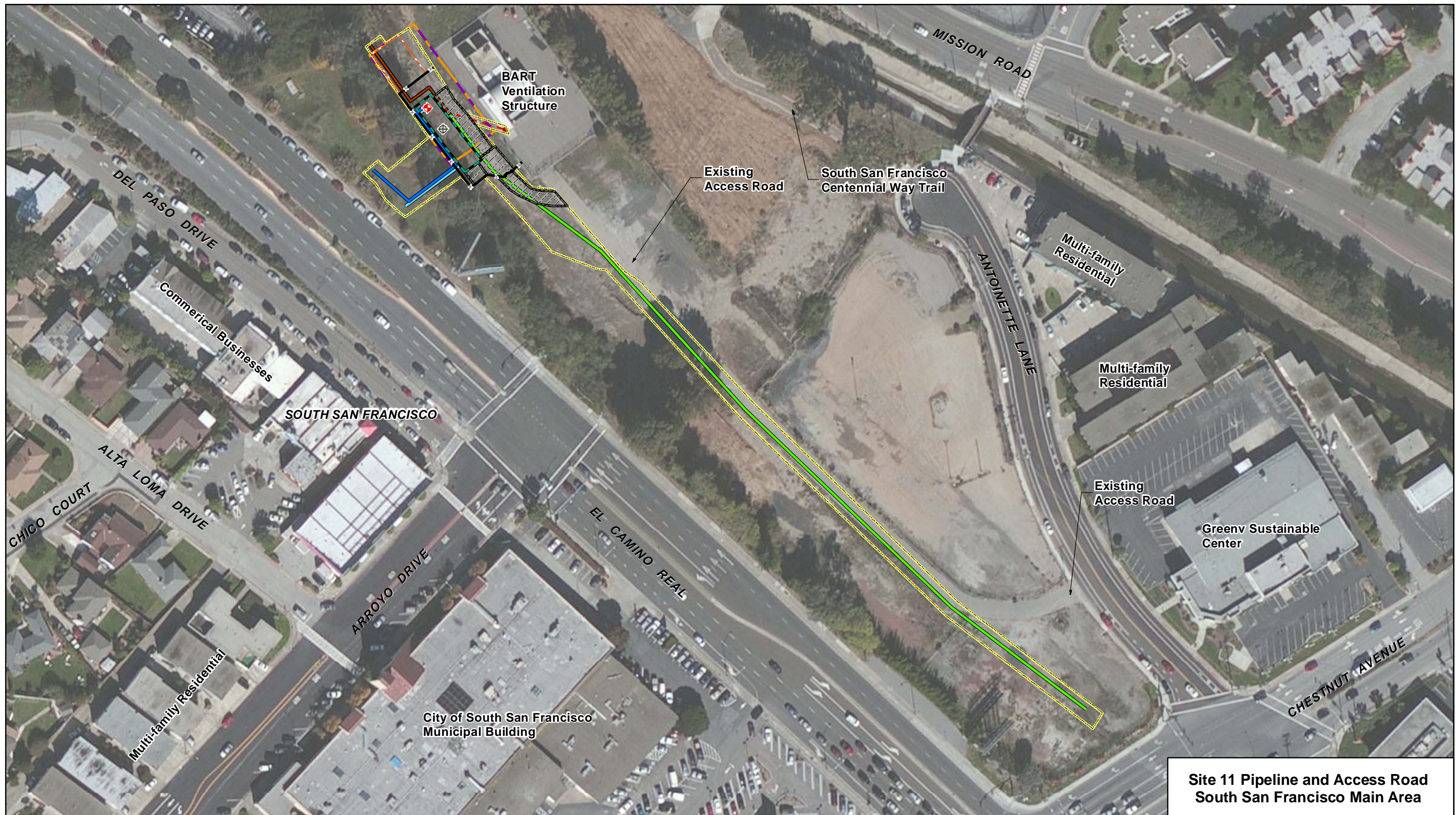

**Site 11 Pipeline and Access Road
South San Francisco Main Area**

Legend			
Proposed Well	Proposed Connection (Water)	Construction Area Boundary	Proposed Chemical Treatment and Filtration Building
Existing Monitoring Well	Proposed Alternate Connection (Water)	Staging Area Boundary	Proposed Footprint of Other Permanent Areas (Concrete, Parking, etc.)
Existing PG&E Power Pole	Proposed Sanitary Sewer	SFPUC Property Boundary	
Proposed Underground Electrical	Proposed Storm Drain		
Proposed Fence			

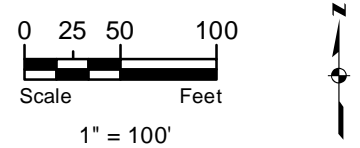

**Regional Groundwater Storage
and Recovery Project**

Figure 3-27

Source: SFPUC and Kennedy/Jenks

This page left intentionally blank



Site 11
South San Francisco Main Area

Regional Groundwater Storage and Recovery Project

Figure 3-28

Legend

- ◆ Proposed Well
- ⊕ Existing Monitoring Well
- Existing PG&E Power Pole
- Proposed Underground Electrical
- Proposed Fence
- Proposed Connection (Water)
- Proposed Alternate Connection (Water)
- Proposed Sanitary Sewer
- Proposed Storm Drain
- Construction Area Boundary
- Staging Area Boundary
- SFPUC Property Boundary
- Proposed Chemical Treatment and Filtration Building
- Proposed Footprint of Other Permanent Areas (Concrete, Parking, etc.)

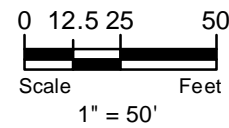

Source: SFPUC and Kennedy/Jenks

This page left intentionally blank

Site 12: Garden Chapel Funeral Home

Layout Type	Well plus chemical treatment facility
Pump Type	Aboveground vertical turbine
Proposed Water Connection	SFPUC
Pipeline Length	925 feet
Alternate Water Connection	Other SFPUC
Pipeline Length	90 feet
Sanitary Sewer & Storm Drains	710 feet
Pavement Size	1,665 square feet
Building Size	1,495 square feet

Site 12 would be located west of El Camino Real and south of Southwood Drive in South San Francisco on SFPUC property. The site layout is shown on Figures 3-29 and 3-30. The site would be adjacent to a parking lot for the Garden Chapel Funeral Home. The proposed Project at Site 12 includes a new production well and continued use of an existing water quality monitoring well. The treatment processes at the site would include disinfection and pH adjustment.

Electrical power would be provided to the site through a new underground connection to an existing PG&E power pole located approximately 75 feet to the west.

Temporary construction access and permanent access would be from Southwood Drive and the existing Garden Chapel Funeral Home driveway. The on-site access driveway would be improved from the funeral home parking lot to the well facility

Site 13: South San Francisco Linear Park

Layout Type	Well plus chemical treatment and filtration facility
Pump Type	Aboveground vertical turbine
Proposed Water Connection	San Bruno
Pipeline Length	1,835 feet
Alternate Water Connection	Cal Water
Pipeline Length	185 feet
Sanitary Sewer & Storm Drains	640 feet
Pavement Size	3,450 square feet
Building Size	2,095 square feet

Site 13 would be located south of South Spruce Avenue in South San Francisco on SFPUC property. The site layout is shown on Figures 3-31 and 3-32. The landscape plan for Site 13 is illustrated on Figure 3-33. The site would be situated between the South San Francisco Centennial Way Trail (bicycle and pedestrian path) and commercial land uses fronting on South Spruce Avenue. The proposed Project at Site 13 includes conversion of an existing test well to a production well and continued use of an existing water quality monitoring well. Drought tolerant native and/or climate-adapted landscape would be planted around the perimeter of the building when construction is complete. The treatment processes at the site would include disinfection, fluoridation, and iron

and/or manganese removal.

Electrical power would be provided to the site through a new underground connection to an existing PG&E power pole located approximately 225 feet to the northwest.

Temporary construction access and permanent access would be from South Spruce Avenue via an existing driveway. The on-site driveway would be improved from South Spruce Avenue to the well facility.

This page left intentionally blank

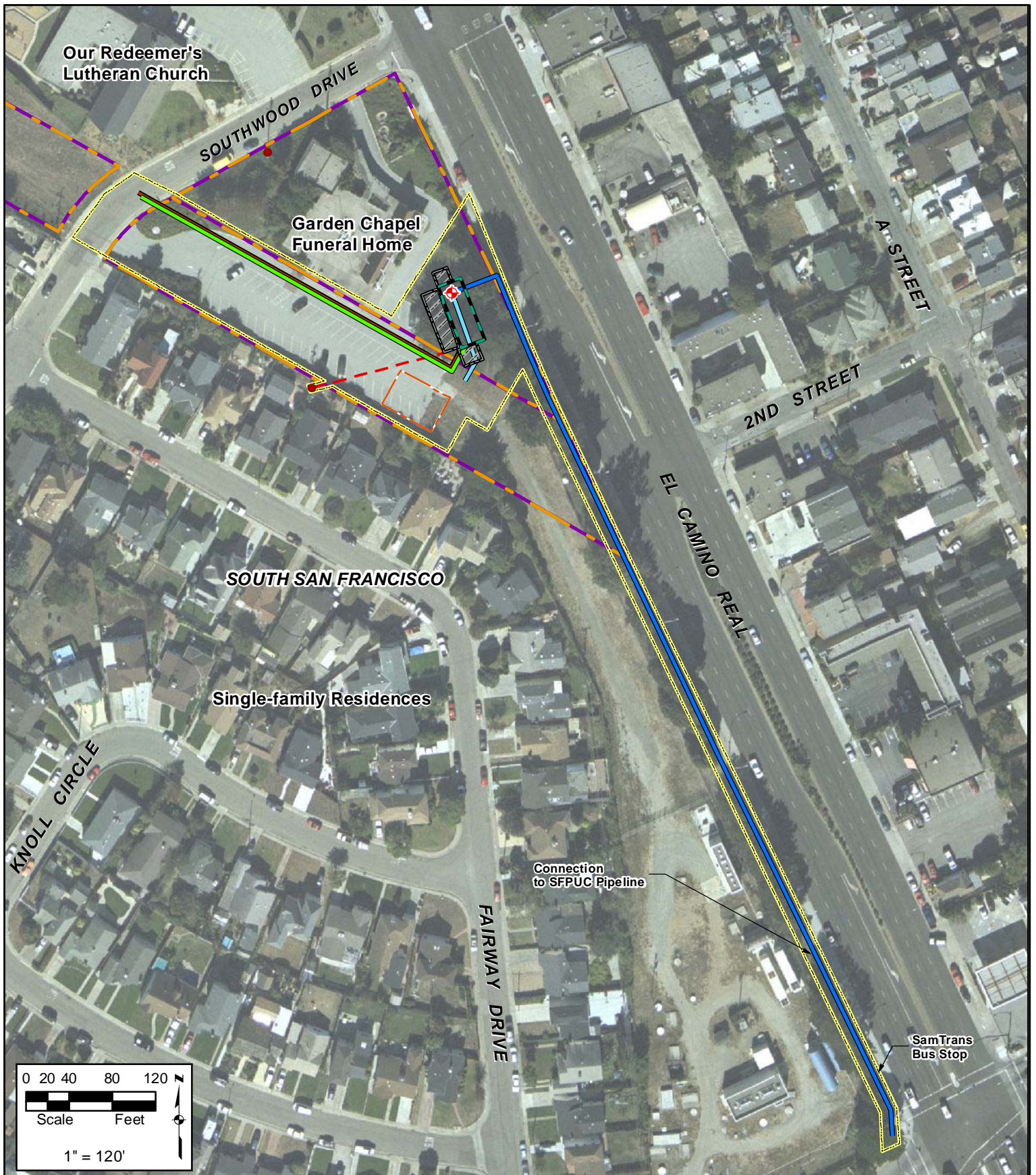

Legend	
	Proposed Well
	Existing Monitoring Well
	Existing PG&E Power Pole
	Proposed Underground Electrical
	Proposed Fence
	Proposed Connection (Water)
	Proposed Alternate Connection (Water)
	Proposed Sanitary Sewer
	Proposed Storm Drain
	Construction Area Boundary
	Staging Area Boundary
	SFPUC Property Boundary
	Proposed Chemical Treatment Building
	Proposed Footprint of Other Permanent Areas (Concrete, Parking, etc.)

Site 12 with Pipelines

Regional Groundwater Storage and Recovery Project

Figure 3-29

Source: SFPUC and Kennedy/Jenks

This page left intentionally blank

















SEE FIGURE 3-29

**Site 12
Garden Chapel Funeral Home**

**Regional Groundwater Storage
and Recovery Project**

Figure 3-30

Legend

-  Proposed Well
-  Existing Monitoring Well
-  Existing PG&E Power Pole
-  Proposed Underground Electrical
-  Proposed Fence
-  Proposed Connection (Water)
-  Proposed Alternate Connection (Water)
-  Proposed Sanitary Sewer
-  Proposed Storm Drain
-  Construction Area Boundary
-  Staging Area Boundary
-  SFPUC Property Boundary
-  Proposed Chemical Treatment Building
-  Proposed Footprint of Other Permanent Areas (Concrete, Parking, etc.)

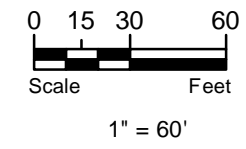

Source: SFPUC and Kennedy/Jenks

This page left intentionally blank

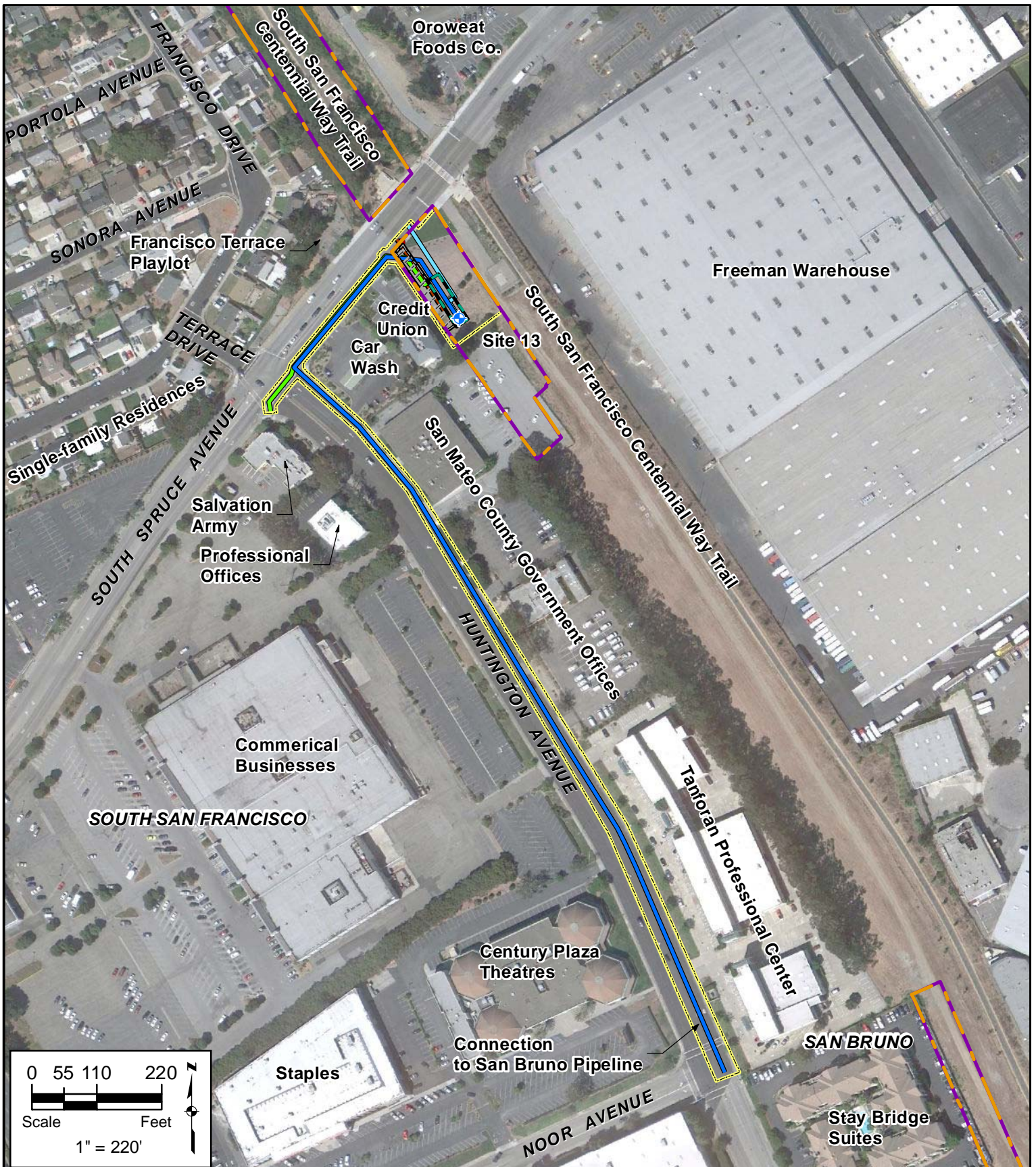

Legend			
	Existing Test Well		Proposed Connection (Water)
	Existing PG&E Power Pole		Proposed Alternate Connection (Water)
	Proposed Underground Electrical		Proposed Sanitary Sewer
	Proposed Storm Drain		Construction Area Boundary
			Staging Area Boundary
			SFPUC Property Boundary
			Proposed Chemical Treatment and Filtration Building
			Proposed Footprint of Other Permanent Areas (Concrete, Parking, etc.)

Site 13 with Pipelines

Regional Groundwater Storage and Recovery Project

Figure 3-31

Source: SFPUC and Kennedy/Jenks

This page left intentionally blank



Site 13
South San Francisco Linear Park

Regional Groundwater Storage and Recovery Project

Figure 3-32

Legend			
Existing Test Well	Proposed Connection (Water)	Construction Area Boundary	Proposed Chemical Treatment and Filtration Building
Existing PG&E Power Pole	Proposed Alternate Connection (Water)	Staging Area Boundary	Proposed Footprint of Other Permanent Areas (Concrete, Parking, etc.)
Proposed Underground Electrical	Proposed Sanitary Sewer	SFPUC Property Boundary	
Proposed Fence	Proposed Storm Drain		

Source: SFPUC and Kennedy/Jenks

This page left intentionally blank



Site 13
South San Francisco Linear Park
Landscape Plan

Regional Groundwater Storage
 and Recovery Project

Figure 3-33

Site 14: Golden Gate National Cemetery (GGNC)

Layout Type	Well with building
Pump Type	Submersible Vertical Turbine
Proposed Water Connection	San Bruno
Pipeline Length	1,785 feet
Alternate Water Connection	See Site 15
Sanitary Sewer Pipeline	1,110 feet
Grass Pavers	1,720 square feet
Building Size	700 square feet

Site 14 would be located north of Sneath Lane in the GGNC in San Bruno on land owned by the U.S. Department of Veterans Affairs (VA). The site layout is shown on Figures 3-34 and 3-35. The well facility would be located on an existing SFPUC easement in the northern portion of the cemetery. The proposed Project at Site 14 includes a new production well. The Project may

also include demolition of an existing, unused pump station, tank, and well located nearby within the cemetery⁶. Demolition would include closure and abandonment of the existing well according to California Well Standards and removal of the pump station, the tank, and any aboveground piping (California Department of Water Resources 1991).

The VA manages the cemetery through its National Cemetery Administration. Construction of new structures and/or demolition at the GGNC would need approval from the VA (see Section 3.9 [Required Permits and Approvals]).

Water pumped from the well at Site 14 would be conveyed to Site 15 for treatment. Treatment processes at Site 15 would include disinfection, pH adjustment (if needed), fluoridation, and iron and/or manganese treatment. If Site 14 is constructed and the well facility at Site 15 is found to be infeasible, a treatment facility would still be constructed at Site 15 to treat water from Site 14.

Electrical power would be provided to the site through a new underground connection to an existing PG&E power pole located approximately 40 feet to the west.

Temporary construction access or permanent access would be from Sneath Lane and existing cemetery roads owned and maintained by GGNC. A new on-site driveway would be constructed from the internal cemetery road network to the well facility. The driveway surface would be constructed of grass pavers⁷.

The SFPUC is working with the VA on the design and location of facilities within GGNC. The enclosure for Site 14 could be a building or a wall. The building would be 700 square feet with dimensions of 34 feet long, 21 feet wide, and six to eight feet high. The wall enclosure would be one foot thick and the footprint would be similar in size to the building (34 feet long, 21 feet wide and six to eight feet high).

The analysis in this EIR was conducted on the building design, which is larger and can be considered a worst case scenario.

⁶ Following preliminary discussions with the VA, the SFPUC is including in the project description and analyses in this Draft EIR the demolition of the pump station, tank, and well. However, this work would only proceed with approval from the VA and only in connection with implementation of a well facility at Site 14.

⁷ Grass pavers are permeable pavers made of plastic or concrete grids. While providing sufficient support for maintenance vehicles, grass pavers also allow grass to grow in the gaps to provide the appearance of a turf surface.

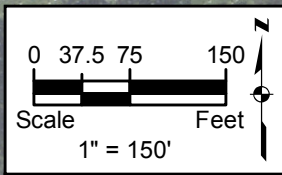
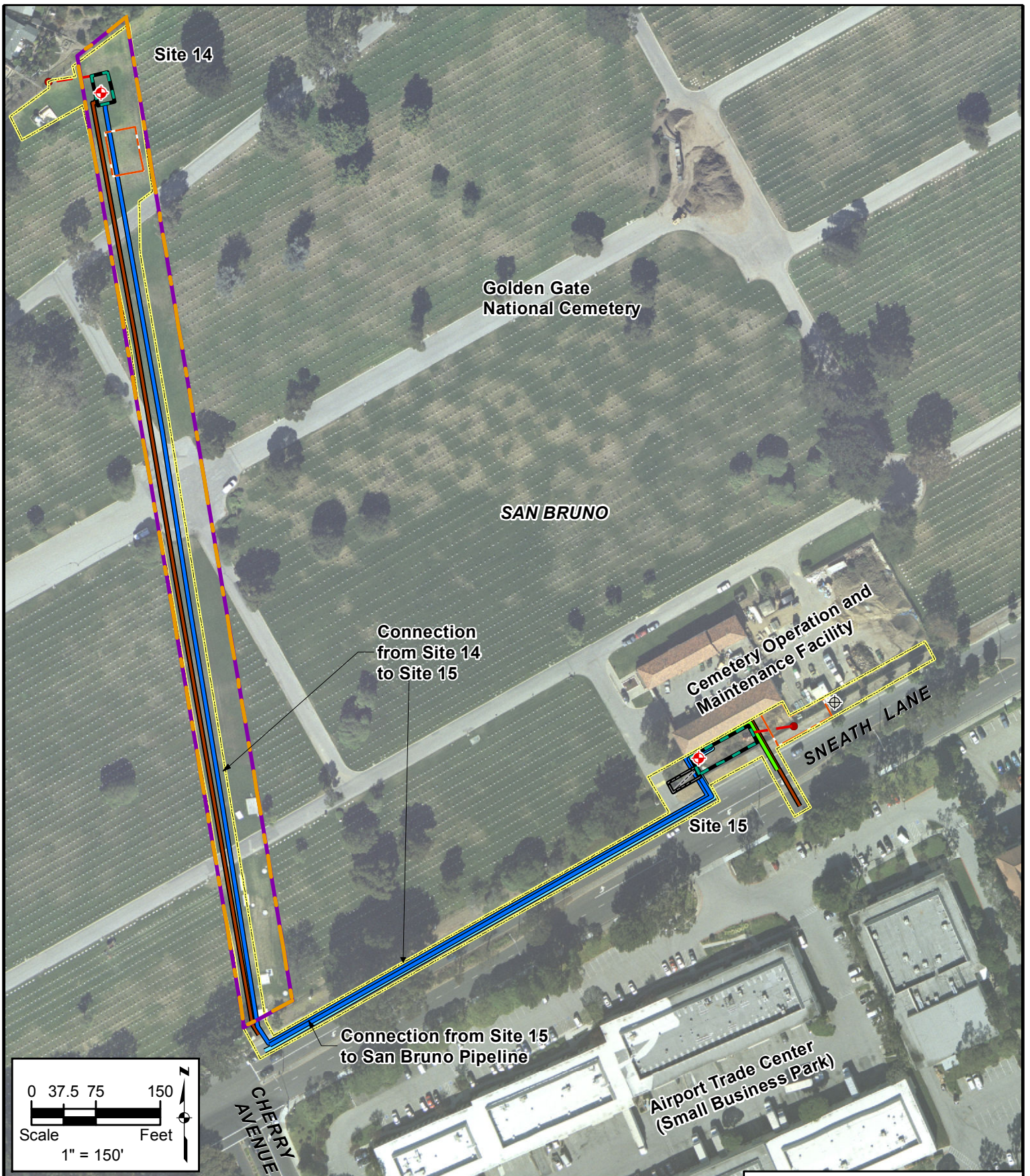

<p>Legend</p> <ul style="list-style-type: none"> Proposed Well Existing Monitoring Well Existing PG&E Power Pole/ Transformer Proposed Underground Electrical Proposed Connection (Water) Proposed Alternate Connection (Water) Proposed Sanitary Sewer Proposed Storm Drain Construction Area Boundary Staging Area Boundary SFPUC Easement (VA Ownership) Proposed Building Enclosure (Site 14) / Chemical Treatment and Filtration Building (Site 15) Proposed Footprint of Other Permanent Areas (Concrete, Parking, etc.) 		<p>Sites 14 & 15 with Pipelines</p> <hr/> <p>Regional Groundwater Storage and Recovery Project</p>
<p>Figure 3-34</p>		

Source: SFPUC and Kennedy/Jenks

This page left intentionally blank

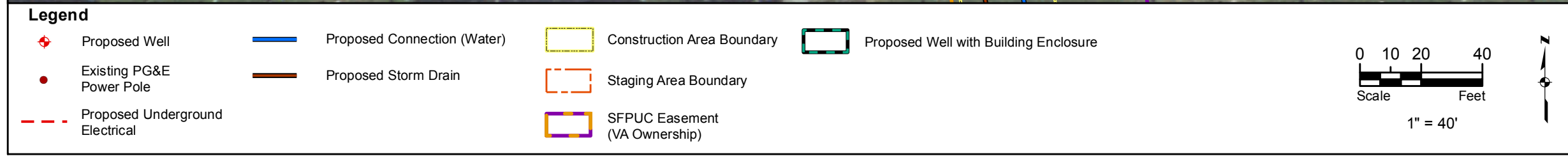

Site 14
Golden Gate National Cemetery

Regional Groundwater Storage
and Recovery Project

Figure 3-35

Source: SFPUC and Kennedy/Jenks

This page left intentionally blank

Site 15: Golden Gate National Cemetery

Layout Type	Well plus chemical treatment and filtration facility
Pump Type	Aboveground vertical turbine
Proposed Water Connection	San Bruno
Pipeline Length	670 feet
Alternate Water Connection	SFPUC
Pipeline Length	680 feet
Sanitary Sewer & Storm Drains	255 feet
Pavement Size	455 square feet
Building Size	2,095 square feet

Site 15 would also be located north of Sneath Lane in the GGNC in San Bruno on property owned by the VA. Site 15 is situated immediately adjacent to the GGNC maintenance building along Sneath Lane. The proposed Project at Site 15 includes a new production well and continued use of an existing water quality monitoring well. The layout at Site 15 is shown on Figure 3-36.

The VA manages the cemetery through its National Cemetery Administration and construction of new structures at the GGNC would need approval from the VA (see Section 3.9 [Required Permits and Approvals]). Treatment processes at Site 15 would include disinfection, pH adjustment (if needed), fluoridation, and iron and/or manganese removal.

Electrical power would be provided to the site through a new underground connection to an existing PG&E power pole located approximately 55 feet to the east.

The building and fencing would be designed to integrate visually with the surrounding structures and landscape.

Temporary construction access and permanent access would be via Sneath Lane and an existing cemetery driveway. A new on-site driveway would be constructed from the cemetery driveway to the well facility.

The SFPUC is working with the VA on the design and location of facilities within GGNC. The design and location of facilities at Site 15 has some flexibility. The facilities include an approximately 2,095 square foot well facility, a chemical treatment and filtration building, and a driveway. A range of designs and locations are being considered by the SFPUC and the VA. The building enclosure for Site 15 could range in size from 90 feet long, 20 feet wide, and 20 feet high located on the eastern side of the site to 36 feet long, 20 feet wide, and 18 feet high located closer to the western side of the site. The smaller western building would also include a fenced enclosure 20 feet long by 72 feet wide. The analysis in this EIR was conducted on the larger building design located on the eastern side of the site. This can be considered a worst case scenario because the facilities are larger and located closer to potential historic resources.

Site 16: Millbrae Corporation Yard

Layout Type	Well plus chemical treatment facility
Pump Type	Aboveground vertical turbine
Proposed Water Connection	SFPUC
Pipeline Length	40 feet
Alternate Water Connection	Other SFPUC
Pipeline Length	700 feet
Sanitary Sewer & Storm Drains	395 feet
Pavement Size	1,585 square feet
Building Size	1,480 square feet

Site 16 would be located east of El Camino Real in Millbrae on SFPUC property on portion of which is leased to Orchard Supply Hardware. The proposed site layout is illustrated in Figure 3-37. The well facility would be located adjacent to a storage area and parking lot for Orchard Supply Hardware. The site would be situated near the Millbrae Manor Apartments to the south and the

Caltrain right-of-way on the east. The proposed Project at Site 16 would include a new production well and the continued use of an existing water quality monitoring well. Treatment processes would include disinfection, pH adjustment, and fluoridation.

Electrical power would be provided to the site through a new underground connection to an existing PG&E power pole located approximately 55 feet to the north.

Temporary construction access and permanent access would be either from Hemlock Avenue and an existing access driveway or from El Camino Real through the Orchard Supply Hardware parking lot. The existing access driveway would be improved from Hemlock Avenue to the well facility. The SFPUC would work with Orchard Supply Hardware, its tenant, to ensure that deliveries could continue by providing a means of delivering materials during construction and operation of the Project. Several options would be available to modify access within the site leased to Orchard Supply Hardware during construction including providing a temporary means of delivering materials through a redesigned access approach to the delivery area or through an alternate delivery access point or by development of a delivery schedule that is compatible with construction activities. Delivery access during Project operation would be developed through delivery access modifications within the site leased by Orchard Supply Hardware. Modifications could include reorientation of the loading area and reconfiguration of the area to allow truck access.

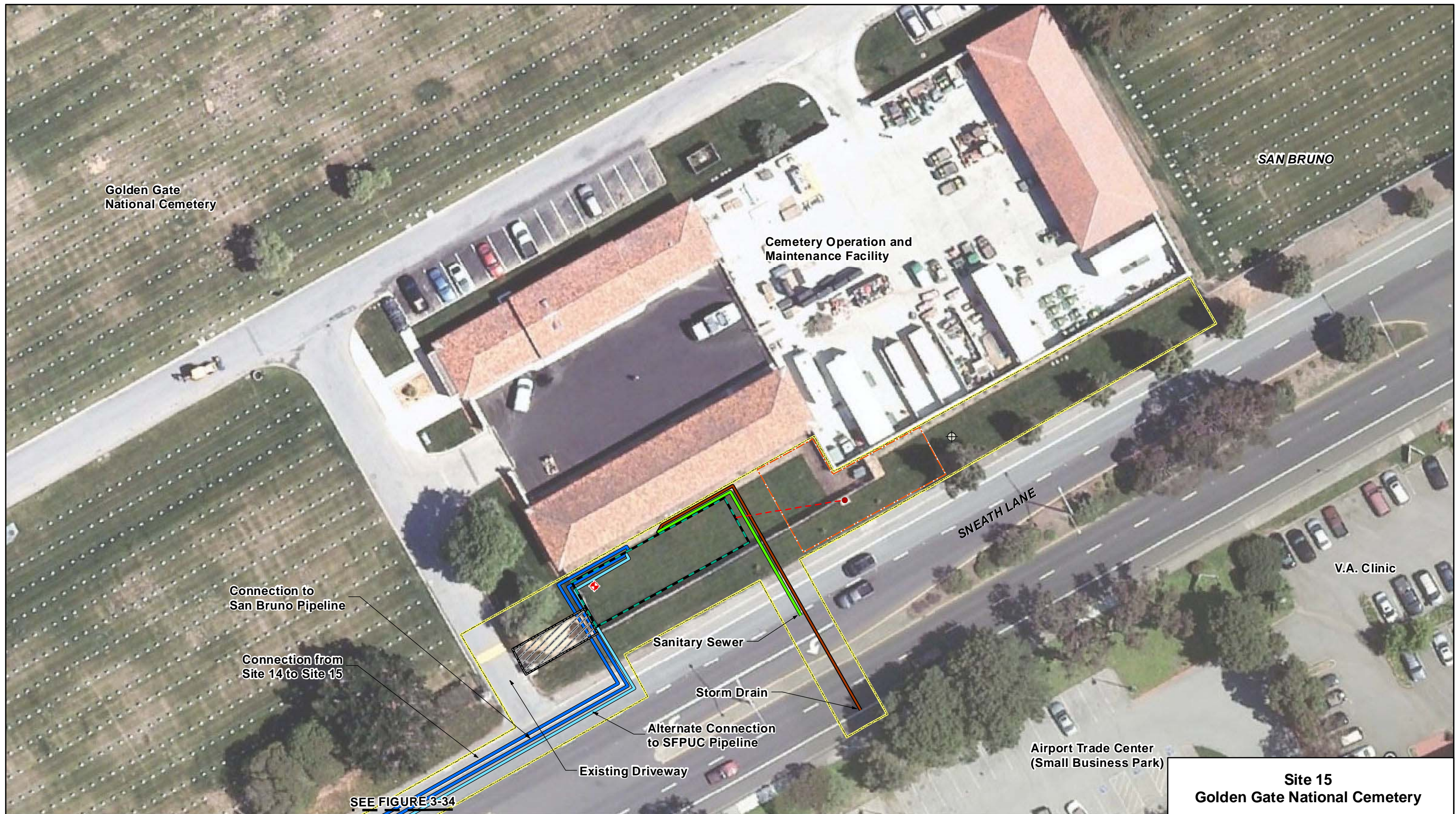

SEE FIGURE 3-34

**Site 15
Golden Gate National Cemetery**

**Regional Groundwater Storage
and Recovery Project**

Legend

- ◆ Proposed Well
- ⊕ Existing Monitoring Well
- Existing PG&E Transformer
- Proposed Underground Electrical
- Proposed Connection (Water)
- Proposed Alternate Connection (Water)
- Proposed Sanitary Sewer
- Proposed Storm Drain
- Construction Area Boundary
- Staging Area Boundary
- Proposed Chemical Treatment and Filtration Building
- Proposed Footprint of Other Permanent Areas (Concrete, Parking, etc.)

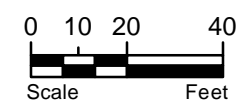

1" = 40'



Figure 3-36

Source: SFPUC and Kennedy/Jenks

This page left intentionally blank



**Site 16
Millbrae Corporation Yard**

**Regional Groundwater Storage
and Recovery Project**

Figure 3-37

Legend

	Proposed Well		Proposed Connection (Water)		Construction Area Boundary		Proposed Chemical Treatment Building
	Existing Monitoring Well		Proposed Alternate Connection (Water)		Staging Area Boundary		Proposed Footprint of Other Permanent Areas (Concrete, Parking, etc.)
	Existing PG&E Power Pole		Proposed Sanitary Sewer		SFPUC Property Boundary		
	Proposed Underground Electrical		Proposed Storm Drain				

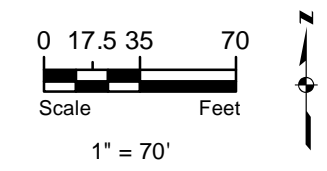

Source: SFPUC and Kennedy/Jenks

This page left intentionally blank

Site 17 (Alternate): Standard Plumbing Supply

Layout Type	Well plus chemical treatment facility
Pump Type	Aboveground vertical turbine
Proposed Water Connection	Cal Water
Pipeline Length	105 feet
Alternate Water Connection	SFPUC
Pipeline Length	20 feet
Sanitary Sewer & Storm Drains	145 feet
Pavement Size	735 square feet
Building Size	1,495 square feet

Site 17 (Alternate) would be located along Collins Avenue west of El Camino Real in Colma on land, a portion of which is owned by Standard Plumbing Supply and the remainder of which is SFPUC property. The site layout is shown on Figure 3-38. The well facility would be located south of Collins Avenue, partially within the Standard Plumbing Supply parking lot; the construction staging would be located

on the north side of Collins Avenue. The site would be adjacent to commercial uses and behind the Cypress Lawn Memorial Park. The proposed Project at Site 17 (Alternate) includes a new production well. The treatment processes at the site would include disinfection and pH adjustment (if needed), and fluoridation.

Electrical power would be provided to the site through a new underground connection to an existing buried line in Collins Avenue.

Temporary construction access and permanent access would be from Collins Avenue. An existing temporary access driveway to the proposed construction staging area would be improved.

A new permanent access driveway would be constructed from Collins Avenue to the well facility, with a permanent loss of two on-street parking spaces on the south side of Collins Avenue to accommodate the new driveway.

Site 18 (Alternate): Alta Loma Drive

Layout Type	Well plus chemical treatment facility
Pump Type	Aboveground vertical turbine
Proposed Water Connection	SFPUC
Pipeline Length	130 feet
Alternate Water Connection	Cal Water
Pipeline Length	120 feet
Sanitary Sewer & Storm Drains	295 feet
Pavement Size	795 square feet
Building Size	1,495 square feet

Site 18 (Alternate) would be located south of Alta Loma Drive within a single-family residential area on a parcel of land owned by the City of South San Francisco. The site layout is shown on Figure 3-39. The proposed Project at Site 18 (Alternate) includes a new production well. The treatment processes at the site would include disinfection, pH adjustment (if needed), and fluoridation.

Electrical power would be provided to the site through a new underground connection to an existing PG&E buried power line in Alta Loma Drive, approximately 55 feet north of the well facility.

Temporary construction access and permanent access would be provided from Alta Loma Drive.

A new permanent access driveway would be constructed from Alta Loma Drive to the well facility, and a new temporary driveway would be constructed from Alta Loma Drive to the staging area. There would be a temporary loss of four on-street parking spaces and a permanent loss of two on-street parking spaces on the south side of Alta Loma Drive to accommodate the driveways.

This page left intentionally blank

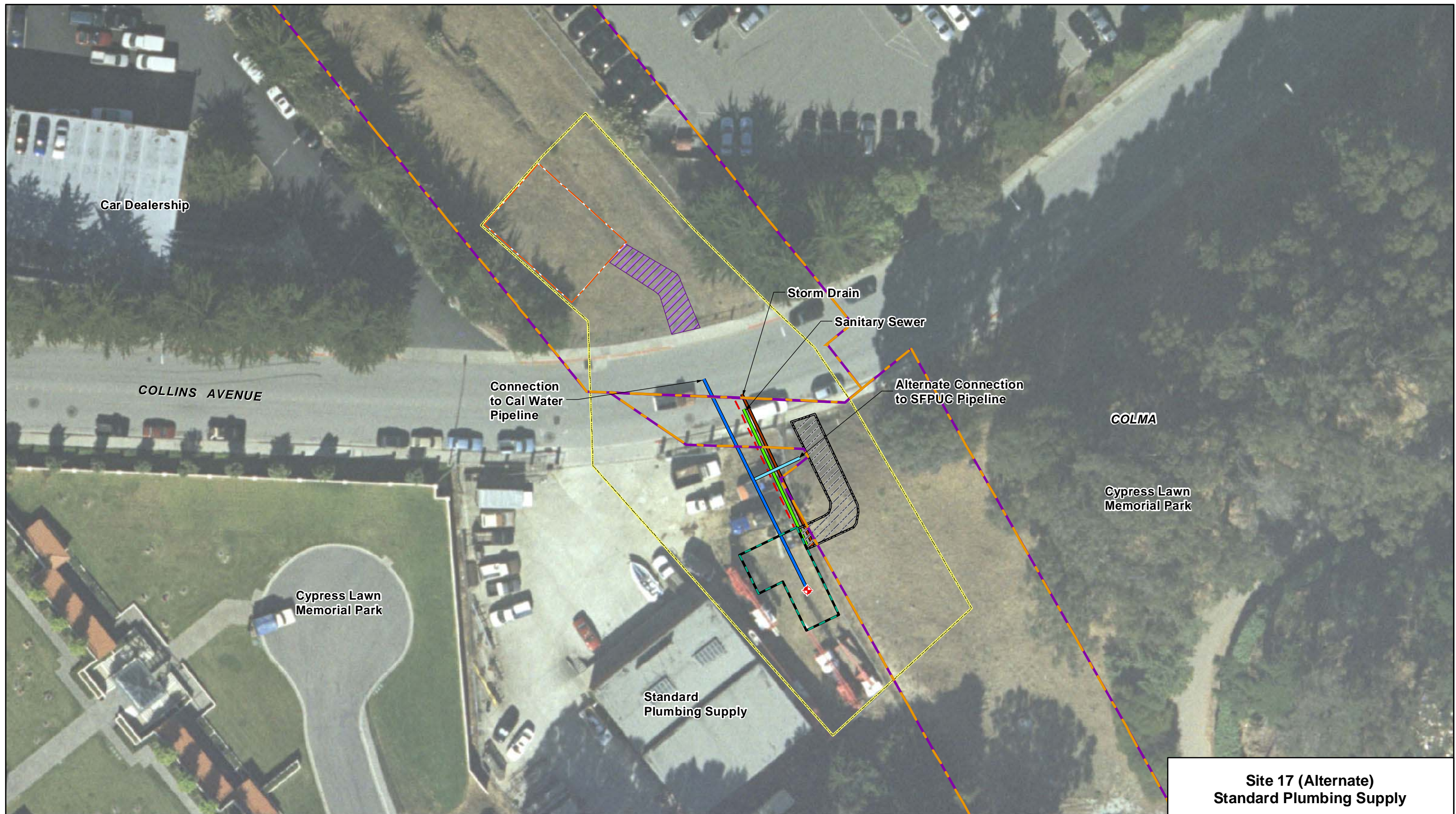

**Site 17 (Alternate)
Standard Plumbing Supply**

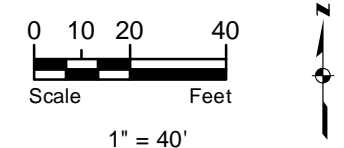
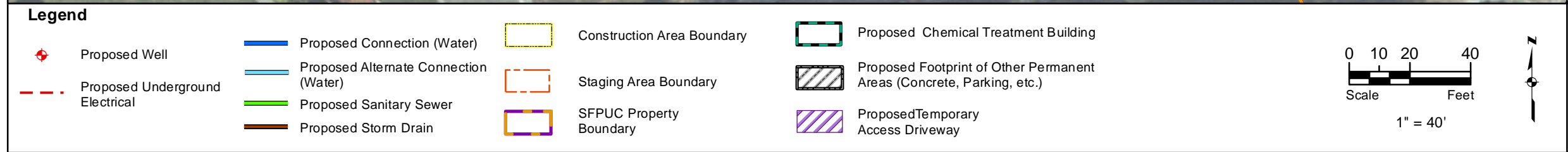

**Regional Groundwater Storage
and Recovery Project**

Figure 3-38

Source: SFPUC and Kennedy/Jenks

This page left intentionally blank



**Site 18 (Alternate)
Alta Loma Drive**

**Regional Groundwater Storage
and Recovery Project**

Legend

- | | | | | | | | |
|--|---------------------------------|--|---------------------------------------|--|----------------------------|--|---|
| | Proposed Well | | Proposed Connection (Water) | | Construction Area Boundary | | Proposed Chemical Treatment Building |
| | Existing PG&E Power Pole | | Proposed Alternate Connection (Water) | | Staging Area Boundary | | Proposed Footprint of Other Permanent Areas (Concrete, Parking, etc.) |
| | Proposed Underground Electrical | | Proposed Sanitary Sewer | | SFPUC Property Boundary | | |
| | | | Proposed Storm Drain | | | | |

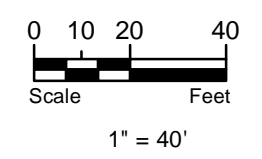

This page left intentionally blank

Site 19 (Alternate): Garden Chapel Funeral Home

Layout Type	Well with fenced enclosure
Pump Type	Submersible vertical turbine
Proposed Water Connection	SFPUC
Pipeline Length	1450 feet
Alternate Water Connection	Other SFPUC
Pipeline Length	150 feet
Storm Drains	190 feet
Pavement Size	1,920 square feet
Building Size	700 square feet

Site 19 (Alternate) would be located west of El Camino Real and north of Southwood Drive in South San Francisco on SFPUC property. The layout is shown on Figure 3-40. The site would be adjacent to Our Redeemer's Lutheran Church and single-family residences. The proposed Project at Site 19 (Alternate) includes a new production well.

Water from Site 19 (Alternate) would be conveyed to Site 12 for treatment. Treatment processes at Site 12 would include disinfection and pH adjustment. If Site 19 (Alternate) is constructed and the well facility at Site 12 is found to be infeasible, a treatment facility would still be constructed at Site 12 to treat water from Site 19 (Alternate).

Temporary construction access and permanent access would be from Southwood Drive. A new access driveway would be constructed from Southwood Drive to the well facility. There would be a permanent loss of two on-street parking spaces on the north side of Southwood Drive to accommodate the new driveway.

3.4.4 Partner Agencies' Wells

The Partner Agencies would continue to operate their existing wells, but would operate them consistent with the Operating Agreement. The Operating Agreement is described in detail in Section 3.8.1 of this Chapter.

This page left intentionally blank

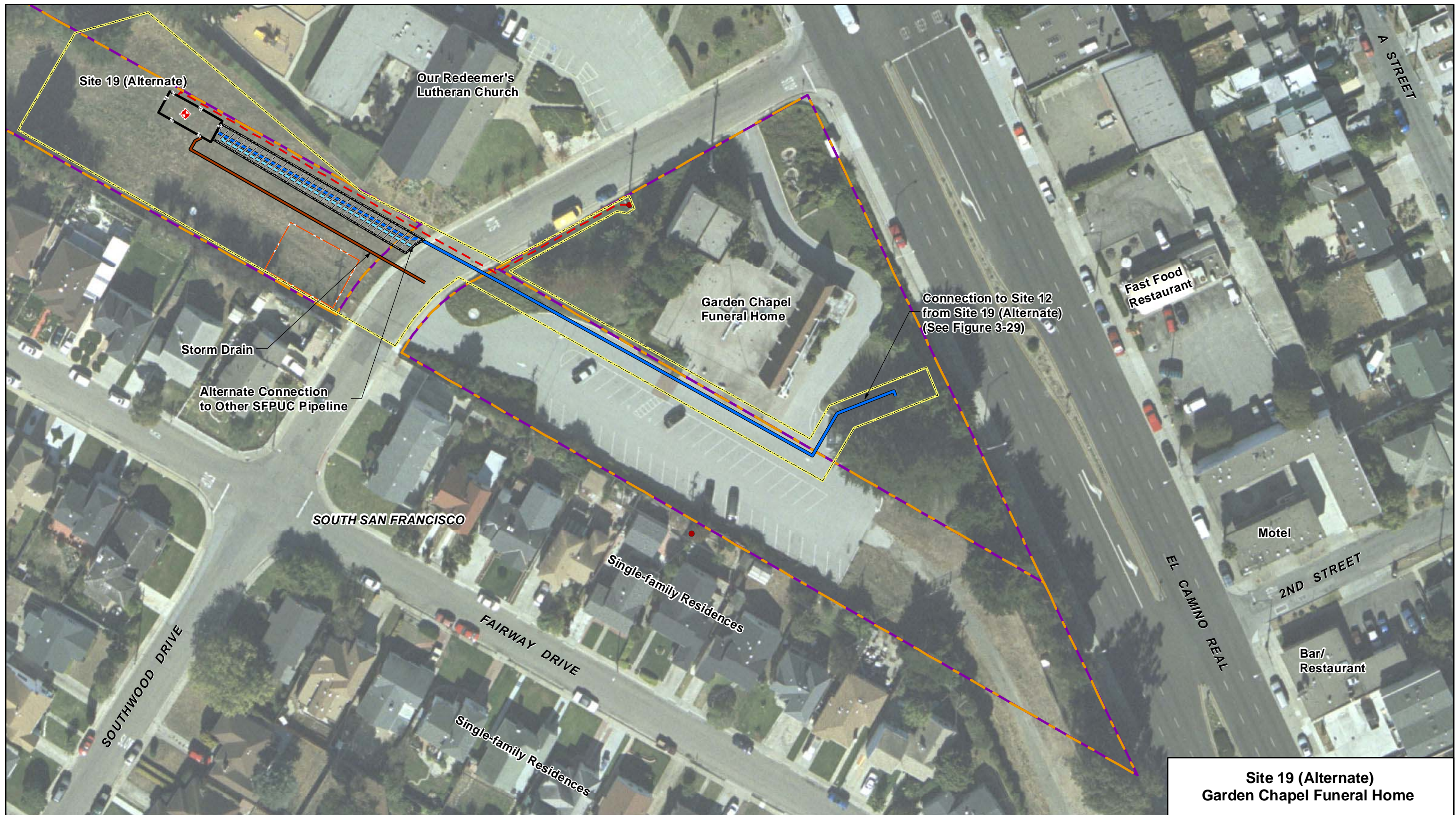

Site 19 (Alternate)

Our Redeemer's Lutheran Church

Garden Chapel Funeral Home

Connection to Site 12 from Site 19 (Alternate) (See Figure 3-29)

Fast Food Restaurant

Storm Drain

Alternate Connection to Other SFPUC Pipeline

SOUTH SAN FRANCISCO

Single-family Residences

Motel

2ND STREET

Bar/Restaurant

SOUTHWOOD DRIVE











FAIRWAY DRIVE

EL CAMINO REAL

**Site 19 (Alternate)
Garden Chapel Funeral Home**

Regional Groundwater Storage and Recovery Project

Legend

-  Proposed Well
-  Existing PG&E Power Pole
-  Proposed Underground Electrical
-  Proposed Connection (Water)
-  Proposed Alternate Connection (Water)
-  Proposed Storm Drain
-  Construction Area Boundary
-  Staging Area Boundary
-  SFPUC Property Boundary
-  Proposed Fenced Enclosure
-  Proposed Footprint of Other Permanent Areas (Concrete, Parking, etc.)

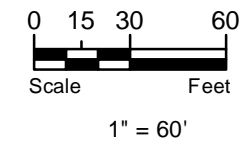

Figure 3-40

Source: SFPUC and Kennedy/Jenks

This page left intentionally blank

3.5 PROJECT CONSTRUCTION

As explained above in Section 3.4.2 (Production Wells and Associated Facilities), the Project consists of the operation of 16 new groundwater well facilities. This EIR evaluates 19 potential well facility sites; however, a maximum of 16 well facilities would ultimately be operated as part of the Project. The SFPUC has selected the 16 well facility sites it proposes to develop; three alternate sites are also evaluated and would be developed in the event that one to three of the 16 preferred sites cannot be successfully implemented and operated for currently unforeseen reasons.

Each well site would include either installation of a new production well or the conversion of an existing test well to a production well. Construction varies at each site, but in general construction would include installation of a well, well pumps and electrical panels, construction of a well facility building, treatment facilities as needed, and water distribution pipelines and other utilities.

This section describes the following:

- Construction Sequencing and Schedule,
- Construction Methods for Production Wells and Well Facilities,
- Pipeline and Power line Excavation,
- Construction Access,
- Construction Staging,
- Construction Equipment, and
- Project Workforce.

3.5.1 Construction Sequencing and Schedule

The SFPUC proposes to construct the Project starting approximately in June 2014 with completion targeted for February 2016. Construction would occur in clusters of approximately four well facilities grouped together as shown in Table 3-7 (Facility Construction Clusters and Construction Sequencing). Well facility construction would begin with production well drilling for those sites without an existing test well. Up to four wells would be drilled within each construction cluster during the first month of the overall 21-month construction schedule. At completion of drilling, well facility construction would begin at the four sites in each cluster and continue for approximately 16 months for sites with buildings and approximately three months for sites with no building, with some exceptions as noted below.

TABLE 3-7
Facility Construction Clusters and Construction Sequencing

Facility Sites	Well Drilling		Well Facilities	
	Estimated Construction Start date	Estimated Construction Finish date	Estimated Construction Start date	Estimated Construction Finish date
Construction Cluster A				
Sites 1, 3, 4, 7	June 2014	July 2014	July 2014	October 2015
Construction Cluster B				
Sites 12, 14, 15, 16, 19 (Alternate)	August 2014	September 2014	September 2014	December 2015
Construction Cluster C				
Sites 9, 11, 18 (Alternate)	October 2014	November 2014	November 2014	February 2016
Sites 10, 13	No well drilling needed	No well drilling needed	November 2014	February 2016
Construction Cluster D				
Sites 2, 5, 6, 8, Westlake Pump Station	No well drilling needed	No well drilling needed	June 2014	September 2015
Site 17 (Alternate)	July 2014	August 2014	August 2014	November 2015

Following is a list of the activities and estimated duration associated with construction of the well facilities and pipelines.

- **Well Drilling** - Production well drilling would require four to six weeks to complete each new well.
- **Well Facility Construction** – Construction timeframes varies between a well with fenced enclosure and a well building:
 - *Wells with Fenced Enclosure.* Sites with fenced enclosures would require a three-month construction period, which would include about one week of site preparation requiring heavy equipment. During the remainder of the construction period heavy equipment would only be operated one or two hours per day. It should be noted that two well sites with fenced enclosures have slightly different proposed construction schedules: 1) Site 2 has a proposed one month construction schedule (SFPUC 2012a) and 2) Site 3 would be constructed over two summers, when the neighboring schools are not in session. During the intervening school year the site would be restored for school use.
 - *Well Facility Building.* Sites with a well facility building would require a 14-month construction period, including the following proposed construction timeframes:
 - Clearing, grubbing, and other site preparation activity: One month
 - Foundation and utility connections: Two months
 - Building and equipment: Nine months

- Start-up and testing: Two months
- **Pipeline Construction** – Pipeline installation would generally proceed at a rate of 300 to 600 feet per week. Installation of pipelines would overlap with construction of the well facility including excavation, disconnection of affected utilities, pipeline replacement, utility reconnection, and backfill of construction trenches.
- **Total Construction Time** – Sites with a well and a well facility building would require approximately 16 months for construction (including conversion to a production well at those sites with an existing test well). Sites with a well and fenced enclosure would require an approximately six-month construction period.

In addition, for construction within or near cemeteries, the SFPUC would temporarily stop construction to accommodate graveside services if requested by the cemetery, and would coordinate with the cemeteries to accomplish this.

3.5.1.1 Construction Methods for Production Wells

To install a production well on a site with no existing test well, the site would first be cleared of vegetation, if present, which would be temporarily stockpiled on-site. Then an area would be graded (as needed) and covered with gravel base rock, to create a level pad for supporting the drill rig and other equipment. A 30-inch steel conductor casing would be installed to a depth of 50 feet and cemented in place. A minimum 22-inch diameter production borehole would be drilled to a depth of approximately 500 to 750 feet, the approximate depth of the aquifer that is proposed for production. Drilling and other drilling related activities (e.g., equipment and material delivery to support drilling) would extend for about a week both during the day and night. The completed borehole would be logged to confirm the hydrogeologic conditions and the proposed well design. The well casing, consisting of a 12-inch diameter stainless steel well casing and well screen would be installed in the borehole. A two-inch diameter steel pipe would be welded to the well casing and installed to a depth of approximately 350 to 400 feet. The pipe would serve as a sounding tube for measuring water levels in the well. This pipe would extend approximately two feet above the ground surface. Finally, an impervious seal consisting of sand/cement grout would be placed in the well annular space above the filter pack⁸.

Development of the well would begin after the annular seal has set for a minimum of 24 hours. Initial development of the well would be performed using airlift pumping and swabbing of the well screen. Final development of the well would be performed by surging and pumping using a temporary test pump.

⁸ A filter pack places filter medium between the screen and the well casing to prevent unwanted materials from entering the well.

Various well pumping tests would be performed after final well development. These tests would include: (a) pumping for durations of two hours each at different discharge rates ("step-drawdown test"); and (b) continuous pumping for 12 to 48 hours at the final design capacity of the well ("constant-discharge aquifer test"). Groundwater samples would be collected during the pumping tests to verify the water quality produced.

When the pumping tests have been completed and the test pump removed, final activities would include video and alignment surveys, as well as disinfection of the completed well. After disinfection, a steel cover plate would be welded on top of the well casing, which would extend approximately two feet above the ground surface. For protection, steel guard posts would be set into the ground around the well casing. The well site would be cleaned, the baserock used for the drilling pad would be removed, and wood chips (mulch) would be spread over the site to prevent soil erosion. Equipment used for well construction would include a truck-mounted drill rig, shaker, support trucks, portable storage tanks, forklift, and loader/backhoe.

Up to three million gallons of groundwater would be produced from a well during the final well development and pumping tests, which would be discharged to the local storm drain and/or the sanitary sewer. The peak discharge rate during well development (lasting for a few hours) would be approximately 800 gpm, although the typical discharge rate would be closer to 500 gpm. The development and testing would occur over the course of approximately 150 hours for each well resulting in an average discharge of 0.5 mgd. Water from the well development and testing would be discharged to the nearest local storm drain and/or sanitary sewer system. The SFPUC would notify the stormwater and wastewater agencies in advance of the well testing discharge to determine the appropriate discharge method and the appropriate discharge rate for the various stormwater and wastewater agencies.

The capacity of the sanitary sewer systems is variable, but if necessary, the groundwater discharge would be pumped to portable storage tanks and then released to the sanitary sewer such that the discharge rate would not exceed the capacity of the individual sanitary sewer system. No discharges from well development, pumping tests, and flushing are expected from Sites 2, 5, 6, 8, 10, and 13, because at these sites there are existing test wells that would be converted to production wells.

The well testing for quantity described above is intended to verify whether the pumping capacity would meet the Project's objectives. Samples would be tested to verify whether the water quality would meet the Project's objectives (with treatment). If the results of the well testing are favorable and the wells are confirmed as permanent production well sites, then further site development would occur, including construction of appropriate enclosures, chemical treatment and filtration facilities, and pipelines, as described in Section 3.5.1.2 (Construction Methods for Well Facilities). If a well is not selected as a permanent well site, it would be decommissioned and sealed, with one of the alternate sites being selected instead. The decommissioned well would be abandoned in accordance with the requirements of the California Water Code (Water Code Division 7 Article 4 §13800), the San Mateo County well ordinance requirements in chapter 4.68 of the San Mateo County Ordinance Code, and to the extent applicable, Title 13, Chapter 13.20 of the Daly City Municipal Code. After construction is complete, well sites would be restored to their general pre-construction conditions, although in accordance with the SFPUC's Vegetation Management Policy, they may be revegetated with alternate plantings (SFPUC

2007a). When construction is complete, all disturbed areas would be hydroseeded and receive erosion control measures as necessary. Equipment and workers needed as well as the construction schedule for each well facility are discussed in Table 3-8 (Estimated Daily Worker and Construction Equipment Trips for Wells and Well Facilities Construction). Diesel generators with self-contained fuel tanks may be used during construction.

TABLE 3-8**Estimated Daily Worker and Construction Equipment Trips for Wells and Well Facilities Construction^(a)**

Project Components and Construction Activities	Construction Vehicles and Equipment	Construction Duration	Daily Construction Worker Trips (round trip)		Daily Construction Equipment Trips per Site (round trips)	
			Typical	Min to Max	Typical ^(b)	Min to Max
Production Well (Sites 1, 3, 4, 7, 9, 11, 12, 14, 15, 16, 17 [Alternate], and 18 [Alternate])						
<ul style="list-style-type: none"> - Site preparation - Pilot hole drilling - Bore hole drilling - Testing 	Grader, mounted drill rig on a support truck, cement truck, pump truck, trailers, pickup trucks, air compressor, submersible diesel pump during well testing.	Well construction, development and testing would require approximately four to six weeks.	3-4	2-5	0	0-4
Fenced Enclosure Construction (Sites 2, 3, 4, 5 [Consolidated Treatment at Site 6], 7 [Consolidated Treatment at Site 6], and 19 [Alternate])						
<ul style="list-style-type: none"> - Site preparation and grading - On-site pipeline installation - Install pumps - Landscaping and site restoration 	Front end loader, backhoe, excavator, fork lift, telescopic crane, cement mixer, concrete pump truck, compactor, hauling trucks, pump-setting rig, arc welder. Diesel generators with self-contained fuel tanks may be used during construction.	Each site would require approximately four months; if test well has already been drilled (Site 2), then duration is one month	3-4	0-12	1-3	0-5

TABLE 3-8

Estimated Daily Worker and Construction Equipment Trips for Wells and Well Facilities Construction^(a)

Project Components and Construction Activities	Construction Vehicles and Equipment	Construction Duration	Daily Construction Worker Trips (round trip)		Daily Construction Equipment Trips per Site (round trips)	
			Typical	Min to Max	Typical ^(b)	Min to Max
Well Facility Building Construction (Sites 1, 5 [On-site Treatment], 6, 7 [On-site Treatment], 8, 9, 10, 11, 12, 13, 14, 15, 16, 17 [Alternate], and 18 [Alternate])						
<ul style="list-style-type: none"> - Site preparation and grading - On-site pipeline installation - Building foundation - Building construction - Install wells and pumps - Landscaping and site restoration 	<p>Front end loader, backhoe, excavator, fork lift, telescopic crane, cement mixer, concrete pump truck, asphalt truck, compactor, hauling trucks, pump-setting rig, arc welder.</p> <p>Diesel generators with self-contained fuel tanks may be used during construction.</p>	Each site would require approx. 14 months	3-4	0-12	1-3	0-5
Utility Pipelines (All Sites, except for the Westlake Pump Station)						
<ul style="list-style-type: none"> - Vegetation removal and grading or pavement cutting depending on the location. - Trench excavation and shoring to stabilize the sides of the trench, if necessary. - Pipeline installation - Trench backfilling and compacting - Surface restoration 	<p>Excavator, front-end loader, hauling trucks, compactor, asphalt trucks, arc welder.</p> <p>Diesel generators with self-contained fuel tanks may be used during construction.</p>	300 to 600 feet per week	3	2-4	1	0-2

TABLE 3-8

Estimated Daily Worker and Construction Equipment Trips for Wells and Well Facilities Construction^(a)

Project Components and Construction Activities	Construction Vehicles and Equipment	Construction Duration	Daily Construction Worker Trips (round trip)		Daily Construction Equipment Trips per Site (round trips)	
			Typical	Min to Max	Typical ^(b)	Min to Max
Westlake Pump Station						
- Install pumps and upgrade treatment systems	Fork lift, telescopic crane, cement mixer, pump-setting rig, arc welder. Diesel generators with self-contained fuel tanks may be used during construction.	Approx. four months	3-4	0-12	1-3	0-5

Notes:

- (a) Haul truck trips associated with cut and fill material are presented in Table 3-10 (Construction Soil Material Haul Amounts and Anticipated Haul Truck Trips) and are not included in the vehicle trip numbers presented in this table.
- (b) A typical construction day would not include movement of construction vehicles on and off the construction site. Construction equipment would be moved on-site as needed, and the equipment would remain on site until it is no longer needed at which point it would be removed from the site. Therefore, a typical construction day would have no construction vehicle trips.

3.5.1.2 Construction Methods for Well Facilities

For sites where test wells already exist (Sites 2, 5, 6, 8, 10, and 13), the test well would be converted to a production well under the proposed Project. Work would include installation of pumps and other equipment, connection to existing power supplies, and installation of transformers and other electrical equipment to facilitate provision of power to the pump station and treatment facilities to operate the well facilities.

For new wells, well facility construction would begin approximately six weeks after the beginning of well drilling. Construction of facilities at the well sites may require additional site clearing and grubbing beyond that conducted for the production well drilling. Site excavation and grading would be minor, with excavation extending to a maximum depth of five feet for the building foundation (if the well facility is intended to have a building) and utilities underneath the building. After the foundation and utilities connections are constructed, the remainder of the building would be constructed and the well pump and other equipment installed, as needed. Construction equipment is expected to include: a front end loader, backhoe, excavator, fork lift, telescopic crane, cement mixer, concrete pump truck, compactor, hauling trucks, pump-setting rig, and arc welder. Equipment and workers needed as well as the construction schedule are discussed in Table 3-8 (Estimated Daily Worker and Construction Equipment Trips for Well Facilities Construction) for each well facility. Diesel generators with self-contained fuel tanks may be used during construction.

3.5.1.3 Construction Methods for Water Distribution and Utility Pipeline Installation

The Project includes installation of pipelines to connect the new wells to the regional water system or to Partner Agency water systems, to connect wells to neighboring well facilities for water treatment and disinfection, and to connect well facilities to the local storm drain system and/or the sanitary sewer system. The Project would also provide underground or overhead electricity lines to the well facility from existing nearby power lines.

New pipelines would be installed below ground using standard open-trench construction methods. Open-trench construction involves the following steps:

- 1) vegetation removal and grading or pavement cutting depending on the location,
- 2) trench excavation and shoring to stabilize the sides of the trench if necessary,
- 3) pipeline installation,
- 4) trench backfilling and compacting, and
- 5) surface restoration.

The width of pipeline construction zones generally would be 20 feet, although the width would be narrower for the underground electrical conduit construction zone. In general, the pipeline trench would be excavated to a depth of up to six feet and would be approximately 10 feet wide and would accommodate multiple pipelines. Shoring for trenches would be installed in accordance with SFPUC Health and Safety, and California Occupational Safety and Health Administration, requirements.

After trenching, the pipe would be placed in the trench. The trench would then be backfilled with native soil excavated from the trench, to the extent feasible and appropriate, and then compacted to meet applicable compaction requirements. However, depending on the soil conditions of the excavated materials, imported backfill could be necessary for compatibility and stability. Once the trenches are backfilled, disturbed areas would be graded to restore to approximate pre-construction conditions and repaved or revegetated with native plant seed mix or turf as appropriate for the site. During installation, open trenches within roadways would be covered at the end of each workday with steel plates or trench backfilling to accommodate vehicle access during non-work hours.

Construction equipment is expected to include an excavator, front-end loader, hauling trucks, compactor, asphalt trucks, and arc welder. Diesel generators with self-contained fuel tanks may be used during construction of these facilities.

Temporary lane closures would be required during construction along some of the pipeline routes as described below, in Section 3.5.2 (Construction Area, Site Preparation, Excavation and Spoil Handling) and Table 3-9 (Construction Area Size and Characteristics), for each site. At least one lane of traffic would be open along all roadways during construction; therefore, no road closures would be required.

3.5.1.4 Dewatering and Other Potential Discharges

Although not expected to be needed during construction, a dewatering system could be required to provide a dry work area if groundwater is encountered during pipeline installation or other excavation activities. Any groundwater encountered during pipeline work would be held in a Baker tank or a similar water storage system and disposed of off-site or added to the existing stormwater facilities in conformance with San Francisco Bay Regional Water Quality Control Board (RWQCB) and applicable local discharge requirements.

Before being placed into service, the new pipelines at all sites and the new treatment facilities at sites with chemical and filtration facilities must be flushed and disinfected to meet water quality regulations. All water used for flushing would come from the new wells and be either dechlorinated and sent to the storm drain or, if not dechlorinated, sent via the nearest sanitary sewer to local wastewater treatment plants for processing.

3.5.1.5 Temporary Lighting

Temporary lighting would be required for nighttime well drilling. Prior to construction, the SFPUC or contractor would prepare a construction lighting plan that specifies locations and methods for minimizing light spillover to adjacent residential areas, such as directing lights downward and inward. The lighting plan would also include specifications for temporary lighting structures and total brightness of the lighting as well as glare control methods. Additional elements of the lighting plan would include suggested corrective actions in the event lighting problems are reported by the public during well drilling operations.

3.5.1.6 Demolition

Demolition of some existing structures would occur at two well facility sites. At Site 1, the restroom at the Lake Merced Golf Club would be demolished. At Site 14, the Project may include demolition of an existing pump station, tank, and well. If the VA, the land owner at Site 14, finds the demolition acceptable, demolition would include closure and abandonment of the well per California regulations and removal of the pump enclosure, small tank, and any exposed piping to below the current grade.

3.5.2 Construction Area, Site Preparation, Excavation and Spoil Handling

Construction of the proposed Project would be accomplished within the construction area delineated for each well facility site. The size of the proposed construction areas varies by site, depending on individual site characteristics and the size and location of proposed facilities on the site. Grading and vegetation removal, including tree removal and tree trimming, would be required at most sites. Table 3-9 (Construction Area Size and Characteristics) includes construction characteristics for each well facility site, including the size of the construction area, the need for temporary construction driveway access, tree removal and trimming, and potential soils hauling and fill requirements.

Construction at the sites would involve excavation and grading, as well as spoil management and handling. Before construction mobilization, the contractor would clear and grade the site of vegetation and debris, as necessary, to provide a relatively level surface for the movement of construction equipment. Workers would clear the site in stages as construction progresses to limit exposure of soil to stormwater runoff and erosion.

Each well facility site layout includes a temporary construction staging area located within the construction area boundary. Staging areas would range in size between 1,725 and 2,205 square feet and would be fenced. The construction staging areas would be used at each site for the entire construction period. The location of the staging area for each well facility site is shown on its site plan (see Figures 3-11 through 3-40).

TABLE 3-9
Construction Area Size and Characteristics

Project Site	Construction Area (square feet)	New Temporary Access Driveway (Yes/No)	Trees in the Construction Area ^(a)	Streets with Temporary Lane Closures and/or Loss of On-Street Parking
Construction Cluster A				
Site 1	16,730	No	1	None
Site 3	65,125	Yes	0	Park Plaza Drive
Site 4 ^(b)	58,723	Yes	24	Park Plaza Drive
Site 7 ^(b)	150,395	No	53	Colma Boulevard
Construction Cluster B				
Site 12	57,040	No	35	Southwood Drive, El Camino Real
Site 14 ^(b)	68,155	No	0	Sneath Lane
Site 15 ^(b)	68,155	No	1	Sneath Lane
Site 16	35,925	No	0	Hemlock Avenue
Site 19 (Alternate)	34,530	No	18	Southwood Drive, El Camino Real
Construction Cluster C				
Site 9	18,690	No	1	None
Site 10	29,415	No	0	Camaritas Avenue
Site 11	35,070	No	8	None
Site 13	69,830	No	0	South Spruce Avenue, Huntington Avenue
Site 18 (Alternate)	23,175	No	3 trees plus willows	Alta Loma Drive
Construction Cluster D				
Site 2 ^(b)	58,723	No	0	Park Plaza Drive
Site 5 ^(b)	150,395	No	0	B St, D St, Hill St
Site 6 ^(b)	150,395	No	0	D St, Hill St
Site 8	28,670	No	0	None
Westlake Pump Station	36,530	No	0	None
Site 17 (Alternate)	24,035	Yes	0	Collins Avenue

Notes:

- (a) Trees reported here include trees inside the construction area boundary which may be removed during construction.
- (b) Some construction area boundaries include two or more sites; this is usually because of connecting pipelines. Combined construction areas include: Sites 2 and 4; Consolidated Treatment for Sites 5, 6, and 7; and Sites 14 and 15.

Soil would be excavated for installation of well facilities and pipelines needed to connect the wells to sanitary sewers, storm drains, and electrical facilities. Soil excavated during well facility construction and pipeline installation may be used as backfill around the facilities, but a large portion of the material would be hauled off-site for recycling or disposal, as presented in Table 3-10 (Construction Soil Material Haul Amounts and Anticipated Haul Truck Trips). It is estimated that fill material may be imported to some well facility sites, since there may be insufficient or inappropriate soil for backfill. The estimated amount of material to be hauled off-site and the amount of fill material to be hauled to the sites are also presented in Table 3-10.

Soils to be disposed of would be tested for hazardous materials prior to disposal. Excavated materials and construction debris found to contain unacceptable levels of hazardous materials would be hauled to a licensed disposal site. Potential hazardous material disposal sites include Waste Management's Kettleman Hills Disposal Site in Kettleman City, California, (for Resource Conservation Recovery Act hazardous [RCRA hazardous] and non-RCRA hazardous waste) and ECDC Environmental in East Carbon, Utah (for non-RCRA hazardous waste, only). Non-hazardous materials would be taken to an approved local disposal area.

Currently, the SFPUC has identified the Ox Mountain Sanitary Landfill in Half Moon Bay, California, as the Project spoil disposal site. The Guadalupe Sanitary Landfill Site in Santa Clara and the Waste Management Altamont Landfill in Livermore are other potential disposal sites. Although some of the excavated soil may be used for backfill at the well facility sites, most would be taken to the appropriate disposal areas listed above, where the material would be reused as alternate daily cover at the landfills.

Vegetation removal would be required at most sites; tree removal and/or trimming would be required at some sites. Tree removal would be required for construction at sites with trees within the construction area boundary or along pipeline routes. Vegetation would be removed and disposed of at an appropriate facility. Vegetation may be stockpiled at staging areas prior to disposal.

Table 3-10 (Construction Soil Material Haul Amounts and Anticipated Haul Truck Trips) lists the estimated cubic yards of soil that would be hauled from each well facility site during well drilling, pipeline construction, and well facility construction. The table also includes the number of haul truck trips required to remove the excavated materials from the site. Excess soil would be reused on-site (for engineering fill) or disposed of at a Class III non-hazardous waste disposal site.

Table 3-10
Construction Soil Material Haul Amounts and Anticipated Haul Truck Trips^(a)

Project Site	Material Export for Well Drilling (Cut Material in Cubic Yards)	Material Export for Pipeline Construction (Cut Material in Cubic Yards)	Material Import for Facility Site Construction (Fill Material in Cubic Yards)	Material Export for Facility Site Construction (Cut Material in Cubic Yards)	Haul Truck Trips (20-Cubic Yard Vehicle, Roundtrips)
Construction Cluster A					
Site 1	100	30	40	0	9
Site 3	110	70	0	0	10
Site 4	110	100	315	0	27
Site 7 ^(b)	110	200	0	20	17
Total	430	400	355	20	63
Construction Cluster B					
Site 12	100	145	25	0	15
Site 14	100	360	0	35	25
Site 15	100	60	0	0	8
Site 16	75	80	0	0	8
Site 19 (Alternate)	110	85	80	0	15
Total	485	730	105	35	71
Construction Cluster C					
Site 9	90	55	0	0	8
Site 10	No well drilling	50	0	75	7
Site 11	110	60	0	0	9
Site 13	No well drilling	270	0	0	14
Site 18 (Alternate)	110	25	25	0	10
Total	310	460	25	75	48
Construction Cluster D					
Site 2	No well drilling	20	20	0	2
Site 5 ^(b)	No well drilling	130	0	0	7
Site 6 ^(b)	No well drilling	25	45	0	4
Site 8	No well drilling	50	0	55	5
Site 17 (Alternate)	110	30	30	0	10
Westlake Pump Station	No well drilling	0	0	0	0
Total	110	255	95	55	28

Table 3-10
Construction Soil Material Haul Amounts and Anticipated Haul Truck Trips^(a)

Project Site	Material Export for Well Drilling (Cut Material in Cubic Yards)	Material Export for Pipeline Construction (Cut Material in Cubic Yards)	Material Import for Facility Site Construction (Fill Material in Cubic Yards)	Material Export for Facility Site Construction (Cut Material in Cubic Yards)	Haul Truck Trips (20-Cubic Yard Vehicle, Roundtrips)
Total Export and Import for All Sites	1,335	1,845	580	185	210

Notes:

- (a) An expansion factor of 20 percent has been added to the volume of well cuttings, spoil from pipelines, and export material for well facility construction.
- (b) The soil excavation volumes for Sites 5, 6, and 7 under the consolidated treatment at Site 6 option are slightly greater than the soil excavation volumes for Sites 5, 6, and 7 under the on-site treatment option, therefore only the volumes for the consolidated treatment option are reported.

3.5.3 Construction Hours, Construction Workforce, and Construction Truck Trips

3.5.3.1 Construction Hours

Typical daily construction hours would be between 7:00 a.m. and 7:00 p.m. Monday through Friday, except for construction of production wells. If necessary, construction work may occasionally occur on Saturdays between the hours of 7:00 a.m. and 5:00 p.m. The nature of production well installation requires continuous operation of the drilling equipment until the desired depth is achieved and the well is constructed because when drilling in unconsolidated sediments such as those present in the Westside Groundwater Basin, there is a risk that the borehole walls could cave sufficiently to require re-drilling of the well. To reduce the risk of caving, the proposed well drilling method is the Reverse Circulation Rotary Method, which uses “what can best be described as muddy water rather than drilling fluids...although a low concentration of polymetric drilling fluid additive may also be used” (Driscoll 1986). Other drilling methods use drilling muds to support and stabilize the bore hole. The Reverse Circulation Rotary Method is proposed for the Project because the absence of drilling mud provides for a potentially higher well capacity and well efficiency (SFPUC 2012b). Therefore, well installation would require nighttime and weekend activity during drilling and other drilling-related activities (for up to seven consecutive days and nights) and during pump testing (for one continuous 48-hour period).

3.5.3.2 Construction Workforce and Delivery Truck Trips

The estimated equipment and workforce required for each phase of construction, as well as daily truck trips, is presented in Table 3-8 (Estimated Daily Worker and Construction Equipment Trips for Well Facilities Construction). The table includes the anticipated workers to complete the construction phases on a daily, minimum, and maximum basis. The table also includes the daily truck trips associated with construction by phase. The maximum number of workers at a site at any time is estimated to be 16.

Primary regional access to the well facility sites during construction would be from I-280. Some sites may be accessed from U.S. Highway 101. Construction truck traffic, deliveries, and most vehicles would enter and exit work sites along local roadways, as noted for each site in Section 3.4.3 (Facility Sites).

3.6 SFPUC STANDARD CONSTRUCTION MEASURES

The SFPUC has established Standard Construction Measures for all WSIP projects (SFPUC 2007b). The main objective of these measures is to reduce impacts on existing resources to the extent feasible. The measures include activities such as early identification of sensitive environmental resources in the WSIP project area and notifying businesses, owners, and residents of adjacent areas potentially affected by the WSIP projects about the nature, extent, and duration of construction activities. The SFPUC project manager, environmental project manager, and contract manager would ensure that the proposed Project contains uniform provisions to address these issues.

3.7 GREENHOUSE GAS REDUCTION ACTIONS

In addition to the above-listed standard construction measures, the SFPUC is committed to the following greenhouse gas (GHG) reduction actions as part of the WSIP program. The SFPUC will include the following measures in all WSIP contractor specifications, which in addition to having other environmental benefits, would also help reduce GHG emissions.

- The SFPUC will require that all contractors maintain tire inflation to the manufacturers' inflation specifications.
- The SFPUC will implement a construction worker education program for all WSIP projects.
- WSIP projects that include construction of new buildings will consult with the SFPUC Power Enterprise's Energy Efficiency Group to incorporate all applicable energy efficiency measures into the project design. Projects with building components will attempt to maximize energy efficiency by exceeding Title 24 minimum requirements by at least 20 percent. Projects with building components will attempt to meet or exceed LEED Silver certification as required by the City and County of San Francisco's (CCSF's) Green Building Ordinance.

3.8 OPERATIONS AND MAINTENANCE

As explained more fully in Section 3.4.1 (Groundwater Storage and Recovery), operation of the GSR Project is designed to provide up to 60,500 af of increased groundwater storage in the South Westside Groundwater Basin, which would be recovered by the SFPUC and Partner Agencies for use during dry years. Operation of the Project by the SFPUC and the Partner Agencies would be governed by an Operating Agreement, which is described below.

3.8.1 Operating Agreement⁹

Under a proposed agreement between the SFPUC and the Partner Agencies for operation of groundwater pumping by these entities from the South Westside Groundwater Basin, the SFPUC would “store” water in the South Westside Groundwater Basin through the mechanism of in-lieu or natural recharge by providing surface water as a substitute for groundwater pumping by the Partner Agencies. As part of its annual April 15 estimate of water supply available to the regional water system, the SFPUC would determine, and give notice to the Partner Agencies of, the availability, anticipated quantities, and timing of the in-lieu water deliveries, thereby requiring the Partner Agencies to accept delivery of surface water in lieu of pumping groundwater from their existing wells (generally during wet and normal water years). This determination would take into consideration the amount of groundwater that the Partner Agencies must continue to pump due to water quality blending or other treatment, distribution system constraints, well maintenance, and other requirements.

During normal and wet years, when water would be stored in the groundwater basin (Put Periods)¹⁰, the SFPUC could require the Partner Agencies to accept delivery of up to 5.52 mgd of regional water system water in lieu of pumping a like amount of groundwater from their existing facilities. As a result of the in-lieu deliveries, up to 60,500 af of groundwater storage or Put credits could accrue to the SFPUC Storage Account, which is described below. During shortages of SFPUC system water due to drought, emergencies, or scheduled maintenance, the Partner Agencies would return to pumping from their existing wells. In addition, the SFPUC and the Partner Agencies would extract groundwater from the SFPUC Storage Account using the new wells installed by the SFPUC as part of the proposed Project (Take Periods)¹¹, at a maximum annual volume of 8,100 af withdrawn at an average rate of 7.2 mgd. The SFPUC would not direct pumping during these Take Periods unless a positive balance exists in the SFPUC Storage Account as described below.

The SFPUC would maintain an accounting of the storage volumes in the SFPUC Storage Account. The SFPUC would track the amount of water that has been stored during normal and wet years (Put Periods), and the amount of water pumped from the SFPUC Storage Account (Take Periods). Accruals in the SFPUC Storage Account would be recorded based on metered, in-lieu surface water deliveries and corresponding metered decreases in groundwater pumping. An Operating Committee would be formed for purposes of Basin management to monitor and track the SFPUC Storage Account, including any losses from the Basin resulting from the Project, and establish annual pumping schedules for Project wells. As discussed in Section 3.3 (Existing Groundwater Use in the Westside Groundwater Basin), the Partner Agencies would continue to maintain and operate their existing wells and associated

⁹ The SFPUC also refers to this agreement in other Project-related documents as the Conjunctive Use Agreement.

¹⁰ Put Periods may also be referred to as “Storage Periods” in the Operating Agreement and other documentation concerning the Project.

¹¹ Take Periods may also be referred to as “Recovery Periods” in the Operating Agreement and other documentation concerning the Project.

infrastructure, and install new or replacement wells in the future, if necessary¹². The Partner Agencies would agree to limit pumping from their existing wells and any new wells to the designated quantities totaling 6.9 mgd over a five-year averaging period. The proposed initial apportionment among the Partner Agencies is as follows:

- Daly City: 3.43 mgd/ 3,840 af per year (Daly City 2011),
- Cal Water: 1.37 mgd/ 1,534 af per year (Cal Water 2011), and
- San Bruno: 2.1 mgd/ 2,350 af per year (San Bruno 2011).

When the SFPUC Storage Account is full, defined as 60,500 af, but there is no shortage requiring the SFPUC to pump groundwater from Project wells (Hold Periods), pumping could not exceed 7.6 mgd in any year of the five-year averaging period under the terms of the proposed Operating Agreement. This 10 percent increase over 6.9 mgd could occur as a result of transfer of designated quantities between Partner Agencies. Such transfers would be permitted under the Operating Agreement (SFPUC 2012c) provided the adjustments receive unanimous approval of the Operating Committee. If a Partner Agency engages in over-production, then that agency would be required to:

- take steps to pump less during future years to bring pumping back within the 6.9 mgd aggregate designated quantity,
- provide a source of water that has the effect of replacing water lost from the Basin due to the over-production, or
- take other actions that may be recommended by the Operating Committee¹³.

During normal and wet years, Project wells would be operated by the SFPUC or the Partner Agencies only periodically to exercise the wells for maintenance purposes. Maintenance pumping of the Project wells would be at a rate of approximately 0.04 mgd. The Partner Agencies would pump their existing wells at a rate of approximately 1.38 mgd to 1.9 mgd for maintenance purposes. In circumstances where the SFPUC determines that delivery of in-lieu water cannot be made due to a dry year, emergencies, system rehabilitation, scheduled maintenance, or malfunctioning of the water system, or upon recommendation of the Operating Committee, the SFPUC may direct the Partner Agencies to extract groundwater from the SFPUC Storage Account using Project wells, in addition to continued pumping from the Partner Agencies' existing wells to meet the remainder of their water supply needs. Pumping from the SFPUC Storage Account by the Partner Agencies and the SFPUC would only occur if a positive balance exists in the SFPUC Storage Account as a result of previous in-lieu recharge.

¹² Future plans for installation of new or replacement wells by the Partner Agencies would be subject to environmental review under CEQA to the extent required.

¹³ The Operating Committee would respond to issues as they arise. Additional CEQA review may be required.

During dry years, the SFPUC would deliver water to the Partner Agencies from two sources: reduced surface water deliveries from the regional water system and groundwater from the proposed Project wells. The Partner Agencies could also pump groundwater from their existing wells up to an amount that would not exceed the annual average rates consistent with the pumping limits expressed in the Operating Agreement. The specific volumes to be pumped during a drought, as shown in Figure 3-2 (Source of Proposed Water Supply for Partner Agencies), are based on proposed Project operations, but actual volumes in any given year could vary depending on factors including:

- 1) the final location and capacity of the Project well facilities;
- 2) the volume of water in the SFPUC Storage Account; and
- 3) direction from the Operating Committee regarding which wells should be used, based on the need to avoid well interference (see Section 5.16, Hydrology and Water Quality) and other basin management considerations¹⁴.

The SFPUC and the Partner Agencies would operate and maintain Project wells connected to their respective water systems. The Partner Agencies may be allowed to use Project facilities for non-Project purposes,¹⁵ but only under certain specified conditions where necessary, with approval of the Operating Committee, and only for periods not to exceed 30-days duration. Pumping by the Partner Agencies from Project wells for non-Project purposes would not result in a debit to the SFPUC Storage Account. In the event of a sudden, non-drought event such as an earthquake or other catastrophic event, the Operating Committee may allow Partner Agency use of Project facilities for the duration of the emergency.

3.8.2 Project Operation

The primary purpose of the Project is to provide a dry-year water supply during a multiple-year drought. As described above, the Project would use vacated storage space in the South Westside Groundwater Basin filled through in-lieu or natural recharge during normal and wet years. Neither Project wells nor Partner Agency wells would be pumped in these Put Periods, apart from volumes needed to periodically exercise the wells. Water would accrue in the SFPUC Storage Account based on the metered reduction in each Partner Agency's designated quantity, as described in Section 3.8.1 (Operating Agreement).

When the SFPUC Storage Account is full, defined as 60,500 af, but there is no shortage requiring the SFPUC to pump groundwater from Project wells (Hold Periods), the Project wells installed by the SFPUC would remain inactive apart from occasional well exercising. Existing Partner Agency wells would be pumped at rates not to exceed an annual amount of 6.9 mgd over the five-year averaging period, with a ceiling of up to 7.6 mgd in any year of the five-year averaging periods, as described in Section 3.8.1 (Operating Agreement). The Partner Agencies would continue to be able to take delivery of their

¹⁴ The Operating Committee would respond to issues as they arise. Additional CEQA review may be required.

¹⁵ For example, wells could be used as a back-up well during normal operation, but not for more than 30 days.

entitlements to surface water from the SFPUC during these Hold Periods, as the SFPUC Storage Account would remain full.

Proposed Project wells would be operated during a Take Period under the following circumstances:

- Beginning in the second dry year of a multiple-year drought;
- During emergencies;
- During system rehabilitation, scheduled maintenance or malfunctioning of the water system;
or
- Upon recommendation of the Operating Committee established by the Operating Agreement for purposes of Basin management¹⁶.

In these circumstances, proposed Project wells could be operated continuously or for shorter intervals, depending on the need for water. During these Take Periods, when groundwater is pumped to provide a dry-year supply, pumping would reduce the balance of water in the SFPUC Storage Account. Project wells would be operated by the Partner Agencies and the SFPUC, depending on whether the water is sent to the Partner Agencies' retail water distribution systems or to the regional water system. Project wells would only be pumped in Take Periods if there is a positive balance in the SFPUC Storage Account, and that pumping may not exceed 8,100 af per "supply year," defined as the period from July 1 to June 30 of the following year, pumped at an average rate of 7.2 mgd. Existing Partner Agency wells would be pumped at up to the rates indicated above during Hold Periods and as described in Section 3.8.1 (Operating Agreement).

3.8.3 Maintenance

Project wells would require exercising to ensure that the facilities remain operational during normal and wet years. Well exercising would occur either weekly or monthly. Wells would be exercised for one hour per week or for a single, four-hour period monthly. Flow rates for exercising are anticipated to be between 300 to 600 gpm. Operators may fine-tune the exercise schedule according to the characteristics of individual wells. A possible maintenance issue is bio-fouling,¹⁷ which may require periodic disinfection as part of the exercise program. Groundwater pumped during exercising would be discharged to a local storm drain. In the event there is still chlorine residual in the groundwater, the water would be discharged to a sanitary sewer or dechlorinated prior to discharging to a storm drain. Partner Agencies would continue pumping their existing wells during Put Years as needed to maintain operability.

¹⁶ The Operating Committee would respond to issues as they arise. Additional CEQA review may be required.

¹⁷ Bio-fouling is the undesirable accumulation of microorganisms in the well. Well screen fouling can occur due to microorganisms which clog the pores of the screen, which in turn reduce flow from the well.

All well stations would be unmanned. Each well station would be visited daily when wells are operating for routine equipment checks, lasting approximately 30 minutes each. During normal and wet years (i.e., Put Years), the wells normally would be turned off, but regular exercising would be conducted as described above. At these times, the wells would be visited on a weekly basis or at a frequency determined by on-site conditions. During dry years (i.e., Take Years), the wells would be operational and in production. Longer term maintenance could include removal and repair or replacement of pumps, valves, and other equipment.

Production wells may require redevelopment and/or rehabilitation on an infrequent basis. The life of production wells is estimated to be at least 50 years, although pumps may need to be replaced every 15 to 20 years.

3.9 REQUIRED PERMITS AND APPROVALS

Well facility construction and operation would be conducted to meet all applicable regulations, including local, State, and federal drinking water standards and the amended California Department of Public Health water supply permits for each Partner Agency. Project operations would be conducted in accordance with the proposed Operating Agreement between the SFPUC and the Partner Agencies (see Subsection 3.8.1 [Operating Agreement]), if approved by the SFPUC and Partner Agencies following certification of this EIR by the San Francisco Planning Commission. Table 3-11 (Regulatory/Permitting Agencies/Utility) lists the federal, State, local, and regional regulatory/permitting agencies that may have permitting or approval authority over certain aspects of the Project.

TABLE 3-11
Regulatory/Permitting Agencies/Utility

Regulatory/Permitting Agency/Utility	Potential Permit/Approval
Federal Regulatory/Permitting Agencies	
U.S. Department of Veterans Affairs (VA)	<p>Agreement for installation and maintenance of well facilities at Site 14 and Site 15; approval to demolish building located adjacent to SFPUC right-of-way on Site 14 and decommissioning pipelines; completion of environmental review under the National Environmental Policy Act (NEPA).</p> <p>Section 106 consultation for review and evaluation of Project impacts on cultural resources under the National Historic Preservation Act.</p>
State Regulatory/Permitting Agencies	
California Department of Public Health	Water supply permit amendments for each Partner Agency and the SFPUC. Approval of well construction and operation.
California Department of Toxics Substances Control	Contaminated Soil Treatment Work Plan (required only if contaminated soil is encountered during construction).
California Re-gional Water Quality Control Board, San Francisco Bay Region (RWQCB)	Discharge permits, if required, for emergency and/or maintenance water discharges, and for "overboard" pumping of wells to waters of the State.
California Department of Transportation (Caltrans)	Encroachment permits for access along, and to construct or operate facilities in, a State roadway and interstate highway right-of-way.
State Water Resources Control Board	Stormwater General Permit and Stormwater Pollution Prevention Plan.
State Historic Preservation Officer	Compliance with Section 106 of the National Historic Preservation Act at Sites 14 and 15.
Local and Regional Regulatory/Permitting Agencies	
Bay Area Air Quality Management District (BAAQMD)	Permit required for stationary equipment that may generate air pollutants.
San Francisco Board of Supervisors	Adoption of CEQA findings, and approval of funding appropriation and property rights acquisition.
San Francisco Public Utilities Commission	<p>Project approval. Adoption of CEQA findings and mitigation monitoring and reporting program. Award of construction contracts.</p> <p>Approval of Operating Agreement, and approval of property rights acquisitions.</p>

TABLE 3-11
Regulatory/Permitting Agencies/Utility

Regulatory/Permitting Agency/Utility	Potential Permit/Approval
San Francisco Planning Commission	Certification of Final EIR.
Local City Councils and/or San Mateo County Board of Supervisors	Easement and/or land sale approval.
San Francisco Historic Preservation Commission	Review of a Memorandum of Understanding pursuant to the federal Section 106 process under the National Historic Preservation Act.
Local School Districts	Approval for construction and use of property under its jurisdiction.
San Francisco Arts Commission	Approval of exterior design of proposed facilities on SFPUC property or right-of-way.
Local Department(s) of Public Health	Approval of Certified Unified Program Agencies (CUPA)/Hazardous Materials Business Plan (for Project operations).
San Mateo County Environmental Health Division	Approval of well construction and well abandonment/destruction in accordance with the California Department of Water Resources standards.
Local Departments of Public Works or Engineering	Approval of excavation permits in local streets, encroachment permits, and temporary occupancy permits for street space.
City of Daly City, Water and Wastewater Department	Permit for well construction or well abandonment/deconstruction.
City of Daly City	Approval of Operating Agreement Approval to access, use and construct improvements at the Westlake Pump Station.
Bay Area Rapid Transit (BART)	Encroachment permits to cross BART property.
City of San Bruno	Approval of Operating Agreement.
California Water Service Company (Cal Water)	Approval of Operating Agreement.
San Mateo County Transit (SamTrans)	Approval to temporarily relocate bus stop.

3.10 PROPERTY RIGHTS ACQUISITION

Several types of property rights would be needed for Project construction and operation, as shown in Table 3-12 (Property Rights Proposed for Acquisition). The process for acquiring right-of-way may involve the preparation of a deed and appraisal map, an appraisal of fair market value, negotiations with property owners, and condemnation (if necessary).

TABLE 3-12
Property Rights Proposed for Acquisition

Property Acquisition Type	Rights
Access Easement	Temporary or permanent rights to enter or cross another property.
Pipeline Easement	Rights to install and maintain a pipeline over or across another property.
Construction Easement	Temporary rights to use another property during construction.
Fee Acquisition	Purchase of all the property rights, land, improvements (if any), etc.
Permanent Easement	Rights to permanent right to operate a well facility on another property.
Encroachment Permit	Rights to encroach across a publicly-owned road or transit rights-of-way for pipeline or other purposes.

Of the 19 potential well sites, 12 sites are on SFPUC property or within SFPUC right-of-way. The other seven well sites are on other public and private parcels, which would require an acquisition of easements and access permits, or other rights, for the construction and maintenance of well facilities, connecting pipelines, and/or access. Lastly, several sites have lengthy connecting pipeline requirements that would most likely be constructed on a combination of public and private parcels.

Table 3-13 (Anticipated Property Rights Requirements) provides information on the various parcels that would be needed for the proposed Project. Permanent and temporary right-of-way acquisition requirements could change as the detailed design progresses. No acquisition of property rights is needed for the Westlake Pump Station.

TABLE 3-13

Anticipated Property Rights Requirements^(a)

Site	Site Name	Well Site Owner	Access Easement/ Temporary Construction Easement	Permanent Well Site Easement	Permanent Pipeline Easement	Encroachment Permit	Notes
Site 1	Lake Merced Golf Club	Lake Merced Golf Club	Yes	Yes	Yes	No	Existing agreement with the SFPUC for one well, but may require additional or modified agreement for proposed site location.
Site 2	Park Plaza Meter	SFPUC ¹⁸	No	No	No	Yes	Proposed pipeline along Park Plaza Drive would need an encroachment permit from the City of Daly City.
Site 3	Ben Franklin Intermediate School	Jefferson School District	Yes	Yes	Yes	No	Would require agreement with the school district to construct and operate well facility. Also includes new pipeline.
Site 4	Garden Village Elementary School	County of San Mateo	No	Yes	Yes	Yes	Would require encroachment permit and permanent easement from the County of San Mateo. Also includes new pipeline adjacent to Park Plaza Drive.

¹⁸ Property owned by the CCSF and managed by the SFPUC.

TABLE 3-13

Anticipated Property Rights Requirements^(a)

Site	Site Name	Well Site Owner	Access Easement/ Temporary Construction Easement	Permanent Well Site Easement	Permanent Pipeline Easement	Encroachment Permit	Notes
Site 5	Right-of-Way at Serra Bowl	SFPUC	No	No	No	Yes	An encroachment permit would be needed for the pipeline route and utility from the City of Daly City. An encroachment permit may be needed for utility installations (e.g., PG&E and AT&T).
Site 6	Right-of-Way at Colma BART	SFPUC	No	No	No	Yes	The SFPUC would need an encroachment permit from the City of Daly City to access the SFPUC parcel and for utility installation.
Site 7	Right-of-Way at Colma Boulevard	SFPUC	No	No	No	Yes	The facility would be constructed entirely on SFPUC land, with access from Colma Boulevard. Would need an encroachment permit from the Town of Colma for utility installation.
Site 8	Right-of-Way at Serramonte Boulevard	SFPUC	Yes	No	Yes	No	Would need access easement to the facility through parking lot of adjacent business (Kohl's).
Site 9	Treasure Island Trailer Court	SFPUC	Yes	No	Yes	No	Access easement would be needed from BART and San Mateo County. May need rights from adjacent property owner to connect to SFPUC Pipeline.

TABLE 3-13

Anticipated Property Rights Requirements^(a)

Site	Site Name	Well Site Owner	Access Easement/ Temporary Construction Easement	Permanent Well Site Easement	Permanent Pipeline Easement	Encroachment Permit	Notes
Site 10	Right-of-Way at Hickey Boulevard	SFPUC	No	No	No	Yes	Access to the facility would be through property owned by City of South San Francisco. May need an encroachment permit from City of South San Francisco for utilities. Set-back area would need to be verified by City.
Site 11	South San Francisco Main Area	SFPUC	Yes	No	Yes	No	May require access agreement from BART and City of South San Francisco between Chestnut Boulevard and well facility. May need agreement from adjacent property owner to connect to the Cal Water distribution system.
Site 12	Garden Chapel Funeral Home	SFPUC	No	Yes	Yes	Yes	Site is SFPUC property, but operations and access would be coordinated with current lessee. Connection to SFPUC pipeline would be in the sidewalk at El Camino Real. Pipeline easement or encroachment permit would be from the City of South San Francisco/Caltrans for the street area.
Site 13	South San Francisco Linear Park	SFPUC	Yes	No	If pipes cross private property	Yes	Existing agreement (negotiated in land sale) with City of South San Francisco. Lengthy pipeline from site to connection in San Bruno.

TABLE 3-13

Anticipated Property Rights Requirements^(a)

Site	Site Name	Well Site Owner	Access Easement/ Temporary Construction Easement	Permanent Well Site Easement	Permanent Pipeline Easement	Encroachment Permit	Notes
Site 14/15	Golden Gate National Cemetery	U.S. Dept. of Veterans Affairs. Site 14 would be located in the SFPUC right-of-way, including pipelines. Site 15 would be on U.S. Dept. of Veterans Affairs property	Yes	Yes	Yes	Yes	Agreement with the VA to construct and maintain well facilities, within the cemetery and potential demolition of existing building at Site 14. Connection to City of San Bruno system is in Sneath Lane.
Site 16	Millbrae	SFPUC	No	No	No	No	Access to the facility would be through parking lot of Orchard Supply Hardware. Existing lease would need to be amended.
Site 17 (Alternate)	Standard Plumbing Supply	Standard Plumbing Supply	Yes	Yes	Yes	Yes	Would require easement from the property owner. An encroachment permit from the Town of Colma would be required.
Site 18 (Alternate)	Alta Loma Drive	City of South San Francisco	Yes	Yes	Yes	Yes	Would require encroachment permit from the City of South San Francisco.
Site 19 (Alternate)	Garden Chapel Funeral Home	SFPUC	No	No	Yes	No	Site is SFPUC land, but access would be coordinated with current lessee.

Note:

- (a) Construction may require acquisition of temporary construction easements at each proposed well facility site.

3.11 REFERENCES

- California Department of Water Resources. 1991. *California Well Standards; Bulletin 74-90*. June.
- California Water Service Company (Cal Water). 2011. *2010 Urban Water Management Plan, South San Francisco District*. June.
- Daly City, City of. 2011. *City of Daly City 2010 Urban Water Management Plan*. June.
- Driscoll, Fletcher G. 1986. *Groundwater and Wells*. Published by Johnson Division, St. Paul Minnesota
- Kennedy/Jenks Consultants (Kennedy/Jenks). 2012. *Task 10.1 Technical Memorandum Groundwater Modeling Analysis for the Regional Groundwater Storage and Recovery Project and San Francisco Groundwater Supply Project*. April.
- Luhdorff & Scalmanini, Consulting Engineers (LSCE). 2010. *Technical Memorandum No. 1. Hydrologic setting of the Westside Basin*. May.
- MWH. 2007. *Final Alternatives Analysis Report, Groundwater Conjunctive Use Project*. October.
- MWH with AGS, M. Lee, and Talavera & Richardson. 2008. *Conceptual Engineering Report (CER), Groundwater Conjunctive Use Project* prepared for Water Resources Division. November.
- San Bruno, City of. 2011. *Urban Water Management Plan*. June.
- San Francisco Planning Department. 2008. *Program Environmental Impact Report on the San Francisco Public Utilities Commission's Water System Improvement Program (San Francisco Planning Department File No. 2005.0159E; State Clearinghouse No. 2005092026)*. October.
- San Francisco Public Utilities Commission (SFPUC). 2007a. *Right of Way Integrated Vegetation Management Policy*. Website accessed April 9, 2009 at:
http://sfwater.org/detail.cfm/MC_ID/20/MSC_ID/354/MTO_ID/504/C_ID/90. February.
- SFPUC. 2007b. *Standard Measures to be Included in Construction Contracts and Project Implementation*. From Susan Leal, General Manager, and Tony Irons, Deputy General Manager, to Michael Carlin, Tom Franza, Barbara Hale, Harlan Kelly, Julie Labonte, Irina Torrey, Ivy Fine, and Tony Winnicker. February.
- SFPUC. 2008. Resolution 08-0200, *Water System Improvement Program California Environmental Quality Act Findings: Findings of Fact, Evaluation of Mitigation Measures and Alternatives, and Statement of Overriding Considerations*. October
- SFPUC. 2009b. *Existing and Future Conditions for Environmental Review Purposes – WSIP Groundwater Projects*. June.
- SFPUC. 2009d. *General Seismic Requirements for Design of New Facilities and Upgrade of Existing Facilities, Revision 2*. October.
- SFPUC. 2011. *Model Assumption Document*. September.
- SFPUC. 2012a. Personal Communication, Robin Cort, May 25, 2012.
- SFPUC. 2012b. Personal Communication, Greg Bartow, August 29, 2012.

SFPUC. 2012c. *Draft Agreement for Groundwater Storage and Recovery from the Southern Portion of the Westside Basin by and among the San Francisco Public Utilities Commission, the City of Daly City, the City of San Bruno, and California Water Service Company.* December 12.

This page left intentionally blank

4 PLANS AND POLICIES

Sections
4.1 Overview
4.2 Plans and Policies Relevant to the Groundwater Storage and Recovery Project
4.3 Inconsistency Evaluation
4.4 References

4.1 OVERVIEW

Pursuant to California Environmental Quality Act (CEQA) Guidelines Section 15125(d), this chapter describes land use plans and policies relevant to the siting, construction, and operation of the proposed Project, and then discusses the Project's potential for inconsistency with the applicable plans and policies. Whether a project is consistent with particular plans for which a consistency determination is required will be decided at the time of Project approval, by the agency charged with that determination. Land use plans typically contain numerous policies emphasizing differing legislative goals; an interpretation of consistency requires balancing of all relevant policies.

The plans and policies addressed in this section include:

U.S. Department of Veterans Affairs (VA), National Cemetery Administration. Facilities Design Guide.

City and County of San Francisco (CCSF). Extraterritorial Lands, San Francisco General Plan, Western Shoreline Area Plan (the coastal plan for San Francisco's western shoreline within the coastal zone), Accountable Planning Initiative, Sustainability Plan, and Municipal Green Building Program.

San Francisco Public Utilities Commission (SFPUC). Water Enterprise Environmental Stewardship Policy, Right of Way Integrated Vegetation Management Policy, and Strategic Sustainability Plan.

Other Local Jurisdictions. General Plans of Daly City, South San Francisco, San Bruno, Millbrae, Colma and San Mateo County. Other Local Jurisdiction Management Plans: South Westside Basin Groundwater Management Plan, Bay Area Rapid Transit (BART) Station Area Specific Plan and the San Mateo County Airport Use Plan.

To the extent the land use plans and policies discussed in this section contain objectives and policies that avoid or mitigate environmental effects, the consistency of the Project with such plans and policies is examined in each relevant Chapter 5 analysis section. For example, Sections 5.2 through 5.19 of this EIR

describe the Project's consistency with pertinent resource-specific plans and policies (e.g., Section 5.8, Air Quality discusses air quality management plans; Section 5.14, Biological Resources discusses consistency with local tree ordinances).

4.2 PLANS AND POLICIES RELEVANT TO THE GROUNDWATER STORAGE AND RECOVERY PROJECT

4.2.1 Federal Plans and Policies

The U.S. Department of Veterans Affairs (VA) land use plans and policies are applicable to projects within the jurisdictional boundaries of VA facilities, including VA cemeteries. Well facility Sites 14 and 15 would be located within the Golden Gate National Cemetery (GGNC), which is under the jurisdiction of the VA.

4.2.1.1 U.S. Department of Veterans Affairs, National Cemetery Administration – Facilities Design Guide

Two VA agencies have plans and policies that govern construction at VA cemeteries – the National Cemetery Administration (NCA) and the Office of Construction and Facility Management. These agencies have jointly issued the NCA Facilities Design Guide (Design Guide) (VA 1999; VA 2010), which consolidates applicable VA standards and criteria for construction and design of VA cemeteries. The relevant policies in the Design Guide pertain to siting maintenance activities and facilities in areas that are not readily visible to the public and away from the Public Information Center and gravesites; accessing wells and pump houses from service roads; and routing utility lines between gravesite areas to avoid obstruction of individual gravesites, and burying utility lines underground. The policies for grading, drainage and planting activities are to:

- Retain the site in as natural a state as possible.
- Keep grading to a minimum, while meeting the functional requirements of the cemetery.
- Leave undisturbed such features as natural drainage ways, valuable trees or tree groups, shrubs, ground covers, rock out-croppings and streams.
- Use construction practices that minimize adverse effects on the natural habitat.

4.2.1.2 Coastal Zone Management Act

The authority to evaluate projects conducted, funded or permitted by the federal government is granted to coastal states through the federal Coastal Zone Management Act (CZMA) of 1972, as amended (16 U.S.C. Section 1451 et seq.). The CZMA is implemented in California through the California Coastal Commission (CCC), a State agency, with the exception of San Francisco Bay which is subject to the jurisdiction of the Bay Conservation and Development Commission (BCDC). The key component of California's Coastal Management Program is the California Coastal Act (Public Resources Code, Division 20, Section 30000 et seq.). The CCC has approved the City and County of San Francisco's (CCSF's) local

coastal program pursuant to the Coastal Act. The San Francisco local coastal program includes the *Western Shoreline Area Plan*, which is the City's coastal plan.

In evaluating whether a federal permitting action is consistent with the State's coastal management program, the CCC would look to policies contained in Chapter 3 of the California Coastal Act which include policies related to coastal access, protection of water-oriented activities and recreational boating, protection of the marine environment, protection of environmentally sensitive habitat areas, agricultural lands, and archaeological and paleontological resources. These policies are embodied in the *Western Shoreline Area Plan*, which includes policies, among others, specific to Lake Merced. The *Western Shoreline Area Plan* is discussed below in Section 4.2.2.2 (San Francisco General Plan).

4.2.2 City and County of San Francisco Plans and Policies

The CCSF land use plans and policies are primarily applicable to projects within the jurisdictional boundaries of San Francisco, although in some cases their underlying goals may apply to projects outside of San Francisco (see Section 4.2.2.1 [Extraterritorial Lands]). Although the proposed facility sites are all located outside of San Francisco, the underlying goals of the following plans are applicable to the proposed Project: the San Francisco General Plan; the Accountable Planning Initiative; the San Francisco Municipal Green Building Program; and the San Francisco Sustainability Plan. In addition, the SFPUC has adopted various plans and policies that further direct its activities, such as the *Water Enterprise Environmental Stewardship Policy* and the *Right of Way Integrated Vegetation Management Policy*, which are discussed below in Section 4.2.3 (SFPUC Plans and Policies).

4.2.2.1 Extraterritorial Lands

Under the San Francisco City Charter (SFCC)¹, the SFPUC has authority over the management, use and control of certain extraterritorial lands; that is, properties outside of the City that the CCSF owns or leases or over which it holds easements that are within the jurisdiction of the SFPUC (SFCC Section 4.112). These lands owned by the CCSF outside of the City are subject to the SFPUC's exclusive charge of the construction, management, use, and control of the City water supplies and utilities (SFCC Section 8B.121). Accordingly, the CCSF considers its own plans and policies on its extraterritorial lands, to the extent applicable.

California Government Code Section 53090, et seq., provides that the SFPUC receives intergovernmental immunity from the zoning and building ordinances of other cities and counties on extraterritorial CCSF lands. The SFPUC, however, seeks to work cooperatively with local jurisdictions where CCSF-owned facilities are sited outside of San Francisco to avoid conflicts with local land use plans and building and zoning codes. Also, the SFPUC is required under Government Code Section 65402(b) to inform local

¹ Section 8B.121 of the City Charter provides that “. . . the Public Utilities Commission shall have exclusive charge of the construction, management, supervision, maintenance, extension, expansion, operation, use, and control of all water, clean water, and energy supplies and utilities of the City as well as the real, personal, and financial assets, that are under the Commission's jurisdiction or assigned to the Commission under Section 4.132.”

governments of its plans to construct buildings or structures or to acquire or dispose of real property. The local governments have a 40-day review period to determine project consistency with their general plans. Under this requirement, the cities' or counties' determinations of consistency are advisory to the SFPUC rather than binding.

4.2.2.2 *San Francisco General Plan*

California planning law (Government Code Sections 65302–65303) requires each city and county within the State to develop and adopt a general plan. General plans are long-range policy documents to guide the use and future development of private and public lands within the boundaries of a city or county. General plans represent a jurisdiction's official position on issues, such as development and resource management.

The San Francisco General Plan sets forth the comprehensive, long-term land use policy for San Francisco. One of the basic goals of the general plan is “coordination of the growth and development of the city with the growth and development of adjoining cities and counties and of the San Francisco Bay Region.” The general plan consists of 10 issue-oriented plan elements. The plan elements that may be relevant to the Project are described below:

- *Air Quality Element.* This element aims to improve air quality and comply with State and federal air quality standards for the Bay Area.
- *Commerce and Industry.* This element sets objectives and policies for economic activities, with a goal of balancing environmental quality and development objectives.
- *Community Safety.* This element aims to minimize death and injuries, property loss, environmental damage, and social and economic disruption from manmade and natural disasters, including protection from geologic and seismic hazards.
- *Environmental Protection.* This element addresses the protection of water resources, biological resources, other natural resources, and addresses construction-related noise.
- *Urban Design.* This element sets objectives and policies for the physical character and order of the city, including the protection of historic and visual resources.

The San Francisco General Plan also contains area plans that cover specific geographic areas within the City. One of the area plans, the *Western Shoreline Area Plan*, is the local coastal plan and is part of the City's Local Coastal Program. The Plan sets objectives and policies for preserving the recreational and natural habitat of Lake Merced and maintaining the water quality of the lake as a standby reservoir for emergency use. These policies call for preserving the recreational facilities, passive activities, playgrounds and vistas of Lake Merced (Objective 5, Policy 5.1), maintaining a recreational pathway around the lake for multiple use (Objective 5, Policy 5.2) and allowing only those activities in the lake which will not threaten its quality for use as a standby emergency reservoir (Objective 5, Policy 5.3).

4.2.2.3 *Golden Gate Park Master Plan*

The *Golden Gate Park Master Plan* (adopted by the San Francisco Recreation and Park Commission in October 1998) is intended to “provide a framework and guidelines to ensure responsible and enlightened stewardship of the park” (SFRPD 1998). The goal of this plan is to “manage the current and future park and recreation demands while preserving the historic significance of the park.” The plan identifies objectives and policies for park landscape, circulation, recreation, visitor facilities, buildings and monuments, utilities and infrastructure, maintenance and operations areas, park management, park funding, and special area plans. Policies and objectives relevant to the GSR Project include: preserving naturalistic parkland, including lakes; preserving the design integrity of Golden Gate Park lakes and water features; and maintaining lake water quality and levels, wildlife habitat, and recreational values.

4.2.2.4 *Accountable Planning Initiative*

In November 1986, the voters of San Francisco approved Proposition M, the Accountable Planning Initiative, which added Section 101.1 to the City Planning Code (San Francisco Planning Department 2006) to establish eight Priority Policies. The Priority Policies serve as the basis upon which inconsistencies in the General Plan are resolved. Of the eight Priority Policies, Policies 6, 7, and 8 are relevant to the proposed Project.

1. Existing neighborhood-serving retail uses shall be preserved and enhanced and future opportunities for resident employment in and ownership of such businesses enhanced.
2. Existing housing and neighborhood character shall be conserved and protected in order to preserve the cultural and economic diversity of our neighborhoods.
3. The City’s supply of affordable housing shall be preserved and enhanced.
4. Commuter traffic shall not impede San Francisco Municipal Railway (MUNI) transit service or overburden our streets or neighborhood parking.
5. A diverse economic base shall be maintained by protecting our industrial and service sectors from displacement due to commercial office development, and future opportunities for resident employment and ownership in these sectors shall be enhanced.
6. The City shall achieve the greatest possible preparedness to protect against injury and loss of life in an earthquake.
7. Landmarks and historic buildings shall be preserved.
8. Parks and open space and their access to sunlight and vistas shall be protected from development.

In accordance with the Accountable Planning Initiative, prior to issuing a permit for any project, or adopting legislation that requires an initial study under CEQA, or adopting any zoning ordinance or development agreement, and before taking any action that requires a finding of consistency with the general plan, the CCSF is required to find that the project is consistent with the Priority Policies established by Proposition M.

4.2.2.5 *San Francisco Sustainability Plan*

The San Francisco Board of Supervisors endorsed the *Sustainability Plan for the City of San Francisco* in 1997, although the Board has not committed the CCSF to perform the actions addressed in the plan. The plan serves as a blueprint for sustainability, with many of its individual proposals requiring further development and public comment. The underlying goals of the plan are to maintain the physical resources and systems that support life in San Francisco and to create a social structure that will allow such maintenance. The plan is divided into 15 topic areas, 10 that address specific environmental issues (air quality; biodiversity; energy, climate change and ozone depletion; food and agriculture; hazardous materials; human health; parks, open spaces and streetscapes; solid waste; transportation; and water and wastewater) and five that are broader in scope and cover many issues (economy and economic development, environmental justice, municipal expenditures, public information and education, and risk management). Under the topic “water,” there are goals addressing water reuse, water quality, water supply, groundwater supply and infrastructure. Each topic area in the plan contains a set of indicators to be used over time in determining whether San Francisco is moving in a sustainable direction in that particular area (San Francisco 1997).

4.2.2.6 *San Francisco Municipal Green Building Program*

San Francisco’s Green Building Program was established in 1999 when the CCSF adopted the Resource Efficient Building Ordinance, which established green building standards for municipal buildings to increase energy efficiency, conserve CCSF finances, reduce the environmental impacts of demolition, construction and operation of buildings, and create safe workplaces for CCSF employees and visitors. In 2004, amendments to Chapter 7 of the Environment Code set Leadership in Energy and Environmental Design (LEED) (U.S. Building Council Leadership in Energy and Environmental Design) Silver Certification as the minimum environmental performance requirement for all municipal projects that would involve buildings with areas of over 5,000 square feet. The Resource Efficient Building (REB) Task Force assists City departments in complying with the LEED Silver Certification requirement and helps to determine which projects are subject to LEED standards. For all municipal construction projects, including those projects that do not involve buildings and are not required to obtain LEED Silver Certification, the REB Task Force provides recommended best practices and sample specifications for building materials such as recycled steel and concrete (San Francisco Department of the Environment 2007).

4.2.2.7 *Significant Natural Resource Areas Management Plan*

The San Francisco Recreation and Park Department is currently completing a Significant Natural Resource Areas Management Plan (SNRAMP) for designated significant natural areas in San Francisco. The purpose of the management plan is to establish a maintenance and preservation program related to the protection and enhancement of natural resource values. While the SNRAMP itself has not been finalized and adopted and thus is not yet in effect, the Recreation and Park Department’s Natural Areas Program was developed to protect and restore the City’s natural areas. In 1995, the Recreation and Park Commission adopted a staff report on the SNRAMP (SFRPD 1995). The staff report set forth general objectives, policies, and management actions to guide development of the SNRAMP. General policies and

management actions in the staff report are relevant to recreational and biological resources at Pine Lake and Lake Merced, including general policies to maintain/promote indigenous plant species and control/remove invasive species, monitor wildlife populations, etc. These policies and management actions are discussed in Sections 5.11, Recreation, and 5.14, Biological Resources.

4.2.3 SFPUC Plans and Policies

The following SFPUC plans and policies are applicable to the proposed Project.

4.2.3.1 *Water Enterprise Environmental Stewardship Policy*

Adopted in 2006, the *SFPUC Water Enterprise Environmental Stewardship Policy* established the long-term management direction for CCSF-owned lands and natural resources affected by operation of the regional water system within the Tuolumne River, Alameda Creek, and Peninsula watersheds (SFPUC 2006). It also addresses rights-of-way and properties in urban areas under SFPUC management. The policy includes the following:

- The SFPUC will proactively manage the watersheds under its responsibility in a manner that maintains the integrity of the natural resources, restores habitats for native species, and enhances ecosystem function.
- To the maximum extent practicable, the SFPUC will ensure that all operations of the regional water system (including water diversion, storage, and transport), construction and maintenance of infrastructure, land management policies and practices, purchase and sale of watershed lands, and lease agreements for watershed lands to protect and restore native species and the ecosystems that support them.
- Rights-of-way and properties in urban areas under SFPUC management will be managed in a manner that protects and restores habitat value where available, as well as encouraging community participation in decisions that significantly interrupt or alter current land use in these parcels.

The Environmental Stewardship Policy calls for integration of this policy into the Water System Improvement Program (WSIP) and WSIP facility improvement projects (such as the proposed Project).

4.2.3.2 *Right of Way Integrated Vegetation Management Policy*

In 2007, the SFPUC adopted a *Right of Way Integrated Vegetation Management Policy* to manage vegetation that poses a threat or hazard to the system's operation, maintenance, and infrastructure throughout its water distribution and collection systems (SFPUC 2007). The roots of large woody vegetation can damage transmission pipelines by causing corrosion of the outer casements. Trees and other vegetation directly adjacent to pipelines can also make emergency and annual maintenance difficult, hazardous, and expensive, and can increase concerns for public safety. Fire danger within the SFPUC rights-of-way is also a concern. The SFPUC is required to comply with local fire ordinances, which require that existing vegetation be identified, reduced, and managed to prevent potential disruption to fire protection services.

One of the other objectives of this policy is to reduce and eliminate as much as practicable the use of herbicides on vegetation within the right-of-way. Specific elements of the SFPUC Vegetation Management Policy address the management and removal of vegetation, annual grasses, and weeds within the SFPUC right-of-way and the management and removal of vegetation and trees on land leased or permitted by the SFPUC.

4.2.3.3 Strategic Sustainability Plan

In 2008, the SFPUC released its *Sustainability Plan and Program*, which focused on long-term sustainability goals for the organization (SFPUC 2008). Later that year, the SFPUC started a strategic planning effort with a 12- to 18-month forward tracking of performance used to manage the SFPUC's priority fiscal year activities. Since then, the SFPUC has integrated the two, resulting in the SFPUC's *Strategic Sustainability Plan* released in March 2011 (SFPUC 2011). It is actively in use for purposes of strategic sustainability planning and management that takes into account the long-term economic, environmental, and social impacts of the SFPUC business. The *Strategic Sustainability Plan* contains goals, objectives, and performance indicators to implement the SFPUC's vision and values. The five goals are as follows: provide high quality services; plan for the future; promote a green and sustainable City; engage the SFPUC's public; and invest in its communities. Using performance indicators provided in the plan, the SFPUC will measure the progress it makes each year in improving its performance relative to reaching its objectives and goals.

4.2.4 Land Use Plans and Policies of Other Local Jurisdictions

4.2.4.1 General Plans

Project facilities are proposed in the cities of Daly City, South San Francisco, and Millbrae; the Town of Colma; unincorporated San Mateo County; and in the city of San Bruno within the Golden Gate National Cemetery (see Figures 3-3, 3-4, and 3-5 in Chapter 3, Project Description). The intent of the general plans of these entities is to preserve and improve the quality of life for their citizens and to consider growth in a manner that appropriately reflects community values. The general plans of these entities set forth plans, policies, and objectives for future development.

The following factors affect the application of the above jurisdictions' general plans to the Project:

- *Local Jurisdiction Approvals.* Specific well facility sites may require encroachment permits from local jurisdictions. Of the 19 potential sites, 11 sites may require encroachment permits for connecting pipelines and/or for site access.
- *Building and Zoning Ordinances.* Building and zoning ordinances represent the most specific expressions of general plan goals, objectives, and policies. State law and judicial interpretation of State law mutually exempt cities and counties from complying with each other's building and zoning ordinances. As noted above in Section 4.2.2.1 (Extraterritorial Lands), the SFPUC, which is part of the CCSF, is therefore exempt from complying with the building and zoning ordinances of other cities and counties.

- *Local Government Notification and Consistency Determination Requirements.* As noted above in Section 4.2.2.1 (Extraterritorial Lands), California Government Code Section 65402(b) requires that the SFPUC inform cities and counties of its plans to construct projects or acquire or dispose of extraterritorial property. The local governments have 40 days to determine project consistency with their general plans; these consistency determinations are advisory to the SFPUC rather than binding. Implementation of WSIP facility improvement projects (such as the proposed Project) would trigger the requirements of Section 65402(b). The SFPUC would notify local governments of the Project as required pursuant to California Government Code Section 65402(b).

Notwithstanding the above, where facilities are proposed to be sited outside of San Francisco, the SFPUC seeks to work cooperatively with local jurisdictions to avoid conflicts with local land use plans and building and zoning codes.

City of Daly City General Plan

Sites 1, 2, 5, and 6 would be located in Daly City.

The most recent Daly City General Plan was adopted in November of 1987, with an update to the Housing Element in September 2009 (Daly City 1987; 2009). The General Plan goals, objectives and policies are aimed at providing opportunities for growth and expansion; providing open space and commercial service in nearby convenient locations for each neighborhood; and preserving and improving the quality of residential neighborhoods. The only land use goal is to create a balanced mixture of land uses that ensures equal opportunities for employment, housing, open space, and services which adequately serve both personal needs of the citizens and economic needs of the community.

Specific policies relevant to the proposed Project are found in the Land Use, Circulation, Noise, and Resource Management elements of the General Plan. These policies include avoiding locating critical facilities in areas containing geologic hazards (e.g., steep slopes, land slide potential, seismically induced ground shaking); and avoiding or mitigating significant disruption of the natural or urban environment, including such aspects as scenic corridors and other visual resources, roadway levels of service, air quality, noise, and historic resources. Resource Management Policy 1.1 is to continue to purchase water from San Francisco and blend this water with Daly City well water to maintain good water quality. Resource Management Policy 3.3 is to protect areas such as cemeteries, golf courses, and other large open space areas, which contribute to the recharge of the Daly City Aquifer. Site 1 would be located on the Lake Merced Golf Club.

Town of Colma General Plan

Sites 7, 8, and 17 (Alternate) would be located in the Town of Colma.

The most recent Colma General Plan was adopted in 1999, with an update to the Housing Element in 2012 (Colma 1999, 2012). The General Plan concept is to strengthen the Town's identity by placing emphasis on the greenbelt theme of Colma, on enhancing its residential environment and on promoting

its status as a regional center for cemeteries and commerce. The policies related to the General Plan goals and objectives that are relevant to the proposed Project are presented in the Land Use, Circulation, Open Space/Conservation, Noise, Safety, and Historic Preservation elements of the General Plan. Section 5.02.161.4 of the General Plan identifies the SFPUC as maintaining lands, easements, and rights-of-way for water projects and water transmission through Colma and recognizes that the SFPUC rights-of-way contribute to open space due to “the fact that the subsurface waterlines prevent structures from being built.”

Land Use Element policies relevant to the Project include: siting, constructing, and operating facilities to be compatible with the tranquil atmosphere required for the Town’s memorial parks; incorporating street trees in projects involving public street frontage, in accordance with an adopted tree planting plan, or if no plan exists, installing trees a minimum spacing of one tree each 25 feet parallel to the public roadway; incorporating a Spanish/Mediterranean architectural theme into facility designs; placing utility lines underground; siting and designing maintenance buildings and other buildings so they do not detract from the greenbelt theme; and consistency with the Cemetery (G) or Executive/Administrative (E) land use categories for developments on parcels located on El Camino Real between F Street and Mission Road. Site 7 would be located along this corridor.

Circulation Element policies relevant to the Project include: working with the SFPUC to see if landscaping and pedestrian improvements are possible on the right-of-way between Serramonte Boulevard and Collins Avenue; and providing sufficient off-street parking for new construction. Site 8 would be located within the SFPUC right-of-way between Serramonte Boulevard and Collins Avenue.

Open Space/Conservation Element policies relevant to the Project include: using seasonal flowers and shrubbery in conjunction with public improvement projects; identifying and preserving selected tree masses, landscape features and other scenic elements important to Colma’s visual setting; and recognizing tree masses² and other vegetative cover indicated on the Open Space Map as natural resources to be managed and preserved and replacing vegetation removed as part of a development project at a 1:1 replacement ratio. Site 7 would be located in an area mapped as having a designated tree mass.

Other policies relevant to the Project include considering the noise generation impacts of new development to ensure that the tranquil atmosphere for the town’s memorial parks is maintained (Noise Element); and including the potential for seismic and geologic hazards as part of the review process for new development (Safety Element).

² The Town of Colma’s General Plan identifies specific tree masses throughout the Town. The General Plan and Tree Ordinance use several terms to when discussing tree masses, including “major” tree masses, “significant” tree mass, and “designated” tree mass. These terms are used interchangeably throughout these Town policy documents. For consistency, this EIR uses the more general terms “tree mass” or “designated” tree mass.

City of South San Francisco General Plan

Sites 9, 10, 11, 12, 13, 18 (Alternate), and 19 (Alternate) would be located in South San Francisco.

The most recent South San Francisco General Plan was adopted in 1999, with an update to the Housing Element in 2010 (South San Francisco 1999, 2010). The General Plan goal is to balance regional growth objectives with conservation of residential and industrial neighborhoods. The General Plan goals and policies that are relevant to the proposed Project are contained in the Land Use, Parks and Recreation, Open Space and Conservation, Water Quality, Air Quality, Historic and Cultural Resources, Health and Safety, and Noise elements.

Relevant Land Use goals and policies include development of a streetscape plan for the El Camino Real SubArea, where Sites 9, 11, 12, and 19 (Alternate) would be located. The streetscape plan specifies a consistent row of trees on either side of El Camino Real for the six-lane stretch that starts at the Kaiser Medical Center garage and parking lot area and runs south (Sites 11, 12, and 19 [Alternate] would be located along this route). Land use policies also encourage the development of the Treasure Island Trailer Court as Medium Density Residential development. Site 9 would be located adjacent to this trailer court.

Maintenance of the residential character of the Winston-Serra area is included in the General Plan (Sites 10 and 18 [Alternate] would be located within this area). Also included in the Land Use Element is a policy to retain steep hillside areas in excess of 30 percent grade in their natural state and keep grading to a minimum when developing hillside sites; and not permitting the industrial uses on the south side of Railroad Avenue to expand or substantially change, unless the properties are upgraded through added parking, landscaping, improved signage, and exterior building remodeling. Site 13 would be located in this area.

Relevant Parks and Recreation policies are to work with the SFPUC to lease and develop linear parks on existing public utility rights-of-way. Site 13 would be located adjacent to Centennial Way Trail. A relevant Open Space and Conservation goal is to protect special-status species and supporting habitats. A water quality goal is to comply with the San Francisco Bay Regional Water Quality Control Board (RWQCB) regulations and standards to maintain and improve the quality of surface and ground water resources.

Relevant Air Quality policies are to use the City's development review process and the CEQA regulations to evaluate and mitigate the local and cumulative effects of new development on air quality and adopt the standard construction dust abatement measures included in the Bay Area Air Quality Management District's (BAAQMD's) CEQA Guidelines.

Relevant Historic and Cultural Resources policies are to conserve historic, cultural, and archaeological resources, to ensure the protection of known archaeological resources by requiring a records review for any development proposed within an area of known resources, and to require the preparation of a resource mitigation plan and monitoring program by a qualified archaeologist in the event that archaeological resources are uncovered.

Relevant Health and Safety policies are to minimize risk to life and property from geologic and seismic hazards; prevent stormwater pollution by working with the RWQCB in implementing the San Mateo Countywide Stormwater Pollution Prevention Program; reduce the generation of solid waste; and minimize the risk to life and property from generation, storage, and transportation of hazardous materials and waste by complying with all applicable federal, State, and local regulations.

Relevant Noise policies are to control noise levels from new development through site and building design, landscaping, hours of operation, and other techniques.

City of San Bruno General Plan

Sites 14 and 15 would be located in San Bruno.

The most recent San Bruno General Plan was adopted in 2009 (San Bruno 2009). The General Plan promotes balanced development, outlines strategies for conserving established neighborhoods and revitalizing downtown and other aging commercial and industrial areas, and fosters development of transit-supportive uses adjacent to the new BART and Caltrain station. The General Plan also outlines strategies for improved bicycle and pedestrian connections between residences, activity centers, and transit stations, as well as seeks to conserve existing natural resources and minimize hazards.

Six of the eight General Plan elements contain policies that are relevant to the proposed Project. The Land Use and Urban Design policies are to ensure that new development is sensitive to existing uses and is of the highest quality design and construction; to assure that new development mitigates impacts on existing public services, including water, sewer and storm drainage systems; and to require buildings 100 feet or longer to use non-reflective materials to minimize glare. Relevant Transportation policies are to maintain acceptable levels of service for vehicular movement along the city's streets; to limit widening, modification or realignment of the city's scenic corridor and to preserve trees and maintain wide setbacks; and to recognize and protect Sneath Lane as a local scenic corridor. Site 15 would be located along Sneath Lane.

Open Space and Recreation policies include protection of mature trees, as feasible, during new construction. Environmental resources and conservation policies include protection of the natural environment, including wildlife, from destruction during new construction; preservation and enhancement of historic, archaeological, and cultural resources; ensuring that new development adjacent to historic structures is compatible with the character of the structures and the surrounding neighborhood; protection of significant paleontological resources; and preservation of mature trees and vegetation along the city's scenic roadways.

Sites 14 and 15 would be located within the GGNC. The GGNC is owned and operated by the VA (see Section 4.2.1 [Federal Plans and Policies]). However, portions of the proposed Project's water, sanitary sewer, and storm drain pipelines would extend into Sneath Lane, which is within the city's jurisdiction. Trenching for placement of pipelines in Sneath Lane would require an encroachment permit from the City.

City of Millbrae General Plan

Site 16 would be located in Millbrae.

The most recent Millbrae General Plan was adopted in 1998, with an update to the Housing Element in 2006 (Millbrae 1998, 2006). Most of the land in Millbrae is developed with urban uses, with a land use pattern that is already well established. General Plan concerns therefore focus on issues such as the preservation of community character; upgrading older areas; strengthening the city's economic base; use of undeveloped and reusable lands; and providing for the community's housing, social, economic development, and safety needs.

Land Use policies relevant to the Project pertain to promoting proper site planning, architectural design, property maintenance, and landscape design for all new development, renovation or remodeling in keeping with Millbrae's suburban character; assuring that noise, traffic, and other conflicts between residential and non-residential land uses are eliminated to the greatest extent possible; assuring that design and scale of a project is appropriate in relation to the neighborhood it is located in; assuring the appropriateness of design for industrial projects including screening unsightly uses; and providing safe, reliable and adequate utility infrastructure, including water supply.

San Mateo County General Plan

Sites 3 and 4 would be located in the Broadmoor neighborhood of unincorporated San Mateo County.

Site 3 would be located on Ben Franklin Intermediate School property and Site 4 would be located on San Mateo County property near the Garden Village Elementary School.

The most recent San Mateo County General Plan was adopted in 1986, with an update to the Housing Element in 2010 (San Mateo County 1986a, 1986b, 2010). The stated General Plan goal is to provide overall policy to assure orderly, balanced utilization, and conservation of all County resources. A goal related to community development is to promote the provision and maintenance of public and private services and facilities that are basic to human habitation, including water supplies, wastewater management, transportation systems, and solid waste management. The Water Supply Element of the General Plan describes water supply sources and water quality and provides policies to guide the actions of decision-makers concerning water supply management. The element states that one possible option to address the problem of emergency water service interruptions could involve the use of water wells. Under this option, local wells could be constructed, carefully sited to reduce risk of contamination, and held in reserve in anticipation of future emergencies.

4.2.4.2 Other Plans and Policies

Local Coastal Program

Pursuant to the California Coastal Act, the CCSF adopted the Local Coastal Program (LCP) for San Francisco, which was certified by the California Coastal Commission in 1984. The policies and objectives

of the LCP have been incorporated into the *Western Shoreline Area Plan* (San Francisco 1988b) as an element of the San Francisco General Plan (San Francisco 1988a). Refer to Section 4.2.2.2 (San Francisco General Plan) above, for a discussion of the objectives and policies of the Western Shoreline Plan relevant to Lake Merced.

South Westside Basin Groundwater Management Plan

The *South Westside Basin Groundwater Management Plan* (GWMP) was developed by the City of San Bruno in cooperation with California Water Service Company, Daly City, and the SFPUC, and completed in 2012 (San Bruno et al. 2012). The goal of the GWMP is to ensure a sustainable, high-quality, reliable water supply at a fair price for beneficial uses achieved through local groundwater management. One element of the plan to help meet the GWMP objectives is the Facilitation of Conjunctive Use Operations in the form of in-lieu recharge, in which other supply sources may replace groundwater, thus offsetting future groundwater pumping during times of reduced imported water supplies. Two related actions in support of the goal and objectives of the GWMP are as follows:

H1. Consider the development, implementation, and maintenance of programs and projects to recharge aquifers. Programs may be local and regional in scope. These may use imported water, recycled water and other waters to offset existing and future groundwater pumping, except in the following situations:

- Groundwater quality would be reduced, unless lower water quality provides maximum benefit;
- Available groundwater aquifers are full; or
- Rising water tables threaten the stability of existing structures.

H2. Support regional groundwater banking operations that are beneficial to the South Westside Basin and the region and support the goals of the GWMP.

Vista Grande Watershed Study and Vista Grande Drainage Basin Alternatives Analysis Report

The *Vista Grande Watershed Study* was prepared for the City of Daly City in conjunction with the City of San Francisco in 2006 to identify planning solutions to meet the goal of resolving flooding at the Vista Grande Drainage Canal, adjacent to Lake Merced (Daly City 2006). The *Vista Grande Drainage Basin Alternatives Analysis Report* was prepared for the City of Daly City in 2011 to evaluate four alternative solutions (Daly City 2011a).

The Vista Grande Drainage Canal serves as the conveyance for stormwater from a 2.5-square mile watershed area in Daly City, unincorporated San Mateo County and San Francisco to the Pacific Ocean. Historically, wet weather flows in excess of the capacity of the canal and the downstream tunnel to the ocean resulted in local flooding and overflows into Lake Merced. Because of the concern over Lake Merced lake levels, the Watershed Study evaluated several lake level augmentation alternatives, including the potential use of Vista Grande Drainage Canal stormwater flows. The *Vista Grande Drainage Basin Alternatives Analysis Report* evaluated four alternative solutions relative to

constructability, operability, public benefit, environmental compliance and cost criteria and recommends implementation of the Lake Merced Alternative. The City of Daly City selected the Lake Merced Alternative to address the flooding issues and enhance Lake Merced at their May 23, 2011 City Council Meeting (Daly City 2011b). In February 2013, the City of Daly City released a Notice of Preparation (NOP)/Notice of Intent (NOI) to prepare a joint EIR/Environmental Impact Statement (EIS) for the Vista Grande Drainage Improvement Project (Daly City 2013).

The Vista Grande Drainage Improvement Project would construct facilities needed to screen storm water; divert flows to the existing Vista Grande Drainage Canal, Lake Merced, or both; improve storm water and authorized non-storm water quality through a surface flow wetland; control the Lake's water surface; and reduce the potential for localized flooding in the watershed. Diverting a portion of the watershed's storm water and non-storm water (after processing through constructed surface wetlands system) into Lake Merced would increase the lake's water volume and increase the lake level management flexibility (Daly City 2011a).

San Francisco International Airport Land Use Plan

The San Francisco International Airport Land Use Plan is a part of the *San Mateo County Comprehensive Airport Land Use Plan* (C/CAG 1996) and applies to the geographic areas in incorporated cities and unincorporated areas in the vicinity of San Francisco International Airport that are impacted by aircraft noise, restrictions on the height of structure and/or objects near the airport and airport/aircraft safety guidelines. The San Francisco Airport Land Use Plan includes policies, standards, and criteria to address each of these issues. Airport/land use compatibility is determined by comparing a proposed land use policy action with the Aircraft Noise/Land Use Compatibility Standards, the relevant height restriction and safety criteria contained in the San Francisco Airport Land Use Plan.

Airport noise contours are the principal tool for analyzing airport/land use compatibility in the vicinity of airports. According to the San Francisco Airport Land Use Plan, industrial uses, including utilities, that are located within a CNEL³ contour of less than 75 dBA⁴, are considered compatible with little or no noise impact and requiring no special noise insulation requirements for new construction. All of the proposed facility sites are located within the CNEL contours of 60, 65, and 70 dBA. The San Francisco Airport Land Use Plan also provides guidelines to determine if an object is an obstruction to air navigation. Any proposed new construction or expansion of existing structures that would penetrate any of the Federal Aviation Regulations (FAR Part 77) imaginary surfaces for obstruction evaluation is deemed to be an incompatible land use unless either the Federal Aviation Administration has determined that the structure does not constitute a hazard or the State Aeronautics Program has issued a permit to allow construction.

³ CNEL is the Community Noise Equivalent level metric. It is a measure of the overall noise experienced during an entire day.

⁴ The dBA, or A-weighted decibel, refers to a scale of noise measurement that approximates the range of sensitivity of the human ear to sounds of different frequencies.

In addition, certain types of land uses are recognized as hazards to air navigation in the vicinity of San Francisco International Airport. This includes any use that would direct a steady or flashing light toward an aircraft engaged in take-off or landing or that would cause sunlight to be reflected toward an aircraft engaged in take-off or landing. It also includes any use that would generate smoke or rising columns of air, or that would attract large concentration of birds within approach-climb-out (i.e., take-off) areas, or that would generate electrical interference that may interfere with aircraft communications or aircraft instrumentation.

BART Station Area Specific Plan

Sites 5 and 6 would be within the area covered by the BART Station Area Specific Plan (San Mateo et al. 1993), in unincorporated San Mateo County and Daly City.

This plan addresses the status and condition of a 110-acre area partially within Daly City and partially within an unincorporated portion of San Mateo County, within which was planned construction of a new Colma BART station (San Mateo et al. 1993). As the lead agency for the BART Station Area, San Mateo County adopted the plan in 1993, and the plan provisions were incorporated into the Daly City and San Mateo County general plans. The plan recommends a process and physical development plan for gradual transition to urban uses that support the area's intended transportation/transit role and complements the character of the adjacent neighborhoods and business districts. It shows the preferred location, intensity and character of all land uses, capital improvements and transportation systems that would implement the Colma Area Plan and Daly City policies and that would be consistent with both Daly City's and San Mateo County's long-range goals. An emphasis was placed on making new and existing uses accessible by foot, bike, transit, or auto. New development located directly adjacent to BART would be linked to the station via a network of public spaces, such as stairways, paths, plazas and new streets.

Sites 5 and 6 would be located in Daly City, within the 110-acre area addressed by the Plan, in a swath identified in the Plan as the Hetch Hetchy right-of-way. The Plan recommends taking advantage of the undevelopable area of the right-of-way around Site 5 when determining building placement, plaza locations, and parking lot access points. At Site 6 the right-of-way is described as a deep swale, unsuitable for use as a parking lot or other public access area, but protection of the right-of-way south of D Street, as permanent landscaped easement is recommended. The Plan states that while underground water pipes prevent trees or buildings in this area, grass and small shrubs should be planted as a gateway symbol. (San Mateo et al. 1993)

4.3 INCONSISTENCY EVALUATION

4.3.1 Approach to Analysis

The evaluation of a project's inconsistency with plans and policies is based on the application of relevant land use plans and policies to the siting, construction and operation of the proposed Project. Because the policy language found in a land use plan can be interpreted in various ways, it is often difficult to determine whether a proposed project is consistent or inconsistent with such policies. Moreover, because

land use plans often contain numerous policies emphasizing differing legislative goals, a proposed project may be consistent with a general plan taken as a whole, even though it may appear to be arguably inconsistent with specific policies within the plan. The board or commission that enacted the plan or policy generally determines the meaning of such policies; these interpretations prevail if they are “reasonable,” even though other reasonable interpretations are also possible. In light of these considerations, the inconsistency evaluation in this EIR represents the best attempt to advise the decision-makers as to whether the proposed Project is inconsistent with applicable land use plans and policies.

Direct and indirect physical impacts resulting from potential conflicts with applicable plans and policies are addressed in Sections 5.2 through 5.19 of the EIR to the extent that they are relevant to the specific significance criteria under CEQA that require an analysis of the incompatibility of the proposed Project with certain aspects of local land use plans and policies. The particular significance criteria that directly relate to inconsistency with plans and policies are listed below, along with the location in this document where the reader can find the relevant impact evaluation. For the purposes of this EIR, the Regional Groundwater Storage and Recovery Project would have a significant effect on Plans and Policies if it were to:

- Conflict with any applicable land use plan, policy, or regulation of an agency with jurisdiction over the project (including, but not limited to the general plan, specific plan, or local coastal program) adopted for the purpose of avoiding or mitigating an environmental effect is addressed in Section 5.2, Land Use and Section 5.3, Aesthetics.
- Conflict with adopted policies, plans, or programs supporting alternative transportation (e.g., conflict with policies promoting bus turnouts and bicycle racks) or causing a substantial increase in transit demand that cannot be accommodated by existing or proposed transit capacity or alternative travel modes is addressed in Section 5.6, Transportation and Circulation.
- Expose people to or generate noise levels in excess of standards established in a local general plan or noise ordinance, or applicable standards of other agencies is addressed in Section 5.7, Noise and Vibration.
- Conflict with any local policies or ordinances protecting biological resources, such as a tree preservation policy or ordinance, is addressed in Section 5.14, Biological Resources.
- The significance criteria for conflict with the provisions of an adopted habitat conservation plan, natural community conservation plan, or other approved local, regional, or State habitat conservation plan are not applicable to the Project, as no such plans have been adopted in the areas that would be affected by the Project.

4.3.2 Federal Plans, Policies, and Guidelines

The VA Facilities Design Guide provides policies and objectives for siting and design of facilities located within the GGNC. Any conflicts between the proposed Project and policies that relate to physical environmental issues are discussed in Sections 5.2 through 5.19 of this EIR. The policies that do not relate to physical environmental issues are as follows: accessing wells and pump houses from service roads; and routing utility lines between gravesite areas to avoid obstruction of individual gravesites, and

burying utility lines underground. Implementation of mitigation measures identified in Chapter 5, Environmental Setting, Impacts, and Mitigation Measures, would ensure that the proposed Project is constructed and operated in a manner that is consistent with the VA design requirements. By implementing mitigation measures in Section 5.3, Aesthetics, and Section 5.5, Cultural and Paleontological Resources, which describe the design elements and design characteristics needed to be consistent with the Facilities Design Guide within the VA cemetery, the Project would preserve the visual and cultural qualities of the cemetery. Overall, there are no apparent inconsistencies between the VA Design Guide and the proposed Project.

The California Coastal Act, an integral element of California's Coastal Management Program developed pursuant to the federal CZMA, includes policies for protection of coastal resources, including recreational facilities and boating, water quality and protection of environmentally sensitive habitat areas (see Section 4.2.1 [Federal Plans and Policies]). These policies for the San Francisco coastal zone are embodied in the *Western Shoreline Area Plan*, the City's local coastal plan. The evaluation of the Project as it relates to these policies is discussed below.

4.3.3 San Francisco Plans and Policies

4.3.3.1 San Francisco General Plan

The San Francisco General Plan provides policies and objectives to guide land use decisions. Any conflicts between the proposed Project and policies that relate to physical environmental issues are discussed in Sections 5.2 through 5.19 of this EIR. The compatibility of the proposed Project with San Francisco General Plan policies that do not relate to physical environmental issues will be considered by the SFPUC as part of its decision to approve or disapprove the proposed Project.

Implementation of mitigation measures identified in Chapter 5, Environmental Setting, Impacts, and Mitigation Measures, would ensure that the proposed Project is constructed and operated in a manner consistent with the five relevant elements of the San Francisco General Plan, as well as policies pertaining to Lake Merced in the General Plan's *Western Shoreline Area Plan* (San Francisco 1988b). The Project would further goals in the Community Safety Element by constructing facilities to current seismic standards, thereby improving the seismic reliability and water delivery reliability of the system. The Project would also support regional water system reliability goals of the Environmental Protection Element by providing an increased level of regional operational flexibility to respond to and restore water service during unplanned outages and/or a loss of a water source. By implementing mitigation measures in Section 5.3, Aesthetics, which includes measures to ensure design consistency with surrounding areas, as well as landscaping plans to maintain existing community character and preserve visual resources, the Project would also be consistent with the Urban Design Element. Also, mitigation measures in Section 5.16, Hydrology and Water Quality would implement lake level management measures for Lake Merced (M-HY-9 [Lake Level Management for Lake Merced]), which would avoid significant impacts on Lake Merced beneficial uses, recreation, and scenic resources and would meet the Lake Merced water quality objectives of the *Western Shoreline Area Plan* (San Francisco 1988b) for the preservation of recreational and natural habitat of Lake Merced. Overall, there are no apparent inconsistencies between the San Francisco General Plan, including the Western Shoreline Plan, and the proposed Project.

4.3.3.2 Golden Gate Park Master Plan

The GSR Project would not conflict with the *Golden Gate Park Master Plan*. As discussed in Section 5.16, Hydrology and Water Quality, because the park lakes do not intersect the groundwater and are not hydraulically connected with the North Westside Groundwater Basin aquifer, no impacts to the lakes would occur. Subsequently, the Project would not interfere with objectives and policies to maintain lake levels, water quality, habitat, or recreation opportunities.

4.3.3.3 Accountable Planning Initiative Priority Policies

Of the eight priority policies contained in the Accountable Planning Initiative, three are relevant to the proposed Project. Policy 6 stipulates that the City achieve the greatest possible preparedness to protect against injury and loss of life in an earthquake. Policy 7 states that landmarks and historic buildings shall be preserved and Policy 8 states that parks and open space, and their access to sunlight and vistas, shall be protected from development.

In general, Chapter 5 of this EIR discusses the consistency of the proposed Project with the environmental topics associated with the priority policies. More specifically, with respect to Policy 6, the primary purpose of the proposed Project is to provide a reliable water supply to protect the City and region from emergencies. Not only would Project facilities be designed to seismic safety standards, but they also would provide an increased level of regional operational flexibility to respond to and restore water service during unplanned outages and/or a loss of a water source, including during a seismic event. The Project's consistency with Policy 7, which states that landmarks and historic buildings shall be preserved, is discussed in Section 5.5, Cultural and Paleontological Resources, which concludes that historic resources would be protected from damage during construction of Sites 14 and 15 through implementation of physical and administrative mitigation measures. The Project's consistency with Policy 8, which requires that parks and open space and their access to sunlight and vistas shall be protected from development, is discussed in Section 5.3, Aesthetics and Section 5.10, Wind and Shadow, which conclude that the Project would not alter vistas or views at parks in the area or have an adverse impact on the visual character of the site or surrounding area or eliminate access to sunlight.

Overall, there are no apparent inconsistencies between the Accountable Planning Initiative and the proposed Project.

4.3.3.4 San Francisco Sustainability Plan

The San Francisco Sustainability Plan was developed for the purpose of addressing San Francisco's long-term environmental and economic sustainability (San Francisco Department of the Environment 1997). The proposed Project would be consistent with the goals of the Sustainability Plan. It would make a beneficial contribution to long-term environmental and economic stability by providing a dry-year water supply, by increasing water delivery reliability, by meeting customer water supply needs, and by improving management of the South Westside groundwater basin. Overall, there are no apparent inconsistencies between the San Francisco Sustainability Plan and the proposed Project.

4.3.3.5 *San Francisco Municipal Green Building Program*

As explained above in Section 4.2.2.6 (San Francisco Municipal Green Building Program), the City's Program was established in 1999 when the CCSF adopted the Resource Efficient Building Ordinance, which established green building standards for municipal buildings. The 2004 amendments to Environment Code Chapter 7 set LEED Silver Certification as the minimum environmental performance requirement for all municipal projects that would involve buildings with areas of over 5,000 square feet. For all municipal construction projects, the REB Task Force provides recommended best practices and sample specifications for building materials.

As discussed in Chapter 3, Project Description, Section 3.7 (Greenhouse Gas Reduction Actions), the SFPUC is committed to GHG reduction actions, including use of green building materials, as part of all WSIP projects, including the proposed Project. Overall, there are no apparent inconsistencies between the San Francisco Municipal Green Building Program and the proposed Project.

4.3.3.6 *Significant Natural Resource Areas Management Plan*

Of the 30 candidate natural areas identified in the San Francisco Recreation and Park Department's SNRAMP staff report, only two are relevant to the proposed Project: Pine Lake and Lake Merced. The proposed Project would not conflict with the general policies and management actions proposed in the 1995 SNRAMP staff report. As mentioned in Section 4.2.2.7 (Significant Natural Resource Area Management Plan), that report is intended to establish a maintenance and preservation program to protect and enhance natural resource values. Although the SNRAMP staff report does not contain policies and management actions specific to Lake Merced or Pine Lake, the policies or management actions in the staff report related to Lake Merced include: maintaining/promoting indigenous plant species and controlling/removing invasive species; monitoring wildlife populations; and maintaining/improving water quality, etc. Mitigation measures described in Sections 5.14, Biological Resources and 5.16, Hydrology and Water Quality, would be implemented to mitigate potential impacts to the beneficial uses of Lake Merced, including management of lake levels to avoid impacts to wetlands and other habitats around the lake. As discussed in Section 5.16, Hydrology and Water Quality, the proposed Project would have little or no effect on groundwater levels near Pine Lake and therefore would not significantly impact wetland or other sensitive habitat at Pine Lake. Overall, there are no apparent inconsistencies between the SNRAMP staff report and the proposed Project.

4.3.4 SFPUC Policies and Plans

4.3.4.1 *Water Enterprise Environmental Stewardship Policy*

The proposed Project would not conflict with the underlying goals of the *Water Enterprise Environmental Stewardship Policy*. Under the proposed Project, the SFPUC would continue to responsibly manage the rights-of-way and properties in urban areas in a manner that protects and restores habitat value where available and would continue to encourage community participation in decisions that significantly interrupt or alter current land uses as a result of the Project. Overall, there are no apparent inconsistencies between the *Water Enterprise Environmental Stewardship Policy* and the proposed Project.

4.3.4.2 *Right of Way Integrated Vegetation Management Policy*

Removal of trees and other vegetation would be required at some of the proposed well facility sites to allow for Project construction and operation (see Section 5.14, Biological Resources and Section 5.3, Aesthetics). All vegetation removal within the SFPUC right-of-way would be in accordance with the Vegetation Management Policy. Specifically, vegetation would be removed as needed to protect system components from damage and to provide for ease of facility maintenance. All vegetation removal work would be reviewed and supervised by a SFPUC qualified professional; the required City and public notification process for planned vegetation removal would be followed. Therefore, the proposed Project would be implemented consistent with the Vegetation Management Policy. Overall, there are no apparent inconsistencies between the *Right-of-Way Integrated Vegetation Management Policy* and the proposed Project.

4.3.4.3 *Strategic Sustainability Plan*

The proposed Project would assist the SFPUC in attaining the following goals and objectives presented in its *Strategic Sustainability Plan*:

Goal: Provide High Quality Services.

Objective B. Enhance partnerships with City Departments, Agencies, and Raker Act entities.

Objective C. Provide high quality service to all customers, including customers who are most vulnerable to service interruptions.

Goal: Plan for the Future

Objective N. Optimize planning to meet water, wastewater, and power demand.

Goal: Environment and Natural Resources

Objective T. Diversify high quality water sources and advance water efficiency, conservation and reuse.

Overall, there are no apparent inconsistencies between the *Strategic Sustainability Plan* and the proposed Project.

4.3.5 Land Use Plans and Policies of Other Local Jurisdictions

4.3.5.1 *General Plans*

As described above in Section 4.2.2.1 (Extraterritorial Lands), the SFPUC is not legally bound by the land use plans of other local jurisdictions (e.g., the Daly City General Plan, Colma General Plan, South San Francisco General Plan, San Bruno General Plan, Millbrae General Plan, and the San Mateo County General Plan). Determinations of Project consistency with local general plans would be made by the pertinent land use jurisdictions following circulation of the environmental documentation for this Project under CEQA and notification by the SFPUC pursuant to State law (Government Code Section 65402).

The local jurisdictions in which the proposed Project would be located are primarily built out, established communities. Current general plans of these jurisdictions generally seek to preserve the existing community character, protect natural resources and unique physical features, protect the health and safety of residents, and support appropriate levels of economic growth and community services.

The intent of general plans is to preserve and improve the quality of life for citizens and to consider growth in a manner that appropriately reflects the community's values. An adequate and reliable water supply is a fundamental public service requirement to accomplish these goals. San Mateo County and each of the cities, in which the proposed Project would be located, receive all or part of their water supply from the SFPUC. Local jurisdictions would also consider whether construction and operation of the Project would be consistent with general plan goals.

Most of the general plans contain land use goals that recognize the need for an adequate and dependable water supply, including the need for easements to allow siting of facilities for water supply development and transmission. The Project would directly respond to these goals. The proposed Project would provide enhanced regional water system reliability for Partner Agencies while simultaneously improving the sustainability and management of groundwater resources in the South Westside Groundwater Basin through groundwater recharge during normal and wet water years.

As described previously in Section 4.2.4 (Land Use Plans and Policies of Other Local Jurisdictions), the general plans of each jurisdiction generally include policies that address facility design and environmental resources, including design of facilities in character with the surrounding areas, locating utilities to avoid or minimize damage from seismic and geologic hazards; protecting sensitive wildlife habitats and plants; locating utility lines underground to minimize visual impacts; conserving and protecting archaeological and historic resources; implementing noise and traffic controls; appropriate design of new development; and tree preservation and planting. In addition, several general plans include policies specifically related to the protection of the SFPUC water supply and call for coordination with the SFPUC to ensure a reliable source of water. All of these policies are addressed where relevant in the substantive analysis of the project's environmental impacts in Chapter 5, Environmental Setting, Impacts, and Mitigation Measures, as well as in Chapter 6, Other CEQA Issues, Section 6.1 (Growth Inducement).

The proposed Project would minimize or avoid inconsistencies with the objectives and policies of local land use plans through implementation of mitigation measures included in Section 5.3, Aesthetics; Section 5.5, Cultural and Paleontological Resources; Section 5.7, Noise and Vibration; Section 5.8, Air Quality; Section 5.9, Greenhouse Gas Emissions; Section 5.11, Recreation; Section 5.14, Biological Resources; Section 5.15, Geology and Soils; Section 5.16, Hydrology and Water Quality; and Section 5.17, Hazards and Hazardous Materials. Regardless, some impacts would remain. However, on the whole, with implementation of these mitigation measures, the proposed Project would mitigate impacts to the extent feasible and would be consistent with the environmental protection policies included in the local land use plans. Overall, for San Mateo County customers who receive all or part of their water from the SFPUC, the proposed Project would seem to conform to the broader goals of their respective general plans to maintain and improve the quality of life of the local population through maintaining high-

quality water supply, reducing vulnerability of the regional water system to earthquakes, increasing water supply reliability and meeting water supply needs.

4.3.5.2 Other Plans and Policies

Local Coastal Program

The evaluation of whether the Project is inconsistent with the *Western Shoreline Area Plan* relating to objectives and policies for Lake Merced is discussed above under Section 4.3.3.1 (San Francisco General Plan).

South Westside Basin Groundwater Management Plan

The Project is consistent with the GWMP, because it provides a conjunctive use project that would increase the volume of groundwater in storage through a reduction in groundwater pumping by the Partner Agencies made possible by increased surface water deliveries from the regional water system (City of San Bruno, et al. 2012). This “conjunctive,” or cooperative, use of the basin would allow the naturally stored water to be pumped during dry years. The Project would help meet a goal of the GWMP to ensure a sustainable, high-quality, reliable water supply.

Vista Grande Watershed Study and Vista Grande Drainage Basin Alternatives Analysis Report

The component of the *Vista Grande Watershed Study* relevant to the proposed Project is the Lake Merced Alternative. The proposed Project would not conflict with the overall objectives of the potential Vista Grande Drainage Basin Improvement Project. As discussed in Section 5.16, Hydrology and Water Quality, measures would be implemented to mitigate the GSR Project’s impacts on Lake Merced water levels and other beneficial uses. Therefore, the GSR Project would be complementary to the Lake Merced Alternative. Overall, there are no apparent inconsistencies between the goal and objectives for the Vista Grande Lake Merced Alternative and the proposed Project.

4.4 REFERENCES

- City/County Association of Governments of San Mateo County (C/CAG) Airport Land Use Commission. 1996. *San Mateo County Comprehensive Airport Land Use Plan*. December.
- Colma, Town of. 1999. *Town of Colma General Plan*. June.
- Colma, Town of. 2012 *Town of Colma General Plan Housing Element*. October 10.
- Daly City, City of. 1987. *City of Daly City General Plan*. November.
- Daly City, City of. 2006. *Vista Grande Watershed Study*. Prepared by RMC. August.
- Daly City, City of. 2009. *General Plan Revised Draft Housing Element*. October.
- Daly City, City of. 2011a. *Vista Grande Drainage Basin Alternatives Analysis Report Executive Summary*. Prepared by Jacobs Associates. February.
- Daly City, City of. 2011b. *City Council Special Meeting Minutes for May 23, 2011*. May 23. Website accessed January 29, 2013 at:
<http://209.234.104.30/sirepub/cache/2/p30oqtyjxncwtsuu5ugiv255/425586201292013032715900.PDF>.
- Daly City, City of. 2013. *Notice of Preparation/Notice of Intent to Prepare a Joint EIR/EIS for the Vista Grande Drainage Basin Improvements Project*. February 28.
- Millbrae, City of. 1998. *City of Millbrae General Plan*. November.
- Millbrae, City of. 2006. *City of Millbrae General Plan Housing Element*. January.
- San Bruno, City of. 2009. *City of San Bruno General Plan*. March.
- San Bruno, City of, California Water Service Company, City of Daly City, and the San Francisco Public Utilities Commission (SFPUC). 2012. *South Westside Basin Groundwater Management Plan*. Prepared by WRIME. July.
- San Francisco, City and County of. 1988a (as amended through 1996). *City and County of San Francisco General Plan*.
- San Francisco, City and County of. 1988b (as amended through 1996). *Western Shoreline Area Plan*. Included as part of the San Francisco General Plan. September.
- San Francisco Department of the Environment. 1997. *Sustainability Plan for the City of San Francisco*. Adopted July 1997.
- San Francisco Department of the Environment. 2007. *San Francisco Municipal Green Building Report 2004-2007*.
- San Francisco Planning Department. 2006. *City and County of San Francisco Municipal Code, Planning Code, Volume 1, Section 101.1*.
- San Francisco Public Utilities Commission (SFPUC). 2006. *SFPUC Water Enterprise Environmental Stewardship Policy*. June 26. Website accessed March 27, 2008 at:
<http://sfwater.org/index.aspx?page=181>.

- SFPUC. 2007. *Right of Way Integrated Vegetation Management Policy*. Website accessed April 9, 2009 at: http://sfwater.org/detail.cfm/MC_ID/20/MSD_ID/354/MTO_ID/504/C_ID/90.
- SFPUC. 2008. *Sustainability Plan and Program*. December.
- SFPUC. 2011. *Strategic Sustainability Plan*. March.
- San Francisco Recreation and Park Department (SFRPD). 1995. *Staff Report on the Significant Natural Resource Areas Management Plan*. Adopted January 19, 1995 [S.F. Recreation and Park Commission Resolution No. 9501-008]
- San Francisco Recreation and Park Department (SFRPD). 1998. *Golden Gate Park Master Plan*. Prepared by Royston Hanamoto Alley & Abey. Adopted October 1998.
- San Mateo County. 1986a. *San Mateo County General Plan Overview Background & Issues Chapters 1-16*. November.
- San Mateo County. 1986b. *San Mateo County General Plan Policies*. November.
- San Mateo County. 2010. *San Mateo County General Plan Housing Element*. March 11.
- San Mateo, County of, City of Daly City and San Mateo County Transit District. 1993. *BART Station Area Specific Plan, Unincorporated Colma/Daly City, San Mateo County, California*. Prepared by Calthorpe Associates. March.
- South San Francisco, City of. 1999. *City of South San Francisco General Plan*.
- South San Francisco, City of. 2010. *City of South San Francisco General Plan Housing Element*. February.
- U.S. Department of Veterans Affairs (VA), National Cemetery Administration/Office of Facilities Management Facility Quality Office. 1999. *National Cemetery Administration (NCA) Facilities Design Guide Chapters 1-4*. June.
- U.S. Department of Veterans Affairs (VA), National Cemetery Administration/Office of Facilities Management Facility Quality Office. 2010. *National Cemetery Administration (NCA) Facilities Design Guide Chapter 5*. March.

This page left intentionally blank

5 ENVIRONMENTAL SETTING, IMPACTS, AND MITIGATION MEASURES

5.1 OVERVIEW

This chapter provides a project-level analysis of the physical environmental effects of implementing the Regional Groundwater Storage and Recovery (GSR) Project. This chapter describes the environmental setting, assesses impacts, and identifies mitigation measures for significant impacts.

5.1.1 Scope of Analysis

This Draft Environmental Impact Report (EIR) analyzes the potential effects of the proposed GSR Project (proposed Project or Project) on the environment under the applicable environmental resource topics listed in the California Environmental Quality Act (CEQA) Initial Study Checklist used by the Environmental Planning (EP) Division of the San Francisco Planning Department. The EP CEQA Initial Study Checklist is based on the CEQA Guidelines Appendix G with some modifications. The checklist includes the environmental resource topics identified below:

- Land Use (see Section 5.2)
- Aesthetics (see Section 5.3)
- Population and Housing (see Section 5.4)
- Cultural and Paleontological Resources (see Section 5.5)
- Transportation and Circulation (see Section 5.6)
- Noise and Vibration (see Section 5.7)
- Air Quality (see Section 5.8)
- Greenhouse Gas Emissions (see Section 5.9)
- Wind and Shadow (see Section 5.10)
- Recreation (see Section 5.11)
- Utilities and Service Systems (see Section 5.12)
- Public Services (see Section 5.13)
- Biological Resources (see Section 5.14)
- Geology and Soils (see Section 5.15)
- Hydrology and Water Quality (see Section 5.16)
- Hazards and Hazardous Materials (see Section 5.17)
- Mineral and Energy Resources (see Section 5.18)
- Agriculture and Forest Resources (see Section 5.19)

Each environmental resource section includes a discussion of the environmental setting, applicable regulations pertaining to the resource area, impact assessment, and mitigation measures where applicable. Each section of Chapter 5 contains the following elements:

Setting. This subsection presents a description of the existing physical environmental conditions in the vicinity of the Project with respect to each resource area at an appropriate level of detail to understand the impact analysis. It describes existing conditions and provides a baseline by which to compare the potential impacts of the proposed Project.

Regulatory Framework. This subsection provides a brief discussion of federal, State, and local regulations and policies that are relevant to the resource.

Impacts and Mitigation Measures. This subsection evaluates the potential for the Project to adversely affect the physical environment described in the setting. Significance criteria for evaluation of environmental impacts are defined in the beginning of the impact analysis section, including an explanation of how the significance criteria are used in the evaluation of impacts for the Project. The subsection includes a discussion of the approach to the analysis, including identification of the significance criteria that are not applicable to the proposed Project. Potential impacts are identified and characterized. Where applicable and feasible, mitigation measures are identified to avoid or reduce the impact to a less-than-significant level.

The Impacts and Mitigation Measures Section in each resource chapter includes an impact statement followed by the evaluation of the impact for each of the facility sites. Each impact statement includes a significance determination at the end of the statement in parentheses. This significance determination reflects the most severe or significant impact level for any of the sites included in the evaluation. For instance, even if some of the sites evaluated under a particular impact statement were deemed to have a less-than significant or no impact and one site was determined to have a significant impact that could be reduced with mitigation, the significance determination shown in parentheses in the impact statement would be less than significant with mitigation, to reflect the one site that has a significant impact. Mitigation is included in the evaluation and applied to sites where the significant impact would occur.

Because of the multiple well facility sites associated with the proposed Project, overlapping impacts may occur from construction and/or operation of well facilities that are in geographic proximity to each other and/or have concurrent construction periods. During construction, combined impacts from groups of individual well facilities could occur based on geographic proximity and concurrent construction periods presented in Table 3-7 (Facility Construction Clusters and Construction Sequencing) in Chapter 3, Project Description, Section 3.5.1 (Construction Sequencing and Schedule). During operation, combined impacts from groups of individual well facilities could occur based on geographic proximity and the concurrent operational activities, as described in Chapter 3, Project Description, Section 3.8 (Operations and Maintenance). These combined impacts from groups of individual well facilities are evaluated only in those cases, and only for those resources, where construction and/or operational impacts from multiple facility sites would overlap to create greater impacts than would have been created by an individual site alone. Where this would be the case, it is identified in the Approach to Analysis section in the resource

chapter. In all other cases, the impacts of the Project would only occur at individual well facility sites and are evaluated accordingly.

Cumulative Impacts and Mitigation Measures. Cumulative impacts are discussed in each environmental resource section following the description of the Project-specific impacts and identified mitigation measures. The cumulative impact analysis considers the effects of the Project together with other past, present, or reasonably foreseeable future projects proposed by the San Francisco Public Utilities Commission (SFPUC) or other entities. The cumulative impact analysis is based on the same setting, regulatory framework, and significance criteria presented in each resource topic section. Additional mitigation measures are identified if the analysis determines that the Project's contribution to an adverse cumulative impact would be cumulatively considerable and, therefore, significant.

5.1.2 Significance Determinations

The impact significance criteria used in this Draft EIR are based on the EP Initial Study Checklist. The significance criteria used for each environmental resource topic are presented in each section of Chapter 5 following the setting and before the discussion of impacts. For the impact analyses, the following categories are used to determine impact significance:

No Impact (NI). This determination is made if a resource is absent or if a resource exists within the Project area or area of potential effect, but there is no potential that the proposed Project could affect the resource.

Less than Significant (LS). This determination applies if there is a potential for some limited impact on a resource, but the impact is not significant under the significance criterion.

Less than Significant with Mitigation (LSM). This determination applies if there is the potential for a substantial adverse effect in accordance with the significance criterion, but mitigation is available to reduce the impact to a less-than-significant level.

Significant and Unavoidable with Mitigation (SUM). This determination applies if it is certain that the Project would result in an adverse effect that meets the significance criteria and there is some mitigation available to lessen the impact, but the residual effect after implementation of the measure would remain significant.

Significant Unavoidable (SU). This determination applies to impacts that are significant, but for which there appears to be no feasible mitigation available to reduce the impact to a less-than-significant level.

Within each section in this chapter, a summary table is included at the beginning of the impact discussion to summarize the potential impacts at each individual facility site. This table also indicates the level of impact significance before and after mitigation. Environmental impacts are numbered throughout this EIR, using the section name (abbreviated) followed by sequentially numbered impacts. Mitigation measures are numbered to correspond to the impact numbers; for example, Mitigation Measure M-LU-1 addresses Land Use Impact LU-1.

5.1.3 Relationship to the WSIP PEIR

As discussed in Chapter 2, Introduction and Background, the proposed Project is one of the facility improvement projects included in the SFPUC's Water System Improvement Program (WSIP). The Program EIR (PEIR), which was certified by the San Francisco Planning Commission on October 30, 2008, addresses the potential environmental impacts of the WSIP and evaluates regional water supply alternatives (San Francisco Planning Department 2008). Because the proposed Project is a component of the WSIP, the Project would also contribute to the WSIP's water supply and system operations impacts.

The PEIR analyzed potential water supply and system operations impacts (separate from environmental impacts associated with the facility improvements) within the following geographic regions: the Tuolumne River, Alameda Creek and Peninsula watersheds, and the Westside Groundwater Basin. The PEIR identified the cumulative effects of implementing the WSIP and system operations in combination with other past, present, and reasonably foreseeable future projects within each of these watersheds. It also discussed the potential effects of climate change and global warming on the regional water system.

The PEIR concluded that the WSIP would result in changes in reservoir levels and associated changes in downstream flows in rivers and creeks in the three affected watersheds, potentially resulting in impacts on groundwater, water quality, fisheries, and terrestrial biological resources. In the event that deliveries to customers exceed an average annual 265 million gallons per day (mgd), streamflow changes in the Tuolumne River watershed could affect fisheries and terrestrial biological resources. In the Alameda Creek and Peninsula watersheds, the WSIP, which includes restoring the historical storage capacities of Calaveras and Lower Crystal Springs reservoirs, could affect reservoir levels, downstream flows, fisheries, and terrestrial biological resources. In addition, the WSIP includes projects, such as the proposed GSR Project (which includes development of groundwater supplies in the Westside Groundwater Basin), which could result in basin overdraft, seawater intrusion, and changes in the water levels of surface water bodies.

As stated above, the proposed Project is a component of the WSIP and, therefore, would contribute to the water supply impacts identified in the PEIR. Tables D-1a through D-1e in Appendix D, WSIP PEIR Water Supply Impact and Mitigation and Consistency Analysis, summarize the WSIP water supply impacts and mitigation measures for each geographic region analyzed in the PEIR. The reader is referred to the complete WSIP PEIR for a detailed explanation of the summary tables. In addition to water supply impacts and mitigation measures, the PEIR provides a program-level analysis of the impacts associated with WSIP facility improvement projects, including construction and operation impacts. This EIR addresses the same issues as the PEIR for the proposed Project at a project level of detail. That is, this EIR provides more project-specific and site-specific descriptions and analysis of Project effects based on a much more detailed Project description and more information about the Project area. Appendix D presents a comparison between the programmatic mitigation measures identified for the Project in the PEIR and the mitigation measures identified for the Project in this EIR.

This project-level EIR tiers from the PEIR, and the analyses relevant to this proposed Project are incorporated by reference into this EIR. CEQA permits tiering from a program EIR to allow agencies to broadly consider the environmental effects of a series of actions and/or policies and then to provide a

more detailed examination of project-specific impacts in project-level EIRs. The PEIR is available for public review at the San Francisco Planning Department, 1650 Mission Street, San Francisco, CA 94103, and is on the Planning Department's website at <http://www.sf-planning.org/index.aspx?page=1829>. The State Clearinghouse Number for the PEIR is 2005092026.

5.1.4 Evaluation of Well Facility Sites and Alternates

This Draft EIR evaluates construction of up to 19 proposed well facilities. The SFPUC has identified 16 preferred well facility sites, three alternate well facility sites, and upgrades at the Westlake Pump Station as the Project evaluated in this EIR. The proposed sites and the alternate sites are both evaluated in the same manner and at the same level of detail in Chapter 5. Any of the alternate well facility sites could replace any of the preferred well facility sites. The conditions under which the alternate sites would be developed instead of the preferred sites are discussed in Chapter 3, Project Description, Section 3.4.2, (Production Wells and Associated Facilities).

This EIR also evaluates pipeline connections to the water distribution system for the 16 preferred and three alternate well facility sites. In addition, alternate connections to water distribution systems at 14 of the well facility sites are evaluated in the EIR. The conditions under which the alternate connection at any of the sites would be developed instead of the proposed connection are discussed in Chapter 3, Project Description, Section 3.4.2 (Production Wells and Associated Facilities).

This Draft EIR also evaluates two different optional designs at Sites 5, 6, and 7. The SFPUC prefers to provide "consolidated treatment" at Site 6, meaning water from Sites 5 and 7 would be conveyed to a centralized treatment facility at Site 6. However, the SFPUC has also identified an option to construct individual, on-site treatment facilities at Sites 5, 6, and 7. This option is also evaluated in this EIR in the instance the SFPUC determines that consolidated treatment at Site 6 is infeasible due to unforeseen circumstances, as further described in Chapter 3, Project Description. These two options are identified as "Consolidated Treatment at Site 6" and "On-site Treatment" (see Chapter 3, Project Description, Section 3.4.3 [Facility Sites]).

5.1.5 Well Facility Sites that are Dependent on Other Sites for Treatment

Some of the well facility sites would not have water treatment systems at the site and would need to rely on treatment systems located at a nearby facility site. Table 5.1-1 (Location of Treatment for Well Facilities without Treatment Systems) lists the well facility sites that would be dependent upon treatment at a nearby facility. The impacts of constructing and operating the well facilities at Sites 2, 3, 4, 5 (Consolidated Treatment at Site 6), 7 (Consolidated Treatment at Site 6), 14, and 19 (Alternate) are therefore a combination of the impacts identified at the location of the well and at the location of the water treatment facility.

TABLE 5.1-1**Location of Treatment for Well Facilities without Treatment Systems**

Site	Proposed Location of Water Treatment
Sites 2, 3, and 4	Westlake Pump Station
Site 5 (Consolidated Treatment at Site 6)	Site 6
Site 7 (Consolidated Treatment at Site 6)	Site 6
Site 14	Site 15
Site 19 (Alternate)	Site 12

5.1.6 Groundwater Modeling Overview

Because the Project evaluated in this EIR is a groundwater storage and recovery project, a key component of the impact analysis is the use of groundwater modeling to evaluate existing conditions and conditions that would occur in the groundwater basin in the future with operation of the project, as well as under cumulative conditions (i.e., with operation of the proposed Project along with other existing and reasonably foreseeable projects). Groundwater models are mathematical computer models of groundwater flow systems and are a standard analytical tool used in the development and evaluation of groundwater projects. The volume of groundwater and the depths of groundwater levels vary from year to year depending on meteorological conditions, pumping by well owners, and historic conditions in the groundwater basin. The relationships among these parameters are complex. Therefore, the groundwater models are utilized by the SFPUC and the Partner Agencies to conduct groundwater supply planning and to evaluate the impacts of proposed groundwater projects. This section provides an overview of the groundwater modeling used for the GSR Project, including basic assumptions and definitions of key terms used in the analysis.

Two groundwater models have been developed and used for the analysis in this EIR: 1) Westside Basin Groundwater Model (for evaluating conditions in the basin as a whole); and 2) Lake-Level Model (for evaluating conditions at Lake Merced). These are described below.

5.1.6.1 *Westside Basin Groundwater Model*

The Westside Basin Groundwater Model is a regional basin-wide groundwater model of the Westside Groundwater Basin, which is located in western San Francisco and San Mateo County. The model was developed using MODFLOW 2000 (a numerical modeling software developed by the United States Geological Survey) and was developed over a period of several years by the City of Daly City, with assistance from the City of San Bruno, the California Water Service Company (Cal Water), and the SFPUC. Each entity contributed and ultimately agreed upon information to be used in the model relative to hydrologic and groundwater pumping conditions in the Westside Groundwater Basin.

Because many aspects of groundwater systems are unknown, most basin-specific groundwater models are calibrated prior to being used for predictions. Calibration is performed using statistical methods and is important in order to have confidence in the model's predictions. The Westside Basin Groundwater Model Version 3.1, which was used for the analysis in this EIR, was calibrated to observed groundwater conditions within the Basin for a period of 51 years, from October 1958 through September 2009 (HydroFocus 2011). The calibration used available records of historical hydrologic and pumping data, including more than 2,000 observed monthly water levels in 125 wells representing a broad range of locations, depths, and hydrologic conditions. The hydrology used in the calibration relied on actual, measured monthly rainfall and temperature data from various climate stations throughout the Westside Groundwater Basin and included conditions ranging from wet periods to droughts of different magnitude and duration.

The adequacy of the model calibration was assessed by calculating the average difference between modeled and observed groundwater levels. The calibrated groundwater levels were on average (throughout the entire modeled area) within 19 feet of the observed water levels, which is approximately four percent of the total range in observed groundwater levels across the modeled area. Typically, calibration is considered adequate when this difference is less than 15 percent (Kennedy/Jenks 2012a). Based on these results, the Westside Basin Groundwater Model is considered reasonably well calibrated and a tool that may be used for basin-scale analyses and comparison of water resources management alternatives.

Modeled Scenarios and Pumping Assumptions

Consistent with CEQA Guidelines Section 15125(e), the baseline year for the hydrologic parameters used in the groundwater modeling for the GSR Project is 2009, which is the year that the Project's Notice of Preparation of an Environmental Impact Report (NOP) was issued (see Appendix A, Notice of Preparation). Using the calibrated model, the Westside Basin Groundwater Model was used to project groundwater levels and other parameters for three scenarios: modeled existing conditions, conditions with the proposed GSR Project, and the cumulative conditions. For each scenario, groundwater conditions were modeled for a 47-year hydrologic sequence derived from hydrologic parameters measured from 1958 to 2005 and using the pumping assumptions listed in Table 5.1-2 (Model Input - Pumping Assumptions for Modeling Scenarios). This 47-year period includes many different types and sequences of actual hydrological events, including years of drought and above-average rainfall of varying magnitude and duration. Because natural groundwater systems are dynamic and vary from year to year, it is a necessary and standard industry practice to use a long-term historical record to represent the range of hydrological conditions that can be expected in the future. The long-term 47-year historical record is used in the model to represent the range of hydrologic conditions that could occur in the future and to assess what types of impacts the Project might have under a range of conditions.

The Westside Basin Groundwater Model considers a Put, Take, Hold sequence to simulate in-lieu groundwater recharge during wet and normal rainfall years and groundwater extraction during dry years. This sequence is defined as follows:

- A Put Period is a period when the SFPUC would provide supplemental surface water to the Partner Agencies. The surface water would be used by the Partner Agencies in lieu of groundwater, allowing them to reduce their groundwater pumping rates. During a Put Period, the reduced pumping would effectively increase the amount of groundwater in storage. The SFPUC would maintain an accounting of the supplemental surface water deliveries to the Partner Agencies, known as the SFPUC Storage Account (see Chapter 3, Project Description, Section 3.8.1 [Operating Agreement]), for a discussion of the SFPUC Storage Account). During a Put Period, Project wells would be operated by the SFPUC or the Partner Agencies periodically to exercise the wells for maintenance purposes.
- A Take Period is a dry period when water shortages could occur and the SFPUC would not provide supplemental surface water to the Partner Agencies. During a Take Period, the volume of water pumped by the Project wells would be limited to the total amount of groundwater included in the SFPUC Storage Account and the Partner Agencies would also pump their municipal wells at their typical rate for municipal supply.
- A Hold Period is a period when the SFPUC Storage Account is full and there would be no supplemental surface water deliveries by the SFPUC. The SFPUC Storage Account is full when 60,500 acre-feet (af) have been stored after accounting for Project-related losses from the Account. During a Hold Period, the Partner Agencies could pump their municipal wells at their typical rate for municipal supply, but Project wells would be operated by the SFPUC or the Partner Agencies periodically to exercise the wells for maintenance purposes.

The pumping assumptions for each scenario are identified in Table 5.1-2 (Model Input - Pumping Assumptions for Modeling Scenarios). The modeled scenarios are described following the table.

TABLE 5.1-2
Model Input – Pumping Assumptions for Modeling Scenarios

		Pumping Rate for Modeling Scenarios Million Gallons per Day (mgd)		
		Existing Conditions	GSR Project	Cumulative Conditions
Pumped Wells				
Municipal Pumping				
Partner Agencies (PA) ^(a)				
	Take Periods	6.84	6.90	6.90
	Put Periods	6.84	1.38	1.38
	Hold Periods	6.84	6.90	6.90
GSR Project				
	Take Periods	0.0	7.23	7.23
	Put Periods	0.0	0.04	0.04
	Hold Periods	0.0	0.04	0.04
San Francisco Groundwater Supply Project (SFGW Project, a cumulative project)				
	Year-round Pumping	0.0	0.0	4.0
Total Municipal Pumping (PA and GSR and SFGW Projects)				
	<i>Take Periods</i>	<i>6.84</i>	<i>14.13</i>	<i>18.13</i>
	<i>Put Periods</i>	<i>6.84</i>	<i>1.42</i>	<i>5.42</i>
	<i>Hold Periods</i>	<i>6.84</i>	<i>6.94</i>	<i>10.94</i>
Irrigation and Other Non-Potable Pumping				
Golden Gate Park	Elk Glen	0.081	0.081	0.0
	South Windmill	0.498	0.498	0.0
	North Lake	0.563	0.563	0.0
Subtotal		1.142	1.142	0.0
Golf Clubs	Burlingame Golf Club	0.150	0.150	0.150
	California Golf Club No. 02	0.192	0.192	0.192
	Green Hills No. 05	0.099	0.099	0.099
	Lake Merced Golf Club No. 01	0.004	0.004	0.004
	Lake Merced Golf Club No. 02	0.004	0.004	0.004

TABLE 5.1-2
Model Input – Pumping Assumptions for Modeling Scenarios

		Pumping Rate for Modeling Scenarios Million Gallons per Day (mgd)		
		Existing Conditions	GSR Project	Cumulative Conditions
Pumped Wells				
	Lake Merced Golf Club No. 03	0.010	0.010	0.010
	Olympic Golf Club ^(b)	0.002	0.002	0.002
	San Francisco Golf Club West	0.035	0.035	0.035
Subtotal		0.495	0.495	0.495
Cemeteries				
	Cypress Lawn Cemetery No. 02	0.020	0.020	0.020
	Cypress Lawn Cemetery No. 03	0.144	0.144	0.144
	Eternal Home Cemetery	0.013	0.013	0.013
	Hills of Eternity Cemetery No. 02	0.020	0.020	0.020
	Holy Cross Cemetery No. 03	0.190	0.190	0.230
	Home of Peace Cemetery No. 02	0.039	0.039	0.039
	Italian Cemetery	0.033	0.033	0.033
	Olivet Memorial Park	0.098	0.098	0.098
	Woodlawn Memorial Park No. 02	0.085	0.085	0.085
Subtotal		0.641	0.641	0.681
Other				
	Hillsborough Residents 1-12	0.291	0.291	0.291
	Edgewood Development Center	0.009	0.009	0.009
	Zoo No. 05	0.321	0.321	0.321
	Stern Grove	0.004	0.004	0.013
Subtotal		0.626	0.626	0.635
Total Irrigation and Other Non-potable Pumping		2.90	2.90	1.81

Source: Kennedy/Jenks 2012a

Notes:

- (a) Total pumping by Partner Agencies was derived from the median values of individual agency pumping over the historical period from 1959 to 2009 (Kennedy/Jenks 2012a).
- (b) Olympic Golf Club No. 9 values include pumping for both Olympic Club Wells.

- **Modeled Existing Conditions.** The purpose of this scenario is to project the results of historical and existing pumping over the wide range of meteorological and hydrologic conditions incorporated into the model. In this way, the modeled existing conditions scenario estimates groundwater levels that would occur, for example, during a drought if historical and existing pumping patterns were maintained. Under this scenario, all historical and existing pumping would continue at its current rate for the entire simulation, as indicated in Table 5.1-2 (Model Input - Pumping Assumptions for Modeling Scenarios), which shows the rate of pumping by each pumper. In this scenario, it is assumed that municipal pumping by the Partner Agencies in the South Westside Groundwater Basin would continue to be 6.84 mgd combined, which would occur year round.

Irrigation pumping from the South Westside Groundwater Basin is estimated to be 0.46 mgd by the golf clubs and 0.641 mgd by the cemeteries. However, it should be noted that these rates represent annual averages. During the summer season actual pumping rates would be higher, and during the winter season they would be lower. The rates would be even higher during dry years when the irrigation and municipal demand would be at its greatest; however, the rates would be lower during wet years when the irrigation demand would be at its lowest. The only other pumping in the South Westside Groundwater Basin under the modeled existing conditions scenario would be 0.29 mgd to account for irrigation wells at residences in Hillsborough. Under the modeled existing conditions, the total pumping from the South Westside Groundwater Basin would be 8.23 mgd.

In the North Westside Groundwater Basin, the existing pumping includes 1.186 mgd of irrigation pumping, 0.321 mgd of pumping at the San Francisco Zoo (Zoo), and 0.004 mgd of pumping at Stern Grove to maintain Pine Lake water levels. As for the irrigation pumping described above, these pumping volumes represent annual averages; actual pumping rates during the irrigation season would be higher, and pumping during the non-irrigation season would be lower. Under the modeled existing conditions, the total pumping from the North Westside Groundwater Basin would be 1.51 mgd.

- **GSR Project.** Under the Project scenario, the SFPUC and the Partner Agencies would operate 16 wells to recover groundwater stored during Put Periods. Pumping would vary according to the Put, Take, Hold sequence described above, as indicated in Table 5.1-2 (Model Input - Pumping Assumptions for Modeling Scenarios), which shows the volume of pumping for each Put, Take, and Hold Period.

Under the terms of the proposed Operating Agreement between the SFPUC and the Partner Agencies (described in Chapter 3, Project Description, Section 3.8.1 [Operating Agreement]), municipal pumping by the Partner Agencies during Take and Hold Periods under this scenario would average 6.9 mgd, compared to 6.84 mgd under modeled existing conditions. During Put Periods, total municipal pumping by the Partner Agencies could be reduced to a minimum of 1.38 mgd because of supplemental surface water deliveries by the SFPUC.

Municipal pumping by the Partner Agencies as input into the Westside Basin Groundwater Model would be consistent with the Urban Water Management Plans (UWMPs) adopted by

the Partner Agencies. During Take and Hold Periods, municipal pumping would be 3.43 mgd for Daly City, 1.37 mgd for Cal Water, and 2.1 mgd for San Bruno, as follows:

- The adopted Daly City 2010 UWMP states: “The modeling study identified that Daly City’s sustainable [pumping] yield is 3.43 mgd.” The document lists the volume of groundwater projected to be pumped in 2035 as 3,842 acre-feet per year (afy), which is equivalent to 3.43 mgd (Daly City 2011b).
- The adopted 2010 Cal Water UWMP states: “Cal Water, Daly City, and San Bruno will coordinate their respective pumping such that the 6.9 mgd value is not exceeded on an annual basis (or other mutually agreed upon averaging period). Cal Water has from the beginning of discussions regarding the GSR Project offered to limit its planned production of groundwater from the Westside Groundwater Basin to 1.37 mgd, which at 1,535 afy is in line with the current pumping capacity and historical production from the basin” (Cal Water 2011b).
- The adopted 2010 San Bruno UWMP lists the volume of groundwater production as part of the projected future water supply in 2035 to be 2.10 mgd (San Bruno 2011).

The Westside Basin Groundwater Model simulates groundwater conditions in five layers, shown on Figure 5.1-1 (North South Geologic Cross Section, Westside Groundwater Basin). Layer 1 approximates the Shallow Aquifer (or shallow water-bearing zone); Layers 2, 3, and 4 approximate the Primary Production Aquifer; and Layer 5 approximates the Deep Aquifer. These aquifers are those that could be affected by the proposed Project; therefore, the discussion of the modeling results focuses on these layers.

Figure 5.1-2 (Effects of Project and Cumulative Conditions relative to Modeled Existing Conditions on Groundwater Storage Volumes and the Westside Groundwater Basin) shows how total groundwater storage increases during Put Periods and decreases during Take Periods.

Project pumping during Take Periods by the SFPUC and the Partner Agencies would be up to 7.2 mgd of water from the 16 wells installed under the proposed Project. During Put and Hold Periods, Project pumping would be reduced to 0.04 mgd for well maintenance. Irrigation pumping under this scenario would be the same as under modeled existing conditions.

During Put Periods when the SFPUC Storage Account is being replenished, total pumping from the South Westside Groundwater Basin would be 2.85 mgd, and the SFPUC would deliver up to a total of 5.52 mgd of supplemental water deliveries for in-lieu recharge of the Basin. During Hold Periods, when the SFPUC Storage Account is full, the total pumping would be 8.33 mgd. During Take Periods, the total pumping would be 15.52 mgd.

As shown in Figure 5.1-2 (Effects of Project and Cumulative Conditions relative to Modeled Existing Conditions on Groundwater Storage Volumes and the Westside Groundwater Basin), groundwater storage volumes in the Westside Groundwater Basin as a whole would

NORTH

SOUTH

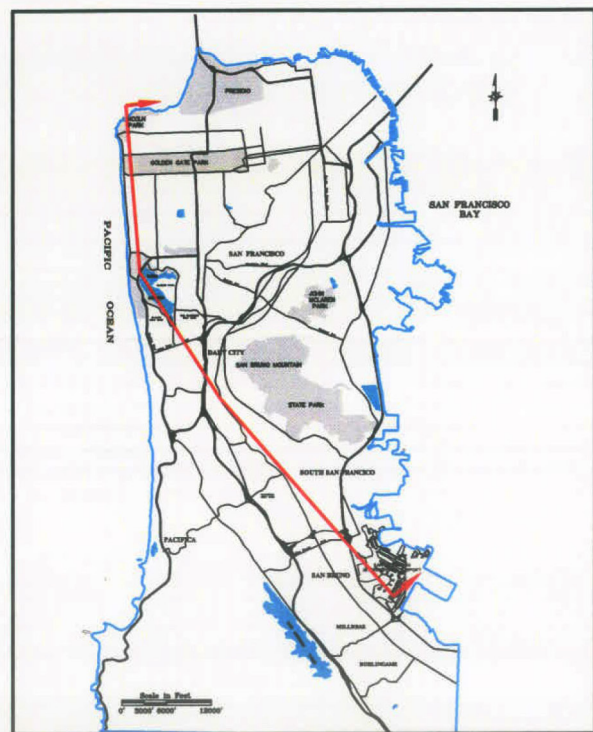
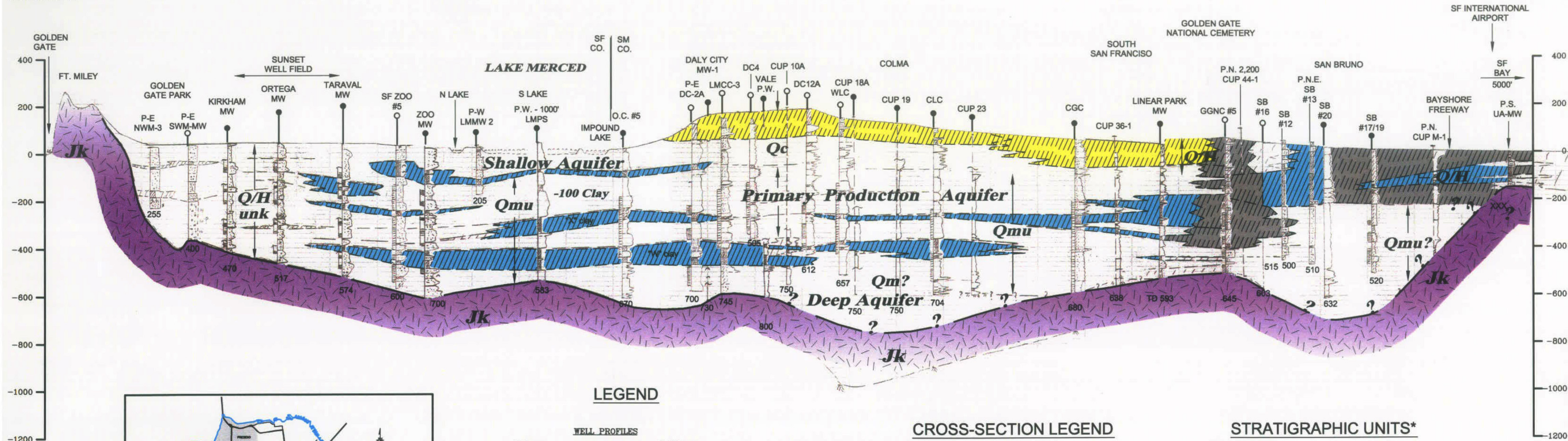

Cross Section Location Map

LEGEND

WELL PROFILES	
E-Log #13	Drill Log #21
PW - Production Well	TH - Test Hole
MW - Monitoring Well	TW - Test Well
Seal	
Clay w/Sand	
Sand/Gravel Screen/Intake	
Clay	
Bedrock at Borehole or From: Philips; 1993 Bonilla; 1964	
647 Total Depth	647
P.N. - Projected North	
P.W. - Projected West	
P.E. - Projected East	
P.NE. - Projected Northeast	
● -Elog Reviewed	
○ -Elog Not Reviewed	

CROSS-SECTION LEGEND

	"Blue" Clay
	Blue & Gray Clays with Sand & Clay, and Sand Beds
	Clay & Sand Red & Brown Soil Zone
	Sand, Sand & Gravel or Sandy Gravel
	Bedrock

STRATIGRAPHIC UNITS*

Q/H	Bay Clays
Q/H unk	Unknown Correlation
Qc	Colma Formation
Qmu	Upper Merced Formation
Qm?	Older Merced Formation - Middle, Lower
Jk	Franciscan Bedrock

* SURFICIAL UNITS NOT SHOWN

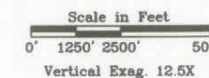

North South Geologic Cross Section, Westside Groundwater Basin

Regional Groundwater Storage and Recovery Project

Figure 5.1-1

This page left intentionally blank

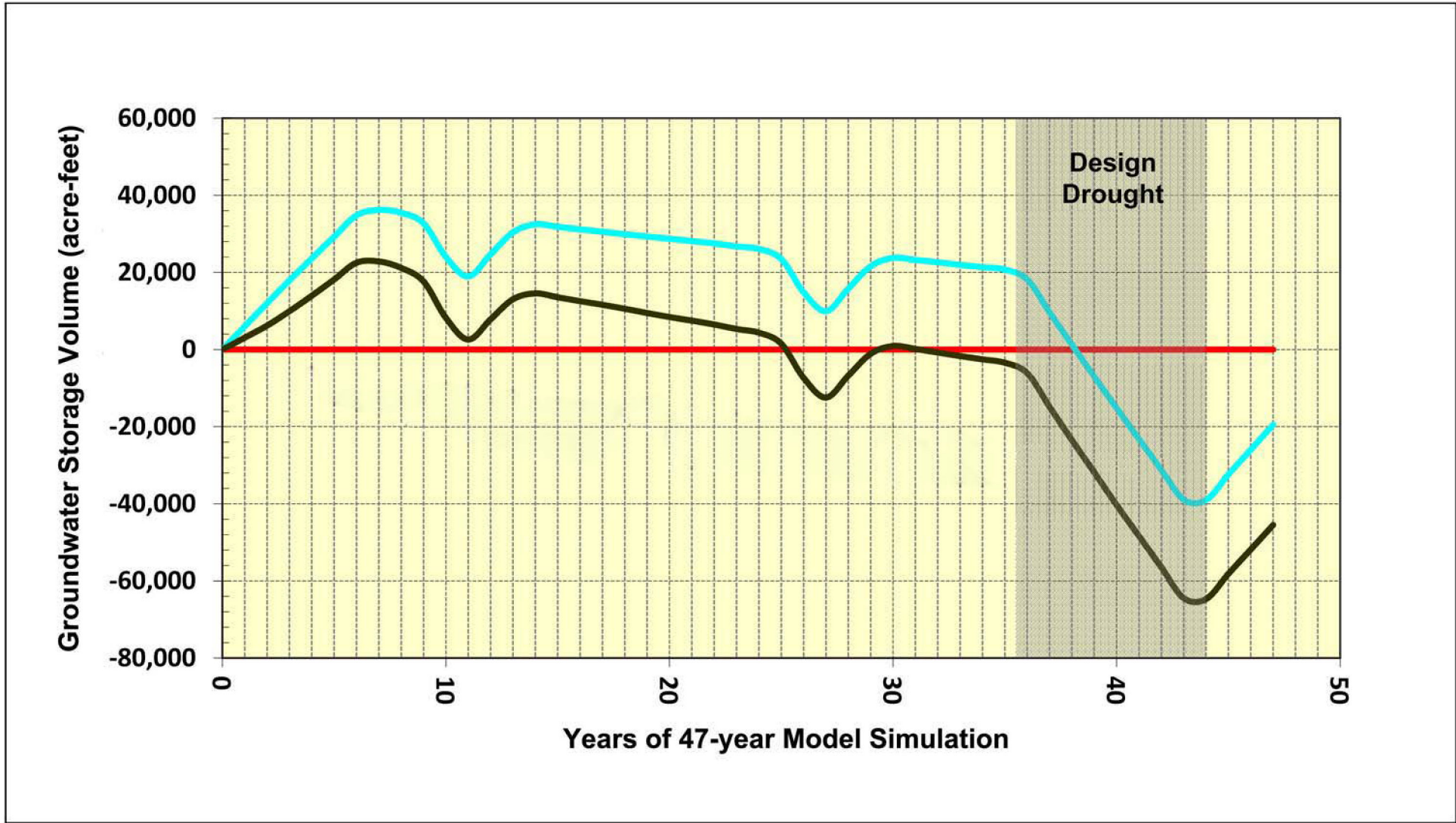

— Modeled Existing Conditions — Project Conditions
— Cumulative Conditions

Effects of Project and Cumulative Conditions relative to Modeled Existing Conditions on Groundwater Storage Volumes in the Westside Groundwater Basin

Regional Groundwater Storage and Recovery Project

Figure 5.1-2

Source: Kennedy/Jenks 2012b

be higher under the Project for 70 to 80 percent of the 47-year simulation than under modeled existing conditions. Groundwater storage volumes would be lower under the Project than under modeled existing conditions for approximately 20 to 30 percent of the simulation.

No Project pumping would occur in the northern portion of the Westside Groundwater Basin and the municipal and private pumping in the northern portion of the Westside Groundwater Basin would be the same as under modeled existing conditions. The model does not account for GSR pumping in response to emergencies (which would be allowed under the proposed Operating Agreement as described in Section 3.8.1 of the Project Description), because such pumping would be unpredictable and temporary.

- **Cumulative Conditions.** The cumulative conditions scenario combines the existing pumping in the Basin (modeled existing conditions) plus the Project pumping described above (GSR Project), with pumping associated with other reasonably foreseeable projects that may affect the Westside Groundwater Basin; the pumping assumptions for these projects are described below. Each of these reasonably foreseeable, or cumulative, projects is described in Table 5.1-3 (Projects Considered for Cumulative Impacts).
 - **San Francisco Groundwater Project (SFGW Project) (cumulative project A-1 through A-6).** Under this scenario, the SFGW Project would pump 4.0 mgd from six wells. Existing irrigation pumping in Golden Gate Park would no longer occur (replaced by the use of recycled water for irrigation), while pumping at the Zoo and at the Edgewood Development Center would be the same as under the existing conditions. For Pine Lake, the pumping at the Stern Grove well would be increased from 0.004 mgd to 0.013 mgd to allow for an increase in the volume of water needed to maintain water levels in Pine Lake. Total pumping from the North Westside Groundwater Basin would be 4.38 mgd. This cumulative project would not change the pumping in the South Westside Groundwater Basin. Table 5.1-2 (Model Input - Pumping Assumptions for Modeling Scenarios) shows the SFGW project pumping under the cumulative conditions column.
 - **Holy Cross Cemetery Expansion (cumulative project E).** For the Holy Cross Cemetery, the groundwater model assumes that groundwater pumping would be increased from 0.190 mgd to 0.230 mgd because of the potential for buildout of the cemetery. Table 5.1-2 (Model Input - Pumping Assumptions for Modeling Scenarios) shows the additional pumping for this cumulative project under the cumulative conditions column.
 - **Vista Grande Drainage Basin Improvement Project (cumulative project B).** For the Vista Grande Drainage Basin Improvements Project, the groundwater modeling assumes that the Lake Merced Alternative, as recommended and described in Daly City's Vista Grande Drainage Basin Alternatives Analysis Report, is a reasonably foreseeable project (Daly City 2011c). The Lake Merced Alternative would divert an average 429 afy of stormwater flow to Lake Merced and lower the Lake Merced

spillway from an elevation of 13 to 9.5 feet City Datum to assist in managing lake levels (Daly City 2011a, 2011c, 2011d). This cumulative project would not change pumping in the Westside Groundwater Basin, so it is not listed in Table 5.1-2 (Model Input - Pumping Assumptions for Modeling Scenarios); however, the groundwater modeling does include model inputs for the Vista Grande Drainage Basin Improvement Project in the modeling for the cumulative scenario.

Other Westside Groundwater Basin Model Assumptions

The modeled hydrologic sequence uses temperature and rainfall data from each year of the 47-year hydrologic record. The sequence of hydrologic data from the historic period of 1958 through 2005 has been altered to include the same 8.5-year “design drought” used in the WSIP water supply modeling, but has been rearranged to allow for filling of the SFPUC Storage Account to occur during Put Years prior to pumping groundwater during a Take Period (Kennedy/Jenks 2012a). A design drought is a planning and operations tool used by water agencies to define a reasonable worst-case drought scenario in order to establish design and operating parameters for the water system.

In addition, the modeled design drought is a more severe drought than any that occurred during the 1958 to 2005 historic period. The modeled design drought is simulated by rearranging the hydrologic sequence such that the actual drought that occurred from December 1975 through December 1977 is repeated and placed after the dry hydrologic conditions of July 1987 to November 1992, for a combined total of an 8.5-year design drought sequence. In the simulations, the design drought is followed by a period of three Put Years to evaluate the rate of recovery after the design drought. Westside Basin Groundwater Model Strengths and Limitations

The Westside Basin Groundwater Model was developed to assist basin-wide data interpretation and system understanding and is considered a reliable data analysis tool for various purposes. The model provides a means to synthesize data and integrate processes that potentially influence groundwater conditions. The Model simulates changes in groundwater levels and storage over time. The strongest predictive ability of the model is estimating relative changes over a broad area, rather than providing absolute predictions of groundwater elevations at local areas or at a single well (Kennedy/Jenks 2012a). As such, the effects estimated under the Project-specific and cumulative conditions scenarios are compared to the effects estimated under the modeled existing conditions scenario (which estimates baseline hydrology under a wide range of rainfall conditions based upon historical hydrologic conditions and absent operation of the proposed Project and the cumulative projects) to determine if the predicted effects are related specifically to the Project. Such relative changes in groundwater parameters are also useful for assessing changes in surface water levels, groundwater storage, water quality, and the potential for seawater intrusion and land subsidence in response to pumping. These related effects are assessed based on the modeling results as supplemented by various analytical approaches, as summarized in the impact analyses in Section 5.16, Hydrology and Water Quality.

While the Westside Basin Groundwater Model provides useful information to inform basin management decisions and impact analyses, there are some specific areas of weakness and/or limitations in the model and model calibration (Kennedy/Jenks 2012a). One weakness is in the Colma and San Bruno subareas of

the modeled area where there was the greatest difference between the modeled and historic groundwater elevations during the model calibration. These differences are likely due to limitations in available historic groundwater level data, model scaling, and the uncertainty in certain aquifer parameters in these subareas. Because of the higher level of differences in these subareas compared to the other subareas, there is a higher degree of uncertainty regarding the model results in the Colma and San Bruno subareas.

Similarly, the Westside Basin Groundwater Model does not allow an input for the maximum elevation of Lake Merced and, during each of the model scenarios, there are instances when the lake levels are predicted to exceed the existing spillway elevation of 13 feet City Datum (which is not possible due to the presence of the outlet in the spillway). This discrepancy results in an artificial filling of the lake above levels that are physically possible (due to the existing elevation of the spillway) and could have an effect on simulated groundwater levels in the Shallow Aquifer, which is in direct hydraulic connection with Lake Merced. To address this limitation, the scenarios were run iteratively to remove excess water from the lake as the lake spills, until the level of the lake remained below the spillway elevation.

Further, while the modeled Lake Merced water levels are generally accurate to within approximately two to three feet of the observed historic water levels during years 1 through 14 and 39 through 47 of the historic simulation, some of the differences during other periods are as great as seven feet. Therefore, the modeled lake levels should be considered representative of relative changes in lake levels in response to groundwater pumping, but are not suitable for estimating absolute changes in lake levels. To address this limitation, the spreadsheet-based Lake-Level Model described below was used for the estimation of water level changes in Lake Merced.

Another limitation is related to the areas where the Westside Groundwater Basin interacts with the Pacific Ocean and San Francisco Bay. The model does not account for the density difference between seawater and freshwater, or the wedge-shape of possible seawater intrusion. To address this limitation, additional analytical tools were used to assess the potential for seawater intrusion as discussed in Section 5.16, Hydrology and Water Quality.

In the Golden Gate Park area, the model may overestimate the drawdown in the well facilities for the cumulative conditions scenario, especially for the future proposed wells associated with the SFGW Project.

The Westside Basin Groundwater Model does not explicitly include changes in hydrologic parameters in response to climate change, because the effect of climate change on the groundwater basin is uncertain. However, if climate change were to cause more frequent drought conditions than observed historically, then such conditions would be included in the Model results through the use of the design drought – a drought that is more severe than any observed during the 47 years of historic records used in creating the Model. In addition, it is possible that climate change might have occurred during the period of the observed rainfall and temperature record. If so, then the observed rainfall and temperature data would include the effects of climate change as part of the overall data record. Since the observed rainfall and temperature data are used as inputs to the Westside Basin Groundwater Model then the possible effects of climate change upon the 47 years of historical record would be included implicitly in the simulations.

Finally, for evaluating the potential effects of pumping that would occur during operation of the Project, the model assumes that the hydrology used in the 47-year historical simulation would be repeated (although the hydrologic sequence has been altered to include the design drought and has been re-sequenced, as described above). Inclusion of the design drought (which is more severe than any drought in the hydrologic record) allows the SFPUC to plan for a drought more severe than has historically occurred. However, the hydrology that may occur over time as the Project is implemented, including parameters such as temperature and rainfall, would not occur exactly as it has in the past; rather, the actual response to pumping could vary from the modeled scenarios in any given year. Although there is inherent uncertainty regarding whether the historical hydrology will be repeated in the future, the use of historical data over the 47-year period provides a wide range of annual variations in hydrology that could be experienced in the future.

Even though the Westside Basin Groundwater Model is not intended to predict precise basin or surface water levels in a given year, over the course of the 47-year model period, the model does portray a reasonable range of anticipated basin and surface water levels such that, for EIR purposes, impacts that would be affected by changes in basin and surface water levels (e.g., biology, hydrology, water quality, etc.) can be conservatively evaluated.

5.1.6.2 Lake Merced Lake-level Model

To provide a more accurate estimate of Lake Merced surface water levels in response to changes in groundwater levels, results from the Westside Basin Groundwater Model were used as input to the Lake-level Model, a spreadsheet-based mass balance model that has been calibrated to 70 years of actual, measured historic water levels in Lake Merced (Kennedy/Jenks 2012a).

Use of the Lake-level Model allows for changes in the surface area of Lake Merced as a function of lake level, a dynamic simulation of changes in lake volume, a more complete evaluation of stormwater runoff, and evaluation of occasional flooding events resulting from overflows of the Vista Grande Drainage Canal. The hydrology used for each scenario in the Lake-level Model was the same as that used for the Westside Basin Groundwater Model, and the measured water level of 5.7 feet City Datum in Lake Merced in June 2009 was used as the initial lake level for the Lake-level Model.

5.1.7 Cumulative Impacts

Cumulative impacts are defined as “two or more individual effects which, when considered together, are considerable or which compound or increase other environmental impacts” (CEQA Guidelines Section 15355). Cumulative impacts can result from individually minor, but collectively significant, actions when added to those of other closely related past, present, or reasonably foreseeable future projects. Guidance for cumulative impact analysis is provided in Section 15130 of the CEQA Guidelines:

- An EIR shall discuss cumulative impacts of a project when the project’s incremental effect is “cumulatively considerable” (i.e., the incremental effects of an individual project are considerable when viewed in connection with the effects of past, current, and probable future projects, including those outside the control of the agency, if necessary).

- An EIR should not discuss impacts that do not result in part from the project evaluated in the EIR.
- A project's contribution is less than cumulatively considerable, and thus not significant, if the project is required to implement or fund its fair share of a mitigation measure or measures designed to alleviate the cumulative impact.
- The discussion of impact severity and likelihood of occurrence need not be as detailed as for effects attributable to the project alone.
- The focus of analysis should be on the cumulative impact to which the identified other projects contribute, rather than on attributes of the other projects that do not contribute to the cumulative impact.

The cumulative impact analysis for each environmental resource topic is described in the appropriate subsections of this Chapter, following the description of direct project impacts and identified mitigation measures. A summary of all cumulative impacts is provided in Chapter 6, Other CEQA Issues, Section 6.2 (Summary of Cumulative Impacts).

5.1.7.1 Approach to Cumulative Impact Analysis

Two approaches to a cumulative impact analysis are discussed in CEQA Guidelines Section 15130(b). The first approach is a list of past, present, and reasonably foreseeable future projects producing related or cumulative impacts. The second approach is a summary of projections contained in an adopted local, regional, or statewide plan, such as a general plan or related planning document, or in an adopted or certified environmental document, which describes or evaluates conditions contributing to cumulative effects. For this EIR, other projects that may cause cumulative impacts have been identified using the list approach.

Three criteria were used to determine an appropriate list of relevant past, present, and future projects to be considered in this cumulative analysis: similar environmental impacts, geographic scope and location, and timing and duration of implementation. A relevant future project is defined as one that is "reasonably foreseeable," such as a proposed project that has approved funding or for which an application has been filed with the approving agency.

Similar Environmental Impacts

Projects that are relevant to the cumulative analysis include projects that could contribute incremental environmental effects on the same resources as, and would have similar impacts to, those discussed in this EIR. Cumulative impacts that could occur when the impacts of the Project are considered in combination with the impacts of other relevant projects are discussed in Sections 5.2 through 5.19 of this EIR.

Geographic Scope

Projects that are relevant to the cumulative analysis include those that are within the defined geographic scope for the cumulative effect. The defined geographic scope is dependent on the environmental resource affected. Generally, the geographic scope includes the area within and adjacent to the well facility sites. However, for certain environmental resource topics the geographic scope extends further, such as the regional roadway network, regional air basin, or the Westside Groundwater Basin.

Timing and Duration of Implementation

Projects that are relevant to the cumulative analysis also include projects that could contribute impacts that coincide with Project impacts during construction and demolition (short-term) or operation (long-term). Construction of the Project would last approximately 21 months (for all of the well facility sites), occurring between approximately June 2014 and February 2016 (see Chapter 3, Project Description, Section 3.5.1 [Construction Sequencing and Schedule]). For temporal impacts such as noise and traffic, cumulative effects could overlap with those of the Project, or could occur immediately prior to or immediately after construction of the Project, and would affect the same environmental resources.

5.1.7.2 List of Relevant Projects

Table 5.1-3 (Projects Considered for Cumulative Impacts) provides a list of the past, present, and reasonably foreseeable projects within and near the Project area, including a brief description of the projects and their anticipated construction schedules. Table 5.1-3 also identifies the potential cumulative effects associated with each of the listed projects. Figure 5.1-3 (Location of Projects Considered in the Cumulative Analysis) shows the location of the cumulative projects. The cumulative impact analysis is presented in each resource topic in the subsections that follow this Chapter. A summary of all the cumulative impacts is provided in Chapter 6, Other CEQA Issues, Section 6.2 (Summary of Cumulative Impacts).

The Bay Area Water Supply and Conservation Agency (BAWSCA) is creating a new groundwater model to evaluate the feasibility of potential brackish groundwater desalination projects. The groundwater model is intended to support planning level, brackish groundwater project feasibility assessments. The model is intended to assist BAWSCA in estimating the yield from brackish aquifers and identify potential locations and regional impacts from brackish groundwater extraction. The model is currently being developed and calibrated. No specific projects are identified at this time. (SFPUC 2013)

This page left intentionally blank

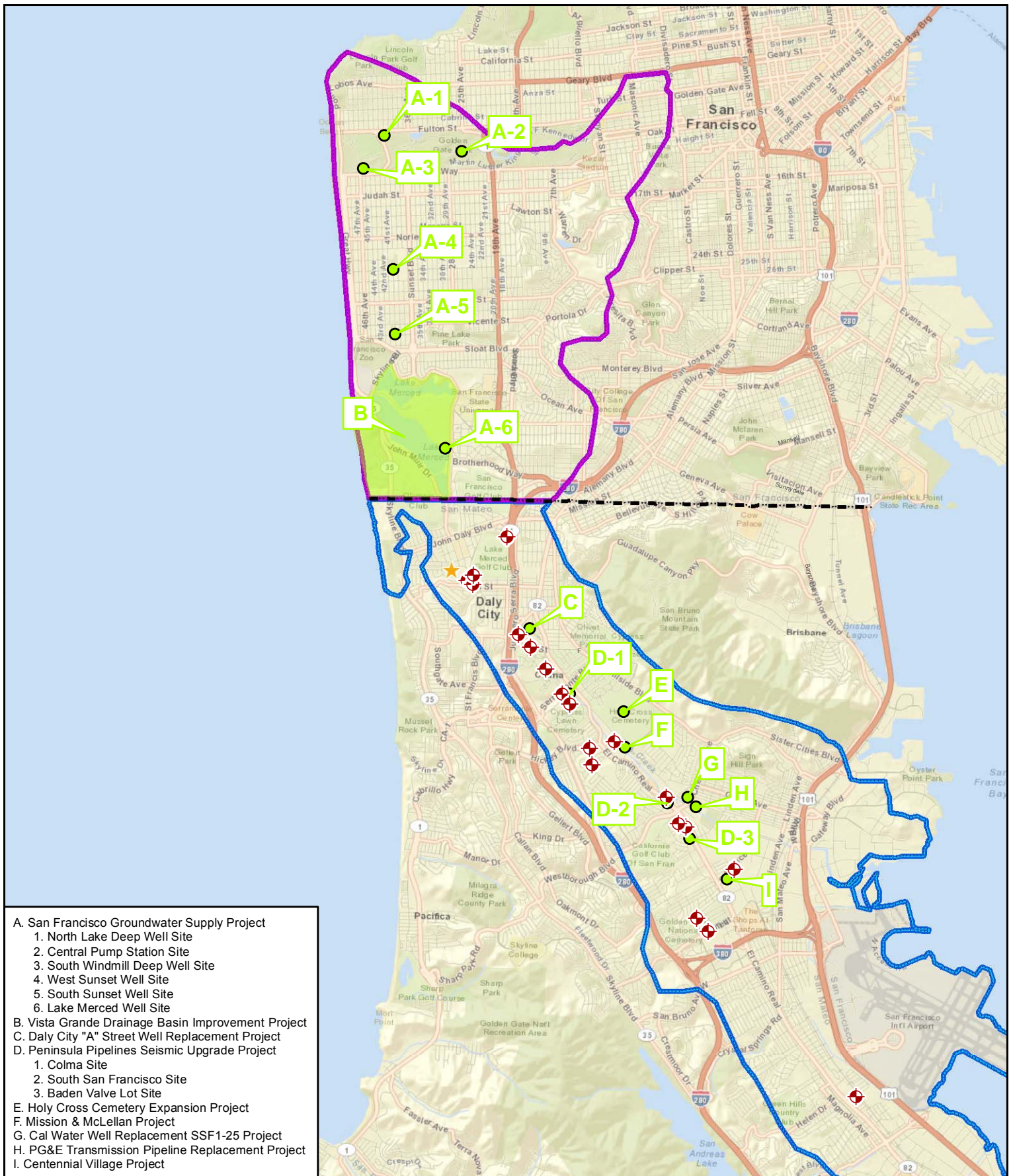

- A. San Francisco Groundwater Supply Project
 1. North Lake Deep Well Site
 2. Central Pump Station Site
 3. South Windmill Deep Well Site
 4. West Sunset Well Site
 5. South Sunset Well Site
 6. Lake Merced Well Site
- B. Vista Grande Drainage Basin Improvement Project
- C. Daly City "A" Street Well Replacement Project
- D. Peninsula Pipelines Seismic Upgrade Project
 1. Colma Site
 2. South San Francisco Site
 3. Baden Valve Lot Site
- E. Holy Cross Cemetery Expansion Project
- F. Mission & McLellan Project
- G. Cal Water Well Replacement SSF1-25 Project
- H. PG&E Transmission Pipeline Replacement Project
- I. Centennial Village Project

Legend

- Proposed Project Well Facility Sites
- Westlake Pump Station
- Cumulative Project Locations
- Cumulative Project Area
- County Boundary
- North Westside¹ Groundwater Basin
- South Westside¹ Groundwater Basin

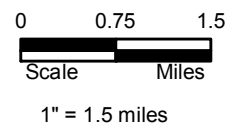

Location of Projects Considered in the Cumulative Analysis

Regional Groundwater Storage and Recovery Project

Figure 5.1-3

¹The Westside Groundwater Basin has been administratively divided at the San Francisco-San Mateo County line.

TABLE 5.1-3
Projects Considered for Cumulative Impacts

Cumulative Project No.	Project Name (Jurisdiction)	Project Description	Potential Cumulative Impact Topics	Potentially Affected Project Components/ Areas of Overlap	Estimated Construction Schedule	Approximate Distance to GSR Project
A-1 to A-6	San Francisco Groundwater Supply Project (SFPUC)	The SFPUC would construct and operate up to six potable groundwater production well facilities. Four would be new well facilities (phase 1) and two would be converted from existing irrigation well facilities (phase 2). Each well facility would include a groundwater production well and a pump station (San Francisco Planning Department 2013a).	Operation: land use, noise, recreation, biological resources, hydrology and water quality, hazards and hazardous materials, energy resources	The southernmost well site (Lake Merced Site) would be located approximately 1.3 miles (6,800 feet) north of GSR Site 1. The San Francisco Groundwater Supply Project would draw groundwater from the Westside Groundwater Basin, the same as the GSR Project.	fall 2014 through spring 2016	Between 1.3 and 5.0 miles north of GSR Site 1
B	Vista Grande Drainage Basin Improvement Project (Daly City)	The project purpose is to address storm-related flooding in the Vista Grande Watershed Drainage Basin, and to provide other environmental benefits, including restoration and management of water levels within Lake Merced, and improving the existing ocean outfall. The project would reconnect a significant portion of Lake Merced's historic watershed. The project includes: <ul style="list-style-type: none"> Partial replacement of the existing Vista Grande Drainage Canal to incorporate a debris screening device, a treatment wetland, and diversion and outfall structures to route some stormwater (and authorized non-stormwater) flows from the Vista Grande Drainage 	Construction: traffic, air quality, utilities and service systems, biological resources, hydrology and water quality, hazards and hazardous materials, energy resources, Operation: recreation, utilities and service systems, biological resources, hazards and hazardous materials, hydrology and water quality, energy resources	Project located north of the northernmost well (Site 1 Lake Merced Golf Club)	Approximately 2014 through 2016	Between 0.58 and 0.89 miles west of GSR Site 1, 0.58 miles northwest of GSR Sites 2 and 3, between 0.44 and 1 mile north of Westlake Pump Station

TABLE 5.1-3
Projects Considered for Cumulative Impacts

Cumulative Project No.	Project Name (Jurisdiction)	Project Description	Potential Cumulative Impact Topics	Potentially Affected Project Components/ Areas of Overlap	Estimated Construction Schedule	Approximate Distance to GSR Project
B Continued		<p>Canal to Lake Merced;</p> <ul style="list-style-type: none"> • Replacement of the existing Vista Grande Tunnel to increase its peak capacity and extend its operating life; and • Replacement of the existing ocean outfall structure at Fort Funston. (Daly City 2013). • Additionally, operational components of the project would include management of water elevations in Lake Merced and a Lake Management Plan that would implement water quality best management practices. 				
C	"A" Street Well Replacement (Daly City)	Replace/upgrade existing well so that it continues to be able to pump up to 0.63 mgd (Daly City 2010).	<p>Construction: cultural and paleontological resources, traffic, noise, air quality, utilities and service systems, biological resources, hydrology and water quality, hazards and hazardous materials, energy resources</p> <p>Operation: land use, noise, utilities and service systems, hazards and hazardous materials, energy resources</p>	Timing of construction could overlap. The well would pump from the Westside Groundwater Basin, the same as the GSR Project.	Funded as part of the FY 13-14 Capital Improvement Program	Estimated between 0.1 mile and 0.5 mile northeast of GSR Site 5, between 0.2 and 0.4 miles northeast of GSR Site 6, and 0.5 mile northeast of GSR Site 7

**TABLE 5.1-3
Projects Considered for Cumulative Impacts**

Cumulative Project No.	Project Name (Jurisdiction)	Project Description	Potential Cumulative Impact Topics	Potentially Affected Project Components/ Areas of Overlap	Estimated Construction Schedule	Approximate Distance to GSR Project
D-1 Colma Site D-2 South San Francisco Site D-3 Baden Valve Lot Site	Peninsula Pipelines Seismic Upgrade Project (SFPUC)	<p>The Peninsula Pipelines Seismic Upgrade (PPSU) project would include seismic upgrades to the SFPUC San Andreas Pipeline No. 2 (SAPL2), San Andreas Pipeline No. 3 (SAPL3), and Sunset Supply Branch Pipeline (SSBPL) that deliver water from the Harry Tracy Water Treatment Plant to the SFPUC's regional water system. The PPSU project would include five separate sites and a staging area:</p> <ul style="list-style-type: none"> The Colma Site covers 2.24 acres of urbanized land between Serramonte Boulevard and Collins Avenue. The project proposes the installation of approximately 700 feet of new 54-inch-diameter steel pipeline to replace an existing pipeline segment of the SAPL2. The construction area includes 0.77 acre for staging and spoils and a 1.47 acre construction zone. The South San Francisco Site covers the area between Arroyo Drive and West Orange Avenue. The project in this area covers approximately 1.34 acres. The project proposes installation of approximately 720 feet of new 54-inch diameter steel pipeline to replace an existing pipeline segment of SAPL2. The construction area includes 0.05 	<p>Construction: land use, aesthetics, cultural and paleontological resources, traffic, noise, air quality, utilities and service systems, biological resources, geology and soils, hydrology and water quality, hazards and hazardous materials, energy resources</p> <p>Operation: utilities and service systems, biological resources, geology and soils, hazards and hazardous materials, energy resources</p>	<p>The PPSU project would replace portions of the San Andreas Pipeline No. 2, the San Andreas Pipeline No. 3, and Sunset Supply Branch Pipeline. Some pipeline replacement construction activities and staging would occur in locations where the GSR Project, if approved, would construct well facilities and pipelines.</p> <ul style="list-style-type: none"> The Colma Site would include construction within GSR Sites 8 and 17 (Alternate). In addition to intersecting geographically, including the overlapping construction sites and potential overlapping staging areas, the timing of construction activities could overlap. 	2014 to 2015	0 miles, overlaps GSR Sites 8 and 17 (Alternate)

**TABLE 5.1-3
Projects Considered for Cumulative Impacts**

Cumulative Project No.	Project Name (Jurisdiction)	Project Description	Potential Cumulative Impact Topics	Potentially Affected Project Components/ Areas of Overlap	Estimated Construction Schedule	Approximate Distance to GSR Project
D Continued		<p>acre for staging and spoils and a 1.29 acre construction zone.</p> <ul style="list-style-type: none"> • The Baden Valve Lot is an approximately 2-acre triangular-shaped site within the SFPUC right-of-way at the corner of El Camino Real and West Orange Ave. A 0.32 acre portion of the lot would be used for staging. • The San Bruno North Site is bounded on the north by San Bruno Avenue West by Interstate 280 (I-280) off-ramps on the west and south, and by a residential neighborhood on the east. The project proposes the stabilization of approximately 140 feet of SAPL2 within a tunnel from San Bruno Avenue West to just before the San Bruno Avenue West northbound exit from I-280 through which SAPL2 currently extends. The construction area includes 0.14 acre for staging and spoil areas and a 0.76-acre construction zone. • The San Bruno South Site is west of I-280 in a residential area immediately to the west and south of Shelter Creek Condominiums and north of the Peninsula High School parking lot. The project proposes the installation of 		<ul style="list-style-type: none"> • The South San Francisco Site would be located approximately 550 feet north of GSR Sites 12 and 19 (Alternate). The timing of construction activities could overlap in close geographic areas. • PPSU construction staging would occur at the Baden Valve Lot site. GSR Project construction staging would also occur in an approximately 0.32 acre portion of the Baden Valve Lot site. • The San Bruno North Site would be located approximately 2.2 miles northwest of GSR Site 16. • The San Bruno South Site would be 		

**TABLE 5.1-3
Projects Considered for Cumulative Impacts**

Cumulative Project No.	Project Name (Jurisdiction)	Project Description	Potential Cumulative Impact Topics	Potentially Affected Project Components/ Areas of Overlap	Estimated Construction Schedule	Approximate Distance to GSR Project
D Continued		<p>approximately 1,170 feet of new 54-inch diameter pipeline to replace an existing pipeline segment of SAPL2 and installation of 1,050 feet of 66-inch pipeline to replace an existing pipeline segment of SAPL3. The construction area includes 2.31 acres for staging and spoils areas and a 1.59 acre construction zone.</p> <ul style="list-style-type: none"> The Millbrae Site extends through a residential neighborhood, City of Millbrae open space and a golf club. The site generally extends east from the intersection of Banbury Lane and Ridgewood Drive, through two residential side yards, and through a portion of the Green Hills Country Club golf club. The site is accessible from I-280 via the Larkspur Drive and Hillcrest Boulevard exits. The project proposes the installation of a new 60-inch diameter steel pipeline to replace an existing 900-foot segment of the SSBPL. The construction area includes 2.03 acres for staging and spoil and a 1.07-acre construction zone. <p>(San Francisco Planning Department 2013b)</p>		<p>located approximately 2 miles west of GSR Site 16.</p> <ul style="list-style-type: none"> The Millbrae Site would be located approximately 1 mile northeast of GSR Site 16. 		

**TABLE 5.1-3
Projects Considered for Cumulative Impacts**

Cumulative Project No.	Project Name (Jurisdiction)	Project Description	Potential Cumulative Impact Topics	Potentially Affected Project Components/ Areas of Overlap	Estimated Construction Schedule	Approximate Distance to GSR Project
E	Holy Cross Cemetery Expansion (Colma)	Holy Cross Cemetery buildout would include an expansion of the cemetery and may require an additional 0.04 mgd to be pumped from the existing wells at the cemetery (Kennedy/Jenks 2012b).	<p>Construction: cultural resources, traffic, noise, air quality, utilities and service systems, biological resources, hydrology and water quality, hazards and hazardous materials, energy resources</p> <p>Operation: utilities and service systems, hydrology and water quality, hazards and hazardous materials, energy resources</p>	Expansion could potentially occur near GSR Site 9. It is unknown whether the timing of expansion of the cemetery would overlap with GSR project construction. The increased pumping would be from the Westside Groundwater Basin, the same as the GSR Project.	No current plans; however, buildout is projected to occur at approximately 1.5 acres per year from 2010 to 2030 (a total of 30 acres over 20 years).	Cemetery is 300 feet east of GSR Site 9, 0.3 miles east of GSR Site 10 and 0.4 mile east of Site 18 (Alternate) Expansion area is assumed to be 0.65 miles east of GSR Site 9 and 1 mile east of GSR Site 18 (Alternate)
F	Mission & McLellan (South San Francisco)	The Mission & McLellan Project is located at 1309 Mission Road and includes 20 condominium units with approximately 6,000 square feet of commercial space on a 1.41-acre site (South San Francisco 2011).	<p>Construction: land use, aesthetics, traffic, noise, air quality, utilities and service systems, biological resources, hydrology and water quality, hazards and hazardous materials, energy resources</p> <p>Operation: land use, aesthetics, traffic, noise, recreation, utilities and service systems, hazards and hazardous materials, energy resources</p>	Potentially overlapping geographically with GSR Site 9. It is unknown whether the timing of construction would overlap.	Approved March 2011 Construction schedule unknown	760 feet southeast of GSR Site 9, 0.4 miles east of GSR Sites 10 and 18 (Alternate)

TABLE 5.1-3
Projects Considered for Cumulative Impacts

Cumulative Project No.	Project Name (Jurisdiction)	Project Description	Potential Cumulative Impact Topics	Potentially Affected Project Components/ Areas of Overlap	Estimated Construction Schedule	Approximate Distance to GSR Project
G	Well Replacement SSF1-25 (Cal Water)	Well replacement (SSF1-25) to be located near South San Francisco, near Mission Road and Chestnut Avenue (Cal Water 2011a).	<p>Construction: construction-related impacts to land use, aesthetics, cultural and paleontological resources, traffic, noise, air quality, utilities and service systems, biological resources, hydrology and water quality, hazards and hazardous materials, energy resources</p> <p>Operation: land use, noise, utilities and service systems, hazards and hazardous materials, energy resources</p>	Timing of construction could overlap. The well would pump from the Westside Groundwater Basin, the same as the GSR Project.	CEQA Approval April 2014. Construction starts in Oct 2014. In-service in July 2015.	630 feet southeast of GSR Site 11 pipelines and 0.2 miles southeast of GSR Site 11. 0.2 miles northeast of GSR Sites 12 and 19 (Alternate).
H	PG&E Transmission Pipeline Replacement (PG&E Project in South San Francisco)	PG&E intends to replace a portion of a gas transmission line. The pipeline route extends from Evergreen Drive to Mission Road, to Chestnut Avenue, to Antoinette Lane then crossing over to El Camino Real between Chestnut Avenue and 1st Street, then continuing along El Camino Real to West Orange Avenue (PG&E 2012).	<p>Construction: land use, aesthetics, cultural and paleontological resources, traffic, noise, air quality, recreation, utilities and service systems, biological resources, hydrology and water quality, hazards and hazardous materials, energy resources</p> <p>Operation: utilities and service systems, hazards and hazardous materials, energy resources</p>	Potentially overlapping geographically with GSR Site 12 and adjacent to Sites 11 and Site 19 (Alternate). Potentially overlapping geographically with construction access route for GSR Sites 11, 12, and Site 19 (Alternate). It is unknown whether the timing of construction would overlap.	Not available	0.3 miles southeast of GSR Site 9, 200 feet southwest of GSR Site 11 pipelines and 0.2 miles southwest of GSR Site 11. 0 miles from GSR Site 12, 0.6 miles northwest of GSR Site 13, 0.6 miles southeast of GSR Site 18 (Alternate), 150 feet east of GSR Site 19 (Alternate) utility lines and 400 feet from GSR Site 19 (Alternate).

TABLE 5.1-3
Projects Considered for Cumulative Impacts

Cumulative Project No.	Project Name (Jurisdiction)	Project Description	Potential Cumulative Impact Topics	Potentially Affected Project Components/ Areas of Overlap	Estimated Construction Schedule	Approximate Distance to GSR Project
I	Centennial Village (South San Francisco)	The Centennial Village project is located at 180 El Camino Real in South San Francisco. The project includes the demolition of the existing Brentwood Shopping Center. The project also includes construction of a new, mixed-use 165,000-square foot shopping center anchored by Safeway Food, CVS Drugstore, and Wells Fargo Bank with 132 apartment units on a 14.5-acre site. As of December 2011, the project is under review by the City of South San Francisco (South San Francisco 2011).	<p>Construction: aesthetics, traffic, noise, air quality, recreation, utilities and service systems, biological resources, hydrology and water quality, hazards and hazardous materials, energy resources</p> <p>Operation: aesthetics, land use, traffic, noise, recreation, utilities and service systems, hazards and hazardous materials, energy resources</p>	Potentially overlapping geographically with GSR Site 13. It is unknown whether the timing of construction would overlap.	Currently under review by the City of South San Francisco	Adjacent to GSR Site 13 pipelines and 400 feet southwest of GSR Site 13 facility.

5.1.8 References

- California Water Service Company (Cal Water). 2011a. *Request for Information to support the SFPUC's Groundwater Storage and Recovery Project EIR*. January 19.
- Cal Water. 2011b. *2010 Urban Water Management Plan, South San Francisco District*. June.
- Daly City, City of. 2010. *Capital Projects Budget 2010-2011/2011-2012 and 20 Year Plan*. September.
- Daly City, City of. 2011a. *City Council Special Meeting Minutes for May 23, 2011*. Website accessed January 29, 2013 at:
<http://209.234.104.30/sirepub/cache/2/p30oqtyjxncwtsuu5ugiv255/425586201292013032715900.PDF>.
- Daly City, City of. 2011b. *City of Daly City 2010 Urban Water Management Plan*. June.
- Daly City, City of. 2011c. *Vista Grande Drainage Basin Alternatives Analysis Report, Alternatives Evaluation Report Executive Summary*. Prepared by Jacobs Associates. February 7 (Final Draft).
- Daly City, City of. 2011d. *Vista Grande Drainage Basin Alternatives Analysis Report, Volume 3 Lake Merced Alternative*. Prepared by Jacobs Associates. February 7.
- Daly City, City of. 2013. *Notice of Preparation/Notice of Intent to Prepare a Joint EIR/EIS for the Vista Grande Drainage Basin Improvement Project*. February 28.
- HydroFocus. 2011. *Technical Memorandum, Westside Basin Groundwater-flow Model: Updated Model and 2008 No Project Simulation Results*. May.
- Kennedy/Jenks Consultants (Kennedy/Jenks). 2012a. *Task 10.1 Technical Memorandum, San Francisco Public Utilities Commission, Groundwater Modeling Analysis for the Regional Groundwater Storage and Recovery Project and San Francisco Groundwater Supply Project*. April 18.
- Kennedy/Jenks. 2012b. *Task 10.4 Technical Memorandum, Changes in Groundwater Levels and Storage for the Regional Groundwater Storage and Recovery Project and San Francisco Groundwater Supply Project*. April 24.
- Luhdorff & Scalmanini, Consulting Engineers (LSCE). 2010. *Technical Memorandum No. 1. Hydrologic setting of the Westside Basin*. May.
- Pacific Gas & Electric Company (PG&E). 2012. Personal Communication, Tom Zlatunich (Land Agent), January 27, 2012.
- San Bruno, City of. 2011. *Urban Water Management Plan*. June.
- San Francisco Planning Department. 2008. *Final Program Environmental Impact Report for the San Francisco Public Utility Commission's Water Supply Improvement Program* (File No. 2005.0159E, State Clearinghouse No. 2005092026). Certified October 30, 2008.
- San Francisco Planning Department. 2013a. *San Francisco Groundwater Supply Project, Draft Environmental Impact Report*. March 13.
- San Francisco Planning Department. 2013b. *San Francisco Public Utilities Commission Peninsular Pipelines Seismic upgrade Project, Public Review Draft Environmental Impact Report*. March 13.

San Francisco Public Utilities Commission (SFPUC). 2013. Personal Communication, Kelley Capone, March 6.
South San Francisco, City of. 2011. *Major Projects City of South San Francisco*. December.

This page left intentionally blank

5.2 LAND USE

This section describes the existing land uses within the vicinity of the proposed facility sites and evaluates the potential land use impacts of the proposed Project. It describes the existing land use setting and regulations that address land use planning in the study area. Potential land use impacts from Project construction and operation are evaluated and mitigation measures that would avoid or reduce significant impacts are identified. Impacts on recreational activities are evaluated in Section 5.11, Recreation. Impacts on irrigated land uses (i.e., golf clubs, cemeteries) due to changes in the pumping of groundwater are evaluated in Section 5.16, Hydrology and Water Quality.

5.2.1 Setting

The study area for land use includes the area within and surrounding the construction area for the facility sites, including sensitive land uses such as schools, residences, parks, and cemeteries that could be affected by construction and operation of the Project.

5.2.1.1 Existing Land Use

Existing land uses were identified and characterized based on field visits, aerial photographs, computer-aided street view tours, and review of planning documents. Proposed facility sites would be located in San Mateo County between Daly City in the north and Millbrae in the south along the urbanized spine of the northern San Francisco Peninsula. Urban land uses in the study area are mixed single- and multi-family residential, commercial, industrial, and public/quasi-public uses. Open spaces in the study area include golf clubs, cemeteries and urban parks. The facility sites would be located within the jurisdictions of unincorporated San Mateo County (Broadmoor), the Town of Colma, and the cities of Daly City, South San Francisco, San Bruno, and Millbrae.

Table 5.2-1 (Land Uses in the Vicinity of Facility Sites) provides the jurisdiction, on-site land uses, surrounding land uses, and duration of construction for the proposed facility sites. Following the table is a description of existing land uses at and surrounding each of the facility sites, organized by jurisdiction. Figures referenced are located in Chapter 3, Project Description; not all surrounding land uses are visible on the figures because of the scale of the drawings.

TABLE 5.2-1
Land Uses in the Vicinity of Facility Sites

Site	Jurisdiction	On SFPUC Land?	Land Use within the Construction Area	Land Uses in the Vicinity of the Construction Area (including Pipelines)	Minimum Distance from Construction Area to Land Use ^(a)	Approximate Construction Duration ^(b)
Site 1	Daly City	No, owned by Golf Club	Golf club maintenance area, restroom and maintenance road	Lake Merced Golf Club	Adjacent	Well and Treatment Facility: 16 months
				Multi-family residential (Westlake Village Apartments)	Adjacent	
				Interstate 280 (I-280)	40 feet	Pipeline: 1 week
Site 2	Daly City	Yes, owned by City and County of San Francisco and managed by the SFPUC	Utility right-of-way and vacant land	Multi-family residential (Westlake Village Apartments)	40 feet	Well Facility: 1 month
				Lake Merced Golf Club	55 feet	
				Intermediate school (Ben Franklin Intermediate School)	60 feet	Pipeline: 2 to 3 weeks
				Elementary school (Garden Village Elementary School)	30 feet	
				Single-family residential	430 feet	
Site 3	San Mateo County	No, owned by Jefferson School District	School playing field and parking lot	Intermediate school (Ben Franklin Intermediate School)	Adjacent	Well and Well Facility: 6 months over two summers
				Single-family residential	20 feet	
				Multi-family residential (Westlake Village Apartments)	65 feet	Pipeline: 2 to 3 weeks
				Lake Merced Golf Club	130 feet	
				Elementary school (Garden Village Elementary School)	330 feet	

TABLE 5.2-1
Land Uses in the Vicinity of Facility Sites

Site	Juris-diction	On SFPUC Land?	Land Use within the Construction Area	Land Uses in the Vicinity of the Construction Area (including Pipelines)	Minimum Distance from Construction Area to Land Use ^(a)	Approximate Construction Duration ^(b)
Site 4	San Mateo County	No, owned by County	County road right-of-way, school playing field, and roadway	Elementary school (Garden Village Elementary School)	Adjacent	Well and Well Facility: 5 months Pipeline: 2 to 4 weeks
				Single-family residential	Adjacent	
				Lake Merced Golf Club	55 feet	
				Intermediate school (Ben Franklin Intermediate School)	100 feet	
West-lake Pump Station	Daly City, San Mateo County	No, owned by City of Daly City	Municipal pump station and corporation yard	Single-family residential	Adjacent	Pump Station Upgrades: 4 months
				Multi-family residential (Westlake Village Apartments)	Adjacent	
				Intermediate school (Ben Franklin Intermediate School)	Adjacent	
Site 5	Daly City	Yes, SFPUC right-of-way	<i>Consolidated Treatment at Site 6:</i> Utility right-of-way and roadway	Commercial (Former Serra Bowl and insurance office)	Adjacent	<i>Consolidated Treatment at Site 6:</i> Well Facility: 3 months Pipeline: 3 to 5 weeks <i>On-site Treatment:</i> Treatment Facility: 14 months Pipelines: 2 to 3 weeks
				Single-family residential	Adjacent	
			<i>On-site Treatment:</i> Utility right-of-way, roadway, and parking lot	Commercial (Car dealership)	Adjacent	
				SFPUC Valve Lot	50 feet	
				SamTrans Park and Ride parking lot	100 feet	
				Bay Area Regional Transit (BART) Colma Station	250 feet	

TABLE 5.2-1
Land Uses in the Vicinity of Facility Sites

Site	Juris-diction	On SFPUC Land?	Land Use within the Construction Area	Land Uses in the Vicinity of the Construction Area (including Pipelines)	Minimum Distance from Construction Area to Land Use ^(a)	Approximate Construction Duration ^(b)
				Elementary school (Holy Angels Elementary School)	475 feet	
Site 6	Daly City	Yes, SFPUC right-of-way	Utility right-of-way, roadway, and vacant	SamTrans Park and Ride parking lot	Adjacent	Treatment Facility: 14 months Pipeline: 2 to 3 weeks
				BART Colma Station	Adjacent	
				Cemetery (Woodlawn Memorial Park)	90 feet	
				Commercial (Former Serra Bowl)	200 feet	
				Multi-family residential	470 feet	
Site 7	Colma	Yes, SFPUC right-of-way	<i>Consolidated Treatment at Site 6:</i> Utility right-of-way and roadway <i>On-site Treatment:</i> Utility right-of-way, roadway, and cemetery	Cemetery (Woodlawn, Greenlawn, and Greek Orthodox Memorial Parks)	Adjacent	<i>Consolidated Treatment at Site 6:</i> Well and Well Facility: 5 months Pipeline: 3 to 6 weeks <i>On-site Treatment:</i> Well and Treatment Facility: 16 months Pipelines: 1 to 2 weeks
				Commercial (Shopping Center, including Home Depot Pro)	120 feet	
Site 8	Colma	Yes, SFPUC right-of-way	Utility right-of-way and parking lot	Commercial (Kohl's Department Store)	Adjacent	Treatment Facility: 14 months Pipeline: 1 to 2 weeks
				Commercial (Car dealerships)	Adjacent	
				Enterprise Car Rental and Collision Center	200 feet	
				Residential (Senior Care Facility)	440 feet	

TABLE 5.2-1
Land Uses in the Vicinity of Facility Sites

Site	Jurisdiction	On SFPUC Land?	Land Use within the Construction Area	Land Uses in the Vicinity of the Construction Area (including Pipelines)	Minimum Distance from Construction Area to Land Use ^(a)	Approximate Construction Duration ^(b)
Site 9	South San Francisco	Yes, SFPUC fee owned-lands	Utility right-of-way and vacant land	Residential (Treasure Island Trailer Court)	Adjacent	Well and Treatment Facility: 16 months Pipeline: 1 to 2 weeks
				Single-family residential	65 feet	
				Commercial (Costco and services along Mission Road)	50 feet	
				Light Industrial	70 feet	
				Multi-family residential (Verano Condominiums)	200 feet	
				Cemetery (Holy Cross Cemetery)	280 feet	
Site 10	South San Francisco	Yes, SFPUC right-of-way	Utility right-of-way, vacant land, and private roadway	Commercial (Chevy's Restaurant and Winston Manor Shopping Center)	25 feet	Treatment Facility: 14 months Pipeline: 1 to 2 weeks
				Single-family residential	165 feet	
				Commercial (Hotel/motel)	225 feet	
Site 11	South San Francisco	Yes, SFPUC fee owned-lands	Utility right-of-way and vacant land	Public/Institutional (BART Ventilation Structure)	Adjacent	Well and Treatment Facility: 16 months Pipeline: 3 to 5 weeks
				Public/Institutional (Kaiser Medical Center garage and parking lot)	100 feet	
				Public/Institutional (Kaiser Medical Center)	725 feet	
				Open Space (South San Francisco Centennial Way Trail)	75 to 230 feet	

TABLE 5.2-1

Land Uses in the Vicinity of Facility Sites

Site	Juris-diction	On SFPUC Land?	Land Use within the Construction Area	Land Uses in the Vicinity of the Construction Area (including Pipelines)	Minimum Distance from Construction Area to Land Use ^(a)	Approximate Construction Duration ^(b)
				Commercial (neighborhood shopping center)	275 feet	
				Single-family residential	400 feet	
Site 12	South San Francisco	Yes, SFPUC right-of-way	Utility right-of-way, parking lot, vacant, and roadway	Commercial (Garden Chapel Funeral Home)	Adjacent	Well and Treatment Facility: 16 months
				Single-family residential	Adjacent	
				Public/Institutional (Our Redeemer's Lutheran Church and R.W. Drake Pre-School Center)	30 feet	
				Commercial (Restaurants, motel, small businesses)	125 feet	
				Multi-family residential (Clubview Apartment Homes)	480 feet	
Site 13	South San Francisco	Yes, SFPUC fee owned-lands	Utility right-of-way and roadway	Commercial (Credit union, carwash, residence motel)	Adjacent	Treatment Facility: 14 months
				Open Space (Francisco Terrace Playlot, South San Francisco Centennial Way Trail)	50 to 70 feet	Pipeline: 5 to 9 weeks
				Public/Institutional (San Mateo County offices and U.S. Post Office)	Adjacent	
				Single-family residential	70 feet	
				Industrial (Freeman Warehouse)	90 feet	

TABLE 5.2-1
Land Uses in the Vicinity of Facility Sites

Site	Juris-diction	On SFPUC Land?	Land Use within the Construction Area	Land Uses in the Vicinity of the Construction Area (including Pipelines)	Minimum Distance from Construction Area to Land Use ^(a)	Approximate Construction Duration ^(b)
Site 14	San Bruno	Yes, SFPUC Right-of-Way	Cemetery and roadway	Cemetery (Golden Gate National Cemetery)	Adjacent	Well and Treatment Facility: 16 months
				Single-family residential	Adjacent	
				Light Industrial (Airport Trade Center)	75 feet	
				Multi-family residential	225 Feet	
Site 15	San Bruno	No, owned by U.S, Department of Veterans Affairs	Cemetery and roadway	Cemetery (Golden Gate National Cemetery)	Adjacent	Well and Treatment Facility: 16 months
				Light Industrial (Airport Trade Center)	75 feet	
				Multi-family residential	110 feet	
				Public/Institutional (Veterans Administration Clinic)	90 feet	
Site 16	Millbrae	Yes, SFPUC right-of-way	Utility right-of-way, parking lot and roadway	Multi-family residential (Millbrae Manor)	Adjacent	Well and Treatment Facility: 16 months
				Commercial (Orchard Supply Hardware, A&W/KFC)	Adjacent	
				Public/Institutional (Convalescent hospital)	120 feet	
				Public/Institutional (SFPUC administrative offices)	Adjacent	
				Commercial (Businesses along El Camino Real)	100 feet	
				Single-family residential	250 feet	

**TABLE 5.2-1
Land Uses in the Vicinity of Facility Sites**

Site	Juris-diction	On SFPUC Land?	Land Use within the Construction Area	Land Uses in the Vicinity of the Construction Area (including Pipelines)	Minimum Distance from Construction Area to Land Use ^(a)	Approximate Construction Duration ^(b)
				Public/Institutional (Millbrae Racquet Club, undeveloped park land, and PG&E substation)	90, 180, and 150 feet respectively	
Site 17 (Alternate)	Colma	Staging area would be on SFPUC Right-of-way; well facility would be located on private property	Utility right-of-way, roadway, vacant land, and parking lot	Commercial (Standard Plumbing Supply)	Adjacent	Well and Treatment Facility: 16 months Pipeline: 1 week
				Cemetery (Cypress Lawn Memorial Park)	Adjacent	
				Commercial (Enterprise Car Rental and Collision Center)	25 feet	
				Commercial (Car dealership)	165 feet	
				Residential (Senior Care Facility)	390 feet	
Site 18 (Alternate)	South San Francisco	No, owned by City of South San Francisco	Utility right-of-way, vacant, and roadway	Single-family residential	Adjacent	Well and Treatment Facility: 16 months Pipeline: 1 to 2 weeks
				Intermediate school (Alta Loma Middle School)	170 feet	
				Pre-school (Little Hugs Preschool)	300 feet	

TABLE 5.2-1
Land Uses in the Vicinity of Facility Sites

Site	Jurisdiction	On SFPUC Land?	Land Use within the Construction Area	Land Uses in the Vicinity of the Construction Area (including Pipelines)	Minimum Distance from Construction Area to Land Use ^(a)	Approximate Construction Duration ^(b)
Site 19 (Alternate)	South San Francisco	Yes, SFPUC Right-of-way	Utility right-of-way, parking lot, roadway, and vacant	Public/Institutional (Our Redeemer's Lutheran Church and R.W. Drake Preschool)	Adjacent	Well and Well Facility: 5 months Pipeline: 3 to 6 weeks
				Commercial Garden Chapel Funeral Home	Adjacent	
				Single-family residential	Adjacent	
				Multi-family residential (Clubview Apartment Homes)	70 feet	
				Commercial (Fairway Plaza)	600 feet	

Notes:

- (a) Measurements are taken from the closest boundary of the construction zone to the closest edge of the land use, including parking areas for the land use.
- (b) Approximate construction duration developed using well facility and pipeline installation timeframes provided in Chapter 3, Project Description, Section 3.5.1 (Construction Sequencing and Schedule). Duration of pipeline installation is not necessarily the same as the duration of lane closures, because lane closures involve connection to existing utilities that may require extra time. The duration of lane closures is discussed below under Impact LU-1; refer to Section 5.6, Transportation and Circulation, for additional information.

The following provides a brief description of the land uses at the facility sites, along the pipeline routes, including alternate pipeline routes, and within the surrounding area. The specific land uses are included in Table 5.2-1, which also lists distances from the proposed construction area to the nearby land use and the duration of construction at the site. A description of land uses along potential routes for construction traffic follows the description of land uses near the facility sites.

Daly City

Site 1

Site 1 would be located on the Lake Merced Golf Club property and within Poncetta Drive, as shown on Figure 3-11. The facility site would be located west of Interstate Highway 280 (I-280) and south of the Westlake Village apartment complex. Surrounding land uses include I-280, multi-family residential uses, and the golf club.

Site 2

Site 2 would be located within the SFPUC utility right-of-way, as shown on Figure 3-12. The surrounding land uses include multi-family residential uses to the north of the site and the Lake Merced Golf Club immediately east of the site. Garden Village Elementary School is located south of the site and Ben Franklin Intermediate School is located to the west across Park Plaza Drive.

Site 5

Site 5 would be located within the SFPUC utility right-of-way and within B Street, as shown on Figures 3-15 and 3-19. The well facility would be constructed adjacent to a single-family residence and commercial businesses including a State Farm Insurance office and the former Serra Bowl bowling alley. A car dealership is located across B Street from the facility site. The SamTrans Park and Ride lot and the Colma Bay Area Rapid Transit (BART) Station are both located southeast of the proposed facility site. Site 5 includes two possible treatment options. The preferred consolidated treatment option includes installation of pipelines to convey water from the well facility at Site 5 to the well facility at Site 6 for treatment. The pipeline route between Sites 5 and 6 would pass through commercial land uses, the SamTrans Park and Ride lot and the Colma BART Station property. Alternately, if it is not feasible to consolidate treatment at Site 6, water may be treated on site at Site 5 with a water system connection within B Street.

Site 6

Site 6 would be located within the SFPUC utility right-of-way and within D Street, as shown on Figures 3-16 and 3-20. The well facility and pipelines would be constructed immediately adjacent to the Colma BART Station and the SamTrans Park and Ride lot. Other land uses near the site include commercial uses to the northwest. The Woodlawn Memorial Park is located approximately 90 feet south of the southern edge of the Site 6 construction area. The size and location of Site 6 would be the same for either the consolidated treatment option at this location for Sites 5 and 7 or the on-site treatment option for Sites 5 and 7.

Westlake Pump Station

The Westlake Pump Station upgrades would be located within the existing pump station property, which also serves as a corporation yard for the City of Daly City. Surrounding land uses include playing fields for the Ben Franklin Intermediate School and single- and multi-family residential uses as shown in Figure 3-13.

Unincorporated San Mateo County

Site 3

Site 3 would be located within the athletic field of Ben Franklin Intermediate School and within the school parking lot as shown on Figure 3-12. Surrounding land uses include single-family residential uses immediately south and west of the well facility and multi-family residential uses north of the access road to the well facility. The Lake Merced Golf Club is located east of the proposed facility site across Park Plaza Drive.

Site 4

Site 4 would be located on San Mateo County road right-of-way and within the playing field at Garden Valley Elementary School, as shown on Figure 3-12. Pipelines would be installed within Park Plaza Drive and 87th Street. Other land uses surrounding the facility site include single-family residences. Lake Merced Golf Club is located adjacent to pipelines that would be installed north of the proposed well facility to connect to the Daly City water distribution system.

Colma

Site 7

Site 7 would be located within the SFPUC utility right-of-way, as shown on Figure 3-17 and 3-21. The well facility would be constructed adjacent to the Woodlawn and Greenlawn Memorial Parks and across Colma Boulevard from the Greek Orthodox Memorial Park. The site would also be located near commercial uses to the southwest, including the Home Depot Pro store, which is part of a larger shopping center. Site 7 includes two possible treatment options. The preferred consolidated treatment option includes installation of a pipeline to convey water from the well at Site 7 to the water treatment facility at Site 6 for treatment. The pipeline between Sites 7 and Site 6 would pass through the Woodlawn Memorial Park as shown on Figure 3-17. Alternatively, if it is not feasible to consolidate treatment at Site 6, water may be treated on-site at Site 7 with a water system connection extending into Colma Boulevard, as shown in Figure 3-21.

Site 8

Site 8 would be located within the SFPUC utility right-of-way and within the parking lot for an adjacent commercial use, Kohl's Department Store, as shown on Figure 3-22. The site is surrounded by commercial land uses (i.e., automobile dealerships). A residential senior care facility is located approximately 440 feet to the southeast of the site.

Site 17 (Alternate)

Site 17 (Alternate) would be located partially within the SFPUC utility right-of-way, but also within the side yard and parking lot of an adjacent commercial use, Standard Plumbing Supply, as shown in Figure 3-38. Pipelines would extend into Collins Avenue. A portion of the construction area would be located within the SFPUC right-of-way across Collins Avenue. Surrounding land uses include commercial uses, a residential care facility to the east across Collins Avenue, and Cypress Lawn Memorial Park to the south and west.

*South San Francisco***Site 9**

Site 9 would be located on vacant land owned by the SFPUC, as shown on Figures 3-23 and 3-24. Surrounding land uses include multi-family residential to the northwest (Treasure Island Trailer Court), single-family residential to the east, and commercial and light industrial to the east and southeast. The San Mateo County Flood Control Channel and the Costco parking lot are located to the southwest. Holy Cross Cemetery is located approximately 280 feet east of the proposed site, across Mission Road.

Site 10

Site 10 would be located within the SFPUC utility right-of-way, as shown on Figure 3-25. Pipelines would extend into Camaritas Avenue. Surrounding land uses include commercial uses east of the proposed facility site (Chevy's Restaurant and Winston Manor Shopping Center). Single-family residences are located to the west and south of the proposed facility site, and additional commercial land uses are located across Hickey Boulevard north of this site.

Site 11

Site 11 would be located on vacant land owned by the SFPUC, as shown on Figures 3-26 and 3-27. Nearby land uses include a BART ventilation structure and a Kaiser Permanente Medical Center garage and parking lot; the Medical Center is approximately 725 feet north of the proposed well facility site. Surrounding land uses are commercial and single- and multi-family residential uses. The South San Francisco Centennial Way Trail is located within 75 to 230 feet as it passes to the north and east. There are public and commercial land uses near the access driveway leading to Antoinette Lane. The South San Francisco City Hall and commercial businesses are located uphill and across El Camino Real from the proposed well facility site.

Site 12

Site 12 would be located within the SFPUC utility right-of-way, a portion of which is currently occupied by the Garden Chapel Funeral Home parking lot and side yard, as shown on Figures 3-28 and 3-29. Pipelines would extend into Southwood Drive. Surrounding land uses include the Our Redeemer's Lutheran Church and R.W. Drake Pre-School Center northwest of the site and a single-family residential area to the south and west of the site. Several commercial businesses are located northeast of the site and across El Camino Real. Site 12 also includes a pipeline route along the western edge of El Camino Real

from the well facility site to West Orange Avenue as shown on Figure 3-29. Land uses in the vicinity of the proposed pipeline route include the SFPUC Baden Valve Lot, single-family residences, and numerous commercial uses.

Site 13

Site 13 would be located on vacant land owned by the SFPUC, as shown on Figures 3-31 and 3-32. Surrounding uses are commercial, residential, and open space/recreation. The South San Francisco Centennial Way Trail and Francisco Terrace Playlot are located northeast and northwest of the well facility site, respectively. A large warehouse is located northeast of the site. Single-family residences are located northwest of the facility site across South Spruce Avenue. Land uses north of the site include commercial and light industrial uses. Construction at the site would include installation of a pipeline along South Spruce Avenue to Huntington Avenue then south along Huntington Avenue to Noor Avenue. Land uses along the proposed pipeline route include governmental uses (San Mateo County offices and a U.S. Post Office) and commercial uses, including a movie theater and an extended stay motel.

Site 18 (Alternate)

Site 18 (Alternate) would be located on a vacant parcel of land owned by the City of South San Francisco, in a single-family residential area, as shown on Figure 3-39. Pipelines would extend into Alta Loma Drive. The SFPUC right-of-way, Alta Loma Middle School, and the Little Hugs Pre-school are located south of the proposed well facility site.

Site 19 (Alternate)

Site 19 (Alternate) would be located within the SFPUC utility right-of-way, as shown on Figure 3-40. The Our Redeemer's Lutheran Church and R.W. Drake Pre-School Center are located adjacent to the well facility site. Surrounding land uses include single-family residences to the southwest, multi-family residences to the west, and commercial uses to the north and east. Water pumped from the well at Site 19 (Alternate) would be conveyed to the facility at Site 12 for treatment. The pipeline to convey water from Site 19 (Alternate) to Site 12 would be installed across Southwood Drive and along the SFPUC right-of-way through the Garden Chapel Funeral Home parking lot.

San Bruno

Site 14

Site 14 would be located within the Golden Gate National Cemetery (GGNC) on land owned by the U.S. Department of Veterans Affairs (VA), as shown on Figure 3-35. The construction area at Site 14 would be located on or adjacent to an existing SFPUC easement near the northern boundary of the cemetery, in proximity to gravesites. Surrounding land uses include the cemetery and single-family residential uses to

the north. Water pumped from the well at Site 14 would be conveyed to Site 15 for treatment¹. The pipeline would be installed within the SFPUC easement through the cemetery to Sneath Lane, as shown in Figure 3-33. Land uses along the proposed pipeline in Sneath Lane include light industrial uses at the Airport Trade Center and multi-family residences.

Site 15

Site 15 would be located at the Golden Gate National Cemetery adjacent to a cemetery operations and maintenance facility along Sneath Lane, as shown on Figure 3-36. Surrounding land uses include the cemetery and commercial uses to the south, across Sneath Lane. A VA Medical Clinic is also located across Sneath Lane to the southeast of the site. A pipeline would extend along Sneath Lane to connect to the San Bruno water distribution system. Multi-family residential uses and light industrial uses occur south of the pipeline route.

Millbrae

Site 16

Site 16 would be located on SFPUC-owned land that is currently occupied by Orchard Supply Hardware and within Hemlock Avenue, as shown on Figure 3-37. The site would be located within the parking lot and a portion of a storage yard associated with the hardware store. Surrounding land uses include the Caltrain rail line, commercial and industrial uses, single- and multi-family residences and a convalescent hospital. To the north of the Caltrans tracks are a tennis club, an undeveloped park, and a PG&E substation.

Construction Traffic Routes

The construction traffic routes would extend from the individual sites to the nearest freeway: I-280, U.S. 101, I-380, and State Route 82 (El Camino Real) and are listed in detail in Section 5.6, Transportation and Circulation. The land uses along the construction traffic routes are similar to the lands uses immediately surrounding the individual facility sites, as the study area is fairly homogeneous: single- and multi-family residential, commercial, public/institutional, golf clubs, and cemeteries. Most of the routes are on collector roads and arterials that have relatively high traffic volumes (see Table 5.6-3 [Local Roadway Existing Level of Service Conditions] in Section 5.6, Transportation and Circulation, for specific volumes). Where the proposed facility sites are located away from arterials within residential neighborhoods, the portion of the route closest to the site would also be lined with residences.

¹ If Site 14 is constructed and the well facility at Site 15 is found to be infeasible, a treatment facility would still be constructed at Site 15 to treat water from Site 14; see discussion in Chapter 3 Project Description, Section 3.4.3 (Facility Sites).

5.2.2 Regulatory Framework

5.2.2.1 *Federal and State Regulations*

No federal or State land use regulations apply to the proposed Project, except at Sites 14 and 15, which would be located on federal land. Please see Chapter 4, Plans and Policies, for a discussion of the regulatory setting related to federal lands.

5.2.2.2 *Local Regulations*

Under California Government Code Section 53090, et seq., the SFPUC receives intergovernmental immunity from city and county zoning and building ordinances. Please see Chapter 4, Plans and Policies, for a discussion of the regulatory setting related to land use plans and policies and more detailed information regarding intergovernmental immunity.

5.2.3 Impacts and Mitigation Measures

5.2.3.1 *Significance Criteria*

For the purposes of this EIR, the Regional Groundwater Storage and Recovery Project would have a significant effect on land use if it were to:

- Physically divide an established community.
- Conflict with any applicable land use plan, policy, or regulation of an agency with jurisdiction over the project (including, but not limited to the general plan, specific plan, local coastal program, or zoning ordinance) adopted for the purpose of avoiding or mitigating an environmental effect.
- Have a substantial impact upon the existing character of the vicinity.
- Substantially disrupt or displace existing land uses or land use activities.

5.2.3.2 *Approach to Analysis*

This analysis evaluates the potential for land use impacts, including short-term impacts on existing land uses that could result from temporary construction activities and long-term impacts that could result from the siting, operation, and maintenance of proposed facilities. The significance criteria identified above were used to determine the level of significance of potential impacts.

Two of the four significance criteria will not be discussed further in this EIR for the following reasons:

Physically divide an established community. This criterion is not applicable to the Project because of the Project's nature and scale. None of the proposed facilities or construction activities would physically divide an established community. During construction, neighborhoods, commercial areas, schools and parks could be temporarily disrupted by pipeline construction and lane closures or detours. These short-term activities and associated impacts pertain more to disrupting

the land use character of a community and are, therefore, discussed below under Impact LU-1. After construction, the largest footprint of above-ground Project facilities at any one site (including structures, paving, and parking) would measure approximately 70 feet by 140 feet. Pipelines to connect the well facilities to existing off-site water lines, sanitary sewer lines, and storm drains would be below ground. Proposed power lines would also be below ground at all the sites except at Site 9, where power lines would be above ground to avoid the need to tunnel beneath the Colma Creek Diversion Channel.

Conflicts with applicable land use plans, policies, or regulations of an agency with jurisdiction over the project.

This criterion is evaluated in Chapter 4, Plans and Policies.

In addition to the two criteria listed above, potential land use disruptions associated with construction noise, dust, and access impacts at cemeteries during funeral services is not discussed further in the land use analysis below for the following reason. The SFPUC proposes to coordinate with cemetery managers to gain information about the dates and times of upcoming funeral services that would coincide with pipeline construction through their properties. The SFPUC also proposes that pipeline construction activities would cease during funeral services, as discussed in Chapter 3, Project Description, Section 3.5.1 (Construction Sequencing and Schedule), which would thereby avoid potential land use disruptions associated with noise dust, and access.

The remaining significance criteria are discussed in the impact analysis. The analysis considers short- and long-term impacts on land uses in the vicinity of the Project which would: (1) substantially affect the existing character of the vicinity by introducing land uses that would be incompatible or conflict with established land uses or (2) substantially disrupt or displace existing land uses or land use activity.

The approach to analysis considers whether temporary adverse impacts on land use would occur due to substantial disruption or displacement of existing land uses or substantial interference with access to land uses during construction, thereby affecting the existing land use character of the area. The analysis also evaluates whether temporary land use disturbance adjacent to Project construction activities would result from a combination of effects, including noise, dust, traffic delays, and/or access disruption. Each of these potential construction effects is evaluated separately in Section 5.6, Transportation and Circulation; Section 5.7, Noise and Vibration; 5.8, Air Quality; and Section 5.11, Recreation; however, the intensity or potential combination of these construction effects is considered in this section as a potential land use disruption issue. Land use displacement would occur if implementation of the Project required temporary relocation of existing land uses to accommodate construction or temporary restrictions on land use activities. Mitigation for construction noise and traffic impacts is referenced throughout this section, as these measures are required to reduce the effects of the temporary land use disturbance associated with Project construction. The complete description of these measures is not repeated in this section, but references to the location of mitigation measures are included in the text.

Air Quality Impacts Affecting Land Use

For example, well facility construction could generate construction-related dust. Although this short-term construction-related air quality impact would not be generated by changes in land use, it would be attributable to well facility construction activities and could, therefore, disturb land uses in the vicinity of

the construction area boundary. Such an impact is analyzed in detail in Section 5.8, Air Quality, and its relationship to potential impacts on existing land use character is explained below. The analysis takes into account the fact that construction-related land use impacts would be temporary and short-term. That is, these impacts would not be continuous over the total construction period and would not extend beyond the estimated construction duration for each site (see Table 5.2-1 [Land Uses in the Vicinity of Facility Sites] for the construction duration at each site). Although construction-related air quality impacts have the potential to temporarily affect land use, for almost all sites, mitigation measures are available that would reduce the severity of the impact sufficiently that land use would not be disturbed, as noted below.

Construction-period Dust Impacts at All Sites

Construction at each of the facility sites would generate construction-related fugitive dust emissions, which would substantially disrupt neighboring land uses, and result in a significant impact. However, as described in Section 5.8, Air Quality, Mitigation Measure M-AQ-2a (BAAQMD Basic Construction Measures), would be included in all construction contracts to reduce impacts from fugitive dust to less-than-significant levels. Since the resulting fugitive dust levels would be temporary and less than significant, they would not substantially alter the existing character of the vicinity or disrupt the land use. As a result, this impact would be *less than significant*.

Construction-period Diesel Particulate Matter Impacts at All Sites

Project construction activities would require the use of heavy-duty diesel vehicles and equipment that emit diesel particulate matter (DPM) as PM_{2.5}, that can pose cancer risk and non-cancer hazards. As described in Section 5.8, Air Quality, Impact AQ-3, to address such potential health risk impacts, estimated emissions data from the proposed construction activities were input to a dispersion model that computes DPM/PM_{2.5} and organic compound concentrations at receptor locations. The dispersion model computed that Project cancer risks, non-cancer hazard indices and PM_{2.5} concentrations would be below regulatory threshold limits at all facility sites except at Site 5 (with On-Site Treatment). Impacts at 18 of the 19 well facility sites, therefore, would be less than significant. As described in Section 5.8, Air Quality, Mitigation Measure M-AQ-3 (Construction Health Risk Mitigation) would reduce the impact at Site 5 (with On-site Treatment) to less than significant with mitigation. Because the residual impacts would be less than significant, they would not substantially alter the existing character of the vicinity or disrupt land uses. As a result, this impact would be *less than significant*.

Operational Emissions All Sites

Facility operations at each of the 19 well facility sites would generate pollutant emissions from groundwater pump operations due to the infrequent use of portable generators in the event of a power failure and vehicle trips for well facility maintenance. As described in Section, 5.8 Air Quality, under Impacts AQ-5 and AQ-6, pollutant emissions from these sources would be quite small, and are therefore not anticipated to cause localized emissions that would lead to significant excess cancer risk, significant acute or chronic hazards, or annual PM_{2.5} concentrations. Therefore, potential air quality impacts attributable to the Project operations would be less than significant. Since air quality

impacts would be less than significant, they would not substantially alter the existing character of the vicinity or disrupt the land use. As a result, this impact would be *less than significant*.

Other Indirect Effects on Land Use

The approach to analysis also evaluates whether permanent impacts on land use that could result from siting and operation of the Project would change the physical environment surrounding the facility site to such an extent that the character of the vicinity would be changed or nearby land uses would be substantially disrupted or displaced. For example, well facility operations could produce a new noise source that could conflict with residential land uses located nearby. Construction-period noise impacts are considered to have the potential to affect land use if nighttime construction is proposed. Daytime noise impacts are not considered to result in a significant disruption in land use.

In a departure from the general organization of this EIR's other analysis sections, any applicable mitigation measures are presented at the end of the impact analysis for each group of sites, rather than following the discussion of each facility site to reduce redundancy. Most of the mitigation measures apply to many of the facility sites. Therefore, it is more efficient to present and discuss the measure once, rather than with each site and referring the reader back to the measure's original discussion in the section. Mitigation measures specific to an individual site are shown under the site analysis.

5.2.3.3 Summary of Impacts

Table 5.2-2 (Summary of Impacts – Land Use) provides a summary of potential land use impacts.

TABLE 5.2-2
Summary of Impacts – Land Use

Sites	Impact LU-1: Project construction would have a substantial impact on the existing character of the vicinity and could substantially disrupt or displace existing land uses or land use activities.	Impact LU-2: Project operations would result in substantial long-term or permanent impacts on the existing character or disrupt or displace land uses.	Impact C-LU-1: Construction and operation of the proposed Project could result in a cumulatively considerable contribution to cumulative impacts related to land use.
Site 1	SUM	LSM	LS
Site 2	LS	LS	LS
Site 3	SUM	LS	LS
Site 4	SUM	LS	LS
Westlake Pump Station	NI	LSM	LS
Site 5 (Consolidated Treatment at Site 6)	LSM	LS	LS
Site 6 (Consolidated Treatment at Site 6)	LS	LS	LS

TABLE 5.2-2
Summary of Impacts – Land Use

Sites	Impact LU-1: Project construction would have a substantial impact on the existing character of the vicinity and could substantially disrupt or displace existing land uses or land use activities.	Impact LU-2: Project operations would result in substantial long-term or permanent impacts on the existing character or disrupt or displace land uses.	Impact C-LU-1: Construction and operation of the proposed Project could result in a cumulatively considerable contribution to cumulative impacts related to land use.
Site 7 (Consolidated Treatment at Site 6)	LSM	LS	LS
Site 5 (On-site Treatment)	SUM	LSM	LS
Site 6 (On-site Treatment)	LS	LS	LS
Site 7 (On-site Treatment)	LS	LS	LS
Site 8	LS	LS	LS
Site 9	SUM	LSM	SUM
Site 10	LSM	LS	LS
Site 11	LSM	LS	LS
Site 12	SUM	LS	SUM
Site 13	LSM	LS	LS
Site 14	SUM	LS	LS
Site 15	LSM	LS	LS
Site 16	SUM	LS	LS
Site 17 (Alternate)	LSM	LS	LS
Site 18 (Alternate)	SUM	LSM	LS
Site 19 (Alternate)	SUM	LS	SUM

Notes:

NI = No Impact

LS = Less than Significant

LSM= Less than Significant with Mitigation

SUM= Significant and Unavoidable with Mitigation

5.2.3.4 Construction Impacts and Mitigation Measures

Impact LU-1: Project construction would have a substantial impact on the existing character of the vicinity and could substantially disrupt or displace existing land uses or land use activities. (Significant and Unavoidable with Mitigation)

As indicated in Chapter 3, Project Description, Section 3.5.1 (Construction Sequencing and Schedule), Project construction activities would take place over an approximate three-month period for construction of the well-only facilities² and associated pipelines and up to 16 months for construction of wells plus treatment and filtration buildings and the associated pipelines. Construction activities involve site preparation work, well drilling, foundation laying, utility connections, and building or enclosure construction (see Chapter 3, Project Description, Section 3.5 [Project Construction]). Construction activities may temporarily remove or damage existing recreational resources on or adjacent to facility sites. Project construction activities would result in construction vehicles traveling to and from facility sites along urban roadways. Construction vehicle traffic could result in increased traffic congestion and traffic safety hazards for automobiles, bicyclists, and pedestrians traveling along the construction access routes, as well as temporary traffic delays associated with construction vehicles.

The following evaluation of impacts discusses sites with no impacts first, followed by sites with less-than-significant impacts, and then sites with significant impacts.

Westlake Pump Station

Westlake Pump Station upgrades would occur within the fenced and paved pump station property, which is bordered by single- and multi-family residential uses and playing fields at the Ben Franklin Intermediate School. The proposed upgrades, including new pipelines, would be inside the existing buildings at the pump station site. *No impact* would occur to neighboring land uses, because construction would occur on the existing Westlake Pump Station site, construction would occur within existing buildings, and no road closures would be needed. As a result, construction activities would not substantially change the character of the vicinity or substantially disrupt or displace adjacent land uses.

Impact Conclusion: No Impact

Sites 2, 6, 7 (On-site Treatment), and 8

Site 2

Construction at Site 2 would occur near the Lake Merced Golf Club, multi-family residences, and the Garden Village Elementary School. Pipeline installation would occur along Park Plaza Drive, as shown in Figure 3-12. Construction at Site 2 would not displace these land uses, and would not disrupt the recreational experience at the Lake Merced Golf Club. The golf playing surface is about 20 feet higher in

² Exceptions to the three-month construction duration for the well-only facilities include Site 3, where construction would occur over two three-month summers and Site 2, where construction would require only about one month.

elevation than the proposed well facility site. The area between the well facility site and the fairway includes a large number of trees and shrubs that provide substantial screening between the well facility site and the fairway. Therefore, construction would not substantially displace the land use at the golf club nor adversely impact its existing land use character, because it would be brief (one month), and golfers would be separated from the construction site by both elevation and vegetative screening.

During the estimated one-month construction period, recreationists using the Garden Village Elementary School athletic fields; nearby residents, including residents of the Westlake Village Apartments; and users of the adjacent playing surface at the golf club would experience noise impacts. However, since the resulting noise levels would be temporary and less than significant, they would not substantially alter the existing character of the vicinity or disrupt the land use. As a result, this impact would be *less than significant*.

Site 6

Site 6 would be located on the SFPUC utility right-of-way between the Colma BART Station and the SamTrans Park and Ride lot. Pipeline construction, including the alternate water connection, would occur underneath the existing pedestrian bridge from the Park and Ride lot to the BART station. Impacts from noise from construction would have little impact on BART customers, because customers would continue to have access to the Park and Ride lot and the BART station as they do now and would experience construction-related effects for only a brief time as they cross the pedestrian bridge (see Section 5.6, Transportation and Traffic, and Section 5.7, Noise and Vibration). Similarly, Woodlawn Memorial Park would experience only minor land use impacts, because the closest gravesites are over 100 feet away from the proposed construction area, screened by mature vegetation, and at a higher elevation than the site. Land use impacts would be the same for both the Consolidated Treatment at Site 6 and for the On-site Treatment options at Sites 5 and 7, and would also be the same for the proposed and alternate water connection pipelines. Therefore, construction activities would not substantially change the character of the vicinity and would not substantially disrupt or displace adjacent land uses. The impact would therefore be *less than significant*.

Site 7 (On-site Treatment)

Site 7 (On-site Treatment) would be located on the SFPUC utility right-of-way near Woodlawn, Greenlawn and Greek Orthodox Memorial Parks, and adjacent to the back of a Home Depot Pro store, as shown in Figure 3-17.

Visitors would experience minor delays on Colma Boulevard due to temporary lane closures when storm drain and sanitary sewer pipelines and electricity conduit are extended into the street. Lane closure would last approximately one week. The proposed water connection pipeline would stay entirely within the SFPUC utility right-of-way, but the alternate water connection pipeline would connect to the California Water Service Company (Cal Water) distribution system within Colma Boulevard, which would also require a temporary lane closure. However, these temporary effects would not substantially change the character of the vicinity or cause a substantial disruption or displacement of the adjacent cemetery land uses.

During daytime construction of the well facility and pipelines, lasting approximately 16 months, visitors to the cemeteries would be exposed to increased noise, (nighttime construction would not affect the cemetery land uses). However, impacts would be temporary (approximately 16 months) and would only briefly affect individuals who may occasionally visit the cemeteries. The resulting impact on the character of the vicinity would therefore be *less than significant* and the land use would not be substantially disrupted or displaced.

Site 8

Site 8 would be located on the SFPUC utility right-of-way, between the back of a Kohl's Department Store and the Serramonte Volkswagen car dealership located immediately southwest and at a higher elevation than the site, beyond an approximately 25-foot high retaining wall, as shown in Figure 3-22. For purposes of this analysis, it is assumed that construction would temporarily delay access to the back of the Kohl's store during installation of the electrical conduit for up to two days, based upon the length of the pipeline, which is approximately 120 feet and the SFPUC's proposed rate of pipeline construction of 300 to 600 feet per week (see Chapter 3 Project Description, Section 3.5.1 [Construction Sequencing and Schedule]). An approximately 50 foot segment of sanitary sewer pipeline would be installed in the parking lot behind the Kohl's store and may require one day to install. Construction noise would not substantially disrupt surrounding land uses because of distance and the presence of intervening structures between the construction site and surrounding land uses. Noise from construction activities would have minimal impact on the neighboring land uses, because Kohl's customers and deliveries would continue to have access to the store, and the few customers of Kohl's, and of the car dealership, who approach the construction area would be only briefly exposed to the construction effects (see Section 5.6, Transportation and Traffic and Section 5.7, Noise and Vibration,). Land use impacts would be the same for both the proposed and alternate water connection pipelines. As a result, construction activities would not substantially change the character of the vicinity or substantially disrupt or displace adjacent land uses. The impact would therefore be *less than significant*.

Impact Conclusion: Less than Significant

Sites 5 (Consolidated Treatment at Site 6), 7 (Consolidated Treatment at Site 6), 10, 11, 13, 15, and 17 (Alternate)

Site 5 (Consolidated Treatment at Site 6)

Construction at Site 5 (with treatment consolidated at Site 6) would occur adjacent to a single-family residence within a mostly commercial area. No nighttime construction would be necessary, because a test well already exists at the site. During daytime construction of the well facility and pipelines (including the proposed water connection pipeline to Site 6, a storm drain and an electrical line), which would occur over approximately three months, noise levels would be elevated. Although these impacts would be temporary (three months), construction of the fenced enclosure would occasionally result in significant noise impacts. Mitigation Measures M-NO-1 (Noise Control Plan) and M-NO-3 (Expanded Noise Control Plan), which are described in Section 5.7, Noise and Vibration, would reduce this temporary impact on the adjacent residence to less-than-significant levels. The proposed water connection pipeline from Site 5 to Site 6 would be constructed across Hill Street and D Street and under the pedestrian bridge from the

SamTrans Park and Ride lot to the BART station. Impacts from noise from construction would have little impact on BART customers, because customers would continue to have access to the Park and Ride lot and the BART station as they do now and would experience construction-related effects for only a brief time as they cross the pedestrian bridge (see Section 5.6, Transportation and Traffic, and Section 5.7, Noise and Vibration). Therefore, impacts on the existing character of the vicinity would be *less than significant with mitigation*, and no land uses would be substantially disrupted or displaced.

Site 7 (Consolidated Treatment at Site 6)

Site 7 (Consolidated Treatment at Site 6) would be located on the SFPUC utility right-of-way near Woodlawn, Greenlawn and Greek Orthodox Memorial Parks, and adjacent to the back of a Home Depot Pro store, as shown in Figure 3-17.

Visitors would experience minor delays on Colma Boulevard due to temporary lane closures when a storm drain pipeline and electrical conduit are extended into the street. Pipeline installation in Colma Boulevard would last approximately one week. The proposed water pipeline connection to Site 6 would stay entirely within the SFPUC utility right-of-way. These temporary effects would not substantially change the character of the vicinity nor cause a substantial disruption or displacement of the cemetery land uses.

During daytime construction of the well facility (which would be a fenced enclosure with no building), lasting approximately three months, visitors to the cemeteries would be exposed to increased noise, dust and equipment exhaust (however, nighttime construction would not affect the cemetery land use). These noise levels would be intermittent and temporary, and the impact on the character of the vicinity would be *less than significant* and the adjacent land uses would not be substantially disrupted or displaced.

In addition, construction would include installation of approximately 1,780 feet of pipeline across the Woodlawn Memorial Park, to convey water to Site 6 for treatment. Noise from the pipeline construction would occur during the estimated five-week construction period for the pipeline crossing Woodlawn Memorial Park. Cemetery visitors would experience construction noise during pipeline installation; however, increased noise levels would be intermittent during the temporary construction. Construction noise would not interrupt funeral services because, as noted in Chapter 3 Project Description, Section 3.5.1 (Construction Sequencing and Schedule), the SFPUC would coordinate with the cemetery and halt construction activities during funeral services. Construction noise affecting individuals who may occasionally visit the Woodlawn Cemetery would be intermittent and temporary, lasting for up to five weeks, and construction would cease during funeral services; therefore, the impact would be *less than significant*.

Pipeline installation across Woodlawn Memorial Park would cross several internal cemetery access roads, which could result in temporary access impediments to portions of the cemetery. This could have a substantial disruption of the cemetery land use and, in which case, would be a *significant* impact. However, Mitigation Measure M-LU-1 (Maintain Internal Cemetery Access) would reduce the land use impact to *less than significant* by providing access to all portions of the cemetery within a reasonable time period for both visitors and maintenance.

Mitigation Measure M-LU-1: Maintain Internal Cemetery Access (Site 7 [Consolidated Treatment at Site 6] and Site 14)

Prior to commencing construction at either Site 7 (where treatment for Site 7 is consolidated at Site 6) or at Site 14, the SFPUC or its construction contractor shall develop an access plan to be implemented during construction to ensure that access is available for visitors to all portions of the Woodlawn Memorial Park and Golden Gate National Cemetery within a reasonable period of time upon their arrival at the cemetery. The access plan shall include, for example, trench plating and alternative routing for visitors. The plan shall also address measures to maintain access for cemetery operations and maintenance. A copy of the access plan shall be submitted to the owner or operator of the Woodlawn Memorial Park and the Golden Gate National Cemetery prior to commencing construction, and they also shall be provided with the name of, and contact information for, a person identified to act as a liaison during construction at these sites.

Site 10

Site 10 would be located on the SFPUC utility right-of-way between single-family residential land uses to the west and commercial land uses to the east, as shown in Figure 3-25.

Installation of the proposed sanitary sewer pipeline at Site 10 would require the partial closure of Camaritas Avenue during pipeline installation, affecting an egress/ingress to the Winston Manor Shopping Center from Camaritas Avenue for approximately one week. However, the shopping center has alternative access points, and temporary delays on Camaritas Avenue would not substantially affect the character of the vicinity or substantially disrupt or displace nearby commercial uses. Land use impacts of the proposed and alternate water connection pipelines would be the same.

No nighttime construction is required at Site 10, because a test well already exists on the site. During daytime construction of the well facility and pipelines, which would occur over approximately 14 months, noise levels would be significant (see Section 5.7, Noise and Vibration). These noise levels could potentially disrupt the adjacent land uses, which would be a *significant* impact. However, Mitigation Measures M-NO-1 (Noise Control Plan) and M-NO-3 (Expanded Noise Control Plan) would reduce potential noise impacts to less-than-significant levels. The resulting noise levels would, therefore, be less than significant during the daytime. As a result, the impact on the character of the vicinity would be *less than significant with mitigation* and the land use would not be substantially disrupted or displaced.

Site 11

Site 11 would be located in an area of public and institutional land uses between El Camino Real and the Colma Creek Flood Control Channel, as shown in Figures 3-27 and 3-28. Neighboring land uses include an adjacent BART ventilation structure, the Kaiser Permanente Medical Center garage and parking lot, and an area used by the City of South San Francisco Public Works Department. The construction area would range from approximately 75 to 230 feet away from the South San Francisco Centennial Way Trail (which is a linear pedestrian and bicycle pathway) as it passes northeast of the site and would be approximately 400 feet from the closest residential uses located to the southwest across El Camino Real and at a higher elevation.

Project construction would not limit access to the trail or require closure of any portion of the trail. Construction would not limit access to the BART ventilation structure or the Kaiser Permanente Medical Center garage and parking lot. Therefore, there would be no land use impacts related to loss of access.

During daytime construction of the well facility and pipelines, which would occur over approximately 16 months, noise levels would not be significant (see Section 5.7, Noise and Vibration) and would not disrupt adjacent land uses. During nighttime construction associated with well drilling, residents would experience significant noise impacts, and therefore construction during this time would substantially disrupt the nearby residential land uses, which would be a *significant* impact. However, Mitigation Measures M-NO-1 (Noise Control Plan) and M-NO-3 (Expanded Noise Control Plan) would reduce nighttime noise impacts to less-than-significant levels at the residences. Since the resulting noise levels would be temporary and less than significant and they would not substantially alter the existing character of the vicinity or disrupt the land use. As a result, this impact would be *less than significant with mitigation*.

Site 13

Site 13 would be located on SFPUC-owned land adjacent to commercial and single-family residential land uses. Approximately 60 feet east of the construction zone boundary is the South San Francisco Centennial Way Trail, which is a linear pedestrian and bicycle pathway. Construction activities would not require closure of the trail, and it would remain available to recreational users during construction.

Construction at Site 13 would require temporary alternating lane closures on segments of South Spruce Avenue and Huntington Avenue. Access to the businesses and offices along Huntington Avenue could be temporarily impacted during construction as installation of the pipeline may limit driveway access. In addition, access to a bank adjacent to Site 13, which only has one driveway off South Spruce Avenue, would also be temporarily blocked for approximately one day during pipeline installation associated with this site. Temporary loss of access to adjacent properties would substantially disrupt these land uses. The land use impact would be *significant*. However, as described in Section 5.6, Transportation and Circulation, Mitigation Measure M-TR-1 (Traffic Control Plan) would reduce the impact of blocked access to the businesses and offices along Huntington Avenue and South Spruce Avenue to a less-than-significant level by limiting lane closures and maintaining access to driveways. Therefore, the impact on transportation access (including emergency access) following mitigation would not disrupt land use. As a result, this impact would be *less than significant with mitigation*.

No nighttime construction would be required at Site 13, because a test well already exists on the site. During daytime construction of the well facility and pipelines, which would occur over approximately 14 months, noise levels would be significant (see Section 5.7, Noise and Vibration). These noise levels could potentially disrupt the adjacent land uses, which would be a *significant* impact. However, Mitigation Measures M-NO-1 (Noise Control Plan) and M-NO-3 (Expanded Noise Control Plan) would reduce noise levels to less-than-significant levels. Since the resulting noise levels would be temporary and less than significant, they would not substantially alter the existing character of the vicinity or disrupt the land use. As a result, the land use impact would be *less than significant with mitigation*.

Site 15

Site 15 would be located at the GGNC along Sneath Lane adjacent to the cemetery's operations and maintenance building and across the street from commercial uses. The pipeline installation associated with Site 15, which would extend along Sneath Lane to Cherry Avenue, would be adjacent to the GGNC, commercial land uses, and near multi-family residential land uses, as shown in Figure 3-36.

The pipeline to connect to the storm drain would require the temporary closure of both westbound and eastbound lanes of Sneath Lane and the temporary closure of the southern entrance to the GGNC. Although construction would affect the southern access to the GGNC, the main access to the cemetery, which is approximately 0.4 mile west of the construction area, would not be blocked, and visitors could continue to access the site via that entrance. As a result, access to the GGNC would be altered, but not eliminated. Land use impacts would be the same for both the proposed and alternate water connection pipelines. As a result, construction activities would not substantially change the character of the vicinity or substantially disrupt or displace adjacent land uses, and the impact would therefore be *less than significant*.

Daytime construction activities would result in temporary noise increases at nearby gravesites located as close as 30 feet away from the construction area. Visitors to the cemetery would also be exposed to construction-related noise.

During daytime construction of the well facility and pipelines, which would occur over approximately 16 months, noise levels would not be significant at the multi-family residences on Cherry Lane, which would therefore not substantially disrupt the land use (see Section 5.7, Noise and Vibration). However, during nighttime construction associated with well drilling, residents would experience significant noise impacts, which would therefore substantially disrupt the nearby residential land uses, which would be a *significant* impact. Nevertheless, Mitigation Measures M-NO-1 (Noise Control Plan) and M-NO-3 (Expanded Noise Control Plan) would reduce noise levels to less-than-significant levels at the residences during the nighttime. Since the resulting noise levels would be less than significant, they would not substantially alter the existing character of the vicinity or disrupt the land use. As a result, this impact would be *less than significant with mitigation*.

Site 17 (Alternate)

Site 17 (Alternate) would be located within the SFPUC utility right-of-way and a portion of the Standard Plumbing Supply Company parking lot, as shown in Figure 3-38. The closest gravesites at Cypress Lawn Memorial Park would be approximately 150 feet from the construction area and separated from the facility site by mature vegetation and an elevation difference of approximately 25 feet. There is a senior care facility located about 400 feet northeast of the site. Visitors to Cypress Lawn would experience elevated levels of noise during the 16 months of construction at Site 17 (Alternate), but the cemetery is shielded from the proposed construction area by a change in elevation and mature landscaping (see Section 5.7, Noise and Vibration). Nighttime construction, which would be required during well drilling, would not disturb or disrupt the cemetery or commercial land uses in the area, since these are not open overnight. During nighttime construction residents at the senior care facility would experience *significant* noise impacts, which would disrupt this residential use. However, Mitigation Measures M-NO-1 (Noise Control Plan) and M-NO-3 (Expanded Noise Control Plan) would reduce nighttime noise impacts to a

less-than-significant level. As a result, this land use impact would be *less than significant with mitigation*. Pipeline installation (proposed water connection, sanitary sewer, storm drain, and electrical) for the site would extend halfway into Collins Avenue, which would require a temporary closure of the eastbound lane during construction, which is assumed for this analysis to last for approximately one week. Land use impacts for the proposed and alternate water connection pipelines would be the same. Standard Plumbing Supply would remain accessible, given that construction would not completely obstruct the driveway at this location. Access to other surrounding land uses, including the Serramonte Volkswagen car dealership and Cypress Lawn Memorial Park, would not be impeded. Although during construction, a portion of the Standard Plumbing Supply parking lot would be inaccessible, the majority of parking spaces would not be affected.

The Project would not substantially change the character of the vicinity or displace or disrupt adjacent commercial or cemetery land uses, which would be able to continue normal operations throughout construction. Nighttime noise impacts at the senior care center would be mitigated to ensure that this land use is not disrupted, and the impact would therefore be *less than significant with mitigation*.

Temporary land use disruption impacts would be reduced to a *less-than-significant* level through implementation of the mitigation measures identified below, as discussed for each well facility site in the preceding analyses.

Impact Conclusion: Less than Significant with Mitigation

Sites 1, 3, 4, 5 (On-site Treatment) 9, 12, 14, 16, 18 (Alternate), and 19 (Alternate)

Site 1

Land uses surrounding Site 1 include multi-family residential (Westlake Village Apartments), the Lake Merced Golf Club, and I-280 as shown on Figure 3-11. Construction of the alternate water connection pipeline (to Daly City) for Site 1 would require temporary closure of end of Poncetta Drive, whereas construction of the proposed water connection pipeline (to SFPUC) would not. The portion of Poncetta Drive that would be temporarily closed would be at the end of the roadway and would not affect access to residences or the apartments' garbage area.

Site 1 would be located within approximately 50 feet of Hole #4 and within 1,000 feet of six other playing holes used by golfers. During construction, Lake Merced Golf Club golfers would experience significant noise levels (see Section 5.7, Noise and Vibration) as they pass by the construction area. Section 5.11, Recreation analyzes the temporary impacts on golfing during construction. Because noise impacts from well drilling and construction of the well facility building would be significant and last over 16 months, the character of the recreational experience would deteriorate within approximately 340 feet of the well facility and the impact on recreation would therefore be *significant*. However, Mitigation Measures M-NO-1 (Noise Control Plan) and M-NO-3 (Expanded Noise Control Plan) would require a Noise Control Plan that would identify the best available noise control practices for the site and implementation of noise barriers such that noise levels would be reduced to less-than-significant levels. Construction of pipelines and the well facility building would therefore not substantially alter the existing character of the vicinity and, as a result, would not cause disruption or displacement of the land use, reducing impacts to *less-than-significant* levels.

During well drilling (which would occur over approximately seven days) residents in the Westlake Apartments closest to the proposed facility site would be exposed to high noise levels both during the day (within approximately 340 feet of the well facility) and night (within approximately 1,900 feet of the well facility). Noise levels during the day would be *significant* (see Section 5.7, Noise and Vibration). During nighttime construction associated with well drilling, residents would experience significant noise impacts, which would therefore substantially disrupt the nearby residential land use (apartment building), which would be a *significant* land use impact. However, Mitigation Measures M-NO-1 (Noise Control Plan) and M-NO-3 (Expanded Noise Control Plan) would require a Noise Control Plan that would identify the best available noise control practices for the site and require the implementation of noise barriers such that noise levels would be reduced at the apartment building. However, the resulting noise levels would still, at times, result in significant daytime impacts (within approximately 110 feet of the well facility for up to 16 months) and would continue to be significant at night (within approximately 190 feet of the well facility for up to seven days). This adjacent residential land use could therefore be disrupted during the nighttime construction. This would be a *significant and unavoidable* land use impact with mitigation, given that, although feasible mitigation is available that can reduce noise impacts (Mitigation Measures M-NO-1 [Noise Control Plan] and M-NO-3 [Expanded Noise Control Plan]), no feasible mitigation is available to reduce noise levels further to an acceptable nighttime level and well drilling must be continuous (see explanation in Chapter 3 Project Description, Section 3.5.3.1 [Construction Hours]).

Site 3

Construction at Site 3 would occur near single-family residences and within the Ben Franklin Elementary School athletic fields. Construction would occur during two summer seasons when the school is not in session.

During daytime construction of the well facility (which includes a fenced enclosure without a building), which would occur over approximately six months, noise levels would be elevated. However, these impacts would be temporary and would not be significant at the neighboring land uses (see Section 5.7, Noise and Vibration). The Ben Franklin Intermediate School athletic field would be closed and inaccessible for recreation during the two summer seasons when construction would occur. These impacts on the recreational land use at the school would be temporary and recreational activities could be relocated to nearby recreational resources; see Section 5.11, Recreation for further information. Impacts on the existing character of the vicinity during daytime construction would therefore be *less than significant*, and no land uses would be substantially disrupted or displaced.

During nighttime construction associated with well drilling, residents located adjacent to Site 3 would experience significant noise impacts. During nighttime construction associated with well drilling, residents located up to 1,900 feet away would experience significant noise impacts, which would therefore substantially disrupt the nearby residential land uses, resulting in a *significant* land use impact. However, Mitigation Measures M-NO-1 (Noise Control Plan) and M-NO-3 (Expanded Noise Control Plan) would reduce noise levels to less-than-significant levels. Although the resulting noise levels would be less than significant during the daytime, they would remain loud enough to disturb the sleep of the nearby residents (within approximately 190 feet of the well facility), which could therefore disrupt the adjacent residential land uses during the period of construction (approximately seven days for well

drilling). Nighttime construction would have a *significant and unavoidable* land use impact with mitigation given that, although feasible mitigation is available that can reduce noise impacts (Mitigation Measures M-NO-1 [Noise Control Plan] and M-NO-3 [Expanded Noise Control Plan]), no feasible mitigation is available to reduce noise levels further to an acceptable nighttime level and well drilling must be continuous (see explanation in Chapter 3 Project Description, Section 3.5.3.1 [Construction Hours]).

Site 4

Construction at Site 4 would occur near single-family residences and within and adjacent to the Garden Village Elementary School playing fields. Installation of the proposed water connection pipeline would occur along Park Plaza Drive within the school athletic field, as shown in Figure 3-12. Installation of the storm drain and electrical conduit would require temporary lane closures in Park Plaza Drive and in the intersection of Park Plaza Drive and 87th Avenue. Lane closures in Park Plaza Drive would occur for approximately one week, and the intersection would require controlled traffic for an additional week. School facilities are sensitive to construction-related noise, and can be more vulnerable to safety hazards, such as increased truck traffic, proximity to construction sites (e.g., open trenches), and construction equipment.

For purposes of this analysis, it is assumed that the Project would temporarily close or alter pedestrian access to the Garden Village Elementary School from Park Plaza Drive for up to two days, but that an alternate access would remain available from Garden Lane and Village Lane.

During daytime construction of the well facility (including only a fenced enclosure without a building), which would occur over approximately three months, noise levels would also be elevated (see Section 5.7, Noise and Vibration). These impacts would be *significant* at the neighboring land uses. However, impacts on the existing character of the vicinity would be *less than significant with mitigation* (M-NO-1 [Noise Control Plan] and M-NO-3 [Expanded Noise Control Plan]), and no land uses would be substantially disrupted or displaced.

During nighttime construction associated with well drilling, residents located up to approximately 1,900 feet away from the well facility would experience significant noise impacts, which could therefore substantially disrupt the nearby residential land uses, resulting in a *significant* land use impact. Mitigation Measures M-NO-1 (Noise Control Plan) and M-NO-3 (Expanded Noise Control Plan) would reduce daytime noise impacts to less-than-significant levels; but residents within approximately 190 feet of the well facility would still experience significant nighttime noise impacts. Although the resulting noise levels would be less than significant during the daytime, they would remain loud enough to disturb the sleep of the nearby residents and could therefore disrupt these residential land uses during the period of construction (approximately seven days for well drilling). This would be a *significant and unavoidable* land use impact with mitigation, given that, although feasible mitigation is available that can reduce noise impacts (Mitigation Measures M-NO-1 [Noise Control Plan] and M-NO-3 [Expanded Noise Control Plan]), no feasible mitigation is available to reduce noise levels further to an acceptable nighttime level and well drilling must be continuous (see explanation in Chapter 3 Project Description, Section 3.5.3.1 [Construction Hours]). Because the school is closed at night, it would not experience significant impacts during nighttime construction. The Garden Village Elementary School classrooms are sufficiently far

away from the well site such that noise levels from well drilling during the daytime would not be *significant*, and therefore would not disrupt or displace the land use.

Site 5 (On-site Treatment)

Construction at Site 5 would occur adjacent to a single-family residence within a mostly commercial area. No nighttime construction would be necessary, because a test well already exists at the site. Pipeline installation, including storm drain, proposed and alternate water connections, sanitary sewer, and electrical line, would occur in B Street. Pipeline installation would require lane closures in B Street for approximately three weeks. Land use impacts of the proposed and alternate water connection pipelines would be the same. During daytime construction of the well facility and pipelines, which would occur over approximately 14 months, noise levels would be significant (for residents within approximately 340 feet of the well facility) (see Section 5.7, Noise and Vibration, for an explanation of terms and an evaluation of impacts). These noise levels could temporarily interfere with speech, which could significantly disrupt the adjacent residential land use due to their duration. Mitigation Measures M-NO-1 (Noise Control Plan) and M-NO-3 (Expanded Noise Control Plan) would reduce noise levels during the daytime; however noise impacts would still be significant for residents within approximately 110 feet of the well facility, resulting in a *significant and unavoidable* land use impact. The SFPUC would prefer to develop the GSR Project with consolidated treatment at Site 6 (refer to the Description of Sites 5, 6, and 7 in Section 3.4.3 of the Project Description), which would have the effect of avoiding the noise and related land use impact. If consolidated treatment at Site 6 is not possible, the noise (and therefore, land use) impact resulting from development of Site 5 with on-site treatment would be *significant and unavoidable* (see Section 5.7, Noise and Vibration).

Site 9

Site 9 would be located on the SFPUC-owned land adjacent to the Treasure Island Trailer Court, as shown in Figure 3-23. A Costco store and commercial uses along El Camino Real lie across the San Mateo County Flood Control Channel to the south; single- and multi-family residences and commercial uses lie across the Colma Creek Diversion Channel to the north.

Access to the proposed facility site would be along an existing San Mateo County Flood Control District (SMCFCD) access road that runs along the Colma Creek Diversion Channel adjacent to the trailers. Construction at the site could result in temporary impacts on the Treasure Island Trailer Court due to increased levels of noise, as described and analyzed under Impacts NO-1 and NO-2 in Section 5.7, Noise and Vibration. The closest trailers at the Treasure Island Trailer Court are located approximately 10 feet from proposed construction activities. At this distance, construction noise levels would be *significant*.

During daytime construction of the well facility and pipelines, which would occur over approximately 16 months, noise impacts would be significant (see Section 5.7, Noise and Vibration). Residences within approximately 340 feet of the well facility would experience significant daytime noise impacts. During nighttime construction associated with well drilling, residences located within approximately 1,900 feet of the well facility would experience significant noise impacts, which could substantially disrupt the nearby residential land use, resulting in a *significant* land use impact. Mitigation Measures M-NO-1 (Noise Control Plan) and M-NO-3 (Expanded Noise Control Plan) would reduce noise levels. Nevertheless, even with mitigation, residences within approximately 110 feet of the well facility would experience significant

daytime noise impacts at times over the course of the 16-month construction period, and residences within approximately 190 feet of the well facility would experience significant noise impacts over the seven-day well drilling period. This would be a *significant and unavoidable* land use impact with mitigation, given that, although feasible mitigation is available that can reduce noise impacts (Mitigation Measures M-NO-1 [Noise Control Plan] and M-NO-3 [Expanded Noise Control Plan]), no feasible mitigation is available to reduce noise levels further to a less-than-significant daytime or nighttime level and well drilling must be continuous (see explanation in Chapter 3 Project Description, Section 3.5.3.1 [Construction Hours]).

Site 12

Site 12 would be located west of El Camino Real on the SFPUC utility right-of-way, as shown in Figures 3-29 and 3-30. Site 12 would be located adjacent to single-family residences and adjacent to the Golden Chapel funeral home. The site would be across Southwood Drive from the Our Redeemer's Lutheran church, which also operates a daycare center. The pipeline route from Site 12 would parallel El Camino Real south along the SFPUC's Baden Valve Lot until reaching West Orange Avenue.

At Site 12, the installation of sanitary sewer, storm drain, and the proposed water connection line (to SFPUC) would require a temporary closure of portions of Southwood Drive, a portion of sidewalk along El Camino Real and portions of the funeral home parking lot. However, the remaining portions of the parking lot would remain available to business patrons during construction. Travel lane closures on Southwood Drive would have a significant impact related to safety hazards for vehicles sharing the road with construction vehicles. As described in Section 5.6, Transportation and Circulation, Mitigation Measure M-TR-1 (Traffic Control Plan) would reduce the potential impact to a less-than-significant level. A SamTrans bus stop on southbound El Camino Real near West Orange Avenue would be located within the construction area boundary of the proposed water connection pipeline for Site 12 (Alternate) (see Figure 3-29). If the alternate water connection line (to a different SFPUC transmission pipeline) were installed instead, impacts on El Camino Real and the SamTrans bus stop would be avoided. However, if the proposed water connection were constructed, the impact on the performance and safety of public transit at this location would be significant, and therefore substantially disrupt this land use, which would be a *significant* impact. However, as described in Section 5.6, Traffic and Circulation, Mitigation Measure M-TR-1 would reduce the impact of construction on the performance and safety of the southbound bus stop on El Camino Real near West Orange Avenue by requiring coordination with SamTrans and the City of South San Francisco to arrange the temporary relocation of the bus stop, as necessary. Since the resulting impact would be less than significant, it would not substantially disrupt this land use. As a result this land use impact would be *less than significant*.

During daytime construction of the well facility and pipelines, which would occur over approximately 16 months, noise levels would be significant (see Section 5.7, Noise and Vibration). The funeral home would also be exposed to significant noise impacts during the daytime. During nighttime construction associated with well drilling residents located up to 190 feet away would experience significant noise impacts, which could substantially disrupt the nearby residential land use (apartment building), resulting in a *significant* land use impact. However, Mitigation Measures M-NO-1 (Noise Control Plan) and M-NO-3 (Expanded Noise Control Plan) would reduce noise levels to less-than-significant levels at the funeral home and adjacent residences during daytime, but would remain significant at the adjacent residences

during the nighttime (within 190 feet of the well) for the period of construction (approximately seven days for well drilling). This would be a *significant and unavoidable* land use impact with mitigation, given that, although feasible mitigation is available that can reduce noise impacts (Mitigation Measures M-NO-1 [Noise Control Plan] and M-NO-3 [Expanded Noise Control Plan]), no feasible mitigation is available to reduce noise levels further to a less-than-significant nighttime level and well drilling must be continuous (see explanation in Chapter 3 Project Description, Section 3.5.3.1 [Construction Hours]).

Site 14

Site 14 would be located within the GGNC and near single-family residences, as shown in Figure 3-35 and Figure 3-35.

Well facility construction and pipeline installation at Site 14 would affect the land use at the GGNC due to increased levels of noise and reduced access to some gravesites during construction activities. Construction activities at Site 14 include installation of approximately 1,130 feet of pipeline through the cemetery within the SFPUC easement to convey water from the well at Site 14 to Sneath Lane (and then to the Site 15 treatment facility along Sneath Lane). The pipeline would cross three internal cemetery access roads, which could affect the circulation of visitors, as well as cemetery maintenance operations, through the cemetery grounds. This could be a substantial disruption of the GGNC's land use and if so, would be a *significant* land use impact. Land use impacts of the proposed water connection pipeline (to San Bruno) and the alternate water connection pipeline (to SFPUC) would be the same. However, Mitigation Measure M-LU-1 (Maintain Internal Cemetery Access) (as described above under Site 7) would reduce the land use impact relative to the existing character of the vicinity and disruption or displacement of the land use to *less than significant* by providing access to all portions of the cemetery within a reasonable time period for both visitors and maintenance.

During daytime construction of the well facility and pipelines, which would occur over approximately 16 months, noise impacts would be significant at the closest single-family residences, in that homes within 340 feet would at times experience significant noise impacts (see Section 5.7, Noise and Vibration). During nighttime construction associated with well drilling, residents located up to 1,900 feet away would experience significant noise impacts, which could substantially disrupt the nearby residential land use, resulting in a *significant* land use impact. However, Mitigation Measures M-NO-1 and M-NO-3 (Noise Control Plan and Expanded Noise Control Plan) would reduce noise impacts to during the daytime. However, residences located within approximately 110 feet of the well facility would still experience significant noise impacts over the 16-month construction period. Noise impacts experienced at residences during the nighttime would also be reduced. However, residences located within approximately 190 feet of the well facility would still experience significant nighttime noise levels during the seven-day well drilling period. The resulting noise levels would therefore remain loud enough to disrupt the residential land use. This would be a *significant and unavoidable* land use impact with mitigation, given that, although feasible mitigation is available that can reduce noise impacts (Mitigation Measures M-NO-1 [Noise Control Plan] and M-NO-3 [Expanded Noise Control Plan]), no feasible mitigation is available to reduce noise levels further to less-than-significant levels either during the daytime or nighttime and well drilling must be continuous (see explanation in Chapter 3 Project Description, Section 3.5.3.1 [Construction Hours]).

Mitigation Measure M-LU-1: Maintain Internal Cemetery Access (Site 7 [Consolidated Treatment at Site 6] and Site 14)

(See above for description.)

Site 16

Site 16 would be located on the SFPUC-owned land currently occupied by Orchard Supply Hardware and used for parking, storage, and delivery truck turnaround. To the south, Site 16 is bordered by multi-family residential land uses and a convalescent hospital is located to the southwest, as shown in Figure 3-37. If the alternate water connection (between the proposed well and El Camino Real) is selected (see Figure 3-37), the pipeline would be installed through the Orchard Supply Hardware and A&W/KFC parking lot. Installation of this alternate pipeline connection would result in limited access to approximately one-third of the existing parking lot, which is assumed for the purposes of this analysis to occur over approximately 10 days. Customers of the hardware store and fast-food restaurant would be subject to increased noise and reduced parking during construction activities, but such effects would be temporary, and individual customers would be exposed for only brief periods of time as they walk to their cars or on the sidewalk along El Camino Real. Therefore, impacts on the existing character of the vicinity would be *less than significant*.

Delivery truck access during construction of the well facility at the site could be impaired because delivery trucks access the loading dock through an area immediately adjacent to the construction area boundary. Delivery trucks may have difficulty maneuvering within the reduced turning space available during construction at the site. As proposed, the SFPUC would work with Orchard Supply Hardware, its tenant, to ensure that deliveries could continue during construction by providing a temporary means of delivering materials either through a redesigned access approach, an alternate access point, or by development of a delivery schedule when access would be made available during Project construction (see Chapter 3, Project Description, Section 3.4.3 [Facility Sites]). Therefore, impact on land use access during construction would be *less than significant*.

During daytime construction of the well facility and pipelines, which would occur over approximately 16 months, noise impacts would be significant at the multi-family residences (see Section 5.7, Noise and Vibration). During nighttime construction associated with well drilling, residents located up to approximately 1,900 feet away would experience significant daytime and nighttime noise impacts, which could substantially disrupt the nearby residential land use, which would be a *significant* land use impact. However, Mitigation Measures M-NO-1 (Noise Control Plan) and M-NO-3 (Expanded Noise Control Plan) would reduce noise levels to less-than-significant levels during daytime but at residences located within approximately 190 feet of the well facility, noise levels would remain significant during the nighttime. Since the resulting noise levels would be less than significant during the daytime, they would not alter the existing character of the vicinity or disrupt or displace land uses. However, since noise levels at night would be significant within 190 feet of the well facility, they could disrupt the nearby residential land use during the period of nighttime construction (approximately seven days for well drilling). This would be a *significant and unavoidable* land use impact with mitigation, given that, although feasible mitigation is available that can reduce noise impacts (Mitigation Measures M-NO-1 [Noise Control Plan] and M-NO-3 [Expanded Noise Control Plan]), no feasible mitigation is available to reduce noise levels

further to a less-than-significant nighttime level and well drilling must be continuous (see explanation in Chapter 3 Project Description, Section 3.5.3.1 [Construction Hours]).

Site 18 (Alternate)

Site 18 (Alternate) would be located on a vacant parcel of land in a single-family residential area, as shown in Figure 3-39. An undeveloped portion of the Alta Loma Middle School grounds is located 170 feet to the southeast of the proposed Site 18 (Alternate) construction area; the nearest school structure would be approximately 415 feet away.

During daytime construction of the well facility and pipelines, which would occur over approximately 16 months, noise impacts would be significant at the adjacent single-family residences to the southwest (residences located within approximately 340 feet of the well facility would experience significant noise impacts at times with speech; see Section 5.7, Noise and Vibration).

Construction of the alternate water connection pipeline (to Cal Water) would require temporary closure of Alta Loma Drive for approximately two days, whereas the proposed water connection pipeline (to the SFPUC) would not result in lane closures. As described in Section 5.6, Transportation and Circulation, under Impacts TR-1 and TR-3, the travel lane closure on Alta Loma Drive would result in a temporary reduction in roadway capacity, but because the roadway would continue to operate satisfactorily during construction, the impact would be less than significant. Construction would also require a temporary closure (up to two days) of an approximately 25-foot stretch of sidewalk along the eastbound lane of Alta Loma Drive (see Figure 3-39). The potential impact would be less than significant, given that any such impact would be short-term and because the sidewalk along the westbound lane of Alta Loma Drive would remain open for pedestrian access around the construction zone. As described in Section 5.6, Transportation and Circulation, under Impact TR-2, the temporary closure also could result in increase in traffic safety hazards for vehicles sharing the road with construction vehicles. However, Mitigation Measure M-TR-1 (Traffic Control Plan) would reduce the potential impact of increased traffic safety hazards resulting from travel lane closures on Alta Loma Drive to a less-than-significant level. Because the impacts from the temporary closure of Alta Loma Drive would be less than significant with implementation of Mitigation Measure M-TR-1, the closure would not substantially disrupt adjacent land uses or affect the existing character of the vicinity. Therefore, this impact would be *less than significant*.

During nighttime construction associated with well drilling, residents located up to approximately 1,900 feet away would experience significant noise impacts, which could substantially disrupt the nearby residential land use, resulting in a *significant* land use impact. However, although Mitigation Measures M-NO-1 (Noise Control Plan) and M-NO-3 (Expanded Noise Control Plan) would reduce noise levels during the daytime, residences located within approximately 110 feet of the well facility would still experience significant daytime noise impacts at times over the course of the 16-month construction period, and during the nighttime, residences located within approximately 190 feet of the well facility would still experience significant nighttime noise impacts during the seven-day well drilling period. This would result in a *significant and unavoidable* land use impact with mitigation, given that, although feasible mitigation is available that can reduce noise impacts (Mitigation Measures M-NO-1 [Noise Control Plan] and M-NO-3 [Expanded Noise Control Plan]), no feasible mitigation is available to reduce noise levels

further to a less-than-significant daytime or nighttime level and well drilling must be continuous (see explanation in Chapter 3 Project Description, Section 3.5.3.1 [Construction Hours]).

Site 19 (Alternate)

Site 19 (Alternate) would be located west of El Camino Real on the SFPUC utility right-of-way, as shown in Figure 3-40. Site 19 (Alternate) would be located adjacent to single-family residences; a church, which also operates a daycare center; and across Southwood Drive from a funeral home.

At Site 19 (Alternate), the installation of storm drain and the alternate water connection line (to SFPUC) would require a temporary closure of Southwood Drive, whereas the proposed water connection pipeline (to a different SFPUC pipeline) would require temporary closure of portions of the funeral home parking lot. However, the remaining portions of the parking lot would remain available to business patrons during construction. Because construction-related access impacts would be temporary and because land uses would remain accessible during construction, the impacts on the existing character of the vicinity would be *less than significant*, and these land uses would not be displaced or significantly disrupted.

During daytime construction of the well facility (involving a fenced enclosure without a building) and pipelines, which would occur over approximately three months, noise impacts would be significant at the church and pre-school (see Section 5.7, Noise and Vibration). During nighttime construction associated with well drilling, residences located up to approximately 1,900 feet away would experience significant nighttime noise impacts, and the closest residences would experience significant daytime and nighttime noise impacts, which could substantially disrupt the nearby residential land use, resulting in a *significant* land use impact. However, Mitigation Measures M-NO-1 (Noise Control Plan) and M-NO-3 (Expanded Noise Control Plan) would reduce noise levels to less-than-significant levels at the church and pre-school during daytime. Nevertheless, at residences located within approximately 190 feet of the well facility, nighttime noise levels would remain significant during the approximately seven days required for well drilling. This would be a *significant and unavoidable* land use impact with mitigation, given that, although feasible mitigation is available that can reduce noise impacts (Mitigation Measures M-NO-1 [Noise Control Plan] and M-NO-3 [Expanded Noise Control Plan]), no feasible mitigation is available to reduce noise levels further to a less-than-significant nighttime level and well drilling must be continuous (see explanation in Chapter 3 Project Description, Section 3.5.3.1 [Construction Hours]).

Impact Conclusion: Significant and Unavoidable with Mitigation

5.2.3.5 Operation Impacts and Mitigation Measures

Impact LU-2: Project operations would result in substantial long-term or permanent impacts on the existing character or disrupt or displace land uses. (Less than Significant with Mitigation)

The following evaluation of impacts discusses sites with less-than-significant impacts first, followed by sites with significant impacts.

Sites 2, 3, 4, 5 (Consolidated Treatment at Site 6), 6, 7, 8, 10, 11, 12, 13, 14, 15, 16, 17 (Alternate), and 19 (Alternate)

As described in Section 5.2.3.2 (Approach to Analysis), permanent displacement or long-term disruption of existing land uses would occur if the Project were to permanently displace existing land uses or permanently disrupt existing land uses or activities. The well facilities at Sites 2, 5 (Consolidated Treatment at Site 6), 6, 7, 8, 10, 12, and 19 (Alternate) would be located within the SFPUC's utility right-of-way. Well facilities at Sites 11 and 13 would be located on land owned by the SFPUC. Therefore, no existing land uses would be displaced or disrupted as a result of construction of the Project at these sites. In addition, operation and maintenance of groundwater well facilities at these locations would be consistent with the intended use of this land, given that these facilities would be located within the SFPUC's existing right-of-way or fee-owned lands, or within an existing public utility building. In addition, noise from operation of these well facilities would not be significant (see Section 5.7, Noise and Vibration, for further analysis). As a result, potential land use impacts on the existing character of the vicinity and/or displacement of existing land uses would be *less than significant*.

Operation and maintenance of the well facilities at Sites 3, 4, and 17 (Alternate) would be located within educational, undeveloped, and commercial land uses, respectively. Development of the well facilities would displace a small portion of these existing land uses. However, the well facilities at Sites 3 and 4 would be small³ and would not be incompatible or conflict with established land uses, given that these facilities would be located within undeveloped or open landscaped areas and, because of their limited size and the passive unobtrusive nature of their operation, they would not require changes to the existing land uses. At Site 17 (Alternate), the existing commercial use's side yard (approximately 4,000 square feet), which appears to be used for storage, would be converted to a public facility use for the well facility building. This loss would reduce the size of the commercial land use in the area, but the parcel would continue to meet requirements for the Commercial zoning designation for setbacks, floor area ratio, and parking (Colma 2012). As a result, operation and maintenance of the well facilities at Sites 3, 4, and 17 (Alternate) would not have a substantial impact on the existing character of the Project vicinity. Residential, commercial, recreational, educational, and other existing land uses in the vicinity of these sites would continue without alteration or interference. Also, the buried pipelines associated with these sites would not interfere with ongoing use of the area, nor would they have a substantial impact on the existing character of the Project vicinity. In addition, noise from operation of these well facilities would not be significant (see Section 5.7 Noise and Vibration, for further analysis). Therefore, potential impacts on land use resulting from operation and maintenance of the well facilities at Sites 3, 4, and 17 (Alternate) would be *less than significant*.

Site 14 would be located at the northern boundary of the GGNC, approximately 80 feet from the cemetery boundary, within the SFPUC easement, which does not include grave sites. Existing roads and paths owned and maintained by GGNC would be used to access the site for operations and maintenance of the well. The well station would be visited daily, at times, during dry years for routine equipment inspections, lasting approximately 30 minutes each (see Chapter 3 Project Description, Section 3.8.3 [Maintenance]). An existing well house and tank facility adjacent to the site may be demolished, which, if

so, could contribute to the existing land use character at this location in that additional open lawn area would be created as a result. Although the well facility building at Site 14 would be visible from surrounding gravesites, the overall character of the area would not change and the cemetery land use would, therefore, not be disrupted or displaced. In addition, noise from operation of the well facility would not be significant (see Section 5.7, Noise and Vibration, for further analysis). Therefore, the land use impact from operations at Site 14 would be *less than significant*.

Site 15 would be situated immediately adjacent to the GGNC maintenance building along Sneath Lane. Access roads for operations and maintenance of the well would be provided by existing roads and paths owned and maintained by GGNC. The well facility located adjacent to the GGNC maintenance building would not alter the use or change the character of the maintenance building because access to the maintenance building would remain unchanged, and the well facility design would be similar in character to the maintenance building as described in Chapter 3, Project Description. Also, noise from operation of the well facility would not be significant (see Section 5.7, Noise and Vibration, for further analysis). As a result, well facility siting, operation, and maintenance would not change the cemetery land use, surrounding land uses near Site 15, or the existing character of the Project vicinity, since access would not be impeded, and no cemetery components would be disrupted or displaced. Therefore, the land use impact from operations at Site 15 would be *less than significant*.

Site 16 would be located within the SFPUC's utility right-of-way. Therefore, no existing land uses would be displaced or disrupted as a result of construction of the Project at this site. In addition, operation and maintenance of groundwater well facilities at this location would be consistent with the intended use of this land, given that this facility would be located within the SFPUC's existing right-of-way. In addition, noise from operation of this well facility would not be significant (see Section 5.7, Noise and Vibration, for further analysis). As a result, potential land use impacts on the existing character of the vicinity would be *less than significant*.

The location of the well facility behind the loading dock of the adjacent commercial use would have the potential to impair delivery truck access during ongoing operation of the Project. Delivery trucks may have difficulty maneuvering within the reduced turning space available, and the limited turning space could affect deliveries for the Orchard Supply Hardware. However, the SFPUC would work with Orchard Supply Hardware, its tenant, to ensure that for deliveries would be maintained (see Chapter 3, Project Description, Section 3.4.3 [Facility Sites]). Several options are available for modified access within the site leased by Orchard Supply Hardware, including reorientation of the loading area, reconfiguration of the area northwest of the well site to allow trucks to use this area for maneuvering, or temporarily roping off a portion of the parking lot as needed to provide delivery trucks with the space necessary to maneuver and deliver supplies. Therefore, the impact on land use access during operation would be *less than significant*.

Impact Conclusion: Less than Significant

³ Sites 3 and 4 would have fenced enclosures sized at 18 feet by 34 feet, or about 600 square feet.

Sites 1, 5 (On-site Treatment), 9, 18 (Alternate), and the Westlake Pump Station

The well facility at Site 5 (On-site Treatment) would be located within the SFPUC's utility right-of-way. The well facility at Site 9 would be located on land owned by the SFPUC. No existing land uses would be displaced or disrupted as a result of construction of the Project at these sites. In addition, operation and maintenance of groundwater well facilities at these locations would be consistent with the intended use of this land, given that these facilities would be located within the SFPUC's existing right-of-way or fee-owned lands.

Operation and maintenance of the well facilities at the Westlake Pump Station would not be incompatible or conflict with established land uses, given that these facilities would be sited within an existing municipal corporation yard. Also, the buried pipelines associated with these sites would not interfere with ongoing use of the area, nor would they have a substantial impact on the existing character of the Project vicinity.

Operation and maintenance of the well facilities at Site 1 would permanently remove a small portion of the golf club property from any future recreational use. Operation and maintenance of the well facilities at Site 18 (Alternate) would permanently remove a small portion of an undeveloped parcel of land from any future residential development. Although the well facilities at both of these sites would permanently displace a small area of an existing recreational use (Site 1) and a small area of land zoned for residential land use (Site 18), because of the limited size of the facilities, the loss of existing land uses and the land use character would be minimal. Existing recreational and residential uses in the vicinity of these sites would continue without substantial alteration. Therefore, the impact on land use from well facilities at Sites 1 and 18 (Alternate) would be *less than significant*.

Because the pipelines associated with the well facilities at all of these sites would be underground, they would not interfere with ongoing use of the areas, nor would they have a substantial impact on the existing character of the Project vicinity.

Operation of the well facilities at these sites would generate nighttime noise levels that could be significant at nearby residences (see Section 5.7, Noise and Vibration). In addition, up to three pumps would be added to the Westlake Pump Station; the size of these pumps is not known at this time and, therefore, this analysis assumes that nighttime operational noise could be significant. Long-term nighttime noise impacts would be a *significant* land use impact. However, Mitigation Measure M-NO-5 (Operational Noise Control Measures) would reduce noise levels to less-than-significant levels. The resulting noise levels would not be significant, and, therefore, the impact on the character of the vicinity would be *less than significant*, and the land use would not be substantially disrupted or displaced.

Impact Conclusion: Less than Significant with Mitigation

5.2.4 Cumulative Impacts and Mitigation Measures

Impact C-LU-1: Construction and operation of the proposed Project could result in a cumulatively considerable contribution to cumulative impacts related to land use. (Significant and Unavoidable with Mitigation)

The geographic scope for the analysis of cumulative impacts on land use consists of each proposed GSR facility site and the immediate vicinity around each of these sites where adverse land use impacts could occur.

Alter the character of the vicinity or disrupt or displace a land use during construction

Construction of most of the cumulative projects listed in Table 5.1-3 (Projects Considered for Cumulative Impacts) would result in construction-related traffic safety hazards, noise, dust, and equipment exhaust in the vicinity of the proposed GSR Project sites. The cumulative projects identified in Table 5.1-3 are typical construction projects that can be assumed to occasionally occur within the cumulative study area on an ongoing basis; some are public works improvement projects, some are replacement of aging water and transportation infrastructure, and some are housing and commercial development projects. Potential cumulative impacts associated with construction period noise could occur at Sites 8, 12, 17 and 19, which overlap with the Peninsula Pipeline Seismic Upgrade Project; at Sites 11, 12, and 19, which overlap or are adjacent to the PG&E Transmission Pipeline Replacement Project (cumulative project H); at Site 11, which is close to the Cal Water Well Replacement SSF1-25 Project (cumulative project G); and at Site 9, which is close to the Mission & McLellan Project (cumulative project F). Land use disruption at Sites 9, 12, and 19 is considered a *significant and unavoidable impact* of the GSR Project because of nighttime construction noise. No nighttime construction is needed at Site 8 because the well has already been drilled at that location, and nighttime noise impacts are less than significant with mitigation at Sites 11 and 17.

Although construction of these projects could overlap with construction of the proposed GSR Project, cumulative impacts related to the existing character of the vicinity would be *less than significant*. Nighttime construction would occur in the same vicinity for both GSR Site 11 and the Cal Water Well Replacement SSF1-25 Project, but with mitigation the GSR Project's contribution to cumulative land use impacts would be *less than significant*. None of the other cumulative projects would require nighttime construction near a GSR Project facility site. Daytime construction noise is less than significant at Sites 8 and 17, and can be reduced to less than significant with mitigation at Sites 11 and 19. As with the proposed Project, the daytime construction activities associated with cumulative projects would be temporary and are not expected to rise to levels that would disrupt land use because the types of construction equipment and vehicles would be similar to those used for typical construction projects throughout the study area. Sites 9, 12, and 19 would result in significant disruptions to land use due to *unavoidable significant* impacts from daytime construction noise. Mitigation Measures M-NO-1 and M-NO-3 would reduce construction noise impacts, but the impact would remain significant at those sites. Combined with impacts of construction of cumulative projects at these sites, the GSR could result in cumulatively considerable contribution to a cumulative land use impact related to the existing character of the vicinity (*significant and unavoidable*).

Alter the character of the vicinity or disrupt or displace a land use during operation

Most of the cumulative projects listed in Table 5.1-3 (Projects Considered for Cumulative Impacts) would be typical of the land uses in the cumulative study area and would have no long-term or permanent effect on the character of the vicinity given their nature. However, two of the cumulative projects, the Mission & McLellan Project (cumulative project F) and the Centennial Village Project (cumulative project I), are infill projects that would at least partially redevelop existing land dedicated to housing or commercial land uses; even so, these would not substantially change the character of the land uses in the vicinity because the two mixed-use projects would be located in an area of commercial and residential land uses.

After construction is complete, the proposed GSR Project would be a passive and unobtrusive land use located on appropriate sites for such public facilities. Therefore, cumulative impacts related to the existing character of the vicinity would be *less than significant*.

Operation of the proposed GSR facilities would also generate sufficient noise such that sleep may be significantly disrupted at nearby residences. These project-specific impacts would occur at GSR Sites 1, 5 (On-site Treatment), 9, 18 (Alternate), and the Westlake Pump Station. However, these impacts would be less-than-significant with implementation of Mitigation Measures M-NO-5 (Operational Noise Control Measures) (see Section 5.7, Noise and Vibration, for the full text of the mitigation measures and an explanation of their effectiveness). The cumulative projects that may also generate incremental additions to the noise environment from operations are: The San Francisco Groundwater Supply Project wells (cumulative projects A1 to A6), the Daly City "A" Street Well Replacement (cumulative project C), the Mission & McLellan Project (cumulative project F), the Cal Water Well Replacement SSF1-25 (cumulative project G), and the Centennial Village Project (cumulative project I). None of these cumulative projects is close enough to the GSR Project facility sites to create cumulative noise impacts. Therefore, cumulative impacts related to disturbance or disruption of land uses would be *less than significant*.

5.2.5 References

Colma, Town of. 2012. *Colma Municipal Code Chapter Five: Planning, Zoning, Use, and Development of Land and Improvements, Subchapter 5.03: Zoning, Section 5.03.290: Restrictions Applicable to "C" Zone*. October.

5.3 AESTHETICS

This section addresses the potential aesthetic and visual quality impacts associated with implementation of the proposed Project. Aesthetic resources, also referred to as visual resources, are defined as the visible natural and built landscape features that surround a given area. This section describes the existing visual setting in the vicinity of each proposed facility site and evaluates the potential effects of the Project on visual resources.

5.3.1 Setting

The discussion below defines the terms used in the aesthetics evaluation. For the purpose of this aesthetics evaluation, the visual study area includes the Project construction areas and the surrounding vicinity from which views could be affected.

5.3.1.1 *Concepts and Terminology*

Visual or aesthetic resources are generally defined as both the natural and built features of the landscape that contribute to the public's experience and appreciation of the environment. Depending on the extent to which a project's presence would alter the visual character and quality of the environment, a visual or aesthetic impact may occur. Familiarity with the following terms and concepts will aid the reader in understanding the content of this chapter.

Visual character, visual quality and visual sensitivity are the terms used throughout the analysis, and are defined below.

Visual Character

Visual character is a general description of the visual attributes of a particular land use setting and the unique set of landscape features. The purpose of defining the visual character of an area is to provide the context within which the visual quality of a particular site or locale is most likely to be perceived by the viewing public. For urban areas, visual character is typically described on the neighborhood level or in terms of areas with common land use; intensity of development; socioeconomic conditions; and/or landscaping and urban design features. For natural and open space settings, visual character is most commonly described in terms of areas with common landscape attributes (such as landform, vegetation, water features).

Visual Quality

Visual quality is defined as the overall visual impression or attractiveness of a site or locale as determined by its aesthetic qualities (such as color, variety, vividness, coherence, uniqueness, harmony, and pattern). Natural and built features combine to form perspectives with varying degrees of visual quality, which is rated in this analysis as low, moderate, and high, as follows:

- **Low.** The location is lacking in natural or cultural visual resource amenities typical of the region. A site with low visual quality will have aesthetic elements that are relatively unappealing and perceptibly uncharacteristic of the surrounding area.
- **Moderate.** The location is typical or characteristic of the region's natural or cultural visual amenities. A site with moderate visual quality maintains the visual character of the surrounding area, with aesthetic elements that do not stand out as either contributing to or detracting from the visual character of an area.
- **High.** The location has visual resources that are unique or exemplary of the region's natural or cultural scenic amenities. A site with high visual quality is likely to stand out as particularly appealing and makes a notable positive contribution to the visual character of an area.

Affected Viewers and Exposure Conditions

Affected viewers and exposure conditions address the variables that affect viewers and their visual exposure to the well facility sites. The identification of *viewer types* and *volumes* describes the type and quantity of potentially affected viewers within the visual study area. Land uses that derive value from the quality of their settings are considered potentially sensitive to changes in visual conditions. *Sensitive viewers* are those who have a strong stake or interest in the quality of the landscape and have a greater level of concern towards changes that degrade or detract from the visual character of an area. Examples of viewers with elevated concern for visual quality include travelers on designated scenic routes, park visitors and other recreationists, bikers, pedestrians, and tourists. Cemetery visitors are included in this category for purposes of this study.

Viewer exposure considers some or all of the following factors: landscape visibility (the ability to see the landscape); viewing distance (the proximity of viewers to the facility sites); viewing angle (whether the facility sites would be viewed from a superior, inferior, or level line of sight); extent of visibility (whether the line of sight is open and panoramic to the facility sites or restricted by terrain, vegetation, and/or structures); and duration of view.

Visual Sensitivity

Visual sensitivity is the overall measure of a site's susceptibility to adverse visual changes. Visual sensitivity is rated as high, moderate, or low and is determined based on the combined factors of visual quality, viewer types and volumes, and visual exposure to the proposed Project as described above. A setting's overall visual sensitivity is the measure of its susceptibility to significant visual impacts as a result of project-caused visual change. Thus, significant adverse impacts are typically unlikely in a setting with low overall sensitivity.

Visual Study Area

The visual study area (viewshed)¹ for each facility site is that from which either well facilities or pipeline construction activities would be visible to the public. Because the proposed facility sites are located in both urban and heavily vegetated open space settings, trees, shrubs, and buildings quickly restrict or block views of facilities as viewers move away from facility sites; consequently, these elements limit the visual study area in most places to publicly accessible locations immediately surrounding proposed facility sites. In some locations, however, favorable topographic relationships or the lack of intervening features extends the distance from which a viewer would be able to observe features of the proposed sites. Further, proposed Project construction activities may remove existing visual screening, particularly trees and other vegetation, extending the area of potential visibility. Because the exact boundaries of the visual study area depend on site conditions (i.e., viewshed, structures, and vegetation), performing an assessment of the visual study area is important in identifying potentially affected viewers and describing the visual quality and character of relevant locations.

Field reconnaissance for the proposed Project was conducted in February 2010, April/May 2011 and March 2012. Observations of the proposed well facility sites and pipeline locations, including the proposed pipeline route and connection and the alternate connection, were performed to identify the visual study area and take representative photographs of existing visual conditions. Photographs are included in this section to document the existing visual conditions of the facility sites and adjacent areas at the time of the 2011 and 2012 field observations. Figures 5.3-1 through 5.3-10 depict views of facility sites and surrounding locations.

5.3.1.2 *Visual Character of the Project Area*

The proposed Project would be located in the northern portion of the San Francisco Peninsula. The 20 possible locations where Project facilities could be sited are located from Daly City to Millbrae, with the Coast Range foothills to the southwest, San Bruno Mountain to the north, and flat lands extending to San Francisco Bay to the east. Each of the proposed well facility sites would be situated within developed portions of the Peninsula, surrounded by man-made features. The Project area is characterized by developed urban/suburban areas, including portions of the urban cores of Daly City, Colma, South San Francisco, San Bruno, and Millbrae. The topography of the Project area is relatively flat, with a few moderate hills. Open spaces in the Project area are suburban in nature, including golf courses, cemeteries, and pedestrian pathways along channelized creeks. Vegetation is generally ornamental and non-native, with mature trees present in some areas.

The following provides a description of the areas where well facilities would be located, including a general description of the locations within the City of Daly City, Broadmoor Village in unincorporated

¹ A viewshed is an area of land, water, or other urban or environmental element that is visible to the human eye from a fixed vantage point.

San Mateo County, the Town of Colma, the City of South San Francisco, the City of San Bruno, and the City of Millbrae.

City of Daly City

Sites 1, 2, and the Westlake Pump Station would be located in the Westlake Neighborhood. Westlake was developed in the late 1940s and early 1950s as a central shopping mall surrounded by single-family and multi-family residences on rolling topography. The single-family residences are primarily one or two stories with the primary living space over a single-car garage. Exterior construction materials and colors tend to be of masonry stucco and finished in pastel shades. This subdivision is one of the first master planned post-WWII suburbs and was known for its appearance of neat rows of homes along the residential streets in the area. The shopping mall forms the core of the neighborhood, with the Westlake Village Apartment complex adjacent to the south, east and west. Different parts of this large apartment complex are within sight of Sites 1, 2, and the Westlake Pump Station. Site 2 also borders on the Broadmoor Village neighborhood, discussed below.

Sites 5 and 6 would be located at the southern end of "Original Daly City" in an area known as the Bay Area Rapid Transit (BART) neighborhood or the Colma neighborhood. This area is mixed commercial, with Junipero Serra Boulevard providing a hard or defined visual boundary on the west. The BART tracks to the east and the cemeteries of Colma to the south also provide hard visual boundaries completing the triangular layout of this neighborhood. Approximately half of the area of this neighborhood is comprised of either parking lots or auto dealer show lot.

Broadmoor Village, Unincorporated San Mateo County

Sites 3 and 4 would be located in Broadmoor Village. The residential neighborhood of Broadmoor Village is within an unincorporated area of San Mateo County surrounded by the Daly City and adjacent to the south of the Westlake Neighborhood. Developed on sloped terrain, Broadmoor contains one-story bungalows with occasional larger two-story structures. Exterior construction materials and colors tend to be of masonry stucco and finished in pastel shades. While some stands of mature trees exist, generally the presence of vegetation is limited to lawns and other similar types of ornamental landscaping. The southern part of the Westlake Village Apartment complex forms a visual boundary between Broadmoor and the Westlake Neighborhood. The south-facing apartments are visible from Sites 3 and 4.

Town of Colma

Sites 7, 8, and 17 (Alternate) would be located within the Town of Colma. Colma is a community dominated by cemeteries surrounding a commercial core. San Bruno Mountain provides a natural visual backdrop to the town from the surrounding areas. Most of the land east of El Camino Real is committed to cemetery use or agricultural fields (e.g., flower growing plots, greenhouses). These uses lead up to the foot of San Bruno Mountain and impart a rural atmosphere. Land west of El Camino Real is oriented more towards commercial uses, although Colma's regionally oriented commercial core is bracketed on the north and south by cemeteries. The aesthetic component of the community's character is largely a function of the cemeteries and associated open space and landscaping. Well-

groomed lawns, rolling hills, manicured landscaping and natural vegetation, quiet scenic areas for meditation, and tranquil paths for strolling are common and essential features of Colma's memorial park uses.

City of South San Francisco

Sites 9, 10, 11, 12, 13, 18 (Alternate), and 19 (Alternate) would be located in South San Francisco. South San Francisco occupies a broad valley formed by San Bruno Mountain on the north and the Coast Range on the west. Most of the valley faces adjacent San Francisco Bay to the east and south, affording sweeping vistas from higher levels and a definite sense of identification with the Bay. The hills to the west shield the city from much of the fog that prevails in neighboring areas (South San Francisco 2012). The facility sites essentially parallel El Camino Real through the heart of the city. This corridor through the city is primarily commercial in appearance, with interspersed residences.

City of San Bruno

Sites 14 and 15 would be located in San Bruno within the Golden Gate National Cemetery (GGNC), a military cemetery bordered by single-family neighborhoods on the north, retail on the east and south and I-280 on the west. An auxiliary entrance to the cemetery is midway along its southern border off Sneath Lane where the cemetery's maintenance buildings are located. Site 14 would be located within the interior of the cemetery and Site 15 would be located adjacent to a GGNC maintenance building along Sneath Lane.

City of Millbrae

Site 16 is located in the east-central portion of Millbrae between El Camino Real and U.S. Highway 101 (U.S. 101) near San Francisco International Airport. The general area has a highway commercial appearance, with residential neighborhoods off of El Camino Real. In addition to El Camino Real, U.S. 101 and the Airport, this area is traversed by the Caltrain commuter rail line and Interstate 380 (I-380).

The visual characteristics and features of the facility locations are described below by jurisdiction and by facility site.

Overall Visual Sensitivity

The overall visual sensitivity of each facility site is described in terms of its visual quality, potentially affected viewers and exposure conditions. Table 5.3-1 (Summary of Visual Sensitivity Findings) summarizes these attributes, which are described in more detail in the remainder of this section. This section refers frequently to the site layout graphics included as Figures 3-11 through 3-40 in Chapter 3, Project Description.

TABLE 5.3-1
Summary of Visual Sensitivity Findings

Facility Site	Visual Quality	Affected Viewers and Exposure Conditions	Overall Visual Sensitivity
Site 1 Lake Merced Golf Club (see Figure 5.3-1) (see Figure 3-11)	Moderate	Partially visible to moderate numbers of golfers from golf links that would be roughly 50 feet away; not visible from I-280 due to tree line and speed of travel. Limited views from some neighboring residences. Site would be upslope from adjoining links; golfers would have an obstructed view of the site due to the angle of the slope and intervening vegetation (the site currently includes an existing restroom structure). Visual exposure is thus low. Viewer concern for visual quality would be moderate (golfers).	Moderately Low
Site 2 Park Plaza Meter (see Figure 5.3-1) (see Figure 3-12)	Moderate	Moderate exposure to numerous viewer groups, including relatively high numbers of motorists on Park Plaza Drive (brief), pedestrians, including students going to and from Garden Village and Ben Franklin schools, some residences, and athletic field users (periodic) who may be exposed for longer periods. Viewer concern of these affected groups would be moderate.	Moderate
Site 3 Ben Franklin Intermediate School (see Figure 5.3-4) (see Figure 3-12)	Moderate	Moderate exposure to Park Plaza Drive across an open athletic field. Exposed to athletic field users (periodic) at very close distance. Limited visual exposure to nearby residences. Viewer concern of these affected groups would be moderate.	Moderate

TABLE 5.3-1
Summary of Visual Sensitivity Findings

Facility Site	Visual Quality	Affected Viewers and Exposure Conditions	Overall Visual Sensitivity
Site 4 Garden Village Elementary School (Figure 5.3-4) (Figure 3-12)	Moderately High	Moderately high exposure to numerous viewer groups, including motorists along Park Plaza Drive (brief), pedestrians including students going to and from school, some nearby residences (limited), and playing field (periodic, distant) users who may be exposed for longer periods. Partial screening by existing trees, fencing. However, these trees would be removed during construction of the Project increasing exposure. Viewer concern of these affected groups would be moderately high.	Moderately High
Westlake Pump Station (Figure 5.3-2) (Figure 3-13)	Low	Minimal exposure. All Project components would be within the confines of the existing pump station.	Low
Site 5 Right-of-Way at Serra Bowl (Figure 5.3-2) (Figure 3-15, Figure 3-19)	Low	Moderately exposed to passing motorists on Junipero Serra Boulevard, B Street, and Hill Street (brief), pedestrians (brief), commercial service patrons (periodic), and to one residence. Viewer concern of these affected groups would be moderate.	Moderately Low
Site 6 Right-of-Way at Colma BART (Figure 5.3-3) (Figure 3-16, Figure 3-20)	Low	Highly exposed to passing motorists on D Street (brief), pedestrians (brief), and BART commuters (brief). Minimal exposure from Woodlawn Memorial Park because the cemetery is located beyond view of the proposed site. Viewer concern of these affected groups would be low.	Low

TABLE 5.3-1
Summary of Visual Sensitivity Findings

Facility Site	Visual Quality	Affected Viewers and Exposure Conditions	Overall Visual Sensitivity
Site 7 Right-of-Way at Colma Boulevard (Figure 5.3-3) (Figure 3-17, Figure 3-21)	Moderately Low	<p>Facility Site: Moderate exposure to passing motorists (brief), pedestrians (brief), and Woodlawn and Greenlawn Memorial Park visitors (periodic). Cemetery visitors at Woodlawn Memorial Park, located north of the facility site, would have limited views of the facility site because topography partially limits views downslope to the site. Cemetery visitors at Greenlawn Memorial Park, located south of the facility site, would have unobstructed views of the facility site.</p> <p>Pipeline Route: highly exposed to Woodlawn Memorial Park visitors (brief and infrequent).</p> <p>Viewer concern would be moderately high (periodic cemetery visitors).</p>	Moderately High
Site 8 Right-of-Way at Serramonte Boulevard (Figure 5.3-8) (Figure 3-22)	Moderately Low	<p>Minimal exposure. Exposed only to motorists on Serramonte Blvd (brief), pedestrians (brief), and employees/patrons at surrounding businesses (periodic, random).</p> <p>Viewer concern of these affected groups would be low.</p>	Low
Site 9 Treasure Island Trailer Court (Figure 5.3-5) (Figure 3-23, Figure 3-24)	Low	<p>Minimal exposure. Isolated location. Exposed to bicyclists and pedestrians (brief) and upper floor residences located south of the facility site. Exposed to trailer court residences to the north.</p> <p>Viewer concern of these affected groups would be low.</p>	Low
Site 10 Right-of-Way at Hickey Boulevard (Figure 5.3-6) (Figure 3-25)	Moderately Low	<p>High exposure to motorists along Hickey Blvd and Camaritas Ave., pedestrians (few), and employees/patrons at neighboring businesses (periodic, random). Views from nearby residences (limited) mostly screened by existing vegetation.</p> <p>Moderate viewer sensitivity/concern.</p>	Moderate

TABLE 5.3-1
Summary of Visual Sensitivity Findings

Facility Site	Visual Quality	Affected Viewers and Exposure Conditions	Overall Visual Sensitivity
Site 11 South San Francisco Main Area (Figure 5.3-6) (Figure 3-27, Figure 3-28)	Low	Facility site is minimally exposed to views from El Camino Real due to terrain and existing intervening trees and the BART structure. Moderately exposed to Centennial Way Trail users (brief) adjacent to a transit-service facility. Trees on El Camino are highly exposed to motorists and would be removed. Viewer concern of trail users and El Camino Real motorists is moderate.	Moderately Low
Site 12 Garden Chapel Funeral Home (Figure 5.3-7) (Figure 3-29, Figure 3-30)	Moderate	Highly exposed to high numbers of passing motorists along El Camino Real and Southwood Drive (brief); pedestrians (brief), and funeral home employees/visitors (periodic). Views from nearby residences highly filtered by existing backyard fences, landscaping. Overall exposure moderate (El Camino). Viewer concern is moderate.	Moderately High
Site 13 South San Francisco Linear Park (Figure 5.3-7) (Figure 3-31, Figure 3-32)	Moderate	Highly exposed to motorists on South Spruce Ave. (brief), pedestrians (brief), some residences, employees/patrons of adjacent businesses (periodic), and Centennial Way Trail users (periodic). Overall high exposure, due to adjacency of the trail. High viewer sensitivity/concern (trail users).	Moderately High
Site 14 Golden Gate National Cemetery (Figure 5.3-9) (Figure 3-34, Figure 3-35)	High	Highly exposed to GGNC cemetery visitors (brief and infrequent). Viewer concern high (GGNC).	High
Site 15 Golden Gate National Cemetery (Figure 5.3-9) (Figure 3-34, Figure 3-36)	Moderately High	Moderately high exposure to motorists along Sneath Lane (brief), pedestrians (brief), employees/patrons of adjacent businesses and V.A. Medical Clinic (periodic), and cemetery visitors (infrequent) users from limited vantage points. Viewer concern moderately high (GGNC).	Moderately High

TABLE 5.3-1
Summary of Visual Sensitivity Findings

Facility Site	Visual Quality	Affected Viewers and Exposure Conditions	Overall Visual Sensitivity
Site 16 Millbrae Corporation Yard (Figure 5.3-10) (Figure 3-37)	Low	Visually inaccessible to the public, except for brief views from adjacent portion of Monterey Street. Exposure is minimal due to the isolated location. Exposed only to employees/patrons of adjacent business (periodic) and a small number of adjacent upper floor residences. Viewer concern of these affected groups would be low.	Low
Site 17 (Alternate) Standard Plumbing Supply (Figure 5.3-10) (Figure 3-38)	Moderate	Moderate exposure to relatively low numbers of motorists on Collins Avenue (brief), few pedestrians (brief), and employees/patrons at Standard Plumbing Supply (periodic, random). Overall exposure is low. Viewer concern would be low (commercial/industrial area).	Low
Site 18 (Alternate) Alta Loma Drive (Figure 5.3-8) (Figure 3-39)	Moderate	Highly exposed to neighboring residential areas/streets and transit stops (brief, periodic). Minimally exposed from Alta Loma Middle School (distant, well-screened). Moderately high viewer sensitivity/concern (neighborhood).	Moderately High
Site 19 (Alternate) Garden Chapel Funeral Home (Figure 5.3-8) (Figure 3-40)	Moderate	Moderately exposed to passing motorists on Southwood Drive (brief) and funeral home employees/visitors (periodic). Views from nearby residences highly filtered by existing backyard fences, landscaping. Overall exposure moderate (El Camino Real). Viewer concern moderate.	Moderate

5.3.1.3 Individual Project Well Facility Sites

Daly City - Sites 1, 2, 5, 6, and the Westlake Pump Station

Site 1

Figure 5.3-1 (Views of Sites 1 and 2) shows the existing views of the site. Figure 3-11 (Site 1 Lake Merced Golf Club) in Chapter 3, Project Description shows the layout of the proposed facility site.

Visual Quality

Site 1, as well as its proposed and alternate water lines, storm drain, and sanitary sewer connections, would be located in the northeastern corner of the Lake Merced Golf Club, a privately owned and operated golf club. The site would be approximately 50 feet away from the fairways, not in direct line of view from these fairways, and lined by mature trees on the east, which partially obscure the view of I-280 to the east. The ground at this site is mostly bare. A restroom facility of concrete block construction is situated in the southern part of the site. At the time of the site visit, piles of vegetative waste were being stored on the site. While the visual quality of the site itself is low, visual quality of the setting for potentially sensitive viewers looking from within the golf club is moderate.

Affected Viewers and Exposure Conditions

Site 1 would be located such that the view from the fairways would be uphill toward I-280 and the Westlake Village Apartment complex. The apartment complex provides a developed backdrop for the site when viewed from the golf club. This site would also be visible to a limited number of residences on the upper floors of the apartment complex and potential views would be very limited in extent. There is sufficient existing vegetation to screen this site from travelers on I-280. Therefore, this site would have limited exposure from publicly accessible vantage points. Potentially affected high-sensitivity viewers would be limited to those on the golf club. Recreationists may be assumed to have high sensitivity to visual quality, although their overall number and, thus, viewer sensitivity in this case would be moderate. However, the site is upslope from adjoining links and, thus, largely screened from the links by intervening slope, partial screening by existing trees, and an existing restroom structure that is proposed for demolition by the Project. Overall exposure to golf club users is, thus, low.

Overall Visual Sensitivity

Site 1 would be located in the northeast corner of the Lake Merced Golf Club, which has limited publicly accessible viewing opportunities. The principal potentially sensitive viewers of Site 1 would be golfers who, as recreationists, would be considered to have high concern for visual quality. The site would be located above the golf links; golfers would have an obstructed view of the site due to the angle of the slope and intervening vegetation. The slope up to the site is landscaped and planted with acacia, which would likely eventually grow taller over time, continuing to effectively block the view of Site 1 from the fairways. Thus, viewer concern is potentially moderate and their exposure is low. Overall visual sensitivity at this site is considered moderately low, given the potential visual sensitivity of the particular viewer group and limited public views.

This page left intentionally blank



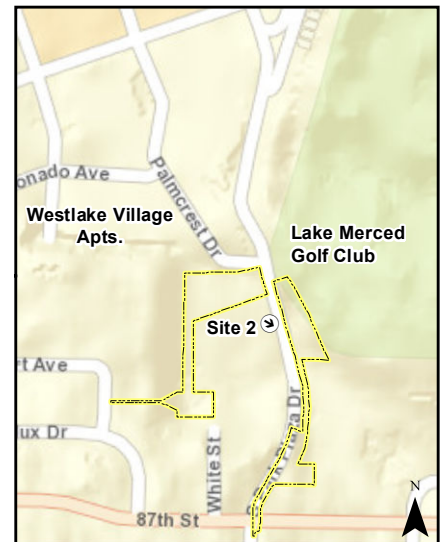

Site 1: View looking southwest toward the facility site from the gate at Poncetta Drive. A restroom facility appears at left and the golf course is in the distance. The Westlake Village Apartments are behind the viewer.



Site 2: View looking southeast toward the facility site, with the Lake Merced Golf Course maintenance road and Park Plaza Drive in the foreground. The Ben Franklin playing fields are behind the viewer.

Legend

-  View Direction
-  Construction Area

Views of Sites 1 and 2

Regional Groundwater Storage and Recovery Project

Figure 5.3-1

Site 2

Figure 5.3-1 (Views of Sites 1 and 2) shows the existing views of Site 2 and Figure 3-12 (Site 2 Park Plaza Meter, Site 3, Ben Franklin Intermediate School, Site 4 Garden Village Elementary School) in Chapter 3, Project Description shows the layout of the facility site.

Visual Quality

Site 2 would be located just outside the southwest corner of the Lake Merced Golf Club and south of the golf club maintenance access road. Site 2's proposed connection to the Daly City pipeline and its storm drain connection would be in the same area. The site would not be visible from the fairways, which are located uphill from the site. This site is located immediately off the street at the edge of an extensive open space area comprised of playing fields of the Garden Village Elementary School and across Park Plaza Drive from the athletic fields at the Ben Franklin Intermediate School. The open space area is characterized by open grassy fields against a backdrop of mature trees to both the northeast and southwest. The large contiguous open space and prominent landscaping lends a park-like character to this segment of Park Plaza Drive. Site 2 is situated at the edge of this open space, demarcating a transition from residential apartments to the north. The site itself may have moderate visual quality, but it also occupies a prominent position within the more attractive and sensitive recreational open space. Visual quality of the open space setting is moderate.

Affected Viewers and Exposure Conditions

Motorists and pedestrians would temporarily see this well facility site traveling either direction on Park Plaza Drive. It would also be periodically visible to users and spectators at the athletic field if looking toward the site. This site would be visible from the south-facing apartments in a section of the Westlake Village Apartment complex. Because it occupies a prominent foreground position adjoining Park Plaza Drive and playfields of Ben Franklin and Garden Village schools, the site would be exposed to unobstructed views from both the street and open space area. Its exposure is considered moderate.

Affected viewer groups at this site include moderately high numbers of motorists, relatively high numbers of school children traveling to and from school, high numbers of students engaged mainly in active recreation on the adjoining playfields, and visitors entering Lake Merced Golf Club. Active recreationists may be considered to have lower levels of viewer concern than those engaged in recreational activity in which scenery is a primary focus. Viewer concern/sensitivity of all these groups is considered moderate.

Overall Visual Sensitivity

Site 2 would be visible from Park Plaza Drive and the athletic fields at the Benjamin Franklin Intermediate School. Recreationists involved in sports activities are assumed to be focused primarily on those activities and only secondarily on the visual setting. Sensitivity of these active recreational viewers is considered moderate. It would also be visible from portions of the Westlake Village Apartment complex. Residents may generally have high viewer sensitivity. However, visual exposure to the site from these homes is limited. Motorists on Park Plaza Drive would also have moderate sensitivity. Given

the moderate visual quality of the vicinity, moderate visual exposure, and moderate viewer concern/sensitivity, overall visual sensitivity is considered moderate.

Westlake Pump Station

Figure 5.3-2 (Views of Westlake Pump Station and Site 5) shows the view of the Westlake Pump Station and Figure 3-13 (Westlake Pump Station Upgrades) in Chapter 3, Project Description illustrates the location of the existing pump station.

Visual Quality

The new facilities at the Westlake Pump Station would be housed inside the building. The pump station is situated within a fenced public works yard adjacent to the Westlake Village Apartments on the north, the Ben Franklin Intermediate School grounds to the south and east, and a single-family residential neighborhood to the west. As the new facilities would be installed within the confines of an existing building at a corporation yard, the visual quality here is considered low.

Affected Viewers and Exposure Conditions

The Westlake Pump Station is located at the northwest corner of the Ben Franklin Intermediate School and is located adjacent to the school's basketball courts and a playfield. Users of these facilities have a clear view of the pump station. This site would also be visible from the upper floors of the Westlake Village Apartment complex. However, proposed new facilities would be contained within the pump station structure, giving it minimal exposure from publicly accessible areas during construction.

Overall Visual Sensitivity

The existing Westlake Pump Station is located within a fenced public works yard adjacent to a section of the Westlake Village Apartment complex and the back side of the Benjamin Franklin Intermediate School. A cluster of mature eucalyptus and Monterey pine trees partially shield views of the pump station yard from residential areas to the west. This site is considered to have low visual sensitivity.

Site 5

Figure 5.3-2 (Views of Westlake Pump Station and Site 5) shows views of the proposed well facility site. The site layout is illustrated on Figure 3-15 (Site 5 [Consolidated Treatment at Site 6] Right-of-Way at Serra Bowl) and Figure 3-19 (Site 5 [On-Site Treatment] Right-of-Way at Serra Bowl) in Chapter 3, Project Description, which show the well facility with consolidated treatment at Site 6 and with the on-site treatment option, respectively.

Visual Quality

Site 5 would be located in a vacant paved lot between a State Farm Insurance Agency office and a single-family residence. The parking lot for the former Serra Bowl is adjacent to the south, with the Serra Bowl building beyond the parking lot. B Street creates the north border of the site; an automobile dealership is located across B Street from the site. Site 5's storm drain connection would be along B Street. There is no vegetation on this site to provide screening.

Site 5 includes two treatment options. The consolidated treatment option includes installation of pipelines to convey water from the well facility at Site 5 to the well facility at Site 6 for water treatment. The pipeline route would pass through the Serra Bowl parking lot, the SamTrans Park and Ride lot, and the Colma BART Station property. Alternately, if it is not feasible to consolidate treatment at Site 6, water may be treated on-site at Site 5 with a water system pipeline connection within B Street.

With the exception of the neighboring residence, Site 5 does not possess unique visual characteristics; therefore, the visual quality here is considered low.

Affected Viewers and Exposure Conditions

Site 5 would be visible to motorists and pedestrians on the surrounding streets, as well as from the Serra Bowl building, the insurance office, and the adjacent single-family residence. This site is on B Street, which is a side street with low levels of traffic. It is used mainly for parking and the area is dominated by the adjacent car dealership and other auto-related facilities. Construction of the pipeline between Sites 5 and 6 would be visible to motorists and pedestrians on D and Hill Streets. Given the neighboring streets and businesses, Site 5 is considered to have moderate exposure and the viewer concern is considered moderate.

Overall Visual Sensitivity

Site 5 would be located in a flat commercial area with no dominant visual features other than these urban land uses and a single residence. The pipeline route traverses an area of similar characteristics. With the predominance of commercial uses, the visual sensitivity of Site 5 is considered moderately low.

Site 6

Views of Site 6 are shown on Figure 5.3-3 (Views of Sites 6 and 7). Figure 3-16 (Site 6 [Consolidated Treatment at Site 6] Right-of-Way at Colma BART) in Chapter 3, Project Description shows the layout for the consolidated treatment option and Figure 3-20 (Site 6 [On-site Treatment] Right-of-Way at Colma BART) shows the on-site treatment option.

Visual Quality

Site 6 would be situated on a grassy area along the south side of D Street, across from the Colma BART Station, which dominates views of the area. Its proposed connection to the SFPUC pipeline, sanitary sewer, and storm drain would be within the immediate area of the site. The alternate connection to the California Water Service Company (Cal Water) pipeline would be in D Street north of the site, but within the SFPUC right-of-way. The SamTrans Park and Ride lot is located upslope from this site to the southwest, beyond a row of trees. The pedestrian bridge over D Street linking the parking lot to the station would have a clear view of this site. The Woodlawn Memorial Park is located to the south and upslope. The immediately adjacent portion of the cemetery is used for outdoor materials storage. As the visual elements of the area are not particularly notable, the visual quality at Site 6 is considered low.

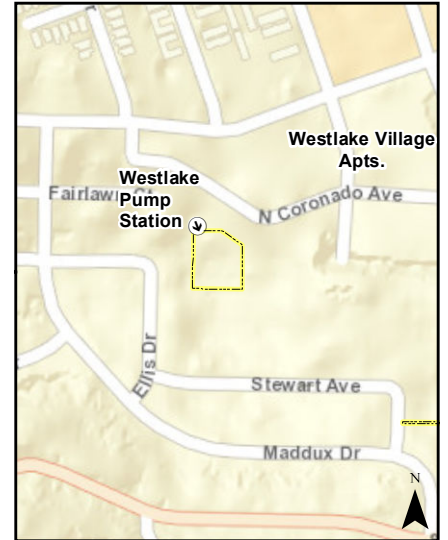

Westlake Pump Station: View looking south toward the pump station from the end of North Coronado Avenue, with the Westlake Village Apartments behind the viewer. All project elements would be installed in the existing building.



Site 5: View looking south across B Street (foreground) toward the facility site, with the former Serra Bowl building in the background and a single-family residence to the left, and the SFPUC valve lot behind the viewer.

Legend



View Direction



Construction Area

**Views of Westlake
Pump Station and Site 5**

**Regional Groundwater Storage
and Recovery Project**

Figure 5.3-2

This page left intentionally blank

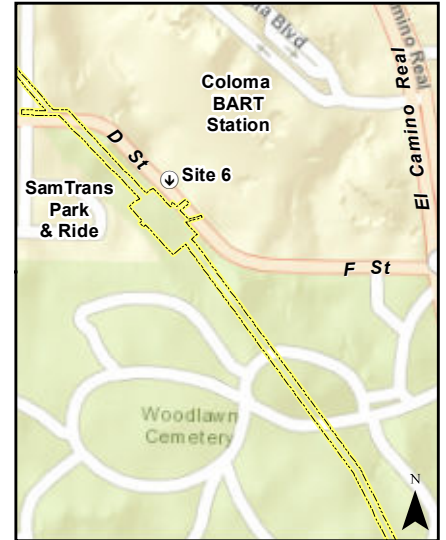

Site 6: View looking south from D Street (foreground) toward the facility site, with the Colma BART station behind the viewer and Woodlawn Memorial Park over the horizon.

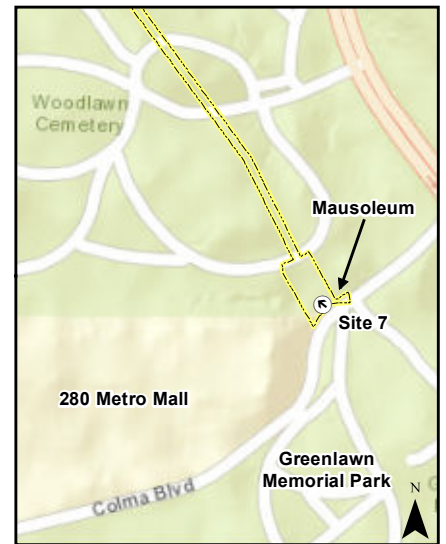

Site 7: View looking northwest from Colma Boulevard toward the well facility site. Woodlawn Memorial Park is beyond the horizon with the Greenlawn Memorial Park to the right, and behind, the viewer.

Legend

 View Direction

 Construction Area

Views of Sites 6 and 7

Regional Groundwater Storage and Recovery Project

Figure 5.3-3

Affected Viewers and Exposure Conditions

Site 6 would be visible from D Street, the Colma BART station, and the station's pedestrian bridge linking it to a park and ride lot. This site is considered to have high, but temporary, exposure from these vantage points. Although adjacent to the grounds of the Woodlawn Memorial Park, Site 6 would not be visible from publicly accessible visitor areas. This site would have minimal exposure from Woodlawn Cemetery. Based on the above description, viewer concern is considered low.

Overall Visual Sensitivity

Site 6 would be visible from D Street and is located adjacent to the Colma BART station, rail track extension and storage yard on a grassy slope, with a row of trees visually separating the site from the adjacent park and ride lot. No high-sensitivity viewer groups are located in the vicinity of the site, giving Site 6 low visual sensitivity.

Unincorporated San Mateo County, Broadmoor - Sites 3 and 4

Views of Sites 3 and 4 are shown on Figure 5.3-4 (View of Sites 3 and 4). While these sites are located in an unincorporated portion of San Mateo County adjacent to Daly City, there is no clear visual transition between the two jurisdictions. Site layouts are shown on Figure 3-12 (Site 2 Park Plaza Meter, Site 3 Ben Franklin Intermediate School, Site 4 Garden Village Elementary School) in Chapter 3, Project Description.

Site 3

Visual Quality

Site 3 would be located in the southwest corner of the athletic field at the Ben Franklin Intermediate School. Site 3's proposed pipeline connection to the Daly City pipeline and its storm drain connection would traverse the same athletic field. The site is covered in turf and located behind a baseball backstop on the field. It is at the foot of a slope, at the top of which single-family residences are located to the southwest; these residences front onto White Street and Maddux Drive. This puts the site low in the field of view from these residential areas. A small wooded area of tall eucalyptus trees directly adjoins the site to the east and southeast. Site 3's visual characteristics are typical of the large recreational open space described above under Site 2. Therefore, the visual quality of this site is moderate.

Affected Viewers and Exposure Conditions

Site 3 would be visible to users of the athletic field and in the distance to motorists and pedestrians on Park Plaza Drive. The view from Park Plaza Drive would be particularly clear in the southbound direction. The small wooded area intervenes somewhat between the site and Park Plaza Drive to the south. Site 3 is not visible from the buildings at Ben Franklin Intermediate School due to intervening topography. It is also not visible from publicly accessible points in the residential areas along White Street and Maddux Drive. Site 3 has moderate exposure to motorists and users of the playing fields, based on the temporary viewing opportunities. Both groups would also have moderate viewer concern/sensitivity.

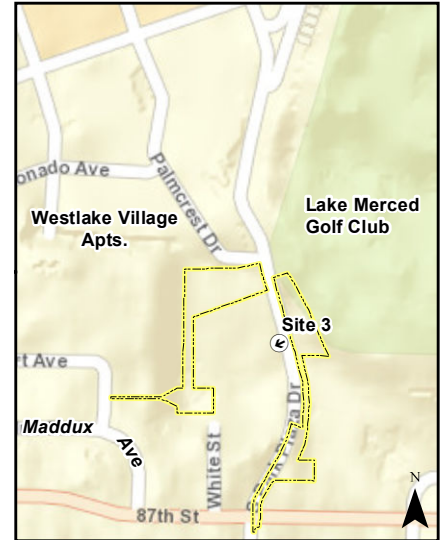

Site 3: View looking southwest toward the facility site from Park Plaza Drive. Residences and Ben Franklin Intermediate School are in the distance upslope from the site, with Park Plaza Drive behind the viewer.



Site 4: View looking northeast along Park Plaza Drive toward the facility site from near the intersection with 87th Street. The grounds of the Garden Village Elementary School are beyond the trees, with the intersection of 87th Street & Park Plaza Drive behind the viewer.

Legend

 View Direction

 Construction Area

Views of Sites 3 and 4

Regional Groundwater Storage and Recovery Project

Figure 5.3-4

Overall Visual Sensitivity

Site 3 would be situated within prominent view of the Ben Franklin Intermediate School athletic fields, and from Park Plaza Drive, particularly in the southbound direction. Although single-family residences are in view to the south and southwest, Site 3 would not be visible from publicly accessible areas in the neighborhood. As discussed previously under Site 2, recreationists involved in sports activities near Site 3 are assumed to be focused primarily on those activities and only secondarily on the visual setting. Sensitivity of these active recreational viewers is considered moderate. Motorists on Park Plaza Drive would also have moderate sensitivity.

Site 4

Visual Quality

Site 4 would be located on a lot adjacent to Park Plaza Drive in the southwest corner of the Garden Village Elementary School grounds. The site is located atop a slope above the school's playing fields, and the slope is covered with grassy vegetation. Mature trees block the view of the site from the Ben Franklin Intermediate School, which is located across Park Plaza Drive. Construction of the well facility would require the removal of most existing trees on the site, and would be visible at foreground distance to the Garden Village Elementary School and Park Plaza Drive. Site 4 is adjacent to single-family residences that front onto 87th Street to the south and other single-family residences across Park Plaza Drive fronting onto White Street to the west. The visual quality of Site 4 is that of the large open space that it adjoins; therefore, the visual quality is considered moderately high.

Affected Viewers and Exposure Conditions

Construction at Site 4, the proposed connection to the Daly City pipeline, and its storm drain connection would be visible to motorists and pedestrians on Park Plaza Drive. There is also a partial view of the site from eastbound 87th Street at its intersection with Park Plaza Drive/Nimitz Drive. Trees currently on the site would block any views from the grounds of the Garden Village Elementary School. The site is in view over fences in the backyards of the residences on 87th Street and White Street, but not directly visible from most publicly accessible areas of the surrounding neighborhood. This site would be exposed to motorists, as well as to students traveling to and from school or using the adjoining playfields. The visual exposure and viewer concern is considered moderately high.

Overall Visual Sensitivity

Site 4 would be in full view of Park Plaza Drive and from most of the activity areas on the Garden Village Elementary School grounds. It would be seen from eastbound 87th Street at Park Plaza Drive/Nimitz Drive. Although visible from residences, it would not be visible from publicly accessible points at those residences. As for Site 3, motorists and students engaged in active recreation would have moderately high visual sensitivity.

Colma - Sites 7, 8, and 17 (Alternate)

Site 7

Figure 5.3-3 (Views of Sites 6 and 7) shows the existing view of Site 7. Figure 3-17 (Site 7 [Consolidated Treatment at Site 6] Right-of-Way at Colma Blvd.) in Chapter 3, Project Description illustrates the layout for Site 7 with the consolidated treatment at Site 6 option, while Figure 3-21 (Site 7 [On-site Treatment] Right-of-Way at Colma Blvd.) shows the layout for the on-site treatment option.

Visual Quality

Site 7 would be located in the foreground of Colma Boulevard in a segment dominated visually by adjoining Woodlawn Memorial Park to the north and Greenlawn Memorial Park to the south. Its storm drain connection would be at the site in Colma Boulevard. Views from the roadway in this segment are characterized by abundant foreground landscaping, long views over open lawn or toward San Bruno Mountain. It is a very intact landscape character dominated by mature tree canopy and natural features.

Site 7 would be located in an undeveloped grassy parcel. A mausoleum is located immediately to the east of the site on an adjacent property and a Greenlawn Memorial Park maintenance building is to the immediate west. The mausoleum is visually separated from the site by a mature stand of 58 trees, which is identified as a “tree mass” in the Town of Colma’s General Plan Figure OS-1 (Colma 1999). The utilitarian maintenance building is the only constructed element in an otherwise predominantly natural setting.

Site 7 includes two treatment options. The consolidated treatment option would include installation of a pipeline to convey water from the well facility at Site 7 to the well facility at Site 6 for treatment. The pipeline route would pass through the eastern portion of Woodlawn Memorial Park and close to the facility’s entrance during construction. Alternately, if it is not feasible to consolidate treatment at Site 6, water may be treated on-site at Site 7 with a water system connection within the SFPUC right-of-way and a sanitary sewer connection in Colma Boulevard. Considering the installation of the proposed connection pipeline from Site 7 to Site 6 under the consolidated treatment option, the visual quality of the setting is moderate as it would cover a more expansive area. However, if water would be treated at Site 7, the area of temporary and permanent disturbance would be entirely within the site’s construction area boundary, making the visual quality of the setting moderately low.

Affected Viewers and Exposure Conditions

Site 7 would be visible to motorists and pedestrians on Colma Boulevard, particularly in the eastbound direction, as well as to visitors to Greenlawn Memorial Park as they enter that site to the south across Colma Boulevard. Due to topography and trees, views of the well facility site from Woodlawn Memorial Park would be limited to a knoll immediately to the west. It would be more visible from Greenlawn Memorial Park to the south. The site would not be visible from the shopping center to the south due to intervening topography. Construction of the pipeline from Site 7 to Site 6, if this treatment option were to be implemented, would be visible from the Woodlawn Memorial Park entrance, office and chapel building (i.e., cemetery employees), and to anyone accessing any part of the cemetery. Given the

moderate level of traffic and numbers of viewers who could see the well facility at Site 7, it would have a moderate exposure. The most sensitive viewer group at this site would be visitors to the adjacent cemeteries, who are assumed to have a moderately high level of concern for visual quality in this setting. However, these viewers would likely be the least frequent visitors during the construction period, and would likely be the least in number.

Overall Visual Sensitivity

Because of viewer expectations associated with the surrounding cemetery land uses and highly intact landscape setting, viewer sensitivity in the portion of Colma Boulevard adjoining Site 7 is considered moderately high.

Site 8

Figure 5.3-5 (Views of Sites 8 and 9) shows the existing view of Site 8, and Site 8 is shown on Figure 3-22 (Site 8, Right-of-Way at Serramonte Blvd.) in Chapter 3, Project Description.

Visual Quality

Site 8, the proposed water connection to the Cal Water system, the alternate connection to SFPUC pipelines, and the storm drain connections would all be located in a narrow grassy strip surrounded by various commercial establishments in a segment of Serramonte Boulevard lined car dealerships, Kohl's Department Store and its associated parking. The streetscape has a visual unity typical of the Central Colma Planning Area (Colma 1999). Site 8 would be shielded from view on all sides except the northeast due to depressed topography. Visual quality of the area is moderately low.

Affected Viewers and Exposure Conditions

Site 8 has quick, passing views for motorists and pedestrians on Serramonte Boulevard and Collins Avenue, due to its topography. For the same reason, it would not be visible from the commercial areas to the southwest due to topography. This site would be plainly visible to employees and patrons from the parking lots of surrounding businesses. With the limited vantage points, Site 8 would have limited visual exposure and low viewer concern.

Overall Visual Sensitivity

Given its location in a primarily commercial district, visual sensitivity of motorists on Serramonte Boulevard and at the businesses in the vicinity of Site 8 would be low. No high-sensitivity land uses (e.g., residential) or viewer groups (e.g., permanent residents) are located within view of the site, which is located in an area of low visual quality and viewer expectation.

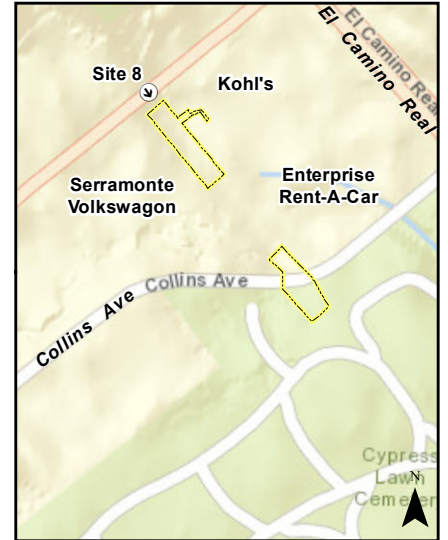

Site 8: View looking southeast from Serramonte Boulevard toward the facility site in the level grassy area. Kohl's Department Store is to the left and the Serramonte Volkswagen car dealership is to the right beyond the retaining wall, with a vacant auto dealership behind the viewer.



Site 9: View looking northwest toward the facility site from a path connecting El Camino Real and Mission Road. The Treasure Island Trailer Court is beyond the site, the Colma Creek Diversion Channel and access road is to the right, and the access road continuing behind the viewer.

Legend

 View Direction

 Construction Area

Views of Sites 8 and 9

Regional Groundwater Storage
and Recovery Project

Figure 5.3-5

Site 17 (Alternate)

Figure 5.3-10 (Views of Sites 16 and 17 [Alternate]) shows the existing view of Site 17 (Alternate), and it is shown on Figure 3-38 (Site 17 [Alternate], Standard Plumbing Supply) in Chapter 3, Project Description.

Visual Quality

Site 17 (Alternate) would be located in a flat, grassy area adjacent to the SFPUC right-of-way and next to Standard Plumbing Supply on a relatively lightly traveled section of Collins Avenue. Its connection to the nearest storm drain and the proposed connection to the Cal Water pipeline would stretch across this area to Collins Avenue. The alternate water pipeline would connect to an existing pipeline in the SFPUC right-of-way. The right-of-way, which is covered in grasses in this area, slopes up from Collins Avenue toward Cypress Lawn Memorial Park to the south, but is visually isolated from the cemetery by sloping terrain and tree cover. The Standard Plumbing Supply property, including this alternate well facility site, is surrounded by chain link fence with exposed parking and storage and poor visual quality typical of light industrial parcels. Visual quality of this segment of Collins Avenue is enhanced by substantial tree plantings and views of San Bruno Mountain, but the vicinity is typified by various commercial/light-industrial land uses. Overall visual quality is moderate.

Affected Viewers and Exposure Conditions

Site 17 (Alternate) would be in brief view of motorists and pedestrians on Collins Avenue, as well as periodically and randomly by patrons of Standard Plumbing Supply. Due to distance, topography, and intervening vegetation, this site would not be directly visible from active areas of Cypress Lawn Memorial Park. Because it would not be exposed to any high-sensitivity viewers, and would be visible to only moderate numbers of low sensitivity viewers, the visual concern and overall visual exposure is considered generally low.

Overall Visual Sensitivity

Because Site 17 (Alternate) would be visually isolated from all nearby high-sensitivity land uses (Cypress Lawn Memorial Park), there are no sensitive viewer groups in the site's viewshed. Visual sensitivity is low.

South San Francisco - Sites 9, 10, 11, 12, 13, 18 (Alternate), and 19 (Alternate)

All of these sites, with the exception of Site 18 (Alternate), would be within the SFPUC right-of-way and, as a result, are undeveloped.

Site 9

Figure 5.3-5 (Views of Sites 8 and 9) shows the existing view of Site 9, and Figures 3-23 (Site 9, Access Road Treasure Island Trailer Court) and 3-24 (Site 9, Treasure Island Trailer Court) in Chapter 3, Project Description illustrate the proposed site layout.

Visual Quality

Site 9, its water pipeline connection, and storm drain connection would be located on an existing undeveloped parcel between the concrete-lined Colma Creek Diversion and the San Mateo County Flood Control channels. The site, in a mixed commercial/residential area, is triangular in shape and covered with low-growing ruderal vegetation and has a lone tree at its center. Views to the south toward the Costco Wholesale Club are blocked by a fabric-covered chain link fence. Views to the northeast look on the rear areas of businesses and single-family residences fronting on Mission Road, including the Verano Condominiums. Views to the northwest look onto the Treasure Island Trailer Court. The site and surroundings are devoid of vivid or attractive visual features, and dominated by the adjacent concrete flood channels and the Costco parking lot. Visual quality is considered to be low.

Affected Viewers and Exposure Conditions

Site 9 would not be visible from any public roadways. An unnamed bicycle/pedestrian path linking El Camino Real to the west and Mission Road to the east provides fleeting views onto the site from the south and southeast. From El Camino Real, this path skirts the north side of the Costco parking lot along the County Flood Control Channel, crosses that channel, passes by the site access point, crosses the Colma Creek Diversion Channel, and proceeds through a landscaped area to Mission Road. Bicyclists and pedestrians would have full view of the site, but in the context of a scene lacking any visual cohesion, consisting of concrete lined flood channels, the Costco parking lot, and back lot fences of nearby residences and industrial parcels. The site would also be visible from the upper floors of the residences to the northeast, including the Verano Condominiums. It would also be partially visible over fencing along the Treasure Island Trailer Court. Given its relatively isolated location and limited opportunity as a public view, Site 9 is considered to have minimal visual exposure and viewer concern is low.

Overall Visual Sensitivity

Site 9 would be located in a mixed residential/commercial area. It would be plainly visible from the bicycle/pedestrian path and the upper floors of surrounding residences. The site would not be visible from Costco due to covered fencing or from the publicly accessible areas around the residences, the Verano Condominiums, and within the Treasure Island Trailer Court. Overall, Site 9 is considered to have low visual sensitivity.

This page left intentionally blank

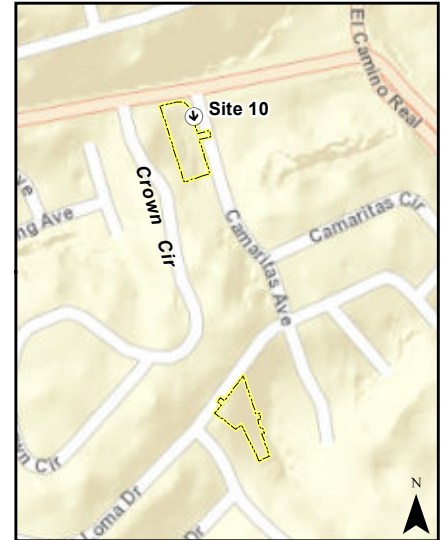

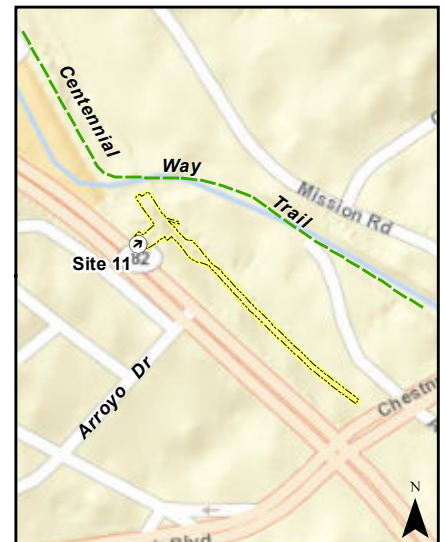

Site 10: View looking south along Camaritas Avenue from Hickey Boulevard toward the facility site in the level foreground area. A tree line screening the site from residences on Crown Circle is to the right, with the Hickey Boulevard and Camaritas Avenue intersection behind the viewer.



Site 11: View looking northeast toward the site from El Camino Real. The facility site would be located beyond the trees.

Legend

-  View Direction
-  Construction Area

Views of Sites 10 and 11

Regional Groundwater Storage
and Recovery Project

Figure 5.3-6

Site 10

Figure 5.3-6 (Views of Sites 10 and 11) shows the existing view of Site 10, and the proposed site layout is illustrated on Figure 3-25 (Site 10, Right-of-Way at Hickey Blvd.) in Chapter 3, Project Description.

Visual Quality

Site 10 would be located on an undeveloped grassy lot on the southwest corner of Hickey Boulevard and Camaritas Avenue. The site's connection to either the Daly City (proposed water connection) or SFPUC (alternate water connection) pipelines, as well as its connection to the sanitary sewer in Camaritas Avenue, would be within this area of the SFPUC right-of-way. This site would be in an area that transitions from commercial activities on the east to residential areas in the other three directions. Trees line the west side of the lot, separating it from the single-family residences beyond Crown Circle to the west. The site slopes upward to the south and remains undeveloped, though single-family residences line Camaritas Avenue beyond stands of mature trees to the southeast. The Winston Manor Shopping Center is located to the east with a Chevy's Restaurant closest to the site across Camaritas Avenue. Immediately to the north across Hickey Boulevard, the topography slopes steeply upward providing partial views through mature trees of the fenced rear yards of single-family residences that front on Duval Drive. The site would be in an area transitioning from commercial strip development of low visual quality to a residential one marked by substantial large-scale tree canopies and grass slopes. Overall visual quality is thus considered moderately low.

Affected Viewers and Exposure Conditions

Site 10 would be prominently visible to high numbers of motorists and pedestrians on Hickey Boulevard and Camaritas Avenue. It would also be visible from the Winston Manor Shopping Center across Camaritas Avenue, though most of the public areas there (e.g., Chevy's outdoor seating) face away from it. The view from the Crown Circle residences is completely blocked by intervening mature trees. Likewise, views from residences on Duval Drive to the north and along Camaritas Avenue to the southeast are effectively blocked by intervening topography and mature stands of trees. Site 10 is considered to have high exposure; however, viewer concern is considered moderate.

Overall Visual Sensitivity

Site 10 would be situated in an area that transitions from commercial to residential areas. It would primarily be briefly visible to high numbers of motorists from Hickey Boulevard, as well as from Camaritas Avenue, and the Winston Manor Shopping Center to the east. The site would not be plainly visible from any publicly-accessible areas in the surrounding residential neighborhoods. Due to the transitory nature of this highly exposed view, visual sensitivity is considered moderate overall.

Site 11

Figure 5.3-6 (Views of Sites 10 and 11) shows the existing view of Site 11, and Figures 3-27 (Site 11, Pipeline and Access Road South San Francisco Main Area) and 3-28 (Site 11, South San Francisco Main Area) in Chapter 3, Project Description illustrate the proposed site layout and pipeline routes.

Visual Quality

Site 11 would be located next to a BART ventilation structure between El Camino Real and Mission Road northwest of Chestnut Avenue and Antoinette Lane. The site's connection to the waterlines and storm drain system would be to the west, with its sanitary sewer connection being in the BART access road. The site is covered in gravel with the adjacent slope covered in unmaintained grasses and mature trees. It would be located about 100 feet east of El Camino Real and at a lower elevation than the roadway. The topography and a row of trees along this portion of El Camino Real obstruct views of the site and the BART ventilation structure just beyond. The BART ventilation structure partially obstructs views of the site from the Centennial Way Trail to the east, which runs along the Colma Creek Diversion Channel, although the view would open up more as one travels north. To the north of the site is a five-story parking garage and surface parking lot for the Kaiser Permanente Medical Center. The remainder of the surrounding land is vacant or commercial without any visually notable features. Given the low visual quality of the highly disturbed setting, dominated by utilitarian features and uses, Site 11 is considered to have low visual quality.

Affected Viewers and Exposure Conditions

Site 11 would be relatively isolated visually. Being at the toe of slope, the site would not be visible to motorists or pedestrians on El Camino Real. It would not be visible from Mission Road due to its juxtaposition to the BART ventilation structure and intervening vegetation. However, a portion of a stand of prominent mature trees at the top of slope within the foreground of El Camino Real would be removed for construction of the well facility at this site. This stand of trees is a prominent feature within the El Camino Real viewshed as seen by high numbers of passing motorists. The principal viewpoint of Site 11 would be the Centennial Way Trail, particularly to bicyclists and pedestrians traveling southbound. These views would be partly screened by the BART ventilation structure and intervening trees. Given this limited view, Site 11 itself would have moderate visual exposure. Viewer concern of Centennial Way Trail users in the vicinity of Site 11 is considered moderate due to lowered scenic expectations as a result of the poor existing visual quality in the vicinity. Viewer concern of motorists on El Camino is also considered moderate.

Overall Visual Sensitivity

The primary sensitive viewer group of Site 11 would be bicyclists and pedestrians on the Centennial Way Trail. Although recreational viewers such as this may be assumed to have high visual sensitivity, this would be greatly moderated by the low visual quality of the vicinity and hence the visual expectations of viewers, as well as the limited duration and exposure to the site as described above. Therefore, the overall visual sensitivity is moderately low.

Site 12

Figure 5.3-7 (Views of Sites 12 and 13) shows the existing view of Site 12. The proposed site layout is shown on Figures 3-29 (Site 12 with Pipelines) and 3-30 (Site 12, Garden Chapel Funeral Home) in Chapter 3, Project Description.

This page left intentionally blank

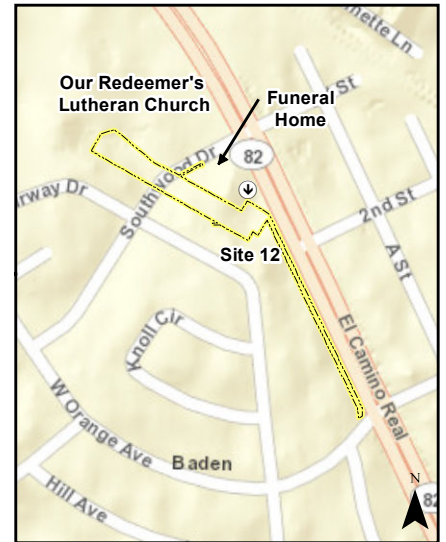

Site 12: View looking south toward the facility site along El Camino Real.



Site 13: View looking south toward the facility site from South Spruce Avenue, with Centennial Way Trail behind the viewer. The Centennial Way Trail pathway is also to the left in the view.

Legend

 View Direction

 Construction Area

Views of Sites 12 and 13

**Regional Groundwater Storage
and Recovery Project**

Figure 5.3-7

Visual Quality

Site 12 would be located just west of El Camino Real in the easternmost portion of the Garden Chapel Funeral Home parking lot. The site is currently comprised of the parking lot, a grassy area with a dirt access for the SFPUC right-of-way, and a number of mature trees and shrubs. Its storm drain and sanitary sewer connections would traverse the parking lot and the proposed SFPUC pipeline connection would run to the southeast along El Camino Real to West Orange Avenue. The site would be at an elevation above El Camino Real and is currently substantially screened from view from that roadway by the mature trees including a dense row of Monterey pine, Monterey cypress, eucalyptus, and Aleppo pine. These trees are contributing resources in the City of South San Francisco's streetscape plan for El Camino Real, as noted in General Plan Implementing Policy 3.4-1-1. This policy calls for trees to line either side of this roadway to support Guiding Policy 3.4-G-1, which seeks to define El Camino Real as a boulevard (South San Francisco 1999). The view of the site from El Camino Real is currently obscured by these trees and the rise in elevation. Similarly, the site is partially screened by fences and vegetation from the single-family residences to the southwest fronting on Fairway Drive. Despite the predominance of the parking area paving, adjacent canopies of large Monterey pines and landscaping of the parking lot and funeral home grounds contribute elements of visual unity and vividness. The site is thus visually isolated from viewers other than visitors to the funeral home. From the perspective of visitors to the funeral home, who would represent the most sensitive and exposed viewer group, visual quality of the site is moderate.

Affected Viewers and Exposure Conditions

Site 12 would potentially be visible from El Camino Real, but is currently substantially screened from El Camino Real by large mature Monterey pine trees. Although the site may be seen from Southwood Drive through the funeral chapel parking lot, this view would be largely obscured by the parking lot in the foreground. It is visible in partially screened views over fences in the backyards of the residences fronting on Fairway Drive, although not from publicly accessible points in that neighborhood. The principal viewers of Site 12 would be visitors to the funeral home, who would view it while parking and entering the funeral home. Visibility would be high for this small, but sensitive, viewer group leading to moderate viewer concern overall. The construction of the water line connection would be plainly visible along El Camino Real. Overall exposure is thus considered moderate.

Overall Visual Sensitivity

Because of its visual isolation as described previously, the primary sensitive viewer group of Site 12 would be visitors to the funeral home as they park and enter or leave the facility, as well as motorists and pedestrians on El Camino Real. Both the owners and visitors to the funeral home would have an interest in maintaining the existing visual quality of that environment. Visual sensitivity is thus considered moderately high for this limited, but continuing, viewer group on-site and motorists on El Camino Real.

Site 13

Figure 5.3-7 (Views of Sites 12 and 13) shows the existing view of Site 13, and the proposed site layout is shown on Figures 3-31 (Site 13 with Pipelines) and 3-32 (Site 13, South San Francisco Linear Park) in Chapter 3, Project Description.

Visual Quality

Site 13 would be located on an undeveloped parcel on the southeast side of South Spruce Avenue covered with unmaintained grassy vegetation. It is bordered by a two-story retail/office building and parking lot on the west and a large beverage distribution warehouse on the east. Between the warehouse and the site is the Centennial Way Trail, with an interpretive panel with a trail map at the entrance on South Spruce Avenue. A fenced-in, buried utility vault is located between the site and the trail. The trail continues immediate across South Spruce Avenue with a large industrial bakery to the north and single-family residential neighborhood to the south. Visual quality of the South Spruce Avenue streetscape in this area is moderate, with substantial landscaping and views of hilltop ridgelines to both east and west. Principal vivid elements in the vicinity are stands of mature trees located within or along the pathway.

Site 13's sanitary sewer and storm drain connections would be in South Spruce Avenue. The proposed water connection to San Bruno would be installed in South Spruce and Huntington avenues. Huntington Avenue is lined with government and professional offices, commercial space, and a movie theater. Given the varied visual appearance of the area – considering the warehouses, commercial activities, office space, residential neighborhoods, and the Park pathway – visual quality is considered moderate.

Affected Viewers and Exposure Conditions

Site 13 would be plainly visible to motorists and pedestrians along South Spruce Avenue and patrons of the adjacent retail/office building. This site is also plainly visible to bicyclists and pedestrians using the Centennial Way Trail. It is visible in partially screened views over fences in the backyards of the residences fronting on Francisco Drive, although not from publicly accessible points in that neighborhood. This site has high visual exposure.

Overall Visual Sensitivity

Site 13 would be prominently visible from the adjacent Centennial Way Trail. Since such recreational destinations may be considered to have high visual sensitivity, Site 13 is considered to have moderately high sensitivity.

Site 18 (Alternate)

Figure 5.3-8 (Views of Sites 18 [Alternate] and 19 [Alternate]) shows the existing view of Site 18 (Alternate). The layout for the site is shown on Figure 3-39 (Site 18 [Alternate], Alta Loma Drive) in Chapter 3, Project Description.

This page left intentionally blank

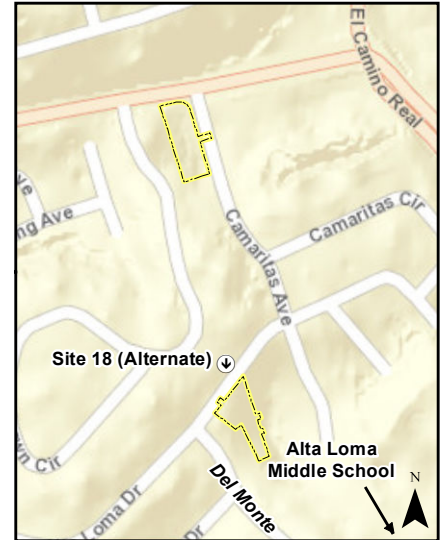

Site 18 (Alternate): View looking south to the facility site from a SamTrans bus stop on Alta Loma Drive. Single-family residences are behind the viewer.

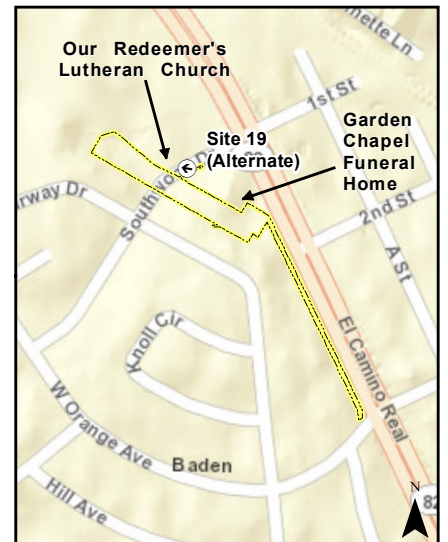

Site 19 (Alternate): View looking west from Southwood Drive toward the facility site, with the Garden Chapel Funeral Home behind the viewer. Our Redeemer's Lutheran Church is on the right and the multi-family housing is in the distance.

Legend



View Direction



Construction Area

Views of Sites 18 (Alternate) and 19 (Alternate)

Regional Groundwater Storage and Recovery Project

Figure 5.3-8

Visual Quality

Site 18 (Alternate) would be located on an undeveloped parcel in a residential neighborhood along Alta Loma Drive on a knoll at street level overlooking a lower, moderately sloped grassy swale. The site's storm drain, sanitary sewer, and connection to the SFPUC pipeline would traverse this swale, which is in the SFPUC right-of-way. The site is densely vegetated with a small stand of willows that is about 15 feet high and covering approximately 3,400 square feet. It is adjacent to single family residences to the southwest fronting on Del Monte Avenue and others directly across Alta Loma Drive. Single-family residences also front on Camaritas Avenue to the east. Vivid elements in the vicinity include views to forested hillsides to the south and San Bruno Mountain to the north. Visual quality is considered moderate.

Affected Viewers and Exposure Conditions

Site 18 (Alternate) would be seen from the single-family residences along Alta Loma Drive and backyards of, and the publicly accessible areas around, the single-family residences fronting Camaritas Avenue on the far side of the swale, as well as the single-family residences fronting on Del Monte Avenue to the south. The site would be somewhat visible from Alta Loma Middle School, where the northern parking lot is about 400 feet away from the site. Site 18 (Alternate) would have high exposure and viewer concern would be moderately high.

Overall Visual Sensitivity

Given its elevated position on a knoll and close proximity to neighboring single-family residences, this site would be plainly visible from the surrounding neighborhood. Although residential viewers may be assumed to have high viewer sensitivity, because the visual quality is moderate and level of exposure is moderately high, this site would have moderately high visual sensitivity.

Site 19 (Alternate)

Figure 5.3-8 (Views of Site 18 [Alternate] and Site 19 [Alternate]) shows the existing view of Site 19 (Alternate). The proposed site layout is shown on Figure 3-40 (Site 19 [Alternate], Garden Chapel Funeral Home) in Chapter 3, Project Description.

Visual Quality

Site 19 (Alternate) would be across Southwood Drive from Site 12 and situated between the Our Redeemer's Lutheran Church and single-family residences fronting on Fairway Drive. The site, covered in mowed grassy vegetation, is partially screened by fences and vegetation from these single-family residences. Multi-family residential developments are also located to the north of this site and have limited views of the site through intervening landscape vegetation and trees. The SFPUC pipeline connection would cross Southwood Drive and traverse the Garden Chapel Funeral Home's parking lot to connect with the treatment facilities at Site 12. The storm drain connection would be in Southwood Drive. While Site 19 (Alternate) may be atypical when considered with its surroundings and provides a visual

transition between the church and residences, it is not considered particularly unique in this urban setting. Its visual quality is considered moderate.

Affected Viewers and Exposure Conditions

Site 19 (Alternate) would be highly visible to a relatively large number of motorists from the immediate adjacent section of Southwood Drive and a portion of the church parking lot to the east. It would also be visible over a hedge separating the site from the R. W. Drake Preschool on the church's property. The eastern end of the site may be visible briefly while traveling north on El Camino Real at its intersection with Southwood Drive. It is also in view over fences in the backyards of the residences fronting on Fairway Drive, although not from publicly accessible points in that neighborhood. There are views of the site from the multi-family residential developments to the north, but these views are broken by intervening landscape vegetation and mature trees. Given this, Site 19 (Alternate) is considered to have moderate visual exposure and moderate viewer concern.

Overall Visual Sensitivity

Site 19 (Alternate) would be along Southwood Drive situated between Our Redeemer's Lutheran Church/R. W. Drake Preschool and single-family residences fronting on Fairway Drive. It would be plainly visible from the immediate section of Southwood Drive and the eastern portion of the church parking lot. Although the eastern end of the site may be visible briefly while traveling north on El Camino Real, it would be only in passing. Although adjacent to the single-family residences fronting on Fairway Drive, fences between these residences and the site partially block the view; it is not be visible from publicly accessible areas of this neighborhood. Site 19 (Alternate) would have moderate visual sensitivity.

San Bruno - Sites 14 and 15

Site 14

Figure 5.3-9 (Views of Sites 14 and 15) shows the existing view of Site 14 while Figures 3-34 (Sites 14 & 15 with Pipelines) and 3-35 (Site 14, Golden Gate National Cemetery) in Chapter 3, Project Description show the proposed site layout and pipeline routes.

Visual Quality

Site 14 would be located on the northern side of the GGNC about 1,600 feet east of a circular monument at the main entrance to the cemetery. The site would not be visible from the monument nor would it be visible from an auxiliary entrance from Sneath Lane at the cemetery's operations and maintenance yard, which is closer to the site. Site 14 would be located within the in a grassy area of the SFPUC right-of-way between the gravesites and close to an existing unused pump station, tank and well in the cemetery. It would be in proximity to the single-family neighborhood adjacent to the north along Greenwood and Rockwood drives, which are screened from the site by fences and mature trees. Site 14 would not be visible from the public roads surrounding the cemetery (i.e., Sneath Lane) due to distance, topography, and intervening trees, but is visible from internal roadways in this section of the cemetery.

This page left intentionally blank

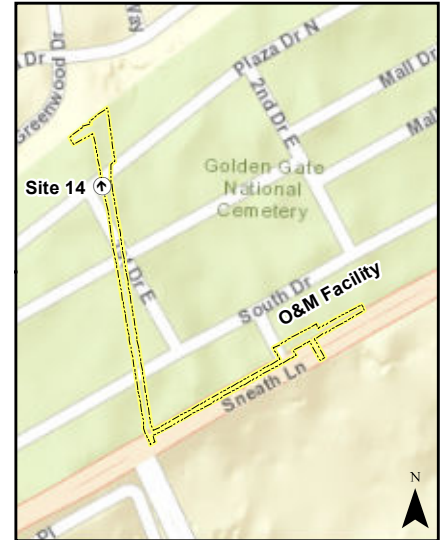

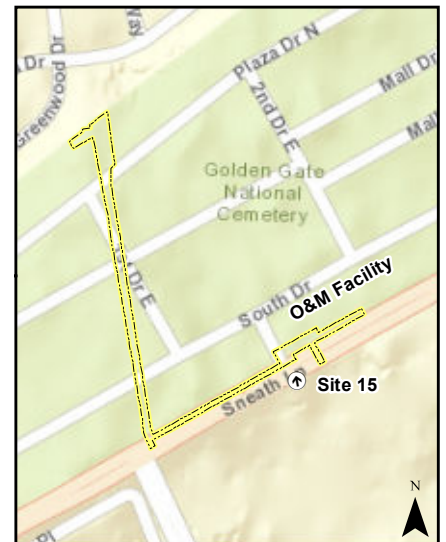

Site 14: View looking north toward the facility site along the SFPUC right-of-way between the internment areas, with internment areas and the SFPUC right-of-way continuing behind the viewer. An inactive well facility is seen to the left in the view.



Site 15: Mitigated View looking north across Sneath Lane (foreground) toward the operations and maintenance buildings on the GGNC, with the Airport Trade Center behind the viewer. A chain link fence borders the GGNC between the buildings and Sneath Lane.

Legend

-  View Direction
-  Construction Area

Views of Sites 14 and 15
Regional Groundwater Storage and Recovery Project

Figure 5.3-9

Water produced at Site 14 would be conveyed to Site 15 for treatment and connection to the SFPUC pipeline. This pipeline, and the site's storm drain, would be within the SFPUC right-of-way and traverse the cemetery to Sneath Lane. The setting of the GGNC is a highly ordered, well-landscaped open space area with high visual unity, intactness, and vivid elements including unobstructed views of ridge tops at the horizon, and old, overhanging tree canopies enclosing Sneath Lane. Visual quality of this setting is high.

Affected Viewers and Exposure Conditions

Site 14 would primarily be visible to people visiting and viewing gravesites in this section of the GGNC. It would not be clearly visible from the neighborhood backyards and publicly accessible areas immediately to the north along Greenwood and Rockwood drives. The pipeline construction at this site would be highly visible from Sneath Lane, although the view would be brief and random to passing traffic. Pipeline construction would not be highly visible from publicly accessible areas of the Peninsula Place apartment complex southwest of Sneath Lane and Cherry Avenue due to intervening vegetation. Given its location within the interment area, Site 14 is considered to have high visual exposure and viewer concern is high. Visits are infrequent and relatively brief; therefore, the number of affected viewers is low.

Overall Visual Sensitivity

Site 14 would be situated in plain view of the gravesites in this area of the GGNC. With the exception of pipeline construction, the site would not be visible from surrounding roadways or other publicly accessible areas. However, given its location within view of interment areas, Site 14 is considered to have high visual sensitivity.

Site 15

Figure 5.3-9 (View of Sites 14 and 15) shows the existing view of Site 15, and Figures 3-34 (Sites 14 & 15 with Pipelines) and 3-36 (Site 15, Golden Gate National Cemetery) in Chapter 3, Project Description illustrate the site layout and pipeline route.

Visual Quality

Site 15 would also be located within the GGNC, situated in a grassy area on the southern edge of the cemetery between Sneath Lane and the cemetery's operations and maintenance yard. The maintenance yard includes buildings designed to be sensitive to the surrounding portions of the cemetery. The connection to the proposed San Bruno pipeline would run from the site west to the SFPUC right-of-way near Cherry Avenue. The sanitary sewer and storm drain connection would primarily be within the site and connect in Sneath Lane at the site. This site would be located at an auxiliary entrance to the GGNC from Sneath Lane. A commercial/office park and a Veteran's Administration Medical Clinic are located to the south across Sneath Lane and are shielded from view somewhat by mature trees and landscaping. The site is located within the same immediate viewshed; however, the visual quality is considered moderately high at this location.

Affected Viewers and Exposure Conditions

Site 15 would be visible to a smaller portion of the cemetery, as the operations and maintenance building would screen it from view. However, it would still be visible from gravesites. Patrons and employees at the commercial/office park across Sneath Lane would have view of the site, although it would be broken by trees and landscaping lining Sneath Lane. Travelers on Sneath Lane would have a full view of the site through a chain link fence bounding the cemetery. Site 15 would not be highly visible from publicly accessible areas of the Peninsula Place apartment complex southwest of Sneath Lane and Cherry Avenue due to intervening vegetation. Given its location within view of interment areas and the alternate cemetery entrance, Site 15 is considered to have moderately high visual exposure and concern.

Overall Visual Sensitivity

Site 15 would be situated in plain view of a smaller number of gravesites in this area of the GGNC. It would be shielded from most neighboring portions of the cemetery by the operations and maintenance yard. The site would also be visible from motorists and pedestrians along Sneath Lane, as well as the commercial/office park and Veteran's Administration Medical Clinic across Sneath Lane. Given the site's highly prominent position on the street-facing front façade of the cemetery operations and maintenance buildings, the well facility would exert a strong visual impression on the many people visiting or passing the cemetery. The site thus would have moderately high visual sensitivity.

Millbrae

Site 16

Figure 5.3-10 (View of Site 16 and Site 17 [Alternate]) shows the existing view of Site 16 and Figure 3-37 (Site 16, Millbrae Corporation Yard) in Chapter 3, Project Description shows the proposed site layout.

Visual Quality

Site 16 would be located on SFPUC right-of-way behind the Orchard Supply Hardware store along El Camino Real. The site's connection to the SFPUC pipeline would be at the site, with the alternate connection traversing the store's parking lot and connecting into another SFPUC pipeline near El Camino Real. The sanitary sewer line would connect in Hemlock Avenue, with the storm drain directed toward existing drainage adjacent to the Caltrain commuter rail line. The paved site would be located in the truck delivery and outdoor storage areas at the rear of the parcel. To the east are the Caltrain line and a large electrical substation with tower. To the south is a three-story Millbrae Manor Apartments complex separated from the site by an alley, two fences, and a small storage yard. Site 16 is typical of a developed urban commercial environment and does not have any unique visual attributes. Therefore, this site is considered to be of low visual quality.

This page left intentionally blank

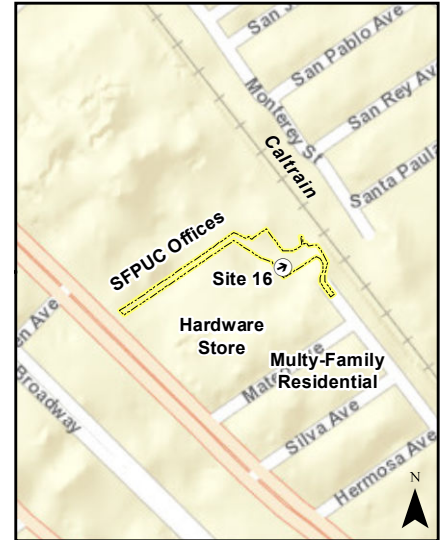

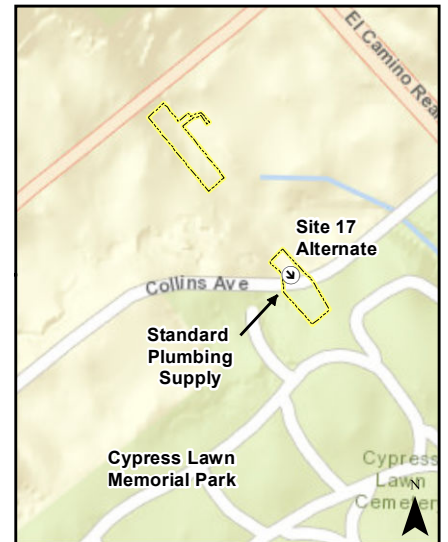

Site 16: View of the facility site looking east from the Orchard Supply Hardware store toward the site and the store's outdoor storage area, with the store and customer parking behind the viewer. Hemlock Avenue is to the right beyond the fence.



Site 17 (Alternate): View of the facility site looking southeast from Collins Avenue. The Standard Plumbing Supply building is to the right and the SFPUC right-of-way is to the left, with the Cypress Lawn Memorial Park out of view over the horizon. The SFPUC right-of-way continues behind the viewer.

Legend

-  View Direction
-  Construction Area

Views of Sites 16 and 17 (Alternate)

Regional Groundwater Storage and Recovery Project

Figure 5.3-10

Affected Viewers and Exposure Conditions

Site 16 would be visible from the upper two stories of residential complex and the hardware store, as well as to patrons and employees in the hardware store parking lot, though it is generally inaccessible to the public. There would be limited views from Hemlock Avenue. Given these limited opportunities for view, this site is considered to have minimal exposure and viewer concern is low.

Overall Visual Sensitivity

Site 16 would be situated in plain view of the hardware parking lot, merchandise delivery, and outdoor storage area. The site would be visible from the upper two stories of the multi-family residence complex. Given the visual nature of the area (see Section 5.3.1.3 [Individual Project Well Facility Sites] above), this site would have low visual sensitivity.

5.3.2 Regulatory Framework

5.3.2.1 Federal

No federal regulations relative to scenic or visual resources would be applicable to the Project.

The U.S. Department of Veterans Affairs (VA), National Cemetery Administration, maintains a Facilities Design Guide that provides guidance for development within national cemeteries and related facilities. Section 5 of the Guide presents design criteria for structures within these facilities. There are no policies or criteria providing specific requirements for the design of facilities situated within the bounds of national cemetery facilities. Item 9.1 in Subsection 5.1 of the Guide states that topography, adjacent facilities, environmental impacts, and future development be considered to produce a design that is both functional and aesthetically successful (VA, National Cemetery Administration 1999, 2010).

5.3.2.2 *State*

California Scenic Highway Program

In 1963, the State of California established the Scenic Highway Program to develop a system of State roadways whose adjacent corridors contained scenic resources worthy of protection and enhancement².

Sections 260 through 263 of the State Streets and Highways Code establish the Scenic Highways Program and require local government agencies to take the following actions to protect the scenic appearance of the scenic corridor:

- Regulate land use and density of development,
- Provide detailed land and site planning,
- Prohibit off-site outdoor advertising and control on-site outdoor advertising,
- Pay careful attention to and control earthmoving and landscaping, and
- Scrutinize the design and appearance of structures and equipment.

See Table 5.3-2 (Designated State, County, and Local Scenic Roads in the Vicinity of Facility Sites) for a list of State-designated scenic highways in the Project vicinity.

5.3.2.3 *Local*

Scenic Roadways

Designation of local scenic routes is part of the local general plan process. For State routes and highways, this local designation also provides the basis for nominating and applying to the California Department of Transportation (Caltrans) for eligibility as a State scenic highway. Local scenic routes are considered notable roadways with scenic values that offer views of creeks, hillsides, open space features, water bodies, and unique visual resources. Development within or adjacent to scenic routes is typically subject to guidelines or restrictions (e.g., setbacks, screening, height limitations) that protect the scenic values of these routes. See Table 5.3-2 (Designated State, County, and Local Scenic Roads in the Vicinity of Facility Sites) for a list of State and local designations of scenic routes in the vicinity of the proposed well facility sites.

² The state Scenic Highway Program lists highways that are either eligible for nomination as scenic highways or have been officially designated. Local governing bodies must nominate and apply to Caltrans in order for an eligible highway to be officially designated a Scenic Highway. Part of the application includes defining and identifying the scenic corridor of the highway, and adopting ordinances, zoning and/or planning policies to preserve the scenic quality of the corridor or documenting that such regulations already exist. These ordinances and policies constitute the Corridor Protection Plan.

TABLE 5.3-2
Designated State, County, and Local Scenic Roads in the Vicinity of Facility Sites

Designated Highway or Route	Description/Location	Potential View Exposure/Distance to Facility Sites ^(a)
State Designated Scenic Highway		
I-280 (Junipero Serra Freeway) ^(b) Designated	I-280 between the Santa Clara County line to the northern San Bruno city limit.	None
I-280 (Junipero Serra Freeway) ^(b) Eligible	I-280 between the northern San Bruno city limit and the San Francisco County line.	Site 1 (approximately 40 feet)
City of Daly City - No Designated Scenic Routes		
San Mateo County Designated Scenic Routes		
Junipero Serra Freeway ^(c)	I-280 from the Santa Clara County line to the City of Millbrae.	None
John Daly Boulevard	From I-280 to State Route 35	None
Town of Colma Designated Scenic Routes		
El Camino Real ^(d)	Segment that passes through Colma is designated as a scenic route. The Town has designated a 400-foot to 900-foot wide scenic corridor on both sides of El Camino Real. The intersection of El Camino Real and F Street is also designated as a Town gateway.	None
City of South San Francisco - No Designated Scenic Routes		
City of San Bruno Designated Scenic Routes		
Sneath Lane ^(e)	Segment of Sneath Lane west of El Camino Real is designated as a scenic corridor.	Pipeline construction for Site 14 (adjacent) Well Facility at Site 15 (approximately 25 feet)

Notes:

- (a) Distances are measured from the construction area boundary.
- (b) Caltrans 2012
- (c) San Mateo 1986
- (d) Colma 1999
- (e) San Bruno 2009

Scenic Trees

Two of the local jurisdictions in the Project area have policies aimed at protecting trees specifically for their contribution to a scenic visual setting. While other Project area jurisdictions may have tree protection or preservation policies, the policies in the Town of Colma and the cities of San Bruno and South San Francisco incorporate the concept of the visual or aesthetic character in its policies.

Town of Colma

The Town of Colma considers its trees important to the community's identity and has developed goals, policies, and ordinances to protect and maintain this resource. This approach to tree protection looks at this resource from a biological and visual perspective. Section 5.14, Biological Resources discusses these goals, policies, and ordinances relative to potential Project impacts to biological resources, including an evaluation of tree preservation policies and ordinances. Tree protection ordinances are also discussed in Chapter 4, Plans and Policies.

The Town's General Plan Figure OS-1 identifies specific tree masses throughout the Town that contribute to the picturesque quality of the Town (Colma 1999)³. The majority of the trees were planted by cemetery owners as buffers or windbreaks and for aesthetic purposes. These tree masses have "grown" into Colma's physical environment and visual setting – becoming part of the Town's character. The General Plan includes Goal 5.04.034, which calls for the identification and preservation of selected tree masses (which are specifically identified in the Town of Colma General Plan), landscape features, and other scenic elements important to the Town's visual setting.

The Town has adopted a tree cutting and removal ordinance to protect both trees and views (Colma 2010). Under the Town's Municipal Code, Chapter 5, Subchapter 5.06, in connection with the issuance of tree permits, the Town may require the replacement of trees that are removed with new trees that will grow to a similar size and form. General Plan Policy 5.04.331 supports this ordinance by stating that tree removal should follow the guidelines of the tree ordinance (Colma 1999). Where appropriate, the Town seeks to have new trees planted that will achieve substantial height, and in groupings which will perpetuate the large massings associated with Colma's visual setting.

Sites 7 and 17 (Alternate) would be situated adjacent to, or within, identified tree masses in Colma. Therefore, Colma's local tree protection policies are discussed in evaluating the significance of aesthetic impacts that may result from implementation of the proposed Project at Sites 7 and 17 (Alternate).

³ The Town of Colma's General Plan identifies specific tree masses throughout the Town. The General Plan and Tree Ordinance use several terms to when discussing tree masses, including "major" tree masses, "significant" tree mass, and designated tree mass. These terms are used interchangeably throughout these Town policy documents. For consistency, this EIR uses the more general terms "tree mass" or "designated" tree mass.

City of San Bruno

The City of San Bruno's General Plan Open Space and Recreation Element includes Policy OSR-33 which calls for the balance of fire prevention goals with the preservation of the mature tree stands along the city's scenic corridors, including Sneath Lane, consistent with the Tree Preservation Ordinance. Policy OSR-34 also calls for the protection mature trees, as feasible, during new construction and redevelopment (San Bruno 2009).

Site 15 would be situated along Sneath Lane in San Bruno. Therefore, San Bruno's Heritage Tree ordinance (Municipal Code, Title 8, Chapter 8.25) is considered in evaluating the significance of aesthetic impacts that may result from implementation of the Project at Site 15 (San Bruno 2002). While Site 14 is situated in San Bruno, the city's tree ordinance does not apply to this site given its location within the GGNC and that no trees would be removed by the Project.

City of South San Francisco

Relevant Land Use goals and policies in the City of South San Francisco's General Plan include development of a streetscape plan for the El Camino Real SubArea, where Sites 11, 12, and 19 (Alternate) would be located along, and within sight of, El Camino Real. The streetscape plan specifies a consistent row of trees on either side of El Camino Real for the six-lane stretch that starts at the Kaiser Permanente Medical Center area and runs south. These trees are contributing resources in the city's streetscape plan, as noted in General Plan Implementing Policy 3.4-1-1. This policy calls for trees to line either side of this roadway to support Guiding Policy 3.4-G-1, which seeks to define El Camino Real as a boulevard (South San Francisco 1999). As noted in the discussion of Impact BR-4 in Section 5.14, Biological Resources, other city-defined heritage trees would be removed or trimmed due to the Project at Sites 9, 10, 13, and 18 (Alternate). However, impacts from removal of these trees are discussed in the context of the City of South San Francisco's tree preservation ordinance (South San Francisco n.d.) and discussed in Section 5.14, Biological Resources.

5.3.3 Impacts and Mitigation Measures

5.3.3.1 Significance Criteria

For the purposes of this EIR, the Regional Groundwater Storage and Recovery Project would have a significant effect on aesthetics if it were to:

- Have a substantial adverse effect on a scenic vista.
- Substantially damage scenic resources, including, but not limited to, trees, rock outcroppings, and other features of the built or natural environment which contribute to a scenic public setting.
- Substantially degrade the existing visual character or quality of the site and its surroundings.
- Create a new source of substantial light or glare which would adversely affect day or nighttime views in the area or which would substantially impact other people or properties.

5.3.3.2 Approach to Analysis

This section evaluates potential impacts on visual resources that could occur during Project construction and operations. For the purpose of this analysis, the visual setting is defined as the natural and built landscape features that can be seen from publicly accessible vantage points (viewshed).

Construction-related impacts on aesthetics could occur during well facility construction, use of construction staging areas, trenching for pipeline placement, and tree removal. Operational impacts on aesthetics could occur from the permanent placement of aboveground well facilities, or from not replacing trees that are removed during construction and not planned for replacement due to their location within the SFPUC right-of-way. See the subsection titled *Visual Quality* below for further discussion.

The visual impact analysis is based on field observations of the facility sites and surrounding viewsheds conducted in February 2010, April and May of 2011, and March 2012, site and aerial photographs, visual simulations, computer-aided street-view tours,⁴ and review of relevant planning documents.

The following impact analysis addresses the short-term (construction-related) and long-term (siting, operations and maintenance-related) impacts on scenic resources, scenic vistas, and the visual quality and character of the facility sites and surroundings. For purposes of this analysis, scenic resources are defined as features of the built or natural environment that contribute to a scenic public setting, including but not limited to, trees and rock outcroppings. Scenic vistas are publicly accessible viewpoints that provide expansive views of a highly valued landscape.

The evaluation of temporary visual impacts during construction considers whether those activities would substantially degrade the existing visual character or quality of the site or surrounding area and the duration over which this change would occur. Being temporary in nature, construction-related effects on visual quality are generally considered to have a less-than-significant impact. However, construction activities that are highly visible to sensitive viewers in publicly-accessible areas – such as public areas in residential neighborhoods or buildings, passersby on public roadways and walkways, users of outdoor recreational facilities, and cemetery visitors – and that would be located at one site for a year or more may result in significant construction-related visual impacts depending on the overall visual context at each facility site.

Permanent visual impacts from facility siting and operation are assessed based on the Project's potential to have a substantial adverse effect on scenic vistas, substantially damage scenic resources, or substantially degrade the existing visual character or quality of the site and its surroundings.

The evaluation of permanent visual impacts of the operation and maintenance of the proposed Project relative to each site's overall visual sensitivity and visual contrast is presented. Table 5.3-3 (Visual Impact

⁴ Available on Google Maps™ and Google Earth™.

Scale) presents a three-point scale using the concepts and terminology discussed in Section 5.3.1 (Setting), for determining the level of impact for each of the above significance criteria for both construction-related and siting and operational impacts.

This table considers overall visual sensitivity of each site and its surroundings, as well as the visual change or contrast that would be caused by the Project. “Overall visual sensitivity” brings together the factors discussed in Section 5.3.1.1 (Concepts and Terminology) into a single consolidated measure: visual quality; affected viewers and exposure conditions; and visual sensitivity. “Visual change/contrast” refers to the transformation or modification of the appearance of the Project and/or its surroundings. As seen in the table, each of these measures are rated high, moderately high, moderate, moderately low, and low, with the significance dependent on how the potential Project impact would compare with both measures.

TABLE 5.3-3
Visual Impact Scale

		Overall Visual Sensitivity				
		High	Moderately High	Moderate	Moderately Low	Low
Visual Contrast/Change	High	Significant	Significant	Significant	Less than Significant	Less than Significant
	Moderately High	Significant	Significant	Significant	Less than Significant	Less than Significant
	Moderate	Significant	Significant	Less than Significant	Less than Significant	Less than Significant
	Moderately Low	Less than Significant	Less than Significant	Less than Significant	Less than Significant	Less than Significant
	Low	Less than Significant	Less than Significant	Less than Significant	Less than Significant	Less than Significant
	No Change/Effect	No Impact	No Impact	No Impact	No Impact	No Impact

The approach to evaluating the effect of the proposed Project under each CEQA significance criterion is briefly discussed below:

Scenic Vistas

This criterion is applicable only to projects that would be located on or disrupt access to a scenic vista, or result in significant visual changes within its viewshed. Scenic vistas may be officially recognized or designated (e.g., within local planning documents or the Caltrans scenic highway program), or they may be informal in nature (e.g., mountain peaks or expansive views). The Project’s effect would be considered

substantial if it were to appreciably damage or remove the visual qualities that make the view unique, unobstructed, and/or exemplary.

Scenic Resources

Damage to a scenic resource is substantial when it is substantially perceptible from affected publicly accessible views and when it appreciably degrades one or more of the aesthetic qualities that contributes to a scenic setting. The presence of and potential damage to scenic resources in this analysis is considered along with Project-related effects on the existing visual character and quality of a site or surroundings.

Visual Quality

This criterion is applicable to all locations where the Project would result in either temporary or permanent visual change. The Project is considered to “substantially degrade” the visual character or quality of a site if it would have a strongly negative influence on the public’s experience and appreciation of the visual environment. As such, visual changes are always considered in the context of a site or locale’s visual sensitivity (as described in the setting). Visual changes caused by the Project are evaluated in terms of their visual contrast with the area’s predominant landscape elements and features, their dominance in views relative to other existing features, and the degree to which they could block or obscure views of aesthetically pleasing landscape elements. Visual changes are also evaluated in terms of potential damage to, or removal of, features of the natural or built environment that contribute to a scenic public setting. The magnitude of visual change that would result in a significant impact (i.e., substantial degradation) is also influenced by its degree of permanence. The significance of visual changes is also a function of the visual sensitivity of a site. Impacts to the visual quality of a site resulting from tree and vegetation removal during construction are addressed under construction-related impacts (Section 5.3.3.4 [Construction Impacts and Mitigation Measures] below). Impacts to the visual quality of a site resulting from long-term operation of Project facilities are addressed under operation-related impacts (Section 5.3.3.5 [Operation Impacts and Mitigation Measures] below), including the long-term visual impact from not replanting trees in the SFPUC right-of-way at some sites, which is guided and required by the SFPUC Integrated Vegetation Management Policy (SFPUC 2007).

Light and Glare

This criterion is applicable to projects that require substantial nighttime lighting (either during construction or operation) or that would include highly reflective surfaces that would create a new source of substantial glare from the sun.

Areas of No Project Impact

Due to the nature of the proposed Project, there would be no construction or operational impacts related specifically to glare; therefore, the issue of glare is not discussed further in this section for the following reasons:

Create a new source of substantial glare which would adversely affect day or nighttime views in the area either during construction or operation. Considering the nature of construction activities, equipment, and materials, there would be very little, if any, glare resulting from the Project. The only potential for Project-related glare would be from reflective surfaces (e.g., windshields) on construction equipment as they carry out construction activities. However, these instances of glare would be momentary and passing, depending on sky conditions. The permanent facilities would be constructed of board-formed concrete and metal panels in gray or earth tone with anti-graffiti coating, which would not be a highly reflective surface that would cause glare. Therefore, the Project would have no impact due to glare.

5.3.3.3 Summary of Impacts

Table 5.3-4 (Summary of Impact – Aesthetics) provides a summary of potential impacts to the aesthetic environment and significance determinations at each well facility site.

TABLE 5.3-4
Summary of Impacts – Aesthetics

Sites	Construction		Operation		Cumulative
	Impact AE-1: Project construction would have a substantial adverse impact on a scenic vista, resource, or on the visual character of a site or its surroundings.	Impact AE-2: Project construction would not create a new source of substantial light that would adversely affect day or nighttime views in the area.	Impact AE-3: Project operation would have a substantial adverse impact on a scenic vista, resource, or on the visual character of a site or its surroundings.	Impact AE-4: Project operation would not create a new source of substantial light that would adversely affect day or nighttime views in the area.	Impact C-AE-1: Construction and operation of the proposed Project could result in a cumulatively considerable contribution to cumulative impacts related to scenic resources and visual character.
Site 1	LS	LS	LS	LS	NI
Site 2	LS	NI	LS	LS	NI
Site 3	LS	LS	LS	LS	NI
Site 4	LSM	LS	LSM	LS	NI
Westlake Pump Station	NI	NI	NI	NI	NI
Site 5 (Consolidated Treatment)	LS	NI	NI	LS	NI
Site 5 (On-site Treatment Option)	LS	NI	LS	LS	NI
Site 6 (Consolidated Treatment and On-site options)	LS	NI	LS	NI	NI
Site 7 (Consolidated Treatment and On-site options)	SUM	NI	LSM	NI	NI
Site 8	LS	NI	LS	NI	LS
Site 9	LS	LS	LS	LS	LS
Site 10	LS	NI	LS	LS	NI
Site 11	LS	NI	LS	NI	LS
Site 12	LSM	LS	LS	LS	LSM
Site 13	LSM	NI	LS	LS	LSM
Site 14	LSM	LS	LSM	LS	NI

TABLE 5.3-4
Summary of Impacts – Aesthetics

Sites	Construction		Operation		Cumulative
	Impact AE-1: Project construction would have a substantial adverse impact on a scenic vista, resource, or on the visual character of a site or its surroundings.	Impact AE-2: Project construction would not create a new source of substantial light that would adversely affect day or nighttime views in the area.	Impact AE-3: Project operation would have a substantial adverse impact on a scenic vista, resource, or on the visual character of a site or its surroundings.	Impact AE-4: Project operation would not create a new source of substantial light that would adversely affect day or nighttime views in the area.	Impact C-AE-1: Construction and operation of the proposed Project could result in a cumulatively considerable contribution to cumulative impacts related to scenic resources and visual character.
Site 15	LSM	LS	LSM	LS	NI
Site 16	LS	LS	NI	LS	NI
Site 17 (Alternate)	LS	NI	LS	NI	LS
Site 18 (Alternate)	LSM	LS	LSM	LS	NI
Site 19 (Alternate)	LS	LS	LS	LS	LS

Notes:

NI = No Impact, LS = Less than Significant, LSM = Less than Significant with Mitigation, SUM = Significant and Unavoidable with Mitigation

5.3.3.4 Construction Impacts and Mitigation Measures

Impact AE-1: Project construction would have a substantial adverse impact on a scenic vista, resource, or on the visual character of a site or its surroundings. (Significant and Unavoidable with Mitigation)

The evaluation of impacts that follows discusses sites with no impacts first, followed by sites with less-than-significant impacts, and sites with significant impacts.

The proposed Project could result in temporary construction-related impacts on the visual character of the facility sites and surrounding areas. Direct views of the facility sites, including views of construction work areas, are available from public roadways and public areas in residential neighborhoods, from outdoor recreational facilities, and from cemeteries in the area. Construction activities would occur over a 16-month period for facilities with chemical treatment facilities and would range from four weeks to six months for well with fenced enclosure facilities (see Chapter 3, Project Description, Section 3.5.1 [Construction Sequencing and Schedule]).

The impact analysis for each well facility site references site layout figures found in Chapter 3, Project Description (Figures 3-6 through 3-8), in addition to the site photographs and simulations included this chapter.

Westlake Pump Station

The Westlake Pump Station is within a fenced public works yard adjacent to the Westlake Village Apartments on the north, the Ben Franklin Intermediate School grounds to the south and east, and a single-family residential neighborhood to the west (Figure 3-13). As noted in Section 5.3.1.3 (Individual Project Well Facility Sites) and in Table 5.3-1 (Summary of Visual Sensitivity Findings), this site has limited visual exposure, low visual quality, and low overall visual sensitivity.

Construction at the Westlake Pump Station would occur inside the existing buildings, with materials staging outside and within the existing fence that surrounds the property. Construction activities would have a temporary minor impact on the visual character of this area given that some materials would be staged outside the pump station building. However, the site has very limited exposure to potential viewers. The effect on overall visual sensitivity would be low with no change in visual contrast. In addition, the site would not be located within a scenic vista, nor along a designated scenic roadway. As a result, no scenic vistas, roadways, or resources would be affected. Therefore, there would be *no impact* on the visual character of the site and its surroundings, and there would be *no impact* on scenic roadways, resources, or vistas.

Impact Conclusion: No Impact

Sites 1, 2, 3, 5, 6, 8, 9, 10, 11, 16, 17 (Alternate), and 19 (Alternate)

Site 1

Site 1 would be located in the northeastern corner of the Lake Merced Golf Club, a privately owned and operated facility. This site is approximately 50 feet away from the fairways and lined by mature trees on the east, which partially obscure the view from I-280 to the east (Figure 3-11). The ground at this site is mostly bare, and a restroom facility of concrete block construction is situated in the southern part of the site. At the time of the site visit, piles of vegetative waste were being stored on the site. As noted in Section 5.3.1.3 (Individual Project Well Facility Sites) and in Table 5.3-1 (Summary of Visual Sensitivity Findings), this site has low visual exposure – though moderate visual sensitivity, moderate visual concern, and moderately low overall visual sensitivity.

Construction of the 1,480-square-foot well and chemical treatment facility at Site 1 (see Figure 3-11) would be visible from the end of Poncetta Drive, the Lake Merced Golf Club, and from a portion of the Westlake Village Apartments to the north. The facility would be approximately 40 feet west of I-280, which has been designated as eligible for the State Scenic Highway Program (see Table 5.3-2 [Designated State, County, and Local Scenic Roads in the Vicinity of Facility Sites], but would be partly screened by intervening vegetation along the eastern edge of the facility site. No scenic vistas or scenic roadways would be affected due to the existing screening between the highway and the site. Though it does not add to the visual quality of the site, the restroom facility currently on this site would be removed as part of the Project (see Chapter 3, Project Description, Section 3.4.3 [Facility Sites]). Views of the site from residences would be seen only by a few individuals in a private setting and would not be visible from public areas within the multi-family residential area. The site would be located above the golf links and golfers would have a relatively unobstructed view of the construction site during the 16-month construction period if

intervening vegetation is not of sufficient height to provide visual screening. However, the views from the golf links would not be publicly accessible and would be available only to the members and workers of this private golf club. Also, the apartments provide a developed backdrop when the site is viewed from the golf club. In this context, the visual quality of the area was rated as moderate because of scenic qualities of the golf club. Visual contrast at this site thus would be moderate. Therefore, the potential impact on the visual character of the site and its surroundings would be *less than significant*; whereas there would be *no impact* on scenic vistas or scenic roadways given that this site is, and would remain shielded from I-280 by existing trees.

Site 2

Site 2 would be located just outside the southwest corner of the Lake Merced Golf Club and south of the golf club maintenance access road (see Figure 3-12). This site is located immediately off the street at the edge of an extensive open space area comprised of playing fields of the Garden Village Elementary School and athletic fields at the Ben Franklin Intermediate School. As noted in Section 5.3.1.3 (Individual Project Well Facility Sites) and in Table 5.3-1 (Summary of Visual Sensitivity Findings), this site has moderate visual exposure, visual quality, and overall visual sensitivity.

Activities associated with construction of a fenced enclosure and associated pipelines at Site 2 (see Figure 3-6) would be visible from Park Plaza Drive, the Ben Franklin Intermediate School's athletic field and portions of the main campus. A new well would not be drilled at this site, as the existing test well would be converted to a production well. Views along Park Plaza Drive would be temporary and fleeting as drivers pass the site. Several single-family residences are above the athletic field to the south at the Ben Franklin School and several multi-family residences are located to the northwest of the site. Views of construction activities would be substantially blocked from the Lake Merced Golf Club by trees and shrubs. No trees or other scenic resources would be affected. In addition, the location is not within a scenic vista, nor along a designated scenic roadway. As a result, no scenic vistas, resources, or roadways would be affected.

As discussed above in Section 5.3.1.3 (Individual Project Well Facility Sites) the site has moderate visual quality that is characteristic of the surrounding area and the overall visual sensitivity of this location is also considered moderate. Construction activities (i.e., fencing, connecting pipelines) would take approximately four weeks at the site (see Chapter 3, Project Description, Section 3.5.1 [Construction Sequencing and Schedule]), and would be seen by a moderate number of viewer groups including motorists, students, and users of the school's athletic and playing fields. The relatively short construction duration would generate temporary, but moderate, visual change in the area. Coupled with the moderate overall visual sensitivity of the site and the moderate number of viewers at this site, the Project would result in a *less-than-significant* impact; whereas there would be *no impact* on scenic roadways, resources, or vistas at this site.

Site 3

Site 3 would be located in the southwest corner of the athletic field at the Ben Franklin Intermediate School (see Figure 3-12). The site is covered in turf and located behind a baseball backstop on the field. It

would be located at the foot of a slope, at the top of which single-family residences are located to the southwest. This puts the site low in the field of view from these residential areas. A small wooded area of tall eucalyptus trees directly adjoins the site to the east and southeast. As noted in Section 5.3.1.3 (Individual Project Well Facility Sites) and in Table 5.3-1 (Summary of Visual Sensitivity Findings), this site has moderate visual exposure, visual quality, and overall visual sensitivity.

Construction of the well with a fenced enclosure at Site 3 (see Figure 3-6) would be visible to a variety of viewer groups from Park Plaza Drive, the Ben Franklin Intermediate School athletic field, single-family residences located to the south and southwest on White Street and Maddux Drive, and the Westlake Village Apartments to the north. Pipeline construction in the athletic field, happening concurrently with the well facility construction, would also be visible from multi-family housing to the north. Construction at Site 3 would occur for a total of six months during two three-month construction periods and would occur during non-school months precluding its use for non-school activities (see Chapter 3, Project Description, Section 3.5.1[Construction Sequencing and Schedule]). Therefore, the potential number of viewers at the site would be reduced during construction.

Site 3 would not be located within a scenic vista, nor along a designated scenic roadway; the Project would not affect these resources. There would be *no impact* on scenic roadways, resources, or vistas at this site. The overall visual sensitivity is considered moderate. Although construction would temporarily degrade visual character during the two three-month construction periods, the duration and number of viewers would be limited in each case because construction would occur during non-school time, resulting in moderate visual change. Therefore, this would constitute a *less-than-significant* visual impact.

Site 5

Site 5 would be located in a vacant paved lot between a State Farm Insurance Agency office and a single-family residence (Figures 3-15 and 3-19). The parking lot for the former Serra Bowl is adjacent to the south, with the Serra Bowl building beyond the parking lot. B Street creates the north border of the site; an automobile dealership is located across B Street from the site. As noted in Section 5.3.1.3 (Individual Project Well Facility Sites) and in Table 5.3-1 (Summary of Visual Sensitivity Findings), this site has moderate visual exposure, low visual quality, and moderately low overall visual sensitivity.

The facility at Site 5 would include a well with a fenced enclosure for the consolidated treatment at Site 6 option (see Figure 3-6 and Figure 3-14). The fenced enclosure and pipelines to deliver water to Site 6 for treatment would require approximately three months to construct (see Chapter 3, Project Description, Section 3.5.1 [Construction Sequencing and Schedule]). A 2,095-square-foot well and chemical treatment facility would be constructed for the on-site treatment option; construction of the well facility would take approximately 16 months to complete if treatment cannot occur at Site 6. The layout for on-site treatment is shown on Figures 3-18 and 3-19 in Chapter 3, Project Description.

Construction at Site 5 would be visible to surrounding commercial buildings, pedestrians along B Street, and the single-family residence east of the site. Construction of the pipeline from Site 5 to Site 6 would be visible to pedestrians and motorists along Hill Street, D Street, surrounding commercial buildings, and BART patrons using the Colma station. However, the location is not within a scenic vista, nor along a

designated scenic roadway. As a result, no scenic vistas, resources, or roadways would be affected. Construction activities would have a temporary minor impact on the visual character of this largely developed commercial area, given that views of the construction activities from roadways would be temporary and fleeting and the overall visual quality is moderately low. The area is not seen by sensitive viewers and construction would generate only moderate visual contrast or change in the area. Therefore, the impact on the visual character of the site and its surroundings would be *less than significant*; whereas there would be *no impact* on scenic roadways, resources, or vistas at this site.

Site 6

Site 6 would be situated on a grassy area along the south side of D Street, across from the Colma BART station, which dominates views of the area (Figures 3-16 and 3-20). The SamTrans Park and Ride lot is located upslope from this site to the southwest, beyond a row of trees. The pedestrian bridge over D Street linking the parking lot to the station has a clear view of this site. The Woodlawn Memorial Park is located to the south and upslope. The immediately adjacent portion of the cemetery is used for outdoor materials storage. As noted in Section 5.3.1.3 (Individual Project Well Facility Sites) and in Table 5.3-1 (Summary of Visual Sensitivity Findings), this site has high visual exposure – but low viewer concern, low visual quality, and low overall visual sensitivity.

The proposed Project at Site 6 would include construction of a 2,990-square-foot, well, chemical treatment, and filtration facility for either the consolidated treatment at Site 6 option or a 2,095-square-foot facility for the on-site treatment option (see Figures 3-8, 3-16, and 3-20). Site 6 would be visible to travelers along D Street and to BART patrons. While El Camino Real is a Colma-designated scenic corridor and its intersection with F Street is designated as a Town gateway, this site would not be visible from either due to intervening vegetation and buildings. In addition, the location is not within a scenic vista. As a result, no scenic vistas, resources, or roadways would be affected.

Construction activities at Site 6 would not be visible from the publicly accessible portions of Woodlawn Memorial Park. The nearest portion of the memorial park from which the site could be visible would be an outdoor materials storage area, which is not open to the public. Also, intervening topography and vegetation (i.e., trees) further block views to Site 6 from this cemetery. Existing views from this portion of Woodlawn Memorial Park may include the Colma BART station and the SamTrans Park and Ride lot also adjacent to Site 6; however, this site would be out of view in these vistas as it would be below and out of the line of sight. The overall visual sensitivity of this site is considered low given its immediate surroundings and the fact that it is screened from potentially sensitive vistas. The change in visual contrast would also be considered low, given the visual environment at and around this site, as described here. Therefore, the impact on the visual character of the site and its surroundings would be *less than significant*; whereas, there would be *no impact* on scenic roadways, resources, or vistas at this site.

Site 8

Site 8 would be located in a narrow grassy strip surrounded by various large-scale commercial establishments in a segment of Serramonte Boulevard lined by car dealerships, Kohl's Department Store and its associated parking. The streetscape is thus dominated by unscreened parked automobiles, little

landscaping and low visual unity. Site 8 would be shielded from view on all sides except the northeast due to depressed topography. As noted in Section 5.3.1.3 (Individual Project Well Facility Sites) and in Table 5.3-1 (Summary of Visual Sensitivity Findings), this site has limited visual exposure, low visual quality, and low overall visual sensitivity.

Construction of the 2,095-square-foot well, chemical treatment, and filtration facility at Site 8 (see Figures 3-8 and 3-22) would be visible from Serramonte Boulevard, Kohl's Department Store rear parking lot, adjacent car dealerships, and distantly from Collins Avenue where it crosses the SFPUC's right-of-way (see Figure 3-22). However, the location is not within a scenic vista, nor along a designated scenic roadway. As a result, no scenic vistas, resources, or roadways would be affected. Construction activities would extend for more than one year, but no sensitive viewers would be affected given the temporary and random presence of potential viewers and the location of the site away from areas frequented by viewers. Construction at Site 8 would have a temporary minor impact on the visual character of this commercial area. However, the effect on overall visual sensitivity would be low, as would the change in visual contrast. Therefore, the impact on the visual character of the site and its surroundings would be *less than significant*; whereas there would be *no impact* on scenic roadways, resources, or vistas at this site.

Site 9

Site 9 would be located on an existing undeveloped parcel between the concrete-lined Colma Creek Diversion and San Mateo County Flood Control channels. The site, in a mixed commercial/residential area, is triangular in shape and covered with low-growing ruderal vegetation and has a lone tree at its center. The site and surroundings are devoid of vivid or attractive visual features, and dominated by the adjacent concrete flood channels and the neighboring Costco parking lot. As noted in Section 5.3.1.3 (Individual Project Well Facility Sites) and in Table 5.3-1 (Summary of Visual Sensitivity Findings), this site has limited visual exposure, low visual quality, and low overall visual sensitivity.

Construction activities for a 2,095-square-foot well, chemical treatment, and filtration facility at Site 9 (see Figures 3-8, 3-23, and 3-24) would be visible from a portion of the Treasure Island Trailer Court, the Costco parking lot, a bicycle and pedestrian path, as well as the Verano Condominiums and other single-family residences on Mission Road to the southeast. However, the location is not within a scenic vista, nor would it be visible from any nearby designated scenic roadways. As a result, no scenic vistas, resources, or roadways would be affected by development of this site, including removal of the one Monterey pine. Therefore, there would be *no impact* on scenic roadways, resources, or vistas due to construction at this site.

Construction activities would have a temporary minor impact on the visual character of this largely developed commercial area for the duration of the 16-month construction period. Given the overall visual quality of the site, the visual contrast or change generated by the Project would be low. There are no sensitive viewers, except for residences; however, the views of the site from residences would be seen by only a few individuals in a private setting. As a result, the visual sensitivity of the site is low. Therefore, construction at the site would not degrade or detract from the visual character of the area, and the impact would be *less than significant*.

Site 10

Site 10 would be located on an undeveloped grassy lot on the southwest corner of Hickey Boulevard and Camaritas Avenue. Trees line the west side of the lot, separating it from the single-family residences beyond Crown Circle to the west. The site slopes upward to the south and remains undeveloped, though single-family residences line Camaritas Avenue beyond stands of mature trees to the southeast. The Winston Manor Shopping Center is located to the east with a Chevy's Restaurant closest to the site across Camaritas Avenue. Immediately to the north across Hickey Boulevard, the topography slopes steeply upward providing partial views through mature trees of the fenced rear yards of single-family residences that front on Duval Drive. The site is not visible from publicly accessible areas in the residential neighborhood. The site is in an area transitioning from commercial strip development of low visual quality to a residential one marked by substantial large-scale tree canopies and grass slopes. As noted in Section 5.3.1.3 (Individual Project Well Facility Sites) and in Table 5.3-1 (Summary of Visual Sensitivity Findings), this site has high visual exposure – though moderate visual sensitivity, moderately low visual quality, and moderate overall visual sensitivity.

Construction of a 2,095-square-foot well, chemical treatment, and filtration facility at Site 10 (see Figures 3-8, 3-25, and 3-26) would be visible from Hickey Boulevard, Camaritas Avenue, the Winston Manor Shopping Center, and from residences across Hickey Boulevard and on Camaritas Avenue (see Figure 3-25). The site would not be visible from the residential area to the west on Crown Circle, due to dense landscaping and topography. The overall visual sensitivity of this site is considered moderate and the change in visual contrast would also be considered moderate (see Section 5.3.1.3 [Individual Project Well Facility Sites]). Construction activities would occur over a 16-month period, with the presence of heavy construction equipment and materials that would temporarily change the visual character of the area. Given the visual environment at and around this site, the overall visual sensitivity and change in visual contrast of this site are considered moderate. Therefore, the Project would have a *less-than-significant* visual impact on the visual character of the site and its surroundings.

In addition, the location is not within a scenic vista nor would it be visible from any nearby scenic roadways. As a result, no scenic vistas resources, or roadways would be affected. Therefore, there would be *no impact* on scenic roadways resources, or vistas.

Site 11

Site 11 would be located next to a BART ventilation structure between El Camino Real and Mission Road northwest of Chestnut Avenue and Antoinette Lane (Figures 3-27 and 3-28). The site is covered in gravel with the adjacent slope covered in unmaintained grasses and mature trees. The topography and a row of trees along this portion of El Camino Real obstruct views of the site and the BART ventilation structure just beyond. The BART ventilation structure partially obstructs views of the site from the Centennial Way Trail to the east. To the north of the site is a five-story parking garage and surface parking lot for the Kaiser Permanente Medical Center. The remainder of the surrounding land is vacant or commercial without any visually notable features. As noted in Section 5.3.1.3 (Individual Project Well Facility Sites) and in Table 5.3-1 (Summary of Visual Sensitivity Findings), this site has limited visual exposure, low visual quality, and moderately low overall visual sensitivity.

Construction of the 2,095-square-foot well, chemical treatment, and filtration facility structure at Site 11 (see Figures 3-8, 3-27, and 3-28) itself would not be visible from El Camino Real given intervening topography and vegetation. The visual sensitivity in the area of Site 11 is moderately low, as it would be located within a transit service corridor. The location is not within a scenic vista, nor along a designated scenic roadway. However, it would be viewed briefly by pedestrians and bicyclists on the Centennial Way Trail along the Colma Creek Diversion Channel, although this view is also partially blocked by an existing BART ventilation structure, giving it low visual quality. Trail users would have a temporary, fleeting, and partially obstructed view of Site 11, which would not significantly detract from their trail use experience. Water pipeline construction would be visible from El Camino Real and adjacent commercial areas, and sanitary sewer construction would be similarly visible from Antoinette Lane. Construction of Site 11 would remove up to seven Lombardy poplars and one Torrey pine tree. In addition, seven other trees adjacent to the construction zone may need to be trimmed. While construction would extend for approximately 16 months, the trees to be removed provide little value as visual buffers from area public vantage points. The Project would generate moderately low visual change. Motorists and pedestrians along El Camino Real would have a temporary and fleeting view of the construction area once the trees are removed. Therefore, the impact on the visual character of the site and its surroundings would be *less than significant*; whereas there would be *no impact* on scenic roadways resources, or vistas at this site.

Site 16

Site 16 would be located on SFPUC right-of-way behind the Orchard Supply Hardware store along El Camino Real (see Figure 3-37). To the east are the Caltrain line and a large electrical substation and tower. To the south is the three-story Millbrae Manor Apartments. As noted in Section 5.3.1.3 (Individual Project Well Facility Sites) and in Table 5.3-1 (Summary of Visual Sensitivity Findings), this site has limited visual exposure, low visual quality, and low overall visual sensitivity.

Construction of a 1,480-square-foot well and chemical treatment facility at Site 16 (see Figure 3-7), including pipeline construction, would be visible from the Orchard Supply Hardware store parking lot, Caltrain, and the three-story Millbrae Manor Apartments to the south. The visual quality of the site is rated as low because of the commercial nature of the area and because the site has low visibility from public vantage points.

Although construction activities would occur over a 16-month period near residences, views from the multi-family residential areas would be seen by only a few individuals in a private setting. Construction at the site would not be visible from public viewing areas within the residential areas. In addition, the visual quality of the site is ranked as low and the number of affected viewers is low. The overall visual sensitivity is, therefore, considered low for the site. Given the existing appearance of the site, there would be minimal visual change during Project construction. Therefore, visual-related construction impacts would be *less than significant*. The location is not within a scenic vista nor would it be visible from any nearby scenic roadways. As a result, there would be *no impact* on scenic roadways, resources, or vistas at this site.

Site 17 (Alternate)

Site 17 (Alternate) would be located in a flat, grassy area adjacent to the SFPUC right-of-way and next to Standard Plumbing Supply on a relatively lightly traveled section of Collins Avenue (See Figure 3-38). The right-of-way, which is covered in grasses in this area, slopes up from Collins Avenue toward Cypress Lawn Memorial Park to the south, but is visually isolated from the cemetery by sloping terrain and tree cover. The Standard Plumbing Supply property is surrounded by chain link fence with exposed parking. The vicinity is typified by various commercial/light-industrial land uses. As noted in Section 5.3.1.3 (Individual Project Well Facility Sites) and in Table 5.3-1 (Summary of Visual Sensitivity Findings), this site has moderate visual exposure – though low visual sensitivity, moderate visual quality, and low overall visual sensitivity.

Construction of a 1,495-square-foot well and chemical treatment facility at Site 17 (Alternate) (see Figure 3-7 and 3-38) would be visible from Collins Avenue and the Standard Plumbing Supply store adjacent to the site to the west. The site would be located north of the Cypress Lawn Memorial Park, which is a representative example of picturesque cemetery design in Colma (see Figure 3-38). However, due to steep intervening topography, the store building and fencing, construction activities at the site would not be directly visible from publicly-accessible areas in Cypress Lawn. The site is not within a scenic vista nor would it be visible from any nearby scenic roadways, as a result no scenic vistas, resources, or roadways would be substantially affected. Construction would occur for approximately 16 months, but would not affect sensitive viewers given the temporary and random presence of potential viewers and the location of the site away from areas frequented by viewers. The effect on overall visual sensitivity would be low, as would the change in visual contrast. Therefore, the impact on the visual character of the site and its surroundings would be *less than significant*; whereas there would be *no impact* on scenic roadways, resources, or vistas at this site.

Site 19 (Alternate)

Site 19 (Alternate) would be across Southwood Drive from Site 12 and situated between the Our Redeemer's Lutheran Church and single-family residences fronting on Fairway Drive (see Figure 3-40). The site, covered in mowed grassy vegetation, is partially screened by fences and vegetation from these single-family residences. Multi-family residential developments are also located to the north of this site and have limited views of the site through intervening landscape vegetation and trees. As noted in Section 5.3.1.3 (Individual Project Well Facility Sites) and in Table 5.3-1 (Summary of Visual Sensitivity Findings), this site has moderate visual exposure, visual quality, and overall visual sensitivity.

The construction zone for the fenced well facility site would be located behind the Our Redeemer's Lutheran Church, where it would be visible from the rear of the church and the R. W. Drake Preschool on church property. Construction of a fenced well facility at Site 19 (Alternate) (see Figure 3-6) would be visible from Southwood Drive, single-family residences to the west, multi-family residential uses to the north, and the Garden Chapel Funeral Home across Southwood Drive. The site is not within a scenic vista nor would it be visible from any nearby scenic roadways. As a result no scenic vistas, resources, or roadways would be substantially affected. Construction would occur for approximately three months, but would not affect sensitive viewers given the temporary presence of potential viewers and the

location. Therefore, the impact on the visual character of the site and its surroundings would be *less than significant*; whereas there would be *no impact* on scenic roadways, resources, or vistas at this site.

Impact Conclusion: Less than Significant

Sites 4, 12, 13, 14, 15, and 18 (Alternate)

Site 4

Site 4 would be located on a lot adjacent to Park Plaza Drive in the southwest corner of the Garden Village Elementary School grounds. The site is atop a slope above the school's playing fields covered with grassy vegetation. It is adjacent to single-family residences that front onto 87th Street to the south and other single-family residences across Park Plaza Drive fronting onto White Street to the west. As noted in Section 5.3.1.3 (Individual Project Well Facility Sites) and in Table 5.3-1 (Summary of Visual Sensitivity Findings), this site has moderately high visual exposure, visual quality, and overall visual sensitivity.

Construction activities associated with the fenced well facility at Site 4 (see Figure 3-6) would be visible from Park Plaza Drive and 87th Street, the Garden Village Elementary School and from single-family residences located to the south and west (see Figure 3-12). Pipeline construction along Park Plaza Drive would also be visible from multi-family housing to the north and the Ben Franklin Intermediate School athletic field. However, the location is not within a scenic vista nor would it be visible from any nearby scenic roadways. As a result, no scenic vistas or scenic roadways would be affected and *no impact* on such resources would be generated.

The visual quality and overall visual sensitivity of the site are identified as moderately high since the site is visible by motorists, recreationalists, and residences. In addition to the trimming of two trees on adjacent properties that may be needed, construction activities at Site 4 would require the removal of up to 19 acacia and five Monterey cypress trees. The removal of these trees would be permanent, as the SFPUC's Integrated Vegetation Management Policy requires vegetation of any size not be allowed to grow within certain critical portions of its rights-of-way (SFPUC 2007). Although not designated visual resources or of a "protected status", the removal of these trees would change the site's appearance and open the area up to views otherwise blocked by existing vegetation within the construction area boundary. This, coupled with a direct view of construction activities and materials storage, would constitute a high degree of visual change in the site's appearance during the three-month construction period and would constitute a *significant* impact.

Implementation of Mitigation Measure M-AE-1a (Site Maintenance) would reduce visual impacts to *less-than-significant* levels through maintaining a relatively clean and inconspicuous construction area. With this mitigation measure, coupled with the three-month temporary construction period, the resulting visual impact would be considered *less than significant with mitigation*.

Mitigation Measure M-AE-1a: Site Maintenance (Sites 4, 7, 12, 13, 14, 15, and 18 [Alternate])

The SFPUC shall require the contractor to ensure that construction-related activity is as clean and inconspicuous as practical by storing construction materials and equipment at areas of the

construction site that are generally away from public view, and by removing construction debris promptly at regular intervals.

Site 12

Site 12 is currently comprised of the Garden Chapel Funeral Home parking lot, a grassy area with a dirt access for the SFPUC right-of-way, and a dense row of Monterey pine, Monterey cypress, eucalyptus, and Aleppo pine shielding it from view from El Camino Real (see Figures 3-29 and 3-30). These trees are contributing resources in the City of South San Francisco's streetscape plan for El Camino Real, as noted in General Plan Implementing Policy 3.4-1-1. The site is partially screened by fences and vegetation from the single-family residences to the southwest fronting on Fairway Drive. The site is not visible from publicly accessible areas in the residential neighborhood. As noted in Section 5.3.1.3 (Individual Project Well Facility Sites) and in Table 5.3-1 (Summary of Visual Sensitivity Findings), this site has moderate visual exposure, moderate visual sensitivity, moderate visual quality, and moderately high overall visual sensitivity to funeral home visitors and motorists.

Construction of a 1,495-square-foot well and chemical treatment facility at Site 12 (see Figure 3-7), including pipeline construction, would be visible from El Camino Real, Southwood Drive, residences to the west, and from the Garden Chapel Funeral Home. Because the construction area would be about 20 feet from the funeral home and clearly visible, the view of construction activities could be disturbing to funeral home visitors. Facility and pipeline construction activities would occur over a 16-month period and potentially scenic resources would be affected, given that 10 Monterey cypress, 13 Monterey pine, nine dwarf blue gum, three Tasmanian blue gum, and one Aleppo pine tree would be removed at this location to accommodate construction of the well facility at Site 12, including installation of the proposed pipeline that would extend along El Camino Real to the southeast, toward the intersection with West Orange Avenue. To accommodate the temporary construction activities, the removal of these trees would be permanent, as the SFPUC's Vegetation Management Policy (SFPUC 2007) requires vegetation of any size not be allowed to grow within certain critical portions of its rights-of-way.

The overall visual sensitivity of this site is considered moderately high and the change in visual contrast would be considered moderate, given the visual environment at and around this site as described above. The Project would have a *significant* impact to visual resources, as discussed below.

The removal of these 36 mature trees would have a *significant* impact on the visual character of the site and its surroundings. These trees, identified as contributing resources in the City of South San Francisco streetscape plan for El Camino Real, enhance the visual character and quality of this site (see the discussion of Site 12 in Section 5.3.1.3 [Individual Project Well Facility Sites], above, and Chapter 4, Plans and Policies, Section 4.2.4.1 [General Plans]). Their removal would open up views of the construction equipment, materials, and activities and result in a *significant* impact.

However, Mitigation Measure M-AE-1b (Tree Protection Measures) and Mitigation Measure M-AE-1c (Develop and Implement a Tree Replanting Plan) would reduce aesthetic impact at this site to a *less-than-significant* level through identification of trees that would be protected during construction, protection of the trees identified, and by replanting trees along El Camino Real to replace the trees removed or

damaged during construction of the pipeline for Site 12. In addition, since the location is not within a scenic vista nor would it be visible from any nearby scenic roadways, there would be *no impact* on designated scenic roadways, resources, or vistas at this site.

Mitigation Measure M-AE-1b: Tree Protection Measures (Sites 3, 4, 7, 10, 11, 12, 13, 14, 15, and 17 [Alternate])⁵

The SFPUC shall identify trees to be protected and retained during construction and minimize potential impact to these trees by implementing the following measures:

- Construction activities within the dripline of trees to be retained adjacent to construction area boundaries or adjacent to pipeline routes shall be avoided.
- A qualified arborist shall identify the location of exclusion fencing to be installed around trees to be retained.
- Prior to the start of construction, the SFPUC or its contractor shall install exclusion fencing around the dripline of trees to be retained and within 50 feet of any grading or construction activity.
- Prior to construction, the SFPUC shall verify that the temporary construction fencing is installed and approved by a qualified arborist. Any encroachment within these areas must first be approved by a qualified arborist and the SFPUC. Temporary fencing shall be continuously maintained by the contractor until all construction activities near the trees are completed. No construction activities shall occur within the exclusion fencing.
- For trees on slopes, exclusion fencing shall consist of a silt fence that will be installed at the upslope base of the tree to prevent soil from moving into the root zone (defined as the extent of the tree dripline) if work is performed upslope of any protected trees.
- Pruning of trees to be retained shall be completed by either a certified arborist or by the contractor under supervision of either an International Society of Arboriculture qualified arborist, American Society of Consulting Arborists consulting arborist, or a qualified horticulturalist.

⁵ Impact AE-1 is not significant for Sites 3, 4, 7, 10, 11, 13, 14, and 17 (Alternate), however the sites are listed here because tree protection measures are required to reduce impacts to trees protected by local tree preservation ordinances as described under Impact BR-4 in the Biological Resources section.

Mitigation Measure M-AE-1c: Develop and Implement a Tree Replanting Plan (Site 12)

The SFPUC shall develop and implement a tree replanting plan to address the removal of trees along El Camino Real at Site 12. The tree replanting plan shall include planting locations (which may include non-SFPUC properties), native tree and shrub species (consistent with those near the well facility site), planting ratios, and irrigation requirements. Tree replanting activities occurring on SFPUC properties or right-of-way shall be consistent with the requirements of the SFPUC's Integrated Vegetation Management Policy (SFPUC 2007). The planting ratio for replacement trees shall be a minimum of 1:1, or in substantial compliance with the City of South San Francisco's tree preservation ordinance (Chapter 13.30.080, Replacement of Protected Trees). Replanting shall occur the first year after completion of construction. The SFPUC shall monitor the replacement trees annually for five years after project completion to ensure that the trees survive; if necessary, the SFPUC shall implement additional measures, such as replanting for trees that did not survive.

Considering the presence of equipment and the duration of construction, and the visibility of the construction area, these activities would have a temporarily *significant* impact on the visual character of the site and its surroundings, as viewed from the funeral home and nearby residences. However, implementation of Mitigation Measure M-AE-1a (Site Maintenance) at this site would mitigate this temporary aesthetic impact to a *less-than-significant* level by requiring that construction activities be as inconspicuous as practical by keeping construction materials and equipment away from public view and keeping staging areas clean. The location is not within a scenic vista, nor would it be visible from any nearby scenic roadways. As a result, there would be *no impact* on scenic roadways or scenic vistas at this site.

Mitigation Measure M-AE-1a: Site Maintenance (Sites 4, 7, 12, 13, 14, 15, and 18 [Alternate])

(See Impact AE-1, Site 4 for a description)

Site 13

Site 13 would be located on an undeveloped parcel on the southeast side of South Spruce Avenue covered with unmaintained grassy vegetation (see Figure 3-31). It is bordered by a two-story retail/office building and parking lot on the west and a large beverage distribution warehouse on the east. Between the warehouse and the site is the Centennial Way Trail, with an interpretive panel with a trail map at the entrance on South Spruce Avenue. A fenced-in, buried utility vault is located between the site and the pathway. The trail continues immediate across South Spruce Avenue with a large industrial bakery to the north and single-family residential neighborhood to the south of the trail. As noted in Section 5.3.1.3 (Individual Project Well Facility Sites) and Table 5.3-1 (Summary of Visual Sensitivity Findings), this site has high visual exposure – though moderate visual sensitivity, moderate visual quality, and moderately high overall visual sensitivity.

Construction of a 2,095-square-foot, well, chemical treatment, and filtration facility at Site 13 (see Figures 3-8 and 3-31) would be visible from South Spruce Avenue, the commercial and industrial uses in the area (i.e., Freeman Warehouse, a credit union, a car wash, San Mateo County offices, Orowheat commercial bakery), the Francisco Drive residential neighborhood across South Spruce Avenue, and from the Centennial Way Trail. The site is not visible from publicly accessible areas in the residential

neighborhood. The Centennial Way Trail is directly adjacent to the proposed location for Site 13. Utility pipeline construction would happen concurrently with the well facility construction and would be visible from Huntington Avenue and the commercial and office uses in this area (e.g., County offices, Tanforan Professional Center, Century Plaza theaters). However, the location is not within a scenic vista nor would it be visible from any nearby scenic roadways. As a result, no scenic vistas, resources, or roadways would be affected.

With the presence of the trail, the overall visual sensitivity of this site is considered moderately high and the change in visual contrast would also be considered moderately high. Given the presence of equipment, construction materials and 16-month construction period, these activities would have a temporary *significant* impact on the visual character of the site and its surroundings, as viewed from nearby residences and by trail users, passers-by, and patrons of nearby commercial establishments. However, with implementation of Mitigation Measure M-AE-1a (Site Maintenance), this temporary aesthetic impact would be mitigated to a *less-than-significant* level by requiring that construction activities are screened from view at street level and staging areas are kept clean. There would be *no impact* on scenic roadways, resources, or vistas at Site 13.

Mitigation Measure M-AE-1a: Site Maintenance (Sites 4, 7, 12, 13, 14, 15, and 18 [Alternate])
(See Impact AE-1, Site 4 for a description)

Site 14

Site 14 would be located on the northern side of the GGNC within a grassy area of the SFPUC right-of-way between the gravesites and close to an existing unused pump station, tank, and well in the cemetery (Figures 3-34 and 3-35). The facility would be in proximity to the single-family neighborhood adjacent to the north along Greenwood and Rockwood Drives, which are screened from the site by fences and mature trees. Site 14 would not be visible from the public roads surrounding the cemetery (i.e., Sneath Lane) due to distance, topography, and intervening trees, but it would be visible from internal roadways in this section of the cemetery. The conveyance pipeline connecting the well at Site 14 with the treatment facility at Site 15 and the site's storm drain would be within the SFPUC right-of-way and the pipelines would traverse the cemetery to Sneath Lane. Through landscape vegetation, construction of the pipeline would be partially visible from publicly accessible areas of the Peninsula Place apartment complex at Sneath Lane and Cherry Avenue. As noted in Section 5.3.1.3 (Individual Project Well Facility Sites) and Table 5.3-1 (Summary of Visual Sensitivity Findings), this site has high visual exposure, visual quality, and overall visual sensitivity.

Construction of a well facility at Site 14 (see Figure 3-6) – including a small 700-square-foot building and approximately 1,100 feet of pipeline in the SFPUC right-of-way through the cemetery and along Sneath Lane – would be visible from the GGNC and partially visible from single-family residences to the north, the Peninsula Place apartment complex, and from Sneath Lane, a locally designated scenic roadway.

Construction would require up to 16 months to complete (see Chapter 3, Project Description, Section 3.5.1 [Construction Sequencing and Schedule]) for the well, well building, pipeline, and storm drain. As noted in the description of Site 14 in Section 5.3.1.3 (Individual Project Well Facility Sites), there is an unused

pump station, tank, and well in the cemetery in close proximity to Site 14. The Project may include demolition and removal of the existing unused well enclosure and tank, which would remove an existing structure that is aesthetically inconsistent with the visual character of the site and surrounding area, given its location in a military cemetery. The removal of that structure would partially offset the impact of the substantial visual change with the proposed new facility.

Construction of the 1,100-foot pipeline would take two to four weeks. Visitors to the northeastern portion of the cemetery would see the pipeline construction and would need to pass the construction area to reach gravesites on both sides of the pipeline route. Another 650 feet of pipeline would be constructed in Sneath Lane adjacent to the cemetery, requiring two to three weeks. This pipeline construction would be concurrent with construction of the well facility building. This pipeline construction in Sneath Lane would not be highly visible from the street level along publicly accessible areas at Peninsula Place apartments due to intervening vegetation. None of the construction area would be visible from the main cemetery entrance and circular monument, which is located about 1,600 feet away to the west.

Well facility and pipeline construction would be visible to visitors in the cemetery. However, the relatively brief and likely infrequent nature of visits to the cemetery by any one individual means that relatively few visitors would be affected by construction activities over the 16-month duration at this location. Therefore, given the low level of traffic and low numbers of viewers over the 16-month construction period, construction activities at Site 14 are considered to have low visual change or contrast. Although construction would be viewed by relatively few people over the construction period, given the high visual quality and the high visual sensitivity of the area, the Project would result in *significant* aesthetic impacts due to its strong contrast with the cemetery during construction. However, implementation of Mitigation Measure M-AE-1a (Site Maintenance) would reduce visual impacts to a *less-than-significant* level through maintaining a relatively clean and inconspicuous construction area during the entire construction period and for all phases of construction in the GGNC. The impact would be further reduced by the requirement in Mitigation Measure M-CR-1a (Minimize Construction-related Impacts on Elements of the Historical Resource at Site 14) to restore grass over the pipeline trench following pipeline installation. With these mitigation measures, coupled with the 16-month temporary construction period, the resulting visual impact would be *less than significant with mitigation*.

Mitigation Measure M-AE-1a: Site Maintenance (Sites 4, 7, 12, 13, 14, 15, and 18 [Alternate])
(See Impact AE-1, Site 4 for a description)

Mitigation Measure M-CR-1a: Minimize Construction-related Impacts on Elements of the Historical Resource at Site 14
(See Impact CR-1 in Section 5.5, Cultural and Paleontological Resources for a description)

Site 14 would not be visible from a State designated scenic roadway (e.g., I-280) nor from a scenic vista. Construction of the storm drain and pipeline connection to Site 15 would be visible in Sneath Lane, a locally designated scenic roadway. However, pipeline and storm drain construction is expected to take place concurrently over a two to four week period. Given this relatively short duration, the Project would have a *less-than-significant impact* on such aesthetic resources.

Site 15

Site 15 would be located within the GGNC, situated on a grassy area along the southern edge of the cemetery between Sneath Lane and the cemetery's operations and maintenance yard, which includes buildings designed to be sensitive to the surrounding portions of the cemetery (see Figure 3-36). This site is located at an auxiliary entrance to the GGNC from Sneath Lane. A commercial/office park and a Veteran's Administration Medical Clinic are located to the south across Sneath Lane and are shielded from view somewhat by mature trees and landscaping. As noted in Section 5.3.1.3 (Individual Project Well Facility Sites) and in Table 5.3-1 (Summary of Visual Sensitivity Findings), this site has high visual exposure, moderately high visual quality, and moderately high visual sensitivity.

Construction of a 2,095-square-foot, well, chemical treatment, and filtration site facility at Site 15 (see Figure 3-8), including pipeline construction, would be visible from the GGNC and from Sneath Lane, which is a locally designated scenic route. Construction would last approximately 16 months. Construction of the well facility at Site 15 would require the removal of one elm tree next to one of the operations and maintenance buildings north of Sneath Lane at the GGNC auxiliary entrance (see photo in Figure 5.3-13 [Visual Simulation of Site 15], with the caption "Visual Simulation of Site 15 without Mitigation"). With the primary view being from Sneath Lane, removal of the tree would alter views of the site.

In addition, the pipeline in Sneath Lane would be approximately 650 feet and would be constructed in two to four weeks concurrent with the well facility structure. This pipeline construction would not be highly visible from the street level along publicly accessible areas at the Peninsula Place apartment complex at Sneath Lane and Cherry Avenue due to intervening vegetation. Also, none of the construction area would be visible from the main cemetery entrance and circular monument, which is located about 1,600 feet away to the west. Well facility construction would be limited to a narrow area between Sneath Lane and the existing cemetery operations and maintenance building.

The overall visual sensitivity and change in visual contrast of this site is considered moderately high, given the varied visual environment at and around this site located within the GGNC. Construction of the well facility at Site 15 would result in a *significant* aesthetic impact on Sneath Lane given that Sneath Lane is a scenic roadway, the number of passers-by and the peaceful visual nature of the cemetery. However, implementation of Mitigation Measure M-AE-1a (Site Maintenance), Mitigation Measure M-AE-1d (Construction Area Screening), and Mitigation Measure M-AE-1b (Tree Protection Measures) at this site would reduce this aesthetic impact to a *less-than-significant* level by requiring that construction activities are screened from view at street level, construction areas are kept as clean and inconspicuous as feasible, and protects the existing elm tree from removal.

Mitigation Measure M-AE-1a: Site Maintenance (Sites 4, 7, 12, 13, 14, 15, and 18 [Alternate])
(See Impact AE-1, Site 12 for a description)

Mitigation Measure M-AE-1d: Construction Area Screening (Site 15)

The SFPUC and its contractors shall screen the construction area at the facility site at Site 15. Screening shall be designed to minimize view of construction equipment and construction activities from views from Sneath Lane and the surrounding areas. Vehicles and other construction equipment shall be parked in the screened construction area at night and when equipment is not actively being used for pipeline construction along Sneath Lane.

Mitigation Measure M-AE-1b: Tree Protection Measures (Sites 3, 4, 7, 10, 11, 12, 13, 14, 15, and 17 [Alternate])

(See Impact AE-1, Site 12 for a description)

Pipeline and treatment facility construction associated with Site 15 would occur along Sneath Lane, a locally designated scenic roadway. However, the location is not within a State designated scenic roadway (e.g., I-280) nor a scenic vista. As a result, there would be a *no impact* on scenic vistas or resources at this site.

Site 18 (Alternate)

Site 18 (Alternate) would be located on an undeveloped parcel in a residential neighborhood along Alta Loma Drive on a knoll at street level overlooking a lower, moderately sloped grassy swale (see Figure 3-39). The site is densely vegetated with a small stand of willows that is about 15 feet high and covering approximately 3,400 square feet. It is adjacent to single-family residences to the southwest fronting on Del Monte Avenue and others directly across Alta Loma Drive. Single-family residences also front on Camaritas Avenue to the east. Vivid elements in the vicinity include views to forested hillsides to the south and San Bruno Mountain to the north. As noted in Section 5.3.1.3 (Individual Project Well Facility Sites) and in Table 5.3-1 (Summary of Visual Sensitivity Findings), this site has high visual exposure – though moderately high viewer concern, moderate visual quality, and moderately high overall visual sensitivity.

Construction of a 1,495-square-foot well and chemical treatment facility at Site 18 (Alternate) (see Figure 3-7) would be visible from Alta Loma Drive and from single-family residences on Alta Loma Drive, Del Monte Avenue, and Camaritas Avenue. To accommodate construction activities, the small stand of willows on the site would be removed; grading and other site preparation activities would be required for construction of both the well facility and staging area. Facility and pipeline construction activities would occur concurrently over a 16-month period at this site. However, the location is not within a scenic vista nor would it be visible from any nearby scenic roadways. As a result, there would be *no impact* on scenic roadways, resources, or vistas at this site.

Nevertheless, construction activities would occur within this residential neighborhood, with the presence of heavy construction equipment and materials. The overall visual sensitivity of this site is considered moderately high and the change in visual contrast would also be considered moderately high, given the visual environment at and around this site (see Section 5.3.1.3 [Individual Project Well Facility Sites], above). The removal of the willow trees would open up the view of the construction site and contribute to the visual impact, as the SFPUC's Integrated Vegetation Management Policy requires vegetation of any

size not be allowed to grow within certain critical portions of its rights-of-way (SFPUC 2007). Considering the presence of equipment and duration of construction, these construction activities would have a temporarily *significant* impact on the visual character of the site and its surroundings, as viewed from nearby residences.

Implementation of Mitigation Measure M-AE-1a (Site Maintenance) would require daily site clean-up, storing construction materials and equipment away from public view, and removing debris promptly to reduce the visual impact of Project construction. With implementation of this measure, coupled with the temporary 16-month construction period, the impact of Project construction to the aesthetic character of Site 18 (Alternate) would be *less than significant with mitigation*. Implementation of the mitigation measure would ensure that the construction areas remain clean and orderly and that equipment would be stored out of public view.

Mitigation Measure M-AE-1a: Site Maintenance (Sites 4, 7, 12, 13, 14, 15, and 18 [Alternate])
(See Impact AE-1, Site 4 for a description)

Impact Conclusion: Less than Significant with Mitigation

Site 7 (Consolidated Treatment at Site 6 and On-site Treatment options)

Site 7 is an undeveloped grassy parcel. A mausoleum is located immediately to the east of the site on an adjacent property and a Greenlawn Memorial Park maintenance building is to the immediate west (see Figures 3-17 and 3-21). The mausoleum is visually separated from the site by a mature stand of trees, which is identified as a “tree mass”⁶ in the Town of Colma’s General Plan. The utilitarian maintenance building is the only constructed element in an otherwise predominantly vegetated setting. The proposed pipeline route connecting Site 7 to Site 6, for the consolidated treatment option, would traverse the grounds of the Woodlawn Memorial Park. As noted in Section 5.3.1.3 (Individual Project Well Facility Sites) and in Table 5.3-1 (Summary of Visual Sensitivity Findings), this site has moderate visual exposure, moderately low visual quality, and moderately high overall visual sensitivity.

If there are no constraints (e.g., existing infrastructure) that would prevent the installation of pipelines from Site 7 to Site 6 (for consolidating treatment at Site 6, as proposed by the SFPUC), the proposed well facility at Site 7 would include a well with a fenced enclosure (see Figure 3-6), plus a pipeline to convey water from the well to Site 6 for treatment (see Figure 3-14). This would require a construction duration of three months at the well facility site and four to seven weeks for pipeline construction across the cemetery. Construction activities at Site 7, in general, would be visible from Colma Boulevard, Woodlawn Memorial Park, Greenlawn Memorial Park, and the Metro Center shopping center to the west. The

⁶ The Town of Colma’s General Plan identifies specific tree masses throughout the Town. The General Plan and Tree Ordinance use several terms to when discussing tree masses, including “major” tree masses, “significant” tree mass, and designated tree mass. These terms are used interchangeably throughout these Town policy documents. For consistency, this EIR uses the more general terms “tree mass” or “designated” tree mass.

overall visual sensitivity of this site is considered moderately high, although the change in visual contrast would be considered moderate, given the lack of constant viewers.

If there are constraints that would prevent consolidating treatment at Site 6, the facility at Site 7 would include a well with a 2,095-square-foot well and chemical treatment building (see Figure 3-7), requiring construction duration of 16 months. Construction activities at Site 7 would be visible from Colma Boulevard, Woodlawn Memorial Park, Greenlawn Memorial Park, and the Metro Center shopping center to the west.

Construction of the facility at Site 7 would be visible from a small section of a publicly accessible area of Woodlawn Memorial Park at its southeastern edge. Existing views from this portion of the cemetery in the direction of Site 7 include a cemetery maintenance building, a large stand of mature eucalyptus trees, the vacant grassy slope where Site 7 is proposed, and Greenlawn Memorial Park across Colma Boulevard. Visitors to the Greenlawn Memorial Park could have a view of the construction area at Site 7. Viewer concern would be moderately high during visits to the memorial park; although it is assumed that cemetery visits would be infrequent and potentially brief.

To clear the SFPUC right-of-way for construction, a number of trees would be removed, including many trees within a major tree mass identified in the Town of Colma's General Plan. Although this tree mass is comprised primarily of eucalyptus, or Tasmanian blue gum (an non-native invasive species⁷), given the height of the trees and conspicuous location relative to viewers along El Camino Real and Colma Boulevard, this tree mass is a prominent contributor to the immediate area's visual context. Construction of the well facility and pipelines at this location would require the removal of up to 54 out of approximately 70 trees within the SFPUC right-of-way. Of the trees to be removed, 41 would be part of the identified tree mass in the eastern portion of the right-of-way, while the remaining 13 are along the western right-of-way boundary. An additional 15 trees adjacent to the northeast part of the construction area boundary may be trimmed to accommodate construction. The remainder of the tree mass identified in the Town of Colma's General Plan would not be affected by construction.

The removal of these trees would be permanent as the SFPUC's Integrated Vegetation Management Policy (SFPUC 2007) requires that vegetation of any size not be allowed to grow within critical portions of its right-of-way and only approved vegetation be allowed to grow in other areas of its right-of-way. During construction at Site 7, portions of the tree mass within the right-of-way cannot remain due to the construction safety hazard they present (i.e., equipment conflict, falling limbs, work space constriction, etc.), which would result in a *significant* aesthetic impact at this site. Nevertheless, Mitigation Measure M-AE-1e (Tree Removal and Replacement) is proposed to reduce the visual impact of that would result from the removal of the trees at this site. However, implementation of this mitigation measure would be limited by the requirements of the SFPUC's Integrated Vegetation Management Policy, in terms of where

⁷ The Tasmanian blue gum has been classified by the California Invasive Plant Council as an invasive plant species, which has given it an inventory rating of 'moderate':

http://www.cal-ipc.org/ip/management/plant_profiles/Eucalyptus_globulus.php

the on-site re-plantings could occur, the allowable tree species to be re-planted, and the visual characteristics of the allowable replacement trees. In addition, even with implementation of this mitigation measure, the resulting impact at Site 7 would be a noticeable change in the appearance of the designated tree mass. The existing tree mass is comprised of tall eucalyptus trees. The SFPUC's Integrated Vegetation Management Policy lists tree species approved for planting on its right-of-way and expressly forbids the planting of eucalyptus within the SFPUC right-of-way. The composition of the tree mass within the SFPUC right-of-way would permanently change as a result of construction at Site 7; and therefore, removal of these trees would have a *significant and unavoidable impact with mitigation* on the visual character of the site and to a tree mass specifically identified in the Town of Colma's General Plan.

Mitigation Measure M-AE-1e: Tree Removal and Replacement (Site 7)

Prior to the removal of any trees within the construction area boundary at Site 7, the SFPUC shall determine if any trees within the Town-designated tree mass can be retained without causing conflicts with construction equipment and/or safety risks during construction at this site. A qualified arborist shall conduct the tree retention survey. Any trees found not to conflict with construction activities or create a safety risks shall be protected during construction.

For each tree to be removed, the SFPUC shall plant replacement trees on-site to the extent allowable by its Integrated Vegetation Management Policy (Section 13.006) (SFPUC 2007). Each replacement tree shall be in a minimum 15-gallon container and shall be of species listed in the vegetation management policy. The on-site plantings shall be located such that the visual continuity of the existing tree mass is restored to the extent feasible. To the extent tree replacement on-site is not feasible, replacement trees shall be planted off-site in substantial compliance with the Town of Colma's Tree Cutting and Removal ordinance.

In all cases, the planting ratio shall be a minimum of 1:1 (i.e., one tree planted for each tree removed). Replanting shall occur within the first year after completion of construction. The SFPUC shall monitor plantings annually for five years after project completion to ensure that the replacement planting(s) has developed and that the trees survive. If necessary, the SFPUC shall implement additional measures (e.g., replanting, installation of irrigation) to address continued survival of the plantings, and shall re-plant additional trees should a significant amount of the original plantings not survive during the monitoring period.

The direct views of the site from surrounding locations during the temporary construction period would be of construction equipment, materials and activities, a substantial change in the site's appearance and visual character, given the moderately high visual sensitivity of this area. Therefore, the temporary impact on the visual character of the site and its surroundings would be *significant*. Nevertheless, implementation of Mitigation Measure M-AE-1a (Site Maintenance) would reduce the visual impacts to a *less-than-significant* level through maintaining a relatively clean and inconspicuous construction area.

Mitigation Measure M-AE-1a: Site Maintenance (Sites 4, 7, 12, 13, 14, 15, and 18 [Alternate])

(See Impact AE-1, Site 4 for a description)

Under the proposed consolidated treatment option at Site 6, construction of the pipeline from Site 7 to Site 6 would be visible to pedestrians on D Street in front of the Colma BART Station and within Woodlawn Memorial Park, as the SFPUC right-of-way crosses the cemetery. The proposed pipeline route through the cemetery would be approximately 2,120 feet long and would take approximately four to seven weeks to construct based on an installation rate of 300 to 600 feet per week (see Chapter 3, Project Description, Section 3.5.1 [Construction Sequencing and Schedule]). This pipeline installation would occur concurrently with construction of the well facility structure. Visitors would see the pipeline construction and would need to pass the construction area to reach the gravesites.

Pipeline construction would be highly visible to the occasional visitor to Woodlawn Memorial Park over the four to seven week construction period. Visual quality in the area is high, as is the viewer sensitivity. However, the relatively brief and likely infrequent nature of visits to the cemetery by any one individual means that relatively few visitors would be affected by construction activities over the four to seven week duration at this location. Therefore, given the low level of traffic and low numbers of viewers over the four to seven week construction duration, the Site 7 pipeline construction area would have limited visual contrast. The pipeline-related visual impact would be *less than significant*, in spite of the high visual quality and high visual sensitivity within the cemetery.

The construction activities associated with the well facility at Site 7 and the pipeline to convey water from Site 7 to Site 6 for treatment are not within a scenic vista nor visible from any nearby scenic roadways. As a result, there would be *no impact* to scenic vistas, resources, or roadways at this location.

Impact Conclusion: Significant and Unavoidable with Mitigation

Impact AE-2: Project construction would not create a new source of substantial light that would adversely affect day or nighttime views in the area. (Less than Significant)

The evaluation of impacts that follows discusses sites with no impacts first, followed by sites with less-than-significant impacts.

As noted in Chapter 3, Project Description, Section 3.5.3.1 (Construction Hours), all construction activities would occur during the day from 7:00 a.m. to 7:00 p.m., Monday through Friday, and if necessary, construction work may occasionally occur on Saturdays between the hours of 7:00 a.m. and 5:00 p.m., except for well drilling, which would require day/night work during drilling and other drilling-related activities (for seven consecutive days/nights), as well as pump tests for the wells (for a continuous 12- to 48-hour period). No nighttime work would be required for any other construction elements of the Project (e.g., site preparation, building construction, pipeline trenching).

Night lighting would be needed during nighttime drilling-related activities and pump tests, which are expected to last for up to seven consecutive nights and nine nights in total. The drilling-related activities and the pump testing may not occur in a single continuous event, but could occur in two distinct events of seven nights and two nights, respectively (see Chapter 3, Project Description, Section 3.5.3.1 [Construction Hours]). Access paths to work areas would be illuminated as necessary.

Lighting at staging areas would also be used on an as-needed basis. Staging areas would not have security lighting that would be illuminated overnight. Lighting would be used only when workers need access at night.

As part of the Project, a lighting plan would be developed to guide the use of lighting during Project construction in such a way as to minimize nuisance and inconvenience to neighboring properties (see Chapter 3, Project Description, Section 3.5.1.5 [Temporary Lighting]). The contents of this lighting plan are proposed to include – but not be limited to – information regarding: time of use, placement relative to sensitive viewers (i.e., SFPUC Standard Construction Measure #10), type of mechanism(s), specifications (e.g., type of shades, bulbs).

Sites 2, 5, 6, 7, 8, 10, 11, 13, 17 (Alternate), and Westlake Pump Station

As noted in Chapter 3, Project Description Section 3.5 (Project Construction), there are six facility sites that already have existing test wells. In these cases, the wells have been pump tested and would be converted to production wells as part of the Project. No well drilling or pump testing would occur at Sites 2, 5, 6, 8, 10, and 13, as well as the Westlake Pump Station. This would eliminate the need for nighttime work and lighting at these locations. As no other Project construction activities would require nighttime work and lighting, the Project would have *no impact* relative to lighting at these locations.

As noted in Section 5.3.1.3 (Individual Project Well Facility Sites), each of these three sites would be located in areas devoid of viewers sensitive to nighttime views (i.e., residential areas). Sites 7 and 17 (Alternate) would be close to cemeteries and commercial uses. Site 11 would be on a relatively undeveloped parcel, with the exception of the BART ventilation structure. The parcel sits below grade of any potential viewers along El Camino Real and any development within view of the site would not be occupied by sensitive nighttime viewers. The Centennial Way Trail is unlikely to be used during nighttime hours. Construction at these sites would create a new temporary source of nighttime lighting in the area during well drilling and pump testing events. However, the amount of nighttime lighting necessary for 24-hour drilling operations would not be substantial, in that such lighting would be directed downward, covering only the area occupied by the drill rig and its immediate surroundings as would be required in the Project lighting plan. Therefore, given the lack of nighttime views (i.e., sensitive viewers) in the vicinity of these sites, *no impact* relative to nighttime lighting would occur at this site during construction.

Impact Conclusion: No Impact

Sites 1, 3, 4, 9, 12, 14, 15, 16, 18 (Alternate), and 19 (Alternate)

As described in Section 5.3.1.3 (Individual Project Well Facility Sites) each of these would be located in areas occupied by viewers that may be sensitive to the quality of existing nighttime views. In the cases of each these sites, the sensitive nighttime viewers would be those living in the single-family neighborhoods or multi-family residential complexes near the sites.

Construction at these sites would create a new temporary source of nighttime lighting to the nearby residential uses. However, the amount of nighttime lighting necessary for 24-hour drilling and pump

testing operations would not be substantial, in that such lighting would be directed downward, covering only the area occupied by the drill rig and its immediate surroundings as would be required in the Project lighting plan. In addition, being located in an urban/suburban area with existing street lighting, commercial lighting, etc., causing reduced nighttime viewing opportunities, there are no nighttime views in the area that could be adversely affected. The nearby residences would not be substantially affected by the downcast lighting due to the temporary nature of the potential impact, which would last for up to seven consecutive days and nights for drilling, with one subsequent additional pump-testing period lasting up to 48 hours. Therefore, this would be a *less-than-significant* aesthetic impact from construction at these sites.

Impact Conclusion: Less than Significant

5.3.3.5 Operation Impacts and Mitigation Measures

The following discussion presents the potential permanent impacts of the operation and maintenance of the proposed Project relative to each site's overall visual sensitivity and visual contrast. The significance criteria and analysis approach are described in Sections 5.3.3.1 (Significance Criteria) and 5.3.3.2 (Approach to Analysis), respectively. Briefly, the overall visual sensitivity is a single, consolidated measure comprised of visual quality (high, medium, low), affected viewers and exposure conditions, and viewer sensitivity/concern, and represents a site's overall susceptibility to adverse impacts. The overall visual sensitivity is compared against the anticipated visual change, or contrast, created by the Project (see Table 5.3-3 [Visual Impact Scale]). This comparison is then applied to each of the significance criteria for this Project to determine the level of impact.

With the exception of the Westlake Pump Station, the Project at each site would include a well facility, underground distribution piping, aboveground or buried utility connections, and an access driveway (where an existing one would not be used). As explained in Chapter 3, Project Description, Section 3.4.2.2 (Well Facility Types), four well station types are proposed for the Project, dependent on the functional needs at each site. The conceptual layouts for each type of facility are shown in Figures 3-6, 3-7, and 3-8. A brief description of each follows, relative to this analysis of aesthetics and lighting. Nevertheless, specific landscaping and architectural design mitigation measures are described in the analysis to specifically address potentially significant impacts at individual sites, as needed.

Well with fenced enclosure: The conceptual layout for the "well with fenced enclosure" well facility type includes either an eight-foot-high, black vinyl-coated fence with one-inch mesh or an eight-foot-high metal picket fence with ¾-inch black pickets to house the wellhead, pump, piping, and associated electrical controls that would be located in a weather-proof control panel. An optional concrete wall may be added as shown in Figure 3-6.

Well with building: The "well with building" well facility type includes a 35- by 20-foot building to house the wellhead, pump, piping and associated electrical controls (Figure 3-6). The building would be about eight feet above finished grade. The building would be concrete and finished with a gray or earth tone stone finish. A galvanized decorative gate would provide access into the building.

Well plus chemical treatment building: There are two conceptual layouts for a well with a chemical treatment building, as illustrated on Figure 3-7. The building's horizontal dimensions would be approximately 44 by 34 feet, or 75 by 20 feet, depending on the number of chemical treatment rooms needed at the site. The building would be concrete and finished with a gray or earth tone stone finish. A galvanized decorative gate would provide access into the building.

Well plus chemical treatment and filtration building: There are two conceptual layouts for well stations with chemical treatment and filtration associated with iron/manganese removal, as shown in Figure 3-8. The dimensions of the building would be 91 by 23 feet, or 103 by 29 feet, depending upon the size of the filtration system needed and the number of rooms at the site. The building would be concrete and finished with a gray or earth tone stone finish. A galvanized decorative gate would provide access into the building. This well station type would be larger than the other types to provide space for the filtration vessels.

Impact AE-3: Project operation would have a substantial adverse impact on a scenic vista, resource, or on the visual character of a site or its surroundings. (Less than Significant with Mitigation)

The impact analysis for each well facility site references site layout figures found in Chapter 3, Project Description, in addition to the site photographs and simulations included this chapter. The evaluation of impacts that follows discusses sites with no impacts first, followed by sites with less-than-significant impacts, and sites with significant impacts.

Sites 5 (Consolidated Treatment at Site 6), 16, and Westlake Pump Station

Westlake Pump Station

The Westlake Pump Station is within a fenced public works yard adjacent to the Westlake Village Apartments on the north, the Ben Franklin Intermediate School grounds to the south and east, and a single-family residential neighborhood to the west (see Figure 3-13). As noted in Section 5.3.1.3 (Individual Project Well Facility Sites) and Table 5.3-1 (Summary of Visual Sensitivity Findings), this site has limited visual exposure, low visual quality, and low overall visual sensitivity.

The well treatment equipment that would be installed at the Westlake Pump Station would be inside the existing buildings or outside within the existing fence. This would not change the visual character of this pump station site. The location is not within a scenic vista nor would it be visible from any nearby scenic roadways; no such resources would be affected. As a result, the effect on overall visual sensitivity would be low and there would be no change in visual contrast. Therefore, the Project would have *no impact* on the visual character of the site and its surroundings, as well as *no impact* on scenic roadways, scenic vistas, or scenic resources.

Site 5 (Consolidated Treatment at Site 6)

Site 5 would be located in a vacant paved lot between a State Farm Insurance Agency office and a single-family residence. The parking lot for the former Serra Bowl is adjacent to the south, with the Serra Bowl building beyond the parking lot. B Street creates the north border of the site; an automobile dealership is

located across B Street from the site. As noted in Section 5.3.1.3 (Individual Project Well Facility Sites) and in Table 5.3-1 (Summary of Visual Sensitivity Findings), this site has moderate visual exposure, low visual quality, and moderately low overall visual sensitivity.

The well facility at Site 5 would be a well with fenced enclosure (see Figure 3-6) if treatment is consolidated at Site 6 (see Figures 3-14 and 3-15). The well facility would be visible to surrounding commercial buildings, travelers along B Street, and the single-family residence just east of the site. However, the location is not within a scenic vista nor would it be visible from any nearby scenic roadways (e.g., I-280). As a result, no scenic vistas or scenic roadways would be affected. As the site is currently fenced, and given the largely developed urban visual environment at and around this site, the proposed well with fenced enclosure would have moderately low visual sensitivity and would not generate a change the visual contrast (see Section 5.3.1.3 [Individual Project Well Facility Sites], above). Therefore, the preferred option at Site 5, with treatment activities consolidated at Site 6, would have *no impact* to aesthetic resources at this location.

Site 16

Site 16 would be located in the SFPUC right-of-way behind the Orchard Supply Hardware store along El Camino Real (see Figure 3-37). To the east are the Caltrain line and a large electrical substation with tower. To the south is the three-story Millbrae Manor Apartments separated from the site by an alley, two fences, and a small storage yard. As noted in Section 5.3.1.3 (Individual Project Well Facility Sites) and Table 5.3-1 (Summary of Visual Sensitivity Findings), this site has limited visual exposure, low visual quality, and low overall visual sensitivity.

The 1,480-square-foot well and chemical treatment facility at Site 16 (see Figure 3-7) would be visible from portions of the Orchard Supply Hardware store parking lot, riders on Caltrain, and from the north facing apartments at the three-story Millbrae Manor Apartments to the south, as shown on Figure 3-37. The structure would have a gray or stone concrete finish, as described in Chapter 3, Project Description, Section 3.4.2.2 (Well Facility Types). The location is not within a scenic vista nor would it be visible from any nearby scenic roadways. As a result, no scenic vistas or scenic roadways would be affected and, since no trees would be removed to develop the well facility, no scenic resources would be affected. The overall visual sensitivity of this site is considered low and the change in visual contrast would also be considered low, given the visual environment at and around this site (see Section 5.3.1.3 [Individual Project Well Facility Sites], above). As a result, the addition of a well facility in this location would not change the visual quality of the area since the surrounding area includes commercial buildings. Therefore, the Project would have *no impact* potential impact on the visual character of the site and its surroundings, or on scenic roadways, scenic vistas, or scenic resources at this site.

Impact Conclusion: No Impact

Sites 1, 2, 3, 5 (On-site Treatment), 6, 8, 9, 10, 11, 12, 13, 17 (Alternate), and 19 (Alternate)**Site 1**

Site 1 would be located in the northeastern corner of the Lake Merced Golf Club, a privately owned and operated golf club. This site is approximately 50 feet away from the fairways, not in direct line of view from these fairways and lined by mature trees on the east, which partially obscure the view of I-280 to the east. The ground at this site is mostly bare. A restroom facility of concrete block construction is situated in the southern part of the site. As noted in Section 5.3.1.3 (Individual Project Well Facility Sites) and in Table 5.3-1 (Summary of Visual Sensitivity Findings), this site has low visual exposure – though moderate visual concern, moderate visual quality, and moderately low overall visual sensitivity.

The 1,480-square-foot well and chemical treatment facility at Site 1 (see Figure 3-7) would be visible from the end of Poncetta Drive, some fairways at the Lake Merced Golf Club, and from a portion of the Westlake Village Apartments to the north (Figure 3-11). The facility would be about 90 feet west of I-280, which is designated by Caltrans as eligible for the State Scenic Highway Program (see Table 5.3-2 [Designated State, County, and Local Scenic Roads in the Vicinity of Facility Sites]), but would be substantially screened by intervening vegetation. No scenic vistas or scenic roadways would be affected because of the small scale of the proposed structure and its relative isolation in the northeast corner of the golf club.

The proposed facility would remove the restroom facility currently on this site; the SFPUC would reimburse the golf club for replacement of the restroom. Views of the site from residences would be seen by only a few individuals in a private setting and not visible from public areas within the multi-family residential area. The site would be located above the golf links and golfers would have a relatively unobstructed view of the site, although it is not in direct line of sight from the golf links and the intervening vegetation would likely grow to sufficient height to provide visual screening. The views from the golf links would not be publicly accessible and would be available only to the members and workers of this private golf club. Also, the apartments provide a developed backdrop when the site is viewed from the golf club. In this context, the visual quality of the area is rated as moderate. Overall visual sensitivity and visual contrast at this site are thus moderately low. Therefore, the potential impact on the visual character of the site and its surroundings would be *less than significant*; whereas there would be *no impact* on scenic vistas or scenic roadways given that this site is, and would remain shielded from I-280 by existing trees.

Site 2

Site 2 would be located just outside the southwest corner of the Lake Merced Golf Club and south of the golf club maintenance access road. This site is located immediately off the street at the edge of an extensive open space area comprised of playing fields of the Garden Village Elementary School and athletic fields at the Ben Franklin Intermediate School. Site 2 is situated at the edge of this open space, demarcating a transition from the Westlake Village Apartments to the north. As noted in Section 5.3.1.3 (Individual Project Well Facility Sites) and in Table 5.3-1 (Summary of Visual Sensitivity Findings), this site has moderate visual exposure, visual quality, and overall visual sensitivity.

The well with a fenced enclosure at Site 2 (see Figure 3-6) would be visible in the immediate foreground of Park Plaza Drive, as well as from the Ben Franklin Intermediate School's athletic field and portions of the main campus, a few single-family residences above the athletic field, and multi-family residences located to the northwest. The facility would be located south of the existing Lake Merced Golf Club access road as shown on Figure 3-12. The fenced facility would introduce a new, relatively small-scale public infrastructure element of appearance that would appear out of place in its landscaped, open space setting. Visual contrast of the facility, particularly chain link and potential concrete fencing, would be moderate given the current undeveloped and landscaped condition of the site. Therefore, in the context of moderate overall visual sensitivity of the setting, the impact on the visual character of the site and its surroundings would be *less than significant*.

Views of the facility would be substantially blocked from the Lake Merced Golf Club by trees and shrubs. No trees or other scenic resources would be affected. In addition, the location is not within a scenic vista, nor along a designated scenic roadway. As a result, no scenic vistas, resources, or roadways would be affected. Therefore, there would be *no impact* on scenic roadways, resources, or vistas at this site.

Site 3

Site 3 would be located in the southwest corner of the athletic field at the Ben Franklin Intermediate School. The site is covered in turf and located behind a baseball backstop on the field. It is at the foot of a slope, at the top of which single-family residences are located to the southwest; these residences front onto White Street and Maddux Drive. This location puts the site low in the field of view from these residential areas. A small wooded area of tall eucalyptus trees directly adjoins the site to the east and southeast. As noted in Section 5.3.1.3 (Individual Project Well Facility Sites) and in Table 5.3-1 (Summary of Visual Sensitivity Findings), this site has moderate visual exposure, visual quality, and overall visual sensitivity.

The well with fenced enclosure at Site 3 (see Figure 3-6) would be visible from Park Plaza Drive, the Ben Franklin Intermediate School athletic field and portions of the main campus, single-family residences located to the south and southwest on White Street and Maddux Drive, and portions of the Westlake Village Apartments located to the north. The facility would be located adjacent to the athletic field near the southeast section of the school grounds as shown on Figure 3-12. The facility would introduce a new, relatively small-scale public infrastructure element that would contrast with the landscaped, open space setting adjacent to an athletic field. However, the visual contrast to motorists would be low due to distance. Visual contrast of the facility with its existing setting would be moderate as it would be situated in a remote corner of the athletic field and low in the field of view from publicly accessible portions of the surrounding residential areas. Therefore, in the context of moderate overall visual sensitivity, the impact on the visual character of the site and its surroundings would be *less than significant*.

No scenic vistas or scenic roadways would be affected. No trees would be removed and no scenic resources would be adversely affected. Therefore, there would be *no impact* on scenic roadways, scenic vistas, or scenic resources at these sites.

Site 5 (On-site Treatment)

Site 5 would be located in a vacant paved lot between a State Farm Insurance Agency office and a single-family residence. The parking lot for the former Serra Bowl is adjacent to the south, with the Serra Bowl building beyond the parking lot. B Street creates the north border of the site; an automobile dealership is located across B Street from the site. As noted in Section 5.3.1.3 (Individual Project Well Facility Sites) and in Table 5.3-1 (Summary of Visual Sensitivity Findings), this site has moderate visual exposure, low visual quality, and moderately low overall visual sensitivity.

The 2,095-square-foot well, chemical treatment, and filtration facility (see Figure 3-8) would be constructed at the site as shown on Figure 3-19. The well facility would be visible to surrounding commercial buildings, travelers along B Street, and the single-family residence just east of the site. However, the location is not within a scenic vista nor would it be visible from any nearby scenic roadways (e.g., I-280). As a result, no scenic vistas or designated scenic roadways would be affected. In addition, with the architectural finish to be used on the treatment building (i.e., gray or earthtone concrete finish, as described in Chapter 3, Project Description, Section 3.4.2.2 [Well Facility Types]), the visual character of the site and its surroundings would not be adversely affected. The overall visual sensitivity of this site is considered low and the change in visual contrast would also be considered low, given the largely developed urban visual environment at and around this site (see Section 5.3.1.3 [Individual Project Well Facility Sites], above). Therefore, the potential impact on the visual character of the site and its surroundings would be *less than significant*. There would be *no impact* on scenic roadways, scenic vistas, or scenic resources at this site.

Site 6

Site 6 would be situated on a grassy area along the south side of D Street, across from the Colma BART station, which dominates views of the area. The SamTrans Park and Ride lot is located upslope from this site to the southwest, beyond a row of trees. The pedestrian bridge over D Street linking the parking lot to the station has a clear view of this site. The Woodlawn Memorial Park is located to the south and upslope. The immediately adjacent portion of the cemetery is used for outdoor materials storage. As noted in Section 5.3.1.3 (Individual Project Well Facility Sites) and in Table 5.3-1 (Summary of Visual Sensitivity Findings), this site has high visual exposure – but low viewer concern, low visual quality, and low overall visual sensitivity.

The well, chemical treatment, and filtration facility at Site 6 (see Figure 3-8) would be visible to travelers along D Street, SamTrans Park and Ride patrons, and BART riders as shown on Figures 3-16 and 3-20. The facility structure would be 2,990 square feet in size if treatment for Sites 5 and 7 is conducted here or it would be 2,095 square feet if treatment is limited to the one on-site well. While El Camino Real is a Town-designated scenic corridor in Colma and its intersection with F Street is designated as a Town gateway, this site would not be visible from El Camino Real due to intervening topography, vegetation, and buildings. In addition, the location is not within a scenic vista. As a result, no scenic vistas or scenic roadways would be affected.

The well facility at Site 6 would not be visible from the publicly accessible portions of Woodlawn Memorial Park. The nearest portion of the memorial park from which it could be visible would be an outdoor materials storage area, which is not open to the public. Also, intervening topography and vegetation (i.e., trees) further block views of Site 6 from this cemetery. Existing views from this portion of Woodlawn Memorial Park in the direction of Site 6 include the Colma BART station, the SamTrans Park and Ride lot also adjacent to Site 6; however, this site would be out of view in these vistas as it would be below and out of the line of sight.

The overall visual sensitivity of this site is considered low given its low visual quality, limited numbers of viewers, and visual isolation from sensitive viewers in Woodlawn Memorial Park. The change in visual contrast would be considered moderate, given the visual dominance of the adjacent BART facilities. Therefore, the potential impact on the visual character of the site and its surroundings would be *less than significant*; whereas, there would be *no impact* on scenic roadways, scenic vistas, or scenic resources at this site.

Site 8

Site 8 would be located in a narrow grassy strip surrounded by various large-scale commercial establishments in a segment of Serramonte Boulevard lined by car dealerships, Kohl's Department Store and its associated parking. The streetscape is thus dominated by unscreened parked automobiles, little landscaping and low visual unity. Site 8 would be shielded from view on all sides except the northeast due to depressed topography. As noted in Section 5.3.1.3 (Individual Project Well Facility Sites) and in Table 5.3-1 (Summary of Visual Sensitivity Findings), this site has limited visual exposure, low visual quality, and low overall visual sensitivity.

The 2,095-square-foot well, chemical treatment, and filtration facility structure at Site 8 (see Figure 3-8) would be on a level grassy parcel visible from Serramonte Boulevard, Kohl's Department Store's rear parking lot, and adjacent car dealerships, and distantly from Collins Avenue where it crosses the SFPUC's right-of-way. The facility layout is shown on Figure 3-22. The location is not within a scenic vista nor would it be visible from any nearby designated scenic roadways. As a result, no scenic vistas or scenic roadways would be affected. In addition, due to the proposed design of the well facility building and its compatibility with its existing surroundings, the visual character of the site and its surroundings would not be adversely affected. The overall visual sensitivity of the site is low, as would be the change in visual contrast given its limited views from publicly accessible areas. Therefore, the potential impact on the visual character of the site and its surroundings would be *less than significant*; whereas, there would be *no impact* on scenic roadways, scenic vistas, or scenic resources at this site.

Site 9

Site 9 would be located on an existing undeveloped parcel between the concrete-lined Colma Creek Diversion and San Mateo County Flood Control channels. The site, in a mixed commercial/residential area, is triangular in shape and covered with low-growing ruderal vegetation and has a lone tree at its center. The site and surroundings are devoid of vivid or attractive visual features, and dominated by the adjacent concrete flood channels and the neighboring Costco parking lot. As noted in Section 5.3.1.3

(Individual Project Well Facility Sites) and in Table 5.3-1 (Summary of Visual Sensitivity Findings), this site has limited visual exposure, low visual quality, and low overall visual sensitivity.

The 2,095-square-foot well, chemical treatment, and filtration facility at Site 9 (see Figure 3-8) would be visible from a portion of the Treasure Island Trailer Court, over the property fence and pedestrian path connecting the Verano Condominium complex on Mission Road to El Camino Real, as well as the Verano Condominiums and other detached residences on Mission Road to the southeast (see Figure 3-24). The power source for Site 9 would be an aerial line extended from an existing off-site source. There are no views of this site from public roadways. The site is not within a scenic vista nor would it be visible from any nearby designated scenic roadways. As a result, no scenic vistas, resources, or roadways would be affected.

Development of the well facility at Site 9 would require the removal of one Monterey pine. The removal of this mature tree would not have an adverse impact on the visual character of the site, given the low overall visual sensitivity of the site and its surroundings. For the same reason, the installation of the overhead power line would not have an adverse impact on the site's visual character, particularly given the presence of other aerial lines in the immediate area. The overhead power line would be consistent with the visual setting of the area. While the overall visual sensitivity of this site is considered low, the change in visual contrast would be moderate, given that a structure would be constructed on a currently undeveloped site. In addition, views of the facility from the residences would be seen by only a relatively few individuals in a private setting. The gray or stone architectural finish described in Chapter 3, Project Description, Section 3.4.2.2 (Well Facility Types) would soften the utilitarian appearance of the structure. Therefore, the Project's impact on the site's visual character and scenic resources would be *less than significant*. As noted above, there would be *no impact* on scenic roadways, resources, or vistas at this site.

Site 10

Site 10 would be located on an undeveloped grassy lot on the southwest corner of Hickey Boulevard and Camaritas Avenue. Trees line the west side of the lot, separating it from the single-family residences beyond Crown Circle to the west. The site slopes upward to the south and remains undeveloped, though single-family residences line Camaritas Avenue beyond stands of mature trees to the southeast. The Winston Manor Shopping Center is located to the east with a Chevy's Restaurant closest to the site across Camaritas Avenue. Immediately to the north across Hickey Boulevard, the topography slopes steeply upward providing partial views through mature trees of the fenced rear yards of single-family residences that front on Duval Drive. The site is in an area transitioning from commercial strip development of low visual quality to a residential one marked by substantial large-scale tree canopies and grass slopes. As noted in Section 5.3.1.3 (Individual Project Well Facility Sites) and in Table 5.3-1 (Summary of Visual Sensitivity Findings), this site has high visual exposure – though moderate visual sensitivity, moderately low visual quality, and moderate overall visual sensitivity.

The 2,095-square-foot well, chemical treatment, and filtration facility at Site 10 (see Figure 3-8) would be visible from Hickey Boulevard, Camaritas Avenue, the Winston Manor Shopping Center, and from single-family residences across Hickey Boulevard and on Camaritas Avenue as seen on Figure 3-25. However, the site would not be visible from publicly accessible points in this residential area. Drought

tolerant native and or climate adapted landscape trees, shrubs, and grasses would be planted around the perimeter of the building when construction is complete. The structure would have a gray or stone concrete finish, as described in Chapter 3, Project Description, Section 3.4.2.2 (Well Facility Types). The site would not be visible from publicly accessible portions of the residential area to the west on Crown Circle, due to dense existing landscaping and topography. The site would not be within a scenic vista, nor would it be visible from any nearby designated scenic roadways. As a result, no scenic vistas or scenic roadways would be affected. Also, since no trees would be removed to develop the well facility, no scenic resources would be affected.

The overall visual sensitivity of this site is considered moderate and the change in visual contrast would be considered moderate with the landscaping around the facility. Therefore, the potential impact on the visual character of the site and its surroundings would be *less than significant*; whereas, there would be *no impact* on scenic roadways, scenic vistas, or scenic resources at this site.

Site 11

Site 11 would be located next to a BART ventilation structure between El Camino Real and Mission Road northwest of Chestnut Avenue and Antoinette Lane. The site is covered in gravel with the adjacent slope covered in unmaintained grasses and mature trees. The topography and a row of trees along this portion of El Camino Real obstruct views of the site and the BART ventilation structure just beyond. The BART ventilation structure partially obstructs views of the site from the Centennial Way Trail to the east. To the north of the site is a five-story parking garage and surface parking lot for the Kaiser Medical Center. The remainder of the surrounding land is vacant or commercial without any visually notable features. As noted in Section 5.3.1.3 (Individual Project Well Facility Sites) and in Table 5.3-1 (Summary of Visual Sensitivity Findings), this site has limited visual exposure, low visual quality, and moderately low overall visual sensitivity.

The 2,095-square-foot well, chemical treatment, and filtration facility at Site 11 (see Figure 3-8) would not be visible while traveling on El Camino Real, while it would be to pedestrians and bicyclists on the Centennial Way Trail along the Colma Creek Diversion Channel north of the site, as shown on Figure 3-28. However, the view from the trail would be mostly blocked by an existing BART ventilation structure which, with its industrial character, contributes to the setting's generally low visual quality and would partially screen the structure from the trail. An intervening stand of trees would also screen views of the structure from the trail. For these reasons, the facility would represent moderately low visual change to viewers on the trail. Trees along El Camino Real block the site from views of travelers along the roadway in both the northbound and southbound directions. Up to seven of these trees (Lombardy poplars and a Torrey pine) would be removed to accommodate installation of the water pipelines to connect the well to the existing regional water system. Removal of the trees would result in motorists along El Camino Real having views of the well facility following construction. However, views of the facility from the roadway would be fleeting, and mostly blocked by topography, as motorists and pedestrian pass the site. The area already includes the industrial character BART structure. The addition of a new well facility in the area would, therefore, generate a low change the visual character of the area. As a result, and in the context of moderately low overall visual sensitivity of this setting, this would be a *less-than-significant* aesthetic impact.

Site 12

Site 12 would be located adjacent to the Garden Chapel Funeral Home. The site includes a portion of the funeral home parking lot, a grassy area with a dirt access for the SFPUC right-of-way, and a dense row of Monterey pine, Monterey cypress, eucalyptus, and Aleppo pine shielding the well facility site from view from El Camino Real. These trees are contributing resources in the City of South San Francisco's streetscape plan for El Camino Real, as noted in General Plan Implementing Policy 3.4-1-1. The removal of trees and mitigation of the impact as a result of Project construction is addressed under Impact AE-1. The site is partially screened by fences and vegetation from the single-family residences to the southwest fronting on Fairway Drive. As noted in Section 5.3.1.3 (Individual Project Well Facility Sites), and Table 5.3-1 (Summary of Visual Sensitivity Findings), this site has moderate visual exposure, moderate visual sensitivity, moderate visual quality, and moderately high overall visual sensitivity.

The 1,495-square-foot well and chemical treatment facility at Site 12 (see Figure 3-7) would be visible from El Camino Real, Southwood Drive, single-family residences to the west, and from the Garden Chapel Funeral Home (Figures 3-29 and 3-30). The structure would have a gray or stone concrete finish, as described in Chapter 3, Project Description, Section 3.4.2.2 (Well Facility Types). It would not be visible from publicly accessible points of the single-family residential neighborhood. Because the structure would be about 20 feet from the funeral home, it would be clearly visible to funeral home visitors and to neighboring residents that may look over their fences toward this area. However, the location is not within a scenic vista nor would it be visible from any nearby designated scenic roadways.

No trees would be removed as part of operations at the site; therefore the aesthetic impacts related to Project operations would be *less than significant*. In addition, since the location is not within a scenic vista nor would it be visible from any nearby scenic roadways, there would be *no impact* on designated scenic roadways, resources, or vistas at this site.

Site 13

Site 13 would be located on an undeveloped parcel on the southeast side of South Spruce Avenue covered with unmaintained grassy vegetation. It is bordered by a two-story retail/office building and parking lot on the west and a large beverage distribution warehouse on the east. Between the warehouse and the site is the Centennial Way Trail, with an interpretive panel with a trail map at the entrance on South Spruce Avenue. A fenced-in, buried utility vault is located between the site and the pathway. The trail continues immediately across South Spruce Avenue with a large industrial bakery to the north and single-family residential neighborhood to the south. As noted in Section 5.3.1.3 (Individual Project Well Facility Sites) and in Table 5.3-1 (Summary of Visual Sensitivity Findings), this site has high visual exposure, but it has moderate visual sensitivity, moderate visual quality, and moderately high overall visual sensitivity.

The 2,095-square-foot well, chemical treatment, and filtration facility at Site 13 (see Figure 3-8) would be visible from South Spruce Avenue, the commercial and industrial uses in the area (i.e., Freeman Warehouse, credit union, a car wash, San Mateo County offices, Orowheat commercial bakery), Francisco Drive residential neighborhood across South Spruce Avenue, and from the Centennial Way Trail (Figures 3-31 and 3-32). The site would not be visible from publicly accessible points in the residential area. The

Centennial Way Trail has an interpretive panel with a trail map at the intersection of the pathway and South Spruce Avenue directly adjacent to Site 13. In Figure 5.3-11 (Visual Simulation of Site 13), a visual simulation of the well facility, driveway, and fencing shows that the well facility would be set back from the trail and interpretive panel. The Project at Site 13 also includes a landscape plan that proposes a mixture of drought-tolerant trees and shrubs and native grasses planted on three sides of the well facility to partially screen views of the facility from the trail and from South Spruce Street. The structure would have a gray or stone architectural finish, as described in Chapter 3, Project Description, Section 3.4.2.2 (Well Facility Types).

In the context of neighboring warehousing, food production, commercial, and government activities, the form of the well and treatment building would contrast to a moderate degree with the setting, as indicated in the simulation. Although the Centennial Way Trail has high exposure and moderately high overall visual sensitivity, the proposed landscaping would reduce the contrast to a moderately low level by providing a vegetative-screened view of the facility. Therefore, the aesthetic impact would be *less than significant*. In addition, the location is not within a scenic vista, nor would it be visible from any nearby scenic roadways. As a result, there would be *no impact* on scenic roadways, scenic vistas, or scenic resources at this site.

Site 17 (Alternate)

Site 17 (Alternate) would be located in a flat, grassy area adjacent to the SFPUC right-of-way and next to Standard Plumbing Supply on a relatively lightly traveled section of Collins Avenue. The right-of-way, which is covered in grass in this area, slopes up from Collins Avenue toward Cypress Lawn Memorial Park to the south, but is visually isolated from the cemetery by sloping terrain and tree cover. The Standard Plumbing Supply property, including this well facility site, is surrounded by chain link fence with exposed parking. The vicinity is typified by various commercial/light-industrial land uses. As noted in Section 5.3.1.3 (Individual Project Well Facility Sites) and in Table 5.3-1 (Summary of Visual Sensitivity Findings), this site has moderate visual exposure – though low visual sensitivity, moderate visual quality, and low overall visual sensitivity.

The 1,495-square-foot well and chemical treatment facility at Site 17 (Alternate) (see Figure 3-7) would be visible from Collins Avenue and the commercial land uses adjacent to the west and north of the site as shown on Figure 3-38. Site 17 (Alternate) would also be located just north of the Cypress Lawn Memorial Park, which is a representative example of picturesque cemetery design in Colma. Site 17 (Alternate) would be located near two tree masses identified in the Town of Colma General Plan. One tree mass is located approximately 100 feet to the east of the site across the SFPUC right-of-way and the other is located approximately 100 feet to the southwest behind the Standard Plumbing Supply building. Development of the site would not remove or damage these trees due to their distance away from this site.



Existing view of Site 13 looking south from South Spruce Avenue.



Visual Simulation of Site 13 from same vantage point with mature landscaping.

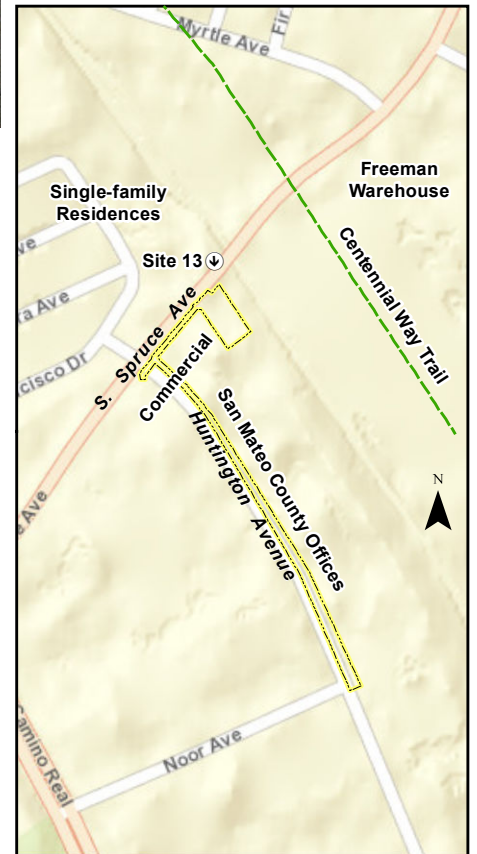

Legend

 View Direction

 Construction Area

Visual Simulation of Site 13

Regional Groundwater Storage and Recovery Project

Figure 5.3-11

Due to steep intervening topography and vegetation (i.e., tree clusters) to the south of the site, the well facility would not be visible from publicly accessible portions of Cypress Lawn Memorial Park. The portion of the Cypress Lawn Memorial Park to the west of the facility site includes a brick fence between the cemetery and Standard Plumbing Supply. The brick fence and the Standard Plumbing Supply building would block views of the well facility from the public use portions of the cemetery, east towards the proposed facility site. As the Standard Plumbing Supply building is immediately adjacent to the site, the visual character of the site to motorists and pedestrians on Collins Avenue would not be adversely impacted following construction of the well facility at this site.

The overall visual sensitivity of the site is low, as would be the change in visual contrast, given that this site is within a commercial area and not in view of publicly accessible portions of Cypress Lawn Memorial Park. The site is not within a scenic vista nor would it be visible from any nearby scenic roadways. As a result, no scenic vistas or scenic roadways would be substantially affected by development of the well facility at this site. Therefore, the impact on the visual character of the site and its surroundings would be *less than significant*. There would be *no impact* on scenic roadways, scenic vistas, or scenic resources at this site.

Site 19 (Alternate)

Site 19 (Alternate) would be across Southwood Drive from Site 12 and situated between the Our Redeemer's Lutheran Church and single-family residences fronting on Fairway Drive. The site, covered in mowed grassy vegetation, is partially screened by fences and vegetation from these single-family residences. Multi-family residential developments are also located to the north of this site and have limited views of the site through intervening landscape vegetation and trees. As noted in Section 5.3.1.3 (Individual Project Well Facility Sites) and in Table 5.3-1 (Summary of Visual Sensitivity Findings), this site has moderate visual exposure, visual quality, and overall visual sensitivity.

The fenced well facility at Site 19 (Alternate) would be visible from Southwood Drive, from single-family residences to the west that face on to Fairway Drive away from the site, from the rear of the Our Redeemer's Lutheran Church and R.W. Drake Preschool to the east, from the parking lot of the Garden Chapel Funeral Home across Southwood Drive to the southeast, and from publicly-accessible portions of the multi-family residential developments to the north, as shown on Figure 3-40. The fenced well facility would introduce a new visual element in an open area, which would result in a moderate contrast, as it would be an introduction of a public infrastructure facility among residential and quasi-public areas. However, given the moderate visual exposure, quality, and visual sensitivity of Site 19 (Alternative), this would be considered a *less-than-significant* impact to the visual environment.

The location is not within a scenic vista nor would it be visible from any nearby scenic roadways. As a result, there would be *no impact* on designated scenic roadways, resources, or vistas at this site.

Impact Conclusion: Less than Significant

Sites 4, 7, 14, 15, and 18 (Alternate)**Site 4**

Site 4 would be located on a lot adjacent to Park Plaza Drive in the southwest corner of the Garden Village Elementary School grounds. The site is atop a slope above the school's playing fields covered with grassy vegetation. It is adjacent to single-family residences, which front onto 87th Street to the south and other single-family residences across Park Plaza Drive fronting onto White Street to the west. As noted in Section 5.3.1.3 (Individual Project Well Facility Sites) and in Table 5.3-1 (Summary of Visual Sensitivity Findings), this site has moderately high visual exposure, visual quality, and overall visual sensitivity.

The well with fenced enclosure at Site 4 (see Figure 3-6) would be visible from the immediate foreground of Park Plaza Drive, from 87th Street, the Garden Village Elementary School, and single-family residences located to the south and west (see Figure 3-12). The facility would introduce a new, relatively small-scale public infrastructure element that would be in contrast with the landscaped, open space setting. The absence of the 24 existing trees would represent a change to the visual quality of the site and its surroundings, and the fenced enclosure would be fully visible by nearby residences and along Park Plaza Drive. These changes would represent a moderately high level of contrast given the removal of trees and placement of a fenced well facility in an area predominately given to residences and community facilities.

The absence of the existing trees and addition of a well facility on the site would generate a high level of change in the visual contrast and character of the site and its surroundings given the prominent location. In the context of the moderately high visual sensitivity of the site, this would be a *significant* impact. However, the location is not within a scenic vista nor would it be visible from any nearby scenic roadways. As a result, no scenic vistas, resources, or roadways would be affected, creating *no impact* on these resources.

Implementation of Mitigation Measure M-AE-3a (Implement Landscape Screening) would reduce the aesthetic impact of placing a fenced well facility at this currently vacant location to *less than significant* levels by partially screening the facility from views along Park Plaza Drive and from residences immediately south of the well facility site.

Mitigation Measure M-AE-3a: Implement Landscape Screening (Sites 4, 7, and 18 [Alternate])

The SFPUC shall develop and implement a landscape-screening plan to screen views of the well facility. The landscape plan shall include native trees and shrubs common to the surrounding areas. The landscape plan shall include plant species, planting specifications, and irrigation requirements necessary to screen the well facility. The SFPUC shall monitor landscape plantings annually for five years after project completion to ensure that sufficient ground coverage has developed and that the shrubs survive. If necessary, the SFPUC shall implement additional measures (e.g., replanting, temporary irrigation) to address continued survival of the plantings, and shall replant additional shrubs should a significant amount of the plantings not survive during the monitoring period.

Site 7

Site 7 is an undeveloped grassy parcel (see Figures 3-17 and 3-21). A mausoleum is located immediately to the east of the site on an adjacent property and a Greenlawn Memorial Park maintenance building is to the immediate west. The mausoleum is visually separated from the site by a mature stand of trees, which is identified as a “tree mass” in the Town of Colma’s General Plan. The utilitarian maintenance building is the only constructed element in an otherwise predominantly natural setting. The pipeline route connecting this site with Site 6, should consolidated treatment occur there, would traverse the grounds of the Woodlawn Memorial Park. As noted in Section 5.3.1.3 (Individual Project Well Facility Sites) and in Table 5.3-1 (Summary of Visual Sensitivity Findings), this site has moderate visual exposure, moderately low visual quality, and moderately high overall visual sensitivity.

The well facility at Site 7 would be a well with fenced enclosure (if treatment is consolidated at Site 6, see Figures 3-6 and 3-17), or a 2,095-square-foot well, chemical treatment, and filtration facility would be constructed to enclose onsite treatment facilities (if treatment is not consolidated at Site 6, see [Figure 3-8 and 3-21]). In either case, the well facility would be visible from Colma Boulevard, Woodlawn Memorial Park, Greenlawn Memorial Park, and the Metro Center shopping center to the west.

Consistent with the SFPUC’s Integrated Vegetation Management Policy (SFPUC 2007), trees removed from Site 7 in order to accommodate construction activities would not be replanted on site, so as not to conflict with the facility’s operation. As noted in the discussion of construction impact at Site 7 in Section 5.3.3.4 (Construction Impacts and Mitigation Measures), the SFPUC has adopted the Integrated Vegetation Management Policy to manage vegetation on distribution and collection system rights-of-way. Although small trees on the approved list can be planted within the right-of-way as long as they are at least 15 to 25 feet (depending on tree species) from any pipelines and are in containers above ground, the existence of large woody vegetation and water transmission lines is not compatible. Under no circumstances are eucalyptus or pine trees permitted within the right-of-way (SFPUC 2007). Plantings of large woody vegetation are not permitted on areas of the regional water system designated as critical portions of rights-of-way. The well facility at Site 7 and connection pipelines would be considered critical portions of the regional water system; therefore, it is assumed for this analysis that no trees would be planted on this portion of the SFPUC’s right-of-way.

The well facility would be visible from a small section of Woodlawn Memorial Park at its southeastern edge. Existing views from this portion of the cemetery in the direction of Site 7 include a cemetery maintenance building (on an adjacent parcel), the open grassy slope on the SFPUC right-of-way where Site 7 is proposed, and Greenlawn Memorial Park across Colma Boulevard. The site has moderate visual quality with moderate exposure to passing motorists along Colma Boulevard and periodic but potentially infrequent viewers that would be visiting the Greenlawn and Woodlawn memorial parks. These viewers would have moderately high concern about the views during cemetery visits, given the nature of such facilities. Therefore, the overall visual sensitivity is moderately high for the site.

The existence of the well facility at Site 7 – whether it is a well with fenced enclosure or with a treatment and filtration facility – would constitute a notable change in the character of the site. In the context of the moderately high visual sensitivity of the site, this would be a *significant* aesthetic impact. However, the

location is not within a scenic vista nor would it be visible from any nearby scenic roadways. As a result, no scenic vistas, resources, or roadways would be affected, creating *no impact* on these resources.

Implementation of Mitigation Measure M-AE-3a (Implement Landscape Screening) would reduce the aesthetic impact of placing a new well facility at this currently vacant location to a *less-than-significant* level by partially screening the well facility from the Greenlawn Memorial Park and reducing the visual contrast.

Mitigation Measure M-AE-3a: Implement Landscape Screening (Sites 4, 7, and 18 [Alternate])
(See Impact AE-3, Site 4 for a description)

Site 14

Site 14 would be located on the northern side of the GGNC within the grassy area of the SFPUC right-of-way between the gravesites and close to an existing, unused pump station, tank and well in the cemetery (see Figures 3-34 and 3-35). It would be near the single-family neighborhood adjacent to the north along Greenwood and Rockwood drives, which are screened from the site by fences and mature trees. Site 14 would not be visible from the public roads surrounding the cemetery (i.e., Sneath Lane) due to distance, topography, and intervening trees, but is visible from internal roadways in this section of the cemetery. The proposed water connection pipeline conveying water from Site 14 to Site 15 would be within the SFPUC right-of-way and cross the cemetery to Sneath Lane then follow along Sneath Lane to Site 15. The proposed storm drain would cross the cemetery to Sneath Lane. As noted in Section 5.3.1.3 (Individual Project Well Facility Sites) and in Table 5.3-1 (Summary of Visual Sensitivity Findings), this site has high visual exposure, visual quality, and visual sensitivity.

The 700-square-foot enclosed well facility at Site 14 (see Figure 3-6) would be visible within the GGNC and from the rear of single-family residences to the west and north that face onto Greenwood Drive away from the site. The new well would be housed in an enclosure as shown in the visual simulation in Figure 5.3-12 (Visual Simulation Site 14; see photo with the caption “Visual Simulation of Site 14 without Mitigation”). The new well facility building, would be concrete and finished with a gray or earth tone stone finish (see Chapter 3, Project Description, Section 3.4.2.2 [Well Facility Types]). A driveway would provide access to the well would be accessible along the SFPUC right-of-way from an internal cemetery roadway. Access would be constructed using grass pavers to provide a stable surface while allowing grass to grow through the gaps of the pavers. Water from Site 14 would be conveyed to the facility at Site 15 for treatment, and the potential visual impacts for the well facility at Site 15 are discussed separately below.

As noted above in Section 5.3.1.3 (Individual Project Well Facility Sites), the overall visual sensitivity of Site 14 is considered high. Visual change/contrast of the facility would also be considered high as viewed from nearby viewpoints within the cemetery (see photo in Figure 5.3-12 with the caption “Visual Simulation of Site 14 without mitigation”), given that the Project would introduce a noticeable structure of public works character into a highly distinctive and formal visual setting consisting of open lawn, highly regular rows of uniform tombstones, and scattered, isolated trees. The form, scale, and character of the facility would not be consistent with the character of the surroundings and potentially in conflict with

the visual expectations of visitors to the cemetery. In this highly sensitive and formally ordered setting, the form, scale, and character of the facility would, therefore, represent a high level of visual change. The facility at Site 14 would thus represent a *significant* aesthetic impact.

Demolition and removal of the existing unused well enclosure and tank would remove an existing structure that is aesthetically inconsistent with the visual character of the site and surrounding area, given its location in a military cemetery. The removal of that structure would partially offset the impact of the substantial visual change with the proposed new facility, which would be mitigated by implementation of Mitigation Measure M-CR-5a (Minimize Facilities Siting Impacts on Elements of the Historical Resource at Site 14).

Even with removal of the existing structure, the aesthetic impact would remain *significant* with the presence of the well building enclosure. Implementation of Mitigation Measure M-CR-5a (Minimize Facilities Siting Impacts on Elements of the Historical Resource at Site 14) would reduce this aesthetic impact to *less-than-significant* levels by requiring the development of a compatible architectural design for this GGNC site (i.e., structure height, cladding material, screening plantings, etc.). The mitigation measure requires that the well facility be located as close to the north GGNC fence as practicable to reduce its intrusion on the orderly rows of gravestones. It also requires the use of plywood temporarily placed on the ground to access the well facility, thereby eliminating the need for permanent grass pavers unless the type and use of grass pavers proposed are determined by SHPO to be compatible with, and not adversely impact, the historic resource as discussed in Section 5.5, Cultural and Paleontological Resources. A visual simulation showing the well facility with the proposed mitigation is presented on Figure 5.3-12 (see photo with the caption “Visual Simulation of Site 14 with application of Mitigation Measure M-CR-5a”). The figure also includes a simulation of the existing conditions at Site 14 and a simulated view of the proposed Project at the site.

Mitigation Measure M-CR-5a: Minimize Facilities Siting Impacts on Elements of the Historical Resource at Site 14

(See Impact CR-5 in Section 5.5, Cultural and Paleontological Resources for a description)

In addition, Site 14 is not within a scenic vista nor would it be visible from any nearby scenic roadways, and no scenic resources such as trees would be removed by development of this site. Therefore, there would be *no impact* on designated scenic roadways, resources, or vistas at this site.



Existing View of Site 14 looking north.





Visual Simulation of Site 14 with application of Mitigation Measure M-CR-5a.

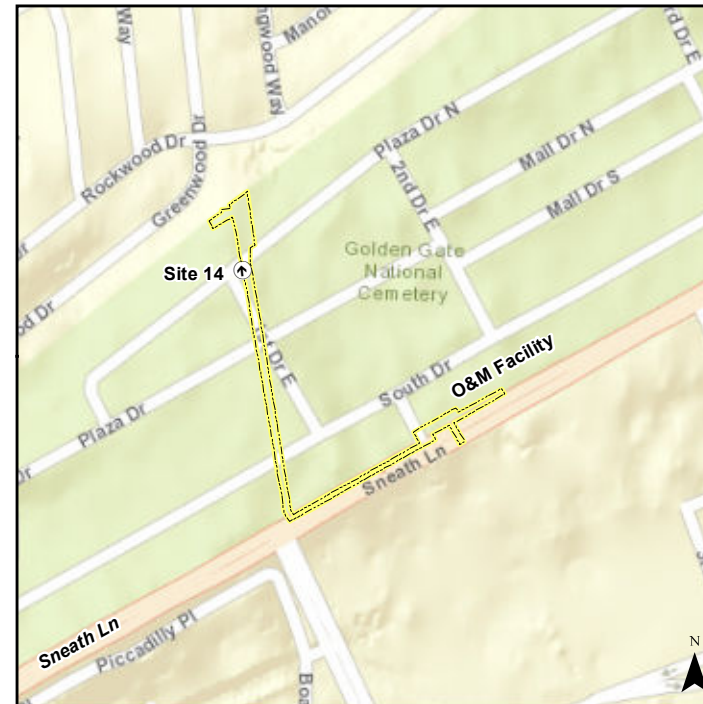

Visual Simulation of Site 14 without mitigation.



Legend

-  View Direction
-  Construction Area

Visual Simulation of Site 14

Regional Groundwater Storage and Recovery Project

Figure 5.3-12

This page left intentionally blank

Site 15

Site 15 would be located within the GGNC, situated in a grassy area on the southern edge of the cemetery between Sneath Lane and the cemetery's operations and maintenance yard (see Figure 3-36). This site is located just east of an auxiliary entrance to the GGNC from Sneath Lane. A commercial/office park and a Veteran's Administration Medical Clinic are located to the south across Sneath Lane and are shielded from view somewhat by mature trees and landscaping. As noted in Section 5.3.1.3 (Individual Project Well Facility Sites) and in Table 5.3-1 (Summary of Visual Sensitivity Findings), this site has high visual exposure, moderately high visual quality, and moderately high visual sensitivity.

The 2,095-square-foot well, chemical treatment, and filtration facility at Site 15 (see Figure 3-8) would be visible from the GGNC and from Sneath Lane, which is a locally designated scenic route. However, the location is not a designated scenic vista.

The overall visual sensitivity of this site is considered moderately high and the change in visual contrast of the proposed building addition would potentially be high, given the prominent position of the site in the immediate foreground of Sneath Lane and associated views of the cemetery grounds. The proposed facility would be viewed in the context of the existing operations and maintenance buildings, characterized by distinctive period architectural design (see Figure 5.3-13 [Visual Simulation of Site 15], with the caption "Visual Simulation of Site 15 without mitigation"). The building and fencing for Site 15 would be designed to integrate visually with the surrounding structures (including the existing maintenance buildings) and landscape, as described for the site in Chapter 3, Project Description, Section 3.4.3 (Facility Sites). Still, the Project would introduce an additional structure of public works character into a highly distinctive and formal visual setting consisting of open lawn, highly regular rows of uniform gravestones, and scattered, isolated trees. The structure could potentially be in conflict with the visual expectations of visitors to the cemetery – many of whom may use the auxiliary entrance on Sneath Lane. In this highly sensitive, formally ordered, and prominent setting, the well facility would, therefore, represent a high level of visual change because the form, scale, and character of the facility could be out of character with the surroundings. The facility at Site 15 would thus represent a *significant* aesthetic impact.

Implementation of Mitigation Measure M-CR-5b (Minimize Facilities Siting Impacts on Elements of the Historical Resource at Site 15) would reduce this aesthetic impact to a *less-than-significant* level. It requires the development of a compatible architectural design more closely resembling the existing GGNC maintenance and operations buildings, minimizing the dimensions of the well facility to the extent practicable, moving the structure further away from the auxiliary entrance, and using landscaping that would be in visual harmony with the site's surroundings. A visual simulation showing the well facility at Site 15 with the prescribed mitigation elements presented below is found in Figure 5.3-13 with the caption "Visual Simulation of Site 15 with application of Mitigation Measure M-CR-5b". The figure also shows the existing conditions at Site 15 and the proposed Project.

Mitigation Measure M-CR-5b: Minimize Facilities Siting Impacts on Elements of the Historical Resource at Site 15

(See Impact CR-5 in Section 5.5, Cultural and Paleontological Resources for a description)

In addition, Site 15 is not within a scenic vista, although it would be visible from a locally designated scenic roadway and require removal of scenic resources such as trees. Again, with implementation of Mitigation Measure M-CR-5b, the impact on designated scenic roadways and resources would be *less than significant with mitigation*.

Site 18 (Alternate)

Site 18 (Alternate) would be located on an undeveloped parcel in a residential neighborhood along Alta Loma Drive on a knoll at street level overlooking a lower, moderately sloped grassy swale (see Figure 3-39). The site is densely vegetated with a small stand of willows that is about 15 feet high and covering approximately 3,400 square feet. It is adjacent to single family residences to the southwest fronting on Del Monte Avenue and others directly across Alta Loma Drive. Single-family residences also front on Camaritas Avenue to the east. Vivid elements in the vicinity include views to forested hillsides to the south and San Bruno Mountain to the north. As noted in Section 5.3.1.3 (Individual Project Well Facility Sites) and in Table 5.3-1 (Summary of Visual Sensitivity Findings), this site has high visual exposure, but it has moderately high visual sensitivity, moderate visual quality, and moderately high overall visual sensitivity.

The 1,495-square-foot well and chemical treatment facility at Site 18 (Alternate) (see Figure 3-7) would be visible from Alta Loma Drive and from single-family residences on Alta Loma Drive, Del Monte Avenue, and Camaritas Avenue. A small stand of willows on the site would be removed and grading and other site preparation activities may be required to accommodate construction of the well facility and staging area. The well structure would introduce a new visual public works element in a residential neighborhood that could appear incompatible and out of character with the existing open space setting, even though it is actually an existing utility right-of-way. The structure would have a gray or stone concrete finish, as described in Chapter 3, Project Description, Section 3.4.2.2 (Well Facility Types). The introduction of a new public infrastructure would represent a significant visual change, even though the proposed well facility would be of smaller scale and height to surrounding residences of the area and the building's stone finish would moderate the contrast. Therefore, in the context of the moderately high overall visual sensitivity of the setting and a moderately high visual contrast given the introduction of an infrastructure facility in what may appear to be an open space area within a residential neighborhood, the potential impact on the visual character of the site and its surroundings would be *significant*. However, there would be *no impact* on scenic roadways, scenic vistas, or scenic resources at this site.

Taken together with the well facility's design, implementation of Mitigation Measure M-AE-3a (Implement Landscape Screening) would reduce the aesthetic impact of placing a new well and chemical treatment facility at this currently vacant location to a *less-than-significant* level by partially screening the facility from the surrounding residential area.

Mitigation Measure M-AE-3a: Implement Landscape Screening (Sites 4, 7, and 18 [Alternate])
(See Impact AE-3, Site 4 for a description)

Impact Conclusion: Less than Significant with Mitigation



Existing View of Site 15 from Sneath Lane looking north.





Visual Simulation of Site 15 with application of Mitigation Measure M-CR-5b.



Visual Simulation of Site 15 without mitigation.



Legend

-  View Direction
-  Construction Area

Visual Simulation of Site 15

Regional Groundwater Storage and Recovery Project

This page left intentionally blank

Impact AE-4: Project operation would not create a new source of substantial light that would adversely affect day or nighttime views in the area. (Less than Significant)

As described in Chapter 3, Project Description, Section 3.4.2.2 (Well Facility Types), the well facilities would have permanent outside lighting meeting the requirements of Title 24 of the California Code of Regulations. Use of outside lighting during nighttime hours would be temporary and random, based on unscheduled, as-needed maintenance events. Outside lighting would be controlled by motion sensor or switch by maintenance staff when they arrive at the well facilities. This outside lighting would be limited to the extent practicable and activated with manual switching with automatic shut-off. To further reduce the impact, the lighting would be placed and shielded to direct light downward. Scheduled and routine maintenance would be conducted during daytime hours, when outdoor lighting would not be necessary. Therefore, the Project would have a *less-than-significant* impact attributable to lighting at any of the facility sites.

The evaluation of impacts that follows discusses sites with no impacts first, followed by sites with less-than-significant impacts, and sites with significant impacts.

Sites 6, 7, 8, 11, 17 (Alternate), and Westlake Pump Station

Sites 6, 7, 8, 11, and 17 (Alternate) would not be located near any stationary sensitive views or viewers that would be affected by the appearance and intermittent frequency of the nighttime lighting occasionally necessary during Project maintenance. It is assumed that any operational activities or routine maintenance would occur during daylight hours. Any transient viewers passing near these sites would likewise not be impacted by the appearance and intermittent frequency of the nighttime lighting proposed, given the use of shielding, focused illumination, and placement. Also, these sites are located in urban and suburban areas where nighttime lighting (e.g., street lighting, security lighting) is already used on adjacent parcels and streets. In these situations, any lighting produced at these sites would blend into the existing surrounding lighting. In the case of the Westlake Pump Station, no new permanent lighting is proposed. As a result, *no impact* from operational nighttime lighting would occur at these sites.

Impact Conclusion: No Impact

Sites 1, 2, 3, 4, 5, 9, 10, 12, 13, 14, 15, 16, 18 (Alternate), and 19 (Alternate)

These proposed sites are located in areas that have nearby stationary sensitive views or viewers. These views and viewers could be affected by the appearance and intermittent frequency of the nighttime lighting occasionally necessary during Project maintenance, due to the added presence of a lighting source that did not exist before. However, as noted above, illumination of outside lighting during nighttime hours would be temporary and random, based on unscheduled, as-needed maintenance events. It is assumed that any operational activities or routine maintenance would occur during daylight hours. Any transient viewers passing near these sites would likewise not be impacted by the appearance and intermittent frequency of the nighttime lighting proposed, given the use of shielding and as-needed use, as described in Chapter 3, Project Description. Also, these sites are located in urban and suburban areas where nighttime lighting (e.g., street, security, ornamental, commercial) is already used on adjacent parcels. In these situations, any lighting produced at these sites would blend into the existing

surrounding lighting. Given the presence of stationary sensitive views and viewers – but also given the intermittent and random nature of outside lighting use for the Project – permanent lighting impacts attributable to the Project are considered *less than significant*.

Impact Conclusion: Less than Significant

5.3.3.6 Cumulative Impacts and Mitigation Measures

Impact C-AE-1: Construction and operation of the proposed Project could result in a cumulatively considerable contribution to cumulative impacts related to scenic resources and visual character. (Less than Significant with Mitigation)

The geographic scope for the analysis of cumulative impacts on aesthetic resources consists of each proposed GSR facility site (including the construction area for the well, the well facility, and the pipelines), and the immediate vicinity around each of these sites.

Construction

Scenic vistas, scenic resources, and visual character

The construction area of some of the cumulative projects listed in Table 5.1-3 (Projects Considered for Cumulative Impacts) would be visible to viewers who can also view proposed GSR Project construction areas (in the event that both the proposed GSR Project and cumulative projects were constructed at the same time): the Peninsula Pipelines Seismic Upgrade (PPSU) Project Colma Site (cumulative project D-1) would be visible from the vicinity of GSR Sites 8 and 17 (Alternate); the PPSU Project South San Francisco Site (cumulative project D-2) would be visible from the vicinity of GSR Sites 12 and 19 (Alternate); the Mission & McLellan Project (cumulative project F) would be visible from the vicinity of GSR Site 9; the PG&E Transmission Pipeline Replacement Project (cumulative project H) would be visible from the vicinity of GSR Sites 11, 12, and 19 (Alternate), and the Centennial Village Project (cumulative project I) would be visible from the vicinity of the pipeline construction areas for proposed GSR Site 13 (see Figures 5.3-5, 5.3-6, 5.3-7, 5.3-8, and 5.3-10 for photographs of these locations). None of these areas of visual overlap include scenic corridors, scenic vistas, or scenic resources. No cumulative projects have been identified that would be visible to viewers who would also be in view of construction areas at Sites 1, 2, 3, 4, 5, 6, 7, 10, 14, 15, 16, or 18 (Alternate).

As described in Impact AE-1, construction of the GSR Project would have less-than-significant impacts at GSR Sites 8, 9, 11, 17 (Alternate), and 19 (Alternate), and significant impacts at Sites 12 and 13, due to some degradation of visual quality from the construction staging areas, equipment, materials storage areas, and tree removal. Depending on the extent of overlap among the construction schedules, the cumulative impacts related to visual quality during construction could be *significant*. Therefore, the GSR Project's contribution to this cumulative impact could be cumulatively considerable given that the GSR Project would require construction staging areas, construction equipment, and material storage in areas with high visual quality.

However, as discussed in Impact AE-1, the GSR Project's impacts related to construction-period impacts on the visual quality in the vicinity of Sites 12 and 13 would be reduced to a less-than-significant level with implementation of Mitigation Measure M-AE-1a (Site Maintenance), Mitigation Measure M-AE-1b (Tree Protection Measures), and Mitigation Measure M-AE-1c (Develop and Implement a Tree Planting Plan at Site 12) (see Impact AE-1, above, for description). Implementation of these mitigation measures would ensure that the construction area is maintained by storing construction materials and equipment generally away from public view and by removing construction debris promptly at regular intervals, and tree removal is minimized. With implementation of these mitigation measures, the GSR Project's contribution to cumulative impacts related to visual quality during construction would not be cumulatively considerable (*less than significant*).

New sources of substantial light

If constructed at the same time, the construction area of some of the cumulative projects listed in Table 5.1-3 (Projects Considered for Cumulative Impacts) would be visible to viewers who can also view proposed GSR Project construction areas, as listed above. None of the cumulative projects listed above under the heading of *Scenic vistas, scenic resources, and visual quality* would be expected to require nighttime construction for which lighting would be required. Although not likely, construction staging areas for these cumulative projects may require nighttime lighting.

As described in Impact AE-2, the GSR Project would have less-than-significant impacts with regard to the creation of new sources of substantial light at GSR Sites 9, 12, and 19 (Alternate), because a lighting plan for those sites that require nighttime construction would be prepared and implemented, ensuring that lighting would be directed downward, covering only the area to be occupied by the drilling rig.

Depending on the extent of overlap between the construction schedules for the projects listed in Table 5.1-3 (Projects Considered for Cumulative Impacts), implementation of these projects together with the proposed GSR Project at Sites 9, 12, and 19 (Alternate) could result in a cumulative impact relative to the creation of new sources of substantial light. However, these impacts would be temporary (only as-needed during construction) and brief (only during drilling for approximately seven days and up to 48 hours for pump testing). Due to the limited need for lighting on the GSR Project and the controls required in the GSR Project's lighting plan, the potential cumulative impact resulting from the creation of new sources of substantial light associated with construction-related activities would be *less than significant*.

Operation

Scenic vistas, scenic resources, and visual character

Two of the cumulative projects listed in Table 5.1-3 (Projects Considered for Cumulative Impacts) would be visible to viewers who can also view proposed GSR Project permanent facilities at Sites 9 and 13. The Mission & McLellan Project (cumulative project F) and Site 9 would be visible to viewers at and in the area of the Verano Condominiums. The Centennial Village Project (cumulative project I) and Site 13 would be visible to those traveling along South Spruce Avenue. These areas of visual overlap would not include scenic corridors, scenic vistas, and scenic resources.

As described in Impact AE-3, the permanent well facilities at GSR Sites 9 and 13 would have a less-than-significant impact upon visual character, because of the low visual quality of GSR Site 9, the landscaping to be used at GSR Site 13, and the low degree of visual change resulting from placement of the GSR well facilities at both sites.

Implementation of the Mission & McLellan Project (cumulative project F) and the Centennial Village Project (cumulative project I) together with the proposed GSR Project would not result in a significant impact on visual quality. There is no reason to believe that the Mission & McLellan Project (cumulative project F), once constructed, would be out of character with the multi-family residential and public institutional land uses in the vicinity. Likewise, there is no reason to believe that the Centennial Village Project (cumulative project I) would be out of character with the surrounding commercial district.

As discussed in Impact AE-3, the GSR Project would have no impacts or less-than-significant impacts at most well facility sites, because the environment surrounding the sites is of low or moderately low overall visual quality or because aesthetic impacts were associated with construction and not operations of the Project. The same would be true for cumulative projects that are proximate to GSR sites including cumulative projects near Sites 8, 9, 11, 12, 13, 17 (Alternate), and 19 (Alternate). Cumulative projects in proximity to these sites are not the types to permanently place receptors in view of these sites. Therefore, the potential cumulative impact on visual quality would be *less than significant*.

New sources of substantial light

Some of the cumulative projects listed in Table 5.1-3 (Projects Considered for Cumulative Impacts) would likely have nighttime lighting, such as the Mission & McLellan Project (cumulative project F) near GSR Site 9 and the Centennial Village Project (cumulative project I) near GSR Site 13. Others may require infrequent nighttime maintenance, which would require outside nighttime lighting, such as the Cal Water Well Replacement SSF1-25 Project (cumulative project G) and Daly City "A" Street Well Replacement Project (cumulative project C) near GSR Sites 11 and 5, respectively). As described in Impact AE-4, the GSR Project would have no or less-than-significant impacts relative to the creation of new sources of substantial light, because the use of outdoor nighttime lighting during maintenance would be infrequent and because the proposed GSR well facilities are located in urban areas with existing nighttime lighting. The same would be true for the cumulative projects. For these reasons, the potential cumulative impact on nighttime lighting from maintenance activities would be *less than significant*.

5.3.4 References

- California Department of Transportation (Caltrans). 2012. Officially Designated State Scenic Highways. Updated March 15. Website accessed March 28, 2012 at: <http://www.dat.ca.gov/hq/LandArch/scenic/schwy.htm>
- Colma, Town of. 1999. *Town of Colma General Plan*. June.
- Colma, Town of. 2010. *Town of Colma Municipal Code, Chapter 5, Subchapter 5.06, Tree Cutting and Removal*. March.
- San Bruno, City of. 2002. *City of San Bruno Municipal Code, Title 8, Chapter 8.25, Heritage Trees*.
- San Bruno, City of. 2009. *San Bruno General Plan*. March 24.
- San Francisco Public Utilities Commission (SFPUC). 2007. *Right of Way Integrated Vegetation Management Policy*.
- San Mateo County. 1986. *General Plan Overview Background & Issues Chapters 1-16*. November.
- South San Francisco, City of. 1999. *City of South San Francisco General Plan*.
- South San Francisco, City of. n.d. *City of South San Francisco Municipal Code. Title 13 Public Improvements, Chapter 13.30 Tree Preservation*
- South San Francisco, City of. 2012. *About South San Francisco*. Website accessed March 21, 2012 at: <http://www.ssf.net/index.aspx?nid=88>
- U.S. Department of Veterans Affairs (VA), National Cemetery Administration/Office of Facilities Management Facility Quality Office. 1999. *National Cemetery Administration (NCA) Facilities Design Guide Chapters 1-4*. June.
- U.S. Department of Veterans Affairs (VA), National Cemetery Administration/Office of Facilities Management Facility Quality Office. 2010. *National Cemetery Administration (NCA) Facilities Design Guide Chapter 5*. March.

This page left intentionally blank

5.4 POPULATION AND HOUSING

This section analyzes the potential for the Project-specific aspects of the proposed Project to induce substantial population growth, displace housing, create a substantial demand for additional housing in the Project area, or necessitate the construction of housing outside the Project area. The growth-inducement effects of the Project within the context of the San Francisco Public Utilities Commission's (SFPUC) Water System Improvement Program (WSIP) and the overall regional water system, as well as the indirect effects of that growth, are analyzed in the Program Environmental Impact Report (PEIR) on the WSIP. That analysis is incorporated into this EIR by reference (San Francisco Planning Department 2008) and is summarized in Chapter 2, Introduction and Background, Section 2.2.2 (SFPUC Water System Improvement Program) and in Chapter 6, Other CEQA Issues, Section 6.1 (Growth Inducement).

5.4.1 Setting

Facilities for the proposed Project would be constructed and operated in the cities of Daly City, South San Francisco, San Bruno, and Millbrae, as well as the Town of Colma and the Broadmoor neighborhood in unincorporated San Mateo County. These places comprise the Project study area for this analysis. Existing land uses in the Project vicinity include a variety of residential (low, medium, and high density), commercial, industrial, and public/quasi-public uses. Other land uses in the area include golf clubs, cemeteries, and urban parks. Refer to Section 5.2, Land Use, for additional information regarding land uses in the Project vicinity.

In 2011, San Mateo County (including the incorporated jurisdictions within the County) was home to approximately 724,702 residents and had approximately 271,428 housing units (State of California Department of Finance 2011). The estimated population and housing units for the various jurisdictions within the Project study area are summarized in Table 5.4-1 (Estimated Population and Housing Units in 2011).

TABLE 5.4-1
Estimated Population and Housing Units in 2011

Jurisdiction	Estimated Population	Estimated Number of Housing Units
City of Daly City	101,920	32,609
Unincorporated San Mateo County (Broadmoor) ^(a)	4,176	1,392
Town of Colma	1,805	586
City of South San Francisco	64,067	21,805
City of San Bruno	41,842	15,516
City of Millbrae	21,714	8,383
TOTAL	235,524	80,291

Sources: State of California Department of Finance 2011; U.S. Census Bureau 2010

Note:

- (a) Broadmoor is a "census designated place" (CDP) as defined by the U.S. Bureau of the Census and is delineated for each decennial census as a statistical counterpart of incorporated places, such as municipalities.

5.4.2 Regulatory Framework

There are no federal, State, or local regulations governing population and housing that apply to the proposed Project.

5.4.3 Impacts and Mitigation Measures

5.4.3.1 *Significance Criteria*

For the purposes of this EIR, the Regional Groundwater Storage and Recovery Project would have a significant effect on population or housing if it were to:

- Induce substantial population growth in an area, either directly or indirectly (for example, by proposing new homes and businesses) or indirectly (for example, through extension of roads or other infrastructure).
- Displace substantial numbers of existing housing units or create demand for additional housing, necessitating the construction of replacement housing.
- Displace substantial numbers of people, necessitating the construction of replacement housing elsewhere.

5.4.3.2 *Approach to Analysis*

Due to the nature of the proposed Project, no impacts would occur related to the three impact criteria listed above for the reasons presented below:

Induce substantial population growth in an area, either directly or indirectly. During the approximate 21-month construction period, the average daily number of persons necessary for all construction activities is estimated to be up to 193 construction workers (refer to Chapter 3, Project Description, Section 3.5.1.2 [Construction Methods for Well Facilities])¹. It is expected that the construction workforce requirements could be met with the local labor force within the San Francisco Bay Area (Bay Area). While some workers might temporarily relocate from other areas, the increase would be minor (not more than 193 workers) and temporary (up to 21 months). Long-term operation and maintenance of the well facilities is discussed in Chapter 3, Project Description, Section 3.8 (Operations and Maintenance) and would be executed by existing staff from the SFPUC or the Partner Agencies. The proposed Project does not include the construction of new homes or

¹ Table 3-8 (Estimated Daily Worker and Construction Equipment Trips for Well Facilities Construction) in Chapter 3, Project Description, Section 3.5.1.2 (Construction Methods for Well Facilities), describes the typical daily construction worker trips for each Project construction component/phase, and identifies the facility sites to which that phase applies. The average daily construction workers was determined by multiplying the typical daily construction worker trips for each phase by the number of facility sites to which that phase applies. Then the results for all phases were added together. A total of 193 average daily construction workers is a conservative figure, because it assumes the simultaneous construction of all phases and all facility sites. However, in actuality, while 19 wells would be constructed (including some test wells being converted to production wells), only 16 facilities would be constructed. Additionally, construction of all 16 facilities would only overlap for a portion of the 21-month construction period.

businesses in the area or extend new roads or other infrastructure into undeveloped areas. Therefore, construction and operational activities associated with the proposed Project would not in themselves result in a substantial increase in the local population and there would be no growth-inducement impact associated with the Project.

As a WSIP facility improvement project, the proposed Project would be a contributing factor in the growth-inducement potential of the overall WSIP. Growth inducement relative to this Project is discussed in Chapter 6, Other CEQA Issues, Section 6.1 (Growth Inducement). Indirect effects of the Project on population and housing growth, due to growth-inducement potential and secondary effects of growth are also discussed in Chapter 6, Other CEQA Issues, Section 6.1.

Displace substantial numbers of housing units or people or create demand for additional housing. There are 80,291 housing units in the larger study area; however, none are situated within the construction area boundary for any well facility site. Therefore, neither construction nor operation of the Project would displace housing units or people.

A maximum of 193 construction workers per day would be employed as part of the proposed Project (refer to Chapter 3, Project Description, Section 3.5.1.2 [Construction Methods for Well Facilities]), but it is expected that the construction workforce requirements could be met by the local labor force within the Bay Area and would not create demand for additional housing. Therefore, no impacts related to the creation of additional housing to accommodate construction workers would be attributable to the Project. In addition, operations and maintenance responsibilities associated with the Project would be performed by existing staff of the SFPUC and Partner Agencies and would not create the need for additional housing. Therefore, the significance criteria are not applicable to the proposed Project and are not discussed further.

5.4.3.3 Construction and Operational Impacts and Mitigation Measures

As discussed above, there would be no additional growth-inducing impact beyond that considered in the WSIP PEIR. The Project would be a groundwater storage and recovery system that would not, independently and separately from its contribution as part of the overall WSIP, result in Project-level impacts to population and housing. Therefore, no mitigation measures related to this resource topic are required.

5.4.3.4 Cumulative Impacts and Mitigation Measures

Because the GSR Project would not result in Project-specific impacts related to population or housing, implementation of the Project would not result in cumulative impacts beyond the secondary and indirect impacts of growth associated with the proposed Project within the context of the WSIP, as described in this EIR in Chapter 6, Other CEQA Issues, Section 6.1 (Growth Inducement).

5.4.4 References

- San Francisco Planning Department. 2008. *Final Program Environmental Impact Report on the San Francisco Public Utilities Commission Water System Improvement Program*. (Case No. 2005.0159E, State Clearinghouse No. 200509206). October 30.
- State of California, Department of Finance. 2011. *E-5 Population and Housing Estimates for Cities, Counties, and the State, with 2010 Benchmark*. May.
- U.S. Census Bureau. 2010. *American Fact Finder. Broadmoor CDP, California. DP-1: Profile of General Population and Housing Characteristics: 2010*. Website accessed March 27, 2012 at: <http://factfinder2.census.gov/faces/nav/jsf/pages/index.xhtml>.

5.5 CULTURAL AND PALEONTOLOGICAL RESOURCES

Cultural resources include historic architectural resources, archaeological resources, paleontological resources and human remains. This section evaluates the potential for implementation of the San Francisco Public Utilities Commission's (SFPUC's) proposed Regional Groundwater Storage and Recovery (GSR) Project to result in adverse impacts to historical resources, including historic-period architectural and archaeological, as well as paleontological resources. This EIR evaluates both historic and unique archaeological resources, as defined in Section 5.5.2.2 (State Regulations). Mitigation measures to reduce impacts to a less-than-significant level are identified, where appropriate.

5.5.1 Setting

5.5.1.1 CEQA Area of Potential Effects

For the purpose of environmental review under the California Environmental Quality Act (CEQA), the definition of the CEQA Area of Potential Effects (C-APE) presented below is modeled after that of the federal Area of Potential Effects (APE) described in the Code of Federal Regulations (36 CFR 800.16[d]):

The C-APE is the geographic area or areas within which an undertaking may directly or indirectly cause alterations in the character or use of historical resources (i.e., California Register-eligible resources), if any such properties exist. The C-APE is influenced by the scale and nature of an undertaking and may be different for different kinds of effects caused by the undertaking.

A portion of the Project (GSR Sites 14 and 15) would be located on lands managed by the U.S. Department of Veterans Affairs (VA) at the Golden Gate National Cemetery (GGNC); therefore, the Project is subject to review under Section 106 of the National Historic Preservation Act, as amended. As part of the Section 106 review process, the VA must identify the federal APE for the well facilities at Sites 14 and 15. It is expected that the VA would determine that the architectural and archaeological federal APEs are identical to the C-APE for Sites 14 and 15.

Architectural C-APE

The C-APE for architectural resources takes into consideration the proposed Project effects on the built environment, including the potential for directly or indirectly altering the setting, character, or use of historical resources. Architectural C-APEs for each well facility site are presented in Table 5.5-1 (Architectural C-APEs), which includes a Notes column that summarizes the assumptions that guided the creation of the C-APEs. The table also includes a summary of the information presented in the Historic Architectural Resources Technical Report (Carey & Co. 2011b). In general, the C-APEs for architectural resources include all parcels where Project activities would occur, including pipeline trenching locations for both proposed and alternate pipeline connections. Adjacent parcels are included for a few of the proposed well sites where the potential for indirect impacts was identified. The limited size of the architectural C-APEs is based on the small footprint and scale of the proposed well facilities and the

developed character of the area surrounding the majority of proposed Project locations. However, for proposed well facilities where construction activities would occur within a potential historical landscape¹, such as a cemetery, the entire landscape area is included in the architectural C-APE. This approach is taken for all well sites where construction activities are proposed within or directly adjacent to cemeteries that are 45 years old or older. For example, Project activities associated with well facilities at Sites 14 and 15 would occur within the VA's GGNC property; therefore, the C-APEs for these well facilities include the entire cemetery. The architectural C-APE for Site 7 also includes the adjacent cemeteries containing buildings or structures that may incur indirect impacts from proposed Project activities, such as introducing elements (e.g., new structures) that have the potential to be out of character with the historic setting. This includes the Woodlawn Memorial Park to the north and a maintenance building and mausoleum managed by the Greenlawn Memorial Park (owned by the Greek Orthodox Memorial Park), adjacent to the Site 7. In general, indirect impacts were not identified for proposed pipeline trenching, as these areas would be returned to their general pre-construction condition following construction and would not introduce permanent above-ground structures or other elements that could affect the historic setting. The C-APEs for architecture consider the proposed removal of trees or vegetative landscaping, as such features can contribute to a historic landscape or the setting of a historical resource.

¹ National Register Bulletin 18 defines a designed historic landscape as "a landscape that has significance as a design or work of art; was consciously designed and laid out by a master gardener, landscape architect, architect, or horticulturalist to a design principle, or an owner or other amateur using a recognized style or tradition in response or reaction to a recognized style or tradition; has a historical association with a significant person, trend, event, etc. in landscape gardening or landscape architecture; or a significant relationship to the theory or practice of landscape architecture."

TABLE 5.5-1
Architectural C-APEs

Well Facility	Site Description	Well Station Type	Proposed Connection Point	Architectural C-APE	Notes
Site 1	Lake Merced Golf Club	Well plus chemical treatment	SFPUC pipeline	Construction area within the golf club property	No impact expected outside of construction area.
Site 2	Park Plaza Meter	Well with fenced enclosure	Daly City pipeline	Construction area	No impact expected outside of construction area.
Site 3	Ben Franklin Intermediate School	Well with fenced enclosure	Daly City pipeline	Construction area and the access road and the parcel it crosses	Assumes no indirect impacts on adjacent parcels due to small size of fenced well enclosure.
Site 4	Garden Village Elementary School	Well with fenced enclosure	Daly City pipeline	Construction area	No impact expected outside of construction area.
Westlake Pump Station	Westlake Pump Station	N/A	Daly City pipeline	Construction area and adjacent parcel	Work entails upgrades to existing pump station. Assumes no potential impact on pump station or adjacent property, since work would occur inside the existing building.
Site 5	Right-of -Way at Serra Bowl	Well with fenced enclosure (Consolidated Treatment at Site 6 Option) or Well plus chemical treatment and filtration (On-site Treatment Option)	SFPUC pipeline	Construction area and adjacent parcel to the east	The San Pedro Valve Lot across the street is not a historical resource.

TABLE 5.5-1
Architectural C-APEs

Well Facility	Site Description	Well Station Type	Proposed Connection Point	Architectural C-APE	Notes
Site 6	Right-of-Way at Colma BART	Well plus chemical treatment and filtration	SFPUC pipeline	Construction area and the parcel boundaries	No impact expected outside of construction area. Assumes no potential for indirect impacts on the nearby cemetery.
Site 7	Right-of-Way at Colma Boulevard	Well with fenced enclosure (Consolidated Treatment at Site 6 Option) or Well plus chemical treatment and filtration (On-site Treatment Option)	SFPUC pipeline	Construction area and nearby Woodlawn Memorial Park, Greenlawn Memorial Park, and Greek Orthodox Memorial Park grounds	Assumes the potential for indirect impacts on the Woodlawn Memorial Park and the Greek Orthodox Memorial Park due to proximity to the construction area. Assumes potential for impacts on Greenlawn Memorial Park due to its historic and current association with buildings adjacent to construction area. Assumes that these cemeteries may be designed historic landscapes and that the entire landscape will be evaluated to determine potential indirect impacts.
Site 8	Right-of-Way at Serramonte Boulevard	Well plus chemical treatment and filtration	Cal Water pipeline	Construction area and parcel	Assumes no potential indirect impacts due to proposed connection pipelines or utility trenching outside of the SFPUC right-of-way.
Site 9	Treasure Island Trailer Court	Well plus chemical treatment and filtration	SFPUC pipeline	Project area and the trailer park	Assumes potential indirect impacts to trailer park due to size of buildings in relation to proposed construction. Included entire trailer park parcel in C-APE.
Site 10	Right-of-Way at Hickey Boulevard	Well plus chemical treatment and filtration	Daly City pipeline	Construction area	No impact expected outside of construction area.

TABLE 5.5-1
Architectural C-APEs

Well Facility	Site Description	Well Station Type	Proposed Connection Point	Architectural C-APE	Notes
Site 11	South San Francisco Main Area	Well plus chemical treatment and filtration	Cal Water pipeline	Construction area	No impact expected outside of construction area.
Site 12	Garden Chapel Funeral Home	Well plus chemical treatment	SFPUC pipeline	Construction area, including developed parcels where construction activity would occur	Assumes potential for indirect impacts on parcels through which construction area runs.
Site 13	South San Francisco Linear Park	Well plus chemical treatment and filtration	San Bruno pipeline	Construction area	No impact expected outside of construction area
Site 14	Golden Gate National Cemetery (GGNC)	Well with building or solid wall enclosure	San Bruno pipeline	Construction area, cemetery and developed parcel where construction activity would occur	The GGNC is considered a historical resource. C-APE assumes that the entire landscape needs to be studied to determine potential impacts.
Site 15	Golden Gate National Cemetery (GGNC)	Well plus chemical treatment and filtration	San Bruno pipeline	Construction area, cemetery and developed parcel where construction activity would occur	The GGNC is considered a historical resource. C-APE assumes that the entire landscape may need to be studied to determine potential impacts.
Site 16	Millbrae Corp Yard	Well plus chemical treatment	SFPUC	Construction area and building adjacent to spoil area	Assumes no potential impact on Orchard Supply Hardware building next to proposed connection pipeline or power line excavation to adjacent parcels.

**TABLE 5.5-1
Architectural C-APEs**

Well Facility	Site Description	Well Station Type	Proposed Connection Point	Architectural C-APE	Notes
Site 17 (Alternate)	Standard Plumbing Supply	Well plus chemical treatment	Cal Water pipeline	Project area along with Standard Plumbing Supply parcel.	Assumes no indirect impacts on the National Register-eligible Cypress Lawn Memorial Park District. Includes Standard Plumbing Supply parcel as construction would occur within the parcel boundaries.
Site 18 (Alternate)	Alta Loma Drive	Well plus chemical treatment	SFPUC pipeline	Construction area and adjacent parcel to the west.	Assumes potential for indirect impacts on the adjacent parcel at the corner of Del Monte Avenue and Alta Loma Drive due to the proximity of proposed construction to this single-family home. Assumes that there are no construction activities, other than those shown on Figure 3-39 in Chapter 3.0 Project Description, occurring within the construction area to the east of buildings fronting on Del Monte Avenue.
Site 19 (Alternate)	Garden Chapel Funeral Home	Well with fenced enclosure	SFPUC pipeline	Construction area, including developed parcels where construction activity would occur.	Assumes potential for indirect impacts on parcels through which construction area runs.

Source: Carey & Co. 2011b

Archaeological C-APE

The C-APE for archaeological resources takes into consideration the proposed Project effects on potential surface and subsurface archaeological deposits that could be affected by Project activities at each of the 16 well facility sites, as well as at the three alternate sites (19 sites in total) and the Westlake Pump Station. Therefore, the archaeological C-APEs have both a horizontal and vertical component. As the Project consists of 19 discrete well facility sites and a pump station site, the archaeological C-APE consists of a series of discrete pieces of land. The horizontal C-APE for each well facility site consists of the entire well facility construction area as shown on Figures 3-11 through 3-40, which encompasses: the location of the

well facility; the chemical/filtration treatment building, where needed; other temporary and permanent improvements, such as paving and parking; and the construction staging area. The horizontal extent of the C-APEs varies from 0.4 acre for Site 1 to 3.0 acres for Sites 2, 3, and 4 combined, depending upon local site conditions and the types of improvements proposed at each location. The vertical C-APE for each well facility site is five feet, which is the proposed depth of construction-related ground disturbance. The horizontal C-APE for pipeline (both proposed and alternate pipeline connections) and utility installation consists of a 20-foot wide swath along pipeline and utility line routes. The vertical C-APE for pipelines is six feet, and for utilities is five feet. The vertical C-APE for the groundwater wells is in excess of 100 feet, and for geotechnical borings is 50 feet.

Paleontological C-APE

The C-APE for paleontological resources includes all areas that could potentially experience subsurface excavation into fossil-bearing geologic units during Project construction. The paleontological C-APE is similar to the archaeological C-APE, except that activities that disturb only the ground surface are excluded. Surface-disturbing activities (e.g., grading at staging areas or for site access) would affect surface soils only, which have already been disturbed by regional urbanization, and not the underlying fossil-bearing geologic units which, therefore, are not considered to be within the paleontological C-APE.

Significant paleontological resources are fossils and fossiliferous deposits, consisting of identifiable vertebrate fossils, large or small, uncommon invertebrate, plant and trace fossils, and other data that provide evolutionary and geologic information. Paleontological resources are considered to be older than recorded human history and/or older than the middle Holocene epoch (i.e., older than about 5,000 radiocarbon years) (SVP 2012b).

5.5.1.2 Paleontological Setting

Paleontological resources are the fossilized remains of plants and animals, including vertebrates (animals with backbones), invertebrates (e.g., starfish, clams, ammonites and marine coral) and fossils of microscopic plants and animals (microfossils). The age and abundance of fossils depend on the location, topographic setting and particular geologic formation in which they are found. Fossil discoveries not only provide a historical record of past plant and animal life but can assist geologists in dating rock formations. In addition, fossil discoveries can expand our understanding of the time periods and the geographic range of existing and extinct flora or fauna.

Paleontological Assessment Standards

The Society of Vertebrate Paleontology (SVP) has established guidelines for the identification, assessment and mitigation of adverse impacts on nonrenewable paleontological resources (SVP 1996, 2012a). Most practicing paleontologists in the United States adhere closely to the SVP's assessment, mitigation and monitoring requirements as outlined in these guidelines, which were approved through a consensus of professional paleontologists and are the standard against which all paleontological monitoring and mitigation programs are judged. Many federal, State, county and city agencies have either formally or informally adopted the SVP's standard guidelines for the mitigation of adverse construction-related

impacts on paleontological resources. The SVP has helped define the value of paleontological resources and, in particular, indicates the following:

- Vertebrate fossils and fossiliferous (fossil-containing) deposits are considered significant nonrenewable paleontological resources and are afforded protection by federal, State and local environmental laws and guidelines.
- A paleontological resource is considered to be older than recorded history, or 5,000 years before present, and is not to be confused with an archaeological resource.
- Invertebrate fossils are not significant paleontological resources unless they are present within an assemblage of vertebrate fossils or they provide undiscovered information on the origin and character of the plant species, past climatic conditions, or the age of the rock unit itself.
- A project paleontologist, local paleontologist, specialist, lead agency, or local government can designate certain plant or invertebrate fossils as significant.

In accordance with these principles, the SVP outlined criteria for screening the paleontological potential of rock units and established assessment and mitigation procedures tailored to such potential (SVP 2012a).

Table 5.5-2 (Criteria for Determining Paleontological Potential) lists the criteria for high-potential, undetermined and low-potential rock units.

**TABLE 5.5-2
Criteria for Determining Paleontological Potential**

Paleontological Potential	Description
High	Geologic units from which vertebrate or significant invertebrate or plant fossils have been recovered. Only invertebrate fossils that provide new information on existing flora or fauna or on the age of a rock unit would be considered significant.
Undetermined	Geologic unit(s) for which little to no information is available.
Low	Geologic units that are not known to have produced a substantial body of significant paleontological material.

Source: SVP 1996, 2012a

Paleontological Potential in Project Area

The following discussion of paleontological resources divides the rock units underlying the Project area into geologic units with a high and low potential to yield significant fossils. Information was compiled based on a review of published geologic maps, geologic unit descriptions and a fossil collections database at the University of California Museum of Paleontology (UCMP) undertaken for the Project by Dr. Kenneth Finger in 2009 (Finger 2009). No new mapping or field study for paleontological resources was conducted during the preparation of this EIR.

Nearly all of the proposed well facility sites are located on surface deposits mapped as the Colma Formation; the exceptions are Site 9, which is on Holocene colluvium, and a portion of Site 10, which is on artificial fill (Brabb et al. 1998). The Colma Formation is of early late Pleistocene age. Its total thickness is unknown, but may be as great as 60 meters (approximately 200 feet). The depositional setting 125,000 years ago for the Colma Formation is that of a narrow straight or coastal embayment that is also thought to have been present during prior deposition in the Pliocene to middle Pleistocene epoch of the estuarine Merced Formation (Lajoie 1986).

Although vertebrate remains in Holocene colluvium are too young to be fossiliferous, thus having low paleontological potential, any such vertebrate remains in this stratum could be of scientific interest to paleontologists, but would not be considered significant paleontological resources. However, artificial fill is material that has been disturbed by previous construction activities. Hence, these mapped units have no paleontological potential.

The Colma Formation, on the other hand, has produced significant marine and terrestrial fossils in the past and, therefore, is considered to have high paleontological potential. Bones and teeth of mammoth and extinct bison have been reported from sand and clays of the Colma Formation that overly the metamorphic Franciscan Complex. Associated fossil diatoms² and pollen indicate deposition in an estuarine environment. A leg bone of a ground sloth (*Glossotherium* sp.) previously recovered from the shallow well in the vicinity of the bones and teeth of the mammoth and bison, has been related to the same bed (Rodda and Baghai 1993). Other vertebrate fossil localities have been listed in the San Francisco Bay region (Savage 1951), which might also be associated with the Colma Formation. Fossil plant remains and a peat layer at the top of the Colma Formation have been reported as possibly representing “an old soil that developed in or near local marshes or lakes.” Marine deposits within the Colma Formation have produced marine megafossils (large fossils), marine and nonmarine algae (Schlocker 1974).

5.5.1.3 *Prehistoric Setting*

The following information is taken from Historic Context and Archaeological Survey Report for the Regional Groundwater Storage and Recovery Project Area, San Mateo County, California (Archeo-Tec 2011a).

Prehistoric Context

Current archaeological evidence suggests humans have continuously occupied California since at least 13,500 years before present (B.P.), beginning during the Pleistocene-Holocene Transition. However, the earliest traces of human habitation on the San Francisco Peninsula date to around 6,000 years B.P., during the Middle Holocene. Since that time, human occupation of the northern part of the peninsula may have been continuous. During the Middle Holocene, people began to exploit more diversified animal species than during the earlier Pleistocene-Holocene Transition and shifted to an increased reliance on plants and

² Microscopic one-celled or colonial algae.

seeds. This resource diversification required a lifestyle of seasonal migrations in order to access different environments throughout the year. Consequently, the “tool kit” of prehistoric peoples became more specialized, expanding to include varied methods of food processing. The diverse habitats and year-round availability of food in central California also contributed to the shift to exploitation of resources other than big game. The increasingly prominent role of seed collecting is reflected in the archaeological record by large numbers of food grinding implements (Wallace 1978). As the utilization of acorns became more predominant, heavy, deep-basined mills and handstones came into use. Middle Holocene archaeological sites often contain human remains and moderate to substantial artifact assemblages are found in multi-activity sites (Rosenthal and Meyer 2004).

Based on evidence from linguistics and burial patterns, this early population movement into the San Francisco Peninsula was possibly a wave of Penutian-speaking Costanoan ancestors either replacing or assimilating their Hokan-speaking predecessors (Moratto 1984). The earliest site found in San Francisco to date is the fragmentary human remains discovered during the course of excavation for the Bay Area Rapid Transit (BART) Civic Center Station. This find points to the possibility of the existence of early, deeply buried prehistoric resources throughout San Francisco. Despite these finds, there are relatively few sites older than 4,500 B.P. on the actual bayshore. This could represent two possible scenarios: 1) the bayshore was inhabited before 4,500 B.P., abandoned when rising sea levels inundated the land, and then reoccupied after the sea retreated; or 2) occupation began after 4,500 B.P., when the marshes began to stabilize.

Beginning around 4,000 B.P., which is the start of the Late Holocene, the climate began to shift from the warm and dry Altithermal period to cooler and wetter conditions. The general cultural trend observed in California was one of adjusting to new environmental conditions. For example, many of the archaeological sites dating to the Late Holocene in the San Francisco Bay region are shellmounds, midden sites containing large quantities of mollusk shells. This site type in the Bay Area includes the West Berkeley shellmound (Wallace 1978), and the nearby Emeryville shellmound, which is an example of a Late Holocene shellmound on a massive scale, over 30 feet (nine meters) in height and spanning the period of time from 2,700-650 B.P. As at West Berkeley, the Emeryville shellmound yielded an extensive array of worked stone and bone, beads and faunal remains that allowed for a detailed analysis of resource exploitation and subsistence at the time (Broughton 1997, 1999). More broadly, N. C. Nelson recorded over 400 of these shellmounds around the edge of the San Francisco Bay in the early twentieth century (Nelson 1909, 1910). This period is characterized by further niche specialization, a refinement of various technologies and specialized exploitation of plant and animal species. Archaeological sites dating to the Late Holocene also have been found in San Francisco, primarily in the South of Market region. These sites are all multi-activity shellmound and midden sites. The oldest date from an occupation site in San Francisco is 2,200 B.P. (Pastron and Ambro 2005).

Ethnohistoric Context

When the Spanish first explored northern California in the last quarter of the eighteenth century, the San Francisco peninsula was territory occupied by the Costanoan people, who are sometimes referred to as the Ohlone in the anthropological and historical literature (e.g., Levy 1978). The Costanoan (Ohlone) language was the most widespread of five distinct languages spoken in the vicinity of the San Francisco

Bay at the time of contact with Spanish explorers (Milliken 1995). An average of about 15 individuals – although this varies considerably – made up an Ohlone household (Broadbent 1972). The next larger social unit was the clan (Harrington 1933). Additionally, the Ohlone were divided into moieties³ following the common central California practice (Kroeber 1925). The largest social unit was the tribelet, or group of interrelated villages under the leadership of a single headman (Heizer 1978), and consisted of about 200 to 400 people (Levy 1978; Milliken 1995). While in some areas of California the families composing a tribelet would share a single central village location for most of the year, tribelets in the Bay Area were settled in a more dispersed fashion (Milliken 1995).

The Ohlone people were primarily collectors and hunters of fish and game. Of significant importance to the aboriginal diet were various molluscan resources, including clams, ocean and bay mussels and oysters. These food sources are well documented in the archaeological record from excavated shellmounds around the bay. Many other littoral food resources, including varieties of gastropods and crustaceans, contributed protein to the Ohlone diet (Greengo 1951, 1952, 1975). Other sources of meat included many species of land and waterfowl, as well as large and small terrestrial and sea mammals (Levy 1978). Fish contributed a large measure of protein to the Ohlone diet and were taken by net, trap, hook, spear and poison (Harrington 1921; Crespi 1927; Font 1930; Bolton 1933).

In common with most Native American groups throughout what today is California, plant foods probably contributed the majority of calories to the diet. The staple was the acorn, pounded by stone mortar and pestle to form mush, gruel, or bread (Gifford 1955). Buckeye yielded edible nuts. Many species of berries were harvested, as were roots, shoots and seeds (Levy 1978). In addition to providing primary subsistence, the flora and fauna of a rich natural habitat provided the remainder of life's necessities for the Ohlone people.

Tules were harvested and utilized as building materials for structures (Kroeber 1925) and for crude balsa canoes (Heizer and Massey 1951). Vegetal resources also provided the fiber for net and cord manufacture and, especially, basket material. Animal parts – bone, tooth, beak, and claw – provided awls, pins, daggers, scrapers, knives, and other tools. Pelts and feathers provided clothing and bedding (Kroeber 1925; Levy 1978). Sinew was used for bow support and bow strings (Harrington 1921). Feather, bone and especially shell were used for items of ornamentation (Mason 1916).

Local rock and mineral sources provided chert, as well as metamorphic and igneous materials for tool manufacture and highly indurate local sandstone yielded suitable material for grinding and pounding tools. Exotic materials, such as steatite and particularly obsidian, could be obtained in trade. The Bay Area inhabitants bartered with locally available commodities, such as cinnabar and hematite (Heizer and Treganza 1972). Other valuable local resources used in trade with inland peoples included salt, shellfish meat and shell as raw material for ornament manufacture (Davis 1961).

³ Either of two kinship groups based on unilateral descent that together make up a tribe or society.

5.5.1.4 *Historic-Period Setting*

The following information is taken from Historic Context and Archaeological Survey Report for the Regional Groundwater Storage and Recovery Project Area, San Mateo County, California (Archeo-Tec 2011a) and Historic Resources Technical Report for the Regional Groundwater Storage and Recovery Project, San Mateo County, California (Carey & Co. 2011b).

The first Spanish explorer to reach the San Francisco Bay was Gaspar de Portolá and his party in 1769. In the spring of 1776, Captain Juan Bautista de Anza established both the Mission Dolores and Presidio of San Francisco. By April 1 of that year, de Anza's men had traveled through San Francisco and down the peninsula, passing near several of the sites proposed for well facilities (Milliken 1995).

The establishment of Mission Dolores in 1776 began the "Mission Period" in the San Francisco Bay area. At its peak in the 1820s, Mission Dolores controlled the entire San Francisco Peninsula as far south as San Francisquito Creek (which forms the border between San Mateo and Santa Clara counties), including the Project area (Bancroft 1886; Dwinelle 1867; Hittell 1897; Soulé et al. 1855). El Camino Real, also known as the California Mission Trail, connected Alta California's missions; many of the proposed well facility sites are located near or alongside El Camino Real (Hackel 1998). Vast tracts of land on the peninsula, including land where the well facility sites would be located, served as grazing land for cattle belonging to Mission Dolores or the Presidio. In 1833, the Mexican Congress passed a bill that secularized the Missions of Upper and Lower California (Hittell 1897).

Rancho Period (1835-1846)

After the secularization of the Missions, the former Mission lands were granted to citizens in recognition of their services to the Mexican government. The area containing the proposed well facility sites was divided into two ranchos: Rancho Laguna de la Merced, granted to José Antonio Galindo; and Rancho Buri Buri, granted to José Antonio Sánchez. GSR Sites 1 through 6 are situated within the former Rancho Laguna de la Merced, Sites 13 and 16 are within former tidal salt marshes that were thus considered public land, and the remaining well facility sites are situated within the former Rancho Buri Buri.

Rancho Laguna de la Merced

José Jesús Castro, the governor of the Mexican state of Alta California, granted 2,200 acres of land around and including Lake Merced to cattle rancher José Antonio Galindo in 1835. The property was named Rancho Laguna de la Merced. Galindo most likely used the land for cattle grazing; an early map he commissioned of the property shows no standing structures, but "ojos de agua" (springs) are labeled at the southern border of the lake. The Galindo Palizada dwelling was built in 1835 and was likely located at the south end of the lake. In 1837, Galindo sold the land to Francisco de Haro, who later became the first alcalde (mayor) of San Francisco. De Haro moved his family into the house built by Galindo and also built another house near the same spot in 1837, which he occupied for a time; after which he built another house, farther towards the north, at the south-eastern extremity of Lake Merced (Hillyer 1906).

Rancho Buri Buri

In 1835, the same year that José Jesús Castro granted Rancho Laguna de la Merced to Galindo, he also granted almost 15,000 acres to José Antonio Sánchez (Stanger 1938). Sánchez improved the land, building an adobe, a grain mill, and a mill house. The adobe was built just off the San Jose Stage Road (present-day El Camino Real) near what is now Capuchino High School in San Bruno. The locations of the other two structures are not known. After Sánchez's death in 1843, the rancho passed into the hands of his 10 children (Iglar 2001). By the time of its formal survey by an engineer in 1848, three of his sons had built their own homesteads on the property: José de la Cruz near Capuchino Golf Course, Isidro at South San Francisco and José Isidro in North Burlingame (Stanger 1938). Comparing the 1848 map with a modern topographical map, none of the houses were near any of the proposed well facility sites.

American Period (1846-1900)

The date of July 8, 1846 marked the conversion of California from Mexican to American jurisdiction. Although the transition was peaceful and uneventful in most of northern California, it had important implications for ranchers and other landowners. In 1851, the United States Congress passed the California Land Claims Act to settle the many conflicting land titles that had arisen from the changes in jurisdiction. The Act held that all holders of Spanish and Mexican land grants were to present their titles for confirmation before the Board of California Land Commissioners; any land that the Board could not confirm reverted to public land. Following is a description of the disposition of the two ranchos discussed above.

Rancho Laguna de la Merced

Upon landholder Francisco de Haro's death in 1849, Rancho Laguna de la Merced passed jointly to his heirs, who brought their claims to Rancho Laguna de la Merced before the Board of Land Commissioners in March 1852. It took the courts 16 years to confirm the title (Baggett 1880). Many challenges to this title arose during this period and as a result of subsequent claims by squatters seeking title on the assumption that it would be declared public land, and by errors on the part of de Haro's heirs (Tuttle 1882; Hillyer 1906), a speculator named John Mahoney was granted title to the shares of at least five of the seven heirs and almost half of that of a sixth. The court records indicate that he gave or sold about 300 acres to others (Tuttle 1882). Later correspondence offering to sell the lake and 1,000 acres surrounding it to the City of San Francisco implies that in 1877, Mahoney, Sharp and P. Donohue considered themselves to be joint and full owners of Lake Merced and the area surrounding it (Mendell 1877). Presently, the Lake Merced Golf Club occupies a portion of the old Rancho.

Rancho Buri Buri

Sánchez's 10 children faced similar obstacles to the land claim as de Haro's heirs. In the final settlement, 11 years later, less than four percent of the original ranch was owned by Sánchez heirs. Title to the other 96 percent was held by 50 different owners (Stanger 1938).

City Period

With the ranchos broken up and divided among dozens of property owners, the stage was set for the foundation of cities and development within the former ranchos. The proposed well facility sites are located in what would become six different municipalities: Daly City, Broadmoor (unincorporated San Mateo County), Colma, South San Francisco, San Bruno and Millbrae. The following presents a brief description of the history of the municipalities.

Daly City (Sites 1, 2, 5, 6, and the Westlake Pump Station Site)

Daly City is named after John Daly, who spent his youth working on a dairy farm in San Mateo County. By 1868, he had purchased 250 acres at the heart of what would become Daly City and established the San Mateo Dairy. Other shops and houses began to cluster along the railroad tracks and El Camino Real. In the early 1890s, a streetcar line was extended from San Francisco over the hill to Daly City and beyond, into the heart of San Mateo County. By the end of the century, the idea of incorporation was being considered, but was largely rejected by the independent farmers who owned much of the land (Gillespie and Gillespie 2011).

After the 1906 earthquake and fires devastated San Francisco, former residents streamed south to Daly City and elsewhere to seek refuge. Agricultural fields were covered in temporary shelters. By 1907, John Daly had subdivided his property and the new lots were quickly occupied by “temporary” refugee houses. With this new population, making the area more residential and town-oriented than before, the residents of Daly City voted to incorporate in 1911 (Gillespie and Gillespie 2011).

Daly City changed little during the war years, but experienced the same post-war housing boom experienced by other Peninsula cities in the late 1940s and early 1950s. Entire planned-development housing communities were constructed, some of which were annexed into Daly City and others of which, like Broadmoor, remained unincorporated. Westlake, which contains Sites 1 and 2 and the northern portion of the Westlake Pump Station site, was a planned community built by Henry Doelger on land that had formerly been sand dunes and cabbage fields; it was annexed to Daly City in 1948 (Gillespie and Gillespie 2011). Folk singer Malvina Reynolds immortalized the pastel colored houses of Westlake in the 1961 song “Little Boxes” (Gillespie 2008).

Broadmoor (Sites 3 and 4)

Entirely surrounded by Daly City, this portion of unincorporated San Mateo County is known as Broadmoor. From the late nineteenth through the early twentieth centuries, this area was characterized as consisting “mostly of hog and dairy farms, and fields of potatoes and artichokes” (Broadmoor Police 2010). Beginning in 1947, a series of single-story houses was constructed and collectively identified as Broadmoor Village. Since then, portions of the unincorporated area have been annexed by Daly City. Today, Broadmoor consists of three separate urban islands, each surrounded by Daly City and/or Colma. Broadmoor contains about 2.5 square miles of land and 7,000 people (Broadmoor Police 2010).

Colma (Sites 7, 8, and 17 [Alternate])

The area known as Colma during the nineteenth century was all of the land between the San Francisco and South San Francisco borders, west to the Pacific Ocean and east to San Bruno Mountain. When the town incorporated in 1924, however, it encompassed only the 2.2 square miles that it consists of today (Shoup and Brack 1994). Colma's community formed in the 1800s as a collection of homes and businesses along El Camino Real, also known as the California Mission Trail. The community also developed along the San Francisco and San Jose Rail Road line, which became operational in 1863, having the School House Station stop in Colma (1869 U.S. Coast Survey map). Valued mainly as a transportation corridor, Colma's accessible rural setting close to, but outside of, the City and County of San Francisco (CCSF) soon became very desirable.

By the 1880s a shortage of land was being felt in San Francisco and areas that had been set aside for cemeteries during earlier years became desirable for other uses. At the turn of the century, the San Francisco Burial Ordinance passed, banning further burials within the City. Eviction notices were sent to all cemeteries to remove the bodies and monuments in 1914. Cemetery owners began to look for new, less expensive property to bury the dead of San Francisco (CHA 2007).

The Rural Cemetery Movement and its Evolution Relative to Colma

In the 1830s a new and different type of cemetery developed in the eastern U.S., specifically in Massachusetts. The initial form of this style was called the rural cemetery, which later developed into the lawn-park, and most recently into the memorial park type of cemetery. While the rural and lawn-park type of cemeteries were principally by and for the rich, the memorial park, while coming out of this tradition, represents a kind of burial place more accessible to the majority of Americans. The rural cemetery was located in the countryside and was based on a naturalistic design with preservation of the natural landscape with winding access roads following existing terrain.

The lawn-park type of cemetery became dominant during the late nineteenth century. It presented a streamlined landscape, open and park-like, less cluttered and less vegetation. Scientific planning, regularity and formality, as well as naturalism, were the watchwords. The most recent modification of the rural cemetery theme has been the memorial park, first established at Forest Lawn in Los Angeles in the twentieth century. Three aspects of the memorial park are central and make it distinctive. First, strict hierarchical control was from the top by professional managers to control the cemetery landscape and assure its appearance and efficiency. Lawns were the main natural features. Second, the banishment of an emphasis on death, in order to preserve the happiness of the living, was a main theme. Public monuments of statuary were used to evoke the values which owners of the park wanted to stress which make this type of cemetery as much a kind of an outdoor museum as a memorial park and visitors were encouraged to have an enjoyable visit. Evergreen trees were planted instead of trees whose leaves fall during winter. As a memorial park, nature was mainly a passive backdrop to artistic memorials (Shoup and Brack 1994).

Having limited natural resources, Colma's chief value has been its location as a transportation corridor and accessible rural area close to, but outside, San Francisco. Always a lightly populated area, it offered what San Francisco needed (i.e., rural scenic space).

A number of cemeteries were set up there during the late nineteenth and early twentieth centuries. In 1887, Holy Cross, the first cemetery in Colma, received its first interment (Archaeological/Historical Consultants 1994). Cypress Lawn opened in 1892. It is the most famous of the cemeteries and boasts the greatest concentration of San Francisco's elite (Shoup and Brack 1994).

With its new focus, Colma underwent an economic boom. In 1889, just as the first cemeteries were being established, Dun's Mercantile Agency Reference Book had five businesses listed for the Colma Area, including a blacksmith, a saloon, a general store, a hotel and a distillery (Dun and Company 1889). By 1901, this list grew to 28 listings (Dun and Company 1901). Once cemeteries became the main business of Colma, the place became known as a necropolis, or city of the dead. The community was run by the Cemetery Association, which was made up of a representative from each cemetery.

Colma remained unincorporated until 1924, when fears that Daly City would try to expand its borders prompted the incorporation of Colma as the "City of Lawndale." The name remained until 1941, when the town was renamed Colma. As of 1990, Colma had increased its living population to approximately 1,100, with a number of shopping centers and other retail. However, the numerous cemeteries, and more than one million interments, still account for the majority of business in Colma today.

South San Francisco (Sites 9, 10, 11, 12, 13, 18 [Alternate], and 19 [Alternate])

The area encompassing Sites 9, 10, 11, 12, 13, 18 (Alternate), and 19 (Alternate) once belonged to Charles Lux and Henry Miller, who joined forces to create Miller & Lux, one of California's most powerful nineteenth century landowners. Lux and Miller continued the Buri Buri ranching tradition by keeping cattle on the land (South San Francisco Historical Society 2004). Early structures in South San Francisco included the Twelve Mile House, a stage coach stop built in 1851 and demolished in 1977 (San Mateo 1986), and Lux's own estate, which was built in 1858 and included a mansion, barns, out buildings and an orchard (South San Francisco Historical Society 2004).

Following the death of Lux in 1887, Gustavus Swift, president of Chico-based Swift and Co., one of the largest meat packing companies in the country, set his sights on Lux's estate as an ideal location to construct not only Chicago-style meat packing plants and related industrial facilities, but also to build an entire planned community that catered to the meat packing industry. In 1890, Peter Iler acquired 3,400 acres, including the Lux estate, and transferred the property to the South San Francisco Land & Improvement Company. A new meat packing facility was opened in 1892, marking the beginning of the modern industrial town of South San Francisco (Blum 1984). After the deaths of Lux and Miller, the land was divided and town plots were laid out. The town, now a company town, was renamed "South San

Francisco” in the tradition of Swift’s Meat Company, whose other plants were “South Chicago” and “South Omaha” (South San Francisco Historical Society 2004).

From its incorporation in 1908, the City of South San Francisco lived up to its nickname as “The Industrial City.” Meat packing, marble, brick and paint production plants rose east of the newly built train yards on Point San Bruno. West of the Chestnut Avenue city limits spread vegetable, flower and duck farms. Dairy cattle and horses roamed the hills west of the El Camino Real stagecoach road (South San Francisco 2011a). The years after World War I saw dozens more industrial concerns become established in South San Francisco, primarily in the meat, chemical and steel industries (South San Francisco 2011b). The well-known sign on the side of Sign Hill was first painted onto the ground in 1923; the 60-foot concrete letters identifying South San Francisco as the Industrial City were added five years later (South San Francisco 2011c). Treasure Island Mobile Home Park, located adjacent to Site 9, most likely was established in response to the Golden Gate International Exposition on Treasure Island of 1939 to provide accommodations to throngs of people who traveled to the Bay Area to attend the fair. It appears to be one of several such parks that opened in San Mateo County before World War II (Foster 1980; Wallis 1991). By mid-century, South San Francisco had firmly established itself as the home of industries vital to the City of San Francisco. In the post-World War II era, housing development patterns changed as the federal government encouraged construction of simple, economical residential units. With these new residential suburbs came the development of commercial areas, as well as religious structures (Shoup and Brack 1994).

The 1925 Sanborn map of South San Francisco shows that Sites 12 and 19 (Alternate) were on land belonging to Baden Farm, the largest buildings of which were a milking barn and a feed storage barn and a neighboring farm. Buildings in the vicinity of Sites 12 and 19 (Alternate) were a bunkhouse, a small farmhouse and several unidentified outbuildings. By 1950, the farms had been converted to a housing development and vacant land belonging to the San Francisco Water Company. Sites 12 and 19 (Alternate) were within the vacant San Francisco Water Company right-of-way, and later the SFPUC right-of-way.

The City of South San Francisco embarked on a vigorous deindustrialization program leading to the closure of the stockyards and slaughterhouse in 1959; the last steel plant closed in 1983. Industrial parks and light industry moved in, and with the establishment of Genentech Corporation in 1976, South San Francisco could claim to be the birthplace of the biotech industry (Blum 1984). Large suburban developments to the west of El Camino Real opened as well, including Buri Buri, Winston Manor and Westborough.

San Bruno (Sites 14 and 15)

The earliest structures in what would become the City of San Bruno were way stations along the stage road between San Francisco and San Jose, which was also El Camino Real. The Fourteen-Mile House was built in the early 1850s at what is now the intersection of El Camino Real and San Mateo Avenue; it survived as a drinking and gambling establishment until it was torn down in 1949 (San Bruno 2011). The San Bruno House was a hotel built along El Camino Real in 1862; it burned down several times and was never rebuilt after the third fire in 1901 (San Bruno 2011). Agriculture was the most common economic activity in San Bruno, particularly dairy farming. The largest of these farms was more than 3,000 acres

owned by Richard Sneath. In 1906, he joined forces with John Daly, of San Mateo Dairy, to form Dairy Delivery Company. In the 1930s, the United States Army acquired 140 acres of Richard Sneath's dairy farm to create the GGNC (San Bruno 2011).

San Bruno continued to develop as a rest and recreational destination with the construction of Tanforan racetrack in 1899. Twice the racetrack served wartime activities. During World War I it was a military training post, and during World War II Tanforan was transformed into a temporary internment camp for 8,000 of the Japanese and Japanese Americans who were evacuated from the Pacific Coast under Executive Order 9066. Horse stables became homes and 170 hastily constructed wooden barracks filled the interior field (Federal Writers Project 1984; Uchida 1998).

Like the rest of the San Francisco Peninsula, San Bruno's history changed significantly during the postwar period. Its farmlands turned into suburban tract housing and its population boomed, more than quadrupling its size from 1940 to 1960. By the 1960s, as all of the cities on the Peninsula had developed, the City of San Bruno had become geographically boxed in, stabilizing its population near its current levels. Single-family housing tracts dominated development through the 1960s, with multi-unit complexes developed during the 1970s (San Bruno 2011).

Millbrae (Site 16)

Darius Ogden Mills, after whom Millbrae is named, bought a share of Rancho Buri Buri, which grew to reach from what is now Skyline Boulevard in the west, Bayshore Highway (U.S. Highway 101) in the east, Millbrae Avenue in the north, and Trousdale Drive in the south (Millbrae 2011). Together with his business partner Alfred Green, Mills established Millbrae Dairy along the east side of El Camino Real, which provided milk and other dairy products to residents of San Francisco and elsewhere (Fredericks 2009). He built a mansion where Spring Valley School stands today. Mills secured the right-of-way for a train depot to be constructed near his home. He also opened a dairy that served his estate and was the primary employer in Millbrae for many years. A porcelain works, farms and nurseries, an electric railway, a commercial street and the telephone came to Millbrae in due time (Millbrae Historical Society 2007).

Originally, a cow pasture owned by Mills, Mills Field was constructed on 150 acres of land in the swamps east of El Camino Real in 1927. It is now San Francisco International Airport. An entire hillside, where the Millbrae Meadows subdivision is now located, was bulldozed during the 1940s to provide landfill for a major expansion effort at the airport (Millbrae 2011; Millbrae Historical Society 2007).

In 1946, after an attempt at annexation by Burlingame, the residents of Millbrae voted to incorporate (Millbrae Historical Society 2007). However, legal battles between Millbrae and Burlingame prevented the incorporation from taking place for three years (Millbrae Historical Society 2007). In the 1950s, the Mills Mansion burned to the ground and the Millbrae Dairy was demolished to make way for new development (Millbrae Historical Society 2007; Fredericks 2009).

A 1949 map of Millbrae shows that the location of Site 16 was owned by the San Francisco Water Department, Peninsula Division. Several storage buildings, an auto repair shop and small garage or carport buildings were located in the vicinity of Site 16.

5.5.1.5 *Archaeological Methods, Survey and Results*

Records Search and Literature Review

A records search and literature review was conducted by Archeo-Tec Consulting Archaeologists (Archeo-Tec) in May 2009 at the Northwest Information Center (NWIC) of the California Historical Resources Information System at Sonoma State University (Archeo-Tec 2011b). The records search and literature review encompassed the area within a 0.25-mile radius of each archaeological C-APE (NWIC File Number 08-1395). The purpose of the records search was to determine the nature and extent of any previous cultural resources studies and to identify the locations of any recorded cultural resources. The literature reviewed included published overviews of the archaeology and ethnohistory of California (Moratto 1984; Jones and Klar 2007; Heizer 1978; Kroeber 1925), as well as inventories of historic structures and sites (Hoover et al. 1990; Gudde 1969; California Department of Parks and Recreation 1988, 1992; Hendry and Bowman 1940). The literature reviewed also included: the San Mateo County historical atlas; General Land Office Plat Maps; Sanborn Company maps; aerial and satellite photographs and topographic maps of the Project sites; and the Peninsula Watershed Management Environmental Impact Report (San Francisco Planning Department 2001).

The literature review found that the National Register of Historic Places (National Register) had no listings for archaeological sites within the review area. Plat maps exhibited as evidence in Land Commission cases settling title disputes to Rancho Laguna de la Merced and Rancho Buri Buri showed that in 1866 there were two houses at Rancho Laguna de la Merced that were within 0.25 mile of the archaeological C-APEs for Sites 2, 3, and 4. These probably belonged to William Higgins, whose lodgings Hittell described as being “at the most southerly end of Laguna de la Merced in San Mateo County” (Hittell 1897; Schussler 1916).

The 1858 General Land Office Plat Map shows that the San Jose Stage Road followed the course of the current railroad tracks, passing near Sites 7, 8, 9, 10, 11, 12, 16, 17 (Alternate), and 19 (Alternate). The maps also show that the former San Bruno House was within 0.25 mile of the C-APEs for Sites 11 and 12, and that the former Irish House and Frenchman’s House were within 0.25 mile of the C-APEs for Sites 12 and 19 (Alternate). The 1925 Sanborn map of South San Francisco shows that Sites 12 and 19 (Alternate) were on land belonging to Baden Farm, the largest buildings of which were a milking barn and a feed storage barn and a neighboring farm. Buildings in the vicinity of Sites 12 and 19 (Alternate) C-APEs are a bunkhouse, a small farmhouse and several unidentified outbuildings. By 1950 the farms had been converted to a housing development and vacant land belonging to the San Francisco Water Company; the Sites 12 and 19 (Alternate) C-APEs were within the vacant San Francisco Water Company right-of-way.

The 1949 Sanborn map of Millbrae shows that the location of Site 16 was owned by the San Francisco Water Department, Peninsula Division. Several storage buildings, an auto repair shop, and small garage or carport buildings were located in the vicinity of the Site 16 C-APE.

The records search revealed that 37 cultural resource studies have been conducted within the 0.25-mile radius of the archaeological C-APEs that comprise the Project area. These studies included cultural resources overviews, subsurface archaeological surveys, resource evaluations and archaeological

excavation and construction monitoring reports. Four of the archaeological surveys included a portion of 12 of the C-APEs for the proposed Project. An Archaeological Reconnaissance prepared for the SFPUC's San Andreas Pipeline No. 3 project transected the C-APEs for Sites 5, 7, 8, 10, 12, 14, 17 (Alternate), 18 (Alternate), and 19 (Alternate) (Baker 1979). A cultural resources assessment of alternative routes for PG&E's Jefferson-Marin Transmission Line (Brown et al. 2003) transected the extreme northern portion of Site 8 and included the routes of the pipelines along Sneath Lane for Sites 14 and Site 15. An archaeological reconnaissance for a Caltrans road widening project crossed the pipeline route for Site 11 (Young n.d.). An archaeological survey for the BART-San Francisco Extension Project encompassed Site 11 and touched the northeast corner of Site 13 (Rice 1994a).

As a result of these cultural resources studies, four archaeological sites (CA-SMA-100, -101, -209H and -343H) have been recorded within a 0.25-mile radius of Sites 11, 12, 14, 15, 16, and 19 (Alternate). Archaeological sites CA-SMA-100 and -101, two prehistoric middens, are within 0.25 mile of Site 15; archaeological site CA-SMA-209H, Tanforan, is within 0.25 mile of Sites 14 and 15; archaeological site CA-SMA-355, a prehistoric shell midden, is approximately 0.25 mile from 11, 12, and 19 (Alternate); and archaeological site CA-SMA-343H, a historic-era artifact concentration, is located within 0.25 mile of Site 16. In addition, CA-SMA-299, a prehistoric shell midden, was identified within the archaeological C-APE for Site 11. A brief description of these archaeological sites and their location in relation to well facility sites are provided in Table 5.5-3 (Recorded Archaeological Sites Near the Proposed Project). The archaeological site that is within the C-APE for Site 11 (CA-SMA-299) is described in more detail below.

TABLE 5.5-3
Recorded Archaeological Sites Near the Proposed Project

Archaeological Site Number	Description	Distance to Nearest Well Facility Site(s)
CA-SMA-100	Low domed earth midden with some shell content; very rich and dark in some places.	0.25 mile from Site 15
CA-SMA-101	Similar to SMA-100; was impacted and possibly destroyed by construction of I-280/I-380 interchange.	0.25 mile from Site 15
CA-SMA-209H	Tanforan racetrack, used as a Japanese internment center during WWII. Currently a shopping center.	0.25 mile from Sites 14 and 15
CA-SMA-299	Shell midden with poorly defined boundaries; condition unknown.	Within Site 11
CA-SMA-343H	Historic-era artifact concentration along east side of railroad tracks.	0.25 mile from Site 16
CA-SMA-355	Shell midden buried under 5-24 feet of overburden with unknown boundaries.	0.25 mile from Sites 11, 12 and 19 (Alternate)

Archaeological site CA-SMA-299 was first reported in 1988 as a large prehistoric shell midden. However, a year later when it was formally recorded, it was described as having been completely destroyed by creek channelization, placement of railroad tracks and other construction and removal of midden for a

commercial soil operation. All that remained were occasional patches of shell and fire-cracked rock. In 1994, subsurface testing of the site was undertaken that consisted of placement of 20 shovel auger test bores to depths of six to 39 inches throughout its boundaries (Rice 1994b). No cultural remains were visible on the ground surface or in the 20 test bores. Subsequent to the 1994 subsurface testing of the CA-SMA-299, substantial but currently unknown subsurface changes have occurred near and possibly within the Site 11 C-APE. Railroad tracks that had lain on the surface of the ground were removed, Colma Creek was rechanneled and a BART subway was excavated to depths varying from 30 to 39 feet. It is possible that some or all of the C-APE has already been disturbed to depths greater than depths proposed for construction of the Project (Baker 1999a, 1999b; Archeo-Tec 2011b).

Sites CA-SMA-299 and CA-SMA-355 are situated in close proximity to each other and their nearest boundaries are unknown. It is possible that they, in fact, compose a single archaeological site. If the two sites are a single site, any remaining archaeological deposit would probably be located more than three feet below the ground surface within the C-APE for Site 11.

Sites 7, 14, 15, and 17 (Alternate) would be located within existing cemeteries. Although the C-APEs for these sites do not include the burial areas of the cemeteries, the possibility of burials or burial-related deposits outside of the officially sanctioned burial areas cannot be entirely discounted.

Based upon the results of the records search and literature review, Archeo-Tec concluded that the archaeological sensitivity of the 19 sites and the Westlake Pump Station ranges from low to high as listed in Table 5.5-4 (Archaeological Sensitivity of Well Facility Sites and Pump Station), below. Sites 11, 12, 15, and 19 (Alternate) have been determined to have a high sensitivity for prehistoric archaeological resources based on their proximity to known prehistoric archaeological resources and to terrain features, such as Colma Creek. Site 11 in particular bears high sensitivity as it is located between two buried midden deposits, the boundaries of which are unknown. In addition, Sites 11, 14, 15, and 16 have been determined to have a high sensitivity for historic-era archaeological resources, based on their proximity to known historic resources.

TABLE 5.5-4
Archaeological Sensitivity of Well Facility Sites and Pump Station

Site	Archaeological Sensitivity ^(a)	
	Historic	Prehistoric
Site 1	Low	Moderate
Site 2	Low	Moderate
Site 3	Low	Moderate
Site 4	Low	Moderate
Westlake Pump Station	Low	Moderate
Site 5	Low	Moderate
Site 6	Low	Moderate
Site 7	Moderate	Moderate
Site 8	Moderate	Moderate
Site 9	Low	High-Moderate
Site 10	Low	Moderate
Site 11	High	High
Site 12	Moderate	High
Site 13	Low	Moderate
Site 14	High	Moderate
Site 15	High	High
Site 16	High	Moderate
Site 17 (Alternate)	Moderate	Moderate
Site 18 (Alternate)	Low	Moderate
Site 19 (Alternate)	Moderate	High

Source: Archeo-Tec 2011b

Notes:

(a) High Sensitivity: Archaeological resources are very likely to be present. Resources are known to exist at this location or immediately adjacent to it.

Moderate Sensitivity: Archaeological resources may be present. Although no resources have been recorded at this location, historical and cultural factors indicate they may be present.

Low Sensitivity: Archaeological resources are unlikely to be present. Either resources were probably never present or portions of the location that may have contained resources have been so heavily disturbed that archaeological remains are unlikely to have survived.

Native American Contacts

On June 3, 2009 the San Francisco Planning Department sent a letter to the Native American Heritage Commission (NAHC) describing the proposed Project and requesting a review of the Sacred Land file to determine if the Project would encroach on any area deemed sacred to the Native American community, as well as requesting a list of Native American individuals/organizations that may have knowledge of cultural resources in the Project area (Sokolove 2009). A letter response from the NAHC dated September 14, 2009 indicated that a search of the Sacred Land file failed to indicate the presence of recorded Native American cultural resources in the immediate Project area. A list of seven Native American individuals/organizations who may have knowledge of cultural resources in the Project area was enclosed (Pilas-Treadway 2009).

In December 2009, the San Francisco Planning Department sent letters to the seven Native American contacts requesting input regarding any concerns about the proposed Project, as well as any comments or input regarding cultural resources, prehistoric and/or ethnographic land uses, or sites of Native American traditional or cultural value known to exist within the project vicinity. The San Francisco Planning Department send follow up letters to the same Native American contacts in February 2013. As of April 2013, no responses have been received from any of the contacts.

Archaeological Field Survey Methods

Archeo-Tec performed a pedestrian surface survey at all proposed well facility sites except Site 5, which is completely paved (Archeo-Tec 2011b). Archeo-Tec also performed extended archaeological surveys (EAS) at Sites 11, 12, 14, 15, 16, and 19 (Alternate) because of their high sensitivity for containing prehistoric and/or historic-era resources as listed in Table 5.5-4 (Archaeological Sensitivity of Well Facility Sites and Pump Station). The EASs employed different strategies at each of these six sites because each site bears a different form of sensitivity. Also, ideal survey methods for one well facility site may not be appropriate at another. Each well facility site was explored using a different method: coring (Site 11), mechanical trenching (Sites 12 and 19 [Alternate]), remote sensing (Sites 14 and 15) and hand excavation (Site 16). The purpose of both the surface surveys and the EASs was to determine the likelihood that any archaeological resources, whether known or unknown, exist within each C-APE.

Surface Survey

Surface surveys of unpaved areas within each C-APE were performed by a crew of two archaeologists from July 27 through July 31, 2009. The survey was conducted on foot employing 6-foot-wide transects.

Extended Archaeological Survey

Following completion of the archaeological surface surveys, EASs were conducted at six of the proposed well facility sites in April 2010 and January 2011. Four different EAS techniques were employed at the sites, reflecting current conditions at each site and the types of resources expected to be found. These are described below by well facility site.

Site 11

The EAS at Site 11 was conducted by ICF Jones & Stokes on January 31, 2011. Site 11 would be adjacent to CA-SMA-299. The primary purpose of the EAS within Site 11 was to determine if CA-SMA-299 is present within the C-APE. Ten geotechnical cores were excavated within the C-APE, starting in the northwest corner where the potential for site CA-SMA-299 to exist is greatest. Of these 10 cores, three encountered impenetrable material at three feet below the surface, well within the current fill layer, and were therefore abandoned. Seven successfully reached depths that might have contained material associated with CA-SMA-299. Each successful core was taken to a depth of eight feet. Each core was drilled using a hollow bore so that extracted subsurface material could be inspected by the archaeologist. Two archaeologists and an Ohlone Native American monitor were present to examine the material from the cores.

The archaeologists examined the soil for stratigraphy and soil changes. Material was then screened for shell, charcoal, bone and stone, any of which might be evidence of archaeological materials. Notes about each core were recorded on testing logs documenting the date, time, bore ID number and location, and a description of the soils as they were removed (ICF International 2011).

Sites 12 and 19 (Alternate)

The EAS at Sites 12 and 19 (Alternate) was conducted by Archeo-Tec on April 6, 2010. Three mechanically excavated trenches were employed within the construction area encompassing Sites 12 and 19 (Alternate). The crew consisted of the backhoe operator and four archaeologists. One trench was placed in the unpaved area along El Camino Real, near the proposed location for the Site 12 well facility, while the other two were placed in the unpaved areas surrounding Site 19 (Alternate) – one near where the well facility is proposed to be placed and the other near Southwood Drive. The trenches were placed to offer good coverage of the site while avoiding existing infrastructure and trees.

The trenches were excavated by a backhoe fitted with a flat-edged bucket. Trenches were three feet wide and 10 to 12 feet long. The backhoe scraped away the overburden in 6-inch layers, stockpiling the removed soil for inspection by the archaeological team. The trenches were excavated to the full depth of expected impacts – generally five or six feet – and were backfilled at the conclusion of the excavation. Trench forms were completed for each trench giving dimensions, stratigraphy, soil types, artifacts observed, and observations; additionally, a profile drawing was completed for each trench and a site plan map was maintained showing the location of each trench.

Sites 14 and 15

The EAS at Sites 14 and 15 was conducted by Archeo-Tec on April 15, 2010. The primary purpose of the EAS within Sites 14 and 15 was to determine if unmarked or misplaced historical burials exist within the C-APEs. However, as these two sites are within a cemetery, the EAS could not disturb the ground in these areas. Accordingly, a program of archival research was carried out to

identify grave locations that may extend outside marked areas and into the C-APEs. This consisted of a search of records held at the National Archives regarding the founding of the cemetery, a search of historic maps and an interview with cemetery personnel.

Additionally, as the research was inconclusive, a ground-penetrating radar (GPR) survey of the construction area was performed on April 15, 2010, in an attempt to locate any subsurface anomalies that may indicate human remains. The GPR survey was conducted by two geotechnical scientists and an archaeologist.

Site 16

The EAS at Site 16 was conducted by Archeo-Tec on April 7 through 9, 2010. Site 16 is within 0.25 mile of historic-era site CA-SMA-343H, which was recorded along the edges of the railroad tracks that pass along the northeast side of the well site. The primary purpose of the EAS within Site 16 was to determine if a similar historical deposit, or a continuation of CA-SMA-343H, exists within the C-APE. Accordingly, two shovel test units, each approximately three feet by three feet, were placed within the C-APE in the unpaved area along the railroad tracks. Excavation was carried out by a crew of four archaeologists. The test units were continued to approximately three feet below the surface, at which point the archaeologists determined the historical layers had been exhausted.

Field Survey Results

No archaeological sites were identified during the surface surveys or the EASs, nor was evidence found suggesting that archaeological sites might be present⁴. Archaeological site CA-SMA-299 was recorded adjacent to Site 11, but no evidence of it was found during the surface survey or EAS. This is consistent with the 1994 records of subsurface testing of a portion of CA-SMA-299 that found no evidence of the site. The explanations offered in those records were that the site was intentionally destroyed in the mid-twentieth century by its sale as “Colma loam” for gardening and landscaping, by creek channelization and/or by the construction of the BART trackway and ventilation structure adjacent to the C-APE.

⁴ During the surface survey, ground surface visibility was very limited at many of the well facility sites, where large portions of the C-APE were paved over. At other sites, surface visibility was entirely clear. In many cases, the unpaved portions of the C-APE were landscaped. Additionally, at the time of survey, work was in progress at many of the well facility sites to place monitoring wells; construction activities at these well facility sites limited the area that the archaeologists were able to survey. Some of the EASs faced additional constraints. Placement of test trenches at Sites 12 and 19 (Alternate) was limited by the need to keep a certain distance away from existing utility pipelines. The EAS at Sites 14 and 15, which involved the use of GPR, was hampered by a network of shallow irrigation lines that may have obscured objects deeper in the earth.

The EAS at Sites 12 and 19 (Alternate) encountered isolated twentieth century artifacts near the surface, but these artifacts either appeared to be less than 45 years old⁵ or were not in any association with each other. At deeper levels, no artifacts were found.

The EAS at Sites 14 and 15 detected many anomalies that could indicate human remains, but these were determined to be sprinkler and other infrastructure trenches. It is possible, however, that anomalies may be present below utility lines and, therefore, not visible via remote sensing.

As with Sites 12 and 19 (Alternate), the EAS at Site 16 encountered a handful of scattered twentieth century artifacts below the railroad berm, but the artifacts were not in any association with each other and were determined to not represent an archaeological site. Deeper levels of the test pits were found to be devoid of cultural materials.

5.5.1.6 *Architectural Methods, Survey and Results*

Records Search and Literature Review

In addition to the records search and literature review conducted by Archeo-Tec in May 2009, as described in Section 5.5.1.5 (Archaeological Methods, Survey and Results), a supplementary record search was conducted by Carey & Company on June 8, 2009 (NWIC File Number 08-152) (Vanderslice and McNeill 2011). The records search encompassed the area within a 0.25-mile radius of each of the architectural C-APEs and consisted of a review of the Office of Historic Preservation Historic Property Data File for San Mateo County, dated May 27, 2009. This data file includes resources listed in the National Register, the California Register of Historical Resources (California Register), California Historical Landmarks, the California Inventory of Historic Resources and the Caltrans Bridge Inventory for San Mateo County. Carey & Company also conducted additional literature review that included historical resource inventories created by local agencies with jurisdiction over the 19 well facility sites, including San Mateo County Historical Resources Inventory, South San Francisco Historic Resource Inventory, Town of Colma's Historical Resources Element and the City of San Bruno Historical Resources Inventory. Also reviewed were other SFPUC Water System Improvement Program (WSIP) cultural resources documents and documents on historic properties produced by the VA, particularly the *National Cemeteries and Soldiers Lots listed in the National Register of Historic Places and designated a National Historic Landmark*. Historical documents and maps also were consulted, including plat maps, historic topographic maps and aerial photographs and Sanborn Company fire insurance maps (Carey & Co. 2011b).

⁵ Fifty years is a general estimate of the time needed to develop historical perspective on the events or individuals associated with the resource, and to evaluate a resource's historic significance. California's Office of Historic Preservation 45-year criterion recognizes the approximate five-year lag between resource identification and implementation of planning decisions (OHP 1995).

Field Survey Methods

Carey & Co. surveyed the sites over the course of six days in July 2009 and in March and July 2010 (Carey & Co. 2011a, 2011b). During the field surveys, any buildings, structures and objects were noted, particularly those that appeared to be at least 45 years old. Each location was documented with digital photography and written notes. Photographs were limited to views from the public right-of-way. At GGNC and Woodlawn Memorial Park, the survey team walked the entire grounds and took photographs from and towards the well facility sites, as well as photographs of significant buildings on the grounds and the general landscape. Primary and secondary research was completed to write a context statement and histories of individual resources. Primary sources included: historic topographical and Sanborn Maps; archival photographs from the South San Francisco Historical Society; photographic collections at the Bancroft Library at the University of California, Berkeley; the United States Census; California Register of Voters; telephone and city directories; and historic newspapers and other publications. Secondary sources focused on the histories of Daly City, Broadmoor Village, Colma, San Bruno, Millbrae, cemeteries, significant persons associated with individual resources, trailer parks, postwar suburban development and residential architecture, and postwar church architecture.

Records Search and Literature Review and Field Survey Results

The resource descriptions presented below include reference to the eligibility criteria for the National Register and the California Register, as applicable. These criteria are explained in detail in Sections 5.5.2.1 (Federal Regulations) and 5.5.2.2 (State Regulations).

Records Search and Literature Review Results

The records searches and literature reviews revealed that 18 cultural resource investigations have been previously conducted within 0.25 mile of the architectural C-APes for the facility sites. These investigations include historic resources literature and record reviews, cultural resources overviews, and historic properties/resources surveys, inventories and evaluations.

Two previously recorded historical resources were identified within the architectural C-APes. The Woodlawn Entry Gatehouse and Office Building is a potential National Register-eligible resource identified by the Town of Colma (Colma 1999) and falls within the C-APE for Site 7. The GGNC, which is within the C-APE for Sites 14 and 15, was formally determined eligible for the National Register in the 1970s and, thus, is eligible for the California Register (VA 2010). The VA is producing an Inter-World War Multiple Property Submission (MPS) that includes the GGNC (VA n.d.). The MPS is in the process of being nominated to the National Register for its association with military action in defense of the country. The Baden Valve Lot at Site 19 (Alternate) was evaluated in 2007-2008 as part of an SFPUC WSIP project (Carey & Co. 2007). The consultant recommended that it be considered ineligible for the both the California Register and National Register.

Fifteen additional historical resources were identified in the 0.25-mile record search area, but outside the C-APes. The following first discusses the two historical resources identified within

the C-APEs and then briefly discusses the historical resources found within 0.25 mile of the C-APEs.

Historical Resources within the Architectural C-APE

Golden Gate National Cemetery (GGNC). The GGNC was one of many cemeteries planned by the U. S. Army in the 1930s and completed in the early 1940s. It is within the architectural C-APE for Sites 14 and 15. The Army designed these cemeteries specifically to provide abundant burial opportunities in or near cities with large veteran populations. As San Francisco had long banned interments within city limits, the Army chose to locate the GGNC in San Bruno, to the south of the Colma cemeteries. Congress authorized construction of the GGNC in 1937 and the first interments occurred in 1941. The cemetery was officially dedicated on Memorial Day, May 30, 1942. In 1973, 82 national cemeteries were transferred from the U.S. Department of the Army to the Veterans Administration, since renamed the U.S. Department of Veterans Affairs. As noted above, this national cemetery is currently undergoing nomination to the National Register by the VA.

Woodlawn Gatehouse Entry. This office and entry building stands at 1000 El Camino Real within the Woodlawn Memorial Park and in the architectural C-APE for Site 7. The building is located approximately 500 feet to the north of the proposed well facility site. The Town of Colma concluded that this building is eligible for the National Register under Criterion C (Colma 1999) (see Section 5.5.2.1 [Federal Regulations], for a list of National Register criteria). Designed by San Francisco architect Thomas Patterson Ross, it combines elements of the Gothic Revival and Richardsonian Romanesque styles. Built in 1904, it also represents an early use of structural concrete.

Historical Resources in the Record Search Area, but Outside the Architectural C-APE

In addition to identifying known resources within the C-APE, it is useful for historians/architectural historians to identify nearby resources, even though they are outside the architectural C-APE and would not be impacted by the Project, to assist in designing the field survey strategy and in providing an understanding of the physical and historical context for the resources within the APE. The historical resources listed in Table 5.5-5 (Historical Architectural Resources in the Record Search Area, but Outside the Architectural C-APE), were previously identified within a 0.25-mile record search radius around the architectural C-APE for eight of the proposed well facility sites, but are located outside the limits of the architectural C-APE. These resources include two National Register-eligible buildings/structures, five National Register-eligible historic districts, two buildings listed in the California Inventory of Historical Resources, three buildings listed in the Office of Historic Preservation Historic Property Data File and one property listed as a California Landmark. In addition, two cemeteries in the record search area were found to be ineligible as individual historic properties, but may be eligible as contributors to a cemetery district that would include pre-mid-twentieth century cemeteries in the Town of Colma that retain their integrity. To date, such a district has not been formally proposed or evaluated.

Table 5.5-5 provides the name and federal, State and local listing status of each resource and the closest well facility sites. The designation in parenthesis following the name of the resources is the State Office of Historic Preservation Historic Property Data File number.

TABLE 5.5-5
Historical Architectural Resources in the Record Search Area, but Outside the Architectural C-APE

Well Facility Site Area	Resource Name	National/California Register Status
Site 7 Area	Italian Cemetery District (P-41-001708)	National Register-eligible district
Site 7 Area	Eternal Home Cemetery (P-41-001723)	Not individually eligible for the National or California registers, but may be eligible as a contributor to a Colma cemetery district
Site 7 Area	Salem Memorial Park (P-41-000402)	Not individually eligible for the National or California registers, but may be eligible as a contributor to a Colma cemetery district
Sites 8 & 17 (Alternate) Area	Salem Memorial Park Office Building (P-41-001659)	National Register-eligible building
Sites 8 & 17 (Alternate) Area	Cypress Lawn Memorial Park District (P-41-001750)	National Register-eligible district
Sites 8 & 17 (Alternate) Area	Holy Cross Cemetery District (P-41-001778)	National Register-eligible district
Sites 8 & 17 (Alternate) Area	Home of Peace Cemetery/Hills of Eternity Memorial Park District (P-41-001724)	National Register-eligible district
Site 9 Area	The Lagomarsino Farm District (P-41-00396)	National Register-eligible district
Site 11 Area	W. J. Martin Home	Listed in the California Inventory of Historical Resources
Site 11 Area	Twelve Mile House	Listed in the California Inventory of Historical Resources
Site 11 Area	1053 Grand Avenue (Residence)	Listed in the Office of Historic Preservation Historic Property Data File (significant at the local level)

**TABLE 5.5-5
Historical Architectural Resources in the Record Search Area, but Outside the Architectural C-APE**

Well Facility Site Area	Resource Name	National/California Register Status
Site 11 Area	Santa Cristo Hall (Community Hall)	Listed in the Office of Historic Preservation Historic Property Data File
Site 11 Area	Lux Kitchen/Weiss Home	Listed in the Office of Historic Preservation Historic Property Data File
Site 13 Area	Arched Cut Stone Bridge/Culvert (P-41-000309	National Register-eligible structure
Sites 14 & 15 Area	The site of the Tanforan Assembly Center	California Landmark 934

Field Survey Results

As a result of the field survey, Carey & Co. identified 13 historic architectural resources within architectural C-APEs that required further research and evaluation. The associated architectural C-APE/closest well facility site, address, name (where applicable), construction year for each resource is provided in Table 5.5-6 (Additional Architectural Resource Identified During Field Surveys), along with the National Register and California Register evaluation. The properties were evaluated for their association with significant events, people and architectural importance; as well as for having the potential to yield information important in prehistory or history. Detailed discussion of evaluation criteria for California Register and National Register follows in Section 5.5.2 (Regulatory Framework).

TABLE 5.5-6

Additional Architectural Resources Identified During Field Surveys

Closest Well Facility Site/ Architectural C-APE	Address of Resource	Name of Resource	Year Constructed	National/California Register Evaluation
Site 5	160 B Street, Daly City	Unnamed residential structure	1925	Not Eligible
Site 7	1000 El Camino Real, Colma	Woodlawn Memorial Park	1904	Gatehouse Entry individually eligible for the National Register and California Register. Memorial Park would be eligible as a contributor to a potential Colma historic cemetery district
Site 7	1100 El Camino Real, Colma	Greenlawn Memorial Park	1903	Would be eligible as a contributor to a potential Colma historic cemetery district
Site 7	1148 El Camino Real, Colma	Greek Orthodox Memorial Park	1934	Would be eligible as a contributor to a potential Colma historic cemetery district
Site 9	1700 El Camino Real, South San Francisco	Treasure Island Mobile Home Park	c. 1939	Not Eligible
Sites 10 & 18 (Alternate)	772 Del Monte Avenue, South San Francisco	Unnamed residential structure	1953	Not Eligible
Sites 10 & 18 (Alternate)	776 Del Monte Avenue, South San Francisco	Unnamed residential structure	1953	Not Eligible
Sites 10 & 18 (Alternate)	780 Del Monte Avenue, South San Francisco	Unnamed residential structure	1953	Not Eligible
Sites 10 & 18 (Alternate)	784 Del Monte Avenue, South San Francisco	Unnamed residential structure	1953	Not Eligible

TABLE 5.5-6
Additional Architectural Resources Identified During Field Surveys

Closest Well Facility Site/ Architectural C-APE	Address of Resource	Name of Resource	Year Constructed	National/California Register Evaluation
Sites 12 & 19 (Alternate)	321 Fairway Drive, South San Francisco	Unnamed residential structure	1942	Not Eligible
Sites 12 & 19 (Alternate)	609 Southwood Drive, South San Francisco	Our Redeemer's Lutheran Church	1955	Not Eligible
Sites 14 & 15	1300 Sneath Lane, San Bruno	Golden Gate National Cemetery (GGNC)	1937-1941	Already formally determined eligible for the National Register and California Register
Sites 14 & 15	54 Greenwood Drive, South San Francisco	Unnamed residential structure	1948	Not Eligible

Source: Carey & Co. 2011b

Of the resources listed in Table 5.5-6, the Gatehouse Entry at Woodlawn Memorial Park appears to be individually eligible for the National Register and California Register, and the Memorial Park itself would be eligible as a contributor to a potential Colma historic cemetery district. The GGNC has already been determined eligible for the National and California Registers. Greenlawn Memorial Park and Greek Orthodox Memorial Park would be eligible as contributors to a potential historic Colma historic cemetery district. The other nine resources listed in Table 5.5-6 do not appear to be eligible for the National Register or the California Register either individually or as contributors to a potential historic district.

The following provides a description and California Register and National Register evaluations for these four National/California Register eligible and potentially eligible resources. Descriptions and evaluations for the other nine resources listed in Table 5.5-6 are contained in the report titled *Historic Architectural Resources Technical Report for the Regional Groundwater Storage and Recovery Project, San Mateo County, California* (Carey & Co. 2011b).

Resource Description and Evaluation

Site 7

1000 El Camino Real, Woodlawn Memorial Park, Colma (1904)

Description: A monumental, rusticated gray stone building designed in a neo-Gothic, Richardsonian Romanesque style divides the entrance drive off El Camino Real from the mortuary grounds at Woodlawn Memorial Park. The building divides into six parts. At the southern end stands a two-story building with a steeply slanted hipped roof and gable dormer. Full-height rounded turrets mark the northern and southern corners of the east (primary) façade. To the north, a massive Roman arch flanked by two smaller Roman arches, connects the southern structure to a central tower. The Roman arches and neo-Gothic building to the north of the tower mirror those to the south. A single-story, flat-roof addition with square windows extends to the north.

Beyond the gates, a series of broad, winding pathways guide visitors around the gently sloping cemetery grounds. Vast expanses of lawn dotted with funeral monuments fill the spaces between the pathways. Two identical, mid-century modernist mausoleums stand at the summit of the cemetery grounds. Directly to their east, a stone wall surrounds The Pillars of Peace, four ionic columns with a shared cornice. A Mission Bell marking the El Camino Real route through the State also stands on the eastern edge of the cemetery grounds, towards its northern boundary along El Camino Real.

Evaluation: Preliminary research indicates that Woodlawn Memorial Park hosts a number of historic figures who are significant to the history of San Francisco, the State and the nation. If further research was undertaken to identify persons buried in the cemetery and it was determined that multiple people of transcendent importance were buried at Woodlawn, the site could be included in the National Register⁶.

The Gatehouse Entry at Woodlawn Memorial Park appears to be individually significant under California Register Criterion 3 and National Register Criterion C. Multiple master architects designed the entrance gates to Woodlawn Memorial Park, which stand out as unique in Colma and as excellent examples of both early twentieth century Richardsonian Romanesque architecture, as well as a modernist adaptation of this style. T. Patterson Ross designed the original chapel, arch, offices and tower, while Bernard Maybeck and William Gladstone Merchant designed the northern arch and offices that mirror Ross's design. Merchant and Maybeck also designed the modernist northern addition to the building. The distinguished architecture and its association with master architects render it individually eligible for the California Register and the National Register. The period of significance of the entrance gates ranges from 1904 when it was constructed to 1950 when the last addition was completed. This encompasses all three master architects work on the structure. The building's character-defining features include rusticated gray stone, steeply pitched roofs, round turrets and narrow arched stained glass windows. The character-

⁶ The potential National Register eligibility of Woodlawn Memorial Cemetery would be under Criterion A, if sufficient evidence supported the conclusion that it is the burial place of persons of transcendent importance.

defining features of the modernist additions to the building are stucco or stone cladding, flat roofs and large windows.

For a historical resource to be considered eligible for the California Register and the National Register, it must retain sufficient integrity to express its significance. Neither the entrance gates nor the grounds have moved and a landscape dominated by other cemeteries still surrounds them. Thus, Woodlawn Memorial Park retains its integrity of location and setting. The property continues to be used as a cemetery, with the entrance building still serving as a gate, administrative offices and a chapel. Thus, the property retains its integrity of association. New mortuary architecture has been added to the landscape over time, including two mid-century modernist mausoleums, and the landscaped grounds have grown in size, but such changes are germane to cemeteries. Thus, the landscape retains excellent integrity of design. The entrance gates have undergone significant additions, but these were both designed by master architects and have achieved significance in their own right. Thus, the building retains integrity of design, materials and workmanship. Woodlawn Memorial Park appears to retain sufficient integrity to express its historical significance.

If the Colma Cemetery Historic District is established, Woodlawn Memorial Park may be eligible for the California Register, under Criterion 1, as a contributor to the District because of its role in the interrelated histories of the City of San Francisco and Town of Colma and the discrete theme of cemeteries in the Town of Colma. At this time the potential historic district has not been fully identified. The landscape's architecture of the cemetery is not distinguished, but it would, together with the other cemeteries in the area, contribute to a potential district under Criterion 3 of the California Register of Historical Resources.

1100 El Camino Real, Greenlawn Memorial Park, Colma (1903)

Description: Colma Boulevard runs east-west through Greenlawn Memorial Park from El Camino Real towards Junipero Serra Boulevard. Only a small, flat patch of the cemetery occupies the area to the north of Colma Boulevard; the gently sloping hill of the cemetery grounds is located mostly to the south. Vast expanses of lawn dominate the landscape, which has a simple road pattern and mostly flat headstones or headstones of modest height. The cemetery features a small number of family crypts. At the end of the first road that runs south from Colma Boulevard stand two buildings. The smaller of the two is a single-story office building with a flat roof, stucco cladding and large metal sash windows. Immediately to its east is a mausoleum, also single-story in height with stucco cladding and a shed roof that slopes to the south. The entrance and two windows that flank it feature a lancet arch and fixed metal windows comprise the entirety of the stepped-back wall to the east of the entrance.

Evaluation: If the Colma Cemetery Historic District is established, Greenlawn Memorial Park may be eligible for the California Register as a contributor to the District because of its role in the interrelated histories of the City of San Francisco and Town of Colma and the discrete theme of cemeteries in the Town of Colma. Greenlawn Memorial Park may be eligible under Criteria 1 and 3 for the California Register as a contributor to a potential Colma Cemetery Historic District. The landscape architecture of the cemetery is not distinguished, but it would, together with the other cemeteries in the area, contribute to a potential district under Criterion 3 of the California Register. The property appears to be eligible for the National Register under Criteria A and C as part of a potential historic district.

1148 El Camino Real, Greek Orthodox Memorial Park, Colma (1934)

Description: Greek Orthodox Memorial Park is L-shaped in plan and characterized by low headstones on open expanses of lawn. The cemetery's chapel is a single-story gable building with stucco cladding and topped by a small dome. A flat-roofed, full-length addition extends to the south and houses administrative offices. A large mausoleum also stands towards the southern end of the grounds. It is an open-air compound of eight rectangular buildings with flat roofs and stucco siding. They step down with the hillside and form a central courtyard.

Evaluation: If the Colma Cemetery Historic District is established, the Greek Orthodox Memorial Park may be eligible for the California Register as a contributor to the District because of its role in the interrelated histories of the City of San Francisco and Town of Colma and the discrete theme of cemeteries in the Town of Colma. The Greek Orthodox Memorial Park may be eligible under Criterion 1 as a contributing property to a potential Colma Cemetery Historic District. The landscape architecture of the cemetery is not distinguished, but it would, together with the other cemeteries in the area, contribute to a potential district under Criterion 3 of the California Register. The property does appear to be eligible for the National Register under Criteria A and C as part of a potential historic district.

Sites 14 and 15*1300 Sneath Lane, Golden Gate National Cemetery, San Bruno (1937-1941)*

Description: GGNC is a nearly 162-acre historic designed landscape. It is L-shaped in plan with asphalt-covered roads planned in a large grid, except at the southwest corner, where the road spirals up a hill to a flagpole monument, which provides unobstructed, panoramic views. The cemetery has three groups of buildings or structures: the entrance gates, chapel maintenance building, and office/superintendent's residence in the southwest corner, at the corner of Sneath Lane and I-280; a maintenance yard located off Sneath Lane, along the eastern arm of the cemetery; and the aforementioned flagpole monument also at the southwest corner of the cemetery. A concrete bridge with stone facing spans a gully in the landscape to the east of the flagpole monument. Headstones are uniformly white and just over two feet in height, except for headstones along the flagpole monument hill, and those along the perimeter fence, which are flat and flush with the grass. . Wrought iron fencing with periodic concrete columns encloses a portion of the cemetery, with chain link fencing around the remaining perimeter.

The Mediterranean Revival Style entrance gates, completed on May 15, 1941, are comprised of three parts, – two grand arches flanking a central post – with wrought-iron gates spanning the distance between the three separate sections. The three parts are constructed of California granite.

The office/superintendent's residence and chapel/maintenance building are also identical in style and plan. The Mediterranean Revival structures, completed on May 15, 1941, are single-story buildings with clay tile covered hipped roofs. California granite veneer clads the hexagonal portion of the buildings, while stucco clads the remaining exterior walls. Primary windows are multi-lite casement. A segmental archway with a scroll keystone distinguishes the entrance to both the chapel and the office. The eastern end of the office building is residential; it features a rounded archway entrance and an exterior, stucco-clad chimney. Alterations to the office/superintendent's residence occurred during 1966 and 1979 and

focused on the residential portion of the building; the original windows were replaced with metal sliders, the porch was enclosed, storm doors were installed, and a private yard off the rear of the building was enclosed. Alterations to the chapel/maintenance building are limited to the installation of storm windows.

The maintenance yard located on Sneath Lane includes three Mediterranean style buildings. All three buildings are one-story in height, rectangular in plan, with clay tile clad hipped roofs and stucco cladding. A concrete wall connects the three buildings and encloses the yard.

Constructed in 1952, the northwest building is comprised of three parts – a center gable section flanked by hipped roof wings. Multi-lite fixed and awning metal windows in a variety of configurations are found on each elevation. The center section, facing the interior yard, features three bays with large fixed multi-lite casement windows which were replaced in 2007. The second building, constructed in 1957 and closest to Well Facility Site 15, has a hip roof and seven identical bays facing the yard with new multi-lite metal garage doors. Both buildings were constructed of concrete block and clad in stucco with simple detailing. The third building, constructed in 2007, functions as a garage and matches the other two structures in style.

Located near the maintenance yard is a secondary entrance to the cemetery. Two large concrete posts, constructed in 1941 and finished in stucco mark this entrance. Arched wrought-iron vehicular gates span these posts. West along Sneath Lane is an identical entrance with stuccoed finished posts and wrought-iron gates. This entrance, constructed in 1941, has been permanently closed with small native shrubs planted along the Sneath side.

The focal point of the cemetery is Flagpole Circle, which is 195 feet in diameter and rises above the surrounding landscape. Atop the manmade mound is a circular monument constructed of California granite. Three sets of steps lead from a paved area to the octagonal granite base which supports the large flagpole. Native plantings surround Flagpole Circle.

North of Flagpole Circle, low, rolling hills are full of rows of perfectly aligned headstones with trees interspersed. An asphalt loop, divided by three intersecting roads, dissects the landscape. East of Flagpole Circle is a gully, which is spanned by a concrete reinforced bridge clad in Raymond Gray Granite. The single-arch bridge, completed in 1942, leads directly down the middle of the cemetery's east leg. Numerous cemetery roadways cut through the relatively flat terrain of the east leg.

Two SFPUC easements run through the property. Pipelines that were laid well before construction of GGNC run through the property in these easements, and at these locations no burials have occurred. The easement within which Well Facility Site 14 is located has two belowground pipelines which were constructed in 1928 and 1979. The easements run from Sneath Lane, south of the cemetery, to the Brentwood neighborhood in the north. Within these easements are various pipes and concrete vaults, most of which are set close to the ground.

Evaluation: The Keeper of the National Register previously deemed Golden Gate National Cemetery eligible for listing in the National Register of Historic Places in 1977. It is deemed nationally significant for its association with the expansion of the National Cemetery System during the period between World War I and World War II. The National Register nomination form states "Continuing and expanding upon

memorial efforts established during the Civil War and the first national cemeteries, [this] inter-war cemetery [is a] symbolic display of the continuing sacrifices of the U.S. military” (VA n.d.). Therefore, because GGNC was determined eligible for listing in the National Register, it is eligible for listing in California Register, but as of now is not listed in either register. It is significant under Criterion 1 of the California Register for its association with events that have made a significant contribution to the broad patterns of California’s history and cultural heritage. GGNC will be formally nominated for listing in the National Register as a historic district (NPS 2011).

According to the National Register Eligibility of National Cemeteries – A Clarification of Policy:

National cemeteries regardless of the date of acquisition or construction, the overall acreage within the boundaries of the national cemetery that has been developed for cemetery purposes is considered one contributing site for National Register purposes. The site includes commemorative sections of the cemetery containing existing graves and memorials, sections having the infrastructure necessary to receive new interments and memorials (for example, streets, utilities, pre-placed crypts, columbaria, and memorial walkways), and areas of the cemetery developed for administrative and maintenance purposes (offices, restrooms, garages, and maintenance yards). [...] Certain smaller-scale features, such as grave markers, street signs, water fountains, curbs and culverts, and plantings are considered integral to the overall contributing site and its identity as a national cemetery (NPS 2011).

Therefore, all built environment features and the designed landscape within GGNC are considered contributing elements to the district.

Character-Defining Built Environment and Landscape Features of the GGNC

Character-defining features refer to distinct aspects of design, style, materials, or qualities of a historic property that contribute to the physical character of the site. Architecturally the GGNC site is defined by one-story structures, the majority with low-sloped hipped roofs. Cladding materials of the structures include stucco and granite. Red clay tile is found on the low sloping roofs and roofs with overhangs have detailed wood rafter tails. Most buildings have multi-lite windows. The buildings near the entrance feature more detail and multiple wall cladding materials, while the structures in the maintenance yard have very little detail and a single wall cladding material (i.e., stucco). Buildings on the site are near the edge of the property and are clustered around primary and secondary gates.

The prominent landscape feature of the site is the rows of perfectly aligned marble headstones, which stand two feet tall among the neatly manicured grass. Grass covers the majority of the acreage. Interspersed among the headstones are varieties of native and non-native trees including Monterey pines, eucalyptus, California *myoporum*, and Monterey cypress and other deciduous, evergreens and palms. Hedges of small trees and shrubs line the fences along the property’s edge, Flagpole Circle and the maintenance yard. Annual and perennial flowers are planted around the main entry gate. The rows of headstones are transected by a system of paved roads that allow access to various parts of the cemetery. A quarter-round concrete curb lines the paved roads. The property is partly enclosed by wrought-iron fencing punctuated by stucco posts with

limestone hipped caps; and in some locations decorative stucco walls with a curved top and an oval cutout stand between two posts. More detailed posts mark secondary entrances to the cemetery and a three-part granite gate marks the main entry to the site. Flagpole Circle is the only feature on the cemetery land that is taller than a one-story structure. Together, the previously mentioned built environment and landscape features define the character of Golden Gate National Cemetery.

Historical Contacts

The San Francisco Planning Department sent letters on July 10, 2009 to the following local historical societies and museums in San Mateo County: Colma Historical Association and Museum, Historical Society of South San Francisco, History Guild of Daly City-Colma, Millbrae Historical Society and San Mateo County History Museum, describing the Project and requesting information about known architectural or archaeological resources at the facility sites.

Sylvia Payne with the South San Francisco Historical Society contacted Diana Sokolove, San Francisco Planning Department, on July 14, 2009. Ms. Payne stated that she is unaware of any archaeological or architectural resources of significance in the Project study area. Dana Neitzel, curator of the San Mateo County Historical Association, emailed Diana Sokolove on July 21, 2009, to inform her that the Association does have relevant research materials on file. Carey & Co. visited this facility and reviewed the materials. No other responses have been received to date.

5.5.2 Regulatory Framework

5.5.2.1 Federal Regulations

National Historic Preservation Act

Cultural resources are protected through the National Historic Preservation Act (NHPA) of 1966, as amended (16 USC 470f), and its implementing regulations. Before a federal agency can engage in an “undertaking,” Section 106 of the NHPA requires the agency – as the “lead agency” – to consider the effects of the undertaking on historic properties (i.e., properties listed in or eligible for listing in the National Register) and to afford the Advisory Council on Historic Preservation a reasonable opportunity to comment on the undertaking.

Federal review of undertakings is referred to as the “Section 106 process.” This process is the responsibility of the federal lead agency. The Section 106 review typically involves a four-step procedure, which is described in detail in the implementing regulations (36 CFR 800):

- Identify historic properties in consultation with the State Historic Preservation Officer (SHPO) and interested parties;
- Assess the effects of the undertaking on historic properties;

- Consult with the SHPO, other agencies, and interested parties to develop an agreement that addresses the treatment of historic properties and notify the Advisory Council on Historic Preservation; and
- Proceed with the project according to the conditions of the agreement.

National Register of Historic Places

Under the NHPA, a property is considered significant if it meets the National Register listing criteria at 36 CFR 60.4, as stated below:

The quality of significance in American history, architecture, archaeology, engineering and culture is present in districts, sites, buildings, structures and objects that possess integrity of location, design, setting, materials, workmanship, feeling and association and that:

- a) Are associated with events that have made a significant contribution to the broad patterns of our history; or
- b) Are associated with the lives of persons significant in our past; or
- c) Embody the distinctive characteristics of a type, period, or method of construction, or that represent the work of a master, or that possess high artistic values, or that represent a significant and distinguishable entity whose components may lack individual distinction; or
- d) Have yielded, or may be likely to yield, information important in prehistory or history.

For a property to qualify under one or more of these Criteria for Evaluation, it must also retain "historic integrity of those features necessary to convey its significance." While a property's significance relates to its role within a specific historic context, its integrity refers to the "property's physical features and how they relate to its significance." To determine if a property retains the physical characteristics corresponding to its historic context, the National Register has identified seven aspects of integrity: location, design, setting, materials, workmanship, feeling, and association (DOI 1997).

In addition to the Criteria for Evaluation, the National Register maintains a list of property types or circumstances that generally do not qualify for the National Register. These are: cemeteries, birthplaces or graves of historical figures; properties owned by religious institutions or used for religious purposes; structures that have been moved from their original locations; reconstructed historic buildings; properties primarily commemorative in nature; and properties that have achieved significance within the past 50 years.

However, the National Register also provides for special consideration if a property described above is either an "integral" contributor to a district that qualifies under the Criteria for Evaluation or one of the following:

- a) A religious property deriving primary significance from architectural or artistic distinction or historical importance; or
- b) A building or structure removed from its original location but which is significant primarily for architectural value, or which is the surviving structure most importantly associated with a historic person or event; or
- c) A birthplace or grave of a historical figure of outstanding importance if there is no appropriate site or building directly associated with his or her productive life; or
- d) A cemetery which derives its primary significance from graves of persons of transcendent importance, from age, from distinctive design features, or from association with historic events; or
- e) A reconstructed building when accurately executed in a suitable environment and presented in a dignified manner as part of a restoration master plan, and when no other building or structure with the same association has survived; or
- f) A property primarily commemorative in intent if design, age, tradition, or symbolic value has invested it with its own exceptional significance; or
- g) A property achieving significance within the past 50 years if it is of exceptional importance (DOI 1997).

5.5.2.2 *State Regulations*

California Environmental Quality Act

CEQA, as codified in California Public Resources Code (PRC) Section 21000, et seq., is the principal statute governing the environmental review of projects in the State. CEQA requires lead agencies to determine if a proposed project would have a significant effect on historical resources and unique archaeological resources. The CEQA Guidelines define a historical resource as: (1) a resource listed in the California Register; (2) a resource included in a local register of historical resources, as defined in PRC Section 5020.1(k), or identified as significant in a historical resource survey meeting the requirements of PRC Section 5024.1(g); or (3) any object, building, structure, site, area, place, record, or manuscript that a lead agency determines to be historically significant or significant in the architectural, engineering, scientific, economic, agricultural, educational, social, political, military, or cultural annals of California, provided the lead agency's determination is supported by substantial evidence in light of the whole record.

If a lead agency determines that an archaeological site is a historical resource, the provisions of PRC Section 21084.1 and CEQA Guidelines Section 15064.5 would apply. If an archaeological site does not meet the CEQA Guidelines criteria for a historical resource, then the site may meet the threshold of PRC Section 21083 regarding unique archaeological resources. A unique archaeological resource is an archaeological artifact, object, or site about which it can be clearly demonstrated that, without merely adding to the current body of knowledge, there is a high probability that it meets any of the following criteria:

- Contains information needed to answer important scientific research questions and that there is a demonstrable public interest in that information;
- Has a special and particular quality, such as being the oldest of its type or the best available example of its type; or
- Is directly associated with a scientifically recognized important prehistoric or historic event or person (PRC Section 21083.2[g]).

The CEQA Guidelines note that if a resource is neither a unique archaeological resource nor a historical resource, the effects of a project on that resource shall not be considered a significant effect on the environment (CEQA Guidelines Section 15064[c][4]).

California Register of Historical Resources

The California Register is “an authoritative listing and guide to be used by state and local agencies, private groups and citizens in identifying the existing historical resources of the state and to indicate which resources deserve to be protected, to the extent prudent and feasible, from substantial adverse change” (PRC Section 5024.1[a]). The criteria for eligibility to the California Register are based on National Register criteria (PRC Section 5024.1[b]). Certain resources are determined by the statute to be automatically included in the California Register, including California properties formally determined eligible for or listed in the National Register.

To be eligible for the California Register as a historical resource, a prehistoric or historic-period resource must be significant at the local or State level under one or more of the following criteria:

- 1) Is associated with events that have made a significant contribution to the broad patterns of California’s history and cultural heritage;
- 2) Is associated with the lives of persons important in our past;
- 3) Embodies the distinctive characteristics of a type, period, region, or method of construction, or represents the work of an important creative individual, or possesses high artistic values; or
- 4) Has yielded, or may be likely to yield, information important in prehistory or history (CEQA Guidelines Section 15064.5 [a][3]).

For a resource to be eligible for the California Register, it must also retain enough integrity to be recognizable as a historical resource and to convey its significance. The seven aspects of integrity are: location, design, setting, materials, workmanship, feeling and association. A resource that does not retain sufficient integrity to meet the National Register criteria may still be eligible for listing in the California Register. A resource that has lost its historic character or appearance may still have sufficient integrity for the California Register if it maintains the potential to yield significant scientific or historical information or specific data (OHP 2011).

California’s list of special considerations is shorter than the criteria considerations for the National Register listed above. It includes some allowances for moved buildings, structures, or objects, as well as

requirements for proving the significance of resources that are less than 50 years old and discussion of the eligibility of reconstructed buildings. Additionally, unlike the criteria considerations for the National Register, cemeteries do not come under the scrutiny of special considerations for the California Register. In addition to separate evaluations for eligibility for the California Register, the State automatically lists in the California Register resources that are listed or formally determined eligible for the National Register.

California Public Resources Code

As part of the determination made pursuant to PRC Section 21080.1, the lead agency must determine whether a project would have a significant effect on archaeological and paleontological resources.

Several sections of the PRC protect cultural resources and PRC Section 5097.5 protects vertebrate paleontological sites located on public land. Under Section 5097.5, no person shall knowingly and willfully excavate upon, or remove, destroy, injure, or deface, any historic or prehistoric ruins, burial grounds, archaeological or vertebrate paleontological site (including fossilized footprints), inscriptions made by human agency, rock art, or any other archaeological, paleontological, or historical feature situated on public lands, except with the express permission of the public agency that has jurisdiction over the lands. Violation of this section is a misdemeanor.

PRC Section 5097.98 states that if Native American human remains are identified within a project area, the landowner must work with the Native American Most Likely Descendant as identified by the NAHC to develop a plan for the treatment or disposition of the human remains and any items associated with Native American burials with appropriate dignity. These procedures are also addressed in Section 15046.5 of the CEQA Guidelines. California Health and Safety Code Section 7050.5 prohibits disinterring, disturbing, or removing human remains from a location other than a dedicated cemetery. Section 30244 of the PRC requires reasonable mitigation for impacts on paleontological and archaeological resources that occur as a result of development on public lands.

California Health and Safety Code

California Health and Safety Code Section 7050.5 regulates the treatment of human remains. In the event of discovery or recognition of any human remains in any location other than a dedicated cemetery, there shall be no further excavation or disturbance of the site or any nearby area reasonably suspected to overlie adjacent remains until the coroner of the county in which the human remains are discovered has determined that the remains are not subject to his or her authority. If the coroner recognizes the human remains to be those of a Native American, or has reason to believe that they are those of a Native American, he or she shall contact the NAHC by telephone within 24 hours.

5.5.2.3 *Local Regulations*

San Francisco Historic Preservation Commission and Planning Code, Articles 10 and 11

The San Francisco Historic Preservation Commission is a seven-member body that makes recommendations on the designation of landmark buildings, historic districts and significant buildings within the CCSF. The Historic Preservation Commission replaces and retains most of the responsibilities of the Landmarks Preservation Advisory Board (Landmarks Board). The Landmarks Board was a nine-member body appointed by the Mayor that served as an advisory board to the San Francisco Planning Commission and San Francisco Planning Department. The Landmarks Board was established in 1967 with the adoption of Article 10 of the Planning Code. The work of the Landmarks Board, San Francisco Planning Department and San Francisco Planning Commission has increased public awareness about the need to protect the CCSF's architectural, historical and cultural heritage.

The Historic Preservation Commission makes recommendations to the San Francisco Board of Supervisors on landmark designations, historic district designations and individual resource designations within historic districts. The Commission may also review and comment on projects affecting historical resources that are subject to environmental review under CEQA or projects subject to review under Section 106 of the NHPA. The Commission also approves Certificates of Appropriateness for Landmarks and properties within Article 10, Historic Districts (explained below).

The State Office of Historic Preservation has included the CCSF on its list of Certified Local Governments, which means that San Francisco has an approved historic preservation ordinance, Historic Preservation Commission and other formal processes related to historic preservation and cultural resources management. CCSF reviews the historical resources designated under Articles 10 and 11 of the San Francisco Planning Code when it evaluates project impacts on historical resources within the CCSF. Article 10 describes procedures regarding the preservation of sites and areas of special character or special historical, architectural, or aesthetic interest or value, such as officially designated city landmarks and buildings included within locally designated historic districts.

Article 11 of the Planning Code designated six downtown conservation districts. There are no CCSF-designated landmarks or properties that contribute to designated historic districts in the Project C-APes.

5.5.3 Impacts and Mitigation Measures

5.5.3.1 *Significance Criteria*

For the purposes of this EIR, the Regional Groundwater Storage and Recovery Project would have a significant effect on cultural and paleontological resources if it were to:

- Cause a substantial adverse change in the significance of a historical resource as defined in CEQA Guidelines Section 15064.5, including those resources listed in Article 10 or Article 11 of the San Francisco Planning Code;
- Cause a substantial adverse change in the significance of a unique archaeological resource pursuant to Section 15064.5;
- Directly or indirectly destroy a unique paleontological resource or site or unique geological feature; or
- Disturb any human remains, including those interred outside of formal cemeteries pursuant to California Health and Safety Code Section 7050.5.

5.5.3.2 *Approach to Analysis*

There would be potential for the Project to adversely affect cultural resources in both the construction and operational phases. Ground disturbance and excavation during construction activities could disturb or destroy known and previously unrecorded buried cultural resources, including archaeological and paleontological resources and human remains. Project operations would not cause additional ground disturbance, and thus would not result in impacts to archaeological or paleontological resources, or human remains. However, the permanent physical presence of aboveground Project elements could adversely change the context or integrity of a historical resource, thereby affecting its significance. The permanent physical changes resulting from the Project are addressed in Section 5.5.4 (Operational Impacts and Mitigation Measures).

Architectural Resources

Potential impacts on historic architectural resources were assessed by determining whether proposed Project activities and facilities could cause a substantial adverse change in the significance of any such resources within the architectural C-APE. A substantial adverse change in the significance of a historic architectural resource means “physical demolition, destruction, relocation, or alteration of the resource or its immediate surroundings such that the significance of the historical resource would be materially impaired” (CEQA Guidelines Section 15064.5[b][1]). A historic architectural resource can be materially impaired through demolition or alteration of the resource’s physical characteristics that convey its historical significance and that justify its inclusion in the California Register (CEQA Guidelines Section 15064.5[b][2][A]). For Sites 14 and 15, which are located on federal land and therefore subject to the National Historic Preservation Act, potential impacts on historic architectural resources were assessed by determining whether proposed Project activities and facilities could alter, directly or indirectly, any of the characteristics of the property that qualify it for inclusion in the National Register in a manner that would

diminish the integrity of the property's location, design, setting, materials, workmanship, feeling, or association (36 CFR 800.5[1]).

Archaeological Resources

The significance of most prehistoric and historic-period archaeological sites is usually determined based on National Register Criterion D and/or California Register Criterion 4, presented above. This criterion stresses the importance of the information potential contained within the site rather than its significance as a surviving example of a type or its association with an important person or event. Archaeological resources may also be assessed under CEQA as unique archaeological resources, defined as archaeological artifacts, objects, or sites that contain information needed to answer important scientific research questions.

Paleontological Resources

For this analysis, "unique paleontological resource" is deemed to include resources that qualify as significant under SVP criteria (see Section 5.5.1.2 [Paleontological Setting]). Potential Project effects on paleontological resources are limited to construction-related disturbance and are discussed below under Impact CR-3. Operation of the proposed Project would not result in impacts on paleontological resources.

Human Remains

Human remains, including those buried outside of formal cemeteries, are protected under several State laws, including PRC Section 5097.98 and Health and Safety Code Section 7050.5. Impacts include intentional disturbance, mutilation, or removal of interred human remains.

5.5.3.3 Summary of Impacts

Table 5.5-7 (Summary of Impacts – Cultural and Paleontological Resources), lists the proposed Project's cultural and paleontological impacts and significance determinations.

TABLE 5.5-7
Summary of Impacts – Cultural and Paleontological Resources

	Construction				Operations	Cumulative
Site	Impact CR-1: Project construction could cause an adverse change in the significance of a historical resource.	Impact CR-2: Project construction could cause an adverse change in the significance of an archaeological resource.	Impact CR-3: Project construction could result in a substantial adverse effect by destroying a unique paleontological resource or site.	Impact CR-4: Project construction could result in a substantial adverse effect related to the disturbance of human remains.	Impact CR-5: Project facilities could cause an adverse change in the significance of a historical resource.	Impact C-CR-1: Construction of the proposed Project could result in a cumulatively considerable contribution to cumulative impacts on historical, archaeological, or paleontological resources, or human remains.
Site 1	NI	LSM	LSM	LSM	NI	LSM
Site 2	NI	LSM	LSM	LSM	NI	LSM
Site 3	NI	LSM	LSM	LSM	NI	LSM
Site 4	NI	LSM	LSM	LSM	NI	LSM
Westlake Pump Station	NI	NI	NI	NI	NI	NI
Site 5 (Consolidated Treatment and On-site options)	NI	LSM	LSM	LSM	NI	LSM
Site 6 (Consolidated Treatment and On-site options)	NI	LSM	LSM	LSM	NI	LSM

TABLE 5.5-7
Summary of Impacts – Cultural and Paleontological Resources

	Construction				Operations	Cumulative
Site	Impact CR-1: Project construction could cause an adverse change in the significance of a historical resource.	Impact CR-2: Project construction could cause an adverse change in the significance of an archaeological resource.	Impact CR-3: Project construction could result in a substantial adverse effect by destroying a unique paleontological resource or site.	Impact CR-4: Project construction could result in a substantial adverse effect related to the disturbance of human remains.	Impact CR-5: Project facilities could cause an adverse change in the significance of a historical resource.	Impact C-CR-1: Construction of the proposed Project could result in a cumulatively considerable contribution to cumulative impacts on historical, archaeological, or paleontological resources, or human remains.
Site 7 (Consolidated Treatment and On-site options)	LS	LSM	LSM	LSM	LS	LSM
Site 8	NI	LSM	LSM	LSM	NI	LSM
Site 9	NI	LSM	NI	LSM	NI	LSM
Site 10	NI	LSM	LSM	LSM	NI	LSM
Site 11	NI	LSM	LSM	LSM	NI	LSM
Site 12	NI	LSM	LSM	LSM	NI	LSM
Site 13	NI	LSM	LSM	LSM	NI	LSM
Site 14	LSM	LSM	LSM	LSM	LSM	LSM
Site 15	LSM	LSM	LSM	LSM	LSM	LSM
Site 16	NI	LSM	LSM	LSM	NI	LSM
Site 17 (Alternate)	NI	LSM	LSM	LSM	NI	LSM

**TABLE 5.5-7
Summary of Impacts – Cultural and Paleontological Resources**

	Construction				Operations	Cumulative
Site	Impact CR-1: Project construction could cause an adverse change in the significance of a historical resource.	Impact CR-2: Project construction could cause an adverse change in the significance of an archaeological resource.	Impact CR-3: Project construction could result in a substantial adverse effect by destroying a unique paleontological resource or site.	Impact CR-4: Project construction could result in a substantial adverse effect related to the disturbance of human remains.	Impact CR-5: Project facilities could cause an adverse change in the significance of a historical resource.	Impact C-CR-1: Construction of the proposed Project could result in a cumulatively considerable contribution to cumulative impacts on historical, archaeological, or paleontological resources, or human remains.
Site 18 (Alternate)	NI	LSM	LSM	LSM	NI	LSM
Site 19 (Alternate)	NI	LSM	LSM	LSM	NI	LSM

Note:

NI = No Impact

LS = Less than Significant

LSM= Less than Significant with Mitigation

5.5.3.4 Construction Impacts and Mitigation Measures

Impact CR-1: Project construction could cause an adverse change in the significance of a historical resource. (Less than Significant with Mitigation)

The evaluation that follows discusses sites with no impacts first, followed by sites with less-than-significant impacts and sites with significant impacts.

Sites 1, 2, 3, 4, 5, 6, 8, 9, 10, 11, 12, 13, 16, 17 (Alternate), 18 (Alternate), 19 (Alternate), and the Westlake Pump Station

There were no historic-period resources identified at these sites; therefore, there would be *no impacts* to historical resources.

Impact Conclusion: No Impact

Sites 7, 14, and 15

Two historic-period architectural resources could be affected by proposed Project construction activities at Site 7 and at Sites 14 and 15: the Gatehouse Entry at Woodlawn Memorial Park (Site 7) and the GGNC (Sites 14 and 15). Both of these resources have been determined to be eligible for listing in the National Register and are, therefore, also eligible for listing on the California Register. As a result, they are considered historical resources for the purposes of CEQA evaluation. In addition, if a Colma Cemetery Historic District is established, Woodlawn Memorial Park may be eligible for the California Register and National Register as a contributor to the District for its role in the interrelated histories of the City of South San Francisco and Town of Colma and the discrete theme of cemeteries in the Town of Colma; the landscape's design would fit the character-defining features of the District.

Site 7

The Woodlawn Memorial Park Gatehouse Entry building is located approximately 500 feet to the north of Site 7. As noted above, the Woodlawn Gatehouse Entry was determined by the Town of Colma to be eligible for listing in the National Register under Criterion C, as it embodies the distinctive characteristics of an architectural type and method of construction. In general, the significance of architectural resources could be materially impaired by a project's construction through physical demolition, destruction, relocation, or alteration of the resource or its immediate surroundings. However, construction of the Project would not demolish, destroy, relocate, or physically alter this historical resource or its immediate surroundings. If the option to consolidate treatment at Site 6 were implemented, trenching for placement of a water pipeline from Site 7 to Site 6 would pass within approximately 180 feet of – and within view of – the Gatehouse Entry building. The presence of construction vehicles and equipment, as well as the disturbance of landscaped grounds by trenching, would be out of character with the resource. But, because trenching activities in the vicinity of the entryway would only take an estimated one week to complete (based on the proposed pipeline installation rate of 300 to 600 feet per week) and the trenching locations would be restored to their general pre-construction condition at the conclusion of construction,

these temporary impacts would not cause an adverse change in the significance of this historical resource. Therefore, the impact on this historical resource would be *less than significant*.

Impact Conclusion: Less than Significant

Sites 14 and 15

The GGNC is eligible for listing in the National Register as a historic district under Criterion A for its association with the expansion of the National Cemetery System during the period between World War I and World War II. In general, the significance of an architectural historical resource could be materially impaired by a project's construction if the project involves physical demolition, destruction, relocation, or alteration of the resource or its immediate surroundings. Because all built environment features and the designed landscape within GGNC are considered contributing elements to the district, any damage or alteration of features within the cemetery, including buildings, landscape, or hardscape (e.g. roadways, curbs, and fencing) features would be considered significant impacts. For purposes of this evaluation, the entire GGNC is considered one historical resource, and all of the individual landscape and constructed features of the GGNC are elements of the resource that contribute to its significance. References to "the historical resource" pertain to the entire GGNC.

Site 14

Site 14 would be located within the SFPUC's easement near the northern property line of the GGNC. The easement is approximately 60 feet wide where the proposed well facility would be located. Rows of headstones, approximately two feet in height, are located to the east and west; the closest being five to 10 feet from the proposed well facility. The activities associated with construction of the well structure, the disturbance of landscaped grounds for trenching for the water line, storm drain, underground electrical equipment, and installation of grass pavers would potentially affect the historical resource. The presence of construction vehicles and equipment and their operation could damage or destroy nearby headstones, or otherwise have an adverse effect on the landscaped grounds by the loss of existing turf where the equipment would be traveling/operating. The staging area appears to be adequately separated from the headstones, but the storage of materials and other activities would adversely affect the landscaped grounds by damaging existing turf. Any impacts to the built environment features or designed landscape at the GGNC would constitute a significant impact. The construction activities associated with the proposed removal of the existing unused pump building, well, and tank would have the potential to affect the historical resource. The presence of construction vehicles and equipment and their operation could damage or destroy nearby headstones, or otherwise have an adverse effect on the landscaped grounds by damaging existing turf where the equipment would be traveling/operating. At this location, approximately eight headstones are within five to 10 feet of the pump building, which contributes to the possibility that they could be negatively affected by removal activities. Therefore, this potential impact is *significant*. The majority of the proposed water pipeline and storm drain between Sites 14 and 15 traverses a portion of the GGNC within the SFPUC easement. However, a segment of the pipeline would run along Sneath Lane next to the historic wrought-iron fence, masonry posts, and an unused secondary entrance, all of which were constructed at the edge of the cemetery between 1941 and 1942 and are contributing elements of the historical resource. The activities associated with construction of the water line and storm

drain within the SFPUC easement would affect elements contributing to the historical resource, because the presence of construction vehicles and equipment and their operation could damage or destroy nearby headstones, or otherwise have an adverse effect on the landscaped grounds by the loss of existing turf upon which the construction vehicles/equipment would be traveling/operating. The perimeter wrought-iron fence and masonry posts face similar potential impacts during construction. Any impacts that would cause an adverse change in the significance of the GGNC due to pipeline construction would constitute a *significant* impact.

However, Mitigation Measure M-CR-1a (Minimize Construction-related Impacts to Elements of the Historical Resource at Site 14) would be implemented to mitigate the potential impacts from construction at Site 14, including pipelines. Implementation of this mitigation measure would minimize the potential construction impacts on the historical resource to *less-than-significant* levels by requiring the SFPUC and its contractors to implement physical and administrative measures to protect elements of the historical resource during construction. Therefore, this potential impact on historical resources would be *less than significant with mitigation*.

Mitigation Measure M-CR-1a: Minimize Construction-related Impacts to Elements of the Historical Resource at Site 14

The SFPUC and its contractor shall implement the following measures during construction at Site 14 to protect elements of the historical resource:

- The SFPUC shall lay plywood or other material down temporarily for access between the cemetery access road and the construction area during construction.
- Temporary protective barriers shall be constructed for protection of the headstones during construction, including those near the existing pump structure to be removed.
- Final plans and specifications shall be submitted to the VA prior to construction.
- Construction workers shall undergo a training program to be made aware of the importance of the site and the contributing elements of the historical resource that would be affected by the proposed work. The training program shall be approved by either a qualified historical architect or architectural historian.
- Through measurements and photographs, a historical architect shall document the roads and concrete curbs where trenching would occur. This documentation shall serve as a reference for replacing the curbs to match the existing curbs where removed for trenching. The SFPUC shall replace curbs removed for trenching with new curbs to match the existing curbs.
- Grass shall be restored where removed for trenching.

Site 15

Site 15 would be located along the southern property line of the cemetery between the GGNC operations and maintenance buildings and Sneath Lane. The area is approximately 40 feet wide where the proposed well facility would be located. In addition to the well facility, paving for parking would be installed next to the Cemetery's entry gate and maintenance yard.

Construction activities associated with the proposed well, well building, and concrete driveway, as well as trenching for placement of water lines, storm drain, and sanitary sewer have the potential to adversely affect elements that contribute to the GGNC's eligibility for listing in the National Register, including the 1952 maintenance complex and the 1940 entry gate. The presence of construction vehicles and equipment and their operation could inadvertently damage the nearby entrance gate and the southern maintenance building. Any impacts that would cause an adverse change in the significance of National Register-eligible properties would constitute a significant impact. As discussed previously, the construction of pipelines associated with Site 15 could impact elements of the historical resource because the presence of construction vehicles and equipment and their operation could damage or destroy nearby headstones, or otherwise materially impair the landscaped grounds by removing turf upon which the construction vehicles/equipment would be traveling/operating. The perimeter wrought-iron fence and masonry posts face similar threats during construction. Any impacts that would cause an adverse change in the significance of National Register-eligible properties due to pipeline construction would constitute a significant impact.

Construction activities for the proposed well facility at Site 15 could affect contributing elements of the historical resource, including the 1952 maintenance complex and the 1941 entry gate, because construction activities associated with the drilling and installation of the well could result in excessive vibrations, which would have the potential of damaging the nearby buildings and result in a *significant* impact. However, vibration studies have been conducted for this site (see Section 5.7, Noise and Vibration) and implementation of Mitigation Measure M-NO-2 (Reduce Vibration Levels during Construction of Pipelines) requires that the construction of pipelines within 25 feet of the structures near Site 15 use either non-vibratory means of compaction or controlled low strength materials (CLSM) as backfill so that compaction is not necessary thereby reducing significant vibration levels near the building to below 0.25 in/sec PPV (this threshold is discussed in detail in Section 5.7). Therefore, this impact would be *less than significant with mitigation*.

Mitigation Measure M-NO-2: Reduce Vibration Levels during Construction of Pipelines (Sites 3, 4, 12, 15, and 18 [Alternate])

(See Impact NO-2 in Section 5.7, Noise and Vibration for a description)

Implementation of Mitigation Measure M-CR-1b (Minimize Construction-related Impacts on Elements of the Historical Resource at Site 15) would minimize impacts on historical resources to *less-than-significant* levels by requiring the SFPUC and its contractors to implement physical and administrative measures to protect elements of the historical resources during construction. Therefore, this potential impact on historical resources would be *less than significant with mitigation*.

Mitigation Measure M-CR-1b: Minimize Construction-related Impacts on Elements of the Historical Resource at Site 15

The SFPUC and its contractor shall implement the following measures during construction at Site 15 to protect elements of the historical resource:

- Temporary protective barriers shall be constructed for protection of the adjacent building to the north during construction.
- Final plans and specifications shall be submitted to the VA prior to construction.
- Construction workers shall undergo a training program to be made aware of the importance of the building adjacent to Site 15 and the contributing elements of the historical resource that would be affected by the proposed work. The training program shall be approved by either a qualified historical architect or architectural historian.
- Through measurements and photographs, a historical architect shall document the roads and concrete curbs where trenching would occur. This documentation shall serve as a reference for replacing the curbs to match the existing curbs where removed for trenching. The SFPUC shall replace curbs removed for trenching with new curbs to match existing. Grass shall be restored where removed for trenching

Impact Conclusion: Less than Significant with Mitigation

Impact CR-2: Project construction could cause an adverse change in the significance of an archaeological resource. (Less than Significant with Mitigation)

The evaluation that follows discusses sites with no impacts first, followed by sites with significant impacts.

Westlake Pump Station

There would be no ground disturbing activities at the Westlake Pump Station. All construction activities would occur within the existing pump station building. Therefore, there would be *no impact* on archaeological resources at this location.

Impact Conclusion: No Impact

Sites 1, 2, 3, 4, 5, 6, 7, 8, 9, 10, 11, 12, 13, 14, 15, 16, 17 (Alternate), 18 (Alternate), and 19 (Alternate)

No potentially California Register-eligible archaeological sites or unique archaeological resources were identified within any of the archaeological C-APEs for the Project and, given the results of the field surveys, extended archaeological surveys (EASs), and Native American contacts described in Section 5.5.1.5 (Archaeological Methods, Survey and Results), it is unlikely that undiscovered resources are present, either on or below the ground surface. However, at Site 11, despite the negative results of archaeological test investigations at the site, there is some potential that remnants of a known prehistoric archaeological site (CA-SMA-299) are located below the ground surface. Any impacts to this known

resource would be *significant*. Nevertheless, implementation of Mitigation Measure M-CR-2 (Discovery of Archaeological Resources) would ensure immediate identification of the resource should it be encountered during construction, and would require the SFPUC and its contractors to adhere to appropriate procedures and protocols for minimizing impacts to the resource. Therefore, this potential impact on archaeological resources would be *less than significant with mitigation*.

Although Project construction would have no impact on known archaeological resources at the remaining sites and there is a low potential for the presence of previously unrecorded and buried (or otherwise obscured) archaeological resources, their presence cannot be entirely ruled out. Excavation, grading, and the movement of heavy construction vehicles and equipment could expose and disturb or damage any such previously unrecorded archaeological resources. Any such impacts on potentially California Register-eligible or unique archaeological resources would be *significant*. However, Mitigation Measure M-CR-2 (Discovery of Archaeological Resources) would be implemented during Project construction. Implementation of this measure would reduce impacts on any previously unrecorded and buried (or otherwise obscured) archaeological deposits to *less-than-significant* levels by requiring the SFPUC and its contractors to adhere to appropriate procedures and protocols for minimizing such impacts, in the event that a possible archaeological resource is discovered during construction activities associated with the Project. Therefore, this potential impact on archaeological resources would be *less than significant with mitigation*.

Mitigation Measure M-CR-2: Discovery of Archaeological Resources (All Sites except Westlake Pump Station)

Archaeological Monitoring Program. Despite the negative results of archaeological test investigations at Site 11, there is some potential that remnants of a known prehistoric archaeological site (CA-SMA-299) are located below the ground surface. Consequently, an archaeological monitoring plan shall be prepared and implemented for construction at Site 11. The monitoring plan shall specify the location and duration of monitoring activities and shall be subject to review by the Environmental Review Officer (ERO). The scope of the monitoring plan shall conform to MEA WSIP Archaeological Guidance No. 4.

Accidental Discovery. To avoid potential adverse effects on accidentally discovered archaeological resources, the SFPUC shall distribute the San Francisco Planning Department's archaeological resource "ALERT" sheet to: the Project prime contractor; any subcontractors (including firms subcontracted to perform demolition, excavation, grading, foundation, pile driving, etc.); and/or any utilities firm involved in soil-disturbing activities within the archaeological C-APE for each well facility site. Prior to any soil-disturbing activities, each contractor shall be responsible for ensuring that the ALERT sheet is circulated to all field personnel, including machine operators, field crew, pile drivers, supervisory personnel, etc. The SFPUC shall provide the ERO with a signed affidavit from the responsible parties (prime contractor, subcontractor(s), and utilities firm) confirming that all field personnel have received copies of the ALERT sheet.

If potential archaeological resources are uncovered, the discovery site shall be secured, personnel and equipment shall be redirected, and the ERO shall be notified immediately. If the ERO determines that an archaeological resource may be present within the C-APE, the SFPUC shall

retain the services of a qualified archaeological consultant. For construction at Site 11, an archaeological monitoring plan shall be prepared and implemented. The monitoring plan shall specify the location and duration of monitoring activities and shall be subject to review by the ERO.

If archaeological resources are discovered at Site 11 or any of the other well facility sites, the archaeological consultant shall advise the ERO as to whether the discovery is an archaeological resource that retains sufficient integrity and is of potential scientific/historical/cultural significance. If an archaeological resource is present, the consultant shall identify and evaluate the archaeological resource. The archaeological consultant shall make a recommendation as to what action, if any, is warranted. Based on this information, the ERO may require, if warranted, specific additional measures to be implemented by the SFPUC.

Measures might include: preservation in situ of the archaeological resource; an archaeological monitoring program; or an archaeological evaluation program. If an archaeological monitoring program or archaeological testing program is required, it shall be subject to review by the ERO. The ERO may also require that the SFPUC immediately implement a site security program if the archaeological resource is at risk from vandalism, looting, or other damaging actions.

For any discovery of an archaeological resource, the archaeological consultant shall submit an archaeological data recovery report (ADRR) to the ERO which, in addition to the usual contents of the ADRR, shall: include an evaluation of the historical significance of any discovered archaeological resource; describe the archaeological and historical research methods employed in the archaeological monitoring/data recovery program(s) undertaken; and present, analyze and interpret the recovered data. Information that may put at risk any archaeological resource shall be provided in a separate removable insert within the final report. Once approved by the ERO, copies of the ADRR shall be distributed as follows: the relevant California Historical Resources Information System Information Center shall receive one copy, and the ERO shall receive one copy of the transmittal letter of the ADRR to the Information Center. The San Francisco Planning Department, Environmental Planning Division, shall receive three copies of the ADRR along with copies of any formal site recordation forms (California Department of Parks and Recreation Form 523 series) and/or documentation for nomination to the National Register/California Register. The SFPUC shall receive copies of the ADRR in the number requested. In instances of high public interest in or high interpretive value of a resource, the ERO may require a different final report content, format and distribution than that presented above. All archaeological work performed under this mitigation measure shall be subject to review by the ERO or designee.

Impact Conclusion: Less than Significant with Mitigation

Impact CR-3: Project construction could result in a substantial adverse effect by destroying a unique paleontological resource or site. (Less than Significant with Mitigation)

The evaluation that follows discusses sites with no impacts first, followed by sites with significant impacts.

Site 9 and the Westlake Pump Station

Site 9 is located on surface deposits mapped as Holocene colluvium. Although vertebrate remains in Holocene colluvium are too young to be fossiliferous, they could be of scientific interest to paleontologists, but would not be considered significant paleontological resources. Therefore, there would be *no impact* on paleontological resources during construction at this site. At the Westlake Pump Station, there would be no ground disturbing activities and, therefore, there would be *no impact* on paleontological resources at this location, either.

Impact Conclusion: No Impact

Sites 1, 2, 3, 4, 5, 6, 7, 8, 10, 11, 12, 13, 14, 15, 16, 17 (Alternate), 18 (Alternate), and 19 (Alternate)

These sites would be located on surface deposits mapped as the Colma Formation, which is of late Pleistocene age. (Although Site 10 is partially underlain by artificial fill, a portion is located on Colma Formation Deposits.) As noted above, the Colma Formation has produced significant marine and terrestrial fossils in the past and is considered to have a high paleontological sensitivity for significant paleontological resources.

Based upon the results of a review of published geologic maps, geologic unit descriptions and a fossil collections database at the University of California Museum of Paleontology (UCMP) undertaken for the Project by Dr. Kenneth Finger in 2009 (Finger 2009), any Project-related activities that would encounter previously undisturbed subsurface sediments have the potential to impact significant paleontological resources. However, pre-construction paleontological field surveys or monitoring during construction are not recommended, because the surfaces of the sites have already been disturbed or covered, the potential for uncovering vertebrate fossils is generally low, and the construction-related excavation for the Project is not extensive (Finger 2009). Although the potential for encountering significant paleontological resources during Project construction is low, in the unlikely event that significant paleontological resources are encountered in undisturbed subsurface sediments, they could be adversely affected. Thus, the Project's potential construction-related impact on paleontological resources is *significant*. However, implementation of Mitigation Measure M-CR-3 (Suspend Construction Work if a Paleontological Resource is Identified) would minimize the Project's potential construction-related impacts on paleontological resources to *less-than-significant* levels by requiring that construction work be temporarily halted or diverted in the event of a paleontological resource discovery, as well as avoidance or salvage of any significant paleontological resources. Therefore, this potential impact on paleontological resources would be *less than significant with mitigation*.

Mitigation Measure M-CR-3: Suspend Construction Work if a Paleontological Resource is Identified (All Sites except Site 9 and Westlake Pump Station)

If a paleontological resource (fossilized invertebrate, vertebrate, plant or micro-fossil) is discovered during construction at any of the proposed well facility sites, all ground disturbing activities within 50 feet of the find shall be temporarily halted but may be diverted to areas beyond 50 feet from the discovery to continue working. An appointed representative of the SFPUC shall notify a qualified paleontologist, who will document the discovery as needed, evaluate the potential resource, and assess the nature and significance of the find. Based on the scientific value or uniqueness of the find, the paleontologist may record the find and allow work to continue, or recommend salvage and recovery of the material, if the SFPUC determines that the find cannot be avoided. The paleontologist shall make recommendations for any necessary treatment that is consistent with the SVP 2012 Guidelines (SVP 2012a) and currently accepted scientific practices. If required, treatment for fossil remains may include preparation and recovery of fossil materials so that they can be housed in an appropriate museum or university collection and may also include preparation and publication of a report describing the find. The paleontologist's recommendations shall be subject to review and approval by the ERO or designee. The SFPUC shall be responsible for ensuring that treatment is implemented and reported to the San Francisco Planning Department. If no report is required, the SFPUC shall nonetheless ensure that information on the nature, location and depth of all finds is readily available to the scientific community through university curation or other appropriate means.

Impact Conclusion: Less than Significant with Mitigation

Impact CR-4: Project construction could result in a substantial adverse effect related to the disturbance of human remains. (Less than Significant with Mitigation)

The evaluation that follows discusses sites with no impacts first, followed by sites with significant impacts.

Westlake Pump Station

There would be no ground disturbing activities at the Westlake Pump Station and, therefore, there would be *no impact* related to potential disturbance of human remains at this location.

Impact Conclusion: No Impact

Sites 1, 2, 3, 4, 5, 6, 7, 8, 9, 10, 11, 12, 13, 14, 15, 16, 17 (Alternate), 18 (Alternate), and 19 (Alternate)

No evidence of human remains was identified on the surface within any of the archaeological C-APEs and, given the results of the field surveys and EASs, including a ground-penetrating radar (GPR) survey of the C-APEs at Sites 14 and 15 described in Section 5.5.1.5 (Archaeological Methods, Survey and Results), it is unlikely that undiscovered human remains are present below the ground surface within the C-APEs. However, the potential for their presence cannot be entirely ruled out. Construction-related excavation and grading could expose and disturb or damage any previously undiscovered human

remains. Therefore, the impact related to the potential disturbance of human remains during construction could be *significant*. However, Mitigation Measure M-CR-4 (Accidental Discovery of Human Remains) would be implemented during Project construction to minimize potential impacts on any buried human remains and associated or unassociated funerary objects that may be accidentally discovered during Project construction activities to *less-than-significant* levels by requiring the SFPUC to adhere to appropriate excavation, removal, recordation, analysis, custodianship, and final disposition protocols. Therefore, this potential impact on buried human remains would be *less than significant with mitigation*.

Mitigation Measure M-CR-4: Accidental Discovery of Human Remains (All Sites except Westlake Pump Station)

The treatment of any human remains and associated or unassociated funerary objects discovered during soil-disturbing activities shall comply with applicable State laws. Such treatment would include immediate notification of the San Mateo County Coroner and, in the event of the coroner's determination that the human remains are Native American, notification of the NAHC, which would appoint a Most Likely Descendant (MLD) (PRC Section 5097.98). A qualified archaeologist, the SFPUC and MLD shall make all reasonable efforts to develop an agreement for the treatment, with appropriate dignity, of any human remains and associated or unassociated funerary objects (CEQA Guidelines Section 15064.5[d]). The agreement would take into consideration the appropriate excavation, removal, recordation, analysis, custodianship, and final disposition of the human remains and associated or unassociated funerary objects. The PRC allows 48 hours to reach agreement on these matters. If the MLD and the other parties could not agree on the reburial method, the SFPUC shall follow Section 5097.98(b) of the PRC, which states that "the landowner or his or her authorized representative shall reinter the human remains and items associated with Native American burials with appropriate dignity on the property in a location not subject to further subsurface disturbance." All archaeological work performed under this mitigation measure shall be subject to review by the ERO or designee.

Impact Conclusion: Less than Significant with Mitigation

5.5.4 Operational Impacts and Mitigation Measures

Impact CR-5: Project facilities could cause an adverse change in the significance of a historical resource. (Less than Significant with Mitigation)

The evaluation that follows discusses sites with no impacts first, followed by sites with less-than-significant impacts and sites with significant impacts.

Sites 1, 2, 3, 4, 5, 6, 8, 9, 10, 11, 12, 13, 16, 17 (Alternate), 18 (Alternate), 19 (Alternate), and the Westlake Pump Station

As noted in Section 5.5.1.5 (Archaeological Methods, Surveys and Results), there are no known historical resources at or near these sites and, therefore, there would be *no impact*.

Impact Conclusion: No Impact

Site 7

The Gatehouse Entry at Woodlawn Memorial Park has been determined to be eligible for listing in the National Register and is, therefore, also eligible for listing in the California Register and considered a historical resource for the purposes of CEQA evaluation. In addition, if a Colma Cemetery Historic District is established, Woodlawn Memorial Park may be eligible for the California Register and National Register as a contributor to the District for its role in the interrelated histories of the City of San Francisco and Town of Colma and the discrete theme of cemeteries in the Town of Colma.

The Woodlawn Memorial Park Gatehouse Entry building is located approximately 500 feet to the north of the proposed well facility at Site 7. As noted above, the Woodlawn Gatehouse Entry was determined by the Town of Colma to be eligible for listing in the National Register under Criterion C, as it embodies the distinctive characteristics of an architectural type and method of construction. However, the well facility at Site 7 would not disturb, alter, or destroy the Woodlawn Gatehouse Entry. In addition, the well facility at Site 7 would not affect the Gatehouse Entryway setting in a manner that would cause an adverse change in the significance of this historical resource because of the small scale of the proposed aboveground facilities, the distance of the facilities from the Gatehouse Entryway (500 feet), and the presence of intervening trees, which would serve to block views of the facilities from the Gate Entryway. In addition, because of the small-scale of the aboveground facilities, the siting of facilities at Site 7 would not cause an adverse change in the significance of the cemetery's landscape, or the landscape of the adjacent Greenlawn Memorial Park, or that of the Greek Orthodox Memorial Park, which also appear to be contributors to a potential Colma cemetery district. Therefore, the potential impact on historical resources from the well facility siting at Site 7 would be *less than significant*.

Impact Conclusion: Less than Significant

Sites 14 and 15

Sites 14 and 15 are located within the GGNC, which is eligible for the National Register of Historic Places as a historic district and is therefore considered a historical resource.

Site 14

Site 14 would be located within the SFPUC's easement near the northern property line of the GGNC. The easement is approximately 60 feet wide where the proposed well facility would be located. The structure enclosing the proposed well varies in height from 6.5 feet to eight feet and is approximately 35 feet long by 20 feet wide. Rows of headstones, approximately two feet in height, are located to the east and west. The Project also includes the removal of a portion of the existing lawn and replacement with grass pavers. The area would be reseeded after installation of the pavers. GGNC is eligible for listing in the National Register under Criterion A for its association with the expansion of the National Cemetery System during the inter-war period. The status of the GGNC as a historical resource under CEQA would be affected by any adverse alteration of a portion of the cemetery and its immediate surroundings, given the conclusion in the eligibility documents that all components of the cemetery are contributing elements and, therefore, the impact would be *significant*. The visual impact on the landscape of an eight- to 10-foot high rectangular structure, placed in the center of an open area, would be imposing when seen next to the two

foot-high headstones. In this location, the headstones define the physical characteristic associated with the setting, feeling, and association of the historical resource. The removal of the existing well structure would alter the immediate setting and result in the loss of a contributing element to the site. This resource is a utilitarian structure whose contribution to the GGNC as a whole is minor; however it is still considered a contributing resource. A potential adverse change to this physical characteristic could materially impair the historical resource.

In addition to the well structure, the proposed Project at Site 14 includes removal of a portion of the existing lawn and its replacement with grass pavers. Natural grass is the predominant ground surface material throughout the cemetery. The use of another material, not already part of the designed roads and other hard surfaced areas, such as the Flag Pole Circle, could materially alter the character defining feature associated with the historical resource because it would be out of character with the setting, materials, and feeling. In addition to the proposed surface material, the area to be affected would be highly visible extending approximately 140 feet (by about 12 feet wide) from the roadway to the proposed well structure thereby upsetting the uniformity of the grass surface, which is uninterrupted from the eastern boundary of the cemetery at El Camino Real to a road to the west; approximately 2,085 feet and 1,260 feet, respectively. This impact would be *significant*. However, Mitigation Measure M-CR-5a (Minimize Facilities Siting Impacts on Elements of the Historical Resource at Site 14) would minimize impacts by screening the new structure, decreasing its prominence on the existing landscape among the headstones, and allow for a design compatible with the overall site. This mitigation measure would further lessen the impacts on the setting, feeling, and association of the historical resource to *less-than-significant* levels by implementing measures to decrease the prominence of Project elements on the landscape. The documentation of the existing pump structure would record this contributing element before it is demolished. Recordation of the contributing element is necessary as this documentation would identify the character of this area of the cemetery prior to demolition. Therefore, this impact would be *less than significant with mitigation*.

Mitigation Measure M-CR-5a: Minimize Facilities Siting Impacts on Elements of the Historical Resource at Site 14

The SFPUC shall implement the following measures to minimize impacts on Site 14:

- The proposed well facility structure shall be located as close to the northern fence as feasible taking into consideration the need of the VA for vehicle access along this fence line. The SFPUC shall confirm with the VA the minimum width of the required access. The SFPUC shall construct a well facility building or a fenced enclosure to house the well and well appurtenances as discussed below:
- If the SFPUC constructs a building to house the well and well appurtenances, the proposed facility building shall be constructed at a height of no more than eight feet. Landscaping shall be planted around the new building to act as a screen, lessening the visual intrusion. Cladding materials for the proposed facility building shall be compatible with those existing on the site and the adjacent maintenance structures (i.e., stucco walls and clay tile hipped roofs). The design of the well facility, including the proposed screening plantings, shall meet any applicable VA planting guidance, and prior

to construction shall be reviewed and approved by appropriate VA officials and a historical architect meeting the Secretary of the Interior's Professional Qualification Standards. The proposed building and associated outside areas shall be constructed in compliance with the Secretary of the Interior's Standards for Rehabilitation and be compatible with the existing maintenance buildings in the use of materials with minimal detailing.

- If the SFPUC constructs a wall around the well and well appurtenances, the wall shall be constructed at a height of no more than eight feet. Landscaping shall be planted around the new fence to act as a screen, lessening the visual intrusion. The design of the well facility, including the proposed screening plantings, shall be reviewed and approved by appropriate VA officials and a historical architect meeting the Secretary of the Interior's Professional Qualification Standards and any applicable VA planting guidance, prior to construction. The proposed fence and associated planted areas shall be constructed in compliance with the *Secretary of the Interior's Standards for Rehabilitation* and be compatible with the existing maintenance buildings in the use of materials with minimal detailing.
- The SFPUC shall lay plywood or other material down temporarily for access between the cemetery access road and construction area during construction, unless the type and use of grass pavers proposed are determined by SHPO to be compatible with the historical resource.
- The existing pump structure and ancillary equipment shall be documented prior to its demolition. The documentation shall follow the Historic American Buildings Survey guidelines. Although a contributing resource, this resource is a utilitarian structure whose contribution to the GGNC as a whole is minor. Therefore, the level of documentation of this resource (Level 1, Level II, Level III, or Level IV) shall be determined by VA officials and an architectural historian meeting the Secretary of the Interior's Professional Qualification Standards.

Site 15

Site 15 would be located near the southern property line of the cemetery between the maintenance yard and Sneath Lane. The area is approximately 40 feet wide where the proposed well facility structure would be located. The proposed well building footprint is approximately 2,095 square feet with an additional 455 square feet of paving for parking next to the cemetery's entry gate and maintenance yard. The GGNC is eligible for listing in the National Register under Criterion A for its "association with the expansion of the National Cemetery System during the inter-war period." The significance of this historical resource could be materially impaired by the Project through physical alteration of a portion of the resource and/or its immediate surroundings.

The visual impact of the structure on the landscape near the secondary entry would be noticeable as the preliminary design for the new building differs greatly from the existing structures and would be out of character with its setting, design, materials and feeling (this can be seen in Figure 5.3-13 [Visual Simulation of Site 15]). These are four of the seven aspects of a historical resource's integrity the others

are location, workmanship, and association. In addition, the proposed well facility would affect two contributing elements of the historical resource: the 1952 maintenance complex and the 1941 entry gate. The location of the proposed well facility would be only several feet away from the historic building. This would have an adverse effect on the historic building to the north of the proposed structure, as the new building would almost completely block the entire south elevation of the historic structure.

The building design could result in a building that is not visually integrated with the surrounding structures and landscape. Further, the type of selected cladding materials, color, roofline, overall volume, and fenestration, could result in the building being incompatible with the surrounding structures. This potential impact would be *significant*. The proposed well building at Site 15 also is a visual intrusion at the cemetery's secondary entrance (see visual simulation of proposed Project presented in Figure 5.3-13 [Visual Simulation of Site 15]). The existing relationship between the maintenance buildings and entry gate would be disturbed. Currently the maintenance buildings are set back approximately 50 feet or more from Sneath Lane. The gate is located closer to the street, within 20 feet of Sneath Lane. Grass, trees, and other ornamental plantings are located in the space between the building and street. Forty linear feet of wrought-iron fence is located immediately next to the entry gate with chain link fencing beginning where the wrought-iron ends. The footprint of the proposed new building would be almost in line with the entry gate, thereby eliminating the plantings and separation of the cemetery facilities from the street. The proximity of the proposed structure also would diminish the importance of the gate. The fence is transparent, but the proposed building would be a solid mass obscuring the historic maintenance building from view. The VA has a potential future project to replace the existing fencing with wrought-iron fencing (VA 2011); however the construction schedule for their project is unknown. The potential impact would, therefore, be *significant*.

The proposed paved parking area would abut the entry gate, a contributing element of the historical resource. This impact would be *significant* because the setting and feeling of the entry gate would be altered.

However, Mitigation Measures M-CR-5b (Minimize Facilities Siting Impacts on Elements of the Historical Resource at Site 15) would minimize potential impacts on the setting, feeling, and association of the elements of the historical resource at Site 15 to *less-than-significant* levels by implementing measures to relocate or redesign Project facilities at the site to be in accordance with the *Secretary of the Interior's Standards for Rehabilitation*. "Generally, a project that follows [...] the Secretary of the Interior's Standards for Rehabilitation and Guidelines for Rehabilitating Historic Buildings (1995), Weeks and Grimmer, shall be considered as mitigated to a level of less than a significant impact on the historical resource." (CEQA Guidelines Section 15064.5 [b][3]). Therefore, this impact would be *less than significant with mitigation*.

Mitigation Measure M-CR-5b: Minimize Facilities Siting Impacts on Elements of the Historical Resource at Site 15

The SFPUC shall implement the following measures to minimize impacts on elements of the historical resource at Site 15:

- The proposed facility building and associated outside areas shall be constructed in compliance with the *Secretary of the Interior's Standards for Rehabilitation* and be compatible with the existing maintenance buildings in the use of materials with minimal detailing.
- The size and scale of the proposed facility building shall be smaller than that of the existing structure, so as not to overwhelm the existing maintenance building.
 - The height shall be below the eave of the adjacent maintenance building. The height of the new 8-foot high concrete wall with stucco finish, perpendicular to the existing building wall, shall be kept below the adjacent maintenance building's window sills.
 - The length shall be kept to the minimum and the building located farther to the east; the east elevation would align with the east elevation of the maintenance building.
 - The western elevation of the new building shall be set back (to the east) from the face of the western elevation of the existing building by at least 10 feet.
 - The fence line along Sneath Lane shall be maintained and shall not wrap around the new building; it is acceptable for the building to break the fence line.
- The proposed facility building shall be separated from the existing building by a minimum of approximately eight feet (the width of the planting area south of the existing maintenance building), to maintain the relationship of the historic maintenance buildings with the entry gates.
- Cladding materials for the proposed facility building shall be compatible with those existing on the site and the adjacent maintenance structures (i.e., stucco walls and clay tile hipped roofs).
- Paved parking shall be kept to the minimum necessary and shall not be within 10 feet of the entry gate.
- Wrought iron, or equivalent, fencing shall replace the existing chain link fencing.
- A landscaping plan shall be developed for the east, south and west elevations and shall reflect the landscaping around nearby structures. The row of existing street trees in front of the maintenance yard fence shall extend to the west to where the wrought iron fence begins. The SFPUC shall work with the VA to develop the landscaping plan.
- The design of the proposed facility, including landscape plantings, shall be reviewed and approved by appropriate VA officials and a historical architect meeting the Secretary of the Interior's Professional Qualification Standards to ensure that proposed structure and associated outside areas are constructed in compliance with the *Secretary of the Interior's Standards for Rehabilitation* and any applicable VA planting guidance, prior to construction.

Impact Conclusion: Less than Significant with Mitigation

5.5.3.5 *Cumulative Impacts and Mitigation Measures*

Impact C-CR-1: Construction of the proposed Project could result in a cumulatively considerable contribution to cumulative impacts on historical, archaeological, or paleontological resources, or human remains. (Less than Significant with Mitigation)

The geographic scope for the analysis of cumulative impacts on cultural resources includes the cultural resources C-APE for the Project (which includes the architectural, archaeological, and paleontological C-APEs) and the immediate vicinity around each of the facility sites. The GSR Project would contribute to cumulative impacts on cultural resources, including historical, archaeological, and paleontological resources, if the GSR Project and other projects listed in Table 5.1-3 (Projects Considered for Cumulative Impacts), were to adversely affect the same cultural resources affected by the Project or would cause impacts on other cultural resources in the Project vicinity. Refer to Figure 5.1-3 (Location of Projects Considered in the Cumulative Analysis) in Section 5.1, Overview, for the location of the cumulative projects.

Historical Resources

One of the cumulative projects listed in Table 5.1-3 (Projects Considered for Cumulative Impacts), the Holy Cross Expansion project (cumulative project E) could cause an adverse change in the significance of a historical resource. As shown in Table 5.5-5 (Historical Architectural Resources in the Record Search Area, but Outside the Architectural C-APE), the Holy Cross Cemetery District is a National Register-eligible district. The Holy Cross Expansion project could have a direct and significant impact on historical resources if the project were to change the character of the cemetery in a way that would compromise its eligibility to be listed in the National Register. However, construction of GSR facilities at Sites 8 and 17, the closest sites to the cemetery, would have no effect on historic resources, so there would be no cumulative impact on the Holy Cross Cemetery District. There are no other cumulative projects with the potential to affect historical resources (*no impact*).

Archaeological Resources and Human Remains

Some of the cumulative projects listed in Table 5.1-3 (Projects Considered for Cumulative Impacts) could result in impacts on previously unrecorded archaeological resources and on human remains that may have been interred outside of a formal cemetery. Cumulative projects in the proposed Project vicinity that would also involve excavation include the "A" Street Well Replacement (cumulative project C), the SFPUC Peninsula Pipelines Seismic Upgrade Project (cumulative project D), the California Water Service Company (Cal Water) Well Replacement SSF-25 (cumulative project G), and the PG&E Upgrade (cumulative project H). These projects could encounter previously unrecorded archaeological resources or human remains, which would be a *potentially significant cumulative* cultural resources impact.

As discussed in Impacts CR-2 and CR-4, construction and excavation associated with the GSR Project would have a *significant* impact related to the potential to encounter previously unrecorded archaeological resources and/or human remains interred outside of a formal cemetery. Therefore, since the GSR Project and other cumulative projects have the potential to adversely impact previously

unrecorded resources and/or human remains, the potential cumulative impact is *significant* and the GSR Project's contribution to this cumulative impact could be cumulatively considerable given that Project's potential to significantly impact such resources that may be present at any of the well facility sites. However, the GSR Project's contribution to cumulative impacts related to the potential to encounter previously unrecorded archaeological resources and/or human remains would be reduced to a less-than-significant level with implementation of Mitigation Measures M-CR-2 (Discovery of Archaeological Resources) and M-CR-4 (Accidental Discovery of Human Remains), as discussed in Impacts CR-2 and CR-4. These measures require the SFPUC to distribute the San Francisco Planning Department's archaeological resource "ALERT" sheet to the Project prime contractor, subcontractors, and/or any utilities involved in soil-disturbing activities within the Project area. If the ERO determines that an archaeological resource may be present within the Project area, the SFPUC is required to retain the services of a qualified archaeological consultant to evaluate the find, make recommendations as to what action, if any, is warranted and submit an archaeological data recovery report to the ERO. With regard to the accidental discovery of human remains, in particular, the San Mateo County Coroner must be immediately notified, and, in the event the coroner determined that the remains were Native American, the NAHC must be notified. Implementation of these measures would effectively avoid significant damage to or loss of any such resources and little to no residual impact would remain after mitigation. With implementation of these mitigation measures, the Project's contribution to this cumulative impact would not be cumulatively considerable (*less than significant with mitigation*).

Paleontological Resources

Some of the cumulative projects listed in Table 5.1-3 (Projects Considered for Cumulative Impacts) could encounter paleontological resources during construction. Cumulative projects in the GSR Project vicinity that would involve excavation in the same geologic units include the "A" Street Well Replacement (cumulative project C), the SFPUC Peninsula Pipelines Seismic Upgrade Project (cumulative project D), the Cal Water Well Replacement SSF-25 (cumulative project G), and the PG&E Upgrade (cumulative project H). These projects could encounter paleontological resources during construction, which would be a *potentially significant cumulative* paleontological resources impact.

As discussed in Impact CR-3, the GSR Project could have a *significant* impact related to the potential to encounter paleontological resources during excavation within the Colma Formation, which has a high paleontological potential. However, the potential for uncovering vertebrate fossils is generally low, and the construction-related excavation for the Project is not extensive (Finger 2009). Therefore, since the GSR Project and other cumulative projects have the potential to impact paleontological resources, the cumulative impact could be *significant* and the GSR Project's contribution to this impact could be cumulatively considerable given that the GSR Project has the potential to impact paleontological resources.

However, the GSR Project's impacts on paleontological resources would be limited to the Project construction areas and would be reduced to a *less-than-significant* level with implementation of Mitigation Measure M-CR-3 (Suspend Construction Work if a Paleontological Resource is Identified), as discussed in Impact CR-3. This measure requires the SFPUC to follow proper procedures in the event that potentially significant resources are unearthed, including the requirement for a paleontologist to assess and salvage

any fossils discovered by the construction crews. Implementation of this mitigation measure would ensure that any paleontological resources encountered during construction would be avoided or recovered and appropriately managed. Therefore, implementation of this measure would effectively minimize to *less-than-significant* levels any damage to, or the potential loss of, significant paleontological resources and little to no residual impact would remain after mitigation. Therefore, with implementation of these mitigation measures, the GSR Project's contribution to this cumulative impact would not be cumulatively considerable (*less than significant with mitigation*).

5.5.4 References

- Archaeological/Historical Consultants. 1994. *Archaeological Reconnaissance of 85 Reiner Street, San Mateo County, California*. Unpublished report on file at the Northwest Information Center, Rohnert Park, California.
- Archeo-Tec. 2011a. *Historic Context and Archaeological Survey Report for the Regional Groundwater Storage and Recovery Project Area, San Mateo County, California*. Prepared for the San Francisco Public Utilities Commission. August.
- Archeo-Tec. 2011b. *San Francisco Public Utilities Commission Regional Groundwater Storage and Recovery Project, Archaeology Survey Plan*. May.
- Baggett, E.T. (ed). 1880. *Pacific Coast Law Journal, Containing all the Decisions of the Supreme Court of California*. Vol. V. Baggett & Co., San Francisco.
- Baker, Suzanne. 1979. *Archaeological Reconnaissance of the Proposed San Andreas Pipeline No. 3, San Mateo County*. Report from Archaeological Consultants, San Francisco, to San Francisco Water Department, San Francisco.
- Baker, Suzanne. 1999a. *BART Construction Archaeological Monitoring, Prehistoric Sites CA-SMa-299*. Letter Report from Archaeological Historical Consultants, Oakland, to CH2M/BART, Millbrae. August 5.
- Baker, Suzanne. 1999b. *BART Construction Archaeological Monitoring, Prehistoric Sites CA-SMa-299*. Letter Report from Archaeological Historical Consultants, Oakland, to CH2M/BART, Millbrae. October 29.
- Bancroft, Hubert Howe. 1886. *History of California*. Vol. I. The History Company, San Francisco.
- Blum, Joseph A. 1984. *South San Francisco: The Making of an Industrial City. California History*. Vol. 63, No. 2. 114-134.
- Bolton, H.E. 1933. *Font's Complete Diary. A Chronicle of the Founding of San Francisco*. University of California Press, Berkeley.
- Brabb, E.E., R.W. Graymer, and D.D. Jones. 1998. *Geology of the onshore part of San Mateo County, California: a digital database. U.S. Geological Survey Open-File Report 98-137*.
- Broadbent, S.M. 1972. *The Rumsen of Monterey: an ethnography from historical sources*. Contributions of the University of California Archaeological Research Facility 14. 45-93.
- Broadmoor Police. 2010. *History of Broadmoor. Welcome to Broadmoor Police*. Website accessed November 16, 2010 at: <http://www.broadmoorpolice.org/history.html>.

- Broughton, J.M. 1997. *Widening Diet Breadth, Declining Foraging Efficiency, and Prehistoric Harvest Pressure: Ichthyofaunal Evidence from the Emeryville Shellmound, California*. *American Antiquity* 71(274). 845-862.
- Broughton, J.M. 1999. *Resource Depression and Intensification during the Late Holocene, San Francisco Bay: Evidence from the Emeryville Shellmound Vertebrate Fauna*. University of California Publications Anthropological Records 32.
- Brown, Kyle, Adam Marlow, James Allan, and William Self. 2003. *Cultural Resource Assessment of Alternative Routes for PG&E's Jefferson-Marin Transmission Line, San Mateo County, California*. Report from William Self Associates, Orinda, to Aspen Environmental Group, San Francisco.
- California Department of Parks and Recreation. 1988. *Five Views: An Ethnic Historic Site Survey for California*. December.
- California Department of Parks and Recreation. 1992. *Points of Historical Interest*. Office of Historic Preservation, Sacramento, California.
- California Office of Historic Preservation (OHP). 1995. *Instructions for Recording Historical Resources*. March.
- OHP. 2011. *California Register and National Register: A Comparison*, Technical Assistance Series 6.
- Carey & Co Inc. 2007. *Baden and San Pedro Valve Lots Improvement Project, Environmental Technical Memorandum, Historical Resources*. Unpublished Report on file with San Francisco Public Utilities Commission. San Francisco, California.
- Carey & Co Inc. 2011a. *Architectural Survey Plan for the Regional Groundwater Storage and Recovery Project, San Mateo County, California*. Prepared for the San Francisco Public Utilities Commission (SFPUC). April.
- Carey & Co Inc. 2011b. *Historic Architectural Resources Technical Report for the Regional Groundwater Storage and Recovery Project, San Mateo County, California*. December.
- Colma Historical Association (CHA). 2007. *The City of Souls, Colma*. Colma Historical Association. Website accessed January 18, 2008 at: <http://colmahistory.org/History.htm>. April 22.
- Colma, Town of. 1999. *Town of Colma General Plan, Historical Resources Element*.
- Crespi, Fra. J. 1927. *Fray Juan Crespi: Missionary Explorer on the Pacific Coast 1769-1774*, H. E. Bolton, ed. and trans. University of California Press, Berkeley.
- Davis, J.T. 1961. *Trade routes and economic exchange among the Indians of California*. Reports of the University of California Archaeological Survey 54. 1-71.
- Dun and Company. 1889. *Dun's Mercantile Agency Reference Book*. Dun and Company, New York.
- Dun and Company. 1901. *Dun's Mercantile Agency Reference Book*. Dun and Company, New York.
- Dwinelle, J.W. 1867. *The Colonial History, City of San Francisco*. Fourth Edition. San Francisco: Towne & Bacon. Reprinted 1978 by Ross Valley Book Co.
- Federal Writers Project 1984. *The WPA Guide to California*. New York: Pantheon Books.

- Finger, Kenneth. 2009. Letter report from Kenneth L. Finger, Consulting Paleontologist to Carol Kielusiak, Winzler & Kelly, regarding Paleontological Records Search for SFPUC Groundwater Conjunctive Use Project (Groundwater Project C). San Mateo County, California. April 6.
- Font, Pedro. 1930. *Font's Complete Diary of the second Anza expedition*. In H. Bolton, editor, *Anza's California expeditions*. Vol. 4. University of California Press, Berkeley.
- Foster, Richard H., Jr. 1980. *Wartime Trailer Housing in the San Francisco Bay Area*. *Geographical Review*. Vol. 70, No. 3. 276-290. July.
- Fredericks, Darold. 2009. *Uncle Tom's Cabin in San Bruno*. *San Mateo Daily Journal*. Website accessed April 15, 2011 at: www.smdailyjournal.com. November 16.
- Gifford, Edward W. 1955. *Central Miwok Ceremonies*. University of California Publications in American Archaeology 1 (1).
- Gillespie, Bunny. 2008. *Images of America: Westlake*. San Francisco: Arcadia Publishing.
- Gillespie, Ken and Bunny Gillespie. 2011. *Overview*. *History of Daly City, California*. Daly City Library. Website accessed April 14, 2011 at: <http://www.dalycityhistory.org/overview.htm>.
- Greengo, R.E. 1951. *Molluscan species in California shell middens*. *Reports of the University of California Archaeological Survey* 13. 1-29.
- Greengo, R.E. 1952. *Shellfish foods of the California Indians*. *Kroeber Anthropological Society Papers* 7:63:114.
- Greengo, R.E. 1975. *Shellfish*. In W. J. Wallace and D. W. Lathrap, *West Berkeley (CA-Ala-307): A culturally stratified shellmound on the east shore of San Francisco Bay*. Contributions of the Archaeological Research Facility 29.
- Gudde, Erwin, G. 1969. *California Place Names: The Origin and Etymology of Current Geographical Names*. University of California Press, Berkeley.
- Hackel, Steven W. 1998. *Land, Labor, and Production: The Colonial Economy of Spanish and Mexican California*. In *Contested Eden, California Before the Gold Rush*, edited by Ramón A. Gutiérrez and Richard J. Orsi. University of California Press, Berkeley. 111-46.
- Harrington, J.P. 1921. *Report of Fieldwork*. U.S. Bureau of American Ethnology Annual Report for the Years 1931-1932. 3.
- Harrington, J.P. 1933. *Report of Fieldwork*. U.S. Bureau of American Ethnology Annual Report for the Years 1931-1932. 3.
- Heizer, R.F. 1978. *Trade and Trails*. In R.F. Heizer (Ed.), *California*, 690-693. W.C. Sturtevant (Gen. Ed.), *Handbook of North American Indians* 8. Smithsonian Institution, Washington, D.C.
- Heizer, R.F. and A.E. Treganza. 1972. *Mines and quarries of the Indians of California*. Ballena Press. Ramona, California.
- Heizer, R.F. and W.C. Massey. 1951. *Aboriginal navigation off the coasts of upper and Baja California*. *Anthropological Papers* 39, Bureau of American Ethnology Bulletin 151. 285-312.

- Hendry, George W. and J.N. Bowman. 1940. *The Spanish and Mexican Adobe and Other Buildings in the Nine San Francisco Bay Counties, 1776 to about 1850*. University of California, Berkeley. Unpublished manuscript, University of California, Berkeley, Berkeley. Bancroft Library, Berkeley.
- Hillyer, Curtis J. 1906. *Reports of Cases Determined in the Supreme Court of the State of California*. Vol. 21. Bancroft-Whitney Company, San Francisco. Website accessed August 27, 2009 at: <http://books.google.com/books?id=e4s7AAAAIAAJ>.
- Hittell, Theodore H. 1897. *History of California*. Vol. I. N.J. Stone & Co., San Francisco.
- Hoover, M. B., H.E. Rensch, and W.N. Abeloe. 1990. *Historic Spots of California*. Revised by Douglas E. Kyle, 5th ed. Stanford University Press, Stanford California.
- ICF International. 2011. Draft Extended Survey Letter Report, San Francisco Public Utilities Commission Regional Groundwater Storage and Recovery Project – Well 11, San Mateo County, California. Report to San Francisco Public Utilities Commission (SFPUC), from ICF International, San Francisco.
- Igler, David. 2001. *Industrial Cowboys: Miller & Lux and the Transformation of the Far West, 1850-1920*. University of California Press.
- Jones, T. L. and K. A. Klar 2007. *California Prehistory: Colonization, Culture, and Complexity*. AltaMira Press.
- Kroeber, A.L. 1925. *Handbook of the Indians of California*. Smithsonian Institution, Bureau of American Ethnology Bulletin 78. Reprint 1976; Dover Publications, New York.
- Lajoie, K.R. 1986. *Coastal Tectonics*. In *Active Tectonics: Impact on Society*. The National Academies Press, Washington, D.C. 95-124.
- Levy, R. 1978. *Costanoan*. In R.F. Heizer, vol. ed., *Handbook of North American Indians vol. 8: California*. Smithsonian Institution, Washington, D.C. 485-495.
- Mason, J.A. 1916. *The Mutsun dialect of Costanoan based on the vocabulary of de la Cresta*. University of California Publications in American Archaeology and Ethnology 11(7). 399-472.
- Mendell, G.H. 1877. *Report on the Various Projects for the Water Supply of San Francisco, Cal*. Spaulding & Barto, San Francisco. Website accessed August 27, 2009 at: <http://books.google.com/books?id=jZdBAAAAIAAJ>.
- Millbrae, City of. 2011. *History of the City. Millbrae*. Website accessed April 15, 2011 at: <http://www.ci.millbrae.ca.us/index.aspx?page=36>.
- Millbrae Historical Society. 2007. *Images of America: Millbrae*. San Francisco: Arcadia Press.
- Milliken, R. 1995. *A Time of Little Choice: The Disintegration of Tribal Culture in the San Francisco Bay Area, 1769- 1810*. Anthropological Papers No. 43. Ballena Press, Menlo Park, California.
- Moratto, M. 1984. *California Archaeology*. Academic Press, New York.
- Nelson, N.C. 1909. *Shellmounds of the San Francisco Bay Region*. University of California Publications in American Archaeology and Ethnology 7(4). 310-357.
- Nelson, N.C. 1910. *Manuscript #11, Pertaining to Archaeological Investigations at CA-SFR-7, the Crocker Site*. Unpublished data on file at the Archaeological Research Facility, University of California at Berkeley.

- Pastron, A.G. and R.D. Ambro. 2005. *The Prehistoric Archaeology of the Westfield San Francisco Centre Project at 835 Market Street, San Francisco, California, and Incidentally, an Expansion of the Boundaries of the site CA-SFR-113*. Unpublished manuscript on file at the Office of Environmental Review, Department of City Planning, City and County of San Francisco.
- Pilas-Treadway, Debbie. 2009. Letter from Debbie Pilas-Treadway, Native American Heritage Commission, to Diana Sokolove, San Francisco Planning Department, regarding Proposed Groundwater Conjunctive Use Project, San Mateo County. September 14.
- Rice, Carolyn. 1994a. *BART-San Francisco Airport Extension Project Draft Environmental Impact Report/Supplemental Draft Environmental Impact Statement: Archaeological Survey Report*. Report from Carolyn Rice, Berkeley, to BART/SamTrans and Ogden Environmental and Energy Services Company.
- Rice, Carolyn 1994b. *BART-San Francisco Airport Extension Project Draft Environmental Impact Report/Supplemental Draft Environmental Impact Statement: Archaeological Resources Technical Report*. Report from Carolyn Rice, Berkeley, to BART/SamTrans and Ogden Environmental and Energy Services Company.
- Rodda, P.U. and N.L. Baghai. 1993. *Late Pleistocene Vertebrates from Downtown San Francisco, California*. *Journal of Paleontology*, 67(6). 1058-1063.
- Rosenthal, J. and J. Meyer. 2004. *Landscape Evolution and the Archaeological Record: A Geoarchaeological Study of the Southern Santa Clara Valley and Surrounding Region*. Number 14. Center for Archaeological Research at Davis.
- San Bruno, City of. 2011. *History*. Website accessed April 15, 2011 at: http://sanbruno.ca.gov/city_history.html.
- San Francisco Planning Department. 2001. *Peninsula Watershed Management Plan Final Environmental Impact Report*. San Francisco Planning Department File No. 96.222E, State Clearinghouse No. 98082030. January 11.
- San Mateo County. 1986. *General Plan Policies*. November.
- Savage, D.E. 1951. *Late Cenozoic Vertebrates of the San Francisco Bay Region, California*. University of California Department of Geological Sciences, Bulletin 28(10). 215-314.
- Schlocker, J. 1974. *Geology of the San Francisco North Quadrangle, California*. U.S. Geological Survey Professional Paper 782:109.
- Schussler, Herman. 1916. *The Locality of the Broderick-Terry Duel on September 13, 1859*. Printed for the Historic Landmarks Committee of the Native Sons of the Golden West. John Henry Nash, San Francisco. Website accessed August 27, 2009 at: <http://books.google.com/books?id=kyguAAAAYAAJ>.
- Shoup, Lawrence H. and Mark Brack with Nancy Fee and Bruno Giberi. 1994. *BART-San Francisco Airport Extension Project Draft Environmental Impact Report/ Supplemental Draft Environmental Impact Statement: A Historic Resources Evaluation Report of Seven Colma Cemeteries, Colma, California*. Report on file at the Northwest Information Center, Sonoma State University, Rohnert Park, California.

- Society of Vertebrate Paleontology (SVP). 1996. *Conditions of Receivership for Paleontologic Salvage Collections*, *Society of Vertebrate Paleontology News Bulletin*. Vol. 166. 31–323. February.
- SVP. 2012a. *Assessment and Mitigation of Adverse Impacts to Nonrenewable Paleontologic Resources: Standard Guidelines*, *Society of Vertebrate Paleontology News Bulletin*. Vol. 163. 22–27.
- SVP. 2012b. *Policy Statements, Conformable Impact Mitigation Guidelines Committee*. Website accessed at: <http://vertpaleo.org/The-Society/Statements-and-Guidelines/Conformable-Impact-Mitigation-Guidelines-Committee.aspx>.
- Sokolove, Diana. 2009. Letter from Diana Sokolove, San Francisco Planning Department, to MS. Debbie Pilas-Treadway, Native American Heritage Commission, regarding Proposed Groundwater Conjunctive Use Project, San Mateo County. June 3.
- Soulé, F., J.H. Gihon and J. Nisbit. 1855. *The Annals of San Francisco*. Appleton and Company, New York.
- South San Francisco, City of. 2011a. *Life in 1909, Local History Articles*. Website accessed April 14, 2012 at: <http://www.ssf.net/index.aspx?NID=1219>.
- South San Francisco, City of. 2011b. *South San Francisco in the teens, Local History Articles*. Website accessed April 14, 2011 at: <http://www.ssf.net/index.aspx?NID=1220>.
- South San Francisco, City of. 2011c. *South San Francisco in the 1920's, Local History Articles*. Website accessed April 14, 2011 at: <http://www.ssf.net/index.aspx?NID=1221>.
- South San Francisco Historical Society. 2004. *Images of America: South San Francisco*. Arcadia Publishing, San Francisco.
- Stanger, Frank M. 1938. *A California Rancho Under Three Flags: A History of Rancho Buri Buri in San Mateo County*, *California Historical Society Quarterly*. Vol. 17, No. 3. 245-259.
- Tuttle, Charles A. 1882. *Reports of Cases Determined in the Supreme Court of the State of California at the January, April, and July Terms, 1871*. Vol. 41. Sumner Whitney & Co., San Francisco. Website accessed August 27, 2009 at: <http://books.google.com/books?id=BMg3AAAAIAAJ>.
- Uchida, Yoshiko. 1998. *Desert Exile: The Uprooting of a Japanese-American Family*. Seattle: University of Washington Press.
- U.S. Department of the Interior (DOI). 1997. *How to Apply the National Register Criteria for Evaluation*, *National Register Bulletin*, No. 15.
- U.S. Department of Veterans Affairs (VA). n.d. *Draft National Register of Historic Places Multiple Property Submission context statement, Inter-World War National Cemeteries, 1934-1941*.
- U.S. Department of Veterans Affairs (VA). 2011. Personal Communication, Kathleen McCall, July 2011.
- U.S. Department of Veterans Affairs (VA), National Cemetery Administration. 2010. Personal Communication, Sarah Leach, August 18, 2010.
- U.S. National Park Service (NPS). 2011. *National Register Eligibility of National Cemeteries – A Clarification of Policy*. Website accessed August 20, 2012 at: http://www.cem.va.gov/CEM/pdf/Final_Eligibility_Policy-rev2011.pdf.

- Vanderslice, Allison and Karen McNeill. 2011. *Architectural Survey Plan for the Regional Groundwater Storage and Recovery Project, San Mateo County, California*. Prepared by Carey & Co. Inc., San Francisco for Winzler & Kelly. April 1.
- Wallace, W.J. 1978. *Post-Pleistocene Archaeology, 9000-2000 B.C.* In *Handbook of North American Indians Vol. 8: California*, edited by R.F. Heizer. Smithsonian Institution, Washington, D.C. 25-36.
- Wallis, Allan D. 1991. *Wheel Estate: The Rise and Decline of Mobile Homes*. New York, Oxford University Press.
- Young, Daniel L. n.d. *Archaeological Survey Report for Widening Project on 4-SMA-82-20.8/22.1*. Report from Office of Environmental Planning, Department of Transportation.