

File No. 170552 Committee Item No. 2
 Board Item No. _____

COMMITTEE/BOARD OF SUPERVISORS
 AGENDA PACKET CONTENTS LIST

Committee: Land Use and Transportation Committee Date July 24, 2017

Board of Supervisors Meeting Date _____

Cmte Board

- | | | |
|-------------------------------------|--------------------------|--|
| <input type="checkbox"/> | <input type="checkbox"/> | Motion |
| <input type="checkbox"/> | <input type="checkbox"/> | Resolution |
| <input checked="" type="checkbox"/> | <input type="checkbox"/> | Ordinance |
| <input checked="" type="checkbox"/> | <input type="checkbox"/> | Legislative Digest |
| <input type="checkbox"/> | <input type="checkbox"/> | Budget and Legislative Analyst Report |
| <input type="checkbox"/> | <input type="checkbox"/> | Youth Commission Report |
| <input type="checkbox"/> | <input type="checkbox"/> | Introduction Form |
| <input type="checkbox"/> | <input type="checkbox"/> | Department/Agency Cover Letter and/or Report |
| <input type="checkbox"/> | <input type="checkbox"/> | MOU |
| <input type="checkbox"/> | <input type="checkbox"/> | Grant Information Form |
| <input type="checkbox"/> | <input type="checkbox"/> | Grant Budget |
| <input type="checkbox"/> | <input type="checkbox"/> | Subcontract Budget |
| <input type="checkbox"/> | <input type="checkbox"/> | Contract/Agreement |
| <input type="checkbox"/> | <input type="checkbox"/> | Form 126 – Ethics Commission |
| <input type="checkbox"/> | <input type="checkbox"/> | Award Letter |
| <input type="checkbox"/> | <input type="checkbox"/> | Application |
| <input type="checkbox"/> | <input type="checkbox"/> | Public Correspondence |

OTHER (Use back side if additional space is needed)

- | | | |
|-------------------------------------|--------------------------|-----------------------------------|
| <input checked="" type="checkbox"/> | <input type="checkbox"/> | <u>PLN GPR 043015</u> |
| <input checked="" type="checkbox"/> | <input type="checkbox"/> | <u>PW Order 185823</u> |
| <input checked="" type="checkbox"/> | <input type="checkbox"/> | <u>Surveyor Map Part 1 061016</u> |
| <input checked="" type="checkbox"/> | <input type="checkbox"/> | <u>Surveyor Map Part 2 061016</u> |
| <input checked="" type="checkbox"/> | <input type="checkbox"/> | <u>PC Reso No. 17912</u> |
| <input checked="" type="checkbox"/> | <input type="checkbox"/> | <u>FEIR Addendum 062812</u> |
| <input type="checkbox"/> | <input type="checkbox"/> | _____ |
| <input type="checkbox"/> | <input type="checkbox"/> | _____ |
| <input type="checkbox"/> | <input type="checkbox"/> | _____ |
| <input type="checkbox"/> | <input type="checkbox"/> | _____ |
| <input type="checkbox"/> | <input type="checkbox"/> | _____ |
| <input type="checkbox"/> | <input type="checkbox"/> | _____ |

Completed by: Erica Major Date July 19, 2017
 Completed by: _____ Date _____

1 [Amending Ordinance No. 1061 - Sidewalk Width Change - Masonic Avenue at Fulton and
2 Turk Streets]

3 **Ordinance amending Ordinance No. 1061 entitled "Regulating the Width of Sidewalks"**
4 **to reduce the official sidewalk width of certain locations along Masonic Avenue at the**
5 **southwest corner of the intersection of Masonic Avenue and Fulton Street, and the**
6 **northeast corner of the intersection of Masonic Avenue and Turk Street; affirming the**
7 **Planning Department's determination under the California Environmental Quality Act;**
8 **and making findings of consistency with the General Plan, and the eight priority**
9 **policies of Planning Code, Section 101.1.**

10 NOTE: **Unchanged Code text and uncodified text** are in plain Arial font.
11 **Additions to Codes** are in *single-underline italics Times New Roman font*.
12 **Deletions to Codes** are in *strikethrough italics Times New Roman font*.
13 **Board amendment additions** are in double-underlined Arial font.
14 **Board amendment deletions** are in ~~strikethrough Arial font~~.
15 **Asterisks (* * * *)** indicate the omission of unchanged Code
16 subsections or parts of tables.

17 Be it ordained by the People of the City and County of San Francisco:

18 Section 1. Findings.

19 (a) The Planning Department, in a letter dated April 30, 2015, found the actions
20 contemplated in this ordinance consistent with the General Plan and in conformance with the
21 eight priority policies of Planning Code Section 101.1. A copy of said letter is on file with the
22 Clerk of the Board of Supervisors in File No. 170552 and is incorporated herein by reference.
23 The Board of Supervisors adopts as its own the findings in said letter.

24 (b) In the same letter, the Planning Department found that the actions contemplated in
25 this ordinance were evaluated in the San Francisco Bicycle Plan Final Environmental Impact
Report (FEIR), certified by the Planning Commission by Resolution No. 17912 on June 25,

1 2009, and the FEIR Addendum, which was issued by the Planning Department on June 28,
2 2012, except for any related sewer work, which is statutorily exempt from the California
3 Environmental Quality Act (California Public Resources Code Sections 21000 *et seq.*) under
4 Section 15282(k) of the CEQA Guidelines, 14 Cal. Code Regs. Section 15000 *et seq.* The
5 Board of Supervisors hereby affirms these determinations, incorporates them by reference
6 herein, and adopts them as its own.

7 (c) By Ordinance No. 182-13, the Board of Supervisors re-adopted the 2009 San
8 Francisco Bicycle Transportation Plan and in so doing adopted modified environmental
9 findings, including a statement of overriding benefits and a mitigation monitoring and reporting
10 program. Said findings are on file with the Clerk of the Board of Supervisors in File No.
11 130527 and are incorporated herein by reference.

12 (d) The Board has reviewed and considered the FEIR, the FEIR Addendum, and the
13 record as a whole, and finds that the FEIR is adequate for its use as the decisionmaking body
14 for the action taken herein. The FEIR is on file with the Clerk of the Board of Supervisors in
15 File No. 130527, the FEIR Addendum is on file with the Clerk of the Board of Supervisors in
16 File No. 170552, and both are incorporated herein by reference.

17 (e) The Board finds that since the FEIR was finalized, there have been no substantial
18 project changes and no substantial changes in project circumstances that would require major
19 revisions to the FEIR due to the involvement of new significant environmental effects or an
20 increase in the severity of previously identified significant impacts, and there is no new
21 information of substantial importance that would change the conclusions set forth in the FEIR.
22 The Board finds that the FEIR Addendum was properly issued.

23 (e) The Public Works Director issued Public Works' Order No. 185823, dated March
24 31, 2017, including sidewalk width change drawing Q-20-838, regarding the actions in this
25 ordinance. The proposed sidewalk changes are associated with the Masonic Avenue

1 Streetscape Improvement Project with the goal to safely and efficiently accommodate the
2 needs of all roadway users and will provide improvements for pedestrians, bicyclists,
3 motorists and transit riders. A copy of said Order is on file with the Clerk of the Board of
4 Supervisors in File No. 170552, and is incorporated herein by reference.
5

6 Section 2. In accordance with the Department of Public Works' Order No. 185823,
7 dated March 31, 2017, Board of Supervisors Ordinance No.1061, entitled "Regulating the
8 Width of Sidewalks," a copy of which is in the Clerk of the Board of Supervisors Book of
9 General Ordinances, in effect May 11, 1910, is hereby amended by adding thereto a new
10 section to read as follows:
11

12 Section 1608. Changing the official sidewalk width of: a) the southwest corner of the
13 intersection of Masonic Avenue and Fulton Street, and; b) the northeast corner of the intersection of
14 Masonic Avenue and Turk Street, as shown on Public Works drawing Q-20-838, a copy of which is in
15 the Clerk of the Board of Supervisors File No. 170552.
16

17 Section 3. The San Francisco Infrastructure Division - Streets and Highways Section,
18 as is necessary as a result of this ordinance, shall make arrangements with public utility
19 companies and City Departments for the relocation, and/or modification of any affected public
20 facilities. Any necessary relocation, modification, or both of such facilities shall be at no cost to
21 the City.
22

23 Section 4. Effective Date. This ordinance shall become effective 30 days after
24 enactment. Enactment occurs when the Mayor signs the ordinance, the Mayor returns the
25

1 ordinance unsigned or does not sign the ordinance within ten days of receiving it, or the Board
2 of Supervisors overrides the Mayor's veto of the ordinance.

3
4 APPROVED AS TO FORM:
5 DENNIS J. HERRERA, City Attorney

6
7 By:

8 MARLENA BYRNE
9 Deputy City Attorney

10 n:\and\as2017\1700550\01183713.docx

LEGISLATIVE DIGEST

[Amending Ordinance No. 1061 - Sidewalk Width Change - Masonic Avenue at Fulton and Turk Streets]

Ordinance amending Ordinance No. 1061 entitled “Regulating the Width of Sidewalks” to change the official sidewalk width of certain locations along Masonic Avenue at: a) the southwest corner of the intersection of Masonic Avenue and Fulton Street, and; b) the northeast corner of the intersection of Masonic Avenue and Turk Street; affirming the Planning Department’s determination under the California Environmental Quality Act; and making findings of consistency with the General Plan, and the eight priority policies of Planning Code, Section 101.1.

Existing Law

Board of Supervisors’ Ordinance No. 1061 established the official sidewalk widths throughout San Francisco. Ordinance No. 1061 is uncodified, but can be located in the Clerk of the Board of Supervisors Book of General Ordinances, in effect May 11, 1910, which is on file with the Clerk of the Board of Supervisors.

Amendments to Current Law

This legislation would amend Ordinance No. 1061 to change the official sidewalk width of certain locations along Masonic Avenue at the intersections of Masonic Avenue and Fulton Street and Masonic Avenue and Turk Street.

The amendments are proposed to further the Masonic Avenue Streetscape Improvement Project, which includes other improvements including a new landscaped median, new cycle tracks, widened portions of sidewalk, repaving, bus bulb-outs, new street trees and sidewalk planters, new lighting in medians and pedestrian scale lighting on sidewalks, and conversion of a triangular space and road along Masonic Avenue into a small park and resident-traffic-only road, which includes public art.



SAN FRANCISCO PLANNING DEPARTMENT

General Plan Referral

Date: April 30, 2015
Case No. Case No. 2014-000603GPR
DPW Masonic Streetscape Improvement Project

Block/Lot No.: N/A

Project Sponsor: Mike Matsuoka
San Francisco Department of Public Works
30 Van Ness Ave., 5th Floor
San Francisco, CA 94102-6099

Applicant: John Dennis
San Francisco Department of Public Works
30 Van Ness Ave., 5th Floor
San Francisco, CA 94102-6099

Staff Contact: Lisa Chen – (415) 575-9124
lisa.chen@sfgov.org

Recommendation: Finding the project, on balance, is in conformity with the General Plan

*Recommended
By:*

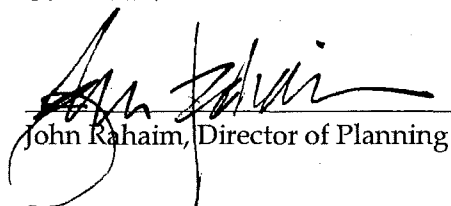
John Rahaim, Director of Planning

1650 Mission St.
Suite 400
San Francisco,
CA 94103-2479

Reception:
415.558.6378

Fax:
415.558.6409

Planning
Information:
415.558.6377

PROJECT DESCRIPTION

The General Plan Referral application was submitted to the Department on October 28, 2014, pursuant to Section 4.105 of the Charter, and Section 2A.53 of the Administrative Code. The proposed project would add transportation improvements to Masonic Avenue between Geary Boulevard and Fell Street north of the Panhandle, including repaving the roadway, constructing a new landscaped median and raised cycle tracks on both sides of Masonic Avenue, widening sidewalks on Masonic Ave (between Geary Blvd and O'Farrell Street on the east side, and between Grove St and Hayes Street on the west side), adding street trees and pedestrian scale lighting, constructing new curb ramps and bulb-outs at intersections, constructing new bus shelters at MUNI platform

loading stops, improving traffic signals, and upgrading irrigation and sewer systems. The project would also enlarge an existing triangular median at the Southwest corner of Geary Boulevard and Masonic Avenue to create a paved public plaza with limited vehicle access. The project preserves the existing number of vehicle travel lanes, and would result in a net loss of 167 parking spaces.

ENVIRONMENTAL REVIEW

The proposed project was evaluated in the San Francisco Bicycle Plan EIR Addendum issued 6/28/12 (Case No. 2011.0935E), except for sewer work, which is statutorily exempt from CEQA under Section 15282(k) of the CEQA Guidelines.

GENERAL PLAN COMPLIANCE AND BASIS FOR RECOMMENDATION

The Project is consistent with the Eight Priority Policies of Planning Code Section 101.1 as described in the body of this letter and is, on balance, **in-conformity** with the following Objectives and Policies of the General Plan:

TRANSPORTATION ELEMENT

OBJECTIVE 1

MEET THE NEEDS OF ALL RESIDENTS AND VISITORS FOR SAFE, CONVENIENT AND INEXPENSIVE TRAVEL WITHIN SAN FRANCISCO AND BETWEEN THE CITY AND OTHER PARTS OF THE REGION WHILE MAINTAINING THE HIGH QUALITY LIVING ENVIRONMENT OF THE BAY AREA.

POLICY 1.2

Ensure the safety and comfort of pedestrians throughout the city.

POLICY 1.3

Give priority to public transit and other alternatives to the private automobile as the means of meeting San Francisco's transportation needs, particularly those of commuters.

POLICY 1.6

Ensure choices among modes of travel and accommodate each mode when and where it is most appropriate.

Comment: The proposed project enhances mode choice and encourages non-automobile travel by improving transportation infrastructure to make it safer and more comfortable to travel by transit, walking, and biking.

OBJECTIVE 2

USE THE TRANSPORTATION SYSTEM AS A MEANS FOR GUIDING DEVELOPMENT AND IMPROVING THE ENVIRONMENT.

POLICY 2.4

Organize the transportation system to reinforce community identity, improve linkages among interrelated activities and provide focus for community activities.

Comment: The proposed project improves community identity while improving pedestrian and bicyclist safety and accessibility. The public plaza, landscaped median, and widened sidewalks beautify the street while improving linkages between community nodes.

OBJECTIVE 14

DEVELOP AND IMPLEMENT A PLAN FOR OPERATIONAL CHANGES AND LAND USE POLICIES THAT WILL MAINTAIN MOBILITY AND SAFETY DESPITE A RISE IN TRAVEL DEMAND THAT COULD OTHERWISE RESULT IN SYSTEM CAPACITY DEFICIENCIES.

POLICY 14.4

Reduce congestion by encouraging alternatives to the single occupant auto through the reservation of right-of-way and enhancement of other facilities dedicated to multiple modes of transportation.

POLICY 14.2

Ensure that traffic signals are timed and phased to emphasize transit, pedestrian, and bicycle traffic as part of a balanced multi-modal transportation system.

POLICY 14.3

Improve transit operation by implementing strategies that facilitate and prioritize transit vehicle movement and loading.

POLICY 14.4

Reduce congestion by encouraging alternatives to the single occupant auto through the reservation of right-of-way and enhancement of other facilities dedicated to multiple modes of transportation.

Comment: The proposed project aims to improve efficiency and safety for all users of Masonic Avenue, by improving transit operations through new loading facilities and improved signal timing, creating dedicated space for bicyclists, and enhancing the pedestrian experience through widened sidewalks, improved street crossings, and street trees and pedestrian scale lighting.

Collectively, these improvements are intended to encourage mode shifts away from single-occupant vehicles to walking, biking, and transit.

OBJECTIVE 15

ENCOURAGE ALTERNATIVES TO THE AUTOMOBILE AND REDUCED TRAFFIC LEVELS ON RESIDENTIAL STREETS THAT SUFFER FROM EXCESSIVE TRAFFIC THROUGH THE MANAGEMENT OF TRANSPORTATION SYSTEMS AND FACILITIES.

POLICY 15.1

Discourage excessive automobile traffic on residential streets by incorporating traffic-calming treatments.

POLICY 15.2

Consider partial closure of certain residential streets to automobile traffic where the nature and level of automobile traffic impairs livability and safety, provided that there is an abundance of alternative routes such that the closure will not create undue congestion on parallel streets.

Comment: The proposed project calms automobile traffic by introducing a landscaped median, safer pedestrian crosswalks and improved signal timing, and a street plaza that diminishes the size of the intersection at Masonic Ave and Geary Blvd. The street plaza will partially close off a section of street except to adjacent building occupants. Transit and vehicle service/capacity will not be compromised as part of these streetscape improvements.

OBJECTIVE 18

ESTABLISH A STREET HIERARCHY SYSTEM IN WHICH THE FUNCTION AND DESIGN OF EACH STREET ARE CONSISTENT WITH THE CHARACTER AND USE OF ADJACENT LAND.

POLICY 18.2

Design streets for a level of traffic that serves, but will not cause a detrimental impact on adjacent land uses, nor eliminate the efficient and safe movement of transit vehicles and bicycles.

Comment: The proposed project preserves the existing number of vehicle lanes, while introducing improvements to improve safety and comfort of all users without compromising transit and vehicle service/capacity.

OBJECTIVE 21

DEVELOP TRANSIT AS THE PRIMARY MODE OF TRAVEL TO AND FROM DOWNTOWN AND ALL MAJOR ACTIVITY CENTERS WITHIN THE REGION.

POLICY 21.9

Improve pedestrian and bicycle access to transit facilities.

Comment: Transit facilities are well-integrated into the proposed street design, and overall the project would improve safety and comfort for pedestrians and bicyclists traveling to transit.

OBJECTIVE 23

IMPROVE THE CITY'S PEDESTRIAN CIRCULATION SYSTEM TO PROVIDE FOR EFFICIENT, PLEASANT, AND SAFE MOVEMENT.

POLICY 23.2

Widen sidewalks where intensive commercial, recreational, or institutional activity is present, sidewalks are congested, where sidewalks are less than adequately wide to provide appropriate pedestrian amenities, or where residential densities are high.

POLICY 23.9

Implement the provisions of the Americans with Disabilities Act and the city's curb ramp program to improve pedestrian access for all people.

Comment: The proposed project would widen sidewalks at key commercial and institutional nodes. The project also enhances access for disabled populations through improved pedestrian crossings and sidewalks.

OBJECTIVE 24

IMPROVE THE AMBIENCE OF THE PEDESTRIAN ENVIRONMENT.

POLICY 24.2

Maintain and expand the planting of street trees and the infrastructure to support them.

Comment: The proposed project would introduce street trees and landscaping along the full length of the project area.

OBJECTIVE 26

CONSIDER THE SIDEWALK AREA AS AN IMPORTANT ELEMENT IN THE CITYWIDE OPEN SPACE SYSTEM.

POLICY 26.2

Partially or wholly close certain streets not required as traffic carriers for pedestrian use or open space.

Comment: The project would introduce a street plaza at Masonic Ave and Geary Blvd that closes off a section of street except to adjacent building occupants. Transit and vehicle service/capacity will not be compromised as part of these streetscape improvements.

OBJECTIVE 27

ENSURE THAT BICYCLES CAN BE USED SAFELY AND CONVENIENTLY AS A PRIMARY MEANS OF TRANSPORTATION, AS WELL AS FOR RECREATIONAL PURPOSES.

POLICY 27.1

Expand and improve access for bicycles on city streets and develop a well-marked, comprehensive system of bike routes in San Francisco.

POLICY 27.3

Remove conflicts to bicyclists on all city streets.

POLICY 27.6

Accommodate bicycles on local and regional transit facilities and important regional transportation links wherever and whenever feasible.

Comment: Dedicated cycle tracks will reduce conflicts with vehicles and pedestrians, and enhance access to transit facilities and to bicycle routes elsewhere in the City.

RECREATION AND OPEN SPACE ELEMENT

OBJECTIVE 3

IMPROVE ACCESS AND CONNECTIVITY TO OPEN SPACE

POLICY 3.1

Creatively develop existing publicly-owned right-of-ways and streets into open space.

POLICY 3.4

Encourage non-auto modes of transportation – transit, bicycle and pedestrian access – to and from open spaces while reducing automobile traffic and parking in public open spaces.

Comment: The introduction of cycle tracks, sidewalks, and transit stops will encourage use of non-auto modes of transportation and strengthen these connections to open spaces, including the Panhandle. Also, the creation of a street plaza will creatively use excess right-of-way to improve access to public open space.

POLICY 3.5

Ensure that, where feasible, recreational facilities and open spaces are physically accessible, especially for those with limited mobility.

Comment: The project will provide sidewalk facilities and transit stops that will be accessible to people with limited mobility and will include curb ramps, bulb outs, marked crossings, and other improvements that facilitate the use of these facilities.

POLICY 3.6

Maintain, restore, expand and fund the urban forest.

Comment: The project proposes additional street trees and landscaping, which would increase the city's urban forest and provide habitat for local fauna.

OBJECTIVE 4

PROTECT AND ENHANCE THE BIODIVERSITY, HABITAT VALUE, AND ECOLOGICAL INTEGRITY OF OPEN SPACES AND ENCOURAGE SUSTAINABLE PRACTICES IN THE DESIGN AND MANAGEMENT OF OUR OPEN SPACE SYSTEM

POLICY 4.1

Preserve, protect and restore local biodiversity.

Comment: Native vegetation will provide expanded habitat for local fauna. Expansion into habitat outside of the existing right-of-way is not proposed.

URBAN DESIGN ELEMENT

OBJECTIVE 1

EMPHASIS OF THE CHARACTERISTIC PATTERN WHICH GIVES TO THE CITY AND ITS NEIGHBORHOODS AN IMAGE, A SENSE OF PURPOSE, AND A MEANS OF ORIENTATION.

POLICY 1.4

Protect and promote large-scale landscaping and open space that define districts and topography.

POLICY 1.5

Emphasize the special nature of each district through distinctive landscaping and other features.

POLICY 1.6

Make centers of activity more prominent through design of street features and by other means.

Comment: The project will enhance and define the character of the neighborhood through a consistent typology of street improvements and a planting palette for street trees and landscaping,

POLICY 1.10

Indicate the purposes of streets by adopting and implementing the Better Streets Plan, which identifies a hierarchy of street types and appropriate streetscape elements for each street type.

POLICY 1.12

Indicate the purposes of streets by means of a citywide plan for street lighting.

Comment: The project will provide a calm, spacious street environment for street users, consistent with its Boulevard street type designation. It will include the installation of new pedestrian scale lighting consistent with what is recommended by the Better Streets Plan.

OBJECTIVE 4

IMPROVEMENT OF THE NEIGHBORHOOD ENVIRONMENT TO INCREASE PERSONAL SAFETY, COMFORT, PRIDE AND OPPORTUNITY

POLICY 4.3

Provide adequate lighting in public areas.

POLICY 4.4

Design walkways and parking facilities to minimize danger to pedestrians.

POLICY 4.8

Provide convenient access to a variety of recreation opportunities.

Comment: The project will improve lighting along streets and open spaces, reduce pedestrian safety hazards, and provide greater mode choice and connection to recreational opportunities.

POLICY 4.12

Install, promote and maintain landscaping in public and private areas.

Comment: As part of the streetscape improvements, additional native landscaping will be provided within the public right-of-way.

PROPOSITION M FINDINGS – PLANNING CODE SECTION 101.1

Planning Code Section 101.1 establishes Eight Priority Policies and requires review of discretionary approvals and permits for consistency with said policies. The proposed project, Mansell streetscape improvements, is found to be consistent with the Eight Priority Policies as set forth in Planning Code Section 101.1 for the following reasons:

1. That existing neighborhood-serving retail uses be preserved and enhanced and future opportunities for resident employment in and ownership of such businesses enhanced.

The proposed project would have no adverse effect on neighborhood serving-retail uses or opportunities for employment in or ownership of such businesses.

2. That existing housing and neighborhood character be conserved and protected in order to preserve the cultural and economic diversity of our neighborhoods.

The proposed project would have no adverse effect on the City's housing stock or on neighborhood character.

3. That the City's supply of affordable housing be preserved and enhanced.

The proposed project would have no adverse effect on the City's supply of affordable housing.

-
- ~~4. That commuter traffic not impede MUNI transit service or overburden our streets or neighborhood parking.~~

The proposed project would not result in commuter traffic impeding MUNI's transit service or overburdening the streets or neighborhood parking. MTA has determined that the existing supply of on-street parking exceeds demand, and that the potential change in roadway level of service due to the reduction of roadway width is acceptable.

5. That a diverse economic base be maintained by protecting our industrial and service sectors from displacement due to commercial office development, and that future opportunities for residential employment and ownership in these sectors be enhanced.

The Project would not adversely affect the existing economic base in this area, displace industrial or service uses, or impede future opportunities for residential employment and ownership in these sectors.

6. That the City achieve the greatest possible preparedness to protect against injury and loss of life in an earthquake.

The proposed project would have no adverse effect on the City's earthquake preparedness.

7. That landmarks and historic buildings be preserved.

The proposed project would have no adverse effect on the City's historic buildings.

8. That our parks and open space and their access to sunlight and vistas be protected from development.

The proposed project would have no adverse effect on the City's sunlight access in parks and open space or on vistas.

RECOMMENDATION:

Finding the Project, on balance, in-conformity with the General Plan

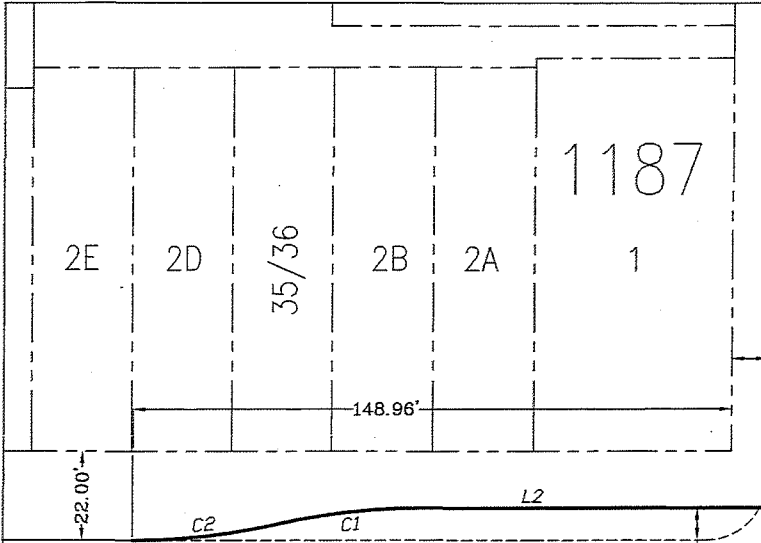

FULTON STREET
(68.75' WIDE)

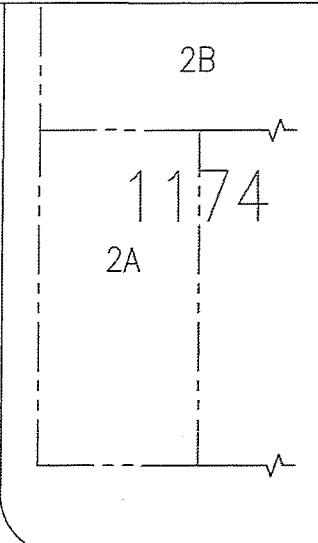

Line Table	
Line #	Length
L1	6.97
L2	58.33

Curve Table			
Curve #	Length	Radius	Delta
C1	36.52	166.00	12°36'12"
C2	36.52	166.00	12°36'12"

8.00'

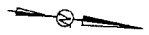

MASONIC AVE
(100' WIDE)

- LEGEND**
- NEW CURB LINE
 - PROPERTY LINE
 - EXISTING OFFICIAL CURB TO REMAIN
 - EXISTING OFFICIAL CURB TO BE REMOVED

REFERENCES:
GM 040

GRAPHIC SCALE

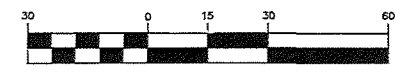

(IN FEET)
1 inch = 30 ft.

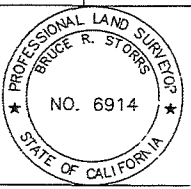
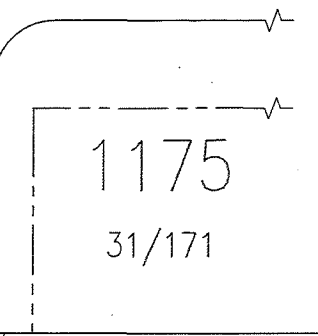
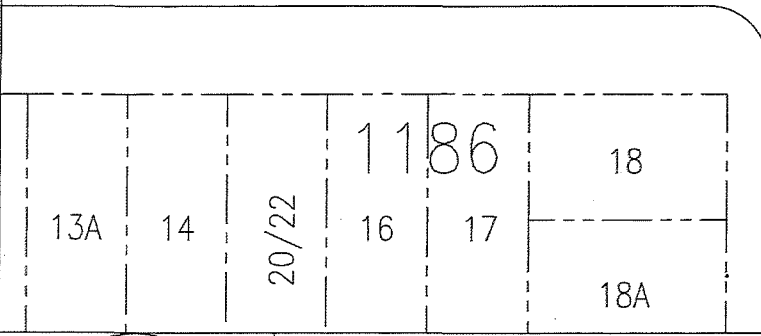

APPROVED:
Bruce R. Storrs
BRUCE R. STORRS
CITY & COUNTY SURVEYOR

6/10/16
DATE

CITY AND COUNTY OF SAN FRANCISCO
DEPARTMENT OF PUBLIC WORKS

OFFICIAL SIDEWALK CHANGE OF THE SOUTHWESTERLY CORNER OF THE INTERSECTION OF
MASONIC AVE. AND FULTON ST., FRONTING AB 1187 LOTS 001, 02A, 02B, 035/036 & 02D

FILE: Q-20-838	SHEET 1 OF 2	SCALE: 1:30	CHANGE
-------------------	--------------	-------------	--------

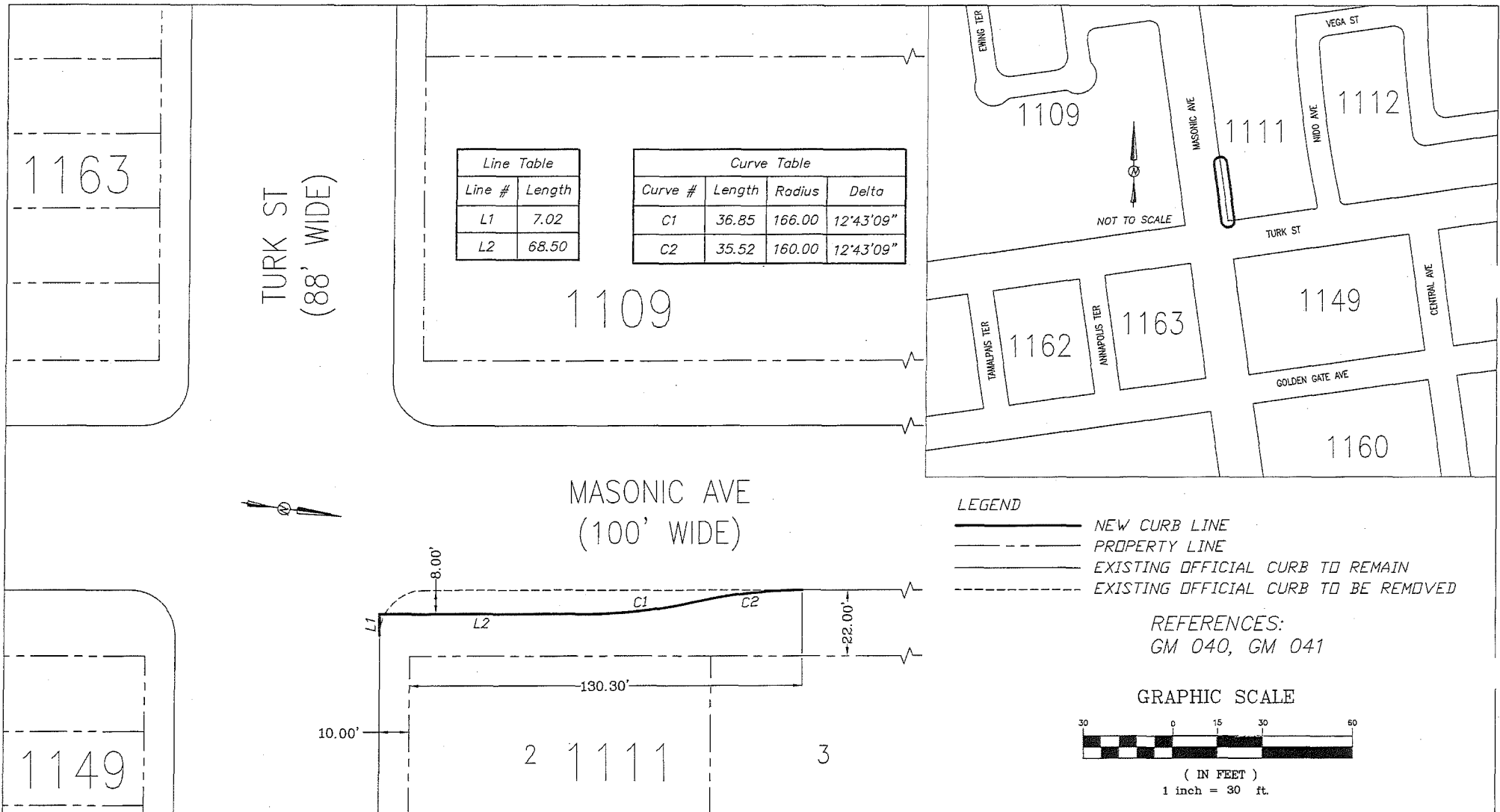

Line Table	
Line #	Length
L1	7.02
L2	68.50

Curve Table			
Curve #	Length	Radius	Delta
C1	36.85	166.00	12°43'09"
C2	35.52	160.00	12°43'09"

LEGEND

- NEW CURB LINE
- PROPERTY LINE
- EXISTING OFFICIAL CURB TO REMAIN
- EXISTING OFFICIAL CURB TO BE REMOVED

REFERENCES:
GM 040, GM 041

GRAPHIC SCALE



(IN FEET)
1 inch = 30 ft.

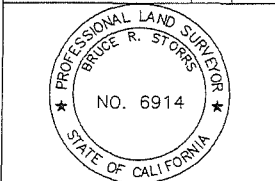

APPROVED:
Bruce R. Storrs
BRUCE R. STORRS
CITY & COUNTY SURVEYOR

6/10/16
DATE

CITY AND COUNTY OF SAN FRANCISCO
DEPARTMENT OF PUBLIC WORKS

OFFICIAL SIDEWALK CHANGES AT THE NORTHEASTERLY CORNER OF THE INTERSECTION OF MASONIC AVENUE AND TURK STREET, FRONTING AB 1111 LOTS 002, 003

FILE: Q-20-838 SHEET 2 OF 2 SCALE: 1:30 CHANGE



Office of the City and County Surveyor
1155 Market Street, 3rd Floor
San Francisco, Ca 94103

(415) 554-5827 ■ www.SFPublicWorks.org



Edwin M. Lee, Mayor
Mohammed Nuru, Director

Bruce R. Storrs, City and County Surveyor

Public Works Order No: 185823

Recommending that the Board of Supervisors approve legislation amending Ordinance No. 1061 entitled "Regulating the Width of Sidewalks" to change the official sidewalk width of certain locations along Masonic Avenue at: a) the southwest corner of the intersection of Masonic Avenue and Fulton Street, and; b) the northeast corner of the intersection of Masonic Avenue and Turk Street, fronting Assessor's Blocks 1111 and 1187, as shown on Public Works Drawing Q-20-838, dated June 10, 2016.

At the request of the San Francisco Public Works Infrastructure Design and Construction – Streets & Highways Section, the Office of the City and County Surveyor conducted an investigation into changing the official sidewalk width fronting Assessor's Blocks 1111 and 1187, as shown on the enclosed Public Works drawing Q-20-838.

The proposed sidewalk changes are associated with the Masonic Avenue Streetscape Improvements Project, 2370J. The goal of the proposed bulb-outs is to create ADA accessibility, bus shelters, and to reduce the amount of time needed to cross the streets.

During its investigation the Department of Public Works determined that:

- a) No objections were received from affected City agencies.
- b) No objections were received from private utility companies.
- c) The Transportation Advisory Staff Committee (TASC) approved project on April 14, 2011 and August 14, 2014.
- d) On April 30, 2015 the Department of City Planning found that the proposed changes are on balance and in conformity with the General Plan, Planning Code Section 101.1, and the California Quality Act. Case No. 2014-000603GPR.
- e) The San Francisco Infrastructure Division - Streets and Highways Section, as is necessary as a result of this ordinance, shall make arrangements with public utility companies and City Departments for the relocation, and/or modification of any affected public facilities. Any necessary relocation, modification, or both of such facilities shall be at no cost to the City.

The following have been approved by the Department of Public Works and are hereby transmitted to the Board of Supervisors:

- a) The proposed Ordinance amending Ordinance No. 1061 entitled "Regulating the Width of Sidewalks" to change the official sidewalk width of certain locations along Masonic Avenue



at: a) the southwest corner of the intersection of Masonic Avenue and Fulton Street, and; b) the northeast corner of the intersection of Masonic Avenue and Turk Street, fronting Assessor's Blocks 1111 and 1187, as shown on Public Works Drawing Q-20-838, dated June 10, 2016.

- b) The General Plan approval form from the Department of City Planning dated April 30, 2015.
- c) Department of Public Works drawing Q-20-838 described above.

It is recommended that the Board of Supervisors adopt this Ordinance.

3/31/2017

3/31/2017

Bruce R. Storrs

Storrs, Bruce
City and County Surveyor
Signed by: Storrs, Bruce

Edgar Lopez

Nuru, Mohammed
Director
Signed by: Lopez, Edgar





SAN FRANCISCO PLANNING DEPARTMENT

Planning Commission Motion 17912

HEARING DATE: June 25, 2009

Hearing Date: June 25, 2009
Case No.: 2007.0347E
Project Title: San Francisco Bicycle Plan
Project Address: N/A, Citywide, primarily within the public right-of-way
Zoning: N/A
Block/Lot: N/A, Citywide, primarily within the public right-of-way
Project Sponsor: Oliver Gajda, Bicycle Program Manager
San Francisco Municipal Transportation Agency
One South Van Ness Avenue
San Francisco, CA 94103
Staff Contact: Debra Dwyer – (415) 575-9031
Debra.Dwyer@sfgov.org

1650 Mission St.
Suite 400
San Francisco,
CA 94103-2479

Reception:
415.558.6378

Fax:
415.558.6409

Planning
Information:
415.558.6377

ADOPTING FINDINGS RELATED TO THE CERTIFICATION OF A FINAL ENVIRONMENTAL IMPACT REPORT FOR THE PROPOSED UPDATE TO THE 2009 SAN FRANCISCO BICYCLE TRANSPORTATION PLAN, WHICH INCLUDES MINOR, LONG-TERM, AND NEAR-TERM IMPROVEMENTS FOR THE BICYCLE ROUTE NETWORK, AND AMENDMENTS TO THE GENERAL PLAN AND PLANNING CODE TO REFLECT SAID BICYCLE PLAN.

MOVED, that the San Francisco Planning Commission (hereinafter "Commission") hereby CERTIFIES the Final Environmental Impact Report identified as Case No. 2007.0347E, the San Francisco Bicycle Plan (hereinafter "Project"), based upon the following findings:

1. The City and County of San Francisco, acting through the Planning Department (hereinafter "Department") fulfilled all procedural requirements of the California Environmental Quality Act (Cal. Pub. Res. Code Section 21000 *et seq.*, hereinafter "CEQA"), the State CEQA Guidelines (Cal. Admin. Code Title 14, Section 15000 *et seq.*, (hereinafter "CEQA Guidelines") and Chapter 31 of the San Francisco Administrative Code (hereinafter "Chapter 31").
 - A. The Department determined that an Environmental Impact Report (hereinafter "EIR") was required and provided public notice of that determination by publication in a newspaper of general circulation on June 5, 2007.
 - B. Public notice was provide on June 5, 2007 of a Public Scoping meeting for the EIR for this project, and such meeting was subsequently held on June 26, 2007.
 - C. On November 26, 2008, the Department published the Draft Environmental Impact Report (hereinafter "DEIR") and provided public notice in a newspaper of general circulation of

the availability of the DEIR for public review and comment and of the date and time of the Planning Commission public hearing on the DEIR; this notice was mailed to the Department's list of persons requesting such notice.

- D. In addition, the Notices of availability of the DEIR (NOA) and of the date and time of the public hearing were mailed to more than 1,400 persons, neighborhood organizations, and agencies on November 26, 2008. The Planning Department also emailed a copy of the NOA on November 26, 2008 to persons for whom an email address had been provided. .
 - E. On November 26, 2008, copies of the DEIR were mailed or otherwise delivered to a list of persons requesting it, to those noted on the distribution list for the DEIR, and to government agencies, the latter both directly and through the State Clearinghouse.
 - F. Notice of Completion was filed with the State Secretary of Resources via the State Clearinghouse on November 26, 2008.
2. The Commission held a duly advertised public hearing on said DEIR on January 8, 2009 at which opportunity for public comment was given, and public comment was received on the DEIR. The period for acceptance of written comments ended on January 13, 2009.
 3. The Department prepared responses to comments on environmental issues received at the public hearing in writing during the 47-day public review period for the DEIR and submitted after the close of the public comment period, prepared revisions to the text of the DEIR in response to comments received or based on additional information that became available during the public review period, and corrected errors in the DEIR. This material was presented in a Comments and Responses document, published on June 11, 2009, distributed to the Commission, to the SFMTA Board, and to all parties who commented on the DEIR, and made available to others upon request at Department offices.
 4. A Final Environmental Impact Report has been prepared by the Department, consisting of the Draft Environmental Impact Report, supporting studies, documents and other materials, any consultations and comments received during the review process, any additional information that became available, and the Comments and Responses document, all as required by law.
 5. Project Environmental Impact Report files have been made available for review by the Commission and the public. These files are available for public review by appointment at the Department offices at 1650 Mission Street, Suite 400, in San Francisco, and are part of the record before the Commission.
 6. On June 25, 2009, the Commission reviewed and considered the Final Environmental Impact Report and hereby does find that the contents of said report and the procedures through which the Final Environmental Impact Report was prepared, publicized, and reviewed comply with the provisions of CEQA, the CEQA Guidelines, and Chapter 31.

7. The project sponsor has indicated that the presently preferred alternative consists of the preferred project design for 47 of the near-term improvements as described in the Final Environmental Impact Report and presented in Exhibit A hereto.
8. The Planning Commission hereby does find that the Final Environmental Impact Report concerning File No. 2007.0347E, the San Francisco Bicycle Plan, reflects the independent judgment and analysis of the City and County of San Francisco, is adequate, accurate and objective, and that the Comments and Responses document contains no significant revisions to the DEIR, and hereby does CERTIFY THE COMPLETION of said Final Environmental Impact Report in compliance with CEQA and the CEQA Guidelines.
9. The Commission, in certifying the completion of said Final Environmental Impact Report, hereby does find that the project described in the Environmental Impact Report and the project preferred by the project sponsor, described in Exhibit A attached hereto:
 - A. Will have project-specific significant effects on the environment resulting in a potential reduction of traffic levels-of-service on some roadway segments and at some intersections, a potential slowing of transit movement in specific locations, and a potential reduction of loading spaces in certain locations within the project area. While none of the policy goals, objectives, and actions taken to support the 2009 Bicycle Plan, now and into the future, would, in themselves, have a significant effect on the physical environment, the predictable indirect impact of implementing the policy goals, objectives, and actions would be the implementation of the proposed physical environmental improvements which are described in the 2009 Bicycle Plan. Therefore, the implementation of policy goals, objectives, and actions could indirectly lead to the same impacts as identified for the actual improvement projects. Specifically, the project may result in the significant and unavoidable impacts described in Exhibit B hereto.

I hereby certify that the foregoing Motion was ADOPTED by the Planning Commission at its regular meeting of June 25, 2009.

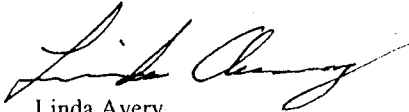
Linda Avery
Commission Secretary

AYES: Miguel, Antonini, Borden, Olague, Sugaya
NOES:
ABSENT: Lee, Moore
ADOPTED: June 25, 2009

EXHIBIT A

**2009 SAN FRANCISCO BICYCLE PLAN
PREFERRED PROJECT ALTERNATIVE**

The Preferred Project Alternative as determined by the San Francisco Municipal Transportation Agency consists of the 2009 Bicycle Plan, the minor and long-term improvements for the bicycle route network as described in the EIR, and the following preferred project options for the near-term improvements for the bicycle route network as described in the Final EIR.

The preferred project designs for the near-term improvements listed in Table A.1 are exactly the same as a project design option analyzed in the Draft EIR.

TABLE A.1 NEAR-TERM IMPROVEMENT PROJECTS		OPTION 1	OPTION 2
PROJECT NO.	PROJECT NAME		
1-2	BROADWAY TUNNEL SIGNAGE IMPROVEMENTS	YES	
2-3	14TH STREET BICYCLE LANE, DOLORES STREET TO MARKET STREET	YES	
2-5	BEALE STREET BICYCLE LANE, BRYANT STREET TO FOLSOM STREET	YES	
2-6	DIVISION STREET BICYCLE LANES, 9TH STREET TO 11TH STREET		YES
2-7	FREMONT STREET SOUTHBOUND BICYCLE LANE, HARRISON STREET TO HOWARD STREET	YES	
2-8	HOWARD STREET WESTBOUND BICYCLE LANE, SHORT EXTENSION AT 9TH STREET	YES	
2-9	HOWARD STREET, WESTBOUND BICYCLE LANE, THE EMBARCADERO TO FREMONT STREET	YES	
2-12	MARKET STREET BICYCLE LANES, OCTAVIA BOULEVARD TO VAN NESS AVENUE	YES	
2-13	MCCOPPIN STREET BICYCLE PATH, MARKET STREET TO VALENCIA STREET	YES	
2-15	OTIS STREET WESTBOUND BICYCLE LANE, COUGH STREET TO SOUTH VAN NESS AVENUE	YES	
3-1	FELL STREET AND MASONIC AVENUE INTERSECTION IMPROVEMENTS	YES	
3-3	MCALLISTER STREET BICYCLE LANE, MARKET STREET TO MASONIC AVENUE	YES	
3-4	POLK STREET BICYCLE LANE, MARKET STREET TO MCALLISTER STREET	YES	
3-5	SCOTT STREET BICYCLE LANE, FELL STREET TO OAK STREET	YES	
3-6	THE "WIGGLE" IMPROVEMENTS	YES	
4-1	16TH STREET BICYCLE LANES, 3RD STREET TO TERRY FRANCOIS BOULEVARD	YES	
4-2	CARGO WAY BICYCLE LANES, 3RD STREET TO JENNINGS STREET	YES	
4-3	ILLINOIS STREET BICYCLE LANES, 16TH STREET TO CARGO WAY	YES	
4-5	MISSISSIPPI STREET BICYCLE LANES, 16TH STREET TO MARIPOSA STREET	YES	
5-3	ALEMANY BOULEVARD BICYCLE LANES, ROUSSEAU STREET TO SAN JOSE AVENUE	YES	

5-5	CESAR CHAVEZ STREET BICYCLE LANES, I-280 TO US 101 FREEWAYS	YES	
5-7B	GLEN PARK AREA BICYCLE LANES, (B) CONNECTION BETWEEN MONTEREY BOULEVARD AND SAN JOSE AVENUE	YES	
5-11	POTRERO AVENUE AND BAYSHORE BOULEVARD BICYCLE LANES, 25TH STREET TO CESAR CHAVEZ STREET	YES	
5-13	SAN BRUNO AVENUE BICYCLE LANES, PAUL TO SILVER AVENUES *	YES *	
6-2	CLIPPER STREET BICYCLE LANES, DOUGLASS STREET TO PORTOLA DRIVE	YES FOR SEGMENT I	YES FOR SEGMENT II ¹
7-2	7 TH AVENUE BICYCLE LANES, LAWTON STREET TO LINCOLN WAY	YES	
7-5	KIRKHAM STREET BICYCLE LANES, 9TH AVENUE TO GREAT HIGHWAY	YES	
7-6	PAGE AND STANYAN STREETS INTERSECTION TRAFFIC SIGNAL IMPROVEMENTS	YES	
8-1	19TH AVENUE MIXED-USE PATH, BUCKINGHAM WAY TO HOLLOWAY AVENUE		YES
8-3	HOLLOWAY AVENUE BICYCLE LANES, JUNIPERO SERRA BOULEVARD TO VARELA AVENUE	YES	
8-4	JOHN MUIR DRIVE BICYCLE LANES, LAKE MERCED BLVD TO SKYLINE BOULEVARD	YES	
8-5	SLOAT BOULEVARD BICYCLE LANES, GREAT HIGHWAY TO SKYLINE BOULEVARD	YES	

* Please note that while Option 1 is the preferred design option for Project 5-13, SFMTA is preserving consideration of Option 2.

The preferred project designs for the near-term improvements listed in Table A.2 are a refinement to a project design option analyzed in the Draft EIR, and are further described in the Comments and Responses document section on staff initiated text changes.

TABLE A.2 NEAR-TERM IMPROVEMENT PROJECTS		MODIFIED OPTION 1	MODIFIED OPTION 2
PROJECT NO.	PROJECT NAME		
1-3	NORTH POINT STREET BICYCLE LANES, THE EMBARCADERO TO VAN NESS AVENUE	YES	
2-1	2ND STREET BICYCLE LANES, KING STREET TO MARKET STREET	YES	
2-2	5TH STREET BICYCLE LANES, MARKET STREET TO TOWNSEND STREET		YES
2-4	17TH STREET BICYCLE LANES, CORBETT AVENUE TO KANSAS STREET, INCLUDING CONNECTIONS TO THE 16TH STREET BART STATION VIA HOFF STREET OR VALENCIA STREET, AND 17TH STREET TO DIVISION STREET VIA POTRERO AVENUE **	YES**	
2-10	MARKET STREET AND VALENCIA STREET INTERSECTION	YES	

¹ Pursuant to refinement of this project, the original Project 6-2 Option I for Segment II on Diamond Heights Boulevard from the intersection of Diamond Heights Boulevard with Clipper Street to the intersection of Diamond Heights Boulevard and Portola Drive is no longer under consideration. Therefore, there is only one option for each segment.

	IMPROVEMENTS		
2-11	MARKET STREET BICYCLE LANES, 17TH STREET TO OCTAVIA BOULEVARD	YES	
2-14	MCCOPPIN STREET BICYCLE LANE, GOUGH STREET TO VALENCIA STREET	YES	
2-16	TOWNSEND STREET BICYCLE LANES, 8TH STREET TO THE EMBARCADERO	YES	
5-1	23RD STREET BICYCLE LANES, KANSAS STREET TO POTRERO AVENUE	YES	
5-2	ALEMANY BOULEVARD BICYCLE LANES, BAYSHORE BOULEVARD TO ROUSSEAU STREET	YES	
5-4	BAYSHORE BOULEVARD BICYCLE LANES, CESAR CHAVEZ STREET TO SILVER AVENUE		YES
5-7A	GLEN PARK AREA BICYCLE LANES, (A) CONNECTION BETWEEN ALEMANY BOULEVARD AND SAN JOSE AVENUE		YES
5-8	KANSAS STREET BICYCLE LANES, 23RD STREET TO 26TH STREET	YES	
5-9	OCEAN AVENUE BICYCLE LANES, ALEMANY BOULEVARD TO LEE AVENUE		YES
5-12	SAGAMORE STREET AND SICKLES AVENUE BICYCLE LANES, ALEMANY BOULEVARD TO BROTHERHOOD WAY	YES	
6-1	CLAREMONT BOULEVARD BICYCLE LANES, DEWEY BOULEVARD TO ULLOA STREET	YES	
6-3	LAGUNA HONDA BOULEVARD BICYCLE LANES, PLAZA STREET TO WOODSIDE		YES
6-4	LAGUNA HONDA BOULEVARD BICYCLE LANES, PORTOLA DRIVE TO WOODSIDE AVENUE	YES	
6-5	PORTOLA DRIVE BICYCLE LANES, CORBETT AVENUE TO O'SHAUGHNESSY BOULEVARD	YES	
6-6	PORTOLA DRIVE BICYCLE LANES, O'SHAUGHNESSY BOULEVARD/WOODSIDE AVENUE TO SLOAT BOULEVARD/ST. FRANCIS BOULEVARD		YES
7-1	INTERSECTION IMPROVEMENTS AT 7TH AVENUE AND LINCOLN WAY	YES	
7-3	GREAT HIGHWAY AND POINT LOBOS AVENUE BICYCLE LANES, EL CAMINODEL MAR TO CABRILLO STREET	YES	
7-4	JOHN F. KENNEDY DRIVE AND KEZAR DRIVE BICYCLE LANES, STANYAN STREET TO TRANSVERSE DRIVE	YES	
8-2	BUCKINGHAM WAY BICYCLE LANES, 19TH AVENUE TO 20TH AVENUE	YES	

** Please note that while Modified Option 1 is the preferred design option for Project 2-4, SFMTA is preserving consideration of Option 2 for the Center Segment of Project 2-4 between Church Street and Potrero Avenue.

The preferred project design for the following five near-term improvement projects has not yet been determined. For these projects, it is anticipated that the preferred project designs, once identified, would be within the range of project options analyzed in the Draft EIR. When a preferred project

design is determined, an assessment will be made regarding whether or not supplemental environmental analysis is required.

Project 1-1 Broadway Bicycle Lanes, Polk Street to Webster Street

Project 3-2 Masonic Avenue Bicycle Lanes, Fell Street to Geary Boulevard

Project 4-4 Innes Avenue Bicycle Lanes, Donahue Street to Hunters Point Boulevard

Project 5-6 Cesar Chavez Street/26th Street Bicycle Lanes, Sanchez Street to US-101

Project 5-10 Phelan Avenue Bicycle Lanes, Judson Avenue to Ocean Avenue

EXHIBIT B

SIGNIFICANT AND UNAVOIDABLE IMPACTS THAT MAY RESULT FROM THE 2009 BICYCLE PLAN PROJECT PREFERRED PROJECT

A. Traffic¹

The 2009 Bicycle Plan Preferred Project has the long-term potential and cumulative potential (which considers impacts of both the Bicycle Plan and other development anticipated to occur around the project area) to increase traffic delay in some areas of the City. Through the reduction of roadway capacity and specifically the reduction in the number of lanes available for automotive vehicle use, the Preferred Project may cause a significant adverse impact to some intersection levels of service.

The 2009 Bicycle Plan Preferred Project also has the near-term potential and cumulative potential (which considers impacts of both the Bicycle Plan and other development anticipated to occur around the project area) to cause a significant adverse impact to intersection levels-of-service at the following locations:

Cluster 2

2nd Street/Bryant Street, Project 2-1 Modified Option 1, Existing plus Project and 2025 Cumulative plus Project conditions

2nd Street/Folsom Street, Project 2-1 Modified Option 1, 2025 Cumulative plus Project conditions

2nd Street/Harrison Street, Project 2-1 Modified Option 1, Existing plus Project and 2025 Cumulative plus Project conditions

2nd Street/Howard Street, Project 2-1 Modified Option 1, 2025 Cumulative plus Project conditions

2nd Street/Townsend Street, Project 2-16 Modified Option 1, 2025 Cumulative plus Project conditions

5th Street/Brannan Street, Project 2-2 Modified Option 2, 2025 Cumulative plus Project conditions

5th Street/Bryant Street, Project 2-2 Modified Option 2, Existing plus Project and 2025 Cumulative plus Project conditions

¹ Unless otherwise noted, the significant and unavoidable traffic and transit impacts are for PM peak hour conditions.

5th Street/Howard Street, Project 2-2 Modified Option 2, 2025 Cumulative plus Project conditions

7th Street/Townsend Street, Project 2-16 Modified Option 1, 2025 Cumulative plus Project conditions

10th Street/Brannan Street/Potrero Street, combined Projects 2-4 Modified Option 1 and 2-6 Option 2, Existing plus Project and 2025 Cumulative plus Project conditions

Church Street/Market Street/14th Street, Combined Projects 2-3 and 2-11 Modified Option 1, 2025 Cumulative plus Project conditions

Church Street/Market Street/14th Street, Project 2-11 Modified Option 1, 2025 Cumulative plus Project conditions

Fremont Street/Howard Street, combined Projects 2-7 and 2-9, Existing plus Project and 2025 Cumulative plus Project conditions

Fremont Street/Howard Street, Project 2-9, Existing plus Project and 2025 Cumulative plus Project conditions

Potrero Street/16th Street, Project 2-4 Modified Option 1, 2025 Cumulative plus Project conditions

Cluster 3

Masonic Avenue/Fell Street, Combined Projects 3-1 and 3-2 Option 1, 2025 Cumulative plus Project conditions

Masonic Avenue/Fell Street, Project 3-2 Option 1, Existing plus Project and 2025 Cumulative plus Project conditions

Masonic Avenue/Fell Street, Project 3-2 Option 2, 2025 Cumulative plus Project conditions

Masonic Avenue/Turk Street, Project 3-2 Options 1 and 2, in the AM peak hour, 2025 Cumulative plus Project conditions

Masonic Avenue/Turk Street, Project 3-2 Option 1, in the PM peak hour, 2025 Cumulative plus Project conditions

Masonic Avenue/Fulton Street, Project 3-2 Options 1 and 2, in the AM peak hour, 2025 Cumulative plus Project conditions

Masonic Avenue/Geary Boulevard, Project 3-2 Option 1, 2025 Cumulative plus Project conditions

Cluster 5

Bryant Street/Cesar Chavez Street, Project 5-6 Options 1 and 2, Existing plus Project and 2025 Cumulative plus Project conditions

Evans Avenue/Cesar Chavez Street, Project 5-5 Option 1, Existing plus Project and 2025 Cumulative plus Project conditions

Guerrero Street/Cesar Chavez Street, Project 5-6 Options 1 and 2, Existing plus Project and 2025 Cumulative plus Project conditions

Mission Street/Cesar Chavez Street, Project 5-6 Options 1 and 2 in the AM peak hour for 2025 Cumulative plus Project conditions, and Project 5-6 Options 1 and 2 in the PM peak hour, Existing plus Project and 2025 Cumulative plus Project conditions

South Van Ness Avenue/Cesar Chavez Street, Project 5-6 Options 1 and 2, Existing plus Project and 2025 Cumulative plus Project conditions

B. Transit

The 2009 Bicycle Plan Preferred Project has the long-term potential to slow some transit movement in some locations, as well as the near-term potential and cumulative potential to slow some transit movement in some locations, specifically:

Cluster 2

Muni bus line 10, Combined Projects 2-1 and 2-16 Modified Option 1, 2025 Cumulative plus Project conditions

Muni bus line 9, Combined Project 2-4 Modified Option 1 and 2-6 Option 2, 2025 Cumulative plus Project conditions

Muni bus line 9, Project 2-4 Modified Option 1, 2025 Cumulative plus Project conditions

Muni bus line 30, Project 2-16 Modified Option 1, Existing plus Project and 2025 Cumulative plus Project plus Project conditions, near the intersection of 4th Street/Townsend Streets

Muni bus line 45, Project 2-16 Modified Option 1, Existing plus Project and 2025 Cumulative plus Project plus Project conditions, near the intersection of 4th Street/Townsend Street

SamTrans bus line 292, Combined Project 2-4 Modified Option 1 and 2-6 Option 2, 2025 Cumulative plus Project conditions

Muni bus line 292, Project 2-4 Modified Option 1, 2025 Cumulative plus Project conditions

Cluster 3

Muni bus line 43, Combined Projects 3-1 and 3-2 Option 1, Existing plus Project and 2025 Cumulative plus Project conditions

Muni bus line 43, Project 3-2 Option 1, Existing plus Project and 2025 Cumulative plus Project conditions

Cluster 5

Muni bus line 12, Project 5-6 Option 1, Existing plus Project and 2025 Cumulative plus Project conditions

Muni bus line 27, Project 5-6 Option 1, Existing plus Project and 2025 Cumulative plus Project conditions

Cluster 6

Muni bus line 48, Projects 6-2, 6-5 Modified Option 1, and 6-6 Option 1, 2025 Cumulative plus Project conditions*

Muni bus line 52, Projects 6-2, 6-5 Modified Option 1, and 6-6 Option 1, 2025 Cumulative plus Project conditions*

* Note: Project 6-2 Segment II Option 1 is no longer being considered for implementation by SFMTA. Also, the preferred project design for Project 6-6 is Modified Option 2.

C. Loading

The 2009 Bicycle Plan Preferred Project has the long-term potential to eliminate some curb space currently used for passenger loading/unloading or commercial freight loading/unloading in as yet undetermined locations, as well as the near-term potential and cumulative potential to eliminate some curb space currently used for passenger loading/unloading or commercial freight loading/unloading.

Cluster 1

Along North Point Street east of Columbus Avenue, Modified Project 1-3, Existing plus Project and 2025 Cumulative plus Project conditions

Cluster 2

Along 2nd Street between Market and Bryant Streets in the 2nd Street Corridor, Project 2-1 Modified Option 1, Existing plus Project and 2025 Cumulative plus Project conditions for commercial freight loading/unloading

Along north side of Market Street near Noe Street, Project 2-11 Modified Option 1, Existing plus Project and 2025 Cumulative plus Project conditions

Cluster 5

Along Bayshore Boulevard between Cesar Chavez Street and Industrial Street, Project 5-4 Modified Option 2, Existing plus Project and 2025 Cumulative plus Project

Along the west side of San Bruno Avenue between Paul Avenue and Silver Avenue, Project 5-13 Option 1 and Option 2, Existing plus Project and 2025 Cumulative plus Project



SAN FRANCISCO PLANNING DEPARTMENT

Addendum to Environmental Impact Report

Addendum Date: June 28, 2012
Case No.: 2011.0935E
Project Title: San Francisco Bicycle Plan Project 3-2
Masonic Avenue Bicycle Lanes, Fell to Geary Streets
EIR: SCL No. 2008032052, certified August 4, 2009
Zoning: n/a, in public right-of-way
Block/Lots: n/a, in public right-of-way
Lot Sizes: n/a, in public right-of-way
Project Sponsor: James Shahamiri, San Francisco MTA
415.701.4732, james.shahamiri@sfmta.com
Lead Agency: San Francisco Planning Department
Staff Contact: Susan Mickelsen – 415.575.9049
susan.mickelsen@sfgov.org

1650 Mission St.
Suite 400
San Francisco,
CA 94103-2479

Reception:
415.558.6378

Fax:
415.558.6409

Planning
Information:
415.558.6377

PROJECT DESCRIPTION

Background

The project sponsor, the San Francisco Municipal Transportation Authority (SFMTA), proposes to implement the Masonic Avenue Bicycle Lanes Project (hereafter "Modified Project"). Two "options" for the 3-2 project were studied in the *San Francisco Bicycle Plan Final Environmental Impact Report* (FEIR, Case No. 2007.0347E), referred to as "Project 3-2", "Option 1" and "Option 2" in that document, and were part of the 60 near-term projects analyzed at a project-level in the FEIR. The San Francisco Planning Commission certified the Bicycle Plan EIR on June 25, 2009. On June 26, 2009, the Municipal Transportation Agency (MTA) Board approved 45 of the 60 near-term Bicycle Plan projects; and Project 3-2 was one of these projects.

The motion to certify the FEIR was appealed to the Board of Supervisors. On August 4, 2009 the Board of Supervisors reaffirmed the Planning Commission's certification of the FEIR. Subsequently, the Board of Supervisors passed an Ordinance adopting the 2009 San Francisco Bicycle Plan, which also amended the *San Francisco General Plan* in connection with the San Francisco Bicycle Plan; adopted environmental findings and findings that the General Plan amendment is consistent with the *General Plan* and eight priority policies of *Planning Code* Section 101.1; as well as authorized other acts in connection thereto.

Project Location

The proposed Masonic Avenue Bicycle Lanes Project is located along Masonic Avenue between the intersections of Fell Street (to the south) and Geary Boulevard (to the north), or approximately 8 blocks within the right-of-way of Masonic Avenue, as shown in Figure 1: Project Area Map. The FEIR described this project area in the following manner:

- Segment 1 extends from Fell Street to Hayes Street
- Segment 2 extends from Hayes Street to Grove Street.
- Segment 3 extends from Grove Street to Anza/O'Farrell Streets.
- Segment 4 extends from Anza/O'Farrell Streets to Geary Boulevard.

Masonic Streetscape Project

Project Area Map

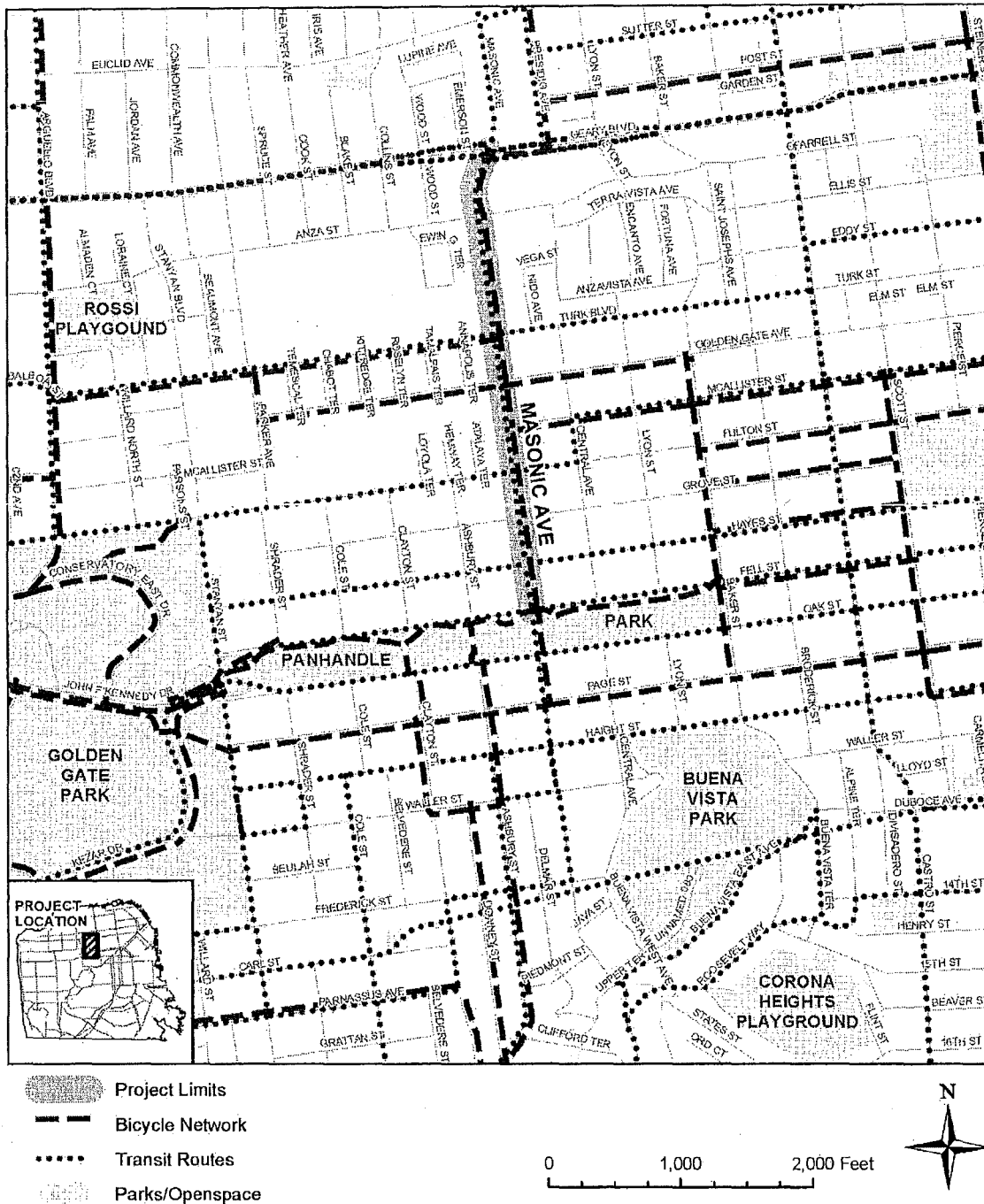

Figure 1: Project Area Map

To aid in the comparison of the FEIR Options 1 and 2 analyzed and the Modified Project designs, the segments along the Masonic Avenue project corridor described below are the same as the four "segments" described in the FEIR. The project location is the same as described for Project 3-2 in the FEIR (pp. IV.B-22 through pp. IV.B-24).

Existing Conditions

The existing street network, as shown in **Figure 2: Existing & Bicycle Plan Options Cross Sections** is described in the Bicycle Plan FEIR (p. V.A.3-84 and V.A.3-85) as follows:

"Masonic Avenue is a north-south major arterial with a mixture of residential, commercial and institutional uses. There are four travel lanes between Geary Boulevard and Grove Street and additional lanes in both directions between Grove and Fell Streets. Masonic Avenue between Fell Street and Geary Boulevard is part of the MTS Roadway Network and the CMP Network. Traffic volumes are high during the AM and PM peak periods, when parking tow-away restrictions provide additional travel lane capacity."

Existing transit on Masonic Avenue is presented in the Bicycle Plan FEIR (pp. V.A.3, 86) as follows:

"Muni bus line 43 runs in both directions on this segment on Masonic Avenue along the entire length of Project 3-2 with approximately six buses per hour, each way, during the AM and PM peak periods. Muni bus line 31BX runs northbound between Turk Street and Geary Boulevard during the AM peak period with approximately six buses per hour, and southbound during the PM peak period with four buses per hour. Bus stops are located at Hayes Street, Fulton Street, Golden Gate Avenue, Turk Street and Geary Boulevard."

Existing parking, pedestrian, bicycle and loading conditions for Masonic Avenue are presented in the Bicycle Plan FEIR (pp. V.A.3, 87-88) as follows:

"On-street parking is generally permitted on both sides along this corridor, but parking is prohibited on the east side of Masonic Avenue during the AM peak period (7:00 a.m. to 9:00 a.m.) and on the west side during the PM peak period (4:00 p.m. to 6:00 p.m.). On-street parking occupancy between Fell Street and Geary Boulevard during the midday varies from approximately 50 percent throughout most of the corridor, particularly on the east side of Masonic Avenue, to approximately 70 to 80 percent on the northern part of the corridor. The corridor has a mixture of residential, commercial and institutional uses. There are four schools along the corridor: Lincoln University on the west side of Masonic Avenue between O'Farrell and Turk Streets, USF on the west side of Masonic Avenue between Anza and Fulton Streets, San Francisco Day School on the east side of Masonic Avenue at Golden Gate Avenue, and City College of San Francisco (CCSF), Adams Campus, on the west side of Masonic Avenue between Grove and Hayes Streets."

"Pedestrian volumes are generally low to moderate along Masonic Avenue, except near the schools during the period before and after school sessions. Pedestrian crosswalks at the intersections of Masonic Avenue with O'Farrell Street, Turk Street, and Golden Gate Avenue are designated as school crossings (yellow markings)."

Masonic Avenue, Typical Section, Looking North
EXISTING

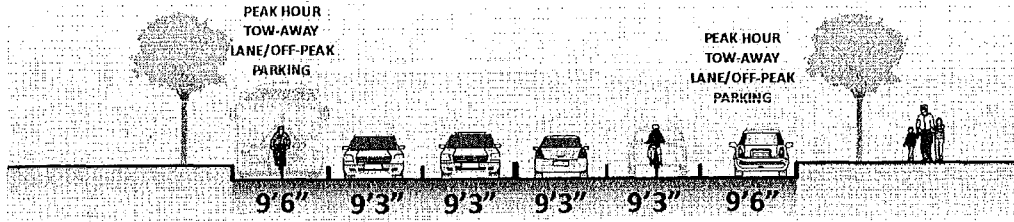

Masonic Avenue, Typical Section, Looking North
BICYCLE PLAN OPTION 1

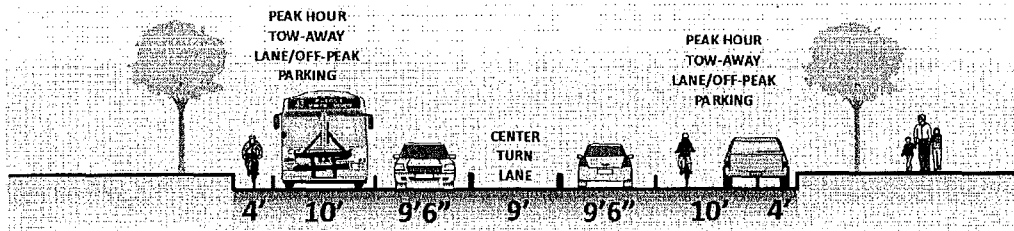

Masonic Avenue, Typical Section, Looking North
BICYCLE PLAN OPTION 2

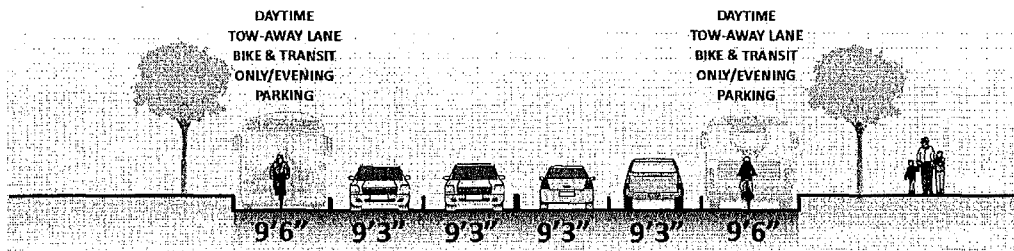

Figure 2: Project 3-2 Existing Conditions & FEIR Bike Plan Options Cross-Sections

"Masonic Avenue is designated as existing Bicycle Route 55 (Class III) in both directions between Fell Street and Geary Boulevard. Existing Bicycle Route 55 intersects existing Bicycle Route 30 (Class I) at the Panhandle Pathway on the south side of Fell Street; existing Bicycle Route 20 (Class II) at McAllister and Turk Streets; and existing Bicycle Route 20 (Class II) at Golden Gate Avenue. Street grades along Project 3-2 generally range from two to five percent, with a nine percent grade between Turk and Fulton Streets. Bicycle volumes on Masonic Avenue are generally low."

"Masonic Avenue has several institutional uses (Lincoln University, San Francisco Day School, USF, CCSF, and Adam Campus) and a few small-scale retail uses. The two larger retail uses at Geary Boulevard and Fulton Street have off-street loading docks to accommodate their deliveries. There is only one on-street yellow commercial freight loading space at the southwest corner of Masonic Avenue and Hayes Street. There are also several white passenger loading zones along both sides of Masonic Avenue. In general truck loading and passenger drop-off activities are accommodated by the on-street parking along Masonic Avenue. No apparent loading shortage (i.e. double parking) was observed during field observations."

Project Characteristics

The Modified Project 3-2 for Masonic Avenue includes two design options, both options, unlike the FEIR Options analyzed, would retain two full-time travel lanes in each direction from Geary Boulevard to Fell Street during peak and off-peak conditions. Compared to existing conditions, the Modified Project designs would remove the rotating AM (northbound) or PM (southbound) peak period travel lane and some parking on both sides of the street to accommodate additional bike facilities (of Class I or Class II design¹), install enhanced bus stops (transit bulbs) at all existing bus stops, move one southbound bus stop from the nearside to the farside of the intersection of Masonic Avenue and Fulton Street (southbound), add corner pedestrian bulbouts at all intersections and include a landscaped center median in portions or all of the center of Masonic Avenue from Fell Street to Geary Boulevard, as described in more detail below. Specific project elements of the Modified Project and how they compare with FEIR Project 3-2 Options 1 and 2 are also presented below.

Modified Project 3-2, (Preferred): Boulevard Design: As introduced above, and shown in **Figure 3: Modified Project 3-2 Boulevard and Gateway Options**, Option 1 Boulevard Design, herein referenced as "Modified Project Boulevard Design" would provide two full-time vehicle travel lanes in each direction from Geary Boulevard to Fell Street, removing parking on both sides of the street and similarly removing the alternating peak hour (northbound in AM peak period; southbound in PM peak period) travel lane; replacing this roadway right-of-way with a separated bike lane (sometimes grade separated, sometimes adjacent but separated (at intersections) and a landscaped center median all along Masonic Avenue. The design would also install transit bulbs at all existing bus stops, relocate one southbound bus stop at Fulton Street from the nearside to the farside of the intersection. The design would also install corner pedestrian bulbouts at all intersections and enhance sidewalks with additional landscaping and wider widths in locations. Left turn restrictions from Masonic Avenue would remain the same as under existing conditions (no left turns during peak periods (7-9 a.m. and 4-7 p.m.) at Hayes, Grove, Fulton, Golden Gate Avenue and Turk Streets). Left turns would continue to be allowed at O'Farrell/Anza

¹ Bikeways are typically classified as Class I, II or III facilities. "Class I bikeways are bicycle paths with exclusive right-of-way for use by bicyclists or pedestrians. Class II bikeways are bicycle lanes striped with the paved areas of roadways, and established for the preferential use of bicycles, while Class III bikeways are signed bicycle routes that allow bicycles to share streets or sidewalks with vehicles or pedestrians." *San Francisco Bicycle Plan FEIR*, Volume 1, p. V.A.1-14. This document is available for review at the Planning Department in Case File No. 2007.0347E.

Streets and from Masonic Avenue onto Geary Boulevard. With the exception of an additional PM peak southbound right-turn lane at Fell Street, turning lanes and pockets on Masonic Avenue would remain the same as under existing conditions.

Masonic Avenue, Typical Section, Looking North
BOULEVARD OPTION

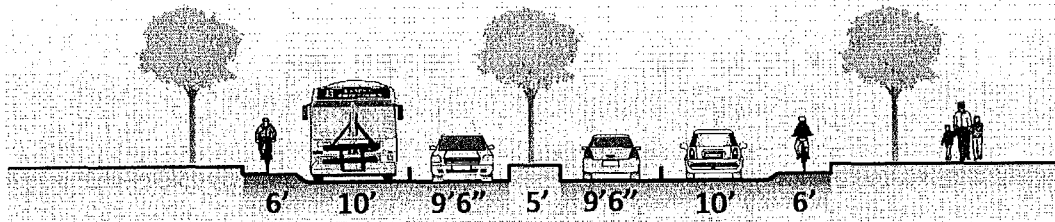

Masonic Avenue, Typical Section, Looking North
GATEWAY OPTION

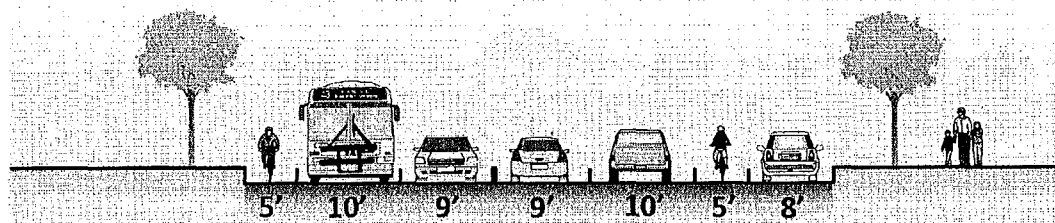

Figure 3: Modified Project 3-2 Cross Sections: Boulevard and Gateway Designs

Similarly, left turns onto Masonic Avenue from side streets would, for the most part, remain the same with the exception of McAllister Street, where left turns would be prohibited by the proposed center median. The Modified Project Boulevard Design also includes the enhancement of the pedestrian plaza located on the southwest corner of Geary Boulevard and Masonic Avenue, including the limitation of the southbound movement west of the plaza from Geary Boulevard to Masonic Avenue to local traffic only. The proposed design of the pedestrian plaza can be seen in **Figure 4: Masonic Avenue/Geary Boulevard Streetscape Improvements**.

Modified Project 3-2: Gateway Design: As introduced above, the Option 2 Gateway Design, herein referenced as “Modified Project Gateway Design” would similarly provide two full-time vehicle travel lanes in each direction from Geary Boulevard to Fell Street, removing parking on the west side of Masonic Avenue and portions of the parking on the east side of Masonic Avenue and removing the alternating peak period travel lane; replacing this roadway right-of-way with Class II bike lanes in each direction, shorter center landscaped medians near certain intersections (Fell Street, Grove Street, McAllister Street, Ewing Terrace, and O’Farrell Street), transit bulbs at existing bus stops, relocating one southbound bus stop at Fulton Street from the near side of the intersection to the farside, enhanced sidewalks with additional landscaping and wider widths in locations, and corner bulbouts at all intersections. Similar to the Boulevard Design, turning lanes and pockets on Masonic Avenue would remain the same as under existing conditions, with the exception of the additional PM peak period right turn onto Fell Street from southbound Masonic Avenue.

The following describes the Modified 3-2 Project designs (Boulevard and Gateway) in comparison to Project 3-2 FEIR Options 1 and 2, presented in segments, similar to pp. IV.B-22 through IV.B-24 of the FEIR.

Segment 1: Fell Street to Hayes Street:

FEIR Option 1: Install Class II bike lanes in both direction by removing one peak hour travel lane in the northbound direction, and removing two travel lanes (one peak hour, one travel lane) in the southbound direction. The FEIR Option 1 retained parking along the west-side of the street and installed a two-way center turn lane in this segment.

FEIR Option 2: Installed Class II bike lanes in both directions by removing a travel lane in each direction, including removing the tow-away lanes but would not include a center-turn lane. FEIR Option 2 also retained parking along west-side of the street.

As compared to the above two FEIR Options, the Modified Project Boulevard Design and Modified Project Gateway Design would be similar in the northbound direction to FEIR Option 1, but as indicated in the Modified Project description above would retain one additional travel lane in the southbound direction and remove parking on both sides of the street, or approximately five additional spaces more than the FEIR analysis. Additionally, both Modified Project options would include pedestrian bulbouts at both the Fell Street and Hayes intersections, as well as an additional peak-period right-turn lane southbound at the intersection of Masonic Avenue and Fell Street. Both modified design options would include the same length of the proposed center landscaped median from Fell Street to Hayes Street.

Segment 2: Hayes Street to Grove Street:

FEIR Option 1: Install Class II bicycle lanes in both directions along with a center turn vehicle lane, through the removal of one travel lane in each direction, leaving one full-time travel lane in both directions, and leaving one rotating peak period tow-away travel lane (northbound in AM and southbound in PM).

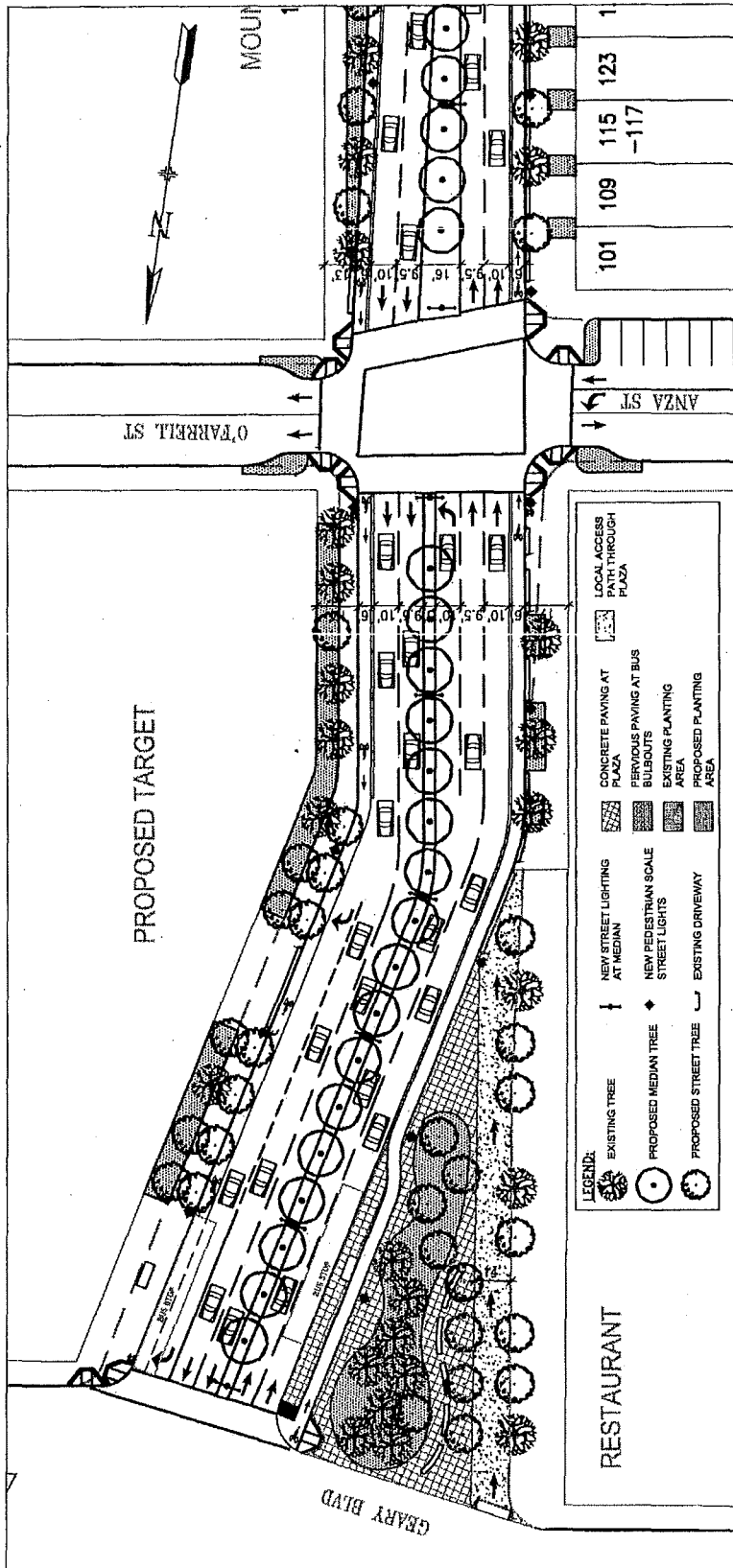

GEARY BOULEVARD TO O'FARRELL STREET

**MASONIC AVENUE STREETScape IMPROVEMENTS
BOULEVARD CONCEPT**

Figure 4: Masonic Avenue/Geary Boulevard Streetscape Improvements

FEIR Option 2: Install Transit-only/bicycle-only lane from 7 a.m. to 6 p.m weekdays in each direction through the removal of one travel lane in each direction and removing parking on both sides of the street. This option would have added sharrows to represent the Class III nature of the roadway between the hours of six p.m. and seven a.m., weekdays and all day on weekends.

As compared to the two FEIR Options, the Modified Project Boulevard Design and Modified Project Gateway Design would be similar to the operating conditions of the FEIR Option 2 during the weekday daytime hours, which removes parking and the peak-hour tow-away lane, retaining two travel lanes during those daytime weekday hours. The Modified Project Boulevard Design and Modified Project Gateway Design would also add a transit bulb for the northbound and southbound bus stops on the northeast and northwest corners of Masonic Avenue and Hayes Street. Both designs place the bicycle lane to the east of the northbound bus stop, and enhance landscaping, where feasible, in between driveway locations. Similar to FEIR Option 1, the Modified Gateway Design retains parking on the eastside of Masonic Avenue in this segment, or approximately 3 parking spaces.

In this Segment (Hayes Street to Grove Street), the Modified Project Boulevard Design adds a center landscape median along the entire block, while the Modified Project Gateway Design adds a short median leading to the Grove Street intersection.

Segment 3: Grove Street to Anza/O'Farrell Streets:

FEIR Option 1: Similar to Segment 2 above (Class II bike lanes in each direction a center turn lane, and removal of one vehicle travel lane in each direction, retaining the rotating peak-period towaway lane.)

FEIR Option 2: Similar to Segment 2 above (Weekday bus-only/bike-only lane, removal of peak-period towaway travel lanes, and removal of parking on both sides of the street.)

Similar to the above Segment 2 discussion, as compared to the two FEIR Options, the Modified Project Boulevard Design and Modified Project Gateway Design would be similar to the operating conditions of the FEIR Option 2, which removes parking and the peak-hour tow-away lane, retaining two travel lanes, with the exception that the Modified Project Boulevard design would not provide a transit-only lane in each direction. The Modified Project Designs would provide one additional travel lane as compared to FEIR Option 1 which retains one directional peak hour travel/towaway lane (three total vehicle lanes during the peak hours). FEIR Option 2 identified approximately 107 parking spaces would be lost in Segment 3. The Modified Project Boulevard Design would have similar parking removal as FEIR Option 2 for this segment, while the Modified Project Gateway Design would retain some (approximately 55), but not all of the parking spaces along the east side of Masonic Avenue. The Modified Project Boulevard Design and Modified Project Gateway Design would also add corner bulbouts at all the intersections (Grove Street, Fulton Street, McAllister Street, Golden Gate Avenue, Turk Street, Ewing Terrace, and O'Farrell/Anza Streets) in this segment. Left turns from Masonic Avenue onto O'Farrell and Anza Streets would continue to be permitted. Additionally, both Modified Project designs would enhance bus stops on Masonic Avenue by installing transit bulbs at the existing stop locations: northbound nearside of Fulton Street, northbound nearside of Golden Gate Avenue, northbound farside of Turk Street, southbound nearside of Turk Street, westbound farside on Turk Street and southbound farside of Golden Gate Avenue and at the relocated southbound farside at Fulton Street, proposed to be relocated as part of the Modified Project designs.

Both Modified Project designs further place the bicycle lane to the east of this enhanced northbound bus stops and add landscaping, where feasible, to both sides of the street in between driveway locations and other existing plantings. In the southbound direction the southbound bike lane in both Modified Project designs, shares the bus zone/bike lane at the bus stops, similar to the FEIR Option 1 design at bus stops.

In this Segment (Grove Street to O'Farrell/Anza Streets), the Modified Project Boulevard Design adds a center landscape median along the entire distance (approximately 6 blocks) of this segment, except at intersection locations. The Modified Project Gateway Design adds shorter center landscaped medians just north of the Grove Street intersection, through the McAllister Street intersection, leading to the Ewing Terrace and O'Farrell Street/Anza Street intersection. For both Modified Project designs most of the existing permitted vehicle movements would not change, with the exception of the left turn movement from McAllister Street onto southbound Masonic Avenue, which is currently permitted, would be prohibited by the placement of the center median in both Modified Project designs.

Of note in this segment, since the certification of the FEIR, the retail project (Target) east of Masonic Avenue at Geary Boulevard was approved and this proposal includes some transportation improvements, namely: 1) an upgrade and optimization of the signal at Masonic Avenue and Anza/O'Farrell Streets; and 2) signalization of the intersection of Ewing Terrace and Masonic Avenue (now 1-way stop-controlled from Ewing Terrace). These improvements are being implemented separate from the Project 3-2 of the Bicycle Plan, and would not substantially alter the operating conditions on Masonic Avenue.

Segment 4: O'Farrell Street/Anza Street to Geary Boulevard:

FEIR Option 1: Install Class II bicycle lanes in both directions by removing a travel lane in one direction and one parking lane (approximately 15 parking spaces). Extend the right-turn only lane onto Geary Boulevard.

FEIR Option 2: Install Class II bicycle lanes in both directions, by removing parking on both sides of the street (approximately 25 parking spaces). This option keeps one additional travel lane in the southbound of this segment.

As compared to the two FEIR Options, the Modified Project Boulevard Design and Modified Project Gateway Design would be similar to the operating conditions of the FEIR Option 1 with two lanes of travel in both directions and retaining the existing right- and left-turn pockets at Geary Boulevard and at O'Farrell/Anza Street. The turning movements at the two traffic signals on the Masonic Avenue overpass and Geary Boulevard on- and off-ramps would remain the same, including the northbound left turn pocket onto Geary Boulevard from Masonic Avenue and southbound left turns from Masonic Avenue onto the Geary Boulevard on-ramp would remain unpermitted. Unlike FEIR Option 1, both Modified Project Designs would include expanding the pedestrian plaza on the southwest corner of the Masonic Avenue/Geary Boulevard, limiting traffic on this portion of Masonic Avenue to local vehicle and loading traffic, as shown in Figure 4, and removing approximately 10 parking spaces. Other traffic movements including the left turn lanes on the Masonic Avenue overpass on The Modified Project Boulevard Design would have separated bicycle path just west of the bus zone, then grade-separated bicycle lane west of the southbound travel lane and similarly a bicycle lane east of the vehicle travel lanes in the northbound direction. The Modified Project Gateway Option, would have a southbound bicycle lane just west of the vehicle lane, and in the northbound direction a bicycle lane that transitions from east of the travel lanes to between the vehicle thru lanes and right-turn lane at Geary Boulevard. In this Segment, there is an existing center landscaped median which would be expanded to the south for the Modified Project Boulevard Design, and would not change for the Modified Project Gateway Design. For both Modified Project designs the existing permitted vehicle movements would not change. As mentioned above, the left-turn movement/pocket onto O'Farrell Street from Masonic Avenue would not change under this project.

ANALYSIS OF POTENTIAL ENVIRONMENTAL EFFECTS

San Francisco Administrative Code Section 31.19(c)(1) states that a Modified Project must be reevaluated and that "If, on the basis of such reevaluation, the Environmental Review Officer determines, based on the requirements of CEQA, that no additional environmental review is necessary, this determination and the reasons therefore shall be noted in writing in the case record, and no further evaluation shall be required by this Chapter."

CEQA Guidelines Section 15164 provides for the use of an addendum to document the basis of a lead agency's decision not to require a Subsequent or Supplemental EIR for a project that is already adequately covered in an existing certified EIR. The lead agency's decision to use an addendum must be supported by substantial evidence that the conditions that would trigger the preparation of a Subsequent EIR, as provided in CEQA Guidelines Section 15162, are not present.

The Initial Study and the FEIR for the Bicycle Plan evaluated the potential impacts of construction and operation of Project 3-2's two options and found that, with implementation of mitigation measures, both options would result in project-specific and cumulative significant and unavoidable operational impacts to traffic and transit service. All other Project 3-2 impacts were determined to be less than significant with mitigation incorporated as part of the overall Bicycle Plan program.

Since certification of the EIR, no changes have occurred in the circumstances under which the original Project 3-2 options or the project as currently proposed would be implemented, that would change the severity of the project's physical impacts as explained herein, and no new information has emerged that would materially change the analyses or conclusions set forth in the FEIR.

Further, proposed modifications and design refinements to Project 3-2, as demonstrated below, would not result in any new significant environmental impacts, substantial increases in the significance of previously identified effects, or necessitate implementation of additional or considerably different mitigation measures than those identified in the EIR. The effects of the Modified Project would be substantially the same as, and in some cases less than, those reported for Project 3-2 in the Bicycle Plan FEIR. The following discussion provides the basis for this conclusion.

Transportation

Traffic

An intersection Level of Service (LOS) analysis was prepared for the Modified Project design and is summarized below.² Similar to the Bicycle Plan FEIR, this Addendum includes an LOS evaluation for Existing, Existing-plus-Project, 2025 Cumulative, and 2025 Cumulative-plus-Project for the Modified Project designs (Boulevard and Gateway) as provided in **Table 1** through **Table 4** below. The analysis from the Bicycle Plan FEIR and the new analysis presented in this Addendum combined, present existing and cumulative conditions for signalized intersections along the Masonic Avenue corridor between Fell Street and Geary Boulevard. The combined analyses are presented in order to demonstrate that the Modified Project designs would not result in significant traffic impacts that were not previously identified in the Bicycle Plan FEIR.

LOS is a qualitative description of the performance of an intersection based on the average delay per vehicle. Intersection levels of service range from LOS A, which indicates free flow or excellent conditions with short delays, to LOS F, which indicates congested or overloaded conditions with extremely long delays. In San Francisco, LOS A through D are considered satisfactory service levels and LOS E and F conditions are considered unsatisfactory service levels.

² SFMTA, 2011/2012. See Appendix A of this document for detailed Level of Service calculations.

Four study intersections along Masonic Avenue were analyzed in the Bicycle Plan FEIR (Masonic Avenue/Fell Street, Masonic Avenue/Fulton Street, Masonic Avenue/Turk Street, Masonic Avenue/Geary Boulevard), with two of those intersections (Masonic Avenue/Fulton Street and Masonic Avenue/Turk Street) analyzed for both the AM and PM peak hours. One additional intersection, Masonic Avenue/O'Farrell Street/Anza Street was added for this analysis for the PM peak hour. Considering the AM peak hour analysis first, for Segment 3, which includes the intersections of Masonic Avenue/Fulton Street and Masonic Avenue/Turk Street, the Modified Project Boulevard Design and Modified Project Gateway Design would be similar to the operating conditions of FEIR Option 2 during the weekday daytime hours, which removes parking and the peak-hour tow-away lane, retaining two travel lanes and a transit-only lane in each direction during the daytime weekday hours; and would improve upon the operating conditions of FEIR Option 1, which removes a travel lane in both directions (leaving two travel lanes in the peak hour direction and one travel lane in the non-peak direction). Since the primary differences in two Modified Project designs are the location and length of the center landscaped medians and the design of the bicycle lanes, traffic conditions under the two Modified Project designs operate the same at all studied intersections. Therefore, as shown in Tables 1 through 4, below, the Modified Project Options (Boulevard or Gateway) LOS are presented together for the discussion of the two intersections modeled for the AM peak hour, as compared to the Bicycle Plan FEIR Options. The LOS analysis for the PM peak hour follows, and similarly the Modified Project Options (Boulevard or Gateway) LOS are presented together, as compared to the Bicycle Plan FEIR Options. Cumulative and 2025 Cumulative-Plus-Project scenarios for the Modified Project are presented in Tables 2 and 4 on the following pages.

**TABLE 1
WEEKDAY AM PEAK HOUR INTERSECTION OPERATING CONDITIONS
EXISTING-PLUS-(MODIFIED) PROJECTS & FEIR BICYCLE PLAN PROJECT 3-2 OPTIONS**

Intersection ^a	Existing AM		FEIR Option 1		FEIR Option 2		Modified Project	
	Average Delay ^b	LOS	Average Delay	LOS	Average Delay	LOS	Average Delay	LOS
59. Masonic Avenue/Turk Street	19.8	B	28.1	C	22.8	C	25.8	C
60. Masonic Avenue/Fulton Street	16.1	B	22.0	C	18.6	B	19.7	B

Sources: Wilbur Smith Associates, October 2008; San Francisco Planning Department 2009 and 2010, SFMTA, 2011/2012.

Notes:

- a. Intersection numbering reflects that presented in Bicycle Plan FEIR.
- b. Average Delay in seconds per vehicle.

As illustrated in Table 1, average vehicle delays are slightly higher than FEIR Option 2, and lower than FEIR Option 1, and overall the AM peak hour LOS associated with the Modified Project designs (Boulevard or Gateway) do not substantially differ from the LOS reported in the FEIR for the weekday AM peak hour for Project 3-2, Options 1 or 2.

TABLE 2
WEEKDAY AM PEAK HOUR INTERSECTION OPERATING CONDITIONS
2025 CUMULATIVE AND 2025 CUMULATIVE PLUS (MODIFIED) PROJECTS
& BICYCLE PLAN PROJECT 3-2 OPTIONS

Intersection ^a	2025 Cumulative			Cumulative + EIR Option 1			Cumulative + EIR Option 2			Cumulative + Modified Project Designs		
	Average Delay ^b	v/c ^c	LOS	Average Delay	v/c ^c	LOS	Average Delay	v/c ^c	LOS	Average Delay	v/c ^c	LOS
59. Masonic Avenue/ Turk Street	>80	1.32	F	>80	1.92	F	>80	1.38	F	>80	1.57	F
60. Masonic Avenue/ Fulton Street	58.3	-	E	>80	1.58	F	>80	1.21	F	>80	1.24	F

Sources: Wilbur Smith Associates, October 2008; San Francisco Planning Department 2009 and 2010.

- a. Intersection numbering reflects that presented in Bicycle Plan FEIR.
- b. Intersections operating at LOS E or LOS F (unacceptable) conditions highlighted in bold.
- c. v/c = volume to capacity ratio, and is reported for intersections operating at LOS F conditions.

Similarly for the AM peak hour LOS, 2025 Cumulative plus Project conditions, Table 2 demonstrates that the Modified Project designs, in combination with traffic growth assumed to occur through the year 2025, would not substantially differ from the LOS findings reported in the FEIR for Project 3-2, which identified significant 2025 Cumulative Plus Project impacts at the intersections of Masonic Avenue/Turk Street (TR-P3-2a & TR-P3-2b) and Masonic Avenue/Fulton Street (TR-P3-2c & TR-P3-2d) during the AM peak hour for FEIR Option 1 and FEIR Option 2, respectively. No feasible mitigation measures were identified for these impacts, therefore both remained as significant and unavoidable impacts in the FEIR. The Modified Project (Boulevard or Gateway designs) would not worsen the LOS or impacts identified at these intersections during the AM peak hour in the Bicycle Plan FEIR.

TABLE 3
WEEKDAY PM PEAK HOUR INTERSECTION OPERATING CONDITIONS
EXISTING-PLUS-(MODIFIED) PROJECTS & BICYCLE PLAN PROJECT 3-2 OPTIONS

Intersection ^a	Existing PM		EIR Option 1		EIR Option 2		Modified Project Designs	
	Average Delay	LOS	Average Delay	LOS	Average Delay	LOS	Average Delay	LOS
43. Masonic Avenue/Fell Street	24.6	C	68.7	E	55.4	E	22.1	C
44. Masonic Avenue/Geary Boulevard	38.2	D	48.4	D	38.2	D	48.4	D
59. Masonic Avenue/ Turk Street	19.5	B	47.6	D	20.8	C	23.3	C
60. Masonic Avenue & Fulton Street	15.8	B	28.0	C	18.6	B	21.9	C
Masonic Avenue & O'Farrell/Anza Streets ^c	14.1	B	N/A ^c	N/A	N/A	N/A	19.5	B

Sources: Wilbur Smith Associates, October 2008; San Francisco Planning Department 2009 and 2010, SFMTA, 2011.

- a. Intersection numbering reflects that presented in Bicycle Plan FEIR.
- b. Average Delay in seconds per vehicle.
- c. Intersection was not analyzed as part of the Bicycle Plan EIR, but added for this analysis.

As illustrated in Table 3, the PM peak hour LOS associated with the Modified Project designs (Boulevard or Gateway) are similar to Existing PM peak conditions at Masonic Avenue/O'Farrell/Anza Streets and Masonic Avenue/Fell Street (actually improving on its operation through the addition of an additional southbound right-turn pocket onto Fell Street). At the Masonic Avenue/Geary Boulevard intersections, project conditions are similar to Project 3-2 FEIR Option 1, and at Masonic Avenue/Turk Street and Masonic Avenue/Fulton Street are in between the FEIR Option 1 and Option 2 PM peak LOS operating conditions. The Bicycle Plan FEIR identified significant unavoidable impacts (TR-P3-2e and TR-P3-2f for Project 3-2 Options 1 and 2, respectively) at Masonic Avenue/Fell Street during the PM peak hour, which the Modified Project designs (both Boulevard and Gateway designs) would avoid since LOS operating conditions under the Modified Project would remain acceptable. The Bicycle Plan FEIR identified one mitigation measure (M-TR-P3-2f) for the FEIR Option 2 impact which, by adding four seconds of green time to the northbound and southbound Masonic Avenue directions reduced the impact to a less than significant level. This mitigation measure would not be required under the Modified Project Designs (Boulevard and Gateway) due to acceptable operating conditions at Masonic Avenue and Fell Street, however would be implemented as part of the Bicycle Plan FEIR.

LOS operating conditions under the Modified Project designs during the PM peak hour at the other intersections would be similar to or better than the operating conditions presented for the Bicycle Plan FEIR Options and would remain at acceptable (LOS A-D) operating conditions.

**TABLE 4
WEEKDAY PM PEAK HOUR INTERSECTION OPERATING CONDITIONS
2025 CUMULATIVE AND 2025 CUMULATIVE PLUS (MODIFIED) PROJECTS
& BICYCLE PLAN PROJECT 3-2 OPTIONS**

Intersection ^a	2025 Cumulative		Cumulative + FEIR Option 1		Cumulative + FEIR Option 2		Cumulative + Modified Project Designs	
	Average Delay	LOS	Average Delay	LOS	Average Delay	LOS	Average Delay	LOS
43. Masonic Avenue/Fell Street	27.7	C	78.3	E	64.2	E	24.4	C
44. Masonic Avenue/Geary Boulevard	41.8	D	68.7	E	41.8	D	68.7	E
59. Masonic Avenue/Turk Street	26.8	C	>80	F	31.0	C	36.0	D
60. Masonic Avenue/Fulton Street	23.1	C	47.0	D	26.6	C	31.9	C
Masonic Avenue & O'Farrell/Anza Streets ^c	27.5	C	N/A ^c	N/A	N/A	N/A	44.2	D

Sources: Wilbur Smith Associates, October 2008; San Francisco Planning Department 2009 and 2010, SFMTA, 2011.

- a. Intersection numbering reflects that presented in Bicycle Plan FEIR.
- b. Intersections operating at LOS E or LOS F (unacceptable) conditions highlighted in bold.
- c. Intersection was not analyzed as part of the Bicycle Plan EIR, but added for this analysis.

Similarly, as illustrated in Table 4, the PM peak hour LOS associated with the Modified Project designs (Boulevard or Gateway) under the 2025 Project plus Cumulative conditions are similar to existing conditions at Masonic Avenue/Fell Street (actually improving on its operation through the addition of another southbound right-turn pocket), are similar to Project 3-2 FEIR Option 1 at Masonic Avenue/Geary Boulevard, and are similar to the FEIR Options PM peak LOS operating conditions at Masonic

Avenue/Turk Street and Masonic Avenue/Fulton Street. Similar to the other intersections, Masonic Avenue/O'Farrell/Anza Street intersection vehicle delay increases under Cumulative plus Modified Project design conditions, however operations would remain at acceptable (LOS A-D) operating conditions.

As shown in Table 4, the Bicycle Plan FEIR identified several significant unavoidable cumulative impacts during the PM peak hour, including for FEIR Option 1 Impact, TR-P3-2g at Masonic Avenue/Fell Street (where LOS degrades from LOS C to LOS E); Impact TR-P3-2i at Masonic Avenue/Geary Boulevard (under FEIR Option 1 degrades from LOS D to LOS E); and Impact TR-P3-2j at Masonic Avenue/Turk Street (under FEIR Option 1 degrades from LOS C to LOS F). One mitigation measure (M-TR-P3-2j) was identified for the impact to the intersection of Masonic Avenue/Turk Street, in which the addition of 10 seconds of green time to the northbound Masonic Avenue direction would improve conditions, but not to a less than significant level, therefore the FEIR Option 1 cumulative impact at Masonic Avenue/Turk Street during the PM peak hour remained significant and unavoidable. Project 3-2 FEIR Option 2 identified one significant cumulative impact at Masonic Avenue/Fell Street during the PM peak hour, but avoided other cumulative traffic impacts during the PM peak hour that were identified under FEIR Option 1. Outside of the one mitigation measure discussed above, no other feasible mitigation measures for the cumulative impacts were identified in the FEIR. The Modified Project designs (Boulevard and Gateway) avoid the significant impacts identified in the Bicycle Plan FEIR at the intersections of Masonic Avenue/Fell Street, and Masonic Avenue/Turk Street, and retain the significant impact identified in the FEIR under Option 1 at Masonic Avenue/Geary Boulevard. However, as shown in Table 4, the delay and LOS under the Modified Project designs would be similar to and not worse than conditions (LOS E at Masonic Avenue/Geary Boulevard) analyzed in the Bicycle Plan FEIR for Project 3-2. Although the Modified Project designs would have a less-than-significant impact at the Masonic Avenue/Turk Street intersection, Mitigation Measure M-TR-P3-2j would be implemented as part of the Bicycle Plan FEIR, to add an addition 10 seconds of green time to the northbound Masonic Avenue direction and further improve acceptable operating conditions.

As previously discussed, the retail development east of Masonic Avenue at Geary Boulevard would include transportation improvements, namely upgrading the signal and signal timing at Masonic Avenue/O'Farrell Street and signaling the intersection of Masonic Avenue and Ewing Terrace, that are separate from Project 3-2 and its modified design. Neither modified designs would conflict, impede or be affected by these transportation improvements, and operations at these intersections would likely improve following these improvements.

In conclusion, the Modified Project Boulevard design and the Modified Project Gateway design would result in similar LOS as reported in the FEIR for Options 1 and 2 during the AM peak hour under Existing-plus-Project and 2025 Cumulative plus Project operating conditions, retaining a significant and unavoidable cumulative impacts at the intersections of Masonic Avenue/Turk Street and Masonic Avenue/Fulton Street (TR-P3-2a through TR-P3-2c). During the PM peak hour, the Modified Project designs would reduce the Existing plus Project impacts identified in the FEIR at Masonic Avenue/Fell Street. Similarly under the 2025 Cumulative plus Project PM peak hour conditions, the Modified Project designs would reduce the significant cumulative traffic impacts identified in the FEIR for the Masonic Avenue/Fell Street and Masonic Avenue/Turk Street intersections and would be similar to (significant and unavoidable) the significant cumulative traffic impact identified in the FIER for Masonic Avenue/Geary Boulevard. The Modified Project would not result in a substantial increase in the significance of the average delay or operation at study intersections or other intersections along the project corridor; nor would the Modified Project designs contribute considerably to cumulative effects

that were not already accounted for in the certified Bicycle Plan FEIR. Overall, Modified Project's traffic impacts, similar to the findings reached in the FEIR, would be "potentially significant and unavoidable" (retaining the impacts at Masonic Avenue/Turk Street (AM peak hour); Masonic Avenue/Fulton Street (AM peak hour); and Masonic Avenue/Geary Boulevard, as presented on Matrix 1.2, Summary of Project Level Impacts, on FEIR pg. V.A.3-628.

Transit

As presented in the FEIR, Muni route 43 Masonic runs in both directions on this segment of Masonic Avenue with approximately six buses per hour each way during the peak periods, with two nearside stops and three farside stops for both northbound and southbound directions. In the Bicycle Plan FEIR, Option 1, reducing travel lanes in both directions (in particular to one lane northbound in the PM peak hour), added 6.4 minutes of delay for the northbound direction and 27 seconds of delay in the southbound direction during the PM peak hour under Existing plus Project conditions, resulting in a significant transit delay impact (TR-P3-2m) to the 43 Masonic line in the northbound direction during the PM peak hour. Similarly the FEIR identified a Cumulative transit delay impact (TR-P3-2n) for 43 Masonic in the northbound direction PM peak hour for Option 1 under Cumulative plus Project conditions. No feasible mitigation measures were identified for these two significant FEIR Option 1 project-related transit delay impacts, and they remained significant and unavoidable. FEIR Option 2, by providing a transit/bicycle only lane avoided these significant transit delay impacts.

The Modified Project Boulevard and Gateway design, while not having a dedicated transit lane (as under FEIR Option 2), would retain two travel lanes in both directions during both the AM and PM peak periods. This would represent one additional travel lane in the northbound direction during the PM peak period as compared to FEIR Option 1. Therefore the delay to the 43 Masonic northbound direction during the PM peak hour would improve over FEIR Option 1 in the northbound direction, being similar to Existing Conditions reported in the FEIR for both Modified Options, and would reduce the impact to a less-than-significant level under the Modified Project designs for the 43 Masonic northbound. Similar to FEIR Option 1 and 2, the project-related transit impact to the 43 southbound under both Modified Project designs would remain less-than-significant. The Modified Project designs install enhanced bus stops (transit bulbs) at all existing bus stops which decrease operational delays (that result from buses pulling in and out of traffic), and relocates one southbound bus stop at Fulton Street from the near side to the farside of the intersection, also reducing transit delay. The Modified Project designs, by retaining two travel lanes in each direction, would also improve upon the less than significant delays analyzed for both FEIR Option 1 and Option 2 for the 31BX Balboa 'B' Express route. Other elements of the Modified Project designs (center landscaped median, pedestrian bulbouts, and an improved pedestrian plaza at Geary Boulevard) would not substantially alter transit operations along Masonic Avenue, and similar elements were analyzed in the Bicycle Plan FEIR.

Similarly, under Cumulative conditions, the Modified Project designs would improve the operation of the 43 Masonic northbound over FEIR Option 1 such that the delay to transit vehicles would be similar to that experienced without the project under Cumulative conditions, and for both Modified Project designs would therefore reduce the significant cumulative impact identified in the FEIR to a less-than-significant level for the 43 northbound under the Modified Project designs. Similarly, the Modified Project designs transit delay, by retaining two travel lanes in each direction, would be similar to or improve upon the less-than-significant cumulative transit delays analyzed for both FEIR Option 1 and Option 2 for the 31BX Balboa 'B' Express route.

Pedestrians

The Modified Project designs (Boulevard and Gateway) would improve the pedestrian conditions along Masonic Avenue as compared to FEIR Options 1 and 2, through the addition of wider sidewalks, additional landscaping, transit bulbs, pedestrian corner bulbs and the improved pedestrian plaza at Geary Boulevard. Similar to the findings in the FEIR, pedestrian impacts would be less than significant with implementation of the Modified Project designs.

Bicycle

The Modified Project designs would improve upon the time/day limited bicycle lanes included in FEIR Options 1 and 2. Instead the Modified Project designs would provide grade separated or Class II bike lanes along both northbound and southbound Masonic Avenue between Fell Street and Geary Boulevard. Similar to both Options 1 and 2 analyzed in the FEIR, the Modified Project designs could have a beneficial effect of improving roadway conditions and safety for bicyclists, would not adversely affect bicycle operations in the project vicinity.

Parking

This parking discussion for the Modified Project designs supplements the parking conditions in the Bicycle Plan FEIR pp. V.A.3, 386-387 for Project 3-2, which indicate that under Existing Conditions (non-peak hours) there are 150 parking spaces along Masonic Avenue between Fell Street and Geary Boulevard. FEIR Option 1 permanently removes an estimated 15 parking spaces along the corridor. FEIR Option 2 permanently removed 27 on-street spaces, and temporarily (weekdays 7 a.m. to 6 p.m.) removed 115 parking spaces. The Modified Project designs (both Boulevard and Gateway designs) through the removal of the peak period towaway lanes (which is parking during the off-peak periods) results in more permanent removal of parking described as temporarily removed under FEIR Option 2. Parking removal and conditions for each of the Masonic Avenue roadway segments, similar to those discussed in the FEIR, would be as follows.

Segment 1: Fell Street to Hayes Street: As compared to the two FEIR Options, the Modified Project Boulevard Design and Modified Project Gateway Design would retain one additional travel lane in the southbound direction and remove parking on both sides of the street, or approximately five additional parking spaces more than the FEIR analysis.

Segment 2: Hayes Street to Grove Street: As compared to the two FEIR Options, the Modified Project Boulevard Design and Modified Project Gateway Design would be similar to the operating conditions of the FEIR Option 2 during the weekday daytime hours, and would remove 14 parking spaces permanently (not just from 7 am – 6 pm on weekdays as discussed under FEIR Option 2). Similar to FEIR Option 1, the Modified Gateway Design retains parking on the eastside of Masonic Avenue in this segment, or approximately 3 parking spaces.

Segment 3: Grove Street to Anza/O'Farrell Streets: Similar to the Segment 2 discussion, as compared to the FEIR Option 1 and 2, the Modified Project Boulevard Design and Modified Project Gateway Design would be similar to the operating conditions of the FEIR Option 2 during the weekday daytime hours, which temporarily (between the hours of 7 a.m. and 6 p.m.) would remove 107 parking spaces. The Modified Project Boulevard Design would have similar parking removal as FEIR Option 2 for this segment, but on a more permanent basis (not just weekdays 7 a.m. to 6 p.m.) while the Modified Project Gateway Design would retain some (approximately 55), but not all parking spaces along the east side of Masonic Avenue.

Segment 4: O'Farrell Street/Anza Street to Geary Boulevard: FEIR Option 1 in this section would remove parking lane (approximately 15 parking spaces, while FEIR Option 2 would remove parking on both sides of the street (approximately 25 parking spaces). The Modified Project designs would be similar to FEIR Option 2, removing 25 parking spaces, plus would remove approximately 10 additional parking spaces for the redesigned pedestrian plaza just west of Masonic Avenue and Geary Boulevard.

In total the Modified Project Boulevard design would remove most if not all of the 150 parking spaces along Masonic Avenue, including 10 additional parking spaces along the redesigned pedestrian plaza at Geary Boulevard and Masonic Avenue. The Modified Project Gateway design would remove all on-street parking on the west side of Masonic Avenue retaining some parking, approximately 58 parking spaces, along the east side of Masonic Avenue. The Modified Project Gateway design would have similar removal of approximately 10 parking spaces related to the pedestrian plaza redesign.

Consistent with the findings reported in the FEIR and presented here for informational purposes, implementation of the Modified Project designs would increase parking demand in the area. San Francisco does not consider parking supply as part of the permanent physical environment. Parking conditions are not static, as parking supply and demand varies from day to day, from day to night, from month to month, etc. Hence, the availability of parking spaces (or lack thereof) is not a permanent physical condition, but changes over time as people change their modes and patterns of travel.

Parking deficits are considered to be social effects, rather than impacts on the physical environment as defined by CEQA. Under CEQA, a project's social impacts need not be treated as significant impacts on the environment. Environmental documents should, however, address the secondary physical impacts that could be triggered by a social impact (CEQA Guidelines § 15131(a)). The social inconvenience of parking deficits, such as having to hunt for scarce parking spaces, is not an environmental impact, but there may be secondary physical environmental impacts, such as increased traffic congestion at intersections, air quality impacts, safety impacts, or noise impacts caused by congestion. In the experience of San Francisco transportation planners, however, the absence of a ready supply of parking spaces, combined with available alternatives to auto travel (e.g., transit service, taxis, bicycles or travel by foot) and a relatively dense pattern of urban development, induces many drivers to seek and find alternative parking facilities, shift to other modes of travel, or change their overall travel habits. Any such resulting shifts to transit service in particular, would be in keeping with the City's "Transit First" policy. The City's Transit First Policy, established in the City's Charter Section 8A.115 provides that "parking policies for areas well served by public transit shall be designed to encourage travel by public transportation and alternative transportation."

The transportation analysis accounts for potential secondary effects, such as cars circling and looking for a parking space in areas of limited parking supply, by assuming that all drivers would attempt to find parking at or near the project site and then seek parking farther away if convenient parking is unavailable. Moreover, the secondary effects of drivers searching for parking is typically offset by a reduction in vehicle trips due to others who are aware of constrained parking conditions in a given area. Hence, any secondary environmental impacts which may result from a shortfall in parking in the vicinity of the Modified Project would be minor, and the traffic assignments used in the transportation analysis, as well as in the associated air quality, noise and pedestrian safety analyses, reasonably addresses potential secondary effects.

Loading

As described in the FEIR, page V.A.3-388, the project area consists of predominantly residential uses, with some institutional and retail use along Masonic Avenue. Commercial loading along Masonic Avenue typically occurs on side streets, or within off-street parking areas. There was one on-street commercial loading zone near Hayes Street reported in the FEIR, which under FEIR Option 2 would be removed during daytime hours (7 a.m. – 6 p.m.). Under both Modified Project designs this commercial parking space would be removed (not just weekdays 7 a.m. to 6 p.m. as under FEIR Option 2.). Under the Modified Project Gateway Design, some general parking would remain along the east side of Masonic Avenue which could be used for commercial parking, while under Modified Project Boulevard Design parking would be removed. Therefore, under the Modified Project designs commercial loading would more likely utilize side streets. This, similar to the conclusion reached in the FEIR for Project 3-2, would be considered a less-than-significant loading impact associated with implementation of the project as modified.

FEIR Mitigation Measures

As discussed above, and shown in Table 5: Bicycle Plan FEIR Project 3-2 Options 1 & 2 and Modified Project Designs Impacts and Mitigation Measures, the Bicycle Plan FEIR identified transportation impacts and two mitigation measures for Project 3-2, including:

**TABLE 5
BICYCLE PLAN FEIR PROJECT 3-2 OPTIONS AND MODIFIED PROJECT DESIGNS
SUMMARY OF IMPACTS & MITIGATION MEASURES**

Bicycle Plan FEIR Significant Impacts	FEIR Mitigation Measure	Level of Significance with Mitigation	Modified Project 3-2 Level of Significance
TR-P3-2a: FEIR Option 1 Cumulative (2025) plus Project impact under at Masonic Avenue/Turk Street operating at LOS F during AM peak hour.	No feasible mitigation identified.	SUI	SUI: Intersection operates at LOS F during AM peak hour under Cumulative Conditions with Modified Project designs.
TR-P3-2b: FEIR Option 2 Cumulative (2025) plus Project impact at Masonic Avenue/Turk Street operating at LOS F during AM peak hour.	No feasible mitigation identified.	SUI	SUI: Intersection operates at LOS F during AM peak hour under Cumulative Conditions with Modified Project designs.
TR-P3-2c: FEIR Option 1 Cumulative (2025) plus Project impact at Masonic Avenue/Fulton Street operating at LOS F during AM peak hour.	No feasible mitigation identified.	SUI	SUI: Intersection operates at LOS F during AM peak hour under Cumulative Conditions with Modified Project designs.
TR-P3-2d: FEIR Option 2 Cumulative (2025) plus Project impact at Masonic Avenue/Fulton Street operating at LOS F during AM peak hour.	No feasible mitigation identified.	SUI	SUI: Intersection operates at LOS F during AM peak hour under Cumulative Conditions with Modified Project designs.
TR-P3-2e: FEIR Option 1 Existing plus Project impact at Masonic Avenue/Fell Street operating at LOS E during the PM peak hour.	No feasible mitigation identified.	SUI	LTS: Intersection operation improves to LOS C during PM peak hour under Existing plus Project conditions with Modified Project designs.
TR-P3-2f: FEIR Option 2 Existing plus Project impact at Masonic Avenue/Fell	M-TR-P3-2f: Add four seconds of green time to	LTS	LTS: Intersection operation improves to LOS C during PM peak hour under

Bicycle Plan FEIR Significant Impacts	FEIR Mitigation Measure	Level of Significance with Mitigation	Modified Project 3-2 Level of Significance
Street operating at LOS E during the PM peak hour.	NB & SB Masonic Avenue movements (and away from Fell Street WB movement).		Existing plus Project conditions with Modified Project designs. Modified Project 3-2 would still implement mitigation measure M-TR-P3-2f to further improve operations.
TR-P3-2g: FEIR Option 1 Cumulative (2025) plus Project impact at Masonic Avenue/Fell Street operating at LOS F during the PM peak hour	No feasible mitigation identified	SUI	LTS: Intersection operation improves to LOS C during PM peak hour under Cumulative plus Project conditions with Modified Project designs.
TR-P3-2h: FEIR Option 2 Cumulative (2025) plus Project impact at Masonic Avenue/Fell Street operating at LOS E during the PM peak hour	No feasible mitigation identified	SUI	LTS: Intersection operation improves to LOS C during PM peak hour under Cumulative plus Project conditions with Modified Project Designs.
TR-P3-2i: FEIR Option 1 Cumulative (2025) plus Project impact at Masonic Avenue/Geary Boulevard operating at LOS E during the PM peak hour	No feasible mitigation identified	SUI	SUI: Intersection operates at LOS E during PM peak hour under Cumulative Conditions with Modified Project designs
TR-P3-2j: FEIR Option 1 Cumulative (2025) plus Project impact at Masonic Avenue/Turk Street operating at LOS F during the PM peak hour	M-TR-P3-2j: Add ten seconds of green time to NB Masonic Avenue direction (and away from Turk Street EB movement	SUI	LTS: Intersection operation improves to LOS D during PM peak hour under Cumulative plus Project conditions with Modified Project designs. Modified Project 3-2 would still implement mitigation measure M- M-TR-P3-2j to further improve operations.
TR-P3-2m: FEIR Option 1 Existing plus Project transit delay impact for the 43 northbound during the PM peak hour	No feasible mitigation identified	SUI	LTS: Transit delay improves with the Modified Project designs.
TR-P3-2n: FEIR Option 1 Cumulative (2025) plus Project transit delay impact for the 43 northbound during the PM peak hour	No feasible mitigation identified	SUI	LTS: Transit delay improves with the Modified Project designs.

As discussed above in more detail, the mitigation measures address significant traffic and transit impacts for Existing-plus-Project and Project-plus-Cumulative 2025 conditions along the Masonic Avenue project corridor as presented in the CEQA Findings adopted by the Planning Commission and in Table 1 through Table 4 of this Addendum. Most of the mitigation measures indicate no feasible mitigations were available, with the exception of mitigation at intersections (M-TR-P3-2f and M-TR-P3-2j), which could be implemented as part of the Bicycle Plan FEIR, although under Modified Project designs the impact would be reduced to a less-than-significant level.

As discussed above, the Modified Project designs would result in similar or less significant unavoidable traffic impacts as identified in the FEIR for Project 3-2. Significant impacts that are retained, but not made worse, under the Modified Project designs include TR-P3-2c, TR-P3-2d and TR-P3-2i. These impacts were found to be significant and unavoidable, because identified mitigation measures could not be implemented to feasibly reduce impacts to less-than-significant levels while also meeting the primary goals and objectives of the project. In summary, the significance of impacts with the Modified Project designs as indicated for traffic, transit, pedestrians, bicyclists, and loading would generally be the same or less than those described for Project 3-2 Options 1 and 2 reported in the certified FEIR.

Aesthetics

The Modified Project would result in physical changes within the street right-of-way along the project corridor as described in this Addendum's Project Description. In summary, physical changes that may have an effect on the visual setting and aesthetic character of the area include removal of on-street parking, establishment of new bicycle lanes, changes to lane and sidewalk widths, transit bulbs, pedestrian corner bulbs, the proposed median (in sections or along entire corridor), and new landscaping and lighting along the project corridor.

The General Plan indicates that Masonic Avenue is a "Street that Extends the Effect of Public Open Space" as well as a street that is "Important for the Quality of its Views" (General Plan, Urban Design Element, p. I.5.16).

The Modified Project would alter public views currently available from Masonic Avenue, as well as the visual character of the street and its immediate surroundings with the addition of corner bulbouts, pedestrian refuges, street-lighting, street trees along the sidewalks and within a new median, new lane stripping, as well as vehicular and pedestrian signage. The addition of these physical elements to the public realm would not adversely affect the streetscape and would contribute to a greater sense of visual organization associated with their specific functions for pedestrians, bicyclists and motorists than currently exists. For example, bulbouts at corners and the landscaped medians would result in traffic calming and enhanced sight lines for both motorists and pedestrians. Bicycle lanes on the north and south sides of Masonic Avenue would provide a visually delineated path of travel for cyclists as well as for motorists. Trees would add greenery along the edges of the roadway. Trees proposed within the median would contribute to greenery within the roadbed, which is currently characterized primarily by views of large expanses of asphalt. No unique scenic resources would be adversely affected.

Like Project 3-2, FEIR Options 1 and 2, the Modified Project designs would likely include the addition of signs along some of these streets, but such signs would not be excessively large and would not obstruct views or cast perceptible shadows. As described in the Bicycle Plan Initial Study (FEIR Appendix A, p. 54):

"Article 6 of the Planning Code governs signs in the City. Section 603 exempts governmental traffic control signs from the provisions of Article 6. Portions of the Proposed Project would include improvements along designated scenic streets, which are identified in Planning Code Section 608.6. Planning Code Section 608.6 regulates the placement of signs along these designated scenic streets, and states that no general advertising sign and no other sign exceeding 200 square feet in area can be placed along such streets. The Proposed Project would include the addition of street signage. However, any new signs installed as a result of the Proposed Project would be smaller than those regulated under Planning Code Section 608.6. Therefore, there would not be a significant impact with respect to scenic street resources."

The Modified Project's physical features would not affect a scenic vista, nor would it create new sources of substantial light or glare, or cast shadows. Therefore, the Modified Project designs, similar to the Bicycle Plan Initial Study findings, would have no significant impacts with respect to scenic vistas, light, or glare. The project would not affect a "Street that Extends the Effect of Public Open Space" or a street that is "Important for the Quality of its Views" in an adverse or demonstrable manner. Thus, similar to the conclusions reached in the Initial Study for the Bicycle Plan, there would be no significant adverse impacts related to visual character and less-than-significant impact with respect to scenic resources resulting from the project as modified.

Air Quality

The Bicycle Plan FEIR (p. V.B, 22) found that:

"Implementation of the Proposed Project would not result in any new traffic volumes being added to the roadway network; therefore, there would be no change in the intersection volume under project conditions. Hence, intersection volumes stay constant between Existing and Existing plus Project Conditions. Similarly, there is no change in intersection volumes between 2025 Cumulative and 2025 Cumulative plus Project Conditions. However, the reduction of travel lanes at major intersections would increase traffic congestion at some intersections... under Cumulative Plus Project conditions, CO [carbon monoxide] would not exceed the ambient air quality standard and TAC [toxic air contaminants] emissions would be less than existing at all intersections. Therefore implementation and operation of the project would not result in significant adverse air quality impacts. "

"Bicycling has no associated emissions and the Proposed Project can reasonably be expected to reduce emissions citywide by shifting a portion of motor vehicle trips to bicycle trips. The Proposed Project could contribute to a new reduction in emissions and thus would have no impact and would not contribute to a cumulative impact... implementation of the Proposed Project does not result in any new automobile trips being added to the roadway network. Under cumulative conditions, with the Proposed Project included, CO and TAC emissions are predicted to decrease."

As illustrated in Table 1 through Table 4 in the Transportation analysis above, the Modified Project Boulevard and Gateway designs would generally be consistent with or improve upon intersection operations at the FEIR study intersections, compared to the delays reported for Project 3-2 Options 1 and 2 in the FEIR. Given the similarity to or reduction of delays expected under Modified Project designs as compared to the Bicycle Plan FEIR traffic analysis, the conclusions reached for the Bicycle Plan Program and Cumulative Conditions in the FEIR in relation to Air Quality impacts would be substantially the same as those for the program that would include the Modified Project. No new or substantially greater air quality impacts would occur.

Archeology

The Initial Study for the Bicycle Plan program determined that the project would have a less-than-significant impact on Archeology, stating on Page 58 of the Initial Study (Appendix A of the Bicycle Plan FEIR):

"The Planning Department found that the Proposed Project may require excavation in places to widen or narrow the roadway in the process of reconfiguring traffic lanes or parking, or to modify, install or remove medians. Excavation would be to a depth no

greater than 24 inches. No project activities were identified that would result in a potential to adversely affect CEQA significant archeological resources.”

And Page 59:

“Given the possibility that unanticipated archeological resources may be impacted by the Proposed Project, MEA Standard Archeological Mitigation Measure 1 (Accidental Discovery) will be implemented. With this mitigation measure, the potential of the Proposed Project to affect significant archeological resources would be reduced to a less-than-significant level.”

Mitigation Measure 1, from the Bicycle Plan Initial Study, addresses how to treat cultural resources in the case that any are discovered during construction of the Proposed Project. Implementation of Mitigation Measure 1 by the Modified Project designs would similarly be applicable and would reduce potential impacts to archeological resources and human remains to a less-than-significant level.

Water Quality & Runoff

The Initial Study for the Bicycle Plan program determined that the project would have a less-than-significant impact on Hydrology and Water Quality, stating on Page 75 of the Bicycle Plan Initial Study (Appendix A of the Bicycle Plan FEIR):

“The Proposed Project, located within the existing street right-of-way, would not change the amount of impervious surface area substantially, or alter the drainage pattern for the affected streets significantly. There are elements of the Proposed Project that would involve minor excavation and grading; however, the Proposed Project would generally replace paved surfaces with paved surfaces, with the exception of trees along streets and sidewalks. In the case of removed trees, some areas that are currently not paved might be paved over and rendered impervious, adding to stormwater runoff. These effects would be limited to small areas and would not be expected to significantly change runoff patterns.”

The Modified Project designs would, consistent with the above description, either replace existing pavement with new pavement, or generally decrease the amount of impervious surface along the Masonic Avenue Corridor by adding in additional permeable landscaping elements. Similarly, although more specific designs of the median elements and pedestrian plaza are included with the Modified Project (Gateway and Boulevard) designs than as described in the Project 3-2 Options analysis in the Bicycle Plan FEIR(pp. IV.B-22 through IV.B-24), the design elements are similar to other projects analyzed in the FEIR, such as Projects 4-4, 5-6, 5-10 and potential elements analyzed under the Long-Term Improvement Projects in the FEIR. During construction, there would be a temporary increase in the potential for erosion and transport of soil particles during any excavation. The Modified Project design construction would be required to comply with all local water quality requirements, including stormwater control measures to reduce potential erosion impacts during construction and runoff would be directed to the City’s combined stormwater/wastewater system and would be treated to standards contained in the City’s NPDES Permit prior to discharge. Therefore, the Modified Project designs would not substantially degrade hydrology and water quality, and impacts on water quality would be less than significant, consistent with the analysis and conclusions made in the Bicycle Plan FEIR Initial Study.

Other Issues

The Initial Study for the Bicycle Plan program determined that for the following topics, any environmental effects associated with the Program and its individual projects would either be insignificant or would be reduced to a less-than-significant level by implementation of the mitigation measures included in as part of the program: land use, population and housing, noise, air quality, recreation, utilities and service systems, public services, biological resources, geology and soils, hydrology and water quality, hazards and hazardous materials, mineral and energy resources, and agricultural resources. The FEIR did not discuss these issues further. The Initial Study, including the significance conclusions reached therein, remains applicable to the Modified Project designs and all mitigation and improvement measures from the Initial Study and the FEIR would be applied to the Modified Project, as appropriate, unless the impact was reduced to a less-than-significant level, as previously described.

CONCLUSION

Based on the foregoing, the Department concludes that the analyses conducted and the conclusions reached in the FEIR certified on June 25, 2009 remain valid, and that no supplemental environmental review is required for the proposed project modifications. The Modified Project would not cause new significant impacts not identified in the FEIR, or result in a substantial increase in the severity of previously identified significant impacts, and no new mitigation measures would be necessary to reduce significant impacts. No changes have occurred with respect to circumstances surrounding the original project that would cause significant environmental impacts to which the modified Project 3-2 would contribute considerably, and no new information has been put forward which shows that the modified project would cause significant environmental impacts. Therefore, no supplemental environmental review is required beyond this addendum.

I do hereby certify that the above determination has been made pursuant to State and Local requirements.

DATE June 28, 2012



Bill Wycko, Environmental Review Officer
for John Rahaim, Director of Planning

cc: James Shahamiri, San Francisco Municipal Transportation Agency, MTA Livable Streets
Bulletin Board / Master Decision File
Distribution List

APPENDIX A
TRAFFIX OUTPUT
INTERSECTION LEVEL OF SERVICE CALCULATIONS

Level of Service Computation Report
 2000 HCM Operations (Base Volume Alternative)
 Future+Project PM (Mod. Opt 1)

Intersection #43: Masonic/Fell

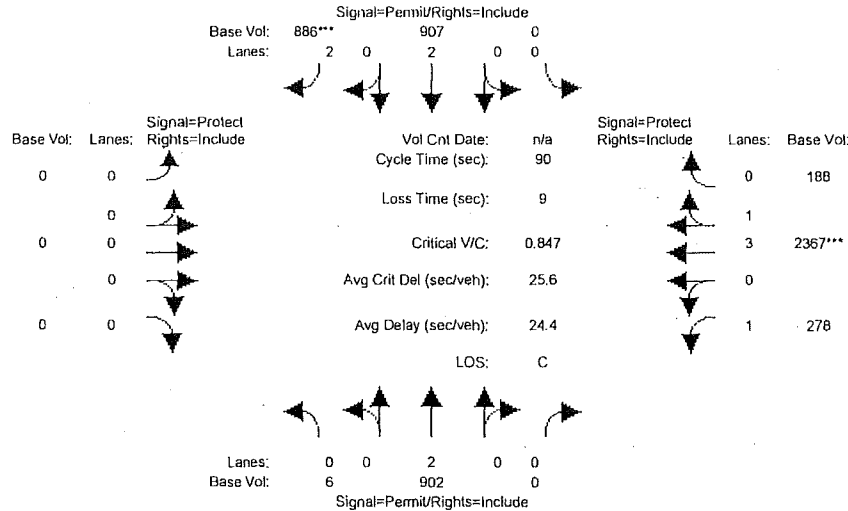

Approach:	North Bound			South Bound			East Bound			West Bound		
Movement:	L	T	R	L	T	R	L	T	R	L	T	R
Min. Green:	38	38	0	0	38	38	0	0	0	15	43	43
Y+R:	4.0	4.0	4.0	4.0	4.0	4.0	4.0	4.0	4.0	4.0	4.0	4.0

Volume Module:	North Bound			South Bound			East Bound			West Bound		
Base Vol:	6	902	0	0	907	886	0	0	0	278	2367	188
Growth Adj:	1.00	1.00	1.00	1.00	1.00	1.00	1.00	1.00	1.00	1.00	1.00	1.00
Initial Bse:	6	902	0	0	907	886	0	0	0	278	2367	188
User Adj:	1.00	1.00	1.00	1.00	1.00	1.00	1.00	1.00	1.00	1.00	1.00	1.00
PHF Adj:	0.95	0.95	0.95	0.95	0.95	0.95	0.95	0.95	0.95	0.95	0.95	0.95
PHF Volume:	6	949	0	0	955	933	0	0	0	293	2492	198
Reduct Vol:	0	0	0	0	0	0	0	0	0	0	0	0
Reduced Vol:	6	949	0	0	955	933	0	0	0	293	2492	198
PCE Adj:	1.00	1.00	1.00	1.00	1.00	1.00	1.00	1.00	1.00	1.00	1.00	1.00
MLF Adj:	1.00	1.00	1.00	1.00	1.00	1.00	1.00	1.00	1.00	1.00	1.00	1.00
Final Volume:	6	949	0	0	955	933	0	0	0	293	2492	198

Saturation Flow Module:	North Bound			South Bound			East Bound			West Bound		
Sat/Lane:	1900	1900	1900	1900	1900	1900	1900	1900	1900	1900	1900	1900
Adjustment:	0.89	0.89	1.00	1.00	0.93	0.68	1.00	1.00	1.00	0.78	0.88	0.82
Lanes:	0.01	1.99	0.00	0.00	2.00	2.00	0.00	0.00	0.00	1.00	3.69	0.31
Final Sat.:	22	3342	0	0	3538	2599	0	0	0	1477	6177	491

Capacity Analysis Module:	North Bound			South Bound			East Bound			West Bound		
Vol/Sat:	0.28	0.28	0.00	0.00	0.27	0.36	0.00	0.00	0.00	0.20	0.40	0.40
Crit Moves:						****					****	
Green Time:	38.0	38.0	0.0	0.0	38.0	38.0	0.0	0.0	0.0	43.0	43.0	43.0
Volume/Cap:	0.67	0.67	0.00	0.00	0.64	0.85	0.00	0.00	0.00	0.41	0.84	0.84
Delay/Veh:	23.5	23.5	0.0	0.0	22.7	31.7	0.0	0.0	0.0	17.1	23.5	23.5
User DelAdj:	1.00	1.00	1.00	1.00	1.00	1.00	1.00	1.00	1.00	1.00	1.00	1.00
AdjDel/Veh:	23.5	23.5	0.0	0.0	22.7	31.7	0.0	0.0	0.0	17.1	23.5	23.5
LOS by Move:	C	C	A	A	C	C	A	A	A	B	C	C
HCM2kAvgQ:	12	12	0	0	10	13	0	0	0	5	21	19

Note: Queue reported is the number of cars per lane.

Level Of Service Computation Report
 2000 HCM Operations (Base Volume Alternative)
 Existing+Project PM (Mod. Opt 1)

Intersection #43: Masonic/Fell

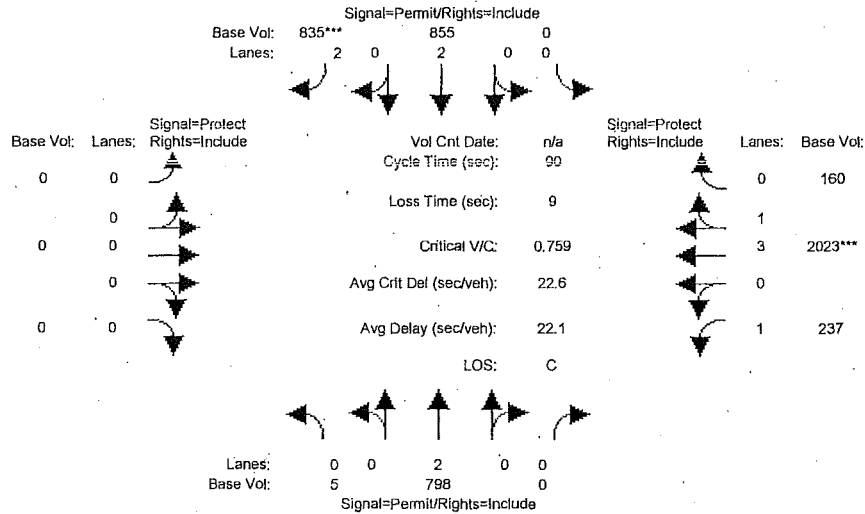

Approach:	North Bound			South Bound			East Bound			West Bound		
Movement:	L	T	R	L	T	R	L	T	R	L	T	R
Min. Green:	38	38	0	0	38	38	0	0	0	15	43	43
Y+R:	4.0	4.0	4.0	4.0	4.0	4.0	4.0	4.0	4.0	4.0	4.0	4.0

Volume Module:	North Bound			South Bound			East Bound			West Bound		
Base Vol:	5	798	0	0	855	835	0	0	0	237	2023	160
Growth Adj:	1.00	1.00	1.00	1.00	1.00	1.00	1.00	1.00	1.00	1.00	1.00	1.00
Initial Bse:	5	798	0	0	855	835	0	0	0	237	2023	160
User Adj:	1.00	1.00	1.00	1.00	1.00	1.00	1.00	1.00	1.00	1.00	1.00	1.00
PHF Adj:	0.95	0.95	0.95	0.95	0.95	0.95	0.95	0.95	0.95	0.95	0.95	0.95
PHF Volume:	5	840	0	0	900	879	0	0	0	249	2129	168
Reduct Vol:	0	0	0	0	0	0	0	0	0	0	0	0
Reduced Vol:	5	840	0	0	900	879	0	0	0	249	2129	168
PCE Adj:	1.00	1.00	1.00	1.00	1.00	1.00	1.00	1.00	1.00	1.00	1.00	1.00
MLF Adj:	1.00	1.00	1.00	1.00	1.00	1.00	1.00	1.00	1.00	1.00	1.00	1.00
Final Volume:	5	840	0	0	900	879	0	0	0	249	2129	168

Saturation Flow Module:	North Bound			South Bound			East Bound			West Bound		
Sat/Lane:	1900	1900	1900	1900	1900	1900	1900	1900	1900	1900	1900	1900
Adjustment:	0.89	0.89	1.00	1.00	0.93	0.68	1.00	1.00	1.00	0.78	0.88	0.82
Lanes:	0.01	1.99	0.00	0.00	2.00	2.00	0.00	0.00	0.00	1.00	3.69	0.31
Final Sat.:	21	3343	0	0	3538	2599	0	0	0	1477	6179	489

Capacity Analysis Module:	North Bound			South Bound			East Bound			West Bound		
Vol/Sat:	0.25	0.25	0.00	0.00	0.25	0.34	0.00	0.00	0.00	0.17	0.34	0.34
Crit Moves:					****	****					****	****
Green Time:	38.0	38.0	0.0	0.0	38.0	38.0	0.0	0.0	0.0	43.0	43.0	43.0
Volume/Cap:	0.60	0.60	0.00	0.00	0.60	0.80	0.00	0.00	0.00	0.35	0.72	0.72
Uniform Del:	20.1	20.1	0.0	0.0	20.1	22.7	0.0	0.0	0.0	14.8	18.7	18.7
IncramntDel:	1.8	1.8	0.0	0.0	1.8	6.2	0.0	0.0	0.0	1.4	1.4	1.4
InitQueueDel:	0.0	0.0	0.0	0.0	0.0	0.0	0.0	0.0	0.0	0.0	0.0	0.0
Delay Adj:	1.00	1.00	0.00	0.00	1.00	1.00	0.00	0.00	0.00	1.00	1.00	1.00
Delay/Veh:	21.9	21.9	0.0	0.0	22.0	28.9	0.0	0.0	0.0	16.2	20.2	20.2
User DelAdj:	1.00	1.00	1.00	1.00	1.00	1.00	1.00	1.00	1.00	1.00	1.00	1.00
AdjDel/Veh:	21.9	21.9	0.0	0.0	22.0	28.9	0.0	0.0	0.0	16.2	20.2	20.2
LOS by Move:	C	C	A	A	C	C	A	A	A	B	C	C
HCM2kAvgQ:	10	10	0	0	10	12	0	0	0	4	15	14

Note: Queue reported is the number of cars per lane.

Level of Service Computation Report
 2000 HCM Operations (Base Volume Alternative)
 Future+Project PM (Mod. Opt 1)

Intersection #44: Masonic/Geary

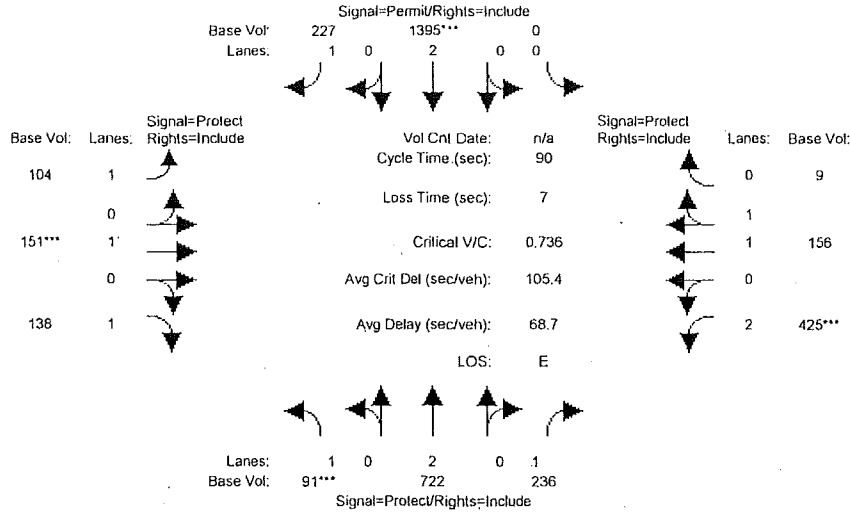

Approach:	North Bound			South Bound			East Bound			West Bound		
Movement:	L	T	R	L	T	R	L	T	R	L	T	R
Min. Green:	19	56	56	33	33	33	11	27	27	11	27	27
Y+R:	4.0	4.0	4.0	4.0	4.0	4.0	4.0	4.0	4.0	4.0	4.0	4.0
Volume Module:												
Base Vol:	91	722	236	0	1395	227	104	151	138	425	156	9
Growth Adj:	1.00	1.00	1.00	1.00	1.00	1.00	1.00	1.00	1.00	1.00	1.00	1.00
Initial Bse:	91	722	236	0	1395	227	104	151	138	425	156	9
User Adj:	1.00	1.00	1.00	1.00	1.00	1.00	1.00	1.00	1.00	1.00	1.00	1.00
PHF Adj:	0.95	0.95	0.95	0.95	0.95	0.95	0.95	0.95	0.95	0.95	0.95	0.95
PHF Volume:	96	760	248	0	1468	239	109	159	145	447	164	9
Reduced Vol:	0	0	0	0	0	0	0	0	0	0	0	0
Reduced Vol:	96	760	248	0	1468	239	109	159	145	447	164	9
PCE Adj:	1.00	1.00	1.00	1.00	1.00	1.00	1.00	1.00	1.00	1.00	1.00	1.00
MLF Adj:	1.00	1.00	1.00	1.00	1.00	1.00	1.00	1.00	1.00	1.00	1.00	1.00
Final Volume:	96	760	248	0	1468	239	109	159	145	447	164	9
Saturation Flow Module:												
Sat/Lane:	1900	1900	1900	1900	1900	1900	1900	1900	1900	1900	1900	1900
Adjustment:	0.93	0.93	0.78	1.00	0.93	0.83	0.93	0.98	0.83	0.90	0.92	0.92
Lanes:	1.00	2.00	1.00	0.00	2.00	1.00	1.00	1.00	1.00	2.00	1.89	0.11
Final Sat.:	1769	3538	1477	0	3538	1583	1769	1862	1583	3432	3318	191
Capacity Analysis Module:												
Vol/Sat:	0.05	0.21	0.17	0.00	0.42	0.15	0.06	0.09	0.09	0.13	0.05	0.05
Crit Moves:	****				****			****		****		
Green Time:	16.9	49.5	49.5	0.0	32.6	32.6	9.9	24.1	24.1	10.2	24.4	24.4
Volume/Cap:	0.29	0.39	0.31	0.00	1.15	0.42	0.56	0.32	0.34	1.15	0.18	0.18
Delay/Veh:	37.4	13.6	13.3	0.0	108	26.5	53.8	31.3	32.1	137.0	28.7	28.7
User DelAdj:	1.00	1.00	1.00	1.00	1.00	1.00	1.00	1.00	1.00	1.00	1.00	1.00
AdjDel/Veh:	37.4	13.6	13.3	0.0	108	26.5	53.8	31.3	32.1	137.0	28.7	28.7
LOS by Move:	D	B	B	A	F	C	D	C	C	F	C	C
HCM2kAvgQ:	2	7	4	0	40	6	4	4	4	14	2	2

Note: Queue reported is the number of cars per lane.

Level Of Service Computation Report
 2000 HCM Operations (Base Volume Alternative)
 Existing+Project PM (Mod. Opt 1)

Intersection #44: Masonic/Geary

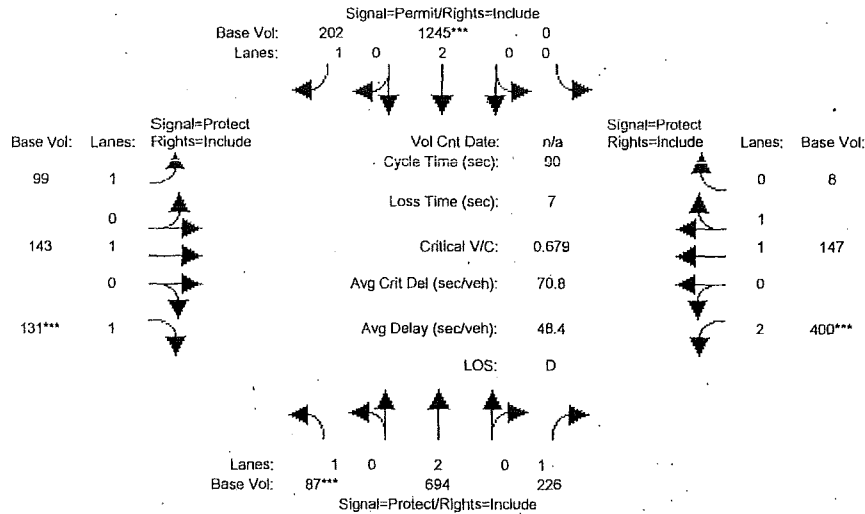

Approach:	North Bound			South Bound			East Bound			West Bound		
	I	T	R	I	T	R	T	T	R	L	T	R
Min. Green:	19	56	56	33	33	33	11	27	27	11	27	27
Y+R:	4.0	4.0	4.0	4.0	4.0	4.0	4.0	4.0	4.0	4.0	4.0	4.0

Volume Module:

Base Vol:	87	694	226	0	1245	202	99	143	131	400	147	8
Growth Adj:	1.00	1.00	1.00	1.00	1.00	1.00	1.00	1.00	1.00	1.00	1.00	1.00
Initial Bse:	87	694	226	0	1245	202	99	143	131	400	147	8
User Adj:	1.00	1.00	1.00	1.00	1.00	1.00	1.00	1.00	1.00	1.00	1.00	1.00
PHF Adj:	0.95	0.95	0.95	0.95	0.95	0.95	0.95	0.95	0.95	0.95	0.95	0.95
PHF Volume:	92	731	238	0	1311	213	104	151	138	421	155	8
Reduct Vol:	0	0	0	0	0	0	0	0	0	0	0	0
Reduced Vol:	92	731	238	0	1311	213	104	151	138	421	155	8
PCE Adj:	1.00	1.00	1.00	1.00	1.00	1.00	1.00	1.00	1.00	1.00	1.00	1.00
MLF Adj:	1.00	1.00	1.00	1.00	1.00	1.00	1.00	1.00	1.00	1.00	1.00	1.00
Final Volume:	92	731	238	0	1311	213	104	151	138	421	155	8

Saturation Flow Module:

Sat/Lane:	1900	1900	1900	1900	1900	1900	1900	1900	1900	1900	1900	1900
Adjustment:	0.93	0.93	0.78	1.00	0.93	0.83	0.93	0.98	0.83	0.90	0.92	0.92
Lanes:	1.00	2.00	1.00	0.00	2.00	1.00	1.00	1.00	1.00	2.00	1.90	0.10
Final Sat.:	1769	3538	1477	0	3538	1583	1769	1862	1583	3432	3328	181

Capacity Analysis Module:

Vol/Sat:	0.05	0.21	0.16	0.00	0.37	0.13	0.06	0.08	0.09	0.12	0.05	0.05
Crit Moves:	****				****				****	****		
Green Time:	16.9	49.1	49.1	0.0	32.1	32.1	10.0	24.1	24.1	10.6	24.7	24.7
Volume/Cap:	0.28	0.38	0.30	0.00	1.04	0.38	0.53	0.30	0.33	1.04	0.17	0.17
Uniform Del:	35.1	13.2	12.5	0.0	32.5	24.1	42.4	29.5	29.7	44.5	27.9	27.9
IncrcmntDel:	2.0	0.6	0.9	0.0	35.6	1.9	9.7	1.6	2.0	54.9	0.4	0.4
InitQueueDel:	0.0	0.0	0.0	0.0	0.0	0.0	0.0	0.0	0.0	0.0	0.0	0.0
Delay Adj:	1.00	1.00	1.00	0.00	1.00	1.00	1.00	1.00	1.00	1.00	1.00	1.00
Delay/Veh:	37.1	13.7	13.4	0.0	68.1	26.0	52.1	31.1	31.7	99.4	28.3	28.3
User DelAdj:	1.00	1.00	1.00	1.00	1.00	1.00	1.00	1.00	1.00	1.00	1.00	1.00
AdjDel/Veh:	37.1	13.7	13.4	0.0	68.1	26.0	52.1	31.1	31.7	99.4	28.3	28.3
LOS by Move:	D	B	B	A	E	C	D	C	C	F	C	C
HCM2kAvgQ:	2	7	4	0	30	5	4	4	4	12	2	2

Note: Queue reported is the number of cars per lane.

Level Of Service Computation Report
 2000 HCM Operations (Base Volume Alternative)
 Future+Project AM (Mod. Opt 1)

Intersection #59: Masonic/Turk

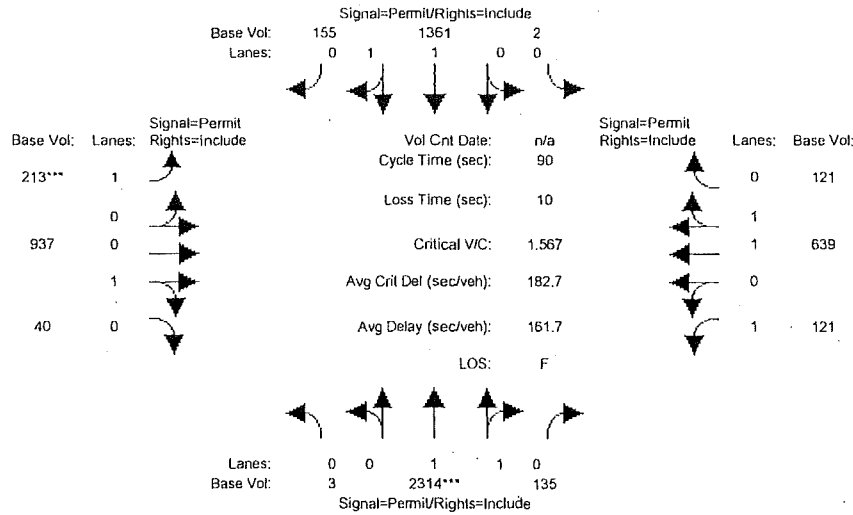

Approach:	North Bound			South Bound			East Bound			West Bound		
Movement:	L	T	R	L	T	R	L	T	R	L	T	R
Min. Green:	53	53	53	53	53	53	27	27	27	27	27	27
Y+R:	4.0	4.0	4.0	4.0	4.0	4.0	4.0	4.0	4.0	4.0	4.0	4.0
Volume Module:												
Base Vol:	3	2314	135	2	1361	155	213	937	40	121	639	121
Growth Adj:	1.00	1.00	1.00	1.00	1.00	1.00	1.00	1.00	1.00	1.00	1.00	1.00
Initial Bse:	3	2314	135	2	1361	155	213	937	40	121	639	121
User Adj:	1.00	1.00	1.00	1.00	1.00	1.00	1.00	1.00	1.00	1.00	1.00	1.00
PHF Adj:	0.95	0.95	0.95	0.95	0.95	0.95	0.95	0.95	0.95	0.95	0.95	0.95
PHF Volume:	3	2436	142	2	1433	163	224	986	42	127	673	127
Reduct Vol:	0	0	0	0	0	0	0	0	0	0	0	0
Reduced Vol:	3	2436	142	2	1433	163	224	986	42	127	673	127
PCE Adj:	1.00	1.00	1.00	1.00	1.00	1.00	1.00	1.00	1.00	1.00	1.00	1.00
MLF Adj:	1.00	1.00	1.00	1.00	1.00	1.00	1.00	1.00	1.00	1.00	1.00	1.00
Final Volume:	3	2436	142	2	1433	163	224	986	42	127	673	127
Saturation Flow Module:												
Sat/Lane:	1900	1900	1900	1900	1900	1900	1900	1900	1900	1900	1900	1900
Adjustment:	0.90	0.90	0.90	0.81	0.81	0.81	0.19	0.99	0.99	0.15	0.93	0.93
Lanes:	0.01	1.88	0.11	0.01	1.79	0.20	1.00	0.96	0.04	1.00	1.68	0.32
Final Sat.:	4	3227	188	4	2761	314	352	1811	77	281	2962	561
Capacity Analysis Module:												
Vol/Sat:	0.75	0.75	0.75	0.52	0.52	0.52	0.64	0.54	0.54	0.45	0.23	0.23
Crit Moves:	****						****					
Green Time:	53.0	53.0	53.0	53.0	53.0	53.0	27.0	27.0	27.0	27.0	27.0	27.0
Volume/Cap:	1.28	1.28	1.28	0.88	0.88	0.88	2.13	1.82	1.82	1.51	0.76	0.76
Uniform Del:	18.5	18.5	18.5	15.8	15.8	15.8	31.5	31.5	31.5	31.5	28.5	28.5
IncrementDel:	130.6	131	130.7	5.4	5.4	5.4	537.2	374	373.8	281.0	3.2	3.2
InitQueueDel:	0.0	0.0	0.0	0.0	0.0	0.0	0.0	0.0	0.0	0.0	0.0	0.0
Delay Adj:	1.00	1.00	1.00	1.00	1.00	1.00	1.00	1.00	1.00	1.00	1.00	1.00
Delay/Veh:	149.1	149	149.2	21.2	21.2	21.2	568.7	405	405.3	312.5	31.7	31.7
User DelAdj:	1.00	1.00	1.00	1.00	1.00	1.00	1.00	1.00	1.00	1.00	1.00	1.00
AdjDel/Veh:	149.1	149	149.2	21.2	21.2	21.2	568.7	405	405.3	312.5	31.7	31.7
LOS by Move:	F	F	F	C	C	C	F	F	F	F	C	C
HCM2kAvgQ:	72	72	72	22	22	22	22	86	86	11	12	12

Level Of Service Computation Report
 2000 HCM Operations (Base Volume Alternative)
 Existing+Project AM (Mod. Opt 1)

Intersection #59: Masonic/Turk

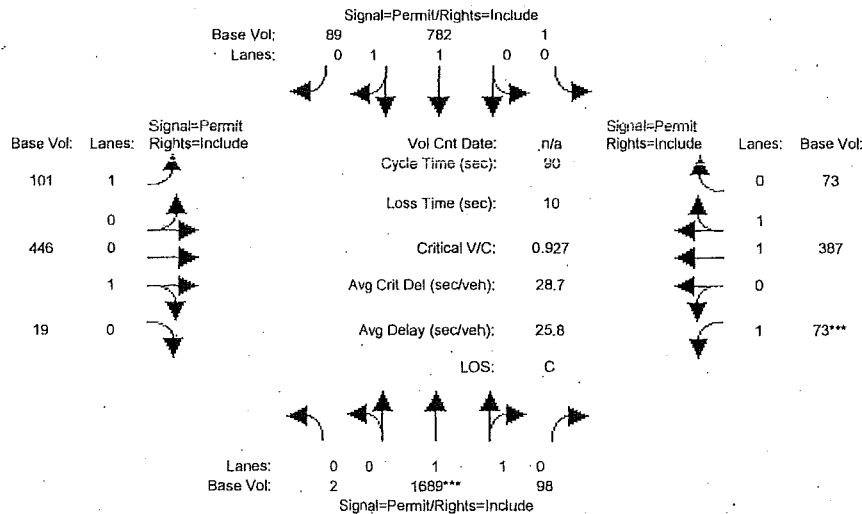

Approach:	North Bound			South Bound			East Bound			West Bound		
Movement:	L	T	R	L	T	R	L	T	R	L	T	R
Min. Green:	53	53	53	53	53	53	27	27	27	27	27	27
Y+R:	4.0	4.0	4.0	4.0	4.0	4.0	4.0	4.0	4.0	4.0	4.0	4.0

Volume Module:	North Bound			South Bound			East Bound			West Bound		
Base Vol:	2	1689	98	1	782	89	101	446	19	73	387	73
Growth Adj:	1.00	1.00	1.00	1.00	1.00	1.00	1.00	1.00	1.00	1.00	1.00	1.00
Initial Bse:	2	1689	98	1	782	89	101	446	19	73	387	73
User Adj:	1.00	1.00	1.00	1.00	1.00	1.00	1.00	1.00	1.00	1.00	1.00	1.00
PHF Adj:	0.95	0.95	0.95	0.95	0.95	0.95	0.95	0.95	0.95	0.95	0.95	0.95
PHF Volume:	2	1778	103	1	823	94	106	469	20	77	407	77
Reduct Vol:	0	0	0	0	0	0	0	0	0	0	0	0
Reduced Vol:	2	1778	103	1	823	94	106	469	20	77	407	77
PCE Adj:	1.00	1.00	1.00	1.00	1.00	1.00	1.00	1.00	1.00	1.00	1.00	1.00
MLF Adj:	1.00	1.00	1.00	1.00	1.00	1.00	1.00	1.00	1.00	1.00	1.00	1.00
Final Volume:	2	1778	103	1	823	94	106	469	20	77	407	77

Saturation Flow Module:	North Bound			South Bound			East Bound			West Bound		
Sat/Lane:	1900	1900	1900	1900	1900	1900	1900	1900	1900	1900	1900	1900
Adjustment:	0.90	0.90	0.90	0.89	0.89	0.89	0.40	0.99	0.99	0.15	0.93	0.93
Lanes:	0.01	1.88	0.11	0.01	1.79	0.20	1.00	0.96	0.04	1.00	1.68	0.32
Final Sat.:	4	3229	187	4	3045	347	756	1811	77	281	2964	559

Capacity Analysis Module:	North Bound			South Bound			East Bound			West Bound		
Vol/Sat:	0.55	0.55	0.55	0.27	0.27	0.27	0.14	0.26	0.26	0.27	0.14	0.14
Crit Moves:	****			****			****			****		
Green Time:	53.0	53.0	53.0	53.0	53.0	53.0	27.0	27.0	27.0	27.0	27.0	27.0
Volume/Cap:	0.94	0.94	0.94	0.46	0.46	0.46	0.47	0.86	0.86	0.91	0.46	0.46
Uniform Del:	16.9	16.9	16.9	10.4	10.4	10.4	25.7	29.8	29.8	30.3	25.6	25.6
IncramntDel:	8.8	8.8	8.8	0.2	0.2	0.2	1.5	13.0	13.0	68.8	0.3	0.3
InitQueueDel:	0.0	0.0	0.0	0.0	0.0	0.0	0.0	0.0	0.0	0.0	0.0	0.0
Delay Adj:	1.00	1.00	1.00	1.00	1.00	1.00	1.00	1.00	1.00	1.00	1.00	1.00
Delay/Veh:	25.8	25.8	25.8	10.6	10.6	10.6	27.2	42.8	42.8	99.2	25.9	25.9
User DelAdj:	1.00	1.00	1.00	1.00	1.00	1.00	1.00	1.00	1.00	1.00	1.00	1.00
AdjDel/Veh:	25.8	25.8	25.8	10.6	10.6	10.6	27.2	42.8	42.8	99.2	25.9	25.9
LOS by Move:	C	C	C	B	B	B	C	D	D	F	C	C
HCM2kAvgQ:	26	26	26	7	7	7	3	16	16	5	6	6

Note: Queue reported is the number of cars per lane.

Level Of Service Computation Report
 2000 HCM Operations (Base Volume Alternative)
 Future+Project PM (Mod. Opt 1)

Intersection #59: Masonic/Turk

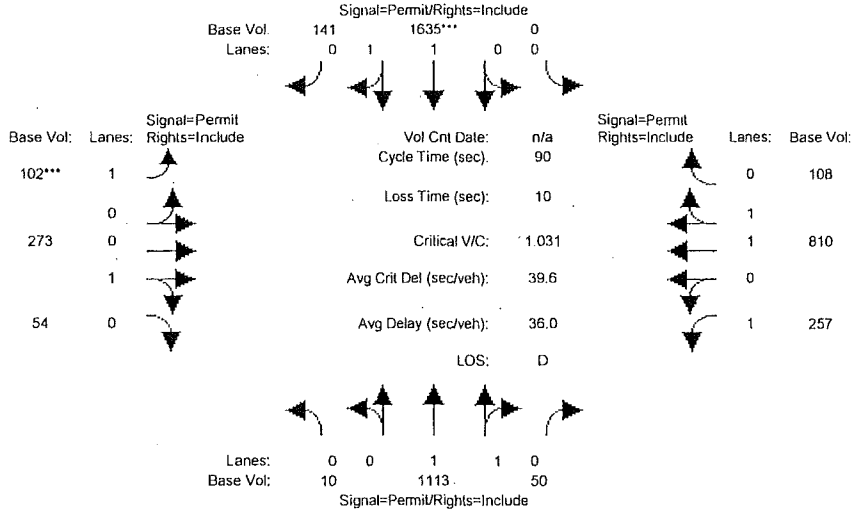

Approach:	North Bound			South Bound			East Bound			West Bound		
Movement:	L	T	R	L	T	R	L	T	R	L	T	R
Min. Green:	49	49	49	49	49	49	31	31	31	31	31	31
Y+R:	4.0	4.0	4.0	4.0	4.0	4.0	4.0	4.0	4.0	4.0	4.0	4.0
Volume Module:												
Base Vol:	10	1113	50	0	1635	141	102	273	54	257	810	108
Growth Adj:	1.00	1.00	1.00	1.00	1.00	1.00	1.00	1.00	1.00	1.00	1.00	1.00
Initial Bse:	10	1113	50	0	1635	141	102	273	54	257	810	108
User Adj:	1.00	1.00	1.00	1.00	1.00	1.00	1.00	1.00	1.00	1.00	1.00	1.00
PHF Adj:	0.95	0.95	0.95	0.95	0.95	0.95	0.95	0.95	0.95	0.95	0.95	0.95
PHF Volume:	11	1172	53	0	1721	148	107	287	57	271	853	114
Reduct Vol:	0	0	0	0	0	0	0	0	0	0	0	0
Reduced Vol:	11	1172	53	0	1721	148	107	287	57	271	853	114
PCE Adj:	1.00	1.00	1.00	1.00	1.00	1.00	1.00	1.00	1.00	1.00	1.00	1.00
MLF Adj:	1.00	1.00	1.00	1.00	1.00	1.00	1.00	1.00	1.00	1.00	1.00	1.00
Final Volume:	11	1172	53	0	1721	148	107	287	57	271	853	114
Saturation Flow Module:												
Sat/Lane:	1900	1900	1900	1900	1900	1900	1900	1900	1900	1900	1900	1900
Adjustment:	0.76	0.76	0.76	1.00	0.94	0.94	0.14	0.98	0.98	0.37	0.93	0.93
Lanes:	0.02	1.90	0.08	0.00	1.84	0.16	1.00	0.83	0.17	1.00	1.76	0.24
Final Sat.:	25	2751	124	0	3284	283	274	1547	306	703	3128	417
Capacity Analysis Module:												
Vol/Sat:	0.43	0.43	0.43	0.00	0.52	0.52	0.39	0.19	0.19	0.38	0.27	0.27
Crit Moves:				****			****					
Green Time:	49.0	49.0	49.0	0.0	49.0	49.0	31.0	31.0	31.0	31.0	31.0	31.0
Volume/Cap:	0.78	0.78	0.78	0.00	0.96	0.96	1.14	0.54	0.54	1.12	0.79	0.79
Delay/Veh:	18.9	18.9	18.9	0.0	32.4	32.4	164.6	24.7	24.7	122.5	30.2	30.2
User DelAdj:	1.00	1.00	1.00	1.00	1.00	1.00	1.00	1.00	1.00	1.00	1.00	1.00
AdjDel/Veh:	18.9	18.9	18.9	0.0	32.4	32.4	164.6	24.7	24.7	122.5	30.2	30.2
LOS by Move:	B	B	B	A	C	C	F	C	C	F	C	C
HCM2kAvgQ:	14	14	14	0	25	25	7	8	8	15	15	15

Note: Queue reported is the number of cars per lane.

Level Of Service Computation Report
 2000 HCM Operations (Base Volume Alternative)
 Existing+Project PM (Mod. Opt 1)

Intersection #59: Masonic/Turk

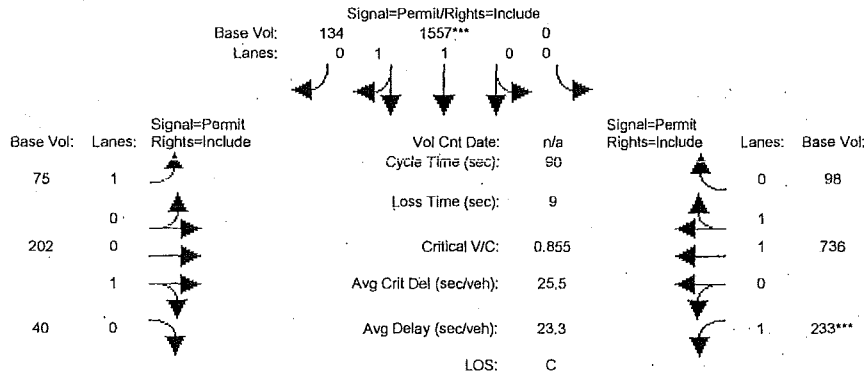

Approach:	North Bound			South Bound			East Bound			West Bound		
Movement:	L	T	R	L	T	R	L	T	R	L	T	R
Min. Green:	49	49	49	49	49	49	31	31	31	31	31	31
Y+R:	4.0	4.0	4.0	4.0	4.0	4.0	4.0	4.0	4.0	4.0	4.0	4.0
Volume Module:												
Base Vol:	9	1011	45	0	1557	134	75	202	40	233	736	98
Growth Adj:	1.00	1.00	1.00	1.00	1.00	1.00	1.00	1.00	1.00	1.00	1.00	1.00
Initial Bse:	9	1011	45	0	1557	134	75	202	40	233	736	98
User Adj:	1.00	1.00	1.00	1.00	1.00	1.00	1.00	1.00	1.00	1.00	1.00	1.00
PHF Adj:	0.95	0.95	0.95	0.95	0.95	0.95	0.95	0.95	0.95	0.95	0.95	0.95
PHF Volume:	9	1064	47	0	1639	141	79	213	42	245	775	103
Reduct Vol:	0	0	0	0	0	0	0	0	0	0	0	0
Reduced Vol:	9	1064	47	0	1639	141	79	213	42	245	775	103
PCE Adj:	1.00	1.00	1.00	1.00	1.00	1.00	1.00	1.00	1.00	1.00	1.00	1.00
MLF Adj:	1.00	1.00	1.00	1.00	1.00	1.00	1.00	1.00	1.00	1.00	1.00	1.00
Final Volume:	9	1064	47	0	1639	141	79	213	42	245	775	103
Saturation Flow Module:												
Sat/Lane:	1900	1900	1900	1900	1900	1900	1900	1900	1900	1900	1900	1900
Adjustment:	0.83	0.83	0.83	1.00	0.94	0.94	0.18	0.98	0.98	0.48	0.93	0.93
Lanes:	0.02	1.90	0.08	0.00	1.84	0.16	1.00	0.83	0.17	1.00	1.76	0.24
Final Sat.:	27	2981	133	0	3284	283	336	1546	306	906	3128	417
Capacity Analysis Module:												
Vol/Sat:	0.36	0.36	0.36	0.00	0.50	0.50	0.23	0.14	0.14	0.27	0.25	0.25
Crit Moves:				****						****		
Green Time:	50.0	50.0	50.0	0.0	50.0	50.0	31.0	31.0	31.0	31.0	31.0	31.0
Volume/Cap:	0.64	0.64	0.64	0.00	0.90	0.90	0.68	0.40	0.40	0.79	0.72	0.72
Uniform Del:	13.8	13.8	13.8	0.0	17.7	17.7	25.3	22.4	22.4	26.5	25.7	25.7
IncrcmntDel:	0.8	0.8	0.8	0.0	5.9	5.9	15.3	0.4	0.4	12.4	2.1	2.1
InitQueueDel:	0.0	0.0	0.0	0.0	0.0	0.0	0.0	0.0	0.0	0.0	0.0	0.0
Delay Adj:	1.00	1.00	1.00	0.00	1.00	1.00	1.00	1.00	1.00	1.00	1.00	1.00
Delay/Veh:	14.7	14.7	14.7	0.0	23.7	23.7	40.6	22.8	22.8	38.9	27.8	27.8
User DelAdj:	1.00	1.00	1.00	1.00	1.00	1.00	1.00	1.00	1.00	1.00	1.00	1.00
AdjDel/Veh:	14.7	14.7	14.7	0.0	23.7	23.7	40.6	22.8	22.8	38.9	27.8	27.8
LOS by Move:	B	B	B	A	C	C	D	C	C	D	C	C
HCM2kAvgQ:	11	11	11	0	21	21	3	5	5	8	12	12

Note: Queue reported is the number of cars per lane.

Level Of Service Computation Report
 2000 HCM Operations (Base Volume Alternative)
 Future+Project AM (Mod. Opt 1)

Intersection #60: Masonic/Fulton

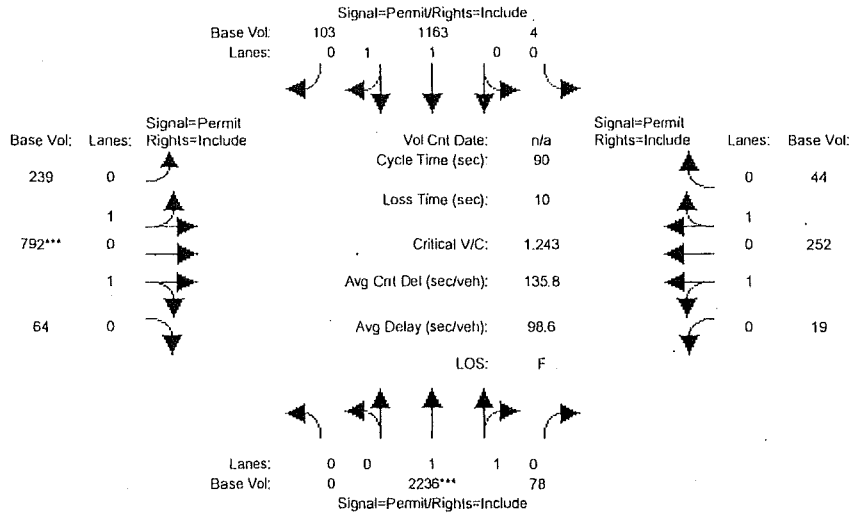

Approach:	North Bound			South Bound			East Bound			West Bound		
Movement:	L	T	R	L	T	R	L	T	R	L	T	R
Min. Green:	52	52	52	52	52	52	28	28	28	28	28	28
Y+R:	4.0	4.0	4.0	4.0	4.0	4.0	4.0	4.0	4.0	4.0	4.0	4.0

Volume Module:	North Bound			South Bound			East Bound			West Bound		
Base Vol:	0	2236	78	4	1163	103	239	792	64	19	252	44
Growth Adj:	1.00	1.00	1.00	1.00	1.00	1.00	1.00	1.00	1.00	1.00	1.00	1.00
Initial Bse:	0	2236	78	4	1163	103	239	792	64	19	252	44
User Adj:	1.00	1.00	1.00	1.00	1.00	1.00	1.00	1.00	1.00	1.00	1.00	1.00
PHF Adj:	0.95	0.95	0.95	0.95	0.95	0.95	0.95	0.95	0.95	0.95	0.95	0.95
PHF Volume:	0	2354	82	4	1224	108	252	834	67	20	265	46
Reduct Vol:	0	0	0	0	0	0	0	0	0	0	0	0
Reduced Vol:	0	2354	82	4	1224	108	252	834	67	20	265	46
PCE Adj:	1.00	1.00	1.00	1.00	1.00	1.00	1.00	1.00	1.00	1.00	1.00	1.00
MLF Adj:	1.00	1.00	1.00	1.00	1.00	1.00	1.00	1.00	1.00	1.00	1.00	1.00
Final Volume:	0	2354	82	4	1224	108	252	834	67	20	265	46

Saturation Flow Module:	North Bound			South Bound			East Bound			West Bound		
Sat/Lane:	1900	1900	1900	1900	1900	1900	1900	1900	1900	1900	1900	1900
Adjustment:	1.00	0.95	0.95	0.78	0.78	0.78	0.71	0.71	0.71	0.64	0.64	0.64
Lanes:	0.00	1.93	0.07	0.01	1.83	0.16	0.43	1.45	0.12	0.12	1.60	0.28
Final Sat.:	0	3471	121	9	2727	242	590	1954	158	146	1937	338

Capacity Analysis Module:	North Bound			South Bound			East Bound			West Bound		
Vol/Sat:	0.00	0.68	0.68	0.45	0.45	0.45	0.43	0.43	0.43	0.14	0.14	0.14
Crit Moves:	****			****			****			****		
Green Time:	0.0	52.0	52.0	52.0	52.0	52.0	28.0	28.0	28.0	28.0	28.0	28.0
Volume/Cap:	0.00	1.17	1.17	0.78	0.78	0.78	1.37	1.37	1.37	0.44	0.44	0.44
Uniform Del:	0.0	19.0	19.0	14.6	14.6	14.6	31.0	31.0	31.0	24.7	24.7	24.7
IncramntDel:	0.0	83.6	83.6	2.3	2.3	2.3	174.8	175	174.8	0.4	0.4	0.4
InitQueueDel:	0.0	0.0	0.0	0.0	0.0	0.0	0.0	0.0	0.0	0.0	0.0	0.0
Delay Adj:	0.00	1.00	1.00	1.00	1.00	1.00	1.00	1.00	1.00	1.00	1.00	1.00
Delay/Veh:	0.0	103	102.6	16.9	16.9	16.9	205.8	206	205.8	25.2	25.2	25.2
User DelAdj:	1.00	1.00	1.00	1.00	1.00	1.00	1.00	1.00	1.00	1.00	1.00	1.00
AdjDel/Veh:	0.0	103	102.6	16.9	16.9	16.9	205.8	206	205.8	25.2	25.2	25.2
LOS by Move:	A	F	F	B	B	B	F	F	F	C	C	C
HCM2kAvgQ:	0	60	60	14	14	14	39	39	39	4	4	4

Note: Queue reported is the number of cars per lane.

Level Of Service Computation Report
2000 HCM Operations (Base Volume Alternative)
Existing+Project AM (Mod. Opt 1)

Intersection #60: Masonic/Fulton

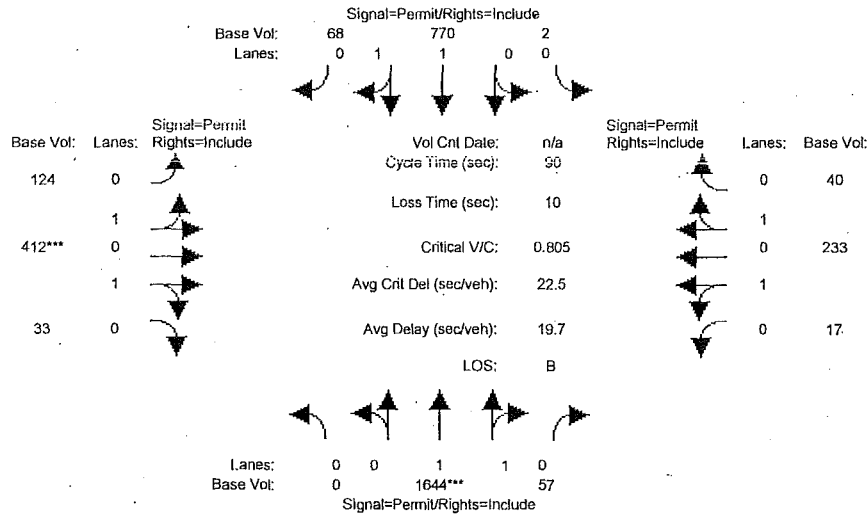

Approach:	North Bound			South Bound			East Bound			West Bound		
	L	T	R	L	T	R	L	T	R	L	T	R
Min. Green:	52	52	52	52	52	52	28	28	28	28	28	28
Y+R:	4.0	4.0	4.0	4.0	4.0	4.0	4.0	4.0	4.0	4.0	4.0	4.0

Volume Module:												
Base Vol:	0	1644	57	2	770	68	124	412	33	17	233	40
Growth Adj:	1.00	1.00	1.00	1.00	1.00	1.00	1.00	1.00	1.00	1.00	1.00	1.00
Initial Bse:	0	1644	57	2	770	68	124	412	33	17	233	40
User Adj:	1.00	1.00	1.00	1.00	1.00	1.00	1.00	1.00	1.00	1.00	1.00	1.00
PHF Adj:	0.95	0.95	0.95	0.95	0.95	0.95	0.95	0.95	0.95	0.95	0.95	0.95
PHF Volume:	0	1731	60	2	811	72	131	434	35	18	245	42
Reduct Vol:	0	0	0	0	0	0	0	0	0	0	0	0
Reduced Vol:	0	1731	60	2	811	72	131	434	35	18	245	42
PCE Adj:	1.00	1.00	1.00	1.00	1.00	1.00	1.00	1.00	1.00	1.00	1.00	1.00
MLF Adj:	1.00	1.00	1.00	1.00	1.00	1.00	1.00	1.00	1.00	1.00	1.00	1.00
Final Volume:	0	1731	60	2	811	72	131	434	35	18	245	42

Saturation Flow Module:												
Sat/Lane:	1900	1900	1900	1900	1900	1900	1900	1900	1900	1900	1900	1900
Adjustment:	1.00	0.95	0.95	0.90	0.90	0.90	0.72	0.72	0.72	0.84	0.84	0.84
Lanes:	0.00	1.93	0.07	0.01	1.83	0.16	0.43	1.45	0.12	0.12	1.61	0.27
Final Sat.:	0	3472	120	8	3122	276	600	1995	160	188	2578	443

Capacity Analysis Module:												
Vol/Sat:	0.00	0.50	0.50	0.26	0.26	0.26	0.22	0.22	0.22	0.10	0.10	0.10
Crit Moves:	****									****		
Green Time:	0.0	52.0	52.0	52.0	52.0	52.0	28.0	28.0	28.0	28.0	28.0	28.0
Volume/Cap:	0.00	0.86	0.86	0.45	0.45	0.45	0.70	0.70	0.70	0.31	0.31	0.31
Uniform Del:	0.0	16.0	16.0	10.8	10.8	10.8	27.3	27.3	27.3	23.6	23.6	23.6
IncrcmntDel:	0.0	4.0	4.0	0.2	0.2	0.2	2.6	2.6	2.6	0.2	0.2	0.2
InitQueuDel:	0.0	0.0	0.0	0.0	0.0	0.0	0.0	0.0	0.0	0.0	0.0	0.0
Delay Adj:	0.00	1.00	1.00	1.00	1.00	1.00	1.00	1.00	1.00	1.00	1.00	1.00
Delay/Veh:	0.0	20.0	20.0	11.0	11.0	11.0	29.9	29.9	29.9	23.8	23.8	23.8
User DelAdj:	1.00	1.00	1.00	1.00	1.00	1.00	1.00	1.00	1.00	1.00	1.00	1.00
AdjDel/Veh:	0.0	20.0	20.0	11.0	11.0	11.0	29.9	29.9	29.9	23.8	23.8	23.8
LOS by Move:	A	B	B	B	B	B	C	C	C	C	C	C
HCM2kAvgQ:	0	24	24	7	7	7	9	9	9	3	3	3

Note: Queue reported is the number of cars per lane.

Level Of Service Computation Report
 2000 HCM Operations (Base Volume Alternative)
 Future+Project PM (Mod. Opt 1)

Intersection #60: Masonic/Fulton

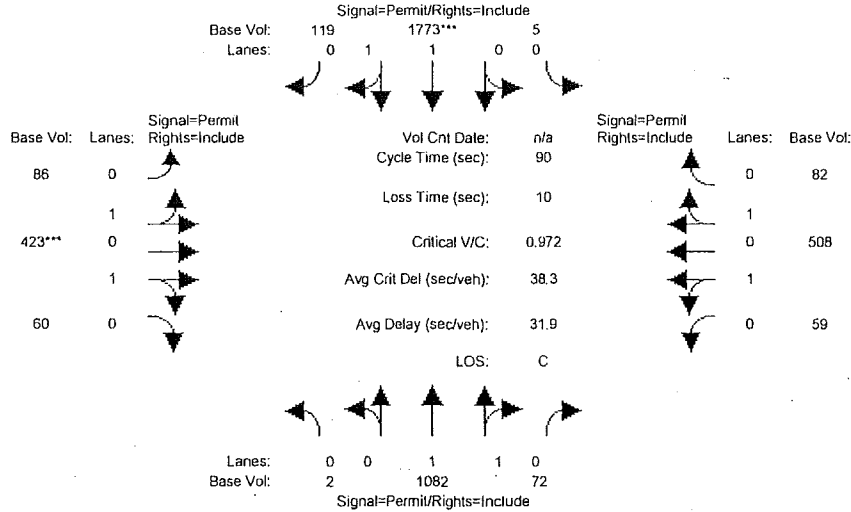

Approach:	North Bound			South Bound			East Bound			West Bound		
	L	T	R	L	T	R	L	T	R	L	T	R
Min. Green:	54	54	54	54	54	54	26	26	26	26	26	26
Y+R:	4.0	4.0	4.0	4.0	4.0	4.0	4.0	4.0	4.0	4.0	4.0	4.0

Volume Module:	North Bound			South Bound			East Bound			West Bound		
Base Vol:	2	1082	72	5	1773	119	86	423	60	59	508	82
Growth Adj:	1.00	1.00	1.00	1.00	1.00	1.00	1.00	1.00	1.00	1.00	1.00	1.00
Initial Bse:	2	1082	72	5	1773	119	86	423	60	59	508	82
User Adj:	1.00	1.00	1.00	1.00	1.00	1.00	1.00	1.00	1.00	1.00	1.00	1.00
PHF Adj:	0.95	0.95	0.95	0.95	0.95	0.95	0.95	0.95	0.95	0.95	0.95	0.95
PHF Volume:	2	1139	76	5	1866	125	91	445	63	62	535	86
Reduct Vol:	0	0	0	0	0	0	0	0	0	0	0	0
Reduced Vol:	2	1139	76	5	1866	125	91	445	63	62	535	86
PCE Adj:	1.00	1.00	1.00	1.00	1.00	1.00	1.00	1.00	1.00	1.00	1.00	1.00
MLF Adj:	1.00	1.00	1.00	1.00	1.00	1.00	1.00	1.00	1.00	1.00	1.00	1.00
Final Volume:	2	1139	76	5	1866	125	91	445	63	62	535	86

Saturation Flow Module:	North Bound			South Bound			East Bound			West Bound		
Sat/Lane:	1900	1900	1900	1900	1900	1900	1900	1900	1900	1900	1900	1900
Adjustment:	0.89	0.89	0.89	0.89	0.89	0.89	0.57	0.57	0.57	0.70	0.70	0.70
Lanes:	0.01	1.87	0.12	0.01	1.87	0.12	0.30	1.49	0.21	0.18	1.57	0.25
Final Sat.:	6	3164	211	9	3176	213	328	1611	228	242	2082	336

Capacity Analysis Module:	North Bound			South Bound			East Bound			West Bound		
Vol/Sat:	0.36	0.36	0.36	0.59	0.59	0.59	0.28	0.28	0.28	0.26	0.26	0.26
Crit Moves:				****	****	****	****	****	****			
Green Time:	54.0	54.0	54.0	54.0	54.0	54.0	26.0	26.0	26.0	26.0	26.0	26.0
Volume/Cap:	0.60	0.60	0.60	0.98	0.98	0.98	0.96	0.96	0.96	0.89	0.89	0.89
Delay/Veh:	11.8	11.8	11.8	32.7	32.7	32.7	57.0	57.0	57.0	43.0	43.0	43.0
User DelAdj:	1.00	1.00	1.00	1.00	1.00	1.00	1.00	1.00	1.00	1.00	1.00	1.00
AdjDel/Veh:	11.8	11.8	11.8	32.7	32.7	32.7	57.0	57.0	57.0	43.0	43.0	43.0
LOS by Move:	B	B	B	C	C	C	E	E	E	D	D	D
HCM2kAvgQ:	11	11	11	28	28	28	13	13	13	13	13	13

Note: Queue reported is the number of cars per lane.

Level Of Service Computation Report
 2000 HCM Operations (Base Volume Alternative)
 Existing+Project PM (Mod. Opt 1)

Intersection #60: Masonic/Fulton

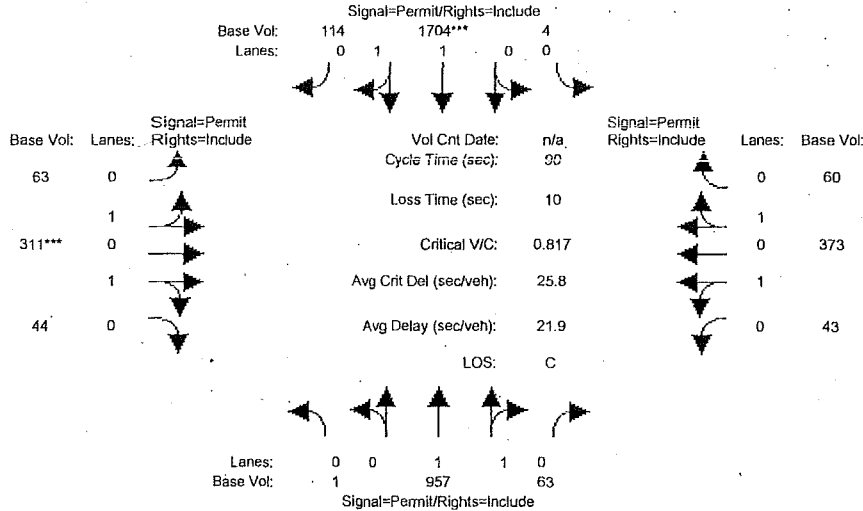

Approach:	North Bound			South Bound			East Bound			West Bound		
Movement:	L	T	R	L	T	R	L	T	R	L	T	R
Min. Green:	54	54	54	54	54	54	26	26	26	26	26	26
Y+R:	4.0	4.0	4.0	4.0	4.0	4.0	4.0	4.0	4.0	4.0	4.0	4.0

Volume Module:												
Base Vol:	1	957	63	4	1704	114	63	311	44	43	373	60
Growth Adj:	1.00	1.00	1.00	1.00	1.00	1.00	1.00	1.00	1.00	1.00	1.00	1.00
Initial Bse:	1	957	63	4	1704	114	63	311	44	43	373	60
User Adj:	1.00	1.00	1.00	1.00	1.00	1.00	1.00	1.00	1.00	1.00	1.00	1.00
PHF Adj:	0.95	0.95	0.95	0.95	0.95	0.95	0.95	0.95	0.95	0.95	0.95	0.95
PHF Volume:	1	1007	66	4	1794	120	66	327	46	45	393	63
Reduct Vol:	0	0	0	0	0	0	0	0	0	0	0	0
Reduced Vol:	1	1007	66	4	1794	120	66	327	46	45	393	63
PCE Adj:	1.00	1.00	1.00	1.00	1.00	1.00	1.00	1.00	1.00	1.00	1.00	1.00
MLF Adj:	1.00	1.00	1.00	1.00	1.00	1.00	1.00	1.00	1.00	1.00	1.00	1.00
Final Volume:	1	1007	66	4	1794	120	66	327	46	45	393	63

Saturation Flow Module:												
Sat/Lane:	1900	1900	1900	1900	1900	1900	1900	1900	1900	1900	1900	1900
Adjustment:	0.90	0.90	0.90	0.90	0.90	0.90	0.70	0.70	0.70	0.81	0.81	0.81
Lanes:	0.01	1.87	0.12	0.01	1.87	0.12	0.30	1.49	0.21	0.18	1.57	0.25
Final Sat.:	3	3202	211	8	3195	214	403	1990	282	279	2423	390

Capacity Analysis Module:												
Vol/Sat:	0.31	0.31	0.31	0.56	0.56	0.56	0.16	0.16	0.16	0.16	0.16	0.16
Crit Moves:				****	****	****	****	****	****	****	****	****
Green Time:	54.0	54.0	54.0	54.0	54.0	54.0	26.0	26.0	26.0	26.0	26.0	26.0
Volume/Cap:	0.52	0.52	0.52	0.94	0.94	0.94	0.57	0.57	0.57	0.56	0.56	0.56
Uniform Del:	10.5	10.5	10.5	16.4	16.4	16.4	27.2	27.2	27.2	27.2	27.2	27.2
IncrcmntDel:	0.3	0.3	0.3	8.8	8.8	8.8	1.0	1.0	1.0	0.8	0.8	0.8
InitQueueDel:	0.0	0.0	0.0	0.0	0.0	0.0	0.0	0.0	0.0	0.0	0.0	0.0
Delay Adj:	1.00	1.00	1.00	1.00	1.00	1.00	1.00	1.00	1.00	1.00	1.00	1.00
Delay/Veh:	10.8	10.8	10.8	25.2	25.2	25.2	28.3	28.3	28.3	28.0	28.0	28.0
User DelAdj:	1.00	1.00	1.00	1.00	1.00	1.00	1.00	1.00	1.00	1.00	1.00	1.00
AdjDel/Veh:	10.8	10.8	10.8	25.2	25.2	25.2	28.3	28.3	28.3	28.0	28.0	28.0
LOS by Move:	B	B	B	C	C	C	C	C	C	C	C	C
HCM2kAvgQ:	9	9	9	26	26	26	6	6	6	7	7	7

Note: Queue reported is the number of cars per lane.

Level Of Service Computation Report
 2000 HCM Operations (Base Volume Alternative)
 Existing PM

Intersection #17628: Anza/Masonic

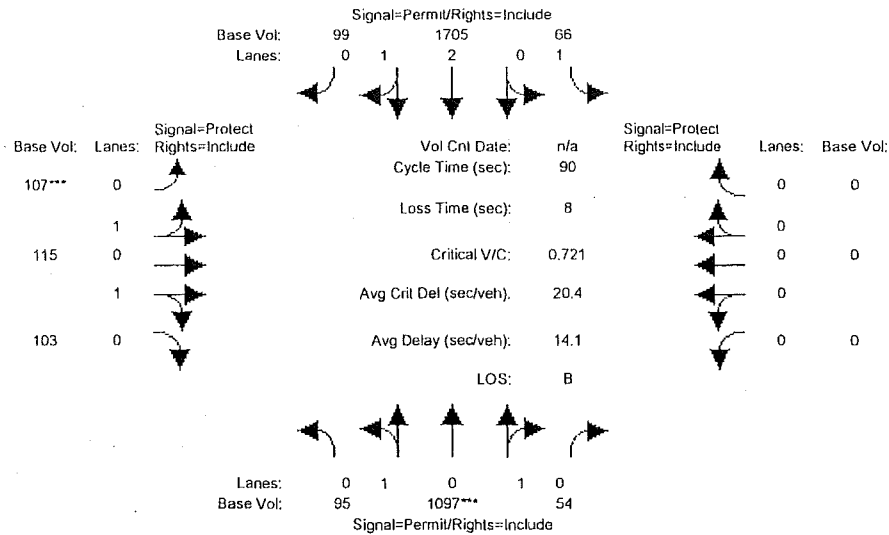

Street Name:	Masonic						Anza					
Approach:	North Bound			South Bound			East Bound			West Bound		
Movement:	L	T	R	L	T	R	L	T	R	L	T	R
Min. Green:	56	56	56	56	56	56	24	24	24	0	0	0
Y+R:	4.5	4.5	4.5	4.5	4.5	4.5	5.0	5.0	5.0	4.0	4.0	4.0
Volume Module:												
Base Vol:	95	1097	54	66	1705	99	107	115	103	0	0	0
Growth Adj:	1.00	1.00	1.00	1.00	1.00	1.00	1.00	1.00	1.00	1.00	1.00	1.00
Initial Bse:	95	1097	54	66	1705	99	107	115	103	0	0	0
User Adj:	1.00	1.00	1.00	1.00	1.00	1.00	1.00	1.00	1.00	1.00	1.00	1.00
PHF Adj:	1.00	1.00	1.00	1.00	1.00	1.00	1.00	1.00	1.00	1.00	1.00	1.00
PHF Volume:	95	1097	54	66	1705	99	107	115	103	0	0	0
Reduct Vol:	0	0	0	0	0	0	0	0	0	0	0	0
Reduced Vol:	95	1097	54	66	1705	99	107	115	103	0	0	0
PCE Adj:	1.00	1.00	1.00	1.00	1.00	1.00	1.00	1.00	1.00	1.00	1.00	1.00
MLF Adj:	1.00	1.00	1.00	1.00	1.00	1.00	1.00	1.00	1.00	1.00	1.00	1.00
FinalVolume:	95	1097	54	66	1705	99	107	115	103	0	0	0
Saturation Flow Module:												
Sat/Lane:	1900	1900	1900	1900	1900	1900	1900	1900	1900	1900	1900	1900
Adjustment:	0.59	0.59	0.59	0.16	0.90	0.90	0.86	0.86	0.86	1.00	1.00	1.00
Lanes:	0.15	1.76	0.09	1.00	2.84	0.16	0.66	0.71	0.63	0.00	0.00	0.00
Final Sat.:	170	1968	97	295	4863	282	1076	1156	1036	0	0	0
Capacity Analysis Module:												
Vol/Sat:	0.56	0.56	0.56	0.22	0.35	0.35	0.10	0.10	0.10	0.00	0.00	0.00
Crit Moves:	****			****			****			****		
Green Time:	58.0	58.0	58.0	58.0	58.0	58.0	24.0	24.0	24.0	0.0	0.0	0.0
Volume/Cap:	0.86	0.86	0.86	0.35	0.54	0.54	0.37	0.37	0.37	0.00	0.00	0.00
Delay/Veh:	18.6	18.6	18.6	8.4	8.9	8.9	27.1	27.1	27.1	0.0	0.0	0.0
User DelAdj:	1.00	1.00	1.00	1.00	1.00	1.00	1.00	1.00	1.00	1.00	1.00	1.00
AdjDel/Veh:	18.6	18.6	18.6	8.4	8.9	8.9	27.1	27.1	27.1	0.0	0.0	0.0
LOS by Move:	B	B	B	A	A	A	C	C	C	A	A	A
HCM2kAvgQ:	16	16	16	1	10	10	4	4	4	0	0	0

Note: Queue reported is the number of cars per lane.

Level of Service Computation Report
 2000 HCM Operations (Base Volume Alternative)
 Existing+Project PM (Mod. Opt 1)

Intersection #17628: Anza/Masonic

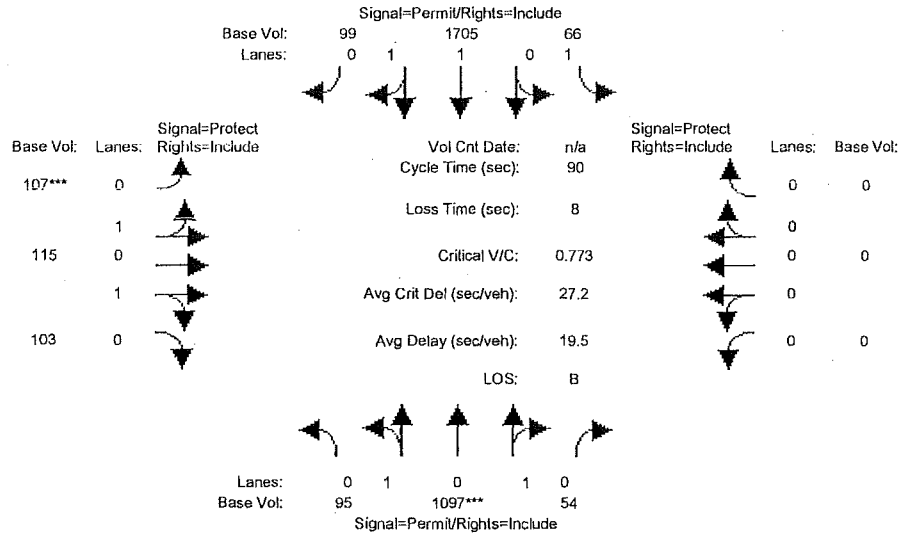

Street Name:	Masonic						Anza					
Approach:	North Bound			South Bound			East Bound			West Bound		
Movement:	L	T	R	L	T	R	L	T	R	L	T	R
Min. Green:	56	56	56	56	56	56	24	24	24	0	0	0
Y+R:	4.5	4.5	4.5	4.5	4.5	4.5	5.0	5.0	5.0	4.0	4.0	4.0

Volume Module:	North Bound			South Bound			East Bound			West Bound		
Base Vol:	95	1097	54	66	1705	99	107	115	103	0	0	0
Growth Adj:	1.00	1.00	1.00	1.00	1.00	1.00	1.00	1.00	1.00	1.00	1.00	1.00
Initial Bse:	95	1097	54	66	1705	99	107	115	103	0	0	0
User Adj:	1.00	1.00	1.00	1.00	1.00	1.00	1.00	1.00	1.00	1.00	1.00	1.00
PHF Adj:	1.00	1.00	1.00	1.00	1.00	1.00	1.00	1.00	1.00	1.00	1.00	1.00
PHF Volume:	95	1097	54	66	1705	99	107	115	103	0	0	0
Reduct Vol:	0	0	0	0	0	0	0	0	0	0	0	0
Reduced Vol:	95	1097	54	66	1705	99	107	115	103	0	0	0
PCE Adj:	1.00	1.00	1.00	1.00	1.00	1.00	1.00	1.00	1.00	1.00	1.00	1.00
MLF Adj:	1.00	1.00	1.00	1.00	1.00	1.00	1.00	1.00	1.00	1.00	1.00	1.00
Final Volume:	95	1097	54	66	1705	99	107	115	103	0	0	0

Saturation Flow Module:	North Bound			South Bound			East Bound			West Bound		
Sat/Lane:	1900	1900	1900	1900	1900	1900	1900	1900	1900	1900	1900	1900
Adjustment:	0.54	0.54	0.54	0.17	0.94	0.94	0.86	0.86	0.86	1.00	1.00	1.00
Lanes:	0.15	1.76	0.09	1.00	1.89	0.11	0.66	0.71	0.63	0.00	0.00	0.00
Final Sat.:	157	1813	89	321	3385	197	1076	1156	1036	0	0	0

Capacity Analysis Module:	North Bound			South Bound			East Bound			West Bound		
Vol/Sat:	0.60	0.60	0.60	0.21	0.50	0.50	0.10	0.10	0.10	0.00	0.00	0.00
Crit Moves:	****						****					
Green Time:	58.0	58.0	58.0	58.0	58.0	58.0	24.0	24.0	24.0	0.0	0.0	0.0
Volume/Cap:	0.94	0.94	0.94	0.32	0.78	0.78	0.37	0.37	0.37	0.00	0.00	0.00
Uniform Del:	14.4	14.4	14.4	7.2	11.5	11.5	26.9	26.9	26.9	0.0	0.0	0.0
IncrementDel:	12.8	12.8	12.8	0.9	1.8	1.8	0.3	0.3	0.3	0.0	0.0	0.0
InitQueueDel:	0.0	0.0	0.0	0.0	0.0	0.0	0.0	0.0	0.0	0.0	0.0	0.0
Delay Adj:	1.00	1.00	1.00	1.00	1.00	1.00	1.00	1.00	1.00	0.00	0.00	0.00
Delay/Veh:	27.2	27.2	27.2	8.1	13.3	13.3	27.1	27.1	27.1	0.0	0.0	0.0
User DelAdj:	1.00	1.00	1.00	1.00	1.00	1.00	1.00	1.00	1.00	1.00	1.00	1.00
AdjDel/Veh:	27.2	27.2	27.2	8.1	13.3	13.3	27.1	27.1	27.1	0.0	0.0	0.0
LOS by Move:	C	C	C	A	B	B	C	C	C	A	A	A
HCM2kAvgQ:	18	18	18	1	17	17	4	4	4	0	0	0

Note: Queue reported is the number of cars per lane.

Level Of Service Computation Report
 2000 HCM Operations (Base Volume Alternative)
 Future without Project PM

Intersection #17628: Anza/Masonic

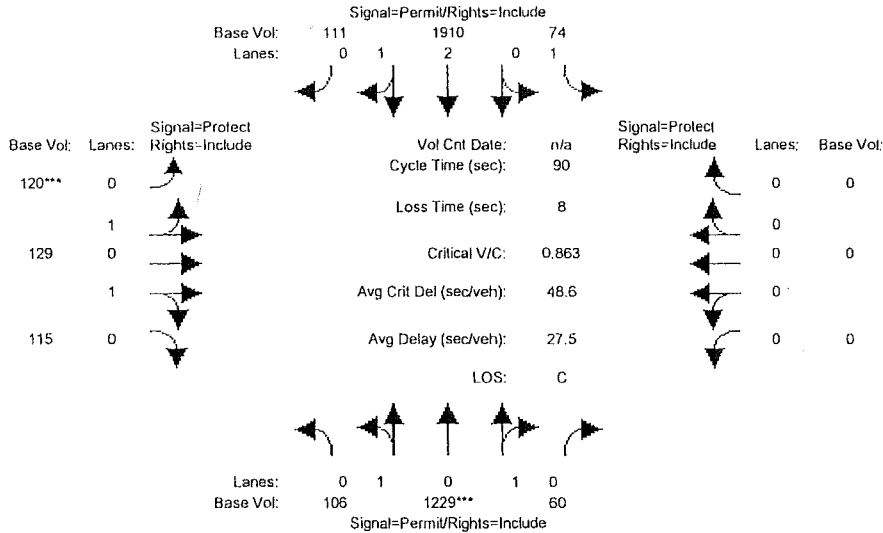

Street Name:	Masonic						Anza					
Approach:	North Bound			South Bound			East Bound			West Bound		
Movement:	L	T	R	L	T	R	L	T	R	L	T	R
Min. Green:	56	56	56	56	56	56	24	24	24	0	0	0
Y+R:	4.5	4.5	4.5	4.0	4.0	4.0	5.0	5.0	5.0	4.0	4.0	4.0

Volume Module:	106	1229	60	74	1910	111	120	129	115	0	0	0
Base Vol:	106	1229	60	74	1910	111	120	129	115	0	0	0
Growth Adj:	1.00	1.00	1.00	1.00	1.00	1.00	1.00	1.00	1.00	1.00	1.00	1.00
Initial Bse:	106	1229	60	74	1910	111	120	129	115	0	0	0
User Adj:	1.00	1.00	1.00	1.00	1.00	1.00	1.00	1.00	1.00	1.00	1.00	1.00
PHF Adj:	1.00	1.00	1.00	1.00	1.00	1.00	1.00	1.00	1.00	1.00	1.00	1.00
PHF Volume:	106	1229	60	74	1910	111	120	129	115	0	0	0
Reduct Vol:	0	0	0	0	0	0	0	0	0	0	0	0
Reduced Vol:	106	1229	60	74	1910	111	120	129	115	0	0	0
PCE Adj:	1.00	1.00	1.00	1.00	1.00	1.00	1.00	1.00	1.00	1.00	1.00	1.00
MLF Adj:	1.00	1.00	1.00	1.00	1.00	1.00	1.00	1.00	1.00	1.00	1.00	1.00
Final Volume:	106	1229	60	74	1910	111	120	129	115	0	0	0

Saturation Flow Module:	1900	1900	1900	1900	1900	1900	1900	1900	1900	1900	1900	1900
Sat/Lane:	1900	1900	1900	1900	1900	1900	1900	1900	1900	1900	1900	1900
Adjustment:	0.54	0.54	0.54	0.12	0.90	0.90	0.86	0.86	0.86	1.00	1.00	1.00
Lanes:	0.15	1.76	0.09	1.00	2.84	0.16	0.66	0.71	0.63	0.00	0.00	0.00
Final Sat.:	157	1821	89	228	4863	283	1079	1159	1034	0	0	0

Capacity Analysis Module:	0.67	0.67	0.67	0.32	0.39	0.39	0.11	0.11	0.11	0.00	0.00	0.00
Vol/Sat:	0.67	0.67	0.67	0.32	0.39	0.39	0.11	0.11	0.11	0.00	0.00	0.00
Crit Moves:	****						****					
Green Time:	58.0	58.0	58.0	58.0	58.0	58.0	24.0	24.0	24.0	0.0	0.0	0.0
Volume/Cap:	1.05	1.05	1.05	0.50	0.61	0.61	0.42	0.42	0.42	0.00	0.00	0.00
Uniform Del:	16.0	16.0	16.0	8.4	9.4	9.4	27.2	27.2	27.2	0.0	0.0	0.0
IncrcmntDel:	38.0	38.0	38.0	2.8	0.3	0.3	0.3	0.3	0.3	0.0	0.0	0.0
InitQueuDel:	0.0	0.0	0.0	0.0	0.0	0.0	0.0	0.0	0.0	0.0	0.0	0.0
Delay Adj:	1.00	1.00	1.00	1.00	1.00	1.00	1.00	1.00	1.00	0.00	0.00	0.00
Delay/Veh:	54.0	54.0	54.0	11.2	9.7	9.7	27.6	27.6	27.6	0.0	0.0	0.0
User DelAdj:	1.00	1.00	1.00	1.00	1.00	1.00	1.00	1.00	1.00	1.00	1.00	1.00
AdjDel/Veh:	54.0	54.0	54.0	11.2	9.7	9.7	27.6	27.6	27.6	0.0	0.0	0.0
LOS by Move:	D	D	D	B	A	A	C	C	C	A	A	A
HCM2kAvgQ:	27	27	27	1	11	11	5	5	5	0	0	0

Note: Queue reported is the number of cars per lane.

Level Of Service Computation Report
 2000 HCM Operations (Base Volume Alternative)
 Future+Project PM (Mod. Opt 1)

Intersection #17628: Anza/Masonic

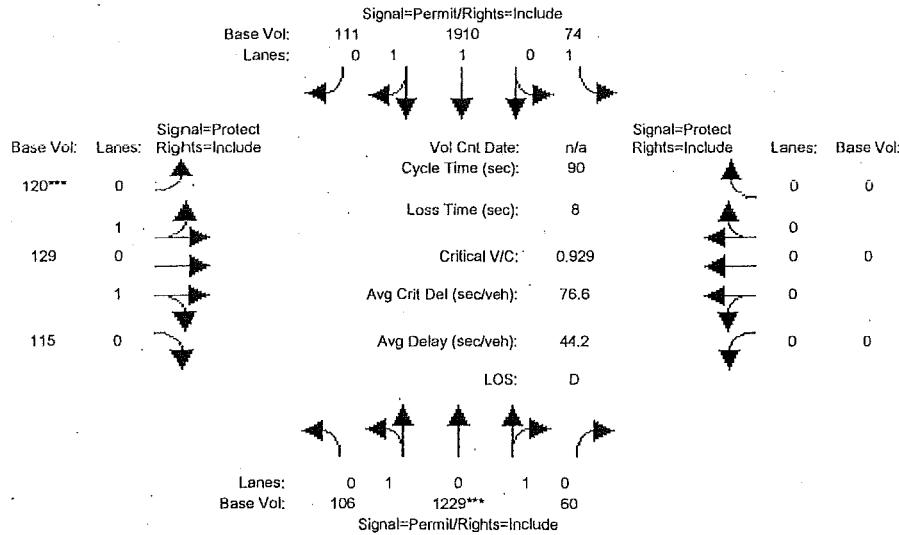

Street Name:	Masonic						Anza					
Approach:	North Bound			South Bound			East Bound			West Bound		
Movement:	L	T	R	L	T	R	L	T	R	L	T	R
Min. Green:	56	56	56	56	56	56	24	24	24	0	0	0
Y+R:	4.5	4.5	4.5	4.5	4.5	4.5	5.0	5.0	5.0	4.0	4.0	4.0

Volume Module:	106	1229	60	74	1910	111	120	129	115	0	0	0
Base Vol:	106	1229	60	74	1910	111	120	129	115	0	0	0
Growth Adj:	1.00	1.00	1.00	1.00	1.00	1.00	1.00	1.00	1.00	1.00	1.00	1.00
Initial Bse:	106	1229	60	74	1910	111	120	129	115	0	0	0
User Adj:	1.00	1.00	1.00	1.00	1.00	1.00	1.00	1.00	1.00	1.00	1.00	1.00
PHF Adj:	1.00	1.00	1.00	1.00	1.00	1.00	1.00	1.00	1.00	1.00	1.00	1.00
PHF Volume:	106	1229	60	74	1910	111	120	129	115	0	0	0
Reduct Vol:	0	0	0	0	0	0	0	0	0	0	0	0
Reduced Vol:	106	1229	60	74	1910	111	120	129	115	0	0	0
PCE Adj:	1.00	1.00	1.00	1.00	1.00	1.00	1.00	1.00	1.00	1.00	1.00	1.00
MLF Adj:	1.00	1.00	1.00	1.00	1.00	1.00	1.00	1.00	1.00	1.00	1.00	1.00
Final Volume:	106	1229	60	74	1910	111	120	129	115	0	0	0

Saturation Flow Module:	1900	1900	1900	1900	1900	1900	1900	1900	1900	1900	1900	1900
Sat/Lane:	1900	1900	1900	1900	1900	1900	1900	1900	1900	1900	1900	1900
Adjustment:	0.50	0.50	0.50	0.13	0.94	0.94	0.86	0.86	0.86	1.00	1.00	1.00
Lanes:	0.15	1.76	0.09	1.00	1.89	0.11	0.66	0.71	0.63	0.00	0.00	0.00
Final Sat.:	144	1672	82	253	3384	197	1079	1159	1034	0	0	0

Capacity Analysis Module:	0.73	0.73	0.73	0.29	0.56	0.56	0.11	0.11	0.11	0.00	0.00	0.00
Vol/Sat:	0.73	0.73	0.73	0.29	0.56	0.56	0.11	0.11	0.11	0.00	0.00	0.00
Crit Moves:	****						****					
Green Time:	58.0	58.0	58.0	58.0	58.0	58.0	24.0	24.0	24.0	0.0	0.0	0.0
Volume/Cap:	1.14	1.14	1.14	0.45	0.88	0.88	0.42	0.42	0.42	0.00	0.00	0.00
Delay/Veh:	89.4	89.4	89.4	10.1	17.2	17.2	27.6	27.6	27.6	0.0	0.0	0.0
User DelAdj:	1.00	1.00	1.00	1.00	1.00	1.00	1.00	1.00	1.00	1.00	1.00	1.00
AdjDel/Veh:	89.4	89.4	89.4	10.1	17.2	17.2	27.6	27.6	27.6	0.0	0.0	0.0
LOS by Move:	F	F	F	B	B	B	C	C	C	A	A	A
HCM2kAvgQ:	32	32	32	1	22	22	5	5	5	0	0	0

Note: Queue reported is the number of cars per lane.