

File No. 130856

Committee Item No. 4

Board Item No. 12

COMMITTEE/BOARD OF SUPERVISORS

AGENDA PACKET CONTENTS LIST

Committee: Budget and Finance Committee

Date: 10/09/2013

Board of Supervisors Meeting

Date: OCTOBER 22, 2013

Cmte Board

- | | | |
|-------------------------------------|-------------------------------------|--|
| <input type="checkbox"/> | <input type="checkbox"/> | Motion |
| <input checked="" type="checkbox"/> | <input checked="" type="checkbox"/> | Resolution |
| <input type="checkbox"/> | <input type="checkbox"/> | Ordinance |
| <input type="checkbox"/> | <input type="checkbox"/> | Legislative Digest |
| <input type="checkbox"/> | <input type="checkbox"/> | Budget and Legislative Analyst Report |
| <input type="checkbox"/> | <input type="checkbox"/> | Legislative Analyst Report |
| <input type="checkbox"/> | <input type="checkbox"/> | Youth Commission Report |
| <input type="checkbox"/> | <input type="checkbox"/> | Introduction Form |
| <input checked="" type="checkbox"/> | <input checked="" type="checkbox"/> | Department/Agency Cover Letter and/or Report |
| <input type="checkbox"/> | <input type="checkbox"/> | MOU |
| <input type="checkbox"/> | <input type="checkbox"/> | Grant Information Form |
| <input type="checkbox"/> | <input type="checkbox"/> | Grant Budget |
| <input type="checkbox"/> | <input type="checkbox"/> | Subcontract Budget |
| <input checked="" type="checkbox"/> | <input checked="" type="checkbox"/> | Contract/Agreement |
| <input type="checkbox"/> | <input type="checkbox"/> | Form 126 – Ethics Commission |
| <input type="checkbox"/> | <input type="checkbox"/> | Award Letter |
| <input type="checkbox"/> | <input type="checkbox"/> | Application |
| <input type="checkbox"/> | <input type="checkbox"/> | Public Correspondence |

OTHER

(Use back side if additional space is needed)

<input type="checkbox"/>	<input type="checkbox"/>	_____
<input type="checkbox"/>	<input type="checkbox"/>	_____
<input type="checkbox"/>	<input type="checkbox"/>	_____
<input type="checkbox"/>	<input type="checkbox"/>	_____
<input type="checkbox"/>	<input type="checkbox"/>	_____
<input type="checkbox"/>	<input type="checkbox"/>	_____
<input type="checkbox"/>	<input type="checkbox"/>	_____
<input type="checkbox"/>	<input type="checkbox"/>	_____
<input type="checkbox"/>	<input type="checkbox"/>	_____
<input type="checkbox"/>	<input type="checkbox"/>	_____

Completed by: Victor Young Date October 4, 2013

Completed by: Victor Young Date 10/16/13

1 [Interconnection Agreement - Pacific Gas and Electric Company - Solar Power Project - 700
2 Pennsylvania Avenue]

3 **Resolution authorizing the Public Utilities Commission's General Manager to enter into**
4 **a long term interconnection agreement with Pacific Gas and Electric Company, to**
5 **commence following Board approval, for a Solar Power Project at the Municipal**
6 **Transportation Agency building located 700 Pennsylvania Avenue, pursuant to Charter,**
7 **Section 9.118(b).**

8
9 WHEREAS, The San Francisco Public Utilities Commission (PUC) is responsible for
10 development of renewable energy generating facilities for the City and County of San
11 Francisco (City); and

12 WHEREAS, On March 30, 2009, the PUC and the San Francisco Municipal
13 Transportation Agency (MTA) entered into a Memorandum of Understanding providing for
14 installation and operation of an on-site solar photovoltaic system to be owned by the PUC at
15 the MTA facility at 700 Pennsylvania Avenue, San Francisco, California (the Project); and

16 WHEREAS, On June 18, 2013, the PUC and the San Francisco Department of Public
17 Works (DPW) entered a letter agreement providing for DPW to act as general contractor for
18 the construction of the Project; and

19 WHEREAS, Funding for the Project was included in the PUC's capital budget for
20 renewable energy projects; and

21 WHEREAS, DPW has completed the construction of the Project, and expects that it
22 may begin generating electricity in mid-October, upon execution of an interconnection
23 agreement with Pacific Gas and Electric Company (PG&E); and

1 WHEREAS, In a determination dated July 15, 2008, the City of County of San
2 Francisco Planning Department found that the Project was categorically exempt from
3 environmental review under the California Environmental Quality Act; and

4 WHEREAS, The City must enter into a Generating Facility Interconnection Agreement
5 (Agreement) with PG&E to interconnect the Project to the electrical grid; and

6 WHEREAS, In Resolutions 554-07, 441-11, and 374-12, the Board of Supervisors
7 approved similar interconnection agreements for other City on-site solar photovoltaic systems;
8 and

9 WHEREAS, The term of the Agreement is of an indefinite duration in order to ensure
10 that the Project can remain interconnected to PG&E's electrical system for its useful life,
11 which is expected to exceed ten (10) years; and

12 WHEREAS, The Agreement is subject to termination by the City for any reason upon
13 sixty (60) days notice; and

14 WHEREAS, The City Attorney has approved the limitation of liability language set forth
15 in section 7 of the Agreement; and

16 WHEREAS, The City's Risk Manager has approved the insurance language set forth in
17 section 8 of the Agreement and has provided to PG&E a letter certifying that the City is self-
18 insured and describing the terms of the City's self insurance program; and

19 WHEREAS, The terms and conditions of the Agreement do not require the payment of
20 any fees or costs by the City to PG&E; and

21 WHEREAS, A copy of the Agreement is on file with the Clerk of the Board of
22 Supervisors in File No. 130856, which is hereby declared to be a part of this motion as if set
23 forth fully herein; now, therefore, be it

24 RESOLVED, That the Board of Supervisors authorizes the San Francisco Public
25 Utilities Commission General Manager to enter into the Agreement with Pacific Gas and

1 Electric Company for interconnection of the Project at the San Francisco Municipal
2 Transportation Agency building at 700 Pennsylvania Avenue , pursuant to San Francisco
3 Charter section 9.118(b), and, be it

4 FURTHER RESOLVED, That within thirty (30) days of the agreement being fully
5 executed by all parties, the General Manager of the San Francisco Public Utilities
6 Commission shall provide the final agreement to the Clerk of the Board for inclusion into the
7 official file.



San Francisco
Water Power Sewer
 Services of the San Francisco Public Utilities Commission

525 Golden Gate Avenue, 13th Floor
 San Francisco, CA 94102
 T 415.554.0706
 TTY 415.554.3488

RECEIVED
 BOARD OF SUPERVISORS
 SAN FRANCISCO
 2013 SEP -9 AM 11:39

TO: Angela Calvillo, Clerk of the Board

FROM: Erin Hagan, Policy and Government Affairs Manager

DATE: September 09, 2013

SUBJECT: Agreement with Pacific Gas and Electric Company to Connect a Solar Power Project

Attached please find an original and two copies of a proposed resolution authorizing the San Francisco Public Utilities Commission General Manager to enter into a long term interconnection agreement with Pacific Gas and Electric Company for a solar power project at San Francisco Municipal Transportation Agency building, 700 Pennsylvania Avenue.

The following is a list of accompanying documents (3 sets):

1. Board of Supervisors Resolution
2. Generating Facility Interconnection Agreement with PG&E
3. Memorandum of Understanding Between SFPUC and MTA
4. Letter of Agreement Between SFPUC and DPW
5. CEQA Exemption Determination
6. Board of Supervisors Resolution No. 554-07
7. Board of Supervisors Resolution No. 441-11
8. Board of Supervisors Resolution No. 374-12
9. Self-Insurance Letter to PG&E

Please contact Erin Hagan at 554-0706 if you need any additional information on these items.

- Edwin M. Lee**
Mayor
- Art Torres**
President
- Vince Courtney**
Vice President
- Ann Moller Caen**
Commissioner
- Francesca Viotor**
Commissioner
- Anson Moran**
Commissioner
- Harlan L. Kelly, Jr.**
General Manager



10560



Electric Sample Form No. 79-973
Generating Facility Interconnection Agreement
For Non-Export Generating Facilities

T

Please Refer to Attached
Sample Form

Advice Letter No: 4110-E
Decision No. 12-09-018

Issued by
Brian K. Cherry
Vice President
Regulatory Relations

Date Filed September 20, 2012
Effective September 20, 2012
Resolution No. _____



PG&E GENERATING FACILITY INTERCONNECTION AGREEMENT FOR NON-EXPORT GENERATING FACILITIES

This *Generating Facility Interconnection Agreement for Non-Export Generating Facilities* (Agreement) is entered into by and between City and County Of San Francisco (Producer), and Pacific Gas and Electric Company (PG&E) a California Corporation. Producer and PG&E are sometimes also referred to in this Agreement jointly as "Parties" or individually as "Party." In consideration of the mutual promises and obligations stated in this Agreement and its attachments, the Parties agree as follows:

1. SCOPE AND PURPOSE

This Agreement provides for Producer to interconnect and operate a Non-Export Generating Facility in parallel with PG&E's Distribution System to serve the electrical loads connected to the electric service account that PG&E uses to interconnect Producer's Generating Facility (or, where permitted under Section 218 of the California Public Utilities Code (PUC), the electric loads of an on-site or neighboring party lawfully connected to Producer's Generating Facility through Producer's circuits).

2. SUMMARY AND DESCRIPTION OF PRODUCER'S GENERATING FACILITY

2.1 A description of the Generating Facility, including a summary of its significant components and a single-line diagram showing the general arrangement of how Producer's Generating Facility and loads are interconnected with PG&E's Distribution System, are attached to and made a part of this Agreement. (Supplied by Producer as Appendix A).

2.2 Generating Facility identification number: 30S115651 (Assigned by PG&E).

2.3 Producer's electric service account number: 7743934005 (Assigned by PG&E).

2.4 Name and address used by PG&E to locate the electric service account used to interconnect the Generating Facility with PG&E's Distribution System:

Name: City & County Of San Francisco

Address: 700 Pennsylvania

City/Zip Code: San Francisco, CA 94107

2.5 The Gross Nameplate Rating of the Generating Facility is: 100 kW.

2.6 The Net Nameplate Rating of the Generating Facility is 87.68 kW.

2.7 The expected annual energy production of the Generating Facility is _____ kWh.

2.8 For the purpose of securing the Competition Transition Charge exemption available under Section 372 of the California Public Utilities Code (PUC), Producer hereby declares that the Generating Facility O does / O does not meet the requirements for Cogeneration as such term is used in Section 216.6 of the California Public Utilities Code.

GENERATING FACILITY INTERCONNECTION AGREEMENT
FOR NON-EXPORT GENERATING FACILITIES

2.9 The Generating Facility's expected date of Initial Operation is _____.
The expected date of Initial Operation shall be within two years of the date of this Agreement.

3. DOCUMENTS INCLUDED; DEFINED TERMS

3.1 This Agreement includes the following exhibits which are specifically incorporated herein and made a part of this Agreement.

Appendix A- Description of Generating Facility and Single-Line Diagram (Supplied by Producer).

Appendix B- Copies of Rules 2 and 21 and other selected rules and tariffs of PG&E (Supplied by PG&E).

Appendix C- A Copy of *PG&E's Agreement for Installation of Allocation of Special Facilities for Parallel Operation of Nonutility-Owned Generation and/or Electrical Standby Service* (Form 79-280) (Special Facility Agreement), if applicable, (Formed by the Parties).

3.2 When initially capitalized, whether in the singular or in the plural, the terms used herein shall have the meanings assigned to them either in this Agreement or in PG&E's Rule 21, Section C.

4. TERM AND TERMINATION

4.1 This Agreement shall become effective as of the last date entered in Section 16, below. The Agreement shall continue in full force and effect until the earliest date that one of the following events occurs:

(a) The Parties agree in writing to terminate the Agreement.

(b) Unless otherwise agreed in writing by the Parties, at 12:01 A.M. on the day following the date the electric service account through which Producer's Generating Facility is interconnected to PG&E's Distribution System is closed or terminated.

(c) At 12:01 A.M. on the 61st day after Producer or PG&E provides written Notice pursuant to Section 9 below to the other Party of Producer's or PG&E's intent to terminate this Agreement.

4.2 Producer may elect to terminate this Agreement pursuant to the terms of Section 4.1(c) for any reason. PG&E may elect to terminate this Agreement pursuant to the terms of Section 4.1(c) for one or more of the following reasons:

(a) A change in applicable rules, tariffs, and regulations, as approved or directed by the Commission, or a change in any local, state or federal law, statute or regulation, either of which materially alters or otherwise affects PG&E's ability or obligation to perform PG&E's duties under this Agreement; or,

**GENERATING FACILITY INTERCONNECTION AGREEMENT
FOR NON-EXPORT GENERATING FACILITIES**

- (b) Producer fails to take all corrective actions specified in PG&E's Notice that Producer's Generating Facility is out of compliance with the terms of this Agreement within the time frame set forth in such Notice; or,
- (c) Producer fails to interconnect and operate the Generating Facility per the terms of this Agreement prior to 120 days after the date set forth in Section 2.9, above, as the Generating Facility's expected date of Initial Operation; or,
- (d) Producer abandons the Generating Facility. PG&E shall deem the Generating Facility to be abandoned if PG&E determines, in its sole opinion, the Generating Facility is non-operational and Producer does not provide a substantive response to PG&E Notice of its intent to terminate this Agreement as a result of Producer's apparent abandonment of the Generating Facility affirming Producer's intent and ability to continue to operate the Generating Facility.

4.3 Notwithstanding any other provisions of this Agreement, PG&E shall have the right to unilaterally file with the Commission, pursuant to the Commission's rules and regulations, an application to terminate this Agreement.

4.4 Any agreements attached to and incorporated into this Agreement shall terminate concurrently with this Agreement unless the Parties have agreed otherwise in writing.

5. GENERATING FACILITY, OPERATION AND CERTIFICATION REQUIREMENTS

5.1 The electric power produced by Producer's Generating Facility shall be used solely to serve electrical loads connected to the electric service account that PG&E uses to interconnect Producer's Generating Facility (or, where permitted under Section 218 of the PUC, the electric loads of an on-site or neighboring party lawfully connected to Producer's Generating Facility through Producer's circuits). Producer shall attempt in good faith to regulate the electric power output of Producer's Generating Facility so as to prevent the flow of electric energy from the Generating Facility to PG&E's electric system. Unless otherwise agreed upon in writing by the Parties, this Agreement does not provide for, nor otherwise require PG&E to receive, purchase, transmit, distribute, or store the electrical power produced by Producer's Generating Facility.

5.2 If Producer declares that its Generating Facility meets the requirements for Cogeneration as such term is used in Section 216.6 of the PUC (or any successor definition of Cogeneration) (Cogeneration Requirements), Producer warrants that, beginning on the date of Initial Operation and continuing throughout the term of this Agreement, its Generating Facility shall continue to meet such Cogeneration Requirements. If Producer becomes aware that its Generating Facility has ceased to meet the Cogeneration Requirements, Producer shall promptly provide PG&E with Notice of such change pursuant to Section 9.1 below. If at any time during the term of this Agreement PG&E determines in its sole discretion that Producer's Generating Facility may no longer meet the Cogeneration Requirements, PG&E may require Producer to provide evidence that its Generating Facility continues to meet the Cogeneration Requirements within 15 business days of PG&E's request

**GENERATING FACILITY INTERCONNECTION AGREEMENT
FOR NON-EXPORT GENERATING FACILITIES**

for such evidence. Additionally, PG&E may periodically (typically, once per year) inspect Producer's Generating Facility and/or require documentation from Producer to monitor the Generating Facility's compliance with Section 216.6 of the PUC. If PG&E determines in its sole judgment that Producer either failed to provide evidence in a timely manner or that it provided insufficient evidence that its Generating Facility continues to meet the Cogeneration Requirements, then the Cogeneration status of the Generating Facility shall be deemed ineffective until such time as Producer again demonstrates to PG&E's reasonable satisfaction that the Generating Facility meets the requirements for a Cogeneration facility (the Status Change).

5.2.1 PG&E shall revise its records and the administration of this Agreement to reflect the Status Change and provide Notice to Producer of the Status Change pursuant to Section 9.1 below. This Notice shall specify the effective date of the Status Change. This date shall be the first day of the calendar year for which PG&E determines in its sole discretion that the Generating Facility first ceased to meet the Cogeneration Requirements. PG&E's Notice shall include an invoice for Competition Transition Charges (CTCs) that were not previously billed during the period between the effective date of the Status Change and the date of the Notice in reliance upon Producer's representations that the Generating Facility complied with the Cogeneration Requirements and therefore was eligible for the exemption from CTCs available under Section 372 of the PUC.

5.2.2 Any amounts to be paid or refunded by Producer, as may be invoiced by PG&E pursuant to the terms of this Section 5.2, shall be paid to PG&E within 30 days of Producer's receipt of such invoice.

6. INTERCONNECTION FACILITIES

6.1 Producer and/or PG&E, as appropriate, shall provide Interconnection Facilities that adequately protect PG&E's Distribution System, personnel, and other persons from damage or injury, which may be caused by the operation of Producer's Generating Facility.

6.2 Producer shall be solely responsible for the costs, design, purchase, construction, operation, and maintenance of the Interconnection Facilities that Producer owns.

6.3 If the provisions of PG&E's Rule 21, or any other tariff or rule approved by the Commission, requires PG&E to own and operate a portion of the Interconnection Facilities, Producer and PG&E shall promptly execute a Special Facilities Agreement that establishes and allocates responsibility for the design, installation, operation, maintenance, and ownership of the Interconnection Facilities. This Special Facilities Agreement shall be attached to and made a part of this Agreement as Appendix C.

7. LIMITATION OF LIABILITY

**GENERATING FACILITY INTERCONNECTION AGREEMENT
FOR NON-EXPORT GENERATING FACILITIES**

Each Party's liability to the other Party for any loss, cost, claim, injury, liability, or expense, including reasonable attorney's fees, relating to or arising from any act or omission in its performance of this agreement, shall be limited to the amount of direct damage actually incurred. In no event shall either Party be liable to the other Party for any indirect, special, consequential, or punitive damages of any kind whatsoever.

8. INSURANCE

8.1 In connection with Producer's performance of its duties and obligations under this Agreement, Producer shall maintain, during the term of this Agreement, general liability insurance with a combined single limit of not less than:

- (a) Two million dollars (\$2,000,000) for each occurrence if the Gross Nameplate Rating of Producer's Generating Facility is greater than one hundred (100) kW;
- (b) One million dollars (\$1,000,000) for each occurrence if the Gross Nameplate Rating of Producer's Generating Facility is greater than twenty (20) kW and less than or equal to one hundred (100) kW; and
- (c) Five hundred thousand dollars (\$500,000) for each occurrence if the Gross Nameplate Rating of Producer's Generating Facility is twenty (20) kW or less.
- (d) Two hundred thousand dollars (\$200,000) for each occurrence if the Gross Nameplate Rating of Producer's Generating Facility is ten (10) kW or less and Producer's Generating Facility is connected to an account receiving residential service from PG&E.

Such general liability insurance shall include coverage for "Premises-Operations, Owners and Contractors Protective, Products/Completed Operations Hazard, Explosion, Collapse, Underground, Contractual Liability, and Broad Form Property Damage including Completed Operations."

8.2 The general liability insurance required in Section 8.1 shall, by endorsement to the policy or policies, (a) include PG&E as an additional insured; (b) contain a severability of interest clause or cross-liability clause; (c) provide that PG&E shall not by reason of its inclusion as an additional insured incur liability to the insurance carrier for payment of premium for such insurance; and (d) provide for thirty (30) calendar days' written notice to PG&E prior to cancellation, termination, alteration, or material change of such insurance.

8.3 If Producer's Generating Facility is connected to an account receiving residential service from PG&E and the requirement of Section 8.2(a) prevents Producer from obtaining the insurance required in Section 8.1, then upon Producer's written Notice to PG&E in accordance with Section 9.1, the requirements of Section 8.2(a) shall be waived.

8.4 Evidence of the insurance required in Section 8.2 shall state that coverage provided is primary and is not in excess to or contributing with any insurance or self-insurance maintained by PG&E.

GENERATING FACILITY INTERCONNECTION AGREEMENT FOR NON-EXPORT GENERATING FACILITIES

- 8.5 Producer agrees to furnish the required certificates and endorsements to PG&E prior to Initial Operation. PG&E shall have the right to inspect or obtain a copy of the original policy or policies of insurance.
8.6 If Producer is self-insured with an established record of self-insurance, Producer may comply with the following in lieu of Sections 8.1 through 8.4:
(a) Producer shall provide to, PG&E, at least thirty (30) calendar days prior to the date of Initial Operation, evidence of an acceptable plan to self-insure to a level of coverage equivalent to that required under Section 8.1.
(b) If Producer ceases to self-insure to the level required hereunder, or if Producer are unable to provide continuing evidence of Producer's ability to self-insure, Producer agrees to immediately obtain the coverage required under Section 8.1.
8.7 All insurance certificates, statements of self-insurance, endorsements, cancellations, terminations, alterations, and material changes of such insurance shall be issued and submitted via email or fax to the following:

Pacific Gas and Electric Company
c/o EXIGIS LLC
support@exigis.com
Fax: 646-755-3327

9. NOTICES

- 9.1 Any written notice, demand, or request required or authorized in connection with this Agreement (Notice) shall be deemed properly given if delivered in person or sent by first class mail, postage prepaid, to the person specified below:

If to PG&E: Pacific Gas and Electric Company
Attention: Generation Interconnection Services- Contract Management
245 Market Street
Mail Code N7L
San Francisco, California 94105-1702

If to Producer: Producer Name:
Address:
City:
Phone: ()
FAX: ()

- 9.2 A Party may change its address for Notices at any time by providing the other Party Notice of the change in accordance with Section 9.1.
9.3 The Parties may also designate operating representatives to conduct the daily communications, which may be necessary or convenient for the administration of this Agreement. Such designations, including names, addresses, and phone

**GENERATING FACILITY INTERCONNECTION AGREEMENT
FOR NON-EXPORT GENERATING FACILITIES**

numbers may be communicated or revised by one Party's Notice to the other.

10. REVIEW OF RECORDS AND DATA

10.1 PG&E shall have the right to review and obtain copies of Producer's operations and maintenance records, logs, or other information such as, unit availability, maintenance outages, circuit breaker operation requiring manual reset, relay targets and unusual events pertaining to Producer's Generating Facility or its interconnection with PG&E's Distribution System.

10.2 Producer authorizes to release to the California Energy Commission (CEC) information regarding Producer's facility, including customer name, location, size, and operational characteristics of the unit, as requested from time to time pursuant to the CEC's rules and regulations.

11. ASSIGNMENT

Producer shall not voluntarily assign its rights nor delegate its duties under this Agreement without PG&E's written consent. Any assignment or delegation Producer makes without PG&E's written consent shall not be valid. PG&E shall not unreasonably withhold its consent to Producer's assignment of this Agreement.

12. NON-WAIVER

None of the provisions of this Agreement shall be considered waived by a Party unless such waiver is given in writing. The failure of a Party to insist in any one or more instances upon strict performance of any of the provisions of this Agreement or to take advantage of any of its rights hereunder shall not be construed as a waiver of any such provisions or the relinquishment of any such rights for the future, but the same shall continue and remain in full force and effect.

13. GOVERNING LAW, JURISDICTION OF COMMISSION, INCLUSION OF PG&E's TARIFF SCHEDULES AND RULES

13.1 This Agreement shall be interpreted, governed, and construed under the laws of the State of California as if executed and to be performed wholly within the State of California without giving effect to choice of law provisions that might apply to the law of a different jurisdiction.

13.2 This Agreement shall, at all times, be subject to such changes or modifications by the Commission as it may from time to time direct in the exercise of its jurisdiction.

13.3 The interconnection and services provided under this Agreement shall at all times be subject to the terms and conditions set forth in the Tariff Schedules and Rules applicable to the electric service provided by, PG&E, which Tariff Schedules and Rules are hereby incorporated into this Agreement by this reference.

13.4 Notwithstanding any other provisions of this Agreement, PG&E shall have the right to unilaterally file with the Commission, pursuant to the Commission's rules and regulations, an application for change in rates, charges, classification, service, tariff or rule or any agreement relating thereto.

**GENERATING FACILITY INTERCONNECTION AGREEMENT
FOR NON-EXPORT GENERATING FACILITIES**

14. AMENDMENT AND MODIFICATION

This Agreement can only be amended or modified in writing, signed by both Parties.

15. ENTIRE AGREEMENT

This Agreement, including any incorporated Tariff Schedules and rules, contains the entire agreement and understanding between the Parties, their agents, and employees as to the subject matter of this Agreement. Each party also represents that in entering into this Agreement, it has not relied on any promise, inducement, representation, warranty, agreement or other statement not set forth in this Agreement or in the incorporated tariff schedules and rules.

16. SIGNATURES

IN WITNESS WHEREOF, the Parties hereto have caused two originals of this Agreement to be executed by their duly authorized representatives. This Agreement is effective as of the last date set forth below.

PRODUCER'S NAME

PACIFIC GAS AND ELECTRIC COMPANY

By: _____
Name: _____
Title: _____
Date: _____

By: _____
Name: _____
Title: _____
Date: _____

**GENERATING FACILITY INTERCONNECTION AGREEMENT
FOR NON-EXPORT GENERATING FACILITIES
PACIFIC GAS AND ELECTRIC COMPANY**

**APPENDIX A
DESCRIPTION OF GENERATING FACILITY
AND SINGLE-LINE DIAGRAM,
(Provided by Producer)**

PACIFIC GAS AND ELECTRIC COMPANY
GENERATING FACILITY INTERCONNECTION AGREEMENT
FOR NON-EXPORT GENERATING FACILITIES

APPENDIX B
RULES "2" AND "21"
(and any other Tariffs pertinent to the situation)
(Provided by PG&E)

(Note: PG&E's tariffs are included for reference only and shall at all times be subject to such changes or modifications by the Commission as the Commission may, from time to time, direct in the exercise of its jurisdiction.)

PACIFIC GAS AND ELECTRIC COMPANY
GENERATING FACILITY INTERCONNECTION AGREEMENT
FOR NON-EXPORT GENERATING FACILITIES

APPENDIX C
(If Applicable)
RULE 21 "SPECIAL FACILITIES" AGREEMENT
(Formed between the Parties)

MEMORANDUM OF UNDERSTANDING
BETWEEN
SAN FRANCISCO PUBLIC UTILITIES COMMISSION
AND
SAN FRANCISCO MUNICIPAL TRANSPORTATION AGENCY

THIS MEMORANDUM OF UNDERSTANDING (herein "MOU") dated hereof for reference purposes only as of March 23, 2009 is entered into by and between the Public Utilities Commission of the City and County of San Francisco ("SFPUC"), and the San Francisco Municipal Transportation Agency ("SFMTA") hereinafter sometimes referred to individually as a "Party" and collectively as the "Parties".

RECITALS

A. The purpose of this MOU is to provide for the installation and operation of two on-site solar photovoltaic systems at appropriate SFMTA locations 700 Pennsylvania Avenue and 1095 Indiana Street, in order to provide solar power to serve SFMTA loads, as part of the City and County of San Francisco's (the City) program to increase its development of solar energy in accordance with the Mayor's Executive Directive 05-107 (Rooftops for Municipal Solar) dated October 26, 2005. This MOU provides for the designation of the roofs at 700 Pennsylvania Avenue and 1095 Indiana Street as Sites for the installation of the first of a series of possible Solar Power Projects on SFMTA property.

B. The City acting by and through the SFPUC currently serves SFMTA electricity needs from hydroelectric power from the Hetch Hetchy system. The SFPUC and SFMTA desire to use on-site photovoltaic systems and associated inverters, isolation switches, relay protection equipment and meters to serve some of the SFMTA load. Notwithstanding the change in generating resources used to serve SFMTA load, nothing in this MOU is intended to interfere with or alter the respective responsibilities of the SFPUC and SFMTA as to supply of power by the SFPUC to SFMTA. Solar Power Projects installed at SFMTA locations pursuant to this MOU will be paid for and owned by the SFPUC.

C. The City acting by and through the SFMTA is the owner of certain properties located at 700 Pennsylvania Avenue and 1095 Indiana Street. SFMTA desires to make appropriate locations at SFMTA facilities including 700 Pennsylvania Avenue and 1095 Indiana Street available for the installation and operation of Solar Power Projects used to serve SFMTA loads.

D. On July 15, 2008 (MUNI Ways & Structures Facility), on July 22, 2008 (MUNI Woods Motor Coach Facility), and on July 22, 2008 (Chinatown Public Health Center) the San Francisco Planning Department issued categorical exemptions for the Solar Power Projects pursuant to the California Environmental Quality Act.

NOW THEREFORE IT IS AGREED AS FOLLOWS:

AGREEMENT

1. Recitals.

The foregoing recitals are true and correct and are incorporated herein by this reference.

MEMORANDUM OF UNDERSTANDING
DB-117, Chinatown Public Health Center, MUNI Woods Motor Coach Facility and MUNI Ways & Structures
Facility

2. Definitions.

Whenever used herein, including all appendices hereto, the following terms, when initially capitalized, shall for the purpose of this MOU have the following respective meanings. The singular of a term shall include the plural and the plural shall include the singular.

- (a) MOU: Memorandum of Understanding.
- (b) Allowed Activities: All activities associated with the design, construction, maintenance and operation of the Solar PV Projects.
- (c) Electric Service: The provision of electric power by the SFPUC to the SFMTA at 700 Pennsylvania Avenue and 1095 Indiana Street pursuant to existing arrangements as set by the SFPUC and approved by the Board of Supervisors from time to time.
- (d) Emergency: A condition that gives rise to, or imminently could give rise to, a serious health and/or safety hazard.
- (e) Environmental Credits: Any and all energy or emission credits or any other renewable energy, emissions reduction or other environmental benefit, whether related to any renewable portfolio standard or other renewable energy purchase requirement or otherwise, whether existing as of the Effective Date or enacted thereafter.
- (f) Normal Operating Hours: The normal operating hours of 8 a.m. to 5 p.m. Monday through Friday.
- (g) Site: The SFMTA properties located at 700 Pennsylvania Avenue and 1095 Indiana Street.
- (h) Prudent Utility Practice: Those practices, methods and procedures, as modified from time to time, that are currently and commonly used by electric utilities to design, construct and operate electric power facilities dependably, reliably, safely, efficiently and economically, with due regard to the state of the art in the electric power industry, as applied in the State of California or in the Western Electricity Coordinating Council area, whichever better represents the application of the considerations above. Such practices, methods and procedures are not limited to the optimum, but rather to any within the scope of those currently and commonly used.
- (i) Solar Power Project: A photovoltaic system installed at a SFMTA Site consisting of photovoltaic panels and their mountings, any bird avoidance devices, as well as associated wiring among panels, and wiring from the panels and other associated wiring (e.g. – data instruments) to the boundary of the Site. Components of the photovoltaic system on the Site shall comprise wiring from the roof boundary to the switching area on the Site, inverter(s), an AC disconnect switch, a DC disconnect switch, junction boxes, wiring, the Solar Power Project Meter and wiring to the PG&E main meter. A draft electrical single-line diagram of the proposed Solar Power Project to be installed at the designated SFMTA sites, including interconnection facilities and the location of the Solar Power Project Meter is set forth in

Appendix A.

- (j) Solar Power Project Meter: A time of use revenue-grade meter which will measure the output of each Solar Power Project.

3. **Effective Date.** The effective date of this MOU (the "Effective Date") shall be the date that this MOU is executed by both Parties, conditioned upon the subsequent approval by SFMTA and the SFPUC, each in their sole discretion.

4. **Term.**

(a) Term for the Designation of Sites. The term for the designation of Sites shall commence on the Effective Date and shall expire 10 years thereafter.

(b) Term for the MOU. The term of this MOU shall commence on the Effective Date and shall expire 25 years after the date of commercial operation of the last Solar Power Project designated during the Term for the Designation of Sites, hereafter (the "Expiration Date"). If, with the permission of the SFMTA, a Solar Power Project remains on a Site after the Expiration Date, such a Site shall continue to be used for a Solar Power Project on all the terms and conditions stated herein, terminable by either Party on ninety (90) days written notice to the other.

5. **Use of the Sites.** Subject to the provisions of this MOU, the SFMTA will make the Premises available for all activities associated with the design, construction, maintenance and operation of the Solar PV Projects, including but not limited to project management and administration, permitting, design, equipment procurement, construction, installation, and commissioning, and all activities associated with contracting for such, including but not limited to, project management and administration, bidding, contracting, and the development and enforcement of performance guarantees and liquidated damages clauses ("Allowed Activities").

6. **Use of the Output from the Solar Power Projects.** Subject to the provisions of this MOU, all of the output of the Solar Power Projects shall be used to supply some or all of SFMTA's electric requirements at various SFMTA sites at the applicable rates set forth in existing arrangements between the Parties for Electric Service.

7. **Cost Responsibility, Ownership, Operation, and Maintenance of the Solar Power Projects.** Subject to the provisions of this MOU, the SFPUC shall be responsible for the costs of procuring, installing, operating, and maintaining the Solar Power Projects and shall be the sole owner of the Solar Power Projects and any and all associated energy or environmental credits.

8. **Designation of Sites and Required Site Documentation.**

(a) Identification of Potential Sites. During the 10-year Term for the Designation of Sites, the SFPUC and the SFMTA will cooperate to identify mutually acceptable Sites at various SFMTA facilities that are suitable for the installation and operation of Solar Power Projects. SFMTA will provide all records concerning roof leaks at the various sites and/or certify that the roof does not have any leaks with a letter from the Deputy Director, Maintenance of Way to the SFPUC. In the event that no such certification is provided, the SFPUC can, at its

MEMORANDUM OF UNDERSTANDING

DB-117, Chinatown Public Health Center, MUNI Woods Motor Coach Facility and MUNI Ways & Structures Facility

option, decide not to proceed at that particular site, or with approval of SFMTA determine the cost of roof repair, and arrange to have the necessary repairs made.

(b) Plans and Descriptions (As-Built Drawings/Reports). Upon the identification of a potential Site by the SFMTA and the SFPUC, and within thirty (30) business days of the SFPUC's written request, the SFMTA will provide to the Manager of Energy Generation Projects at the SFPUC Power Enterprise one set of drawings of the potential Site, that include in particular: the roof and the roof's structural support, electrical drawings that show all relevant details of the electric room where the output from the Solar Power Project could potentially be connected to the grid, the possible conduit routing of the output from the Solar Power Project to the electrical room, and final as-built drawings for the facility. If the SFMTA does not provide such drawings and description, the SFMTA shall work with the SFPUC to create specifications for the conduit routing and any necessary repair or maintenance of the roof prior to the installation of a Solar Power Project.

(c) Electrical, Structural, and Roof Condition Assessment Review and Designation of Sites. Upon receipt or development of the information set forth in subparagraph (b) above, the SFPUC shall undertake an electrical and structural review of a potential Site to determine whether it is electrically or structurally adequate to support a Solar Power Project, as well as undertake a Roof Condition Assessment Review. If the SFMTA and the SFPUC determine that a potential Site is adequate to support a Solar Power Project, the project will become a candidate for funding by the SFPUC.

(d) Roof Leak Test. As part of any eventual contract to install a solar system at a designated site, the SFPUC may require the Contractor to perform a roof leak test prior to the start of any construction. The SFPUC shall provide SFMTA at least five (5) business days advance written notice of any such roof leak test and shall afford SFMTA a reasonable opportunity to have a representative present upon such test. Also, the Contractor will be required to perform their own Roof Condition Assessment and review, and agree with any of the above mentioned SFPUC Electrical and Structural Reports prior to the start of construction.

9. Access To and Use of the Sites. Subject to the provisions of this MOU, the SFMTA will make the Premises available for the **Allowed Activities**. Any amendments or alterations to the Allowed Activities must be pre-approved in writing by SFMTA. SFMTA approval will not be unreasonably withheld, and in any event, notification by the SFMTA of its decision will be given within two (2) weeks. Subject to the execution by SFMTA and the SFPUC of a mutually acceptable written agreement regarding compensation and other key terms, SFMTA may undertake any of the Allowed Activities on behalf of the SFPUC consistent with the agreement thereon between the Parties.

(a) Access to the Sites. The SFPUC and its agents shall have the non-exclusive right of ingress and egress to and from the Sites over roads, ramps, walkways, and other areas of the Sites designated by the Deputy Director, Maintenance of Way of SFMTA ("**Director**"). Without limiting the foregoing, the Director shall have the right to alter or amend access routes at any time, and to impose reasonable restrictions on such access; provided SFMTA gives the SFPUC reasonable notice of any such alteration or amendment or imposition of any such restrictions. The SFMTA shall allow the SFPUC, its employees, agents, contractors and sub-

contractors entry to the Premises subject to notice of two (2) business days and prior approval by the SFMTA. All such access shall be subject to SFMTA rules and regulations as amended from time to time, including those pertaining to badge, permitting, and other security requirements, and the requirements of this MOU.

- (b) Rights-of-Way for the Benefit of the SFPUC. The SFPUC shall have the use and enjoyment of suitable rights-of-way over lands at the various SFMTA sites in a manner first to be approved by the Director in writing. Such rights-of-way shall be for the purpose of enabling the SFPUC to install and maintain conduits, connections, ducts, pipes, wires, sewer, gas, telephone, and incidental accessories, equipment and devices which are necessary or convenient in connection with the Allowed Activities, including any installations necessary to provide connectivity to the SFMTA electricity grid and the statewide interconnected electricity grid (collectively, the "Infrastructure"), and shall not interfere with the SFMTA facility. All costs relative to the installation, maintenance, repair and replacement of the Infrastructure shall be paid for by the SFPUC; provided, the SFPUC shall not be required to pay for the use of the land or related facilities in which the Infrastructure is placed.
- (c) Rights-of-Way for the Benefit of the SFMTA. SFMTA shall have the right, at all times and for any purpose, to enter upon the Sites without unreasonably or unduly interfering with the Allowed Activities.
- (d) Changes to SFMTA Sites. The SFPUC acknowledges and agrees that (a) the SFMTA shall have the right at all times to reasonably change, alter, expand, and contract SFMTA sites or any portion thereof, and (b) SFMTA has made no representations, warranties, or covenants to the SFPUC regarding the design, construction, pedestrian traffic, SFMTA schedules, or views of or relating to SFMTA or any of the Sites. Without limiting the generality of the foregoing, the SFPUC acknowledges and agrees that the SFMTA may from time to time adopt rules and regulations relating to security and other operational concerns that may affect the SFPUC's business and its use of the Sites. The SFMTA will use reasonable efforts to minimize the effect of SFMTA changes on the SFPUC's business.
- (e) Notice of Scheduled Work. Unless otherwise agreed by the Parties, at least two weeks before any scheduled work by the SFPUC, the SFPUC shall provide notice to SFMTA's Deputy Director, Maintenance of Way.
- (f) Compliance with Laws/Permits and Approvals. The SFPUC, at its expense, shall comply with all laws, regulations and requirements of the Federal, State, County and Municipal authorities, now in force or which may hereafter be in force relative to the SFPUC's use of each of the Sites.
- (g) Roof Repairs. The SFPUC will be responsible, at the SFPUC's sole cost and expense, prior to the installation of the Solar Power Project to perform any roof repair or maintenance necessitated by or required to enable or support the Solar Power Project. In the event that the SFPUC determines, in its sole discretion, that the cost associated with said roof repair or maintenance are prohibitive, the SFPUC may elect to terminate this MOU and not to proceed with the Solar Power Project on the Premises.

MEMORANDUM OF UNDERSTANDING
DB-117, Chinatown Public Health Center, MUNI Woods Motor Coach Facility and MUNI Ways & Structures
Facility

- (h) Removal. The SFPUC, at its sole cost and expense, shall remove each of the Solar Power Projects upon expiration or SFPUC's termination of this MOU. The SFPUC shall surrender each of the Sites in the same condition as received, free from hazards and clear of all debris. Subject to any applicable building permits, the SFPUC shall remove all of its property and improvements from each of the Sites. The SFPUC shall provide at least thirty (30) days written notice to the SFMTA of its intention to remove each Solar Power Project and shall complete removal of such Solar Power Project within one hundred and eighty (180) days of such notice.
- (i) Repairs After the Installation of the Solar Power Project. The SFMTA shall provide the Manager of the Energy Generation Projects, Power Enterprise at the SFPUC with written notice at least one hundred and eighty (180) days prior to any planned roof repair, rehabilitation projects or other projects that could affect a Solar Power Project. Subject to any applicable building permits, if a Solar Power Project must be moved or removed to accommodate such SFMTA projects, the SFPUC shall move or remove the Solar Power Project within one hundred and eighty (180) days, unless the Parties agree otherwise. Thereafter, the SFPUC, at its sole option, may reinstall the Solar Power Project on the respective Site subject to the conditions of this MOU.
- (j) "As Is" Condition. Subject only to the requirements of subparagraph 9(g) above, the SFPUC accepts each of the Sites in its "As Is" condition, without representation, warranty or covenant of any kind by the SFMTA, including without limitation, the suitability of the Sites for the SFPUC's proposed use. The SFPUC waives any and all rights to seek reimbursement or indemnity from SFMTA for any loss or cost relating to the condition of the Premises.
- (k) Maintenance: SFPUC's Responsibilities. Except as set forth in subparagraph (l) below, the SFPUC shall at all times during the term of this MOU, at its sole expense and cost, maintain in good working order, condition and repair all improvements placed in or on the Sites pursuant to this MOU. The SFMTA shall not be obligated to make any repairs, replacement or renewals of any kind to the Solar Power Projects. The SFPUC shall utilize best efforts to repair damage to any of the Sites caused by the SFPUC or its agents within ninety (90) days from receipt of written notice from the SFMTA.
- (l) Maintenance: SFMTA's Responsibilities. The SFMTA shall, at its sole cost and expense, maintain the structural and physical integrity of each Site in the "As Is" condition in which it was made available for the installation of the Solar Power Project. The SFPUC shall ensure that the contract for each solar installation includes a 5-year maintenance agreement that the installer must provide as part of its performance guarantee. At the end of the five-year performance guarantee, SFMTA and SFPUC shall mutually agree on the form of a maintenance agreement for future years.
- (m) Charges. There shall be no charge for the use of the Sites for the Allowed Activities in accordance with this MOU. Any utilities or services provided by the SFMTA to the SFPUC in connection with the Allowed Activities shall be at the SFMTA's standard rates, as applied to other SFMTA tenants. If any possessory interest taxes are due as a result of the SFPUC's use of the Sites, then such taxes shall be the SFPUC's responsibility.

(n) Limitations on Use. The SFPUC shall not (i) create a nuisance or commit or permit any waste on any of the Sites; (ii) permit the dumping or other disposal of landfill, refuse, hazardous material or any other material that could pose a hazard to health or safety or the environment, on any of the Sites; (iii) create or permit any liens, including mechanic's, materialmen's or tax liens, to be placed on any of the Sites as a result of the SFPUC's activities without promptly discharging the same; and (iv) do anything in, on, under or about any of the Sites that could cause damage or interference to any of SFMTA's facilities.

(o) Antennae and Telecommunications Dishes. No antennae, telecommunications dish, wireless telecommunications system, or other similar facilities other than solar monitoring, metering, and meteorological equipment may be installed on any of the Sites without prior written approval of the SFMTA Superintendent, Buildings and Grounds.

(p) Exercise of Due Care. The SFPUC shall use, and shall cause its agents to use, due care at all times to avoid any damage or harm to SFMTA facilities and all of the Sites.

10. Procurement and Installation of Solar Power Projects by the SFPUC.

(a) Installation of Solar Power Projects by the SFPUC. If the SFMTA and the SFPUC so agree with respect to a particular Site, the SFPUC may itself install a Solar Power Project at the Site in accordance with the requirements of this MOU. Before beginning any work on installation of a Solar Power Project, the SFPUC shall obtain any and all necessary permits and other approvals, including without limitation, building permits and other federal, state, county and municipal permits or approvals, and other taxes, fees or other assessments as may be applicable to the City by reason of its ownership of the Solar Power Project for the installation of a Solar Power Project on the Site and shall maintain such approvals as necessary throughout the Term of this MOU. Upon request, the SFPUC shall provide to the SFMTA copies of all such permits and approvals.

(b) Cost Responsibility for the Procurement and Installation of the Solar Power Project by the SFPUC. If the SFPUC is responsible for the purchase and installation of a Solar Power Project on a Site, the SFPUC will be responsible for all the costs of such purchase and installation, including but not limited to all utility services provided to the premises and all of the construction management costs.

11. Procurement and Installation of Solar Power Projects by the SFMTA.

(a) Installation of Solar Power Projects by the SFMTA. If the SFMTA and the SFPUC so agree with respect to a particular Site, the SFMTA shall procure and install a Solar Power Project on that Site. Ownership of the solar system shall remain with the SFPUC. Before beginning any work on procurement and installation of a Solar Power Project, the SFMTA shall obtain any and all necessary permits and other approvals, including without limitation, building permits and other federal, state, county and municipal permits or approvals for the installation of a Solar Power Project on the Site. The SFMTA shall maintain such approvals as necessary throughout the Term of this MOU. Permits issued by SFMTA will be charged at standard rates. The SFMTA shall provide to the SFPUC copies of all such permits and approvals.

- (b) Cost Responsibility for the Procurement and Installation of Solar Power Projects by the SFMTA. If the SFMTA procures and installs a Solar Power Project on a Site with approval by the SFPUC, the SFPUC will be responsible for the SFMTA's actual, documented, and reasonable costs of designing, purchasing and contracting to install the Solar Power Project, including but not limited to the costs of the photovoltaic panels, the inverters, the meters to measure the output of the Solar Power Projects, the electrical wiring and conduit between a Solar Power Project and the interconnection to the SFMTA electrical system at the Sites, the installation of the Solar Power Projects, and any necessary permits. The SFPUC will be responsible for reimbursement of the SFMTA's reasonable construction management costs for the procurement and installation of the Solar Power Projects.

The SFPUC shall have the right to review all purchases and contract work associated with the SFMTA's procurement and installation, or contracting to install any Solar Power Project, including but not limited to all scopes of work, designs, drawings, specifications, contracts, task orders, invoices and other relevant project matters. SFPUC shall respond to a SFMTA's request for review of any of these documents within a reasonable period of time, not to exceed two (2) weeks.

- (c) Terms for Installation. In cases where the SFPUC and the SFMTA agree that the SFMTA shall procure and install a Solar Project on a Site, the SFMTA and the SFPUC shall execute mutually acceptable written Terms for Installation that include, but need not be limited to, the following key terms:
- (1) an estimate of the SFMTA's costs to be paid by the SFPUC;
 - (2) milestones for the completion of key tasks by the SFMTA or its third party contractor and an associated schedule for payments by the SFPUC to the SFMTA;
 - (3) specifications for the warranties that will be required for the photovoltaic system components;
 - (4) specifications for the performance guarantee that will be required of a third party contractor installing a Solar Power Project that addresses (a) project performance characteristics, based on a photovoltaic system that operates at a certain standard, and (b) the delivery date;
 - (5) the process and method for determining compliance with the performance guarantee;
 - (6) the liquidated damage amounts that will be required of a third party contractor for a failure to meet the components of the performance guarantee and delivery dates; and
 - (7) a line diagram of the Solar Power Project to be installed including interconnection facilities and the location of the Solar Power Project Meter.

This MOU in conjunction with the Terms for Installation for a particular Site shall set forth the respective responsibilities of the SFMTA and the SFPUC regarding the procurement and installation of a Solar Power Project at that particular Site.

- (d) Warranty for the Photovoltaic System. Irrespective of the entity named in any warranty for a photovoltaic system component that comprises a Solar Power Project, all benefits from any such warranty shall accrue to the SFPUC.

- (e) Performance Guarantees and Liquidated Damages. Irrespective of the entity named in any performance guarantee or liquidated damages clause from a third party contractor for the installation of a Solar Power Project, all benefits from any such performance guarantee or liquidated damages clause shall accrue to the SFPUC except for Special SFMTA liquidated damages. The SFMTA shall promptly provide to the SFPUC any amounts collected pursuant to a performance guarantee and any liquidated damages it receives from a third party contractor associated with the installation of a Solar Power Project except for Special SFMTA liquidated damages. If at the time that a contract for the installation of a Solar Power Project is developed, the SFMTA and the SFPUC agree that the SFMTA may suffer damages due to interruptions in SFMTA operations or loss of SFMTA revenues caused by third party contractor delays, Special SFMTA liquidated damages will be separately identified in the contract documents and will be separately assessed against the contractor from standard liquidated damages. Such Special SFMTA liquidated damages will be payable to the SFMTA.
- (f) Payments by the SFPUC to the SFMTA. Payments by the SFPUC to the SFMTA for the procurement and installation of a Solar Power Project on a Site shall be made in accordance with the schedule in the Terms for Installation.
- (g) As-Build Drawings/O&M Manuals/Reports. Promptly upon completion of a Solar Power Project, the SFMTA shall furnish to the Manager of Energy Generation Projects at the SFPUC two (2) complete copies of final as-built drawings (with electronic files on a CD-ROM in pdf and AutoCad) and two (2) complete copies of the O&M Manuals (with electronic files on a CD-ROM) for the Solar Power Project, which drawings shall include sufficient detail so as to allow the SFPUC to precisely locate the Solar Power Project. In the event that the SFMTA or its agents prepares any environmental, seismic, geophysical or other written report relating to any of the Sites and/or any work performed thereon, the SFMTA shall furnish these reports to the SFPUC.

12. Ownership of the Solar Power Projects.

- (a) Each Solar Power Project shall be and shall remain the property of the SFPUC. Any and all of the Environmental Credits associated with the Solar Power Projects shall be and shall remain the property of the SFPUC. The SFPUC will be solely responsible for the payment of federal, state, local and other taxes, fees or other assessments as may be applicable to the SFPUC by reason of its ownership of the Solar Power Projects. Fixed and unmovable parts of the Solar Power Projects (including conduit and replacement roofing material) will become the property of the SFMTA upon final removal of the Solar Power Projects by the SFPUC upon expiration or termination of this MOU.

13. Operation of the Solar Power Projects.

- (a) Operation of the Solar Power Projects. The SFPUC will be responsible for all the Allowed Activities, including operation, associated with the Solar Power Projects that are not made the responsibility of the SFMTA pursuant to this MOU or an executed written agreement between the Parties. The SFPUC shall undertake the Allowed Activities in accordance with

MEMORANDUM OF UNDERSTANDING
DB-117, Chinatown Public Health Center, MUNI Woods Motor Coach Facility and MUNI Ways & Structures
Facility

the terms of this MOU and Prudent Utility Practice; and in compliance with all permits and applicable laws and regulations.

(b) Planned Service Interruptions. The SFPUC will work with the SFMTA to minimize the number and extent of any interruptions in Electric Service related to the Allowed Activities. All planned Electric Service interruptions related to the Allowed Activities shall be subject to approval by the SFMTA, which approval shall not be unreasonably withheld. In the event of a planned Electric Service interruption, the SFPUC shall submit a written request to the Deputy Director, Maintenance of Way for the SFMTA at least ten (10) business days before the interruption date. A failure on the part of the SFMTA to respond within five (5) business days shall be deemed an approval of the service interruption. The SFPUC will not be responsible for any of the SFMTA's direct or indirect expenses caused by or related to an Electric Service interruption or its cancellation.

(c) Planned and Emergency Shut Downs by SFMTA. In the event that SFMTA needs to shut down all or a portion of the electrical system at any of the Sites, the SFMTA shall provide as much advance notice to the Manager of Energy Generation Projects of the SFPUC, as possible. For planned shutdowns, the SFMTA shall provide at least ten (10) business days written notice to the SFPUC. In the event of a process or emergency shutdown, the SFMTA shall provide the SFPUC as much prior notice as possible.

(d) Operation of the Solar Power Projects during Emergencies. In an Emergency, if necessary to protect the health or safety of the public or the SFMTA employees, the SFMTA may shut down a Solar Power Project, provided that it notifies and seeks approval for these actions from the Manger of Energy Generation Projects of the SFPUC. The SFMTA shall make all reasonable attempts to notify the SFPUC and to obtain approval for such actions prior to taking them. If prior notice and approval are impossible, the SFMTA shall notify the SFPUC and obtain approval as soon as possible thereafter. The SFMTA shall work with the SFPUC to reconnect the Solar Power Project as soon as possible. The parties shall establish mutually agreeable emergency protocols for implementation during Emergencies.

14. Use of the Output from the Solar Power Project.

(a) Use of the Output. The SFMTA agrees to use the output from the Solar Power Project to serve SFMTA's electric needs at the Premises.

(b) Metering. The SFPUC shall meter the output of the Solar Power Project using meters owned, operated, maintained and read by the SFPUC. The SFPUC shall be solely responsible for all costs and charges associated with such metering. The SFMTA shall provide, at no expense to the SFPUC, a suitable location for all meters and associated equipment. The meters shall be sealed and the seals shall be broken only upon occasions when meters are to be inspected, tested or adjusted, and representatives of the SFMTA shall be afforded reasonable opportunity to be present upon such occasions. The meters shall be tested at any reasonable time upon request therefore by either Party. Any metering equipment found to be defective or inaccurate shall be repaired and re-adjusted or replaced. If a meter fails to register or if the measurement made by a meter during a test varies by more than two (2) percent from the measurement made by the standard meter used in the test, an adjustment to correct all meter

MEMORANDUM OF UNDERSTANDING
DB-117, Chinatown Public Health Center, MUNI Woods Motor Coach Facility and MUNI Ways & Structures
Facility

records of measurements made by the inaccurate meter shall be made for: (i) the period since the last meter test, or (ii) the actual period during which inaccurate measurements were made if the City determines this period can be established, provided that the period covered by the correction shall not exceed six (6) months or half the time since the previous test. If necessary, the corrections may be estimated from the best information available for the period of defect or inaccuracy.

- (c) Payment for Electricity from the Solar Power Project. The SFMTA shall pay the SFPUC for the output from the Solar Power Project used to serve the electrical requirements at the Premises, as measured by the Solar Power Project Meter, at the otherwise applicable rates for the provision of Electric Service by the SFPUC to the SFMTA.

15. Insurance. The SFPUC shall require that its vendors, contractors, and agents obtain and maintain insurance coverage as relates to the Solar Power Projects in the types and amounts approved by the City's Risk Manager and approved by SFMTA. All insurance policies shall contain a cross-liability clause, and shall name as additional insured the City and County of San Francisco, the SFMTA, the SFPUC, and their officers, directors, employees, and agents.

16. Security. The SFMTA shall provide the same level of security at the Premises as it otherwise provides at each of the SFMTA's facilities.

17. Damages/Indemnity. It is the understanding of the parties that the SFMTA shall not expend any funds due to or in connection with the SFPUC's construction and installation or maintenance of the Solar Power Project, or the use of the Premises, except as otherwise set forth herein. Therefore, the SFPUC agrees to indemnify the SFMTA and to be responsible for all costs associated with all claims, damages, liabilities or losses which arise (i) out of the SFPUC's construction and installation or maintenance of the Solar Power Project, (ii) the use of the Premises, including but not limited to the release or handling of hazardous materials on or about the Premises by the SFPUC, its agents or contractors, but excluding pre-existing hazardous materials (which are the responsibility of the SFMTA or its tenants), or (iii) out of any injury or death of any person or damage of any property occurring in, on or about the Premises from any cause other than the sole negligence or willful misconduct of the SFMTA. The foregoing obligation of the SFPUC shall survive the expiration or termination of this MOU. As used herein, "hazardous materials" shall mean any substance, water or material which has been determined by any state, federal or local government authority to be capable of posing a risk of injury to health, safety or property. In addition, the SFPUC will ensure that the SFMTA is indemnified to the same extent that the SFPUC is indemnified by any of the SFPUC's vendors, contractors or agents for the Solar Power Project.

18. No Assignment. The SFPUC shall not assign, sublet, encumber, or otherwise transfer, whether voluntary or involuntary or by operation of law, the Premises or any part thereof, or any interest herein, without the SFMTA's prior written consent.

19. Liability of Each Party. Except as set forth in Section 15 above, the SFPUC shall not be responsible for any damage to persons or property as a result of the use, misuse or failure of any equipment used by the SFMTA or by any of its employees, even though such equipment is furnished, installed or loaned by the SFMTA. Notwithstanding Section 17 above, in no event shall the SFPUC be

liable, regardless of whether any claim is based on contract or tort, for any special, consequential, indirect or incidental damages including, but not limited to, lost profits, arising out of or in connection with this MOU or the services performed in connection with this MOU.

20. Cooperation. Subject to the terms and conditions of this MOU, the SFMTA and SFPUC agree to use reasonable efforts to do, or cause to be done, all things reasonably necessary or advisable to carry out the purposes of this MOU and SFPUC's use of the Premises contemplated hereby as expeditiously as practicable, including, without limitation, performance of further acts and the execution and delivery of

any additional documents in form and content reasonably satisfactory to both Parties. Notwithstanding anything to the contrary in this MOU, neither the SFMTA nor the SFPUC are in any way limiting their discretion or the discretion of any department, board or commission with jurisdiction over the Solar Power Project from exercising any discretion available to such department, board or commission with respect to the Solar Power Project, including but not limited to the discretion to (i) make such modifications deemed necessary to mitigate significant environmental impacts, (ii) select other feasible alternatives to avoid such impacts, (iii) balance the benefits against unavoidable significant impacts prior to taking final action if such significant impacts cannot otherwise be avoided, or (iv) determine not to proceed with the proposed Solar Power Project. In addition to any conditions described in this MOU, the obligations of the SFMTA and the SFPUC are expressly subject to the receipt of all legally required approvals following environmental review.

21. Dispute Resolution. The SFMTA and the SFPUC will cooperate to attempt to resolve issues that arise under this MOU informally, promptly and fairly. If staff involved in accomplishing the tasks set forth in this MOU are unable to resolve an issue after good faith attempts to do so, either Party may request a meeting of the appropriate Managers of each department to address the issue. If such a meeting is requested, it shall be held within two (2) weeks unless the Parties agree to a later date.

22. Miscellaneous.

(a) This MOU may be amended or modified only by a written agreement signed by the SFMTA and the SFPUC.

(b) No waiver by any Party of any of the provisions of this MOU shall be effective unless in writing and signed by an authorized representative, and only to the extent expressly provided in such written waiver.

(c) This MOU (including the Attachments) contains the entire understanding between the Parties as of the date of this MOU, and all prior written or oral negotiations, discussions, understandings and agreements are merged herein.

(d) Notwithstanding anything to the contrary set forth herein, no officer, director or employee of the SFMTA has the authority to bind the SFMTA hereto unless and until the San Francisco SFMTA Board approves this MOU.

(e) All transactions described herein are subject to and must be conducted in accordance with the applicable requirements of the City's Charter and codes and applicable state and/or federal laws.

23. Notices.

All notices, demand, consents or approvals which are or may be required to be given by either Party to the

MEMORANDUM OF UNDERSTANDING

DB-117, Chinatown Public Health Center, MUNI Woods Motor Coach Facility and MUNI Ways & Structures Facility

other under this MOU shall be in writing and shall be deemed to have been fully given when delivered in person to such representatives of the SFMTA and the SFPUC as shall from time to time be designated by the Parties for the receipt of notices, or when deposited in the United States mail, postage prepaid, and addressed, if to the SFPUC to:

San Francisco Public Utilities Commission
Attn: Barbara Hale
Assistant General Manager, SFPUC Power Enterprise
1155 Market Street, 4th Floor
San Francisco CA, 94103

Tel No. (415) 934- 5751
Fax No. (415) 554-2465

and if to the SFMTA to:

Thomas Kennedy, SFMTA Deputy Director
Maintenance of Way
SFMTA Infrastructure Maintenance
700 Pennsylvania Ave
Bldg D. Room 226
San Francisco, CA 94107

Fax No. (415) 401-3159
Tel No. (415) 401-3156

or such other address with respect to either Party as that Party may from time to time designate by notice to the other given pursuant to the provisions of this Paragraph.

MEMORANDUM OF UNDERSTANDING
DB-117, Chinatown Public Health Center, MUNI Woods Motor Coach Facility and MUNI Ways & Structures
Facility

IN WITNESS WHEREOF, the Parties have caused this agreement to be executed as of the date first written above.

AGREED TO AS WRITTEN ABOVE:

CITY AND COUNTY OF SAN FRANCISCO, a municipal corporation operating by and through its SAN FRANCISCO MTA BOARD OF DIRECTORS

By: [Signature]
SFMTA Executive Director/CEO

Date: 3/30/09

San Francisco Municipal Transportation Authority Board Resolution No. _____

Approved: _____

AGREED TO AS WRITTEN ABOVE:

CITY AND COUNTY OF SAN FRANCISCO, a municipal corporation operating by and through its PUBLIC UTILITIES COMMISSION

By: [Signature]
General Manager

Date: _____

San Francisco Public Utilities Commission Resolution No. _____

Approved: _____

MEMORANDUM OF UNDERSTANDING
DB-117, Chinatown Public Health Center, MUNI Woods Motor Coach Facility and MUNI Ways & Structures Facility

APPENDIX A

MEMORANDUM OF UNDERSTANDING
DB-117, Chinatown Public Health Center, MUNI Woods Motor Coach Facility and MUNI Ways & Structures
Facility

AEPIC Group, LLC
 10000 Wilshire Blvd., Suite 1000
 Beverly Hills, CA 90210
 Phone: (310) 277-1111
 Fax: (310) 277-1112
 Website: www.aepic.com

REVISIONS

NO.	DATE	DESCRIPTION
1	08/11/10	ISSUED FOR PERMIT
2	08/11/10	ISSUED FOR PERMIT
3	08/11/10	ISSUED FOR PERMIT
4	08/11/10	ISSUED FOR PERMIT
5	08/11/10	ISSUED FOR PERMIT
6	08/11/10	ISSUED FOR PERMIT
7	08/11/10	ISSUED FOR PERMIT
8	08/11/10	ISSUED FOR PERMIT
9	08/11/10	ISSUED FOR PERMIT
10	08/11/10	ISSUED FOR PERMIT
11	08/11/10	ISSUED FOR PERMIT
12	08/11/10	ISSUED FOR PERMIT
13	08/11/10	ISSUED FOR PERMIT
14	08/11/10	ISSUED FOR PERMIT
15	08/11/10	ISSUED FOR PERMIT
16	08/11/10	ISSUED FOR PERMIT
17	08/11/10	ISSUED FOR PERMIT
18	08/11/10	ISSUED FOR PERMIT
19	08/11/10	ISSUED FOR PERMIT
20	08/11/10	ISSUED FOR PERMIT

MUNICIPALITY OF SAN FRANCISCO
 DEPARTMENT OF PUBLIC WORKS
 SAN FRANCISCO, CA
 PHOTOVOLTAIC PROJECT



ELECTRICAL SINGLE LINE DIAGRAM

E5.1

NOTES:
 1. SEE SHEET E5.2 FOR THE REMAINDER OF THE SYSTEM.

SEE SHEET E5.2 FOR THE REMAINDER OF THE SYSTEM.

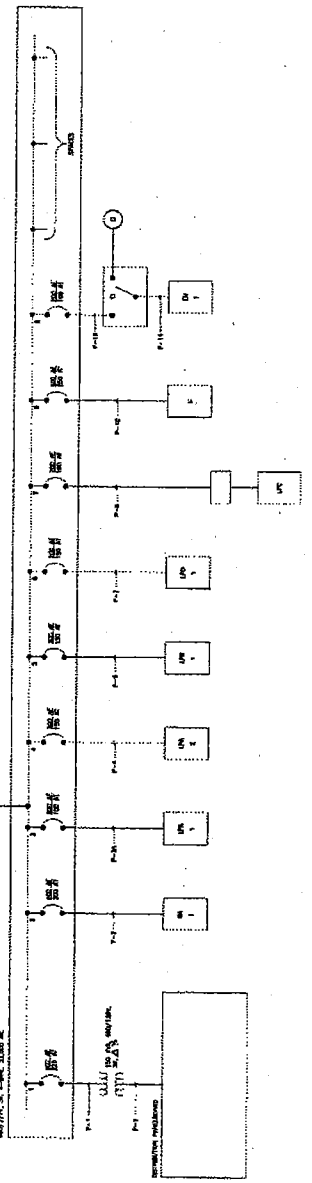
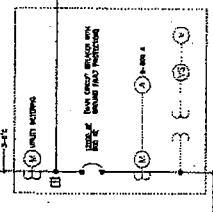

ELECTRICAL - SINGLE LINE DIAGRAM
 SCALE: NTS





Executive Directive 05-107
Rooftops for Municipal Solar

October 26, 2005

By virtue of the power and authority vested in me by Section 3.100 of the San Francisco Charter to provide administration and oversight of all departments and governmental units in the executive branch of the City and County of San Francisco, I do hereby issue this Executive Directive to become effective immediately:

1. The City declares its commitment to increasing the pace of municipal solar development.

San Francisco City Government has long led the country in its commitment to renewable energy. With the expertise and drive of our SFPUC, we have built the nation's largest City-owned solar photovoltaic installation (675 kWp) at the Moscone Convention Center. We have completed our newest photovoltaic installation at our Southeast Water Pollution Control Plant (255 kWp) in the Bayview neighborhood. We are about to enter into a contract to install another 283 kWp photovoltaic system at Pier 96 adjacent to PG&E's Hunter's Point Power Plant. Next year, the City will be building four smaller photovoltaic systems on public libraries and medical centers in the Western Addition, Chinatown and Pacific Heights. While these are great first steps, the City set a goal in 2002 to reduce San Francisco's greenhouse gas emissions by 20% below 1990 levels by 2012, and to have 28 MW solar on municipal buildings, residences and businesses by 2008. The City commits to increasing our development of solar energy, and encourages residences and businesses to follow.

2. Departments shall assist the Public Utilities Commission (PUC) in advancing municipal solar development by taking the following actions:

- a) Identify facilities that could be good locations for photovoltaic systems. Specifically, buildings with:
 - o New roofs that are not shaded on the south side,
 - o Roofs with at least 20,000 square feet of open space, and
 - o Buildings with space for an additional meter and an inverter in their electrical rooms.
- b) Before November 30, 2005, send to the PUC a list of the locations of recommended facilities, as well as the name of the department staff member who can accompany an SFPUC representative to review these locations' roofs and electrical rooms. This report should be transmitted to Barbara Hale, Assistant GM for Power at the PUC, and copied to my office.
- c) Make your facility rooftops the PUC's solar development space.

- 3. PUC shall prepare a yearly report each September on the efforts that departments are making towards the City's renewable energy goals through the municipal solar program.**

The PUC will continue to provide reliable, low cost power to all city departments. Departments participating in the municipal solar development program will continue to pay the same electricity tariff they are now paying but they can use clean, on-site energy from the installed photovoltaic system, which helps all San Franciscans by reducing greenhouse gas emissions. For more information about this program and how you can help, please contact John Doyle of the Public Utilities Commission at 554-1541 or jdoyle@sfgwater.org.

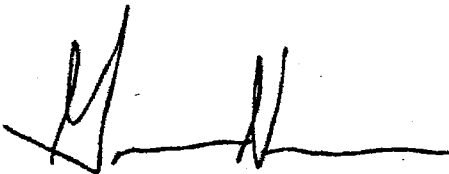
A handwritten signature in black ink, appearing to be 'Gavin Newsom', written over a horizontal line.

Gavin Newsom
Mayor



**LETTER OF AGREEMENT BETWEEN
SAN FRANCISCO PUBLIC UTILITIES COMMISSION / POWER ENTERPRISE
AND
THE DEPARTMENT OF PUBLIC WORKS / BUREAU OF BUILDING REPAIR
FOR
MUNI WAYS & STRUCTURES FACILITY
100kW SOLAR ELECTRIC PROJECT**

This LETTER OF AGREEMENT (LOA) between the SAN FRANCISCO PUBLIC UTILITIES COMMISSION'S POWER ENTERPRISE (PE), and the DEPARTMENT OF PUBLIC WORKS BUREAU OF BUILDING REPAIR (DPW/BBR), formalizes the roles and responsibilities, project scope, costs, and other terms associated with the CONSTRUCTION SERVICES to be provided by DPW/BBR to PE for the above named project.

The purpose of this LOA is for PE to secure project management, construction, and procurement services from DPW/BBR to support the development, planning, approvals, design, and construction phases of the project as is further defined below, for the 100kW solar electric project be located at the MUNI Ways & Structures Facility. PE has no in-house construction resources and, therefore, DPW/BBR shall become the construction entity on behalf of the project owner, PE.

RECITALS

The "MUNI Ways & Structures Solar Electric Project" is a clean distributed generation resource to be developed on MUNI's property; promoting sustainability and good stewardship of our resources. This project will put to good use the available roof space within MUNI's portfolio of buildings to generate cost effective renewable energy in accordance with the Mayor's Executive Directive 05-107 (Roof Tops for Municipal Solar), dated October 26, 2005.

The resulting renewable greenhouse gas-free electric energy will serve the City's municipal loads as served by PE.

B. And whereas,

1. PE oversees energy policy and energy trading and strives to increase the City's Renewables Portfolio Standard (RPS) qualifying energy generation; and, as such, typically funds, develops, and owns renewable generation projects, and;
2. PE has, at the date of execution of this LOA, sufficient funding in place to cover project development, design engineering, and construction.

Edwin M. Lee
Mayor

Art Torres
President

Vince Courtney
Vice President

Ann Moller Caen
Commissioner

Francesca Viator
Commissioner

Anson Moran
Commissioner

Harlan L. Kelly, Jr.
General Manager



3. Whereas the essence of the agreement between SFUSD and PE is:
- a. PE will fully fund the solar electric plant.
 - b. PE will plan, design, and manage the construction of the plant.
 - c. MUNI will review and approve design submittals.
 - d. PE shall retain ownership of the plant, and the energy benefits, i.e. capacity, energy, and renewable energy certificates, per the Memorandum of Understanding (MOU) between the SFPUC and MUNI.

ROLES AND RESPONSIBILITIES OF PARTIES

Roles and responsibilities of the parties shall be in accordance with the Project Scope of Services (see **Attachment A** -- Scope of Services, June 10, 2013). Attachment A spells out the detailed plan for the project.

More generally,

- San Francisco Public Utilities Commission (SFPUC) shall be considered the Project Owner, and Project Manager, and shall perform design engineering, permitting, and project engineering support.
- MUNI shall be considered the Host with its primary focus on design and construction activity approval.
- DPW/BBR shall be considered the General Contractor for construction, with assistance from PE in providing project engineering and technical support.

SCOPES OF WORK AND BUDGETS

The Cost for DPW/BBR construction services to be provided herein shall not exceed \$212,725.01. The services are explained, estimated, and itemized per **DPW/BBR Service Order – 424198 (Attachment B)** and are based on the Scope of Services document, Attachment A. Any change orders to the cost proposal, as submitted by DPW/BBR, shall be reviewed and approved by PE prior to any work being performed. DPW/BBR shall submit its Change Order Request with scope of services described, cost estimate, and reason for change or deviation from original scope of work.

PE may also submit a Change Order Request to DPW/BBR for work requested by PE which is a change from the base scope of work. DPW/BBR will submit its proposal for this requested change with cost, schedule, and other information to PE for approval prior to proceeding with the work.

PROJECT SCHEDULE

The project schedule is provided in **Attachment C**, MUNI Ways & Structures Solar Electric Project Preliminary Schedule. Generally, it is anticipated that construction activities will occur during June and July 2013 (June 10, 2013 – August 15, 2013). Several variables such as DBI permit approval and material procurement will all bear upon the feasibility of this goal. It will be incumbent upon the parties to work diligently toward this goal, yet necessary adjustments from unforeseen or uncontrolled influences may extend the schedule.

TERM

This LOA shall become effective on the date of execution by all parties. Termination of this LOA shall be upon the completion of the solar electric plant and project acceptance by PE as defined in the Scope of Services, Attachment A.

MISCELLANEOUS

A. Communication: The parties shall communicate at all times to support the work effectiveness of the project team. A PE and DPW/BBR organization chart and a list of all staff / project team personnel with roles and contact information shall be developed at the start of the work and updated as necessary.

Routine progress reports shall be shared and project and progress meetings held.

B. Documentation Control: DPW/BBR shall follow typical PE documentation control procedures and requirements in the execution of this work. Details will be worked out between the parties at the beginning of the project.

C. Payment: SFPUC will establish an interdepartmental reallocation for the project based on the following payment schedule:

- a. Project Initiation (Executed LOA) 40% Contract Labor Value and 100% Materials and DPW-External Contractor Cost
- b. Payment #2 – 20% Contract Value
- c. Payment #3 – 20% Contract Value
- d. Payment #4 – 20% Contract Value

Changes in cost shall be approved prior to any work being performed. DPW/BBR shall provide bi-weekly project reports covering labor hours expended to date, tasks accomplished, costs expended, and updated schedule. DPW/BBR shall charge to that account as needed. However, should the project work stop or be canceled by PE, PE may request DPW/BBR to itemize and calculate actual work completed, and reimburse PE the unspent balance whether or not remaining in the project reallocation index fund.

D. Notices: All notices and principal communications shall be directed to the following:

SFPUC -- Power Enterprise:
Jamie Seidel, Project Manager
SFPUC – Power Enterprise
525 Golden Gate Avenue, 7th Floor
San Francisco, CA 94103

DPW/ BBR:
Sue Black, Superintendent
DPW/BBR
2323 Cesar Chavez Street
San Francisco, CA 94124

ACCEPTED:



SFPUC Power Enterprise, Barbara Hale, Assistant General Manager

6/11/13

Date



6/18/13

DPW/BBR, Sue Black, Superintendent,

Date

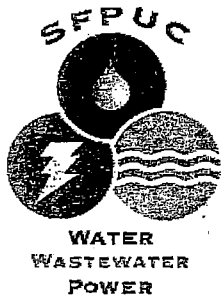

SAN FRANCISCO PUBLIC UTILITIES COMMISSION

1155 Market St., 4th Floor, San Francisco, CA 94103 • Tel. (415) 554-0725 • Fax (415) 554-1854 • TTY (415) 554.3488



July 7, 2008

POWER ENTERPRISE

JUL 17 2008

RECEIVED

GAVIN NEWSOM
MAYOR

ANN MOLLER CAEN
PRESIDENT

E. DENNIS NORMANDY
VICE PRESIDENT

RICHARD SKLAR
DAVID HOCHSCHILD
F.X. CROWLEY

ED HARRINGTON
GENERAL MANAGER

Bill Wycko
Environmental Review Officer
Major Environmental Analysis Section
San Francisco Planning Department
1650 Mission Street, Suite 400
San Francisco, CA 94103

RE: CEQA Exemption for Solar Photovoltaic Project at MUNI Ways & Structures Facility

Dear Mr. Wycko:

The Power Enterprise of the San Francisco Public Utilities Commission (SFPUC) has prepared the following project information on the proposed solar photovoltaic project at MUNI Ways & Structures Facility. Per the authority to issue Class 1 Minor Alteration exemptions for Solar Projects, granted to our office by SF Planning Department (Paul Maltzer letter of June 9, 2006), we believe the proposed project meets the test for exemption, with no unique or unusual environmental impact. Consequently, we request concurrence from your office.

Project Description

The SFPUC Power Generation Group is proposing to install a 168 kilowatt (kW) solar photovoltaic (PV) system on the roof of the MUNI Ways & Structures Facility, Building A, located at 700 Pennsylvania Avenue (see **Site Vicinity Map**) and owned by the City of San Francisco (Block 4167, Lot 010).

The MUNI Ways & Structures Facility, Building A is a two-story concrete structure built in 1966 and used for workshops/light maintenance and administrative offices. It is approximately 56,000 square feet in area. Weather protection for the roof is achieved by built-up roofing, which slopes at approximately 3 percent (see **Site Map** and **Site Photographs**).

The proposed installation of this system will reduce peak demand loads and the daily energy consumption for the MUNI complex and provide reliable, high quality power with minimal environmental impacts. The load for the facility is 52,560 kW hours per month.

There are two possible system designs, both of which use solar photovoltaic (PV) cells, and each with a total array size of 168 kW (DC-peak). The DC output from the PV modules will be converted to 480 volt 3-phase alternating current (AC) via a single inverter:

RECEIVED

JUL 08 2008

CITY & COUNTY OF S.F.
PLANNING DEPARTMENT
M.E.A.

2008.0810E

- 1) The first design is a roof-integrated membrane with embedded poly or mono-crystalline solar PV cells installed on the facility's roof. The BIPV design would become part of the roofing structure and will allow for a low profile that will blend in to the existing building's profile. The BIPV system shall also provide thermal insulation and protect the roof membrane from harsh UV rays and thermal degradation, which reduces heating and cooling energy costs as well as extend the life of the roof.
- 2) The second design would be composed of rigid crystalline PV panels, mounted on a rack to allow rain to drain into the roof's gutters and provide easy accessibility for maintenance. This system would also provide thermal insulation and protect the roof from UV rays and thermal degradation.

All work, facilities, equipment, materials, and ongoing operation and maintenance would be in compliance with the requirements of SFPUC Power Department's specifications and safe practices.

The project is currently being designed and is scheduled to bid out in early Summer 2008, with construction commencing early Fall 2008. Construction will be for approximately two months.

Environmental Impacts

Population and Housing:

The proposed project would install a 168 kW PV solar system on the existing MUNI facility roof. The electric power generated by the solar system will be used to meet the facility's energy demands. Therefore, the proposed project would not induce population growth by serving new customers.

Aesthetics:

Visual: It is anticipated that a low profile tilted solar PV installation will be deployed at this site. The facility roof is not visible from the street or nearby buildings and is only partially visible from the hills to the west and southwest. Due to the low profile of the PV installation, and the non-glare features of the solar panels, it appears there would be no significant visual effects.

Transportation (during construction):

The proposed project would be constructed during normal daytime work hours. During the construction of the project, the facility would continue to function during its normal hours of operation. PV Modules would be stored offsite and scheduled in partial shipments for site delivery. It is anticipated that no public right-of-way would be infringed upon by work or storage of equipment. The potential construction traffic at the project site would be considered temporary and would not contribute more than

approximately 10 round-trip vehicles per day. Therefore, the project would not cause major traffic hazards or contribute to cumulative traffic increases in the area.

Noise:

The inverter and transformer cooling fans, etc. would be equipped with noise-dampening equipment; any noise generated would not exceed residential noise standards (refer to City & County of San Francisco Municipal Code, Police Code – Article 29: Regulation of Noise).

Hazardous Materials & Waste:

The proposed project would not increase the use or storage of any hazardous materials at this site. This site is not listed on any State or Federal environmental priority lists (such as Cortese or LUST). It is not expected that any hazardous materials will be encountered; however, if any abatement is required, SFPUC will use the Department of Public Work's Site Assessment and Remediation Division to fully abate any hazards prior to construction.

CEQA Compliance Determination

The proposed project and its associated construction would not require additional undeveloped land to be disturbed or the acquisition of new property. During the construction and upon completion of the construction of the project, the existing facility would continue to function during its normal hours of operation. Therefore, the SFPUC (per the Delegation of Categorical Exemption Authority for Solar Projects, as referenced above) has determined that the project meets the criteria for a categorical exemption under the following CEQA Section:

Section 15303, Class 3(d) - New Construction or Conversion of Small Structures: Water main, sewage, electrical, gas and other utility extensions, including street improvements, or reasonable length to serve such construction.

Should you have questions regarding the proposed project, please contact me at 415-554-1541.

SAN FRANCISCO DEPARTMENT OF CITY PLANNING
CATEGORICALLY EXEMPT FROM ENVIRONMENTAL REVIEW

Sincerely,

John Doyle
John Doyle

Energy Generation Services
SFPUC Power Enterprise

CLASS 1(b) - Existing Facilities:

Existing facilities of both investor and publicly-owned utilities used to provide electric power, natural gas, sewerage, or other public utility services.

Attachments: Fig. 1: Site Vicinity Map

Vikoriya Wise

7/15/08.

Fig. 2: Site Map
Roof photos

Cc: Randall Smith, Utility Specialist, SFPUC
Darwin Helmuth, Utility Specialist, SFPUC
Viktoriya Wise, SF

1 [Solar Power Projects Long Term Interconnection Agreements.]
2

3 **Resolution authorizing the San Francisco Public Utilities Commission General Manager**
4 **to enter into long term interconnection agreements for photovoltaic power plants**
5 **projects on City buildings, pursuant to San Francisco Charter Section 9.118.**
6

7 WHEREAS, The San Francisco electorate in November 2001 adopted Propositions B
8 and H, requiring the development and use of renewable energy on buildings owned by the
9 City and County of San Francisco; and

10 WHEREAS, The San Francisco Public Utilities Commission (SFPUC) was given
11 responsibility for implementing those renewable energy projects; and,

12 WHEREAS, The SFPUC has installed several photovoltaic power plant systems on
13 City Buildings, including the Moscone Center, the Southeast Treatment Plant and the
14 recycling facility at Pier 96; and

15 WHEREAS, the construction, or installation and operation agreements for these
16 Projects were approved by the Board of Supervisors respectively in the following resolutions:
17 Moscone Center, Resolution 621-02; Southeast Treatment Plant, Resolution 443-04; and Pier
18 96, Resolution 189-06; and

19 WHEREAS, The SFPUC has authorized and developed five additional projects that
20 are nearing completion, including Chinatown Public Library, Maxine Hall Medical Center, City
21 Distribution Division (CDD) Warehouse, North Point Treatment Plant and San Francisco
22 International Airport Terminal 3 rooftop (the Solar Projects); and

23 WHEREAS, On August 8, 2006, the SFPUC authorized a contract with Design-Build
24 Solutions, Inc, the Power Enterprise funded agreement No. DB 112, Solar Photovoltaic
25 Renewable Energy Plants, for turnkey design and construction of two solar photovoltaic

1 renewable energy plants, for an amount not to exceed \$492,964.16 over the life of the
2 Chinatown Branch Public Library and Maxine Hall Neighborhood Medical Center projects;
3 and,

4 WHEREAS, On September 26, 2006, the SFPUC authorized a contract with Stellar
5 Energy Solutions, the Mayor's Energy Conservation Account-funded agreement No. DB-110-
6 R, Photovoltaic Power Plants at CDD and North Point, to provide design, construction, and
7 commissioning of a 86.75 kW photovoltaic system at City Distribution Division's warehouse
8 and a 157 kW system at North Point Wet Weather Facility for an amount not to exceed
9 \$2,968,434 ; and

10 WHEREAS, The Airport Commission awarded Airport Contract No. 8684, Terminal 3
11 Solar Power System to Bay Area Systems and Solutions, dba Bass Electric Company, in the
12 amount of \$5,533,608.00 and approved an additional \$100,000.00 for Type I Modifications;
13 and

14 WHEREAS, The SFPUC must enter into Generating Facility Interconnection
15 Agreements (GFIs) with Pacific Gas and Electric Company (PG&E) to interconnect and
16 operate the Solar Projects in parallel with PG&E's Distribution System and to serve the
17 electrical loads at the City buildings in question, and

18 WHEREAS, The GFIs for the Solar Projects are based on a form agreement
19 approved by the California Public Utilities Commission; and

20 WHEREAS, The term of the GFIs for the Solar Projects is indefinite and hence
21 exceeds ten (10) years, and thus is subject to approval by this Board of Supervisors pursuant
22 to San Francisco Charter section 9.118; and

23 WHEREAS, The GFIs for the Solar Projects are subject to termination by the City for
24 any reason upon sixty days notice; and

1 WHEREAS, It is to the City's benefit for the GFIA's to have indefinite terms since this
2 allows the Solar Projects to remain interconnected indefinitely subject to the City's right to
3 terminate the GFIA's and disconnect the Solar Projects for any reason, upon sixty days notice;
4 and

5 WHEREAS, In order to qualify for financial incentives for each of the pending Solar
6 Projects (with the exception of Chinatown Library, which is below the limit to qualify), the
7 SFPUC must execute the GFIA for each of the projects by certain deadlines to provide PG&E
8 with Proof of Authorization to interconnect the solar systems; such dates being Maxine Hall
9 (11/6/2007); City Distribution Division (11/8/2007); North Point (12/13/2007); and San
10 Francisco International Airport (12/29/2007); and

11 WHEREAS, Because of time considerations related to obtaining a sizeable financial
12 incentive, the SFPUC entered into a GFIA with PG&E for a solar project at Pier 96 with a term
13 of 9 year 11 months; and

14 WHEREAS, The SFPUC desires to amend the GFIA for Pier 96 to extend the term to
15 an indefinite term, subject to termination by the City for any reason, upon sixty days notice,
16 consistent with the GFIA's for the Solar Projects; and

17 WHEREAS, The City Risk Manager has approved the Limitation of Liability language
18 set forth in section 7 and the Insurance language set forth in section 8 of the GFIA's for the
19 Solar Projects and for Pier 96; and

20 WHEREAS, The SFPUC may also be required by PG&E to enter into an Export
21 Addendum (Uncompensated) to the GFIA to address the distribution of any unused energy
22 produced by those projects (the Export Addendums), which addendums modify the GFIA and
23 will remain in effect for the same term as the GFIA; and

1 WHEREAS, A copy of the GFIA's for the Solar Projects, with the exception of the
2 Chinatown Library project GFIA, which will be in substantially the same form as the other
3 Solar Project GFIA's, and the form of the Export Addendums are on file with the Clerk of the
4 Board of Supervisors in File No. ⁰⁷¹²⁹⁵, which is hereby declared to be a part of this resolution as
5 if set forth fully herein; and,

6 WHEREAS, This Board supports the use and development of renewable energy on
7 City Buildings; now, therefore, be it

8 RESOLVED, That this Board of Supervisors authorizes the San Francisco Public
9 Utilities Commission General Manager to enter into the GFIA's for the Solar Projects, and to
10 amend the Pier 96 GFIA to extend the term to an indefinite term, and to enter into Export
11 Addendums where required, pursuant to San Francisco Charter section 9.118.



City and County of San Francisco

City Hall
1 Dr. Carlton B. Goodlett Place
San Francisco, CA 94102-4689

Tails
Resolution

File Number: 071295

Date Passed:

Resolution authorizing the San Francisco Public Utilities Commission General Manager to enter into long term interconnection agreements for photovoltaic power plants projects on City buildings, pursuant to San Francisco Charter Section 9.118.

October 16, 2007 Board of Supervisors — ADOPTED

Ayes: 11 - Alioto-Pier, Ammiano, Daly, Dufty, Elsbernd, Chu, Maxwell, McGoldrick, Mirkarimi, Peskin, Sandoval

File No. 071295

I hereby certify that the foregoing Resolution was ADOPTED on October 16, 2007 by the Board of Supervisors of the City and County of San Francisco.

10/22/2007

Date Approved

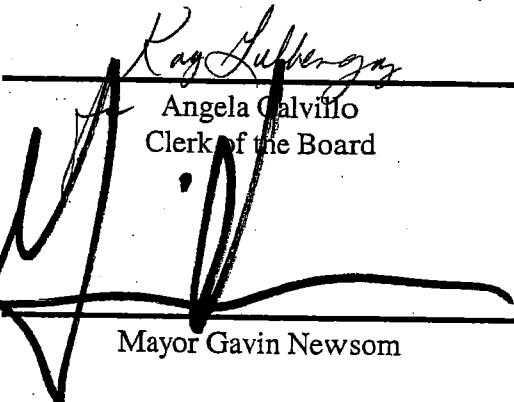
Angela Galvillo
Clerk of the Board

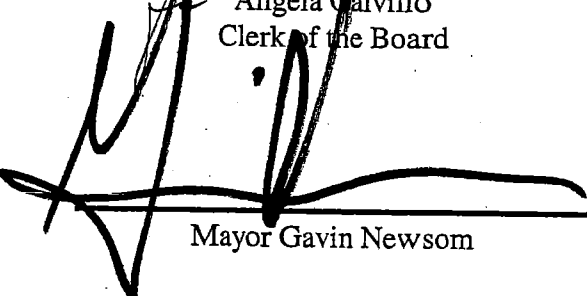
Mayor Gavin Newsom

1 [Interconnection Agreements - Renewable Energy Generating Facilities]

2
3 **Resolution authorizing the San Francisco Public Utilities Commission General Manager**
4 **to enter into two long term interconnection agreements for renewable energy**
5 **generating facilities, pursuant to San Francisco Charter Section 9.118.**
6

7 WHEREAS, The San Francisco Public Utilities Commission (SFPUC) is responsible for
8 implementing renewable energy generating facilities for the City and County of San Francisco
9 (City); and,

10 WHEREAS, The SFPUC has installed renewable energy generating facilities on a
11 number of City properties; and

12 WHEREAS, The Board of Supervisors approved agreements for construction,
13 installation, and operating of these projects in the following resolutions: Moscone Center,
14 Resolution 621-02; Southeast Treatment Plant, Resolution 443-04; and Pier 96, Resolution
15 189-06; Chinatown Public Library, Maxine Hall Medical Center, City Distribution Division
16 Warehouse, North Point Treatment Plant and San Francisco International Airport Terminal 3,
17 Resolution 554-07; and

18 WHEREAS, The SFPUC has developed two additional solar projects at the Chinatown
19 Public Health Center and the MUNI Woods Motor Coach Facility (Solar Projects); and

20 WHEREAS, On November 12, 2009, the SFPUC authorized a contract with BASS
21 Electric in the amount of \$1,397,749, for turnkey design and construction of these two Solar
22 Projects (SFPUC Power Enterprise funded agreement No. DB 117 for Solar Photovoltaic
23 Renewable Energy Plants); and

24 WHEREAS, Construction and installation of the Solar Projects is nearly completed; and
25

1 WHEREAS, The SFPUC must enter into Generating Facility Interconnection
2 Agreements (GFIs) with Pacific Gas and Electric Company (PG&E) to interconnect and
3 operate the Solar Projects and to serve the electrical loads at each facility; and

4 WHEREAS, The GFIs for the Solar Projects are based on a PG&E form agreement
5 approved by the California Public Utilities Commission; and

6 WHEREAS, The term of the GFIs for the solar projects is of an indefinite duration,
7 because the term is commensurate with the useful lives of the Solar Projects, which are
8 expected to exceed ten (10) years; and

9 WHEREAS, The GFIs for the Solar Projects are subject to approval by this Board of
10 Supervisors, pursuant to San Francisco Charter section 9.118, because the agreements are
11 likely to exceed ten (10) years; and

12 WHEREAS, It is to the City's benefit for the GFIs to have terms commensurate with
13 the lives of the Solar Projects, because this ensures that the Solar Projects can remain
14 interconnected to PG&E's distribution system for their useful lives; and

15 WHEREAS, The GFIs for the Solar Projects are subject to termination by the City for
16 any reason upon sixty days notice; and

17 WHEREAS, The City Attorney has approved the limitation of liability language set forth
18 in section 7 of the GFIs for the Solar Projects; and

19 WHEREAS, The City's Risk Manager has approved the insurance language set forth in
20 section 8 of the GFIs for the Solar Projects; and

21 WHEREAS, A copy of the GFIA for each of the Solar Projects is on file with the Clerk of
22 the Board of Supervisors in File No. 111023, which are hereby declared to be a part of this
23 resolution as if set forth fully herein; now, therefore, be it

24 RESOLVED, That the Board of Supervisors supports and encourages the use and
25 development of renewable energy on City properties; and, be it

1 FURTHER RESOLVED, That the Board of Supervisors, pursuant to San Francisco
2 Charter section 9.118, authorizes the San Francisco Public Utilities Commission General
3 Manager to enter into Generating Facilities Interconnection Agreements for renewable energy
4 generating facilities located at the Chinatown Public Health Center and the MUNI Woods
5 Motor Coach Facility.

6
7
8
9
10
11
12
13
14
15
16
17
18
19
20
21
22
23
24
25



City and County of San Francisco
Tails
Resolution

City Hall
1 Dr. Carlton B. Goodlett Place
San Francisco, CA 94102-4689

File Number: 111023

Date Passed: October 18, 2011

Resolution authorizing the San Francisco Public Utilities Commission General Manager to enter into two long term interconnection agreements for renewable energy generating facilities, pursuant to San Francisco Charter Section 9.118.

October 12, 2011 Budget and Finance Committee - RECOMMENDED

October 18, 2011 Board of Supervisors - ADOPTED

Ayes: 11 - Avalos, Campos, Chiu, Chu, Cohen, Elsbernd, Farrell, Kim, Mar, Mirkarimi and Wiener

File No. 111023

I hereby certify that the foregoing Resolution was ADOPTED on 10/18/2011 by the Board of Supervisors of the City and County of San Francisco.

Angela Calvillo
Clerk of the Board

Mayor Edwin Lee

Date Approved

1 [Agreement with Pacific Gas and Electric Company to Connect a Solar Power Project]

2
3 **Resolution pursuant to San Francisco Charter Section 9.118(b) authorizing the San**
4 **Francisco Public Utilities Commission General Manager to enter into a long term**
5 **interconnection agreement with Pacific Gas and Electric Company for a solar power**
6 **project at the Alvarado Elementary School.**

7
8 WHEREAS, The San Francisco Public Utilities Commission (SFPUC) is responsible for
9 implementing renewable energy generating facilities for the City and County of San Francisco
10 (City); and,

11 WHEREAS, In Resolution No. 124-12, the Board of Supervisors approved a Master
12 License Agreement between the SFPUC and the San Francisco Unified School District
13 (SFUSD) authorizing the SFPUC to install and maintain solar power projects on certain
14 SFUSD buildings that the SFPUC and SFUSD mutually agree are suitable for such use; and

15 WHEREAS, The SFPUC and SFUSD have agreed that the first solar power project
16 under the Master License Agreement would be developed and installed at the Alvarado
17 Elementary School (the Project); and

18 WHEREAS, Funding for the Project was included in the SFPUC's capital plan for small
19 renewable energy projects; and

20 WHEREAS, The SFPUC has nearly completed the construction and installation of the
21 Project, and expects that it may begin generating electricity in September 2012; and

22 WHEREAS, In a determination dated June 12, 2012, the City and County of San
23 Francisco Planning Department found that the Project was categorically exempt from
24 environmental review under the California Environmental Quality Act; and

1 WHEREAS, The SFPUC must enter into a Generating Facility Interconnection
2 Agreement (Agreement) with Pacific Gas and Electric Company (PG&E) to interconnect the
3 Project to the electrical grid; and

4 WHEREAS, The Agreement is based on a PG&E form agreement approved by the
5 California Public Utilities Commission that is not subject to negotiation; and

6 WHEREAS, The term of the Agreement is commensurate with the useful life of the
7 Project in order to ensure that the Project can remain interconnected to PG&E's electrical
8 system for its useful life, which is expected to exceed ten (10) years; and

9 WHEREAS, The Agreement is subject to approval by the Board of Supervisors,
10 pursuant to San Francisco Charter section 9.118(b), because the term of the Agreement is
11 likely to exceed ten (10) years; and

12 WHEREAS, The Agreement is subject to termination by the City for any reason upon
13 sixty (60) days notice; and

14 WHEREAS, The City Attorney has approved the limitation of liability language set forth
15 in section 7 of the Agreement; and

16 WHEREAS, The City's Risk Manager has approved the insurance language set forth in
17 section 8 of the Agreement; and

18 WHEREAS, The terms and conditions of the Agreement do not require the payment of
19 any fees or costs to PG&E from the SFPUC; and

20 WHEREAS, A copy of the Agreement is on file with the Clerk of the Board of
21 Supervisors in File No. 120938, which is hereby declared to be a part of this resolution as if
22 set forth fully herein; and

23 WHEREAS, The Board of Supervisors recommends that, in connection with the
24 Project, the SFPUC work with the SFUSD to develop educational materials to instruct the
25

1 students of Alvarado Elementary School about renewable energy and the solar power facility
2 located at their school, now, therefore, be it

3 RESOLVED, That the Board of Supervisors supports and encourages the use and
4 development of renewable energy within the City and County of San Francisco, including by
5 installing solar power projects on buildings owned by the San Francisco Unified School
6 District and instructing students at those schools about the benefits of renewable energy; and,
7 be it

8 FURTHER RESOLVED, That the Board of Supervisors, pursuant to San Francisco
9 Charter section 9.118(b), authorizes the San Francisco Public Utilities Commission General
10 Manager to enter into a Generating Facility Interconnection Agreement with Pacific Gas and
11 Electric Company for the solar power project installed at the Alvarado Elementary School.



City and County of San Francisco

**Tails
Resolution**

City Hall
1 Dr. Carlton B. Goodlett Place
San Francisco, CA 94102-4689

File Number: 120938

Date Passed: October 16, 2012

Resolution authorizing the San Francisco Public Utilities Commission General Manager to enter into a long term interconnection agreement with Pacific Gas and Electric Company for a solar power project at the Alvarado Elementary School pursuant to San Francisco Charter Section 9.118(b).

October 03, 2012 Budget and Finance Committee - RECOMMENDED

October 16, 2012 Board of Supervisors - ADOPTED

Ayes: 11 - Avalos, Campos, Chiu, Chu, Cohen, Elsbernd, Farrell, Kim, Mar, Olague and Wiener

File No. 120938

I hereby certify that the foregoing Resolution was ADOPTED on 10/16/2012 by the Board of Supervisors of the City and County of San Francisco.

Angela Calvillo
Clerk of the Board

Mayor

10/23/12
Date Approved



Edwin M. Lee, Mayor
Naomi Kelly, City Administrator

**OFFICE OF THE
CITY ADMINISTRATOR
RISK MANAGEMENT DIVISION**



August 20, 2013

Pacific Gas and Electric Company
Attention: Tariffs and Compliance Department
PO Box 770000
Mail Code B8C
San Francisco, CA 94177

**RE: PG&E Generating Facility Interconnection Agreement – City and County of San Francisco
Generating Facility ID 30S115651 – Producer’s Electric Service Account 7743934005**

This letter certifies that the City and County of San Francisco is self-insured and self-funded for the following insurance programs, which cover the City and County of San Francisco, its officers and employees.

General Liability insurance in the amount of \$1,000,000 per occurrence and \$2,000,000 general aggregate limit for bodily injury, property damage, and personal injury to third parties for liability arising out of the City’s negligence in performance of this agreement.

Workers’ Compensation in Statutory amounts with Employer’s Liability of \$1,000,000 per accident, injury or illness.

Automobile Liability combined single limit per accident for bodily injury and property damage in the amount of \$1,000,000 per accident/incident.

The City and County of San Francisco’s self insurance program is not commercial insurance and has no legal capacity to name another entity as additional insured.

Do not hesitate to contact this office should you have any questions.

Sincerely,

Matt Hansen
Director

cc: Jamie Seidel
Power Enterprise, SF Public Utilities Commission

