

File No. 150107

Committee Item No. 8

Board Item No. _____

COMMITTEE/BOARD OF SUPERVISORS

AGENDA PACKET CONTENTS LIST

Committee: Budget & Finance Sub-Committee

Date March 25, 2015

Board of Supervisors Meeting

Date _____

Cmte Board

- | | | |
|-------------------------------------|--------------------------|--|
| <input type="checkbox"/> | <input type="checkbox"/> | Motion |
| <input checked="" type="checkbox"/> | <input type="checkbox"/> | Resolution |
| <input type="checkbox"/> | <input type="checkbox"/> | Ordinance |
| <input type="checkbox"/> | <input type="checkbox"/> | Legislative Digest |
| <input checked="" type="checkbox"/> | <input type="checkbox"/> | Budget and Legislative Analyst Report |
| <input type="checkbox"/> | <input type="checkbox"/> | Youth Commission Report |
| <input type="checkbox"/> | <input type="checkbox"/> | Introduction Form |
| <input checked="" type="checkbox"/> | <input type="checkbox"/> | Department/Agency Cover Letter and/or Report |
| <input type="checkbox"/> | <input type="checkbox"/> | MOU |
| <input type="checkbox"/> | <input type="checkbox"/> | Grant Information Form |
| <input type="checkbox"/> | <input type="checkbox"/> | Grant Budget |
| <input type="checkbox"/> | <input type="checkbox"/> | Subcontract Budget |
| <input checked="" type="checkbox"/> | <input type="checkbox"/> | Contract/Agreement |
| <input checked="" type="checkbox"/> | <input type="checkbox"/> | Form 126 – Ethics Commission |
| <input type="checkbox"/> | <input type="checkbox"/> | Award Letter |
| <input type="checkbox"/> | <input type="checkbox"/> | Application |
| <input type="checkbox"/> | <input type="checkbox"/> | Public Correspondence |

OTHER

(Use back side if additional space is needed)

- | | | |
|-------------------------------------|--------------------------|---------------------------------------|
| <input checked="" type="checkbox"/> | <input type="checkbox"/> | <u>Airport Commission Resolutions</u> |
| <input type="checkbox"/> | <input type="checkbox"/> | _____ |
| <input type="checkbox"/> | <input type="checkbox"/> | _____ |
| <input type="checkbox"/> | <input type="checkbox"/> | _____ |
| <input type="checkbox"/> | <input type="checkbox"/> | _____ |
| <input type="checkbox"/> | <input type="checkbox"/> | _____ |
| <input type="checkbox"/> | <input type="checkbox"/> | _____ |
| <input type="checkbox"/> | <input type="checkbox"/> | _____ |
| <input type="checkbox"/> | <input type="checkbox"/> | _____ |
| <input type="checkbox"/> | <input type="checkbox"/> | _____ |
| <input type="checkbox"/> | <input type="checkbox"/> | _____ |

Completed by: Linda Wong Date March 20, 2015

Completed by: _____ Date _____

1 [Contract Approval - T1 Cubed - Professional Services for the Airport's Terminal 1, New
2 Boarding Area B Project - Not to Exceed \$29,000,000]

3 **Resolution approving Airport Contract 10010.41, Project Management Support Services**
4 **for the San Francisco International Airport, Terminal 1, New Boarding Area B Project**
5 **between T1 Cubed, a Joint Venture, consisting of Parsons Brinckerhoff, Inc., and AGS,**
6 **Inc., and the City and County of San Francisco, acting by and through its Airport**
7 **Commission, in a not to exceed amount of \$29,000,000 with a contract duration of six**
8 **years, to commence following Board approval, pursuant to Charter, Section 9.118(b).**

9
10 WHEREAS, Through the implementation of the Terminal 1/Boarding Area B
11 Redevelopment Program ("Program"), the Airport will demolish aging infrastructure, realign
12 aircraft taxilanes, construct temporary and permanent facilities, and renovate the existing
13 structures, all while maintaining Airport operations. The Program will result in a new 1.1 million
14 square foot facility; and

15 WHEREAS, Two of the major projects in the Program are the Terminal 1 Center
16 Renovation ("T1 Center") Project and the New Boarding Area B ("BAB") Project. The BAB
17 Project includes construction of an approximately 550,000 square foot boarding area with 24
18 gates to replace the existing 40-year old facility, provide for a concession and amenity
19 program consistent with the standards incorporated in Terminal 2 and Terminal 3 Boarding
20 Area E, and help the Airport serve the increasing passenger forecasts. Several of the new
21 gates will be configured to accommodate international arrivals. The Project will also include
22 new Passenger Boarding Bridges, Pre-Conditioned Air, and 400 Hz power systems; and a
23 new aircraft apron and jet fuel hydrant system; and

24 WHEREAS, By Resolution No. 14-0026 dated February 18, 2014, the Airport
25 Commission ("Commission") authorized the issuance of a Request for Proposals ("RFP") for

1 Professional Services for two project management support services contracts, one for the T1
2 Center Project and one for the BAB Project; and

3 WHEREAS, The Airport received four proposals in response to the RFP; and

4 WHEREAS, The Airport staff performed standardized reference checks of former
5 clients for firms and key personnel submitted by the respondents; and

6 WHEREAS, A five-member selection panel, consisting of one Commission employee
7 and four members of the aviation and/or project management industry, evaluated the written
8 proposals of each firm, and scored the firms in accordance with the criteria contained in the
9 RFP; and

10 WHEREAS, The RFP stated that following the evaluation of the written proposals and
11 reference checks, up to four of the highest-ranked proposers would be invited to an oral
12 interview conducted and scored by the evaluation panel; and

13 WHEREAS, The selection panel interviewed all four respondents including key
14 personnel from each firm, appraised their qualifications, and scored the firms, with ACJV, a
15 Joint Venture, receiving the highest combined score for the written proposal and interview. As
16 the highest-ranked proposer, ACJV, a Joint Venture, indicated its preferred project to be the
17 T1 Center Project; and

18 WHEREAS, T1 Cubed - a Joint Venture received the second-highest combined score
19 for the written proposal and interview; and

20 WHEREAS, By Resolution No. 15-0004 dated January 20, 2015, the Commission
21 awarded the professional services contract to T1 Cubed – a Joint Venture in the not-to exceed
22 amount of \$4,300,000 for the first year of services; and

23 WHEREAS, The Airport Director estimates that the total amount for full project support
24 services for the BAB Project will not exceed \$29,000,000 for six years of services; and
25

1 WHEREAS, San Francisco Charter Section 9.118(b) provides that the agreements
2 entered into by a department, board, or commission requiring anticipated expenditures by the
3 City and County of ten million dollars, shall be subject to approval by the Board of Supervisors
4 by resolution; and

5 WHEREAS, By Resolution No. 283-14 dated July 22, 2014, incorporated herein by this
6 reference as though fully set forth, the Board adopted findings under the California
7 Environmental Quality Act (Public Resources Code Section 21000 et seq.) for the Program;
8 now, therefore, be it

9 RESOLVED, That the Board of Supervisors hereby approves the Professional Services
10 Contract No. 10010.41, Project Management Support Services for the Terminal 1, New
11 Boarding Area B Project between T1 Cubed – a Joint Venture and the City and County of San
12 Francisco, acting by and through its Airport Commission, for a term of up to six years and a
13 final contract value up to \$29,000,000, copies of which are contained in Clerk of the Board of
14 Supervisors in File No. 150107; and, be it

15 FURTHER RESOLVED, That within thirty (30) days of the contract being fully executed
16 by all parties, the Airport Commission shall provide the final contract to the Clerk of the Board
17 for inclusion into the official file.

<p>Item 8 File 15-0107</p>	<p>Department: San Francisco International Airport (Airport)</p>
--	---

EXECUTIVE SUMMARY

Legislative Objectives

- The proposed resolution would approve Airport Contract 10010,41 between the Airport and T1 Cubed, a joint venture of Parsons Brinckerhoff, Inc. and AGS, Inc., for a twelve-month period, with five one-year options to renew at the Airport’s discretion. T1 Cubed will provide project management services for the New Boarding Area B Project at the San Francisco International Airport (Airport).

Key Points

- The Terminal 1 Redevelopment Program at the San Francisco International Airport will design and construct a new facility of approximately 1.1 million square feet, while allowing for uninterrupted services for airport patrons during the project period, and includes the Terminal 1 Center Renovation Project and the New Boarding Area B Project. The Terminal 1 Boarding Area B Project will create a new boarding area of approximately 550,000 square feet with 24 gates, updated concession and amenity program standards to match those of Terminal 2 and Terminal 3 Boarding Area E, as well as increased capacity to manage the projected increase in passengers. The Boarding Area B Project budget is \$575.5 million.
- The Airport selected T1 Cubed to provide project management services following a competitive Request for Proposals process. The contract between the Airport and T1 Cubed for project management services includes five key functions: (i) general management, which ensure adherence to safety and quality assurance standards, (ii) project controls which includes the estimation of ongoing costs, task scheduling, and the handling of project changes, (iii) oversight of trade and construction contracts; (iv) contract administration, and (v) inspection services.
- The contract is for a total of six years with a maximum budget of \$29,000,000 over the six-year period. The contract caps first year costs at \$4,300,000.

Fiscal Impact

- The first year contract budget is approximately \$4,250,263. Over the six-year project period, the City will pay a maximum budget of \$29,000,000. The contract is funded through the Terminal 1 Redevelopment Program, which is funded by Airport Revenue Bonds

Recommendations

- Amend the proposed resolution to specify the 10 percent cap on the Owner’s Contingency and the 5 percent cap on Other Allowable Direct Costs.
- Approve the proposed resolution as amended.

MANDATE STATEMENT**Mandate Statement**

City Charter Section 9.118 (b) states that with the exception of construction contracts entered into by the City and County, any other contracts or agreements entered into by a department, board or commission having a term in excess of ten years, or requiring anticipated expenditures by the City and County of ten million dollars, or the modification or amendments to such contract or agreement having an impact of more than \$500,000 shall be subject to approval of the Board of Supervisors by resolution.

BACKGROUND

The Terminal 1 Redevelopment Program at the San Francisco International Airport will design and construct a new facility of approximately 1.1 million square feet, while allowing for uninterrupted services for airport patrons during the project period, and includes the Terminal 1 Center Renovation Project and the New Boarding Area B Project.

The Terminal 1 Boarding Area B Project will create a new boarding area of approximately 550,000 square feet with 24 gates, updated concession and amenity program standards to match those of Terminal 2 and Terminal 3 Boarding Area E, as well as increased capacity to manage the projected increase in passengers. The Boarding Area B Project budget is \$575.5 million shown in Table 1 below, and funded by Airport revenue bonds.

Table 1. Boarding Area B Budget Summary

Direct Construction	\$477,000,000
Boarding Area B Project Fees*	64,000,000
Airport Project Management	5,500,000
Project and Construction Management T1 Cubed Contract	29,000,000
Total Cost	\$575,500,000

Source: Airport Staff.

*This includes fees for contractor management, design-build¹, design and engineering, and bonds.

¹ The Board of Supervisors approved the use of design-build contracts for the Terminal 1 Center Renovation and Boarding Area B projects in July 2014 (File 14-0700). For design-build projects, both design and construction services are obtained from the same firm, instead of hiring different contractors for these two services. It allows for an integrated approach to construction projects. The Airport awarded the Boarding Area B design-build contract to Austin Webcor Joint Venture for a preliminary contract amount of \$63,277,453 and an initial term of 300 consecutive calendar days through a competitive bidding process.

Requests for Proposals

On February 18, 2014, the Airport Commission authorized the release of a Request for Proposals (RFP) seeking two contracts to support the Terminal 1 Center Renovation project and the Boarding Area B project to provide construction management services. The Airport issued the RFP on June 2, 2014.

The Airport received five proposals in response to the RFP on August 10, 2014 from ACJV (a joint venture of AECOM and Cooper Pugeda Management); Abadjis Systems Ltd.; J+D Aviation (a joint venture of Jacobs and Dabri, Inc.); PGH Wong Engineering, Inc.; and T1 Cubed (a joint venture of Parsons Brinckerhoff, Inc. and AGS, Inc.). To determine which firms would be awarded the two contracts, the Airport assembled a five-member selection panel, including one employee of the Airport and four members representing other City Departments and firms. Each member of the selection panel reviewed and scored the submitted proposals, using the criteria outlined in the RFP which included the (a) introductions and executive summaries of each firm's proposal, (b) qualifications and professional experience, (c) the identification of proposed key project personnel and technical staff, (d) the project approach, and finally, (e) an oral interview with the selection panel, which featured problem solving activities. The RFP required submission of a rate schedule and fee proposal.

Following the evaluation of the five submitted proposals, the selection panel identified the four highest ranked bidders for interviewing, as required by the RFP. These firms included ACJV, T1 Cubed, Abadjis Systems Ltd., and J+D Aviation. ACJV was offered the first choice of the two contracts because they received the highest combined score for their proposal and interview. ACJV chose the Terminal 1 Center Renovation project contract (see File 15-0151 of the Budget and Legislative Analyst's Report to the Budget and Finance Committee). T1 Cubed, the firm with the second highest ranking combined score, was awarded the New Boarding Area B Project contract on January 20, 2015 to provide construction management services.

DETAILS OF PROPOSED LEGISLATION

The proposed resolution would approve a contract between the Airport and T1 Cubed, a joint venture of Parsons Brinckerhoff, Inc. and AGS, Inc., to provide construction management services for the New Boarding Area B Project in Terminal 1 of the San Francisco International Airport for a term of one year, with five one-year options to renew and for an amount not-to-exceed \$29,000,000 over the six-year term. T1 Cubed will subcontract 11 firms, who will contribute to the completion of this project.²

The contract between the Airport and T1 Cubed for project management services includes five key functions: (i) general management, which ensure adherence to safety and quality assurance

² The 11 subcontractors included in this agreement are Ambient Energy, BAC Engineering, BLC Partners, CAGE, CMPROS, Faithful & Gould (F&G), Joseph Chow & Associates (JCA), Meridian Surveying Engineering, Inc., NBA Engineering (NBA), Inc., RES Engineering (RES), Inc., and Yolanda's Construction and Administration & Traffic Control, Inc. (YCAT).

standards, (ii) project controls which includes the estimation of ongoing costs, task scheduling, and the handling of project changes, (iii) oversight of trade and construction contracts; (iv) contract administration, and (v) inspection services.

Contract Terms

The proposed contract between the Airport and T1 Cubed is for one year, with five one-year options to renew the contract at the Airport’s discretion. Key points in the terms of agreement are summarized in Table 2 below.

Table 2. Key Points in Terms of Agreement

Contract Term	One year from approximately April 2015 through March 2016.
Optional Contract Extensions	5 one-year options to extend at the discretion of the Airport through March 2021.
Maximum First-Year Payment	\$4,300,000
Maximum Total Compensation over Six Years	\$29,000,000
Direct Labor Rates and Overhead Rates	Direct labor rates were negotiated by the Airport and T1 Cubed for each labor classification (such as construction manager, quality assurance manager, cost estimators, surveyors, and other classifications assigned to the contract). Overhead rates for each T1 Cubed prime contractor and subcontractor are calculated as a percentage of direct labor rates. Overhead rates vary by contractor/subcontractor from 129 percent to 229 percent for overhead attributed to the contractor’s home office; and from 111 percent to 209 percent for overhead attributed to the field office.
Annual Adjustments to Direct Labor Rates	Based on Consumer Price Index (CPI) or collective bargaining agreements at the option of the Airport.
Contractor's Fee	10 percent of direct labor rates
Contractor Mark Up on Subcontractors	2 percent
Other Direct Costs (ODC)	Unless authorized, the Airport will not reimburse the Contractor for costs of business travel, contractor meals, and accommodations. When authorized, travel expenses shall be in accordance with the City & County of San Francisco Travel Guidelines. Airport Project Manager must pre-approve any ODC expense in excess of \$500.
Local Business Enterprise (LBE) Requirement	20 percent. T1 Cubed exceeds this requirement.

Source: SFO Staff; and Contractual Agreement 10010.41 between the City and County of San Francisco and T1 Cubed – A Joint Venture.

FISCAL IMPACT

The contract budget in the first year is \$4,250,263 and over six years is \$29,057,497. This amount includes an owner’s contingency to account for change orders initiated by the Airport and a contingency for other allowable direct costs. Contract costs are included in the Terminal 1

Boarding Area B Project budget, shown in Table 1 above, and are funded by Airport revenue bonds.

Table 3: Year One and Total Six-Year Contract Budget*

Task	Year One	Total Six Years
Construction management services ^a	\$424,483	\$5,581,099
Project Controls ^b	843,850	4,603,775
Oversight of Trade/Construction Contractors	827,153	4,076,230
Architectural support	890,753	4,080,928
Contract Administration	709,642	4,254,174
Inspection	0	2,961,292
Subtotal	\$3,695,881	\$25,557,497
Owner's Contingency (up to 10%)	369,588	2,500,000
Subtotal	\$4,065,469	\$28,057,497
Other Allowable Direct Costs (up to 5%)	184,794	1,000,000
Total³	\$4,250,263	\$29,057,497

Source: Airport staff

a/ Construction management services encompass the oversight of adherence to safety measures and compliance to quality assurance standards.

b/ Project controls refer to estimating ongoing costs, scheduling tasks, and managing project changes.

*The costs in Table 3 include the 2 percent allowable markup on all subcontractor invoices as well as a projected (but optional) 3.5 percent annual adjustment to direct labor costs.

Although the Airport provided a budget for an Owner's Contingency and Other Allowable Direct Costs, the contract between T1 Cubed and the Airport does not specify these funds. Therefore, the Budget and Legislative Analyst's Office recommends amending the proposed resolution to include caps on contingency funds of up to 10 percent for the Owner's Contingency and up to 5 percent for Other Allowable Direct Costs, consist with the Airport's budget for this contract.

RECOMMENDATIONS

1. Amend the proposed resolution to specify the 10 percent cap on the Owner's Contingency and the 5 percent cap on Other Allowable Direct Costs.
2. Approve the proposed resolution as amended.

³ According to Mr. Reuben Halili, Terminal 1 Redevelopment Program Director, the Airport and Contractor will adjust the Owner's Contingency, Other Allowable Direct Costs, and other contract costs to stay within the contract not-to-exceed amount of \$29,000,000.



San Francisco International Airport

RECEIVED
BOARD OF SUPERVISORS
SAN FRANCISCO
JAN 28 PM 1:54
AK

January 23, 2015

Ms. Angela Calvillo
Clerk of the Board
Board of Supervisors
City Hall
1 Dr. Carlton B. Goodlett Place, Room 244
San Francisco, CA 94102-4689

Subject: Contract Approval - T1 Cubed – a Joint Venture – Professional Services for Terminal 1, New Boarding Area B Project – Not-to-Exceed \$29,000,000

Dear Ms. Calvillo:

Pursuant to Section 9.118 of the City Charter, I am forwarding for the Board of Supervisor's approval, a contract between the City and County of San Francisco, by and through its Airport Commission ("Commission"), for Project Management Support Services from T1 Cubed - a Joint Venture consisting of Parsons Brinckerhoff, Inc. and AGS, Inc.

By Resolution 15-0004 dated January 20, 2015; the Commission awarded the contract to T1 Cubed – a Joint Venture. The Commission authorized a not-to-exceed amount of \$4,300,000 for the first year of services. The anticipated final contract not-to-exceed amount is \$29,000,000 for six years of services through the completion of the Terminal 1, New Boarding Area B Project.

The original and two (2) sets of the following documents are enclosed for review:

- Board of Supervisors Resolution;
- Adopted Airport Commission Resolution No. 15-0004;
- Form SFEC-126 for the Board of Supervisors;
- Form SFEC-126 for Mayor Lee; and
- Copy of Airport Contract No. 10010.41 with T1 Cubed – a Joint Venture for Project Management Support Services.

Please contact Cathy Widener, Airport Governmental Affairs Manager at (650) 821-5023 if you have questions or concerns regarding this matter.

Very truly yours,

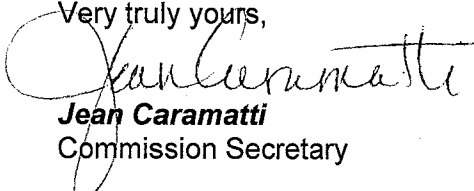
Jean Caramatti
Commission Secretary

Enclosures

Cc: Cathy Widener
Reuben Halili
Geri Rayca

AIRPORT COMMISSION CITY AND COUNTY OF SAN FRANCISCO

EDWIN M. LEE MAYOR	LARRY MAZZOLA PRESIDENT	LINDA S. CRAYTON VICE PRESIDENT	ELEANOR JOHNS	RICHARD J. GUGGENHIME	PETER A. STERN	JOHN L. MARTIN AIRPORT DIRECTOR
-----------------------	----------------------------	------------------------------------	---------------	-----------------------	----------------	------------------------------------

150107

AIRPORT COMMISSION
CITY AND COUNTY OF SAN FRANCISCO
RESOLUTION NO. 15-0004

AWARD PROFESSIONAL SERVICES CONTRACT NO. 10010.41, PROJECT MANAGEMENT SUPPORT SERVICES FOR THE NEW BOARDING AREA B PROJECT TO T1 CUBED – A JOINT VENTURE IN AN AMOUNT NOT TO EXCEED \$4,300,000 FOR THE FIRST YEAR OF SERVICES

- WHEREAS, the New Boarding Area B Project (Project), as part of the overall Terminal 1 Redevelopment Program, will provide for a new 24-gate boarding area with all associated systems; and
- WHEREAS, on February 18, 2014, pursuant to Resolution 14-0026, the Commission authorized the Director to issue a Request for Qualifications/Proposals (RFQ/RFP) for Professional Services Contract No. 10010.41, Project Management Support Services for the New Boarding Area B Project and Professional Services Contract No. 10011.41, Project Management Support Services for the Terminal 1 Center Renovation Project and to negotiate with the highest-ranked proposers; and
- WHEREAS, on August 10, 2014, the Airport received five proposals in response to the RFQ/RFP, from ACJV (a joint venture of AECOM and Cooper Puga Management); Abadjis Systems Ltd.; J+D Aviation (a joint venture between Jacobs and Dabri, Inc.); PGH Wong Engineering, Inc.; and T1 Cubed - a Joint Venture (a joint venture of Parsons Brinckerhoff, Inc. and AGS, Inc.); and
- WHEREAS, the Airport convened a five-member Selection Panel that thoroughly reviewed the proposals, interviewed the firms and key personnel; and
- WHEREAS, the highest ranked proposer, ACJV, chose the Terminal 1 Center Renovation Project as their "preferred project" and T1 Cubed - a Joint Venture is the second highest-ranked proposer; and
- WHEREAS, Staff has successfully negotiated scope, contract terms and conditions, and fee with T1 Cubed - a Joint Venture for the first year of services on the New Boarding Area B Project; and
- WHEREAS, the Project will be a multi-year, phased program, Staff estimates that the total contract amount will be an estimated \$29,000,000 with a total duration of six years; and
- WHEREAS, the Contract will be renewed each year based on the Airport's evaluation of T1 Cubed - a Joint Venture's quality of work and performance; and
- WHEREAS, since the contract is anticipated to exceed \$10,000,000, Board of Supervisors' approval is required by San Francisco Charter Section 9.118(b); now, therefore, be it

AIRPORT COMMISSION

CITY AND COUNTY OF SAN FRANCISCO

RESOLUTION NO. 14 0026

AUTHORIZATION TO IMPLEMENT THE REDEVELOPMENT OF TERMINAL 1/BOARDING AREA B AND AUTHORIZATION TO ISSUE A REQUEST FOR QUALIFICATIONS/ PROPOSALS FOR CONTRACT NO. 10010.41, BOARDING AREA B RECONSTRUCTION PROJECT MANAGEMENT SUPPORT SERVICES AND FOR CONTRACT 10011.41, TERMINAL 1 CENTER RENOVATION PROJECT MANAGEMENT SUPPORT SERVICES.

- WHEREAS, the Commission intends to proceed with implementation of the Terminal 1/Boarding Area B Redevelopment Project and other related projects (T1 Program) and will consider a number of requests to issue Requests for Proposals and calls for bids for project management support services, design build services, and other construction services and work required to implement the T1 Program; and
- WHEREAS, by Resolution No. 92-0284 dated November 3, 1992, and incorporated herein by this reference as though fully set forth, the Airport Commission approved the San Francisco International Airport Master Plan ("Master Plan") and adopted findings, including a Statement of Overriding Considerations, and a Mitigation Monitoring and Reporting Program pursuant to the California Environmental Quality Act, Cal. Public Resources Code Sec. 21000 et seq. ("CEQA"); and
- WHEREAS, The Master Plan was the subject of a Program Environmental Impact Report ("EIR") prepared by the City and County of San Francisco, Office of Environmental Review (OER), and certified by the San Francisco Planning Commission on May 28, 1992 by Motion No. 13356, all in accordance with the requirements of CEQA, Title 14, Section 15000 et seq. of the California Code of Regulations ("CEQA Guidelines") and Chapter 31 of the San Francisco Administrative Code; and
- WHEREAS, the T1 Program is a project included and generally described in the Master Plan and is analyzed in the EIR; and
- WHEREAS, Section 15168 of the CEQA Guidelines requires subsequent activities in a program that are covered by a program EIR be examined in light of the program EIR to determine whether additional environmental documentation must be prepared; and
- WHEREAS, after reviewing information regarding the T1 Program, OER prepared an addendum to the Master Plan Program EIR, dated October 27, 2007, to evaluate impacts of the modifications to the T1 Program and concluded that the T1 Program, as modified from its description in the EIR, is within the scope of the Master Plan Program; that the modifications to the T1 Program would not cause new significant environmental impacts not identified in the EIR nor require new mitigation measures; and that no supplemental environmental review is required; and
- WHEREAS, the Commission has reviewed and considered the San Francisco International Airport Master Plan Program EIR, and the Master Plan Program EIR Addendum, dated October 24, 2007; and

AIRPORT COMMISSION

CITY AND COUNTY OF SAN FRANCISCO

RESOLUTION NO. 14 0026

- WHEREAS, Staff seeks to hire two project management support services (PMSS) consultants (Consultants) that each have a proven ability to work in a highly collaborative environment with the appropriate expertise in airport terminal and boarding area projects; and
- WHEREAS, one of the Consultants will assist the Airport Staff in monitoring, managing, and coordinating the design and construction of the renovation of Terminal 1 Center; and
- WHEREAS, the other Consultant will assist Airport staff in monitoring, managing, and coordinating the design and construction of the new Boarding Area B; and
- WHEREAS, the Consultants will each provide project management support services including project planning, project controls, reporting, scheduling, budgeting, document control, coordination, design management, construction management and constructability review for their respective projects; and
- WHEREAS, the duration for these services for each contract is 72 months at an estimated total cost of \$17 million for the Terminal 1 Center PMSS and \$23 million for the Boarding Area B PMSS; now, therefore be it
- RESOLVED, that the Commission hereby authorizes the implementation of the redevelopment of Terminal 1/Boarding Area B; and, be it further
- RESOLVED, that the Commission hereby authorizes the Director to issue a Request for Qualifications/Proposal for Contract No. 10011.41, Terminal 1 Center Renovation Project Management Support Services and Contract No. 10010.41, New Boarding Area B Reconstruction Project Management Support Services; and, be it further
- RESOLVED, that the Commission also authorizes the Director to negotiate with the two highest ranked proposers, and failing successful negotiation with either of the highest ranked proposers, the Commission authorizes the Director to negotiate with the next successively ranked proposers in order until negotiations are successful with two of the qualified firms; and, be it further
- RESOLVED, that following successful negotiations, Staff will present for Commission consideration recommendations to award Contract No. 10011.41, Terminal 1 Center Renovation Project Management Support Services and Contract No. 10010.41, New Boarding Area B Reconstruction Project Management Support Services.

Page 2 of 2

I hereby certify that the foregoing resolution was adopted by the Airport Commission

at its meeting of _____

FEB 18 2014

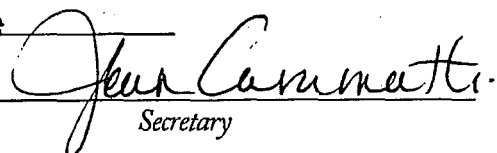
Secretary

**City and County of San Francisco
Airport Commission
P.O. Box 8097
San Francisco, California 94128**

Agreement between the City and County of San Francisco and

T1 Cubed - a Joint Venture

**Contract No. 10010.41
Project Management Support Services for
New Boarding Area B Project**

This Agreement is made this **20th day of January, 2015**, in the City and County of San Francisco, State of California, by and between: **T1 Cubed - a Joint Venture, at 303 Second Street, Suite 700, San Francisco, California 94107** (the "Contractor") and the City and County of San Francisco, a municipal corporation (the "City"), acting by and through its Airport Commission (the "Commission").

Recitals

- A. The Commission wishes to engage Contractor to provide Project Management Support Services for New Boarding Area B Project for the San Francisco International Airport (the "Airport" or "SFO"); and,
- B. The Commission is authorized to enter into all contracts which relate to matters under its jurisdiction; and
- C. On June 2, 2014, the Commission issued a Request for Proposals ("RFP") and as a result of the selection process prescribed in the RFP and upon the recommendation of the Airport Director, the Commission determined that the Contractor was the qualified proposer receiving the highest evaluation score; and
- D. On **January 20, 2015**, by Resolution No. 15-0004, the Commission awarded this Agreement to the Contractor; and
- E. On [insert date], by Resolution No. [insert resolution number], the Board of Supervisors approved the Agreement under San Francisco Charter Section 9.118; and
- F. Approval for this Agreement was obtained when the Civil Service Commission approved Contract number 47898 – 13/14 on May 19, 2014; and
- G. The Contractor represents and warrants that it is qualified to perform the services required by City under this Agreement;

Now, THEREFORE, the parties agree as follows:

Terms and Conditions

- 1. Certification of Funds; Budget and Fiscal Provisions; Termination in the Event of Non-Appropriation.** This Agreement is subject to the budget and fiscal provisions of the City's Charter.

Charges will accrue only after prior written authorization certified by the Controller, and the amount of City's obligation under this Agreement shall not at any time exceed the amount certified for the purpose and period stated in such advance authorization. This Agreement will terminate without penalty, liability or expense of any kind to City at the end of any fiscal year if funds are not appropriated for the next succeeding fiscal year. If funds are appropriated for a portion of the fiscal year, this Agreement will terminate, without penalty, liability or expense of any kind at the end of the term for which funds are appropriated. City has no obligation to make appropriations for this Agreement in lieu of appropriations for new or other agreements. City budget decisions are subject to the discretion of the Mayor and the Board of Supervisors. Contractor's assumption of risk of possible non-appropriation is part of the consideration for this Agreement.

THIS SECTION CONTROLS AGAINST ANY AND ALL OTHER PROVISIONS OF THIS AGREEMENT.

2. Term of the Agreement. Subject to Section 1, the term of this Agreement shall be the duration of twelve (12) months, starting on the first working day following contract certification. The Commission has the option to renew this Agreement each year for a total duration of six (6) years.

3. Effective Date of Agreement. This Agreement shall become effective when the Controller has certified to the availability of funds and Contractor has been notified in writing.

4. Services Contractor Agrees to Perform. The Contractor agrees to perform the services provided for in Appendix A, "Services to be Provided by Contractor," attached hereto and incorporated by reference as though fully set forth in this Agreement. If Appendix A includes as-needed services, such services shall be requested by City through the issuance of a written task order signed by City and Contractor, which task order shall be made a part of and incorporated into the Agreement as though fully set forth in this Agreement without the need for a formal amendment to the Agreement. The task order shall include a description of the as-needed services, the deliverables, schedule for performance, cost, and method and timing of payment.

5. Compensation. Compensation shall be made in monthly payments on or before the last day of each month for work, as set forth in Section 4 of this Agreement, that the Deputy Airport Director, in his or her sole discretion, concludes has been performed as of the last day of the immediately preceding month. In no event shall the amount of this Agreement exceed **Four Million Three Hundred Thousand Dollars (\$4,300,000)**. Any compensation increases, including for services beyond the first twelve (12) months of this Agreement, shall require the approval of the Airport Commission. The breakdown of costs associated with this Agreement appears in Appendix B, "Calculation of Charges," attached hereto and incorporated by reference as though fully set forth in this Agreement. No charges shall be incurred under this Agreement nor shall any payments become due to Contractor until reports, services, or both, required under this Agreement are received from Contractor and approved by Design and Construction as being in accordance with this Agreement. City may withhold payment to Contractor in any instance in which Contractor has failed or refused to satisfy any material obligation provided for under this Agreement. In no event shall City be liable for interest or late charges for any late payments.

6. Guaranteed Maximum Costs. The City's obligation under this Agreement shall not at any time exceed the amount certified by the Controller for the purpose and period stated in such certification. Except as may be provided by laws governing emergency procedures, officers and employees of the City are not authorized to request, and the City is not required to reimburse the Contractor for, Commodities or Services beyond the agreed upon contract scope unless the changed scope is authorized by amendment and approved as required by law. Officers and employees of the City are not authorized to offer or promise, nor is the City required to honor, any offered or promised additional funding in excess of the

maximum amount of funding for which the contract is certified without certification of the additional amount by the Controller. The Controller is not authorized to make payments on any contract for which funds have not been certified as available in the budget or by supplemental appropriation.

7. Payment; Invoice Format. Invoices furnished by Contractor under this Agreement must be in a form acceptable to the Controller, and must include a unique invoice number. All amounts paid by City to Contractor shall be subject to audit by City. Payment shall be made by City to Contractor at the address specified in the section entitled "Notices to the Parties."

8. Submitting False Claims; Monetary Penalties. Pursuant to San Francisco Administrative Code §§6.80-6.83, any contractor, subcontractor, supplier, consultant or subconsultant who submits a false claim shall be liable to the City for the statutory penalties set forth in those sections. The text of Sections 6.80-6.83, along with the entire San Francisco Administrative Code is available on the web at: [http://www.amlegal.com/nxt/gateway.dll/California/administrative/administrativecode?f=templates\\$fn=default.htm\\$3.0\\$vid=amlegal:sanfrancisco_ca\\$sync=1](http://www.amlegal.com/nxt/gateway.dll/California/administrative/administrativecode?f=templates$fn=default.htm$3.0$vid=amlegal:sanfrancisco_ca$sync=1) . A contractor, subcontractor, supplier, consultant or subconsultant will be deemed to have submitted a false claim to the City if the contractor, subcontractor or consultant: (a) knowingly presents or causes to be presented to an officer or employee of the City a false claim or request for payment or approval; (b) knowingly makes, uses, or causes to be made or used a false record or statement to get a false claim paid or approved by the City; (c) conspires to defraud the City by getting a false claim allowed or paid by the City; (d) knowingly makes, uses, or causes to be made or used a false record or statement to conceal, avoid, or decrease an obligation to pay or transmit money or property to the City; or (e) is a beneficiary of an inadvertent submission of a false claim to the City, subsequently discovers the falsity of the claim, and fails to disclose the false claim to the City within a reasonable time after discovery of the false claim.

9. Disallowance. NOT APPLICABLE

10. Taxes

10.1 Payment of any taxes, including possessory interest taxes and California sales and use taxes, levied upon or as a result of this Agreement, or the services delivered pursuant hereto, shall be the obligation of Contractor.

10.2 Contractor recognizes and understands that this Agreement may create a "possessory interest" for property tax purposes. Generally, such a possessory interest is not created unless the Agreement entitles the Contractor to possession, occupancy, or use of City property for private gain. If such a possessory interest is created, then the following shall apply:

10.2.1 Contractor, on behalf of itself and any permitted successors and assigns, recognizes and understands that Contractor, and any permitted successors and assigns, may be subject to real property tax assessments on the possessory interest;

10.2.2 Contractor, on behalf of itself and any permitted successors and assigns, recognizes and understands that the creation, extension, renewal, or assignment of this Agreement may result in a "change in ownership" for purposes of real property taxes, and therefore may result in a revaluation of any possessory interest created by this Agreement. Contractor accordingly agrees on behalf of itself and its permitted successors and assigns to report on behalf of the City to the County Assessor the information required by Revenue and Taxation Code section 480.5, as amended from time to time, and any successor provision.

10.2.3 Contractor, on behalf of itself and any permitted successors and assigns, recognizes and understands that other events also may cause a change of ownership of the possessory interest and result in the revaluation of the possessory interest. (see, e.g., Rev. & Tax. Code section 64, as amended from time to time). Contractor accordingly agrees on behalf of itself and its permitted successors and assigns to report any change in ownership to the County Assessor, the State Board of Equalization or other public agency as required by law.

10.2.4 Contractor further agrees to provide such other information as may be requested by the City to enable the City to comply with any reporting requirements for possessory interests that are imposed by applicable law.

11. Payment Does Not Imply Acceptance of Work. The granting of any payment by City, or the receipt thereof by Contractor, shall in no way lessen the liability of Contractor to replace unsatisfactory work, equipment, or materials, although the unsatisfactory character of such work, equipment or materials may not have been apparent or detected at the time such payment was made. Materials, equipment, components, or workmanship that do not conform to the requirements of this Agreement may be rejected by City and in such case must be replaced by Contractor without delay.

12. Qualified Personnel. Work under this Agreement shall be performed only by competent personnel under the supervision of and in the employment of Contractor. Contractor will comply with City's reasonable requests regarding assignment of personnel, but all personnel, including those assigned at City's request, must be supervised by Contractor. Contractor shall commit adequate resources to complete the project within the project schedule specified in this Agreement.

13. Responsibility for Equipment. City shall not be responsible for any damage to persons or property as a result of the use, misuse or failure of any equipment used by Contractor, or by any of its employees, even though such equipment be furnished, rented or loaned to Contractor by City.

14. Independent Contractor; Payment of Taxes and Other Expenses

14.1 Independent Contractor. Contractor or any agent or employee of Contractor shall be deemed at all times to be an independent contractor and is wholly responsible for the manner in which it performs the services and work requested by City under this Agreement. Contractor or any agent or employee of Contractor shall not have employee status with City, nor be entitled to participate in any plans, arrangements, or distributions by City pertaining to or in connection with any retirement, health or other benefits that City may offer its employees. Contractor or any agent or employee of Contractor is liable for the acts and omissions of itself, its employees and its agents. Contractor shall be responsible for all obligations and payments, whether imposed by federal, state or local law, including, but not limited to, FICA, income tax withholdings, unemployment compensation, insurance, and other similar responsibilities related to Contractor's performing services and work, or any agent or employee of Contractor providing same. Nothing in this Agreement shall be construed as creating an employment or agency relationship between City and Contractor or any agent or employee of Contractor. Any terms in this Agreement referring to direction from City shall be construed as providing for direction as to policy and the result of Contractor's work only, and not as to the means by which such a result is obtained. City does not retain the right to control the means or the method by which Contractor performs work under this Agreement.

14.2 Payment of Taxes and Other Expenses. Should City, in its discretion, or a relevant taxing authority such as the Internal Revenue Service or the State Employment Development Division, or both, determine that Contractor is an employee for purposes of collection of any employment taxes, the amounts payable under this Agreement shall be reduced by amounts equal to both the employee and

employer portions of the tax due (and offsetting any credits for amounts already paid by Contractor which can be applied against this liability). City shall then forward those amounts to the relevant taxing authority. Should a relevant taxing authority determine a liability for past services performed by Contractor for City, upon notification of such fact by City, Contractor shall promptly remit such amount due or arrange with City to have the amount due withheld from future payments to Contractor under this Agreement (again, offsetting any amounts already paid by Contractor which can be applied as a credit against such liability). A determination of employment status pursuant to the preceding two paragraphs shall be solely for the purposes of the particular tax in question, and for all other purposes of this Agreement, Contractor shall not be considered an employee of City. Notwithstanding the foregoing, should any court, arbitrator, or administrative authority determine that Contractor is an employee for any other purpose, then Contractor agrees to a reduction in City's financial liability so that City's total expenses under this Agreement are not greater than they would have been had the court, arbitrator, or administrative authority determined that Contractor was not an employee.

15. Insurance

15.1 Without in any way limiting Contractor's liability pursuant to the "Indemnification" section of this Agreement, Contractor, or each of Contractor's Joint Venture Partners, must maintain in force, during the full term of the Agreement, insurance in the following amounts and coverage:

15.1.1 Workers' Compensation, in statutory amounts, with Employers' Liability Limits not less than \$1,000,000 each accident, injury, or illness; and

15.1.2 Commercial General Liability Insurance with limits not less than \$1,000,000 each occurrence Combined Single Limit for Bodily Injury and Property Damage, including Contractual Liability, Personal Injury, Products and Completed Operations; and

15.1.3 Commercial Automobile Liability Insurance with limits not less than \$1,000,000 each occurrence Combined Single Limit for Bodily Injury and Property Damage, including Owned, Non-Owned and Hired auto coverage, as applicable.

15.1.4 Professional liability insurance, applicable to Contractor's profession, with limits not less than \$1,000,000 each claim with respect to negligent acts, errors or omissions in connection with professional services to be provided under this Agreement. If the Contractor is a Joint Venture, each member of the Joint Venture must maintain individual Professional Liability insurance and each policy must include 'Joint Venture' coverage, but only for the liability arising out of the professional services performed by the Joint Venture Member. The Contractor may be asked to provide all applicable policies for verification of coverage.

15.2 Commercial General Liability and Commercial Automobile Liability Insurance policies must be endorsed to provide:

15.2.1 Name as Additional Insured the City and County of San Francisco, its Officers, Agents, and Employees. If the Contractor is a Joint Venture, each Joint Venture Partner's policies must be endorsed to include each other Joint Venture partner AND the Joint Venture as additional insureds.

15.2.2 That such policies are primary insurance to any other insurance available to the Additional Insureds, with respect to any claims arising out of this Agreement, and that insurance applies separately to each insured against whom claim is made or suit is brought.

15.3 Regarding Workers' Compensation, Contractor, and each Joint Venture Partner, hereby agrees to waive subrogation which any insurer of Contractor or any Joint Venture Partner may acquire from Contractor or a Joint Venture Partner by virtue of the payment of any loss. Contractor and each Joint Venture Partner agree to obtain any endorsement that may be necessary to effect this waiver of subrogation. Each Workers' Compensation policy shall be endorsed with a waiver of subrogation in favor of the City for all work performed by the Contractor or any Joint Venture Partner, their employees, agents and subcontractors.

15.4 All policies shall provide thirty days' advance written notice to the City of reduction or nonrenewal of coverages or cancellation of coverages for any reason. Notices shall be sent to the City address in the "Notices to the Parties" section.

15.5 Should any of the required insurance be provided under a claims-made form, Contractor or the Joint Venture Partners shall maintain such coverage continuously throughout the term of this Agreement and, without lapse, for a period of three years beyond the expiration of this Agreement, to the effect that, should occurrences during the contract term give rise to claims made after expiration of the Agreement, such claims shall be covered by such claims-made policies.

15.6 Should any of the required insurance be provided under a form of coverage that includes a general annual aggregate limit or provides that claims investigation or legal defense costs be included in such general annual aggregate limit, such general annual aggregate limit shall be double the occurrence or claims limits specified above.

15.7 Should any required insurance lapse during the term of this Agreement, requests for payments originating after such lapse shall not be processed until the City receives satisfactory evidence of reinstated coverage as required by this Agreement, effective as of the lapse date. If insurance is not reinstated, the City may, at its sole option, terminate this Agreement effective on the date of such lapse of insurance.

15.8 Before commencing any operations under this Agreement, Contractor shall furnish to City certificates of insurance and additional insured policy endorsements with insurers with ratings comparable to A-, VIII or higher, that are authorized to do business in the State of California, and that are satisfactory to City, in form evidencing all coverages set forth above. Failure to maintain insurance shall constitute a material breach of this Agreement.

15.9 Approval of the insurance by City shall not relieve or decrease the liability of Contractor under this Agreement.

15.10 If a subcontractor will be used to complete any portion of this agreement, the Contractor shall ensure that the subcontractor shall provide all necessary insurance and shall name the City and County of San Francisco, its officers, agents and employees and the Contractor listed as additional insureds.

16. Indemnification. Contractor shall indemnify and save harmless City and its officers, agents and employees from, and, if requested, shall defend them against any and all loss, cost, damage, injury, liability, and claims for injury to or death of a person, including employees of Contractor or loss of or damage to property, arising directly or indirectly from Contractor's performance of this Agreement, including, but not limited to, Contractor's use of facilities or equipment provided by City or others, regardless of the negligence of, and regardless of whether liability without fault is imposed or sought to be imposed on City, except to the extent that such indemnity is void or otherwise unenforceable under applicable law in effect on or validly retroactive to the date of this Agreement, and except where such loss, damage, injury, liability or claim is the result of the active negligence or willful misconduct of City

and is not contributed to by any act of, or by any omission to perform some duty imposed by law or agreement on Contractor, its subcontractors or either's agent or employee. The foregoing indemnity shall include, without limitation, reasonable fees of attorneys, consultants and experts and related costs and City's costs of investigating any claims against the City. In addition to Contractor's obligation to indemnify City, Contractor specifically acknowledges and agrees that it has an immediate and independent obligation to defend City from any claim which actually or potentially falls within this indemnification provision, even if the allegations are or may be groundless, false or fraudulent, which obligation arises at the time such claim is tendered to Contractor by City and continues at all times thereafter. Contractor shall indemnify and hold City harmless from all loss and liability, including attorneys' fees, court costs and all other litigation expenses for any infringement of the patent rights, copyright, trade secret or any other proprietary right or trademark, and all other intellectual property claims of any person or persons in consequence of the use by City, or any of its officers or agents, of articles or services to be supplied in the performance of this Agreement.

17. Incidental and Consequential Damages. Contractor shall be responsible for incidental and consequential damages resulting in whole or in part from Contractor's acts or omissions in an amount not to exceed the value of the Contract or as modified. Nothing in this Agreement shall constitute a waiver or limitation of any rights that City may have under applicable law.

18. Liability of City. CITY'S PAYMENT OBLIGATIONS UNDER THIS AGREEMENT SHALL BE LIMITED TO THE PAYMENT OF THE COMPENSATION PROVIDED FOR IN SECTION 5 OF THIS AGREEMENT. NOTWITHSTANDING ANY OTHER PROVISION OF THIS AGREEMENT, IN NO EVENT SHALL CITY BE LIABLE, REGARDLESS OF WHETHER ANY CLAIM IS BASED ON CONTRACT OR TORT, FOR ANY SPECIAL, CONSEQUENTIAL, INDIRECT OR INCIDENTAL DAMAGES, INCLUDING, BUT NOT LIMITED TO, LOST PROFITS, ARISING OUT OF OR IN CONNECTION WITH THIS AGREEMENT OR THE SERVICES PERFORMED IN CONNECTION WITH THIS AGREEMENT.

19. Liquidated Damages. NOT APPLICABLE

20. Default; Remedies

20.1 Each of the following shall constitute an event of default ("Event of Default") under this Agreement:

20.1.1 Contractor fails or refuses to perform or observe any term, covenant or condition contained in any of the following Sections of this Agreement:

- | | |
|---|---------------------------------------|
| 8. Submitting False Claims; Monetary Penalties. | 37. Drug-Free Workplace Policy |
| 10. Taxes | 53. Compliance with Laws |
| 15. Insurance | 55. Supervision of Minors |
| 24. Proprietary or Confidential Information of City | 57. Protection of Private Information |
| 30. Assignment | |

20.1.2 Contractor fails or refuses to perform or observe any other term, covenant or condition contained in this Agreement, and such default continues for a period of ten days after written notice of an Event of Default from City to Contractor.

20.1.3 Contractor (a) is generally not paying its debts as they become due, (b) files, or consents by answer or otherwise to the filing against it of, a petition for relief or reorganization or arrangement or any other petition in bankruptcy or for liquidation or to take advantage of any bankruptcy, insolvency or

other debtors' relief law of any jurisdiction, (c) makes an assignment for the benefit of its creditors, (d) consents to the appointment of a custodian, receiver, trustee or other officer with similar powers of Contractor or of any substantial part of Contractor's property or (e) takes action for the purpose of any of the foregoing.

20.1.4 A court or government authority enters an order (a) appointing a custodian, receiver, trustee or other officer with similar powers with respect to Contractor or with respect to any substantial part of Contractor's property, (b) constituting an order for relief or approving a petition for relief or reorganization or arrangement or any other petition in bankruptcy or for liquidation or to take advantage of any bankruptcy, insolvency or other debtors' relief law of any jurisdiction or (c) ordering the dissolution, winding-up or liquidation of Contractor.

20.2 On and after any Event of Default, City shall have the right to exercise its legal and equitable remedies, including, without limitation, the right to terminate this Agreement or to seek specific performance of all or any part of this Agreement. In addition, City shall have the right (but no obligation) to cure (or cause to be cured) on behalf of Contractor any Event of Default; Contractor shall pay to City on demand all costs and expenses incurred by City in effecting such cure, with interest thereon from the date of incurrence at the maximum rate then permitted by law. City shall have the right to offset from any amounts due to Contractor under this Agreement or any other agreement between City and Contractor all damages, losses, costs or expenses incurred by City as a result of such Event of Default and any liquidated damages due from Contractor pursuant to the terms of this Agreement or any other agreement.

20.3 All remedies provided for in this Agreement may be exercised individually or in combination with any other remedy available under this Agreement or under applicable laws, rules and regulations. The exercise of any remedy shall not preclude or in any way be deemed to waive any other remedy.

21. Termination for Convenience

21.1 City shall have the option, in its sole discretion, to terminate this Agreement, at any time during the term hereof, for convenience and without cause. City shall exercise this option by giving Contractor written notice of termination. The notice shall specify the date on which termination shall become effective.

21.2 Upon receipt of the notice, Contractor shall commence and perform, with diligence, all actions necessary on the part of Contractor to effect the termination of this Agreement on the date specified by City and to minimize the liability of Contractor and City to third parties as a result of termination. All such actions shall be subject to the prior approval of City. Such actions shall include, without limitation:

21.2.1 Halting the performance of all services and other work under this Agreement on the date(s) and in the manner specified by City.

21.2.2 Not placing any further orders or subcontracts for materials, services, equipment or other items.

21.2.3 Terminating all existing orders and subcontracts.

21.2.4 At City's direction, assigning to City any or all of Contractor's right, title, and interest under the orders and subcontracts terminated. Upon such assignment, City shall have the right, in its sole discretion, to settle or pay any or all claims arising out of the termination of such orders and subcontracts.

21.2.5 Subject to City's approval, settling all outstanding liabilities and all claims arising out of the termination of orders and subcontracts.

21.2.6 Completing performance of any services or work that City designates to be completed prior to the date of termination specified by City.

21.2.7 Taking such action as may be necessary, or as the City may direct, for the protection and preservation of any property related to this Agreement which is in the possession of Contractor and in which City has or may acquire an interest.

21.3 Within 30 days after the specified termination date, Contractor shall submit to City an invoice, which shall set forth each of the following as a separate line item:

21.3.1 The reasonable cost to Contractor, without profit, for all services and other work City directed Contractor to perform prior to the specified termination date, for which services or work City has not already tendered payment. Reasonable costs may include a reasonable allowance for actual overhead, not to exceed a total of 10% of Contractor's direct costs for services or other work. Any overhead allowance shall be separately itemized. Contractor may also recover the reasonable cost of preparing the invoice.

21.3.2 A reasonable allowance for profit on the cost of the services and other work described in the immediately preceding subsection (1), provided that Contractor can establish, to the satisfaction of City, that Contractor would have made a profit had all services and other work under this Agreement been completed, and provided further, that the profit allowed shall in no event exceed 5% of such cost.

21.3.3 The reasonable cost to Contractor of handling material or equipment returned to the vendor, delivered to the City or otherwise disposed of as directed by the City.

21.3.4 A deduction for the cost of materials to be retained by Contractor, amounts realized from the sale of materials and not otherwise recovered by or credited to City, and any other appropriate credits to City against the cost of the services or other work.

21.4 In no event shall City be liable for costs incurred by Contractor or any of its subcontractors after the termination date specified by City, except for those costs specifically enumerated and described in the immediately preceding subsection (c). Such non-recoverable costs include, but are not limited to, anticipated profits on this Agreement, post-termination employee salaries, post-termination administrative expenses, post-termination overhead or unabsorbed overhead, attorneys' fees or other costs relating to the prosecution of a claim or lawsuit, prejudgment interest, or any other expense which is not reasonable or authorized under such subsection (c).

21.5 In arriving at the amount due to Contractor under this Section, City may deduct: (1) all payments previously made by City for work or other services covered by Contractor's final invoice; (2) any claim which City may have against Contractor in connection with this Agreement; (3) any invoiced costs or expenses excluded pursuant to the immediately preceding subsection (d); and (4) in instances in which, in the opinion of the City, the cost of any service or other work performed under this Agreement is excessively high due to costs incurred to remedy or replace defective or rejected services or other work, the difference between the invoiced amount and City's estimate of the reasonable cost of performing the invoiced services or other work in compliance with the requirements of this Agreement.

21.6 City's payment obligation under this Section shall survive termination of this Agreement.

22. Rights and Duties upon Termination or Expiration. This Section and the following Sections of this Agreement shall survive termination or expiration of this Agreement:

- | | |
|---|---|
| 8. Submitting False Claims | 24. Proprietary or Confidential Information of City |
| 9. Disallowance | 26. Ownership of Results |
| 10. Taxes | 27. Works for Hire |
| 11. Payment does not Imply Acceptance of Work | 28. Audit and Inspection of Records |
| 13. Responsibility for Equipment | 48. Modification of Agreement. |
| 14. Independent Contractor; Payment of Taxes and Other Expenses | 49. Administrative Remedy for Agreement Interpretation. |
| 15. Insurance | 50. Agreement Made in California; Venue |
| 16. Indemnification | 51. Construction |
| 17. Incidental and Consequential Damages | 52. Entire Agreement |
| 18. Liability of City | 56. Severability |
| | 57. Protection of Private Information |

Subject to the immediately preceding sentence, upon termination of this Agreement prior to expiration of the term specified in Section 2, this Agreement shall terminate and be of no further force or effect. Contractor shall transfer title to City, and deliver in the manner, at the times, and to the extent, if any, directed by City, any work in progress, completed work, supplies, equipment, and other materials produced as a part of, or acquired in connection with the performance of this Agreement, and any completed or partially completed work which, if this Agreement had been completed, would have been required to be furnished to City. This subsection shall survive termination of this Agreement.

23. Conflict of Interest. Through its execution of this Agreement, Contractor acknowledges that it is familiar with the provision of Section 15.103 of the City's Charter, Article III, Chapter 2 of City's Campaign and Governmental Conduct Code, and Section 87100 et seq. and Section 1090 et seq. of the Government Code of the State of California, and certifies that it does not know of any facts which constitutes a violation of said provisions and agrees that it will immediately notify the City if it becomes aware of any such fact during the term of this Agreement.

24. Proprietary or Confidential Information of City. Contractor understands and agrees that, in the performance or contemplation of the work or services under this Agreement, Contractor may have access to private or confidential information which may be owned or controlled by City and that such information may contain proprietary or confidential details, the disclosure of which to third parties may be damaging to City. Contractor agrees that all information disclosed by City to Contractor shall be held in confidence and used only in performance of the Agreement. Contractor shall exercise the same standard of care to protect such information as a reasonably prudent contractor would use to protect its own proprietary data.

25. Notices to the Parties. Unless otherwise indicated elsewhere in this Agreement, all written communications sent by the parties may be by U.S. mail, e-mail or by fax, and shall be addressed as follows:

To City: Kristin Allen
Airport Project Manager
Design & Construction
San Francisco International Airport
P.O. Box 8097
San Francisco, California 94128

Fax: 650-821-7799
Email: kristin.allen@flysfo.com

To Contractor: Arnold Rosenberg
Senior Vice President
Parsons Brinckerhoff, Inc.
303 Second Street, Suite 700
San Francisco, California 94107-1317
Fax: 415-243-9501
Email: rosenberg@pbworld.com

Bahram Khamenehpour
Senior Principal
AGS, Inc.
5 Freelon Street
San Francisco, California 94107
Fax: 415-777-2167
Email: bkhamenehpour@agsinc.com

Any notice of default must be sent by registered mail.

26. Ownership of Results. Any interest of Contractor or its Subcontractors, in drawings, plans, specifications, blueprints, studies, reports, memoranda, computation sheets, computer files and media or other documents prepared by Contractor or its subcontractors in connection with services to be performed under this Agreement, shall become the property of and will be transmitted to City. However, Contractor may retain and use copies for reference and as documentation of its experience and capabilities.

27. Works for Hire. If, in connection with services performed under this Agreement, Contractor or its subcontractors create artwork, copy, posters, billboards, photographs, videotapes, audiotapes, systems designs, software, reports, diagrams, surveys, blueprints, source codes or any other original works of authorship, such works of authorship shall be works for hire as defined under Title 17 of the United States Code, and all copyrights in such works are the property of the City. If it is ever determined that any works created by Contractor or its subcontractors under this Agreement are not works for hire under U.S. law, Contractor hereby assigns all copyrights to such works to the City, and agrees to provide any material and execute any documents necessary to effectuate such assignment. With the approval of the City, Contractor may retain and use copies of such works for reference and as documentation of its experience and capabilities.

28. Audit and Inspection of Records. Contractor agrees to maintain and make available to the City, during regular business hours, accurate books and accounting records relating to its work under this Agreement. Contractor will permit City to audit, examine and make excerpts and transcripts from such books and records, and to make audits of all invoices, materials, payrolls, records or personnel and other data related to all other matters covered by this Agreement, whether funded in whole or in part under this Agreement. Contractor shall maintain such data and records in an accessible location and condition for a period of not less than five years after final payment under this Agreement or until after final audit has been resolved, whichever is later. The State of California or any federal agency having an interest in the subject matter of this Agreement shall have the same rights conferred upon City by this Section.

29. Subcontracting. Contractor is prohibited from subcontracting this Agreement or any part of it unless such subcontracting is first approved by City in writing. Neither party shall, on the basis of this

Agreement, contract on behalf of or in the name of the other party. An agreement made in violation of this provision shall confer no rights on any party and shall be null and void.

30. Assignment. The services to be performed by Contractor are personal in character and neither this Agreement nor any duties or obligations under this Agreement may be assigned or delegated by the Contractor unless first approved by City by written instrument executed and approved in the same manner as this Agreement.

31. Non-Waiver of Rights. The omission by either party at any time to enforce any default or right reserved to it, or to require performance of any of the terms, covenants, or provisions hereof by the other party at the time designated, shall not be a waiver of any such default or right to which the party is entitled, nor shall it in any way affect the right of the party to enforce such provisions thereafter.

32. Earned Income Credit (EIC) Forms. Intentionally omitted.

33. Local Business Enterprise Utilization; Liquidated Damages

33.1 The LBE Ordinance. Contractor, shall comply with all the requirements of the Local Business Enterprise and Non-Discrimination in Contracting Ordinance set forth in Chapter 14B of the San Francisco Administrative Code as it now exists or as it may be amended in the future (collectively the "LBE Ordinance"), provided such amendments do not materially increase Contractor's obligations or liabilities, or materially diminish Contractor's rights, under this Agreement. Such provisions of the LBE Ordinance are incorporated by reference and made a part of this Agreement as though fully set forth in this section. Contractor's willful failure to comply with any applicable provisions of the LBE Ordinance is a material breach of Contractor's obligations under this Agreement and shall entitle City, subject to any applicable notice and cure provisions set forth in this Agreement, to exercise any of the remedies provided for under this Agreement, under the LBE Ordinance or otherwise available at law or in equity, which remedies shall be cumulative unless this Agreement expressly provides that any remedy is exclusive. In addition, Contractor shall comply fully with all other applicable local, state and federal laws prohibiting discrimination and requiring equal opportunity in contracting, including subcontracting.

33.2 Compliance and Enforcement

33.2.1 Enforcement. If Contractor willfully fails to comply with any of the provisions of the LBE Ordinance, the rules and regulations implementing the LBE Ordinance, or the provisions of this Agreement pertaining to LBE participation, Contractor shall be liable for liquidated damages in an amount equal to Contractor's net profit on this Agreement, or 10% of the total amount of this Agreement, or \$1,000, whichever is greatest. The Director of the City's Contract Monitoring Division ("CMD") or any other public official authorized to enforce the LBE Ordinance (separately and collectively, the "Director of CMD") may also impose other sanctions against Contractor authorized in the LBE Ordinance, including declaring the Contractor to be irresponsible and ineligible to contract with the City for a period of up to five years or revocation of the Contractor's LBE certification. The Director of CMD will determine the sanctions to be imposed, including the amount of liquidated damages, after investigation pursuant to Administrative Code §14B.17. By entering into this Agreement, Contractor acknowledges and agrees that any liquidated damages assessed by the Director of the CMD shall be payable to City upon demand. Contractor further acknowledges and agrees that any liquidated damages assessed may be withheld from any monies due to Contractor on any contract with City. Contractor agrees to maintain records necessary for monitoring its compliance with the LBE Ordinance for a period of three years following termination or expiration of this Agreement, and shall make such records available for audit and inspection by the Director of CMD or the Controller upon request.

33.2.2 Subcontracting Goals. The LBE subcontracting participation goal for this contract is **twenty percent (20%)**. Contractor shall fulfill the subcontracting commitment made in its bid or proposal. Each invoice submitted to City for payment under this Agreement shall also be uploaded to the City's LBEUTS. Contractor is also required to enter subcontractor payment information and payment confirmation information into LBEUTS for each payment request. Failure to provide the required information for each invoice or payment request shall entitle City to withhold 20% of the amount of that invoice until the information is entered and the invoice uploaded into LBEUTS by Contractor. For more information regarding LBEUTS and training sessions, please go to <http://www.sfgov.org/LBEUTS>. Contractor shall not participate in any back contracting to the Contractor or lower-tier subcontractors, as defined in the LBE Ordinance, for any purpose inconsistent with the provisions of the LBE Ordinance, its implementing rules and regulations, or this Section.

33.2.3 Subcontract Language Requirements. Contractor shall incorporate the LBE Ordinance into each subcontract made in the fulfillment of Contractor's obligations under this Agreement and require each subcontractor to agree and comply with provisions of the ordinance applicable to subcontractors. Contractor shall include in all subcontracts with LBEs made in fulfillment of Contractor's obligations under this Agreement, a provision requiring Contractor to compensate any LBE subcontractor for damages for breach of contract or liquidated damages equal to 5% of the subcontract amount, whichever is greater, if Contractor does not fulfill its commitment to use the LBE subcontractor as specified in the bid or proposal, unless Contractor received advance approval from the Director of CMD and contract awarding authority to substitute subcontractors or to otherwise modify the commitments in the bid or proposal. Such provisions shall also state that it is enforceable in a court of competent jurisdiction. Subcontracts shall require the subcontractor to a) log into LBEUTS and confirm receipt of each payment from Contractor, b) maintain records necessary for monitoring each subcontractor's compliance with the LBE Ordinance for a period of three years following termination of this contract, and c) make such records available for audit and inspection by the Director of CMD or the Controller upon request.

33.2.4 Payment of Subcontractors. Contractor shall pay its subcontractors within three working days after receiving payment from the City unless Contractor notifies the Director of CMD in writing within ten working days prior to receiving payment from the City that there is a bona fide dispute between Contractor and its subcontractor and the Director waives the three-day payment requirement, in which case Contractor may withhold the disputed amount but shall pay the undisputed amount. Contractor further agrees, within ten working days following receipt of payment from the City, to file the CMD Payment Affidavit with the Controller, under penalty of perjury, that the Contractor has paid all subcontractors. The affidavit shall provide the names and addresses of all subcontractors and the amount paid to each. Failure to provide such affidavit may subject Contractor to enforcement procedure under Administrative Code §14B.17.

33.3 LBEUTS. The Controller is not authorized to pay invoices submitted by Contractor prior to Contractor's submission of payment information into the Local Business Enterprise Utilization Tracking System (LBEUTS), a secure web-based tracking system. CMD will use the submitted information to monitor compliance with the 14B LBE Ordinance. If Contractor fails to upload the invoice or enter required information into LBEUTS and such failure is not explained to CMD's satisfaction, Controller may withhold 20% of the payment due pursuant to the invoice until Contractor enters the information into LBEUTS.

34. Nondiscrimination; Penalties

34.1 Contractor Shall Not Discriminate. In the performance of this Agreement, Contractor agrees not to discriminate against any employee, City and County employee working with such contractor or

subcontractor, applicant for employment with such contractor or subcontractor, or against any person seeking accommodations, advantages, facilities, privileges, services, or membership in all business, social, or other establishments or organizations, on the basis of the fact or perception of a person's race, color, creed, religion, national origin, ancestry, age, height, weight, sex, sexual orientation, gender identity, domestic partner status, marital status, disability or Acquired Immune Deficiency Syndrome or HIV status (AIDS/HIV status), or association with members of such protected classes, or in retaliation for opposition to discrimination against such classes.

34.2 Subcontracts. Contractor shall incorporate by reference in all subcontracts the provisions of §§12B.2(a), 12B.2(c)-(k), and 12C.3 of the San Francisco Administrative Code (copies of which are available from Purchasing) and shall require all subcontractors to comply with such provisions. Contractor's failure to comply with the obligations in this subsection shall constitute a material breach of this Agreement.

34.3 Nondiscrimination in Benefits. Contractor does not as of the date of this Agreement and will not during the term of this Agreement, in any of its operations in San Francisco, on real property owned by San Francisco, or where work is being performed for the City elsewhere in the United States, discriminate in the provision of bereavement leave, family medical leave, health benefits, membership or membership discounts, moving expenses, pension and retirement benefits or travel benefits, as well as any benefits other than the benefits specified above, between employees with domestic partners and employees with spouses, and/or between the domestic partners and spouses of such employees, where the domestic partnership has been registered with a governmental entity pursuant to state or local law authorizing such registration, subject to the conditions set forth in §12B.2(b) of the San Francisco Administrative Code.

34.4 Condition to Contract. As a condition to this Agreement, Contractor shall execute the "Chapter 12B Declaration: Nondiscrimination in Contracts and Benefits" form (form CMD-12B-101) with supporting documentation and secure the approval of the form by the San Francisco Contract Monitoring Division.

34.5 Incorporation of Administrative Code Provisions by Reference. The provisions of Chapters 12B and 12C of the San Francisco Administrative Code are incorporated in this Section by reference and made a part of this Agreement as though fully set forth in this Agreement. Contractor shall comply fully with and be bound by all of the provisions that apply to this Agreement under such Chapters, including but not limited to the remedies provided in such Chapters. Without limiting the foregoing, Contractor understands that pursuant to §§12B.2(h) and 12C.3(g) of the San Francisco Administrative Code, a penalty of \$50 for each person for each calendar day during which such person was discriminated against in violation of the provisions of this Agreement may be assessed against Contractor and/or deducted from any payments due Contractor.

35. MacBride Principles—Northern Ireland. Pursuant to San Francisco Administrative Code §12F.5, the City and County of San Francisco urges companies doing business in Northern Ireland to move towards resolving employment inequities, and encourages such companies to abide by the MacBride Principles. The City and County of San Francisco urges San Francisco companies to do business with corporations that abide by the MacBride Principles. By signing below, the person executing this agreement on behalf of Contractor acknowledges and agrees that he or she has read and understood this section.

36. Tropical Hardwood and Virgin Redwood Ban. Pursuant to §804(b) of the San Francisco Environment Code, the City and County of San Francisco urges contractors not to import, purchase,

obtain, or use for any purpose, any tropical hardwood, tropical hardwood wood product, virgin redwood or virgin redwood wood product.

37. Drug-Free Workplace Policy. Contractor acknowledges that pursuant to the Federal Drug-Free Workplace Act of 1989, the unlawful manufacture, distribution, dispensation, possession, or use of a controlled substance is prohibited on City premises. Contractor agrees that any violation of this prohibition by Contractor, its employees, agents or assigns will be deemed a material breach of this Agreement.

38. Resource Conservation. Chapter 5 of the San Francisco Environment Code ("Resource Conservation") is incorporated in this Agreement by reference. Failure by Contractor to comply with any of the applicable requirements of Chapter 5 will be deemed a material breach of contract.

39. Compliance with Americans with Disabilities Act. Contractor acknowledges that, pursuant to the Americans with Disabilities Act (ADA), programs, services and other activities provided by a public entity to the public, whether directly or through a contractor, must be accessible to the disabled public. Contractor shall provide the services specified in this Agreement in a manner that complies with the ADA and any and all other applicable federal, state and local disability rights legislation. Contractor agrees not to discriminate against disabled persons in the provision of services, benefits or activities provided under this Agreement and further agrees that any violation of this prohibition on the part of Contractor, its employees, agents or assigns will constitute a material breach of this Agreement.

40. Sunshine Ordinance. In accordance with San Francisco Administrative Code §67.24(e), contracts, contractors' bids, responses to solicitations and all other records of communications between City and persons or firms seeking contracts, shall be open to inspection immediately after a contract has been awarded. Nothing in this provision requires the disclosure of a private person or organization's net worth or other proprietary financial data submitted for qualification for a contract or other benefit until and unless that person or organization is awarded the contract or benefit. Information provided which is covered by this paragraph will be made available to the public upon request.

41. Public Access to Meetings and Records. If the Contractor receives a cumulative total per year of at least \$250,000 in City funds or City-administered funds and is a non-profit organization as defined in Chapter 12L of the San Francisco Administrative Code, Contractor shall comply with and be bound by all the applicable provisions of that Chapter. By executing this Agreement, the Contractor agrees to open its meetings and records to the public in the manner set forth in §§12L.4 and 12L.5 of the Administrative Code. Contractor further agrees to make-good faith efforts to promote community membership on its Board of Directors in the manner set forth in §12L.6 of the Administrative Code. The Contractor acknowledges that its material failure to comply with any of the provisions of this paragraph shall constitute a material breach of this Agreement. The Contractor further acknowledges that such material breach of the Agreement shall be grounds for the City to terminate and/or not renew the Agreement, partially or in its entirety.

42. Limitations on Contributions. Through execution of this Agreement, Contractor acknowledges that it is familiar with section 1.126 of the City's Campaign and Governmental Conduct Code, which prohibits any person who contracts with the City for the rendition of personal services, for the furnishing of any material, supplies or equipment, for the sale or lease of any land or building, or for a grant, loan or loan guarantee, from making any campaign contribution to (1) an individual holding a City elective office if the contract must be approved by the individual, a board on which that individual serves, or the board of a state agency on which an appointee of that individual serves, (2) a candidate for the office held by such individual, or (3) a committee controlled by such individual, at any time from the commencement of negotiations for the contract until the later of either the termination of negotiations for such contract or six

months after the date the contract is approved. Contractor acknowledges that the foregoing restriction applies only if the contract or a combination or series of contracts approved by the same individual or board in a fiscal year have a total anticipated or actual value of \$50,000 or more. Contractor further acknowledges that the prohibition on contributions applies to each prospective party to the contract; each member of Contractor's board of directors; Contractor's chairperson, chief executive officer, chief financial officer and chief operating officer; any person with an ownership interest of more than 20 percent in Contractor; any subcontractor listed in the bid or contract; and any committee that is sponsored or controlled by Contractor. Additionally, Contractor acknowledges that Contractor must inform each of the persons described in the preceding sentence of the prohibitions contained in Section 1.126. Contractor further agrees to provide to City the names of each person, entity or committee described above.

43. Requiring Minimum Compensation for Covered Employees

43.1 Contractor agrees to comply fully with and be bound by all of the provisions of the Minimum Compensation Ordinance (MCO), as set forth in San Francisco Administrative Code Chapter 12P (Chapter 12P), including the remedies provided, and implementing guidelines and rules. The provisions of Sections 12P.5 and 12P.5.1 of Chapter 12P are incorporated in this Agreement by reference and made a part of this Agreement as though fully set forth. The text of the MCO is available on the web at www.sfgov.org/olse/mco. A partial listing of some of Contractor's obligations under the MCO is set forth in this Section. Contractor is required to comply with all the provisions of the MCO, irrespective of the listing of obligations in this Section.

43.2 The MCO requires Contractor to pay Contractor's employees a minimum hourly gross compensation wage rate and to provide minimum compensated and uncompensated time off. The minimum wage rate may change from year to year and Contractor is obligated to keep informed of the then-current requirements. Any subcontract entered into by Contractor shall require the subcontractor to comply with the requirements of the MCO and shall contain contractual obligations substantially the same as those set forth in this Section. It is Contractor's obligation to ensure that any subcontractors of any tier under this Agreement comply with the requirements of the MCO. If any subcontractor under this Agreement fails to comply, City may pursue any of the remedies set forth in this Section against Contractor.

43.3 Contractor shall not take adverse action or otherwise discriminate against an employee or other person for the exercise or attempted exercise of rights under the MCO. Such actions, if taken within 90 days of the exercise or attempted exercise of such rights, will be rebuttably presumed to be retaliation prohibited by the MCO.

43.4 Contractor shall maintain employee and payroll records as required by the MCO. If Contractor fails to do so, it shall be presumed that the Contractor paid no more than the minimum wage required under State law.

43.5 The City is authorized to inspect Contractor's job sites and conduct interviews with employees and conduct audits of Contractor.

43.6 Contractor's commitment to provide the Minimum Compensation is a material element of the City's consideration for this Agreement. The City in its sole discretion shall determine whether such a breach has occurred. The City and the public will suffer actual damage that will be impractical or extremely difficult to determine if the Contractor fails to comply with these requirements. Contractor agrees that the sums set forth in Section 12P.6.1 of the MCO as liquidated damages are not a penalty, but are reasonable estimates of the loss that the City and the public will incur for Contractor's noncompliance.

The procedures governing the assessment of liquidated damages shall be those set forth in Section 12P.6.2 of Chapter 12P.

43.7 Contractor understands and agrees that if it fails to comply with the requirements of the MCO, the City shall have the right to pursue any rights or remedies available under Chapter 12P (including liquidated damages), under the terms of the contract, and under applicable law. If, within 30 days after receiving written notice of a breach of this Agreement for violating the MCO, Contractor fails to cure such breach or, if such breach cannot reasonably be cured within such period of 30 days, Contractor fails to commence efforts to cure within such period, or thereafter fails diligently to pursue such cure to completion, the City shall have the right to pursue any rights or remedies available under applicable law, including those set forth in Section 12P.6(c) of Chapter 12P. Each of these remedies shall be exercisable individually or in combination with any other rights or remedies available to the City.

43.8 Contractor represents and warrants that it is not an entity that was set up, or is being used, for the purpose of evading the intent of the MCO.

43.9 If Contractor is exempt from the MCO when this Agreement is executed because the cumulative amount of agreements with this department for the fiscal year is less than \$25,000, but Contractor later enters into an agreement or agreements that cause contractor to exceed that amount in a fiscal year, Contractor shall thereafter be required to comply with the MCO under this Agreement. This obligation arises on the effective date of the agreement that causes the cumulative amount of agreements between the Contractor and this department to exceed \$25,000 in the fiscal year.

44. Requiring Health Benefits for Covered Employees. Contractor agrees to comply fully with and be bound by all of the provisions of the Health Care Accountability Ordinance (HCAO), as set forth in San Francisco Administrative Code Chapter 12Q, including the remedies provided, and implementing regulations, as the same may be amended from time to time. The provisions of section 12Q.5.1 of Chapter 12Q are incorporated by reference and made a part of this Agreement as though fully set forth in this Agreement. The text of the HCAO is available on the web at www.sfgov.org/olse. Capitalized terms used in this Section and not defined in this Agreement shall have the meanings assigned to such terms in Chapter 12Q.

44.1 For each Covered Employee, Contractor shall provide the appropriate health benefit set forth in Section 12Q.3 of the HCAO. If Contractor chooses to offer the health plan option, such health plan shall meet the minimum standards set forth by the San Francisco Health Commission.

44.2 Notwithstanding the above, if the Contractor is a small business as defined in Section 12Q.3(e) of the HCAO, it shall have no obligation to comply with part (a) above.

44.3 Contractor's failure to comply with the HCAO shall constitute a material breach of this agreement. City shall notify Contractor if such a breach has occurred. If, within 30 days after receiving City's written notice of a breach of this Agreement for violating the HCAO, Contractor fails to cure such breach or, if such breach cannot reasonably be cured within such period of 30 days, Contractor fails to commence efforts to cure within such period, or thereafter fails diligently to pursue such cure to completion, City shall have the right to pursue the remedies set forth in 12Q.5.1 and 12Q.5(f)(1-6). Each of these remedies shall be exercisable individually or in combination with any other rights or remedies available to City.

44.4 Any Subcontract entered into by Contractor shall require the Subcontractor to comply with the requirements of the HCAO and shall contain contractual obligations substantially the same as those set forth in this Section. Contractor shall notify City's Office of Contract Administration when it enters into

such a Subcontract and shall certify to the Office of Contract Administration that it has notified the Subcontractor of the obligations under the HCAO and has imposed the requirements of the HCAO on Subcontractor through the Subcontract. Each Contractor shall be responsible for its Subcontractors' compliance with this Chapter. If a Subcontractor fails to comply, the City may pursue the remedies set forth in this Section against Contractor based on the Subcontractor's failure to comply, provided that City has first provided Contractor with notice and an opportunity to obtain a cure of the violation.

44.5 Contractor shall not discharge, reduce in compensation, or otherwise discriminate against any employee for notifying City with regard to Contractor's noncompliance or anticipated noncompliance with the requirements of the HCAO, for opposing any practice proscribed by the HCAO, for participating in proceedings related to the HCAO, or for seeking to assert or enforce any rights under the HCAO by any lawful means.

44.6 Contractor represents and warrants that it is not an entity that was set up, or is being used, for the purpose of evading the intent of the HCAO.

44.7 Contractor shall maintain employee and payroll records in compliance with the California Labor Code and Industrial Welfare Commission orders, including the number of hours each employee has worked on the City Contract.

44.8 Contractor shall keep itself informed of the current requirements of the HCAO.

44.9 Contractor shall provide reports to the City in accordance with any reporting standards promulgated by the City under the HCAO, including reports on Subcontractors and Subtenants, as applicable.

44.10 Contractor shall provide City with access to records pertaining to compliance with HCAO after receiving a written request from City to do so and being provided at least ten business days to respond.

44.11 Contractor shall allow City to inspect Contractor's job sites and have access to Contractor's employees in order to monitor and determine compliance with HCAO.

44.12 City may conduct random audits of Contractor to ascertain its compliance with HCAO. Contractor agrees to cooperate with City when it conducts such audits.

44.13 If Contractor is exempt from the HCAO when this Agreement is executed because its amount is less than \$25,000 (\$50,000 for nonprofits), but Contractor later enters into an agreement or agreements that cause Contractor's aggregate amount of all agreements with City to reach \$75,000, all the agreements shall be thereafter subject to the HCAO. This obligation arises on the effective date of the agreement that causes the cumulative amount of agreements between Contractor and the City to be equal to or greater than \$75,000 in the fiscal year.

45. First Source Hiring Program. This Section incorporates the requirements of the First Source Hiring Program pursuant to San Francisco Administrative Code Chapter 83 (entitled "First Source Hiring Program"). Contractor agrees to participate and comply with the provisions of the First Source Hiring Program. As part of the Contractor's Agreement with the City, the Contractor shall incorporate provisions of the First Source Hiring Program into any Joint Venture Partnership and shall require subcontractors to do the same. The Mayor's Office of Economic and Workforce Development is the Contractor's main contact for the First Source Hiring Program. For more information regarding First Source Hiring Program, please go to: <http://www.workforcedevelopmentsf.org/>.

45.1 Definitions. The provisions of Chapter 83 of the San Francisco Administrative Code apply to this Agreement. Contractor shall comply fully with, and be bound by, all of the provisions that apply to this Agreement under such Chapter, including but not limited to the remedies provided in this Agreement. Capitalized terms used in this Section and not defined in this Agreement shall have the meanings assigned to such terms in Chapter 83.

45.1.1 Entry Level Position: Any non-managerial position that requires either: (a) no education above a high school diploma or certified equivalency; or (b) less than two years training or specific preparation; and (c) shall include temporary positions and paid internships.

45.1.2 Trainee: A economically disadvantaged worker identified by the First Source Hiring Program as having the appropriate training, employment background and skill set for an available Entry Level Position specified by the Contractor.

45.2 First Source Hiring Goals.

45.2.1 Over the life of the Agreement, the Contractor shall make good faith efforts to hire a minimum number of Trainees referred by the First Source Hiring Program to fulfill available Entry Level Positions based on the Contractor Fee Schedule below:

Contractor Fee Schedule	Minimum Number of Trainees to be Hired (over the life of the contract)
\$0 – \$499,999	0
\$500,000 – \$899,999	1
\$900,000 – \$1,999,999	2
\$2,000,000 – \$4,999,999	3
\$5,000,000 – \$7,999,999	4
\$8,000,000 – \$10,999,999	5
\$11,000,000 – \$13,999,999	6
(> = \$14M, for each additional \$3 million in Contractor fees, add one additional Trainee)	

45.2.2 Contractor may decline to hire a Trainee if the Contractor considers the Trainee in good faith and deems the Trainee is not qualified. The final decision to hire a Trainee shall be made by the Contractor.

45.2.3 The Contractor shall hire the Trainee on a full-time basis for at least 12 months or on part-time basis for 24 months.

45.2.4 Trainees must be obtained through the First Source Hiring Program and the Contractor must consider all Trainees fairly and equally and comply with the non-discrimination provisions pursuant to local, state and federal laws. No existing employee may count toward the total number of Trainees hired.

45.3 Procedures.

45.3.1 Within 30 days of award of contract, the Contractor will email the First Source Hiring Administrator and schedule to meet with staff from the First Source Hiring Program. At the meeting, the Contractor will provide information on Entry Level Positions, number of Trainees to be hired, job description, start date and rate of pay. If the Contractor cannot quantify the numbers of Trainees to be

hired, the Contractor must still meet with the First Source Hiring Program and present a workforce plan of good faith efforts towards the First Source Hiring Goals.

45.3.2 Contractors are required to notify the First Source Hiring Program of all available Entry Level Positions.

45.3.3 Contractor will designate a representative to monitor all employment related activity and be the main contact for the First Source Hiring Program.

45.3.4 Contractor will maintain documentation and records supporting good faith efforts toward the First Source Hiring Program.

45.4 As-Needed Contracts. Contractors awarded As-Needed contracts shall follow the provisions of the First Source Hiring Program. However, the First Source Hiring Goals will not be based on each individual Contract Service Order (CSO) but rather from the total number of CSOs issued to the Contractor. Since a Contractor does not know when or how many CSOs will be issued, the Contractor shall hire Trainees only if the increase in CSOs creates entry-level employment opportunities.

45.5 Noncompliance. Failure to meet the criteria of the First Source Hiring Program does not impute bad faith but rather will trigger a review for compliance. If the City deems a Contractor is noncompliant and acted in bad faith towards the First Source Hiring Program, then the City may withhold progress payments and assess liquidated damages as defined in San Francisco Administrative Code Chapter 83.

46. Prohibition on Political Activity with City Funds. In accordance with San Francisco Administrative Code Chapter 12.G, Contractor may not participate in, support, or attempt to influence any political campaign for a candidate or for a ballot measure (collectively, "Political Activity") in the performance of the services provided under this Agreement. Contractor agrees to comply with San Francisco Administrative Code Chapter 12.G and any implementing rules and regulations promulgated by the City's Controller. The terms and provisions of Chapter 12.G are incorporated in this Agreement by this reference. In the event Contractor violates the provisions of this section, the City may, in addition to any other rights or remedies available under this Agreement, (i) terminate this Agreement, and (ii) prohibit Contractor from bidding on or receiving any new City contract for a period of two (2) years. The Controller will not consider Contractor's use of profit as a violation of this section.

47. Preservative-treated Wood Containing Arsenic. Contractor may not purchase preservative-treated wood products containing arsenic in the performance of this Agreement unless an exemption from the requirements of Chapter 13 of the San Francisco Environment Code is obtained from the Department of the Environment under Section 1304 of the Code. The term "preservative-treated wood containing arsenic" shall mean wood treated with a preservative that contains arsenic, elemental arsenic, or an arsenic copper combination, including, but not limited to, chromated copper arsenate preservative, ammoniacal copper zinc arsenate preservative, or ammoniacal copper arsenate preservative. Contractor may purchase preservative-treated wood products on the list of environmentally preferable alternatives prepared and adopted by the Department of the Environment. This provision does not preclude Contractor from purchasing preservative-treated wood containing arsenic for saltwater immersion. The term "saltwater immersion" shall mean a pressure-treated wood that is used for construction purposes or facilities that are partially or totally immersed in saltwater.

48. Modification of Agreement. This Agreement may not be modified, nor may compliance with any of its terms be waived, except by written instrument executed and approved in the same manner as this Agreement. Contractor shall cooperate with Department to submit to the Director of CMD any

amendment, modification, supplement or change order that would result in a cumulative increase of the original amount of this Agreement by more than 20% (CMD Contract Modification Form).

49. Administrative Remedy for Agreement Interpretation. Should any question arise as to the meaning and intent of this Agreement, the question shall, prior to any other action or resort to any other legal remedy, be referred to Purchasing who shall decide the true meaning and intent of the Agreement.

50. Agreement Made in California; Venue. The formation, interpretation and performance of this Agreement shall be governed by the laws of the State of California. Venue for all litigation relative to the formation, interpretation and performance of this Agreement shall be in San Francisco.

51. Construction. All paragraph captions are for reference only and shall not be considered in construing this Agreement.

52. Entire Agreement. This contract sets forth the entire Agreement between the parties, and supersedes all other oral or written provisions. This contract may be modified only as provided in Section 48, "Modification of Agreement."

53. Compliance with Laws. Contractor shall keep itself fully informed of the City's Charter, codes, ordinances and regulations of the City and of all state, and federal laws in any manner affecting the performance of this Agreement, and must at all times comply with such local codes, ordinances, and regulations and all applicable laws as they may be amended from time to time.

54. Services Provided by Attorneys. Any services to be provided by a law firm or attorney must be reviewed and approved in writing in advance by the City Attorney. No invoices for services provided by law firms or attorneys, including, without limitation, as subcontractors of Contractor, will be paid unless the provider received advance written approval from the City Attorney.

55. Supervision of Minors. NOT APPLICABLE

56. Severability. Should the application of any provision of this Agreement to any particular facts or circumstances be found by a court of competent jurisdiction to be invalid or unenforceable, then (a) the validity of other provisions of this Agreement shall not be affected or impaired thereby, and (b) such provision shall be enforced to the maximum extent possible so as to effect the intent of the parties and shall be reformed without further action by the parties to the extent necessary to make such provision valid and enforceable.

57. Protection of Private Information. Contractor has read and agrees to the terms set forth in San Francisco Administrative Code Sections 12M.2, "Nondisclosure of Private Information," and 12M.3, "Enforcement" of Administrative Code Chapter 12M, "Protection of Private Information," which are incorporated in this Agreement as if fully set forth. Contractor agrees that any failure of Contractor to comply with the requirements of Section 12M.2 of this Chapter shall be a material breach of the Contract. In such an event, in addition to any other remedies available to it under equity or law, the City may terminate the Contract, bring a false claim action against the Contractor pursuant to Chapter 6 or Chapter 21 of the Administrative Code, or debar the Contractor.

58. Graffiti Removal. Intentionally omitted.

59. Food Service Waste Reduction Requirements. Effective June 1, 2007, Contractor agrees to comply fully with and be bound by all of the provisions of the Food Service Waste Reduction Ordinance, as set forth in San Francisco Environment Code Chapter 16, including the remedies provided, and

implementing guidelines and rules. The provisions of Chapter 16 are incorporated in this Agreement by reference and made a part of this Agreement as though fully set forth. This provision is a material term of this Agreement. By entering into this Agreement, Contractor agrees that if it breaches this provision, City will suffer actual damages that will be impractical or extremely difficult to determine; further, Contractor agrees that the sum of one hundred dollars (\$100) liquidated damages for the first breach, two hundred dollars (\$200) liquidated damages for the second breach in the same year, and five hundred dollars (\$500) liquidated damages for subsequent breaches in the same year is reasonable estimate of the damage that City will incur based on the violation, established in light of the circumstances existing at the time this Agreement was made. Such amount shall not be considered a penalty, but rather agreed monetary damages sustained by City because of Contractor's failure to comply with this provision.

60. Slavery Era Disclosure. NOT APPLICABLE

61. Cooperative Drafting. This Agreement has been drafted through a cooperative effort of both parties, and both parties have had an opportunity to have the Agreement reviewed and revised by legal counsel. No party shall be considered the drafter of this Agreement, and no presumption or rule that an ambiguity shall be construed against the party drafting the clause shall apply to the interpretation or enforcement of this Agreement.

62. Dispute Resolution Procedure. NOT APPLICABLE

63. Airport Intellectual Property. Pursuant to Resolution No. 01-0118, adopted by the Airport Commission on April 18, 2001, the Airport Commission affirmed that it will not tolerate the unauthorized use of its intellectual property, including the SFO logo, CADD designs, and copyrighted publications. All proposers, bidders, contractors, tenants, permittees, and others doing business with or at the Airport (including subcontractors and subtenants) may not use the Airport intellectual property, or any intellectual property confusingly similar to the Airport intellectual property, without the Airport Director's prior consent.

64. Labor Peace / Card Check Rule. Without limiting the generality of other provisions in this Agreement requiring Contractor to comply with all Airport Rules, Contractor shall comply with the Airport's Labor Peace / Card Check Rule, adopted on February 1, 2000, pursuant to Airport Commission Resolution No. 00-0049 (the "Labor Peace / Card Check Rule"). Capitalized terms not defined in this provision are defined in the Labor Peace/Card Check Rule. To comply with the Labor Peace/Card Check Rule, Contractor shall, among other actions: (a) Enter into a Labor Peace/Card Check Rule Agreement with any Labor Organization which requests such an agreement and which has registered with the Airport Director or his / her designee, within thirty (30) days after Labor Peace/Card Check Rule Agreement has been requested; (b) Not less than thirty (30) days prior to the modification of this Agreement, Contractor shall provide notice by mail to any Labor Organization or federation of labor organizations which have registered with the Airport Director or his / her designee (registered labor organization"), that Contractor is seeking to modify or extend this Agreement; (c) Upon issuing any request for proposals, invitations to bid, or similar notice, or in any event not less than thirty (30) days prior to entering into any Subcontract, Contractor shall provide notice to all registered Labor Organizations that Contractor is seeking to enter into such Subcontract; and (d) Contractor shall include in any subcontract with a Subcontractor performing services pursuant to any covered Contract, a provision requiring the Subcontractor performing services pursuant to any covered Contract, a provision requiring the Subcontractor to comply with the requirements of the Labor Peace/Card Check Rule. If Airport Director determines that Contractor violated the Labor Peace/Card Check Rule, Airport Director shall have the option to terminate this Agreement, in addition to exercising all other remedies available to him / her.

65. Federal Non-Discrimination Provisions. Contractor for itself, its personal representatives, successors in interest, and assigns, as part of the consideration hereof, does hereby covenant and agree that Contractor shall maintain and operate the Airport facilities and services in compliance with all requirements imposed pursuant to Title 49, Code of Federal Regulations, DOT, Subtitle A, Office of the Secretary, Part 21, Nondiscrimination in Federally-Assisted Programs of the Department of Transportation – Effectuation of Title VI of the Civil Rights Act of 1964, as said regulations may be amended. Contractor, for itself, its personal representatives, successors in interest, and assigns, agrees that Contractor in its operation at and use of San Francisco International Airport, covenants that (1) no person on the grounds of race, color, national origin or sex shall be excluded from participation in, denied the benefits of, or be otherwise subjected to discrimination in the use of said facilities; (2) that in the construction of any improvements on, over, or under the Airport and the furnishing of services thereon, no person on the grounds of race, color, national origin or sex shall be excluded from participation or denied the benefits of, or otherwise be subject to discrimination, (3) that Contractor shall use all City premises in compliance with all other requirements imposed by or pursuant to Title 49, Code of Federal Regulations, DOT, Subtitle A – Office of the Secretary of Transportation, Part 21, Nondiscrimination in Federally-Assisted Programs of the Department of Transportation – Effectuation of Title VI of the Civil Rights Act of 1964, and as said Regulations may be amended. These Regulations are incorporated as though fully set forth in this Agreement. Contractor agrees to include the above statements in any subsequent contract that it enters into with subcontractors and cause those agreements to similarly include the statements, and cause those businesses to include the statements in further agreements.

Failure by the contractor to comply with the requirements of this section is a material breach of this contract, which may result in the termination of this contract or such other remedy as the Airport deems appropriate.

66. Quality Standards Program. This Agreement is subject to the Airport's Quality Standards Program. The Airport's Employment and Quality Standards (EQS) office oversees the Airport's Quality Standards Program (QSP) which is applicable to Service Providers at the Airport whose employees are involved in performing services that have an impact on Airport security and safety. More information may be found at: <http://www.flysfo.com/about-sfo/the-organization/rules-and-regulations> . EQS may be contacted at (650) 821-1003.

IN WITNESS WHEREOF, the parties hereto have executed this Agreement on the day first mentioned above.

<p>CITY AIRPORT COMMISSION CITY AND COUNTY OF SAN FRANCISCO</p> <p>By: _____ John L. Martin, Airport Director</p> <p>Attest:</p> <p>By _____ Jean Caramatti, Secretary Airport Commission</p> <p>Resolution No: <u>15-0004</u></p> <p>Adopted on: January 20, 2015</p> <p>Approved as to Form:</p> <p>Dennis J. Herrera City Attorney</p> <p>By <u>Heather Wolnick</u> Heather Wolnick Deputy City Attorney</p>	<p>CONTRACTOR</p> <p>By signing this Agreement, I certify that I comply with the requirements of the Minimum Compensation Ordinance, which entitle Covered Employees to certain minimum hourly wages and compensated and uncompensated time off.</p> <p>I have read and understood paragraph 35, the City's statement urging companies doing business in Northern Ireland to move towards resolving employment inequities, encouraging compliance with the MacBride Principles, and urging San Francisco companies to do business with corporations that abide by the MacBride Principles.</p> <p><u>Arnold Rosenberg</u> Authorized Signature</p> <p>Arnold Rosenberg Senior Vice President</p> <p><u>Bahram Khamenehpour</u> Authorized Signature</p> <p>Bahram Khamenehpour Senior Principal</p> <p>T1 Cubed - a Joint Venture 303 Second Street, Suite 700 San Francisco, California 94107</p> <p>96000 Vendor Number</p> <p>47-2256316 Federal Employer ID Number</p>
--	---

Appendices

- A: Services to be Provided by Contractor
- B: Calculation of Charges
- C: Strategic Plan
- D: Partnering Requirements
- E: Other Transaction Agreement (OTA) HSTS04-13-H-CT1058 and OTA HSTS04-13-H-CT1140



APPENDIX A SERVICES TO BE PROVIDED BY CONTRACTOR

This Appendix A attached to, and incorporated by reference in the Agreement made on **January 20, 2014** between the City and County of San Francisco, acting by and through its Airport Commission (“Commission”), and **T1 Cubed - a Joint Venture** (“Contractor”) to provide Project Management Support Services (“PMSS”) for New Boarding Area B (“BAB”) Project (“Project”) for the San Francisco International Airport (“Airport”).

The Contractor shall provide overall management and oversight of the Project throughout its lifecycle under the direction of the Airport Project Manager. The final scope of work will be negotiated, on a yearly basis at a minimum based on the requirements of each phase of the Project and associated tasks assigned to the Contractor.

The Contractor shall support the Airport as needed through each phase of the Project, in its compliance with the existing Design and Construction Other Transaction Agreements (OTAs) between the Transportation Security Administration (TSA) and Airport for the baggage handling component constructed within this Project. The OTAs are attached for reference to this Agreement as Appendix E.

The following scope of services is as comprehensive as possible at the outset of the Project. Because individual services may be added and/or deleted as the Project progresses, it is not possible to present a complete list of services that could be finally assigned to the Contractor. Tasks listed herein within a particular section may be required at any time throughout the Project. During the contract, all work to be performed by the Contractor will either be included in a scope of work similar to this document or in mutually-agreed-upon, contract amendments or specific task orders.

1. PROJECT LIFE CYCLE PHASES:

1.1 PRE-PROGRAMMING PHASE

The intent of the Pre-Programming Phase is to review and validate existing Project information and schematic plans, if available. As part of the Pre-Programming Phase, the Contractor shall:

- 1.1.1 Review and validate existing Project information and plans.
- 1.1.2 Develop preliminary Project schedules in coordination with all components of the Program and all other affected Airport activities and stakeholders.
- 1.1.3 Provide a Rough Order of Magnitude Cost Model for the Project and develop strategies to ensure meeting the Project budget.

- 1.1.4 Prepare a list of Project permits and requirements pertaining to environmental quality, including, but not limited to Air Quality, Water Quality, and the California Environmental Quality Act (CEQA). The Contractor shall ensure proper permits are obtained and facilitate adherence to all applicable requirements.

1.2 PROGRAMMING PHASE

The intent of the Programming Phase is to provide clarity and agreement on the Project scope, cost and schedule between all parties and to provide an approved Basis of Design. Programming shall commence at the completion of the Pre-Programming Phase and the procurement of the Project's Design-Build team. As part of the Programming Phase, the Contractor shall:

- 1.2.1 Provide oversight, coordination, and review of the Design-Builder in all aspects of Project programming.
- 1.2.2 Schedule, manage, and facilitate the Stakeholder Engagement Groups and Subgroups (SEP Groups and Subgroups), so that the Design-Builder is able to define the project scope and formulate the Basis of Design. Thoroughly document and distribute meeting discussions and verify completion of action items.

SEP Groups and Subgroups shall be determined based on the project scope. Refer to www.sfoconstruction.com for the Airport's "Delivering Exceptional Projects" document for a more detailed description of the Stakeholder Engagement Process.

- 1.2.3 Ensure information is accurately assembled by the Design-Builder in a comprehensive narrative report to be used as the Basis of Design, which shall include, but is not limited to:

A. Project Description:

- 1) A comprehensive narrative of the scope of work and programming requirements for the Project. Requirements shall incorporate input from the SEP, which will be coordinated by the Contractor and led by the Design-Builder.
- 2) Diagrammatic design drawings incorporating efficient Project site layout.

B. Provide oversight and coordination of the Design-Builder in generating Project design criteria and standards. Criteria shall incorporate Airport and other regulatory standards as well as input from the SEP. Design criteria shall include but is not limited to:

- 1) Identification of preliminary architectural, engineering, security and special systems for the Project.
- 2) Compilation of architectural, engineering, security and special systems specification outlines based on conceptual design. The outline specifications shall include minimum performance criteria and standards and preferred manufacturers.
- 3) Identification of preliminary building code classifications, accessibility, egress requirements, and life safety requirements.

- 4) Coordinate the application of sustainability requirements to be in conformance with the Airport defined sustainability Principles, Goals, Outcomes, and Guidelines.
- 5) Preliminary schedules and cost models based on the proposed Basis of Design.
- 6) Reconcile the Project with the Airport's budget. Advise the Airport if the Project and budget are not in compliance and recommend potential solutions.
- 7) Prepare reports, exhibits, and presentation materials to convey the Project as requested by the Airport Project Manager.
- 8) Identify, analyze and conform to the requirements of governmental and private authorities having jurisdiction to approve the design of the Project and participate in consultations with such authorities.
- 9) Provide a staffing plan for PMSS for each phase of the remainder of the Project and an anticipated direct labor cost for the remainder of the Project.
- 10) Provide oversight and review of proposed design fees and construction fees.

1.3 DESIGN PHASE

The Design Phase commences upon the completion and approval of Programming. As part of the Design Phase, the Contractor shall:

- 1.3.1 Provide management, administration and oversight of Airport issued design contract(s). The Airport anticipates procuring a Design-Build contract.
- 1.3.2 Provide reviews of design deliverables and construction documents produced by the Design-Builder and verify that all design review comments are incorporated. Further, the Contractor shall ensure that the Design-Builder implements the standards and Basis of Design developed in the SEP.
- 1.3.3 Coordinate and facilitate additional SEP meetings so that the Design-Builder may resolve design issues that do not conform to the Basis of Design developed during the Programming Phase.
- 1.3.4 Provide design oversight, monitor design progress and deliverables, and recommend corrective action when required.
- 1.3.5 Coordinate proposed design elements and phasing in conjunction with all components of the Project and all other affected Airport activities and stakeholders.
- 1.3.6 Provide reviews and verification that the Airport's sustainability requirements are being incorporated.
- 1.3.7 Coordinate with the Airport's sustainability Commissioning Authority, the Architects and the Builder to verify that the Commissioning Plan is being implemented and that any outstanding commissioning items are implemented.

- 1.3.8 Provide coordination between the Program Sustainability Manager and the Design-Builder in all aspects of the Sustainable building practices:
- A. Facilitate review of the Architect's Design proposals, whole building and product Life Cycle Assessments, Building Energy Efficiency Design proposals, modeled energy calculations, and proposed LEED certification proposals.
 - B. Facilitate review of the building product information as provided by the Design-Builder that includes Life Cycle Assessments (LCA), Life Cycle Costs (LCCA), Environmental Product Declarations (EPD), and Health Product Declarations (HPD).
 - C. Facilitate review of the Design-Builder's Construction Documents to confirm compliance with the sustainability requirements and codes, and confirm that the sustainability elements are sufficiently documented such that the documents will allow for compliance monitoring during the construction phase. Assist in the preparation of a list of non-conforming items and assist in back checking the documents until resolution is achieved.
 - D. Review and monitor the Design-Builder's LEED certification process
 - E. Monitor the Sustainability Commissioning process.
- 1.3.9 Manage and coordinate all design documents to ensure compliance with the TSA Planning Guidelines Design Standards (PGDS).
- 1.3.10 Support the management and coordination of all supporting documents needed to ensure compliance with the existing OTAs between the TSA and Airport.

1.4 CONSTRUCTION PHASE

In addition to the overall project management services, the Contractor will act as the Construction Manager for all construction activities. As part of the Construction Phase, the Contractor shall:

- 1.4.1 Provide procurement support, management, administration and oversight of Project construction contract(s). The Airport anticipates procuring a Design-Build contract.
- 1.4.2 Perform as the Construction Manager during the entire Project lifecycle. At a minimum, the Contractor shall provide the following construction management services:
 - A. Establish a job specific safety program with the Builder(s) and provide competent safety professional(s) to enforce jobsite safety.
 - B. Review construction documents for constructability, impact to Airport operations, and consistency with the Project schedule.
 - C. Review construction work and phasing plans and make recommendations to minimize disruption to Airport operations.

- D. Ensure construction activities/shutdowns/closures are properly coordinated with, and approved by, Airport Operations, Duty Managers, and all affected parties.
- E. Participate in trade subcontract procurement processes as applicable.
- F. Review and/or prepare construction quality assurance/quality control plans.
- G. Provide technical, full-time, on-site quality assurance and code compliance oversight and inspection, including specialty inspections, of the progress and quality of the construction work. (Note; During the construction phase, the Contractor may need to integrate, within its technical support staff, Airport staff to provide on-site observation of the Work, depending upon availability of Airport personnel.)
- H. Ensure that the Builder has scheduled all formal code inspections with the Airport's Building Inspection and Code Enforcement (BICE) Division once a pre-inspection has been performed with the Builder. Prior to the formal BICE inspection, the pre-inspection shall confirm that all contract and code requirements are satisfied for the specific inspection being requested. In addition, the pre-inspection will verify that any ancillary or otherwise supporting work activities associated with the specific inspection meets contract and code requirements. Take all necessary measures to ensure the Builder corrects all non-conforming or otherwise deficient work discovered at any level of inspection.
- I. Monitor environmental inspection for Builder's compliance with environmental regulations.
- J. Examine materials and equipment being incorporated into the work to verify that they are supported by approved submittals, handled, stored, and installed properly.
- K. Prepare inspector's daily reports and engineer's reports for submission to the Airport.
- L. Manage and review the submission of samples, shop drawings, Operation & Maintenance (O&M) manuals, and other submittals between Design-Builders for contract and code compliance. The Contractor shall maintain a log of all submittals.
- M. Identify problems encountered in accomplishing the construction work and recommend appropriate action to the Airport in order to resolve problems with a minimum effect on the timely completion of the Project.
- N. Provide all testing, including specialty testing, as required by the California Building Code and by Airport Commission. The Contractor shall coordinate and/or procure the services of certified testing laboratories to assure that the proper number and type of tests are being performed in a timely manner. The Airport building official has the authority to require additional testing based on final code requirements and interpretation.
- O. Maintain a log of any requests for information and manage responses for approval by the Airport Project Manager and/or the Engineer-of-Record.
- P. Review progress pay requests for accuracy and recommend approval. The Contractor shall prepare all supporting documentation for progress pay requests, including but

not limited to, certified payroll tracking forms. All payment documentation shall utilize Airport standard templates.

- Q. Review Builder reports, as-built drawings, and other construction documentation and ensure information is appropriately captured in Airport records.
- R. Coordinate job site meetings and prepare meeting minutes. The Contractor shall review and communicate information presented to Airport managers and all attendees.
- S. Assist Airport with compliance of all contract terms and conditions including, but not limited to, Contract Monitoring Division (CMD) requirements, certified payroll, labor standards, drug policy, security requirements, site cleanliness, and safety.
- T. Administer the evaluation and negotiation of change orders, prepare and process change orders and contract modifications for Airport approval, and maintain a change log. All change documentation shall utilize Airport standard templates.
- U. Coordinate with the Program Sustainability Manager for the review of the building contractor's submittals, RFIs and Change Orders for conformance with project sustainability and LEED requirements.
- V. Review and monitor the Design-Builder's LEED certification process
- W. Coordinate with the Airport's sustainability Commissioning Authority, the Design-Builder and the Airport to verify that the Sustainability Commissioning Plan is being implemented and that any outstanding commissioning items are implemented.
- X. Manage and coordinate all BHS construction documents to ensure compliance with the Transportation Security Administration (TSA) Planning Guidelines Design Standards (PGDS).
- Y. Support the management and coordination of all supporting documents needed to ensure compliance with the existing Design and Construction Other Transaction Agreement (OTA) between the TSA and Airport.

1.5 ACTIVATION PHASE

The building activation process is intended to ensure that all requirements and performance criteria are identified early in the design process, are managed throughout the Project, and are successfully implemented. Activation includes physical testing of the facility and hands-on training of personnel who will use, operate and maintain the facility and its systems. As part of the Activation Phase, the Contractor shall:

- 1.5.1 Assemble the Activation SETs to facilitate and coordinate the activation activities prior to the completion of construction.
- 1.5.2 Through the SEP, develop and schedule an Activation Plan, including Simulation Plans as required.

- 1.5.3 Manage activation activities and prepare written status reports. Status reports shall verify that the facility and all of its systems and assemblies are constructed, installed, tested, operated and maintained to meet the Project's requirements.
- 1.5.4 Coordinate the various entities required to successfully implement the Activation Plan including representatives from the Airport, airlines, SETs, TSA, Architects, Builder, etc.

1.6 COMMISSIONING PHASE

Commissioning is the process of verifying and documenting that a building and all its systems and assemblies are planned, designed, installed, tested, operated, and maintained to meet the airport's Project requirements. This process uses planning, documentation, and verification of testing to review and oversee the activities of the Architect and the Builder. Commissioning services will start in Programming and will continue through Closeout.

- 1.6.1 This project requires two forms of commissioning:
 - A. Airport Commissioning of the numerous building systems
 - B. Sustainability Commissioning in accordance with the LEED v4 and California Building Code Title 24 requirements for Building Commissioning (Cx) and Building Envelope Commissioning (BECx) (Note: BECx is also called Building Enclosure Commissioning).
- 1.6.2 As part of the Commissioning Phase, the Contractor shall:
 - A. Coordinate with the Airport's Commissioning Authority, Airport's sustainability Commissioning Authority, the Design-Builder and the Airport to verify that the Commission Authority's Commissioning Plan is being implemented and that any outstanding commissioning items are implemented.
 - B. Coordinate and conduct final inspections prior to Project acceptance, and administer acceptance procedures and tests for each phase of the Project.
 - C. Review and report on progress of the Design-Builder regarding testing procedures and documentation as identified in the Master Test Plan as it pertains to technology infrastructure.
 - D. Review and report on progress of training for operation and maintenance of new systems as required by the Airport and/or individual Project specifications.
 - E. Provide support for move-in from existing facilities to the newly constructed facilities.
 - F. Coordinate and conduct final inspections on the BHS to ensure all TSA reports have been approved and work meets all the TSA requirements for commissioning/certification.

1.7 CLOSEOUT PHASE

Closeout will commence at the completion of Activation and the performance based Commissioning. As part of the Closeout Phase, the Contractor shall:

- 1.7.1 Support closeout activities for all associated Project contracts including but not limited to: ensuring compliance is adhered through contract closeout and the existing BHS OTA's between the TSA and Airport are properly closed out. All procedures and documentation shall utilize Airport standards for the closeout process.
- 1.7.2 Confirm that the Design-Builder has completed their LEED certification requirements and have submitted a sustainability report to the Airport.
- 1.7.3 Review the completed construction project for compliance with Sustainability and Building Codes, per the approved construction documents.
- 1.7.4 Support dispute and/or claim resolution analysis and reconciliation efforts.

2. OVERALL PROJECT MANAGEMENT SUPPORT SERVICES:

2.1 PROJECT CONTROLS AND REPORTING

The Contractor shall:

- 2.1.1 Utilize a project control system(s) as required by the Airport.
- 2.1.2 Utilize systems that are compatible with current Airport project control software. These include, but not to be limited to, Primavera P6 EPPM (scheduling), CIP Planner (project financial planning), OpenText eDocs (document control), Turner E.Docs (close-out documentation), Microsoft Outlook (email), AutoCAD, and Revit.
- 2.1.3 Perform data entry into the project control system to ensure that real-time data is readily available. The Contractor shall perform quality control to reduce input error.
- 2.1.4 Review progress pay requests for accuracy and recommend approval. The Contractor shall prepare all supporting documentation for progress pay requests, including but not limited to, certified payroll tracking forms utilizing Airport standard templates. Further, the Contractor shall work with the Airport to ensure proper supporting documents for TSA reimbursement.
- 2.1.5 Produce reports and deliverables in electronic format to the greatest extent possible; however, at the request of the Airport, hard copy color duplicates shall also be made available. The reports and deliverables shall include, but are not limited to, the following:
 - A. Monthly safety report.
 - B. Monthly progress report to the Airport on services provided to the Airport under the Agreement in a format consistent with the Airport reporting process.
 - C. Cost and budget reports as part of the required monthly report in a format determined by the Airport to include total project budget amounts, total project cost to date, earned value estimates, trends and forecasts. Reports shall include costs and payments to Design-Builders, and Airport cost and expenses.

- D. Updated schedule by monitoring progress in relationship to the existing baseline schedules for the Program. Prepare detailed monthly schedule reports and schedule trend reports. Provide schedule recovery recommendations on a monthly basis.
 - E. Monthly cash flow and trend reports.
 - F. Report all potential project risks and issues. Provide cost recovery recommendations on a monthly basis.
 - G. Report on quality assurance and quality control processes and how these are being engaged on a monthly basis.
 - H. If requested, the Contractor shall prepare other reports so that varying levels of details can be communicated to different management levels within the Airport organization as well as to the Public.
- 2.1.6 Support the Airport in the production of reports and deliverables that meet Transportation Security Administration (TSA) requirements. Reports and deliverables shall be in electronic format to the greatest extent possible; however, at the request of the TSA and/or Airport, hard copy color duplicates shall also be made available. The reports and deliverables shall include, but are not limited to, the following:
- A. Monthly status reports to the TSA.
 - B. Monthly schedule updates to the TSA in Microsoft Project.
 - C. Assist Airport in reimbursement requests to the TSA.

2.2 PROJECT SCHEDULING SERVICES

The Contractor shall be prepared to support Airport project scheduling and analyses in the following manner:

- 2.2.1 Compile and validate applicable schedules from Airport staff, Design-Builders, and other agencies to prepare a master schedule for the Project. The master schedule will follow a work breakdown structure as directed by the Airport and shall include, at a minimum, the following activities: duration and timing for permitting, timing to conduct design, solicit proposers, solicit trade bid packages, complete construction, testing and commissioning and closeout of the Project.
- 2.2.2 Review, report, verify, and validate Level 1, 2 and 3 Project schedules as requested, as well as a two-week look ahead, prepared by the Architect and Builder.
 - A. The Level 1, or Contract Master Schedule, is a summary level schedule that establishes key completion objectives for the Project. It defines the overall period of performance, shows major milestones, including contractual milestones, deliveries, and other major project phases. It may also show milestones that interface with other projects within the Program or adjoining projects.

- B. The Level 2, or Intermediate Schedule, should contain a detailed reflection of the activities that must be accomplished to achieve Level 1 schedule objectives. In addition, a Level 2 schedule shall include, but is not limited to, contractually required deliveries of critical long lead items, hardware, software, and performance requirements.
 - C. The Level 3, or Detailed Schedule, contains a detailed set of activities that must be accomplished to achieve Level 2 schedule objectives. This schedule should contain enough detail for the Airport Project Manager to plan, direct, and monitor the completion of work and to reliably calculate the Project's critical path. The Level 3 schedule shall reflect the Contractor's review and monitoring of construction schedules and the coordination of those schedules with other Airport projects, including but not limited to, other projects within the Program, either planned or ongoing.
- 2.2.3 Identify and analyze dependencies, controls, and interfaces among utility projects, with other airport operational activities, and/or with external projects and perform alternative analysis project sequence to optimize Project implementation within the Level 3 schedule.
 - 2.2.4 Develop, review, update, and monitor project schedules to the required management level during all Project phases as directed by the Airport Project Manager.
 - 2.2.5 Develop, review, update and monitor the TSA procurement and testing schedules with the local TSA Site Lead during all Project phases and as directed by the Airport Project Manager.

2.3 PROJECT BUDGET AND ESTIMATING SERVICES

The Contractor shall support Airport financial analyses by performing the following not less frequently than on a weekly basis:

- 2.3.1 In accordance with the Airport's Work Breakdown Structure, prepare and review Project hard and soft cost budget estimates, resulting in the establishment of the Project baseline budget.
- 2.3.2 Analyze financial consequences of design alternatives, alternatives resulting from value engineering reviews of design and construction techniques, and costs due to site and schedule constraints.
- 2.3.3 Utilizing cost management system (s) provided by the Airport, provide project level cost and trend management services. Include pre-construction, concept, budgetary, design, construction, and engineer's estimates.
- 2.3.4 Establish, review, and support Airport staff in making appropriate budgetary contingencies and reviewing Project risks.
- 2.3.5 Provide budget and funding report services, documenting sources of funds and cash flow projections for the Project.

- 2.3.6 Develop and maintain procedures to forecast Project costs and advise the Airport on corrective actions if forecasted budgets are to be exceeded.
- 2.3.7 Reconcile the Project scope with appropriated budgets.
- 2.3.8 Prepare Current Work Estimates (CWE) of the design and construction costs for the TSA. Ensure all funds allowable and allocable to be TSA funded are tracked and clearly discernible for the Airport to seek reimbursement in a timely and efficient manner.

2.4 DOCUMENT CONTROL SERVICES

The Contractor shall:

- 2.4.1 Maintain all the Project documentation in an integrated, accessible electronic format with a hard copy stored in a retrievable system as directed by the Airport.
- 2.4.2 Maintain status logs of Project documents such as design activities and status, requests for information, submittals, substitution requests, etc.
- 2.4.3 Develop and maintain systems for the efficient distribution of Project documents to Design-Builders, external agencies, City departments, and other stakeholders.

2.5 SFO STRATEGIC PLAN 2011-2016

The Contractor shall adhere to guidelines in the SFO Strategic Plan, which is provided in Appendix C of this Agreement.

2.6 REACH

The Contractor shall adhere to the Principles of REACH, which can be found at <http://www.flysfo.com/business-at-sfo>.

2.7 PARTNERING GUIDELINES

The Contractor shall participate in and provide for formal Partnering facilitation. Refer to www.sfoconstruction.com and Appendix D for partnering requirements.

2.8 STAKEHOLDER ENGAGEMENT PROCESS

The Contractor shall provide for, coordinate, participate in and document the Stakeholder Engagement Process (SEP) and utilize Stakeholder Engagement Groups and Subgroups (SEP Groups and Subgroups) throughout the Project lifecycle. Refer to www.sfoconstruction.com

2.9 SUSTAINABILITY PRINCIPLES

The Contractor shall provide the following to support the sustainability services:

- 2.9.1 Assist the Program Sustainability Manager in the review of the Design-Builder's design and construction documents, and construction work. Assist in confirming and verifying that the Design-Builder's work conforms to the Airport's sustainability requirements and codes, as defined in the project programming phase.

- 2.9.2 Provide oversight assistance of the LEED certification process. The Design-Builder will be responsible for obtaining the LEED-NC v4 minimum Gold certification for the project.
- 2.9.3 Provide oversight of the Sustainability Commissioning Process for the project. Coordinate and incorporate the Sustainability Commissioning activities that include Building Commissioning (Cx) and Building Envelope Commissioning (BECx) as required by LEED v4. The Airport will provide the services of a Commissioning Authority who will provide complete sustainability commissioning process services.

2.10 PROJECT COORDINATION

The Contractor shall provide the following project coordination services:

- 2.10.1 Assist Airport staff with Project coordination and development efforts with Airport operations, airlines, agencies, SETs and other stakeholders, as required and directed by the Airport.
- 2.10.2 Coordinate Project work with all ongoing Airport activities, including but not limited, to concurrent T1 Program, Runway Safety Area (RSA), and other adjacent or coordinated projects.
- 2.10.3 Assist with the establishment, implementation, and modification of Project administrative procedures.
- 2.10.4 Implement and support an Action Item system to track key Project activities.
- 2.10.5 Develop and monitor a Risk Register to identify, track and respond to Project risk.
- 2.10.6 Coordinate and document stakeholder programming and design review input.
- 2.10.7 Coordinate, lead, and document appropriate weekly Project meetings throughout each phase of the Project lifecycle.
- 2.10.8 Assist Airport staff with identifying and coordinating Airport and tenant utility infrastructure documentation.
- 2.10.9 Assist Airport staff with any security systems and equipment coordination.
- 2.10.10 Assist Airport staff with maintaining active terminal, airfield and landside security and operations, phasing, environmental issues, off-hours work, utility cutovers and associated activities.
- 2.10.11 Coordinate any hazardous material survey, reporting and abatements work to ensure Airport compliance with appropriate entities.
- 2.10.12 Assist Airport staff with the San Francisco Arts Commission Civic Design Review and Arts Enrichment processes, as appropriate to the size and scope of this Project.

2.11 INTEGRATED RESOURCE TEAMS

The Terminal 1 Program requires close coordination and cooperation from all Program parties, including the Contractor and the PMSS team for the Terminal 1 Center Renovation (T1C) Project, ACJV, under Contract 10011.41. To support this concept, all parties have agreed to establish the following integrated resource teams to support BAB and T1C Projects, which also includes Contract 10012.66, Design Build Baggage Handling System Project (BHS).

In addition to the below mutually agreed-upon integrated resource teams, the Airport reserves the right to create additional integrated resource team(s) from among the BAB and T1C PMSS Contractors for any or all PMSS work elements related to either BAB, T1C or BHS Projects. The BAB and T1C PMSS Contractors agree to work in a cooperative and highly collaborative manner to provide the Airport Commission an integrated PMSS team, as may be requested.

By mutual agreement, all parties have agreed to establish the following integrated resource teams:

Stakeholder Engagement Process (SEP)/Design Manager:

Team Leader: T1 Cubed - a Joint Venture

Support: ACJV

Project Controls:

Team Leader: ACJV

Support: T1 Cubed - a Joint Venture

Baggage Handling Systems:

Team Leader: T1 Cubed - a Joint Venture

Support: ACJV

Special Systems:

Team Leader: ACJV

Support: T1 Cubed - a Joint Venture

Construction Management:

Team Leader: ACJV

Support: T1 Cubed - a Joint Venture

END OF APPENDIX A



APPENDIX B CALCULATION OF CHARGES

This is Appendix B attached to, and incorporated by reference in the Agreement made on **January 20, 2015** between the City and County of San Francisco, acting by and through its Airport Commission (Commission), and **T1 Cubed - a Joint Venture** (Contractor) providing for Project Management Support Services for New Boarding Area B Project at the San Francisco International Airport.

1. GENERAL

- 1.1 Compensation for complete and satisfactory performance of the services detailed in Appendix A of this Agreement is set forth in paragraph 5 "Compensation" of the Agreement.
- 1.2 No charges shall be incurred under this Agreement nor shall any payments become due to Contractor until reports, services, or both required under this Agreement are received from Contractor and approved by the Commission as being in accordance with this Agreement. In no event shall the Commission be liable for interest or late charges for any late payments.
- 1.3 Compensation for work performed under this Agreement will be on a time and materials basis and lump sum (if approved by the Airport Project Manager). Such compensation shall be allowable only to the extent that costs incurred, or otherwise established prices, are consistent with the Federal Cost Principles (Title 48, Code of Federal Regulations, Part 31).
- 1.4 A lump sum allowance in the amount of **Two Hundred Twenty-Five Thousand Dollars (\$225,000)** for mobilization costs has been included in the not-to-exceed amount of **\$4,300,000** for the first year of services.

2. METHOD OF PAYMENT

- 2.1 Unless approved otherwise by the Commission, Contractor's services shall be invoiced on a monthly basis and payment will be made within thirty (30) days of receipt of an acceptable invoice with satisfactory backup documentation, approved by the Airport Project Manager. As used herein, the term "invoice" shall include Contractor's bill or written request for payment under this Agreement for services performed. All invoices shall be made in writing.
- 2.2 Contractor shall invoice for the Work performed in conformance with procedures approved by the Commission.
 - 2.2.1 Such invoices shall segregate current costs from previously invoiced costs.
 - 2.2.2 Costs for individual labor shall be segregated by task and subtasks, if any.

- 2.2.3 Notwithstanding the above, in no case shall Contractor invoice include costs which Airport has disallowed or otherwise indicated that it will not recognize.
- 2.2.4 For professional services contracts, if applicable, each invoice shall clearly distinguish Contractor staff that is invoiced at the home office rate versus the field office rate. See paragraph 4.1 below for rate definitions.
- 2.3 Such invoices shall be as a minimum, (i) mechanically accurate, (ii) substantially vouchered and properly supported and (iii) in compliance with generally accepted accounting principles.
- 2.4 Contractor shall also certify, for each invoice, that (i) the hourly rates for direct labor, whether for Contractor or its subcontractor(s), to be reimbursed under this Agreement are not in excess of the actual hourly rates in effect for Contractor or subcontractor employees engaged in the performance of services under this Agreement at that time, and (ii) that such hourly rates are in conformance with the Agreement.
- 2.5 The fee for Contractor or any of its subcontractors shall be billed monthly on all direct labor and indirect costs for services provided in the current invoice at the percentage described in paragraph 5 below.
- 2.6 The Airport's Project Manager reserves the right to withhold payment(s) otherwise due Contractor in the event of Contractor's material non-compliance with any of the provisions of this Agreement, including, but not limited to, the requirements imposed upon Contractor in Article 15, Insurance, and Article 16, Indemnification. The Airport shall provide notice of withholding, and may continue the withholding until Contractor has provided evidence of compliance which is acceptable to the Airport.
- 2.7 All invoices shall be made in writing and delivered or mailed to the Airport as follows:

By US mail: Kristin Allen
Airport Project Manager
Design and Construction
Airport Commission Building
San Francisco International Airport
P.O. Box 8097
San Francisco, CA 94128

By Personal Delivery
or Express Mail: Kristin Allen
Airport Project Manager
Design and Construction
San Francisco International Airport
710 N. McDonnell Road, 2nd Floor
San Francisco, CA 94128

3. DIRECT SALARY RATE AND DIRECT SALARY RATE ADJUSTMENT

- 3.1 Salaried personnel shall be paid on a maximum of forty (40) hours per week, with no overtime. Salaried personnel assigned to multiple Projects shall be paid on a pro-rata share of a forty (40)-hour week. Signed time cards shall be provided showing all assigned Projects and the shared calculation.

- 3.2 The approved direct labor rates stated in the Agreement shall remain in effect for the first (1st) year of contract services. As, at the option of the Airport, this is a multi-year contract, the Airport may approve an annual adjustment to the direct hourly labor rates effective July 1st, based on an increase in the Consumer Price Index for the preceding twelve (12) months for the San Francisco Bay Area as published by the U.S. Department of Labor, Bureau of Labor Statistics, under the title of: "Services Less Rent or Shelter – All Urban Consumers – San Francisco/Oakland/San Jose, California" or on an increase in the wages of comparable classifications as reflected in the collective bargaining agreements between the City and County of San Francisco and the labor organization representing those classifications, whichever is lower. Such adjustment is subject to prior written approval by the Airport and in no event will exceed the lower of the above specified indices unless the proposed adjustment is made pursuant to other specific terms of this contract or is necessary to meet the requirements of prevailing or minimum wage legislative mandates.

4. BILLING RATES

- 4.1 Billing rates and overhead rates shall be used for reimbursement of the cost portion of this Agreement. Billing rates shall be the sum of approved hourly base rates as set forth in paragraph 7 below plus indirect cost. Indirect cost rates are as follows:

FIRM	HOME OFFICE OVERHEAD RATE	FIELD OFFICE OVERHEAD RATE
Parsons Brinckerhoff	153.10%	111.20%
AGS, Inc.	165%	135%
CAGE, Inc.	138%	138%
CM Pros	160%	133.20%
Faithful + Gould	129.7%	125%
Joseph Chow & Associates	160%	150%
NBA Engineering, Inc.	169%	167.50%
RES Engineers, Inc.	150%	150%
Meridian Surveying Engineering, Inc.	160%	135%
Bay Area Consulting Engineers, Inc.	190%	125%
Yolanda's Construction Administration & Traffic Control, Inc.	137%	125%
BLC Partners	190%	135%
Ambient Energy	229%	209%

- 4.2 Whenever possible, billing rates shall be established for home office work using a home office indirect cost rate and field office work using a field office indirect cost rate. The home office indirect cost rate shall be used when staff works in an office provided by Contractor. The field office indirect cost rate shall be used when staff is assigned full time to an office provided by the Commission.
- 4.3 To qualify for the field office indirect cost rate the Commission shall provide utilities, telephone service, internet access, and computers.
- 4.4 Calculation and documentation of the indirect cost rate, home and/or field office, shall be provided to the Commission for review and approval prior to Contract award.

5. **FEE**

The Fee for Contractor's work effort shall be **ten percent (10%)** of direct labor of Contractor. The cumulative fee of all subcontractors at any tier shall not exceed ten percent (10%) of the total direct labor of all subcontractors at any tier. There shall be no additional fee markup on indirect costs of Contractor or any subcontractor at any tier.

The Prime Contractor or Joint Venture will be allowed a **two percent (2%)** mark-up on first tier subcontractor invoices.

6. **OTHER DIRECT COST (ODC)**

6.1 Unless authorized by the Airport, the Airport will not reimburse Contractor for the costs of business travel, contractor meals, and accommodations, this includes specialists that are based out of town and not assigned to the jobsite office. Travel and per diem expenses for the project team's management, jobsite personnel, or staff that commute to or from other offices or residences is not allowed. The Airport will not reimburse Contractor for deliveries, and fax, long distance, and cellular telephone charges. Regional (remote) executive's travel expenses to visit the local job office are not reimbursable and part-time jobsite personnel who are shared with other out-of-town clients are not reimbursed for travel expenses. When authorized, travel expenses shall be in accordance with the City & County of San Francisco Travel Guidelines.

6.2 Any ODC expenses in excess of \$500 shall be pre-approved by the Airport Project Manager.

7. **THE APPROVED DIRECT BASE LABOR RATES ARE AS FOLLOWS:**

CLASSIFICATION	RANGE OF RATES
PARSONS BRINCKERHOFF	
Project Manager/Construction Manager	\$90.00 - \$98.00
QA/QC Manager	\$75.00 - \$85.00
Safety Manager	\$70.00 - \$85.00
Lead Package Manager	\$70.00 - \$85.00
Airside Manager	\$70.00 - \$80.00
Contracts/Change Control	\$60.00 - \$75.00
Utilities Package Manager	\$60.00 - \$75.00
BIM/GIS/Modeling	\$57.00 - \$75.00
Senior Office Engineer	\$55.00 - \$75.00
Office Engineer	\$30.00 - \$55.00
AGS, INC.	
Concurrent Project Facilitator	\$75.00 - \$90.00
Design Manager	\$75.00 - \$90.00
Building Systems Manager	\$75.00 - \$80.00
Demo Package Manager	\$62.50 - \$75.00
Arch/Shell Package Manager	\$62.00 - \$75.00
Package Manager	\$62.00 - \$80.00
Inspectors/Res	\$45.00 - \$70.00
Office Engineer	\$30.00 - \$55.00
AMBIENT ENERGY	
Commissioning Manager	\$45.00 - \$52.00
LEED/Enviro.	\$29.00 - \$34.00

BAC ENGINEERING	
Electrical Engineer	\$55.00 - \$65.00
BLC PARTNERS	
Security Special Systems	\$58.00 - \$65.00
Special Systems/IT Support	\$58.00 - \$65.00
CAGE	
BHS Construction Package Manager	\$65.00 - \$70.00
CMPROS	
Stakeholder Engagement Manager	\$65.00 - \$85.00
Cost Estimating	\$60.00 - \$75.00
Scheduling	\$60.00 - \$75.00
FAITHFUL & GOULD	
Conveyance Design Manager	\$80.00 - \$85.00
Loading Bridge Manager	\$65.00 - \$80.00
Project Controls Manager	\$60.00 - \$85.00
JOSEPH CHOW & ASSOCIATES	
Concessions Development	\$60.00 - \$79.00
MERIDIAN SURVEYING ENGINEERING, INC.	
Surveying	\$40.00 - \$70.00
NBA ENGINEERING, INC.	
Mech/Plumbing/Bldg. Sys	\$70.00 - \$80.00
RES ENGINEERS, INC.	
Materials Testing	\$90.00
YOLANDA'S CONSTRUCTION ADMINISTRATION & TRAFFIC CONTROL, INC.	
Document Controls	\$30.00 - \$50.00
Office Administration	\$30.00 - \$50.00

END OF APPENDIX B



APPENDIX C

STRATEGIC PLAN 2011-2016

SFO



Strategic Plan 2011-2016

SAN FRANCISCO INTERNATIONAL AIRPORT

A Message from the Director



I AM PLEASED TO PRESENT SAN FRANCISCO INTERNATIONAL AIRPORT'S NEW FIVE-YEAR STRATEGIC PLAN, ALONG WITH THE CORE VALUES AND PHILOSOPHIES THAT WILL GUIDE US IN THE YEARS AHEAD. OUR PRINCIPAL PURPOSE, WHICH WE REFER TO AS OUR MISSION, IS "TO PROVIDE AN EXCEPTIONAL AIRPORT IN SERVICE TO OUR COMMUNITIES." OUR OVERALL ASPIRATION FOR THE FUTURE, OUR VISION, IS "REACHING FOR #1."

The highest overall goals in our five-year plan are to be the top-rated airport among passengers, and to be one of the Bay Area's best places to work. Six other overall goals, each with supporting objectives and strategic initiatives, are presented in this document. Many of the strategic initiatives are based on recommendations made by 23 "Reaching for #1" Task Forces that were comprised of cross-organizational representatives, and who worked with the guidance of three steering committees for eight months' time. Of the 216 Task Force recommendations, 207 have been adopted and will become part of the SFO five-year plan and/or the various divisions' operating plans. All of the Task Force recommendations and decisions made about their

adoption and implementation are available on www.sfoconnect.com, our employee-based website.

I am proud of the excellent work by employees that went into the development of SFO's five-year objectives and strategic plan, and I am confident that together we will fulfill our new mission and vision, and meet our objectives and thus become an even more exceptional airport in service to our communities.

A handwritten signature in black ink, appearing to read "John L. Martin". The signature is stylized and written in a cursive-like font.

JOHN L. MARTIN,
AIRPORT DIRECTOR

REACHING FOR
Number



EDWIN M. LEE, Mayor, City and County of San Francisco

SAN FRANCISCO AIRPORT COMMISSION

LARRY MAZZOLA, President

LINDA S. CRAYTON, Vice President

ELEANOR JOHNS

RICHARD J. GUGGENHIME

PETER A. STERN

JOHN L. MARTIN, Airport Director

Mission, vision, overall goals, core values

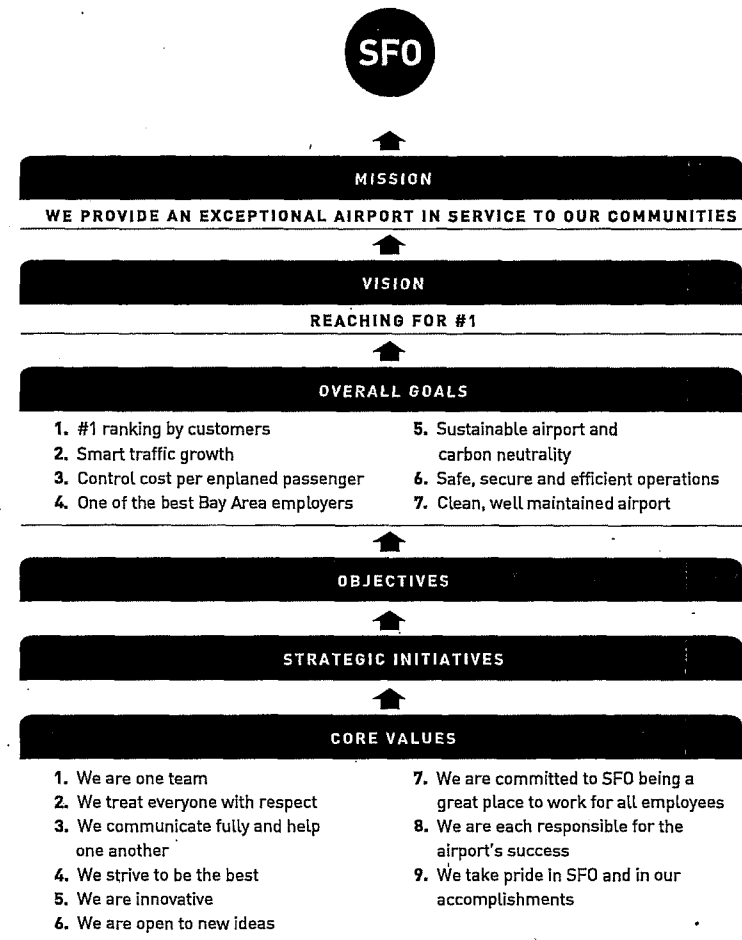

Objectives

THE AIRPORT HAS ESTABLISHED 30 KEY OBJECTIVES, LISTED BELOW IN ONE OF THE FOLLOWING OVERALL CATEGORIES

SAN FRANCISCO INTERNATIONAL			
CUSTOMERS/ PASSENGERS	AIRLINES / AIRCRAFT / ROUTES	NON-AIRLINE REVENUE	EMPLOYEES AND ORGANIZATION
<p>1. Be ranked #1 by passengers in the following categories:</p> <ul style="list-style-type: none"> U.S. International Gateway airport in customer satisfaction by ACI-ASQ survey. U.S. International Airport in customer satisfaction for overseas travelers by Skytrax survey. <p>2. Be considered a world-class airport by customers.</p> <p>3. Be nimble about meeting passenger demands and needs for services.</p> <p>4. Be the airport of choice for premium passengers.</p> <p>5. Have the most efficient airport ground transportation system in the country.</p>	<p>1. Ensure SFO can meet passenger traffic growth in the next five years and improve airlines' on time arrival performance to 75%.</p> <p>2. Ensure competitive air service.</p> <p>3. Increase current international passenger traffic by 30% in five years.</p> <p>4. Maintain average CPE below \$18.90 in constant FY07-08 dollars in order to maintain and attract airline service.</p>	<p>1. As part of maintaining average CPE below \$18.90, achieve non-airline revenues below:</p> <p>2011 / 2012 \$358 M 2012 / 2013 \$375 M 2013 / 2014 \$387 M 2014 / 2015 \$396 M 2015 / 2016 \$403 M</p> <p>2. Increase per passenger spending annually as follows:</p> <p>Food&Beverage: 2.5% Retail: 3.0% Duty Free: 3.5%</p>	<p>1. Be ranked one of the Bay Area's best employers in SF Business Times' annual list.</p> <p>2. Be known for innovation, expertise, and management excellence in the aviation industry.</p>

AIRPORT FIVE-YEAR OBJECTIVES			
ENVIRONMENTAL SUSTAINABILITY	SAFETY / SECURITY	INFRASTRUCTURE	EXTERNAL RELATIONS
<p>1. Be one of the first airports to achieve carbon neutrality by 2012 and maintain it thereafter.</p> <p>2. Achieve 50% reduction in baseline GHG emissions from SFO – controlled operations by 2015.</p> <p>3. Increase the solid waste recycling rate to 80% (GHG mitigation).</p> <p>4. We will achieve LEED gold in all new buildings.</p>	<p>1. To be an airport innovative leader in safety & security and implement at least two new industry-leading security programs in the next five years.</p> <p>2. Maintain SFO's airfield in as safe as possible condition through the use of technology, procedures, inspections and continual evaluation of airfield best practices.</p> <p>3. Be the least vulnerable U.S. airport to terrorist activity and possess the best integrated response capability.</p> <p>4. Coordinate the sharing of information and planning among all federal and local law enforcement agencies to ensure all the dots are continually connected.</p>	<p>1. As part of maintaining average CPE below \$18.90, invest in capital projects strategically.</p> <p>2. Minimize overall life cycle costs of facilities.</p> <p>3. Maintain the airport's infrastructure in optimal condition.</p> <p>4. Continue to invest in capital projects that make the airport environmentally sustainable.</p> <p>5. Implement projects that will generate net revenue to the extent possible, while meeting the airport's mission.</p>	<p>1. Support awareness among government entities of SFO as a successful enterprise, that is well managed and a valuable asset to San Francisco and the Bay Area communities.</p> <p>2. Develop and maintain productive relationships with government agencies and local cities and counties.</p> <p>3. Increase local business participation with SFO.</p> <p>4. Develop and maintain a model employment development program for the benefit of the communities that SFO serves.</p>

Customers and passengers

San Francisco International Airport has set a goal of being the #1-ranked airport among U.S. international gateway airports in customer satisfaction. For overseas travelers, our goal is to achieve this ranking by 2012 via the Skytrax International Survey. For North American travelers, our goal is achievement by 2016, via the ACI-ASQ survey.

We have identified the other U.S. international gateway airports as those serving the cities of Boston, New York, Newark, Washington D.C., Atlanta, Chicago, Miami, Houston, Dallas and Los Angeles.

OBJECTIVE I: BE RANKED #1 BY PASSENGERS IN THE FOLLOWING CATEGORIES:

- U.S. international gateway airport for customer satisfaction by ACI-ASQ survey
- U.S. international airport in customer satisfaction for overseas travelers by Skytrax survey

STRATEGIC INITIATIVES TO ACHIEVE OBJECTIVE I	
STRATEGIC INITIATIVES	LEAD DIVISION(S)
1. Provide an attractive, modern, inviting, efficient and comfortable airport with world-class services and amenities and service-oriented staff.	Chief Operating Officer
2. Enhance way-finding and other signage by engaging an industry consultant to complete a program review by the end of 2011.	Operations
3. Work closely with U.S. Customs and Border Protection, TSA and Covenant Aviation to remedy security line delays and to ensure that line wait times are predictable and shorter than U.S. lines on average.	Operations
4. Work closely with TSA to provide more space and lighting at checkpoints and to improve overall ambience.	Chief Operating Officer, Bureau of Design & Construction, Operations
5. Further work with TSA to ensure checkpoint staff is friendly and courteous.	Operations & Marketing & Communications

OBJECTIVE II: CUSTOMERS WILL CONSIDER SFO FACILITIES AND SERVICES WORLD CLASS

STRATEGIC INITIATIVES TO ACHIEVE OBJECTIVE II	
STRATEGIC INITIATIVES	LEAD DIVISION(S)
1. By 2012, develop a plan for Secure Connector from International Terminal Boarding Area A to T-1 and onto T-2.	Bureau of Design & Construction
2. By 2012, establish a schedule and program to build a new Boarding Area B.	Bureau of Design & Construction
3. Provide world class quality facilities (including restrooms).	Bureau of Design & Construction
4. Develop a program and Ground Transportation Plan by 2012 to reduce curbside congestion. Evaluate the following: <ul style="list-style-type: none"> • Commercial Ground Transportation Center • Roadway level assignments • Promotion of High Speed Rail long-term (2020 and beyond). 	Operations
5. Develop by 2011 and begin to implement by 2012 a program to expand information accessibility, the number of Ambassadors, and foreign language services.	Marketing & Communications
6. By 2012, implement a customer Technology Enhancement Program which would include the following: <ul style="list-style-type: none"> • Fast, free, quality WiFi • Add rapid charging stations and power outlets throughout Airport. • Invest in common-use cabling structure to support electronic boarding passes and self-tagging of luggage. • Offer applications for mobile devices. • Enhance interactive website. 	Business & Finance
7. Add more post-security children's play areas by 2012.	Business & Finance Business & Finance (rapid charging stations) Facilities (Power Outlets) Administration Marketing & Communications Marketing & Communications Business & Finance

OBJECTIVE III: BE NIMBLE ABOUT MEETING PASSENGER DEMANDS AND NEEDS FOR SERVICES

STRATEGIC INITIATIVES TO ACHIEVE OBJECTIVE III	
STRATEGIC INITIATIVES	LEAD DIVISION(S)
1. By 2011, develop a program to significantly expand concessions in T-3.	Business & Finance
2. By 2013, develop a program for new and expanded concessions in the International Terminal.	Business & Finance
3. By 2012, evaluate viability of following new services: <ul style="list-style-type: none"> • Sleeping pods/hotel in T-3 • Airport Gas Station/Convenience Store • Airport Pet Motel 	Business & Finance
4. Offer a common-use baggage re-check counter in the International Terminal.	Marketing & Communications
5. Enhance post-security museum displays.	Museums
6. Improve customer service and overall customer experience by instituting customer service level agreements for vendors and tenants.	Marketing & Communications and Business & Finance
7. Provide work areas and work stations for business travelers.	Facilities and Business & Finance
8. Develop a program by 2012 to provide information, hotlines, and targeted services for passengers who have significant delays.	Marketing & Communications

OBJECTIVE IV: SFO WILL BE THE AIRPORT OF CHOICE FOR PREMIUM PASSENGERS

STRATEGIC INITIATIVES TO ACHIEVE OBJECTIVE IV	
STRATEGIC INITIATIVES	LEAD DIVISION(S)
1. Develop program by 2012 to ensure adequacy of space for airlines to open new clubs and to expand existing clubs.	Business & Finance
2. Offer first-class/premium checkpoint lines in all terminals.	Operations
3. Offer full range of services desired by business travelers (for example, quality restaurants, work stations, free WiFi, short and predictable security lines, on-time flights).	Business & Finance
4. Expand and reconfigure T-3 checkpoints by 2014.	Bureau of Design & Construction

OBJECTIVE V: HAVE THE MOST EFFICIENT AIRPORT GROUND TRANSPORTATION SYSTEM IN THE COUNTRY

STRATEGIC INITIATIVES TO ACHIEVE OBJECTIVE V	
STRATEGIC INITIATIVES	LEAD DIVISION(S)
1. Increase airport transportation ridership* by 10 percent within 5 years *Airport transportation ridership will be defined as public transit (BART, Samtrans, Caltrain), shared ride, charters, hotel courtesy shuttle and scheduled airporter service. Currently airport transportation ridership is approximately 28 percent (12 percent transit and 16 percent other). The goal would be to obtain 31 percent ridership by 2015.	Operations, with Marketing & Communications
2. Create an environmentally sustainable system through the implementation of the airport's clean vehicle policy and other environmental initiatives.	Operations
3. Obtain 100 percent cost recovery by each mode within 5 years	Operations and Business & Finance
4. Develop a new ground transportation master plan	Operations

Airlines, aircrafts, routes

The Airport anticipates strong international growth in the next five years (estimated four percent to six percent) and modest domestic growth (slightly more than one percent). Elsewhere in the Bay Area, Oakland and San Jose airports should see domestic passenger growth as more East and South Bay residents use their closest airports for domestic travel. We will take a leadership role in supporting regional planning efforts to ensure the Bay Area's airports can meet passenger demands.

We will target new Asian and Middle East flights, especially China and India, which

are expected to experience the strongest global economic growth and which have strong ties to the Bay Area. Additionally, new flights serving Europe, South America and Australia/New Zealand will be important to our growth.

Recognizing that we have limited runway capacity, we will work to increase those flights that produce the greatest numbers of passengers – i.e. international, wide-body flights, and will implement NextGen FAA technology as it becomes available.

OBJECTIVE I: ENSURE SFO CAN MEET PASSENGER TRAFFIC GROWTH IN THE NEXT FIVE YEARS AND IMPROVE AIRLINES' ON TIME ARRIVAL PERFORMANCE TO 75 PERCENT

STRATEGIC INITIATIVES TO ACHIEVE OBJECTIVE I	
STRATEGIC INITIATIVES	LEAD DIVISION(S)
1. Support regional airport planning efforts and an approved new Regional Airport System Plan by 2012.	Planning
2. Manage growth to meet runway capacity	Planning and Business & Finance

OBJECTIVE I: CONTINUED

STRATEGIC INITIATIVES TO ACHIEVE OBJECTIVE I - CONTINUED	
STRATEGIC INITIATIVES	LEAD DIVISION(S)
3. Seek to reduce delays a) Work with FAA to install NextGen technology (ADSB with multi-lateration) by 2014.	Planning
b) Work with FAA to allow use of PRM/SQIA at ceiling levels down to 1,600 feet by 2011 (current limit is 2100 feet).	Planning
c) Engage FAA and airlines in discussions on delays with goal of improving airline scheduling (2011, and every two years thereafter).	Planning

OBJECTIVE II: ENSURE COMPETITIVE AIR SERVICE

STRATEGIC INITIATIVES TO ACHIEVE OBJECTIVE II	
STRATEGIC INITIATIVES	LEAD DIVISION(S)
1. Maintain at least 22 percent non-legacy carriers' market share.	Marketing & Communications
2. Encourage and support airline service and fare competition.	Marketing & Communications
3. Encourage airlines to provide high level of responsiveness to passengers when delays and cancellations occur.	Marketing & Communications
4. Within five years, commence work on a new air cargo facility to replace outdated cargo buildings; and refurbish existing cargo buildings to extend their useful lives and improve operating efficiencies.	Business & Finance
5. Maintain common-use operation and flexible leasing policies to make it easy for airlines to grow or for new entrant airlines to start service.	Business & Finance
6. Be committed to an open and level playing field for both existing and new airlines.	Business & Finance
7. Support airline alliances and passenger connectivity by supporting airlines to relocate adjacent to their alliance partners.	Business & Finance
8. By 2012, develop a plan for secure connector from T-1 and T-2 to the International Terminal Boarding Area A.	Bureau of Design & Construction

OBJECTIVE III: INCREASE CURRENT INTERNATIONAL PASSENGER TRAFFIC BY 30 PERCENT IN FIVE YEARS

STRATEGIC INITIATIVES TO ACHIEVE OBJECTIVE III	
STRATEGIC INITIATIVES	LEAD DIVISION(S)
1. Target new Asian and Middle East flight growth, achieving at least four (4) new daily Asian flights by 2015.	Marketing & Communications
2. Target China and India markets with at least two (2) new cities receiving service by 2013.	Marketing & Communications
3. Target new flights to/from Europe, South America, and Australia, with at least three (3) new daily flights by 2015.	Marketing & Communications
4. Promote SFO and SF to foreign visitors, in partnership with the SF Travel Association.	Marketing & Communications
5. Attract three (3) new daily flights to Mexico by 12/31/11.	Marketing & Communications

OBJECTIVE IV: MAINTAIN AVERAGE CPE BELOW \$18.90* IN ORDER TO MAINTAIN AND ATTRACT AIRLINE SERVICE

STRATEGIC INITIATIVES TO ACHIEVE OBJECTIVE IV	
STRATEGIC INITIATIVES	LEAD DIVISION(S)
1. Manage capital costs to the airport and airlines	Business & Finance
a) Invest strategically in projects	Business & Finance
b) Maximize our grants	Business & Finance
c) Be strategic about use of Passenger Facility Charges (PFCs)	Business & Finance
d) Achieve the highest appropriate bond rating to minimize the airport's borrowing costs.	Business & Finance
2. Control operating expenses	Business & Finance
3. Increase non-airline revenue	Business & Finance
4. Increase the number of international passengers	Marketing & Communications

* In constant FY 07-08 dollars.

Non-airline revenue

In order to remain competitive, maintain a suitable mix of airlines and to attract new air service, it is essential that we control our Costs Per Enplaned passenger (CPE) to airlines. It is a given in the airline industry that revenue yields and costs are key considerations by airlines in determining new and current markets.

CPE by nearly 40 percent. Since 2000, the airport has attracted a net gain of 16 new airlines, many of which are directly attributable to a lowered CPE.

Our challenge today is to control the CPE even as we make necessary capital improvements to the airport. We have set the CPE at an amount not to exceed \$18.90 in constant FY 07-08 dollars. A key component to meeting this goal is to increase non-airline revenues.

When SFO's International Terminal opened in 2000, our CPE increased to an all-time high. We reduced costs and increased non-airline revenue to successfully reduce the

OBJECTIVE I: AS PART OF MAINTAINING AVERAGE CPE BELOW \$18.90*, ACHIEVE NON-AIRLINE REVENUES BELOW:

OBJECTIVE I					
	FY 11 / 12	FY 12 / 13	FY 13 / 14	FY 14 / 15	FY 15 / 16
TOTAL (\$MILL):	\$ 357.7	\$ 374.6	\$ 386.7	\$ 395.6	\$ 402.8
INCREASE:	\$ 11.2	\$ 16.9	\$ 12.1	8.8 %	7.2 %
PERCENT:	3.2 %	4.7 %	3.2 %	2.3 %	1.8 %

* In constant FY 07-08 dollars.

OBJECTIVE II: INCREASE PER PASSENGER SPENDING ANNUALLY AS FOLLOWS:

OBJECTIVE II					
FOOD & BEVERAGE:	2.5 %	RETAIL:	3.0 %	DUTY FREE:	3.5 %

FOR THE FIRST YEAR:

STRATEGIC INITIATIVES TO ACHIEVE OBJECTIVES I & II	
STRATEGIC INITIATIVES	LEAD DIVISION(S)
1. Conduct a review of public parking rates to see what adjustments can be made to increase public parking revenue.	Business & Finance
2. Pursue non-traditional advertising mediums on a test basis; institute a new approval process for non-traditional revenue opportunities, and retain a consultant to advise on the installation of new dynamic concessions/promotional signage	Business & Finance
3. Develop an umbrella program for public information, including ways to improve way-finding and concession signage in an integrated manner.	Business & Finance Operations Marketing & Communications
4. Develop and lease 26,120 square feet of additional concession space; maximize certain storefronts, and commercially develop Boarding Area F Hub mezzanine space.	Business & Finance
5. Investigate the feasibility of creating a luxury pod hotel.	Business & Finance
6. Investigate realigning storefronts to improve visibility of concessions and flow of passengers to concessions, thus improving concession sales.	Business & Finance
7. Investigate facilitation of greater representation of small and local businesses in our concessions program.	Business & Finance
8. Develop an outreach plan to market vacant space to potential tenants such as airlines and other firms in the air travel industry.	Business & Finance

IN THREE YEARS:

STRATEGIC INITIATIVES TO ACHIEVE OBJECTIVES I & II	
STRATEGIC INITIATIVES	LEAD DIVISION(S)
1. Ensure a luxury pod-hotel is in place, if deemed feasible.	Business & Finance
2. Complete periodic reassessments of the viability of an on-airport hotel.	Business & Finance
3. Implement new, non-traditional advertising initiatives and new, dynamic concessions/promotional signage.	Business & Finance
4. Implement a gas station/fast food/convenience store, which is currently in the initial environmental review stage.	Business & Finance
5. Ensure the vast majority of vacant space is rented.	Business & Finance
6. Implement new concession opportunities identified in Year One, such as a pet-hotel and yoga/meditation center.	Business & Finance

IN FIVE YEARS:

STRATEGIC INITIATIVES TO ACHIEVE OBJECTIVES I & II	
STRATEGIC INITIATIVES	LEAD DIVISION(S)
1. Acquire land adjacent to SFO and pursue development for uses such as aviation support, cargo, and automobile parking.	Business & Finance

Employees and organization

SFO employees have demonstrated their pride in the Airport and in the services and amenities it provides to customers. For SFO to fulfill its mission and goals and to be prepared to respond effectively to any major challenges in the years ahead, it is our desire that all commission

employees be engaged, committed and energetic. In turn our management must be prepared to respond to the needs of employees and to increase workplace and training opportunities. Accordingly, two overarching objectives have been established:

OBJECTIVE I: TO BE RANKED ONE OF THE BAY AREA'S BEST EMPLOYERS IN S.F. BUSINESS TIMES' ANNUAL LIST

STRATEGIC INITIATIVES TO ACHIEVE OBJECTIVE I	
STRATEGIC INITIATIVES	LEAD DIVISION(S)
1. Increase career development opportunities.	Administration
2. Ensure regular acknowledgement and rewards for outstanding employee contributions.	Administration Marketing & Communications
3. Increase coaching and mentoring opportunities.	Administration
4. Make specific workplace enhancements.	Administration Facilities
5. Ensure inclusiveness and sociability.	Marketing & Communications

OBJECTIVE II: TO BE KNOWN FOR INNOVATION, EXPERTISE, AND MANAGEMENT EXCELLENCE IN THE AVIATION INDUSTRY

STRATEGIC INITIATIVES TO ACHIEVE OBJECTIVE II	
STRATEGIC INITIATIVES	LEAD DIVISION(S)
1. Increase formal and informal communications.	Marketing & Communications
2. Improve understanding of the entire Airport among all sections.	Marketing & Communications
3. Communicate shared Mission, Vision, Core Values, Five-Year Objectives and Strategic Plan.	Marketing & Communications
4. Encourage greater use of cross-organizational task forces, committees, forums, cohort groups.	Chief Operating Officer & Senior Staff
5. Provide greater opportunities for employees to contribute to the Airport beyond their designated roles.	Chief Operating Officer & Senior Staff
6. Ensure easier and more productive cross-organization interactions and collaboration.	Chief Operating Officer & Senior Staff
7. Provide leadership development opportunities.	Administration
8. Place emphasis on personal and organizational accountability.	Chief Operating Officer & Senior Staff

Environmental sustainability

We take our role seriously as a steward of the environment and we have been an airport industry leader in implementing new initiatives to reduce our carbon footprint. We desire to become one of the first airports in the world to achieve carbon neutrality without the use of carbon offset purchases.

We also intend to achieve a 50 percent reduction in green house gas (GHG) emissions from SFO-controlled operations by 2015 and to work with all stakeholders (tenants, vendors and permittees) to ensure environmental gains in all areas. We will seek to be a catalyst for change in stake-

holder practices by utilizing education, partnerships, financial incentives and new policy initiatives.

A sustainability committee will be charged with continuously exploring new options to ensure our leadership and continued progress. The committee will develop an established formula to gauge proposals' economic and environmental returns; will consider environmental minimum standards in Airport contracts and leases, and will work closely with the City's Department of the Environment, the Mayor's Office environmental staff and the PUC to identify energy saving opportunities.

OBJECTIVE I: BE ONE OF THE FIRST AIRPORTS TO ACHIEVE CARBON NEUTRALITY BY 2012 AND MAINTAIN IT THEREAFTER

STRATEGIC INITIATIVES TO ACHIEVE OBJECTIVE I	
STRATEGIC INITIATIVES	LEAD DIVISION(S)
1. Provide pre-conditioned air (PC Air) to Boarding Areas B and E.	Bureau of Design & Construction
2. Provide PC Air at T2.	Bureau of Design & Construction
3. Implement energy efficiency projects including replacing an existing inefficient boiler and chiller in the Central Plant.	Bureau of Design & Construction
4. Provide for enhanced recycling through the new solid waste management contract.	Bureau of Design & Construction

OBJECTIVE II: ACHIEVE 50 PERCENT (50%) REDUCTION IN BASELINE GHG EMISSIONS FROM SFO-CONTROLLED OPERATIONS BY 2015

STRATEGIC INITIATIVES TO ACHIEVE OBJECTIVE II	
STRATEGIC INITIATIVES	LEAD DIVISION(S)
1. Implement energy efficiency projects including replacing an existing inefficient boiler and chiller in the Central Plant Facilities.	Bureau of Design & Construction and Facilities
2. Complete the ongoing lighting efficiency projects.	Bureau of Design & Construction and Facilities
3. Implement other energy efficiency projects identified in the SFPUC audit.	Bureau of Design & Construction and Facilities
4. Implement natural gas efficiency projects.	Bureau of Design & Construction and Facilities
5. Replace aging fleet vehicles.	Facilities
6. Install additional solar panels.	Facilities
7. Require commercial ground transportation operators to comply with the airport's clean vehicle policy.	Operations

OBJECTIVE III: ACHIEVE INCREASE IN THE SOLID WASTE RECYCLING RATE TO 80 PERCENT (ADDITIONAL GHG MITIGATION OF 1,000 TONS PER YEAR). BDC/FACILITIES

STRATEGIC INITIATIVES TO ACHIEVE OBJECTIVE III	
STRATEGIC INITIATIVES	LEAD DIVISION(S)
1. Develop the new solid waste management contract to be issued in January 2011 with a minimum offsite recycling rate of 40 percent and with an annual increase of two percent in the amount of recycling occurring at the service provider's facility.	Bureau of Design & Construction and Facilities
1. Increase the source separation rate for paper, bottles, cans, metals, etc. at SFO by an additional five percent in the next five years.	Bureau of Design & Construction and Facilities

OBJECTIVE IV: ACHIEVE LEED GOLD CERTIFICATION IN ALL NEW BUILDINGS

STRATEGIC INITIATIVES TO ACHIEVE OBJECTIVE IV	
STRATEGIC INITIATIVES	LEAD DIVISION(S)
1. Revise the Airport design contract boilerplate to include the obligation for the architectural/engineering (A/E) firm to design all new buildings to achieve LEED Gold certification.	Bureau of Design & Construction and Facilities
2. Develop Airport design guidelines that provide direction to A/E firms on pursuing LEED certification points that take advantage of airport systems and policies.	Bureau of Design & Construction and Facilities
3. Aggressively pursue solar projects, which have a significant benefit in achieving LEED points.	Bureau of Design & Construction and Facilities
4. Explore the cost and feasibility for obtaining LEED O&M certification for the entire terminal complex and obtain the required certification if practical.	Bureau of Design & Construction and Facilities

Safety and security

The safety and security of SFO is a basic tenet in the Airport's doctrine. Passengers, airlines, tenants and employees depend on the Airport and international security systems to provide a safe and secure environment for aviation travel.

We are committed to meeting and exceeding all aviation safety and security

regulations. We set internal standards that exceed regulatory compliance and encourages teamwork among all security-related agencies. Through the use of advanced technology, implementation of best practices and expert outside evaluations, we are continually improving our safety and security profile.

OBJECTIVE I: TO BE AN INNOVATIVE LEADER IN AIRPORT SAFETY AND SECURITY, IMPLEMENTING AT LEAST TWO NEW INDUSTRY-LEADING SECURITY PROGRAMS IN THE NEXT FIVE YEARS

STRATEGIC INITIATIVES TO ACHIEVE OBJECTIVE I	
STRATEGIC INITIATIVES	LEAD DIVISION(S)
1. Remain aware of global best practices; seize industry leading and cutting edge opportunities after careful evaluation of prospective benefits, risks, and costs.	Operations
2. Pursue cutting edge passenger security checkpoint designs by expanding the T2 state-of-the-art checkpoint layout into T3 and T1.	Operations
3. Completion of key technology upgrade projects for the CCTV and Access Control Systems with deployment throughout all terminals.	Operations

OBJECTIVE II: MAINTAIN SFO'S AIRFIELD IN AS SAFE AS POSSIBLE CONDITION THROUGH THE USE OF TECHNOLOGY, PROCEDURES, INSPECTIONS AND CONTINUAL EVALUATION OF AIRFIELD BEST PRACTICES

STRATEGIC INITIATIVES TO ACHIEVE OBJECTIVE II	
STRATEGIC INITIATIVES	LEAD DIVISION(S)
1. Coordinate the FAA's installation and construction of a comprehensive Runway Status Light, Multilateration and Runway Safety Area systems for completion by 2015	Operations
2. Establish an improved wildlife management program; including the appointment of a dedicated wildlife control safety officer.	Operations
3. Adoption and use of a Safety Management System in planning for all airfield activities.	Operations

OBJECTIVE III: BE THE LEAST VULNERABLE U.S. AIRPORT TO TERRORIST ACTIVITY AND POSSESS THE BEST INTEGRATED RESPONSE CAPABILITY

STRATEGIC INITIATIVES TO ACHIEVE OBJECTIVE III	
STRATEGIC INITIATIVES	LEAD DIVISION(S)
1. Complete recommendations from the 2010 Airport Threat and Vulnerability Assessment Report by 2013. Secure five-year capital plan funding to support the recommendations.	Operations
2. Work in partnership with the TSA to best understand and anticipate its procedures, plans, and likely policy and technology evolution.	Operations

OBJECTIVE IV: COORDINATE THE SHARING OF INFORMATION AND PLANNING AMONG ALL FEDERAL AND LOCAL LAW ENFORCEMENT AGENCIES TO INSURE ALL THE DOTS ARE CONTINUALLY CONNECTED

STRATEGIC INITIATIVES TO ACHIEVE OBJECTIVE IV	
STRATEGIC INITIATIVES	LEAD DIVISION(S)
1. SFPD, SFFD and Airfield Safety staffing levels, equipment and training will be current and appropriate for their mission.	Operations
2. Airport staff will coordinate the activity, intelligence sharing and preparedness among all departments that share in the security of SFO.	Operations
3. Continue the nine-year history of holding weekly security operational meetings.	Operations

Infrastructure

Given the capital-intensive nature and the age of some SFO facilities, along with continued traffic growth and an ongoing commitment to controlling costs to the airlines, we will invest in capital projects strategi-

cally over the next five years. At the same time, we will keep an eye toward infrastructure investments needed beyond that timeframe.

OBJECTIVE I: AS PART OF MAINTAINING AVERAGE AIRLINE COST PER ENPLANED PASSENGER BELOW \$18.90, SFO WILL INVEST STRATEGICALLY IN CAPITAL PROJECTS

STRATEGIC INITIATIVES TO ACHIEVE OBJECTIVE I	
STRATEGIC INITIATIVES	LEAD DIVISION(S)
1. Prioritize projects based on implications for meeting federal/state/local mandates, on contribution to enhanced safety and security on preservation and on maintenance of existing assets, enhancement of customer service, and environmental sustainability.	Business & Finance
2. Maximize grants for eligible projects, but evaluate the full implications of proceeding with an otherwise low-priority project, including operating cost implications.	Business & Finance
3. Deliver facilities on a just-in-time basis to meet demand, thereby minimizing debt-carrying costs.	Bureau of Design & Construction and Planning
4. Implement the recommendations of the Process Mapping Study for the Airport's Capital Improvement Program (CIP).	Chief Operating Officer

OBJECTIVE II: MINIMIZE OVERALL LIFE-CYCLE COSTS OF FACILITIES

STRATEGIC INITIATIVES TO ACHIEVE OBJECTIVE II	
STRATEGIC INITIATIVES	LEAD DIVISION(S)
1. Get the full value out of the Airport's assets—maximizing the use of underutilized or vacant space such as office space cargo facilities and (in the future) hangars.	Business & Finances
2. Assess total maintenance and operating costs for each asset over time, and identify the optimal timing for routine maintenance, major maintenance, renovation and asset replacement.	Facilities & Administration

OBJECTIVE III: MAINTAIN THE AIRPORT'S INFRASTRUCTURE IN OPTIMAL CONDITION

STRATEGIC INITIATIVES TO ACHIEVE OBJECTIVE III	
STRATEGIC INITIATIVES	LEAD DIVISION(S)
1. Identify infrastructure projects needed to keep pace with traffic growth.	Chief Operating Officer & Planning
2. Implement a comprehensive asset management function supported by appropriate software systems to document the condition of existing assets, anticipate rehabilitation and replacement needs, and ensure SFO maintains its assets in the most cost-effective manner.	Chief Operating Officer
3. Deliver needed infrastructure projects on time and on budget.	Chief Operating Officer

OBJECTIVE IV: CONTINUE TO INVEST IN CAPITAL PROJECTS THAT MAKE THE AIRPORT ENVIRONMENTALLY SUSTAINABLE

STRATEGIC INITIATIVES TO ACHIEVE OBJECTIVE VI	
STRATEGIC INITIATIVES	LEAD DIVISION(S)
1. Complete installation of pre-conditioned air (PC Air) at all airport gates.	Facilities and Bureau of Design & Construction
2. Implement energy efficiency projects, such as replacing a boiler and chiller at the Central Plant, lighting efficiency projects, and other projects identified in the SF PUC Audit.	Facilities
3. Replace aging fleet vehicles.	Facilities
4. Increase solid waste recycling.	Facilities

OBJECTIVE V: IMPLEMENT PROJECTS THAT WILL GENERATE NET REVENUE TO THE EXTENT POSSIBLE, WHILE MEETING THE AIRPORT'S MISSION

STRATEGIC INITIATIVES TO ACHIEVE OBJECTIVE V	
STRATEGIC INITIATIVES	LEAD DIVISION(S)
1. Identify optimal terminal space reconfiguration and concession projects to enhance security checkpoints and increase airport net revenue.	Business & Finance
2. Implement a gas station/fast food/convenience store development project.	Business & Finance
3. Investigate the feasibility of potential revenue-producing projects that would enhance the customer experience, such as a luxury pod hotel, pet hotel, and yoga/meditation center.	Business & Finance
4. Evaluate the potential financial return and optimal timing for future projects that may be undertaken beyond a five-year time-frame, such as an additional garage adjacent to the existing long-term parking garage and an on-airport hotel.	Business & Finance
5. Identify and acquire land adjacent to SFO to pursue future development for uses such as aviation support, cargo, and automobile parking.	Business & Finance

External relations

A key component in the success of SFO is its strong and successful relationship with local communities and government agencies. As a major Bay Area economic engine, we serve local communities by providing jobs and business opportunities. In addition, our positive relationship with local communities builds credibility and support for our mission and goals of SFO.

A strategic outreach and communications plan is necessary to ensure stakeholder participation and input on our operations. Local communities should be partners and benefit from SFO's role as an economic driver in the region. We are committed to the creation of business opportunities, careers, jobs and internship programs that benefit area residents and businesses.

OBJECTIVE I: SUPPORT AWARENESS AMONG GOVERNMENT ENTITIES OF SFO AS A SUCCESSFUL ENTERPRISE AND A VALUABLE ASSET TO SAN FRANCISCO AND BAY AREA COMMUNITIES

OBJECTIVE II: DEVELOP AND MAINTAIN PRODUCTIVE RELATIONSHIPS WITH GOVERNMENT AGENCIES AND LOCAL CITIES AND COUNTIES WHICH WILL PROVIDE FOR AN OPEN EXCHANGE OF IDEAS AND COLLABORATION OPPORTUNITIES

STRATEGIC INITIATIVES TO ACHIEVE OBJECTIVES I & II	
STRATEGIC INITIATIVES	LEAD DIVISION(S)
1. Assess the adequacy of communications and relationship management between SFO and the various governmental agencies and stakeholder communities.	Government Affairs
2. Ensure continuous positive interactions with counterparts in other city agencies.	Government Affairs

OBJECTIVE III: INCREASE LOCAL BUSINESS PARTICIPATION WITH SFO

OBJECTIVE IV: DEVELOP AND MAINTAIN A MODEL EMPLOYMENT DEVELOPMENT PROGRAM FOR THE BENEFIT OF THE COMMUNITIES THAT SFO SERVES

STRATEGIC INITIATIVES TO ACHIEVE OBJECTIVES III & IV	
STRATEGIC INITIATIVES	LEAD DIVISION(S)
1. Conduct greater outreach to better inform local communities about business opportunities at SFO.	Administration Business & Finance
2. Increase the amount of business SFO does with local firms.	Business & Finance
3. Encourage and facilitate SFO business partners' (e.g., airlines) hiring of local interns	Administration
4. Improve the quality and breadth of select internship programs.	Administration

Standard operating procedures (SOPs) at SFO (Our Code of Conduct, developed by employees)

1. WE INTERACT with one another consistent with our core values, in an environment of mutual trust and cooperation.
2. WE RESOLVE past disputes so they do not hinder current or future work relationships.
3. WE TRY to meet everyone's needs in resolving issues. If an employee is coming to you with a problem, it is not THEIR problem - it is OUR problem. If you are asked for help, your best efforts are expected.
4. WE ASSIST willingly. Assistance should not be given begrudgingly. It is part of our jobs to help one another in a spirit of good will.
5. WE LISTEN to what others have to say, and be sure to understand it. We make genuine attempts to make ourselves clearly understood.
6. WE MAXIMIZE face-to-face meetings or telephone calls and minimize the use of email to discuss problems and issues. Emails are best used to transmit factual information and not opinions, especially in potentially volatile situations.
7. WE SHARE information willingly with one another.
8. WE ALLOW those closest to the issues first attempt to resolve problems.
9. WE RAISE issues that are not resolved expeditiously to higher levels in a professional, non-personal manner.
10. WE HAVE shared responsibilities to uphold our core values. We are accountable for our behavior. We will not tolerate rude, uncooperative, disrespectful or dismissive behavior.

San Francisco International Airport Fact Sheet

PASSENGERS (CALENDAR YEAR 2009)			
Total Airport Passengers (10th in U.S., 21st in the world in 2008)	37,402,455	Bay Area Market Share	56.3 %
Domestic Enplaned and Deplaned Passengers (75.8%)	28,102,527	Bay Area Market Share	50.1 %
International Enplaned and Deplaned Passengers (24.2%)	8,964,202	Bay Area Market Share	93.2 %
Traffic by Region (Share of International SFO International Passengers)		Asia	46.5%
		Europe	26.2%
		Canada	13.7%
		Mexico/Caribbean/ Central America	8.1%
		Australia/Oceania	5.3%
Average Number of Passengers per Day (2010)	102,192		
Most Passengers in a Year (2000)	41,040,995		

OPERATIONS (CALENDAR YEAR 2009)	
Total Operations.	387,710
Total Air Carrier Operations (73%)	284,163
Total Commuter Operations (22%)	85,394
Total General Aviation Operations (4%)	15,478
Total Military Operations (<1%)	2,675
Average Number of Operations per Day	1059
Most Operations in a Year (1999)	438,685

CARGO (CALENDAR YEAR 2009)			
Total Loaded and Unloaded Cargo (Air Mail & Freight)	493,628 metric tons	Bay Area Market Share	42.9%
Total Domestic Cargo (Air Mail & Freight)	205,210 metric tons	Bay Area Market Share	27.2%
Total International Cargo (Air Mail & Freight)	288,418	Bay Area Market Share	91.1%

San Francisco International Airport Fact Sheet

AIRLINES AT SFO (CALENDAR YEAR 2009)	
Total Number of Airlines Operating at SFO	54
Domestic Passenger Carriers	17
International Carriers	23
Commuter Air Carriers	5
Seasonal / Charter Air Carriers	2
Cargo Only Air Carriers	9

AIRLINE MARKET SHARE AT SFO			
United Airlines	41.0 %	Air Canada	1.5%
American	9.0%	Cathay Pacific	1.2%
Southwest	5.7%	JetBlue	1.2%
Virgin America	4.9%	Lufthansa	1.1%
US Airways	4.6%	British Airways	1.1%
Delta Airlines	4.2%	Frontier	1.0%
Northwest Airlines	3.7%	Singapore	1.0%
Continental Airlines	3.6%	All Other Air Carriers (each)	1.0%
Alaska Airlines	2.9%		

TOP FIVE DOMESTIC MARKETS (WEEKLY FLIGHTS)	
Los Angeles - (BUR / LAX / ONT / SNA)	500
New York - (JFK / EWR)	220
Las Vegas - (LAS)	167
San Diego - (SAN)	148
Chicago - (ORD / MDW)	131

REACHING FOR
Number





SAN FRANCISCO, CALIFORNIA 94128

WWW.FLYSFO.COM



APPENDIX D

PARTNERING REQUIREMENTS

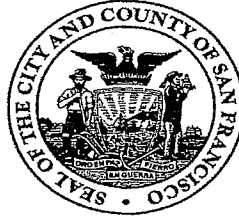

**APPENDIX D
PARTNERING REQUIREMENTS**

1. GENERAL

1.1 PARTNERING LEVEL

This Project shall incorporate the required partnering elements for **Partnering Level 5**.

Level	Estimated Construction Amount	Complexity	Political Significance	Relationships
5	\$200 million +	Highly technical and complex design & construction	High visibility/oversight; significant strategic project	New project relationships; high potential for conflict (strained relationship, previous litigation, or high probability of claims)
4	\$50 - \$200 million	High complexity – schedule constraints, uncommon materials, etc.	Probable	New contractors or CM, new subs
3	\$20 - \$50 million	Increased complexity	Likely, depending on the location and other project characteristics	Established relationships; new CM, subs, or other key stakeholders
2	\$5 - \$20 million	Moderate complexity	Unlikely, unless in a place of importance	Established relationships; new subs, new stakeholders
1	\$100,000 - \$5 million	Standard complexity	Unlikely, unless in a place of importance	Established relationships; new subs, new stakeholders

1.2 SUMMARY

- 1.2.1 This Section specifies the requirements for establishing a collaborative partnering process. The partnering process will assist the City and Contractor to develop a collaborative environment so that communication, coordination, and cooperation are the norm, and to encourage resolution of conflicts at the lowest responsible management level.
- 1.2.2 The partnering process is not intended to have any legal significance or to be construed as denoting a legal relationship of agency, partnership, or joint venture between the City and Contractor.
- 1.2.3 This Section does not supersede or modify any other provisions of the Contract, nor does it reduce or change the respective rights and duties of the City and Contractor under the Contract, nor supersede contractual procedures for the resolution of disputes.

1.3 PURPOSE/GOALS

1.3.1 The goals of project partnering are to:

- A. Use early and regular communication with involved parties;
- B. Establish and maintain a relationship of shared trust, equity and commitment;
- C. Identify, quantify, and support attainment of mutual goals;
- D. Develop strategies for using risk management concepts and identify potential project efficiencies;
- E. Implement timely communication and decision-making;
- F. Resolve potential problems at the lowest possible level to avoid negative impacts;
- G. Hold periodic partnering workshops throughout the life of the contract to maintain the benefits of a partnered relationship;
- H. Establish periodic joint evaluations of the partnering process and attainment of mutual goals.

1.4 DEFINITIONS

1.4.1 Unless specifically defined in this Appendix D, all terms have the same meaning as defined in Section 00 72 00, General Conditions.

1.4.2 **Stakeholders:** Any person or entity that has a stake in the outcome of a construction project. Examples include the end users, neighbors, vendors, special interest groups, those who must maintain the facility, those providing funding, and those who own one or more of the systems.

1.4.3 **Project Team:** Key members from the City and Contractor organizations responsible for the management, implementation, and execution of the Project, and will participate in the partnering process.

2. PARTNERING PROCESS

2.1 SELECTION OF A FACILITATOR

2.1.1 An Internal Facilitator or a Professional Neutral Facilitator shall be retained for projects with a Partnering Level of 1 through 3. A Professional Neutral Facilitator must be retained for projects with a Partnering Level of 4 or 5. The City and Contractor shall meet as soon as practicable after award of Contract to work cooperatively and in good faith to select a Facilitator.

- 2.1.2 An Internal Facilitator is a trained employee or representative of the City who provides partnering facilitation services.
- 2.1.3 A Professional Neutral Facilitator must have the following qualifications:
- A. The Facilitator shall be trained in the recognized principles of partnering;
 - B. The Facilitator shall have at least three (3) years' experience in partnering facilitation with a demonstrated track record, including public sector construction for a city or other municipal agency;
 - C. The Facilitator shall have a skill set that may include construction management, negotiations, labor-management mediation, and/or human relations; and
 - D. The Facilitator must be in the business of providing partnering services for construction projects.
- 2.1.4 Within thirty (30) days of NTP, Contractor and the selected Professional Neutral Facilitator shall execute an agreement that establishes a budget for fees and expenses of the Facilitator, workshop site costs, if any, and the describe the Facilitator's role for the Project consistent with the requirements of this Section. The scope of the Facilitator's role is for descriptive purposes only and is not a guarantee for payment as the scope of work will be revised as needed throughout the Project. The agreement shall be terminable at will.
- 2.1.5 The Facilitator shall be evaluated by the Project Team: (1) at the end of the Kick-off Partnering Workshop; and (2) at the Project close-out partnering session.
- 2.1.6 In the event that either Contractor or the City is not satisfied by the services provided by the Facilitator, a new mutually acceptable Facilitator shall be chosen in a reasonable amount of time in the same manner pursuant to Subparagraph A above, and a new agreement shall be executed by Contractor and the new Professional Neutral Facilitator pursuant to Subparagraph D above.

2.2 PARTNERING ELEMENTS

- 2.2.1 All Partnering Levels require the following elements:
- A. **Executive Sponsorship.** Commitment to and support of the partnering process from the senior most levels of the City and Contractor organizations.
 - B. **Collaborative Partnering.** A structured and scalable process made up of elements that develop and grow a culture (value system) of trust among the parties of a construction contract. Together, the combination of elements including the Partnering Charter, Executive Sponsorship, partnering workshops, an accountability tool for the Project Team (Scorecards), and the Facilitator create a collaborative atmosphere on each project.

- C. **Facilitator.** Depending on the Project's Partnering Level, the City and Contractor shall retain either an Internal Facilitator or a Professional Neutral Facilitator according to the process listed in subparagraph 2.1 above to lead workshops.
- D. **Partnering Charter and/or mission statement.** The City and Contractor shall create a Partnering Charter that is the guiding focus for the Project Team. It documents the team's vision and commitment to work openly and cooperatively together toward mutual success during the life of the Project. The Partnering Charter helps to maintain accountability and clarity of agreements made and allows for broader communication of the team's distinct goals and partnering process. At a minimum, the Partnering Charter must include the following elements:
- 1) Mutual goals, including core project goals and may also include project-specific goals and mutually-supported individual goals. The required core project goals relate to project schedule, budget, quality, and safety.
 - 2) Partnering maintenance and close-out plan, including partnering session attendees and frequency of workshops.
 - 3) Dispute resolution plan that includes an Escalation Resolution Ladder.
 - 4) Team commitment statement and signatures.
- E. **Partnering Workshops.** At a minimum, the following two workshops are required:
- 1) **Kick-off Partnering Workshop.** Within 45 days of NTP, the City and Contractor shall meet for the Kick-off Partnering Workshop; determine the workshop site and duration, and other administrative details. At the Kick-off Partnering Workshop, the City, Contractor, and Facilitator shall meet to mutually develop a strategy for a successful partnering process and to develop their Partnering Charter.
 - 2) **Close-out Partnering Workshop.** Prior to final closeout, the City and Contractor shall schedule the Close-out Partnering Workshop. At the Close-Out Partnering Workshop, the City, Contractor, and Facilitator, shall meet to discuss lessons learned throughout the Project, focus on ensuring continued collaboration and cooperation through the end of the Project, and to discuss requirements for the close-out process. At the conclusion of the workshop, a summary of the lessons learned should be prepared to be distributed to the Project Team. The City and Contractor shall also evaluate the Facilitator.

The Project Team may participate in additional workshops during the life of the Project as they agree is necessary and appropriate. Each workshop is a formalized meeting focused on developing a collaborative culture among the Project Team. The Project Team will use these workshops to set Project goals, define Project commitments, attend joint training sessions, and perform other tasks.

F. **Multi-tiered Partnering (Core Team – Executive – Stakeholder).** The Partnering Team will divide into smaller groups and convene multiple workshops including a Core Team Workshop, an Executive Workshop, and a Stakeholder Workshop.

1) **Core Team Workshop.** The Core Team is made up of Project Team members who are a part of the Project for its duration, including the following (not in order of hierarchy):

City:	Contractor:
Resident Engineer	Building Superintendent
Project Manager	Project Executive
Construction Manager	Jobsite Supervisor
Engineer, Architect	Project Engineer
Division Manager	Subcontractors
Construction Engineer	Key suppliers
Inspectors	Senior Management (e.g. Area Manager, Operations Manager, VP, President, Owner)
Client Department representative	
Critical third parties: stakeholders, other agencies, utilities, etc., or anyone who could potentially stop or delay the project.	

2) **Executive Workshop.** The senior leaders of the City and Contractor may form a Project Board of Directors. The Project Board of Directors is charged with steering the project to success.

3) **Stakeholder Workshop.** As the Project progresses, various systems and processes will be the focus. The Stakeholder Workshop is a meeting of the key stakeholder groups, made up of Stakeholders that are involved in the current focus of the systems or processes.

4) **Special Task Forces.** The Project Team may task a subset of its members to work on a particular issue or opportunity for the good of the overall project.

G. **Escalation Resolution Ladder.** The City and Contractor shall mutually develop an Escalation Resolution Ladder, which is a stepped process that formalizes the negotiation between the Parties. The intent of this ladder is to provide a process that elevates issues up the chain of command between the Parties. The objective is to resolve issues at the lowest practical level and to not allow individual project issues to disrupt project momentum. When an issue is escalated one level, it is expected that a special meeting focusing on the negotiated settlement for that issue will be called with the goal of settling as quickly as possible.

Sample Escalation Resolution Ladder:

Level	Awarding City Department	Contractor	Time to Elevate
I	Inspector or Resident Engineer	Foreman/ Superintendent	1 day
II	Project Manager	Project Manager	1 week
III	Program Manager	Area Manager	1 week

IV	Division Manager	Operations Manager	2 weeks
V	Deputy Department Director	Owner; President	2 weeks

H. **Project Scorecards.** The City and Contractor shall participate in periodic partnering evaluation surveys to measure progress on mutual goals and short-term key issues as they arise. Project Scorecards are an accountability tool that allows the City and the Contractor to measure how well they are doing at following through on commitments made to one another. Typically the Project Scorecards are confidential surveys prepared and submitted to the Project Team by the Facilitator. The Facilitator typically then compiles the responses into a report which is then sent out to the Project Team for review.

2.2.2 **Level 1 Projects** require all of the following elements:

- A. Kickoff Workshop
- B. Partnering Workshops:
 - Executive Board Workshops – As Needed
 - Stakeholder Workshops – As Needed
 - Core Team Workshops – As Needed
- C. Close-Out Workshop
- D. No Project Scorecards are required. The City and Contractor may agree to participate in partnering evaluation surveys.

2.2.3 **Level 2 Projects** require all of the following elements:

- A. Kickoff Workshop
- B. Partnering Workshops:
 - Core Team Workshops – As Needed
 - Executive Board Workshops – As Needed
 - Stakeholder Workshops – As Needed
- C. Close-Out Workshop
- D. Two Project Scorecards are required. The City and Contractor may agree to participate in more regular partnering evaluation surveys.

2.2.4 **Level 3 Projects** require all of the following elements:

- A. Kickoff Workshop
- B. Partnering Workshops:

- Core Team Workshops – Quarterly. Additional workshops may be led by the Professional Neutral Facilitator, and Internal Facilitator, or may be self-directed by the Project Team.
- Executive Board Workshops – As Needed
- Stakeholder Workshops – As Needed

C. Close-Out Workshop

D. Quarterly Project Scorecards are required. The City and Contractor may agree to participate in more regular partnering evaluation surveys. Monthly Project Scorecards are recommended.

2.2.5 Level 4 Projects require all of the following elements:

A. Kickoff Workshop

B. Partnering Workshops:

- Core Team Workshops – Quarterly. Additional workshops may be led by the Professional Neutral Facilitator, and Internal Facilitator, or may be self-directed by the Project Team.
- Executive Board Workshops – Quarterly
- Stakeholder Workshops – Quarterly

C. Close-Out Workshop

D. Quarterly Project Scorecards are required. The City and Contractor may agree to participate in more regular partnering evaluation surveys. Monthly Project Scorecards are recommended.

2.2.6 Level 5 Projects require all of the following elements:

A. Kickoff Workshop

B. Partnering Workshops:

- Core Team Workshops – Monthly. Additional workshops may be led by the Professional Neutral Facilitator, and Internal Facilitator, or may be self-directed by the Project Team.
- Executive Board Workshops – Quarterly
- Stakeholder Workshops – Quarterly

C. Close-Out Workshop

D. Monthly Project Scorecards are required.

2.3 COSTS

- 2.3.1 The fees and expenses of the Internal Facilitator, if any, shall be paid by the City.
- 2.3.2 The fees and expenses of the Professional Neutral Facilitator, if any, and workshop site costs, if any, shall be shared equally by the City and the Contractor as set forth in the Third Party Agreement.
- 2.3.3 The Contractor shall pay the invoices of the Facilitator and/or workshop site costs after approval by both parties. Upon receipt of satisfactory evidence of payment of the invoices of the Facilitator by Contractor, the City will then reimburse the Contractor for such invoices from a fixed cash allowance included as an item in the Bid Prices. No mark-up, overhead or other fees shall be added to the partnering costs. If the total cost of the partnering is greater than the allowance amount, the Contract Sum shall be adjusted by Change Order and Contract Modification.
- 2.3.4 With the exception of the Facilitators fees and workshop site costs described in subparagraph A above, all costs associated with the Partnering workshops and sessions, partnering evaluation surveys, or partnering skills trainings are deemed to be included in the Bid Price(s).

END OF APPENDIX D



APPENDIX E

OTHER TRANSACTION AGREEMENTS

OTA HSTS04-13-H-CT1058

OTA HSTS04-13-H-CT1140

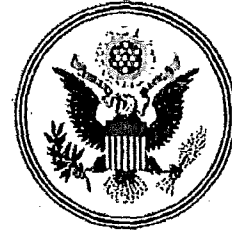

OTHER TRANSACTION AGREEMENT

BETWEEN

**DEPARTMENT OF HOMELAND SECURITY
TRANSPORTATION SECURITY ADMINISTRATION**

AND

**CITY AND COUNTY OF SAN FRANCISCO
RELATING TO**

**SAN FRANCISCO INTERNATIONAL AIRPORT (SFO)
Checked Baggage Recapitalization Screening Design Services Project**

Negotiated by the TSA pursuant to
Aviation and Transportation Security Act, Pub. L. 107-71, 115 Stat. 597
49 U.S.C. §114(m)(1) and 106(l)(6) and

HSTS04-13-H-CT1058

ARTICLE I – PARTIES

The parties to this Other Transaction Agreement (OTA or Agreement) are the U.S. Department of Homeland Security, Transportation Security Administration (TSA) and THE CITY AND COUNTY OF SAN FRANCISCO COMMISSION (CITY) as owner and operator of SAN FRANCISCO INTERNATIONAL AIRPORT (SFO). The TSA and City agree to cooperate in good faith and to perform their respective obligations in executing the purpose of this Agreement.

ARTICLE II – LEGAL AUTHORITY

This Agreement is entered into under the authority of the Aviation and Transportation Security Act, Pub. L. 107-71, 115 Stat. 597, specifically 49 U.S.C. § 114(m)(1) and 106(l)(6), which authorizes other transactions.

ARTICLE III – SCOPE

Objectives

The purpose of this Agreement is to set forth the terms and conditions, as well as establish the respective cost-sharing obligations of the TSA and City with respect to the design services necessary to implement the TSA Recapitalization effort at San Francisco International Airport. The design services will result in 100% drawings and specifications, and will be submitted to TSA for review in accordance with the published TSA Planning Guidelines and Design Standards (PGDS) Version 4.1, which can be found at:

<http://www.tsa.gov/research-center/airport-checked-baggage-guidance-materials>

The City will be responsible for developing various cost-effective solutions to replace fifteen (15) Explosive Detection System (EDS) machines currently located in Terminal 1 of the airport, while minimizing the impact to operations and reducing the number of EDS by using higher throughput technology units (as appropriate) (Attachment 1). The solutions that the City proposes should be based upon a baggage screening rate derived from the current baggage screening rate and a projected, future screening rate. Solutions based upon such a combined current and future rate will allow the TSA to consider all cost factors available when making its decision of the optimal solution

Background

The Electronic Baggage Screening Program (EBSP) of the Transportation Security Administration monitors the status of its existing EDS equipment to ensure compliancy with the PGDS, functionality and efficiency. The TSA Headquarters keeps the following detailed, historical records relating to each EDS machine: age, maintenance logs, performance (rate), technical obsolescence, and local TSA reported issues, among others. When triggered by one or more of these factors, an examination of the system becomes warranted and TSA develops a modification plan to correct any outstanding conditions. The TSA has established the Recapitalization Program to address these needs.

- **Recapitalization** is the replacement of EDS equipment that has reached the end of its

useful life. Typically, such EDS machines will be replaced with a newer model of EDS machine that has similar throughput and capabilities. The EDS replacement may include some minor modifications to the existing conveyor shunts and Programmable Logic Controllers (PLC) programming to foster the EDS machine placement and operation. NOTE: Baggage Handling System (BHS) modifications that extend beyond the scope of work of this design OTA are classified as "Optimization".

Typically, the aging CTX 9000 EDS machine (400 bph) will be replaced with an MDI 9800 EDS machine (680 bph); and the aging L3 6600 (400 bph) will be replaced with the L3 6700 (540 bph) or the L3 6700ES (680 bph). Although these are typical plans, TSA reserves the right to determine the model of EDS machine(s) to be used in a recapitalization project at an airport. The differences in processing capabilities – when applied to the future needs of the airport - may provide for a "Return on the Investment" (ROI) when the quantity of required EDS is reduced. When applicable, the ROI for the Recapitalization process, which is to be calculated based on a 10 year period, shall be specifically identified by the CITY.

Project Summary

Deliverables:

- 1) Establish and provide to TSA the current baggage rates in accordance with the PGDS (v.4.1), Chapter 5. The baggage rate analysis must be for the current year (2013), and forecast the baggage rate 6 years into the future (through 2019). The quantity of EDS machines as a result of Recap will be based on the future demand, which is based on the baggage rate analysis. The report shall include information (graphs, charts, tables, figures, diagrams, etc) about the steps and calculations performed (see PGDS Chapter 5).
- 2) Provide a report containing a minimum of two solutions (including a cost estimate formatted to the CWE in Appendix F of PGDS) that reflects the most cost efficient solution to recapitalize the EDS units (candidate units and terminal information are included in Attachment 1). The solutions shall take into account the available speed EDS machine options and the costs associated with the following elements:
 - a. EDS price
 - b. EDS maintenance
 - c. Phasing required to install the new EDS units
 - d. Necessary modifications to the Baggage Handling System (BHS) (e.g. egress, quick disconnect, accommodations for new EDS machines)
- 3) The report shall include a cost/benefits analysis comparison, advantages and disadvantages for each solution, and a suggestion as to the best solution proposed. Provide documentation of airport/airline configuration changes that will affect the current and future baggage rates (additional gates, airline moves, additional flights, etc). This documentation shall also include the CITY master plan, when available.
- 4) Identify and provide a required statement of work, whenever minor BHS changes are necessary to accommodate the replacement EDS machines. By providing this statement of work, the CITY is not entitled to reimbursement of the costs of such work unless allowed for in a separate OTA or other agreement with TSA.
- 5) If major BHS system modifications are needed, the CITY shall provide a scope of work with a solution to support the increased baggage rate requirement (see "Constraints", paragraph 4).

By providing this statement of work, the CITY is not entitled to reimbursement of the costs of such work unless allowed for in a separate OTA or other agreement with TSA.

Constraints:

- A) The CITY must comply with the following rules and regulations governing the deliverables to be provided in support of the TSA Recapitalization Program:
- 1) Reports shall contain ALL supporting documentation. This documentation includes, but is not limited to: flight schedules, airport master plan, arrival distributions applied, equipment demand calculations, and cost analysis tools. The TSA reserves the right to request any additional information that is not provided along with the deliverables listed in this section.
 - 2) PGDS where applicable.
 - 3) Contact TSA to obtain the available historical data of the airport in study. The historical data includes:
 - Monthly total passengers per checkpoint
 - Daily total passengers per checkpoint
 - Hourly total passenger per hour
 - Bag information reports (a.k.a. FDRS reports) for all the EDS for the ADPM
 - Bags per passengers for each airline
 - Enhanced Staffing Model results and reports
 - 4) If the existing BHS is unable to sustain the future expected baggage rate, as predicated by EDS machine replacement alone, the system may not be a viable candidate for the Recapitalization effort. If this is the case, please contact the TSA Regional Deployment Coordinator (RDC).
 - 5) If the Field Data Reporting System (FDRS) reports are available and can be provided by the TSA, the CITY shall use this data to establish the baggage rate demands and contrast it with the flight schedule analysis.
 - 6) When possible, the replacement EDS units shall be of the same type as the existing EDS equipment that is currently deployed at the airport, to eliminate an unnecessary need for a new network system, and any other unnecessary modifications to the system.
 - 7) The CITY shall examine the existing BHS's status and ensure that the conveyor system is capable of supporting the new EDS rate, independently and as a system. (The intent is that the EDS machines can be fully utilized at their rated capacity). Redundant EDS machines – as per the PGDS – are to be an integral requirement. If major BHS modifications are needed, and only with the RDM's approval, the CITY may produce a scope of work with a solution to support the increased rate requirements. By providing a scope of work, the CITY is not entitled to reimbursement of the costs of such work unless allowed for in a separate OTA or other agreement with TSA.

In both solutions provided pursuant to this OTA, the CITY shall identify the removal path for the EDS machines, include special requirements, and/or identify limitations or constraints.

This Design Services Project requires the CITY to provide the architect and engineering services to develop the design and construction specifications to install the inline systems designated for replacement within the Airport Terminal (hereinafter the Design Project). The Checked Baggage Inspection System (CBIS) design needs to address Airport Terminal modifications required to be made to incorporate the new systems to include required changes per the instructions below: The objective of the Design Services Agreement is to provide the design documents and specifications to identify the necessary construction modifications required to install an inline CBIS to enhance the security and baggage screening capabilities at the Airport. The TSA detailed design deliverables for each Design Phase to be provided by the CITY are outlined per Appendix A of this Agreement. The Design Phases include:

1. Pre-Design Phase: Preliminary Alternative Analysis Report and Preferred Analysis Report
2. Schematic Design Phase: Basis of Design Report and associated deliverables
3. Detailed Design Phase
 - a. 30 % Design Submittals and associated deliverables
 - b. 70% Design Submittals and associated deliverables
 - c. 100% Design Submittals and associated deliverables
4. Construction Bid proposal documentation to include contract solicitation, requirements issued to prospective contractors, bid specifications and other applicable documents that complete the local request for proposal package listed at the CITY's public point of entry.
5. Construction Bid proposal evaluation.

Any future allowable, allocable and reasonable costs for Recapitalization Project construction, project management, construction management, and commissioning/site acceptance testing is anticipated to be funded through a separate Agreement or OTA modification in accordance with Article XIII "Changes and/or Modifications" between the CITY and the TSA. This Design Agreement shall not be construed to obligate the TSA, in any manner, to provide construction cost funding or obligate the TSA to enter into an Agreement with the CITY for reimbursement of construction costs related to the Recapitalization Project. TSA funding for the construction portion of the project is subject to the Congressional authorization and appropriation budget process.

ARTICLE IV – COST SHARING AND OTHER RESPONSIBILITIES

1. Capital Costs: The estimated cost of the Design Project refers to the design services to be completed by the CITY to develop the necessary design documents for the construction modifications needing to be made to the Terminal building and associated baggage conveyor system to support the Recapitalization Project. It does not include the costs of acquisition, delivery or installation of the EDS equipment itself. All work performed by the CITY pursuant to this Agreement shall be accomplished in accordance with the TSA PGDS in effect at the time this Agreement is executed and in accordance with the applicable federal, state, and local Building Standards and Criteria. Recognizing the uniqueness of this Design Project, in the event

of any conflicts between the provision of the PGDS and this Agreement, the Parties agree to resolve such conflicts through the design review and Alternative Analysis processes described in the TSA PGDS.

2. The estimated cost for the design services for the Design Project is \$1,082,895. TSA agrees to reimburse the CITY for (100%) of the allowable, allocable and reasonable costs of the design services for the Design Project, not to exceed a total reimbursement of \$1,082,895. TSA reimburses for allowable, allocable and reasonable costs submitted by the CITY for reimbursement up to the TSA funded amount of \$1,082,895.

3. TSA will determine allowable and allocable costs in accordance with the OMB Circular A-87 "Cost Principles for State, Local and Indian Tribal Governments" codified at 2 C.F.R. Part 225 (together with Appendices A – D) and Appendix F of the TSA PGDS in effect upon the signing of this Agreement by both parties. TSA will reimburse the CITY on an actual expense basis supported by one or more invoices submitted by the CITY in accordance with Article X – Payment. The parties understand and agree that all design costs in excess of \$1,082,895, as well as any costs that are inconsistent with OMB A-87 and the guidance set forth in Appendix F of the TSA PGDS in effect at the time the Agreement is executed, shall be borne solely by the CITY unless otherwise agreed by the TSA in a modification in accordance with Article XIII – Changes and/or Modifications. Should the TSA contributions of \$1,082,895 represent more than the total final TSA allowable, allocable, and reasonable design costs for the Design Project, the CITY will refund TSA sufficient funds such that TSA's total reimbursement will be no more than the total allowable, allocable and reasonable costs submitted by the THE CITY.

4. The Design Project costs which TSA will reimburse are limited specifically to those costs associated with the Design Deliverables mandated by the TSA PGDS, outlined in Appendix A "TSA PGDS Design Deliverables Checklist."

5. Change orders shall not be considered authorization to exceed TSA's reimbursement limit of \$1,082,895 for the Design Project, unless the TSA Deployment Manager and TSA Contracting Officer have been notified in advance of the impact the Change Order has on the total cost of the design services for the Design Project, and TSA provides its written approval to proceed with the work identified in the Change Order. Use of contingency funds for the TSA Design Project requires TSA's prior written approval.

ARTICLE V: PROJECT RESPONSIBILITIES

The primary Project responsibilities of the TSA and the CITY are outlined below. The Design Project will be overseen by the CITY.

A. TSA Responsibilities

1. Review and concur with the Recapitalization Project design, plans, and specifications for alternative analysis, schematic, 30%, 70% and 100% design packages for the installation of the replacement EDS units in the CBIS based upon the recommendations and guidelines in the TSA PGDS in effect at the time of execution of this Agreement.
2. The CITY must receive concurrence from TSA at each stage of the design review in

order to proceed to the next design review stage.

3. Consider design alternatives during the design review process in order to achieve the most efficient screening solution for both TSA and the CITY.
4. Provide the applicable version of the TSA PGDS as well as the EDS equipment specification(s) as required.
5. Advise the type of EDS equipment to be provided at each stage of the design.
6. Provide EDS Original Equipment Manufacturer Technical Advisory Support Services to the CITY regarding integration of the EDS units into the baggage handling system (BHS).
7. Review and consider requested changes to the design and associated costs.

B. CITY Responsibilities

1. Except for the responsibilities of the TSA, as outlined above, the Design Project will be managed and overseen by the CITY. The CITY, acting through such contractors as it may engage, will provide the engineering and design services necessary for successful completion of the Design Project. The CITY will provide oversight of such contractor(s) to ensure the design of the Recapitalization Project conforms to the TSA design guidelines identified in the PGDS and is completed within the project milestone schedule.
2. The CITY must receive concurrence from TSA at each stage of the design review in order to proceed to the next design review stage.
3. Provide a budgetary construction cost estimate with the schematic, 30% design review and subsequent 70% and 100% design reviews for the Recapitalization Project.
4. Obtain all necessary licenses, insurance permits and approvals.
5. Ensure the EDS OEM site planning, installation, integration and networking guidelines are incorporated into the design to ensure operational, maintenance and environmental specifications are met.
6. As part of the design, provide reasonable measures to protect the EDS and ETD equipment from harm, theft, and water intrusion in the screening area.
7. Incorporate heating, ventilation, air conditioning into the design as well as OSHA requirements for those spaces occupied by TSA personnel.
8. Submit monthly progress reports by the 10th of each month to the TSA Deployment Manager via e-mail at OSTCBD@tsa.dhs.gov

ARTICLE VI - EFFECTIVE DATE AND TERM

The period of performance for this Agreement is effective on the date signed by TSA and ends on December 31, 2013 unless earlier terminated by the parties pursuant to Article XV "Termination" as provided herein or extended by mutual written agreement pursuant to Article XIII "Changes and/or Modifications." The period of performance allows the CITY time to submit a final invoice, close out the Design Project, and address any other issues.

The CITY will establish and provide Design Schedule Milestones to the TSA that allow objective measurement of progress toward completion. Design Schedule Milestones will be provided to the TSA within 30 days after the CITY has established their design services contract(s). TSA maintains the right to identify any additional milestones to be tracked.

ARTICLE VII - ACCEPTANCE AND TESTING

TSA will deem the Design Project complete upon review and concurrency of the 100% design package for each Terminal. The design must conform to the TSA PGDS in effect at the time that this Agreement is executed.

ARTICLE VIII - AUTHORIZED REPRESENTATIVES

The authorized representative for each party shall act on behalf of that party for all matters related to this Agreement. Each party's authorized representative may appoint one or more personnel to act as an authorized representative for any administrative purpose related to this Agreement, provided written notice of such appointments is made to the other party to this Agreement. The authorized representatives for the parties are as follows:

A. TSA Points of Contact:

Regional Deployment Coordinator/Contracting Officer's Representative:

Shahzan Akber

Mail Stop TSIF #32

Transportation Security Administration

1 Post Office Road

Washington, DC 20528-6032

Phone: 571-227-5645

E-Mail: Shahzan.Akber@dhs.gov

Contracting Officer:

Kerry Toscano

701 South 12th Street

Arlington, VA 20598-6025

Phone: 571-227-4932

E-Mail: Kerry.Toscano@dhs.gov

Contract Specialist:

Tiffany Limbacher

701 South 12th Street

Arlington, VA 20598-6025

Phone: 571-227-5375

E-Mail: Tiffany.Limbacher@dhs.gov

Only the TSA Contracting Officer (CO) shall have the authority to bind the Federal government with respect to funding and liability. The TSA Regional Deployment Coordinator (RDC) is also the TSA Contracting Officer Representative (COR) and is responsible for the technical administration of this Agreement and technical liaison with the CITY and the Airport. The TSA COR is not authorized to change the scope of work, to make any commitment or otherwise obligate the TSA, or authorize any changes which affect the liability of the TSA such as amount or level of funding.

The CITY must notify the TSA CO and COR in the event that any TSA employee or TSA contracted agent takes any action that may be interpreted by the CITY as direction which could increase the Design Project costs and could cause the CITY to seek reimbursement from TSA in excess of the of the TSA's total reimbursement liability as defined in Articles IV and IX of this Agreement.

B. CITY Points of Contact:

The CITY Point of Contact for all correspondence is:

Reuben Halili
Project Manager
San Francisco International Airport
Planning, Design and Construction
P.O. Box 8097
San Francisco, California 94128
Phone: 650-821-7803
E-mail: Reuben.Halili@flysf.com

ARTICLE IX - FUNDING AND LIMITATIONS

TSA will provide funding to the CITY in an amount not to exceed \$1,082,895. Funds in the amount of \$1,082,895 are hereby obligated and made available for payment for performance of this Agreement. Expenses incurred in executing the work identified herein are chargeable to:

Procurement Request: 21-13-203-CT1058

Accounting Code:

5CF09XB010D2013SWE044GE013723006200622CTO/5903001518010000/251B/TSA

DIRECT/DEF. TASK

Amount: \$1,082,895

In the event of termination or expiration of this Agreement, any TSA funds that have not been spent or incurred for allowable expenses prior to the date of termination and are not reasonably necessary to cover termination expenses will be returned and/or de-obligated from this Agreement. TSA's liability to make payments to the CITY is strictly limited to the amount of funds obligated and available for payment hereunder, including written modifications to this Agreement.

Under no circumstances will TSA be responsible to reimburse the CITY for profit or the general costs of government. The CITY may recover the allowable direct costs of the CITY personnel performing work necessary under this Agreement, as well as the allowable and allocable costs of the contractors hired by the CITY to perform the necessary work under this Agreement. Profit and overhead costs for the CITY's contractors performing work on the TSA Project are allowable costs. Submission of a cost allocation plan is required to address any indirect costs, to include CITY employees, who work on multiple activities that will result in a request for reimbursement under this Agreement. TSA will not be responsible for costs incurred by the CITY, its contractors or agents to perform work not in compliance with the TSA requirements in

this Agreement. The TSA has the right to recoup any payments made to the CITY if the TSA Contracting Officer determines that the invoices submitted by the CITY exceed the actual costs incurred, or if the work substantially deviates from the TSA-approved design requirements for the Project pursuant to this Agreement.

TSA will reimburse only for allowable, allocable and reasonable costs in accordance with the OMB Circular No. A-87 in effect on the Effective Date of the Agreement (codified at 2 C.F.R. Part 225) and the allowable/not-allowable costs identified in the TSA PGDS in effect as of the effective date of this Agreement.

ARTICLE X – PAYMENT

The United States Coast Guard Finance Center performs the payment function on behalf of the TSA. For purposes of submission to the Coast Guard Finance Center, the CITY must submit a completed Summary Invoice. Registration in the System for Award Management (SAM) is mandatory for invoice payment; for information regarding SAM, please refer to <https://www.sam.gov/portal/public/SAM/>.

Invoices for reimbursable expenses will be submitted every thirty (30) days, as expenses are incurred. For periods in which the CITY has not incurred a reimbursable expense, an invoice is not required. Expenses are considered to accrue on the date that the CITY is invoiced from a subcontractor, supplier, or provider of services. Reimbursement by TSA is conditioned upon submission to TSA of an invoice identifying the Project costs that have been incurred and paid. The TSA intends to make payment to the CITY within 120 days of receipt of each properly prepared invoice for reimbursement of incurred costs.

In the event that an invoice for reimbursable expenses is not received by the TSA within a twelve (12) month period, the TSA reserves the right to terminate the Agreement per Article XV "Termination."

The TSA reimbursement process consists of two steps.

Step 1 – Summary Invoice Submittal to the U.S. Coast Guard Finance Center for Payment, and at a minimum should contain the following information:

- (1) Agreement Number
- (2) Invoice Number and Invoice Date
- (3) Complete Business Name and Remittance Address
- (4) Point of Contact with address, telephone, fax and e-mail address
- (5) Tax Identification Number and DUN's Number
- (6) Dollar Amount of Reimbursement requested
- (7) Signature of the THE CITY's authorized representative and the following certification language: *"This is to certify that the services set forth herein were performed during the period stated and that the incurred costs billed were actually expended for the Project."*

The Summary Invoice may be submitted by standard email or by electronic transmission to the following address(s):

Mailing Address: TSA Commercial Invoices
USCG Finance Center
P.O. Box 4111
Chesapeake, VA 23327

Email: FIN-SMB-TSAINVOICES@uscg.mil

**Step 2 – Submission of Summary Invoice and Supporting Documentation
Submittal to TSA for Approval of Payment:**

The TSA CO and the COR are required to review and approve all invoices prior to payment. To aid in this review, the CITY shall provide a copy of the Summary Invoice along with all receipts, contractor pay requests and other supporting information which specify the vendor, services provided, and products delivered as well as the appropriate identifications that the CITY has paid these obligations. The CITY should provide this supporting information simultaneously with Step 1 to expedite the payment process.

The Support Documentation should contain the following items:

- Summary Invoice from Step 1
- An executive summary project overview with the first invoice
- A summary spreadsheet providing a categorized breakdown of the amount invoiced.
- Signed, approved and legible copies of each individual contractor's invoice to include schedules of values statements of work.
 - Copies of contracts and change orders that provide support for the actual work being invoiced
 - Vendor and subcontractor invoices with specific details about services provided
 - Rationale for all allocations or unusual calculations or assumptions
 - Proof of delivery to the project sponsor
 - Copies of subcontractor's invoices if listed on a prime contractor's invoice as a single amount (copies of timesheets and detailed backup not required if descriptions are clear and specific).
- Proof of payment by the CITY for each invoice in the form of copies of check/warrants, bank wire transfers, or accounting systems transactions

The Summary Invoice and supporting documentation may be submitted by email or mail via CD or paper documents to the below addresses. The final closeout invoice should include proof that all required deliverables have been provided.

Shahzan Akber
Mail Stop TSA TSIF - #32
Transportation Security Administration
1 Post Office Way
Washington, D.C. 20528-6032
Email: OSTCBD@tsa.dhs.gov

Henry Edquist
Faithful & Gould
1725 Duke Street, Suite #200
Alexandria, VA 22314
Phone: 571-403-8777
Email: Henry.Edquist@fgould.com

Upon completion of the review of the supporting documentation for the Summary Invoice, the TSA CO and the TSA RDM/COR will advise the Coast Guard Finance Center regarding payment of the Summary Invoice.

ARTICLE XI - AUDITS

The Federal Government, including the Comptroller General of the United States, has the right to examine or audit relevant financial records for a period not to exceed three (3) years after expiration of the terms of this Agreement. The CITY's and its contractors must maintain an established accounting system that complies with generally accepted accounting principles. Records related to disputes arising out of this Agreement shall be maintained and made available until such disputes have been resolved. As used in this provision, "records" includes books, documents, accounting procedures and practices, and other data, regardless of type and regardless of whether such items are in written form, in the form of computer data, or in any other form.

The CITY shall maintain all records and other evidence sufficient to reflect costs claimed to have been incurred or anticipated to be incurred directly or indirectly in performance of this Agreement. The TSA CO or the authorized representative of the TSA CO shall have the right to examine and audit those records at any time, or from time to time. The right of examination shall include inspection at all reasonable times at the offices of the CITY or at the offices of the THE CITY's contractor(s) responsible for the Project. The CITY will be required to submit cost or pricing data and supporting information in connection with any invoice relating to this Agreement if requested by the TSA CO.

This Article XI shall not be construed to require the CITY or its contractors or subcontractors to create or maintain any record that they do not maintain in the ordinary course of business pursuant to a provision of law, provided that those entities maintain records which conform to generally accepted accounting practices.

The CITY shall insert a clause containing the terms of Article XI – Audits in all its contracts and subcontracts under this Agreement that exceed \$100,000.00 (One Hundred Thousand Dollars).

ARTICLE XII – REQUIRED FEDERAL PROCUREMENT PROVISIONS

Competition in the award of contracts or procurements resulting from this Project is strongly encouraged and the CITY should promote competition to the maximum extent practicable. The CITY agrees to include in its contract(s) a provision that the Airport Terminal designs for this Project are required to comply with the TSA's PGDS.

ARTICLE XIII – CHANGES AND/OR MODIFICATIONS

Changes and modifications to this Agreement shall be in writing and signed by the TSA CO and duly executed by the authorized representative of the CITY. Any modification shall cite this Agreement and shall state the exact nature of the change and/or modification. No oral statement by any person shall be interpreted as modifying or otherwise affecting the terms of this

Agreement. The properly signed written modification shall be attached to this Agreement and thereby become a part of this Agreement.

ARTICLE XIV – DISPUTES

When possible, disputes will be resolved by informal discussion between the parties. All disputes arising under or related to this Agreement shall be resolved under this Article. Disputes, as used in this Agreement, mean a written demand or written assertion by one of the parties seeking, as a matter of right, the adjustment or interpretation of Agreement terms, or other relief arising under this Agreement. The dispute shall be made in writing and signed by a duly authorized representative of the CITY or the TSA. At a minimum, a dispute under this Agreement shall include a statement of facts, adequate supporting data. In the event that the parties are unable to resolve any disagreement through good faith negotiations, the dispute will be resolved by the TSA Assistant Secretary or his or her designee. The parties agree that the TSA Assistant Secretary's decision shall be final and not subject to further judicial or administrative review and shall be enforceable and binding upon the parties.

ARTICLE XV – TERMINATION

In addition to any other termination rights provided by this Agreement, either party may terminate this Agreement at any time prior to its expiration date, with or without cause, and without incurring any liability or obligation to the terminated party (other than payment of amounts due and performance of obligations accrued, in each case on or prior to the termination date) by giving the other party at least thirty (30) days prior written notice of termination. Upon receipt of a notice of termination, the receiving party shall take immediate steps to stop the accrual of any TSA additional obligations that might require payment.

In the event of termination or expiration of this Agreement, any TSA funds that have not been spent or incurred for allowable expenses prior to the date of termination and are not reasonably necessary to cover termination expenses will be returned and/or de-obligated from this Agreement.

ARTICLE XVI – CONSTRUCTION OF THE AGREEMENT

This Agreement is an "other transaction" issued under 49 U.S.C. § 106(l) and 114(m)(1) and is not a procurement contract, grant or cooperative agreement. Nothing in this Agreement shall be construed as incorporating by reference or implication any provision of Federal acquisition law or regulation. It is not intended to be, nor shall it be construed as creation of a partnership, corporation, or other business entity between the parties.

Each party acknowledges that all parties hereto participated equally in the negotiation and drafting of this Agreement and any amendments thereto, and that, accordingly, this Agreement shall not be construed more stringently against one party than against the other.

This Agreement constitutes the entire agreement between the parties with respect to the subject matter hereof and supersedes all prior agreements, understandings, negotiations and discussions, whether oral or written, of the parties.

In the event that any Article and/or parts of this Agreement are determined to be void or otherwise invalid or unenforceable, such Article or portions thereof shall lapse. No such lapse will affect the rights, responsibilities, and obligations of the parties under this Agreement, except as provided therein. If either party determines that such lapse has or may have a material effect on the performance of the Agreement, such party shall promptly notify the other party, and shall negotiate in good faith a mutually acceptable amendment to the Agreement if appropriate to address the effect of the lapse.

ARTICLE XVII - PROTECTION OF INFORMATION

The parties agree that they shall take appropriate measures to protect all proprietary, privileged, confidential, or otherwise Sensitive Security Information (SSI) that may come into their possession as a result of this Agreement.

A. RELEASE OF TECHNICAL DATA

No Sensitive Security Information (SSI), as defined in 49 CFR Parts 15 and 1520, concerning the scope of this Agreement, shall be published or released to the public without prior written approval of the TSA Assistant Secretary or his or her designee. Guidance regarding SSI may be found in Appendix G, "Checked Baggage Screening Equipment Sensitive Security Information Identification Guide", of the TSA PGDS.

B. RECORDS AND RELEASE OF INFORMATION

All Sensitive Security Information (SSI), as defined in 49 CFR Part 1520, shall be handled in accordance with TSA policies and regulations. All employees, contractors, and subcontractors assigned to work under this Agreement are subject to the provisions of 49 CFR Part 1520, Protection of Sensitive Security Information, because they act for, or carry out duties for, or on behalf of the TSA. SSI may not be disclosed except in accordance with the provisions of that rule or where TSA otherwise approves.

C. MEDIA

Neither the CITY, nor its contractors shall make publicity or public affairs activities related to the subject matter of this Agreement unless written approval has been received from the TSA Office of Security Technology or the TSA Office of Strategic Communication and Public Affairs. The purpose of this provision is to preclude the inadvertent release of SSI to the general public.

ARTICLE XVIII - SURVIVAL OF PROVISIONS

The following provision of this Agreement shall survive the termination of this Agreement: Article XII – Required Federal Procurement Provisions; Article XI – Audits; Article XIV – Disputes, Article XVII – Protection of Information and Article XVIII – Survival of Provisions.

IN WITNESS WHEREOF, the Parties have entered into this Agreement by their duly authorized officers this 23rd day of April, 2013.

U. S. Department of Homeland Security
Transportation Security Administration

City and County of San Francisco Airport
Commission

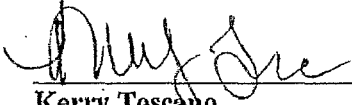
Kerry Toscano
Contracting Officer

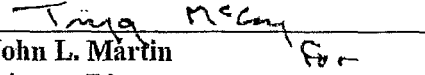
John L. Martin
Airport Director

4/23/2013
Date

4-4-13
Date

Authorized by Airport Commission

Resolution No. 13-0047

Adopted: MARCH 4, 2013

Attest: 
Jean Caramatti
Secretary, Airport Commission

Approved as to Form
Dennis J. Herrera, City Attorney

By: 
Sheryl Bregman, Airport General Counsel

Appendix A
TSA Planning Guidelines and Design Standards
Design Deliverables Checklist

Figure 2-4
DELIVERABLES CHECKLIST

PROJECT PHASE DELIVERABLES	SECTION	Completed	PROJECT PHASE DELIVERABLES	SECTION	Completed
Pre-Design Phase	2.2.1		Detailed Design Phase (continued)		
Preliminary Alternatives Analysis Report			70% Design Submittals (continued)		
Preferred Alternatives Analysis Report			Description of Operations		
Schematic Design Phase			Preliminary Contingency Plan		
Basis of Design Report	2.2.2		70% Specifications		
Detailed Program Requirements			Draft Site Specific Configuration Management Plan		
High-Level Flow-Based Modeling Assumptions and Results			Stakeholder Review and Approval Documentation		
Preliminary Concept Plans			70% Estimate of Probable Construction and O&M Costs		
Phasing and Constructability Technical Memoranda			Phasing Schedule		
ROM Estimate of Probable Construction and O&M Costs			Conveyor Manifest		
Stakeholder Review and Approval Documentation			Updated EDS Equipment List		
Preliminary Project Schedule			100% Design Submittals	2.2.3.3	
Detailed Design Phase	2.2.2		Bid Documents		
30% Design Submittals	2.2.3.1		Final Description of Operations		
Updated Basis of Design Report			Contingency Plans		
Operational Standards Assessment			Project Specifications		
Preliminary Plans			Final Site Specific Configuration Management Plan		
Cross Sections			Stakeholder Review and Approval Documentation		
Description of Operations			Final Estimate of Probable Construction and O&M Costs		
Baggage and Data Flow Charts			Final Phasing Schedule		
Table of Contents for CBIS			Updated EDS Equipment List		
Screening Equipment Installation Guidelines			Operations Training Materials and Documentation		
Outline of Reporting Capabilities			Construction Phase	2.2.4	
Stakeholder Review and Approval Documentation			Changes to Approved 100% Design Submittals		
30% Estimate of Probable Construction and O&M Costs			Construction Schedule		
Preliminary Phasing Schedule			Courtesy Copies of Shop and Installation Drawings		
Conveyor Manifest			Testing and Commissioning Phase	2.2.5	
EDS Equipment List			Pre-ISAT Documentation		
70% Design Submittals	2.2.3.2		ISAT Documentation		
Updated Basis of Design Report			Project Closeout Phase	2.2.6	
Updated Operational Standards Assessment			As-built CBIS Documentation Submittal		
70% Design Drawings			Final Copy of the PLC Program with Drawings		
Cross Sections			Final Copy of Disaster Recovery Procedures		

FOCCENT F031

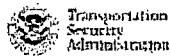

APPENDIX B: SCHEDULE OF DELIVERABLES

The following deliverables are required to be submitted by the THE CITY.

Item	Submitted To:	Frequency or Due Date
Schedule to include Project Milestones (Design and proposed Construction)	TSA Deployment Manager, OSTCBD@tsa.dhs.gov and TSA Contracting Officer	Within 30 days of the CITY awarding the design contract. Updates submitted with monthly TSA report.
Pre-Design Phase, Schematic, 30%, 70% and 100% Design deliverables	TSA Deployment Manager, OSTCBD@tsa.dhs.gov	In accordance with the TSA PGDS Deliverables Checklist
Preferred Alternative Package	TSA Deployment Manager, OSTCBD@tsa.dhs.gov	April 2013
30% Design	TSA Deployment Manager, OSTCBD@tsa.dhs.gov	June 2013
Design Contract Schedule of Fees	TSA Deployment Manager, TSA Contracting Officer, OSTCBD@tsa.dhs.gov	Provide upon issuing Design Contract
Copies of the Design Contract(s) and Change Orders	TSA Deployment Manager, TSA Contracting Officer, OSTCBD@tsa.dhs.gov	Change Orders requiring advanced TSA approval.
Monthly Project Report	TSA Deployment Manager, OSTCBD@tsa.dhs.gov	By the 10 th of each month. Electronic submission is requested.
Requests for Information or Clarification	TSA Deployment Manager	As needed
Final Invoice	TSA Deployment Manager TSA Contracting Officer, OSTCBD@tsa.dhs.gov	No later than 90 days after completion of the CBIS Construction Project.

The Monthly Project Report is to be submitted by the 10th of each month to the TSA Deployment Lead, and OSTCBD@tsa.dhs.gov and shall address the following:

- Design Schedule in both PDF and "live"/usable format to depict the critical path, baseline and actual date information; predecessors/successors. The Design Schedule will be used for all planned TSA activities.

Attachment 1: FY 13 SFO Recapitalize EDS Candidate Units

Terminal 1: 15 Units	G316, G317, G314, G277, G184, G194, G187, G265, G270, G243, G259, G182, G188, G191, G185
-------------------------	--

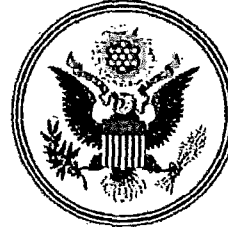

OTHER TRANSACTION AGREEMENT

BETWEEN

**DEPARTMENT OF HOMELAND SECURITY
TRANSPORTATION SECURITY ADMINISTRATION**

AND

**THE CITY AND COUNTY OF SAN FRANCISCO
Operating through its Airport Commission ("Commission")**

RELATING TO

**SAN FRANCISCO INTERNATIONAL AIRPORT (SFO)
Checked Baggage Recapitalization & Optimization Screening Construction Services
Project**

Negotiated by the TSA pursuant to
Aviation and Transportation Security Act, Pub. L. 107-71, 115 Stat. 597
49 U.S.C. §114(m)(1) and 106(l)(6).

HSTS04-13-H-CT1140

ARTICLE I – PARTIES

The parties to this Other Transaction Agreement (OTA) are the U.S. Department of Homeland Security, Transportation Security Administration (TSA) and the City and County of San Francisco, operating through its Airport Commission ("Commission"), as owner and operator of the San Francisco International Airport (SFO or Airport). The TSA and the Commission agree to cooperate in good faith and to perform their respective obligations in executing the purpose of this OTA.

ARTICLE II – LEGAL AUTHORITY

This OTA is entered into under the Commission of the Aviation and Transportation Security Act, Pub. L. 107-71, 115 Stat. 597, specifically 49 U.S.C. § 114(m)(1) and 106(l)(6), which authorizes other transaction agreements.

ARTICLE III – SCOPE

The purpose of this OTA is to set forth the terms and conditions, as well as establish the respective cost-sharing obligations of the TSA and the Commission with respect to the design, engineering and construction-related services necessary to implement the construction of the TSA recapitalization and optimization project design submitted by the Commission and reviewed by TSA pursuant to the TSA Planning Guidelines and Design Standards (PGDS) Version 4.1 found at:

<http://www.tsa.gov/research-center/airport-checked-baggage-guidance-materials>

This Project undertaken by the Commission involves the modification to or construction of the Airport terminal building infrastructure to recapitalize and optimize the TSA EDS systems located within the Checked Baggage Inspection System (CBIS). Terminal modifications include required changes to baggage conveyor components, mechanical, plumbing, electrical, structural, and telecommunications infrastructure to provide for the installation of Explosive Detection Equipment (EDS) within the baggage screening area, Explosive Trace Detection (ETD) equipment in the Checked Baggage Resolution areas, and the installation of applicable CBIS hardware and software for use with a checked baggage in-line baggage screening system. The objective of the Project is to enhance Airport security and baggage screening capabilities and throughput.

This OTA also includes design services for 70% and 100% drawings and specifications that will be submitted to TSA for review in accordance with the published TSA PGDS Version 4.1. This OTA does not include design services for the 30% design deliverable. The Commission will be responsible for developing various cost-effective solutions to replace fifteen (15) Explosive Detection System (EDS) machines currently located in Terminal 1 of the Airport, while minimizing the impact to operations and reducing the number of EDS by using higher throughput technology units (as appropriate). The solutions that the Commission proposes should be based upon a baggage screening rate derived from the current baggage screening rate and a projected, future screening rate. Solutions based upon such a combined current and future rate will allow the TSA to consider all cost factors available when making its decision of the optimal solution.

ARTICLE IV – COST SHARING AND OTHER RESPONSIBILITIES

1. **Capital Costs:** The estimated cost of the Project (Total Project Cost) relates to the activities to modify the airport terminal building infrastructure and the baggage handling system (BHS) to support the installation and operation of the EDS and ETD equipment. It does not include the costs of acquisition, delivery or installation of the EDS and ETD equipment itself. TSA will be solely responsible for the acquisition, delivery, installation, and testing of the EDS and ETD equipment at the designated Project location(s). The Total Project Cost includes the cost for the construction effort and the design effort for 70% and 100% design deliverables, but does not include the cost for the 30% design deliverable. All work performed by the Commission pursuant to this OTA shall be accomplished in accordance with the TSA PGDS v. 4.1.

2. The cost of the security-related portion of the Project has been determined to be \$59,429,406.00 (CBIS Project Costs).

A. **Recapitalization and Optimization:** TSA agrees to reimburse the Commission for 100% of the allowable, allocable, and reasonable CBIS Project Costs specifically related to the **Recapitalization and Optimization** scope of effort that is estimated at \$59,429,406.

B. **Total:** The CBIS Project Cost for Recapitalization and Optimization includes design and construction management in addition to construction costs. This OTA is not to exceed a total reimbursement of \$59,429,406.00 (TSA Reimbursement Limit).

3. TSA will determine allowable and allocable costs in accordance with the OMB Circular A-87 "Cost Principles for State, Local and Indian Tribal Governments" codified at 2 C.F.R. Part 225 (together with Appendices A – D) and Appendix F of the TSA PGDS. TSA will reimburse the Commission on an actual expense basis supported by one or more invoices submitted by the Commission in accordance with Article X "Payment." The parties understand and agree that all Project costs in excess of the TSA Reimbursement Limit of \$59,429,406, as well as any costs that are inconsistent with OMB A-87 and the guidance set forth in the TSA PGDS, shall be borne solely by the Commission unless otherwise agreed by the TSA in a written modification in accordance with this Article IV and Article XIII "Changes and/or Modifications." Should the TSA reimbursements of \$59,429,406, as adjusted pursuant to Article XIII, represent more than 100% percent of the final allowable and allocable, and reasonable CBIS Project Costs for the **Recapitalization and Optimization** scope of effort, the Commission will refund TSA sufficient funds such that TSA's total reimbursement will equal no more than 100% of the final allowable, allocable and reasonable CBIS Project Costs for the **Recapitalization and Optimization** scope of effort.

4. All costs requested for reimbursement must satisfy the requirements of both TSA's PDGS v. 4.1 and OMB Circular A-87. In general, the costs for which TSA will provide reimbursement under this OTA are limited to those costs associated with the CBIS area, the Checked Baggage Resolution Area (CBRA), and EDS network equipment room (if applicable to the CBIS Project) as defined in TSA's PDGS. Appendix F of the TSA's PDGS provides guidance regarding the reimbursable costs for TSA CBIS Projects.

A. Examples of costs commonly considered reimbursable under this OTA include:

- Soft cost allowances consisting of Design Fees, Project Management, Construction Management, Escalation, Design Contingency and Construction Contingency
- Construction Costs:
 - Demolition (airport building or BHS components related to the CBIS area.)
 - BHS infrastructure upgrades, platforms, catwalks located within the CBIS screening area.
 - BHS: The BHS portion located within the CBIS screening area, including redesign and upgrading of conveyors to support the integration of the EDS screening system.
 - Conveyor redesign and upgrade within the CBIS screening area.
 - Build out of the EDS network equipment room
 - Acoustical treatment in the CBRA area.
 - Heating, Ventilation, Air Conditioning (HVAC) to maintain equipment and employee environmental requirements for CBIS, CBRA and EDS network equipment room.
 - Electrical and communications infrastructure (cabling, control panels) and basic lighting fixtures for the CBIS and CBRA.
 - Telephone systems/pager systems for TSA CBIS screening area.
 - Basic architectural finishes.

Identification of cost classifications herein does not create any obligation on TSA's part beyond the requirements found in OMB Circular A-87 and TSA's PDGS v. 4.1.

B. Examples of costs not considered reimbursable include, but are not limited to:

- Exterior Building Shell.
- Baggage make-up carrousel or outbound sortation systems.
- Maintenance, repair parts or spare parts (other than spare parts which are initially provided by the Original Equipment Manufacturer during the installation of new equipment) for airport terminal improvements including the baggage handling conveyor components installed under this Project.
- Manual encoding consoles or stations.
- Employee break rooms, administrative office space and restrooms not intended for the sole use of TSA staff.
- Architecturally pleasing enhancements.
- Extended warranties beyond one (1) year.

5. TSA will review the Commission's requests for changes or associated costs beyond the scope of the Project. Requests from the Commission for modifications or revisions must be submitted in the form of a change order request. Change Orders shall not be considered authorization to exceed the TSA Reimbursement Limit unless the Commission submits to the TSA Contracting Officer and Contracting Officer's Representative (COR) prior written notification of the expected impact to the CBIS Project Cost and the corresponding impact to the TSA Reimbursement Limit, and the TSA Contracting Officer agrees in writing to the proposed Change Order, including the proposed increase to the CBIS Project Cost and the TSA Reimbursement Limit. The Commission may not use the TSA contingency funds provided for the Project, as identified by TSA as part of this OTA, without prior written approval from the TSA Contracting Officer. The Commission will not be reimbursed for any work performed

under a change order unless approved in writing by the TSA Contracting Officer in accordance with Article XIII of the OTA.

ARTICLE V: PROJECT RESPONSIBILITIES

The primary Project responsibilities of the TSA and the Commission are outlined below. In addition to primary Project Responsibilities, specific technical responsibilities for the two parties are contained in Appendix B, "Project and Acceptance Testing Requirements", attached hereto and incorporated by reference into this OTA. The Project will be overseen by the Commission, except for those portions of the Project that are TSA's sole responsibility as set forth in this OTA.

A. TSA Responsibilities

1. Provide the TSA's PGDS, as well as the EDS equipment specification upon request from the Airport.
2. Advise as to the type of EDS equipment to be provided at each Project design phase submission.
3. Furnish, deliver, install and test the EDS and ETD equipment.
4. Provide EDS Original Equipment Manufacturer Technical Support Advisory Services to the Airport regarding installation, integration and networking of the EDS units into the BHS.
5. Provide the CBIS System Specific Test Plan (SSTP) to the Airport for the commissioning, coordination and testing of the CBIS. See PGDS Appendix D for testing details. See Appendix B for further specifics relating to the TSA testing portion of the Project.
6. Establish and conduct the Integrated Site Acceptance Testing (ISAT) for the in-line CBIS performance capabilities with joint support from the Airport.
7. Review and approve ISAT results before the in-line CBIS is certified as ready for operational use.
8. Provide training for Transportation Security Officer personnel on the EDS equipment.
9. Evaluate the in-line CBIS in operation for 30 days after substantial use begins.
10. Review and consider requested changes submitted by the Airport to the CBIS design. Any changes in scope or associated costs must be approved in accordance with Article XIII "Changes and/or Modifications".
11. Provide maintenance, repair, and refurbishment to all TSA EDS and ETD equipment throughout its life cycle at no cost to the Commission.
12. Review and concur with the Recapitalization Project design, plans, and specifications for 70% and 100% design packages for the installation of the replacement EDS units in the CBIS based upon the recommendations and guidelines in the TSA PGDS in effect at the time of execution of this OTA.

B. Commission/Airport Responsibilities

1. Except for the responsibilities of the TSA, as outlined above, the CBIS Project will be managed and overseen by the Commission. The Commission, acting through such contractors as it may engage, will provide the engineering and design services, as well

as the associated construction and baggage handling system contractors, necessary for successful completion of the Project. The Commission will provide oversight of such contractor(s) to ensure the Project conforms to the TSA endorsed design, PGDS criteria and is completed within the prescribed costs and schedule identified and incorporated herein as Appendix C.

2. CBIS designs should be OSHA compliant; adhere to the applicable EDS and ETD installation and integration guide specifications; and should comply with all applicable Federal, State, and local building regulations. Provisions will be made in the CBIS design that will allow TSA and its contractor's full ingress to and egress from the CBIS area for the installation, operation, testing, maintenance, and repair of the EDS and ETD equipment.
3. Obtain all necessary construction licenses; insurance permits and approvals.
4. The Commission shall deliver a firm EDS delivery schedule requirement date to TSA no later than 60 days after construction contract award. This schedule will be reviewed and approved by TSA based on OEM EDS delivery schedules. If project cannot meet the acceptance date, the Commission will be responsible for the safekeeping of the EDS in a secure and climate controlled environment until such time the system(s) can be installed at the agreed upon site. The Commission will be solely responsible for any damages and or extra startup costs associated with or that occur during this delay.
5. Ensure the Project site will be ready to accommodate the installation of the EDS units when delivered. Project site preparation includes, but is not limited to, BHS modifications, mechanical, heating, electrical site preparation, including infrastructure to protect electrical or fiber optic cables, environmental controls, and any other airport terminal infrastructure work required to support the operational environment of the EDS and ETD units.
6. Facilitate the installation of the EDS units by providing a clear path during rigging and EDS installation, and provide sufficient space to allow for initial deployment activities (such as uncrating the device).
7. Provide three (3) feet of maintenance access space around the equipment so that spare parts may be removed and replaced.
8. Once installed, provide reasonable measures to protect the EDS and ETD equipment from harm, theft, and water intrusion in the screening area.
9. Prior to TSA ISAT Testing, it shall be the Commission /Airport's responsibility to exercise due diligence to protect and insure the EDS equipment from damage due to ongoing construction or weather.
10. The Airport shall provide for personnel, assistance, equipment and support services to jointly execute the Test Readiness Review (TRR) and ISAT leading to the commissioning and acceptance of the CBIS. Support will include but not be limited to:
 - a. Test bag laydown and storage areas secure and protected from the elements.
 - b. Baggage handlers for test bag staging, induction and retrieval during testing and commissioning including personnel and equipment necessary to move test bags between staging and ISAT areas.
 - c. Ensure representatives of the Baggage Handling System Contractor (BHSC), and System Programmer(s) are on site to run the CBIS during ISAT and resolve deficiencies found during testing.

- d. Airport badging required for TSA contractor ISAT team members shall be executed in a timely manner such that no greater than two (2) trips to the airport are necessary to complete all badging requirements to be issued and receive an airport badge. Should this requirement not be met, the Airport/ILDT shall provide all escorts necessary to allow the TSA ISAT Team to conduct the ISAT and follow-on live operations run-in observation.
 - e. Provide TSA and their Contractors full and complete most recent documentation of the project to include "approved for Construction" sets of the mechanical, electrical and controls drawings and control descriptions, see Appendix B for details.
11. Perform and bear all cost of the operation, maintenance and repairs for the airport terminal installed property such as the baggage handling conveyor system, including the conveyors in the baggage screening matrix, heating, air conditioning, electrical and mechanical infrastructure in support of this Project.
 12. Submit monthly milestone and project progress status reports by the 10th of each month to the TSA Contracting Officer's Representative (COR)/Regional Deployment Coordinator (RDC), TSA Site Lead Contractor and TSA Contracting Officer. Specific requirements for the content of the monthly project status report are identified in Appendix D.
 13. CBIS designs and construction shall meet all requirements of the TSA Security Technology Integrated Program (STIP) Data Requirements for Checked Baggage Systems as shown in Appendix E. The Airport shall provide all deliverables required in the STIP Data Requirements to the TSA COR/RDC.
 14. Receive concurrence from TSA at each stage of the design review in order to proceed to the next design review stage.
 15. Provide a budgetary construction cost estimate with the 70% and 100% design reviews for the Project.
 16. Ensure the EDS OEM site planning, installation, integration and networking guidelines are incorporated into the design to ensure operational, maintenance and environmental specifications are met.
 17. As part of the design, provide reasonable measures to protect the EDS and ETD equipment from harm, theft, and water intrusion in the screening area.
 18. Incorporate heating, ventilation, air conditioning into the design as well as OSHA requirements for those spaces occupied by TSA personnel.

For additional clarification regarding roles and responsibilities see Appendix B.

C. Operation and Maintenance Costs

It is understood and agreed that the EDS and ETD security screening equipment are and will at all times remain the property of the TSA. TSA will maintain, repair, and refurbish the EDS and ETD units at no cost to the Commission.

Except for the EDS and ETD security screening equipment owned by the TSA and separately provided for use at the Airport, the Commission shall own and have title to all airport terminal building improvements made in accordance with this OTA such as heating, ventilation, air conditioning, electrical and mechanical infrastructure, baggage handling conveyor systems and controls, or other assets which are acquired and installed under this OTA in support of this

Project. It will remain the responsibility of the Commission, its contractors or lessees acting through such agents as it may use, to maintain, repair and or replace such airport property to sustain the operational environment of the EDS and ETD security screening equipment. Title to all airport terminal building improvements that were purchased or reimbursed using Federal funds for this Project, shall become the property of the Commission, whether purchased with TSA or the Commission's funds.

D. Deliverables

Appendix D identifies other required deliverables to be submitted by the Commission and/or Airport.

ARTICLE VI - EFFECTIVE DATE AND TERM

The term of this OTA shall be from the date of execution of the OTA until five years from the date of execution, unless earlier terminated by the parties pursuant to Article XV "Termination" as provided herein or extended by mutual agreement pursuant to Article XIII "Changes and/or Modifications", in order to allow the Commission time to submit a final invoice, close out the Project, and address any other issues. The Commission agrees to work with TSA to close this OTA within six (6) months of completion of the Project including successful ISAT acceptance testing and operational run-in of the in-line CBIS.

The Commission will establish and provide to the TSA Regional Deployment Coordinator (RDC) and TSA CO, within 30 days of execution of this OTA, Project Milestones that allow objective measurement of progress toward completion. TSA maintains the right to identify any additional Project Milestones to be tracked by the Commission.

ARTICLE VII - ACCEPTANCE AND TESTING

TSA will deem the Design Project complete upon review and concurrency of the 100% design submittal package for the Commission. The 100% design submittal package must conform to the TSA PGDS Version 4.1, where feasible.

TSA will deem the CBIS-related portion of the Project complete upon successful results of the TSA ISAT (Integrated Site Acceptance Test) as conducted by the TSA independent Acceptance Test Contractor and successful completion of the 30-day Operational Run-In period. TSA ISAT will evaluate the CBIS against the TSA PGDS version stated in this OTA as well as assess and comment on functional and performance differences to the most current version of the PGDS version published at the time of ISAT.

Successful completion of Project requires the correction of CBIS deficiencies identified during the TSA ISAT as documented in the Quick Look Report (QLR) and as followed up at the end of the Operational Run-In period in the Test Summary Report (TSR). TSA will release the funds retained pursuant to Article X only after the CBIS has passed the ISAT test and Operational Run-In period and the deficiencies have been corrected. Additional details are contained in Appendix C, "Project and Acceptance Testing Requirements"

ARTICLE VIII - AUTHORIZED REPRESENTATIVES

The authorized representative for each party shall act on behalf of that party for all matters related to this OTA. Each party's authorized representative may appoint one or more personnel to act as an authorized representative for any administrative purpose related to this OTA, provided written notice of such appointment is made to the other party to this OTA. The authorized representatives for the parties are as follows:

A. TSA Points of Contact:

Contracting Officer's Representative/Regional Deployment Coordinator:

Shahzan Akber

Mail Stop TSIF #32

Transportation Security Administration

1 Post Office Road

Washington, DC 20528-6032

Phone: 571-227-5645

E-Mail: Shahzan.Akber@tsa.dhs.gov

Contracting Officer:

Kerry Toscano

701 South 12th Street

Arlington, VA 20598-6025

Phone: 571-227-4932

E-Mail: Kerry.Toscano@dhs.gov

Only the TSA Contracting Officer (CO) shall have the authority to bind the Federal government with respect to scope of work, funding and liability. The TSA Regional Deployment Coordinator (RDC) is also the TSA Contracting Officer Representative (COR) and is responsible for the technical administration of this OTA and technical liaison with the Commission. The TSA COR is not authorized to change the scope of work, to make any commitment or otherwise obligate the TSA, or authorize any changes which affect the liability of the TSA such as amount or level of funding.

The Commission must notify the TSA CO and COR in the event that any TSA employee or TSA contracted agent takes any action that may be interpreted by the Commission as direction which could increase the Project costs and could cause the Commission to seek reimbursement from TSA in excess of the TSA's total reimbursement liability as defined in Articles IV and IX of this OTA.

B. Commission/Airport Points of Contact:

The Commission/Airport Point of Contact for all correspondence is:

Greg McCarthy

Project Manager

San Francisco International Airport

Design, Construction, & Technology

Phone: 650-821-5204

E-Mail: Greg.McCarthy@flysfo.com

ARTICLE IX - FUNDING AND LIMITATIONS

TSA will provide funding to the Commission in an amount not to exceed \$59,429,406.00 (TSA Reimbursement Limit). Funds in the amount of \$59,429,406.00 are hereby obligated and made available for payment for performance of this OTA. Expenses incurred in executing the work identified herein are chargeable to:

Procurement Request (PR)	Accounting Code	Funding Amount
2113203CT1140	5CF05XB010D2013SWE044GE013723006200622CTO/59030 01518010000/251B/TSA DIRECT/DEF. TASK	\$6,000,246
	5CF12XB010D2013SWE044GE013723006200622CTO/59030 01518010000/251B/TSA DIRECT/DEF. TASK	\$53,429,160
TOTAL FUNDING AMOUNT:		\$59,429,406

In the event of termination or expiration of this OTA, any TSA funds that have not been spent or incurred for allowable expenses prior to the date of termination and are not reasonably necessary to cover allowable and allocable costs as of the date of termination will be returned and/or de-obligated from this OTA. TSA's liability to make payments to the Commission is limited to the funds obligated and available for payment hereunder, including written modifications to this OTA.

Under no circumstances will TSA be responsible to reimburse the Commission/Airport for profit or the general costs of government. The Commission may recover the allowable direct costs of the Commission personnel performing work necessary under this OTA, as well as the allowable and allocable costs of the contractors hired by the Commission to perform the necessary work under this OTA. Profit and overhead costs for the Commission contractors performing work on the Project are allowable costs. Submission of a cost allocation plan is required to address any indirect costs, to include the Commission/Airport employees, who work on multiple activities that will result in a request for reimbursement under this OTA. TSA will not be responsible for costs incurred by the Commission/Airport, its contractors or agents to perform work not in compliance with the TSA requirements in this OTA. The TSA CO has the right to recoup any payments made to the Commission/Airport if the TSA CO determines that the invoices exceed the actual costs incurred, or if the work substantially deviates from the TSA approved CBIS design requirements for the Project pursuant to this OTA.

TSA will reimburse only for allowable, allocable and reasonable costs in accordance with the OMB Circular No. A-87 in effect on the Effective Date of the OTA (codified at 2 C.F.R. Part 225) and the allowable/not-allowable costs identified in Appendix F of TSA's PGDS v 4.1.

ARTICLE X – PAYMENT

The United States Coast Guard Finance Center performs the payment function on behalf of the TSA. For purposes of submission to the Coast Guard Finance Center, the Commission must submit a completed Summary Invoice. Registration in the System for Award Management (SAM) is mandatory for invoice payment. To obtain information regarding SAM, please refer to <https://www.sam.gov/portal/public/SAM/>.

Invoices for reimbursable expenses will be submitted every sixty (60) days, as expenses are incurred, and must be prepared properly in accordance with the terms of this Agreement. For periods in which the Commission has not incurred a reimbursable expense, an invoice is not required. Expenses are considered to accrue on the date that the Commission is invoiced from a contractor, sub-contractor, supplier, or provider of services. Reimbursement by TSA is conditioned upon submission to TSA of an invoice identifying the Project costs that have been incurred and paid. The TSA will make its best effort to make payment to the Commission within 90 days from receipt of each properly prepared invoice for reimbursement of incurred Project costs.

Ten percent (10%) of all submitted costs identified by TSA as allowable, allocable and reasonable shall be retained by TSA until completion of the Project, and shall only be reimbursed to the Commission upon successful completion of all of its obligations under this OTA, including, completed system documentation submitted to TSA and successful completion of all testing as required in Article VII of this OTA.

In the event that an invoice for reimbursable expenses is not received by the TSA within a twelve (12) month period, the TSA reserves the right to terminate the OTA per Article XV. "Termination."

The TSA reimbursement process consists of two steps.

Step 1 – Summary Invoice Submittal to the U.S. Coast Guard Finance Center for Payment, and at a minimum should contain the following information:

- (1) Other Transaction Agreement Number
- (2) Invoice Number and Invoice Date
- (3) Complete Business Name and Remittance Address
- (4) Point of Contact with address, telephone, fax and e-mail address
- (5) Tax Identification Number and DUN's Number
- (6) Dollar Amount of Reimbursement requested
- (7) Signature of the Commission's authorized representative and the following certification language: *"This is to certify that the services set forth herein were performed during the period stated and that the incurred costs billed were actually expended for the Project."*

The Summary Invoice may be submitted by standard mail or by electronic transmission to the following address(s):

Mailing Address: TSA Commercial Invoices
USCG Finance Center
P.O. Box 4111
Chesapeake, VA 23327

Email: FIN-SMB-TSAINVOICES@uscg.mil

Step 2 – Submission of Summary Invoice and Supporting Documentation

Submittal to TSA for Approval of Payment:

The TSA CO and the COR are required to review and the TSA CO will approve all invoices prior to payment. To aid in this review, the Commission shall provide a copy of the Summary Invoice along with all receipts, contractor pay requests and other supporting information which specify the vendor, services provided, and products delivered as well as the appropriate documentation that the Commission has paid these obligations. The Commission should provide this supporting information simultaneously with Step 1 to expedite the payment process.

The Support Documentation should contain the following items:

- Summary Invoice from Step 1
- An executive summary project overview with the first invoice
- A summary spreadsheet providing a categorized breakdown of the amount invoiced
- Signed, approved and legible copies of each individual contractor's invoice to include schedules of values scope of work
 - Copies of contracts and change orders that provide support for the actual work being invoiced
 - Vendor and subcontractor invoices with specific details about services provided
 - Rationale for all allocations or unusual calculations or assumptions
 - Copies of subcontractor's invoices if listed on a prime contractor's invoice as a single amount (copies of timesheets and detailed backup not required if descriptions are clear and specific)
- Proof of payment by the Commission for each invoice in the form of copies of check/warrants, bank wire transfers, or accounting systems transactions

The Summary Invoice and supporting documentation may be submitted by email or mail via CD or paper documents to the below addresses. The final closeout invoice should include proof that all required deliverables have been provided.

TSA Contracting Officer's Representative
 Shahzan Akber
 Transportation Security Administration
 TSA Systems Integration Facility
 1 Post Office Way
 Washington, D.C. 20528-6032
 Mail Stop TSA TSIF - #32
 Email: OSTCBD@tsa.dhs.gov

TSA Contracting Officer
 C/O Mr. Henry Edquist
 Faithful & Gould
 1725 Duke Street, Suite #200
 Alexandria, VA 22314
 Phone: 571-403-8777
 Email: Henry.Edquist@fgould.com

Upon completion of the review of the supporting documentation for the Summary Invoice, the TSA CO and the TSA RDC/COR will advise the Coast Guard Finance Center regarding payment of the Summary Invoice.

TSA may pay any charges due under this OTA by electronic funds transfer, check, or other means.

ARTICLE XI - AUDITS

The Federal Government, including the Comptroller General of the United States, has the right to examine or audit relevant financial records for a period not to exceed three (3) years after expiration of the terms of this OTA. The Commission and its contractors must maintain an established accounting system that complies with generally accepted accounting principles. Records related to disputes arising out of this OTA shall be maintained and made available until such disputes have been resolved. As used in this paragraph, "records" includes books, documents, accounting procedures and practices, and other data, regardless of type and regardless of whether such items are in written form, in the form of computer data, or in any other form related to this OTA.

The Commission shall maintain all records and other evidence sufficient to reflect costs claimed to have been incurred or anticipated to be incurred directly or indirectly in performance of this OTA. The TSA CO or the authorized representative of the TSA CO shall have the right to examine and audit those records at any time, or from time to time. The right of examination shall include inspection at all reasonable times at the offices of the Commission or at the offices of the Commission's contractor(s) responsible for the Construction Project. The Commission will be required to submit cost or pricing data and supporting information in connection with any invoice relating to this OTA if requested by the TSA CO.

This Article XI shall not be construed to require the Commission or its contractors or subcontractors to create or maintain any record that they do not maintain in the ordinary course of business pursuant to a provision of law, provided that those entities maintain records which conform to generally accepted accounting practices.

The Commission shall insert a clause containing the terms of Article XI – Audits in all of its contracts and subcontracts under this OTA that exceed \$100,000.00 (One Hundred Thousand Dollars).

ARTICLE XII – REQUIRED FEDERAL PROCUREMENT PROVISIONS

Competition in the award of contracts or procurements resulting from this Project is strongly encouraged and the Commission should promote competition to the maximum extent practicable. The Commission may follow its local procurement requirements for this OTA. The Commission agrees to include in its contract(s) a provision that the Commission's designs and work for this Construction Project are required to comply with the TSA's PGDS Version 4.1, where feasible.

ARTICLE XIII – CHANGES AND/OR MODIFICATIONS

Changes and modifications to this OTA shall be in writing and signed by the TSA CO and duly executed by the authorized representative of Commission. Any modification shall cite to this OTA and shall state the exact nature of the change and/or modification. No oral statement by any person shall be interpreted as modifying or otherwise affecting the terms of this OTA. The properly signed written modification shall be attached to this OTA and thereby becomes a part of this OTA.

ARTICLE XIV – DISPUTES

When possible, disputes will be resolved by informal discussion between the parties. All disputes arising under or related to this OTA shall be resolved under this Article. Disputes, as used in this OTA, mean a written demand or written assertion by one of the parties seeking, as a matter of right, the adjustment or interpretation of OTA terms, or other relief arising under this OTA. The dispute shall be made in writing and signed by a duly authorized representative of the Commission or the TSA. At a minimum, a dispute under this OTA shall include a statement of facts, adequate supporting data and a request for relief. In the event that the parties are unable to resolve any disagreement through good faith negotiations, the dispute will be reviewed and adjudicated by the TSA Assistant Secretary or his or her designee. If a party disagrees with the decision of the TSA Assistant Secretary or his or her designee, they may pursue other available legal remedies.

ARTICLE XV – TERMINATION

In addition to any other termination rights provided by this OTA, either party may terminate this OTA at any time prior to its expiration date, with or without cause, and without incurring any liability or obligation to the terminated party (other than payment of amounts due and performance of obligations accrued, in each case on or prior to the termination date) by giving the other party at least thirty (30) days prior written notice of termination. Upon receipt of a notice of termination, the receiving party shall take immediate steps to stop the accrual of any additional obligations that might require payment.

In the event of termination or expiration of this OTA, any TSA funds that have not been spent or incurred for allowable expenses prior to the date of termination and are not reasonably necessary to cover termination expenses will be returned and/or de-obligated from this OTA.

ARTICLE XVI – CONSTRUCTION OF THE AGREEMENT

This OTA is an “other transaction” issued under 49 U.S.C. § 106(l) and 114(m)(1) and is not a procurement contract, grant or cooperative agreement. Nothing in this OTA shall be construed as incorporating by reference or implication any provision of Federal acquisition law or regulation. It is not intended to be, nor shall it be construed as creation of a partnership, corporation, or other business entity between the parties.

Each party acknowledges that all parties hereto participated equally in the negotiation and drafting of this OTA and any amendments thereto, and that, accordingly, this OTA shall not be construed more stringently against one party than against the other.

This OTA constitutes the entire agreement between the parties with respect to the subject matter hereof and supersedes all prior agreements, understandings, negotiations and discussions, whether oral or written, of the parties.

In the event that any Article and/or parts of this OTA are determined to be void or otherwise invalid or unenforceable, such Article or portions thereof shall lapse. No such lapse will affect the rights, responsibilities, and obligations of the parties under this OTA, except as provided therein. If either party determines that such lapse has or may have a material effect on the

performance of the OTA, such party shall promptly notify the other party, and shall negotiate in good faith a mutually acceptable amendment to the OTA if appropriate to address the effect of the lapse.

ARTICLE XVII - PROTECTION OF INFORMATION

The parties agree that they shall take appropriate measures to protect all proprietary, privileged, confidential, or otherwise Sensitive Security Information (SSI) that may come into their possession as a result of this OTA.

A. RELEASE OF TECHNICAL DATA

No Sensitive Security Information (SSI), as defined in 49 CFR Parts 15 and 1520, concerning the scope of this OTA, shall be published or released to the public without prior written approval of the TSA Assistant Secretary or his or her designee. Guidance regarding SSI may be found in Appendix G, Checked Baggage Screening Equipment Sensitive Security Information Identification Guide”, of the TSA PGDS.

B. RECORDS AND RELEASE OF INFORMATION

All Sensitive Security Information (SSI), as defined in 49 CFR Part 1520, shall be handled in accordance with TSA policies and regulations. All employees, contractors, and subcontractors assigned to work under this OTA are subject to the provisions of 49 CFR Part 1520, Protection of Sensitive Security Information, because they act for, or carry out duties for, or on behalf of the TSA. SSI may not be disclosed except in accordance with the provisions of that rule or where TSA otherwise approves.

C. MEDIA

Neither the Commission, nor its contractors shall include in its publicity or public affairs activities related to the subject matter of this OTA any SSI unless written approval has been received from the TSA Office of Security Capabilities or the TSA Office of Strategic Communication and Public Affairs. The purpose of this provision is to preclude the inadvertent release of SSI to the general public.

ARTICLE XVIII - SURVIVAL OF PROVISIONS

The following provision of this OTA shall survive the termination of this OTA: Article IV – Cost Sharing and Other Responsibilities; Article IX – Funding and Limitations; Article XI – Audits; Article XII – Required Federal Procurement Provisions; Article XIV – Disputes, Article XVII – Protection of Information and Article XVIII – Survival of Provisions.

IN WITNESS WHEREOF, the Parties have entered into this Agreement by their duly authorized officers this 26th day of September, 2013.

U. S. Department of Homeland Security
Transportation Security Administration

The City and County of San Francisco
(Acting through its Airport Commission
as owner and operator of the San Francisco
International Airport)

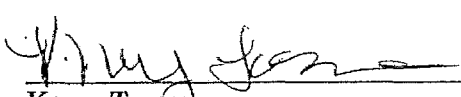
Kerry Toscano
TSA Contracting Officer

John L. Martin
Airport Director

9/26/2013
Date

9/20/13
Date

Authorized by Airport Commission

Resolution No. 13-0180

Adopted: Aug. 12, 2013

Attest: 
Jean Caramatti
Commission Secretary

Approved as to Form

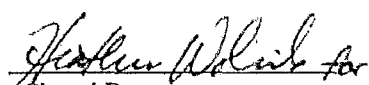
By: 
Sheryl Bregman
City Attorney

**Appendix A
TSA Planning Guidelines and Design Standards
Deliverables Checklist**

**Figure 2-4
DELIVERABLES CHECKLIST**

PROJECT PHASE DELIVERABLES	SECTION	Completed		PROJECT PHASE DELIVERABLES	SECTION	Completed	
		Yes	No			Yes	No
Pre-Design Phase	2.2.1			Detailed Design Phase (continued)			
Preliminary Alternatives Analysis Report				70% Design Submittals (continued)			
Preferred Alternatives Analysis Report				Description of Operations			
Schematic Design Phase				Preliminary Contingency Plan			
Basis of Design Report	2.2.2			70% Specifications			
Detailed Program Requirements				Draft Site Specific Configuration Management Plan			
High-Level Flow-Based Modeling Assumptions and Results				Stakeholder Review and Approval Documentation			
Preliminary Concept Plans				70% Estimate of Probable Construction and O&M Costs			
Phasing and Constructability Technical Memoranda				Phasing Schedule			
ROM Estimate of Probable Construction and O&M Costs				Conveyor Manifest			
Stakeholder Review and Approval Documentation				Updated EDS Equipment List			
Preliminary Project Schedule				100% Design Submittals	2.2.3.3		
Detailed Design Phase	2.2.2			Site Documents			
30% Design Submittals	2.2.3.1			Final Description of Operations			
Updated Basis of Design Report				Contingency Plans			
Operational Standards Assessment				Project Specifications			
Preliminary Plans				Final Site Specific Configuration Management Plan			
Cross Sections				Stakeholder Review and Approval Documentation			
Description of Operations				Final Estimate of Probable Construction and O&M Costs			
Baggage and Data Flow Charts				Final Phasing Schedule			
Table of Contents for CBIS				Updated EDS Equipment List			
Screening Equipment Installation Guidelines				Operations Training Materials and Documentation			
Outline of Reporting Capabilities				Construction Phase	2.2.4		
Stakeholder Review and Approval Documentation				Changes to Approved 100% Design Submittals			
30% Estimate of Probable Construction and O&M Costs				Construction Schedule			
Preliminary Phasing Schedule				Courtesy Copies of Shop and Installation Drawings			
Conveyor Manifest				Testing and Commissioning Phase	2.2.5		
EDS Equipment List				Pre-ISAT Documentation			
70% Design Submittals	2.2.3.2			ISAT Documentation			
Updated Basis of Design Report				Project Closeout Phase	2.2.6		
Updated Operational Standards Assessment				As-built CBIS Documentation Submittal			
70% Design Drawings				Final Copy of the PLC Program with Drawings			
Cross Sections				Final Copy of Disaster Recovery Procedures			

Appendix B

Project and Acceptance Testing Requirements

Scope: TSA support for the in-line Checked Baggage Inspection System (CBIS) solution will encompass design, construction and commissioning to support the in-line CBIS.

A. TSA responsibilities with regard to the Project are listed below in sections 1.1 to 1.7 . Many responsibilities are delegated to TSA contractors such as the EDS Original Equipment (OEM) Manufacturer, TSA Site Lead Contractor, and TSA Acceptance Test Contractor but ultimate responsibility resides with TSA.

1.1 EDS PLACEMENT

If applicable, TSA will ship, rig and install EDS machines and associated EDS screening equipment, to include any necessary ETD screening equipment, in their respective operational locations within the CBIS Project location. TSA, through the EDS OEM or other TSA contractors, shall be responsible for coordinating and integrating activities regarding placement of EDS equipment with the local TSA Point of Contact and Airport Point of Contact.

1.2 INSTALLATION SUPPORT

1.2.1 Project Management

As applicable, the TSA Site Lead Contractor and the EDS OEM shall be responsible for providing technical support throughout the entire period of performance during the installation Project. The OEM shall be responsible for all labor, materials, equipment, and support services required for planning, managing, and supervising all items related to the installation of the EDS units and associated ancillary equipment.

1.2.2 Technical Support

TSA will provide technical support to the Project through existing TSA contracts with the EDS OEM, TSA Site Lead Contractor, and TSA Acceptance Testing Contractor.

- The identified TSA Site Lead Contractor should be included in all relevant CBIS planning/project meetings relevant to TSA contributions to the Project. Project schedules and updates should be provided to the TSA Site Lead Contractor to ensure TSA has timely and sufficient notice of deliverable dates. The TSA Site Lead Contractor will assess the project progress against the project schedule and approved design to advise TSA of issues related to cost, schedule and/or performance impacts to the in-line project.
- The EDS OEM shall provide technical consultations to the TSA Regional Deployment Coordinator (RDC), TSA Site Lead Contractor, TSA Acceptance Test Lead, TSA Acceptance Testing Contractor and Airport regarding Project efforts that may include, but are not limited to: teleconferences; reviews of drawings and specifications; and exchanges of technical documentation such as specifications, manuals, and guides.
- TSA Acceptance Testing Contractor shall support ISAT of the CBIS (the EDS units, BHS and the integration between them) and will develop relevant CBIS test plans and reports that will be shared with the Airport.

- Support for the development and execution of the TSA Other Transaction Agreement in place between TSA and the Commission will be provided by TSA Office of Acquisition.
- Oversight and coordination of technical aspects of the Project will be provided by the TSA Regional Deployment Coordinator.
- Local TSA personnel shall support coordination of issues between TSA Regional Deployment Coordinator (RDC) and the Airport as directed by the Federal Security Director (FSD).

1.2.3 Commissioning Services

TSA, through the EDS OEM and its other TSA contractors, shall be responsible for all labor, materials, equipment, and support services needed to assemble, power up, configure, and install the EDS machines into the required operational condition. The EDS OEM shall provide technical support, documentation, and installation of the EDS units and the associated local Baggage Viewing Stations (BVS) after confirmation that all pre-installation requirements have been met. The EDS OEM shall coordinate with the TSA RDC, TSA Site Lead Contractor, TSA Acceptance Test Lead, and the Airport to perform system testing.

1.3 Acceptance Testing

Mandatory testing for this system includes Site Acceptance Testing (SAT) for the EDS units following installation; pre-Integrated Site Acceptance Testing following the integration of the EDS units with the BHS is affirmed through a Test Readiness Review (TRR) and Test Readiness Notice (TRN); and Integrated Site Acceptance Testing (ISAT) is conducted prior to TSA acceptance of the CBIS system for operational use. TSA may elect to oversee BHS pre-ISAT conduct to confirm readiness of the system and conduct the TRR within the timeline of the ISAT to reduce the overall testing timeline. See the following table for minimum lead time requirements for testing activities.

Table 1. ISAT Timeline

Lead Times for ISAT (Days Prior to projected test date)	Activity	Responsible Parties
Site Initiation or ≥ 180 days from ISAT	Site Survey Data Collection Checklist provided to the ILDT to complete to support the ISAT Site Specific Test Plan (SSTP) development.	TSA RDC, TSA Site Lead Contractor
≥ 120 days	<p>Completed Site Survey Data Collection Checklist and supporting site documentation received by TSA Acceptance Test Contractor from TSA Site Lead Contractor, to include:</p> <ul style="list-style-type: none"> • Any and All Approved Request for Variance (RFV) • Basis of Design Report • Sample BHS & CBIS Reports for all PGDS required Reports • BHS & EDS Network Diagrams and Server Architecture • Local Procedures for Fail-Safe, E-Stop, Jam Clearing and IQ Test Conduct • Airport/Airline Bag Induction/Hygiene Procedures • BHS Specifications • Controls Description and/or Description of Operation (if both exist then provide both) • Fail-safe and/or E-Stop Zone Drawings • BHS Mechanical Plan and Elevation Drawings from Natural Induction Locations to & through the CBIS, CBRA and Make-up Locations with Conveyors labeled, Plan View Drawings and Electrical Drawings of the BHS/CBIS with Control Station & Photoeye Locations and labeling. All drawings will be "Approved for Construction" by the Airport and not Pre-Bid or Bid Use Only versions. • At least 1 Plan/OverView Drawing that shows the entire CBIS in a single view • Conveyor Motor Manifest to include not less than (Conveyor Name, Phase, Conveyor Type, Degree of Turn, Degree 	ILDT, TSA Site Lead Contractor

	<p>of Incline/Decline, Length, Speed in FPM, Motor HP, Control Type (VFD yes/no), Brake Type, Motor Type, drive Type, FLA Rating).</p> <ul style="list-style-type: none"> • Installation & Commissioning Phasing Plan Narrative and Phasing Plan Drawings • Construction and Testing Schedule(s) 	
≥90 days	<p>On-site Site Survey Meeting held. to conduct initial test coordination and review the draft SSTP. This visit will allow the TSA Acceptance Test Contractor to tour the site, review the draft SSTP with the ILDT, coordinate logistics and manpower and initiate the SIDA badge application process, if required. TSA Site Lead Contractor coordinates schedule with the ILDT and TSA's Acceptance Test Contractor.</p>	<p>ILDT, TSA RDC, TSA Site Lead Contractor, TSA Acceptance Test Contractor</p>
≥45 days	<p>Final SSTP Review Meeting between the TSA Acceptance Test Contractor and the ILDT to review the final SSTP, include any other approved RFV, verify logistics & manpower, and review specific tests to be performed. <u>Any requests for variance from the SSTP testing requirements must be delivered in writing to the TSA RDC prior to this meeting for review and response.</u> This is the last chance for the ILDT to disclose any test standards that cannot be met in writing and formally justify exemption from test criteria. Any final revisions to the SSTP will be made and distributed to the ILDT and RDC prior to test execution.</p>	<p>ILDT, TSA Site Lead Contractor, TSA Acceptance Test Contractor, TSA RDC</p>
Typically 14 days to 1 day	<p>TSA Acceptance Test Contractor will ship test articles to the ILDT. The ILDT receives the test articles and stores in a secure and weather protected laydown area as agreed to by the ILDT and TSA Acceptance Testing Contractor in the Final SSTP Review Meeting.</p>	<p>ILDT, TSA Acceptance Test Contractor</p>
≥11 business days	<p>CBIS pre-testing - The ILDT conducts pre-testing. The TSA Site Lead contractor will provide oversight of CBIS pre-testing to validate the Test Readiness Notification (TRN) to the TSA RDC and Acceptance Test</p>	<p>ILDT, TSA Site Lead Contractor</p>

	<p>Team. The ILDT delivers internal pre-ISAT test results to the TSA Site Lead Contractor and the Site and TRR readiness confirmation letter to the TSA RDC and Acceptance Test Team. Upon successful review, the TSA Site Lead Contractor is deployed to the site within 7 days.</p> <p>Note: TSA may combine TRN with CBIS pre-testing and/or conduct TRR as a subset of ISAT</p>	
≥7 business days	<p>TSA Acceptance Testing Contractor or Site Lead Contractor initiates & performs the TRR.</p> <p>Note: TRR Performance by Acceptance Testing Contractor will be a subset of overall ISAT duration and permit passed tests to be credited toward ISAT completion. TRR failure will result in 2 week moratorium.</p>	ILDT, TSA Site Lead Contractor
≥3 business days	<p>When notice of successful TRR is completed and delivered to the TSA Acceptance Testing Contractor via a TRN no later than COB Wednesday (5:00 p.m. EST), ISAT deployment will occur the following Monday. If delivered any time Thursday through Sunday, the TSA Test Team deployment will occur on the second Monday.</p>	TSA Site Lead Contractor, TSA Acceptance Test Contractor
1 business days	<p>TSA Acceptance Test Contractor travel day (normally Monday)</p>	TSA Acceptance Test Contractor
Test start	<p>TSA Acceptance Test Contractor travel day (normally Monday) with mobilization activities and an in-brief meeting with ILDT on the next business day. Prior to start of testing, TSA Acceptance Test Contractor will accept PLC code from TSA Site Lead Contractor or ILDT prior to the start of testing. TSA Acceptance Test Contractor and ILDT will work together to perform ISAT and collect BHS and EDS performance documentation. Prior to departing the site, an Out-brief meeting will be held for all site stakeholders.</p>	ILDT, TSA Acceptance Test Contractor, TSA Site Lead Contractor
≤2 business days after ISAT complete	<p>QLR is submitted by the TSA Test Acceptance Contractor to the TSA Acceptance Test Lead and RDC for review</p>	TSA Acceptance Test Contractor, TSA Acceptance

	and approval	Test Lead, TSA RDC
X business days after QLR receipt	TSA conducts ISAT review board based on QLR results to determine readiness of CBIS to enter Live Operations and Bag Screening or whether to return CBIS to ILDT for correction of deficiencies prior to Live Operations	TSA RDC, TSA Acceptance Test Lead,
5 business days after ISAT review board decision	QLR is distributed by the TSA Deployment RDC	TSA RDC
For 30+ days from start of substantial use	The TSA Acceptance Test Contractor remotely monitors system performance during live operations run-in period and observes system on-site for 3+ days	ILDT, TSA Acceptance Test Contractor, TSA Test Lead
5 business days following completion of data collection and onsite observation for run-in	The TSA Acceptance Test Contractor provides a Test Summary Report (TSR) to the TSA Acceptance Test Lead and RDC for review and approval.	TSA Acceptance Test Contractor, TSA RDC, TSA Acceptance Test Lead
5 business days	RDC distributes TSA approved TSR to ILDT	ILDT, TSA RDC

1.3.1. Site Acceptance Testing (SAT)

The EDS OEM shall coordinate and conduct SAT testing on the EDS machines in the presence of a TSA designated government witness. The EDS OEM shall implement and coordinate testing by issuing a Test Readiness Notification (TRN) at least 7 days prior to the scheduled Acceptance testing. Passing SAT results are required prior to final integration of EDS to the BHS and to certify equipment readiness for operational use in screening baggage. In the event that the TSA supplied EDS units cannot meet SAT test requirements, TSA will ensure that any EDS machine defects are corrected or that the EDS unit is replaced.

1.3.2. Site Specific Test Plan Development (SSTP)

TSA has arranged for its Acceptance Test Contractor to develop a SSTP based on testing criteria outlined in the TSA PGDS Appendix D. The Draft SSTP will be based on the Airport's responses to a Site Planning Checklist to be completed ≥ 120 days in advance of ISAT. The Final SSTP shall be delivered to the Airport between 60 and 30 days in advance of projected ISAT start-up. The ILDT and TSA Acceptance Testing Contractor will conduct review meetings of the Draft SSTP and Final SSTP per schedule in Table 1, Section 1.3 of this OTA prior to ISAT. Any requests for deviation from the SSTP testing requirements must be delivered in writing through a RFV to the TSA RDC and Acceptance Test Lead prior to this Final SSTP meeting for review and response.

The TSA RDC and TSA Acceptance Test Lead will review/evaluate any requests for phased testing (e.g. non-consecutive testing activities requiring multiple TSA Test Team trips). Such

requests must be supported by compelling justification and submitted in writing through a RFV to the TSA RDC and TSA Acceptance Test Lead during the design process and well in advance of SSTP development. Programming or mechanical changes made before ISAT (typically during Contractor pre-testing) must be documented and provided to the TSA RDC and TSA Acceptance Testing Contractor. Once a system enters TRR, no variances will be permitted to the testing criteria.

1.3.3. Integrated Site Acceptance Testing (ISAT)

Scheduling and Coordination: Construction schedule including the ISAT start date(s) and duration(s) shall be shared with the TSA Site Lead Contractor, TSA RDC, TSA Acceptance Test Lead and TSA Acceptance Test Contractor through weekly and monthly meetings and reports upon submission of the SSTP checklist to ensure all stakeholders maintain schedule awareness. This schedule shall be distributed each time changes are made to the ISAT start date and/or duration. Changes made to the schedule within two weeks of the planned ISAT start date may relieve the TSA of the obligation to begin testing within three business days of the TRR. In this situation, the ISAT start date could depend on TSA's testing workload and resource allocation.

Test Results and Reports:

Testing results will be shared in hard copy format with the Airport from the RDC through the local TSA Point of Contact. Test results will identify security, efficiency and safety concerns.

There are four (4) possible test outcomes:

- **Meets PGDS Criteria** – The system under test meets CBIS design and PGDS criteria.
- **Minor Defects Found** – The system under test had no security failures and performance deficiencies would not impede system performance and staffing levels.
- **Major Defects Found** – The system under test had no security failures but performance deficiencies would be detrimental to system performance and/or staffing levels.
- **Fail** – The system under test produced security failures and/or deficiencies that would be excessively detrimental to system performance and staffing levels.

In the event of a failed ISAT result, TSA reserves the right to defer any subsequent re-tests for a period of at least 30 days.

1.4 INTEGRATION SERVICES

1.4.1. BHS Support

The EDS OEM shall assist the Commission's contractor to establish digital and serial communication for the EDS units. Once communication between devices has been established, the EDS OEM shall provide the following support and integration services.

- Assist the BHS contractor to obtain efficient EDS operation.
- Provide on-site Integration Engineer Support Services to facilitate the entire integration effort with the BHS.
- Be available to support system testing and validation conducted by internal or external organizations including the Integrated Site Acceptance Test (ISAT) and pre-ISAT Project testing and throughout the planning phases including the issuance of the ISAT TRN and TRR.

- During initial Live Operations Run-In , provide system performance documentation and technical assistance as requested by TSA, TSA Acceptance Testing Contractor and/or the ILDT.

1.4.2. Software and Hardware

Following SAT and throughout the integration effort, the EDS OEM shall install and test the required software and hardware to allow for digital and serial communication between the EDS and the BHS PLC if required. Functionality of the EDS BHS interface hardware and software shall be verified by the EDS OEM at the interface box prior to working with the Airport BHS contractor to ensure a proper operating PLC interface and to avoid delays.

1.5 SYSTEM NETWORKING

1.5.1 Network Infrastructure

The EDS OEM shall provide required patch cables and miscellaneous hardware to interface between network patch panel and EDS OEM supplied networking components.

1.5.2 Network Services

The EDS OEM shall provide: training for TSA staff; coordination and support for TSA and testing certification; and resources to conduct installation, testing, and initial operational support for networking. No other network may interface with the networked airport screening solution. The implemented assigned network for operation shall be an isolated, stand-alone network.

1.6. TRAINING

TSA will provide training for TSA screening staff on the operation of the EDS and ETD equipment.

1.7. MAINTENANCE

Upon successful completion of SAT testing for each unit, TSA will maintain and repair the EDS and ETD units throughout their lifecycles.

B. COMMISSION'S RESPONSIBILITIES with regard to the Project are listed below in sections 2.1 to 2.5 listed below.

2.0 DESIGN

The Commission will undertake design of a baggage screening system in accordance with the TSA PGDS to meet the needs of the Airport and TSA FSD. The Commission shall submit all applicable design requirements to the TSA RDC for review and as further defined in Chapter 2 of PGDS Version 4.1. The Commission shall respond to TSA design review comments promptly and in writing prior to the start of the next design phase for the CBIS Project.

2.1 EDS PLACEMENT

If applicable, the Commission shall ensure that the Project site will be ready to accommodate the installation of the EDS and associated equipment. The Commission shall provide adequate protection to the EDS machines and to the airport infrastructure during any and all EDS

movements. The Commission shall coordinate with the EM to integrate all activities regarding placement of EDS equipment. The Commission shall provide reasonable measures to protect the EDS and ETD equipment from damage in the screening area.

2.1.1 Site Readiness and Storage

The Commission shall confirm site readiness to receive EDS units to the TSA Site Lead Contractor no later than 10 business days prior to requested delivery date. Site readiness shall address availability of temporary or permanent power; removal of obstacles to the rigging path; and adequacy of physical environmental conditions within the delivery area that meet EDS OEM standards for protecting the EDS units. The Commission shall provide secure storage for the EDS units and any ancillary screening equipment if site conditions at the time of delivery do not provide adequate protection. The Commission shall provide secure storage space for hardware associated with EDS integration and multiplexing until it can be installed by EDS OEM Integration Support Staff. Failure to meet these minimum requirements may result in reallocation of equipment to other sites, thus affecting the airport's overall project schedule.

2.1.2 Rigging Services

The Commission will be responsible for providing rigging path verification, ingress path, and/or structural analysis. If required, the Airport will remove and replace any walls, windows, glass, doors, or other physical barriers in support of rigging activities.

2.2 INSTALLATION SUPPORT

2.2.1 Power Requirements

The Commission will provide terminations to the EDS for electrical power. The Commission will be responsible for providing all infrastructure power requirements including separate metering. If applicable, the Commission will design and install all power requirements to terminal locations within the Checked Baggage Resolution Areas and at EDS locations. The Commission will provide cabling from terminations to EDS equipment. The Commission shall attest to the availability of power supply to adequately support the EDS and associated equipment in accordance with OEM specifications and be liable for damage to this equipment resulting from intentional deviations to accepted power supply conditions.

2.2.2 Commissioning Services

The Commission will be responsible for obtaining all other infrastructures not mentioned in Section 2.2.1 to support EDS operations and maintenance.

2.3 INTEGRATION SERVICES

The Commission shall ensure that the BHS Contractor coordinates with EDS OEM in support of integration activities (e.g. installation and testing the required software and hardware to allow for digital and serial communication between the EDS and the BHS PLC) as needed. Terminations to the EDS for BHS PLC communication shall be performed by the Commission.

2.4 NETWORKING

2.4.1. Network Infrastructure

The Commission will design and install all communication conduit, fiber, etc. as required by the EDS OEM's design criteria for the EDS and EDS networking system, including but not limited

to connectivity of Checked Baggage Resolution Areas, TSA network control room, and BHS Control Room as required. Exact parameters will be reviewed at Project start-up by TSA.

The Commission will provide cabling and network patch panels in TSA control rooms, ETD search areas, and the TSA network room as determined by the network design conducted in conjunction with the Commission. The EDS OEM shall provide required patch cables and miscellaneous hardware to interface between network patch panel and EDS OEM-supplied networking components. The Commission will provide all electrical outlets to support installation and operation of a fully multiplexed explosive detection system.

2.4.2. Network Services

No other network may interface with the networked airport screening solution. The implemented assigned network for operation shall be an isolated, stand-alone network.

2.5. ACCEPTANCE - TESTING SUPPORT

The Project schedule shall allow for sufficient time to conduct mandatory testing of the EDS units after installation and integration. The Project schedule shall also factor in minimum lead times for notification of readiness for testing (7 days for SAT; 3 days for TRR; and at least 3 business days for ISAT). The Commission shall identify operational windows in time in which testing activities can be accomplished. Testing activities will be scheduled for normal 8-hour business days (Monday-Friday) and should not include holidays.

Testing activities shall also be scheduled such that test articles shall not be comingled either physically with Live Passenger Bags on existing or new screening systems or their electronic screening images shall not appear on consoles being used for Live Passenger Bag screening. Use of temporary networks or phased testing to accommodate the separation of Live Bags and Test Articles must be approved in writing through a RFV in advance of TRR/ISAT by the TSA RDC and TSA Acceptance Test Lead.

Requests for overtime or multiple shifts are discouraged and will only be considered based on compelling justification. The TSA RDC and TSA Acceptance Test Lead will review/evaluate any requests for phased testing (e.g. non-consecutive testing activities requiring multiple test team trips). Such requests must be in writing supported by compelling justification and submitted to the TSA RDC well in advance of SSTP development. Programming or mechanical changes made before ISAT (typically during Contractor pre-testing or TRR) must be documented and provided to the TSA RDC and Acceptance Test Contractor.

2.5.1 Site Specific Test Plan (SSTP)

The Commission shall ensure that information needed to develop an accurate SSTP is provided to TSA Test Acceptance Lead at the earliest opportunity, but no later than 120 days prior to the requested testing date. Required documentation includes:

- Completed Site Survey Data Collection Checklist
- Any and All Approved Request for Variance (RFV)
- Basis of Design Report
- Sample BHS & CBIS Reports for all PGDS required Reports
- BHS & EDS Network Diagrams and Server Architecture
- Local Procedures for Fail-Safe, E-Stop, Jam Clearing and IQ Test Conduct
- Airport/Airline Bag Induction/Hygiene Procedures
- BHS Specifications
- Controls Description and/or Description of Operation (if both exist then provide both)
- Fail-safe and/or E-Stop Zone Drawings
- BHS Mechanical Plan and Elevation Drawings from Natural Induction Locations to & through the CBIS, CBRA and Make-up Locations with Conveyors labeled Plan View Drawings and Electrical Drawings of the BHS/CBIS with Control Station & Photoeye Locations and labeling. All drawings will be "Approved for Construction" by the Airport and not Pre-Bid or Bid Use Only versions.
- At least 1 Plan/Overview Drawing that shows the entire CBIS in a single view
 - Conveyor Motor Manifest to include not less than (Conveyor Name, Phase, Conveyor Type, Degree of Turn, Degree of Incline/Decline, Length, Speed in FPM, Motor HP, Control Type (VFD yes/no), Brake Type, Motor Type, drive Type, FLA Rating).
 - Installation & Commissioning Phasing Plan Narrative and Phasing Plan Drawings
- Construction and Testing Schedules provided through weekly and monthly meetings and reports prior to ISAT.

All drawings shall be clearly visible and readable when plotted on Arch D Size Stock. All documents shall be submitted electronically (e.g. text documents in MS Word or PDF and drawings in AutoCAD [.dwg] or PDF.)

Any system constraints that will prevent compliance with TSA testing and performance criteria must be disclosed in writing to TSA as far in advance as possible to allow for evaluation of applicable waivers. Any restrictions on system availability and accessibility for testing shall be disclosed. Cutover plans including any phasing plans that will affect the TSA Acceptance Test Contractor's ability to test the full system from ticket counters and curbside inductions (if applicable) through the outbound/sortation system shall also be disclosed to allow for the development of an accurate SSTP. Cutover plans that will result in multiple testing phases shall also be presented to the TSA RDC in writing for review and approval prior to the Test Coordination Meeting and no later than 30 days prior to ISAT.

The Commission will have the opportunity to review and comment on SSTP in advance of testing. Comments and/or questions should be directed to the TSA RDC and the TSA Site Lead Contractor.

2.5.2. Test Readiness Report (TRR)

This pre-ISAT activity is conducted by TSA Site Lead Contractor in coordination with the Commission (typically the BHS Contractor.) The purpose of this testing activity is to assure TSA of site readiness for ISAT and is a precursor for TSA authorization for TSA Acceptance

Test Contractor to deploy. The Commission will be provided TRR data sheets by the TSA Site Lead Contractor. BHS/CBIS configuration and operation shall be in final form intended for bag screening operations. Unless mutually agreed to, changes/improvements to BHS/CBIS between TRR and ISAT are not authorized. The Commission must address security and efficiency defects found during TRR and be prepared to implement mutually agreed upon corrective actions prior to ISAT.

Required input from the Project Team will include:

Functional Testing Documentation: Testing authentication must be clearly reported and show every test with bag ID and declared status on printed EDS FDRS (Field Data Reports) and on the printed Critical Tracking PEC Report (as required in PGDS Section 7.2.14) resulting bag destination. Ledger forms should show test date, type of test, identification of bag destination location, and ID number of the bags arriving at that location. These reports should be organized and indexed in an electronic media/file or loose-leaf binder(s)

- Each test shall conclude with an indication of successfully passing the required criteria of BHS specification and testing criteria and if conflict or failure exists, then so indicate with an explanation.
- Presentation of completed testing and TRR required documentation to TSA Site Lead not less than 7 business days prior to anticipated Pre-ISAT date is required.

System Mixed Bag Test and System Throughput Test Observation: Sufficient numbers of test bags (no less than 100 test bags per EDS) will be utilized to "stress" the BHS/CBIS as would occur during peak operating times. Test bag set profile should be similar to the TSA Acceptance Test Contractor's test bag profile.

- A real-time observation by TSA Site Lead Contractor of a global BHS/CBIS System Mixed Bag Test and System Throughput Test using clear and suspect bags is required.
- All EDS equipment must be operational.
- All baggage entry points must be utilized.

The TSA Site Lead Contractor or Acceptance Testing Contractor performs the TRR. If successful, a Test Readiness Notice is issued to the TSA RDC and the TSA Acceptance Test Contractor for ISAT deployment. If delivered by COB Monday through Wednesday (5:00 p.m. EST), ISAT deployment will occur the following Monday. If delivered any time Thursday through Sunday, ISAT deployment will occur on the second Monday. If changes are made to the system following TRR without prior coordination with TSA, ISAT testing shall be postponed pending submission of documentation for review and evaluation by TSA and its Acceptance Test Contractor (see paragraph 2.5.7)

2.5.3. Logistical Support Needs: The Commission shall identify and provide any logistical or support needs that will impact TRR and ISAT testing, to include:

- any process needed to obtain sufficient baggage tags should the system use IATA baggage tracking mechanisms, pier tags should the system use pier tags, or blank bag tags if the system does not use IATA baggage tracking mechanisms; Quantities of tags needed will be coordinated during the Site Survey Meeting and the SSTP review Meetings

- any process needed to obtain sufficient baggage tubs/totes (typically 20 per installed EDS)
- any process needed to obtain sufficient bag transportation devices (tugs, totes, carts, etc.) needed to move test articles in and around the CBIS, CBRA, laydown area and sort/claim devices
- any process needed to obtain safety training and/or General Contractor access for TSA Acceptance Test Contractor, as required"
- any process needed to obtain airport badges/access for TSA Acceptance Test Contractor personnel; and/or personnel escorts. Airport SIDA Badging Process shall not require more than 2 trips of test team personnel to the site, 1 work week maximum duration each, to obtain SIDA badges including fingerprinting, SIDA Training, testing, issuing and pickup.
- availability of BHSC and BHS Programmer to operate BHS during ISAT and provide support for ISAT Testing and diagnostic activities (BHS reports, investigations, and explanations to questions from the TSA Acceptance Test Contractor)
- provide baggage handling support for testing activities including bag loading, unloading, transport, fault recovery, during ISAT and TRR including movement between test and laydown/storage areas; and
- availability of support for delivery and secure and weather protected storage of TSA Acceptance Contractor test bags for ISAT (100 bags per EDS contained in 2 LD3s per 100 bags.)

2.5.4. ISAT Testing: The TSA Acceptance Test Contractor will meet with the Commission between 30 and 45 days prior to testing to coordinate the conduct of ISAT testing. The TSA Acceptance Test Lead and the Commission will finalize details relating to the scheduling and duration of the testing. (Generally allow one day of travel for ISAT Testing Team in and out; one day for Site Mobilization; one day per EDS Spur Line; one day per System Level Test (Dieback, Mixed Bag Sortation and Throughput; one day for demobilization and cleanup). It is recommended to schedule one to two additional days for unforeseen testing delays or contingencies.

2.5.5. Test Results and Reports

The Airport shall report corrective actions to be applied and the timeline associated with deficiency corrections. Corrective actions shall address all defects identified in the TRR/TRN (pre-ISAT) or QLR (ISAT). TSA is not obligated to accept or operate a baggage screening system that does not meet the minimum test standards.

2.5.6. Operational Run-In

The Run-In period will extend for a minimum of 30 days from the start of substantial operations with cutover of substantial input and output lines. This period of time shall be discussed and agreed to by all parties during the SSTP development process, and reconfirmed at the completion of the ISAT. Substantial Operations shall normally be defined as when the CBIS is processing 85% or greater of its normal (not peak) operational daily load of "checked bags or luggage" for the time period at hand (i.e. not based on future dates of operation). This period shall also be dependent on resolution of deficiencies found during testing and Run-In. Once a week during the Run-In period, the Airport or their authorized representatives shall forward electronic

versions of all CBIS Reports required by PGDS Chapter 7, Section 7.2.14. to the TSA Acceptance Testing Contractor. After receipt, review and analysis of at least 21 days of performance data, TSA and their Acceptance Test Contractor will deploy to the site in either the 4th or 5th week of Substantial Live Operations to physically verify closure of open deficiencies, and assess observe system operation against the data reported. The ILDT or their Contractors will also pull and provide the PLC Code for the same PLCs as provided at ISAT start. Based on the data analysis and physical observations, a recommendation will be made to TSA via a Test Summary Report (TSR) to end the Run-In period, extend the Run-In period, and/or change the operational status of the CBIS.

2.5.7. Post Commissioning Activities:

The TSA Site Lead Contractor will conduct 30-day operational run-in observations of the system following successful ISAT testing.

The Airport shall provide the TSA RDC a written response outlining corrective actions that will be taken due to outstanding deficiencies, issues, and action items identified in the Quick Look Report (QLR) and Test Summary Report within two (2) weeks of receipt of the QLR or TSR.

For the continued and secure operation of the CBIS, all changes to the BHS system that impact the CBIS operation during and after its initial commissioning must be reviewed, evaluated, and endorsed by TSA before they are implemented by the Airport. The Post-ISAT changes procedure must be provided in accordance with PGDS Appendix D. The procedure is to be followed for all changes to CBIS systems other than those required for normal routine and periodic maintenance/repairs to the BHS system. The Airport responsible for the BHS system shall assemble an information package for submittal to TSA RDC which includes the following minimum information.

- Written description of all proposed physical and programming changes to the BHS and CBIS system(s)
- Reason for proposed change(s)
- Anticipated impact to system operation (e.g. increased throughput, lowered tracking losses, elimination of bag jams)
- Drawings showing affected areas
- Any potential security, tracking or efficiency impacts, including impacts on TSA manpower or operations
- Testing procedures
- Proposed date of changes

A CBIS Configuration Change Request Form will be provided by TSA. This package shall be delivered to the local TSA FSD who shall review the package. The local TSA FSD shall add any comments he/she may have and forward the form to the following email address: OSTCBD@dhs.gov.

The TSA will review and analyze the efficacy and impact of these changes to determine if it may be necessary for TSA to re-certify the CBIS system(s). Once the review has been completed, TSA shall notify the local TSA FSD and the Airport with the TSA recommendation and testing requirements for the system changes,

**APPENDIX C
Milestone Schedule**

Design & Construction Services Milestones	[Dates to be included]
Project Validated / Notice to Proceed (NTP)	
Design OTA Awarded	
Facility Modification OTA Awarded	
Pre-Design Deliverables Submitted	
Pre-Design Deliverables Approved	
Schematic Design Deliverables Submitted	
Schematic Design Deliverables Approved	
30% TSA Design Deliverables Submitted	
30% TSA Design Deliverables Approved	
70% TSA Design Deliverables Submitted	
70% TSA Design Deliverables Approved	
100% TSA Design Deliverables Submitted	
Final Construction Drawings Approved	
Facility Modification NTP (if applicable)	
Facility Modification Progress Meetings (reoccurring)	
Facility Modification Substantially Complete (if applicable)	
Site Assessment and Survey Report Submitted	
Site Installation Plan (SIP) Submitted	
SIP Approved	
EDS Delivered and Placed	
Site Acceptance Test (SAT) Passed	
Integrated Site Acceptance Test (iSAT) Test Readiness Review Complete (if applicable)	
iSAT Passed (if applicable)	
EDS Installation/Networking Start	
EDS Installation/Networking Finish	
EDS Decommissioned (if applicable)	
EDS Removal Start (if applicable)	
EDS Removal Finish (if applicable)	
Live Bag Screening (LBS) Start	
Record Dwgs / CAD As-Built Submitted	
TSA Final Sign-off of Project	
Final Invoice Submitted	
Project Completion Notification Submitted	
Project Finish / Contract Closeout	

APPENDIX D, SCHEDULE OF DELIVERABLES

The following deliverables are required to be submitted by the Commission:

Item	Submitted To:	Frequency or Due Date
Design: 70% and 100% to include detailed construction cost estimate	TSA Regional Deployment Coordinator	In accordance with the TSA PGDS, version 4.1
EDS Delivery Schedule	TSA Regional Deployment Coordinator	NLT 30 Days after Construction Contract Award
Schedule of Values (Design, Construction, Baggage Handling Contracts)	TSA Regional Deployment Coordinator TSA Contracting Officer	Within 30 days after execution of the TSA Agreement or upon issuing Notice to Proceed to Contractor. To be updated on a monthly basis and submitted with the monthly report.
Copies of the Design and related Construction Contracts and Change Orders	TSA Regional Deployment Coordinator TSA Contracting Officer	Upon contract award. Change Orders affecting the CBIS Project require advance TSA approval.
Monthly Milestone and Project Status Report	TSA Regional Deployment Coordinator TSA Contracting Officer TSA Site Lead Contractor	By the 10 th of each month. Electronic submission is requested if feasible.
Quarterly Project Financial Statement	TSA Regional Deployment Coordinator TSA Contracting Officer FinanceConfirm@tsa.dhs.gov	Quarterly upon execution of the OTA.
Summary report of Small Business/Disadvantage Business Enterprises utilization Report	TSA Contracting Officer	By September 30 th each year and upon completion of the Project via email
CONSTRUCTION PHASE		
Mechanical and Electrical Shop Drawings	TSA Regional Deployment Coordinator TSA Site Lead Contractor	Upon completion by the Commission
Close Out Process		
Close Out Process – Correction of testing deficiencies	Close Out Report submitted to TSA Regional Deployment Coordinator and TSA Site Lead Contractor	Airport responses within (2) weeks of receipt of QLR and TSR to address noted CBIS
Final Copy of PLC program and software disaster recovery	TSA Regional Deployment Coordinator	No later than 30 days after commissioning of system(s)

procedure in electronic format.		
As Built Drawings in electronic format, .dwg (AutoCAD) or comparable format to include final description of operations; mechanical layouts, including belt speeds in CAD and PDF file format.	TSA Regional Deployment Coordinator	No later than 30 days after 30-day operational run-in period
Overview of drawings of the Matrix/Node, Resolution Room, OSR Room as applicable. dwg (AutoCAD) or comparable format	TSA Regional Deployment Coordinator	30 days after 30-day operational run-in period
Final Invoice	TSA Regional Deployment Coordinator TSA CO	No later than 90 days after final sign-off of system by TSA Deployment Manager, following successful operational run-in period and start of live bag screening
POST COMMISSIONING CHANGES		
CBIS Changes after Commissioning	OSTCBD@dm.gov	See Post Commissioning Requirements, Appendix B, paragraph 2.5.7

The Monthly Milestone and Project Report are to be submitted by the 10th of each month. A draft Monthly report template will be submitted via separate correspondence. The Monthly Milestone and Project Report shall address the following:

- a. Actual start and/or finish dates for updated/completed activities.
- b. Remaining duration, required to complete each activity started, or scheduled to start, but not completed
- c. The Project's progress to include Project Percent Completion; cost incurred and invoiced to date; a forecast the Project completion date and final costs; as well as monthly schedule and budget variances throughout the Project.
- d. Percentage for completed and partially completed activities.
- e. Any CO approved changes including but not limited to new activities, deleted activities, activity duration changes, and change in logic relationships between activities.
- f. Status date for the schedule update.
- g. A statement that identifies and describes any current or anticipated delays that includes the following information: identification of the delayed activity by description and activity code; type of delay; cause of the delay; effect of the delay on other activities, milestones, and completion dates; identification of actions needed to avoid or mitigate the delay.
- h. Summary of cost incurred and invoiced to date.

- i. Description of lessons learned
- j. Construction Schedule in both PDF and "live"/usable format to depict the critical path, baseline and actual date information; predecessors/successors and shall be broken down to a minimum of three (3) WBS levels where applicable.

The construction schedule will be used for all planned TSA activities (delivery of equipment, scheduling of testing, etc).

APPENDIX E

STIP DATA REQUIREMENTS FOR CHECKED BAGGAGE SYSTEMS

The TSA HQ Office of Information Technology (OIT) and Security Technology Integrated Program (STIP) require STIP-enabled transportation security equipment (TSE) to have specific connections to securely and reliably network the equipment. Multiple parties play a role in this portion of Checked Baggage Inspection System (CBIS) specification and execution.

Roles and Responsibilities for Implementing STIP

As CBISs are recapitalized or optimized, the project owner's contractor will provide new telecommunications outlets and cables as needed to support new technology. If a CBIS reconfiguration is initiated as part of a recapitalization/optimization, safety effort, new technology deployment or any other CBIS redesign initiative, the CBIS contractor will be responsible for restoring the previous state of connectivity ("make whole"), including development of the scope of work (SOW). Implementation in the field will occur via the CBIS contractor. A working group, or Integrated Local Design Team (ILDT) must be formed consisting of representatives from the Airport Authority, FSD staff, OSC, OIT and STIP. The group should meet immediately via conference call once it has been determined that a CBIS is going to be recapitalized or optimized. This action will ensure that ALL aspects of the CBIS redesign have been identified and assigned to a specific group for action and funding. The ILDT will organize the working group members, develop, review and approve the SOW. The OIT Field Regional Manager (FRM) shall always be consulted when a CBIS redesign is initiated and will provide the necessary routing information to ensure the checked baggage systems are appropriately cabled to a networked TSA IT cabinet.

The IMAC Process

The IMAC Process is the mechanism by which TSA OIT will procure and install IT hardware (e.g. network switch) following the IT infrastructure build-out of a CBIS contractor. The OSC Regional Deployment Manager (RDM) shall be responsible for engaging OIT at project initiation and including the respective regional Field Relations Manager (FRM) throughout the construction process.

The IMAC process takes between 30 and 45 days and needs to be initiated to complete the following tasks:

- Procurement, configuration and shipment of IT hardware
- Installation of IT hardware
- Patch cabling of checked baggage equipment
- Validation of network connectivity for checked baggage equipment
- Validations of STIP EM sever registration for checked baggage equipment.



It is imperative to engage each team member as early as possible in order to avoid any gaps in IT services.

Specific Design Standards and Requirements

Two modular jacks consisting of a flush-mounted telecommunications outlet box plus/minus 10 feet from the equipment are required. Even though one is redundant, both terminations should be connected using Cat5e or Cat6 4-pair 100 ohm unshielded twisted pair (UTP) or screened twisted pair (ScTP) cable and terminated on the patch panel in the closest TSA IT cabinet. The data cable type should be based on the existing conditions at the Checked Baggage Inspection System (CBIS). The purpose of this connectivity is so that TSA HQ can review statistical data over the network from screening equipment for a particular airport and time period without having to go to the site.

Installation and/or relocation of Cat5e/Cat6 data cabling will meet or exceed the specifications listed in the TSA Structured Cabling System Guidelines dated July 2012 [Attached]. This document will be provided by the TSA to the ILDT.

In addition, the following requirements should be met:

- All ETDs and stand-alone EDSs will have 1 “dual telecommunications outlet”.
- It is assumed that when a multiplex server is present, connectivity to TSANet will terminate at the multiplex server cabinet, therefore connectivity to TSANet for each EDS is not required.
- All core drilling will support a minimum of 4 “modular jacks”.
- All new fiber installations will be multimode fibers, either multimode fiber, either 50/125 or 62.5/125 micron fibers or 50/125 or 62.5/125 micron fibers, six-strand bundles enclosed in inner duct.
- All cabinet installations require 2 110v 20A service.
- All cabinet installations will meet the local seismic rating requirements and can be floor/bracket mounted.
- All cabling outside of TSA controlled space must be in Rigid Metal Tubing (RMT) conduit. Any deviance will must be approved through existing RFV procedures.
- All newly installed and existing data jacks and associated patch panels must comply with TSA’s approved scheme [see provided TSA Structured Cabling System Guidelines dated July 2012].
- Provide TSA completed Data Capture Sheet [Attached] and cable certification paperwork prior to established I-Sat date.

Figure 1 illustrates all of the equipment that must be connected to the Main Distribution Frame (MDF)/Intermediate Distribution Frame (IDF) IT cabinet for a stand-alone CBIS configuration. When the EDS are in a stand-alone configuration, each EDS must be connected to the patch panel.

Figure 1
STAND-ALONE CBIS CONFIGURATION

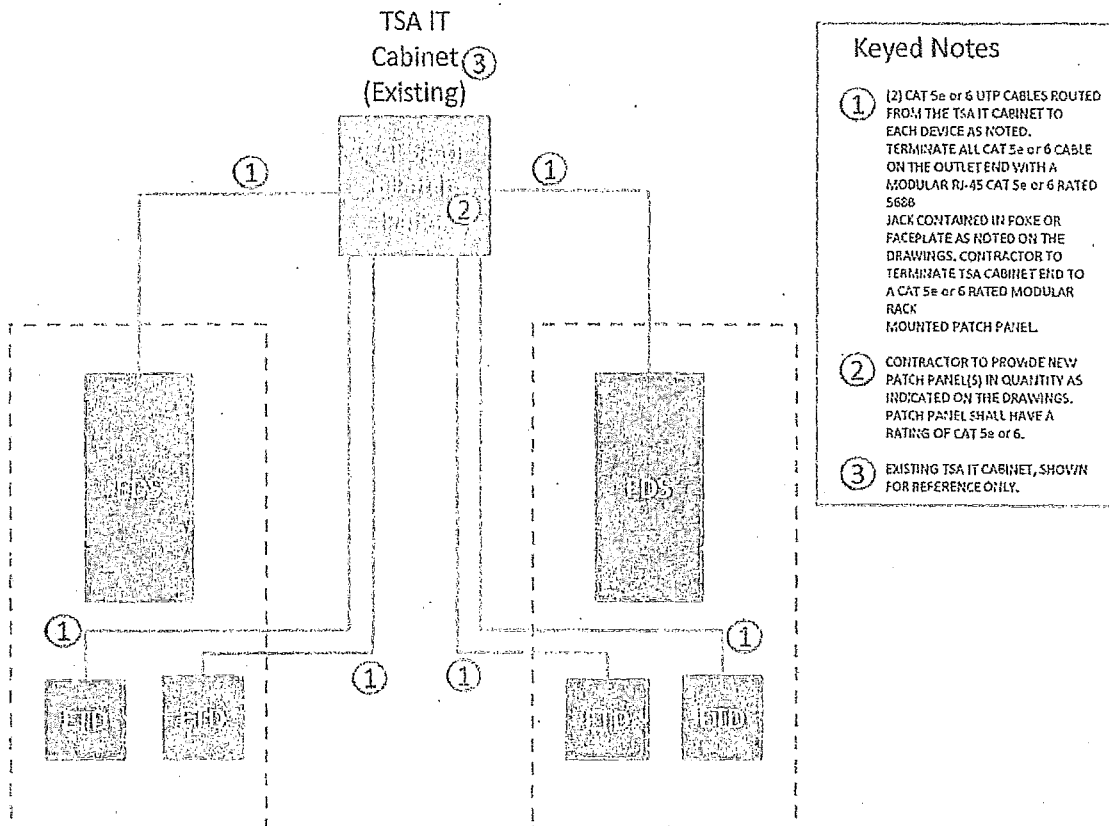

- Keyed Notes**
- ① (2) CAT 5e or 6 UTP CABLES ROUTED FROM THE TSA IT CABINET TO EACH DEVICE AS NOTED. TERMINATE ALL CAT 5e or 6 CABLE ON THE OUTLET END WITH A MODULAR RJ-45 CAT 5e or 6 RATED 568B JACK CONTAINED IN FOKE OR FACEPLATE AS NOTED ON THE DRAWINGS. CONTRACTOR TO TERMINATE TSA CABINET END TO A CAT 5e or 6 RATED MODULAR RACK MOUNTED PATCH PANEL.
 - ② CONTRACTOR TO PROVIDE NEW PATCH PANEL(S) IN QUANTITY AS INDICATED ON THE DRAWINGS. PATCH PANEL SHALL HAVE A RATING OF CAT 5e or 6.
 - ③ EXISTING TSA IT CABINET, SHOWN FOR REFERENCE ONLY.

Figure 2 illustrates all of the equipment that must be connected to the IDF IT cabinet for a CBIS where the EDS machines are already networked together. When the EDS machines are networked together (i.e., MUX, NEDS, etc.), the connection only needs to be made to the EDS Network Server(s).

Figure 2
NETWORKED CBIS CONFIGURATION

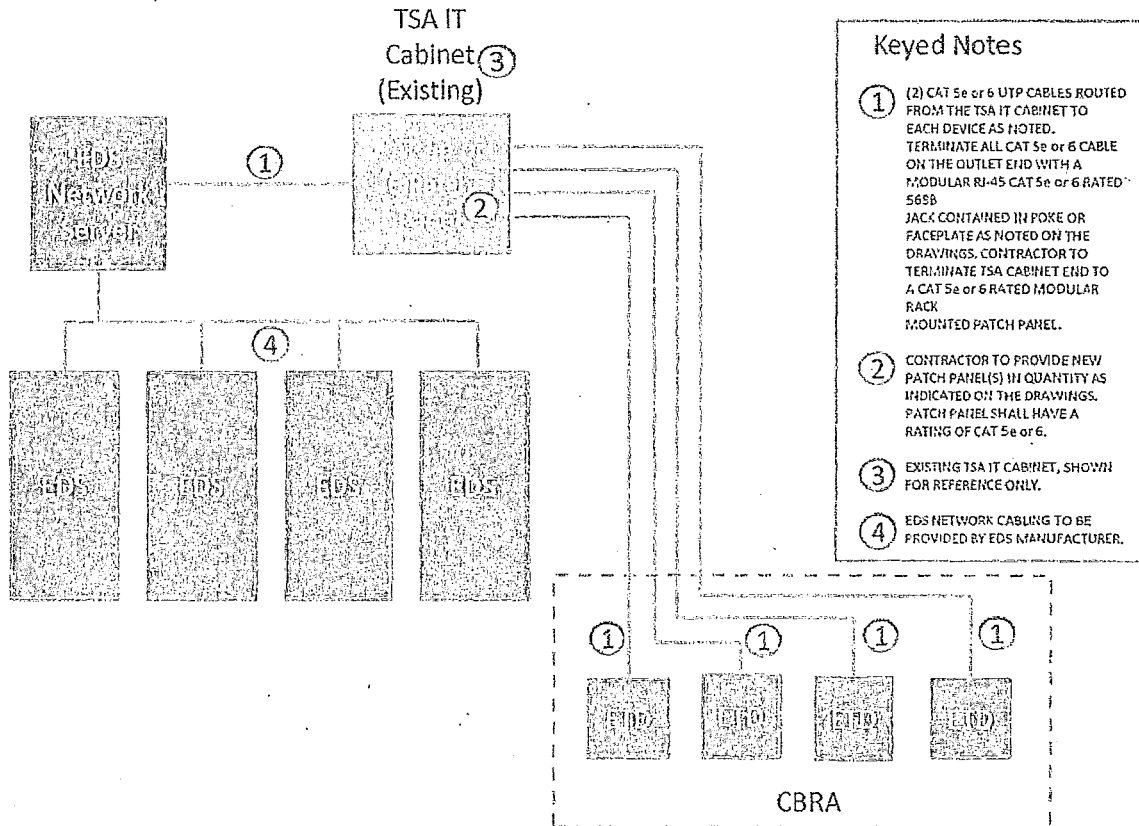

At a minimum, the following guidelines should be considered when designing a new CBIS or reconfiguring an existing CBIS.

- If an existing TSA IT cabinet is within 295 feet of the CBIS:
 - Verify that the existing switches have sufficient open ports to accommodate the required number of drops
 - Notify TSA OIT FRM if the existing switch capacity will not accommodate the required number of drops so that additional equipment can be procured.
 - Punch down cabling from the individual CBIS devices in the patch panel of the IT cabinet

- If there is no IT cabinet within 295 feet of the CBIS:
 - Install an appropriate IT cabinet. Refer to **Figure 3** for the IT cabinet specifications
 - Run fiber optic cable from the IT cabinet to an existing TSA IT cabinet
 - Notify TSA OIT FRM so that additional equipment can be procured.
 - Punch down cabling from the individual CBIS devices in the patch panel of the IT cabinet
 - Initiate IMAC group to install jumper cables from the patch panel to the switch and activate port

Figure 3
IT CABINET

IT Cabinet	Size	1 or more per checkpoint depending on size	For 24H, 36H and 48H: • Dedicated • 30A, 125V, 3KVA/Cabinet • 2 Pole, 3 Wire Grounding • NEMA 16-30R Receptacle • 3KVA UPS • 8' power cord from the IT cabinet to the receptacle	• Size patch panels to accommodate all TSA data outlets at the checkpoint plus 100% spare, minimum • Size gigs by network switch to accommodate all data outlets in checkpoint plus 10% • Provide a minimum of four pair single mode fiber optic cable from IT cabinet to the TSA main distribution frame.	• 30" front and rear access is required. • These cabinets will receive all data communication lines from the SSCB, so the cabinet should be located as close to the SSCB as possible, but in a secure location. Careful consideration needs to be given to the IT cabinet location because the exhaust fan for cooling can be loud when located in a confined space with TSA or airport personnel. • Equipment racks can be loaded into the cabinet from the front or the back at the location where the cabinet is installed. A trough not required, side access would improve rack accessibility and TSA personnel mobility around the cabinet. • Refer to Program of Requirements dated July 2005, Section 18.0 for labeling, cable management and administration of IT cabinet. • Refer to Program of Requirements dated July 2005, Section 19.0 for acceptance testing of IT results. • Unattended cabinets are an option in some instances, but must adhere to all applicable local codes and standards. Recommend consultation with the Field Regional Manager (FRM) when considering a non-mounted operation.
	Size 24H 24.0"H x 27.3"W x 30.0"D Weight 97 lbs				
	Size 36H 35.0"H x 27.3"W x 30.0"D Weight 124 lbs				
	Size 48H 49.0"H x 27.3"W x 30.0"D Weight 161 lbs				
	Size 60H 60.0"H x 27.3"W x 30.0"D Weight 245 lbs		For 60H and 72H • Dedicated • 30A, 208V, 6KVA/Cabinet • 2 Pole, 3 Wire Grounding • NEMA 16-30R Receptacle • 6KVA UPS • 8' power cord from the IT cabinet to the receptacle		
	Size 72H 72.0"H x 27.3"W x 30.0"D Weight 274 lbs				

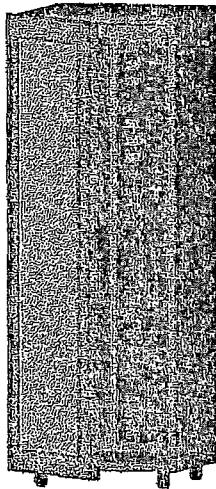

Isometric View

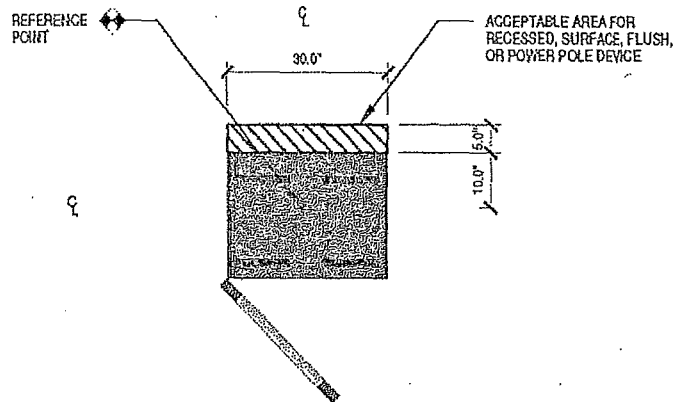

PLAN VIEW

FORM SFEC-126:
NOTIFICATION OF CONTRACT APPROVAL
(S.F. Campaign and Governmental Conduct Code § 1.126)

City Elective Officer Information *(Please print clearly.)*

Name of City elective officer(s):
Members, Board of Supervisors

City elective office(s) held:
Members, Board of Supervisors

Contractor Information *(Please print clearly.)*

Name of contractor:

T1 Cubed - a Joint Venture of Parsons Brinckerhoff, Inc. and AGS, Inc.

Please list the names of (1) members of the contractor's board of directors; (2) the contractor's chief executive officer, chief financial officer and chief operating officer; (3) any person who has an ownership of 20 percent or more in the contractor; (4) any subcontractor listed in the bid or contract; and (5) any political committee sponsored or controlled by the contractor. Use additional pages as necessary.

Parsons Brinckerhoff Inc. (T1 Cubed, Joint Venture Partner)

(1) Members of the contractor's board of directors;

Michael J. Abrahams, Chair; Gregory A. Kelly, President and CEO, US Region; George J. Pierson, Exec. VP; Lloyd Graham, Sr. VP; Gary E. Griggs, Sr. VP; Lisa G. Nungesser, Sr. VP; Scott L. Danielson, VP; James T. Ruddell, VP;

(2) The contractor's chief executive officer, chief financial officer and chief operating officer;

CEO – Greg Kelly
CFO – Pat Sheridan
COO – None

(3) Any person who has an ownership of 20 percent or more in the contractor;

Parsons Brinckerhoff, Inc. is a 100% wholly owned subsidiary of Parsons Brinckerhoff Group LLC and does not have individual owners.

(4) Any subcontractor listed in the bid or contract;

Ambient Energy
Bay Area Consulting Engineers, Inc.
Barich, Inc.
BLC Partners
CAGE, Inc.
CM Pros
Dabri Inc.
Faithful+Gould
Joseph Chow & Associates
Meridian Surveying Engineering, Inc.
RES Engineers
Yolanda's Construction Administration and Traffic Control, Inc.

(5) Any political committee sponsored or controlled by the contractor

Parsons Brinckerhoff Political Action Committee (PAC) is sponsored by Parsons Brinckerhoff, Inc. PAC has its own organizational structure which is distinct from Parsons Brinckerhoff, Inc.

AGS, Inc. (T1 Cubed Joint Venture Partner)

(1) Members of the contractor's board of directors;

Bahram Khamenehpour, Tina Wong, Dennis Wong, Robert Wong

(2) The contractor's chief executive officer, chief financial officer and chief operating officer;

CEO – Bahram Khamenehpour
CFO – Tina Wong
COO - None

(3) Any person who has an ownership of 20 percent or more in the contractor;

Bahram Khamenehpour, Tina Wong

(4) Any subcontractor listed in the bid or contract;

Ambient Energy
Bay Area Consulting Engineers, Inc.
Barich, Inc.
BLC Partners
CAGE, Inc.
CM Pros
Dabri Inc.
Faithful+Gould
Joseph Chow & Associates
Meridian Surveying Engineering, Inc.
RES Engineers
Yolanda's Construction Administration and Traffic Control, Inc.

(5) Any political committee sponsored or controlled by the contractor

None

Ambient Energy

(1) Members of the contractor's board of directors;

None

(2) The contractor's chief executive officer, chief financial officer and chief operating officer;

CEO – Renee Azergegi
CFO – Sammi Lynes
COO - None

(3) Any person who has an ownership of 20 percent or more in the contractor;

Renee Azerbegi

(4) Any subcontractor listed in the bid or contract;

None

(5) Any political committee sponsored or controlled by the contractor

None

Bay Area Consulting Engineers, Inc.

(1) Members of the contractor's board of directors;

Lito Magbitang, Wilma Magbitang, Ferdinand Magbitang

(2) The contractor's chief executive officer, chief financial officer and chief operating officer;

CEO – Lito Magbitang
CFO – Ferdinand Magbitang
COO – None

(3) Any person who has an ownership of 20 percent or more in the contractor;

Lito Magbitang, Wilma Magbitang, Ferdinand Magbitang

(4) Any subcontractor listed in the bid or contract;

(5) Any political committee sponsored or controlled by the contractor

None

Joseph Chow & Associates

(1) Members of the contractor's board of directors;

Joyce Chow, Joseph Chow, Celeste Chow

(2) The contractor's chief executive officer, chief financial officer and chief operating officer;

CEO – Joyce Chow

CFO – Joseph Chow

COO - None

(3) Any person who has an ownership of 20 percent or more in the contractor;

Joyce Chow, Joseph Chow, Celeste Chow

(4) Any subcontractor listed in the bid or contract;

None

(5) Any political committee sponsored or controlled by the contractor

None

Meridian Surveying Engineering, Inc.

(1) Members of the contractor's board of directors;

None

(2) The contractor's chief executive officer, chief financial officer and chief operating officer;

CEO – Stanley T. Gray

CFO – None

COO - None

(3) Any person who has an ownership of 20 percent or more in the contractor;

Stanley T. Gray

(4) Any subcontractor listed in the bid or contract;

None

(5) Any political committee sponsored or controlled by the contractor

None

NBA Engineering, Inc.

(1) Members of the contractor's board of directors;

None

(2) The contractor's chief executive officer, chief financial officer and chief operating officer;

CEO – Natalie Alavi

CFO – None

COO - None

(3) Any person who has an ownership of 20 percent or more in the contractor;

Natalie Alavi

(4) Any subcontractor listed in the bid or contract;

None

(5) Any political committee sponsored or controlled by the contractor

None

CM Pros

(1) Members of the contractor's board of directors;

Samir Messiah

(2) The contractor's chief executive officer, chief financial officer and chief operating officer;

CEO – Samir Messiah

CFO – None

COO - None

(3) Any person who has an ownership of 20 percent or more in the contractor;

Samir Messiah

(4) Any subcontractor listed in the bid or contract;

None

(5) Any political committee sponsored or controlled by the contractor

None

Dabri, Inc.

(1) Members of the contractor's board of directors;

Ravinder P. Kaur

(2) The contractor's chief executive officer, chief financial officer and chief operating officer;

CEO – Ravinder P. Kaur

CFO – None

COO – None

(3) Any person who has an ownership of 20 percent or more in the contractor;

Ravinder P. Kaur

(4) Any subcontractor listed in the bid or contract;

None

(5) Any political committee sponsored or controlled by the contractor

None

Faithful+Gould

(1) Members of the contractor's board of directors;

None – wholly owned subsidiary of Atkins Group

(2) The contractor's chief executive officer, chief financial officer and chief operating officer;

CEO – Donald Lawson

CFO – Mark Sowerby

COO - None

(3) Any person who has an ownership of 20 percent or more in the contractor;

None

(4) Any subcontractor listed in the bid or contract;

None – wholly owned subsidiary of Atkins Group

None

(5) Any political committee sponsored or controlled by the contractor

None

Barich, Inc.

(1) Members of the contractor's board of directors;

Frank Barich, David Jividen, Justin Phy

(2) The contractor's chief executive officer, chief financial officer and chief operating officer;

CEO – Justin Phy

CFO – David Jividen

COO – None

(3) Any person who has an ownership of 20 percent or more in the contractor;

Frank Barich

(4) Any subcontractor listed in the bid or contract;

None

(5) Any political committee sponsored or controlled by the contractor

None

BLC Partners

(1) Members of the contractor's board of directors;

None

(2) The contractor's chief executive officer, chief financial officer and chief operating officer;

CEO – LaTonya Olivier

CFO – Ann Kinnard

COO – None

(3) Any person who has an ownership of 20 percent or more in the contractor;

Jerry Olivier, LaTonya Olivier

(4) Any subcontractor listed in the bid or contract;

None

(5) Any political committee sponsored or controlled by the contractor

None

CAGE, Inc.

(1) Members of the contractor's board of directors;

Carl J. Clause, Robert Bagley, David Sinclair, Ralph Richardi, John Boodee, Tom Kiernan, Dan Beaulne

(2) The contractor's chief executive officer, chief financial officer and chief operating officer;

CEO – Carl J. Clause

CFO – David Sinclair

COO – John Boodee

(3) Any person who has an ownership of 20 percent or more in the contractor;

Carl J. Clause

(4) Any subcontractor listed in the bid or contract;

None

(5) Any political committee sponsored or controlled by the contractor

None

RES Engineers

(1) Members of the contractor's board of directors;

None

(2) The contractor's chief executive officer, chief financial officer and chief operating officer;

CEO – Ross Esfandiari

CFO – None

COO - None

(3) Any person who has an ownership of 20 percent or more in the contractor;

Ross Esfandiari

(4) Any subcontractor listed in the bid or contract;

None

(5) Any political committee sponsored or controlled by the contractor

None

Yolanda's Construction Administration and Traffic Control, Inc.

(1) Members of the contractor's board of directors;

Yolanda Jones, Lyn-Tise Jones, Rays élan Jones Sr

(2) The contractor's chief executive officer, chief financial officer and chief operating officer;

CEO – Yolanda Jones

CFO – None

COO - None

(3) Any person who has an ownership of 20 percent or more in the contractor;

Yolanda Jones

(4) Any subcontractor listed in the bid or contract;

None

(5) Any political committee sponsored or controlled by the contractor

None

Contractor address:

Parsons Brinckerhoff, Inc.: 303 Second Street, Suite 700 N., San Francisco, California 94107

AGS Inc.: 5 Freelon Street, San Francisco, California 94107

Ambient Energy: 201 Spear Street, Suite 1100, San Francisco, California 94105

Bay Area Consulting Engineers, Inc.: 311 California Street, Suite 720, San Francisco, California 94104

Barich, Inc.: 2241 E. Pecos Road, Suite 2, Chandler, Arizona 85225

BLC Partners: #319 353-E East 10th Street, Gilroy, California 95020

CAGE, Inc.: 6440 N. Beltline Road, Suite 125, Irving, Texas 75063

CM Pros: 1067 Market Street, Suite 1028, San Francisco, California 94103

Dabri Inc.: 850 S. Van Ness Avenue, Suite 08, San Francisco, California 94110

Faithful+Gould: 332 Pine Street 5th Floor, San Francisco, California 94104

Joseph Chow & Associates: 650 Delancey Street, Suite 211, San Francisco, California 94107

Meridian Surveying Engineering, Inc.: 1812 Union Street, San Francisco, California 94123

NBA Engineering, Inc.: 897 Hyde Street, 2nd Floor, San Francisco, California 94109

RES Engineers: 1250 Missouri Street, Suite 207, San Francisco, California 94107

Yolanda's Construction Administration and Traffic Control, Inc.: 280 Newhall Street, San Francisco, California 94124

Date that contract was approved: <i>(By the SF Board of Supervisors)</i>	Amount of contract: Not-to-exceed \$29,000,000
Describe the nature of the contract that was approved: The contractor will provide project management support services to assist the Airport for the Airport's Terminal 1, Boarding Area B Reconstruction Project ("Project") in a coordinated and methodical manner. Specific areas of expertise required include: Airport boarding area design management and construction phasing, project-level cost/schedule controls, solicitations and contract preparation, alternative project delivery processes, project management/construction management coordination, cost estimating, industry outreach/workshops, document control, program management systems, and other administrative support functions and operations. The Project will include: demolition of the 40 year old, 18-gate Boarding Area B facility and the construction of a new Boarding Area B facility of approximately 560,000 square feet with 24-gates to include a concessions and amenity program consistent with Terminal 2 and Boarding Area E, and to meet the increasing passenger forecast envisioned.	
Comments: Requesting Board of Supervisors to approve the Professional Services Agreement for Airport Contract 10010.41 – Project Management Support Services for New Boarding Area B Project between T1 Cubed - a Joint Venture and the City and County of San Francisco for six years of services with an anticipated final contract value not-to-exceed \$29,000,000.	

This contract was approved by (check applicable):

the City elective officer(s) identified on this form

a board on which the City elective officer(s) serves: San Francisco Board of Supervisors
Print Name of Board

the board of a state agency (Health Authority, Housing Authority Commission, Industrial Development Authority Board, Parking Authority, Redevelopment Agency Commission, Relocation Appeals Board, Treasure Island Development Authority) on which an appointee of the City elective officer(s) identified on this form sits.

Print Name of Board

Filer Information <i>(Please print clearly.)</i>	
Name of filer: Angela Calvillo, Clerk of the Board	Contact telephone number: (415) 554-5184
Address: City Hall, Room 244, 1 Dr. Carlton B. Goodlett Pl., San Francisco, CA 94102	E-mail: Board.of.Supervisors@sfgov.org

Signature of City Elective Officer (if submitted by City elective officer)

Date Signed

Signature of Board Secretary or Clerk (if submitted by Board Secretary or Clerk)

Date Signed