



88 BROADWAY FAMILY + 735 DAVIS SENIOR AFFORDABLE HOUSING

CERTIFICATE OF APPROPRIATENESS - REVISION 5 / SECTION 315



03/09/18

EXHIBIT

A - 2016-007850COA - 04/04/18

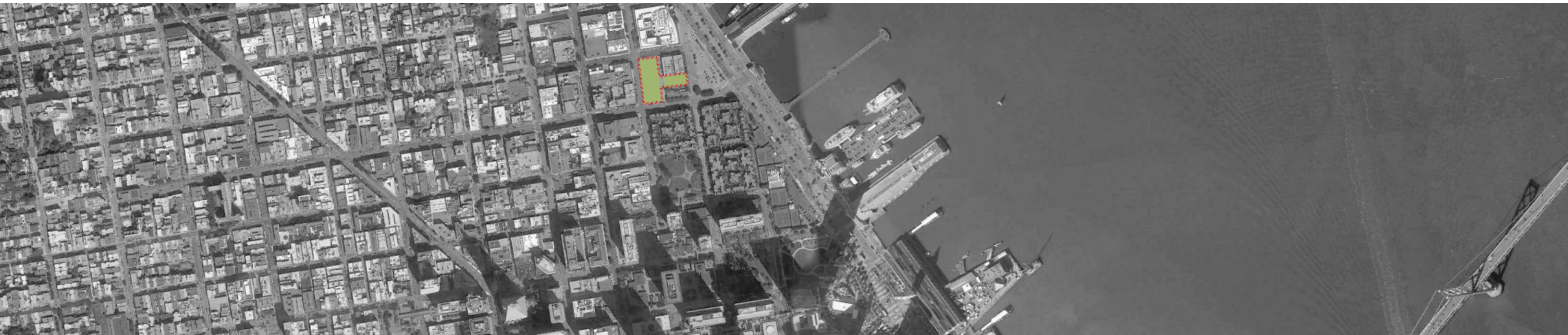

0

PROJECT DATA

VICINITY MAP

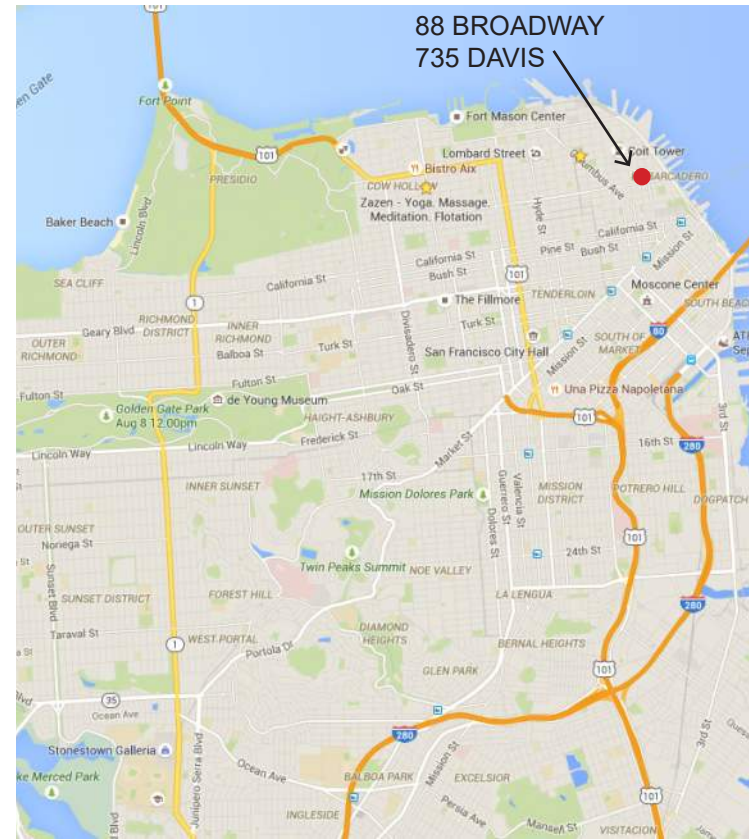

PROJECT TEAM DIRECTORY

PROJECT SPONSOR
 BRIDGE HOUSING
 600 California Street, Suite 900
 San Francisco, CA 94108
 t: .949.229.7075
 Contact: Marie-Therese Debor
 mdebor@bridgehousing.com
 Kelly Hollywood
 khollywood@bridgehousing.com

THE JOHN STEWART COMPANY
 1388 Sutter St. #11
 San Francisco, CA 94109
 T: 415. 345.4400
 Margaret Miller
 mmiller@jso.net

ARCHITECT
 LEDDY MAYTUM STACY ARCHITECTS
 677 Harrison Street,
 San Francisco, CA 94107
 t: 415.495.1700
 Contact: Aaron Thornton / Bill Leddy
 athornton@lmsarch.com
 bleddy@lmsarch.com

PROJECT DESCRIPTION

ADDRESS
 88 Broadway Family & 735 Davis Senior
 Affordable Housing
 88 Broadway/735 Davis street
 San Francisco, CA 94111

ASSESSOR'S PARCEL
88 BROADWAY **735 DAVIS**
 FAMILY BUILDING SENIOR BUILDING
 Block: 140 Block: 140
 Lot: 007 Lot: 008

LOT AREA
88 BROADWAY
 FAMILY BUILDING
 Site Area: 37,812.50 SQ. FT. (0.86 acres)
 Lot Dimensions: 275' X 137.5'
 Total Lot Area: 37,812 SF

735 DAVIS
 SENIOR BUILDING
 Site Area: 10,805 SQ.FT. (.24 acres)
 Lot Dimensions: 137.5' X 78.58'
 Total Lot Area: 10,805 SF

ZONING

C-2: Community Business
Special Use District: Waterfront 3
Height and Bulk District: 65-X
Planning Area: North East Waterfront/ Northeast Embarcadero Study

UNIT COUNT
88 BROADWAY:

	Studio	1BR	2BR	3BR	TOTAL	GSF
LVL 6	2	10	5	3	20	14,713
LVL 5	4	7	11	4	26	20,299
LVL 4	3	7	10	5	25	20,312
LVL 3	3	7	10	5	25	20,312
LVL 2	3	6	10	5	24	19,713
LVL 1	0	1	2	2	5	5,361
TOTAL	15	38	48	24	125	100,710
%	12%	31%	38%	19%	100%	

735 DAVIS:

	Studio	1BR	2BR	TOTAL	GSF
LVL 6	4	4	0	8	4,011
LVL 5	4	4	0	8	4,011
LVL 4	5	7	0	12	6,364
LVL 3	5	7	0	12	6,367
LVL 2	5	5	1	11	5,974
LVL 1	1	1	0	2	1,023
TOTAL	24	28	1	53	27,750
%	45%	53%	2%	100%	





AREA MAP - FAMILY HOUSING
APN: BLOCK 140 LOT 007

GENERAL NOTES
DEFINITIONS:

Unit Gross Square Footage (GSF): The sum of all areas on all floors of unit included within the outside faces of its exterior walls.

Building Gross Square Footage (GSF): The sum of all areas on all floors of building included within the outside faces of its exterior walls.

TRASH COLLECTION & LOADING

See A2.1 for location of Trash Room. Residential trash collection will be on Front Street. Commercial trash collection will be on Broadway Street.

REQUESTED PUD MODIFICATIONS

- 134 Rear yard configuration
- 151 Off street loading
- 151 Off street parking at childcare

BIRD SAFE STANDARDS

88 Broadway is 450' from the Bay, outside of the 300' zone. Location hazards do not apply. Building will comply with feature related hazards where they apply.

UNIT MIX

	STUDIO	1 BR	2 BR	3 BR	TOTAL	GSF
LEVEL 6	2	10	5	4	21	14,713
LEVEL 5	4	7	10	4	25	20,299
LEVEL 4	3	7	10	5	25	20,312
LEVEL 3	3	7	10	5	25	20,312
LEVEL 2	3	6	10	5	24	19,713
LEVEL 1	0	1	2	2	5	5,361
TOTAL:	15	38	47	25	125	100,710
PERCENTAGE	12%	30%	38%	20%	100%	
TCAC REQ:				30% min*		

* at least 30% required to be 3-bd or larger units; waiver may be granted under At-Risk set-aside application

UNIT TYPES

UNIT TYPE:	FORMAT:	ACCESSIBILITY:	SIZE (GSF):	SIZE (NSF):	TCAC REQ (NSF):	COUNT:
STUDIO						
ADPT-0BR-A	FLAT	ADAPTABLE	430	368	N/A	11
ADPT-0BR-A-R	FLAT	ADAPTABLE REPOSITIONABLE	430		N/A	1
ADPT-0BR-B	FLAT	ADAPTABLE	430	368	N/A	2
MOBL-0BR-A	FLAT	MOBILITY	430	370	N/A	1
						15
1-BR						
ADPT-1BR-A	FLAT	ADAPTABLE	585	502	450	20
ADPT-1BR-A-C	FLAT	ADAPTABLE COMMUNICATION	585		450	2
ADPT-1BR-A-R	FLAT	ADAPTABLE REPOSITIONABLE	585		450	2
ADPT-1BR-B	FLAT	ADAPTABLE	558	507	450	8
ADPT-1BR-C	FLAT	ADAPTABLE	489	507	450	1
ADPT-1BR-LW	FLAT/LIVEWORK	ADAPTABLE	608		450	1
MOBL-1BR-A	FLAT	MOBILITY	591		450	4
						38
2-BR						
ADPT-2BR-A	FLAT	ADAPTABLE	893	763	700	33
ADPT-2BR-A-C	FLAT	ADAPTABLE COMMUNICATION	893		700	2
ADPT-2BR-A-R	FLAT	ADAPTABLE REPOSITIONABLE	893		700	1
ADPT-2BR-B	FLAT	ADAPTABLE	861	783	700	5
ADPT-2BR-C	FLAT	ADAPTABLE	945	783	700	1
ADPT-2BR-LW	FLAT/LIVEWORK	ADAPTABLE	914	765	700	1
MOBL-2BR-A	FLAT	MOBILITY	890	763	700	4
MOBL-2BR-LW	FLAT/LIVEWORK	MOBILITY	928		700	1
						48
3-BR						
ADPT-3BR-A	FLAT	ADAPTABLE	1198	1136	900	15
ADPT-3BR-A-C	FLAT	ADAPTABLE COMMUNICATION	1198		900	1
ADPT-3BR-A-R	FLAT	ADAPTABLE REPOSITIONABLE	1198		900	1
ADPT-3BR-B	FLAT	ADAPTABLE	1347	1012	900	3
ADPT-3BR-LW	FLAT/LIVEWORK	ADAPTABLE	1393		900	1
MOBL-3BR-A	FLAT	MOBILITY	1185		900	2
MOBL-3BR-LW	FLAT/LIVEWORK	MOBILITY	1519		900	1
Total Units:						125

PLANNING DATA

FAMILY HOUSING	PERMITTED	PROVIDED
FAR (1:5)	189,062.5 MAX	146,037
RESIDENTIAL DENSITY (1:200 RC-4)	189 UNITS	125
REAR YARD 25% (275.0'X34.37')	9,453 FT.	11,629 S.F.
RES OPEN SPACE (48 SF *125 du)	6,000 S.F.	7,128 S.F.
PARKING (COMMERCIAL OR PORT)	2 / Childcare	0
LOADING	1 Space	2 Street
HEIGHT	65 FT.	65 FT.

ACCESSIBLE UNIT SUMMARY

UNIT TYPE	MOBILITY UNIT (11B) 10% PER 2015 TCAC, COMPLIES WITH 2016 CBC 11B	ADAPTABLE HEARING + VISUAL IMPAIRED ADAPTABLE UNIT (4% PER 2015 TCAC, COMPLIES WITH 2016 CBC 11A)	ADAPTABLE UNIT 11A (86% PER 2016 CBC 11a)	ADAPTABLE REPOSITIONABLE COUNTERTOPS (IN 5% OF TOTAL 90% ADAPTABLE UNITS, COMPLIES WITH 2016 CBC 11A)
STUDIO	1	0	12	1
1 BD	4	2	33	2
2 BD	5	2	40	1
3 BD	3	1	22	1
SUBTOTAL	* 13	5	107	5
GRAND TOTAL:			125	

* Note: Accessible mobility TBD

CODES + REGULATIONS

APPLICABLE CODES AND REGULATIONS

- Codes:**
 2016 California Building Code
 2016 California Electrical Code
 2016 California Mechanical Code
 2016 California Plumbing Code
 2016 California Building Code
 2016 California Energy Code
 2010 ADA Standards
 Federal Fair Housing Act
 Outdoor Developed Area Guidelines (Access Board)
 San Francisco Health Code, Article 38

Funding Requirements:
TCAC, Attachment 10

Green Building:
GreenPoint Rated: Goal 176

FAMILY HOUSING	PERMITTED	PROVIDED
RES BICYCLE PARKING (CLASS I)	106 SPACES	110 SPACES
RES BICYCLE PARKING (CLASS II)	6	SEE COM II
COM BICYCLE PARKING (CLASS I)	1	SEE RES I
COM BICYCLE PARKING (CLASS II)	7	16
CHILDCARE BICYCLE PARKING (CLASS I)	3	SEE RES I
CHILDCARE BICYCLE PARKING (CLASS II)	3	SEE COM II
STREET TREES 1 PER 20'	27	18

BUILDING AREA

GROSS BUILDING AREA	
PROGRAM	AREA
Level 1	
MULTI-PURPOSE SPACE/KITCHEN/STORAGE/FILE/ PM OFFICE/WC/LOBBY/MAIL/	4,819
COMMERCIAL	5,246
CHILDCARE	4,306
MAINT/PUMP ROOMS/ MPOE/JAN	2,961
BIKE PARKING	1,259
RESIDENTIAL	5,153
CIRCULATION	429
SERVICE (MECH / TRASH)	1,208
	23,381
LEVEL 2	
RESIDENTIAL	19,397
CIRCULATION	4,967
SERVICE(LAUNDRY/TRASH/MECH)	753
	23,117
LEVEL 3	
RESIDENTIAL	19,827
CIRCULATION	4,537
SERVICE(LAUNDRY/TRASH/MECH)	753
	23,117
LEVEL 4	
RESIDENTIAL	19,827
CIRCULATION	4,537
SERVICE(LAUNDRY/TRASH/MECH)	753
	23,117
LEVEL 5	
RESIDENTIAL	18,607
CIRCULATION	4,537
SERVICE(LAUNDRY/TRASH/MECH)	753
	23,897
LEVEL 6	
RESIDENTIAL	16,118
CIRCULATION	4,537
SERVICE(LAUNDRY/TRASH/MECH)	753
	21,408
TOTAL GSF	146,037
TOTAL GFA (PLANNING CODE) 2017.05.04 TIS	122,044



AREA MAP - SENIOR HOUSING

APN: BLOCK 140 LOT 008

GENERAL NOTES

DEFINITIONS:

Unit Gross Square Footage (GSF): The sum of all areas on all floors of unit included within the outside faces of its exterior walls.

Building Gross Square Footage (GSF): The sum of all areas on all floors of building included within the outside faces of its exterior walls.

TRASH COLLECTION & LOADING

See A2.1 for location. Trash collection will be on Davis Street.

REQUESTED PUD MODIFICATIONS

- 134 Rear yard configuration and size
- 140 Exposure for 12 units

BIRD SAFE STANDARDS

735 Davis is 421' from the Bay, outside of the 300' zone. Location hazards do not apply. Building will comply with feature related hazards where they apply.

UNIT MIX

	STUDIO	1 BR	2 BR	TOTAL	GSF
LEVEL 6	4	4	0	8	4,044
LEVEL 5	4	4	0	8	4,044
LEVEL 4	5	7	0	12	6,415
LEVEL 3	5	7	0	12	6,415
LEVEL 2	5	5	1	11	5,896
LEVEL 1	0	2	0	2	1,208
TOTAL:	23	29	1	53	28,022
PERCENTAGE	43%	55%	2%	100%	
TCAC REQ:			20% max*		

* no more than 20% of low income units should be larger than 1 BD

UNIT TYPES

UNIT TYPE:	FORMAT:	ACCESSIBILITY:	SIZE (GSF):	SIZE (NSF):	TCAC REQ (NSF):	COUNT:
STUDIO						
ADPT-0BR-A	FLAT	ADAPTABLE	433	347	N/A	14
ADPT-0BR-A-C	FLAT	ADAPTABLE COMMUNICATION	433		N/A	1
ADPT-0BR-A-R	FLAT	ADAPTABLE REPOSITIONABLE	433		N/A	1
ADPT-0BR-B	FLAT	ADAPTABLE	422		N/A	5
ADPT-0BR-C	FLAT	ADAPTABLE	412		N/A	1
MOBL-0BR-A	FLAT	MOBILITY	431		N/A	2
						24
1-BD						
ADPT-1BR-A	FLAT	ADAPTABLE	573	500	450	17
ADPT-1BR-A-C	FLAT	ADAPTABLE COMMUNICATION	573		450	1
ADPT-1BR-A-R	FLAT	ADAPTABLE REPOSITIONABLE	573		450	1
ADPT-1BR-B	FLAT	ADAPTABLE	564	541	450	5
ADPT-1BR-C	FLAT	ADAPTABLE	778	667	450	1
MOBL-1BR-A	FLAT	MOBILITY	581		450	1
MOBL-1BR-B	FLAT	MOBILITY	611		450	1
MOBL-1BR-C	FLAT	MOBILITY	778		450	1
						28
2-BD						
ADPT-2BR-A	FLAT	ADAPTABLE	958	784	700	1
						1
Total Units:						53

PLANNING DATA

SENIOR HOUSING	PERMITTED	PROVIDED
FAR (1:5)	54,023 MAX	45,319 S.F.
RESIDENTIAL DENSITY (1:200 RC-4)	54 UNITS	53
REAR YARD 25% (137.5*.25)*78.58	2,701 S.F.	1,706 S.F.
RES OPEN SPACE (24 SF *53 du)	1,272 S.F.	3,102 S.F.
PARKING	NONE	NONE
LOADING	NONE	1 Street
HEIGHT	65 FT.	65 FT.
RES BIKE PARKING CLASS I 1:10 du	5 SPACES	10 SPACES
RES BIKE PARKING CLASS II 1:50 du	2	2
COM BIKE PARKING CLASS I 1:7500 sf	0	0
COM BIKE PARKING CLASS II 1:7500 sf	2	2
STREET TREES 1 PER 20'	3	3

ACCESSIBLE UNIT SUMMARY

UNIT TYPE	ACCESSIBLE MOBILITY UNIT (11B) 10% PER 2015 TCAC, COMPLIES WITH 2016 CBC11B	ADAPTABLE HEARING + VISUAL IMPAIRED ADAPTABLE UNIT (4% PER 2015 TCAC, COMPLIES WITH 2016 CBC 11A)	ADAPTABLE UNIT 11A(86% PER 2016 CB	REPOSITIONABLE COUNTERTOPS (IN 5% OF TOTAL 90% ADAPTABLE UNITS, COMPLIES WITH 2016 CBC 11A)
STUDIO	2	1	20	1
1 BD	3	1	25	1
2 BD	0	0	1	0
SUBTOTAL	* 5	2	46	2
GRAND TOTAL:			53	

* Note: Accessible mobility TBD

CODES + REGULATIONS

APPLICABLE CODES AND REGULATIONS

Codes:

- 2016 California Building Code
- 2016 California Electrical Code
- 2016 California Mechanical Code
- 2016 California Plumbing Code
- 2016 Green Building Code
- 2016 California Energy Code
- 2010 ADA Standards
- Federal Fair Housing Act
- Outdoor Developed Area Guidelines (Access Board)
- San Francisco Health Code, Article 38

Funding Requirements:

TCAC, Attachment 10

Green Building:

GreenPoint Rated: Goal 176

BUILDING AREA

SENIOR BUILDING

GROSS BUILDING AREA	
PROGRAM	AREA

LEVEL 1

MULTI-PURPOSE SPACE/KITCHEN/STORAGE/FILE/ PM OFFICE/WC/LOBBY/MAIL/	2,039
COMMERCIAL	1,190
BIKE PARKING	138
RESIDENTIAL	1,208
CIRCULATION	1,209
SERVICE (MECH /ELEC/PUMP/ TRASH)	1,677
	7,461

LEVEL 2

RESIDENTIAL	5,986
CIRCULATION	1,798
SERVICE(LAUNDRY/TRASH/MECH)	262
	8,046

LEVEL 3

RESIDENTIAL	6,415
CIRCULATION	1,989
SERVICE(LAUNDRY/TRASH/MECH)	262
	8,666

LEVEL 4

RESIDENTIAL	6,415
CIRCULATION	1,989
SERVICE(LAUNDRY/TRASH/MECH)	262
	8,666

LEVEL 5

RESIDENTIAL	4,044
CIRCULATION	1,934
SERVICE(LAUNDRY/TRASH/MECH)	262
	6,240

LEVEL 6

RESIDENTIAL	4,044
CIRCULATION	1,934
SERVICE(LAUNDRY/TRASH/MECH)	367
	6,345

TOTAL GSF **45,424**

TOTAL GFA (PLANNING CODE) 37,960
2017.05.04 TIS

PROJECT DESCRIPTION

Design Concept

1. The Architectural Design Concept for 88 Broadway / 735 Davis is an integrated design response to the multifaceted requirements of Site, Context and Program. It will welcome and nurture families and seniors, enhance the diverse context of the Northeast Waterfront Historic District, and enrich the urban experience of the broader community. The design addresses five key areas:
2. **Connected Community:** The design provides a variety of generous networked community spaces, indoors and out, that will encourage social engagement at many scales – from small play groups to larger community gatherings; between residents, their neighborhood and the city beyond.
3. **Healthy City Living:** The project will provide 178 healthy, sustainable and affordable homes with bright, inviting living spaces that connect residents to the natural world on a daily basis.
4. **Intergenerational Integration:** A multi-generational community of families, seniors, and a neighborhood-serving child care center, will come together in a supportive enclave of landscaped courtyards, roof terraces and pedestrian passages.
5. **Urban Vitality:** Retail and community spaces, restaurant, café, a child care center and live-work flats will enliven the block's four street frontages, enriching urban life. Two intersecting mid-block passages will invite pedestrians into the landscaped interior of the site for outdoor dining and strolling.
6. **Historic Context:** The new construction is designed to fully comply with the Secretary of the Interiors Standards for the Treatment of Historic Properties as well as Section 6, Appendix D, Article 10—Northeast Waterfront Historic District, of the San Francisco Planning Code. The overall design is compatible with the defining elements of the Northeast Waterfront Historic District, while clearly expressing its contemporary condition. Through a variety of integrated design elements, the project avoids a false sense of historical development by drawing upon the essential character of this historically industrial district: authenticity; a forthright use of simple, industrial materials; and a clear expression of structural rhythms and proportions.

Site Plan

The Site Plan is organized around two landscaped pedestrian passages that take their cue from alleys throughout the district such as Ice House Alley and John Maher Street. They cross the two lots and intersect near the center of the block. A north/south passage on the Port Site extends from Broadway north to Vallejo Street, while an east/west passage on the DPW Site passes under the Senior Apartments on Davis Street, opening into an interior courtyard and extending to the Family Apartment Building Lobby on Front Street. In addition to enriching the urban experience of the neighborhood, the passages also help to articulate the massing of the buildings into smaller elements more compatible with the scale of the surrounding historic context. Active retail and community-serving spaces line the street frontages on all four sides of the block, while the mid-block passages host more private uses, including courtyards, ground floor live-work units and a playground for the neighborhood child care center.



Site Plan

Family Apartment Building (5 stories over Podium)

- Occupying the Port Site (Seawall Lot 322-1) and facing Broadway, Front and Vallejo Streets, this building contains 125 apartments for families, with ground floor retail and community-serving spaces and rooftop common spaces.
- Massing: The building mass is articulated into smaller elements compatible with the typical scale and rhythm of adjacent structures in the historic district. The massing steps in and down along Front Street, and at the eastern ends of the Broadway and Vallejo Street facades. Additional step back occur at the corner of Broadway and Front Street.
- Facades: The dominant façade treatment at the site perimeter is inspired by the historic frame-and-infill structures surrounding the site, expressing vertical bearing lines and horizontal floor lines. Infill panels echo the texture and color of nearby concrete buildings. Projecting panels strategically arrayed throughout the façade provide detail, accent color, and relief. The facades at the interior of the site are finished in a simpler and lighter cladding to amplify the available daylight. Brick facades provide a secondary accent to the frame and infill elements.



Frame & Infill



Bearing Wall



Front St. Elevation

- Ground Floor Broadway: Space for retail and restaurant uses is provided at the corner of Broadway and Front Streets, extending east along Broadway to the entry to north/south passage. The restaurant space opens onto an arcade, providing space for outdoor dining that will activate the street and invite people into the mid-block zone.
- Front Street: On Front Street, the Lobby entry – providing access to both the apartments and the east/west passage - and social service spaces are recessed behind a small landscaped plaza. Social service spaces include a private office, meeting room and a community space for events and gatherings. Live-work units, entered directly from the street through small garden courts, activate the northern end of the Front Street façade. These flexible spaces could easily be converted to retail spaces as the neighborhood evolves.
- Vallejo Street: A child care center is located at the northeast corner, opening onto both Vallejo Street and the east/west passage. An arcade, similar to the one on the south side, provides a secure, covered play space for the children in rainy weather. A large, enclosed courtyard off the passage provides a playground for the children. During off hours, the playground can serve the residents of the Family Building.
- Roof: The roof provides a 6th floor terrace for the residents, along with space for vegetable gardens and alternative energy systems. Green roofs and rooftop planters provide a more inviting space, manage stormwater, and enhance the views of neighbors.



Front St. X Broadway St.



Roof Plan

Senior Apartment Building (3 and 5 stories over 1)

Occupying the “DPW Site” and facing Davis Street, this building provides 53 apartments for seniors with ground floor retail, administration, and common spaces and a roof terrace.

- **Massing:** The U-shaped building steps down two floors at Davis Street to match the scale of the adjacent brick structure to the north.
- **Façade:** Unlike the Family Apartment Building, the Senior Apartment Building is flanked by historic brick buildings on Davis Street. Here, the frame-and-infill cladding is replaced by a planar façade with tall, deep-set openings and brick cladding. “French balconies” set within some of the openings reinforce this compatibility with the historic context. Similar to the Family Apartment Building, the cladding at the interior courtyard would be constructed of simpler and lighter panels to amplify daylight.
- **Ground Floor:** The east façade on Davis Street is occupied by the building Lobby, a café space and a two-story tall portal leading to the east/west passage. The café opens into both the portal and an interior courtyard to allow for outdoor dining. The interior courtyard is shared by the senior’s Community Room, fostering greater community connection.
- **Roof:** A 5th Floor roof terrace overlooking Davis Street provides additional common outdoor space and gardening space for the residents, along with stunning views of the waterfront.



Senior Building



Davis St. Elevation

Mid-Block Passages

- The two mid-block passages will offer a major new public pedestrian experience to the Northeast Waterfront.
- **North/South Passage:** The broad passage on the Port Site will be anchored at the north by a neighborhood-serving child care center and playground, and at the south by a new restaurant with outdoor seating. At the mid-block, six ground floor apartments enter off the passage through small private entry porches. A landscaped “ribbon” will divide the passage, with lush planting, and seating, creating a variety of community gathering spaces. The passage offers a great opportunity for public art to further enliven the shared public place.
- **East/West Passage:** The passage on the DPW Site is narrower and will provide a more intimate pedestrian experience. At the eastern entry on Davis Street, a two-story portal frames a view west through both sites all the way to Front Street. A café with outdoor seating activates the portal. Further along, one arrives at an inviting interior courtyard with landscaping, more café tables and outdoor seating for senior Common Room. After passing through another, lower portal, one arrives at the intersection with the north/south passage and a celebration of public art. Ahead, the passage is enclosed to create a glassy Lobby for the Family Apartment Building that opens out onto Front Street.



Davis St. Passage



Broadway St. Passage

Construction Type and Building Materials

Brick masonry, reinforced concrete, and stucco are the predominant historic materials in the district. These materials, serving as both structure and exterior finish, were typical for their respective historic periods and reflect an industrial simplicity and durability. They provide a record of the evolution of construction technologies within the district over time, particularly after the devastation of the 1906 earthquake and fire.

The new buildings are designed as physical records of their time, place and use, offering compatible yet contemporary interpretations of the defining characteristics of the historic district. In accordance with the Secretary of the Interiors Standards for the Treatment of Historic Properties Standard Nine, the architecture avoids creating a false sense of historical development by using contemporary materials and detailing to create a meaningful dialogue with history. It extends the historic evolution of construction technologies already displayed within the district by respectfully articulating 21st century construction technologies. Consistent with this evolution, the new building will use simple, durable structural systems typical of our own time: up to five stories of wood-framed construction above a one-story concrete podium. At the frame and infill portions of the building, lightweight cement board panels in a rain screen application will retain the simple, durable character of the district while providing a high-performance building envelope appropriate to 21st century requirements.

In order to blend with the character of the surrounding district, a rustic, red, sand finished brick cladding will be used on significant portions of both buildings. Different from bearing walls of the historic district, the thin brick veneer is applied to a wood framed structure. The thin veneer takes cues from the horizontal bond and narrow deep-set openings of the district. As a contemporary interpretation, the brick façade is stacked instead of a running bond; the window frames and brick edges, while deep, are trimmed with metal. Together the cement panels and brick veneer are compatible with the texture and material of the Northeast Waterfront Historic District.

Green Building Strategies

- **General:** Construction materials and systems will be selected for both durability and sustainability with an emphasis on healthy living environments and advanced energy and water conservation.
- **Healthy Homes:** Non-toxic materials, natural ventilation and abundant daylight will be combined to provide the healthiest possible indoor environments for the residents.
- **Stormwater Management:** Green roofs will retard and filter rainwater runoff while providing an appealing view to surrounding neighbors. Filtered rainwater will be directed to an underground cistern to be used as non potable water for flushing toilets and for site landscape irrigation.
- **Organic Gardens:** The roof terraces of both buildings feature garden boxes that allow families and seniors to grow their own vegetables, providing food while fostering healthy social interaction.
- **Alternative Energy:** Rooftop photovoltaic and solar thermal canopies are estimated to provide up to 20% of the electrical demand, and up to 70% of the domestic hot water demand.
- **Water Conservation:** Ultra water-efficient fixtures, combined with draught-tolerant landscaping, will reduce water use by an estimated 45% from baseline.
- We expect to achieve a Green Point Rated Multifamily score of approximately 175 points for the Family Building and 137 points for the Senior Building.



Materials



Roof Axon

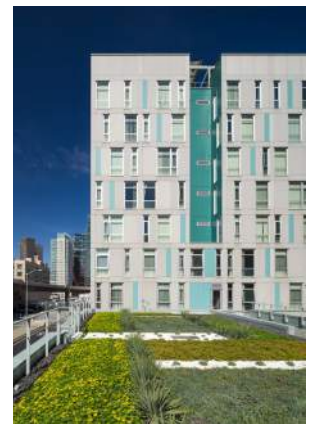

Green Roof

1

SITE CONTEXT

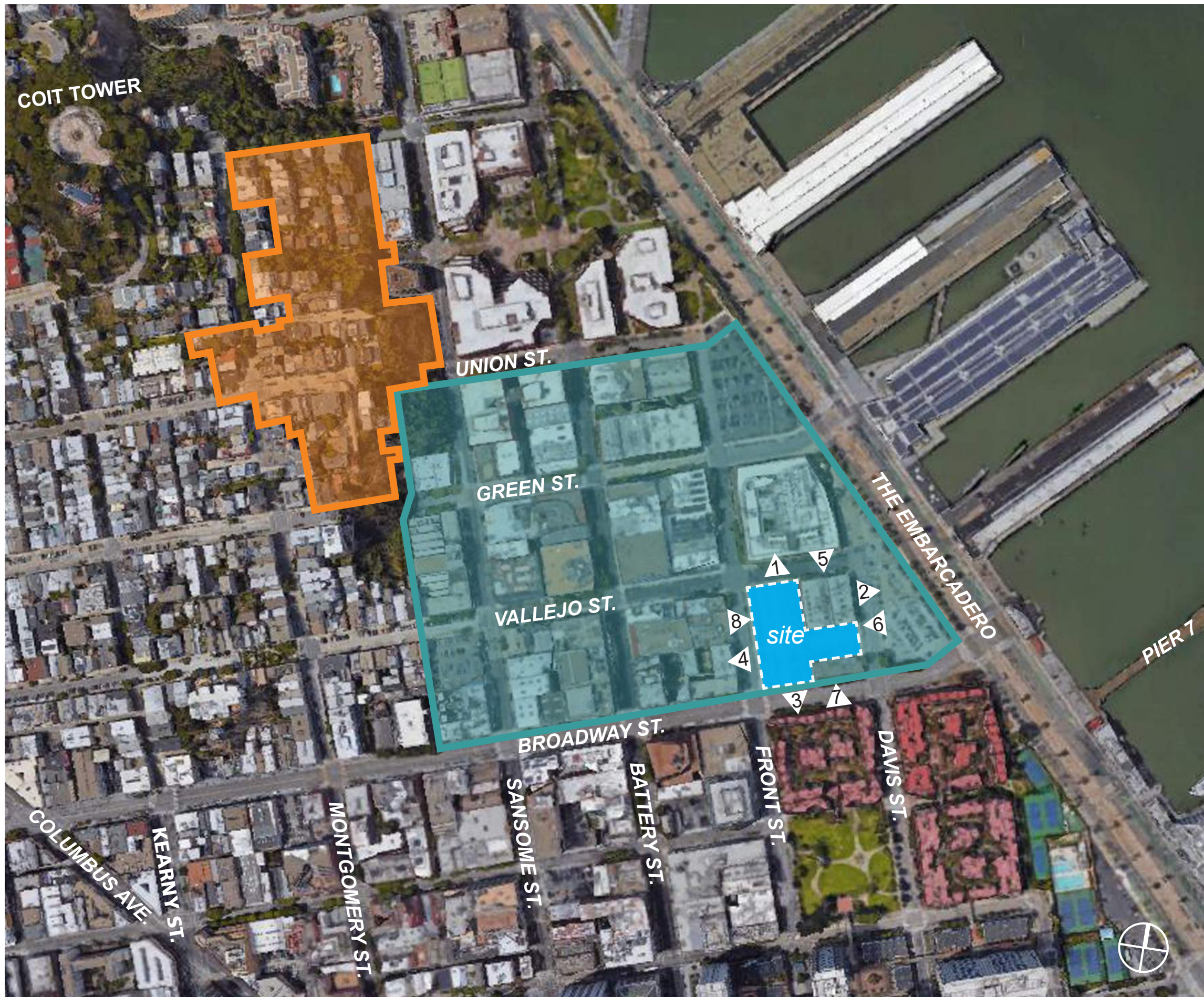

 NORTHEAST WATERFRONT HISTORIC DISTRICT

 TELEGRAPH HILL HISTORIC DISTRICT

SITE CONTEXT - HISTORIC DISTRICTS

CERTIFICATE OF APPROPRIATENESS
REV-5 / SECTION 315



A1.1 LMSA 88 BROADWAY/+735 DAVIS



VIEW 1 LOOKING SOUTH ON FRONT STREET



VIEW 2 LOOKING NORTH ON FRONT STREET X BROADWAY

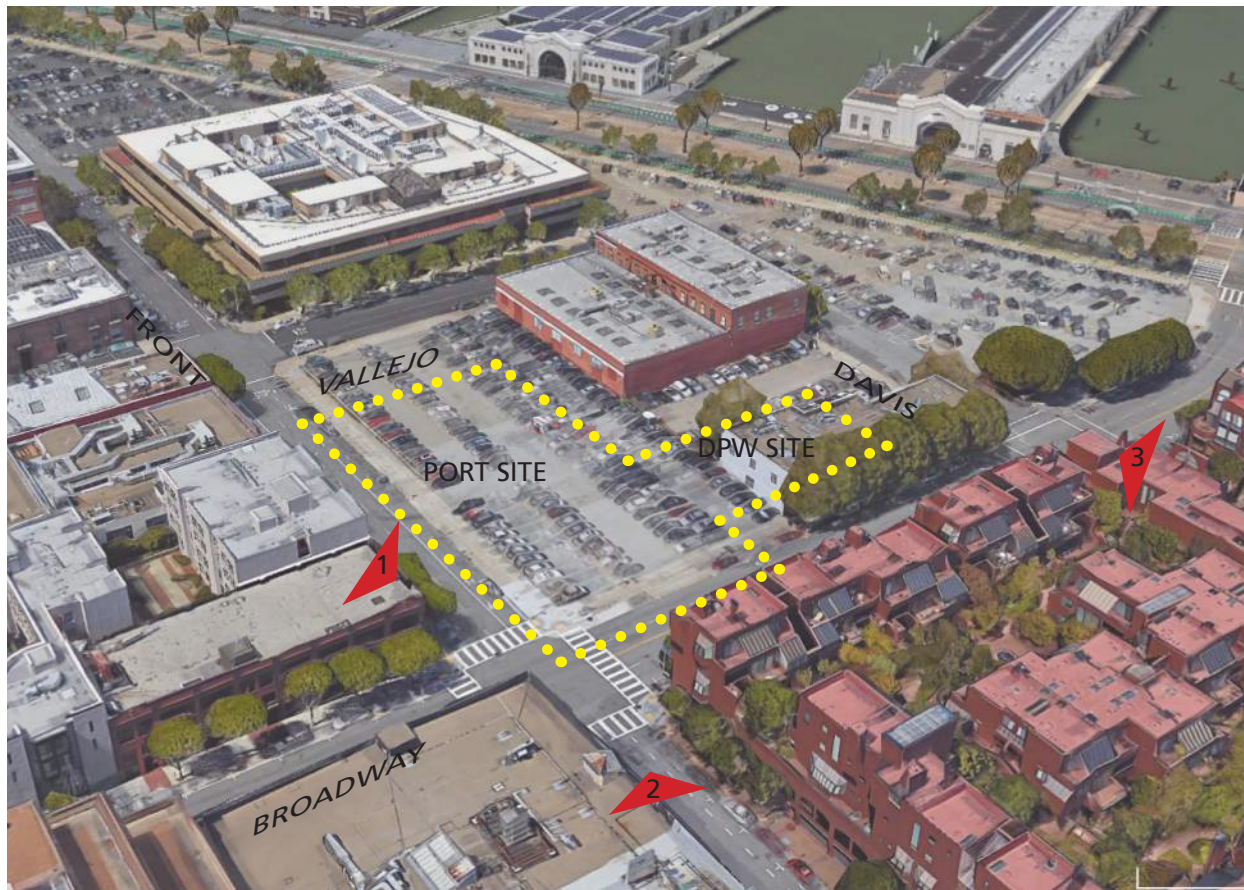

AERIAL VIEW + KEY



VIEW 3 LOOKING NORTH WEST ON BROADWAY AND DAVIS STREET



1 VALLEJO STREET



2 DAVIS STREET



3 BROADWAY STREET



4 FRONT STREET



5 VALLEJO STREET



6 DAVIS STREET



7 BROADWAY STREET



8 FRONT STREET



LEGEND

- HISTORIC BEARING WALL BLDGS.
- HISTORIC FRAME & INFILL BLDGS.
- NON-CONTRIBUTING
- NE WATERFRONT DISTRICT BOUNDARY

BEARING WALL BLDGS.

28%

FRAME & INFILL BLDGS.

46%

NON-CONTRIBUTING

26%

BEARING WALL BLDGS. 28%

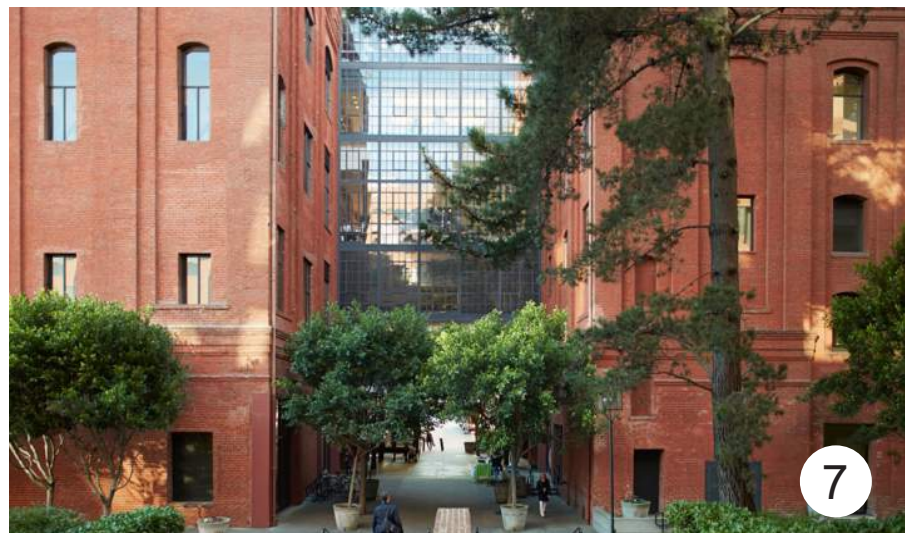

FRAME & INFILL BLDGS. 46%



NON-CONTRIBUTING 26%



2

ARCHITECTURAL DRAWINGS

MID BLOCK PASSAGES

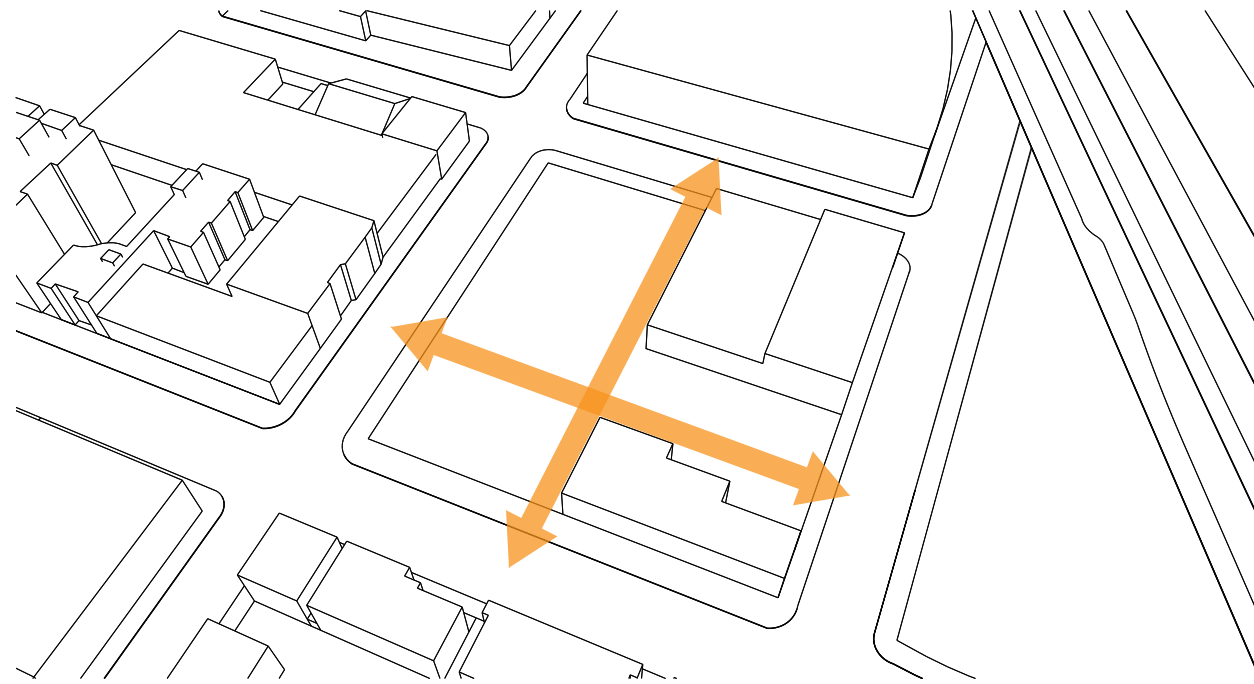

CONTEXTUAL HARMONY

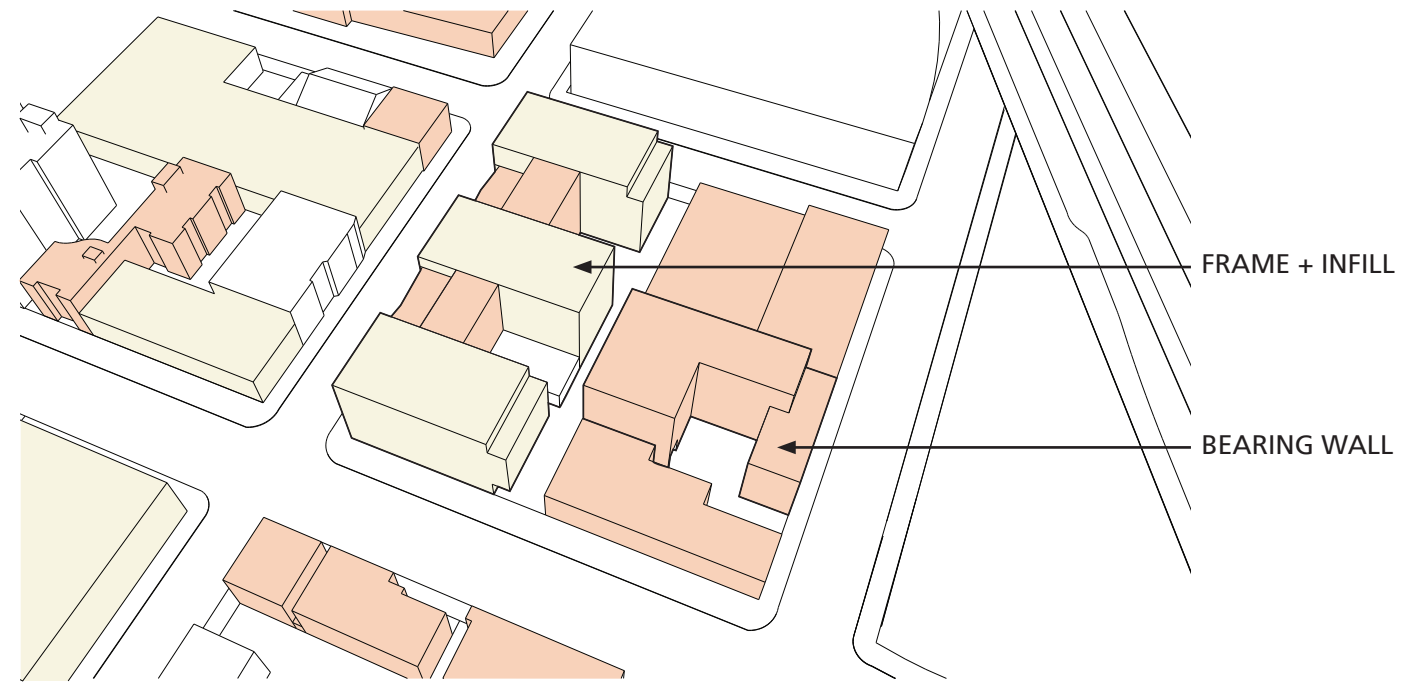

NETWORKED GREEN + OPEN SPACE

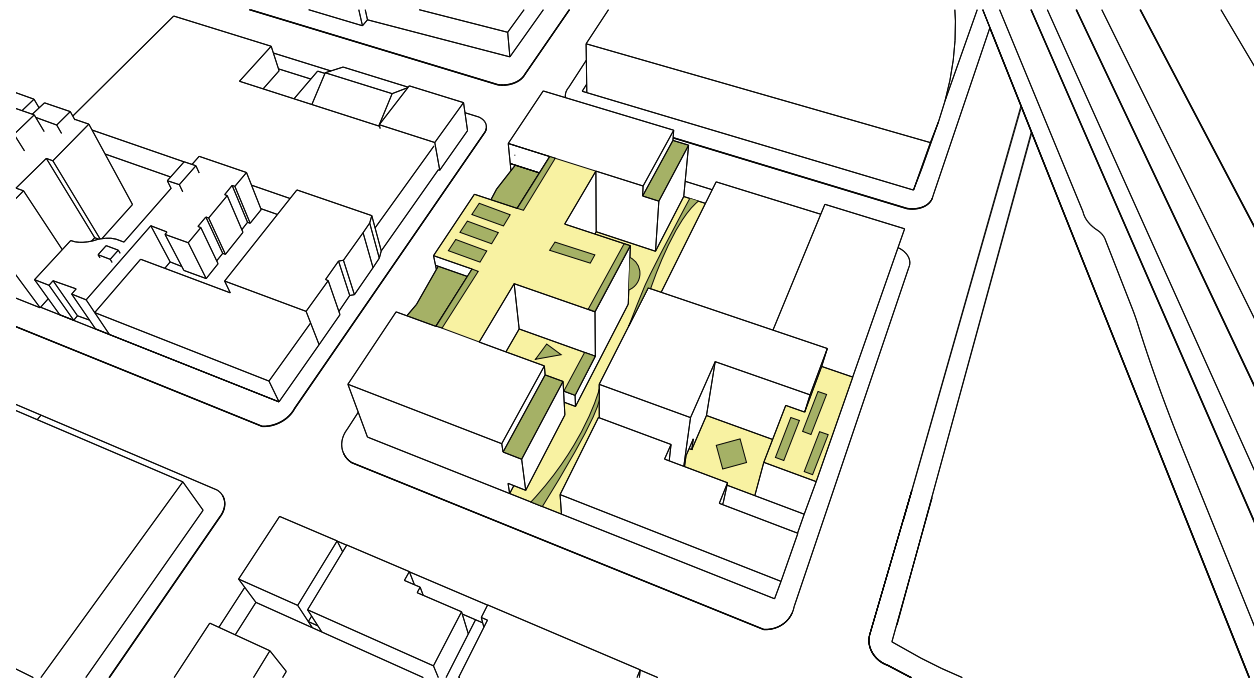

LIGHT AND VIEWS



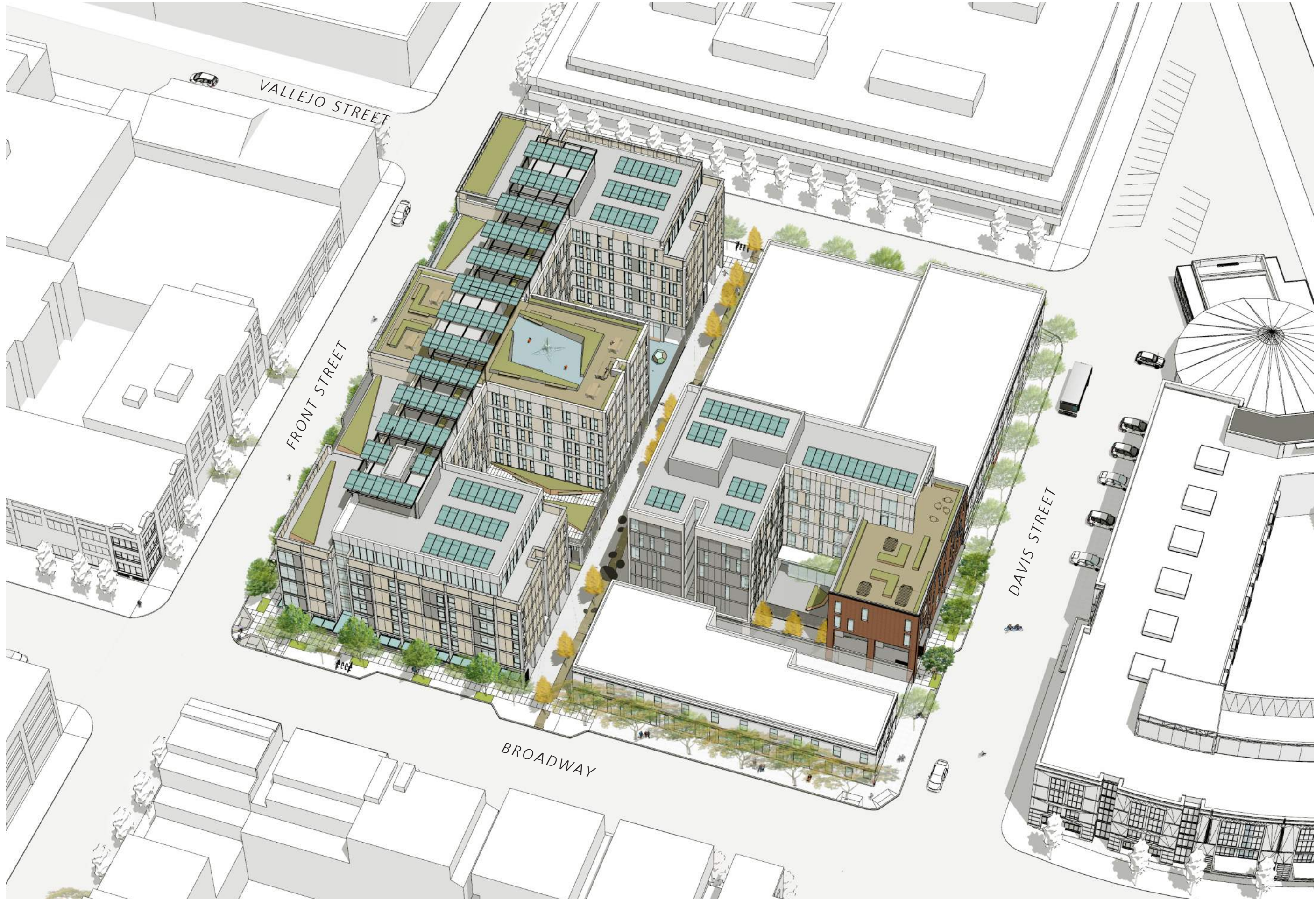

- ① COMMON COURTYARD AT GRADE
- ② EW MIDBLOCK PASSAGE
- ③ N/S MIDBLOCK PASSAGE
- ④ UNIT GARDEN ENTRY
- ⑤ COMMERCIAL ENTRY
- ⑥ FUTURE DEVELOPMENT (TEATRO ZINZANNI)
- ⑦ PLAYGROUND AT GRADE
- ⑧ NEW BULB OUT
- ⑨ GREEN ROOF AT LVL. 6
- ⑩ GREEN ROOF AT LVL. 5
- ⑪ GREEN ROOF NOT HABITABLE
- ⑫ FAMILY ROOF DECK
- ⑬ SENIOR ROOF DECK
- ⑭ FAMILY PODIUM COURTYARD AT LVL. 2

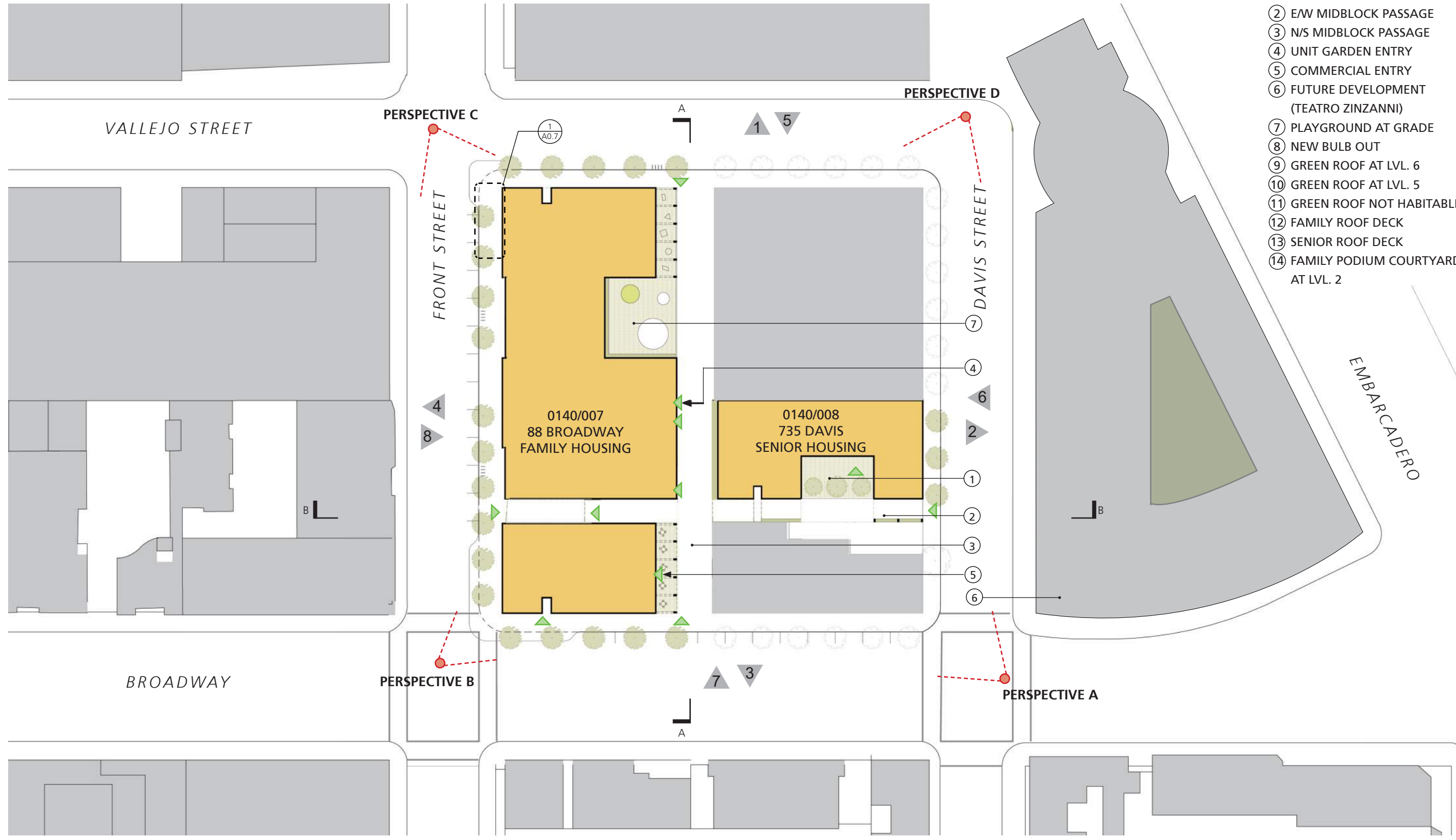

▲ PANORAMIC SEE A0.8-A0.9

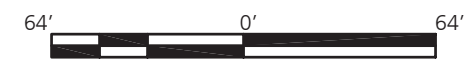

KEY PLAN



A2.3 LMSA 88 BROADWAY/+735 DAVIS
 CERTIFICATE OF APPROPRIATENESS
 REV-5 / SECTION 315



PERSPECTIVE A - BROADWAY X DAVIS STREET

CERTIFICATE OF APPROPRIATENESS
REV-5 / SECTION 315



PERSPECTIVE B - BROADWAY X FRONT STREET

CERTIFICATE OF APPROPRIATENESS
REV-5 / SECTION 315





- ① COMMON COURTYARD AT GRADE
- ② E/W MIDBLOCK PASSAGE
- ③ N/S MIDBLOCK PASSAGE
- ④ UNIT GARDEN ENTRY
- ⑤ COMMERCIAL ENTRY
- ⑥ FUTURE DEVELOPMENT (TEATRO ZINZANNI)
- ⑦ PLAYGROUND AT GRADE
- ⑧ NEW BULB OUT
- ⑨ PV SOLAR ARRAY
- ⑩ NOT HABITABLE GREEN ROOF AT LVL. 6
- ⑪ NOT HABITABLE ROOF AT LVL. 6
- ⑫ FAMILY ROOF DECK
- ⑬ SENIOR ROOF DECK
- ⑭ FAMILY PODIUM COURTYARD AT LVL. 2

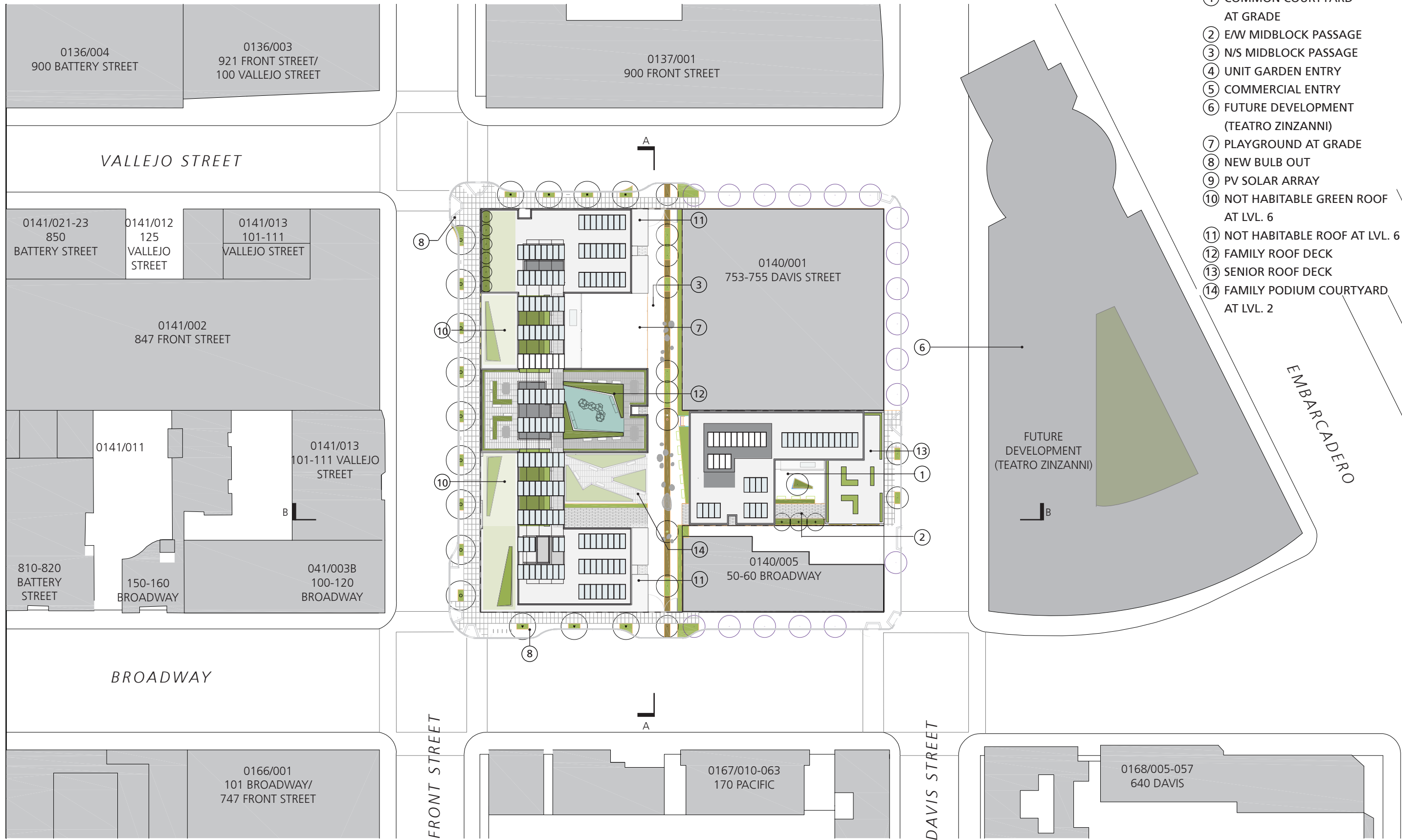

SCALE: 1/64" = 1'-0"

CERTIFICATE OF APPROPRIATENESS

REV-5 / SECTION 315

SITE PLAN



A2.8 LMSA 88 BROADWAY/+735 DAVIS



LEVEL 1 PLAN

A2.9 LMSA 88 BROADWAY/+735 DAVIS

FLOOR PLAN KEYNOTES:

- ① UNIT ENTRY GATE / FENCE
- ② TREE WELL COVER; S.L.D.
- ③ TEXTURED PAVEMENT, CONC. PAVERS; S.L.D.
- ④ MID-BLOCK GATE
- ⑤ GRADE PLANTER
- ⑥ NEW STREET TREE
- ⑦ CLASS II BIKE PARKING
- ⑧ MTL. & GLASS CANOPY
- ⑨ BENCH S.L.D.
- ⑩ COURTYARD FENCE
- ⑪ NEW CURB RAMP
- ⑫ NEW CURB CUT
- ⑬ EXISTING CURB CUT TO REMAIN
- ⑭ EXISTING CURB CUT TO BE REMOVED
- ⑮ ELEVATORS
- ⑯ PAVERS
- ⑰ HORIZONTAL EXIT
- ⑱ GREEN ROOF NOT HABITABLE
- ⑲ NEW BULB OUT
- ⑳ PLAY STRUCTURE
- ㉑ FURNITURE BY OTHERS
- ㉒ RAISED PLANTERS
- ㉓ PV SOLAR ARRAY
- ㉔ SENIOR ROOF TERRACE LVL. 5
- ㉕ STL. & CABLE RAILING

LEGEND:

- COMMERCIAL / CHILDCARE
- RESIDENTIAL UNITS
- CIRCULATION & SUPPORT
- SERVICE



FLOOR PLAN KEYNOTES:

- ① UNIT ENTRY GATE / FENCE
- ② TREE WELL COVER; S.L.D.
- ③ TEXTURED PAVEMENT, CONC. PAVERS; S.L.D.
- ④ MID-BLOCK GATE
- ⑤ GRADE PLANTER
- ⑥ NEW STREET TREE
- ⑦ CLASS II BIKE PARKING
- ⑧ MTL. & GLASS CANOPY
- ⑨ BENCH S.L.D.
- ⑩ COURTYARD FENCE
- ⑪ NEW CURB RAMP
- ⑫ NEW CURB CUT
- ⑬ EXISTING CURB CUT TO REMAIN
- ⑭ EXISTING CURB CUT TO BE REMOVED
- ⑮ ELEVATORS
- ⑯ PAVERS
- ⑰ HORIZONTAL EXIT
- ⑱ GREEN ROOF NOT HABITABLE
- ⑲ NEW BULB OUT
- ⑳ PLAY STRUCTURE
- ㉑ FURNITURE BY OTHERS
- ㉒ RAISED PLANTERS
- ㉓ PV SOLAR ARRAY
- ㉔ SENIOR ROOF TERRACE LVL. 5
- ㉕ STL. & CABLE RAILING

LEGEND:

- COMMERCIAL / CHILDCARE
- RESIDENTIAL UNITS
- CIRCULATION & SUPPORT
- SERVICE

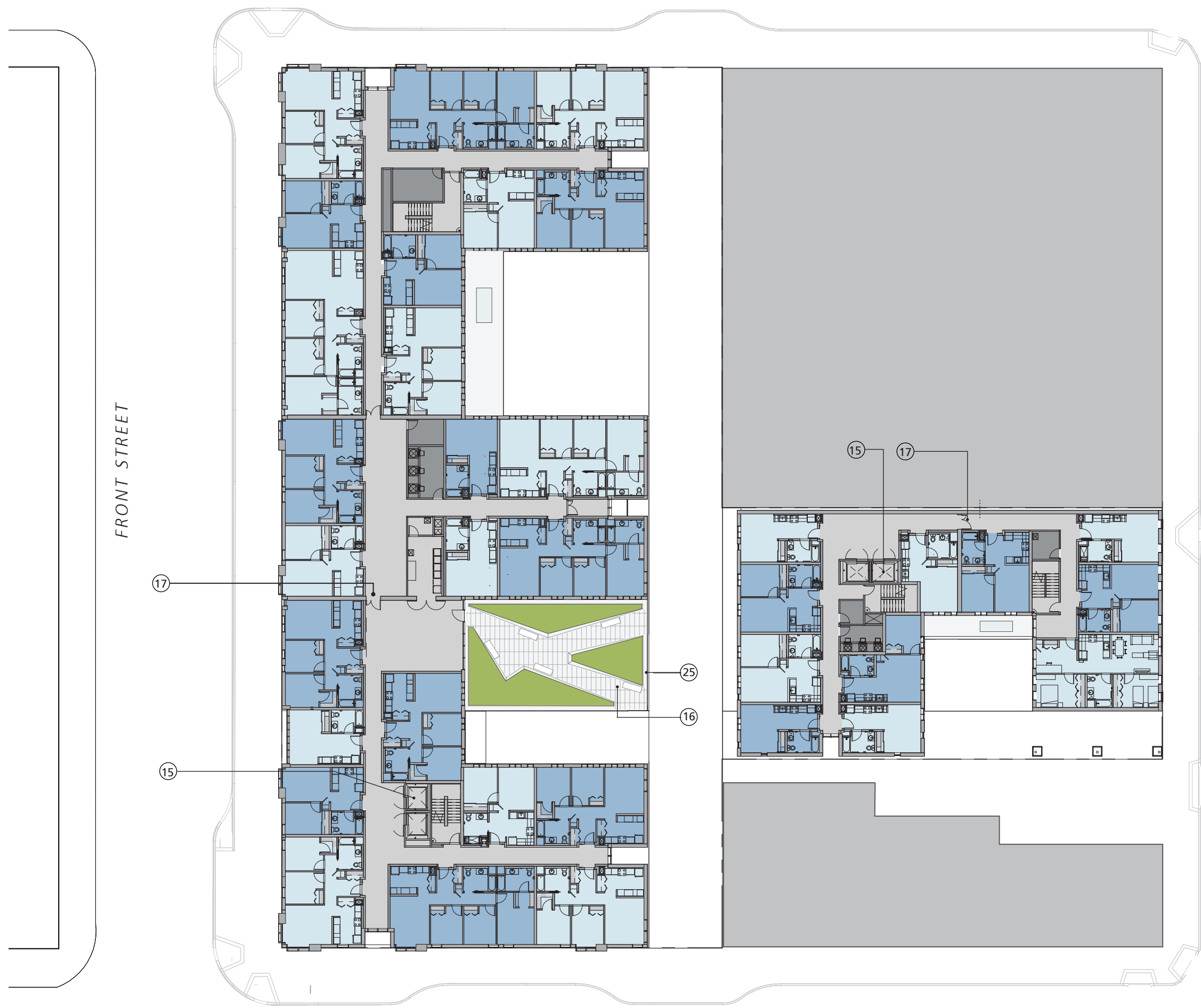

FRONT STREET

DAVIS STREET

BROADWAY STREET

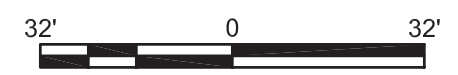

SCALE: 1/32" = 1'-0"

LEVEL 2 PLAN



A2.10 LMSA 88 BROADWAY/+735 DAVIS CERTIFICATE OF APPROPRIATENESS REV-5 / SECTION 315

FLOOR PLAN KEYNOTES:

- ① UNIT ENTRY GATE / FENCE
- ② TREE WELL COVER; S.L.D.
- ③ TEXTURED PAVEMENT, CONC. PAVERS; S.L.D.
- ④ MID-BLOCK GATE
- ⑤ GRADE PLANTER
- ⑥ NEW STREET TREE
- ⑦ CLASS II BIKE PARKING
- ⑧ MTL. & GLASS CANOPY
- ⑨ BENCH S.L.D.
- ⑩ COURTYARD FENCE
- ⑪ NEW CURB RAMP
- ⑫ NEW CURB CUT
- ⑬ EXISTING CURB CUT TO REMAIN
- ⑭ EXISTING CURB CUT TO BE REMOVED
- ⑮ ELEVATORS
- ⑯ PAVERS
- ⑰ HORIZONTAL EXIT
- ⑱ GREEN ROOF NOT HABITABLE
- ⑲ NEW BULB OUT
- ⑳ PLAY STRUCTURE
- ㉑ FURNITURE BY OTHERS
- ㉒ RAISED PLANTERS
- ㉓ PV SOLAR ARRAY
- ㉔ SENIOR ROOF TERRACE LVL. 5
- ㉕ STL. & CABLE RAILING

LEGEND:

- COMMERCIAL / CHILDCARE
- RESIDENTIAL UNITS
- CIRCULATION & SUPPORT
- SERVICE

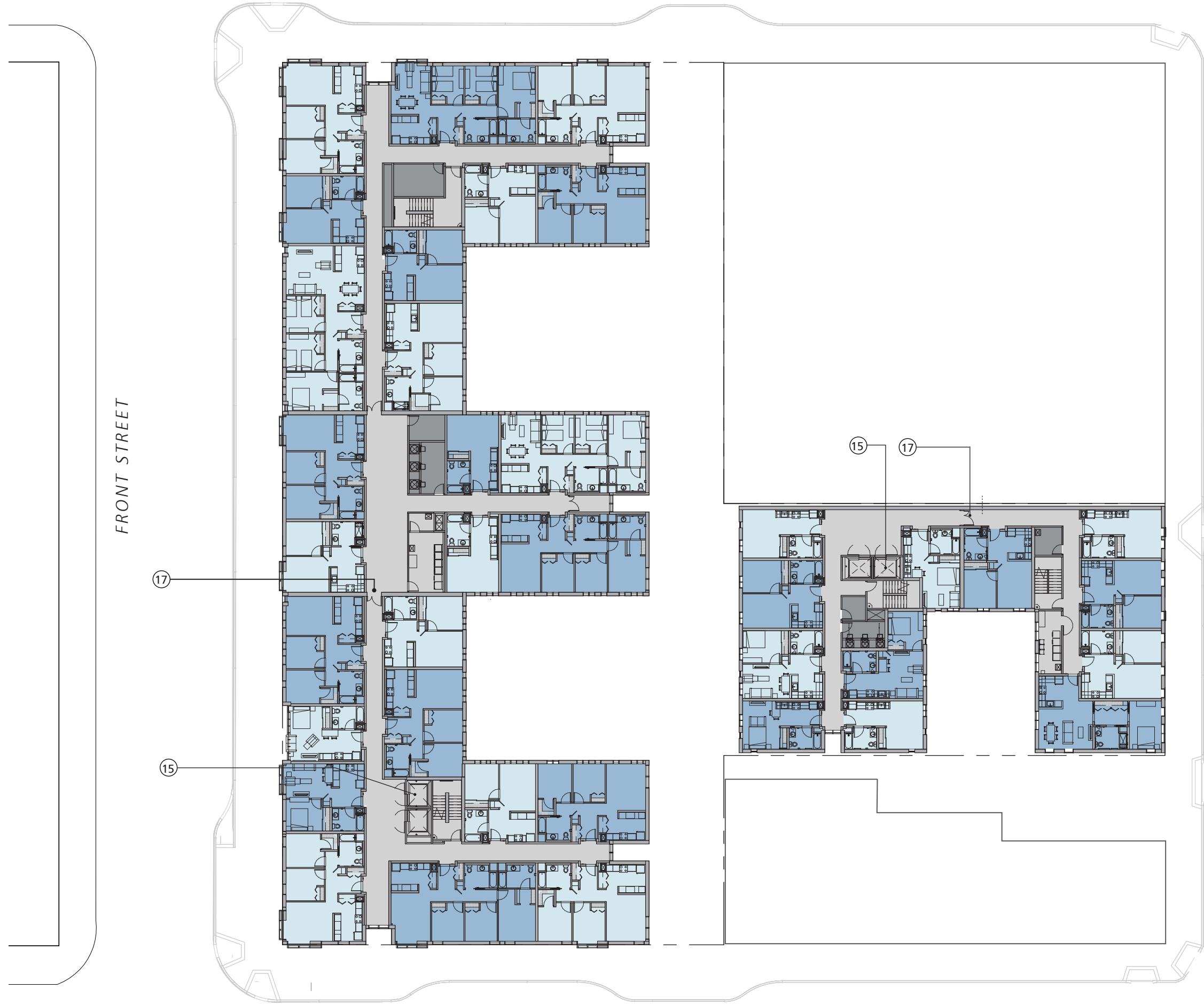

FRONT STREET

DAVIS STREET

BROADWAY STREET

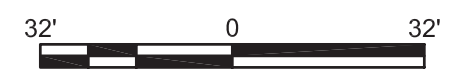

SCALE: 1/32" = 1'-0"

LEVEL 3 PLAN



A2.11 LMSA 88 BROADWAY/+735 DAVIS CERTIFICATE OF APPROPRIATENESS REV-5 / SECTION 315

FLOOR PLAN KEYNOTES:

- ① UNIT ENTRY GATE / FENCE
- ② TREE WELL COVER; S.L.D.
- ③ TEXTURED PAVEMENT, CONC. PAVERS; S.L.D.
- ④ MID-BLOCK GATE
- ⑤ GRADE PLANTER
- ⑥ NEW STREET TREE
- ⑦ CLASS II BIKE PARKING
- ⑧ MTL. & GLASS CANOPY
- ⑨ BENCH S.L.D.
- ⑩ COURTYARD FENCE
- ⑪ NEW CURB RAMP
- ⑫ NEW CURB CUT
- ⑬ EXISTING CURB CUT TO REMAIN
- ⑭ EXISTING CURB CUT TO BE REMOVED
- ⑮ ELEVATORS
- ⑯ PAVERS
- ⑰ HORIZONTAL EXIT
- ⑱ GREEN ROOF NOT HABITABLE
- ⑲ NEW BULB OUT
- ⑳ PLAY STRUCTURE
- ㉑ FURNITURE BY OTHERS
- ㉒ RAISED PLANTERS
- ㉓ PV SOLAR ARRAY
- ㉔ SENIOR ROOF TERRACE LVL. 5
- ㉕ STL. & CABLE RAILING

LEGEND:

- COMMERCIAL / CHILDCARE
- RESIDENTIAL UNITS
- CIRCULATION & SUPPORT
- SERVICE

FRONT STREET

DAVIS STREET

BROADWAY STREET

⑰

⑮

⑮

⑰



SCALE: 1/32" = 1'-0"

LEVEL 4 PLAN



A2.12 LMSA 88 BROADWAY/+735 DAVIS CERTIFICATE OF APPROPRIATENESS REV-5 / SECTION 315

FLOOR PLAN KEYNOTES:

- ① UNIT ENTRY GATE / FENCE
- ② TREE WELL COVER; S.L.D.
- ③ TEXTURED PAVEMENT, CONC. PAVERS; S.L.D.
- ④ MID-BLOCK GATE
- ⑤ GRADE PLANTER
- ⑥ NEW STREET TREE
- ⑦ CLASS II BIKE PARKING
- ⑧ MTL. & GLASS CANOPY
- ⑨ BENCH S.L.D.
- ⑩ COURTYARD FENCE
- ⑪ NEW CURB RAMP
- ⑫ NEW CURB CUT
- ⑬ EXISTING CURB CUT TO REMAIN
- ⑭ EXISTING CURB CUT TO BE REMOVED
- ⑮ ELEVATORS
- ⑯ PAVERS
- ⑰ HORIZONTAL EXIT
- ⑱ GREEN ROOF NOT HABITABLE
- ⑲ NEW BULB OUT
- ⑳ PLAY STRUCTURE
- ㉑ FURNITURE BY OTHERS
- ㉒ RAISED PLANTERS
- ㉓ PV SOLAR ARRAY
- ㉔ SENIOR ROOF TERRACE LVL. 5
- ㉕ STL. & CABLE RAILING

LEGEND:

- COMMERCIAL / CHILDCARE
- RESIDENTIAL UNITS
- CIRCULATION & SUPPORT
- SERVICE

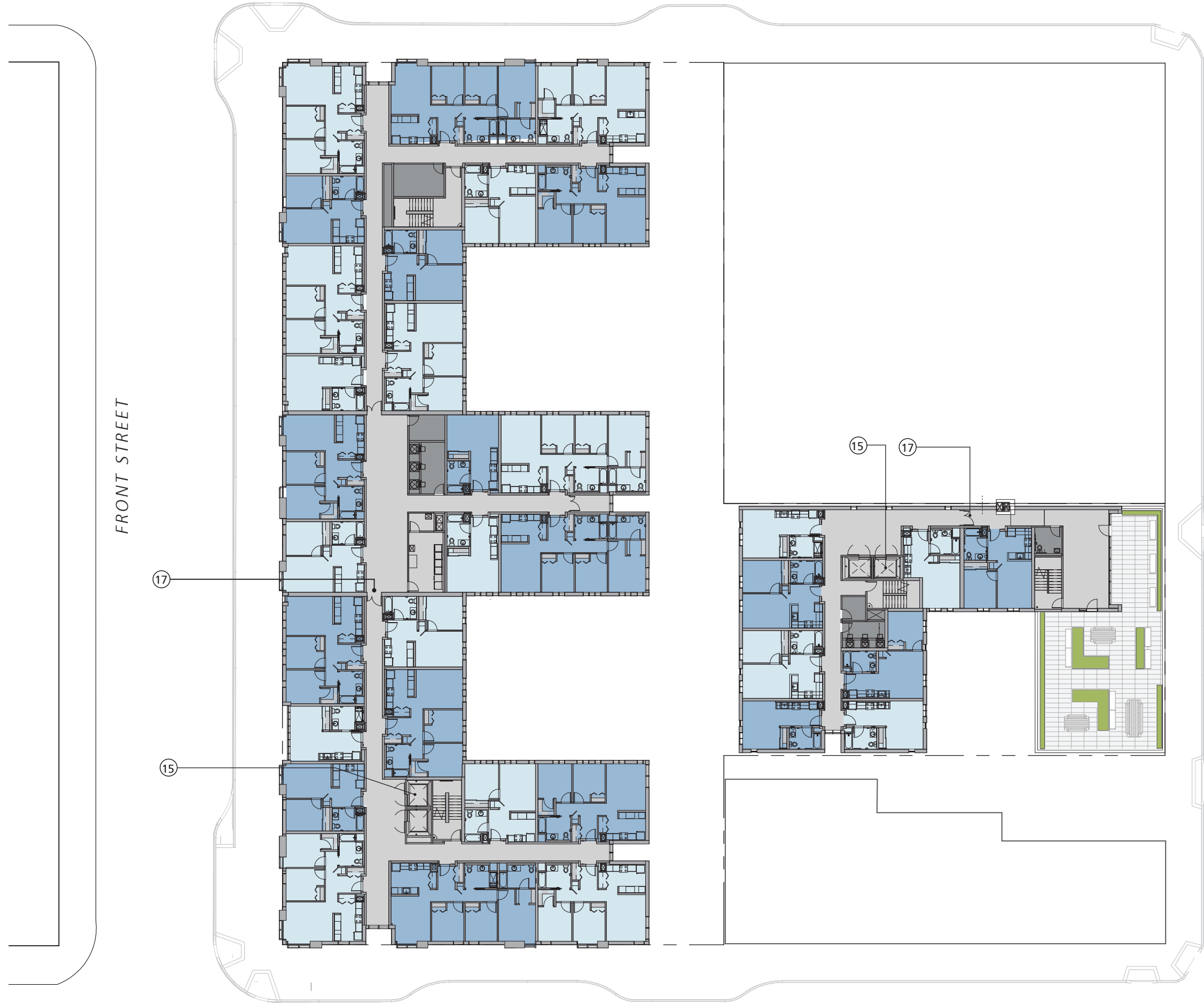

DAVIS STREET

FRONT STREET

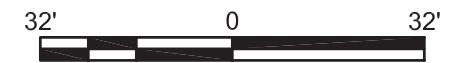

SCALE: 1/32" = 1'-0"

LEVEL 5 PLAN



A2.13 LMSA 88 BROADWAY/+735 DAVIS CERTIFICATE OF APPROPRIATENESS REV-5 / SECTION 315

FLOOR PLAN KEYNOTES:

- ① UNIT ENTRY GATE / FENCE
- ② TREE WELL COVER; S.L.D.
- ③ TEXTURED PAVEMENT, CONC. PAVERS; S.L.D.
- ④ MID-BLOCK GATE
- ⑤ GRADE PLANTER
- ⑥ NEW STREET TREE
- ⑦ CLASS II BIKE PARKING
- ⑧ MTL. & GLASS CANOPY
- ⑨ BENCH S.L.D.
- ⑩ COURTYARD FENCE
- ⑪ NEW CURB RAMP
- ⑫ NEW CURB CUT
- ⑬ EXISTING CURB CUT TO REMAIN
- ⑭ EXISTING CURB CUT TO BE REMOVED
- ⑮ ELEVATORS
- ⑯ PAVERS
- ⑰ HORIZONTAL EXIT
- ⑱ GREEN ROOF NOT HABITABLE
- ⑲ NEW BULB OUT
- ⑳ PLAY STRUCTURE
- ㉑ FURNITURE BY OTHERS
- ㉒ RAISED PLANTERS
- ㉓ PV SOLAR ARRAY
- ㉔ SENIOR ROOF TERRACE LVL. 5
- ㉕ STL. & CABLE RAILING

LEGEND:

- COMMERCIAL / CHILDCARE
- RESIDENTIAL UNITS
- CIRCULATION & SUPPORT
- SERVICE

FRONT STREET

DAVIS STREET

BROADWAY STREET

17

15

15

17



SCALE: 1/32" = 1'-0"

LEVEL 6 PLAN



A2.14 LMSA 88 BROADWAY/+735 DAVIS CERTIFICATE OF APPROPRIATENESS REV-5 / SECTION 315

FLOOR PLAN KEYNOTES:

- ① UNIT ENTRY GATE / FENCE
- ② TREE WELL COVER; S.L.D.
- ③ TEXTURED PAVEMENT, CONC. PAVERS; S.L.D.
- ④ MID-BLOCK GATE
- ⑤ GRADE PLANTER
- ⑥ NEW STREET TREE
- ⑦ CLASS II BIKE PARKING
- ⑧ MTL. & GLASS CANOPY
- ⑨ BENCH S.L.D.
- ⑩ COURTYARD FENCE
- ⑪ NEW CURB RAMP
- ⑫ NEW CURB CUT
- ⑬ EXISTING CURB CUT TO REMAIN
- ⑭ EXISTING CURB CUT TO BE REMOVED
- ⑮ ELEVATORS
- ⑯ PAVERS
- ⑰ HORIZONTAL EXIT
- ⑱ GREEN ROOF NOT HABITABLE
- ⑲ NEW BULB OUT
- ⑳ PLAY STRUCTURE
- ㉑ FURNITURE BY OTHERS
- ㉒ RAISED PLANTERS
- ㉓ PV SOLAR ARRAY
- ㉔ SENIOR ROOF TERRACE LVL. 5
- ㉕ STL. & CABLE RAILING
- ㉖ SOLAR HOT WATER PANELS

LEGEND:

- COMMERCIAL / CHILDCARE
- RESIDENTIAL UNITS
- CIRCULATION & SUPPORT
- SERVICE

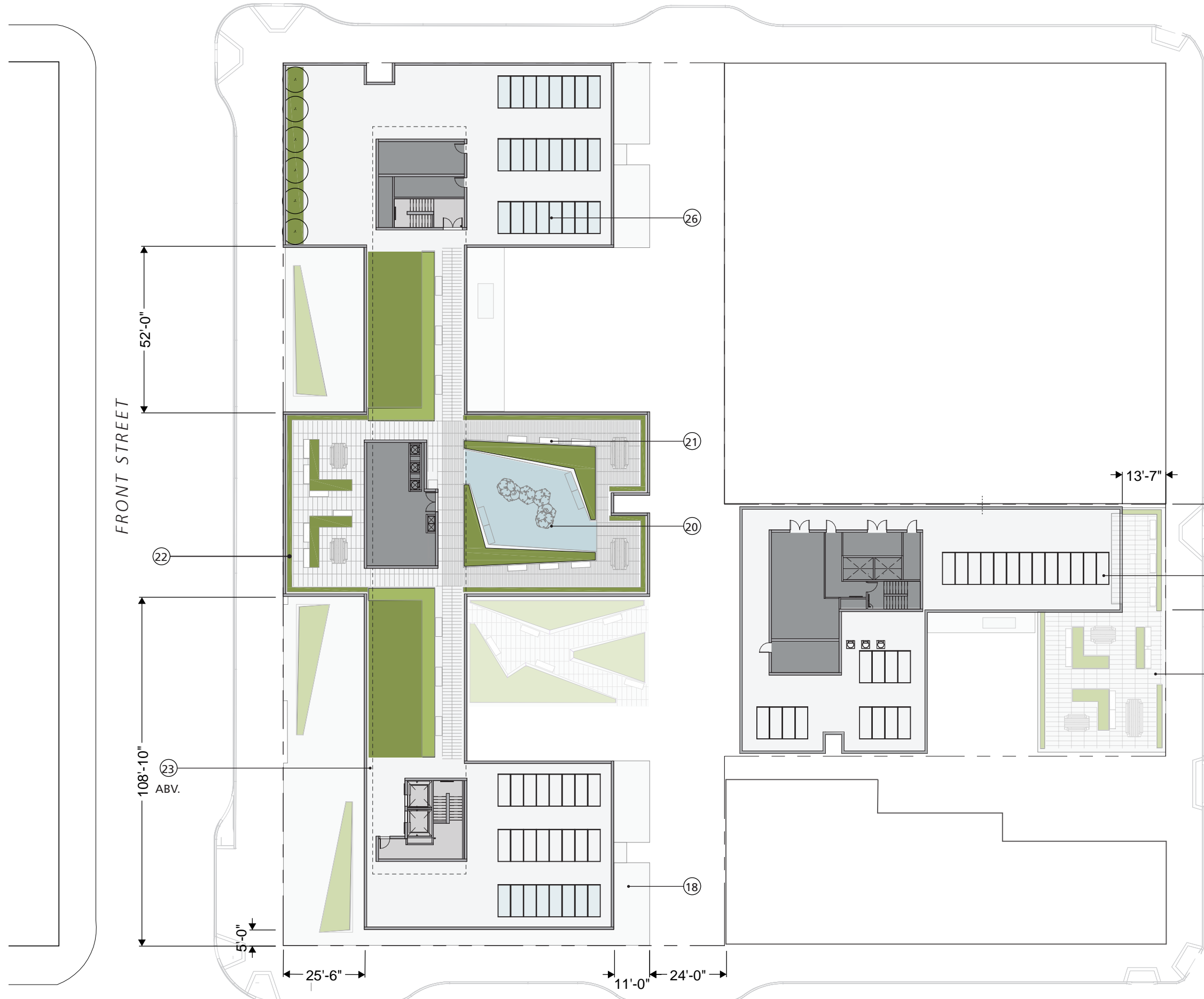

SCALE: 1/32" = 1'-0"

ROOF PLAN



3

HISTORIC COMPATIBILITY

FRONT STREET
(PACIFIC THROUGH BROADWAY)

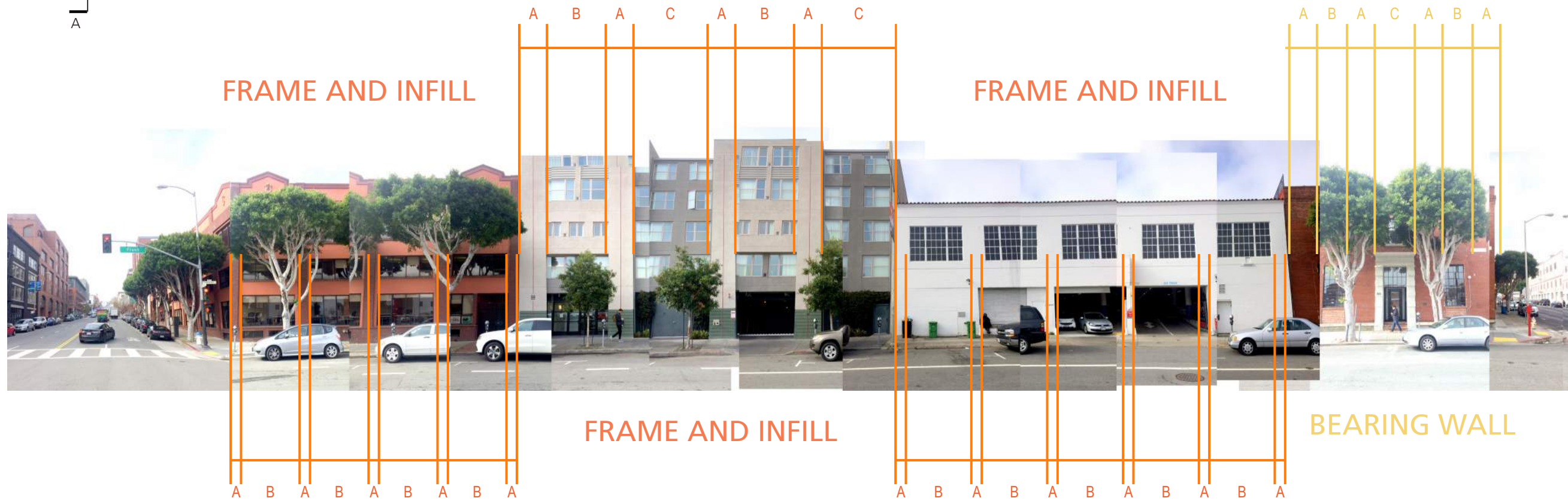
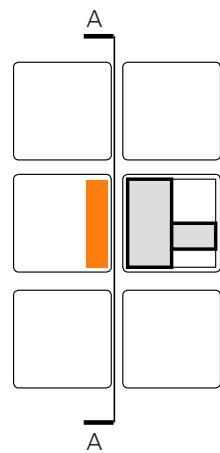

BROADWAY

FRONT STREET AA

VALLEJO

**SAN FRANCISCO PLANNING CODE
SECTION 6. FEATURES:**

- (B) SCALE AND PROPORTION. THE BUILDINGS ARE OF TYPICAL **WAREHOUSE DESIGN**, LARGE IN BULK, OFTEN WITH LARGE ARCHES AND OPENINGS ORIGINALLY DESIGNED FOR EASY VEHICULAR ACCESS.
- THERE IS A **REGULARITY OF OVERALL FORM**.
- THE EARLIER BRICK STRUCTURES BLEND EASILY WITH THE SCALED-DOWN BEAUX ARTS FORMS OF THE TURN OF THE CENTURY AND THE PLAIN REINFORCED-CONCRETE STRUCTURES CHARACTERISTIC OF TWENTIETH CENTURY INDUSTRIAL ARCHITECTURE.

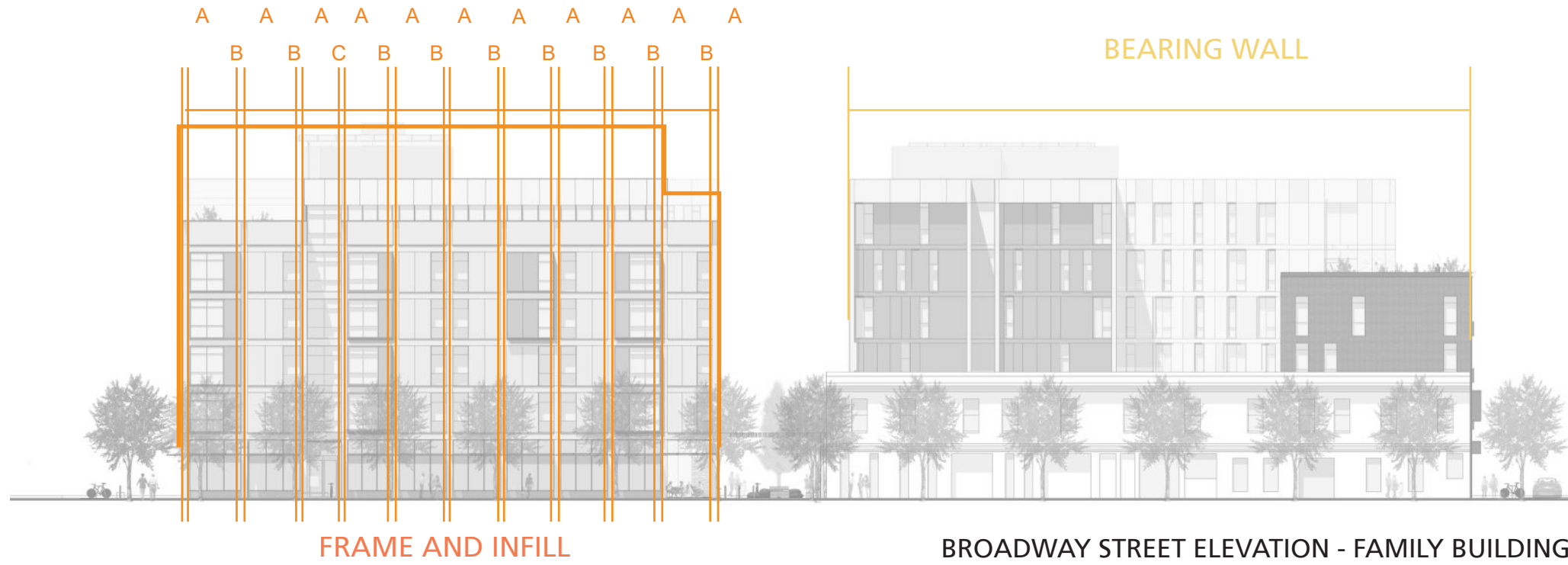

FRAME AND INFILL

BROADWAY STREET ELEVATION - FAMILY BUILDING

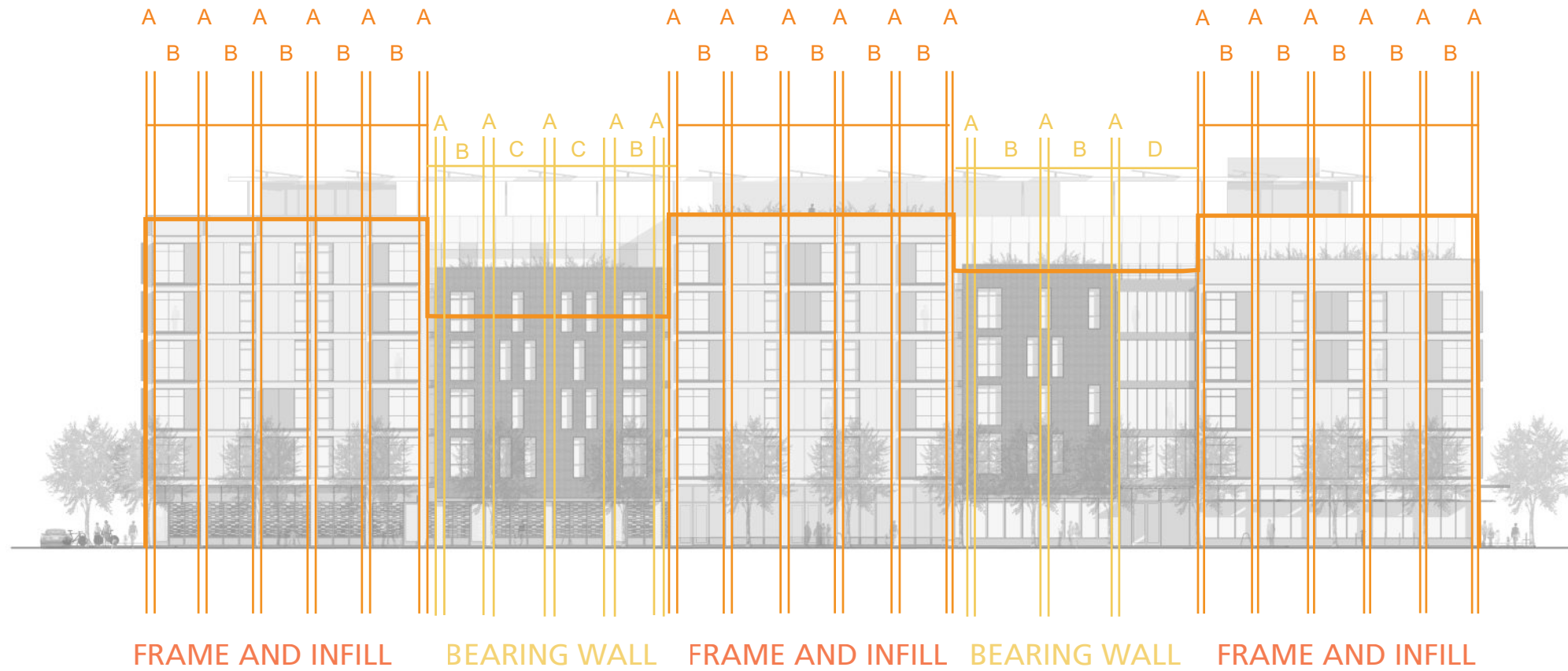

FRAME AND INFILL

BEARING WALL

FRAME AND INFILL

BEARING WALL

FRAME AND INFILL

FRONT STREET ELEVATION - FAMILY BUILDING

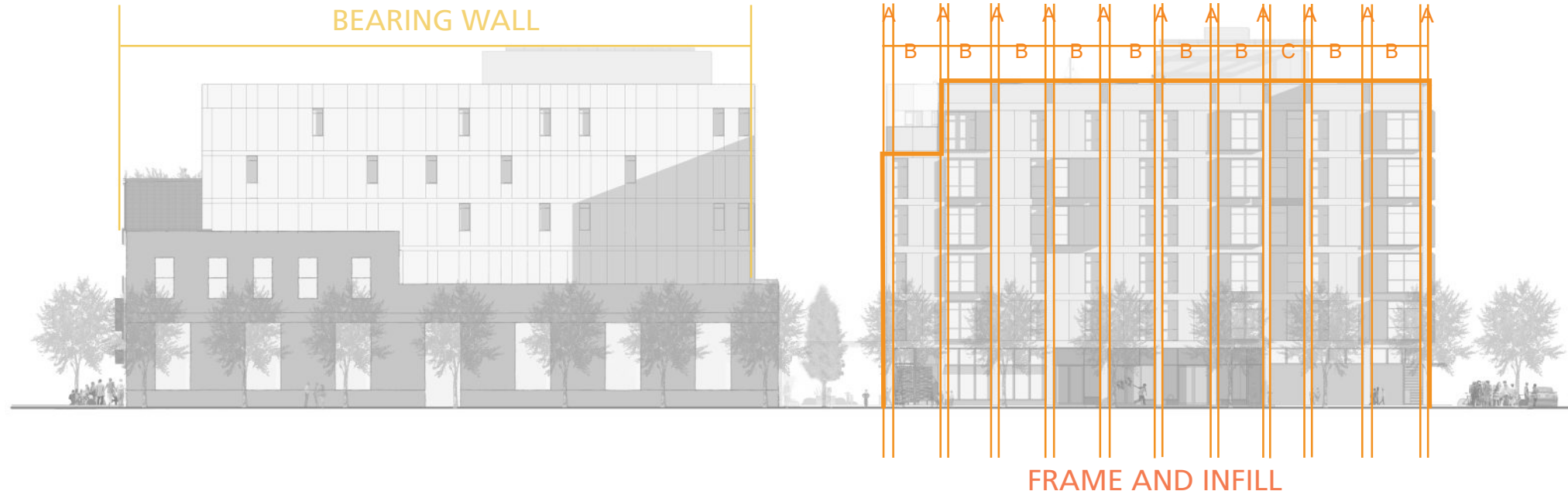

VALLEJO STREET ELEVATION

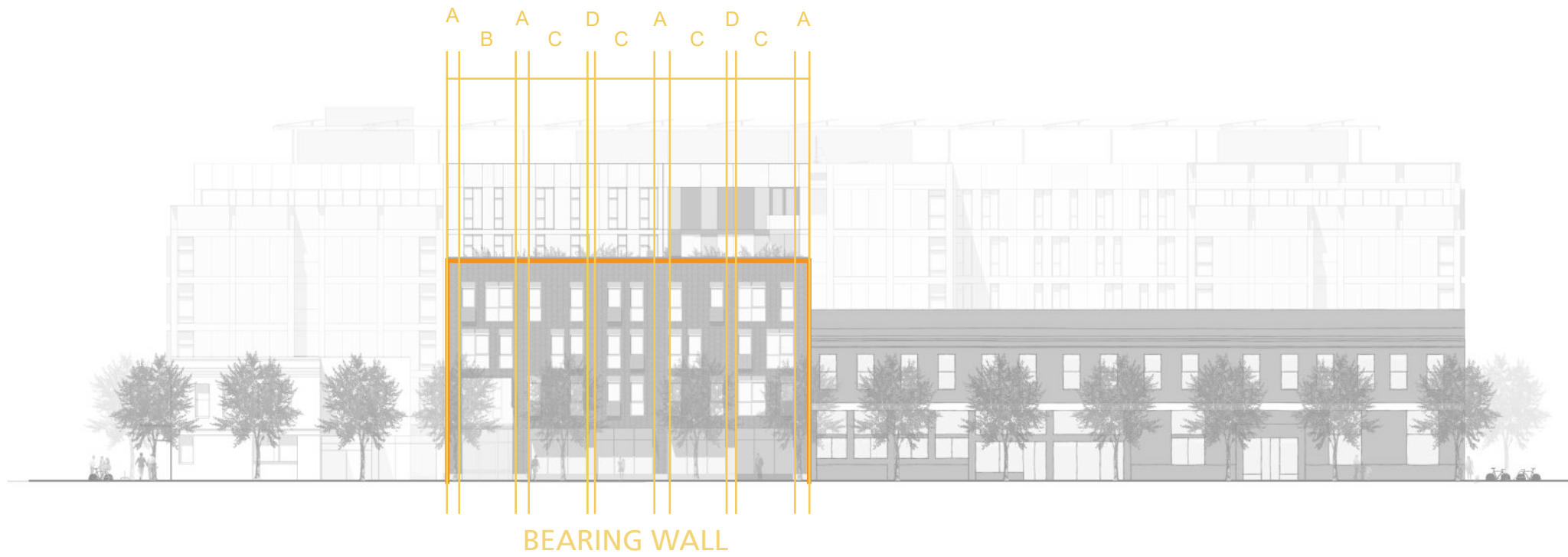

DAVIS STREET ELEVATION - SENIOR BUILDING

ELEVATION AND SECTION KEYNOTES:

- ① TYPE 1 CEMENTITIOUS PANEL "FRAME"
- ② TYPE 2 CEMENTITIOUS PANEL "PROJECTION"
- ③ TYPE 3 CEMENTITIOUS PANEL "INFILL"
- ④ ALUMINUM WINDOW
- ⑤ CONCRETE COLUMNS
- ⑥ STANCHION MOUNTED ROOF SOLAR PANELS
- ⑦ METAL AND GLASS AWNING
- ⑧ PROJECTED WINDOW, METAL EDGE
- ⑨ METAL ROLL UP GARAGE DOOR
- ⑩ THIN BRICK
- ⑪ METAL GRATE + GLASS PANEL FENCE/GATE
- ⑫ ENCLOSED ROOFTOP MECHANICAL SPACES
- ⑬ PERFORATED METAL JULIET BALCONY
- ⑭ ALUMINUM STOREFRONT
- ⑮ PAINTED STUCCO
- ⑯ BALCONY
- ⑰ PARAPET COPING 42" ABOVE ROOF PLANE
- ⑱ PROPOSED TREE
- ⑲ EXISTING TREE
- ⑳ RAISED PLANTER
- ㉑ SIGNAGE
- ㉒ CONCRETE "BULK HEAD"
- ㉓ METAL GUARD RAIL
- ㉔ METAL PLANTER
- ㉕ PLATE METAL CANOPY



BROADWAY--SOUTH ELEVATION

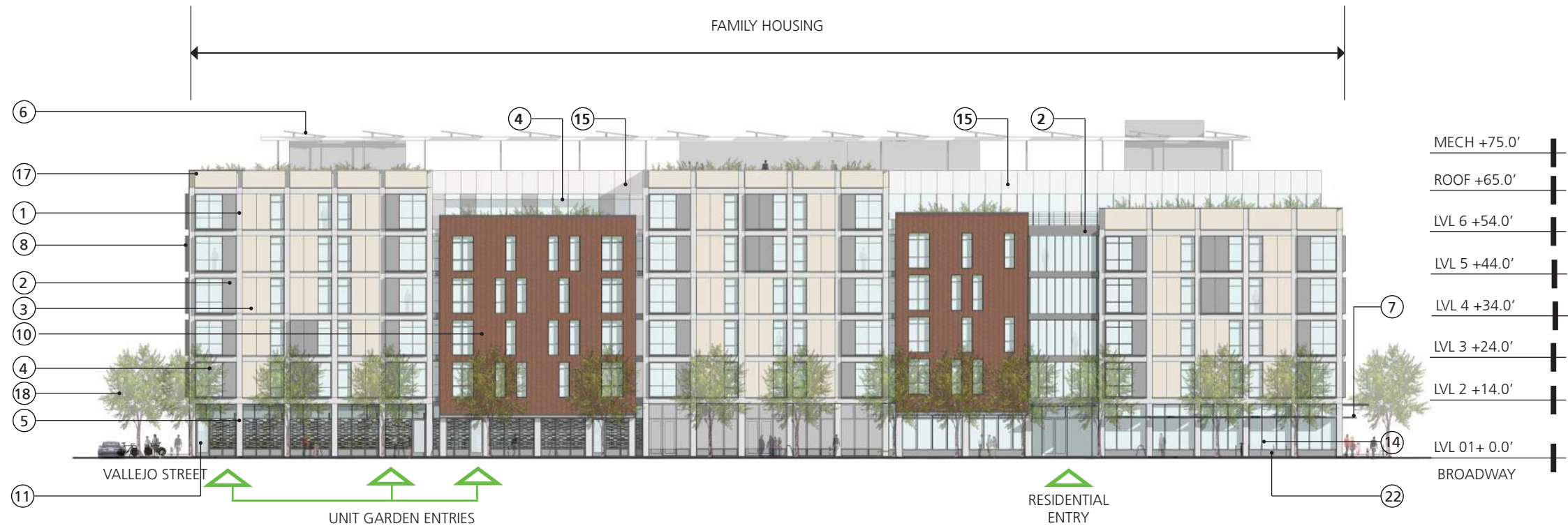

FRONT STREET--WEST ELEVATION



SCALE: 1/32" = 1'-0"

ELEVATIONS



A3.4 LMSA 88 BROADWAY/+735 DAVIS CERTIFICATE OF APPROPRIATENESS REV-5 / SECTION 315

ELEVATION AND SECTION KEYNOTES:

- ① TYPE 1 CEMENTITIOUS PANEL "FRAME"
- ② TYPE 2 CEMENTITIOUS PANEL "PROJECTION"
- ③ TYPE 3 CEMENTITIOUS PANEL "INFILL"
- ④ ALUMINUM WINDOW
- ⑤ CONCRETE COLUMNS
- ⑥ STANCHION MOUNTED ROOF SOLAR PANELS
- ⑦ METAL AND GLASS AWNING
- ⑧ PROJECTED WINDOW, METAL EDGE
- ⑨ METAL ROLL UP GARAGE DOOR
- ⑩ THIN BRICK
- ⑪ METAL GRATE + GLASS PANEL FENCE/GATE
- ⑫ ENCLOSED ROOFTOP MECHANICAL SPACES
- ⑬ PERFORATED METAL JULIET BALCONY
- ⑭ ALUMINUM STOREFRONT
- ⑮ PAINTED STUCCO
- ⑯ BALCONY
- ⑰ PARAPET COPING 42" ABOVE ROOF PLANE
- ⑱ PROPOSED TREE
- ⑲ EXISTING TREE
- ⑳ RAISED PLANTER
- ㉑ SIGNAGE
- ㉒ CONCRETE "BULK HEAD"
- ㉓ METAL GUARD RAIL
- ㉔ METAL PLANTER
- ㉕ PLATE METAL CANOPY

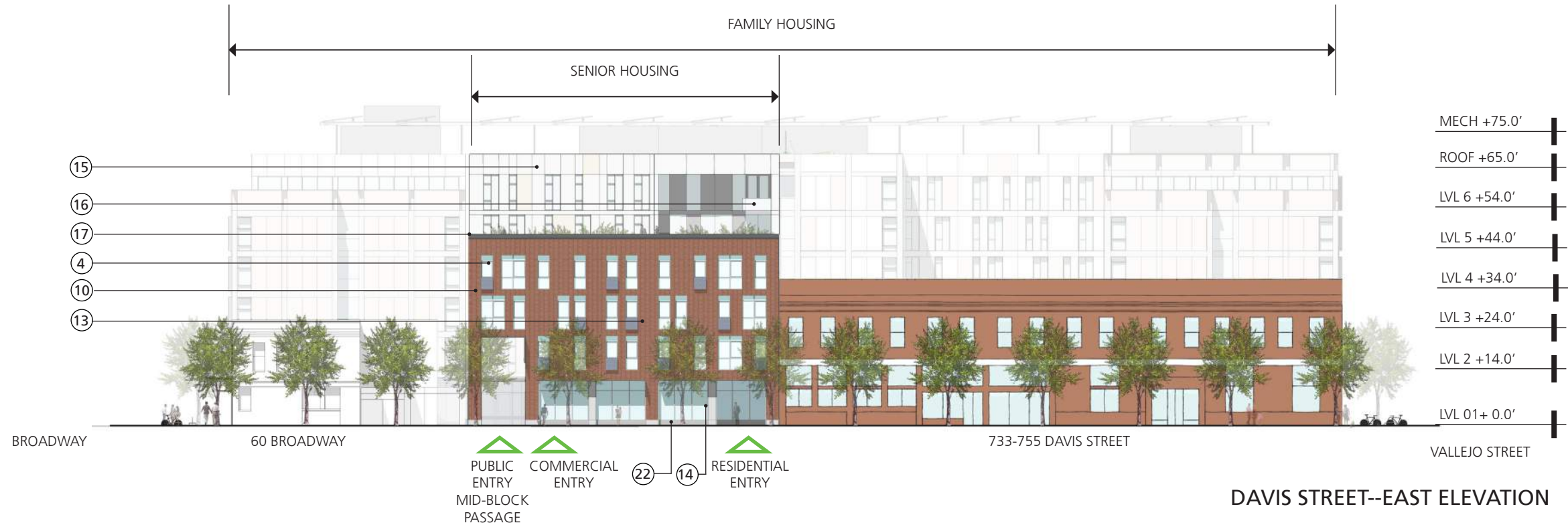

SCALE: 1/32" = 1'-0"

ELEVATIONS

THE JOHN STEWART COMPANY
BRIDGE Housing

A3.5 LMSA 88 BROADWAY/+735 DAVIS
 CERTIFICATE OF APPROPRIATENESS
 REV-5 / SECTION 315

4

MASSING AND BUILDING HEIGHT



BASE ALLOWABLE ENVELOPE

CERTIFICATE OF APPROPRIATENESS
REV-5 / SECTION 315



AERIAL VIEW FROM SOUTH EAST

CERTIFICATE OF APPROPRIATENESS
REV-5 / SECTION 315

LMSA 88 BROADWAY/+735 DAVIS



AERIAL VIEW FROM SOUTH WEST

CERTIFICATE OF APPROPRIATENESS
REV-5 / SECTION 315



A4.3 LMSA 88 BROADWAY/+735 DAVIS



**SAN FRANCISCO PLANNING CODE
SECTION 6. FEATURES:**

- (A) OVERALL FORM AND CONTINUITY. **BUILDING HEIGHT** IS GENERALLY WITHIN A **SIX-STORY RANGE**, WITH THE **HIGHER STRUCTURES CLOSER TO THE BASE** OF TELEGRAPH HILL AND LOWER BUILDINGS NEAR THE WATER.
- MANY OF THE OLDEST STRUCTURES ARE ONE OR TWO STORIES IN HEIGHT.

5

MATERIALS

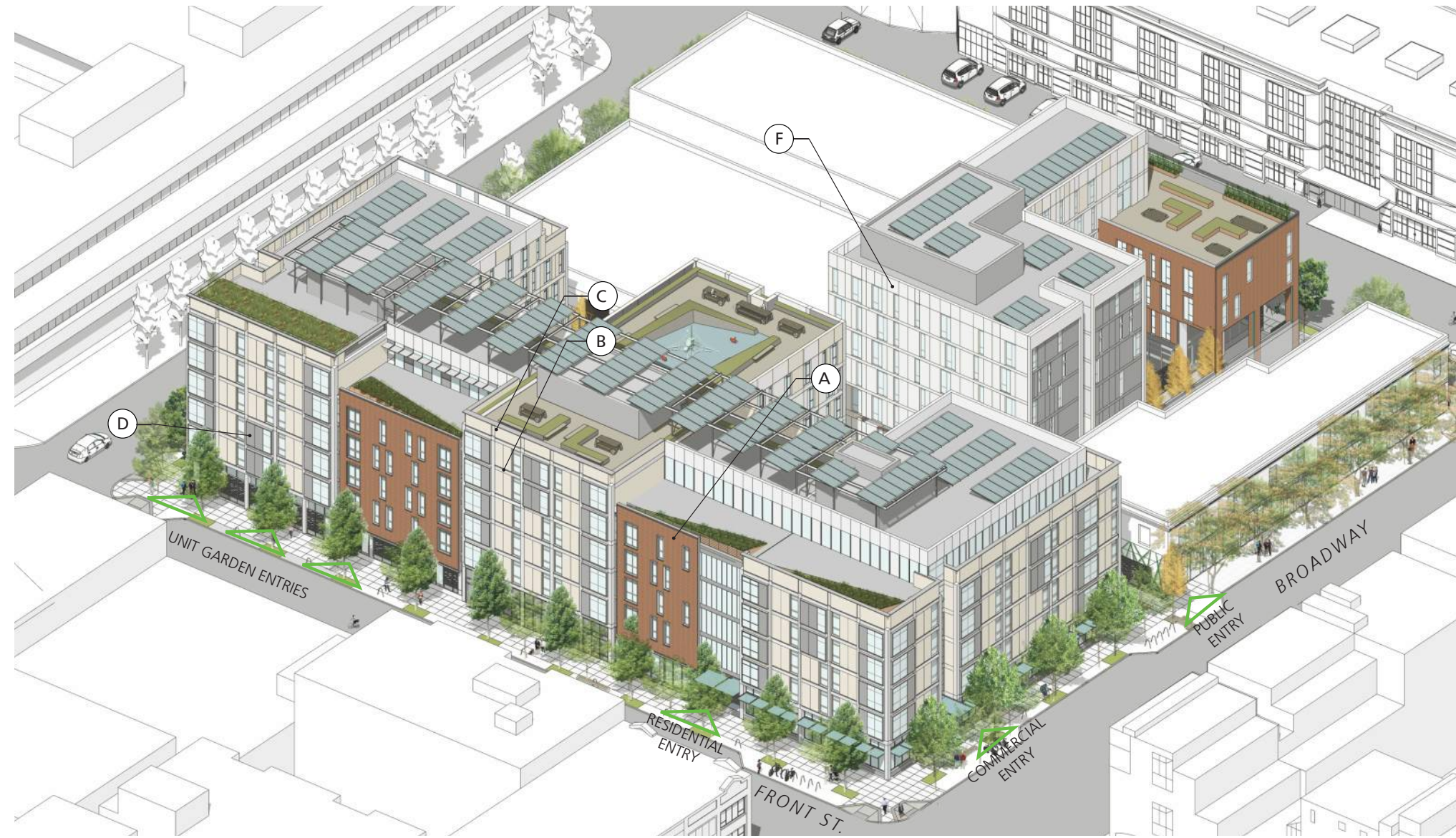

MATERIAL KEY

- A. Roman Thin Brick- Autumn Sand
- B. Minerit Cement Siding - HD Grey
- C. Cembrit Patina Cement Siding - 911 Sand
- D. Cembrit Patina Cement Siding - 921 Flint
- E. Davis Concrete - Silversmoke
- F. Stucco

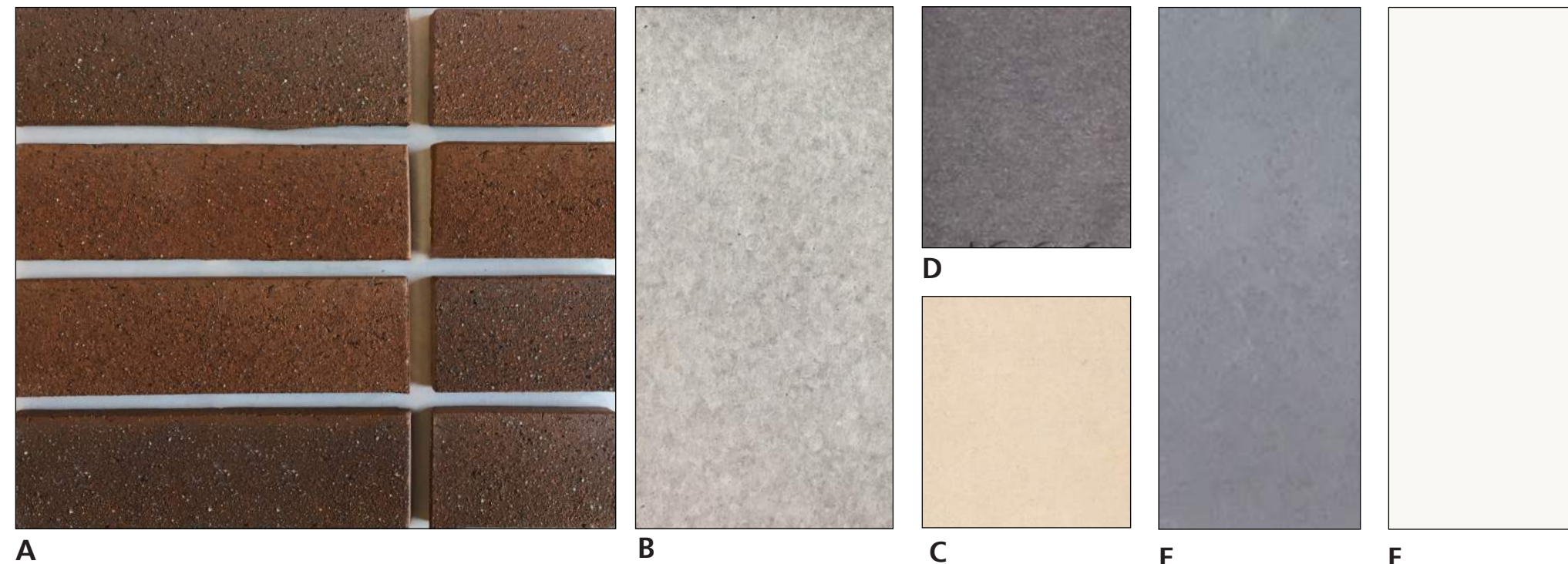
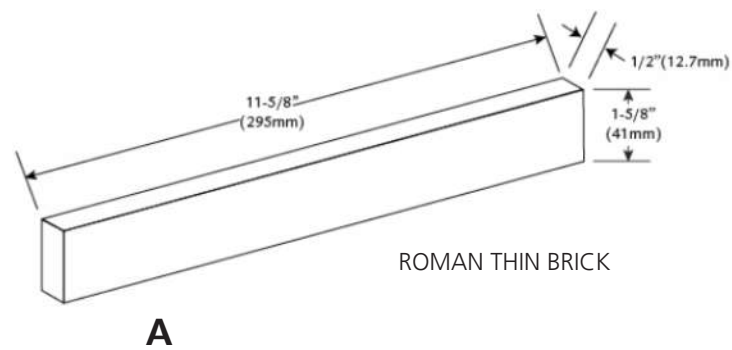



BRICK/GLASS CONTRAST EXAMPLE WITHIN DISTRICT
Ice House, 1150 Sansome St.

**SAN FRANCISCO PLANNING CODE
SECTION 6. FEATURES:**

FRONT STREET ELEVATION - FAMILY BUILDING

NEIGHBORHOOD										NEIGHBORHOOD							
PROPOSED										PROPOSED							
A	THIN BRICK	B	ALUMINUM WINDOWS	C	NATURAL CEMENT SIDING "FRAME"	D	PROJECTION	E	PAINTED CEMENT SIDING "INFILL"	F	CONCRETE	G	ALUMINUM STOREFRONT	H	CONTRASTING CEMENT PANEL	I	BULKHEAD

- (D) MATERIALS. STANDARD **BRICK MASONRY** IS PREDOMINANT FOR THE OLDEST BUILDINGS IN THE DISTRICT, WITH **REINFORCED CONCRETE** INTRODUCED AFTER THE 1906 FIRE.
- SOME OF THE BRICK FACADES HAVE BEEN STUCCOED OVER.
- ONE OF THE STRUCTURES STILL HAS ITS **METAL SHUTTERS**, WHICH WERE ONCE TYPICAL OF THE AREA.



WINDOW OFFSETS WITHIN DISTRICT 1 Union Street



BRICK CONTRAST WITHIN DISTRICT 101 Green St.



WINDOW PROPORTIONS EXAMPLE WITHIN DISTRICT 60-70 Broadway

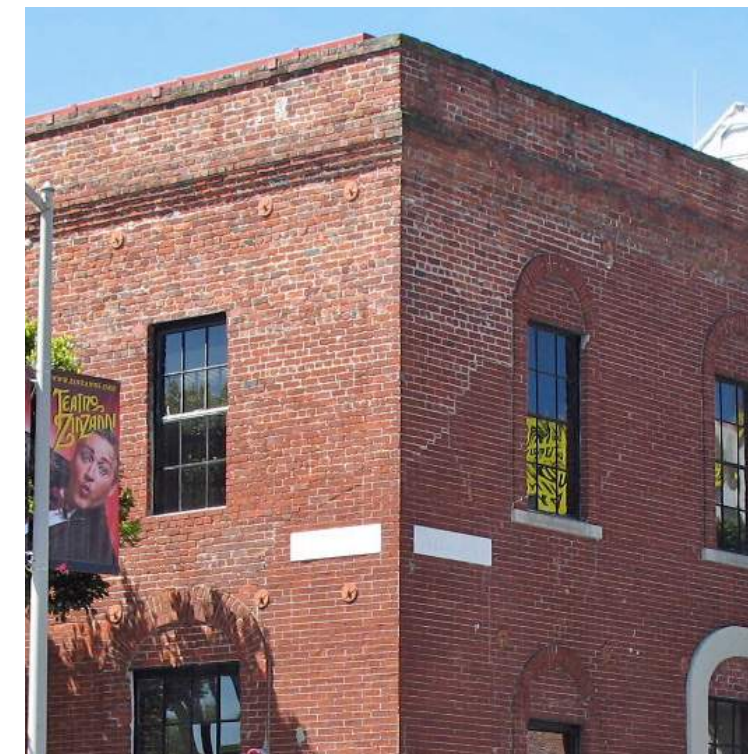

SIMPLE CORNICE EXAMPLE WITHIN DISTRICT 855 Front St.

SAN FRANCISCO PLANNING CODE

SECTION 6. FEATURES:

- (C) FENESTRATION. MINIMAL GLAZING IS DEEPLY RECESSED, PRODUCING A **STRONG SHADOW LINE**. THE EARLIEST STRUCTURES HAVE FEW WINDOWS EXPRESSING THEIR WAREHOUSE FUNCTION.
- THEY ARE **VARIED IN SIZE, RHYTHMICALLY SPACED**, AND RELATE IN SHAPE AND PROPORTION TO THOSE IN NEARBY BUILDINGS.
- **LARGER INDUSTRIAL SASH WINDOWS** BEGAN TO BE INCORPORATED IN STRUCTURES BUILT FROM THE 1920'S AND ONWARD. DOOR OPENINGS ARE OFTEN MASSIVE TO FACILITATE EASY ACCESS OF BULK MATERIALS.



- (G) DETAIL. ARCHES ARE COMMON AT THE GROUND FLOOR, AND ARE FREQUENTLY REPEATED ON UPPER FLOORS.
- FLATTENED ARCHES FOR WINDOW TREATMENT ARE TYPICAL.
- CORNICES ARE SIMPLE AND GENERALLY TEND TO BE ABSTRACT VERSIONS OF THE MORE ELABORATE CORNICES FOUND ON DOWNTOWN COMMERCIAL STRUCTURES FROM THE NINETEENTH CENTURY. MOST OF THE **SURFACES OF THE LATER BUILDINGS ARE PLAIN AND SIMPLE**, REFLECTING THEIR FUNCTION. SOME OF THE EARLIER BRICKWORK CONTAINS SUGGESTIONS OF PILASTERS, AGAIN HIGHLY ABSTRACTED.
- WHERE **DETAIL** OCCURS, IT IS OFTEN FOUND **SURROUNDING ENTRYWAYS**.



- (F) TEXTURE. TYPICAL FACING MATERIALS GIVE A **ROUGH-TEXTURED APPEARANCE**. THE OVERALL TEXTURE OF THE FACADES IS ROUGH-GRAINED.

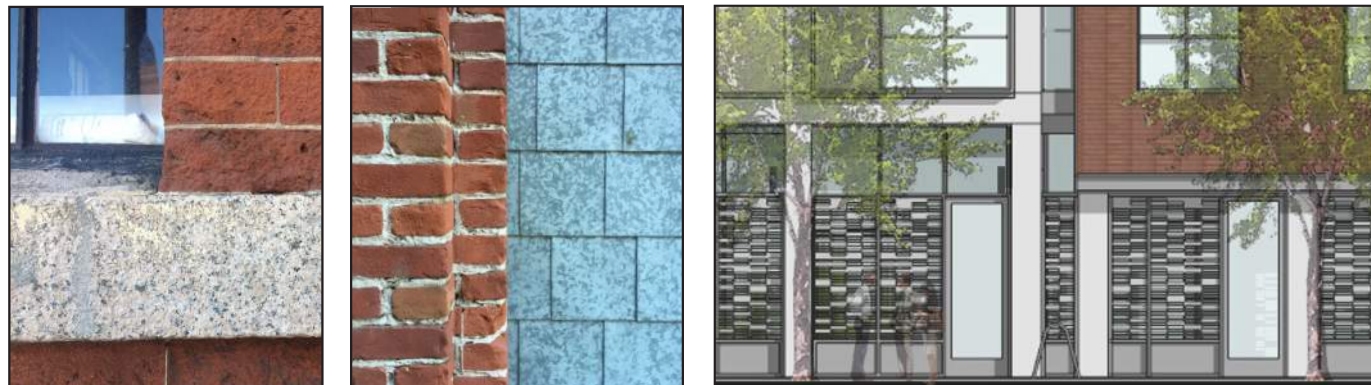

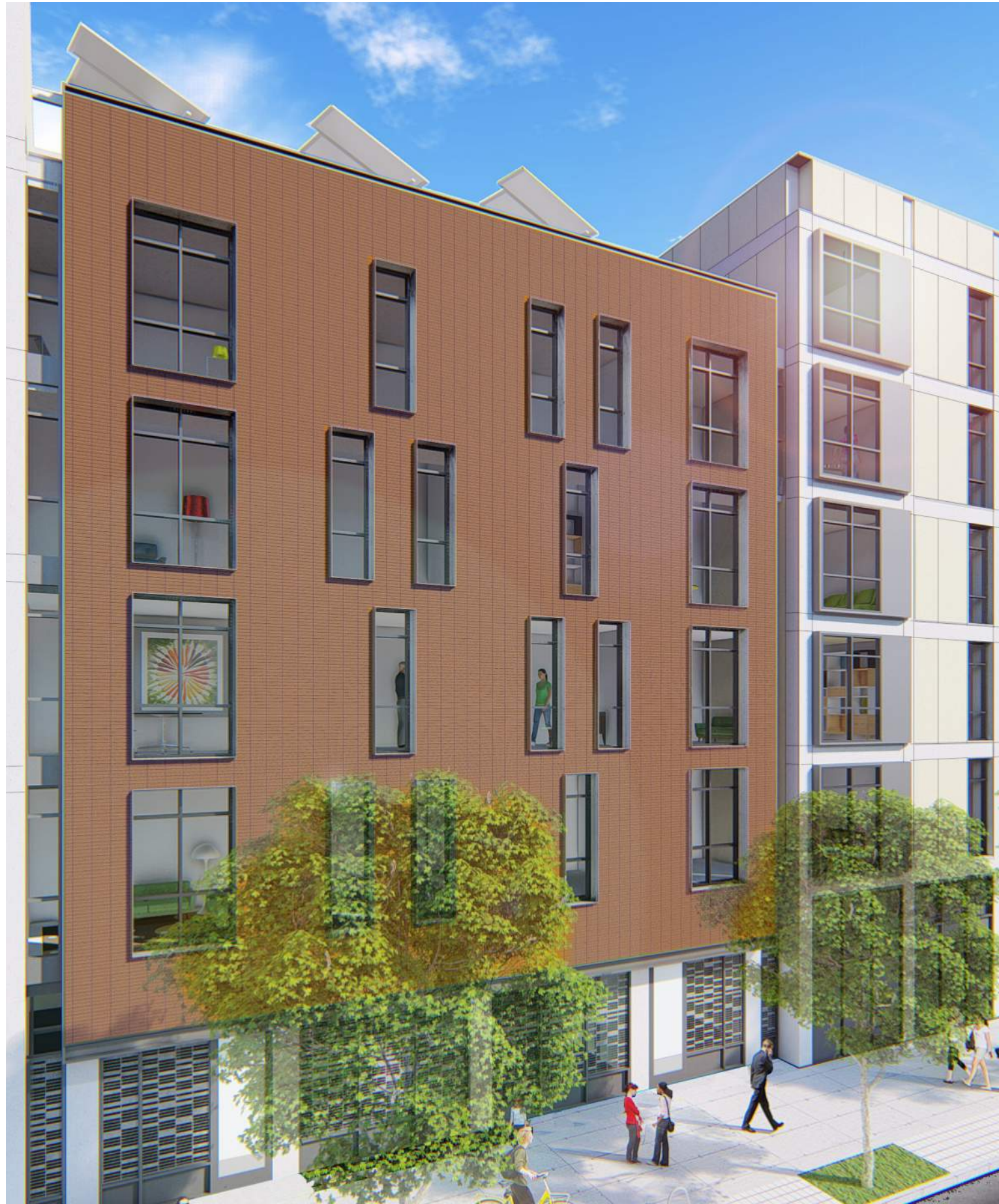

FRONT STREET ELEVATION ENLARGEMENT

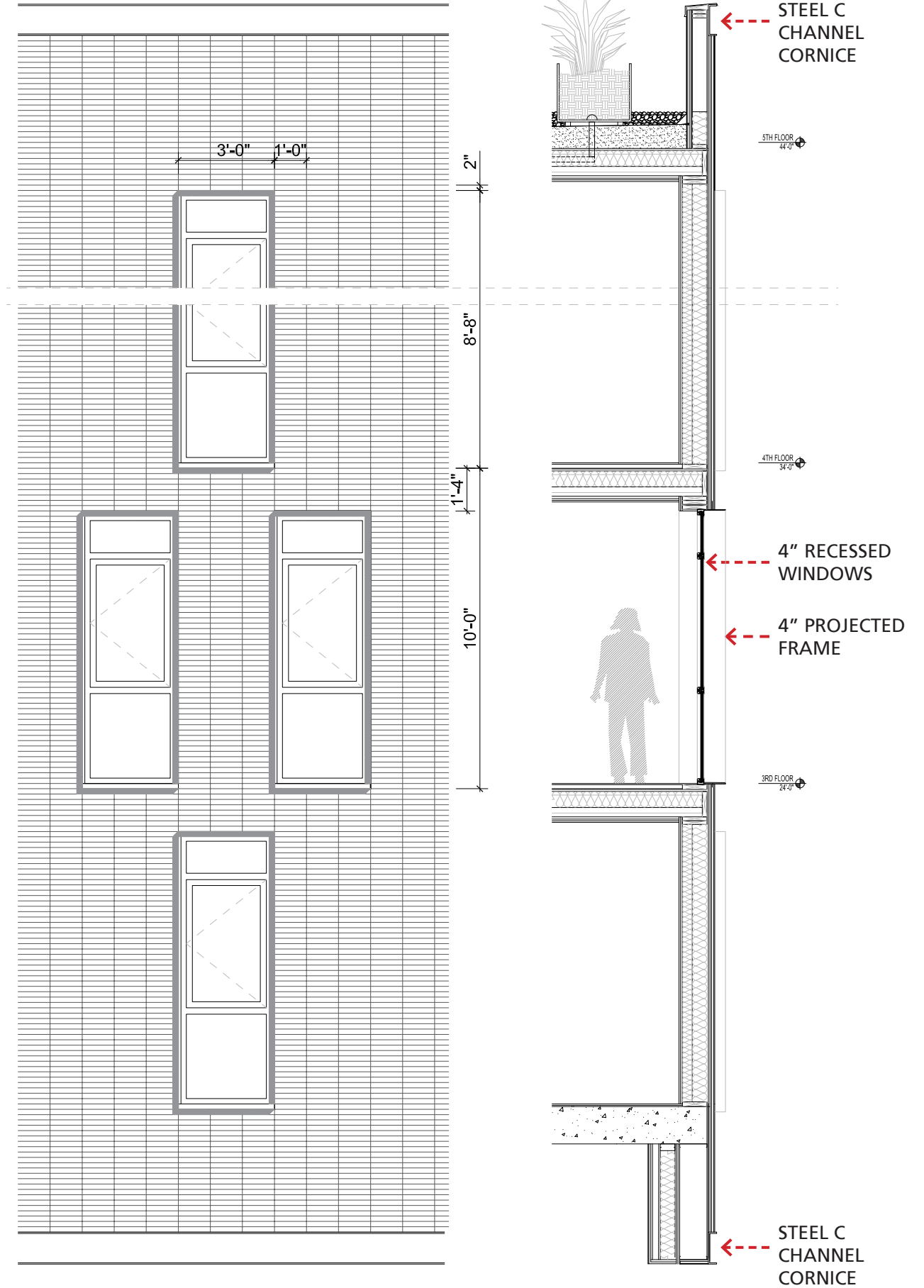

FRONT STREET ELEVATION DETAIL



**SAN FRANCISCO PLANNING CODE
SECTION 6. FEATURES:**

DAVIS STREET ELEVATION - SENIOR BUILDING

NEIGHBORHOOD									NEIGHBORHOOD						
PROPOSED									PROPOSED						
A	<i>BULKHEAD</i>	B	<i>THIN BRICK</i>	C	<i>ALUMINUM WINDOWS</i>	D	<i>JULIETTE BALCONY</i>	E	<i>STAGGERED WINDOWS</i>	F	<i>ALUMINUM STOREFRONT</i>	G	<i>CONTRASTING CEMENT PANEL</i>	H	<i>STUCCO</i>

- (D)MATERIALS. STANDARD **BRICK MASONRY** IS PREDOMINANT FOR THE OLDEST BUILDINGS IN THE DISTRICT, WITH **REINFORCED CONCRETE** INTRODUCED AFTER THE 1906 FIRE.
- SOME OF THE BRICK FACADES HAVE BEEN STUCCOED OVER.
- ONE OF THE STRUCTURES STILL HAS ITS **METAL SHUTTERS**, WHICH WERE ONCE TYPICAL OF THE AREA.



DAVIS STREET ELEVATION ENLARGEMENT

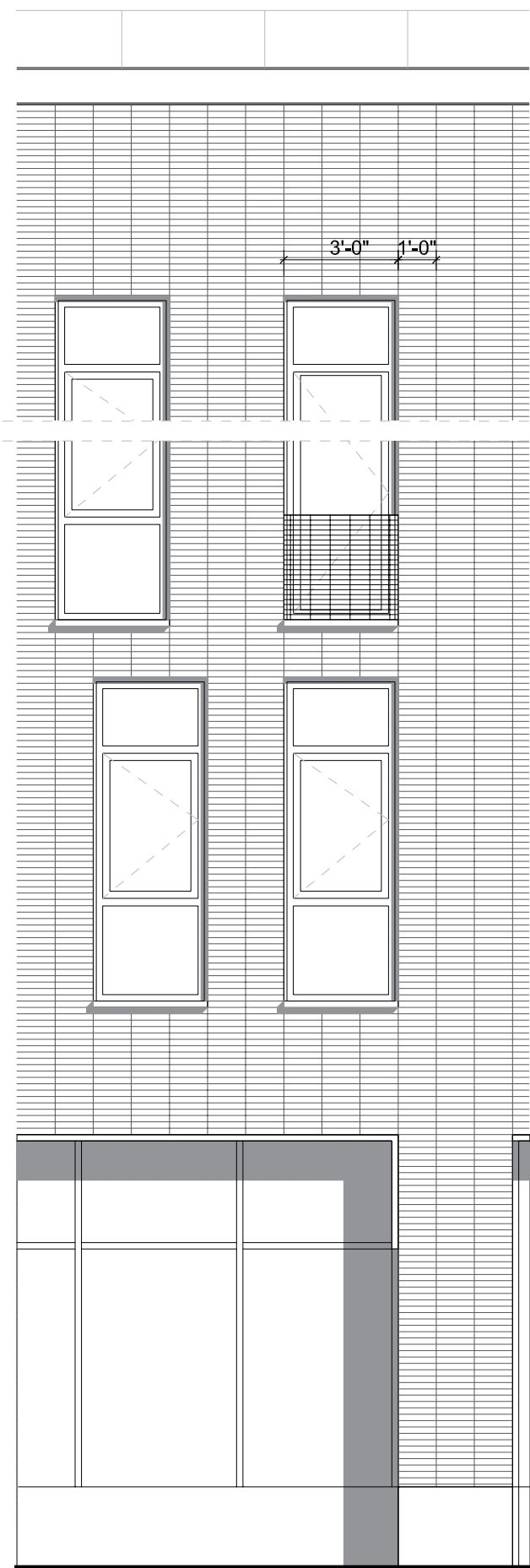

DAVIS STREET ELEVATION DETAIL

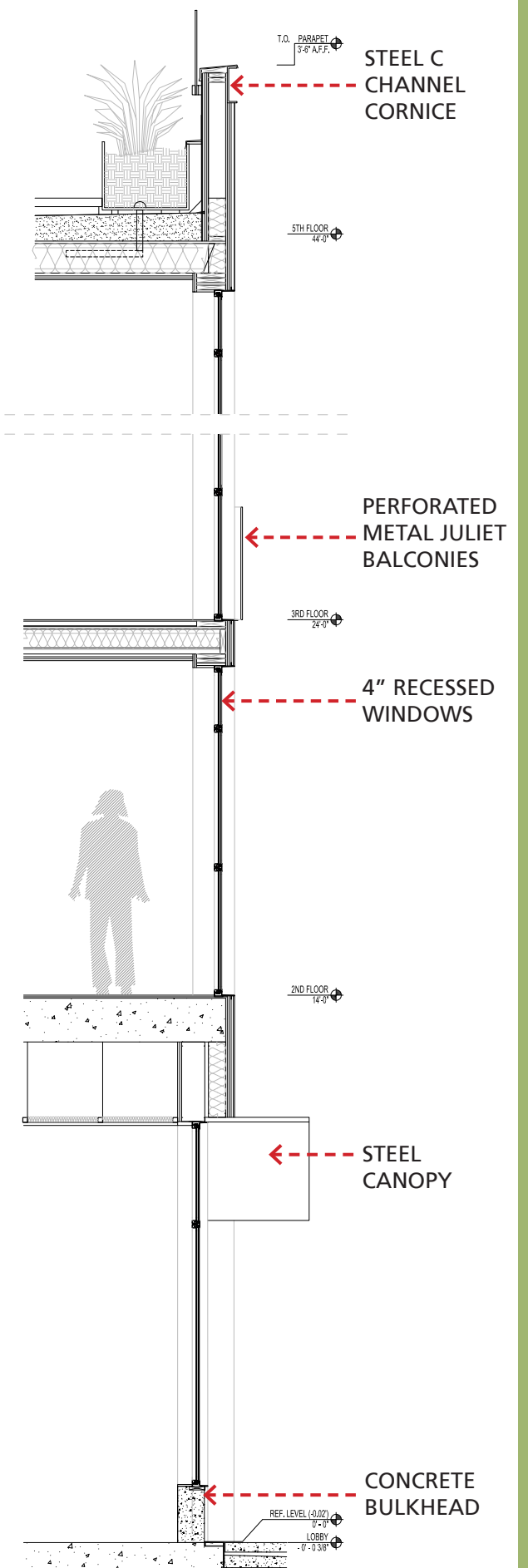

6

FENESTRATION



OPERABLE WINDOW

HIGH PERFORMANCE GLAZING, TYP.

4" RECESS + 4" PROJECTION PAINTED ALUMINUM FRAME

ROMAN THIN BRICK

ALUMINUM WINDOW WITH GLAZING RECESSED APPROX. 1-1/4"

ALUMINUM SILL

88 BROADWAY FACADE DETAIL



OFFSET WINDOWS EXAMPLE WITHIN DISTRICT
915 Front St.



PROJECTED WINDOW FRAME WITHIN DISTRICT
915 Battery St.



STACK BOND BRICK WALL

WINDOWS AT 'BRICK' FACADES

CERTIFICATE OF APPROPRIATENESS
REV-5 / SECTION 315



OPERABLE WINDOW

HIGH PERFORMANCE GLAZING, TYP.

4" RECESS, PAINTED ALUMINUM FRAME

ROMAN THIN BRICK

ALUMINUM WINDOW WITH GLAZING RECESSED APPROX. 1-1/4"

PROJECTED ALUMINUM SILL



WINDOW PROPORTION EXAMPLE WITHIN DISTRICT
60-70 Broadway

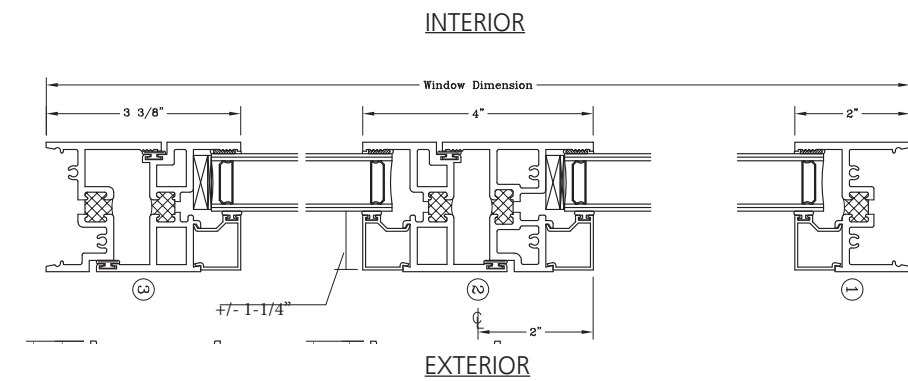

WINDOW FRAME EXAMPLE
Graham Series 6500
casement window detail (N.T.S.)

735 DAVIS FACADE DETAIL



- NATURAL CEMENT PANEL W/ FASTENERS
- PAINTED CEMENT PANEL W/ FASTENERS
- ALUMINUM WINDOW, GLAZING RECESSED FROM FRAME APPROX. 1-1/4"
- 4" MIN RECESS METAL
- DARK GRAY CEMENT PANEL AT FACE OF PROJECTION
- BELT COURSE
- TRIPARTITE WINDOW AND PANEL SYSTEM IS EXPRESSIVE OF FRAME AND INFILL
- SUBTLE CONTRAST IN COLOR BETWEEN FRAME AND INFILL SIMILAR TO DISTRICT EXAMPLES

88 BROADWAY - ENHANCED "BELT COURSE"



FRAME AND INFILL WITHIN DISTRICT
100-120 Broadway



FRAME AND INFILL WITHIN DISTRICT
1005 Sansome St.



FRAME AND INFILL WITHIN DISTRICT
300 Broadway



FRAME AND INFILL WITHIN DISTRICT
901 Battery St.

WINDOWS AT 'FRAME & INFILL' FACADES

CERTIFICATE OF APPROPRIATENESS
REV-5 / SECTION 315

88 BROADWAY/+735 DAVIS



CONTINUOUS AWNING ACCENTS

STOREFRONTS W/ TRANSOM

PROJECTING AWNINGS - BROADWAY AND FRONT STREET CORNER



CONTINUOUS AWNING. FASCIA RUNS ACROSS COLUMNS AND WINDOWS

PROJECTING AWNINGS - BROADWAY ELEVATION



CANOPY EXAMPLE ADJACENT TO DISTRICT
Lombard St and Montgomery St.



CANOPY EXAMPLE WITHIN DISTRICT
1025 Battery St.



CANOPY WITHIN ANOTHER HISTORIC DISTRICT
BAKER HAMILTON
SHOWPLACE SQUARE/NE MISSION HISTORIC DISTRICT



PROPOSED PROJECT JULIET BALCONIES DAVIS ST. ELEVATION

SMALL, TRANSPARENT, SOMETIMES RANDOM, BALCONIES PROVIDE VARIATION, SHADOW, AND VISUAL INTEREST TO FACADES



BALCONIES EXAMPLE WITHIN DISTRICT
915 Front Street (Balconies later addition)

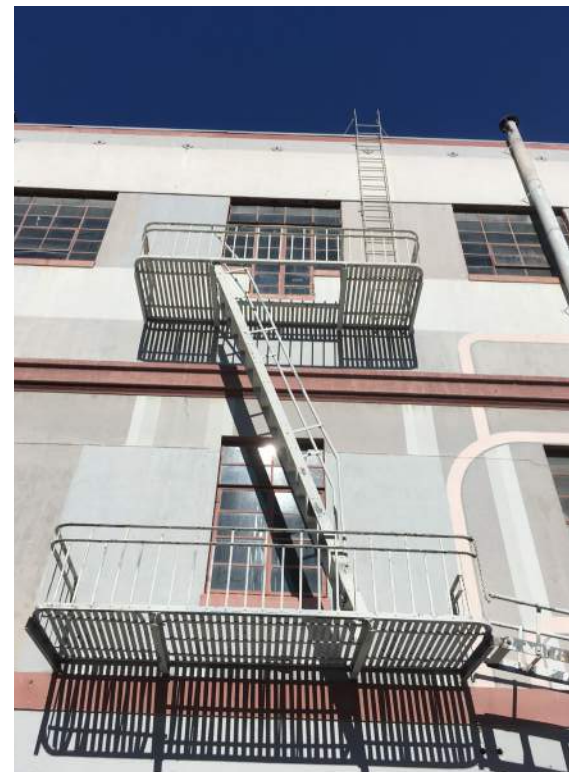

4 Vallejo St.



402 Jackson St.



945 Battery St.

FIRE ESCAPE EXAMPLES WITHIN DISTRICT

7

CORNER TREATMENT



CORNER TREATMENT AT BROADWAY AND FRONT STREET



FRAME AND INFILL CORNER WITHIN DISTRICT
1005 Sansome St.



FRAME AND INFILL CORNER WITHIN DISTRICT
901 Battery St.

CORNER TREATMENT



CERTIFICATE OF APPROPRIATENESS
REV-5 / SECTION 315

A7.1 LMSA 88 BROADWAY/+735 DAVIS

8

GROUND FLOOR UNITS



- METAL GRATE SCREEN
- CONCRETE COLUMNS
- TRANSLUCENT GLAZED DOOR
- LANDSCAPING INSIDE
- SOLID METAL PANELS, 1'-10" HIGH

PERSPECTIVE 1



TRANSPARENCY/GATES WITHIN DISTRICT
55 Union St.

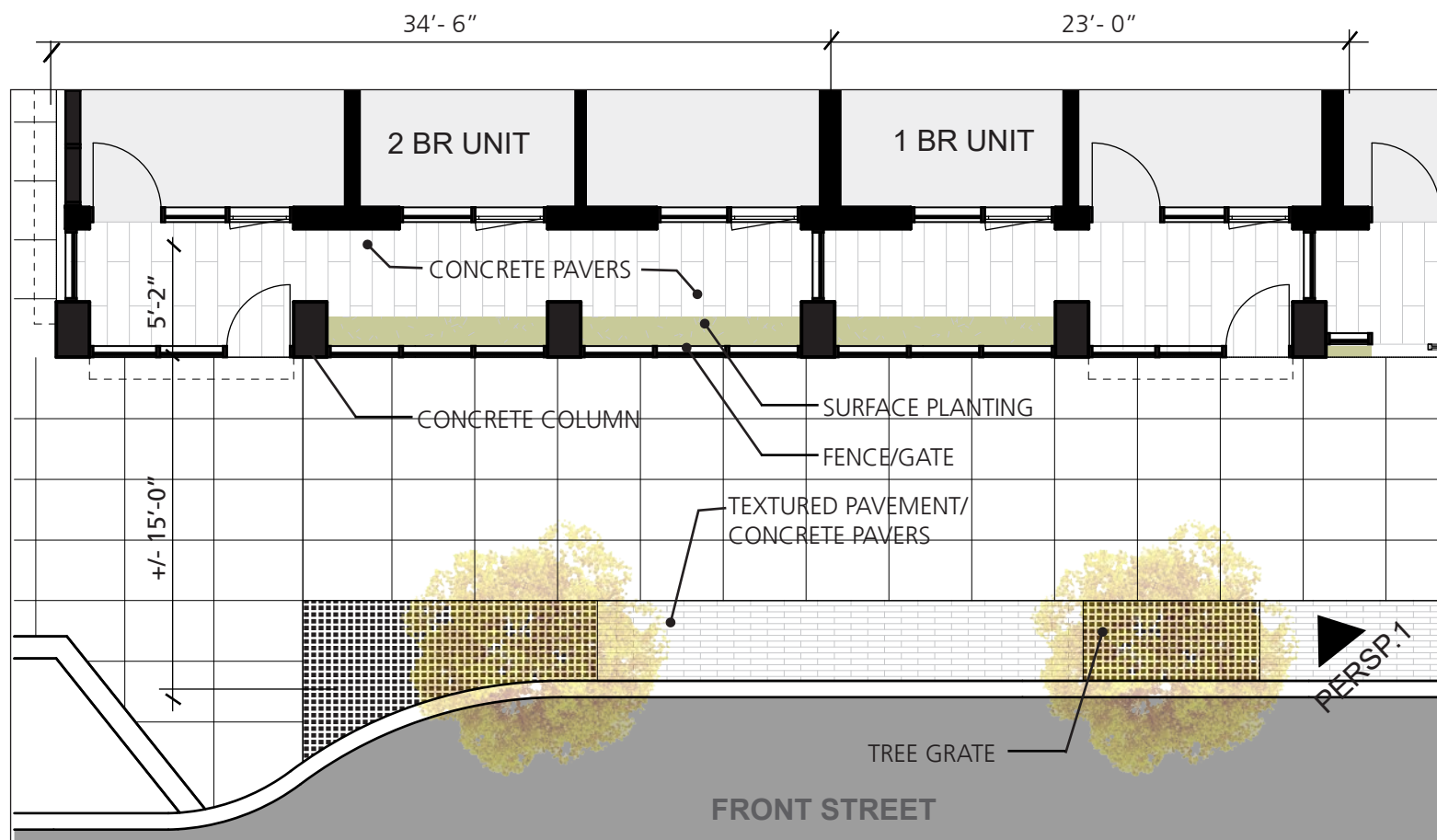

1. STREETScape PLAN
SCALE: 1/8"=1'-0"



EXAMPLE OUTSIDE DISTRICT
474 NATOMA STREET, LEDDY MAYTUM STACY ARCHITECTS

9

MID-BLOCK PASSAGES

ELEVATION AND SECTION KEYNOTES:

- ① TYPE 1 CEMENTITIOUS PANEL "FRAME"
- ② TYPE 2 CEMENTITIOUS PANEL "PROJECTION"
- ③ TYPE 3 CEMENTITIOUS PANEL "INFILL"
- ④ ALUMINUM WINDOW
- ⑤ CONCRETE COLUMNS
- ⑥ STANCHION MOUNTED ROOF SOLAR PANELS
- ⑦ METAL AND GLASS AWNING
- ⑧ PROJECTED WINDOW, METAL EDGE
- ⑨ METAL ROLL UP GARAGE DOOR
- ⑩ THIN BRICK
- ⑪ METAL GRATE + GLASS PANEL FENCE/GATE
- ⑫ ENCLOSED ROOFTOP MECHANICAL SPACES
- ⑬ PERFORATED METAL JULIET BALCONY
- ⑭ ALUMINUM STOREFRONT
- ⑮ PAINTED STUCCO
- ⑯ BALCONY
- ⑰ PARAPET COPING 42" ABOVE ROOF PLANE
- ⑱ PROPOSED TREE
- ⑲ EXISTING TREE
- ⑳ RAISED PLANTER
- ㉑ SIGNAGE
- ㉒ CONCRETE "BULK HEAD"
- ㉓ METAL GUARD RAIL
- ㉔ METAL PLANTER
- ㉕ PLATE METAL CANOPY



BROADWAY MID-BLOCK PASSAGE LOOKING NORTH



BROADWAY MID-BLOCK PASSAGE LOOKING NORTH AT INTERSECTION WITH DAVIS PASSAGE



BROADWAY MID-BLOCK PASSAGE LOOKING NORTH

SCALE: 1/32" = 1'-0"

SECTIONS - MID-BLOCK PASSAGE

CERTIFICATE OF APPROPRIATENESS
REV-5 / SECTION 315

A9.1 LMSA 88 BROADWAY/+735 DAVIS

ELEVATION AND SECTION KEYNOTES:

- ① TYPE 1 CEMENTITIOUS PANEL "FRAME"
- ② TYPE 2 CEMENTITIOUS PANEL "PROJECTION"
- ③ TYPE 3 CEMENTITIOUS PANEL "INFILL"
- ④ ALUMINUM WINDOW
- ⑤ CONCRETE COLUMNS
- ⑥ STANCHION MOUNTED ROOF SOLAR PANELS
- ⑦ METAL AND GLASS AWNING
- ⑧ PROJECTED WINDOW, METAL EDGE
- ⑨ METAL ROLL UP GARAGE DOOR
- ⑩ THIN BRICK
- ⑪ METAL GRATE + GLASS PANEL FENCE/GATE
- ⑫ ENCLOSED ROOFTOP MECHANICAL SPACES
- ⑬ PERFORATED METAL JULIET BALCONY
- ⑭ ALUMINUM STOREFRONT
- ⑮ PAINTED STUCCO
- ⑯ BALCONY
- ⑰ PARAPET COPING 42" ABOVE ROOF PLANE
- ⑱ PROPOSED TREE
- ⑲ EXISTING TREE
- ⑳ RAISED PLANTER
- ㉑ SIGNAGE
- ㉒ CONCRETE "BULK HEAD"
- ㉓ METAL GUARD RAIL
- ㉔ METAL PLANTER
- ㉕ PLATE METAL CANOPY

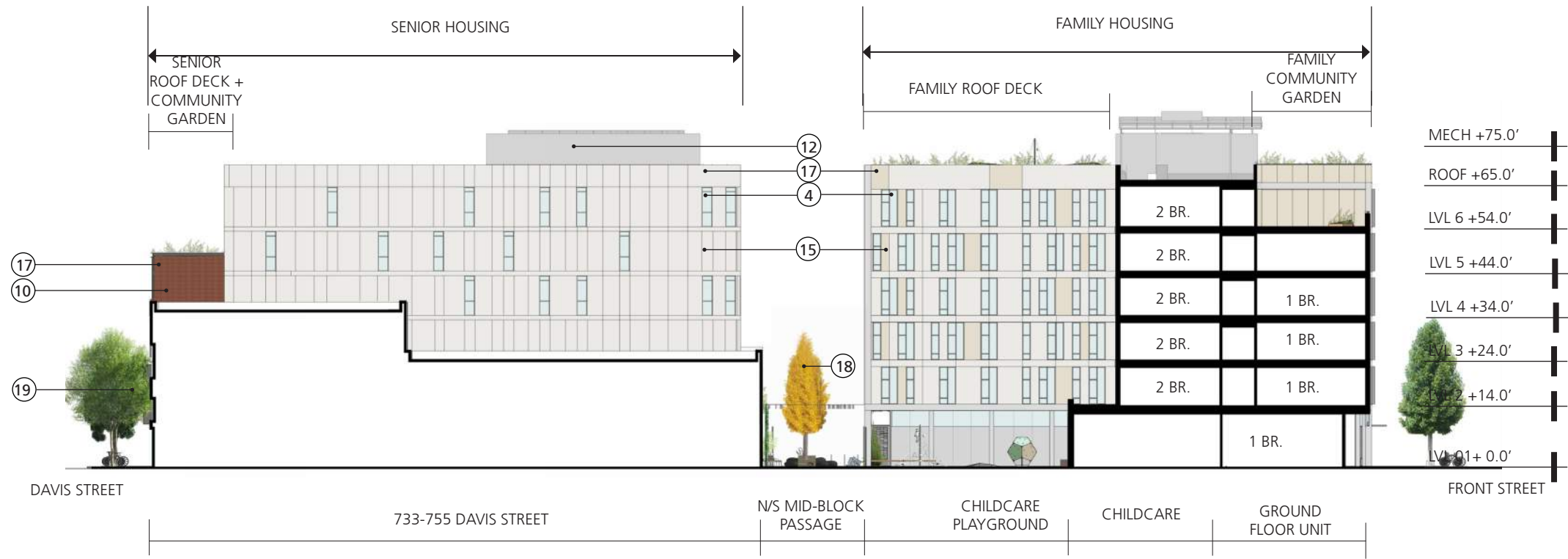

SECTION - E/W FAMILY BUILDING



SECTION THROUGH N / S PASSAGE



JOHN MAHER STREET



SECTIONS - MID-BLOCK PASSAGE

CERTIFICATE OF APPROPRIATENESS
REV-5 / SECTION 315

THE JOHN STEWART COMPANY
BRIDGE Housing

A9.2 LMSA 88 BROADWAY/+735 DAVIS



DAVIS MID-BLOCK PASSAGE

CERTIFICATE OF APPROPRIATENESS
REV-5 / SECTION 315



A9.3 LMSA 88 BROADWAY/+735 DAVIS



10

PLANNING ANALYSIS

	REQUIRED	PROPOSED: Family BLDG.	PROPOSED: Senior BLDG.	COMPLIANCE	
SAN FRANCISCO PLANNING CODE	PUD - PLANNED UNIT DEVELOPMENT (Sec. 304)		Proposed PUD Modifications: Rear Yd. configuration Open Space configuration Rear Yard Off-Street Loading	Proposed PUD Modifications: Rear Yd. configuration Open Space configuration Rear Yard Exposure	
	LOT SIZE (Sec. 121)	10,000 SF	37,812 SF Approximately 275' X 137.5'	10,805 SF Approximately 137.5' X 78.58'	Applying for Conditional Use Permit (Sec. 303)
	HEIGHT- BULK (Sec. 250-252)	65-X: Front st. + Broadway st. + Vallejo st. + Davis st. 10' Mechanical Exemption 16' Elevator Exemption	Front: 65'-0" Broadway: 65'-0" Vallejo: 65'-0"	Davis: 65'-0" Broadway: 65'-0" Vallejo: 65'-0"	Complies
	ACTIVE USE DEPTH (145.1)	25'-0" Active Use Depth Setback			Complies
	OFF ST. PARKING (Table 151)	none required in affordable housing project Commercial (Restaurant) Not required Childcare 1:25	0 0 2	0 0 0	Complies
	OFF ST. LOADING (Table 152)	Req'd for apartments: 1: 100,000 - 200,000 10' wide X 25' deep X 12' high	0 On-Street Loading (Front Street)	0 On-Street Loading (Davis Street)	PUD Modification for 88 Broadway only
	RESIDENTIAL DENSITY (Sec 209.3)	RC-4 1 Unit per 200 SF of Lot Area Senior: Permitted up to 2x allowable meeting 202.2(f)	189 Units Allowed 135 Units Proposed	108 Units Allowed 54 Units Proposed	Complies
	DWELLING UNIT DENSITY (Sec 207 (c)(2))	Affordable units do not count toward density + not limited by lot area.	n/a	n/a	Complies
	BAY WINDOWS (sect. 136(c)2))	Max. width: 15 ft.	Largest Width: 12 ft.	n/a	PUD Modification
	FRONT SETBACK (Sec. 132)	NONE	NONE	Stepdown on Davis St. frontage as condition of the RFP	Complies
	OBSTRUCTIONS (Sunshades) (Sec 136(c)(1))	Min. Headroom: 7'-6" Max Projection: 4'-0"	Min. Headroom: 8'-0" Max Projection: 4'-0"		Complies
OBSTRUCTIONS (Awnings) (Sec 136.1(a)(2))	Min. Headroom: 8'-0" Max. Height above Grade: 16'-0" Max. Projection: 4'-0"	Min. Headroom: 8'-0" Max. Height above Grade: 16'-0" Max. Projection: 4'-0"	Min. Headroom: 8'-6" Max. Height above Grade: 12'-0" Max. Projection: 4'-0"	Complies	

SECTION 136: OBSTRUCTIONS & PROJECTIONS

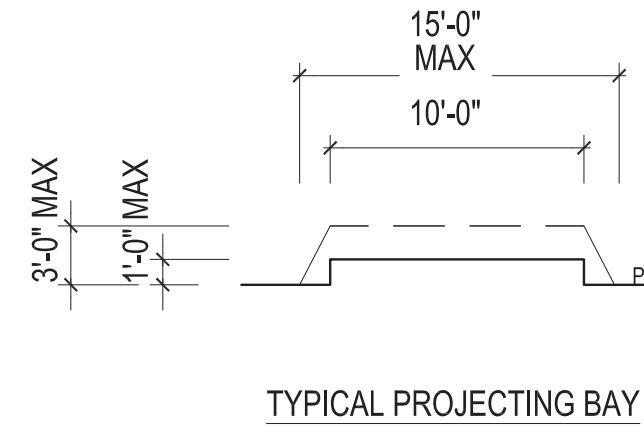

SECTION 134: REAR YARD

REQUIRED	PROPOSED: Family BLDG.	PROPOSED: Senior BLDG.	COMPLIANCE
25% Lot Depth	25% LOT DEPTH (137.5 SF) = 34.38' 275' X 34.38' = 9,454.5 SF REQ'D 9,662.0 SF PROVIDED (25.6%)	25% LOT DEPTH (137.5 SF) = 34.38' 76.54' X 34.38' = 2,631 SF REQUIRED 1,622 PROVIDED (15%) *PORTION OF REAR YARD LOCATED ADJACENT	PUD Modification for configuration for 88 Broadway PUD Modification for configuration & size for 735 Davis

FAMILY BUILDING: REAR YARD

LOT AREA 37,812 SF

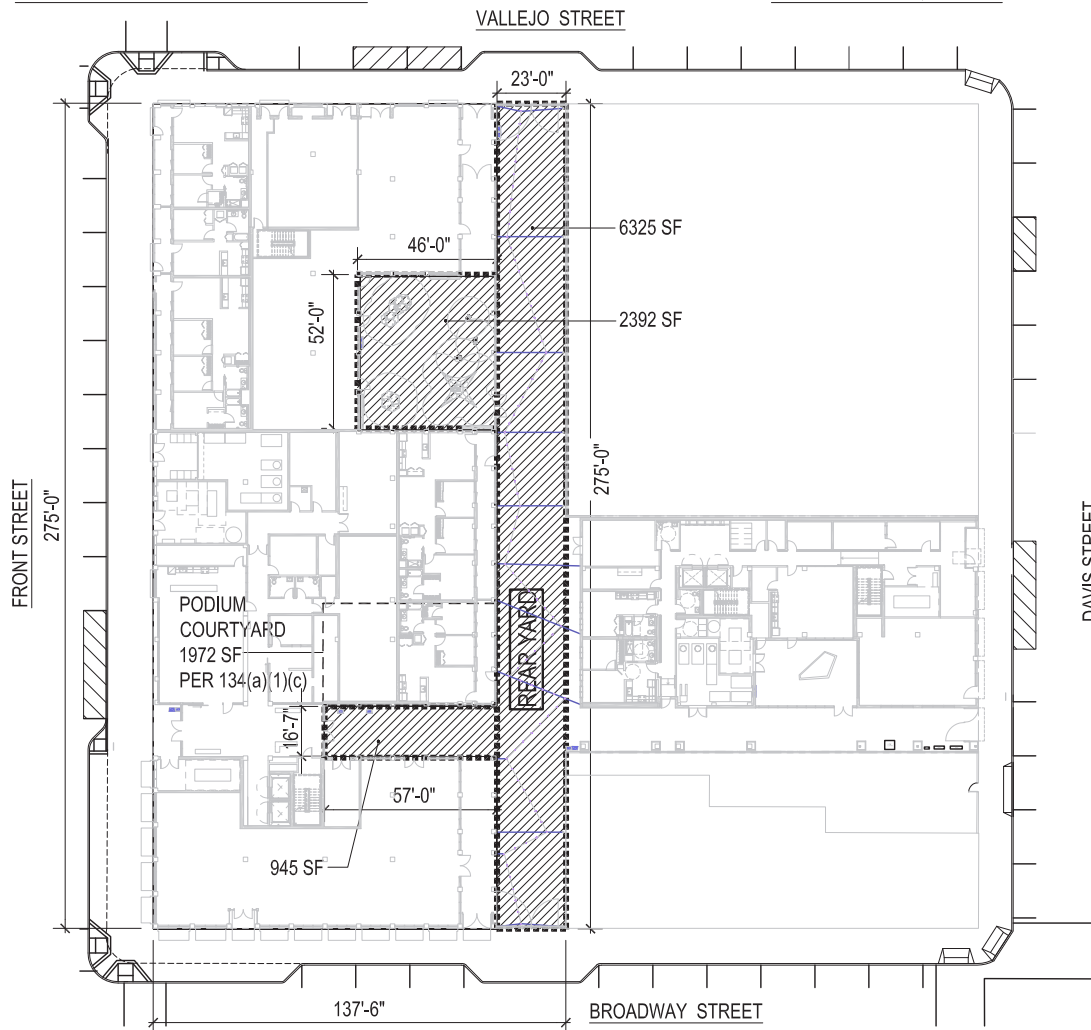

SENIOR BUILDING: REAR YARD

LOT AREA 10,805 SF

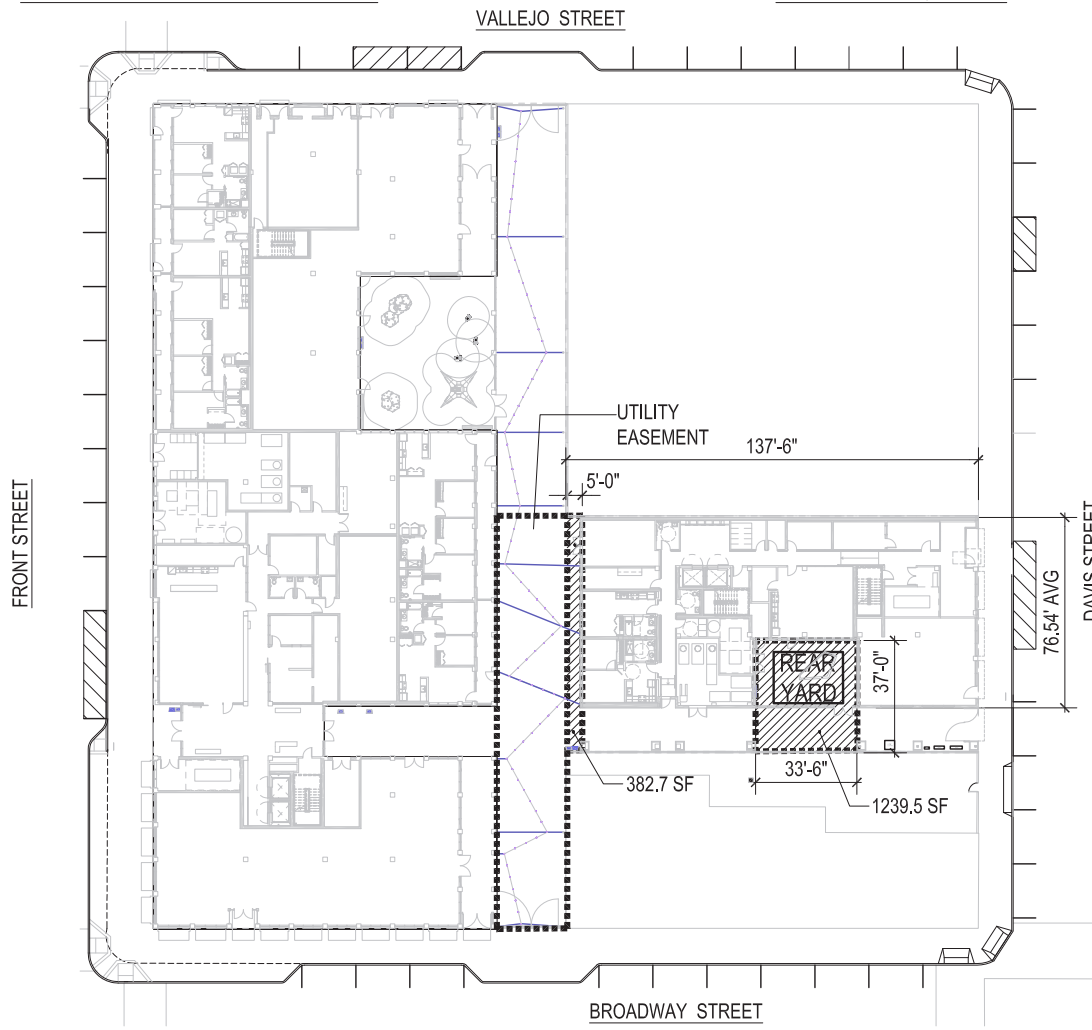

SECTION 135: OPEN SPACE

REQUIRED	PROPOSED: Family BLDG.	PROPOSED: Senior BLDG.	COMPLIANCE
Common Open Space Area: 48 SF/Unit FAMILY BLDG. 1/2 AMOUNT SENIOR BLDG. FAMILY (135 x 48) = 6,480 SF SENIOR (135(d)(3)) (54 x 48) x .5 = 1,296 SF	Common Usable Open Space Family Roof Deck 3650 SF Family Community Garden (Roof) 1400 SF Family Courtyard 1900 SF TOTAL: 6950 SF	Common Usable Open Space Senior Roof Deck + Community Garden 2100 SF TOTAL: 2100 SF	Complies
<u>FAMILY ROOF DECK</u> Min. Dimensions: 15'-0" Min. Area: 300 SF	<u>FAMILY ROOF DECK</u> Min. Dimensions: 56'-0" Min. Area: 3201SF		
<u>FAMILY COMMUNITY GARDEN</u> Min. Dimensions: 15'-0" Min. Area: 300 SF	<u>FAMILY COMMUNITY GARDEN</u> Min. Dimensions: 47'-0" Min. Area: 1448 SF		
5th Floor Terrace Min. Dimensions: 15'-0" Min. Area: 300 SF	5th Floor Terrace Min. Dimensions: 19'-0" Min. Area: 1066 SF		
6th Floor Terrace Min. Dimensions: 15'-0" Min. Area: 300 SF	6th Floor Terrace Min. Dimensions: 22'-0" Min. Area: 1178 SF		
<u>SENIOR ROOF DECK + GARDEN</u> Min. Dimensions: 15'-0" Min. Area: 300 SF		<u>SENIOR ROOF DECK + GARDEN</u> Min. Dimensions: 33'-0" Min. Area: 2108 SF	



AXON - OPEN SPACE DIAGRAM (Complies with planning code dimensions)

SECTION 140: Exposure

REQUIRED	PROPOSED: Family BLDG.	PROPOSED: Senior BLDG.	COMPLIANCE
<p>At least one 120 SF min. room per dwelling unit shall face directly on an open area:</p> <ol style="list-style-type: none"> Public Street, 20' wide public alley, 25' side yard or rear yard Open area which is unobstructed and is no less than 25' in every horizontal dimension for the floor at which the dwelling unit in question is located and the floor immediately above it, with an increase of 5' in every horizontal dimension at each subsequent floor. 	<p>All units are compliant except those described below:</p>	<p><u>LOCATION #1: Section A-A</u> Faces 28'-0" wide rear yard with neighboring Family Building</p>	<p>SENIOR BLDG. Floor 1: Complies Floor 2: PUD Modification/ 2 Units Floor 3: PUD Modification/ 2 Units Floor 4: PUD Modification/ 2 Units Floor 5: PUD Modification/ 2 Units Floor 6: PUD Modification/ 2 Units</p>
			<p>TOTAL: 135 Family Units Compliant 10 Senior Units Non-Compliant 44 Senior Units Compliant</p>

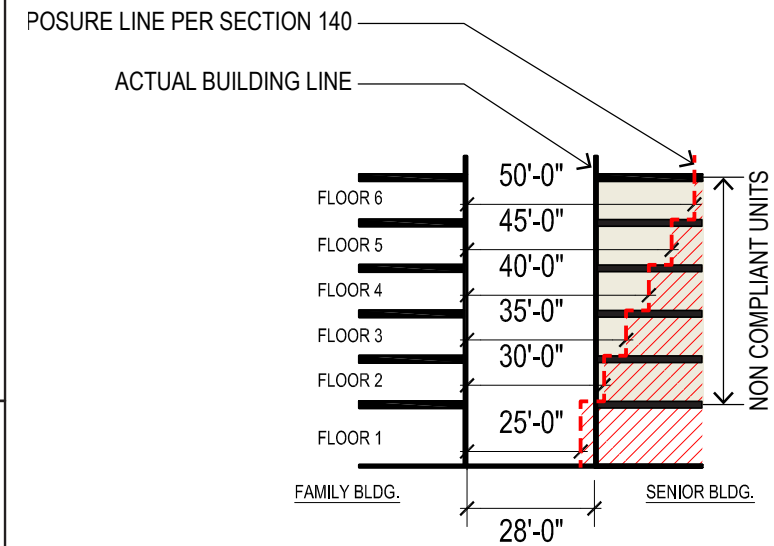

GROUND FLOOR PLAN



TYPICAL UPPER FLOOR PLAN (FLOORS 2-6)

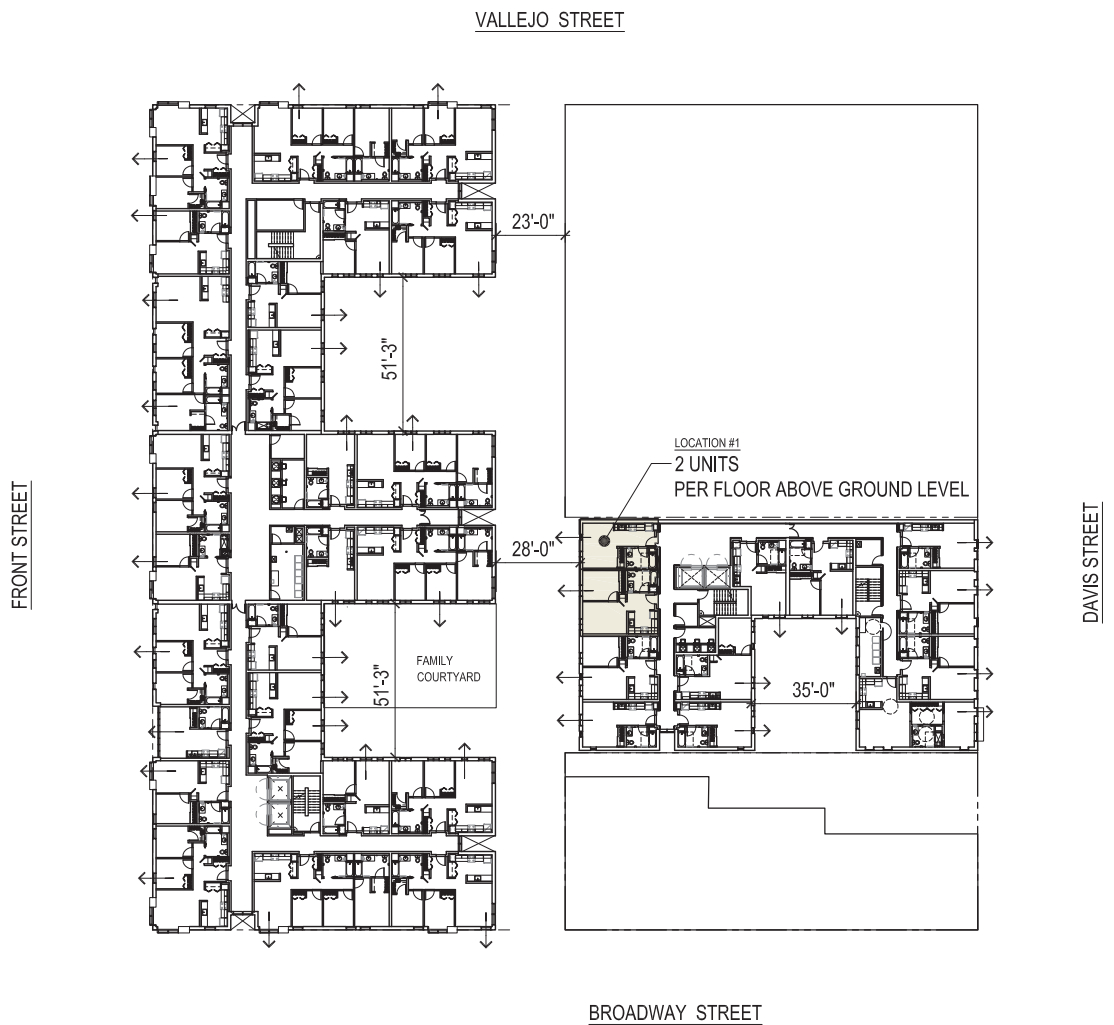

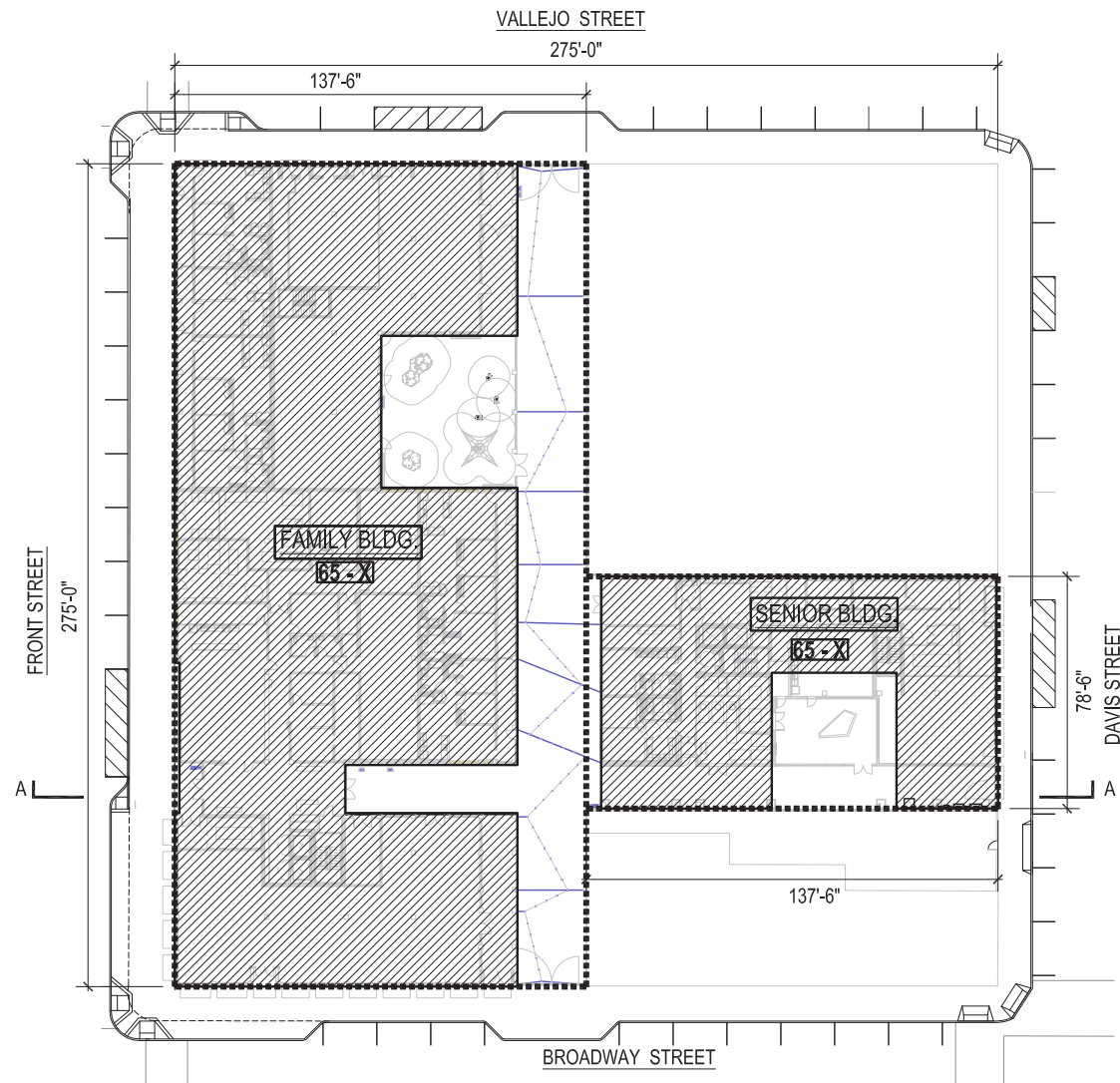

ZONING HEIGHT LIMITS

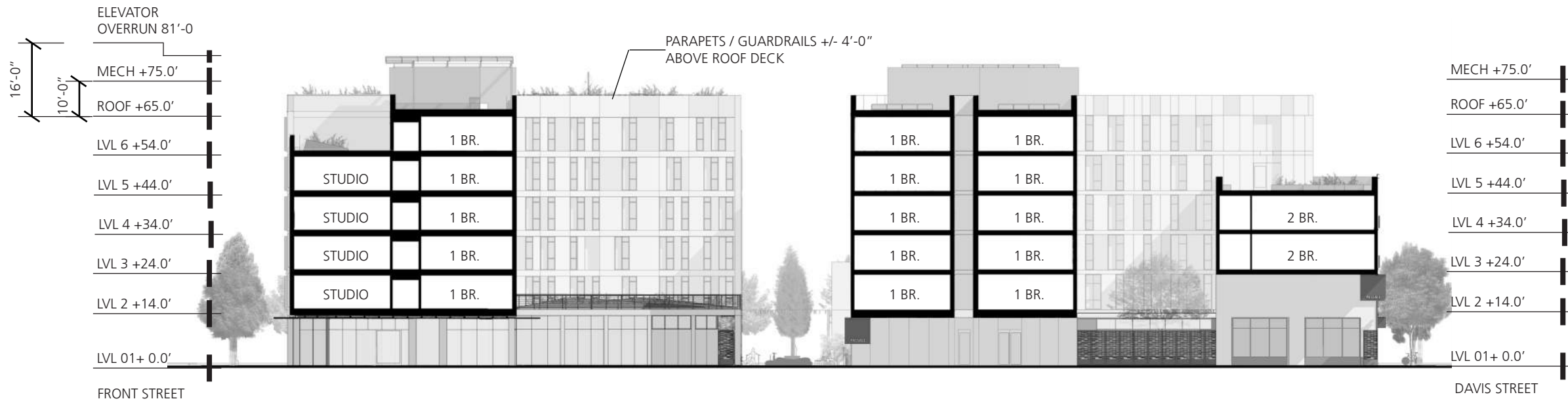

SECTION A-A

VALLEJO STREET

FRONT STREET

DAVIS STREET

BROADWAY STREET

SECTION 149 SOLAR ZONE

03/09/18

TOTAL SOLAR ZONE PER CALIFORNIA TITLE 24 PART SIX 110.10 (b) THROUGH (e) 15% OF TOTAL ROOF AREA

FAMILY BUILDING

Total roof area: 28,110 S.F.

Solar zone required: 4,216 S.F.

Solar zone provided: 8,122 S.F.

SENIOR BUILDING

Total roof area: 8,657 S.F.

Solar zone required: 1,299 S.F.

Solar zone provided: 1,742 S.F.

LEGEND

 SOLAR ZONE

 TOTAL ROOF AREA

SECTION 151 CLASS I & II BICYCLE PARKING

108 DERO DECKER LIFT ASSIST SPACES

4 CARGO BIKE SPACES

112 SPACES TOTAL

LEGEND:

- COMMERCIAL / CHILDCARE
- RESIDENTIAL UNITS
- CIRCULATION & SUPPORT
- SERVICE



CLASS I SPACES - DERO DECK LIFT ASSIST BIKE RACK



CLASS II - INVERTED 'U' BIKE RACK WITH SQUARE TUBE

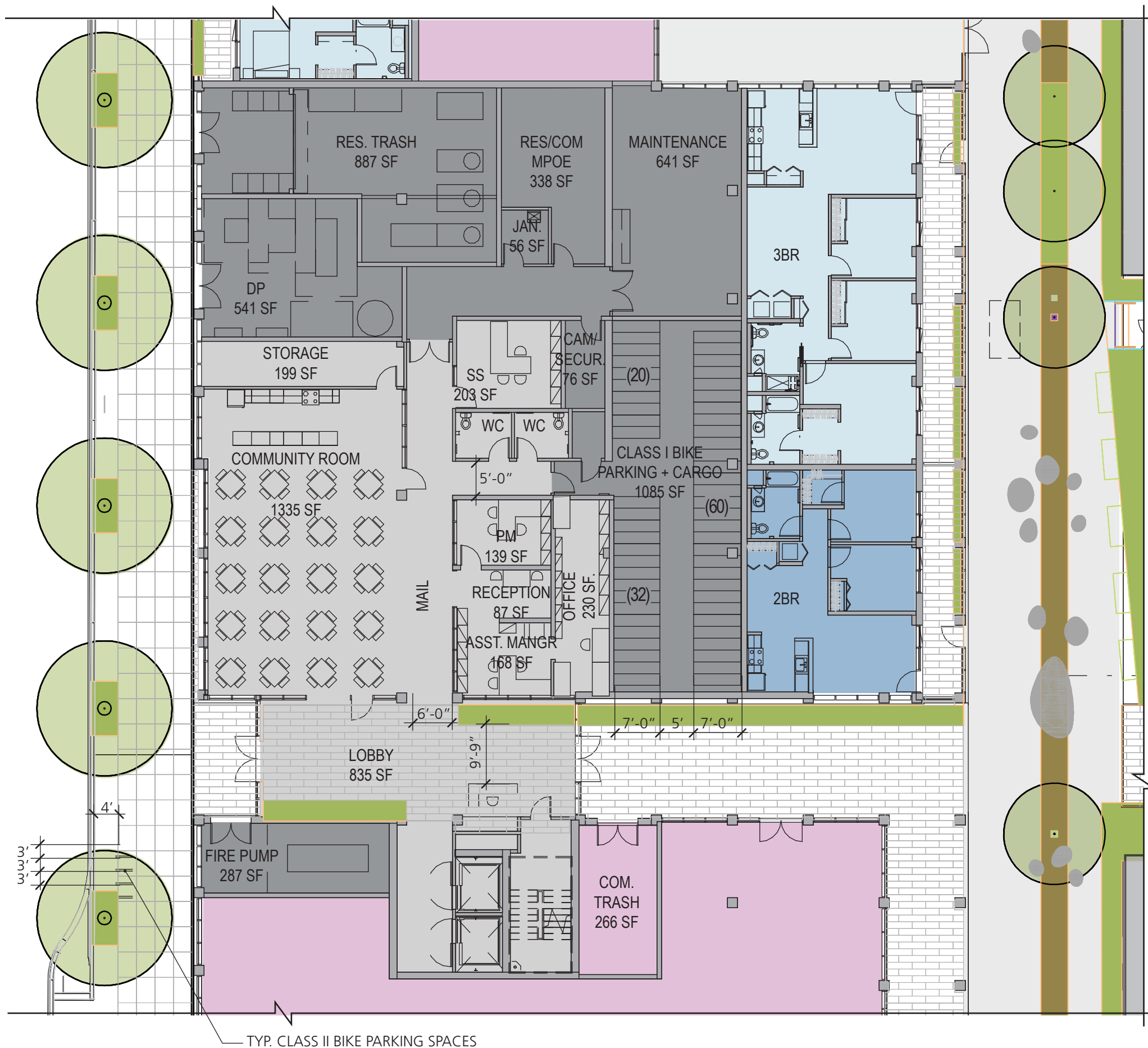

TYP. CLASS II BIKE PARKING SPACES



SECTION 151 CLASS I & II BICYCLE PARKING

10 DERO DECKER LIFT ASSIST SPACES

LEGEND:

- COMMERCIAL / CHILDCARE
- RESIDENTIAL UNITS
- CIRCULATION & SUPPORT
- SERVICE

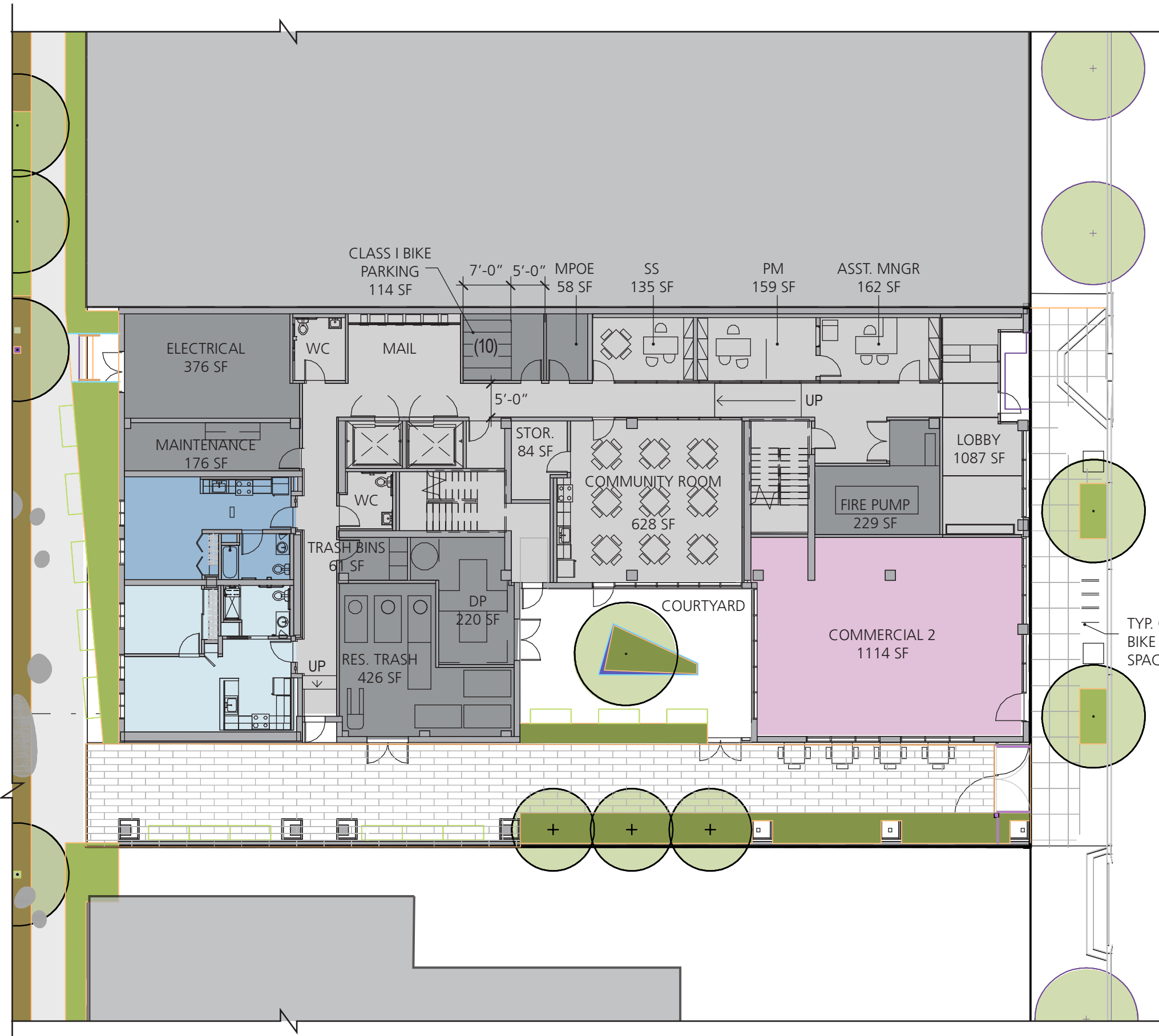

CLASS I SPACES - DERO DECK LIFT ASSIST BIKE RACK



CLASS II - INVERTED 'U' BIKE RACK WITH SQUARE TUBE



BOUNDARY SURVEY
SCALE: 1"=20'

VALLEJO STREET
(88.75' WIDE)

AB 0140

STATE OF CALIFORNIA
RE 7453 IMG 456
APN 0140-007

CITY & COUNTY OF SAN FRANCISCO
DOC. NO. 94-F736015 (PARCEL 4)
APN 0140-008

REALTIME PROPERTIES, LLC
DOC. NO. 2001-0016408
APN 0140-002

BROADWAY
(82.50' WIDE)

FRONT STREET
(69.21' WIDE)

DAVIS STREET
(88.75' WIDE)

LEGEND

SYMBOLS	DESCRIPTION
---	BOUNDARY - SUBJECT PROPERTY
---	RIGHT OF WAY LINE
---	RIGHT OF WAY CENTERLINE
---	MONUMENT LINE
---	12" SANITARY SEWER
---	12" WATER LINE
---	12" HIGH PRESSURE FIRE SYSTEM
---	24" STORM DRAIN LINE
---	3" GAS LINE
---	CHAIN LINK FENCE
---	STREET LIGHT
---	TRAFFIC SIGNAL POLE
---	CATCH BASIN
---	CLEARY BOX
---	SANITARY SEWER MAN HOLE
---	SANITARY SEWER CLEAN OUT
---	STORM DRAIN MAN HOLE
---	WATER VALVE
---	RECLAIMED WATER VALVE
---	WATER METER
---	PACIFIC GAS & ELECTRIC BOX
---	FIRE HYDRANT
---	TREE WELL
---	TEMPORARY POWER POLE
---	ELECTRICAL BOX
---	CABLE TELEVISION
---	GAS METER
---	BACKFLOW PREVENTOR
---	SINGLE LIGHT BOX
---	TRAFFIC SIGNAL BOX
---	PARKING METER
---	BOLLARD
---	SIGN
---	ASPHALT CONCRETE
---	BRICK LOCK
---	CONCRETE
---	CHAIN LINK FENCE
---	TRAFFIC SIGNAL INTERCONNECT
---	TRAFFIC SIGNAL INTERCONNECT
---	EDGE OF PAVEMENT
---	GAS METER
---	GROUND
---	IRRIGATION CONTROL VALVE
---	IRRIGATION CONTROL VALVE
---	MANHOLE COVER
---	TOP OF PAVEMENT
---	FOUND MONUMENT AS NOTED
---	CENTERLINE
---	MONUMENT LINE TO MONUMENT LINE
---	TOTAL
---	TOP OF CURB ELEVATION
---	FLOW LINE ELEVATION
---	RECORD INFORMATION
---	DELTA
---	LENGTH
---	RADIUS
---	SEARCHED FOR NOT FOUND
---	PRELIMINARY TITLE REPORT
---	ASSESSOR'S PARCEL NUMBER
---	PARCEL MAPS
---	DOCUMENT NUMBER
---	MEASURED
---	LOT NUMBER

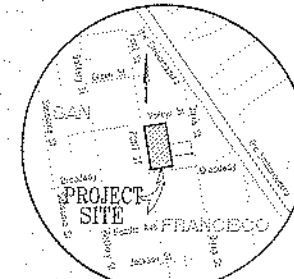

VICINITY MAP
NOT TO SCALE



TITLE IS VESTED IN:

STATE OF CALIFORNIA, ACTING BY AND THROUGH THE SAN FRANCISCO PORT AUTHORITY

THE INTEREST IN THE LAND IS:

A FEE

TITLE REPORT

THE TITLE REPORT USED IN THIS SURVEY WAS ISSUED BY OLD REPUBLIC TITLE COMPANY, ORDER NO. 111008031-01 UPGRADE, DATED AS OF AUGUST 29, 2016, AT 7:30 AM. REFERRED TO HEREIN AS THE "TFR".

LEGAL DESCRIPTION

THE LAND REFERRED TO IS SITUATED IN THE COUNTY OF SAN FRANCISCO, CITY OF SAN FRANCISCO, STATE OF CALIFORNIA, AND IS DESCRIBED AS FOLLOWS:

BEGINNING AT THE POINT OF INTERSECTION OF THE NORTHERLY LINE OF BROADWAY WITH THE EASTERLY LINE OF BROADWAY WITH THE EASTERLY LINE OF FRONT STREET; THENCE NORTHERLY ALONG SAID EASTERLY LINE OF FRONT STREET, 275.0 FEET TO THE POINT OF INTERSECTION OF SAID EASTERLY LINE WITH THE SOUTHERLY LINE OF VALLEJO STREET; THENCE EASTERLY ALONG SAID SOUTHERLY LINE OF VALLEJO STREET TO A POINT; THENCE SOUTHERLY AT RIGHT ANGLES FROM SAID SOUTHERLY LINE AND PARALLEL WITH SAID EASTERLY LINE OF FRONT STREET, 275.0 FEET TO A POINT IN THE NORTHERLY LINE OF BROADWAY; THENCE Westerly ALONG SAID NORTHERLY LINE OF 137.5 FEET TO THE POINT OF BEGINNING.

APN: 004, BLOCK 0140

NOTES

- DATE OF FIELD SURVEY: SEPTEMBER 8 & 9, 2016 AS TO THE BOUNDARY AND TOPOGRAPHIC SURVEY OF THE SUBJECT PROPERTY
- THE UTILITIES SHOWN HEREON ARE BY SURFACE OBSERVATION AND RECORD INFORMATION ONLY AND NO WARRANTY IS GIVEN HEREIN AS TO THEIR EXACT LOCATION, DEPTH OR RESPONSIBILITY OF THE BEHOLDER AND/OR CONTRACTOR TO VERIFY THE EXACT LOCATION OF THE UTILITIES WITH THE APPROPRIATE UTILITY COMPANY OR AGENCY.
- UTILITY ABANDONMENTS / PROVIDERS ARE AS FOLLOWS:
STORM DRAINS: CITY AND COUNTY OF SAN FRANCISCO
SANITARY SEWER: CITY AND COUNTY OF SAN FRANCISCO
WATER: CITY AND COUNTY OF SAN FRANCISCO
ELECTRICITY: PACIFIC GAS & ELECTRIC COMPANY
NATURAL GAS: PACIFIC GAS & ELECTRIC COMPANY
- THERE ARE NO CONCERNS ON OR WITHIN 100 FEET OF THE SUBJECT PROPERTY.

BENCHMARK

BENCHMARK AS SHOWN ON CITY OF SAN FRANCISCO BENCHMARK BOX 1, BLOCK 490 AT FACE 22, BEING LETTER 'O' AN OPEN TOP IRON INVERTAL AT THE NORTHWEST CORNER OF BROADWAY AND FRONT STREET, ELEVATION - 2.500 FEET, METRIC, DATUM: CITY AND COUNTY OF SAN FRANCISCO.

BASIS OF BEARINGS

BASIS OF SURVEY IS FOUND MONUMENTS ON BROADWAY BETWEEN DAVIS AND GASKINE STREETS AS SHOWN ON MONUMENT MAPS NOS. 2 AND 4 ON FILE IN THE OFFICE OF THE CITY ENGINEER.

SURVEYOR'S CERTIFICATE

THIS IS TO CERTIFY THAT THE WAY OR PLAN AND THE SURVEY ON WHICH IT IS BASED WERE MADE IN ACCORDANCE WITH THE 2009 MINIMUM STANDARD DETAIL REQUIREMENTS FOR ALTA AND NSPS LAND TITLE SURVEYS, JOINTLY ESTABLISHED AND ADOPTED BY ALTA AND NSPS, AND INCLUDED PLENS 1, 2, 3, 4, 5, 6, 7, 8, 9, 10, 11, 12, 13, 14, 15, 17, 18, 19, AND 20 OF SAID "TFR". THE FIELD WORK WAS COMPLETED ON SEPTEMBER 8, 2016.

DATE: 09/26/2016
FOR LUK & ASSOCIATES, INC.



TABLE A NOTES

- USDA MONUMENTS ARE SHOWN ON THIS SHEET OF THE SURVEY.
- THE STREET ADDRESS OF THE PROPERTY IS BLOCK 0140, LOT 007, SAN FRANCISCO, CA.
- FLOORED ZONE: ACCORDING TO FEMA PRELIMINARY FLOOD INSURANCE RATE MAP (FIRM) NUMBER 1706001001A, DATED NOVEMBER 19, 2015, THE PROPERTY IS NOT LOCATED IN A SPECIAL FLOOD HAZARD AREA.
- THE TOTAL GROSS LAND AREA IS 27,812.5 SQUARE FEET +/- OR 637.7 ACRES MORE OR LESS.
- ZONING REQUIREMENTS: PER THE CITY OF SAN FRANCISCO PLANNING AND DEVELOPMENT, THE PROPERTIES ARE ZONED "C-2", ALTHOUGH AS COMMUNITY BUSINESS DISTRICT.
- REFERENCE IS MADE HERE TO THE CITY OF SAN FRANCISCO ZONING CODE, ARTICLE 2, SECTION 21E1 REGARDING PROPERTY DEVELOPMENT STANDARDS, MINIMUM YARDS, BUILDING HEIGHT LIMITATION, BUILDING SETBACK REQUIREMENTS ARE AS FOLLOWS:
MINIMUM FRONT YARD: 80% REQUIRED
MINIMUM SIDE YARD: NOT REQUIRED
REAR YARD: REQUIRED FOR COMMERCIAL DEVELOPMENTS, 25% MINIMUM OF LOT LENGTH AT LEVEL OCCUPIED BY BUILDING UNITS
- HEIGHT AND AREA RESTRICTIONS: 65'-8"

- THERE ARE NO BUILDINGS ON THE SUBJECT PROPERTY.
- SUBSTANTIAL IMPROVEMENTS OBTAINED IN THE PROCESS OF CONDUCTING THE SURVEY ARE SHOWN.
- THERE ARE NO REGULAR PARKING SPACES AND 5 ADA PARKING SPACES ON THE SUBJECT PROPERTY.
- THERE ARE NO DRIVeways OR PARTY WALLS LOCATED ON THE SUBJECT PROPERTY WITH RESPECT TO ADJOINING PROPERTIES.
- LOCATION OF UTILITIES EXISTING ON OR SERVING THE SURVEYED PROPERTY AS DETERMINED BY OBSERVED EVIDENCE TOGETHER WITH EVIDENCE FROM PLANS OBTAINED FROM UTILITY COMPANIES OR PROVIDED BY CLIENT ARE SHOWN.
- NAMES OF ADJOINING OWNERS OF HEATED LANDS ARE SHOWN.
- DISTANCE TO THE NEAREST INTERSECTING STREET IS SHOWN.
- THERE IS NO OBSERVABLE EVIDENCE OF CURRENT EARTH MOVING WORK, DEADING CONSTRUCTION OR BUILDING ALTERATIONS.
- THERE IS NO OBSERVABLE EVIDENCE OF RECORD STREET OR SIDEWALK CONSTRUCTION OR REPAIRS.
- THERE ARE NO WETLAND AREAS IN THE SUBJECT PROPERTY.
- THERE ARE NO EARTH ENCLOSURES TO THE SUBJECT PROPERTY.
- PROFESSIONAL LIABILITY INSURANCE IN THE AMOUNT OF \$1,000,000 IS HELD BY ME SEPARATELY.

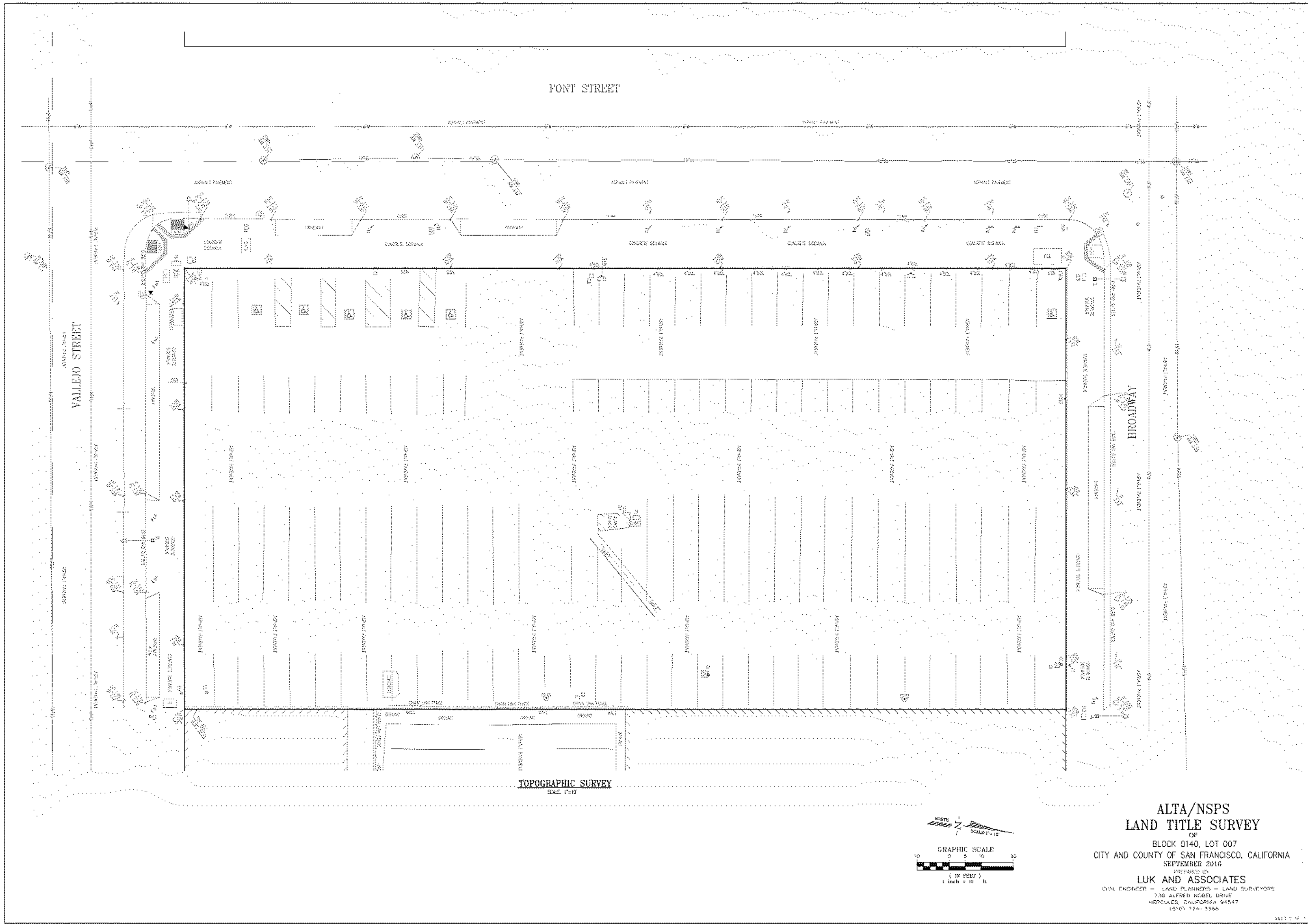

SITE SURVEY - FAMILY LOT

CERTIFICATE OF APPROPRIATENESS
REV-5 / SECTION 315

A10.10 LMSA 88 BROADWAY/+735 DAVIS



1: \s\cas\181204\14222410140_07-152016.dwg

DATE: 09/09/16
JOB NO.: 180343
PLOT DATE: SEPTEMBER 2016

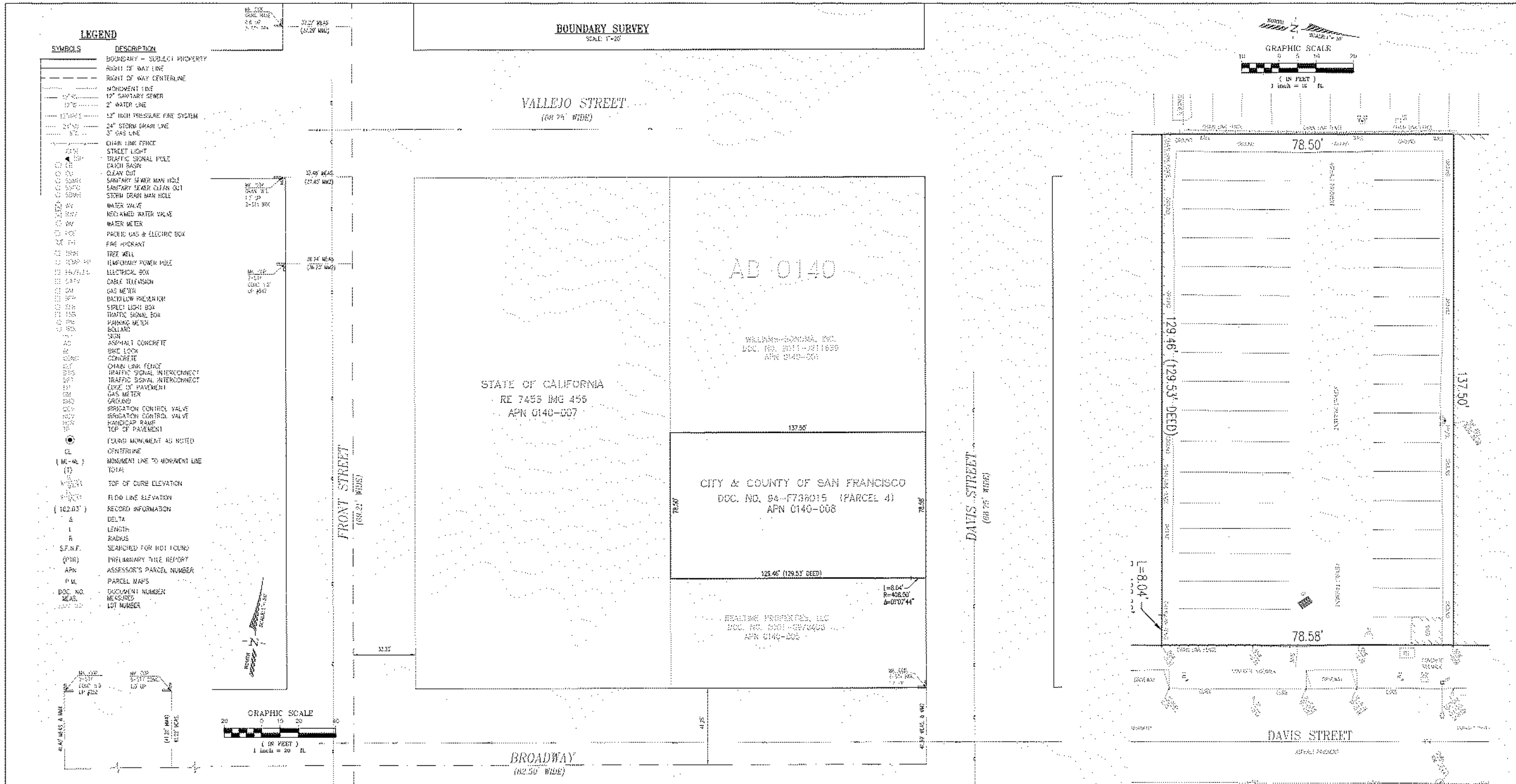

TITLE IS VESTED IN:
CITY AND COUNTY OF SAN FRANCISCO

THE INTEREST IN THE LAND IS:
A 1/4

TITLE REPORT
THE TITLE REPORT USED IN THIS SURVEY WAS ISSUED BY OLD REPUBLIC TITLE COMPANY, ORDER NO. 11767776-48, DATED AS OF AUGUST 22, 2016, AT 2:30 AM, REFERRED TO HEREIN AS THE "TRR".

NOTES

- DATE OF FIELD SURVEY: SEPTEMBER 8 & 9, 2016 AS TO THE BOUNDARY AND TOPOGRAPHIC SURVEY OF THE SUBJECT PROPERTY.
- THE UTILITIES SHOWN HEREON ARE OF SURFACE OBSERVATION AND RECORD INFORMATION ONLY AND NO WARRANTY IS GIVEN HEREIN AS TO THEIR EXACT LOCATION. IT IS THE RESPONSIBILITY OF THE DEVELOPER AND/OR CONSTRUCTOR TO VERIFY THE EXACT LOCATION OF THE UTILITIES WITH THE APPROPRIATE UTILITY COMPANY OR AGENCY.
- UTILITY JURISDICTIONS / PROVIDERS ARE AS FOLLOWS:
GROWTH ENERGY - CITY AND COUNTY OF SAN FRANCISCO
SANITARY SEWER - CITY AND COUNTY OF SAN FRANCISCO
WATER - CITY AND COUNTY OF SAN FRANCISCO
ELECTRICITY - PACIFIC GAS & ELECTRIC COMPANY
NATURAL GAS - PACIFIC GAS & ELECTRIC COMPANY
- THERE ARE NO EASEMENTS ON OR WITHIN 100 FEET OF THE SUBJECT PROPERTY.

LEGAL DESCRIPTION
THE LAND REFERRED TO IS SITUATED IN THE COUNTY OF SAN FRANCISCO, CITY OF SAN FRANCISCO, STATE OF CALIFORNIA, AND IS DESCRIBED AS FOLLOWS:
A PORTION OF THAT PARCEL OF LAND (STATE PARCEL NO. 12929) CONVEYED TO THE STATE OF CALIFORNIA BY INSTRUMENT RECORDS FILED WITH 18, 1952, IN VOLUME 5085, PAGE 526, OFFICIAL RECORDS OF THE CITY AND COUNTY OF SAN FRANCISCO, AND BEING MORE PARTICULARLY DESCRIBED AS FOLLOWS:
COMMENCING AT THE POINT OF INTERSECTION OF THE NORTHERLY LINE OF BROADWAY AND THE WESTERLY LINE OF DAVIS STREET, RUNNING THENCE WESTERLY AND ALONG SAID LINE OF BROADWAY 137 FEET AND 6 INCHES, THENCE AT A RIGHT ANGLE NORTHERLY 137 FEET AND 6 INCHES, THENCE AT A RIGHT ANGLE EASTERLY 137 FEET AND 6 INCHES TO THE WESTERLY LINE OF DAVIS STREET, THENCE AT A RIGHT ANGLE SOUTHERLY ALONG SAID LINE OF DAVIS STREET 137 FEET AND 6 INCHES TO THE POINT OF COMMENCEMENT,
BEING PART OF 50 VARS BLOCK 140.

EXCLUSIONS THEREFROM ALL THAT PORTION OF LAND CONVEYED BY DEED RECORDED NOVEMBER 30, 1959, IN VOLUME 4-59, PAGE 345, OFFICIAL RECORDS OF THE CITY AND COUNTY OF SAN FRANCISCO, AND RECORDED THEREIN AS FOLLOWS:
COMMENCING AT A POINT ON THE EASTERLY LINE OF THE PARCEL OF LAND DESCRIBED IN DEED NO. 12929 TO THE STATE OF CALIFORNIA, RECORDED FEBRUARY 16, 1955, IN VOLUME 4549, PAGE 526, OFFICIAL RECORDS OF THE CITY AND COUNTY OF SAN FRANCISCO, RUNNERS ALONG SAID EASTERLY LINE SOUTH 9° 02' 10" EAST 78.58 FEET FROM THE NORTHEASTERLY CORNER OF SAID PARCEL, SAID EASTERLY LINE ALSO BEING THE WESTERLY LINE OF DAVIS STREET, THENCE FROM A POINT THAT BEARS SOUTH 87° 07' 28" WEST, ALONG A CURVE TO THE LEFT WITH A RADIUS OF 408.00 FEET, THROUGH AN ANGLE OF 7° 07' 44" AND A LENGTH OF 8.04 FEET, THENCE SOUTH 86° 54' 47" WEST, 129.53 FEET TO THE WESTERLY LINE OF SAID PARCEL, THENCE ALONG SAID LINE SOUTH 9° 02' 10" EAST, 137 FEET TO THE NORTHERLY LINE OF BROADWAY STREET, THENCE ALONG SAID LINE WEST 87° 04' 45" EAST 137.07 FEET TO THE EASTERLY LINE, THENCE ALONG SAID LINE OF 10° 10' 10" WEST, 58.92 FEET TO THE POINT OF COMMENCEMENT.

APN 101 008 0008 140

BENCHMARK
BENCHMARK AS SHOWN ON CITY OF SAN FRANCISCO BENCHMARK BOB 1, BLOCK 482 AT PACE 22, BEING LETTER "O" IN OPEN TRIP 4975 NEAREST, AT THE NORTHEAST CORNER OF BROADWAY AND FRONT STREET, ELEVATION = 6.891 FEET, METRIC DATUM: CITY AND COUNTY OF SAN FRANCISCO.

BASIS OF BEARINGS
BASIS OF SURVEY IS FOUND MONUMENTS ON BROADWAY BETWEEN DAVIS AND SANSOME STREETS AS SHOWN ON MONUMENT MAPS NO. 2 AND 4 ON FILE IN THE OFFICE OF THE CITY ENGINEER.

SURVEYOR'S CERTIFICATE
I, SURVEYOR, STATE OF CALIFORNIA, CITY AND COUNTY OF SAN FRANCISCO, AND 323 PUBLIC TRUST COMPANY,
THIS IS TO CERTIFY THAT THIS MAP OR PLAN AND THE SURVEY ON WHICH IT IS BASED WERE MADE IN ACCORDANCE WITH THE 2016 UNIFORM STANDARD LEGAL REQUIREMENTS FOR ALTA AND NSPS LAND TITLE SURVEYS, JOINTLY ESTABLISHED AND ADOPTED BY ALTA AND NSPS, AND INCLUDES ITEMS 1, 2, 3, 4, 6, 8, 9, 10, 11, 12, 13, 14, 16, 17, 18, 19, AND 20 OF TABLE A, HEREON. THE FIELD WORK WAS COMPLETED ON SEPTEMBER 8, 2016.

DATE: SEPT 26, 2018
FOR L&K & ASSOCIATES, INC.

TABLE A NOTES

- FIXED MONUMENTS ARE SHOWN ON THIS SHEET OF THE SURVEY.
- THE STREET ADDRESS OF THE PROPERTY IS BLOCK 0140, LOT 008, SAN FRANCISCO, CA.
- FLOOD ZONE, ACCORDING TO FEMA PRELIMINARY FLOOD INSURANCE RATE MAP (FIRM) NUMBER DE0000174, DATED NOVEMBER 12, 2015, A PORTION OF THE PROPERTY IS SHADDED ORANGE, ZONE X, DEFINED AS OCEAN WINDWAVE CHARGE FLOOD HAZARD, AREAS OF 18 ANNUAL CHARGE FLOOD WITH AVERAGE DEPTH LESS THAN ONE FOOT OR WITH EXPOSURE AREAS OF LESS THAN ONE SQUARE MILE.
- THE TOTAL GROSS LAND AREA IS: 10,794 SQUARE FEET (1/4) OR 0.25 ACRES MORE OR LESS.
- (B) ZONING REQUIREMENTS: PER THE CITY OF SAN FRANCISCO PLANNING AND DEVELOPMENT, THE PROPERTIES ARE ZONED "O-2", DEFINED AS COMMUNITY BUSINESS DISTRICT.
REFERENCE IS MADE HERE TO THE CITY OF SAN FRANCISCO ZONING CODE, ARTICLE 2, SECTION 24.01 REGARDING PROPERTY DEVELOPMENT STANDARDS, MINIMUM YARDS, BUILDING HEIGHT LIMITATION, MISSING SETBACK REQUIREMENTS ARE AS FOLLOWS:
MINIMUM FRONT YARD WITH PERMISSIBLE MINIMUM ONE (1) CAR, NOT REQUIRED.
REAR: NOT REQUIRED FOR COMMERCIAL DEVELOPMENTS, 25 PERCENT OF LOT LENGTH AT LEVEL OCCUPIED BY DWELLING UNITS.
HEIGHT AND BULK DISTRICT: O-2
- THERE ARE NO BUILDINGS ON THE SUBJECT PROPERTY.
- SUBSTANTIAL IMPROVEMENTS OBSERVED IN THE PROCESS OF DEMONSTRATED THE SURVEY ARE SHOWN.

- THERE ARE 51 NEARBY PARKING SPACES ON THE SUBJECT PROPERTY.
- THERE ARE NO EVIDENCES OF PARTY WALLS LOCATED ON THE SUBJECT PROPERTY WITH RESPECT TO ADJOINING PROPERTIES.
- LOCATION OF UTILITIES EXISTING OR OR SURVEYING THE SURVEYED PROPERTY AS DETERMINED BY VISUAL INSPECTION TOGETHER WITH EVIDENCE FROM PLANS OBTAINED FROM UTILITY COMPANIES OR PROVIDED BY CLIENT ARE SHOWN.
- NAMES OF ADJOINING OWNERS OF PLATTED LOTS ARE SHOWN.
- DISTANCE TO THE NEAREST INTERSECTING STREET IS SHOWN.
- THERE IS NO CONSIDERABLE EVIDENCE OF CURRENT EARTH MOVING WORK, BUILDING CONSTRUCTION OR EROSION.
- THERE IS NO OBSERVABLE EVIDENCE OF RECENT STREET OR SIDEWALK CONSTRUCTION OR REPAIRS.
- THERE ARE NO WETLAND AREAS IN THE SUBJECT PROPERTY.
- THERE ARE NO OFFSHORE EASEMENTS TO THE SUBJECT PROPERTY.
- PROFESSIONAL LIABILITY INSURANCE IN THE AMOUNT OF \$2,000,000 IS HELD BY THE SURVEYOR.

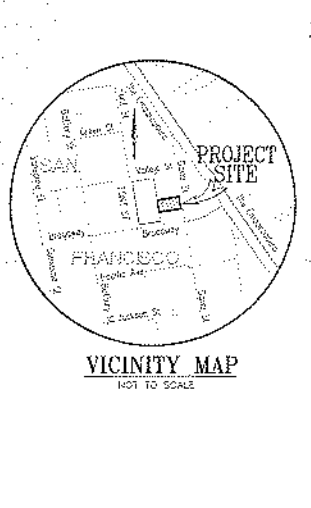

TOPOGRAPHIC SURVEY
SCALE: 1"=10'

ALTA/NSPS LAND TITLE SURVEY
OF
BLOCK 0140, LOT 008
CITY AND COUNTY OF SAN FRANCISCO, CALIFORNIA
SEPTEMBER 2018
PREPARED BY
LUK AND ASSOCIATES
CIVIL ENGINEER - LAND PLANNERS - LAND SURVEYORS
738 ALFRED NOBEL DRIVE
HERCULES, CALIFORNIA 94547
(916) 724-3388

DATE: 03/09/18
JOB NO.: 1806240
PLOT DATE: SEPTEMBER 26, 2018

11

APPENDIX

- To provide separation and visual transition between adjacent buildings by providing publicly accessible mid-block pedestrian alleys and pocket parks or equivalent alternative design concepts.

c) HEIGHT, BULK AND MASSING:

- To build within the 65 ft. height limit on the Port Site with massing step-downs toward the waterfront and build within 50 ft. height on the Davis Street frontage of the DPW Site.
- To avoid creating a “wall-like” effect on any façade facing a public street, but particularly Broadway and Front Streets by breaking the façade with setbacks on the upper floors and/or other architectural details to reduce apparent visual massing.
- To ensure that the construction type and materials relate to the Developments’ context and location in the Northeast Waterfront Historic District as outlined in the Neighborhood Analysis findings in the community design workshop presentation. See: <http://www.sfmohcd.org/index.aspx?page=322>.
- To consider the scale of neighborhood warehouse buildings when making massing adjustments.
- To consider the appearance of the roof(s) from above (i.e. from Telegraph Hill) by minimizing roof structures, including elevators, stair and mechanical penthouses, and incorporating attractive potential resident amenities such as roof decks, landscaping, open space.

d) FACILITATION OF ACTIVE USES ALONG STREET FRONTAGES:

- To comply with the site’s C-2 zoning requirements for active uses along the Broadway, Front, Vallejo and Davis Street frontages by exceeding the code required minimum 25 ft. depth for such uses wherever feasible.
- To design the commercial spaces at ground level in a manner that will facilitate neighborhood-serving retail such as a cafe, small market, hardware store, or bookstore with an emphasis on commercial uses on Broadway.
- To further encourage activation of street frontages where feasible by maintaining sidewalks wide enough to accommodate seating for commercial space customers.

e) NEIGHBORHOOD/COMMUNITY AMENITIES:

- To provide benefits to the broader community by incorporating, to the extent they are feasible, community-oriented amenities such as an after-school program open to older non-resident children and a senior center open to non-resident seniors.
- To provide design amenities such as “pocket parks”, landscaped open space at least visually accessible to the public, or a mid-block corridor or alley for pedestrian passage through the Development during daylight hours.

f) SUSTAINABILITY:

- To maximize the overall sustainability of the Development to the extent possible through the integrated use of sustainable building elements, including those that improve indoor air quality, reduce resource consumption, and approach zero-energy consumption.

PRE-RFP MASSING COMPARISON

A11.2 LMSA 88 BROADWAY/+735 DAVIS



NEIGHBORHOOD MASSING STUDY - PRE RFP



CURRENT MASSING



March 3, 2017

Aaron Thornton, AIA
LMS
677 Harrison St
San Francisco, California, 94107

Project: 88 Broadway St, San Francisco, CA
Project No.: 16-1902

Dear Aaron:

PAE has completed our initial Title 24 initial Schematic Design Energy Model for the 88 Broadway project. The results indicate the building will minimally pass Title 24 requirements based on the initial building envelope and MEP systems.

One of the key factors in Title 24 compliance is optimizing the Window to Wall ratio (WWR). The 2016 Building Energy Efficiency Standards (Title 24, Part6) prescriptively allow 40% WWR.

Figure 1: Title 24 Part 6 – 140.3

CONTINUED: TABLE 140.3-C – PRESCRIPTIVE ENVELOPE CRITERIA FOR HIGH-RISE RESIDENTIAL BUILDINGS AND GUEST ROOMS OF HOTEL/MOTEL BUILDINGS

Envelope	Fenestration	Vertical	All Climate Zones			
				Fixed Window	Operable Window	Curtainwall/Storefront
Skylights	Area-Weighted Performance Rating	Max U-factor	0.36	0.46	0.41	0.45
		Max RSHGC	0.25	0.22	0.26	0.23
		Min VT	0.42	0.32	0.46	0.17
		Maximum WWR%	40%			
	Area-Weighted Performance Rating		Glass, Curb Mounted	Glass, Deck Mounted	Plastic, Curb Mounted	
		Max U-factor	0.58	0.46	0.88	
		Max SHGC	0.25	0.25	NR	
		Min VT	0.49	0.49	0.64	
Maximum SRR%	5%					

Notes:
1. Light mass walls are walls with a heat capacity of at least 7.0 Btu/ft²-oF and less than 15.0 Btu/ft²-oF. Heavy mass walls are walls with a heat capacity of at least 15.0 Btu/ft²-oF.
2. Glazed Doors applies to both site-built and to factory-assembled glazed doors.

It is acceptable to follow the performance approach of energy compliance where a higher WWR is allowed. If our design was to proceed with a higher WWR, our performance energy model would be compared to a Standard Title 24 building with a 40% WWR. As such to have a higher WWR the building has to trade off energy efficiency measures with MEP systems to overcome this challenge.

On our 88 Broadway St project increasing the WWR from the currently designed 35% WWR to 50% WWR would have a significant impact on the energy model results. The currently selected MEP systems with a 50% WWR would fail to pass a Title 24 Energy model by the required 10% as stipulated by Green Building Ordinance in San Francisco.

March 3, 2017

In summary any request to increase the project WWR will a negative impact on energy efficiency and achieving the required City of San Francisco ordnances regarding Green Building Design.

Please let us know if you have any questions.

Sincerely,

Grant Craig
Associate Principal