

File No. 170940

Committee Item No. 5

Board Item No. \_\_\_\_\_

### COMMITTEE/BOARD OF SUPERVISORS

#### AGENDA PACKET CONTENTS LIST

Committee: Land Use and Transportation Committee Date February 5, 2018

Board of Supervisors Meeting

Date \_\_\_\_\_

Cmte Board

- Motion
- Resolution
- Ordinance
- Legislative Digest
- Budget and Legislative Analyst Report
- Youth Commission Report
- Introduction Form
- Department/Agency Cover Letter and/or Report
- MOU
- Grant Information Form
- Grant Budget
- Subcontract Budget
- Contract/Agreement
- Form 126 – Ethics Commission
- Award Letter
- Application
- Public Correspondence

**OTHER** (Use back side if additional space is needed)

- Planning Commission Resolution No. 20019, 20020 and 20021
- Port Commission Resolution No. 18-04
- \_\_\_\_\_
- \_\_\_\_\_
- \_\_\_\_\_
- \_\_\_\_\_
- \_\_\_\_\_
- \_\_\_\_\_
- \_\_\_\_\_
- \_\_\_\_\_
- \_\_\_\_\_

Completed by: Victor Young Date February 2, 2018

Completed by: \_\_\_\_\_ Date \_\_\_\_\_

1 [Planning Code, Zoning Map - Mission Rock Special Use District]

2  
3 **Ordinance amending the Planning Code and the Zoning Map to add the Mission Rock**  
4 **Special Use District, generally bounded by China Basin to the north; Pier 48, the**  
5 **marginal wharf between Pier 48 and Pier 50, the associated shoreline area and Terry**  
6 **Francois Boulevard to the east; Mission Rock Street to the south; and 3rd Street to the**  
7 **west; to amend other related provisions; making findings under the California**  
8 **Environmental Quality Act; and making findings of consistency with the General Plan,**  
9 **the eight priority policies of Planning Code, Section 101.1, and Planning Code, Section**  
10 **302.**

11 NOTE: **Unchanged Code text and uncodified text** are in plain Arial font.  
12 **Additions to Codes** are in *single-underline italics Times New Roman font*.  
13 **Deletions to Codes** are in *strikethrough italics Times New Roman font*.  
14 **Board amendment additions** are in double-underlined Arial font.  
15 **Board amendment deletions** are in ~~strikethrough Arial font~~.  
16 **Asterisks (\* \* \* \*)** indicate the omission of unchanged Code  
17 subsections or parts of tables.

18 Be it ordained by the People of the City and County of San Francisco:

19 Section 1. Findings.

20 (a) California Environmental Quality Act.

21 The actions contemplated in this ordinance are within the scope of the project  
22 for which the Board adopted the resolution in Board File No. 171286, affirming the Planning  
23 Commission's certification of the Final Environmental Impact Report for the Seawall Lot 337  
24 and Pier 48 Mixed-Use Project ("FEIR") and making findings in accordance with the

25 ///

///

1 California Environmental Quality Act (California Public Resources Code section 21000 et  
2 seq.) and the Administrative Code Chapter 31. Said resolution is incorporated herein by this  
3 reference.

4 (b) On October 5, 2017, the Planning Commission, in Resolution No. 20019,  
5 adopted findings that the actions contemplated in this ordinance are consistent, on balance,  
6 with the City's General Plan and eight priority policies of Planning Code Section 101.1. The  
7 Board adopts these findings as its own. A copy of said Resolution is in Board of Supervisors  
8 File No. 170940, and is incorporated herein by reference.

9 (c) Pursuant to Planning Code Section 302, this Board finds that this Planning Code  
10 Amendment will serve the public necessity, convenience, and welfare for the reasons set forth  
11 in Planning Commission Resolution No. 20019, and the Board incorporates such reasons  
12 herein by reference.

13 (d) On June 30, 2014, the voters of the City and County of San Francisco approved  
14 an initiative requiring voter approval for any future construction projects on the San Francisco  
15 waterfront that required an increase in existing height limits ("Proposition B"). On November  
16 3, 2015, in satisfaction of the requirements of Proposition B, the voters of the City and County  
17 of San Francisco approved the "Mission Rock Affordable Housing, Parks, Jobs and Historic  
18 Preservation Initiative" ("Proposition D") which established policies and modifications to the  
19 San Francisco General Plan and Planning Code for an approximately 28 acre site located  
20 between AT&T Park and the City's new Public Safety Building (the "Mission Rock Site").  
21 These modifications included adding a new Section 291 to the Planning Code creating a  
22 Mission Rock Height and Bulk District for the Mission Rock Site and establishing revised  
23 maximum building height limits therein.

24 ///

25 ///

1 (e) Section 291 of the Planning Code and Section 7 (Implementing Action) of  
2 Proposition D also directs the establishment of design controls that will be applicable to the  
3 Mission Rock Site.

4 (f) On January 30, 2018 and October 5, 2017, the Port Commission and the  
5 Planning Commission, respectively, conducted duly noticed public hearings on proposed  
6 Mission Rock Design Controls ("Design Controls") and by Resolution 18-04 and Motion  
7 20021, respectively, approved the Design Controls.

8 Section 2. The Planning Code is hereby amended by revising Section 201, adding  
9 Section 249.80, and amending Sections 291, 901, and 902 to read as follows:

10 **SEC. 201. CLASSES OF DISTRICTS.**

11 In order to carry out the purposes and provisions of this Code, the City is hereby  
12 divided into the following classes of use districts:

13 \* \* \* \*

<b><u>Mission Rock Mixed Use District</u></b>	
<i>(Also see Section 249.80)</i>	
<u>MR-MU</u>	<u>Mission Rock Mixed Use District (Defined in Section 249.80(f)(1))</u>

18 \* \* \* \*

19 **SEC. 249.80. MISSION ROCK SPECIAL USE DISTRICT.**

20 (a) **Purpose and Boundaries.** *A Special Use District entitled the Mission Rock Special Use*  
21 *District (SUD), the boundaries of which are shown on Sectional Map SU08 of the Zoning Maps of the*  
22 *City and County of San Francisco, is hereby established to facilitate the City's long-term goal of*  
23 *development of a new Mission Rock neighborhood. The purpose of this SUD is to implement the*  
24 *Mission Rock Affordable Housing, Parks, Jobs and Historic Preservation Initiative approved by City*  
25 *voters on November 3, 2015 (Proposition D), and give effect to the Development Agreement (DA),*

1 Disposition and Development Agreement (DDA) and related transactional documents as approved by  
2 the Board of Supervisors in legislation in File No. 171313 and 180092, which will provide benefits to  
3 the City such as, among other things, development of a mixed-use, transit-oriented community on the  
4 waterfront near public transit, major new housing, including a significant amount of affordable  
5 housing, increased public access and open spaces, extensive infrastructure improvements, shops,  
6 restaurants, cafes, neighborhood-serving retail, community spaces, commercial/office and light  
7 industrial/production space, preservation and renovation of historic Pier 48, job creation,  
8 responsiveness to climate change and resulting sea level rise, and the generation of revenue to fund  
9 public improvements.

10 (b) **Role of Port Commission.** The property within the SUD is under the jurisdiction of the  
11 Port Commission. As authorized under the Burton Act and AB 2797, the Port may hold, use, conduct,  
12 operate, maintain, manage, administer, regulate, improve, sell, lease, encumber, and control non-trust  
13 lands and improvements within the SUD for any purpose on conditions specified in the Burton Act and  
14 AB 2797. In the event of a conflict between this Code and the Burton Act, AB 2797, or the McAteer-  
15 Petris Act (Cal. Gov't Code §§ 66600 et seq.), state law shall prevail.

16 (c) **Relationship to Design Controls.** The Mission Rock Design Controls (Design Controls  
17 or DC), adopted by the Planning Commission and the Port Commission and as may be periodically  
18 amended, sets forth Standards and Guidelines, applicable within the SUD. A copy of the Design  
19 Controls is on file with the Clerk of the Board of Supervisors in File No. 170940 and available on the  
20 Board's website, and is incorporated herein by reference as though fully set forth. Any term  
21 used in this Section 249.80 and not otherwise defined in the SUD or this Code shall have the meaning  
22 ascribed to it in the Design Controls. The Port shall have exclusive jurisdiction and approval rights  
23 over amendments to the Design Controls that affect only open space and right-of-way (including  
24 streetscape) development within the SUD, which includes Chapters 2 through 4 of the Design Controls  
25 and could include, depending on the context and application to the open space/streetscape areas within

1 Port jurisdiction, the following: Design Controls Section 5.1 (Designing for Environmental Change:  
2 Site Grading and Differential Settlement), Section 5.3 (Active Edges), Section 5.4 (Public Passages),  
3 Section 5.7 (Parkfront Zone), Section 6.6 (Environmental Comfort), Section 7.1 (Interpretative Signage,  
4 Regionally Appropriate Vegetation), Section 7.4 9 (Signage), and Section 7.5 (Lighting). Other than  
5 amendments to sections of the Design Controls identified in this subsection (c) as being within the  
6 exclusive jurisdiction of the Port Commission as specified above, the Port Commission and the  
7 Planning Commission may amend the Design Controls upon initiation by either body or upon  
8 application by an Applicant, to the extent that such amendment is consistent with this Section, the  
9 General Plan, and the DA. Both the Port Commission and Planning Commission must approve any  
10 amendment to the Design Controls that does not exclusively affect the open space and right-of-way  
11 Chapters under the exclusive jurisdiction of the Port Commission. In the event of any conflict between  
12 the SUD and the Design Controls, the SUD shall prevail.

13 (d) **Relationship to Other Planning Code Provisions.** The provisions of this SUD and the  
14 Design Controls shall supersede the Planning Code in its entirety, with the result that the Planning  
15 Code shall not apply in the SUD, except with respect to (1) Planning Code definitions as specified in  
16 subsection (e) below; (2) Planning Code sections adopted or amended in connection with this Special  
17 Use District as follows: Section 105 (Zoning Maps), Section 201 (Mission Rock Mixed Use District),  
18 Section 249.80 (Mission Rock Special Use District), Section 291 (Mission Rock Height and Bulk  
19 District;) and Section 901 (Applicability of Article 9 Provisions and Other Provisions of the Planning  
20 Code); (3) Planning Code sections adopted by ballot proposition prior to the effective date of the  
21 ordinance (in Board of Supervisors File No. 170940) adopting this SUD as follows, and only to the  
22 extent that such provisions are applicable under the ballot proposition to development within the SUD;  
23 sections of the Planning Code adopted or amended by Proposition M (November, 1986) (Sections  
24 101.1, 164, and 320-325); Proposition K (June, 1984) (Section 295); and Proposition G (March, 2002)  
25 (Sections 602.7 (recodified at 602) and 611; and (4) any other section of the Planning Code referenced

1 herein (but only to the extent and for the purposes stated herein). Sections of the Planning Code  
2 adopted by ballot proposition that are limited geographically and do not apply to the SUD are  
3 Proposition G (Small Business Protection Act) (November, 2006) (Section 303.1); and Proposition X  
4 (Limitation on Conversion of Production, Distribution, and Repair Use, Institutional Community Use,  
5 and Arts Activities Use) (November, 2016) (Section 202.8). In the event of a conflict between any  
6 provisions of the Planning Code that are incorporated herein by reference pursuant to subsection  
7 (d)(4) above and the Design Controls or this Section 249.80, this Section 249.80 and the Design  
8 Controls shall control. Later amendments to the code sections referenced in this subsection as  
9 applicable in the SUD shall apply where not conflict with this SUD, the DC or the DA.

10 (e) **Definitions.** If not explicitly superseded by definitions established in this SUD or in the  
11 DC, the definitions in this Code shall apply. In addition to the specific definitions set forth elsewhere in  
12 this Section 249.80, the following definitions shall govern interpretation of this Section:

13 “Active Uses” means Active Uses as defined and described in Chapter 1 of the Design Controls.

14 “Applicant” means the ground lessee, owner, or authorized agent of the owner or ground lessee of a  
15 development parcel on the Project Site.

16 “Block” is a development Block as depicted on Figure 249.80-MR-1.

17 “Building Standards” means the standards applicable to Buildings and any associated privately-  
18 owned open spaces within the Project Site as specified in subsection (g).

19 “Commercial Uses” means all Institutional Uses and Non-Retail Sales and Services, but excluding  
20 Hospital, Commercial Storage, Wholesale Sales, and Wholesale Storage.

21 “DDA” means the Disposition and Development Agreement by and between the Port and Developer  
22 regarding development of Vertical Improvements and Horizontal Improvements on the Project Site.

23 “Executive Director” means the Executive Director of the Port of San Francisco.

24 “Horizontal Improvement” means public capital facilities and infrastructure built or installed at the  
25 Project Site. Horizontal Improvement include Shoreline Improvements, Public Space, Public ROWs,

1 and Utility Infrastructure, and exclude Site Preparation and Vertical Improvements, all as such terms  
2 are more particularly defined in the DDA.

3 “Major Modification” means a deviation of 10% or more from any dimensional or numerical Standard  
4 in the Design Controls or Building Standard in the SUD, except as limited by subsection (j)(1) below;  
5 provided, however, that any such deviation from a Standard in Chapter 5 of the Design Controls shall  
6 be deemed a minor modification. Major Modification also means a change to a standard that is non-  
7 numeric but is absolute, such as locations of curb cuts.

8 “Minor Modification” means a deviation of (1) less than 10% from any dimensional or numerical  
9 Standard in the Design Controls or Building Standard in the SUD, except as limited by subsection  
10 (j)(1) below; or (2) from any non-numerical (other than non-numeric, absolute) or qualitative Standard  
11 in the Design Controls.

12 “Other Uses” means Community Recycling Collection Center, Open Recreation Area, Passive  
13 Outdoor Recreation, Public Transportation Facility, Utility Installation, and Wireless  
14 Telecommunications Facility.

15 “Parking Garage” means either a Private Parking Garage or Public Parking Garage as further  
16 described in subsection 249.80(g)(7) and the Design Controls.

17 “Phase” means a phase of development as defined in the DDA.

18 “Production Uses” means all Agricultural and Industrial Uses, but excluding Large Scale Urban  
19 Agriculture; Automobile Wrecking; Food, Fiber and Beverage Processing 2; Hazardous Waste  
20 Facility; Junk Yard; Power Plant; Shipyard; Storage Yard; Storage, Volatile Materials; Truck  
21 Terminal; and all Non-Retail Automotive Uses.

22 “Project Site” means the Project Site for the Mission Rock development, as more particularly  
23 described in the DDA.

24 “Proposition D” means the Mission Rock Affordable Housing, Parks, Jobs and Historic Preservation  
25 Initiative, which San Francisco voters approved on November 3, 2015.



1 “Residential Uses” means Residential Uses as defined in Section 102, including Single Room  
2 Occupancy and Student Housing and excluding any residential component of an Institutional Use.

3 “Retail Uses” means all Retail Sales and Services, and Retail Entertainment, and Arts and Recreation  
4 Uses; but excluding Adult Business, Motel, Fringe Financial Services, Self-Storage, Livery Stable, and  
5 Sports Stadium. Retail Automotive Uses are not permitted.

6 “Standard” means the category of design control described in the Chapter Summary to the Design  
7 Controls.

8 “Vertical DDA” means a Vertical Disposition and Development Agreement between the Port and an  
9 Applicant that sets forth contractual terms and conditions governing the Applicant’s development of  
10 Vertical Improvements at the Project Site.

11 “Vertical Improvements” means new construction of a Building or the rehabilitation of Pier 48 at the  
12 Project Site, and any later expansion or major alteration of or addition to a previously approved  
13 Building at the Project Site.

14 (f) Uses.

15 (1) Mission Rock Mixed Use District Zoning Designation. The Mission Rock  
16 Mixed Use District (MR-MU) is the zoning designation for the Mission Rock site and is co-terminus  
17 with the boundaries of the Mission Rock Special Use District. This Special Use District Section 249.80  
18 and other Sections referenced herein establish all zoning controls for the MR-MU district.

19 (2) Permitted Uses. Uses principally permitted within the SUD are set forth in  
20 Table 249.80-MR1. Figure 249.80-MR1 and Table 249.80-MR1 identify each development block and a  
21 primary land use designation for that development block. Additional requirements that apply to  
22 certain primary land use designations in a block, and the clarification of permitted uses on publicly-  
23 accessible open spaces described in the Design Controls are set forth in subsections (f)(2)(A) through  
24 (D) below. Permitted uses at the ground floor are set forth in subsection (f)(3) below. All uses are  
25 allowed in this SUD unless otherwise explicitly prohibited as identified in this subsection (f). The intent

1 of this subsection is that the Planning Director, or the Executive Director in the case of temporary and  
2 interim uses, interpret permitted uses broadly to allow for uses that may not currently exist or be  
3 identified in this subsection (f) but that are consistent with the classes of expressly identified permitted  
4 uses. The major categories of permitted uses in the SUD as set forth in Table 249.80-MR1 are:  
5 Residential, Production (which includes Industrial and Agricultural uses), Commercial, Retail, Parking  
6 Garage and Other Uses.

7 (A) On Blocks primarily designated as Residential Mixed Use, at least 60%  
8 of the gross square footage of the Buildings above the ground floor in each Block shall consist of  
9 Residential Uses. The minimum 60% requirement shall be considered cumulatively on each subject  
10 Block, starting with the first Vertical Improvement on the Block. No Vertical Improvement or change  
11 of use may be approved if it causes the gross square footage on the Block as a whole, considering all  
12 existing and approved uses on the Block, to fall below 60% Residential Uses.

13 (B) On Blocks primarily designated as Commercial Mixed Use, at least 60%  
14 of the gross square footage of the Buildings above the ground floor in each Block shall consist of Non-  
15 Residential Uses. The minimum 60% requirement shall be considered cumulatively on each subject  
16 Block, starting with the first Vertical Improvement on the Block. No Vertical Improvement or change  
17 of use may be approved if it causes the gross square footage on the Block as a whole, considering all  
18 existing and approved uses on the Block, to fall below 60% Non-Residential Uses.

19 (C) Hotel Uses are considered Retail Uses in this SUD and in the DC except  
20 where otherwise specified therein, and in the DA for fee calculation purposes; provided however, that  
21 for purposes of permitted land use location only, Hotels shall (i) be allowed in any location in which  
22 Residential Uses are permitted; and (ii) count as Residential Uses for purposes of the 60% calculation  
23 in this subsection (f)(2)(A). The Design Controls contain a more detailed description of design and  
24 other controls that govern Hotel Uses.

25 ///

(D) The principally permitted use on publicly accessible open spaces as described in the Design Controls is Open Space/public access, subject to continuing maritime use on the south side of the apron and consistency of public access therewith, all as set forth in the DA and the Design Controls.

**Table 249.80-MR1 Land Uses(1)**

P=Permitted.

<u>Mission Rock Parcels (as shown in Figure 249.80- MR1)</u>	<u>Residential Uses</u>	<u>Production Uses(2)</u>	<u>Commercial Uses</u>	<u>Retail Uses</u>	<u>Parking Garage(3)</u>	<u>Other Uses</u>
<u>A (Residential Mixed Use)(4)</u>	<u>P</u>	<u>P</u>	<u>P</u>	<u>P</u>	<u>NP</u>	<u>P</u>
<u>B (Commercial Mixed Use)(5)</u>	<u>P</u>	<u>P</u>	<u>P</u>	<u>P</u>	<u>NP</u>	<u>P</u>
<u>C (Commercial Mixed Use)(5)</u>	<u>P</u>	<u>P</u>	<u>P</u>	<u>P</u>	<u>NP</u>	<u>P</u>
<u>D1 (Residential Mixed Use)(4)</u>	<u>P</u>	<u>P</u>	<u>P</u>	<u>P</u>	<u>NP</u>	<u>P</u>
<u>D2</u>	<u>NP</u>	<u>NP</u>	<u>NP</u>	<u>NP</u>	<u>P</u>	<u>NP</u>
<u>E (Commercial Mixed Use)(5)</u>	<u>P</u>	<u>P</u>	<u>P</u>	<u>P</u>	<u>NP</u>	<u>P</u>
<u>F (Residential Mixed Use)(4)</u>	<u>P</u>	<u>P</u>	<u>P</u>	<u>P</u>	<u>NP</u>	<u>P</u>
<u>G (Commercial Mixed Use)(5)</u>	<u>P</u>	<u>P</u>	<u>P</u>	<u>P</u>	<u>NP</u>	<u>P</u>
<u>H (Flex Commercial or Residential Mixed Use)(6)</u>	<u>P</u>	<u>P</u>	<u>P</u>	<u>P</u>	<u>NP</u>	<u>P</u>
<u>I (Flex Commercial or Residential Mixed Use)(6)</u>	<u>P</u>	<u>P</u>	<u>P</u>	<u>P</u>	<u>NP</u>	<u>P</u>

<u>J (Flex Commercial or Residential Mixed Use)(6)</u>	<u>P</u>	<u>P</u>	<u>P</u>	<u>P</u>	<u>NP</u>	<u>P</u>
<u>K (Residential Mixed Use)(4)</u>	<u>P</u>	<u>P</u>	<u>P</u>	<u>P</u>	<u>NP</u>	<u>P</u>
<u>Pier 48 (7)</u>	<u>NP</u>	<u>P</u>	<u>NP</u>	<u>NP</u>	<u>NP</u>	<u>P</u>

NP=Not Permitted.

Notes:

(1) See Table 249.80-MR2 and Figure 249.80-MR2 for Ground Floor Controls. This Table 249.80-MR1 applies to uses above the ground floor.

(2) The following uses are permitted in areas designated for Production Uses only as accessory to Production Uses in accordance with subsection 249.80 (f)(7): Heavy Manufacturing 1 (woodworking mill only), Heavy Manufacturing 2 (rendering or reduction of fat, bones, or other animal material only), Heavy Manufacturing 3 (candles (from tallow); dye, enamel, lacquer, perfume, printing ink, refuse mash, refuse grain, or soap only), Wholesale Sales, and Wholesale Storage.

(3) See Section 249.80(g)(7) for Building Standards that apply to off-street parking. Automotive Repair and Automotive Wash are permitted as accessory to all Parking Garages.

(4) See Section 249.80(f)(2)(A) for additional requirements that apply on Residential Mixed Use Blocks. Hotel uses (up to 300 rooms) are permitted in any location in which Residential Uses are permitted. See Section 249.80(f)(2)(C) for additional requirements that apply to Hotels.

(5) See Section 249.80(f)(2)(B) for additional requirements that apply to Commercial Mixed Use Blocks.

(6) A Flex Block can be developed as either a Commercial Mixed Use or Residential Mixed Use Block.

(7) District-Serving Utility Installation as defined in the Design Controls is the only Other Use permitted; in addition, Active Uses are permitted.

///

///

///

///

**Figure 249.80-MR1 Land Use Designation by Block**

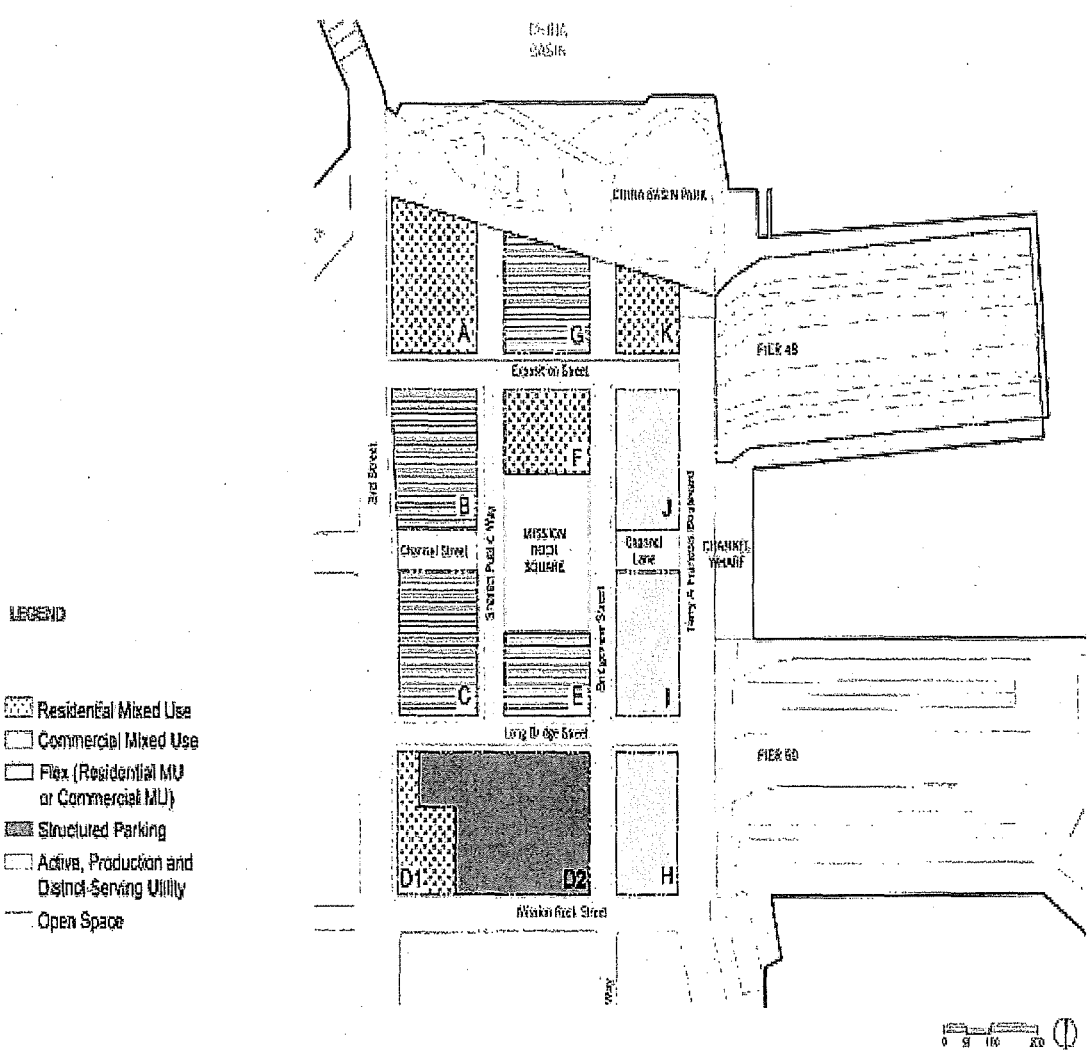

1  
2  
3  
4  
5  
6  
7  
8  
9  
10  
11  
12  
13  
14  
15  
16  
17  
18  
19  
20  
21  
22  
23  
24  
25

(3) Ground Floor Frontage Zones. *Ground Floor Frontage Zones are required as indicated in Table 249.80-MR2 and Figure 249.80-MR2 below and include permitted land uses and minimum frontage depths.*

///  
///  
///

**Table 249.80-MR2 – Ground Floor Frontage Zone Controls(1), (2)**

<u>Ground Floor Frontage Zone</u>	<u>Allowed Ground Floor Uses</u>	<u>Minimum Frontage Depth</u>
<u>High Retail Zone</u>	<u>Retail Use</u>	<u>40 feet</u>
<u>Parkfront Zone</u>	<u>Retail Use</u>	<u>40 feet</u>
<u>Working Waterfront Zone</u>	<u>Production Use, Retail Use</u>	<u>40 feet</u>
<u>Neighborhood Street Zone: Residential</u>	<u>Residential Use</u>	<u>20 feet</u>
<u>Neighborhood Street Zone: Non- Residential</u>	<u>Retail Use, Production Use, other uses that qualify as Active Uses Parking (only on Parcel D2 and as otherwise allowed in DA/DDA). Active Uses not required on the parking garage frontages.</u>	<u>20 feet</u>

Notes:

(1) See Design Controls Table 5.5 for more detailed controls that govern these zones.

(2) A Child Care Facility is a permitted use in all ground floor frontage zones.

///

///

///

///

///

///

///

**Figure 249.80-MR2 Frontage Zones**

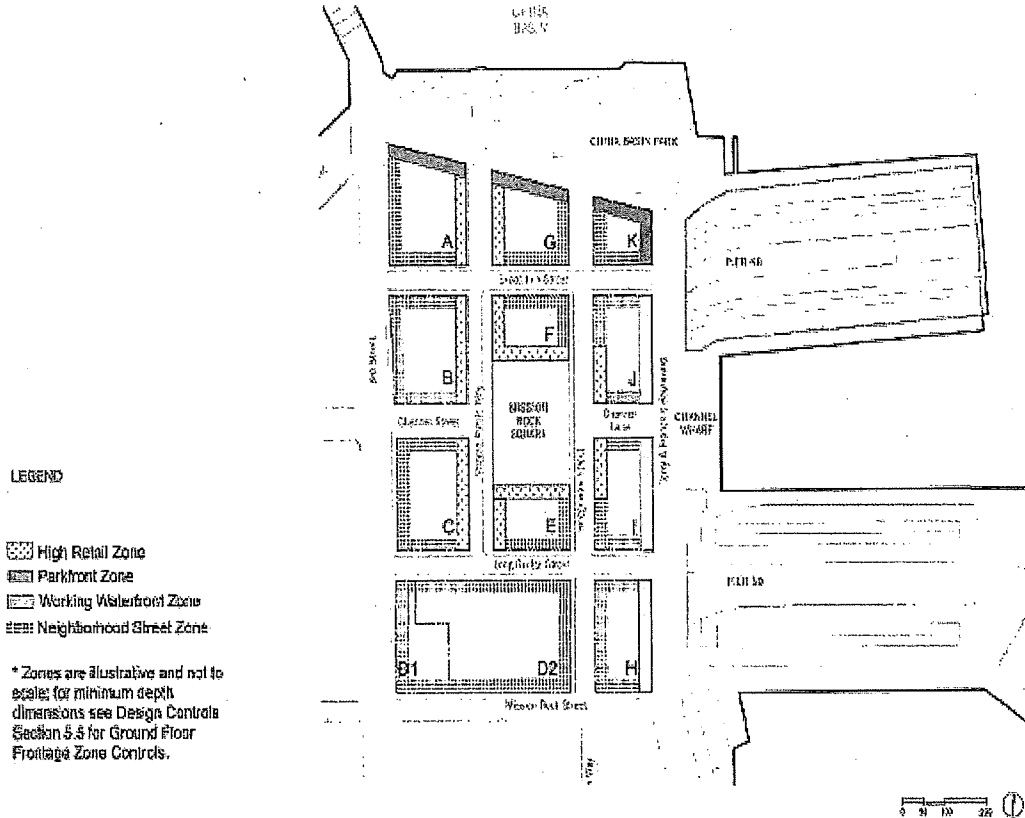

**(4) Temporary Uses.** The Executive Director may approve without a public hearing

any of the following uses ("Temporary Uses") for a period not to exceed 90 days, or for such longer period of time as may be approved by the Executive Director under any Port lease or license: booths for charitable, patriotic or welfare purposes; markets; exhibitions, festivals, circuses, musical and theatrical performances and other forms of live entertainment including setup/load-in and demobilization/load-out; athletic events; open-air sales of agriculturally-produced seasonal decorations such as Christmas trees and Halloween pumpkins; meetings rooms and event staging; mobile food and temporary retail establishments; and automobile and truck parking and loading

///

1 associated with any authorized temporary use. The Executive Director may authorize recurring  
2 Temporary Uses (such as a weekly farmers market or concert series) under a single authorization.

3 (5) Interim Uses. The Executive Director may approve any interim use listed in this  
4 section without a public hearing for a period not to exceed five years if the Executive Director finds  
5 that such use will not impede orderly development consistent with this Section 249.80, the Design  
6 Controls, and the DA. Interim uses under this Section are limited to uses at Pier 48 and the existing  
7 unimproved areas, open space and surface parking lots in the SUD area. Any interim use listed in this  
8 section that is integral to development under the DA, DDA or Vertical DDA and permitted by the Port  
9 under any Port lease or license shall not require separate authorization as an interim or temporary use  
10 (for example, uses incidental to environmental clean-up, demolition and construction, storage, and  
11 automobile and truck parking and loading related to construction activities.) Any authorization  
12 granted pursuant to this subsection (f)(5) shall not exempt the Applicant from obtaining any other  
13 permit required by law. Additional time for such uses may be authorized upon a new application.  
14 Interim uses that the Executive Director may authorize include, but are not limited to the following or  
15 similar activities:

16 (A) Retail activities, which may include the on-site assembly, production or  
17 sale of food, beverages and goods, the operation of restaurants or other retail food service in  
18 temporary structures, outdoor seating, food trucks, and food carts;

19 (B) Temporary art installations, exhibits, and sales;

20 (C) Recreational facilities and uses (such as play and climbing structures and  
21 outdoor fitness classes);

22 (D) Motor vehicle and bicycle parking;

23 (E) On-site assembly and production of goods in enclosed or unenclosed  
24 temporary structures;

25 ///



1                    (F) Educational activities, including but not limited to after-school day camp  
2 and associated activities;

3                    (G) Site management service, administrative functions and customer  
4 amenities and associated loading;

5                    (H) Rental or sales offices incidental to new development; and,

6                    (I) Entertainment uses, both unenclosed and enclosed, which may include  
7 temporary structures to accommodate stages, seating and support facilities for patrons and operations.

8                    (6) Nonconforming Uses. The Executive Director may allow the reasonable  
9 continuance, modification, or expansion of existing uses and structures that do not comply with this  
10 Section or the Design Controls under the terms and conditions set forth in the DDA.

11                    (7) Accessory Uses. Accessory uses are governed by the provisions of Planning  
12 Code Section 204 that apply to C Districts, with the following modifications:

13                    (A) Table 249.80-MR1 identifies certain Production Uses and two non-Retail  
14 Sales and Service Uses (Wholesale Sales and Storage, Wholesale) that are permitted in the SUD only  
15 as accessory to another principally permitted Production Use. Such accessory uses must be related to  
16 the underlying principal Production Use and are limited to up to 33% of the total floor area occupied  
17 by such principal Production Use.

18                    (B) In parking garages, car washing and minor automotive maintenance and  
19 repair activities shall be permitted as accessory uses.

20                    (g) Building Standards.

21                    (1) Density of Dwelling Units. There shall be no dwelling unit density limit within  
22 the SUD.

23                    (2) Floor Area Ratio. There shall be no floor area ratio limit within the SUD.

24                    (3) Lot Coverage and Rear Yard. There shall be no lot coverage or rear yard  
25 requirements in the SUD.

1                   (4) Usable Open Space Requirements for Dwelling Units. *In addition to any*  
2 *publicly-accessible open spaces described in the Design Controls, a minimum of 36 square feet of open*  
3 *space if private, or 48 square feet of open space if common, shall be provided for each dwelling unit.*  
4 *Such open space may be on the ground and on decks, balconies, porches or other facilities and shall be*  
5 *provided on the same development block as the unit to be served. The standards for open spaces shall*  
6 *be governed by the Design Controls.*

7                   (5) Dwelling Unit Exposure. *All dwelling units shall face onto a public or private*  
8 *right-of-way, or onto an open area, defined as:*

9                   (A) A public street, publicly accessible alley, or mid-block passage (public or  
10 private) at least 20 feet in width.

11                   (B) An exterior courtyard or terrace that is open to a public street, public  
12 alley, mid-block passage (public or private), or public open space and at least 25 feet in width.

13                   (C) An interior courtyard at least 25 feet in width, with adjacent walls up to a  
14 maximum height of 55 feet, or 40 feet in width with adjacent walls 55 feet or higher.

15                   (D) Undeveloped airspace over rooftops of either adjacent Buildings within  
16 the SUD or a Building on the same parcel where such Building has been built to the maximum height  
17 allowed pursuant to Section 291.

18                   (6) Building Height and Bulk. *Building height and bulk limits and controls within*  
19 *the SUD shall be as set forth in Planning Code Section 291.*

20                   (7) Off-Street Parking. *Off-street automobile parking shall not be required for any*  
21 *use in this SUD. At Project buildout, total parking spaces in the SUD shall not exceed 3,100. Up to*  
22 *3,000 parking spaces are permitted in the Parcel D2 parking garage or a combination of Parcel D2*  
23 *parking garage and a below grade parking garage beneath Mission Rock Square. A maximum of 100*  
24 *additional spaces in aggregate are permitted in other Vertical Improvements in the SUD. There shall*  
25 *be a minimum of 31 car share spaces at buildout of the SUD, located in any combination of the parking*

1 garage on Parcel D2, underground parking garage beneath Mission Rock Square and other Vertical  
2 Improvements in the SUD area. Phasing and amounts of parking for each Vertical Improvement shall  
3 be governed by the DDA.

4 (8) **Off-Street Loading.** Off-street loading spaces are not required in the SUD, and  
5 loading shall be governed by Design Controls Chapters 4 and 5.

6 (9) **Bicycle Parking; Showers and Lockers.** Bicycle parking, and the provision of  
7 showers and lockers shall be governed by Planning Code Sections 155.1-155.4 provided, however,  
8 that:

9 (A) the number of Class I bicycle parking spaces shall be provided at the higher  
10 of the ratios set forth in Planning Code Section 155.2 or the following: Residential: one space per  
11 dwelling unit; Commercial and Production Uses: one space per 2,500 square feet of Commercial or  
12 Production Use; and Retail: one space per 3,750 square feet of Retail Use;

13 (B) Class II bicycle parking spaces shall not be required pursuant to Section  
14 155.2 but shall be provided at the ratios and based on the criteria and locations set forth in the  
15 Transportation Demand Management requirements in the DDA on a Phase basis pursuant to the DDA  
16 in connection with Horizontal Improvements; and,

17 (C) in lieu of the Zoning Administrator waiver process, the Minor Modification  
18 and Major Modification process in subsection (m) below shall apply.

19 (10) **Signage.** Signage in the publicly accessible open spaces described in subsection  
20 (f)(2) and along public realm streets and rights-of-way identified in the Design Controls Chapters 2  
21 through 4, shall be subject to public realm signage standards and guidelines to be established as part  
22 of the first Phase submittal, as set forth in the DA and DDA. Signage for Buildings, including parking  
23 garages, in the SUD shall be governed by the provisions of Planning Code Article 6 that apply in the  
24 C-3 District. In lieu of the permit process described in Planning Code Section 604, all signage in the  
25 SUD shall be reviewed and approved by the Port in accordance with the DA and DDA.

1                    (11) **Transportation Demand Management.** *Transportation Demand Management*  
2 *requirements shall be governed by the DA and DDA.*

3                    (h) **Zoning Procedures.**

4                    (1) **Institutional Master Plans.** *Each Post-Secondary Educational Institutional use,*  
5 *including Group Housing affiliated with and operated by any such institution, shall comply with the*  
6 *applicable provisions of Planning Code Section 304.5, following the requirements and procedures for*  
7 *such uses in C-3 Districts.*

8                    (2) **Removal of Dwelling Units.** *The removal of Dwelling Units in the SUD shall be*  
9 *governed by Planning Code Section 317, in accordance with the procedures of Section 303 of this*  
10 *Code.*

11                    (3) **Health Care Services Master Plan.** *Any change of use to a Medical Use that*  
12 *would occupy 10,000 gross sf of floor area, or any expansion of an existing Medical Use that would*  
13 *add at least 5,000 gross square feet of floor area, is subject to Planning Code Section 342.*

14                    (4) **Places of Entertainment.** *Planning Code Section 314 (Places of Entertainment)*  
15 *shall not apply in the SUD. In lieu of this requirement, through the DDA the Port will address*  
16 *disclosures to residents regarding the proximity of Places of Entertainment to the Residential Uses.*

17                    (5) **Good Neighbor Policies.** *Planning Code Section 803.5 (Good Neighbor*  
18 *Policies) shall not apply in the SUD. The Port will enforce substantially similar policies through the*  
19 *DDA and Vertical DDA.*

20                    (6) **Retail Leasing Program.** *Planning Code Section 303.1 (Formula Retail) shall*  
21 *not apply in the SUD. In lieu of this requirement, through the DDA the Port will require a*  
22 *Merchandising Program as part of each Phase submittal. Each Vertical Improvement will be required*  
23 *to be consistent with the Merchandising Program, which will include standards and guidelines that,*  
24 *among other things, provide for a range of retail types and an appropriate mix of local, regional and*  
25 *national retail tenants.*

1            (i) Processing and Impact Fees. Processing and impact fees, including inclusionary  
2 housing requirements, for development in the SUD are governed by the DDA and DA.

3            (j) Modification to Building Standards. Modification of the Building Standards may be  
4 approved as authorized by this subsection (j) on a project-by-project basis according to the procedures  
5 of subsection (m).

6            (1) No Modifications Permitted. Major and Minor Modifications under subsection  
7 (m) are not permitted for:

8                            (A) maximum height and bulk established in Section 291;

9                            (B) maximum off-street parking amounts established in subsection (g);

10                           (C) minimum Class 1 bicycle parking quantities established in subsection (g); or.

11                           (D) land use requirements established in subsections (f).

12 Modifications to other Building Standards and provisions of this SUD are governed by subsection (m).

13            (2) Minor Modifications. The Planning Director may approve a Minor  
14 Modification administratively according to the procedures described in subsection (m).

15            (3) Major Modifications. The Planning Commission shall hear any application for  
16 a Major Modification according to the procedures described in subsection (m).

17            (k) Review and Approval of Development Phases. The Port must approve a Phase  
18 application in accordance with the DDA for the Phase that includes the applicable Vertical  
19 Improvements before Planning may approve an application for design review under this Section  
20 249.80. In addition to any hearings required under the DDA, prior to Port Commission approval and  
21 during the applicable Phase Submittal review period, the Developer shall make an informational  
22 presentation of each Phase Submittal to the Planning Commission and only as to the Phase Submittal  
23 that includes Pier 48, also to the Historic Preservation Commission, and seek comment from these  
24 Commissions.

1           (l) **Review and Approval of Open Space.** The Port has exclusive jurisdiction over the  
2 review of proposed publicly-owned open space and right-of-way (including streetscape) within the  
3 SUD. The Port's exclusive jurisdiction review authority includes determinations of consistency with  
4 the Design Controls, including program, design, and the inclusion of any associated or ancillary  
5 structures. Any privately-owned, publicly-accessible open space on any of the development parcels  
6 shall be reviewed and approved by Planning as part of the associated Vertical Improvement.

7           (m) **Design Review and Approval of Vertical Improvements.**

8           (1) **Applications.** Applications for design review are required for all Vertical  
9 Improvements prior to issuance of site or building permits. An Applicant shall file for design review at  
10 the Port for the property for which the design review is sought, with a copy delivered simultaneously to  
11 the Planning Department. Each application shall include the documents and materials necessary to  
12 determine consistency with this Section and the Design Controls, including site plans, sections,  
13 elevations, renderings, landscape plans, and exterior material samples to illustrate the overall concept  
14 design of the proposed Buildings. If an Applicant requests a Major or Minor Modification, the  
15 application shall contain descriptive material such as narrative or supporting imagery, if appropriate,  
16 that describes how the proposed Vertical Improvement meets the intent of the SUD and Design  
17 Controls and provides architectural treatment and public benefit that are equivalent or superior to  
18 strict compliance with the Standards or Building Standards.

19           (2) **Completeness.** Port and Planning staff shall review the application for  
20 completeness and jointly advise the Applicant in writing of any deficiencies within 30 days after receipt  
21 of the application or, if applicable, within 15 days after receipt of any supplemental information  
22 requested pursuant to this Section. Completeness review by Port staff will also include a review for  
23 compliance with the requirements of the applicable Vertical DDA (or, if the Vertical DDA has not been  
24 executed at the time of application submittal, for compliance with the requirements of the form of  
25

1 Vertical DDA approved by the Board of Supervisors and the information provided in Developer's  
2 applicable Appraisal Notice submitted under the DDA).

3 (3) **Staff Design Review for Buildings.** Each application for Vertical Improvements  
4 shall be subject to the administrative design review process set forth in this subsection (m)(3). Upon a  
5 determination of completeness (or deemed completeness), staff shall conduct design review and  
6 prepare a joint staff report determining compliance of the Vertical Improvement with this Section  
7 249.80 and the Design Controls, including a recommendation regarding any modifications sought.  
8 Such staff report shall be delivered to the Applicant and any third parties requesting notice in writing,  
9 shall be kept on file, and posted on the Department's website for public review, within 60 days after the  
10 determination of completeness (or deemed completeness). If staff determines that the Vertical  
11 Improvement is not compliant with the Design Controls and this Section 249.80, it will notify the  
12 Applicant within the applicable 60-day period, in which case the Applicant may resubmit the  
13 application and the requirements under this subsection (m)(3) shall apply anew, except that the time for  
14 staff review shall be 30 days.

15 (4) **Port Review for Pier 48.** Port staff shall review the schematic design for Pier 48  
16 in accordance with the timeframes and procedures set forth in this subsection (m) above or as  
17 otherwise set forth in the DDA, except that the Port will not refer the application to the Planning  
18 Department. The application will be processed by Port staff, and actions designated for the Planning  
19 Director in subsection (m) will be undertaken by the Port Director. Port staff review shall include a  
20 determination of consistency with the Design Controls and applicable mitigation measures, including  
21 compliance with Secretary of the Interior's Standards for the Treatment of Historic Properties.

22 (5) **Approvals and Public Hearings for New Development.**

23 (A) **New Construction.** Within 20 days after the delivery and posting of the  
24 staff report in accordance with subsection (m)(3), the Planning Director shall approve or disapprove  
25 the Vertical Improvement design and any Minor Modifications based on its compliance with this

1 Section 249.80 and the Design Controls and the findings and recommendations of the staff report. If  
2 the Vertical Improvement is consistent with the numeric Building Standards set forth in this Section  
3 249.80 and the Standards in Design Controls, then the Planning Director's discretion to approve or  
4 disapprove the Vertical Improvement shall be limited to the Vertical Improvement's consistency with  
5 the non-numeric elements of the Design Controls or the General Plan. Notwithstanding any other  
6 provisions of this Section 249.80, the Planning Director may refer an application that proposes  
7 modification to the non-numeric elements of the Design Controls to the Planning Commission, even if  
8 not otherwise classified as a Major Modification, if the Planning Director determines that the proposed  
9 modification does not meet the intent of the Standards in the Design Controls.

10 (B) **Vertical Improvements Seeking Major Modifications.** This subsection  
11 applies to Vertical Improvements seeking one or more Major Modifications and any Vertical  
12 Improvements seeking Minor Modifications that the Planning Director, in his or her sole discretion,  
13 refers as a Major Modification. Upon delivery and posting of the staff report under subsection (m)(3),  
14 the Planning Commission shall calendar the item for a public hearing within 20 days or at the next  
15 regularly scheduled Planning Commission meeting thereafter (or a special meeting, at the Planning  
16 Commission's discretion), subject to any required noticing. The Planning Commission shall consider  
17 all comments from the public, the recommendations of the consolidated Port/Planning staff report, and  
18 the recommendations of the Planning Director in making a decision to approve or disapprove the  
19 Vertical Improvement design, including the granting of any Major or Minor Modifications.

20 (C) **Notice of Hearings.** Notice of hearings required by subsection (m)(5)(B)  
21 above shall be provided as follows:

22 (i) by mail not less than 20 days prior to the date of the hearing to  
23 the Vertical Improvement Applicant, to property owners within 300 feet of the exterior boundaries of  
24 the property that is the subject of the application, using for this purpose the names and addresses as  
25



1 shown on the citywide assessment roll in the Office of the Tax Collector, and to any person who has  
2 requested such notice; and

3 (ii) by posting on the subject property at least 10 days prior to the  
4 date of the hearing.

5 (n) **Building Permit Approval.** The Chief Harbor Engineer shall review each site/building  
6 permit application for consistency with the authorizations granted pursuant to this Section. The Chief  
7 Harbor Engineer shall not issue any site/building permit for work within the SUD that is inconsistent  
8 with such authorization.

9 (o) **Change of Use.** Before issuing any building permit or other permit or license, or for a  
10 permit of Occupancy that would authorize a new use, a change of use or maintenance of an existing use  
11 of any land, Building or Structure, the Chief Harbor Engineer shall refer the matter to the Planning  
12 Department for a consistency determination within 15 days of referral. If the determination is not  
13 provided within 15 days, then the submittal shall be deemed consistent.

14 (p) **Discretionary Review.** No requests for discretionary review shall be accepted by the  
15 Planning Department or heard by the Planning Commission for any Buildings or Structures in the  
16 SUD.

## 17 **SEC. 291. MISSION ROCK HEIGHT AND BULK DISTRICT.**

18 (a) **Purpose.** The purpose of the Mission Rock Height and Bulk District is to enable  
19 development of Mission Rock as a mixed use, transit-oriented neighborhood, with significant  
20 open space, public access and affordable housing. The property within the District is *planned*  
21 ~~to be~~ divided into a number of separate blocks and varying height limits shall apply within such  
22 blocks as provided below. Design controls shall be adopted for the District to guide the design  
23 of improvements within the established height limits.

24 In approving the "Mission Rock Affordable Housing, Park, Jobs and Historic Preservation  
25 Initiative" ("Proposition D") on November 3, 2015, the voters of the City and County of San Francisco



1 with all of the requirements set forth ~~below~~ in the following subsections (a)(1) through (5), which  
2 requirements may not be amended without voter approval:

3 (1) **Open Space.** Approximately 8 acres of open space shall be provided  
4 within the District, and in these open space areas any buildings shall be limited in height to a  
5 single story, consistent with the height and bulk designation of OS (Open Space) in effect  
6 prior to the adoption of this Section 291 and the provisions of Planning Code Section 916.

7 (2) **Pier 48.** Pier 48, totaling approximately 5 acres (exclusive of the apron  
8 which shall remain as open space), shall be subject to a height limit of 40 feet, ~~consistent with~~  
9 ~~the prior height~~ and bulk designation of 40-X. No height limit in excess of 40 feet shall be  
10 established in the District within 100 feet landward of the shoreline of San Francisco Bay,  
11 measured from the mean high tide line as of the adoption of this Section 291.

12 (3) **Lots Fronting Terry A. Francois Boulevard.** Building frontages along  
13 the west side of the reconfigured Terry A. Francois Boulevard shall be no more than 40 feet in  
14 height, with height in excess of 40 feet stepping back from the street in accordance with the  
15 Design Controls ~~design controls to be adopted~~. The maximum height of buildings on blocks  
16 fronting on the west side of reconfigured Terry A. Francois Boulevard shall be 120 feet,  
17 provided that floor area above 90 feet shall be used exclusively for residential uses and uses  
18 accessory thereto and/or restaurant uses.

19 (4) **Elsewhere in the District.** Three buildings within the District shall be  
20 permitted to exceed a height of 190 feet; provided that (i) occupied floor area above 190 feet  
21 shall be used exclusively for residential uses and uses accessory thereto and/or restaurant  
22 uses, (ii) the maximum height of such buildings shall be 240 feet, and (iii) the ~~design controls~~  
23 Design Controls are in effect to ensure slender towers, including a requirement that typical  
24 floors above a height of 190 feet do not exceed 12,000 square feet of gross floor area, with  
25 minor variation permitted for articulation. Consequently, the typical floors above 190 feet in the

1 three buildings combined shall comprise no more than about 3% of the approximately 28 acre  
2 area of the Mission Rock Height and Bulk District. The height limit on all other blocks within  
3 the Mission Rock Height and Bulk District shall not exceed 190 feet or such lower height limit  
4 as may be required in accordance with the provisions of paragraphs (1) through (3) above.

5 (5) **Maximum Area Subject to Increased Height Limit.** As compared to the  
6 height limits in effect prior to the adoption of this Section 291, the height limit shall be  
7 increased on a maximum of 10 acres of the approximately 28 acre Mission Rock Height and  
8 Bulk District. The 18 acres on which the height limit is not increased shall include: (i) areas to  
9 be devoted to open space (approximately 8 acres), (ii) the circulation network for pedestrians,  
10 bicycles and vehicles (approximately 5 acres), and (iii) Pier 48 (approximately 5 acres).

11 (b) Height Limits. The height limits applicable to the blocks within the Mission Rock Height  
12 and Bulk District are as shown on the graphic below.

**Figure 291-MR1, Maximum Height and Bulk Plan**

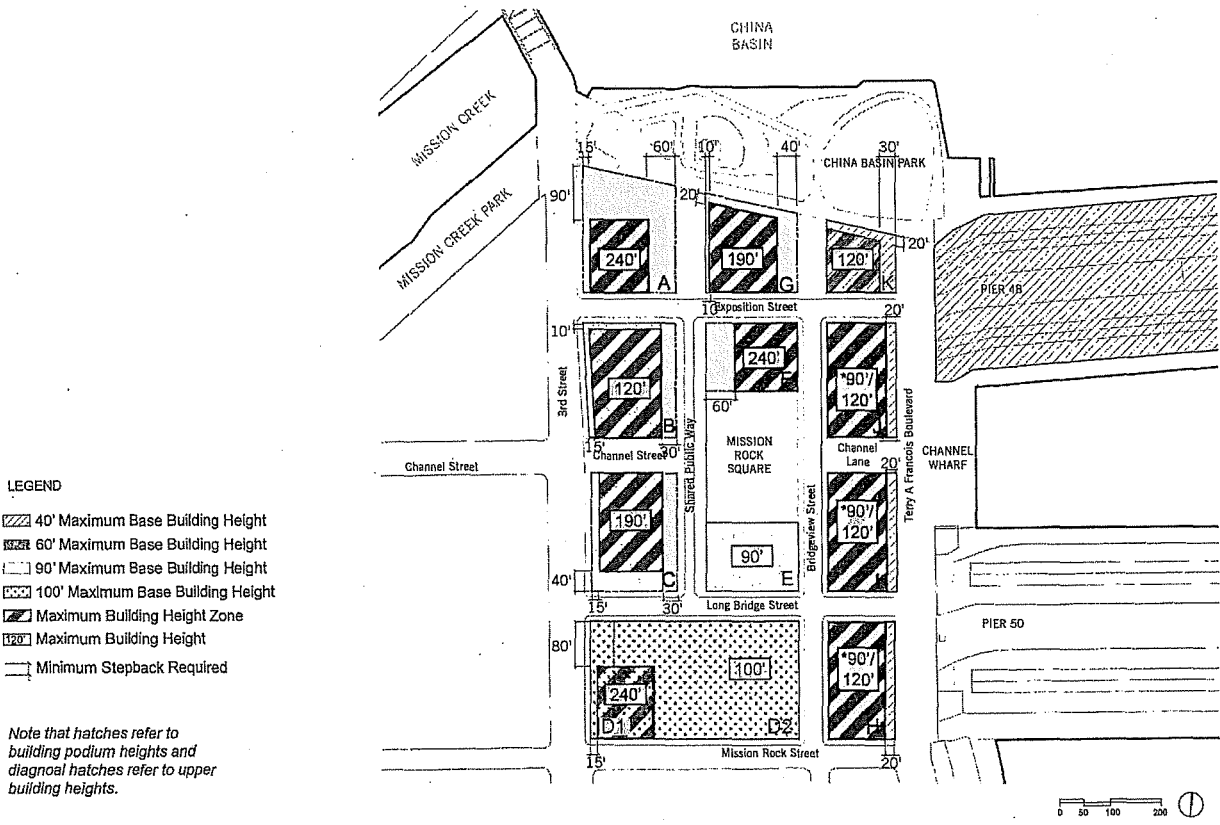

(c) **Height and Bulk Measurement.** Maximum building heights shall be measured from the highest point of the finished grade (as referenced in the Design Controls) along the property line, up to the highest point of the uppermost structural slab in the case of a flat roof, and up to the average height of the rise in the case of a pitched or stepped roof, or similarly sculptured roof form. Maximum Base Building heights shall be measured from the highest point of the finished grade (as referenced in the Design Controls of the finished grade (as referenced in the Design Controls) along the property line up to the highest point on the uppermost structural slab of the Base Building in the case of a flat roof, and

1 the average height of the rise in the case of a pitched or stepped roof, or similarly sculptured roof form  
2 of the Base Building.

3 (d) **Building Envelopes.** Building envelopes shall consist of the Base Building and the  
4 Upper Building, as illustrated in Figure 291-MR2, Components of the Building Envelope. Upper  
5 building massing must be located within the hatched zones and stepbacks are required above Base  
6 Buildings, both as indicated on Figure 291-MR1, Maximum Height and Bulk Plan.

7 ///

8 ///

9 ///

10 ///

11 ///

12 ///

13 ///

14 ///

15 ///

16 ///

17 ///

18 ///

19

20

21

22

23

24

25

**Figure 291-MR2. Components of the Building Envelope**

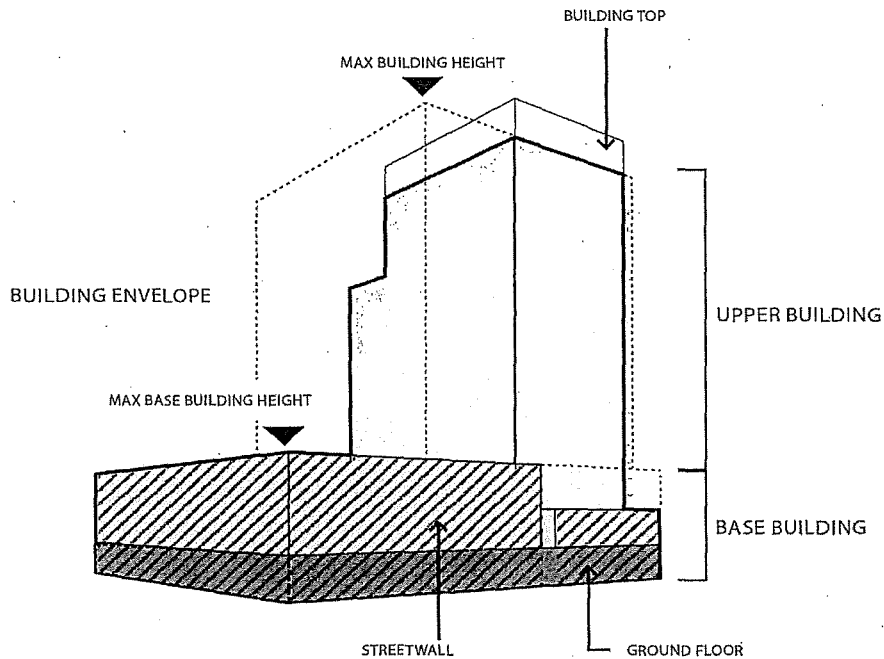

(e) Upper Building Tops. The tops of Upper Buildings may extend up to 20 feet vertically above the maximum permitted building height, except on Block F, where the building may extend up to 40 feet vertically above the maximum permitted building height. In both cases, the extension is allowed only for non-occupied architectural features.

(f) Rooftop Elements. The following rooftop elements may extend beyond the maximum permitted building height as specified below, provided that in no event shall the maximum height in subsection (e) be exceeded: mechanical enclosures, and sustainable infrastructure such as photovoltaic panels, windmills, fog catchers and Greenhouses (up to 20 feet in height). On the Base Building, rooftop elements must step back at a minimum ratio of 1.2 feet horizontally from the streetwall for every foot that they exceed the maximum permitted height limit. Common use structures

1 are permitted on the Base Building up to 20 feet in height, provided that they are limited to 25% of the  
2 roof area for each Base Building. On the Upper Building, rooftop elements must be screened or  
3 enclosed within the building top. Railings, planters and visually permeable building elements no  
4 greater than 42 inches above the roof are exempt from step-back requirements.

5 (g) **Upper Building Floorplate Reduction and Bulk Controls.** For buildings taller than  
6 160 feet, bulk floorplate reduction and controls shall be required in accordance with Figure 291-MR3  
7 and Table 291-MR1 as follows:

8 **Figure 291-MR3. Floorplate Reduction**

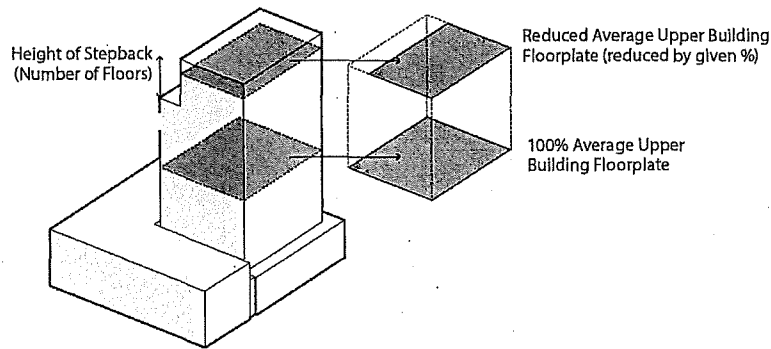

9  
10  
11  
12  
13  
14  
15  
16  
17 ///  
18 ///  
19 ///  
20 ///  
21 ///  
22 ///  
23 ///  
24 ///  
25 ///



Table 291-MR1 – Upper Building Bulk Controls

<u>Block</u>	<u>Primary Land Use</u>	<u>Upper Building Max Plan Dimension</u>	<u>Upper Building Max Diagonal Dimension</u>	<u>Height of Building Top</u>	<u>Upper Building Max Average Floorplate</u>	<u>% Reduction of Max Average Floorplate</u>	<u>Height of Stepback</u>
<u>Block A</u>	<u>Residential</u>	<u>140 feet</u>	<u>160 feet</u>	<u>20 feet</u>	<u>11,001-12,000</u>	<u>25%</u>	<u>Uppermost 5 floors</u>
					<u>11,000 square feet or less</u>	<u>None Required</u>	<u>Not Applicable</u>
<u>Block B</u>	<u>Commercial</u>	<u>NA</u>	<u>NA</u>	<u>20 feet</u>	<u>25,000 square feet</u>	<u>None Required</u>	<u>Not Applicable</u>
<u>Block C</u>	<u>Commercial</u>	<u>NA</u>	<u>NA</u>	<u>20 feet</u>	<u>20,000 square feet</u>	<u>10%</u>	<u>Uppermost 2 floors</u>
<u>Block D</u>	<u>Residential</u>	<u>140 feet</u>	<u>160 feet</u>	<u>20 feet</u>	<u>12,000 square feet</u>	<u>None Required</u>	<u>Not Applicable</u>
<u>Block E</u>	<u>Commercial</u>	<u>NA</u>	<u>NA</u>	<u>20 feet</u>	<u>NA</u>	<u>None Required</u>	<u>Not Applicable</u>
<u>Block F</u>	<u>Residential</u>	<u>140 feet</u>	<u>160 feet</u>	<u>40 feet</u>	<u>11,001 - 12,000 square feet</u>	<u>25%</u>	<u>Uppermost 5 floors</u>
					<u>11,000 square feet or less</u>	<u>None Required</u>	<u>Not Applicable</u>

1	<u>Block</u> <u>G</u>	<u>Commercial</u>	<u>NA</u>	<u>NA</u>	<u>20 feet</u>	<u>20,000</u> <u>square</u> <u>feet</u>	<u>10%</u>	<u>Uppermost</u> <u>2 floors</u>
2								
3	<u>Block</u> <u>H</u> <u>(flex)</u>	<u>If</u> <u>Residential</u>	<u>115 feet</u>	<u>150 feet</u>	<u>20 feet</u>	<u>10,000</u> <u>square</u> <u>feet</u>	<u>None</u> <u>Required</u>	<u>Not</u> <u>Applicable</u>
4		<u>If</u> <u>Commercial</u>	<u>NA</u>	<u>NA</u>	<u>20 feet</u>	<u>20,000</u> <u>square</u> <u>feet</u>	<u>None</u> <u>Required</u>	<u>Not</u> <u>Applicable</u>
5								
6	<u>Block</u> <u>I</u> <u>(flex)</u>	<u>If</u> <u>Residential</u>	<u>115 feet</u>	<u>150 feet</u>	<u>20 feet</u>	<u>10,000</u> <u>square</u> <u>feet</u>	<u>None</u> <u>Required</u>	<u>Not</u> <u>Applicable</u>
7		<u>If</u> <u>Commercial</u>	<u>NA</u>	<u>NA</u>	<u>20 feet</u>	<u>20,000</u> <u>square</u> <u>feet</u>	<u>None</u> <u>Required</u>	<u>Not</u> <u>Applicable</u>
8								
9	<u>Block</u> <u>J</u> <u>(flex)</u>	<u>If</u> <u>Residential</u>	<u>115 feet</u>	<u>150 feet</u>	<u>20 feet</u>	<u>10,000</u> <u>square</u> <u>feet</u>	<u>None</u> <u>Required</u>	<u>Not</u> <u>Applicable</u>
10		<u>If</u> <u>Commercial</u>	<u>NA</u>	<u>NA</u>	<u>20 feet</u>	<u>20,000</u> <u>square</u> <u>feet</u>	<u>None</u> <u>Required</u>	<u>Not</u> <u>Applicable</u>
11								
12	<u>Block</u> <u>K</u>	<u>Residential</u>	<u>115 feet</u>	<u>150 feet</u>	<u>20 feet</u>	<u>10,000</u> <u>square</u> <u>feet</u>	<u>None</u> <u>Required</u>	<u>Not</u> <u>Applicable</u>
13								
14								
15								
16								
17								
18								
19								
20								

**SEC. 901. SCOPE AND PURPOSE OF ARTICLE 9.**

(a) **Applicability of Article 9 Provisions and Provisions of Other Parts of the Planning Code.** This Article is adopted specifically for Mission Bay Use Districts. Notwithstanding any other provision of this Article 9, the term "Mission Bay Use Districts" is defined for purposes of this Article 9 to include only the non-shaded areas indicated on

1 Figure 1. The shaded areas on Figure 1 are now governed by the Mission Bay North and  
2 Mission Bay South Redevelopment Plans, and in MB-OS and P20, Sections 249.80 and 291, and  
3 are not subject to any provisions of this Article 9. The provisions set forth or referenced in this  
4 Article 9 shall apply to any use, property, structure, or development, both public and private,  
5 which is located in a Mission Bay Use District, unless otherwise provided for within this Article.  
6 Other provisions of this Code referenced in this Article are applicable in Mission Bay Use  
7 Districts shall apply only to the extent indicated in the reference. Other provisions of this Code  
8 which by their general terms would apply to Mission Bay Use Districts shall apply only to the  
9 extent expressly provided in this Article. The "Mission Bay Plan," formerly a part of the  
10 General Plan for the City and County of San Francisco, has been rescinded and adopted, as  
11 to the non-shaded areas on Figure 1, by the Planning Commission as the "Mission Bay  
12 Guidelines." Any reference in this Article 9 to the Mission Bay Plan shall be deemed to refer to  
13 the Mission Bay Guidelines adopted by the Planning Commission.

14 \* \* \* \*

15 **SEC. 902. ESTABLISHMENT AND LOCATION OF MISSION BAY USE DISTRICTS.**

16 \* \* \* \*

17 ///  
18 ///  
19 ///  
20 ///  
21 ///  
22 ///  
23 ///  
24 ///  
25 ///



1  
2  
3  
4  
5  
6  
7  
8  
9  
10  
11  
12  
13  
14  
15  
16  
17  
18  
19  
20  
21  
22  
23  
24  
25

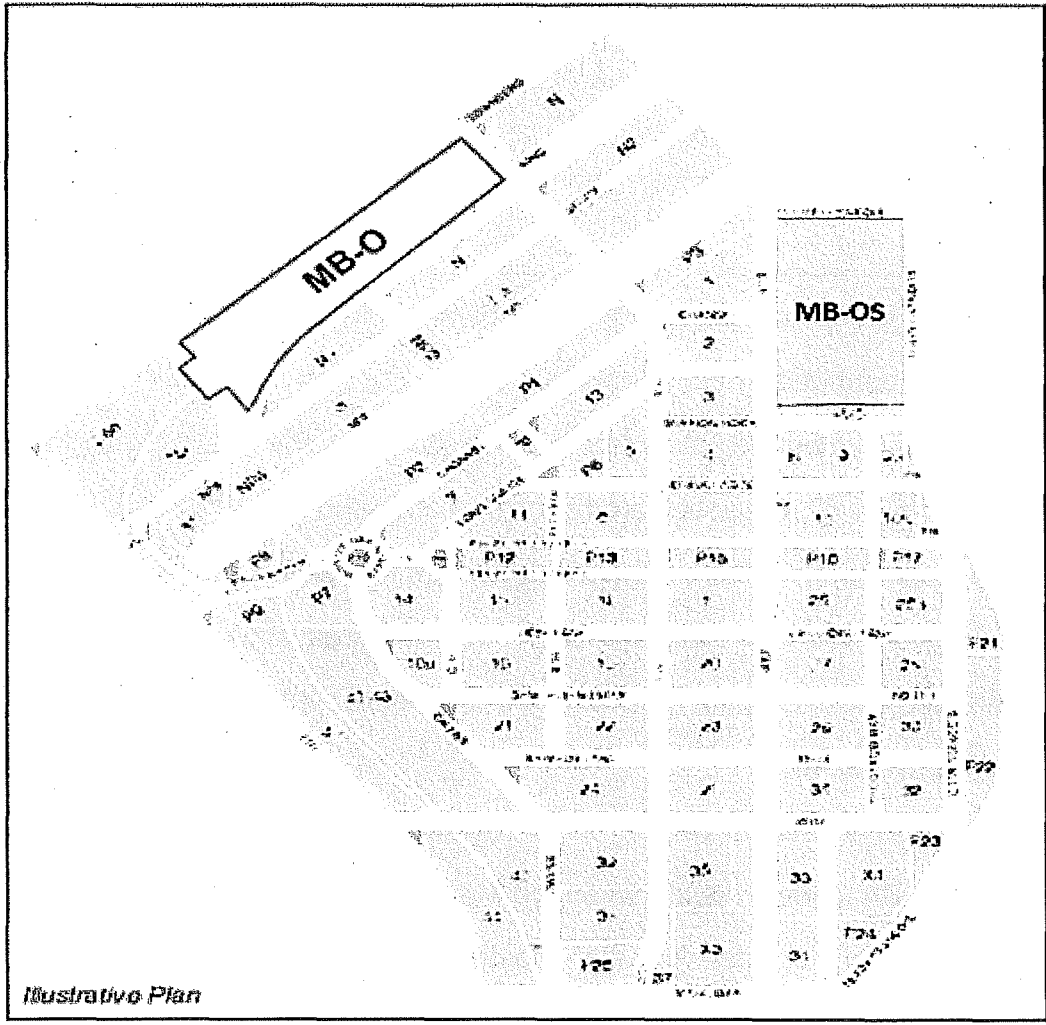

Section 3. The Planning Code is hereby amended by revising Zoning Map ZN08 and Sectional Map SU08, as follows:

(a) To change the Zoning Map (ZN08) from MB-OS and M-2 to Mission Rock Mixed Use District:

///  
///

Assessor's Block	Lot	Current Zoning to be Superseded	Proposed Zoning to be Approved
9900	048	M-2	Mission Rock Mixed Use (MR-MU) District
8719	006	MB-OS	Mission Rock Mixed Use (MR-MU) District

(b) Sectional Map SU08 is hereby amended to create the new Mission Rock Special Use District, bounded by the following streets:

Generally bounded by China Basin to the north; Pier 48, the marginal wharf between Pier 48 and Pier 50, the associated shoreline area and Terry Francois Boulevard to the east; Mission Rock Street to the south; and 3rd Street to the west; and consisting of Assessor's Block 8719/Lot 006, and Block 9900/Lot 048. The area is also referred to as Seawall Lot 337, including the existing China Basin Park; the 0.3-acre strip of land on the south side of Seawall Lot 337; and Pier 48.

Section 4. Effective Date. This ordinance shall become effective 30 days after enactment. Enactment occurs when the Mayor signs the ordinance, the Mayor returns the ordinance unsigned or does not sign the ordinance within ten days of receiving it, or the Board of Supervisors overrides the Mayor's veto of the ordinance.

Section 5. Scope of Ordinance. In enacting this ordinance, the Board of Supervisors intends to amend only those words, phrases, paragraphs, subsections, sections, articles, numbers, punctuation marks, charts, diagrams, or any other constituent parts of the Municipal Code that are explicitly shown in this ordinance as additions, deletions, Board amendment additions, and Board amendment deletions in accordance with the "Note" that appears under

///

///

///

///

1  
2  
3  
4  
5  
6  
7  
8  
9  
10  
11  
12  
13  
14  
15  
16  
17  
18  
19  
20  
21  
22  
23  
24  
25

the official title of the ordinance.

APPROVED AS TO FORM:  
DENNIS J. HERRERA, City Attorney

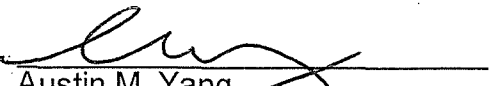
By:   
Austin M. Yang  
Deputy City Attorney  
n:\legana\as2018\1800029\01250108.docx

**REVISED LEGISLATIVE DIGEST**

(Substituted, 1/30/2018)

[Planning Code, Zoning Map - Mission Rock Special Use District]

**Ordinance amending the Planning Code and the Zoning Map to add the Mission Rock Special Use District, generally bounded by China Basin to the north; Pier 48, the marginal wharf between Pier 48 and Pier 50, the associated shoreline area and Terry Francois Boulevard to the east; Mission Rock Street to the south; and 3rd Street to the west; to amend other related provisions; making findings under the California Environmental Quality Act; and making findings of consistency with the General Plan, the eight priority policies of Planning Code, Section 101.1, and Planning Code, Section 302.**

Existing Law

The Mission Rock area of San Francisco is Port property directly south of the AT&T ballpark, consisting of China Basin Park, a surface parking lot leased to the Giants, and Pier 48. On November 3, 2015, in satisfaction of the requirements of Proposition B, which requires voter approval to increase height limits on certain Port property, the voters approved the "Mission Rock Affordable Housing, Parks, Jobs and Historic Preservation Initiative" ("Proposition D"). Proposition D established policies and modifications to the San Francisco General Plan to guide future development and added Section 291 to the Planning Code, establishing new height and bulk standards. Proposition D left the existing site zoning in place. Pier 48 is zoned Heavy Industrial (M-2) and the rest of the area is zoned Mission Bay Open Space (MB-OS).

Amendments to Current Law

This Ordinance adds Section 249.80 to the Planning Code, which establishes the Mission Rock Special Use District (SUD). The SUD envisions development of a mixed-use, transit-oriented community on the waterfront near public transit, new housing, increased public access and open spaces, infrastructure improvements, retail, community spaces, commercial/office and light industrial/production space, and preservation and renovation of historic Pier 48, job creation.

The SUD in conjunction with the Mission Rock Design Controls (Design Controls) establish land use controls and building standards for the area. The Design Controls document, adopted by the Planning and Port Commissions, describes standards and guidelines for development in detail.

The Ordinance defines permitted land uses, and temporary, and interim uses on the Project site. The building standards address dwelling unit density, floor area ratio, lot coverage, rear yard and open space requirements, dwelling unit exposure, off-street parking and loading,



bicycle parking, signage, and transportation demand management. The Ordinance addresses various zoning procedures, processing and impact fees, and modifications to the building standards. The Ordinance establishes procedures for review and approval of development phases, open space, and vertical improvements. The Ordinance also augments height and bulk controls through amendments to Planning Code Section 291.

Finally, the Ordinance amends Sections 201, 901 and the Zoning Map to (a) change the use of the site from MB-OS (Mission Bay Open Space) and M-2 (Heavy Industrial) to the Mission Rock Mixed Use District (MR-MU), and (b) create the Mission Rock SUD in the sectional map.

### Background Information

The Mission Rock project site is generally bounded by China Basin to the north; Pier 48, the marginal wharf between Pier 48 and Pier 50, the associated shoreline area and Terry Francois Boulevard to the east; Mission Rock Street to the south, and 3rd Street to the west. The Project involves construction of infrastructure, public open space and other public facilities, new building construction, and rehabilitation of historic Pier 48, resulting in a mix of market-rate and affordable residential uses, commercial use, retail/light-industrial uses, open space, and shoreline improvements. The Planning Department has prepared an environmental impact report (EIR) on the Project under the California Environmental Quality Act (CEQA). Related separate legislation that would further development of the project address establishment of a financing district and approval of a development agreement, disposition and development agreement, lease with the Port, and public trust exchange.

n:\legana\as2017\1800029\01217754.docx



# SAN FRANCISCO PLANNING DEPARTMENT

---

October 26, 2017

Ms. Angela Calvillo, Clerk  
Supervisor Jane Kim  
Board of Supervisors  
City and County of San Francisco  
City Hall, Room 244  
1 Dr. Carlton B. Goodlett Place  
San Francisco, CA 94102

1650 Mission St.  
Suite 400  
San Francisco,  
CA 94103-2479

Reception:  
415.558.6378

Fax:  
415.558.6409

Planning  
Information:  
415.558.6377

**Re: Transmittal of Planning Department Case Number :  
2013.0208 ENV/PCA/MAP/DEV/CWP  
Mission Rock (aka Seawall Lot 337 / Pier 48)  
BOS File No: 170940 (pending)  
Planning Commission Recommendation: Approval**

Dear Ms. Calvillo and Supervisor Kim,

On October 5, 2017 the San Francisco Planning Commission (hereinafter "Commission") conducted a duly noticed public hearing at a regularly scheduled meeting to consider the proposed Ordinances for the Mission Rock Development Project.

As envisioned, the proposed project would entail development of a mixed-use, multi-phase project at Seawall Lot 337 and Parcel P20, rehabilitation and reuse of Pier 48, and construction of approximately 5.4 acres of net new open space, for a total of approximately 8 acres of open space on the project site. The project would include up to 2.7 to 2.8 million gross square feet (gsf) of mixed uses on 11 proposed development blocks. The mixed-use development would comprise approximately 1.1 to 1.6 million gsf of residential uses (estimated at 1,000 to 1,600 units, 40% of which would be designated as below market rate), approximately 972,000 to 1.4 million gsf of commercial/office uses, and 241,000 to 244,800 gsf of active/retail and production uses on the lower floors of each block. Additionally, the project would include up to approximately 1.1 million gsf of above- and below-ground parking (approximately 3,000 spaces) in one or two centralized garages; 100 additional parking spaces would be allowed throughout the remaining parcels on the site. Also as part of the project, 242,500 gsf at Pier 48 would be rehabilitated for industrial, restaurant, active/retail, tour, exhibition, and meeting space use. The 11 blocks on Seawall Lot 337 would be developed with building heights ranging from 90 feet to a maximum of 240 feet for the tallest building, excluding the mechanical and other accessory penthouse roof enclosures and unoccupied building tops, subject to specified standards. The project would be built in several phases.

The proposed Ordinances would amend the Planning Code and would enable the City to enter into a Development Agreement with the Project Sponsor, Seawall Lot 337 Associates, LLC. More specifically, the Ordinances include the following:

Mission Rock Development Project

1. **Planning Code Text and Map Amendments:** Introduced by the Board of Supervisors on September 5, 2017, the Planning Code Text Amendments would add Section 249.80 to establish the Mission Rock Special Use District ("SUD") and amend Planning Code Section 291 "The Mission Rock Height and Bulk District" and other minor amendments. The Map Amendments would amend Zoning Map (ZN08) and Special Use District (SU08) by assigning the subject site to the newly created Mission Rock Mixed-Use District and the Mission Rock Special Use District respectively. The Planning Commission included in their approval minor changes to the Ordinance as provided to them on September 28, 2017. The City Attorney will provide new versions of the Ordinance that incorporates those changes on request.
2. **The Development Agreement.** The Development Agreement would be between the Project Sponsor and the City and County of San Francisco and would establish development vesting rights on behalf of the Project Sponsor in exchange for the requirement to construct and operate community benefits, including but not limited to all new streets, 8 acres of open space, and a commitment that 40% of the on-site housing units be affordable. This Ordinance has not yet been introduced by the Board of Supervisors. This transmittal includes a version of the Development Agreement Ordinance that incorporates changes introduced at the Commission hearing and included in their approval.

The proposed Amendments were analyzed in *the Seawall Lot 337 / Pier 58 Mixed Use Project EIR* (the "EIR"). The Commission certified the EIR on October 5, 2017 with Motion No. 20017 and adopted CEQA findings at the same hearing with Motion No. 20018.

At the October 5, 2017 hearing, the Commission voted to recommend approval of the proposed Ordinances including changes provided to the Commission after the initial Ordinances were drafted. Please find attached documents relating to the Commission's action.

If you have any questions or require further information please do not hesitate to contact me.  
Sincerely,

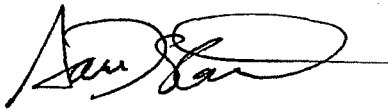

Aaron D. Starr  
Manager of Legislative Affairs

- cc: Barbara Lopez, Aide to Supervisor Kim  
Elaine Warren, Deputy City Attorney  
Erica Major, Office of the Clerk of the Board  
John Carroll, Office of the Clerk of the Board  
Adam Van der Water, Office of Economic and Workforce Development  
Mike Martin, Port of San Francisco

**Transmittal Materials**

**2013.0208V/PCA/MAP/DEV/CWP  
Mission Rock Development Project**

Attachments (one copy of the following):

Planning Commission Resolution No. 20019 (Planning Code Text and Map Amendments)  
Planning Commission Resolution No. 20020 (Development Agreement)

Planning Commission Executive Summary  
Planning Code Text and Map Amendment Draft Ordinance  
Errata to the Draft Planning Code Text and Map Amendments  
Development Agreement Draft Ordinance  
Planning Commission Motion No. 20018 (CEQA Findings)

*I:\Citywide\Coordination Inter-Agency\Port\SWL 337\BOS Transmittal\Mission Rock - BOS transmittal.doc*



# SAN FRANCISCO PLANNING DEPARTMENT

## Planning Commission Motion No. 20018

HEARING DATE: OCTOBER 5, 2017

1650 Mission St.  
Suite 400  
San Francisco,  
CA 94103-2479

Reception:  
415.558.6378

<i>Case No.:</i>	2013.0208 ENV	
<i>Project Name:</i>	Mission Rock (aka Seawall Lot 337 and Pier 48 Mixed-Use Project)	Fax: 415.558.6409
<i>Existing Zoning:</i>	Mission Bay Open Space (MB-OS); M-2 (Heavy Industrial) Zoning District; Mission Rock Height and Bulk Districts	Planning Information: 415.558.6377
<i>Block/Lot:</i>	8719/ 006; 9900/048	
<i>Proposed Zoning:</i>	Mission Rock Mixed-Use District / Mission Rock Special Use District; Mission Rock Height and Bulk District	
<i>Project Sponsor:</i>	Port of San Francisco and SWL 337 Associates, LLC.	
<i>Staff Contact:</i>	Mat Snyder – (415) 575-6891 <a href="mailto:mathew.snyder@sfgov.org">mathew.snyder@sfgov.org</a>	

**ADOPTING ENVIRONMENTAL FINDINGS PURSUANT TO THE CALIFORNIA ENVIRONMENTAL QUALITY ACT, INCLUDING FINDINGS OF FACT, FINDINGS REGARDING SIGNIFICANT IMPACTS AND SIGNIFICANT AND UNAVOIDABLE IMPACTS, EVALUATION OF MITIGATION MEASURES AND ALTERNATIVES, AND A STATEMENT OF OVERRIDING CONSIDERATIONS RELATED TO APPROVALS FOR THE MISSION ROCK (AKA SEAWALL LOT 337 AND PIER 48 MIXED-USE PROJECT) ("PROJECT"), LOCATED ON ASSESSOR'S BLOCK 8719 LOT 006 AND BLOCK 9900 LOTS 048.**

### PREAMBLE

The project sponsor, Seawall Lot 337 Associates, LLC, applied for environmental review of a mixed-use phased development at Seawall Lot 337, and rehabilitation and reuse of Pier 48 ("Project") on May 31, 2013.

The Project is located on an approximately 28-acre project site that consists of the following: the 14.2-acre Seawall Lot 337; the 0.3-acre strip of land on the south side of Seawall Lot 337, referred to as Parcel P20; the 6.0-acre Pier 48; the existing 2.2-acre China Basin Park; and 5.4 acres of streets and access areas within or adjacent to the boundaries of Seawall Lot 337 and Pier 48. The project site is adjacent to the Mission Bay neighborhood of the city and the Mission Bay South Redevelopment Area. The site is currently used for open space (China Basin Park); a surface parking lot (Seawall Lot 337 and P20); and indoor parking, storage, warehouse uses and special events (Pier 48).

The Project would include 2.7 to 2.8 million gross square feet ("gsf") of mixed-uses on 11 proposed development blocks on Seawall Lot 337, with building heights ranging from 90 feet to a maximum of 240 feet. The mixed use development would comprise approximately 1.1 to 1.6 million gsf of residential uses (estimated at 1,000 to 1,600 units, consisting of both market-rate and affordable housing), approximately 972,000 to 1.4 million gsf of commercial uses, and 241,000 to 244,800 gsf of active/retail uses on the lower floors of each block. Additionally, the Project would include approximately 1.1 million gsf of

aboveground and underground parking (approximately 3,100 parking spaces) and rehabilitation of 242,500 gsf of space within Pier 48 to provide industrial, restaurant, active/retail, tour, exhibition, and meeting space for reuse by an industrial use, specifically analyzed as a proposed brewery. The Project would also include a total of approximately 8.0 acres of open space. The Project is more particularly described in Attachment A.

Pursuant to and in accordance with the requirements of Section 21094 of CEQA and Sections 15063 and 15082 of the CEQA Guidelines, the San Francisco Planning Department, as lead agency, published and circulated a Notice of Preparation ("NOP") on December 11, 2013, that solicited comments regarding the scope of the environmental impact report ("EIR") for the proposed project. The NOP and its 30-day public review comment period were advertised in a newspaper of general circulation in San Francisco and mailed to governmental agencies, organizations and persons interested in the potential impacts of the proposed project. The Planning Department held a public scoping meeting on January 13, 2014, in the Bayside Room at the Port of San Francisco, Pier 1, The Embarcadero.

During the approximately 51-day public scoping period that ended on January 31, 2014, the Planning Department accepted comments from agencies and interested parties who identified environmental issues that should be addressed in the EIR. On the basis of public comments submitted in response to the NOP and at the public scoping meeting, the Planning Department found that potential areas of controversy and unresolved issues for the proposed project included: consistency of the Project with the Mission Bay Plan, the San Francisco Waterfront Plan, and the Mission Bay development guidelines; potential impacts along specific viewpoints, the waterfront and surrounding areas; the scale and height of the proposed project and the future use of Parcel P20; provision of affordable housing and population density; potential impacts on submerged cultural resources in the project area; increases in traffic and traffic congestion, connections to the City's transportation network, lack of public transportation in the area, pedestrian safety, traffic during game days, fair share contributions, and potential impacts of increased traffic on emergency vehicle delay; potential noise impacts from additional residents; potential greenhouse gas ("GHG") impacts, adequate mitigation measures for GHG impacts, and inclusion of a GHG emissions analysis consistent with Assembly Bill 32, the California Global Warming Solutions Act; potential shadow impacts along the waterfront, China Basin Park, and the proposed Mission Rock Square; potential impacts on loss of green space, and preservation of public lands for public and recreational use; adequacy of water and sewer systems with the addition of the proposed project, including a Water Supply Assessment; and potential impacts on the marine environment, as well as state- and federally listed species, and pile-driving impacts on fish, birds, and mammals. Comments received during the scoping process also were considered in preparation of the Draft EIR.

In June 2014, subsequent to the publication of the NOP, the City's voters approved Proposition B (Voter Approval for Waterfront Development Height Increases), which states that voter approval is required for any height increases on property, such as the project site, within the jurisdiction of the Port of San Francisco. Accordingly, on November 3, 2015, the City's voters approved Proposition D (the Mission Rock Affordable Housing, Parks, Jobs, and Historic Preservation Initiative), which amended the height and bulk restrictions for the project site by establishing the Mission Rock Height and Bulk District. Under Proposition D, the proposed heights for buildings on some of the proposed development blocks are lower than originally contemplated in the NOP, and there have been no increases in the height, density or intensity of development for the proposed Project since publication of the NOP.

To allow for flexibility to respond to future market demands and conditions, the project sponsor proposes flexible zoning and land uses on 3 of the 11 proposed development blocks on Seawall Lot 337. Specifically, Blocks H, I, and J are proposed to be designated to allow either residential or commercial as

the predominant use above the lower-floor active/retail uses. The project sponsor would determine the primary land uses of the three flexible zoning blocks above the lower floor (i.e., residential or commercial) at the time of filing for design approvals for block development proposals. These flexible blocks are analyzed in the EIR as ranges and land use assumptions (High Commercial or High Residential).

The San Francisco Planning Department then prepared the Draft EIR, which describes the Project and the environmental setting, analyzes potential impacts, identifies mitigation measures for impacts found to be significant or potentially significant, and evaluates project variants and alternatives to the Draft EIR Project. The Draft EIR assesses the potential construction and operational impacts of the Project on the environment, and the potential cumulative impacts associated with the Project in combination with other past, present, and future actions with potential for impacts on the same resources. The analysis of potential environmental impacts in the Draft EIR utilizes significance criteria that are based on the San Francisco Planning Department Environmental Planning Division guidance regarding the environmental effects to be considered significant. The Environmental Planning Division's guidance is, in turn, based on CEQA Guidelines Appendix G, with some modifications.

The Planning Department published a Draft EIR for the project on April 26, 2017, and circulated the Draft EIR to local, state, and federal agencies and to interested organizations and individuals for public review. On April 26, 2017, the Planning Department also distributed notices of availability of the Draft EIR; published notification of its availability in a newspaper of general circulation in San Francisco; posted the notice of availability at the San Francisco County Clerk's office; and posted notices at locations within the project area. The Planning Commission held a public hearing on June 1, 2017, to solicit testimony on the Draft EIR during the public review period. The Draft EIR public review period ended on June 12, 2017. A court reporter, present at the public hearing, transcribed the oral comments verbatim, and prepared written transcripts. The Planning Department also received written comments on the Draft EIR, which were sent through mail, fax, hand delivery, or email.

The San Francisco Planning Department then prepared the Comments and Responses ("C&R"). The C&R document was published on September 21, 2017, and includes copies of all of the comments received on the Draft EIR and written responses to each comment.

The C&R document provided additional, updated information, clarification and modifications on issues raised by commenters, as well as Planning Department staff-initiated text changes to the Draft EIR. The Final EIR, which includes the Draft EIR, the C&R document, the Appendices to the Draft EIR and C&R document, and all of the supporting information, has been reviewed and considered. The C&R documents and appendices and all supporting information do not add significant new information to the Draft EIR that would individually or collectively constitute significant new information within the meaning of Public Resources Code Section 21092.1 or CEQA Guidelines Section 15088.5 so as to require recirculation of the Final EIR (or any portion thereof) under CEQA. The C&R documents and appendices and all supporting information contain no information revealing (1) any new significant environmental impact that would result from the Project or from a new mitigation measure proposed to be implemented, (2) any substantial increase in the severity of a previously identified environmental impact, (3) any feasible project alternative or mitigation measure considerably different from others previously analyzed that would clearly lessen the environmental impacts of the Project, but that was rejected by the project sponsor, or (4) that the Draft EIR was so fundamentally and basically inadequate and conclusory in nature that meaningful public review and comment were precluded.

On October 5, 2017, the Planning Commission by Motion No. 20017, found that the Final EIR was adequate, accurate, and objective, reflected the independent judgment of the Planning Commission and that the C&R document contains no significant revisions to the Draft EIR, and adopted findings of significant impact associated with the Project and certified the completion of the Final EIR for the Project in compliance with CEQA, and the CEQA Guidelines and Chapter 31.

The Planning Department prepared proposed Findings, as required by CEQA, regarding the alternatives, mitigation measures and significant impacts analyzed in the Final EIR and overriding considerations for approving the Project and a proposed mitigation monitoring and reporting program ("MMRP"), attached as Exhibit 1 to Attachment A, which material was made available to the public and this Planning Commission for the Planning Commission's review, consideration and actions.

The Commission, in certifying the FEIR, found that the Project described in the FEIR will have the following significant and unavoidable environmental impacts:

- The proposed Project would result in an adverse impact by increasing ridership by more than 5 percent on two individual Muni routes that exceed 85 percent capacity utilization under baseline conditions.
- The proposed Project would result in an adverse impact related to a substantial increase in transit delays on Third Street between Channel Street and Mission Rock Street.
- The proposed Project would have significant impacts on pedestrian safety at the unsignalized intersections of Fourth Street/Mission Rock Street and Fourth Street/Long Bridge Street.
- The proposed Project would contribute considerably to a significant cumulative transit impact because it would increase ridership by more than 5 percent on one individual Muni route that would exceed 85 percent capacity utilization.
- The proposed Project would contribute considerably to significant cumulative impacts related to transit delays.
- The proposed Project would contribute considerably to significant cumulative pedestrian impacts.
- Construction of the proposed Project would generate noise levels in excess of standards or result in substantial temporary increases in noise levels.
- Operation of the proposed Project could result in the exposure of persons to or generation of noise levels in excess of the San Francisco Noise Ordinance or a substantial temporary, periodic or permanent increase in ambient noise levels in the Project vicinity, above levels existing without the Project.
- Construction of the proposed Project would expose persons to or generate excessive ground-borne vibration or ground-borne noise levels related to annoyance. Construction of the proposed Project could expose persons to or generate excessive ground-borne vibration or ground-borne noise levels related to damage to buildings.



- Construction activities for the proposed Project, in combination with other past, present, and reasonable future projects in the city, would result in a substantial temporary increase in noise or noise levels in excess of the applicable local standards.
- Construction activities associated with Project-related development, in combination with other past, present, and reasonable future projects in the city, would expose sensitive receptors to excessive ground-borne vibration related to annoyance and could result in similar impacts related to damage to buildings. (Significant and Unavoidable for Annoyance).
- Operation of the proposed Project, in combination with other past, present, and reasonable future projects in the city, would result in the exposure of persons to noise in excess of the applicable local standards or a substantial permanent ambient noise level increase in the Project vicinity.
- Construction of the proposed Project would generate fugitive dust and criteria air pollutants, which for criteria air pollutants but not fugitive dust, would violate an air quality standard, contribute substantially to an existing or projected air quality violation, or result in a cumulatively considerable net increase in criteria air pollutants. (Significant and Unavoidable with Mitigation for Criteria Air Pollutants).
- During Project operations, the proposed Project would result in emissions of criteria air pollutants at levels that would violate an air quality standard, contribute to an existing or projected air quality violation, or result in a cumulatively considerable net increase in criteria air pollutants.
- During combined Project construction and operations, the proposed Project would result in emissions of criteria air pollutants at levels that would violate an air quality standard, contribute to an existing or projected air quality violation, or result in a cumulatively considerable net increase in criteria air pollutants.
- The proposed Project's construction and operation, in combination with other past, present, and reasonable future projects, would contribute to cumulative regional air quality impacts.
- The proposed Project would alter wind in a manner that would substantially affect public areas.
- The proposed Project, in combination with past, present, and reasonably foreseeable future projects, would alter wind in a manner that would substantially affect public areas.

The Planning Commission Secretary is the custodian of records for the Planning Department materials, located in the File for Case No. 2013.0208ENV, at 1650 Mission Street, Fourth Floor, San Francisco, California.

On October 5, 2017, the Planning Commission conducted a duly noticed public hearing at a regularly scheduled meeting and adopted this Motion No. 20018, adopting CEQA findings, including a Statement of Overriding Considerations, and adopting an MMRP, and adopted other Motions and Resolutions with respect to the Project.

On October 5, 2017, the Planning Commission conducted a duly noticed public hearing at a regularly scheduled meeting on the various approvals necessary to implement the Project, including, but not limited to, Planning Code Text and Zoning Map Amendments, approval of the Mission Rock Design

Motion No. 20018  
October 5, 2017

CASE NO. 2013.0208ENV  
Mission Rock Mixed-Use Project

Controls document, approval of a Development Agreement and made findings of General Plan consistency. (See Planning Commission Resolution and Motions numbers 20019, 20020, and 20021. The Planning Commission makes these findings and adopts the MMRP as part of each and all of these approval actions.

**MOVED**, that the Planning Commission has reviewed and considered the Final EIR and the record associated therewith, including the comments and submissions made to this Planning Commission and the Planning Department's responses to those comments and submissions, and based thereon, hereby adopts the Project Findings required by CEQA attached hereto as Attachment A including a statement of overriding considerations, and adopts the MMRP, included as Exhibit 1 to Attachment A, as a condition of approval for each and all of the approval actions set forth in the Resolutions and Motions described above.

I hereby certify that the Planning Commission **ADOPTED** the foregoing Motion on Thursday, October 5, 2017.



Jonas P. Ionin

Commission Secretary

AYES: Hillis, Richards, Fong, Johnson, Koppel, Melgar, Moore

NAYS: None

ABSENT: None

ADOPTED: October 5, 2017



# SAN FRANCISCO PLANNING DEPARTMENT

## Planning Commission Resolution No. 20019

HEARING DATE: OCTOBER 5, 2017

*Case No.:* 2013.0208 ENV/PCA/MAP/DVA  
*Project Name:* **Mission Rock (aka Seawall Lot 337 / Pier 48)**  
*Existing Zoning:* Mission Bay Open Space (MB-OS); M-2 (Heavy Industrial) Zoning District; Mission Rock Height and Bulk District  
*Block/Lot:* 8719/ 006; 9900/048  
*Proposed Zoning:* Mission Mixed-Use Zoning District / Mission Rock Special Use District; Mission Rock Height and Bulk District  
*Project Sponsor:* Port of San Francisco and SWL 337 Associates, LLC  
*Staff Contact:* Mat Snyder – (415) 575-6891  
[mathew.snyder@sfgov.org](mailto:mathew.snyder@sfgov.org)

1650 Mission St.  
Suite 400  
San Francisco,  
CA 94103-2479

Reception:  
415.558.6378

Fax:  
415.558.6409

Planning  
Information:  
415.558.6377

RESOLUTION RECOMMENDING THAT THE BOARD OF SUPERVISORS APPROVE AMENDMENTS TO THE PLANNING CODE TO ESTABLISH THE MISSION ROCK MIXED-USE DISTRICT, THE MISSION ROCK SPECIAL USE DISTRICT, ALONG WITH OTHER RELATED MINOR CHANGES TO ARTICLE 2 AND ARTICLE 9 OF THE PLANNING CODE; AND BY AMENDING ZONING MAP ZN 08 BY DESIGNATING ASSESSOR'S BLOCK AND LOT: 8719/ 006 AND 9900/-48 AS PART OF THE MISSION ROCK MIXED-USE DISTRICT AND BY AMENDING SPECIAL USE DISTRICT MAP SD 08 BY DESIGNATING ASSESSOR'S BLOCK AND LOTS: 8719/ 006 AND 9900/048 AS PART OF THE MISSION ROCK SPECIAL USE DISTRICT; ADOPT FINDINGS OF CONSISTENCY WITH THE GENERAL PLAN AND PLANNING CODE SECTION 101.1 AND FINDINGS UNDER PLANNING CODE SECTION 302, AND INCORPORATING FINDINGS UNDER THE CALIFORNIA ENVIRONMENTAL QUALITY ACT.

WHEREAS, on September 5, 2017, Mayor Edwin Lee and Supervisor Jane Kim introduced an ordinance (Board File 170940) for Planning Code Text Amendments to establish the Mission Rock Mixed-Use District and the Mission Rock Special Use District (herein "SUD"), and for Planning Code Map Amendments by amending Zoning Map ZN08 by designating Assessor's Block and Lot: 8719/006 as part of the Mission Rock Mixed-Use District and by amending Special Use District Map SD08 by designating assessor's block and lots: 8719/ 006 and 9900/048 to the Mission Rock SUD.

WHEREAS, pursuant to Planning Code Section 302(b), on September 5, 2017, the San Francisco Board of Supervisors initiated these Planning Code Text and Map Amendments.

WHEREAS, these Planning Code Text and Map Amendments would enable the Project. The Project includes new market-rate and affordable residential uses, commercial uses, retail, light industrial uses, parking, shoreline improvements, infrastructure development and street improvements, and public open space. Depending on the uses proposed, the Project would include approximately 1.1 to 1.6 million gross square feet (gsf) of residential uses (estimated as between 1,000 to 1,600 residential units) (of which 40% will be below market rate), approximately 972,000 to 1.4 million gsf of commercial-office uses, and a maximum of approximately 245,000 gsf of retail uses. The Project also includes construction of transportation and circulation improvements, new and upgraded utilities and infrastructure, geotechnical

and shoreline improvements, up to 3,000 off-street parking spaces in one or two new garages and 100 spaces elsewhere throughout the site. The Project is more comprehensively described in the Seawall Lot 337 and Pier 48 Mixed-Use Project Draft EIR.

WHEREAS, the Project would construct new buildings that would range in height from 90 to 240 feet, as is consistent with Proposition D which was passed by the voters of San Francisco in November 2015.

WHEREAS, these Planning Code Text Amendments would establish the Mission Rock Mixed Use District and Mission Rock SUD, which would outline the land use controls for the Project site.

WHEREAS, these Planning Code Map Amendments would designate the newly created Mission Rock Mixed-Use District and the Mission Rock Special Use District to the Project Site; the newly created SUD outline the land use controls for the Project site.

WHEREAS, this Resolution approving these Planning Code Text and Map Amendments is a companion to other legislative approvals relating to the Project, including approval of the Mission Rock Design Controls document, and recommendation for approval of the Development Agreement.

WHEREAS, as part of the implementation of the Project, the Office of Community Investment and Infrastructure (OCII) will consider removing certain property identified as Mission Bay Parcel P20 (a 0.3-acre, approximately 20-foot-wide strip of land adjacent to the south side of Seawall Lot 337, along the north side of Mission Rock Street) from the Mission Bay South Redevelopment Plan, and such removal would be part of the Project implementation as described in the Development Agreement. Parcel P20 is currently subject to the Mission Bay South Redevelopment Plan and is designated in that plan as a small open-space buffer. When it adopted AB 2797, the state legislature recognized the need to remove P20 from the Redevelopment Plan, on the basis that "the revitalization of Seawall Lot 337 . . . is of particular importance to the state." As such, AB 2797 calls for the amendment of the Redevelopment Plan to remove P20 without State-level review under Health & Safety Code Sections 34163(c)-(f) and 34164(a) and (b).

WHEREAS, on October 5, 2017, the Planning Commission reviewed and considered the Final EIR for the Mission Rock Project ("FEIR") and found the FEIR to be adequate, accurate and objective, thus reflecting the independent analysis and judgment of the Department and the Commission, and that the summary of comments and responses contained no significant revisions to the Draft EIR, and certified the FEIR for the Project in compliance with the California Environmental Quality Act ("CEQA"), the CEQA Guidelines and Chapter 31 by Motion No. 20017.

WHEREAS, on October 5, the Commission by Motion No. 20018 approved CEQA Findings, including adoption of a Mitigation Monitoring and Reporting Program (MMRP), under Case No. 2013.0208ENV, for approval of the Project, which findings and MMRP are incorporated by reference as though fully set forth herein.

WHEREAS, on October 5, 2017, the Commission conducted a duly noticed public hearing at a regularly scheduled meeting on the proposed Planning Code Text and Map Amendments and has considered the information included in the File for these Amendments, the staff reports and presentations, public testimony and written comments, as well as the information provided about the Project from other City departments.

WHEREAS, a draft ordinance, substantially in the form attached hereto as Exhibit A, approved as to form, including those minor changes to Exhibit A as provided by staff on September 28, 2017, would

establish the Mission Rock Mixed Use District, Mission Rock SUD, and make other related Planning Code Text and Map amendments.

**NOW THEREFORE BE IT RESOLVED**, that the Planning Commission hereby finds that the Planning Code Text Amendments and Zoning Map Amendments promote the public welfare, convenience and necessity for the following reasons:

1. The Amendments would help implement the Mission Rock Mixed-Use Project development, thereby evolving currently under-utilized surface parking lot for needed housing, commercial space, and parks and open space.
2. The Amendments would help implement the Mission Rock Mixed-Use Project, which in turn will provide employment opportunities for local residents during construction and post-occupancy, as well as community facilities and parks for new and existing residents.
3. The Amendments would help implement the Mission Rock Mixed-Use Project by enabling the creation of a mixed-use and sustainable neighborhood, with fully rebuilt infrastructure. The new neighborhood would improve the site's multi-modal connectivity to and integration with the surrounding City fabric, and connect existing neighborhoods to the City's waterfront.
4. The Amendments would enable the construction of a new vibrant, safe, and connected neighborhood, including new parks and open spaces. The Amendments would help ensure a vibrant neighborhood with active streets and open spaces, high quality and well-designed buildings, and thoughtful relationships between buildings and the public realm, including the waterfront.
5. The Amendments would enable construction of new housing, including new on-site affordable housing, and new retail and manufacturing uses. These new uses would create a new mixed-use neighborhood that would strengthen and complement nearby neighborhoods.
6. The Amendments would facilitate the preservation and rehabilitation of Pier 48 - an important historic resource listed in the National Register of Historic Places.

**AND BE IT FURTHER RESOLVED**, that the Planning Commission finds the Planning Code Text and Map Amendments are in general conformity with the General Plan and Planning Code Section 101.1 as set forth below.

**AND BE IT FURTHER RESOLVED**, that the Planning Commission finds the Project and its approvals associated therein, including the amendment to the Mission Bay South Redevelopment Plan to remove Parcel P20 from that Plan, all as more particularly described in Exhibits B and C to the Development Agreement on file with the Planning Department in Case No. 2013.0208DVA, are on balance consistent with the Objectives and Policies of the General Plan, as described herein as follows:

**HOUSING ELEMENT**

***OBJECTIVE 1***

***IDENTIFY AND MAKE AVAILABLE FOR DEVELOPMENT ADEQUATE SITES TO MEET THE CITY'S HOUSING NEEDS, ESPECIALLY PERMANENTLY AFFORDABLE HOUSING.***

**POLICY 1.1**

*Plan for the full range of housing needs in the City and County of San Francisco, especially affordable housing.*

**POLICY 1.8**

*Promote mixed use development, and include housing, particularly permanently affordable housing, in new commercial, institutional or other single use development projects.*

**POLICY 1.10**

*Support new housing projects, especially affordable housing, where households can easily rely on public transportation, walking and bicycling for the majority of daily trips.*

The Project is a mixed-use development with approximately 1.1 to 1.6 million gsf of residential uses (estimated at between 1,100 and 1,600 dwelling units) at full project build-out, which will provide a wide range of housing options. As detailed in the Development Agreement, the Project substantially exceeds the inclusionary affordable housing requirements of the Planning Code, through a partnership between the developer and the City to reach a 40% affordable level.

**OBJECTIVE 11**

**SUPPORT AND RESPECT THE DIVERSE AND DISTINCT CHARACTER OF SAN FRANCISCO'S NEIGHBORHOODS.**

**POLICY 11.1**

*Promote the construction and rehabilitation of well-designed housing that emphasizes beauty, flexibility, and innovative design, and respects existing neighborhood character.*

**POLICY 11.2**

*Ensure implementation of accepted design standards in project approvals.*

**POLICY 11.7**

*Respect San Francisco's historic fabric, by preserving landmark buildings and ensuring consistency with historic districts.*

The Project, as described in the Development Agreement and controlled in the Design Controls (DC), includes a program of substantial community benefits and detailed plans designed to create a vibrant new mixed-use amenity-rich neighborhood at the location of an existing surface parking lot. The new neighborhood will feature small blocks and well-articulated buildings with a human scale modeled off of features characteristic of San Francisco neighborhoods. Through the standards and guidelines in the DC and through the Development Agreement (DA), the Project Sponsor has committed to the rehabilitation of Pier 48 pursuant to the Secretary of Interior Standards.

**OBJECTIVE 12**

**BALANCE HOUSING GROWTH WITH ADEQUATE INFRASTRUCTURE THAT SERVES THE CITY'S GROWING POPULATION.**

**POLICY 12.1**

*Encourage new housing that relies on transit use and environmentally sustainable patterns of movement.*

**POLICY 12.2**

*Consider the proximity of quality of life elements, such as open space, child care, and neighborhood services, when developing new housing units.*

The Project appropriately balances housing with new and improved infrastructure and related public benefits.

The project site is located proximate to both major regional and local public transit, including Muni Metro and Caltrain. The Project includes incentives for the use of transit, walking and bicycling through its TDM program. In addition, the Project's streetscape design would enhance vehicular, bicycle and pedestrian access and connectivity through the site. Therefore, new residential and commercial buildings constructed as part of the Project would rely on transit use and environmentally sustainable patterns of movement.

The Project will provide over eight acres of new open space for a variety of activities, including an expanded China Basin Park, a central town square-like space, a waterfront wharf, and other small plazas and pedestrian connections throughout.

The Project includes substantial contributions related to quality of life elements such as open space, affordable housing, transportation improvements, childcare, public art, workforce development, youth development, and historic preservation.

**COMMERCE AND INDUSTRY ELEMENT**

**OBJECTIVE 1**

**MANAGE ECONOMIC GROWTH AND CHANGE TO ENSURE ENHANCEMENT OF THE TOTAL CITY LIVING AND WORKING ENVIRONMENT.**

**POLICY 1.1**

*Encourage development which provides substantial net benefits and minimizes undesirable consequences. Discourage development which has substantial undesirable consequences that cannot be mitigated.*

The Project is intended to provide a distinct mixed-use development with residential, office, retail, cultural, and open space uses. The Project would leverage the Project site's location on the waterfront and close proximity to major regional and local public transit by building a dense mixed-use development that allows people to work and live close to transit. The Project would incorporate varying heights, massing and scale, maintaining a strong human-scaled streetwall along streets, and focused attention around public open spaces. The Project would create a balanced commercial center with a continuum of floorplate sizes for a range of users, substantial new on-site open space, and sufficient density to support and activate the new active ground floor uses and open space in the Project.

The Project would help meet the job creation goals established in the City's Economic Development Strategy by generating new employment opportunities and stimulating job creation across all sectors. The Project would also construct high-quality housing with sufficient density to contribute to 24-hour activity on the Project site, while offering a mix of unit types, sizes, and levels of affordability to accommodate a range of potential residents. The Project would facilitate a vibrant, interactive ground plane for Project and neighborhood residents, commercial users, and the public, with public spaces that could accommodate a variety of events and programs, and adjacent ground floor building spaces that include elements such as transparent building frontages and large, direct access points to maximize circulation between, and cross-activation of, interior and exterior spaces.

**OBJECTIVE 2**

*MAINTAIN AND ENHANCE A SOUND AND DIVERSE ECONOMIC BASE AND FISCAL STRUCTURE FOR THE CITY.*

**POLICY 2.1**

*Seek to retain existing commercial and industrial activity and to attract new such activity to the city.*

See above (Commerce and Industry Element Objective 1 and Policy 1.1) which explain the Project's contribution to the City's overall economic vitality.

**OBJECTIVE 3**

*PROVIDE EXPANDED EMPLOYMENT OPPORTUNITIES FOR CITY RESIDENTS, PARTICULARLY THE UNEMPLOYED AND ECONOMICALLY DISADVANTAGED.*

**POLICY 3.2**

*Promote measures designed to increase the number of San Francisco jobs held by San Francisco residents.*

The Project would help meet the job creation goals established in the City's Economic Development Strategy by generating new employment opportunities and stimulating job creation across all sectors. The Project will provide expanded employment opportunities for City residents at all employment levels, both during and after construction. The Development Agreement, as part of the extensive community benefit programs, includes a Workforce Development Plan, including a local hire participation level of 30% per trade. Vertical developers will contribute \$1,000,000 to OEWD in 11 parcel-by-parcel installments. Half of the funds will support community-based organizations that provide barrier removal services and job readiness training for individuals within at-risk populations, and half will support city programs that provide job training for local residents.

**OBJECTIVE 6**

*MAINTAIN AND STRENGTHEN VIABLE NEIGHBORHOOD COMMERCIAL AREAS EASILY ACCESSIBLE TO CITY RESIDENTS.*

**POLICY 6.1** *Ensure and encourage the retention and provision of neighborhood-serving goods and services in the city's neighborhood commercial districts, while recognizing and encouraging diversity among the districts.*



**POLICY 6.2**

*Promote economically vital neighborhood commercial districts which foster small business enterprises and entrepreneurship and which are responsive to economic and technological innovation in the marketplace and society*

**POLICY 6.4**

*Encourage the location of neighborhood shopping areas throughout the city so that essential retail goods and personal services are accessible to all residents.*

**POLICY 6.5**

*Discourage the creation of major new commercial areas except in conjunction with new supportive residential development and transportation capacity.*

**POLICY 6.7**

*Promote high quality urban design on commercial streets.*

The Project meets and furthers the Objectives and Policies of the Commerce and Industry Element by reinforcing the typical San Francisco pattern of including resident serving uses along with mixed-use development. The Amendments will generally permit small-scale retail and community-related uses throughout the site by requiring it at key locations along China Basin Park and along the pedestrian-oriented "Shared Public-Way." The Project calls for neighborhood commercial and other retail be established in a pedestrian-oriented active environment typical of San Francisco neighborhoods and specifically called for in the Commerce and Industry Element. The provision of retail space will provide entrepreneurial opportunities for local residents and workers. As noted above, streets will be designed to Better Streets standards with the particular goal of assuring an active and engaging environment for pedestrians.

**TRANSPORTATION ELEMENT**

**OBJECTIVE 2**

**USE THE TRANSPORTATION SYSTEM AS A MEANS FOR GUIDING DEVELOPMENT AND IMPROVING THE ENVIRONMENT.**

**POLICY 2.1**

*Use rapid transit and other transportation improvements in the city and region as the catalyst for desirable development, and coordinate new facilities with public and private development.*

**POLICY 2.5**

*Provide incentives for the use of transit, carpools, vanpools, walking and bicycling and reduce the need for new or expanded automobile and automobile parking facilities.*

The Project is located along Third Street and the Muni T-Line, whose service will substantially expand in the near future with the opening of the Central Subway. The Project is also in close proximity to the San Francisco Caltrain station along with other major bus lines. The Project includes a detailed TDM program, including various performance measures, physical improvements and monitoring and enforcement measures designed to create incentives for

transit and other alternative to the single occupancy vehicle for both residential and commercial buildings. In addition, the Project's design, including its streetscape elements, is intended to promote and enhance walking and bicycling.

**OBJECTIVE 23**

*IMPROVE THE CITY'S PEDESTRIAN CIRCULATION SYSTEM TO PROVIDE FOR EFFICIENT, PLEASANT, AND SAFE MOVEMENT.*

**POLICY 23.1**

*Provide sufficient pedestrian movement space with a minimum of pedestrian congestion in accordance with a pedestrian street classification system.*

**POLICY 23.2**

*Widen sidewalks where intensive commercial, recreational, or institutional activity is present, sidewalks are congested, where sidewalks are less than adequately wide to provide appropriate pedestrian amenities, or where residential densities are high.*

**POLICY 23.6**

*Ensure convenient and safe pedestrian crossings by minimizing the distance pedestrians must walk to cross a street.*

The Project will establish a new tight-knit street network on the project site, and will provide pedestrian improvements and streetscape enhancement measures as described in the DC and reflected in the mitigation measures, the Transportation Plan, and in the Development Agreement. The Project would establish two new north-south rights-of-way and three new east-west rights-of-way through the site, increasing the sites connectivity and access. All streets will be constructed to Better Street standards; the transportation network will include robust bike facilities and will improve and complete a missing link in the Bay Trail and Blue Greenway.

**URBAN DESIGN ELEMENT**

**OBJECTIVE 1**

*EMPHASIS OF THE CHARACTERISTIC PATTERN WHICH GIVES TO THE CITY AND ITS NEIGHBORHOODS AN IMAGE, A SENSE OF PURPOSE, AND A MEANS OF ORIENTATION.*

**POLICY 1.1**

*Recognize and protect major views in the city, with particular attention to those of open space and water.*

As explained in the DC, the Project is very carefully designed with particular emphasis on assuring a vibrant and engaging pedestrian realm. Buildings are to be scaled and shaped specific to their immediate context by assuring streetwalls are well proportioned relative to adjacent streets and open spaces. The Project's proposed tallest buildings will be sited at key locations to mark important gateway locations assuring that the buildings taken together create a dynamic skyline. The overall heights of the project are harmonious with and complementary to the overall city skyline when viewed from various distances.

**POLICY 1.2**

*Recognize, protect and reinforce the existing street pattern, especially as it is related to topography.*

**POLICY 1.3**

*Recognize that buildings, when seen together, produce a total effect that characterizes the city and its districts.*

**POLICY 1.5**

*Emphasize the special nature of each district through distinctive landscaping and other features.*

**POLICY 1.6**

*Make centers of activity more prominent through design of street features and by other means.*

**POLICY 1.7**

*Recognize the natural boundaries of districts, and promote connections between districts.*

**POLICY 2.9**

*Review proposals for the giving up of street areas in terms of all the public values that streets afford.*

**POLICY 2.10**

*Permit release of street areas, where such release is warranted, only in the least extensive and least permanent manner appropriate to each case.*

The Project will create a new fine-knit street network on the project site where it does not currently exist, increasing public access and circulation through the site. Buildings will be constructed between a maximum height range of 90 and 240 feet, with buildings stepping down to bases of 40 to 65 feet along streets. Building heights and urban design requirements in the DC assure that Pier 48, the site's existing historic Pier, will be respected and retain its predominance along the bayfront. The Project is envisioned as an extension and improvement to the Mission Bay neighborhood

**OBJECTIVE 2**

**CONSERVATION OF RESOURCES WHICH PROVIDE A SENSE OF NATURE, CONTINUITY WITH THE PAST, AND FREEDOM FROM OVERCROWDING.**

**POLICY 2.4**

*Preserve notable landmarks and areas of historic, architectural or aesthetic value, and promote the preservation of other buildings and features that provide continuity with past development.*

**POLICY 2.5**

*Use care in remodeling of older buildings, in order to enhance rather than weaken the original character of such buildings.*

Pier 48 will be rehabilitated to Secretary of Interior's Standards.

**OBJECTIVE 3**

*MODERATION OF MAJOR NEW DEVELOPMENT TO COMPLEMENT THE CITY PATTERN, THE RESOURCES TO BE CONSERVED, AND THE NEIGHBORHOOD ENVIRONMENT.*

**POLICY 3.3**

*Promote efforts to achieve high quality of design for buildings to be constructed at prominent locations.*

**POLICY 3.4**

*Promote building forms that will respect and improve the integrity of open spaces and other public areas.*

**POLICY 3.5**

*Relate the height of buildings to important attributes of the city pattern and to the height and character of existing development.*

**POLICY 3.7**

*Recognize the special urban design problems posed in development of large properties.*

**POLICY 3.8**

*Discourage accumulation and development of large properties, unless such development is carefully designed with respect to its impact upon the surrounding area and upon the city.*

While large in scope, the Project will be constructed in such a way to be an integral part of the San Francisco urban fabric. Blocks are being established at smaller-than-typical sizes to assure buildings are well-scaled, and that the site is permeable and accessible to all. Buildings will be shaped to assure that their fronting streetwalls are well proportioned relative to their adjacent streets and open spaces. The tallest of the site's buildings will be placed at key gateway and central locations and well-spaced to assure they work well together in adding to the City's skyline.

**RECREATION AND OPEN SPACE ELEMENT**

**OBJECTIVE 1**

*ENSURE A WELL-MAINTAINED, HIGHLY UTILIZED, AND INTEGRATED OPEN SPACE SYSTEM.*

**POLICY 1.1**

*Encourage the dynamic and flexible use of existing open spaces and promote a variety of recreation and open space uses, where appropriate.*

**POLICY 1.7**

*Support public art as an essential component of open space design.*

The Project would build a network of waterfront parks, playgrounds and recreational facilities on the 28-Acre Site that will greatly enhance access to and along the Bay. China Basin Park will be significantly expanded to provide a multi-use Bayfront park that provides both active and

contemplative space, while providing a space for planned community events. A central town square-like space will enable the proposed high-retail corridor to spill into open space creating an active and engaging central civic space. The Project will provide approximately eight acres of new and expanded open space for a variety of activities, including a great lawn, a small ballfield, kayak boat launches, wharf, along with small pedestrian plazas throughout. In addition, the Project would provide new private and/or common open space for the new dwelling units.

**POLICY 1.12**

*Preserve historic and culturally significant landscapes, sites, structures, buildings and objects.*

See Discussion in Urban Element Objective 2, Policy 2.4 and 2.5.

**OBJECTIVE 3**

**IMPROVE ACCESS AND CONNECTIVITY TO OPEN SPACE.**

**POLICY 3.1**

*Creatively develop existing publicly-owned right-of-ways and streets into open space.*

The Project provides approximately eight acres of new and expanded public open space and opens up new connections to the shoreline in the Mission Bay neighborhood. The Project would encourage non-automobile transportation to and from open spaces, and would ensure physical accessibility within these open spaces. The Project features robust bike facilities to both assure continuity of the Bay Trail and Blue Greenway, and improve bike access for its residents, workers, and visitors.

**ENVIRONMENTAL PROTECTION ELEMENT**

**OBJECTIVE 1**

**ACHIEVE A PROPER BALANCE AMONG THE CONSERVATION, UTILIZATION, AND DEVELOPMENT OF SAN FRANCISCO'S NATURAL RESOURCES.**

**Policy 1.4**

*Assure that all new development meets strict environmental quality standards and recognizes human needs.*

**OBJECTIVE 15**

**INCREASE THE ENERGY EFFICIENCY OF TRANSPORTATION AND ENCOURAGE LAND USE PATTERNS AND METHODS OF TRANSPORTATION WHICH USE LESS ENERGY.**

**POLICY 15.3**

*Encourage an urban design pattern that will minimize travel requirements among working, shopping, recreation, school and childcare areas.*

The Project is consistent with and implements the Environmental Protection Element in that it calls for mixed-use, high density, transit-friendly, sustainable development.

The Project's approvals include a Sustainability Plan, that among other things, set goals for the Project Sponsor that include sea level resilience through the year 2100, 100% operational energy from renewable sources, 100% non-potable water met with non-potable sources, and 20% single occupancy vehicle trip reduction.

**PUBLIC SAFETY ELEMENT**

**OBJECTIVE 2 REDUCE STRUCTURAL AND NON-STRUCTURAL HAZARDS TO LIFE SAFETY, MINIMIZE PROPERTY DAMAGE AND RESULTING SOCIAL, CULTURAL AND ECONOMIC DISLOCATIONS RESULTING FROM FUTURE DISASTERS.**

*POLICY 2.1 Assure that new construction meets current structural and life safety standards.*

*POLICY 2.3 Consider site soils conditions when reviewing projects in areas subject to liquefaction or slope instability.*

*POLICY 2.9 Consider information about geologic hazards whenever City decisions that will influence land use, building density, building configurations or infrastructure are made.*

*POLICY 2.12 Enforce state and local codes that regulate the use, storage and transportation of hazardous materials in order to prevent, contain and effectively respond to accidental releases.*

The Project is consistent with and implements the Community Safety Element. All improvements, including infrastructure, buildings and open space improvements will be constructed to local seismic standards, taking into account, among other considerations, the geological condition of the soil.

**AIR QUALITY ELEMENT**

**OBJECTIVE 3 DECREASE THE AIR QUALITY IMPACTS OF DEVELOPMENT BY COORDINATION OF LAND USE AND TRANSPORTATION DECISIONS.**

*POLICY 3.1 Take advantage of the high density development in San Francisco to improve the transit infrastructure and also encourage high density and compact development where an extensive transportation infrastructure exists.*

*POLICY 3.2 Encourage mixed land use development near transit lines and provide retail and other types of service oriented uses within walking distance to minimize automobile dependent development.*

*POLICY 3.6 Link land use decision making policies to the availability of transit and consider the impacts of these policies on the local and regional transportation system.*

*POLICY 3.9 Encourage and require planting of trees in conjunction with new development to enhance pedestrian environment and select species of trees that optimize achievement of air quality goals*

**OBJECTIVE 6 LINK THE POSITIVE EFFECTS OF ENERGY CONSERVATION AND WASTE MANAGEMENT TO EMISSION REDUCTIONS.**

**POLICY 6.2** *Encourage recycling to reduce emissions from manufacturing of new materials in San Francisco and the region.*

The Project is consistent with and implements the Air Quality Element in that it calls for mixed-use, high density, sustainable development that will enable efficient use of land and encourage travel by transit, bicycle and by foot, thereby reducing auto use. The Sustainability Plan and TDM Plan governing development of the Project mandate a 20% single occupancy vehicle trip reduction.

**AND BE IT FURTHER RESOLVED**, that the Planning Commission finds the Project and its approvals associated therein, all as more particularly described in Exhibits B and C to the Development Agreement on file with the Planning Department in Case No. 2013.0208DVA, are in general conformity with the Planning Code Section 101.1 priority policies, as follows:

1. That existing neighborhood serving retail uses be preserved and enhanced and future opportunities for resident employment in or ownership of such businesses enhanced.

*The Project will preserve and enhance existing neighborhood serving retail uses. The Project includes adding roughly 245,000 square feet of new retail uses, that will be focused along a central pedestrian "Shared Public Way" and fronting the site's major parks. The project does not include the removal of any existing neighborhood serving retail.*

2. That existing housing and neighborhood character be conserved and protected in order to preserve the cultural and economic diversity of our neighborhoods.

*The Project accommodates new development on land currently a surface parking lot. It would not accommodate removing or changing the character of existing residential neighborhoods. The Project includes a robust affordable housing program setting aside 40-percent of the on-site housing for below-market-rate units. The Project lays out requirements to assure the new development has characteristics of mixed-use neighborhoods throughout San Francisco, including but not limited to a fine-grained system of streets, well-modulated buildings with active frontages, and the ability to establish diverse retail and community uses where nothing exists today.*

3. That the City's supply of affordable housing be preserved and enhanced.

*The Project calls for development that would have a positive effect on the City's affordable housing stock. The Project would accommodate up to 1.6 million gsf of new residential units (estimated at 1,600 new units), of which 40-percent will be designated as Below-Market Rate. There is no housing on the site today; the Project would not accommodate the removal of any existing dwelling units.*

4. That commuter traffic not impede MUNI transit service or overburden our streets or neighborhood parking.

*The Project anticipates substantial new transit service improvements along Third Street with the opening of the Central Subway in 2019, as well as substantial improvement to nearby Caltrain service through the ongoing electrification project. Streets have been designed to emphasize travel by bicycle or by foot. On-street parking is generally not proposed thereby allowing more street space to be designated for bicyclists, pedestrians, and those arriving by transit, or taxi/TNCs, as well as for deliveries. While a large centralized parking facility (up to 3,000 spaces in one or two centralized garages) is proposed, the total number of spaces site-wide would not represent a substantial net gain of spaces for the site overall from existing conditions. At present, approximately 2,900 parking spaces are on the site between Lot A and Pier 48. Only 100 parking spaces are allowed elsewhere on the site in addition to the centralized garages.*

5. That a diverse economic base be maintained by protecting our industrial and service sectors from displacement due to commercial office development, and that future opportunities for resident employment and ownership in these sectors be enhanced.

*The Project would not adversely affect the industrial sector or service sectors. No such uses would be displaced by the Project. The Project includes the rehabilitation of Pier 48, which will provide about 250,000 gsf of new or improved space for production uses. Additional small production spaces would also be required along Terry Francois Boulevard, providing industrial space where none exists today.*

6. That the City achieves the greatest possible preparedness to protect against injury and loss of life in an earthquake.

*All new construction would be subject to the City's Building Code, Fire Code and other applicable safety standards. Thus, the Project would improve preparedness against injury and loss of life in an earthquake by prompting development that would comply with applicable safety standards.*

7. That landmarks and historic buildings be preserved.

*Pier 48 would be rehabilitated pursuant to the Secretary of Interior's Standards.*

8. That our parks and open space and their access to sunlight and vistas be protected from development.

*The Project would not significantly adversely affect existing open spaces or their access to sunlight and vistas. The Project includes a robust parks and open space program including the substantial expansion of China Basin Park and the establishment of two new additional parks and*



*other pedestrian plazas throughout. The Project includes a fine-grained network of new streets thereby assuring the site permeability and access through it.*

I hereby certify that the Planning Commission ADOPTED the foregoing Motion on Thursday, October 5, 2017.



Jonas P. Ionin

Commission Secretary

AYES: Hillis, Richards, Fong, Johnson, Koppel, Melgar, Moore

NAYS: None

ABSENT: None

ADOPTED: October 5, 2017



# SAN FRANCISCO PLANNING DEPARTMENT

## Planning Commission Resolution No. 20020

HEARING DATE: OCTOBER 5, 2017

1650 Mission St.  
Suite 400  
San Francisco,  
CA 94103-2479

Reception:  
415.558.6378

Fax:  
415.558.6409

Planning  
Information:  
415.558.6377

*Case No.:* 2013.0208 ENV/PCA/MAP/DVA  
*Project Name:* Mission Rock (aka Seawall Lot 337 / Pier 48)  
*Existing Zoning:* Mission Bay Open Space (MB-OS); M-2 (Heavy Industrial) Zoning District;  
 Mission Rock Height and Bulk District  
*Block/Lot:* 8719/006; 9900/048  
*Proposed Zoning:* Mission Mixed-Use Zoning District / Mission Rock Special Use District;  
 Mission Rock Height and Bulk District  
*Project Sponsor:* Port of San Francisco and San Francisco Giants  
*Staff Contact:* Mat Snyder – (415) 575-6891  
[mathew.snyder@sfgov.org](mailto:mathew.snyder@sfgov.org)

RESOLUTION RECOMMENDING THAT THE BOARD OF SUPERVISORS APPROVE A DEVELOPMENT AGREEMENT BETWEEN THE CITY AND COUNTY OF SAN FRANCISCO AND SEAWALL LOT 337 ASSOCIATES, LLC, FOR A CERTAIN REAL PROPERTY LOCATED ON SEAWALL LOT 337, PIER 48 AND MISSION BAY PARCEL 20, COMPROMISED OF ASSESSOR'S BLOCKS AND LOTS: BLOCK 8719/ LOT 006 AND BLOCK 9900 / LOT 048, ALTOGETHER CONSISTING OF APPROXIMATELY 28 ACRES, FOR A 30-YEAR TERM AND ADOPTING VARIOUS FINDINGS, INCLUDING FINDINGS UNDER THE CALIFORNIA ENVIRONMENTAL QUALITY ACT AND FINDINGS OF CONSISTENCY WITH THE GENERAL PLAN AND PLANNING CODE SECTION 101.1.

WHEREAS, Chapter 56 of the San Francisco Administrative Code sets forth the procedure by which a request for a development agreement will be processed and approved in the City and County of San Francisco.

WHEREAS, the Development Agreement would enable the Mission Rock Project. The Project includes new market-rate and affordable residential uses, commercial uses, retail, light industrial uses, parking, shoreline access improvements, infrastructure development and street improvements, and public open space. Depending on the uses proposed, the Project would include between 1.1 to 1.6 million gross square feet (gsf) of residential uses (estimated at 1,000 to 1,600 residential units) (of which 40% will be below market rate), approximately 972,000 to 1.4 million gsf of commercial-office use, and a maximum of approximately 245,000 gsf of retail use. The Project also includes construction of transportation and circulation improvements, new and upgraded utilities and infrastructure, geotechnical and shoreline improvements, up to 3,000 off-street parking spaces in one or two new garages and 100 spaces elsewhere throughout the site.

WHEREAS, in 2010, the Port of San Francisco ("Port") selected through a competitive process, the Seawall Lot 337 Associates, LLC, (an affiliate of the San Francisco Giants) to serve as master developer for the Project.

WHEREAS, in 2013, the Board of Supervisors ("Board") endorsed a Term Sheet and Development Plan for the Project, which set forth the terms of the Project.

WHEREAS, the Mission Rock Height and Bulk District was approved and established by the voters in Proposition D in 2015.

WHEREAS, the Board will be taking a number of actions in furtherance of the Project, including the approval of a disposition and development agreement ("DDA") between the City and County of San Francisco acting by and through the San Francisco Port Commission and the San Francisco Giants.

WHEREAS, the DDA includes an exhibit, referenced in the DA, that sets restrictions on when the project sponsor may seek permits to construct office space, effectively metering out the office components of the project over at least five years.

WHEREAS, these actions include the adoption of the Mission Rock Special Use District ("SUD") and its associated Design Controls document ("DC"), which together outline land use controls and design guidance for both horizontal and vertical development and improvements to the site.

WHEREAS, in furtherance of the Project and the City's role in subsequent approval actions relating to the Project, the City and the San Francisco Giants negotiated a development agreement for development of the Project site, a copy of which is attached as Exhibit A (the "Development Agreement").

WHEREAS, the City has determined that as a result of the development of the Project site in accordance with the Development Agreement and the DDA, clear benefits to the public will accrue that could not be obtained through application of existing City ordinances, regulations, and policies, as more particularly described in the Development Agreement and the DDA. The Development Agreement will eliminate uncertainty in the City's land use planning for the Project site and secure orderly development of the Project site consistent with the Design Controls and the DDA.

WHEREAS, the Development Agreement shall be executed by the Director of Planning, City Administrator, Director of Public Works, City Attorney, and Port Director, subject to prior approval by those Commissions and the Board of Supervisors.

WHEREAS, on October 5, 2017, the Planning Commission reviewed and considered the Final EIR for the Mission Rock Project ("FEIR") and found the FEIR to be adequate, accurate and objective, thus reflecting the independent analysis and judgment of the Department and the Commission, and that the summary of comments and responses contained no significant revisions to the Draft EIR, and certified the FEIR for the Project in compliance with the California Environmental Quality Act ("CEQA"), the CEQA Guidelines and Chapter 31 by Motion No. 20017.

WHEREAS, on October 5, the Commission by Motion No. 20018 approved CEQA Findings, including adoption of a Mitigation Monitoring and Reporting Program (MMRP), under Case No. 2013.0208ENV, for approval of the Project, which findings and MMRP are incorporated by reference as though fully set forth herein.

WHEREAS, on October 5, 2017, the Commission conducted a duly noticed public hearing at a regularly scheduled meeting on the proposed Development Agreement. At the hearing, City staff introduced proposed changes to the associated draft Ordinance for the DA ("Mission Rock Development Agreement Ordinance Errata (10/5/17)"). The Commission's actions regarding the DA hereby incorporate such changes.

WHEREAS, on October 5, 2017, by Motion No. 20019 the Commission adopted findings in connection with its consideration of, among other things, the adoption of amendments to the Planning Code, under CEQA, the State CEQA Guidelines and Chapter 31 of the San Francisco Administrative Code and made certain findings in connection therewith, which findings are hereby incorporated herein by this reference as if fully set forth.

WHEREAS, on October 5, 2017, by Motion 20019, the Commission adopted findings regarding the Project's consistency with the General Plan and Planning Code Section 101.1, including all other approval actions associated with the project therein, which findings are hereby incorporated herein by this reference as if fully set forth .

**NOW THEREFORE BE IT RESOLVED**, that the Planning Commission hereby approves the Development Agreement, in substantially the form attached hereto as Exhibit A.

**AND BE IT FURTHER RESOLVED**, that the office development described in the DA and allocated over time in the DDA promotes the public welfare, convenience and necessity under Planning Code Section 321(b)(3) as follows: (1) the land use plan, phasing of infrastructure, open space and public benefits, and apportionment of office over time maintains a balance between economic growth and housing, transportation and public services; (2) the office development is consistent with and promotes the objectives and policies of the General Plan and Planning Code Section 101.1 as set forth in Motion No. 20019; (3) the Design Controls and process for design review under the Mission Rock Special Use District ensure that the office development will be of high quality; (4) the office is located at an appropriate location, in close proximity to other office development in SoMa and the Downtown, near housing and major transit; and (5) the space is suitable for a broad range of uses and can accommodate a variety of tenants of various sizes.

**AND BE IT FURTHER RESOLVED**, that the Commission finds that the application, public notice, Planning Commission hearing, and Planning Director reporting requirements regarding the Development Agreement negotiations contained in Administrative Code Chapter 56 required of the Planning Commission and the Planning Director have been substantially satisfied in light of the regular monthly meetings held for the last two and a half years, the multiple public informational hearings provided by the Planning Department staff at the Planning Commission, the information contained in the Director's Report regarding the Mission Rock Development Agreement negotiations, and the mailed and published notice issued for the Development Agreement.

**AND BE IT FURTHER RESOLVED**, that the Commission authorizes the Planning Director to take such actions and make such changes as deemed necessary and appropriate to implement this Commission's recommendation of approval and to incorporate recommendations or changes from the Port Commission, San Francisco Municipal Transportation Agency (SFMTA) Board of Directors, the San Francisco Public Utilities Commission (SFPUC) and/or the Board, provided that such changes do not materially increase any obligations of the City or materially decrease any benefits to the City contained in the Development Agreement attached as Exhibit A.

Resolution No. 20020  
October 5, 2017

Case No. 2013.0208DVA  
Mission Rock Development Agreement

I hereby certify that the Planning Commission ADOPTED the foregoing Resolution on Thursday, October 5, 2017.



Jonas P. Ionin

Commission Secretary

AYES: Hillis, Richards, Fong, Johnson, Koppel, Melgar, Moore

NAYS: None

ABSENT: None

ADOPTED: October 5, 2017



# SAN FRANCISCO PLANNING DEPARTMENT

## Planning Commission Motion No. 20021

HEARING DATE: OCTOBER 5, 2017

*Case No.:* 2013.0208 ENV/PCA/MAP/DVA/CWP  
*Project Name:* Mission Rock (aka Seawall Lot 337 / Pier 48)  
*Existing Zoning:* Mission Bay Open Space (MB-OS); M-2 (Heavy Industrial) Zoning District;  
Mission Rock Height and Bulk District  
*Block/Lot:* 8719/006; 9900/048  
*Proposed Zoning:* Mission Mixed-Use Zoning District / Mission Rock Special Use District;  
Mission Rock Height and Bulk District  
*Project Sponsor:* Port of San Francisco and San Francisco Giants  
*Staff Contact:* Mat Snyder – (415) 575-6891  
[mathew.snyder@sfgov.org](mailto:mathew.snyder@sfgov.org)

1650 Mission St.  
Suite 400  
San Francisco,  
CA 94103-2479

Reception:  
415.558.6378

Fax:  
415.558.6409

Planning  
Information:  
415.558.6377

**APPROVING THE MISSION ROCK DESIGN CONTROLS (DC) DOCUMENT, AND INCORPORATING VARIOUS FINDINGS, INCLUDING FINDINGS UNDER THE CALIFORNIA ENVIRONMENTAL QUALITY ACT AND FINDINGS OF CONSISTENCY WITH THE GENERAL PLAN AND PLANNING CODE SECTION 101.1.**

WHEREAS, on September 5, 2017, Mayor Edwin Lee and Supervisor Jane Kim introduced an ordinance (Board File 170940) for Planning Code Text Amendments to establish the Mission Rock Mixed-Use District and the Mission Rock Special Use District (herein "SUD").

WHEREAS, the SUD, in turn, refers to the Mission Rock Design Controls Document (herein "DC") for further controls, standards, and guidelines specific to the site, providing development requirements for both infrastructure and community facilities as well as private development of buildings. The DC would therefore be a companion document to the Mission Rock SUD, and is incorporated by reference therein.

WHEREAS, as an extension of the Planning Code Text Amendments, the DC would enable and guide the Project. The Project includes new market-rate and affordable residential uses, commercial uses, retail, light industrial uses, parking, shoreline improvements, infrastructure development and street improvements, and public open space. Depending on the uses proposed, the Project would include between 1.1 to 1.6 million gross square feet (gsf) of residential uses (estimated at 1,000 to 1,600 residential units) (of which 40% will be below market rate), approximately 972,000 to 1.4 million gsf of commercial-office uses, and a maximum of approximately 245,000 gsf of retail uses. The Project also includes construction of transportation and circulation improvements, new and upgraded utilities and infrastructure, geotechnical and shoreline improvements, up to 3,000 off-street parking spaces in one or two new garages and 100 spaces elsewhere throughout the site. The DC includes specific controls for the Project's new streets and open spaces and provides more detailed controls and guidelines for building design on a more detailed level than provided in the Planning Code.

WHEREAS, the Project would construct new buildings that would range in height from 90 to 240 feet, as is consistent with Proposition D which was passed by the voters of San Francisco in November 2015.

WHEREAS, this Motion approving these Design Controls is a companion to other legislative approvals relating to the Project, including recommendation of approval of Planning Code Text and Map Amendments, and recommendation for approval of the Development Agreement (DA).

WHEREAS, together with the Mission Rock SUD, the DC will be the key source for development controls and design guidelines for land use, buildings, parking, streets and public open spaces. Parks and open spaces will also follow a subsequent design review and approval process as further defined in the other project documents, including the DA and Disposition and Development Agreement (DDA). The DC addresses street layout, open space, and blocks, and establishes overarching strategies for placement of uses and buildings relative to street and open space typologies. The DC will be incorporated into the Planning Code by reference in the proposed Mission Rock SUD. Following adoption, any amendments to the DC will occur through joint approval of the Planning and Port Commissions, while any amendments to the Mission Rock SUD would require legislative approval by the Board of Supervisors.

WHEREAS, on October 5, 2017, the Planning Commission reviewed and considered the Final EIR for the Mission Rock Project ("FEIR") and found the FEIR to be adequate, accurate and objective, thus reflecting the independent analysis and judgment of the Department and the Commission, and that the summary of comments and responses contained no significant revisions to the Draft EIR, and certified the FEIR for the Project in compliance with the California Environmental Quality Act ("CEQA"), the CEQA Guidelines and Chapter 31 by Motion No. 20017.

WHEREAS, on October 5, the Commission by Motion No. 20018 approved CEQA Findings, including adoption of a Mitigation Monitoring and Reporting Program (MMRP), under Case No. 2013.0208ENV, for approval of the Project, which findings and MMRP are incorporated by reference as though fully set forth herein.

WHEREAS, on October 5, 2017, the Commission conducted a duly noticed public hearing at a regularly scheduled meeting on the proposed Design Controls document.

**NOW THEREFORE BE IT RESOLVED**, that the Planning Commission hereby finds that the Mission Rock Design Controls document promotes the public welfare, convenience and necessity for the following reasons:

1. The Mission Rock Design Controls would help implement the Mission Rock Mixed-Use Project development, thereby replacing a currently under-utilized surface parking lot with needed housing, commercial space, and parks and open space.
2. The Mission Rock Design Controls would help implement the Mission Rock Mixed-Use Project, which in turn will provide employment opportunities for local residents during construction and post-occupancy, as well as community facilities and parks for new and existing residents.
3. The Mission Rock Design Controls would help implement the Mission Rock Mixed-Use Project by enabling the creation of a mixed-use and sustainable neighborhood, with fully rebuilt infrastructure. The new neighborhood would improve the site's multi-modal connectivity to and integration with the surrounding City fabric, and connect existing neighborhoods to the City's central waterfront.

4. The Mission Rock Design Controls would enable the construction of a new vibrant, safe, and connected neighborhood, including new parks and open spaces. The DC would help ensure a vibrant neighborhood with active streets and open spaces, high quality and well-designed buildings, and thoughtful relationships between buildings and the public realm, including the waterfront.
5. The Mission Rock Design Controls would enable construction of new housing, including new on-site affordable housing, and new retail and manufacturing uses. These new uses would create a new mixed-use neighborhood that would strengthen and complement nearby neighborhoods.
6. The Mission Rock Design Controls would facilitate the preservation and rehabilitation of Pier 48 - an important historic resource listed in the National Register of Historic Places.

**AND BE IT FURTHER RESOLVED**, that the Commission finds the Mission Rock Design Controls are in conformity with the General Plan and Planning Code Section 101.1 as set forth in Resolution No. 20019.

I hereby certify that the Planning Commission ADOPTED the foregoing Motion on Thursday, October 5, 2017.



Jonas P. Ionin

Commission Secretary

AYES: Hillis, Richards, Fong, Johnson, Koppel, Melgar, Moore

NAYS: None

ABSENT: None

ADOPTED: October 5, 2017







# SAN FRANCISCO PLANNING DEPARTMENT

---

## Executive Summary Mission Rock Mixed-Use Project CEQA Findings Planning Code Text Amendment Zoning Map Amendment Design Controls Development Agreement

HEARING DATE: OCTOBER 5, 2017

1650 Mission St.  
Suite 400  
San Francisco,  
CA 94103-2479

Reception:  
415.558.6378

Fax:  
415.558.6409

Planning  
Information:  
415.558.6377

*Date:* September 21, 2017  
*Case No.:* 2013.0208 ENV/PCA/MAP/DVA  
*Project Name:* Mission Rock (aka Seawall Lot 337 / Pier 48)  
*Existing Zoning:* Mission Bay Open Space (MB-OS); M-2 (Heavy Industrial) Zoning District;  
Mission Rock Height and Bulk Districts  
*Block/Lot:* 8719/002 and 006; 9900/048  
*Proposed Zoning:* Mission Rock Mixed-Use District / Mission Rock Special Use District;  
Mission Rock Height and Bulk District  
*Project Sponsor:* Port of San Francisco and SWL 337 Associates, LLC  
*Staff Contact:* Mat Snyder – (415) 575-6891  
[mathew.snyder@sfgov.org](mailto:mathew.snyder@sfgov.org)  
*Reviewed By:* Joshua Switzky – (415) 575-6815  
[joshua.switzky@sfgov.org](mailto:joshua.switzky@sfgov.org)  
  
*Recommendation:* **Approval with Conditions**

### SUMMARY

On October 5, 2017, the Planning Commission ("Commission") will consider a series of approval actions related to the proposed Mission Rock Project ("Project"). The Commission has previously reviewed the Project as part of: 1) informational hearings on December 8, 2016; and 2) the Draft Environmental Impact Report ("DEIR") on June 1, 2017. The Commission has also heard about the Project in the context of the Southern Bayfront Strategy in informational hearings on March 9, 2017 and May 5, 2016. The following is a summary of actions that the Commission will consider at this public hearing, all of which are required to implement the Project:

1. Adoption of CEQA Findings, including a Mitigation and Monitoring Plan ("MMRP");
2. Recommendation to the Board of Supervisors to approve Zoning Map Amendments and Planning Code Text Amendments to establish the Mission Rock Mixed Use District and the Mission Rock Special Use District ("SUD") and to make conforming changes to Planning Code text regarding height and bulk controls and re Article 9 for Parcel P20;
3. Approval of the Design Controls ("DC"); and

4. Approval of the Development Agreement ("DA")

Staff from the Planning Department, the Office of Economic and Workforce Development (OEWD), Port of San Francisco (Port) and other agencies have worked extensively with the developer, Seawall Lot 337 Associates, LLC, to formulate a comprehensive plan, entitlement structure and implementation program for the site.

The Project outlines a vision to reintegrate and restore the 28.1-Acre Site into the fabric of San Francisco to create an active, sustainable neighborhood. As set forth in greater detail in the Design Controls, Mission Rock will provide a concentration of City life and waterfront activity for the larger Mission Bay district, the Central Bayfront, SoMA and the City, providing a place for people to live and work in a mixed use, urban neighborhood. It will transform a surface parking lot into a neighborhood that prioritizes pedestrians, bikes and transit and water edge access. The Project will also deliver major new public spaces, including, among others, China Basin Park, a year-round regional facility that will serve greater San Francisco and the Bay Area community and Mission Rock Square, a focal point of the overall district, transitioning from the larger blocks of surrounding Mission Bay to an intimate scale similar to other San Francisco neighborhood spaces. It is proposed as a major civic space, with active space along its perimeter. The Project includes a re-imagined Terry A Francois Boulevard that supports an active working waterfront connects the Blue Greenway to China Basin Park and the Embarcadero, and establishes uninterrupted public waterfront access from Fisherman's Wharf to Candlestick Point.

## **PROJECT DESCRIPTION**

As envisioned, the proposed project would entail development of a mixed-use, multi-phase project at Seawall Lot 337 and Parcel P20, rehabilitation and reuse of Pier 48, and construction of approximately 5.4 acres of net new open space, for a total of approximately 8 acres of open space on the project site. The project would include up to 2.7 to 2.8 million gross square feet (gsf) of mixed uses on 11 proposed development blocks. The mixed-use development would comprise approximately 1.1 to 1.6 million gsf of residential uses (estimated at 1,000 to 1,600 units, 40% of which would be designated as below market rate), approximately 972,000 to 1.4 million gsf of commercial/office uses, and 241,000 to 244,800 gsf of active/retail and production uses on the lower floors of each block. Additionally, the project would include up to approximately 1.1 million gsf of above- and below-ground parking (approximately 3,000 spaces) in one or two centralized garages; 100 additional parking spaces would be allowed throughout the remaining parcels on the site. Also as part of the project, 242,500 gsf at Pier 48 would be rehabilitated for industrial, restaurant, active/retail, tour, exhibition, and meeting space use. The 11 blocks on Seawall Lot 337 would be developed with building heights ranging from 90 feet to a maximum of 240 feet for the tallest building, excluding the mechanical and other accessory penthouse roof enclosures and unoccupied building tops, subject to specified standards. The project would be built in several phases.

Of the 11 development blocks, 4 are designated as primarily residential, 4 as primarily commercial development, with the remaining 3 designated as flex parcels, where either residential or commercial could be emphasized (though total buildout by use would be limited to the overall ranges above as evaluated in the EIR.)

The project would introduce a new street grid with two new rights-of-way running north-south (one a traditional street and the other a pedestrian-priority shared public way) and two new rights-of-way

running east-west. Streets would be designed to Better Streets standards and would feature robust dedicated bicycle facilities assuring the continuity of the Bay Trail through the site. The Design Controls (DC) document will assure that design of streets and of building frontages are well coordinated to create a lively public realm. Retail would be allowed in all buildings, and would be focused on the north-south pedestrian street (referred to in the DC as the "Shared Public Way") and along the frontages facing China Basin Park. Frontages along Terry François would feature light-industrial production and similar uses in keeping with the established working waterfront.

Three parks would be incorporated into the project. China Basin Park would be enlarged to include 4.4 acres; facing China Basin on one side and the Bay on the other, the enlarged park would include a great lawn, small ballfield, entry plazas, and waterfront trails and access points throughout. A second park, 1.1-acre Mission Rock Square, would act as a town square at the center of the site, while a third waterfront open space, ½-acre Channel Wharf, would be established on a wharf between Pier 48 and 50. Smaller plazas and pedestrian thoroughways that connect these open spaces with the street network are also proposed at several locations, along with open space along the Pier 48 aprons, bringing the total public open space to approximately 8 acres.

As noted above, building heights would range from 90 feet to 240 feet tall, consistent with voter approved Proposition D (November 2015). Buildings would be required to step down at key locations, including to 60' along the main retail pedestrian thoroughway and to 40' along Terry Francois to assure that building streetwalls are well-proportioned to the fronting streets, waterfront, and open spaces. Buildings reaching up to 240-feet would be restricted to three specific locations. Parking would predominantly be provided in one or two centralized parking facilities, including an above-grade garage on the south side of the site along Mission Rock Street and possibly also in a below-grade facility underneath Mission Rock Square. The Design Controls document requires that the above-grade garage be fronted with ground floor active uses and residential use at all floors above the ground floor along Third Street, and at other key frontages with active frontage at the ground level.

## **SITE DESCRIPTION AND PRESENT USE**

The project site currently includes an approximately 14.2-acre parking lot (referred to as "Lot A"), a 0.3-acre strip of land on the south side of the lot (referred to as Mission Bay Parcel P20), the 6-acre Pier 48 and the existing 2.2-acre China Basin Park. Existing streets, access areas, and a marginal wharf between Piers 48 and 50, bring the project site total to 28.1 acres. The existing Seawall Lot 337 site consists primarily of a paved surface parking lot holding approximately 2,200 cars, and no permanent structures. Pier 48, with sheds totaling approximately 181,000 gsf, is primarily used for indoor parking and storage/warehousing uses.

The lot portion of the site is zoned MB-OS; Pier 48 is zoned M-2 (Heavy Industrial); Parcel P20 is within the Mission Bay Redevelopment Project Area.

The site is located adjacent to the Mission Bay neighborhood, though not included within the Mission Bay Redevelopment Project Area (with the exception of the 0.3-acre Parcel P20). The site is generally bounded on the west by Third Street, the City's major thoroughfare for the southeast quadrant of the

City, on the north by China Basin Park, on the east by the Bay and Piers 48 and 50, and on the south by Mission Rock Street. The Bay Trail alignment runs through the east side of the site.

Seawall lots are tidelands that were filled and cut off from the waterfront by the construction of the seawall in the late 19th and early 20th centuries, and by the construction of the Embarcadero roadway which lies, in part, over a portion of the seawall. Seawall Lot 337, the largest of the designated seawall lots, is located just south of China Basin and for years has been used as a surface parking lot.

Through legislation, commonly known as SB 815, as amended by AB 2797, the California Legislature found that the revitalization of Seawall Lot 337 and Pier 48 is of particular importance to the State of California. Under SB 815, the Port is authorized to ground lease portions of the Project Site for the development of improvements that may be used for non-trust uses to enable higher economic development and revenues. Some of the revenues from these leases will be advanced initially to pay for infrastructure serving the Project Site, then repaid with project-generated special taxes and property taxes. The Port will use revenues from leases for non-trust uses, as well as its return on funds advanced for infrastructure investment, to preserve its historic resources and for other public trust consistent uses permitted under the state legislation.

Following a public solicitation process to implement goals and objectives developed through a multi-year community process, the Port Commission awarded the Developer (an affiliate of the San Francisco Giants) the opportunity to negotiate exclusively for the lease, construction, and operation of the Project Site in 2010. Negotiations resulted in a Term Sheet that the Port Commission and the Board of Supervisors endorsed in 2013.

Mission Bay Parcel P20, on the southern edge of SWL 337, is currently subject to the Mission Bay South Redevelopment Plan and is designated in that plan as a small open-space buffer. When it adopted AB 2797, the state legislature recognized the need to remove P20 from the Redevelopment Plan, on the basis that "the revitalization of Seawall Lot 337 . . . is of particular importance to the state." As such, AB 2797 calls for the amendment of the Redevelopment Plan to remove P20 without State-level review under Health & Safety Code Sections 34163(c)-(f) and 34164(a) and (b). The OCII Commission will consider taking action to remove P20 from the Redevelopment Plan subsequent to Planning Commission action on Mission Rock.

## **ENVIRONMENTAL REVIEW**

On April 26, 2017, the Department published the Seawall Lot 337 and Pier 48 Mixed-Use Project Draft Environmental Impact Report ("DEIR") for public review (Case No. 2013.0208ENV). The DEIR was available for public comment until June 12, 2017.

On June 1, 2017, the Commission conducted a duly noticed public hearing at a regularly scheduled meeting to solicit comments regarding the DEIR.

On September 21, 2017, the Department published a Comments and Responses document, responding to comments made regarding the DEIR.

On October 5, 2017, the Commission will consider certification of the Final Environmental Impact Report ("FEIR") for the Project, and will determine if it is adequate, accurate and complete.

In addition, on October 5, 2017, the Commission must adopt the CEQA Findings for the FEIR, prior to the approval of the Project (See Case No. 2013.0203 ENV/PCA/MAP/DVA).

**HEARING NOTIFICATION**

TYPE	REQUIRED PERIOD	REQUIRED NOTICE DATE	ACTUAL NOTICE DATE	ACTUAL PERIOD
Classified News Ad	20 days	September 15, 2017	September 13, 2017	22 days
Posted Notice	n/a	Not Required	n/a	n/a
Mailed Notice	10 days	September 25, 2017	September 15, 2017	20

**PUBLIC COMMENT**

To date, the Department has not received any specific public comment in support or opposition to the Project, other than comments submitted regarding the DEIR that are responded to in the Comments and Responses document. The Project Sponsor and Port have engaged in a robust community outreach program throughout the development of the Project, which has been under development for many years. The project was the subject of a voter initiative, Proposition D, in November 2015, which approved (74% in favor) changes to height limits to accommodate the project by rezoning the project site to a new Mission Rock Height and Bulk District.

**PLANNING COMMISSION REQUIRED ACTIONS FOR THE PROJECT**

As summarized above, the Commission must take several actions to approve the Project. These actions include:

General Plan Consistency Findings

The Commission must adopt findings of General Plan consistency for all approval and implementation actions related to the project. These findings are included in the first approval action being considered by the Commission, which is consideration of the ordinance to amend the Planning Code and Zoning Maps. Note that these findings cover the future minor amendment to the Mission Bay South Redevelopment Plan to remove Parcel P20 from that Redevelopment Plan.

Planning Code Text Amendment – Mission Rock Special Use District (SUD)

On September 5, 2017, Mayor Edwin Lee and Supervisor Jane Kim initiated the ordinance that would amend the Planning Code to establish the Mission Rock SUD and make other conforming Code amendments.

The Mission Rock SUD will provide specific land use and development controls for the project site, which encompasses Seawall Lot 337, Parcel P20, and Pier 48. The Mission Rock SUD extracts and codifies basic zoning requirements found in the DC, including:

- Uses, including allowed uses per parcel and ground floor requirements
- Building Standards, including Off-Street Parking, Bicycle Parking, Dwelling Unit Exposure, Open Space for Dwelling Units, Permitted Obstructions and Signage.

- Incorporation by reference of the Design Controls document, which contains additional standards and guidelines for development of the site

In addition, the Mission Rock SUD outlines the design review process for the Development Phases, Vertical Improvements and Minor/Major Modifications to Building Standards. The Design Review procedures include:

- Phase Approval: An overarching "Phase application" will be submitted to the Port of San Francisco for approval in accordance with a Disposition and Development Agreement ("DDA"). The Phase approval would assure that the Master Developer is moving forward with infrastructure and community improvements at the same time as the development of the buildings (Vertical Improvements). The Phase approval is required before Planning can begin review on a specific Vertical Improvement.
- Design Review and Approval of Vertical Improvements: Design review and applications for Vertical Improvements (new construction of a building or any later expansion/major alteration or addition to a previously-approved building) will be submitted concurrently to Planning and the Port of San Francisco. Planning staff shall review these applications for consistency with the DC. The Planning Director shall have discretion over minor modifications (deviation of less than 10 percent from any dimensional or numerical standard in the DC), while the Planning Commission shall review and approval any major modification. Other than major modifications, the Planning Director would approve all Vertical Improvements.
- Review and Approval of Horizontal Development: Horizontal Development includes construction of utility infrastructure; recreational, open space, and public access areas; public rights-of-way; and other improvements in the public realm. The Port of San Francisco will be responsible for coordinating review and approval of all Horizontal Development by the appropriate City agencies, including Planning, and will include a public process for further refinement of the program by Phase and final design for the site's public open spaces.

Also included in the Planning Code ordinance is amendment to Section 291, the Mission Rock Height and Bulk District, which was established through voter approval of Proposition D. The amendments to this Section provide further final delineation of height and bulk limits, all within the parameters established by the voters. Additional amendments reorganize the Section for readability to reflect adoption of the project. Text amendments also include modification of Article 9 to reflect the rezoning of Parcel P20.

#### Zoning Map Amendments

The same ordinance introduced on September 5, 2017 by Mayor Edwin Lee and Supervisor Jane Kim would also amend the Zoning Map and Height and Bulk District Map for the project site. The project site would be rezoned from MB-OS and M-2 to the newly created Mission Rock Mixed-Use Zoning District. The Mission Rock Mixed-Use Zoning District will provide reference to the Mission Rock SUD.

It should be noted that Height and Bulk Designations will remain the same as established through Proposition D, which established the Mission Rock Height and Bulk District and Planning Code Section 291; Section 291 designates sub-height zones across the site that range from 45-feet to 240-feet.

Design Controls Document (DC)

The DC articulates a vision and goals for the character of the overall project, and provides specificity on aspects of land use, building frontage, open space, streets and streetscapes, parking and loading, buildings, lighting, and signage. The scope of the DC is expansive, and includes standards and guidelines for each topic area. The following is a summary of the main chapters of the DC:

- *Land Use:* The Project will provide flexible land use regulations where a wide breadth of uses is allowed throughout. Of the 11 development blocks, 4 are designated as primarily residential (one of which also includes a centralized garage), 4 as primarily commercial development, with the remaining 3 designated as flex parcels, where either residential or commercial could be emphasized. Residential and commercial blocks are interspersed to help assure the new neighborhood is activated throughout the day and week and to create an interesting and lively diversity.

The land use controls also require active uses along almost all frontages, with particular retail focus along the pedestrian shared right-of-way, and along the park edges. Ground floor frontage along Terry Francois has been designated for production and maker uses in keeping with the industrial nature of the existing working piers.

*Open Space Network:* The Project will create approximately 8-acres of public open space throughout the site. The Project identifies three main open spaces as described above.

*Streets and Streetscapes:* The Project will establish a new street network, which will connect the project site to the larger City and the Mission Bay neighborhood. The street will be designed in compliance with the Mission Rock Transportation Plan and Infrastructure Plan, both of which are adopted along with the DA and DDA.

- *Parking and Loading:* The DC allows for the construction of a maximum of 3,100 parking spaces that would replace the existing surface parking lot and parking on Pier 48 (which together provide approximately 2,900 existing spaces). Up to 3,000 of these spaces would be in an above grade garage and possibly also in a below-grade garage beneath Mission Rock Square. Only up to 100 spaces total would be allowed on parcels other than these one or two centralized garages. The DC includes design regulations specifically for the above-grade garage to assure the structure would be appropriately treated and include active frontages at key locations.
- *Buildings:* The Project establishes standards and guidelines for massing and architecture, streetwall, building base and ground floor, facades and materiality, projections, roofs, residential building elements and open space, garages and service entry design, and sustainability. The DC emphasizes design considerations for pedestrians by including robust requirements for activation, modulation, and scaling building frontages with respect to the scale and function of the adjacent street or open space.
- *Lighting, Signage and Art:* Finally, the DC concludes with an approach towards lighting, signage/wayfinding and public art.

Development Agreement (DA)

The DA between the City of San Francisco and the Master Developer, Seawall Lot 337 Associates, LLC, will set forth vesting rights for the Mission Rock 28-Acre Site and establish a set of committed public benefits. The vested elements include: the proposed land use plan and parcelization; the location and numbers of Vertical Improvements (buildings); the maximum density, intensity and gross square



footages; the permitted uses; and the provisions for open space, vehicular access and parking. The Project's commitments to public benefits include:

- *Creation or improvement of approximately 8 acres of public open space*, including expansion of China Basin Park, creation of Mission Rock Square, creation of Channel Wharf, improvement of the Pier 48 aprons, and other pedestrian pathways and spaces throughout the site.
- *Rehabilitation of Pier 48*: The Project includes renovation and rehabilitation of Pier 48, including public access and maritime use of the Pier 48 aprons.
- *On-Site Affordable Housing*: The Project would create a significant amount of affordable housing units. Overall, at least 40% of the residential units developed on-site will be inclusionary units affordable to low and moderate income households.

*Jobs & Workforce Development Program*: The Project will implement a robust workforce commitment program to encourage local business participation, including a local hire participation level of 30% per trade. Vertical developers will contribute \$1,000,000 to OEWD in 11 parcel-by-parcel installments. Half of the funds will support community-based organizations that provide barrier removal services and job readiness training for individuals within at-risk populations, and half will support city programs that provide job training for local residents.

- *Transportation*: The Project would construct major new transportation infrastructure and would contribute toward other transportation and other infrastructure critical to serving Mission Rock through payment of a Transportation Fee in lieu of the existing TSF and Transit Impact Fee, estimated at about \$40 million. The Project includes a robust Transportation Demand Management program with a requirement to reduce single occupancy vehicle trips by 20% from baseline metrics.
- *Sustainability and Sea Level Rise Protection*: The Project would implement sustainability measures to enhance livability, health and wellness, mobility and connectivity, climate protection, resource efficiency, and ecosystem stewardship and provide funding sources needed to protect the Mission Rock shoreline and site from sea level rise. Most of the Project's site's grade will be raised to protect buildings and utilities against 66 inches of sea level rise (projected 2100).
- *Maintenance of Public Spaces and other Areas*: A services Community Facilities District will be established to provide private financing by the project for the cost of long-term management and maintenance of public spaces and certain portions of public rights-of-way with improvements that exceed basic city standards.
- *Community Facilities*. If requested, the Project will make available to the City up to 15,000 gsf of community space, which may be distributed in two or more buildings.

In conjunction with the Development Agreement, it is proposed that the Port and the Board of Supervisors would approve various transactional documents, including the DDA, which is between the master developer and the Port. Other City agencies retain a role in reviewing and issuing later approvals for the Project (for example, subdivision of the site and construction of infrastructure and other public facilities), as memorialized in the DA and other implementing documents. Among other things, the DA gives the master developer the right to develop the Project in phases accordance with the DDA and the DA, requires certain public benefits, describes the application of existing and future City laws, and establishes fees and exactions. It is also proposed as part of approval of the DA that

the City will consent to waive or modify certain procedures and requirements under existing Codes in consideration of alternative provisions in the DA and/or DDA.

## ISSUES AND OTHER CONSIDERATIONS

- Office Development Authorization/Planning Code Section 321: Since the project site is under the jurisdiction of the San Francisco Port Commission, as provided in Planning Code Section 321(2)(a), new office space under the jurisdiction of the San Francisco Port Commission will count against the annual maximum limit. The Port of San Francisco will notify the Planning Department when new office development is authorized. An exhibit to the DDA, referenced in the DA, sets restrictions on when the project sponsor may seek permits to construct office space, effectively metering out the office components of the project over at least five years.
- Open Space/Recreation and Parks Commission: The Port of San Francisco would maintain ownership of all publicly-accessible open space on the site. Therefore, Planning Code Section 295 (Height Restrictions on Structures Shadowing Property under the Jurisdiction of the Recreation and Park Commission, aka Prop K) is not applicable to parks on the project site. None of the proposed structures on the site would shadow any existing or planned properties under jurisdiction of Recreation & Parks.
- Planning Code/Zoning Map Ordinance Errata: A set of errata is included in this packet as recommended amendments to the ordinance. These amendments are primarily corrections of typos and minor technical clarifications. Staff recommends that the Planning Commission include these errata in their resolution on the ordinance.

## REQUIRED COMMISSION ACTION

In order for the Project to proceed, the Commission must:

- 1) Certify the Final Environmental Impact Report (FEIR) pursuant to the California Environmental Quality Act (CEQA);
- 2) Adopt findings under the California Environmental Quality Act (CEQA), including findings rejecting alternatives as infeasible and adopting a Statement of Overriding Considerations and the Mitigation Monitoring and Reporting Program (MMRP);
- 3) Recommend that the Board of Supervisors approve the ordinance amending the Planning Code Text to establish the Mission Rock Mixed Use District and Mission Rock Special Use District among other amendments, and amend the associated Zoning Maps, including the errata; and adopt the findings of consistency with the General Plan and Priority Policies of Planning Code Section 101.1;
- 4) Adopt the proposed the Mission Rock Design Controls (DC) document; and,
- 5) Recommend that the Board of Supervisors approve the Development Agreement (DA) for the Project.

## BASIS FOR RECOMMENDATION

- The Project will add substantial housing opportunities in an infill, transit-accessible area and will put into more productive use an existing surface parking lot.
- The Project will provide space for job growth in an appropriate central city location very close to high quality local and regional transit, including Muni Metro and Caltrain, consistent with and advancing the objectives of Plan Bay Area;
- The Project will add retail and manufacturing uses that will contribute to the employment base of the City and bolster the viability of the neighborhood.
- The site is currently underutilized, and the addition of new ground-floor retail spaces and publicly-accessibly open spaces will enliven the streetscape and will provide new access to the waterfront.
- The Design Controls document will provide specific guidance for the character of the overall Project, resulting in high-quality architecture, extensive streetscape and public realm improvements, and abundant publicly-accessible open space.
- The Development Agreement will provide substantial public benefits in areas including affordable housing, funding for transportation improvements, workforce development, and historic preservation, among other benefits.
- The Project is, on balance, consistent with the Goals, Policies, and Objectives of the General Plan.

<b>RECOMMENDATION:</b> <b>Approval with Conditions</b>
--

### Attachments:

Draft Motion-CEQA Findings  
Draft Resolution-Planning Code Text Amendment & Zoning Map Amendments, General Plan and Planning Code Section 101.1 Consistency Findings  
Draft Planning Code Text and Map Amendments Ordinance initiated by Board of Supervisors  
Draft Motion-Design Controls Document Adoption  
Draft Resolution-Development Agreement  
[Draft DA Ordinance to be sent under separate cover]  
Zoning Map, Height & Bulk Map, Aerial Photograph  
DDA Summary  
Housing Plan  
Workforce Development Plan  
LBE Utilization Plan  
Development Agreement between City and County of San Francisco & Seawall Lot 337 Associates, LLC  
TDM Plan  
Mission Rock Design Controls  
Mission Rock Sustainability Strategy  
Mission Rock Transportation Plan  
Mission Rock Infrastructure Plan

## Mission Rock SUD Errata (9/28/17)

### 1. Page 8, "Production Uses" definition.

Revise as follows: "Production Uses" means all Agricultural and Industrial, ~~and Non-Retail~~ Uses, but excluding Large Scale Urban Agriculture; Automobile Wrecking; Food, Fiber and Beverage Processing 2; Hazardous Waste Facility; Junk Yard; Power Plant; Shipyard; Storage Yard; Storage, Volatile Materials; Truck Terminal; and all Non-Retail Automotive Uses.

### 2. Pages 11-12, Table 249.80-MR1 Land Uses.

(a) In the top left cell, replace reference to Figure 249.80-MR2 with reference to Figure 249.800-MR1.

(b) In Note (1), replace references in Tables and Figures labeled 249.XX to 249.80.

### 3. Page 14, Table 249.80-MR2.

Add a note (2) as follows: Child Care is a permitted use in all ground floor frontage zones.

### 4. Page 29, subsection (c), Height and Bulk Measurement.

Revise the paragraph as follows: (c) Height and Bulk Measurement. ~~Height and Bulk shall be measured and regulated as provided in this Section 291 and the Design Controls and not as provided in Planning Code Article 2.5. Maximum building heights shall be measured from the site datum, up to the highest point of the finished grade ( as referenced in the Design Controls) along the property line, up to the highest point of the uppermost structural slab roof in the case of a flat roof, and up to the average height of the rise in the case of a pitched or stepped roof, or similarly sculptured roof form. Maximum Base Building heights shall be measured from the highest point of the finished grade ( as referenced in the Design Controls) along the property line, up to the site datum to the highest point on the uppermost structural slab of the Base Building finished roof of the based building in the case of a flat roof, and the average height of the rise in the case of a pitched or stepped roof, or similarly sculptured roof form of the Base Building.~~

### 5. Page 30, subsection (f), Rooftop Elements.

Revise the paragraph as follows: (f) Rooftop Elements. The following rooftop elements may extend beyond the maximum permitted building height as specified below, provided that in no event shall the maximum height in subsection (e) be exceeded: mechanical enclosures, and sustainable infrastructure such as photovoltaic panels, windmills, or fog catchers, and greenhouses (up to 20 feet in height) ~~and greenhouses (up to 12 feet in height)~~. On the Base Building, rooftop elements must step back at a minimum ratio of 1.2 feet horizontally from the streetwall for every foot that they exceed the maximum permitted height limit. Common use

structures are permitted on the Base Building up to 20 feet in height, provided that they are limited to 25 percent of the roof area for each Base Building. On the Upper Building, rooftop elements must be screened or enclosed within the building top. Railings, planters and visually permeable building elements no greater than 42 inches above the roof are exempt from step-back requirements.

**PORT COMMISSION  
CITY AND COUNTY OF SAN FRANCISCO**

**RESOLUTION NO. 18-04**

- WHEREAS, Beginning in 2006, the Port initiated an intensive planning process that has culminated in a project that would restore and redevelop an approximately 28-acre site located along the Central Waterfront comprised of (1) Seawall Lot 337, bounded by Third Street on the west, Parcel P20 and Mission Rock Street on the south, Pier 48 to the east, and China Basin Park on the north; (2) Pier 48; (3) China Basin Park; (4) the marginal wharf between Pier 48 and Pier 50; and (5) Parcel P20 (collectively, the "Site"); and
- WHEREAS, From 2007 to 2010, the Port conducted a community process that evaluated the unique site conditions and opportunities at the Site and built a public consensus for its future that nested within the policies established for the South Beach/China Basin Waterfront in the Port's Waterfront Land Use Plan; and
- WHEREAS, In May 2010, by Resolution No. 10-32, the Port Commission awarded to Seawall Lot 337 Associates, LLC, a Delaware limited liability company ("Developer"), through a competitive process, the opportunity to negotiate exclusively for the mixed-use development of Seawall Lot 337 and Pier 48, and the Port Commission later added China Basin Park, the marginal wharf between Pier 48 and Pier 50, and Parcel P20 to the development (collectively, the "Project"); and
- WHEREAS, Developer is a wholly-owned subsidiary of Giants Development Services, LLC, which in turn is a wholly-owned subsidiary of San Francisco Baseball Associates, LLC, the Major League Baseball franchise holder of the San Francisco Giants; and
- WHEREAS, In March 2013, by Resolution No. 13-10, the Port Commission endorsed the Term Sheet for the Project; and
- WHEREAS, In May 2013, by Resolution No. 142-13, the Board of Supervisors found the Project fiscally feasible under Administrative Code, Chapter 29 and endorsed the Term Sheet for the Project, which is now known as "Mission Rock"; and
- WHEREAS, Because the Project would not comply with many of the existing zoning controls which affect the Site, the Port and Developer, as project sponsors, have proposed the establishment of a Mission Rock Special Use District and the adoption of various Planning Code text amendments described below that would articulate a unique set of

zoning regulations and approval processes for the development of the Site; and

WHEREAS, To implement the Port's vision for the development of the Site, on September 5, 2017 Mayor Edwin Lee and Supervisor Jane Kim introduced an ordinance that would establish the Mission Rock Mixed-Use District and the Mission Rock Special Use District (herein "Mission Rock SUD"), add the Mission Rock SUD in Planning Code Section 249.80, and amend Zoning Map No. ZN08 by designating Assessor's Block and Lot 8719 / 006 as part of the Mission Rock Mixed-Use District and by amending Special Use District Map SD08 by designating Assessor's Block and Lots 8719 / 006 and 9900 / 048 to the Mission Rock SUD (collectively, the "Planning Code Amendments"); and

WHEREAS, The Planning Code Amendments would enable the development of the Site for new market-rate and affordable residential uses, commercial use, retail uses, parking, shoreline area improvements, infrastructure development and street improvements, and public open space; and

WHEREAS, Under the Disposition and Development Agreement ("DDA") and other transaction documents that the Port and Developer have negotiated, at full build-out, the Project will include: (1) 1.1 million to 1.6 million gross square feet ("gsf") of new residential uses (an estimated 1,000 to 1,950 new residential units), at least 40% of which will be on-site housing affordable to a range of low- to moderate-income households as described in the Housing Plan in the DDA; (2) 972,000 to 1.4 million gsf of new commercial and office space; (3) 241,000 to 244,800 gsf of active retail and production uses on 11 proposed development blocks on Seawall Lot 337 in buildings that would range in height from 90 to 240 feet, consistent with Proposition D, passed by the voters of San Francisco in November 2015, which increased building height limits on the Site up to 240 feet; (4) the rehabilitation and reuse of Pier 48, a significant contributing resource to the Port of San Francisco Embarcadero Historic District; (5) up to approximately 1.1 million gsf of above- and below-grade parking in one or two garages; (6) transportation demand management on-site and payment of impact fees that the Municipal Transportation Agency will use to improve transportation service in the area; (7) approximately 5.4 acres of net new open space for a total of approximately 8 acres of new and expanded open space, including an expansion of China Basin Park, a new central Mission Rock Square, and waterfront access along the shoreline; (8) public access areas, assembly areas, and an internal grid of public streets, shared streets, and utilities infrastructure; and (9) on-site strategies to protect against sea level rise; and

WHEREAS, The Planning Code Amendments would establish the Mission Rock SUD, which would outline the land use controls for the Site, alongside the Mission Rock SUD Design Controls (“DC”) that include further controls, standards and guidelines specific to the Site, providing development requirements for both infrastructure and community facilities as well as private development of buildings. The DC would therefore implement the Planning Code Amendments; and

WHEREAS, Together with the Planning Code Amendments, the DC will be the key source for development controls and design guidelines for land use, buildings, parking, streets and public open spaces, architecture, and more. Parks and open spaces will also follow a subsequent design review and approval process to ensure that they meet Port standards. The DC addresses street layout, open space, and blocks, and establishes overarching strategies for placement of uses and buildings relative to street and open space typologies. Following adoption, any amendments to the DC would be approved by both Planning and Port Commissions, except for certain amendments affecting only open space and rights-of-way (including streetscape) development, which would require approval only by the Port Commission, and any further amendments to the Planning Code Amendments would be approved by the Board of Supervisors, following recommendations by the Planning and Port Commissions; and

WHEREAS, On October 5, 2017, the Planning Commission (1) reviewed and considered the Final Environmental Impact Report for the Seawall Lot 337 and Pier 48 Mixed-Use Project (“FEIR”) (Case No. 2013.0208E); (2) found the FEIR to be adequate, accurate and objective, thus reflecting the independent analysis and judgment of the Planning Department and the Planning Commission; and (3) by Motion No. 20017, certified the FEIR as accurate, complete and in compliance with the California Environmental Quality Act (“CEQA”), the CEQA Guidelines, and Chapter 31 of the San Francisco Administrative Code; and

WHEREAS, At the same hearing, the Planning Commission approved the Project and in so doing, adopted findings under CEQA by Motion No. 20018, including a Statement of Overriding Considerations (the “Mission Rock CEQA Findings”), and adopted a Mitigation Monitoring and Reporting Program (“MMRP”). A copy of the Planning Commission Motions, the Mission Rock CEQA Findings, and the MMRP are on file with the Port Commission Secretary and may be found in the records of the Planning Department at 1650 Mission Street, San Francisco, CA, and are incorporated in this resolution by reference as if fully set forth herein; and



- WHEREAS, The Port Commission finds that the land use plan with the proposed mix of commercial and residential uses is appropriate for the Site, due to (i) the public planning process to date, (ii) the incorporation of between 1,000-1,950 new residential units, including on-site housing affordable to a range of low- to moderate-income households, and (iii) the Port's responsibilities as trustee under the Burton Act to protect Port property, including funding critical seawall repairs and implementing protective and adaptive measures to address sea level rise; and
- WHEREAS, The Port Commission has reviewed the FEIR, the MMRP and the CEQA Findings, and finds that the approvals before the Port Commission are within the scope of the FEIR and that no substantial changes in the Project or the circumstances surrounding the Project have occurred and no new information that could not have been known previously showing new significant impacts or an increase in severity in impacts has been discovered since the FEIR was certified; and
- WHEREAS, On October 5, 2017, the Planning Commission by Resolution No. 20019 recommended approval by the Board of Supervisors of a draft ordinance, substantially in the form attached hereto as Exhibit A that would establish the Mission Rock SUD and amend the Zoning Map for the Project as provided in the Planning Code Amendments; and
- WHEREAS, At the same meeting, the Planning Commission by Resolution No. 20021 approved the DC; and
- WHEREAS, The Port Commission is concurrently approving amendments to the Waterfront Land Use Plan and Design and Access Element to be consistent with the Planning Code Amendments and the DC; now, therefore, be it
- RESOLVED, That the Port Commission adopts the Mission Rock CEQA Findings as its own and adopts the MMRP. Where applicable, the Port Commission has imposed the measures in the MMRP as conditions in the approval documents for the Project; and be it further
- RESOLVED, That the Port Commission has considered the Planning Code Amendments and recommends approval thereof by the Board of Supervisors; and be it further
- RESOLVED, That the Port Commission approves the DC, contingent on approval of the Planning Code Amendments by the Board of Supervisors, for the following reasons:

1. The DC would help implement the Project to transform currently underused surface parking into a vibrant new mixed-use and sustainable neighborhood, with newly built infrastructure and a network of new parks and open space serving residents and visitors alike, and will improve the Site's multi-modal connectivity to and integration with the surrounding City fabric, and connect existing neighborhoods to the City's South Beach/China Basin waterfront.
2. The DC would help ensure that new development on Port property will be high quality, with active streets, open spaces and physical and visual connections with the waterfront; and be it further

RESOLVED, That the Port Commission finds the DC is in general conformity with the Waterfront Land Use Plan as amended as set forth in Port Commission Resolution No. 18-05; and be it further

RESOLVED, That the Port Commission delegates to the Port Executive Director the authority to take all such actions as are contemplated by and reasonably necessary to effectuate the DC, including, without limitation, the authority to review and approve the Building Signage Plan contemplated under the Disposition and Development Agreement.

***I hereby certify that the foregoing resolution was adopted by the San Francisco Port Commission at its meeting of January 30, 2018.***

Amy Quesada

Secretary

Digitally signed by Amy Quesada  
DN: cn=Amy Quesada, o=Port of San Francisco,  
ou=Port Executive, email=amyquesada@port.com,  
c=US  
Date: 2018.01.31 13:24:37 -0800

BOARD of SUPERVISORS

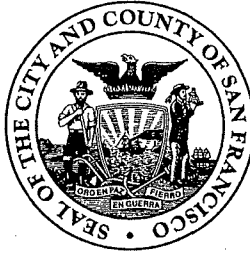

City Hall  
1 Dr. Carlton B. Goodlett Place, Room 244  
San Francisco 94102-4689  
Tel. No. 554-5184  
Fax No. 554-5163  
TDD/TTY No. 554-5227

December 12, 2017

Planning Commission  
Attn: Jonas Ionin  
1650 Mission Street, Ste. 400  
San Francisco, CA 94103

Dear Commissioners:

On December 5, 2017, Mayor Lee introduced the following substitute legislation and proposed legislation:

**File No. 170940**

**Ordinance amending the Planning Code and the Zoning Map to add the Mission Rock Special Use District, generally bounded by China Basin to the north; Pier 48, the marginal wharf between Pier 48 and Pier 50, the associated shoreline area and Terry Francois Boulevard to the east; Mission Rock Street to the south; and 3rd Street to the west; to amend other related provisions; making findings under the California Environmental Quality Act; and making findings of consistency with the General Plan, the eight priority policies of Planning Code, Section 101.1, and Planning Code, Section 302.**

**File No. 171286**

**Resolution affirming the Planning Department's certification of the Final Environmental Impact Report and adopting environmental findings under the California Environmental Quality Act (CEQA), CEQA Guidelines, and San Francisco Administrative Code, Chapter 31, including findings of fact, findings regarding significant impacts and significant and unavoidable impacts, evaluation of mitigation measures and alternatives, a statement of overriding considerations, and adoption of a mitigation monitoring and reporting program related to the approvals for the proposed Seawall Lot 337 and Pier 48 Mixed-Use Project.**

The proposed legislations are being transmitted pursuant to Planning Code, Section 302(b), for public hearing and recommendation. The legislations are pending before the Land Use and Transportation Committee and will be scheduled for hearing upon receipt of your response.

Angela Calvillo, Clerk of the Board

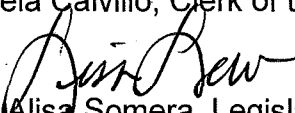
*for* By:  Alisa Somera, Legislative Deputy Director  
Land Use and Transportation Committee

- c: John Rahaim, Director of Planning
- Aaron Starr, Acting Manager of Legislative Affairs
- Scott Sanchez, Zoning Administrator
- Lisa Gibson, Acting Environmental Review Officer
- AnMarie Rodgers, Senior Policy Advisor
- Laura Lynch, Environmental Planning
- Joy Navarrete, Environmental Planning

BOARD of SUPERVISORS



City Hall  
1 Dr. Carlton B. Goodlett Place, Room 244  
San Francisco 94102-4689  
Tel. No. 554-5184  
Fax No. 554-5163  
TDD/TTY No. 554-5227

## MEMORANDUM

TO: John Rahaim, Director, Planning Department  
Kate Hartley, Acting Director, Mayor's Office of Housing and Community Development  
Elaine Forbes, Executive Director, Port Department  
Amy Quesada, Commission Secretary, Port Commission  
Phil Ginsburg, General Manager, Recreation and Parks Department  
Jonas Ionin, Commission Secretary, Historic Preservation Commission

FROM: *el*  
*fn* Alisa Somera, Legislative Deputy Director  
Land Use and Transportation Committee

DATE: December 12, 2017

SUBJECT: LEGISLATION INTRODUCED

---

The Board of Supervisors' Land Use and Transportation Committee has received the following proposed legislations, introduced by Mayor Lee on December 5, 2017:

**File No. 170940**

**Ordinance amending the Planning Code and the Zoning Map to add the Mission Rock Special Use District, generally bounded by China Basin to the north; Pier 48, the marginal wharf between Pier 48 and Pier 50, the associated shoreline area and Terry Francois Boulevard to the east; Mission Rock Street to the south; and 3rd Street to the west; to amend other related provisions; making findings under the California Environmental Quality Act; and making findings of consistency with the General Plan, the eight priority policies of Planning Code, Section 101.1, and Planning Code, Section 302.**

**File No. 171286**

**Resolution affirming the Planning Department's certification of the Final Environmental Impact Report and adopting environmental findings under the California Environmental Quality Act (CEQA), CEQA Guidelines, and**

**San Francisco Administrative Code, Chapter 31, including findings of fact, findings regarding significant impacts and significant and unavoidable impacts, evaluation of mitigation measures and alternatives, a statement of overriding considerations, and adoption of a mitigation monitoring and reporting program related to the approvals for the proposed Seawall Lot 337 and Pier 48 Mixed-Use Project.**

If you have comments or reports to be included with the file, please forward them to me at the Board of Supervisors, City Hall, Room 244, 1 Dr. Carlton B. Goodlett Place, San Francisco, CA 94102 or by email at: [alisa.somera@sfgov.org](mailto:alisa.somera@sfgov.org).

c: Scott Sanchez, Planning Department, Historic Preservation Commission  
Lisa Gibson, Planning Department, Historic Preservation Commission  
AnMarie Rodgers, Planning Department, Historic Preservation Commission  
Aaron Starr, Planning Department  
Joy Navarrete, Planning Department, Historic Preservation Commission  
Laura Lynch, Planning Department  
Eugene Flannery, Mayor's Office of Housing and Community Development  
Amy Chan, Mayor's Office of Housing and Community Development  
Daley Dunham, Port Department  
Sarah Madland, Recreation and Parks Department  
John Rahaim, Historic Preservation Commission  
Tim Frye, Historic Preservation Commission  
Andrea Ruiz-Esquide, Historic Preservation Commission  
Georgia Powell, Historic Preservation Commission

BOARD of SUPERVISORS

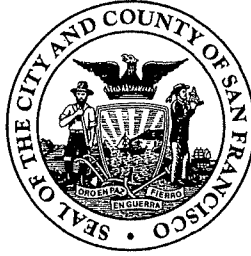

City Hall  
1 Dr. Carlton B. Goodlett Place, Room 244  
San Francisco 94102-4689  
Tel. No. 554-5184  
Fax No. 554-5163  
TDD/TTY No. 554-5227

September 12, 2017

Planning Commission  
Attn: Jonas Ionin  
1650 Mission Street, Ste. 400  
San Francisco, CA 94103

Dear Commissioners:

On September 5, 2017, Mayor Lee introduced the following legislation:

**File No. 170940**

**Ordinance amending the Planning Code and the Zoning Map to add the Mission Rock Special Use District, generally bounded by China Basin to the north; Pier 48, the marginal wharf between Pier 48 and Pier 50, the associated shoreline area and Terry Francois Boulevard to the east; Mission Rock Street to the south; and 3rd Street to the west; to amend other related provisions; making findings under the California Environmental Quality Act; and making findings of consistency with the General Plan, the eight priority policies of Planning Code, Section 101.1, and Planning Code, Section 302.**

The proposed ordinance is being transmitted pursuant to Planning Code, Section 302(b), for public hearing and recommendation. The ordinance is pending before the Land Use and Transportation Committee and will be scheduled for hearing upon receipt of your response.

Angela Calvillo, Clerk of the Board

A handwritten signature in cursive script, appearing to read "Erica Major".

By: Erica Major, Assistant Clerk  
Land Use and Transportation Committee

- c: John Rahaim, Director of Planning
- Aaron Starr, Manager of Legislative Affairs
- Scott Sanchez, Zoning Administrator
- Lisa Gibson, Acting Environmental Review Officer
- AnMarie Rodgers, Senior Policy Advisor
- Laura Lynch, Environmental Planning
- Joy Navarrete, Environmental Planning

BOARD of SUPERVISORS



City Hall  
1 Dr. Carlton B. Goodlett Place, Room 244  
San Francisco 94102-4689  
Tel. No. 554-5184  
Fax No. 554-5163  
TDD/TTY No. 554-5227

## MEMORANDUM

TO: John Rahaim, Director, Planning Department  
Kate Hartley, Acting Director, Mayor's Office of Housing and Community Development  
Elaine Forbes, Executive Director, Port Department  
Amy Quesada, Commission Secretary, Port Commission  
Phil Ginsburg, General Manager, Recreation and Parks Department  
Jonas Ionin, Commission Secretary, Historic Preservation Commission

FROM: Erica Major, Assistant Clerk, Land Use and Transportation Committee

DATE: September 12, 2017

SUBJECT: LEGISLATION INTRODUCED

---

The Board of Supervisors' Land Use and Transportation Committee has received the following proposed legislation, introduced by Mayor Lee on September 5, 2017:

**File No. 170940**

**Ordinance amending the Planning Code and the Zoning Map to add the Mission Rock Special Use District, generally bounded by China Basin to the north; Pier 48, the marginal wharf between Pier 48 and Pier 50, the associated shoreline area and Terry Francois Boulevard to the east; Mission Rock Street to the south; and 3rd Street to the west; to amend other related provisions; making findings under the California Environmental Quality Act; and making findings of consistency with the General Plan, the eight priority policies of Planning Code, Section 101.1, and Planning Code, Section 302.**

If you have comments or reports to be included with the file, please forward them to me at the Board of Supervisors, City Hall, Room 244, 1 Dr. Carlton B. Goodlett Place, San Francisco, CA 94102 or by email at: [erica.major@sfgov.org](mailto:erica.major@sfgov.org).



Referral from Board of Supervisors  
Land Use and Transportation Committee

- c: Scott Sanchez, Planning Department  
Lisa Gibson, Planning Department  
AnMarie Rodgers, Planning Department  
Aaron Starr, Planning Department  
Joy Navarrete, Planning Department  
Laura Lynch, Planning Department  
Eugene Flannery, Mayor's Office of Housing and Community Development  
Amy Chan, Mayor's Office of Housing and Community Development  
Daley Dunham, Port Department  
Sarah Madland, Recreation and Parks Department  
Tim Frye, Historic Preservation Commission  
Andrea Ruiz-Esquide, Historic Preservation Commission  
Georgia Powell, Historic Preservation Commission



OFFICE OF THE MAYOR  
SAN FRANCISCO

TO: Angela Calvillo, Clerk of the Board of Supervisors  
FROM: Mayor Mark E. Farrell  
RE: Planning Code, Zoning Map - Mission Rock Special Use District  
DATE: January 30, 2018

---

Attached for introduction to the Board of Supervisors is an ordinance amending the Planning Code and the Zoning Map to add the Mission Rock Special Use District, generally bounded by China Basin to the north; Pier 48, the marginal wharf between Pier 48 and Pier 50, the associated shoreline area and Terry Francois Boulevard to the east; Mission Rock Street to the south; and 3rd Street to the west; to amend other related provisions; making findings under the California Environmental Quality Act; and making findings of consistency with the General Plan, the eight priority policies of Planning Code, Section 101.1, and Planning Code, Section 302.

This Ordinance is substitute legislation for File No. 170940, pending in the Land Use and Transportation Committee.

I respectfully request that this item be heard in the Land Use and Transportation Committee on February 5, 2018.

Should you have any questions, please contact Mawuli Tugbenyoh (415) 554-5168.