

File No. 190579

Committee Item No. 2

Board Item No. 30

COMMITTEE/BOARD OF SUPERVISORS

AGENDA PACKET CONTENTS LIST

Committee: Budget & Finance Sub-Committee

Date July 17, 2019

Board of Supervisors Meeting

Date July 23, 2019

Cmte Board

- | | | |
|-------------------------------------|-------------------------------------|--|
| <input type="checkbox"/> | <input type="checkbox"/> | Motion |
| <input checked="" type="checkbox"/> | <input checked="" type="checkbox"/> | Resolution |
| <input type="checkbox"/> | <input type="checkbox"/> | Ordinance |
| <input type="checkbox"/> | <input type="checkbox"/> | Legislative Digest |
| <input checked="" type="checkbox"/> | <input checked="" type="checkbox"/> | Budget and Legislative Analyst Report |
| <input type="checkbox"/> | <input type="checkbox"/> | Youth Commission Report |
| <input checked="" type="checkbox"/> | <input checked="" type="checkbox"/> | Introduction Form |
| <input checked="" type="checkbox"/> | <input checked="" type="checkbox"/> | Department/Agency Cover Letter and/or Report |
| <input type="checkbox"/> | <input type="checkbox"/> | MOU |
| <input type="checkbox"/> | <input type="checkbox"/> | Grant Information Form |
| <input type="checkbox"/> | <input type="checkbox"/> | Grant Budget |
| <input type="checkbox"/> | <input type="checkbox"/> | Subcontract Budget |
| <input checked="" type="checkbox"/> | <input checked="" type="checkbox"/> | Contract/Agreement |
| <input type="checkbox"/> | <input type="checkbox"/> | Form 126 – Ethics Commission |
| <input type="checkbox"/> | <input type="checkbox"/> | Award Letter |
| <input type="checkbox"/> | <input type="checkbox"/> | Application |
| <input type="checkbox"/> | <input type="checkbox"/> | Public Correspondence |

OTHER (Use back side if additional space is needed)

- | | | |
|--------------------------|-------------------------------------|---------------------------------|
| <input type="checkbox"/> | <input checked="" type="checkbox"/> | <u>Power Point Presentation</u> |
| <input type="checkbox"/> | <input type="checkbox"/> | _____ |
| <input type="checkbox"/> | <input type="checkbox"/> | _____ |
| <input type="checkbox"/> | <input type="checkbox"/> | _____ |
| <input type="checkbox"/> | <input type="checkbox"/> | _____ |
| <input type="checkbox"/> | <input type="checkbox"/> | _____ |
| <input type="checkbox"/> | <input type="checkbox"/> | _____ |
| <input type="checkbox"/> | <input type="checkbox"/> | _____ |
| <input type="checkbox"/> | <input type="checkbox"/> | _____ |
| <input type="checkbox"/> | <input type="checkbox"/> | _____ |
| <input type="checkbox"/> | <input type="checkbox"/> | _____ |
| <input type="checkbox"/> | <input type="checkbox"/> | _____ |

Completed by: Linda Wong Date July 12, 2019

Completed by: Linda Wong Date July 18, 2019

1 [Revenue Agreement - Retroactive - JC Decaux San Francisco, LLC. - Public Toilets and
2 Public Service Kiosk Agreement - \$12,950,000]

3 **Resolution retroactively approving a Revenue Agreement between Public Works and**
4 **JC Decaux San Francisco, LLC, for an automatic public toilet and public service kiosk**
5 **program with anticipated revenues of over \$12,950,000 and a term of 21.5 years**
6 **commencing on July 1, 2019; and affirming the Planning Department's determination**
7 **under the California Environmental Quality Act.**

8
9 WHEREAS, San Francisco Public Works issued a competitive solicitation through its
10 Request for Proposals dated April 26, 2016, for Public Toilets and Advertising Kiosks; and

11 WHEREAS, JC Decaux San Francisco, LLC ("JC Decaux") was the only company that
12 responded to this solicitation with a proposal dated June 24, 2016; and

13 WHEREAS, JC Decaux has been providing similar services for over 20 years under the
14 First and Second Amended and Restated Automatic Public Toilet and Public Service Kiosk
15 Agreement, effective as of August 2, 1994, and as further amended from time to time; and

16 WHEREAS, After receiving comments on the initially proposed design, Public Works
17 and JC Decaux ran an invitation-only design competition of local San Francisco design and
18 architecture firms and on May 28, 2018 selected a winning design; and

19 WHEREAS, This new design received approval from the Historic Preservation
20 Commission on October 17, 2018 and the Arts Commission on December 3, 2018; and

21 WHEREAS, On October 5, 2018, the Planning Department issued an Addendum to the
22 Final Negative Declaration for the Kiosk and Automatic Toilet Replacement Project, originally
23 issued September 23, 1993, and concluded that the analyses conducted and the conclusions
24 reached in the Final Negative Declaration adopted and issued on September 23, 1993 for the
25 original project remain valid and that no supplemental environmental review is required, and a

1 copy of the Addendum to the Negative Declaration for the Kiosk and Automatic Toilet
2 Replacement Project is on file with the Clerk of the Board of Supervisors in File No. 190579
3 and is incorporated by reference; and

4 WHEREAS, In the new Agreement, JC Decaux will maintain and operate automatic
5 public toilets free of charge for the public on public right of ways and public land, replace and
6 upgrade all 25 existing and approved automatic public toilets with a new design, compensate
7 the City in the form of guaranteed fee payments and potential payments tied to gross
8 advertising revenue, display public service messages, and provide 48,180 hours of attendant
9 services annually in exchange for the right to operate up to 114 advertising kiosks on public
10 right of ways, replace and upgrade 114 existing advertising kiosks, and add digital screens to
11 its current advertising program over the course of a 21.5 year term; and

12 WHEREAS, In implementing the static and digital public service messaging program
13 and allocating the use of space within the vending kiosks, Public Works will develop and
14 adopt a policy defining the fair and equitable use of these public spaces as well as continue
15 the Arts Commission's role in programming the public service messages for the kiosks on
16 Market Street; and

17 WHEREAS, Upon completion of the policy, Public Works will bring it before the Board
18 of Supervisors for approval by Resolution; and

19 WHEREAS, The anticipated value of attendant services is an estimated \$57,760,000
20 over the term of the Agreement; and

21 WHEREAS, Anticipated revenues from this Agreement are an estimated \$12,950,000
22 and Charter Section 9.118(a) requires that all contracts that when entered into by a
23 department, having anticipated revenue to the City and County of \$1,000,000 or more shall be
24 subject to approval of the Board of Supervisors by resolution; and

1 WHEREAS, The term of this Agreement will be 21.5 years, commencing on July 1,
2 2019, and Charter Section 9.118(b) requires that all agreements entered into by a department
3 having a term in excess of ten years shall be subject to approval of the Board of Supervisors
4 by resolution; now, therefore, be it

5 RESOLVED, That the Board of Supervisors approves the proposed Public Toilet and
6 Public Service Kiosk Agreement; and, be it

7 FURTHER RESOLVED, That the Board of Supervisors has reviewed and considered
8 the Final Negative Declaration and Addendum, and affirms the Planning Department's
9 determination that the analyses conducted and the conclusions reached in the Final Negative
10 Declaration for the original project remain valid and that no supplemental environmental
11 review is required; and, be it

12 FURTHER RESOLVED, That within 30 days of the Agreement being fully executed by
13 all parties, Public Works shall provide the final amendment to the Clerk of the Board for
14 inclusion into the official file.

<p>Item 2 File 19-0579 <i>(Continued from July 10, 2019)</i></p>	<p>Department: Public Works</p>
<p>EXECUTIVE SUMMARY</p>	
<p>Legislative Objectives</p>	
<p>The proposed resolution (1) approves a revenue agreement between Public Works and JC Decaux for an automatic public toilet and public service kiosk program with anticipated revenues of over \$12,950,000 over a term of 21.5 years commencing July 1, 2019; and (2) affirms the Planning Department's determination under the California Environmental Quality Act.</p>	
<p>Key Points</p>	
<ul style="list-style-type: none"> • Since 1994, JC Decaux has owned and maintained 25 public toilets and 114 advertising kiosks under an agreement with Public Works. • Public Works is seeking to replace the public toilets, which have been in place since the 1990s, and to expand potential lease options for the kiosks. • In mid-2015, Public Works issued an RFP for the program and received three bids, but the bids could not be evaluated due to a lack of clarity in the RFP. In April 2016, Public Works re-issued a revised RFP and JC Decaux was the only responsive bidder. 	
<p>Fiscal Impact</p>	
<ul style="list-style-type: none"> • In 2018, Public Works received a total of \$599,263 in fees and revenues from JC Decaux under the existing agreement. In 2019, the City will incur General Fund costs of \$2,402,223 for service attendants to monitor activities at 12 of the 25 public toilets. As a result, Public Works' net revenues from the current arrangement are negative amounts. • Public Works is projected to receive approximately \$13,480,000 in revenues and fees over the 21.5-year term of the agreement. Since the City would provide attendant services for 12 public toilets in the first year of the agreement at a cost of approximately \$2.4 million and at 1 public toilet for the remainder of the term at a cost of approximately \$200,000 per year, the City's net revenues would total approximately \$6,980,000 or an average of \$324,419 per year. 	
<p>Recommendation</p>	
<ul style="list-style-type: none"> • Because the proposed agreement would result in positive revenues to the City, the Budget and Legislative Analyst recommends approval. 	

MANDATE STATEMENT

City Charter Section 9.118(a) states that contracts entered into by a department, board, or commission that (i) have anticipated revenues of \$1 million or more, or (ii) have anticipated revenues of \$1 million or more and require modifications, are subject to Board of Supervisors approval.

BACKGROUND

In 1994, San Francisco Public Works (Public Works) and JC Decaux San Francisco, LLC (JC Decaux) entered into an agreement for a public toilet and public service kiosk pilot program. Under the agreement, JC Decaux installs, owns, and maintains the toilets and kiosks, in exchange for the right to sell advertisements. In December 1998, the Board of Supervisors approved an expansion of the agreement (File No. 98-1599) beyond the pilot phase, extending the term through October 17, 2016. The Board of Supervisors subsequently approved four additional amendments to the agreement¹, extending the term through January 25, 2019.

Public Works issued a Request for Proposals (RFP) in mid-2015 for vendors to continue the program and received three bids: JC Decaux, Intersection, and Clear Channel. However, because the RFP lacked clarity, the bids could not be evaluated. As a result, Public Works rejected all bids. On April 29, 2016, Public Works re-advertised the revised RFP, and JC Decaux was the only responsive bidder.

According to Ms. Julia Dawson, Deputy Director of Finance and Administration at Public Works, Public Works is seeking to replace the public toilets, which have been in place since the 1990s, and to expand potential lease options for the kiosks. According to Ms. Dawson, currently the kiosks can only be leased as newsstands, which have decreased in use substantially over the term of the existing agreement.

DETAILS OF PROPOSED LEGISLATION

The proposed resolution (1) approves a revenue agreement between Public Works and JC Decaux for an automatic public toilet and public service kiosk program with anticipated revenues of over \$12,950,000 over a term of 21.5 years commencing July 1, 2019; and (2) affirms the Planning Department's determination under the California Environmental Quality Act.

Under the proposed agreement, JC Decaux will maintain and operate automatic public toilets free of charge for the public on public right of ways and public land, replace and upgrade all 25 existing and approved automatic public toilets with a new design, compensate the City in the form of guaranteed fee payments and potential payments tied to gross advertising revenue, display public service messages, and provide 48,180 hours of attendant services annually in exchange for the right to operate up to 114 advertising kiosks on public right of ways, replace

¹ Second Amendment (File 16-1019; Resolution No. 447-16); Third Amendment (File 17-0994; Resolution No. 409-17); Fourth Amendment (File 18-0135; Resolution No. 106-18); Fifth Amendment (File 18-0964; Resolution No. 386-18).

and upgrade 114 existing advertising kiosks, and add digital screens to its current advertising program over the course of a 21.5 year term.

FISCAL IMPACT

Under the existing agreement with JC Decaux, Public Works receives both an annual base fee and 7 percent of advertising revenue each calendar year. The base fee was \$25,000 at the beginning of the agreement in 1998 and has been adjusted annually based on the Consumer Price Index (CPI), to the most recent amount of \$45,460 in 2019. In 2018, the total advertising revenue was \$7,911,475, and the revenue share paid to Public Works was approximately \$553,803. Between the base fee and the revenue share, Public Works received \$599,263 in total in 2018. Public Works currently pays for service attendants to monitor activities at 12 of the 25 public toilets using General Fund monies at a General Fund cost to the City of \$2,402,223 in calendar year 2019. JC Decaux currently provides maintenance services for the public toilets and would continue to provide maintenance services under the proposed agreement. As a result, Public Works' net revenues from the current arrangement are negative amounts since the attendant costs exceed the base fee and advertising revenue share.

Under the proposed agreement, there would be a 1.5-year transition period during which time JC Decaux would build out the new public toilets and kiosks at an estimated cost to JC Decaux of approximately \$28.3 million. During this period, Public Works would receive (1) a one-time payment of \$1,500,000; (2) a non-advertising percentage fee of 50 percent of non-advertising revenue², if any, from leasing space on or inside the public service kiosk or public toilet; (3) an annual administrative fee of \$275,000 beginning on the first anniversary of the start date; and (4) an advertising revenue percentage fee of 50 percent on revenue earned by JC Decaux above the threshold amount of \$16,000,000 per year. As shown in Table 1 below, Public Works is projected to receive \$1,775,000 during the 1.5-year transition period, since the gross advertising revenue is projected to be below the threshold amount of \$16,000,000 and any non-advertising revenue would be generated after the new public toilets and kiosks are installed.

Following the transition period, for the remaining 20 years of the agreement term, Public Works would receive (1) an annual administrative fee of \$275,000, adjusted annually by CPI; (2) in-kind attendant services of up to \$2,125,000 per year³, adjusted annually by CPI, which is the equivalent of 11 locations; (3) an advertising revenue percentage fee of 50 percent on revenue generated above the threshold amount of \$16,000,000 per year, adjusted by CPI annually beginning in the sixth contract year; and (4) a non-advertising percentage fee of 50 percent of non-advertising revenue from leasing space on or inside the public service kiosk or public toilet.

² According to Ms. Dawson, the options for non-advertising revenue under the proposed agreement are broader than under the existing agreement. For example, Ms. Dawson reports that JC Decaux has been approached by telecommunications carriers interested in placing repeater devices on the public toilets and kiosks, which is not allowed under the existing agreement and would be allowed under the proposed agreement.

³ The proposed agreement provides an option for the City to receive a service fee in cash if the City determines that a decreased amount of attendant services are needed at the public toilets, with the amount determined by mutual agreement between JC Decaux and Public Works.

As shown in Table 1 below, Public Works is projected to receive approximately \$13,480,000 in revenues and fees over the 21.5-year term of the agreement. Since the City would provide attendant services for 12 public toilets in the first year of the agreement at a cost of approximately \$2.4 million and at 1 public toilet for the remainder of the term at a cost of approximately \$200,000 per year, the City's net revenues would total approximately \$6,980,000 or an average of \$324,419 per year. If the assumptions shown in Table 1 are realized, Public Works would begin receiving positive net revenues for the program in Year 2, unlike the current arrangement which is costing the department more than it is receiving in revenues. Because the proposed agreement would result in positive revenues to the City, the Budget and Legislative Analyst recommends approval.

Table 1: Projected Annual Revenues Less Service Costs (\$ in millions)

Description	Baseline ^a	Year 1	Year 2	Year 3	Year 4	Year 5	Year 6	Year 7	Year 8	Year 9	Year 10	Year 11	Year 12	Year 13	Year 14	Year 15	Year 16	Year 17	Year 18	Year 19	Year 20	Year 21	Year 22 (half)	Total
Gross Advertising Revenue	8.50	8.93	9.80	10.98	12.29	13.65	15.01	16.21	17.22	17.90	18.44	18.99	19.56	20.15	20.76	21.38	22.02	22.68	23.36	24.06	24.78	25.53	12.77	
Year-over-year % change		5%	10%	12%	12%	11%	10%	8%	6%	4%	3%	3%	3%	3%	3%	3%	3%	3%	3%	3%	3%	3%	3%	
City Revenues and Fees																								
City Advertising Revenue Share ^b	0.60								0.12	0.21	0.22	0.22	0.23	0.24	0.24	0.25	0.26	0.27	0.27	0.28	0.29	0.30	0.15	3.55
City Non-Advertising Revenue ^c		0.02	0.02	0.02	0.02	0.02	0.02	0.02	0.02	0.02	0.02	0.02	0.03	0.03	0.03	0.03	0.03	0.03	0.03	0.03	0.03	0.03	0.02	0.52
Administrative Fee ^d	0.04	0.28	0.28	0.28	0.29	0.30	0.31	0.32	0.33	0.34	0.35	0.36	0.37	0.38	0.39	0.40	0.42	0.43	0.44	0.45	0.47	0.48	0.24	7.91
One-Time Payment		1.50																						1.50
Total City Revenue and Fees	0.64	1.78	0.30	0.30	0.31	0.32	0.33	0.34	0.47	0.57	0.59	0.60	0.63	0.65	0.66	0.68	0.71	0.73	0.74	0.76	0.79	0.81	0.41	13.48
City Expenditures																								
Attendant Services ^d	(2.40)	(2.40)	(0.2)	(0.2)	(0.2)	(0.2)	(0.2)	(0.2)	(0.2)	(0.2)	(0.2)	(0.2)	(0.2)	(0.2)	(0.2)	(0.2)	(0.2)	(0.2)	(0.2)	(0.2)	(0.2)	(0.2)	(0.1)	(6.50)
City Net Revenue	(1.76)	(0.62)	0.30	0.30	0.31	0.32	0.33	0.34	0.47	0.57	0.59	0.60	0.63	0.65	0.66	0.68	0.71	0.73	0.74	0.76	0.79	0.81	0.41	6.98

^a Represents the current calendar year revenues, fees, and expenditures under the existing agreement.

^b Assumes that the threshold amount of \$16,000,000 will increase by 3 percent each year beginning in Year 6. Actual CPI adjustments to the threshold amount will vary.

^c Assumes that non-advertising revenues will be generated after the transition period and will increase by 3 percent each year. Actual annual non-advertising revenue changes will vary.

^d Assumes that the administrative fee of \$275,000 will increase by 3 percent each year. Actual CPI adjustments to the administrative fee will vary.

^d Subject to future Board of Supervisors appropriation approval.

3147

RECOMMENDATION

Approve the proposed resolution.

<p>Item 13 File 19-0579</p>	<p>Department: General Services Agency - Department of Public Works (DPW)</p>
<p>EXECUTIVE SUMMARY</p>	
<p>Legislative Objectives</p>	
<p>The proposed resolution (1) approves a revenue agreement between Public Works and JC Decaux for an automatic public toilet and public service kiosk program with anticipated revenues of over \$12,950,000 over a term of 21.5 years commencing July 1, 2019; and (2) affirms the Planning Department’s determination under the California Environmental Quality Act.</p>	
<p>Key Points</p>	
<ul style="list-style-type: none"> • Since 1994, JC Decaux has owned and maintained 25 public toilets and 114 advertising kiosks under an agreement with Public Works. • Public Works is seeking to replace the public toilets, which have been in place since the 1990s, and to expand potential lease options for the kiosks. • In mid-2015, Public Works issued an RFP for the program and received three bids, but the bids could not be evaluated due to a lack of clarity in the RFP. In April 2016, Public Works re-issued a revised RFP and JC Decaux was the only responsive bidder. 	
<p>Fiscal Impact</p>	
<ul style="list-style-type: none"> • In 2018, Public Works received a total of \$599,263 in fees and revenues from JC Decaux under the existing agreement. In 2019, the City will incur General Fund costs of \$2,402,223 for service attendants to monitor activities at 12 of the 25 public toilets. As a result, Public Works’ net revenues from the current arrangement are negative amounts. • Public Works is projected to receive approximately \$13,480,000 in revenues and fees over the 21.5-year term of the agreement. Since the City would provide attendant services for 12 public toilets in the first year of the agreement at a cost of approximately \$2.4 million and at 1 public toilet for the remainder of the term at a cost of approximately \$200,000 per year, the City’s net revenues would total approximately \$6,980,000 or an average of \$324,419 per year. 	
<p>Recommendation</p>	
<ul style="list-style-type: none"> • Approval of the proposed resolution is a policy matter for the Board of Supervisors. 	

MANDATE STATEMENT

City Charter Section 9.118(a) states that contracts entered into by a department, board, or commission that (i) have anticipated revenues of \$1 million or more, or (ii) have anticipated revenues of \$1 million or more and require modifications, are subject to Board of Supervisors approval.

BACKGROUND

In 1994, San Francisco Public Works (Public Works) and JC Decaux San Francisco, LLC (JC Decaux) entered into an agreement for a public toilet and public service kiosk pilot program. Under the agreement, JC Decaux installs, owns, and maintains the toilets and kiosks, in exchange for the right to sell advertisements. In December 1998, the Board of Supervisors approved an expansion of the agreement (File No. 98-1599) beyond the pilot phase, extending the term through October 17, 2016. The Board of Supervisors subsequently approved four additional amendments to the agreement¹, extending the term through January 25, 2019.

Public Works issued a Request for Proposals (RFP) in mid-2015 for vendors to continue the program and received three bids: JC Decaux, Intersection, and Clear Channel. However, because the RFP lacked clarity, the bids could not be evaluated. As a result, Public Works rejected all bids. On April 29, 2016, Public Works re-advertised the revised RFP, and JC Decaux was the only responsive bidder.

According to Ms. Julia Dawson, Deputy Director of Finance and Administration at Public Works, Public Works is seeking to replace the public toilets, which have been in place since the 1990s, and to expand potential lease options for the kiosks. According to Ms. Dawson, currently the kiosks can only be leased as newsstands, which have decreased in use substantially over the term of the existing agreement.

DETAILS OF PROPOSED LEGISLATION

The proposed resolution (1) approves a revenue agreement between Public Works and JC Decaux for an automatic public toilet and public service kiosk program with anticipated revenues of over \$12,950,000 over a term of 21.5 years commencing July 1, 2019; and (2) affirms the Planning Department's determination under the California Environmental Quality Act.

Under the proposed agreement, JC Decaux will maintain and operate automatic public toilets free of charge for the public on public right of ways and public land, replace and upgrade all 25 existing and approved automatic public toilets with a new design, compensate the City in the form of guaranteed fee payments and potential payments tied to gross advertising revenue, display public service messages, and provide 48,180 hours of attendant services annually in exchange for the right to operate up to 114 advertising kiosks on public right of ways, replace

¹ Second Amendment (File 16-1019; Resolution No. 447-16); Third Amendment (File 17-0994; Resolution No. 409-17); Fourth Amendment (File 18-0135; Resolution No. 106-18); Fifth Amendment (File 18-0964; Resolution No. 386-18).

and upgrade 114 existing advertising kiosks, and add digital screens to its current advertising program over the course of a 21.5 year term.

FISCAL IMPACT

Under the existing agreement with JC Decaux, Public Works receives both an annual base fee and 7 percent of advertising revenue each calendar year. The base fee was \$25,000 at the beginning of the agreement in 1998 and has been adjusted annually based on the Consumer Price Index (CPI), to the most recent amount of \$45,460 in 2019. In 2018, the total advertising revenue was \$7,911,475, and the revenue share paid to Public Works was approximately \$553,803. Between the base fee and the revenue share, Public Works received \$599,263 in total in 2018. Public Works currently pays for service attendants to monitor activities at 12 of the 25 public toilets using General Fund monies at a General Fund cost to the City of \$2,402,223 in calendar year 2019. JC Decaux currently provides maintenance services for the public toilets and would continue to provide maintenance services under the proposed agreement. As a result, Public Works' net revenues from the current arrangement are negative amounts since the attendant costs exceed the base fee and advertising revenue share.

Under the proposed agreement, there would be a 1.5-year transition period during which time JC Decaux would build out the new public toilets and kiosks at an estimated cost to JC Decaux of approximately \$28.3 million. During this period, Public Works would receive (1) a one-time payment of \$1,500,000; (2) a non-advertising percentage fee of 50 percent of non-advertising revenue², if any, from leasing space on or inside the public service kiosk or public toilet; (3) an annual administrative fee of \$275,000 beginning on the first anniversary of the start date; and (4) an advertising revenue percentage fee of 50 percent on revenue earned by JC Decaux above the threshold amount of \$16,000,000 per year. As shown in Table 1 below, Public Works is projected to receive \$1,775,000 during the 1.5-year transition period, since the gross advertising revenue is projected to be below the threshold amount of \$16,000,000 and any non-advertising revenue would be generated after the new public toilets and kiosks are installed.

Following the transition period, for the remaining 20 years of the agreement term, Public Works would receive (1) an annual administrative fee of \$275,000, adjusted annually by CPI; (2) in-kind attendant services of up to \$2,125,000 per year³, adjusted annually by CPI, which is the equivalent of 11 locations; (3) an advertising revenue percentage fee of 50 percent on revenue generated above the threshold amount of \$16,000,000 per year, adjusted by CPI annually beginning in the sixth contract year; and (4) a non-advertising percentage fee of 50 percent of non-advertising revenue from leasing space on or inside the public service kiosk or public toilet.

² According to Ms. Dawson, the options for non-advertising revenue under the proposed agreement are broader than under the existing agreement. For example, Ms. Dawson reports that JC Decaux has been approached by telecommunications carriers interested in placing repeater devices on the public toilets and kiosks, which is not allowed under the existing agreement and would be allowed under the proposed agreement.

³ The proposed agreement provides an option for the City to receive a service fee in cash if the City determines that a decreased amount of attendant services are needed at the public toilets, with the amount determined by mutual agreement between JC Decaux and Public Works.

As shown in Table 1 below, Public Works is projected to receive approximately \$13,480,000 in revenues and fees over the 21.5-year term of the agreement. Since the City would provide attendant services for 12 public toilets in the first year of the agreement at a cost of approximately \$2.4 million and at 1 public toilet for the remainder of the term at a cost of approximately \$200,000 per year, the City's net revenues would total approximately \$6,980,000 or an average of \$324,419 per year. If the assumptions shown in Table 1 are realized, Public Works would begin receiving positive net revenues for the program in Year 2, unlike the current arrangement which is costing the department more than it is receiving in revenues.

Table 1: Projected Annual Revenues Less Service Costs (\$ in millions)

Description	Baseline ^a	Year 1	Year 2	Year 3	Year 4	Year 5	Year 6	Year 7	Year 8	Year 9	Year 10	Year 11	Year 12	Year 13	Year 14	Year 15	Year 16	Year 17	Year 18	Year 19	Year 20	Year 21	Year 22 (half)	Total
Gross Advertising Revenue	8.50	8.93	9.80	10.98	12.29	13.65	15.01	16.21	17.22	17.90	18.44	18.99	19.56	20.15	20.76	21.38	22.02	22.68	23.36	24.06	24.78	25.53	12.77	
Year-over-year % change		5%	10%	12%	12%	11%	10%	8%	6%	4%	3%	3%	3%	3%	3%	3%	3%	3%	3%	3%	3%	3%	3%	
City Revenues and Fees																								
City Advertising Revenue Share ^b	0.60								0.12	0.21	0.22	0.22	0.23	0.24	0.24	0.25	0.26	0.27	0.27	0.28	0.29	0.30	0.15	3.55
City Non-Advertising Revenue ^c		0.02	0.02	0.02	0.02	0.02	0.02	0.02	0.02	0.02	0.02	0.02	0.03	0.03	0.03	0.03	0.03	0.03	0.03	0.03	0.03	0.03	0.02	0.52
Administrative Fee ^d	0.04	0.28	0.28	0.28	0.29	0.30	0.31	0.32	0.33	0.34	0.35	0.36	0.37	0.38	0.39	0.40	0.42	0.43	0.44	0.45	0.47	0.48	0.24	7.91
One-Time Payment		1.50																						1.50
Total City Revenue and Fees	0.64	1.78	0.30	0.30	0.31	0.32	0.33	0.34	0.47	0.57	0.59	0.60	0.63	0.65	0.66	0.68	0.71	0.73	0.74	0.76	0.79	0.81	0.41	13.48
City Expenditures																								
Attendant Services ^d	(2.40)	(2.40)	(0.2)	(0.2)	(0.2)	(0.2)	(0.2)	(0.2)	(0.2)	(0.2)	(0.2)	(0.2)	(0.2)	(0.2)	(0.2)	(0.2)	(0.2)	(0.2)	(0.2)	(0.2)	(0.2)	(0.2)	(0.1)	(6.50)
City Net Revenue	(1.76)	(0.62)	0.30	0.30	0.31	0.32	0.33	0.34	0.47	0.57	0.59	0.60	0.63	0.65	0.66	0.68	0.71	0.73	0.74	0.76	0.79	0.81	0.41	6.98

^a Represents the current calendar year revenues, fees, and expenditures under the existing agreement.

^b Assumes that the threshold amount of \$16,000,000 will increase by 3 percent each year beginning in Year 6. Actual CPI adjustments to the threshold amount will vary.

^c Assumes that non-advertising revenues will be generated after the transition period and will increase by 3 percent each year. Actual annual non-advertising revenue changes will vary.

^c Assumes that the administrative fee of \$275,000 will increase by 3 percent each year. Actual CPI adjustments to the administrative fee will vary.

^d Subject to future Board of Supervisors appropriation approval.

3153

RECOMMENDATION

Approval of the proposed resolution is a policy matter for the Board of Supervisors.

FL# 190579
Received in Committee
7/17/19 *fw*

5.12 Attendant Services for Public Toilets

K. In selection of the local community organizations tasked with sourcing attendants, CONTRACTOR must consider the extent to which a local community organization can assure "Labor Harmony" in its operations to minimize the possibility of disruption of Attendant Services. This agreement construes "Labor Harmony" broadly, and does not require Contractor and selected local community organization to adopt any particular method of assuring labor harmony, but requires the Contractor to provide documentation as part of the approval process detailed in Section 5.12E indicating the extent to which the selected local community partner is committed to ensuring labor harmony in performing Attendant Services.

File # 190579
Received in Committee
7/17/19
jm

PUBLIC TOILET AND PUBLIC SERVICE KIOSK AGREEMENT

Between

the City and County of San Francisco

and

JCDecaux San Francisco, LLC

Table of Contents

1.0 General Provisions 2

1.1 Definitions 2

1.2 Certification of Funds Budget and Fiscal Provisions: Termination in the Event of Non-Appropriation... 5

1.3 Term of Agreement 5

1.4 CONTRACTOR to Provide Public Toilets and to Install and Maintain Public Service Kiosks as
Consideration for Public Toilets 5

1.5 General Terms and Conditions for the Installation of Street Furniture 6

1.6 Grant of Advertising Rights..... 6

1.7 Ownership of Public Toilets and Public Service Kiosks 7

1.8 Fees due by CONTRACTOR to CITY..... 7

1.9 Late Payment 9

1.10 Cost Related to the Installation of Public Toilets After the Installation of All Replacement Public Toilet
Costs..... 9

1.11 Fee Reporting and Annual Reconciliation of Amounts 10

1.12 Books and Records 10

1.13 Performance Bond or Letter of Credit for Installation..... 11

1.14 Performance Bond or Letter of Credit for Performance 14

1.15 Insurance..... 15

1.16 Indemnification 17

1.17 Notices: When Effective..... 18

1.18 Subcontracting 18

1.19 Financial Reports..... 19

1.20 Management Reports 19

1.21 Guaranty of Obligation 19

2.0 Public Toilets 19

2.1 Design and Construction of Public Toilets: Prototype 19

2.2 No Real Property Interest 20

2.3 Approval Requirements for Public Toilet 20

2.4 CITY Review of Plans and Submittals..... 21

2.5 Replacement and Installation Covenants 21

2.6 Locations and Siting of Additional Public Toilets 23

2.7 Relocation of Public Toilets After Installation 23

2.8 Clearance Requirements for Public Toilets 25

2.9 Approval of Other Agencies 25

2.10 Location Drawings and Engineering Plans for Public Toilets 25

2.11 Electrical, Sewer, Telephone and Water Services; Installation..... 26

2.12 Restoration of Sites After Installation 26

2.13 Compliance Regarding Public Toilets 27

3.0 Public Service Kiosk License..... 27

3.1 Design and Installation of Public Service Kiosks 27

3.2 Permit Approvals for Public Service Kiosks..... 28

3.3 No Real Property Interest in Public Service Kiosks 28

3.4 Usage of Public Service Kiosks 29

3.5 Locations of Public Service Kiosks 29

3.6 Relocation and Temporary Removal of Public Service Kiosks..... 29

3.7 Clearance Requirements for Public Service Kiosks 31

3.8 Public Service Kiosk Design 31

3.9 Approval of Other Agencies 31

3.10	Location Drawings and Engineering Plans for Public Service Kiosks	32
3.11	Electrical Connections and Service Responsibility of CONTRACTOR.....	32
3.12	Other Regulatory Issues for Public Service Kiosks	33
3.13	Restoration of Sites.....	33
4.0	Advertising	33
4.1	Advertising Displays	33
4.2	Size and Luminosity of Advertising	33
4.3	Commercial Advertising and Public Service Messaging.....	34
4.4	Authorized Advertising Material.....	34
4.5	Prohibited Advertising Content	35
4.6	Changes in Authorized Advertising.....	36
4.7	Advertising Displays Equivalence.....	36
4.8	Experiential Advertising	36
4.9	Advertising Pilots	37
5.0	Maintenance, Attendants and Operations.....	37
5.1	Public Toilet and Public Service Kiosk Maintenance and Operations	37
5.2	Public Toilet Operations	37
5.3	Services to be Provided by CONTRACTOR	37
5.4	Sidewalk Repairs	38
5.5	Inspection and Clean-Up of Public Toilets and Public Service Kiosks	38
5.6	Approved Cleaning Products.....	38
5.7	Repair and Replacement	38
5.8	No Charge for Use of Public Toilets.....	39
5.9	Use of Public Service Kiosks	39
5.10	Additional Installation and Relocation Terms.....	40
5.11	Utilities	41
5.12	Attendant Services for Public Toilets	41
5.13	Technology for Public Service Kiosks and Public Toilets	42
6.0	Accessibility Requirements	43
6.1	Accessibility.....	43
6.2	Accessible Design, Construction, and Operation	43
6.3	Path of Travel	43
7.0	Termination of Agreement	43
7.1	Relocation and Termination: Waiver of Rights.....	43
7.2	Termination of Agreement	44
7.3	Event of Default; Remedies.....	4544
7.4	No Waiver of Subsequent Breaches or Defaults.....	46
8.0	Miscellaneous Contract Provisions.....	46
8.1	San Francisco Office	46
8.2	Regulatory Compliance; Conflicts of Interest	46
8.3	Other Agreements between CITY and CONTRACTOR	47
8.4	Assignment	47
8.5	Binding Effect of Agreement	47
8.6	Taxes	4847
8.7	Legal Relationship	49
8.8	Independent Contractor	49
8.9	Payment of Employment Taxes and Other Expenses	5049
8.10	Qualified Personnel and Regulatory Compliance.....	50

8.11	Local Business Enterprise Utilization	50
8.12	Nondiscrimination; Penalties	<u>51</u> 50
8.13	Tropical Hardwood and Virgin Redwood Ban	51
8.14	Resource Conservation	51
8.15	Sunshine Ordinance	<u>52</u> 51
8.16	Advertising Rights	<u>52</u> 51
8.17	Cooperative Drafting; Cooperation.....	52
8.18	Non-Waiver of Rights.....	52
8.19	Modification and Amendment of Agreement	52
8.20	Section Headings.....	52
8.21	Agreement Made in California; Venue.....	52
8.22	Construction.....	52
8.23	Entire Agreement	<u>53</u> 52
8.24	MacBride Principles - Northern Ireland	53

List of Appendices

- A Location of Approved and Existing Public Toilets
- B Location of Licensed Public Service Kiosks
- C Form of Guaranty of JCDecaux North America, Inc.
- D Approved Toilet and Kiosk Designs

**PUBLIC TOILET AND PUBLIC SERVICE KIOSK AGREEMENT
BY AND BETWEEN THE CITY AND COUNTY OF SAN FRANCISCO AND
JCDECAUX SAN FRANCISCO, LLC.**

This AGREEMENT is made and entered into this ____ day of _____ 2019, by and between the CITY AND COUNTY OF SAN FRANCISCO, a municipal corporation, acting by and through its Department of Public Works, and JCDECAUX SAN FRANCISCO, LLC, a California limited liability company, hereinafter referred to as "CONTRACTOR". Both the CITY and CONTRACTOR are a "Party" and together they are referred to as the "Parties".

Recitals

WHEREAS, the Department of Public Works issued a competitive solicitation through its Request for Proposal dated April 26, 2016 for Public Toilets and Advertising Kiosks ("Request for Proposal"); and

WHEREAS, CONTRACTOR was the only company that responded to this solicitation with a proposal dated June 24, 2016; and

WHEREAS, CONTRACTOR has experience providing similar services as requested under the Request for Proposal pursuant to an existing relationship with the CITY for over 20 years under the First and Second Amended and Restated Automatic Public Toilet and Public Service Kiosk Agreement by and between The City and County of San Francisco and JCDecaux San Francisco, Inc. (formerly JCDecaux United Street Furniture, Inc.), effective as of August 2, 1994, as further amended from time to time; and

WHEREAS, now CITY has selected CONTRACTOR to, and CONTRACTOR desires to, provide Public Toilets and Attendants for certain Public Toilets during certain hours, and provide related street furniture in exchange for the right to sell and place advertising and provide other services on Public Service Kiosks and related street furniture on public property pursuant to this Agreement; and

WHEREAS, the City determined that the design proposed for the program should be one chosen through an invitation-only design competition of local San Francisco design and architecture firms, instead of the concepts proposed by the CONTRACTOR and the CONTRACTOR agreed; and

WHEREAS, on May 28, 2018, designs by the DESIGNER were selected out of a pool of 20 local design and architecture firms after the invitation-only competition; and

WHEREAS, the CITY and CONTRACTOR wish to enter into an Agreement to document the provision of these rights and duties; and

WHEREAS, approval for this agreement was obtained from the Board of Supervisors by Resolution _____ dated _____;

Now, THEREFORE, the Parties agree as follows:

1.0 General Provisions

1.1 Definitions

Where any word or phrase defined below or a pronoun used in place thereof, is used in any part of this Agreement, it shall have the meaning set forth here.

1. "Additional Public Toilet Costs" means the amounts payable by the CITY to the CONTRACTOR for the recurring costs including, but not limited to, utilities, taxes and maintenance of additional Public Toilets installed after the CONTRACTOR has installed the twenty-five (25) replacement Public Toilets, as specified in the Section 2.5 (l) of this Agreement.
2. "Advertising Revenue" means gross revenue generated by the CONTRACTOR from the sale of commercial advertising on the Public Service Kiosks, excluding advertising agency commissions and any pass-through payments to the CONTRACTOR by any party, which are not derived from the display of content on advertising panels, calculated on an accrual basis in accordance with U.S. generally accepted accounting principles.
3. "Advertising Revenue Percentage Fee" means a revenue share of fifty percent (50%) paid by the CONTRACTOR to the CITY, as specified in Section 1.8.
4. "Agreement" means this contract, as originally executed and as amended or extended from time to time; words such as "herein," "hereinafter," "hereof," "hereto" and "hereunder," when used with reference to this Agreement, refer to this Agreement as a whole, unless the context otherwise requires.
5. "Annual Administrative Fee" means two hundred and seventy-five thousand dollars (\$275,000) paid by the CONTRACTOR to the CITY on a twelve (12) month basis (and pro-rated for any time period that is not a full twelve (12) month period) and which shall be due and payable as specified in Section 1.8.
6. "Annual Service Fee" means two million, one-hundred fifty thousand dollars (\$2,150,000) paid by the CONTRACTOR on a Contract Year basis (and pro rated for any time period that is not a full Contract Year) and which shall be due and payable as specified in Section 1.8.
7. "Attendant" or "Attendants" means the individual/s who will provide Attendant Services pursuant to the terms and conditions of this Agreement.
8. "Attendant Service Credit" shall mean the Annual Service Fee less in-kind payment made in the form of Attendant Services for each Contract Year.
9. "Attendant Services" means services provided by Attendants in connection with Public Toilets pursuant to the terms and conditions of this Agreement.
10. "Authorization" means an order or other written directive of the CITY properly executed by the Director, or his or her designated agent, unless the context otherwise requires.

11. "Certified Annual True-Up Amount" means a calculation of all revenues owed to the CITY by the CONTRACTOR minus any expenses owed to the CONTRACTOR by the CITY, resulting in an amount owed the CITY or the CONTRACTOR as specified in Section 1.11. This calculation is performed annually.
12. "CITY" means the City and County of San Francisco, a municipal corporation; except where otherwise indicated by the context, all references to CITY shall also mean and include the Port of San Francisco.
13. "CITY Approvals" means the written approvals and notifications provided by the CITY to the CONTRACTOR.
14. "Contract Year" means each twelve (12) month period, beginning on the day after the end of the Transition Period and continuing until the Expiration Date.
15. "CONTRACTOR" has the meaning ascribed to it in the preamble.
16. "CPI" means the Consumer Price Index (CPI) (Urban Wage Earners and Clerical Workers in San Francisco – Oakland Standard Metropolitan Statistical Area (1984/86)).
17. "DESIGNER" means the SmithGroup.
18. "Director" means the Director of the CITY's Department of Public Works.
19. "Downtown Area" means the geographic area of the CITY bounded on the south by the southerly line of Folsom Street, on the west by the westerly line of Van Ness Avenue extended north to the San Francisco Bay, and on the north and east by the shoreline of the San Francisco Bay.
20. "Expiration Date" means the last day of the Term.
21. "Force Majeure" means delays in CONTRACTOR's performance of its obligations hereunder due to actions outside of its control, including but not limited to, acts of God or of the public enemy, fires, floods, strikes and other technical or operational impediments, criminal acts of Third Parties, freight embargoes, unusually severe weather, delays in the issuance of permits required by governmental authorities, or a legal action filed which challenges (a) the implementation of the Agreement, (b) the installation of an Automatic Public Toilet or Public Service Kiosk, or (c) prohibits the operation of ten percent (10%) or more of the advertising panels.
22. "Fee" or "Fees" means amount/s to be paid to the CITY by the CONTRACTOR under the terms and conditions of this Agreement.
23. "Initial Costs" means any and all costs of purchasing and installing a Public Toilet including, but not limited to, the cost of constructing the unit, associated shipping, taxes and duties, as well as all construction work undertaken to install the Public Toilet in its desired location.

24. "Non-Advertising Percentage Fee" means fifty percent (50%) of Non- Advertising Revenue payable to the CITY by the CONTRACTOR in accordance with this Agreement.
25. "Non-Advertising Revenue" means all revenue generated by the CONTRACTOR, which is based on leasing space on or inside the Public Service Kiosk or the Public Toilet and excludes any payments to the CONTRACTOR by any Third Party for the CONTRACTOR to pay another Third Party in connection with products and/or services provided by such Third Party.
26. "Notice to Proceed" or "Notices to Proceed" means the written communication(s) from the Director on behalf of the CITY to the CONTRACTOR, specifying the request for and location of installation for a Public Toilet or a Public Service Kiosk to be installed by the CONTRACTOR.
27. "Party" and "Parties" has the meanings referred to in the preamble.
28. "PORT" means the Port of San Francisco.
29. "Port Director" means the Executive Director of the Port of San Francisco.
30. "Port Property" means the geographic area of the CITY under the jurisdiction of the Port Commission.
31. "Prototype" means the full scale, fully-operational Public Toilet that is installed by the CONTRACTOR for review and approval by the CITY during the Initial Phase prior to the construction and installation of any Public Toilets under this Agreement.
32. "Public Service Kiosk" means a free-standing kiosk, the exterior of which is divided into three sections, which include two panels, which may be digital or back-lit, not exceeding fifty-two (52) square feet each, reserved to display commercial advertising and one section which may include a panel reserved to display Public Services Messages or provide other public services authorized in this Agreement.
33. "Public Service Messages" means the non-commercial content provided by the CITY to the CONTRACTOR for display on the Public Toilets and the Public Services Kiosks and shall include, but is not limited to, information about local events, public art, cultural or public service announcements, wayfinding or maps, vending locations, and business improvement district services.
34. "Public Toilet" means a free-standing enclosure containing at a minimum an automatic self-cleaning ADA toilet. The Public Toilets shall be available for use by the general public as provided in this Agreement and as depicted on Appendix F Specifications for Public Toilets.
35. "Reference Rate" means the reference rate charged by the Bank of America, N.A. located at 555 California Street, San Francisco, California, at the beginning of each month.
36. "Relocation Cap" means one million, two hundred thousand dollars (\$1,200,000) over the Term of this Agreement at the CONTRACTOR's expense for the relocation of Automatic Public Toilets and Public Service Kiosks that are installed.

37. "Start Date" shall mean the first day of the calendar month following the date this Agreement is signed by the CITY and the CONTRACTOR.
38. "Term" has the meaning referred to in Section 1.3.
39. "Threshold Amount" shall mean sixteen million dollars (\$16,000,000) for a twelve (12) month period, specified in Section 1.8.
40. "Third Party" means any entity that is not the CONTRACTOR or the CITY.
41. "Transition Period" means the period beginning on the Start Date and ending on the date after eighteen (18) months from such date.
42. "Vandalism" shall mean willful or malicious damage or destruction of a Public Toilet or Public Service Kiosk or any part thereof, caused by a Third Party, but shall exclude ordinary wear and tear and any damage caused during riots and other civil disturbances.
43. Whenever the words "as directed", "as required", "as permitted", or words of like effect are used, it shall be understood as the direction, requirement, or permission of the Department of Public Works. The words "sufficient", "necessary", or "proper", and the like mean sufficient, necessary or proper in the judgment of the Department of Public Works. The words "approval", "acceptable", "satisfactory", or words of like import, shall mean approved by, or acceptable to, or satisfactory to the Department of Public Works, unless otherwise expressly provided herein.

1.2 Certification of Funds Budget and Fiscal Provisions: Termination in the Event of Non-Appropriation

This Agreement is subject to the budget and fiscal provisions of the CITY's Charter.

CITY has no obligation to make appropriations for this Agreement in lieu of appropriations for new or other agreements. CITY budget decisions are subject to the discretion of the Mayor and the Board of Supervisors. CONTRACTOR's assumption of risk of possible non-appropriation is part of the consideration for this Agreement. THIS SECTION CONTROLS AGAINST ANY AND ALL OTHER PROVISIONS OF THIS AGREEMENT.

1.3 Term of Agreement

The Term of this Agreement shall begin on the Start Date and shall continue until the twenty first and one-half anniversary of the Start Date (21.5 years), subject to any extension based on the terms and conditions of this Agreement.

1.4 CONTRACTOR to Provide Public Toilets and to Install and Maintain Public Service Kiosks as Consideration for Public Toilets

On public property, CONTRACTOR shall install, operate and maintain, Public Toilets as provided in Section 2 "Public Toilet Installation" of this Agreement and in consideration for such installation, operation and maintenance, as well as consideration in the form of amounts payable pursuant to Section 1.9 "Payment to the City", the CITY hereby agrees to grant to CONTRACTOR the right, to

occupy and use public property for the installation, operation and maintenance of Public Service Kiosks and the right to place advertising on such Public Service Kiosks, all rights and obligations are subject to the terms and conditions set forth in this Agreement.

1.5 General Terms and Conditions for the Installation of Street Furniture

CONTRACTOR shall install twenty-five (25) new Public Toilets, replacing all of the approved and existing Public Toilets.

If the CITY chooses not to replace an installed Public Toilet in its current location, the CONTRACTOR shall be responsible for restoring the right of way. The CITY shall be responsible for selecting the new location in accordance with the terms and conditions of this Agreement, and the costs associated with the installation in the new location and shall provide a Notice to Proceed for such new location.

From the Start Date until the date that is the third (3rd) anniversary of the Start Date), the CITY may issue a Notice to Proceed in connection with a request for the CONTRACTOR to install up to fifteen (15) additional new Public Toilets in new locations for which the City shall reimburse the CONTRACTOR for costs in accordance with Section 1.10 of this Agreement.

CONTRACTOR is licensed to replace one-hundred fourteen (114) Public Service Kiosks in the locations specified on Appendix B.

1.6 Grant of Advertising Rights

- A. CITY grants to CONTRACTOR, and represents and warrants that CONTRACTOR shall have, during the term of this Agreement, the exclusive license to replace and maintain one-hundred fourteen (114) Public Service Kiosks currently installed on CITY property (and specified in Appendix B), and the exclusive right to place advertising on these Public Service Kiosks as authorized. CITY shall retain and reserve to itself and its assigns all advertising rights not expressly granted to CONTRACTOR hereunder, subject to the limitations and conditions of this Agreement.

- B. Except for advertising displayed by the CONTRACTOR on Public Service Kiosks authorized hereunder, and except as provided in Paragraph C and D below, CITY agrees not to display, authorize or permit the display of advertising panels of eighteen (18) to fifty-five (55) square feet on any freestanding structure located on any public right-of-way or other CITY owned property:
 - 1. Anywhere within the Downtown Area; and
 - 2. Outside the Downtown Area, within a sixty (60) foot radius of any Public Service Kiosk authorized hereunder.

For purposes of this Section, the term "freestanding structure" includes structures of any shape, size or number of advertising panels, but shall not include buildings of at least 250 square feet of floor area.

- C. Notwithstanding any other provisions of Paragraph A and Paragraph B of this Section, CITY shall have the right to display, authorize or permit display of advertising panels, each of which shall not

exceed twenty-four (24) square feet in area, provided that such advertising panels are physically attached to:

1. Transit shelters (including high- or low-level transit platforms) in connection with the Transit Shelter Advertising Agreement between the CITY and Clear Channel, Inc. dated as of December 10, 2007 (the "Clear Channel Agreement"); or
2. Kiosks located on Market Street, to the extent permitted by the Clear Channel Agreement, and which existing or future kiosks may be relocated along Market Street by the CITY, in its sole discretion.

The CITY's right to display advertising on such transit shelters shall survive the expiration or termination of the Clear Channel Agreement.

- D. Notwithstanding the provisions of Paragraph A and Paragraph B above, the PORT shall have the right to display or to authorize or permit display of advertising, including informational and directional displays, related exclusively to the business activities of the PORT, its lessees and licensees, within Port Property; except that any such displays of a commercial nature on freestanding structures shall be no larger than eighteen (18) square feet.
- E. CITY shall not enter into any contract or agreement granting to any Third Party any exclusive advertising rights, which would have the effect of precluding the CITY from permitting Public Service Kiosks to be installed anywhere in the CITY otherwise permitted hereunder; provided, however, that CITY may impose reasonable standards on the distance between individual pieces of street furniture containing advertising.

1.7 Ownership of Public Toilets and Public Service Kiosks

All Public Toilets and Public Service Kiosks constructed, installed and maintained pursuant to this Agreement shall be and remain the property of CONTRACTOR at all times.

1.8 Fees due by CONTRACTOR to CITY

In connection with the rights and privileges granted to the CONTRACTOR under this Agreement, amounts shall be due by the CONTRACTOR to the CITY as set forth below:

A. Fees paid during the Transition Period

During the Transition Period, the CONTRACTOR shall pay the CITY as follows:

1. A one- time payment of One Million Five Hundred Thousand Dollars (\$1,500,000), payable to the CITY in cash within thirty (30) days of the Start Date or payable in-kind by the payment of Attendant Services, at the sole discretion of the CITY, which determination shall be notified by CITY to the CONTRACTOR through an Authorization to the CONTRACTOR within twenty (20) days of the Start Date; and
2. Non-Advertising Percentage Fee; and
3. Beginning on the first anniversary of the Start Date, the Annual Administrative Fee, which is due and payable to the CITY in cash on such date; and

4. The Advertising Revenue Percentage Fee on revenue generated over the Threshold Amount.
5. The Non-Advertising Percentage Fee and the Advertising Revenue Percentage Fee shall be paid within thirty (30) days of the end of the Transition Period.

B. Fees paid after the Transition Period

After the Transition Period, the CONTRACTOR shall pay the CITY as follows:

1. The Annual Administrative Fee. Beginning with the second (2nd) Contract Year and each subsequent Contract Year, the Annual Service Fee shall be adjusted by CPI. Such adjustment shall be calculated by multiplying two hundred seventy-five thousand dollars (\$275,000) by a fraction, the numerator of which shall be the CPI of the first (1st) month of each such subsequent Contract Year and the denominator of which shall be the CPI of the first (1st) month of the first (1st) Contract Year; and
2. The Annual Service Fee. Beginning with the second (2nd) Contract Year and each subsequent Contract Year, the Annual Service Fee shall be adjusted by CPI. Such adjustment shall be calculated by multiplying two million, one hundred fifty thousand dollars (\$2,150,000) by a fraction, the numerator of which shall be the CPI of the first (1st) month of each such subsequent Contract Year and the denominator of which shall be the CPI of the first (1st) month of the first (1st) Contract Year.

At any time, the CITY may determine it shall desire the Annual Service Fee, or any portion of the Annual Service Fee, for the Attendant Services to be paid in cash to the CITY, in which case, the CITY shall provide written notice to the CONTRACTOR specifying the reduction in hours it desires for Attendant Services and the total cash payment it desires to be paid to the CITY in place of Attendant Services and CITY; the CONTRACTOR shall agree to the terms and conditions of the reduction; provided, however, the notice must be provided sixty (60) days in advance of such reduction in Attendant Services.; and

3. The Advertising Revenue Percentage Fee on revenue generated over the Threshold Amount. Beginning on the sixth (6th) anniversary of the first day of the Contract Year, the Threshold Amount shall be adjusted annually by a fraction, the numerator of which shall be the CPI of the first month of each such subsequent Contract Year and the denominator of which shall be CPI of the first (1st) month of the fifth (5th) Contract Year; and
4. The Non-Advertising Percentage Fee.

C. Timing for Payment to the CITY of the Annual Administrative Fee, the Advertising Percentage Fee, Non-Advertising Percentage Fee and Attendant Services Credit.

The Administrative Fee, Advertising Percentage Fee, Non-Advertising Percentage Fee and any Attendant Service Credit due to the CITY for any Contract Year shall be paid within ninety (90) days of the end of such Contract Year, in accordance with Section 1.11 "Fee Reporting and Annual Reconciliation of Amounts".

1.9 Late Payment

A. Payments due hereunder, which are not received by the CITY within thirty (30) calendar days after such amount becomes due, shall bear interest at the Reference Rate from and after the date said payment was due until the date paid.

B. CONTRACTOR shall make all payments electronically using the CITY's service provider.

<https://sfcontroller.org/electronic-payments-ach-vendors> - FAQs

http://www.paymode.com/city_countyofsanfrancisco - Instructions and link to sign-up.

Any inquiries about payments may be addressed to:

Public Works Accounting Section
City and County of San Francisco
1155 Market Street, Second Floor
San Francisco, California 94103
Attention: Accounting Manager

or at such other place as CITY may designate in a Notice to the CONTRACTOR.

1.10 Cost Related to the Installation of Public Toilets After the Installation of All Replacement Public Toilet Costs

A. After the installation of the twenty-five (25) replacement Public Toilets, CITY shall pay all Initial Costs required for the installation of any additional Public Toilet/s that the CITY determines it would like the CONTRACTOR to install; provided however, CONTRACTOR must provide the CITY with documentation detailing such Initial Costs and an invoice for such Initial Costs.

B. The payment for such Initial Costs may be made by the CITY, at its option, through a cash payment to the CONTRACTOR, and/or by using a portion or the full Certified Annual True-up Amount, as described in Section 1.11B.

C. CONTRACTOR shall be authorized to deduct Additional Public Toilet Costs incurred in connection with each additional Public Toilet from the Fees payable to the CITY each Contract Year.

D. To the extent CITY requests the installation of more than twenty (25) Public Toilets, which results in any additional taxes for CONTRACTOR, such increase will be deducted from the Fees payable to the CITY each Contract Year.

E. The deductions allowable pursuant to this Section 1.10 shall be reconciled with other deductions that may be taken in a Contract Year, as specified in Section 1.11 below.

F. If a Third Party is paying for any or all of the Initial Cost and/or ongoing expenses of an additional Public Toilet, the CITY shall not be liable to the CONTRACTOR for such portion of costs paid by the Third Party.

1.11 Fee Reporting and Annual Reconciliation of Amounts

- A. Within ninety (90) days of the end of each Contract Year, CONTRACTOR shall furnish to CITY a statement with the Certified Annual-True Up Amount, certified as accurate and complete by an independent certified public accountant, detailing the following amounts for such prior Contract Year and calculating as follows:
1. Advertising Revenue Percentage Fee (if any), plus
 2. Non-Advertising Percentage Fee (if any), plus
 3. The Annual Service Fee, plus
 4. The Attendant Service Credit (if any), plus
 5. Amounts due to the CITY for any relocations and/or replacements of Public Toilets and/or Public Service Kiosks that the CITY removed and/or relocated on behalf of the CONTRACTOR pursuant to Section 2.7D and Section 3.7D (if any); plus
 6. The Annual Administrative Fee, less
 7. Additional Public Toilet Costs (if any), less
 8. Additional taxes incurred in connection with Additional Public Toilet Costs (if any), less
 9. The deductions of any amounts permitted to be taken by the CONTRACTOR in connection with the Relocation Cap or any other term of this Agreement.
- B. If the Certified Annual-True Up Amount is a positive number, under receipt of such statement, the CITY shall inform the CONTRACTOR, if such positive amount shall be payable by the CONTRACTOR in cash as a Fee or use as a deduction to finance the Initial Costs of Additional Public Toilets (if any) in the subsequent Contract Year. If the Certified Annual-True Up Amount is payable in cash, CONTRACTOR shall, within five (5) business days of receipt by the CONTRACTOR of the CITY's payment instructions, pay such amount to the CITY as the Fee that is due to the CITY in such Contract Year. In the event that such calculation results in a negative amount, the CONTRACTOR shall be allowed to deduct the amount from the payment of any Fees due to the CITY in the subsequent Contract Year.
- C. For the CONTRACTOR's final payment of the Term, the payment of all Fees due to the CITY shall be made at the same time as the submittal of the Certified Annual True-Up Amount and, if any amounts are due for payment to the CONTRACTOR by the CITY after such final Certified Annual True-up Amount, the CITY shall pay the CONTRACTOR such amounts within ninety (90) days of the Expiration Date.

1.12 Books and Records

- A. CONTRACTOR shall maintain accurate and complete books and records of all Advertising Revenue and Non-Advertising Revenue and shall retain such books and records for not less than five (5) years after the end of each such Contract Year.

- B. CITY shall be entitled to audit, copy and inspect CONTRACTOR's books in accordance with this Section 1.12 and CONTRACTOR agrees to make such books and records available to the CITY in San Francisco with thirty (30) calendar days' prior notice.
- C. If such audit discloses any discrepancies which result in an underpayment of the amounts due to CITY for any Contract Year during the term of the Agreement, CONTRACTOR shall immediately pay to CITY the amount of such underpayment, plus interest thereon at the Reference Rate, or the maximum amount allowable by law.
- D. If any such discrepancy disclosed by the audit has resulted in an underpayment to CITY of more than five percent (5%) of the amount due to the CITY for any Contract Year, then CONTRACTOR shall reimburse CITY for the cost of such audit. If such audit discloses an overpayment, CITY shall promptly return such overpayment without interest.

1.13 Performance Bond or Letter of Credit for Installation

- A. CONTRACTOR shall, at its option, provide CITY with a Letter of Credit or Performance Bond according to the following terms and conditions, which shall constitute security for the faithful performance by CONTRACTOR to supply and install Public Toilets in accordance with the terms and conditions of this Agreement.
- B. Performance Bond for the Installation of Public Toilets.

If the CONTRACTOR provides a performance bond, the requirements shall be as follows:

1. Initial Amount of Bond. CONTRACTOR agrees that within thirty (30) calendar days after the Start Date of this Agreement, CONTRACTOR shall deliver to the Department of Public Works a performance bond valued at three million dollars (\$3,000,000).
2. Qualifications of Surety. The bond shall be executed by a guaranty or Surety Company legally authorized to engage in the business of furnishing performance bonds in the State of California and listed in the latest issue of the United States Treasury Circular 570. The total bond liability of any guaranty or surety company engaged by CONTRACTOR shall not exceed the therein specified underwriting limitation for that company.
3. Duration of Bond Requirement. Except as otherwise provided herein or authorized in writing by the Director, CONTRACTOR shall maintain said performance bond in full force and effect throughout the period of installation of the Public Toilets. After CONTRACTOR has completed replacement of twenty (20) Public Toilets in accordance with the requirements of this Agreement, the required amount of such performance bond shall be reduced to Five Hundred Thousand Dollars (\$500,000). When CONTRACTOR has satisfactorily completed installation of all twenty-five (25) Public Toilets in accordance with the requirements of this Agreement, such performance bond shall no longer be required.
4. If the Parties agree that the CONTRACTOR shall install additional Public Toilets, CONTRACTOR shall provide the CITY with a Performance Bond in the amount of one

hundred-thousand dollars (\$100,000) per Public Toilet until CONTRACTOR completes installation of each additional Public Toilet installed hereunder.

5. If CONTRACTOR defaults with respect to its obligation to supply and install the Public Toilets required hereunder and the CONTRACTOR has delivered a performance bond, CITY may, but shall not be required to, make its demand under the performance bond for all or any portion thereof to compensate CITY for any loss or damage which CITY may have incurred by reason of CONTRACTOR's default.

C. Letter of Credit for the Installation of Public Toilets

If the CONTRACTOR provides a Letter of Credit, the requirements shall be as follows:

1. Initial Amount of the Letter of Credit. CONTRACTOR agrees that within thirty (30) calendar days after the Start Date of this Agreement, CONTRACTOR shall deliver to the Department of Public Works an irrevocable Letter of Credit in the amount of three million dollars (\$3,000,000) in favor of the City and County of San Francisco, a municipal corporation, acting by and through its Department of Public Works.
2. Duration of Letter of Credit Requirement. Except as otherwise provided herein or authorized in writing by the Director, CONTRACTOR shall maintain said letter of credit in full force and effect throughout the period of installation of the Public Toilets. After CONTRACTOR has completed replacement of twenty (20) Public Toilets in accordance with the requirements of this Agreement, the required amount of such letter of credit shall be reduced to five hundred thousand dollars (\$500,000). When CONTRACTOR has satisfactorily completed installation of all twenty-five (25) Public Toilets in accordance with the requirements of this Agreement, such letter of credit shall no longer be required.
3. If the Parties agree that the CONTRACTOR shall install additional Public Toilets, CONTRACTOR shall provide a Letter of Credit in the amount of one-hundred thousand dollars (\$100,000) per Public Toilet until CONTRACTOR completes installation of each additional Public Toilet installed hereunder.
4. Non-Extension of Letter of Credit: Replacement. The Letter of Credit permitted under this Section 1.13 shall provide for sixty (60) days' notice by the issuer to CITY in the event of termination or non-renewal of the Letter of Credit. Upon receipt of notice from the issuer that the Letter of Credit will not be renewed or extended, CITY may demand that CONTRACTOR replace the Letter of Credit within at least twenty (20) days prior to its expiration. If CONTRACTOR fails to do so, CITY shall be entitled to present its written demand for payment of the entire face amount of the Letter of Credit. Any amounts so received by CITY shall be held as cash collateral and shall be returned to CONTRACTOR upon replacement of the Letter of Credit.
5. Financial Institution. Any Letter of Credit shall be established with a financial institution acceptable to the CITY. The Letter of Credit shall have an original term of one (1) year, with automatic extensions of the full amount required hereunder to be maintained until the 25 replacement Public Toilets are installed. The original of the Letter of Credit shall be held by

CITY throughout its term. The Letter of Credit shall provide that payment of the entire face amount of the letter of credit, or any portion thereof, shall be made to the CITY and County of San Francisco, upon presentation of a written demand to the Bank signed by the Director on behalf of the City and County of San Francisco, accompanied by a copy of the demand for performance delivered to CONTRACTOR and a copy of the certified mail, return receipt requested form.

6. If CONTRACTOR defaults with respect to its obligation to supply and install the Public Toilets required hereunder, CITY may, but shall not be required to, make its demand under the Letter of Credit for all or any portion thereof to compensate CITY for any loss or damage which CITY may have incurred by reason of CONTRACTOR's default. CITY shall present its written demand to the bank for payment under the Letter of Credit only after the CITY shall have made its demand for performance directly to CONTRACTOR by certified mail, return receipt requested, and after five (5) full business days have elapsed without performance by CONTRACTOR.

D. Failure to Provide Performance Bond or Letter of Credit; Failure of Surety.

1. If CONTRACTOR fails to deliver any Performance Bond or letter of credit as required by the Agreement, the CITY shall be entitled to cancel the Agreement effective immediately upon notice to CONTRACTOR and shall be entitled to exercise any other rights and remedies granted hereunder or by law.
2. During the period covered by this Agreement, if any of the sureties upon the bond shall become insolvent or, in the opinion of the Department of Public Works, unable to pay promptly the amount of such bond to the extent to which the surety might be liable, CONTRACTOR, within thirty (30) days after notice given by the Department of Public Works to CONTRACTOR, shall by supplemental bond or otherwise, substitute another and sufficient surety approved by the Director in place of the surety becoming insolvent or unable to pay. If CONTRACTOR fails within such thirty (30) day period to substitute another and sufficient surety, the Department of Public Works may elect to find CONTRACTOR in default of the performance of its obligations under this Agreement. The Department of Public Works, in addition to any and all other remedies available to it by law, may terminate the Agreement, withhold monies then due or which thereafter may become due to CONTRACTOR, and bring any proper suit or proceeding against CONTRACTOR under the Agreement. The amount for which the surety shall have justified on the bond and the monies so deducted shall be held by CITY as collateral for the performance of the conditions of the bond.
3. Wrongful or Excessive Demand: Return of Receipts. If the CITY receives any payments from the aforementioned financial institution under the letter of credit by reason of having made a wrongful or excessive demand for payment, CITY shall return to CONTRACTOR the amount by which CITY's total receipts from CONTRACTOR and from the financial institution under the letter of credit exceeds the amount to which CITY is rightfully entitled, together with interest thereon at the Reference Rate, but CITY shall not otherwise be liable to CONTRACTOR for any damages or penalties.

1.14 Performance Bond or Letter of Credit for Performance

CONTRACTOR shall, at its option, provide CITY with a performance bond or letter of credit according to the following terms and conditions, which shall constitute security for the faithful performance by CONTRACTOR of all terms, covenants, and conditions, including all monetary obligations set forth in this Agreement.

A. If the CONTRACTOR provides a performance bond, the requirements shall be as follows:

1. Amount of Bond. CONTRACTOR agrees that within thirty (30) calendar days after the Start Date of this Agreement, CONTRACTOR shall deliver to the Department of Public Works a performance bond valued at two million dollars (\$2,000,000).
2. Qualifications of Surety. The bond shall be executed by a guaranty or Surety Company legally authorized to engage in the business of furnishing performance bonds in the State of California and listed in the latest issue of the United States Treasury Circular 570. The total bond liability of any guaranty or surety company engaged by CONTRACTOR shall not exceed the therein specified underwriting limitation for that company.
3. If CONTRACTOR defaults with respect to its obligations under the terms and conditions of this Agreement and the CONTRACTOR has delivered a performance bond, CITY may, but shall not be required to, make its demand under the performance bond for all or any portion thereof to compensate CITY for any loss or damage which CITY may have incurred by reason of CONTRACTOR's default.

B. If the CONTRACTOR provides a Letter of Credit, the requirements shall be as follows:

1. Amount and Term of Letter of Credit. If CONTRACTOR elects to provide a letter of credit with respect to this Section 1.14, CONTRACTOR shall establish a confirmed irrevocable letter of credit in the amount of two million dollars (\$2,000,000) in favor of the City and County of San Francisco, a municipal corporation, acting by and through its Department of Public Works. The letter of credit shall be established at a financial institution acceptable to the CITY. The letter of credit shall have an original term of one (1) year with automatic renewals of the full amount to be maintained throughout the term of this Agreement. The original copy of the letter of credit shall be held by the CITY throughout the term of the Agreement.
2. Payment on Demand. The letter of credit shall provide that payment of the entire face amount of the letter of credit, or any portion thereof, shall be made to CITY, upon presentation of a written demand to the bank signed by Director of Public Works on behalf of CITY, accompanied by a copy of the demand for payment delivered to CONTRACTOR and a copy of the certified mail, return receipt requested form.
3. Default of CONTRACTOR. If CONTRACTOR defaults with respect to any provision of this Agreement, CITY may, but shall not be required to, make its demand under the letter of credit for all or any portion thereof to compensate CITY for any loss or damage which the CITY may have incurred by reason of CONTRACTOR's default. CITY shall present its written

demand to the bank for payment under the letter of credit only after the CITY shall have made its demand for payment directly to CONTRACTOR by certified mail, return receipt requested, and after ten (10) business days have elapsed without payment by CONTRACTOR. CITY need not terminate this Agreement to receive compensation for its damages hereunder. If any portion of the letter of credit is so used or applied, CONTRACTOR, within twenty (20) business days after written demand therefore, shall reinstate the letter of credit to its original amount, and upon such reinstatement, the excess of the proceeds of the letter of credit over the amount of the loss or damage suffered by the CITY shall be returned to CONTRACTOR. CONTRACTOR's failure to comply with any of the provisions herein above shall constitute a material breach of this Agreement.

4. Non-Extension of Letter of Credit Replacement. The letter of credit shall provide for sixty (60) days' notice by the issuer to CITY in the event of termination or non-renewal of the letter of credit. Upon receipt of notice from the issuer that the letter of credit will not be renewed or extended, CITY may demand that CONTRACTOR replace the letter of credit within at least twenty (20) days prior to its expiration. If CONTRACTOR fails to do so, CITY shall be entitled to present its written demand for payment of the entire face amount of the letter of credit.
5. Wrongful or Excessive Demand: Return of Receipts. If the CITY receives any payments from the aforementioned financial institution under the letter of credit by reason of having made a wrongful or excessive demand for payment, CITY shall return to CONTRACTOR the amount by which CITY's total receipts from CONTRACTOR and from the financial institution under the letter of credit exceeds the amount to which CITY is rightfully entitled, together with interest thereon at the Reference Rate, but CITY shall not otherwise be liable to CONTRACTOR for any damages or penalties.
6. Return on Faithful Performance. The letter of credit shall be returned to CONTRACTOR upon the termination of the Agreement, provided that the CONTRACTOR has faithfully performed throughout the duration of the Agreement and, upon termination of the Agreement, has removed all Public Toilets and Public Service Kiosks and has restored all affected CITY streets and sidewalks.

1.15 Insurance

- A. Without in any way limiting CONTRACTOR's liability pursuant to the "Indemnification" section of this Agreement, CONTRACTOR shall maintain in force, during the full term of this Agreement, insurance as follows:
 1. Workers' Compensation, with Employers' Liability limits not less than One Million Dollars (\$1,000,000) each accident. The Workers' Compensation policy shall be endorsed with a waiver of subrogation in favor of the CITY for all work performed by the CONTRACTOR, its employees, agents and subcontractors;
 2. Commercial General Liability Insurance, including all coverages with limits not less than Two Million Dollars (\$2,000,000) each occurrence, Ten Million Dollars (\$10,000,000)

aggregate, Combined Single Limit Bodily Injury and Property Damage. Such form includes Contractual Liability, Personal Injury, Advertising Liability, Broad Form Property Damage, Products and Completed Operations coverages;

3. Comprehensive Automobile Liability Insurance with limits not less than One Million Dollars (\$1,000,000) each occurrence, Two Million Dollars (\$2,000,000) aggregate, Combined Single Limit Bodily Injury and Property Damage, including owned, non-owned and hired auto coverages, as applicable; and
4. Excess Liability Coverage following the provisions of the insurance referred to in clauses (1), (2) and (3) above in the amount of Five Million Dollars (\$5,000,000) per occurrence, Combined Single limit, and Five Million Dollars (\$5,000,000) in the aggregate for each annual policy period.

B. Endorsements. Commercial General Liability, Comprehensive Automobile Liability Insurance and Workers Compensation Insurance policies shall be endorsed to provide the following:

1. To name as additional insureds with respect to the operations of CONTRACTOR under this Agreement the City and County of San Francisco, and its officers, agents, and employees, and,
2. To provide that such policies are primary insurance to any other insurance available to the additional insureds, with respect to any claims arising out of this Agreement, and that insurance applies separately to each insured against whom claim is made or suit is brought.
3. The Workers' Compensation policy(ies) shall be endorsed with a waiver of subrogation in favor of the CITY for all work performed by the CONTRACTOR, its employees, agents and subcontractors.

C. Notices. All policies shall be endorsed to provide that there will be thirty (30) days advance written notice to CITY of cancellation, non-renewal or reduction in coverage, which shall be mailed to the following address:

Public Works
Contract Administration
1155 Market Street, 4th Floor
San Francisco, California 94103

with a copy by email to: contractadmin.staff@sfdpw.org

D. Condition Precedent. Certificates of insurance, satisfactory to CITY, evidencing all coverages above, shall be furnished to CITY before the Start Date of this Agreement, with complete copies of policies to be delivered to CITY upon its request.

E. Approval by CITY. Approval of insurance contracts required under this Agreement shall not relieve CONTRACTOR, its subcontractors, consultants, successors or assigns, from the obligation to indemnify the CITY.

- F. Copies of Policies and General Provisions. If at any time during the term of this Agreement CONTRACTOR fails to maintain the required insurance in full force and effect, CONTRACTOR shall discontinue immediately all work under the Agreement and shall not resume work until authorized by the Department of Public Works after having given proper notice that the required insurance has been restored to full force and effect and that the premiums therefor have been paid and are current.
- G. Insurers. Before commencing any Services, CONTRACTOR shall furnish to CITY certificates of insurance and additional insured policy endorsements with insurers with ratings comparable to A-, VIII or higher, that are authorized to do business in the State of California, and that are satisfactory to CITY, in form evidencing all coverages set forth above.
- H. Breach. In the event of any uncured breach of any provision of this Section 1.15, or in the event that any insurance coverage required by this Agreement is canceled or diminished in any way, during any period that any insurance coverage or endorsements required under this Section 1.15 is not in effect, CITY, in addition to any other remedies available under this Agreement or by law, and notwithstanding any other provision of this Agreement to the contrary, shall have the option, upon notice to the CONTRACTOR, to suspend the further exercise by CONTRACTOR of all rights and privileges granted to CONTRACTOR under this Agreement until such coverage is provided.

1.16 Indemnification

- A. CONTRACTOR shall defend and indemnify CITY and its officers, agents and employees from and against any and all claims, demands, losses, damages, costs, expenses, and liability (legal, contractual, or otherwise) (collectively, "Claims") arising from or as a result of: (i) injury to, or death of, a person, including employees of either Party ; (ii) material loss of or damage to property; (iii) violation of local, state, or federal common law, statute or regulation including, but not limited to, privacy or personally identifiable information, health information, disability and labor laws or regulations; or (iv) strict liability imposed by any law or regulation; so long as such injury, violation, loss, or strict liability (as set forth in subsections (i) - (iv) above) arises directly or indirectly from CONTRACTOR's performance of this Agreement, including, but not limited to, CONTRACTOR's use of facilities or equipment provided by CITY or others, except to the extent that such indemnity is void or otherwise unenforceable under applicable law, and except to the extent any Claims are the result of the active negligence or willful misconduct of CITY. The foregoing indemnity shall include, without limitation, reasonable attorneys' fees, consultants and experts and directly-related reasonable costs and CITY's reasonable and direct costs of investigating any Claims against the CITY.
- B. In addition to CONTRACTOR's obligation to indemnify CITY, CONTRACTOR specifically acknowledges and agrees that it has an immediate and independent obligation to defend CITY from any Claims that falls within this indemnification provision, even if the allegations are or may be groundless, false or fraudulent, which obligation arises at the time such Claims are tendered to CONTRACTOR by CITY and continues at all times thereafter.
- C. CONTRACTOR shall indemnify and hold CITY harmless from all loss and liability, including attorneys' fees, court costs and all other litigation expenses for any infringement of the patent rights, copyright, trade secret or any other proprietary right or trademark, and all other

intellectual property claims of any person or persons arising directly or indirectly from the receipt by CITY, or any of its officers or agents, of CONTRACTOR's services under this Agreement. Obligations of the CONTRACTOR to indemnify the CITY under this Agreement shall be reduced by any insurance amounts received by the CITY in connection with any Claims.

- D. The CITY agrees to indemnify and hold CONTRACTOR harmless against any losses, damages and reasonable costs, payments, and expenses (such as, but not limited to, court costs and reasonable attorney's fees and disbursements), incurred by the CONTRACTOR and proximately caused by any CITY-provided Public Service Messaging.

1.17 Notices: When Effective

Notices, as herein provided, shall be given by either personal service or by overnight delivery and shall be addressed as follows:

To CITY: Public Works
 Contract Administration
 1155 Market Street, 4th Floor
 San Francisco, California 94103
 Attention: Contracts Manager

With a copy by email to contractadmin.staff@sfdpw.org

To CONTRACTOR: JCDecaux San Francisco, LLC.
 81 Dorman Avenue, Suite B
 San Francisco, CA 94124
 Attention: Chief Operating Officer

With a copy to:

JCDecaux San Francisco, LLC
Empire State Building
350 5th Avenue
New York, New York 10118
Attention: General Counsel

With a copy by email to:
Francois.nion@jcdecaux.com

Notices shall be deemed effective upon delivery, if given by personal service, or, if by mail, three (3) days after deposit in the mail. In the event of any change in the above mailing addresses, the affected Party shall notify the other promptly in writing.

1.18 Subcontracting

CITY grants CONTRACTOR the authority to hire such subcontractors as CONTRACTOR deems necessary to fulfill the requirements detailed in this Agreement.

1.19 Financial Reports

Upon CITY's request, CONTRACTOR shall provide financial information in a format reviewed and approved by the CITY for the Term, such information shall be in accordance with U.S. generally accepted accounting principles and on a calendar year basis. In addition to any reporting required under Section 1.11, CONTRACTOR shall provide the CITY with any financial information reasonably requested by the CITY in connection with the rights, duties and obligations governed under this Agreement.

1.20 Management Reports

- A. **Maintenance Reports**. CONTRACTOR shall prepare for the CITY monthly reports on maintenance activities and submit to CITY copies of the report for the preceding month within fifteen (15) days after the end of every month. CONTRACTOR shall also furnish to the Director within thirty (30) days after the end of each calendar quarter a narrative summary of its maintenance operations during the preceding quarter, noting problem areas, corrective actions taken, and the number and cost of repairs attributable to Vandalism.
- B. **Complaint Reports**. CONTRACTOR shall maintain and make available to CITY a written complaint report in format reasonably acceptable to CITY. The purpose of this document will be to record complaints and/or incidents that occur with respect to the Public Toilets and Public Service Kiosks. In addition to the date, time, location, etc., the report shall include disposition and final resolution of the complaint. Copies of this document will be submitted to the CITY monthly.
- C. **Other Reports**. CONTRACTOR shall provide the CITY with any other information reasonably requested in connection with rights, duties and obligations governed under this Agreement.

1.21 Guaranty of Obligation

CONTRACTOR shall, on the Start Date, provide a guaranty from JCDecaux North America, Inc., of the CONTRACTOR's obligation to pay amounts due to the City, from time to time, under this Agreement and to install the Public Toilets hereunder, which guaranty shall be substantially in the form attached hereto as Appendix E.

2.0 Public Toilets

2.1 Design and Construction of Public Toilets: Prototype

- A. The CONTRACTOR shall begin the review process for engineering the Prototype as soon as practicable after execution of this Agreement and shall work with the CITY throughout this process. CONTRACTOR shall provide CITY with specifications, engineering, plans and other documentation required to engineer a Prototype, and after receipt of such documentation, the Director shall issue a Notice to Proceed to the CONTRACTOR. As soon as practicable, after receipt of the Notice to Proceed, the CONTRACTOR shall construct and install one (1) Prototype at a location, which shall be mutually agreed upon by the CITY and the CONTRACTOR, and at which there is, as of the date hereof, an existing Public Toilet. The Prototype shall be installed within twenty-four (24) months of the Start Date, which timeline and any other timeline for installation may be extended by the Director, in his sole discretion with consideration based upon any

unforeseeable delays in the design, engineering, construction or installation of the Prototype and Public Toilet/s.

- B. After the installation of the Prototype, the CITY and the CONTRACTOR shall have ninety (90) days to review the Prototype, determine and discuss with the CONTRACTOR any revisions it requires to the design. The CONTRACTOR shall work with the DESIGNER to revise the design of the Prototype, as requested by the CITY, to correct errors, omissions, and non-functionality of the Prototype caused by a material deviation from the scope of the Prototype mutually agreed upon by the Parties. The CONTRACTOR shall not be required to make (i) material design or construction changes to the Public Toilet/s, (ii) changes that materially increase the costs of producing the Public Toilets as compared to the costs of producing units that are identical to the Prototype, or (iii) changes that are reasonably likely to delay receipt by CONTRACTOR of permits and other approvals for the installation of the Public Toilets.
- C. Once all the revisions related to the Prototype have been agreed upon by the CITY and the CONTRACTOR, and no later than thirty (30) days from the end of the ninety (90) day review period specified in Section 2.1 B, the Director shall provide CONTRACTOR with a Notice to Proceed for each Public Toilet location, which may include more than twenty-five (25) locations. If the CITY does not intend to install a Public Toilet in a location that has a Public Toilet installed or been previously approved at the date of this Agreement, CITY must notify the CONTRACTOR by the end of the Prototype review period.
- D. Unless otherwise requested by the Director, within ninety (90) days of receipt of a Notice to Proceed, the CONTRACTOR shall provide the CITY with modifications or revisions required (if any) in connection with the requirements of the Notice to Proceed, and submit a plan to the Department of Public Works in accordance with Section 2.5.
- E. CONTRACTOR shall engineer, construct and install the Public Toilets contracted for under this Agreement in conformity with Appendix E and as modified during the Prototype review period, subject to any agreed upon revisions during the ninety (90) day revision period. The specifications may be modified by the CONTRACTOR with the prior written approval of the Director. Such approval shall not be unreasonably withheld, if the proposed change (i) does not materially affect the external appearance or the disabled access requirements of the Public Toilets, or (ii) adversely affect the operation of the Public Toilets.

2.2 No Real Property Interest

CONTRACTOR agrees that it shall neither have nor acquire any real property interest in any of the CITY's real property, such as a lease or exclusive easement, on which a Public Toilet has been installed pursuant to this Agreement. Such acknowledgment in no way affects or limits CONTRACTOR's obligation to pay any possessory interest taxes specified in Section 8.6 of this Agreement.

2.3 Approval Requirements for Public Toilet

- A. CONTRACTOR must obtain all applicable permits and pay all required permit fees before proceeding with installation to replace the existing automatic Public Toilets.

- B. For any new locations for Public Toilets, the Department of Public Works shall review each location drawing, inspect each location and site, and notify the public as required before proceeding with installation.
- C. The Department of Public Works shall review each location drawing, inspect each location and site, and thereafter, shall approve and issue encroachment and excavation permits for each proposed Public Toilet site all in accordance with the procedures and guidelines set forth by CITY, which may be modified from time to time by the Director. To the extent such procedures and guidelines are more stringent than the San Francisco Public Works Code, they shall be deemed to supersede the Public Works Code.
- D. If a Public Toilet is to be installed on PORT Property, CONTRACTOR shall submit location drawings to the PORT's Chief Harbor Engineer, together with an encroachment permit fee for each such Public Toilet, and the PORT (in lieu of the Department of Public Works) shall, as required or as necessary, review such drawings, conduct inspections and hold public hearings in accordance with the terms of this Agreement. CONTRACTOR shall obtain building permits from the PORT's Chief Harbor Engineer prior to any Public Toilet installation on Port Property. No PORT building permit fee shall be payable for such sites on Port Property.

2.4 CITY Review of Plans and Submittals

CONTRACTOR shall submit applications for permits for Public Toilets as promptly as practicable after receipt of the Notice to Proceed, and CITY shall use best efforts to review, approve permits and facilitate the issuance of permits, as promptly as practicable after each application is filed.

2.5 Replacement and Installation Covenants

- A. The Parties shall work together to establish a reasonable schedule for the review of the replacement of each existing Public Toilet and the installation of new Public Toilets, including the engineering, site plans and construction timetables.
- B. CONTRACTOR agrees to install replacement Public Toilets in accordance with this Agreement and shall replace the twenty-five (25) currently approved and existing Public Toilets in all locations as identified on Appendix A within four (4) years of receiving the Notice to Proceed from the CITY, or any revised rollout schedule as approved by both Parties, subject to receiving CITY Approval for all such Public Toilets. Notwithstanding such replacement duty, the design by the DESIGNER of the replacement Public Toilets may not be able to be sited in all locations the Public Toilets are currently installed on due to technical, "clear path" requirements or other unforeseeable obstacles and in the event that a replacement Public Toilet may not be installed in a current location, the Parties will work together to secure another location, which solution the CONTRACTOR and the Director shall determine.
- C. The specific order of replacement locations shall be agreed in writing between the CITY and the CONTRACTOR.
- D. In the event any of the replacement locations are determined to be unsuitable for Public Toilet installation for any reason, including but not limited to, (i) a technical or operational issue, which may include the condition of underground electrical or sewerage connections or the location

cannot accommodate the installation of a replacement Public Toilet, or (ii) community concerns regarding the replacement Public Toilet/s, the Parties will work together, in a manner specified in Section 2.6, to secure an alternative location/s and CONTRACTOR shall be entitled to recoup the corresponding additional installation costs incurred, if any, from amounts due the CITY.

- E. Following the replacement of the twenty-five (25) Public Toilets and prior to the third anniversary of the Start Date, the CITY may, at its sole discretion, but subject to the terms and conditions of this Agreement, request CONTRACTOR to install and maintain up to fifteen (15) additional Public Toilets during the term of the Agreement, provided that the CITY does not request more than eight (8) additional Public Toilets in any one (1) Contract Year.
- F. In the event that the CITY requests a new Public Toilet to be installed by the CONTRACTOR, the CITY shall provide a Notice to Proceed to the CONTRACTOR detailing the requirement for such additional Public Toilet/s, its proposed location/s and additional relevant information regarding details of the Public Toilet/s and its installation.
- G. No later than sixty (60) days after receipt of the Notice to Proceed for such additional Public Toilet/s, the CONTRACTOR shall confirm in writing to the CITY its receipt of the request and the total amount of the installation of such additional Public Toilet and the Additional Public Toilet Costs, as well as a proposed schedule for installation and any other material information related to such Public Toilet/s.
- H. The CITY shall confirm its approval by issuing a final Notice to Proceed, which specifies how payment will be made and if such payment shall be in cash, such cash payment shall accompany the final Notice to Proceed. Within thirty (30) days of receipt of the final Notice to Proceed related to such additional Public Toilet/s and payment for the installation of such additional Public Toilet/s, CONTRACTOR shall begin the application and approval process related to such location/s.
- I. Upon receipt of all regulatory and siting approvals required for the installation of any such additional Public Toilet, the CONTRACTOR shall order the structures and upon receipt of the structures shall install such new Public Toilet/s. At the appropriate times, the CONTRACTOR shall apply for approvals from required utilities in such a manner that approval from such utilities will be received in a reasonably timely manner, and upon receipt of the structures, the Public Toilet/s may be connected and installed. Notwithstanding, so long as the CONTRACTOR applies for utility approvals in a reasonably timely manner, it shall bear no responsibility or liability for any delays in receipt of utility approvals that are due to the utility's own processes. As used in this Section 2.5, "utility" shall mean water, electrical, sewer and internet connections.
- J. Upon installation of such additional Public Toilet/s, CITY will be provided with documentation detailing the costs of such additional Public Toilet/s as follows:
 - 1. Copies of invoices for the actual cost for each unit at the time that the Notice to Proceed was issued.
 - 2. The actual cost of installation per unit at the time the cost was incurred.

3. The expected cost of the related utilities and maintenance, including, but not limited to repairs, replacement of parts and other costs associated with keeping the Public Toilet/s in working order.
4. Any additional taxes for CONTRACTOR resulting from the installation of the additional Public Toilets

The actual costs of such related utilities and maintenance shall be provided to the CITY annually for the year in which the costs are incurred. CONTRACTOR shall be authorized to deduct any Additional Public Toilet Costs incurred from its payment of Fees, as described in Section 1.11 and shall provide the CITY with documentation to evidence the Additional Public Toilet Costs from time to time.

2.6 Locations and Siting of Additional Public Toilets

CONTRACTOR shall install the additional Public Toilets at locations designated and approved in accordance with this Section.

- A. In the event any of the new locations are determined by the CITY to be unsuitable for Public Toilet installation prior to the issuance of permits therefor, or are disapproved by CONTRACTOR, then the CITY may designate an alternate location.
- B. CITY and CONTRACTOR shall inspect the proposed locations and exchange information regarding the suitability of each such location for a Public Toilet. CITY acknowledges that the installation of the Public Toilets requires clear space of at least three and one-half (3 1/2') feet below the surface of the slab. If a proposed location will not provide the clear space necessary for the installation of the Public Toilet, CONTRACTOR may disapprove the location and CITY shall designate a substitute location. CONTRACTOR shall be obligated to incur the cost for the cost of utility connections for each Public Toilet, including sewer, electrical, water and telephone connections, and the costs of any trenching and street restoration required in connection with such utility connections and costs of extraordinary site preparation, such as demolition of existing structures or construction of a sidewalk bulb. In the event that such costs are projected to exceed a total of two hundred thousand dollars (\$200,000), CONTRACTOR may disapprove the location, and CITY shall designate a substitute location.
- C. CONTRACTOR shall present site plans showing the precise site of the Public Toilet to the Department of Public Works for approval, for which approval shall not be unreasonably withheld. At some locations, the Public Toilet may be installed on a new sidewalk bulb to be constructed by CONTRACTOR, subject to CITY approval and upon the conclusion of proper street encroachment proceedings. Without limitation on the provisions of Paragraph B above, if CONTRACTOR finds a location to be unsuitable or infeasible as a site for installation of a Public Toilet, CONTRACTOR may appeal to the Director for abandonment of that location and for a substitute location.

2.7 Relocation of Public Toilets After Installation

- A. CONTRACTOR may not relocate or remove a Public Toilet without the CITY's permission.

B. The CITY may, in any Contract Year, through an Authorization provided to the CONTRACTOR, direct the removal and/or relocation of Public Toilets installed pursuant to this Agreement and for which CONTRACTOR will bear the cost of removals and/or relocations up to the total Relocation Cap available at such time, which is calculated as follows:

1. The cost of any removal and/or relocation for a Public Toilet requested by the CITY shall be aggregated with any amounts already spent by the CONTRACTOR for removal and/or relocation of Public Toilet/s and Public Service Kiosk over the Term;
2. if the cost of such removal and/or relocation to be borne by the CONTRACTOR shall result in an amount higher than the Relocation Cap, on a cumulative basis over the Term, such removal and/or relocation shall be undertaken by the CONTRACTOR at the sole cost of the CITY;
3. the cost of any removal and/or relocation of any Public Toilet beyond the Relocation Cap shall be included in the calculation of the Certified True-up Amount pursuant to Section 1.11 and shall be deducted from the Fee paid to the CITY for such Contract Year; and
4. CONTRACTOR shall provide CITY with such documentation as to evidence the actual cost of removal and/or relocation as soon as practicable, and in any case, prior to including such amount in the calculation of the Certified True-up Amount pursuant to Section 1.11.

C. In the event that the CONTRACTOR has all permits and approval for a removal and/or relocation and fails to remove and/or relocate such Public Toilet within the time directed by the CITY, CITY may, at its sole discretion, cause the removal and storage or relocation of such Public Toilet and recover any and all costs incurred from CONTRACTOR, as follows.

1. Any reimbursement of costs in connection with the removal and/or relocation of any Public Toilet that the CONTRACTOR failed to remove shall be paid to CITY by CONTRACTOR as part of the Fee due to the CITY in such Contract Year;
2. CITY shall provide CONTRACTOR with such documentation details as to evidence the actual cost of the removal and/or relocation as soon as practicable, and in any case, prior to the inclusion of such amount in the calculation of the Certified True-up Amount pursuant to Section 1.11;
3. CONTRACTOR may, with the CITY's permission, elect instead to remove and/or relocate another Public Toilet, for which CONTRACTOR shall bear the full cost of removal and relocation, including sidewalk and curb repair if the same is affected by the removal; and
4. The new location of any such removed Public Toilet shall be determined in accordance with the procedures set forth in this Agreement.

- D. If the removal and/or relocation of any Public Toilet is due to a request from the PORT, CITY construction or any Third Party, the CITY will facilitate payment to the CONTRACTOR for the removal and/or relocation costs from the PORT, the applicable CITY department or the Third Party.

2.8 Clearance Requirements for Public Toilets

- A. All Public Toilets shall be placed in accordance with the terms of Department of Public Work Orders issued by the Director from time to time, and as modified from time to time, and must be reasonably accessible for pedestrian traffic to access the Public Toilet.
- B. The Parties acknowledge that the CONTRACTOR requires vehicular access and temporary short term parking at each Public Toilet to perform daily maintenance and repairs as needed, and CITY agrees to facilitate that vehicular access; provided further that after the installation of a Public Toilet, CITY shall use its best efforts not to place any new structures or obstacles within the specified clearance area or which would obstruct the access to such Public Toilet. If after the installation of the Public Toilet, CITY shall place any new structures or obstacles within the specified clearance area, CONTRACTOR shall not be required to relocate that Public Toilet to accommodate the CITY's structure.

2.9 Approval of Other Agencies

- A. Approval of Port Commission: Bay Conservation Development Commission - When Required. Locations of Public Toilets on real property owned by or under the jurisdiction of the PORT shall be subject to review and approval by the PORT Commission, which shall consider the Department of Public Works Work Orders in issuing such approval or disapproval. In addition, any such additional locations within one hundred feet (100') of the San Francisco Bay shoreline shall be reviewed by the Bay Conservation and Development Commission.
- B. Approval of Port Director - When Required. Location, relocation or removal of any Public Toilet on PORT Property shall be subject to the review and approval of the PORT Director and of PORT engineering staff (in lieu of the Department of Public Works), in accordance with this Agreement.
- C. Approval of Recreation and Park Commission - When Required. Additional locations of Public Toilets on real property owned by or under the jurisdiction of or fronting the property of the San Francisco Recreation and Park Department shall be subject to review and approval by the Recreation and Park Commission.
- D. CITY Best Efforts. CITY shall use its best efforts to assist CONTRACTOR to receive permit approvals from any applicable local, state or regional agencies with jurisdiction over any particular locations.

2.10 Location Drawings and Engineering Plans for Public Toilets

- A. Location drawings shall provide a scale of twenty feet (20') to one inch (1") (e.g. 20: 1 scale) representation of the proposed Public Toilet site covering the area from the property line to the street centerlines at the nearest intersection. Mid-block sites can be shown with broken line ties.
- B. The drawing also shall give all necessary street dimensions, such as sidewalk width and street width, and denote all surface and subsurface structures, including hydrants, utility poles and catch basins, sub-sidewalk basements, transit shelters, bus stops and their accurate positions.

- C. After approval of a particular location (including any required public hearing), CONTRACTOR must also submit to the Department of Public Works engineering plans showing sewer connections, water service connections, electrical service connections and foundation details for each Public Toilet, which plans must be stamped and signed by a licensed engineer registered with the State of California.
- D. CONTRACTOR is responsible for identifying all utility lines located beneath the Public Toilet and for showing all such utility lines on the location drawing and notifying underground service alert prior to any excavation. Under this Agreement, the CITY must approve the location and engineering drawings and issue encroachment and excavation permits before CONTRACTOR may commence work on a specific site or location.

2.11 Electrical, Sewer, Telephone and Water Services; Installation.

- A. CONTRACTOR shall bear the full cost of the connection of the Public Toilets to water supply and electrical, sewer and telephone services, and the operating charges for water supply and electrical, sewer and telephone service charge to each Public Toilet. If feasible, CITY shall permit CONTRACTOR to use the CITY's electrical system, in which event CONTRACTOR shall pay the same rate charged to CITY agencies. CONTRACTOR has the authority to reuse existing utility connections, except with regards to new toilet site installations.
- B. Electrical Connections and Related Work. CONTRACTOR shall arrange and perform all internal electrical components and hook-up procedures in accordance with the San Francisco Electrical Code. All electrical service lines in each Public Toilet site shall be underground and shall originate from the point-of-services designated by CITY or by Pacific Gas & Electric Company ("PG&E"). CONTRACTOR shall contact PG&E and arrange for additional service not provided by CITY and shall pay CITY or PG&E directly for all charges for service connections and electricity.
- C. Sewer Service, Water Service and Drainage. CONTRACTOR shall contact the San Francisco Public Utilities Commission and arrange for water service for any new locations and shall pay for all charges related to service connections and water use. CONTRACTOR shall arrange and perform sewer hook-up procedures in accordance with San Francisco code requirements. CONTRACTOR shall contact the San Francisco Public Utilities Commission to establish sewer service for any new locations and to arrange to pay for all sewer service charges.
- D. Unanticipated Conditions. In the event that during the installation of any new or replacement Public Toilet, the CONTRACTOR encounters unanticipated conditions beyond its reasonable control, which would significantly increase the cost of installation or replacement of the Public Toilet, CONTRACTOR, upon notice to the CITY, may restore the work area to its pre-installation condition, and work with the CITY to identify an alternate location for the Public Toilet.

2.12 Restoration of Sites After Installation

When each Public Toilet installation is complete, CONTRACTOR shall remove all excess materials and restore the work area.

2.13 Compliance Regarding Public Toilets

- A. The Parties shall work in good faith to enable the CONTRACTOR to secure permit approvals from any applicable local, state or regional agencies with jurisdiction over any desired locations.
- B. CONTRACTOR shall install Public Toilets only for which (i) the design complies with all of the requirements in this Agreement, (ii) all required permits have been issued and all associated amounts due have been paid by CONTRACTOR, and (iii) locations have been determined and approved.
- C. CONTRACTOR shall have no liability for a delay in the installation of any Public Toilet if:
 - 1. Any required permit or approval is not received in a timely manner such that the schedule for installation may occur as agreed upon in the terms and conditions of this Agreement; or
 - 2. Any public utility fails to perform any service connection in a timely manner such that the schedule for installation may occur as agreed in the terms and conditions of this Agreement.

Notwithstanding the foregoing, the CONTRACTOR must have made all required applications to secure such permit or approval or service connection within the prescribed timelines.

3.0 Public Service Kiosk License

3.1 Design and Installation of Public Service Kiosks

- A. CONTRACTOR shall have an exclusive license, subject to the terms and conditions of this Agreement, to install, operate and maintain a maximum of one-hundred fourteen (114) Public Service Kiosks in the same locations as Public Service Kiosks are currently installed. If CONTRACTOR installs fewer than one-hundred fourteen (114) units, it remains obligated to provide all Services and pay all the Fees to the CITY as described in the terms and conditions of this Agreement. If CONTRACTOR determines that it wishes to install fewer than the maximum permitted kiosks, CITY reserves the right to review and approve the revised list of locations.
- B. Notwithstanding the right of the CONTRACTOR to install, operate and maintain such Public Services Kiosks, CONTRACTOR is subject to the requirements that:
 - 1. The design complies with the requirements in this Agreement;
 - 2. All required permits have been issued in connection with the location for installation; and
 - 3. All applicable amounts due have been paid by the CONTRACTOR.

Unless otherwise directed by the Director, within thirty (30) days of the Start Date, the CONTRACTOR shall submit an initial installation plan for the replacement of up to one hundred fourteen (114) Public Service Kiosks to the Department of Public Works. After such submission, the CONTRACTOR, the DESIGNER and the CITY shall work together to finalize all the necessary details so that the CONTRACTOR may provide an updated installation plan, which may be for all or a portion of the Public

Service Kiosks, with detailed information for the installation, including engineering of the Public Service Kiosks, an installation schedule, the type of Public Service Kiosks to be installed in each location and site drawings to the Department of Public Works as soon as practicable thereafter. CITY shall issue a final Notice to Proceed as promptly as practicable, but no longer than thirty (30) days, after receipt of such detailed information from the CONTRACTOR. Should the number of Public Service Kiosks included in the initial replacement plan be less than one hundred fourteen (114), the CONTRACTOR may, from time to time, submit additional installation plans for the remainder of these units until the total number of Public Service Kiosks replaced is one-hundred fourteen (114) and the process for replacement shall be as described in this Section 3.1B.

3.2 Permit Approvals for Public Service Kiosks

- A. CONTRACTOR shall submit applications for permits for Public Service Kiosks as promptly as practicable after receipt of an initial Notice to Proceed or the final Notice to Proceed, as applicable, and CITY shall use best efforts to review applications, approval and issue permits as promptly as practicable after each application is filed.
- B. CONTRACTOR must obtain all applicable permits before proceeding with installation of any Public Service Kiosk. The Department of Public Works shall review each location drawing and inspect each location and site, and thereafter, unless the site is determined to be unsuitable for re-installation of a Public Service Kiosk, shall approve and issue encroachment and excavation permits for each Public Service Kiosk site. CITY shall use its best efforts to assist CONTRACTOR to receive permit approvals from any applicable local, state or regional agencies with jurisdiction over any particular locations including, but not limited to, San Francisco Bay Conservation and Development Commission and the California Department of Transportation.
- C. If CONTRACTOR has faithfully submitted site plans as required by this Agreement, CITY agrees to use its best efforts to review and, if appropriate, approve permits in a timely manner.
- D. When any Public Service Kiosk is to be installed on PORT Property, CONTRACTOR shall submit location drawings to the PORT's Chief Harbor Engineer, together with any required fees for each Public Service Kiosk, and the PORT (in lieu of the Department of Public Works) shall, as required or as necessary, review such drawings, conduct inspections and hold public hearings in accordance with this Agreement. CONTRACTOR shall obtain building permits from the PORT's Chief Harbor Engineer prior to any Public Service Kiosk installation on PORT Property. No PORT building permit fee shall be payable for such sites on Port Property.

3.3 No Real Property Interest in Public Service Kiosks

CONTRACTOR agrees that it shall neither have nor acquire any real property interest in any of the CITY's real property (such as a lease or exclusive easement), on which a Public Service Kiosk has been installed pursuant to this Agreement. Such acknowledgment in no way affects or limits CONTRACTOR's obligation to pay any possessory interest taxes specified in Section 8.6 of this Agreement.

3.4 Usage of Public Service Kiosks

- A. **Public Service Usage.** The Public Service Kiosks may be used for the provision of Public Service Messages, public service activities, non-profit and cultural activities and local commercial enterprises in accordance with the procedures agreed upon by the CONTRACTOR and the CITY.
- B. **Interactive Media Displays.** CONTRACTOR shall install fifteen (15) small individual interactive media displays which shall have a media display area of between thirty-six inches (36") and forty-six inches (46") measured diagonally and will display informational content related to the CITY, including but not limited to, tourist locations, festivals and street fairs, and CITY maps. The CONTRACTOR shall display any local content requested and approved by the CITY, whether created by the CITY or a local provider, but such content must meet the CONTRACTOR specifications for all content displayed on its data network.
- C. **Other Usage Activities.** Public Services Kiosks may be used for a range of other services which may include, but are not limited to, automatic teller machines, vending locations, display of information for visitors, wayfinding information, and storage areas and such use is agreed to be a public service. The Public Service Kiosks may also be used to contain technology equipment from information service providers, including, but not limited to, small cells, Wi Fi equipment, sensors, counters, beacons and other devices for the collection and distribution of data and the provision of communication services. Kiosks may also be used for other services, products or information displays.
- D. All uses must be approved by the Director or designee. CONTRACTOR shall inform the CITY in writing if it intends to use a Public Service Kiosk in a manner other than to communicate messages and CITY shall confirm its approval in writing within thirty (30) days of receipt of CONTRACTOR information. The use will be deemed approved if Director has not raised an objection to the use by the thirty-first (31st) day. If circumstances change after approval that cause the use to be unacceptable to the Director or designee, both parties will work together to address the concern and change the use if necessary.

3.5 Locations of Public Service Kiosks

CONTRACTOR shall be responsible for determining the precise location and orientation for the installation of the advertising and public service panels for each replacement Public Service Kiosk at its designated location and shall present site plans to the Department of Public Works for approval.

3.6 Relocation and Temporary Removal of Public Service Kiosks

- A. CONTRACTOR may not relocate or remove a Public Service Kiosk without CITY's permission. CITY does not guarantee any specific location or site for the duration of this Agreement.
- B. The CITY may, in any Contract Year, through an Authorization provided to the CONTRACTOR, direct the relocation of Public Service Kiosks installed pursuant to this Agreement and for which CONTRACTOR will bear the cost of removal and relocation up to the total Relocation Cap, as follows:

1. The cost of any removal or relocation for a Public Service Kiosk requested by the CITY shall be aggregated with any amounts already spent by the CONTRACTOR for removal and/or relocation of Public Toilet/s and Public Service Kiosk/s over the Term;
 2. If the total of such removal and/or relocation total shall result in an amount higher than the Relocation Cap, such removal and/or relocation shall be undertaken by the CONTRACTOR at the sole cost of the CITY;
 3. The cost of the removal and/or relocation of any Public Service Kiosk beyond the Relocation Cap shall be included in the calculation of the Certified True-up Amount pursuant to Section 1.11 and deducted from the Fee paid to the CITY for such Contract Year; and
 4. CONTRACTOR shall provide CITY with such documentation as to evidence the actual cost of such removal and/or relocation as soon as practicable, and in any case, prior to including such amount in the calculation of the Certified True-up Amount pursuant to Section 1.11.
- C. In the event that the CONTRACTOR has all permits and approval for the relocation and fails to remove and relocate a Public Service Kiosk within the time directed by the CITY, CITY may, at its sole discretion, cause the removal and storage or relocation of such Public Service Kiosk and recover any and all costs incurred from CONTRACTOR, as follows:
1. Any reimbursement of costs in connection with the removal and/or relocation of any Public Service Kiosk that the CONTRACTOR failed to remove shall be paid to CITY by CONTRACTOR as part of the Fee due to the CITY in such Contract Year;
 2. the cost of such removal and/or relocation by the CITY shall be included in the calculation and payment of Fees due to the CITY in such Contract Year; and
 3. CITY shall provide CONTRACTOR with such documentation details as to evidence the actual cost of the removal and/or relocation as soon as practicable, and in any case, prior to the inclusion of such amount in the calculation of the Certified True-up Amount pursuant to Section 1.11.
- D. The new location of any such relocated Public Service Kiosk shall be determined in accordance with the procedures set forth in this Agreement.
- E. If the removal and/or relocation is due to CITY construction or private development, the CITY will facilitate payment between the applicable CITY agency or THIRD PARTY for the costs of relocations or removals.
- F. In the event the Port Director directs CONTRACTOR to remove any Public Service Kiosk on Port Property, CONTRACTOR shall remove such kiosk within seventy-two (72) hours (excluding Sundays and federal holidays) provided that the PORT has at the time of removal issued permits for installation at another location for the Public Service Kiosk, which location shall have been approved by CONTRACTOR under the terms of this Agreement. Such removal and relocation shall be subject to the limits set forth in this Agreement.

- G. The CITY and CONTRACTOR will work together during the Market Street construction and relocate any Public Service Kiosk and Public Toilet installed on Market Street, such relocation shall include foundation and utilities connections, as part of the CITY's Better Market Street capital improvement project.
- H. The Parties agree that once installed, the CITY will make every effort to not request the relocation of Public Service Kiosks with digital screens during the term of the Agreement. In the event that the CITY determines that any Public Service Kiosks with digital screens must be relocated, after reviewing and exhausting all options that would not require relocation, the CITY will work with the CONTRACTOR to identify a new location that is equivalent in terms of such location's potential to produce comparable revenue to the previous location. In the event of any deliberation regarding the relocation of any Public Service Kiosks with digital screens, the Parties agree to work together in good faith to determine a solution which is beneficial to both Parties.

3.7 Clearance Requirements for Public Service Kiosks

All Public Service Kiosks, wherever located, shall be placed in accordance with the terms of all applicable Department of Public Works Orders, issued by the Director, and as modified from time to time by subsequent Director's orders; provided, however, that such subsequent orders are subject to the provisions of Section 8.23(D). After the installation of a Public Service Kiosk, to the extent feasible, CITY shall use its best efforts not to place any new structures or obstacles within the specified clearance area or which would obstruct the line of sight of, or access to, such Public Service Kiosk. If after the installation of a Public Service Kiosk, the CITY must place such an obstruction after reviewing other options, the Parties shall work together in good faith to determine a solution which is beneficial to both Parties.

3.8 Public Service Kiosk Design

- A. CONTRACTOR shall construct and install the Public Service Kiosks provided under this Agreement in conformity with Appendix E, designs which were selected in the local invitation-only design competition and have been approved by CITY, including its Art Commission, Historic Preservation Commission, and any other entity with review rights under CITY policy or ordinance.
- B. Such plans and specifications may be modified by CONTRACTOR only with the prior written approval of the Director. Such approval shall not be unreasonably withheld if the proposed change does not materially affect the external appearance or accessibility of the Public Service Kiosks. Unless expressly approved by the Director and all appropriate CITY agencies and departments, all Public Service Kiosk structures shall be stationary and shall not rotate, except manually for service.

3.9 Approval of Other Agencies

- A. Approval of Recreation and Park Commission - When Required. Locations of Public Service Kiosks on real property owned by or under the jurisdiction of or immediately adjacent to property of the San Francisco Recreation and Park Department shall be subject to review and approval by the Recreation and Park Commission.

- B. Approval of Port Commission: Bay Conservation and Development Commission - When Required. Locations of Public Service Kiosks on real property owned by or under the jurisdiction of the Port of San Francisco shall be subject to review and approval by the Port Commission, which shall consider the Department of Public Works Work Orders as may be modified from time to time by subsequent Director's orders in issuing such approval or disapproval. In addition, locations of Public Service Kiosks on real property located within one hundred feet (100') of the San Francisco Bay shoreline shall be reviewed by the Bay Conservation and Development Commission, in addition to any other necessary approvals.

3.10 Location Drawings and Engineering Plans for Public Service Kiosks

- A. Location drawings submitted to CITY for approval for each licensed Public Service Kiosk shall provide a scale of twenty (20) feet to one (1) inch (20:1 scale) representation of the proposed Public Service Kiosk site covering the area from the property line to the street centerlines at the nearest intersection. Mid-block sites can be shown with broken line ties. The drawing also shall give all necessary street dimensions, such as sidewalk width and street width, and denote the accurate positions of all surface and subsurface structures, including hydrants, utility poles and catch basins, sub-sidewalk basements, transit shelters, and bus stops.
- B. After approval of a particular location (including any required public hearing), CONTRACTOR must also submit to the Department of Public Works engineering plans showing electrical service connections and foundation details for each replacement Public Service Kiosk, which plans must be stamped and signed by a licensed engineer registered with the State of California. CONTRACTOR is responsible for identifying all utility lines located beneath the Public Service Kiosk site and for showing all such utility lines on the location drawing. The CITY must approve the location and engineering drawings and issue encroachment and excavation permits before CONTRACTOR may commence work on a particular site or location.

3.11 Electrical Connections and Service Responsibility of CONTRACTOR

- A. CONTRACTOR shall bear the full responsibility, including all costs, of furnishing, installing and maintaining electrical services to each Public Service Kiosk permitted under this Agreement. CONTRACTOR shall arrange and perform all internal electrical components and hook-up procedures necessary to the installation of the Public Service Kiosks in accordance with the San Francisco Electrical Code. All electrical service lines at each Public Service Kiosk site shall be underground and shall originate from the point-of-service designated by CITY or by Pacific Gas & Electric Company (PG&E) or its successor agency, respectively.
- B. CONTRACTOR may use CITY owned street lighting conduit provided that there is available space in the conduits. CONTRACTOR must obtain prior approval from CITY's SFPUC Bureau of Light, Heat and Power and provide said Bureau with a schedule in advance of any work on conduits and pull boxes. The CONTRACTOR must also maintain a log of its activities when performing such work. CONTRACTOR has the authority to reuse existing utility connections.
- C. CONTRACTOR may not tap into the street lighting circuit unless approved by the SFPUC Bureau of Light, Heat and Power. CONTRACTOR shall pay the same rate charged to CITY agencies.

CONTRACTOR shall contact PG&E and arrange for additional service not provided by CITY and shall pay CITY or PG&E directly for all charges for service connections and electricity.

3.12 Other Regulatory Issues for Public Service Kiosks

A. CONTRACTOR shall have no liability for a delay in the installation of any Public Service Kiosk if:

1. Any required permit or approval is not received in a timely manner such that the schedule for installation may occur as agreed in the terms and conditions of this Agreement; or
2. Any public utility fails to perform any service connection in a timely manner such that the schedule for installation may occur as agreed in the terms and conditions of this Agreement.

Notwithstanding the foregoing, the CONTRACTOR must have made all required applications to secure such permit or approval or service connection within the prescribed timeline.

B. CONTRACTOR shall submit applications for permits for Public Service Kiosks as promptly as practicable after receipt of the Notice to Proceed, and CITY shall use best efforts to issue permits, and facilitate the issuance of permits, as promptly as practicable after each application is filed.

3.13 Restoration of Sites

When each Public Service Kiosk installation is complete, CONTRACTOR shall remove all excess materials and restore the work area.

4.0 Advertising

4.1 Advertising Displays

- A. CONTRACTOR shall have the right, but not the requirement, to install up to two (2) panels reserved for the placement of commercial advertising on each Public Service Kiosk. Panels may be static or digital. This determination is within the sole discretion of the CONTRACTOR.
- B. CONTRACTOR shall provide the CITY a list on the locations of digital panels in Public Services Kiosks and provide updates of any changes to these locations in its monthly reports thereafter.
- C. The minimum display interval for digital advertising shall have a dwell time no shorter than three (3) seconds and no longer than fifteen (15) seconds and shall not include sound effects, strobe light effects, or animation; provided however, the restrictions described in this Paragraph C may be adjusted with the approval of the Director.

4.2 Size and Luminosity of Advertising

- A. Advertising displays pursuant to this Agreement shall not exceed fifty-two (52) square feet in area nor be greater than twelve feet (12') in height nor five feet (5') in width.
- B. The panels on the Public Service Kiosks may be illuminated up to twenty-four (24) hours a day. The brightness of all digital displays shall follow the market standard for digital advertising

displays installed on urban streetscapes in the top five (5) designated United States market areas (known as "DMAs") as rated by the Nielsen Company and shall automatically respond to reductions in light, growing less bright when sunlight is reduced.

4.3 Commercial Advertising and Public Service Messaging

- A. Commercial Advertising. CONTRACTOR, its employees or approved subcontractors, may contract with others to sell space for commercial advertising on the Public Service Kiosks. Commercial advertising may be in the form of paper posters or digital content. CONTRACTOR may also display on such panels its own advertisements and promotions and employ any sales strategy consistent with industry standards to increase the sale of advertising space.
- B. Noncommercial Advertising Space.
1. CONTRACTOR agrees to install and display Public Service Messaging provided by CITY on one static panel of each Public Service Kiosk, determined in the sole discretion of the CONTRACTOR, and on each Public Toilet, at no cost to CITY. The display of Public Service Messaging shall be in a manner which neither interferes with advertising placed by CONTRACTOR nor generates overtime costs for CONTRACTOR.
 2. CITY agrees not to sell such reserved space to commercial advertisers either directly or through any intermediary.
 3. The display material for panels on Public Service Kiosks allocated to display Public Service Messaging, which are located on Port Property, shall be determined by the PORT.
 4. The CONTRACTOR shall display digital Public Service Messages in one (1) out of eight (8) spots in a digital loop, provided that, if digital loop of content does not consist of eight spots, then the Public Service Messages will be displayed in an amount equal to twelve and one-half percent (12.5%) of the total time in which content is displayed and included regularly throughout the digital rotations.
 5. CONTRACTOR shall have the right, at its own discretion, to display free of charge Public Service Messages on space not contracted for use by paid advertisers and not otherwise being used by CONTRACTOR for purposes described in Section 4.3A.

4.4 Authorized Advertising Material

- A. CONTRACTOR shall adhere to its advertising policy, a copy of which policy has been proved to the CITY, in accepting any material for advertising on Public Service Kiosks. Such policy may be amended or revised from time to time and CONTRACTOR agrees to provide the CITY with such amended or revised policy.
- B. CONTRACTOR agrees to remove promptly, upon written demand by the Director of Public Works, or, with respect to advertising displays on Port Property, upon written demand by the Port Director, any advertisement that violates the restrictions contained in this Agreement.

4.5 Prohibited Advertising Content

- A. Advertising is prohibited if it includes any content that falls under one or more of the following categories:
1. False or Misleading. Any material that is or the sponsor reasonably should have known is false, fraudulent, misleading, deceptive, or would constitute a tort of defamation or invasion of privacy.
 2. Copyright, Trademark or Otherwise Unlawful Infringement. Any material that infringes on any copyright, trade or service mark, title or slogan.
 3. Obscenity or Pornographic. Any material that is obscene or pornographic.
 4. Defamation or Lawless Action. Any material that is clearly defamatory or advocates imminent lawlessness or violent action.
 5. Alcohol, Tobacco, or Firearms. Any material that constitutes commercial advertising of alcohol, tobacco, tobacco-related products or firearms.
 6. Profanity and Violence. Advertisement that contains any profane language, or portrays images or descriptions of graphic violence, including dead, mutilated or disfigured human beings or animals, the act of killing, mutilating or disfiguring human beings or animals, or intentional infliction of pain or violent action towards or upon a person or animal, or that depicts weapons or devices that appear to be aimed or pointed at the viewer or observer in a menacing manner.
 7. Insulting, Degrading, Disparaging, Demeaning or Offensive. Any material directed at a person or group that is intended to be (or reasonably could be interpreted as being) (i) insulting, degrading, disparaging, demeaning or offensive so as to be reasonably foreseeable that it will incite or produce lawless action in the form of retaliation, vandalism or other breach of public safety, peace and order, or (ii) disparaging or disrespectful to persons, groups, governments, businesses or organizations, including advertisements that portray individuals as inferior, evil or contemptible.
 8. Cannabis. Any material that constitutes commercial advertising of cannabis, cannabis products, cannabis businesses, or cannabis services.
 9. CONTRACTOR and City shall work together in good faith should any substances be banned for sale by the City of San Francisco after the date of this Agreement.
- B. This prohibition shall not apply to any advertisement sponsored by a state, local or non-profit entity, which advertisement is designed to communicate the health hazards of cannabis, alcohol, cigarettes or tobacco products or to encourage people not to drink, smoke or to stop smoking.

4.6 Changes in Authorized Advertising

- A. The Parties mutually acknowledge and agree that the advertising rights granted under this Agreement are only incidental to the conduct of the CITY's municipal business. Accordingly, CONTRACTOR understands and agrees that the advertising rights granted herein may be affected by changes in the conduct of the CITY's municipal affairs (such as rerouting traffic).
- B. CITY shall have no liability for any such change affecting the level or scope of advertising authorized by this Agreement other than any abatement in the Annual Service Fee, which abatement that will be agreed in good faith and shall be proportional to reflect the reduction in Advertising Revenue as demonstrated by CONTRACTOR based on an actual before-and-after analysis of the impact of such change on Advertising Revenues for the two (2) years prior to such change.
- C. CONTRACTOR acknowledges that the particular locations available for Public Service Kiosks may vary from time to time for various reasons, including administrative and/or legislative determinations by CITY relative to the desirability of having Public Service Kiosks in a particular location. CITY will give CONTRACTOR at least ninety (90) days written notice of any decision regarding changes required in advertising Public Service Kiosks. CITY will, where possible, identify replacement locations for any such advertising required to be removed from another location pursuant to such administrative and or legislative determination.
- D. Nothing in this Section 4.6 shall be construed to limit the provisions of other Sections of this Agreement. It is the intent of both CITY and CONTRACTOR to provide an advertising program which is effective and aesthetically pleasing to residents and visitors of San Francisco and which will be beneficial to both Parties. The Parties accordingly agree to maintain throughout the term of this Agreement a continual liaison and exchange of plans and information to assure successful implementation of this Agreement.

4.7 Advertising Displays Equivalence

CITY and CONTRACTOR agree that the intent of this Agreement with respect to the permitted number and locations of advertising panels permitted under this Agreement shall be of equivalent commercial value to the current advertising program. In the event that such total number and/or locations of advertising panels shall not be consistent with or equivalent to the current advertising program, the Parties shall agree on an appropriate solution reflective of the lost revenue which may include, but is not limited to, an abatement or a reduction in installations, until the total number and/or locations are consistent.

4.8 Experiential Advertising

The Parties shall work together to create, approve and install interactive and/or experiential advertising content affixed to the outside of Public Service Kiosks to enhance the customer experience in the CITY. CITY must approve CONTRACTOR's use of any such interactive or experiential advertising content.

4.9 Advertising Pilots

To reflect the changing nature of the digital advertising market, the Parties shall work together to pilot new advertising modes and methods on Public Service Kiosks. All pilots must be reviewed and approved by the Director.

5.0 Maintenance, Attendants and Operations

5.1 Public Toilet and Public Service Kiosk Maintenance and Operations

CONTRACTOR shall have full responsibility to operate and maintain all Public Toilets and Public Service Kiosks installed under this Agreement as provided herein. The Parties acknowledge that the CONTRACTOR requires vehicular access and temporary short-term parking at each Public Toilet and Public Service Kiosk to perform maintenance and repairs as needed, and CITY agrees to facilitate that vehicular access.

5.2 Public Toilet Operations

Each Public Toilet shall be operational twenty-four (24) hours every day unless otherwise required by the Director. The CONTRACTOR may determine, due to community needs or operational requirements, that a Public Toilet/s needs to be temporarily closed and the CONTRACTOR shall be permitted to close such Public Toilet/s and inform the CITY. In the event that the CONTRACTOR closes such Public Toilet/s for more than twenty-four (24) hours, as soon as reasonably practicable, the CONTRACTOR shall discuss the closure with the CITY and both Parties shall use their best efforts to work out a plan to reopen the Public Toilet/s.

5.3 Services to be Provided by CONTRACTOR

CONTRACTOR, its employees, or authorized subcontractors agrees to provide the following in connection with the maintenance and operation of the Public Toilets and Public Service Kiosks during the entire term of this Agreement, unless otherwise agreed upon by the Parties:

- A. The maintenance of all Public Toilets, Public Service Kiosks, advertising panels, and any other displays installed under this Agreement in a clean, graffiti-free, safe, and "first-class" condition, consistent with the standards provided in this Agreement, including refurbishing, reconditioning, and if necessary, replacing any Public Toilets and Public Service Kiosks at no cost to the CITY;
- B. Attendant Services for Public Toilets up to the Annual Service Fee, and as so agreed upon by the Parties;
- C. To place, replace and maintain all advertising content, digital advertising display panels, posters, Public Service Messaging and any other display materials in a clean, graffiti-free, safe, in "first-class" condition in a manner that is consistent with the more specific standards elsewhere provided in this Agreement;
- D. A continuous, full-time, and good faith effort to sell the greatest practicable amount of advertising;
- E. An experienced sales force for the sale of advertising;

- F. An office and shop facilities in the City and County of San Francisco for JCDecaux San Francisco, LLC, for JCDecaux public toilets;
- G. Assure that the best quality design and production of exhibits and advertising material shall be installed or used in advertising displays; and
- H. Provide the necessary personnel to assure the maintenance of Public Toilets and Public Service Kiosks and displays of advertising as provided herein.

5.4 Sidewalk Repairs

CONTRACTOR shall be responsible for any sidewalk repairs or upgrades required as a result of damage caused by the CONTRACTOR or any agents acting on its behalf in connection with construction work at the relevant site area but shall not be responsible for any other necessary sidewalk repairs or upgrades.

5.5 Inspection and Clean-Up of Public Toilets and Public Service Kiosks

- A. CONTRACTOR shall inspect each Public Toilet at least once per day (Sundays and federal holidays included) and shall inspect each Public Service Kiosk at least once per week. CONTRACTOR acknowledges that two (2) inspections per day of the Public Toilets may be required, particularly at certain locations and CONTRACTOR shall inspect any site more frequently if conditions at that site so require.
- B. At the time of every inspection, CONTRACTOR shall, if necessary, clean and wash each Public Toilet and Public Service Kiosk. In addition, CONTRACTOR shall inspect all fixtures at each site and, if needed, shall replace defective fixtures within the time frames as specified in this Agreement. CONTRACTOR shall remove all graffiti, stickers, unauthorized posters and flyers, litter, dust, dirt and weeds and other rubbish from each Public Toilet and Public Service Kiosk.
- C. Notwithstanding any other provision of this Agreement, including the requirement to provide Attendants, CONTRACTOR shall not be required to provide security personnel at the site of the Public Toilets or Public Service Kiosks and the Attendants shall not be required to engage in any activities that would, in the belief of a reasonable person, be undertaken by security personnel.

5.6 Approved Cleaning Products

CONTRACTOR shall only use cleaning products that meet all applicable laws and regulations pertaining to accommodation of chemical sensitivities.

5.7 Repair and Replacement

- A. Upon observing or receiving notification of any damage, Vandalism, or graffiti in, on or within three (3) feet of any Public Toilet or Public Service Kiosk, CONTRACTOR shall commence to repair or replace said damage, Vandalism, or graffiti, within twenty-four (24) hours.
- B. If a Public Toilet or Public Service Kiosk is destroyed, CONTRACTOR shall within twenty-four (24) hours secure or remove the remains of the Public Toilet or Public Service Kiosk and shall thereafter replace the Public Toilet or Public Service Kiosk with a similar fixture at that site as

soon as practicable. In conjunction with such removal, CONTRACTOR shall, at its own expense, restore the affected sidewalk and curb area to a safe, finished condition.

- C. If CONTRACTOR does not maintain inspections as scheduled and remedy existing deficiencies within such time periods, CITY shall be entitled, upon twenty-four (24) hour notice to CONTRACTOR (or such shorter notice as may be feasible in an emergency), to make the repairs and recover any and all costs incurred from CONTRACTOR.
- D. Any reimbursement of costs in connection with the repairs that the CONTRACTOR failed to undertake pursuant to Section 5.7C, shall be paid directly to CITY by CONTRACTOR upon the invoice therefor provided by the CITY and evidencing the cost incurred by the CITY. CONTRACTOR may, with the CITY's permission, elect instead to relocate and remove any Public Toilet or Public Service Kiosk, for which CONTRACTOR shall bear the full cost of removal and relocation, including sidewalk and curb repair if the same is affected by the removal.
- E. Subject to extension for Force Majeure, if any Public Toilet requires repair such that it is out of operation for forty-eight (48) consecutive hours, or if any Public Toilet is destroyed and has not been replaced with a fixture within six (6) months, then CONTRACTOR shall pay to CITY the sum of one thousand dollars (\$1,000) per each day thereafter that such Public Toilet remains out of operation.

5.8 No Charge for Use of Public Toilets

CONTRACTOR shall not charge the public for use of the Public Toilets, unless the Director requests otherwise at specific locations and the CONTRACTOR agrees.

5.9 Use of Public Service Kiosks

- A. The public service panel of the Public Service Kiosks may display Public Service Messaging, a vending area or interactive elements as determined by CITY, which displays shall, in all events, be of a non-commercial nature.
- B. A "non-commercial nature" shall be evidenced so long as the display identifying any commercial sponsorship is no larger than ten percent (10%) of the display, contained in a band along the bottom of the display poster. Advertisements or announcements of or for nonprofit cultural events or institutions shall be considered of non-commercial nature, so long as they contain limited commercial sponsorship as defined above.
- C. CITY shall have sole responsibility for the selection, scheduling and coordination of all materials to be displayed on the public-service panels of the Public Service Kiosks, and CITY is expected at all times to use good judgment in accepting any materials for such display. CITY will be responsible for the delivery to CONTRACTOR of the information to be displayed, printed in the size and the material specified by CONTRACTOR and ready for installation or in the acceptable format for a digital file if applicable, including all specific instructions regarding the display locations.
- D. CONTRACTOR will be responsible for the installation of such materials in designated locations; provided, however, that CONTRACTOR may only be required to install such materials on the same day as it is otherwise installing new advertising posters in such Information Kiosks, which

installation shall be performed at least monthly and on a schedule which CONTRACTOR shall provide to the CITY in advance.

- E. The public service panel of a Public Art Kiosk may be used for the display of art, designs, photos and graphics ("Public Art") furnished by the Art Commission. All Public Art display panels shall be displayed in the same manner as the CONTRACTOR's static advertising panels and shall, in all events, be of a non-commercial nature.
- F. All public agencies or non-profit arts groups wishing to display public art on the Public Art Kiosk display panels shall contact the Art Commission which will have sole responsibility for the selection, scheduling and coordination of all materials to be displayed on the Public Art panels, except that the Port Director shall also review and approve all Public Art displayed on kiosks on Port Property.
- G. The Art Commission will be responsible for the delivery to CONTRACTOR of the Public Art displays, printed in the size specified by CONTRACTOR and ready for installation, and for the provision of any specific instructions regarding the display locations for particular posters or digital content. CITY is expected at all times to use good judgment in accepting any Public Art for display on the Public Art Kiosks.
- H. CONTRACTOR will be responsible for the installation of the Public Art in designated locations; provided, however, that CONTRACTOR may only be required to install or remove such Public Art materials on the same day as it is otherwise installing new advertising posters in such Public Art Kiosk, which installation shall be performed at least monthly and on a schedule which CONTRACTOR shall provide in advance to the Art Commission. CONTRACTOR shall use good faith efforts to carefully remove Public Art from the Public Art Kiosks and shall return any undamaged Public Art to the Art Commission; provided, however, that CONTRACTOR shall in no event be liable for damage to Public Art.
- I. From time to time during the Term, CONTRACTOR may develop and make available additional public services, which may be incorporated into the Public Service Kiosk program. If such additional public services and the terms and conditions upon which such services will be provided are agreed upon by the Director and CONTRACTOR, such new or additional public services shall be a permitted use of the Public Service Kiosks.

5.10 Additional Installation and Relocation Terms

- A. The Director shall, on behalf of a Third Party, have the right to request that the CONTRACTOR install or relocate a Public Toilet or a Public Service Kiosk. The CONTRACTOR shall install or relocate such Public Toilet or a Public Service Kiosk, if requested in writing by the Director. Nonetheless, such installation or relocation of such Public Toilet or a Public Service Kiosk shall be fully paid by the Third Party requesting such installation or relocation and no expense shall be paid by the CONTRACTOR. The Director and the CONTRACTOR shall work together to establish a schedule of installation and payment for such Public Toilet or a Public Service Kiosk as soon as reasonably practicable after the request has been made.
- B. All installation and relocations of Public Toilet or a Public Service Kiosk shall be executed in accordance with the terms of this Agreement. Any Public Service Kiosk with commercial

advertising display panels that had been removed at the request of the CITY on its own account or on behalf of a Third Party shall be reinstalled at an equivalent location that is mutually agreed between the CITY and the CONTRACTOR.

5.11 Utilities

The CONTRACTOR shall have the authority to reuse any existing utility connections for the installation and/or replacement of units. CONTRACTOR shall initiate new utility connections in accordance with the terms and conditions of this Agreement for the installation of new Public Toilets.

5.12 Attendant Services for Public Toilets

- A. Beginning eighteen (18) months after the Start Date, during each Contract Year of the Term, the CONTRACTOR shall provide Attendant Services by paying the Annual Service Fee, which is the equivalent as of the Start Date of forty-eight thousand, one hundred and eighty (48,180) hours for eleven (11) Public Toilets, twelve (12) hours per day, 365 days per year.
- B. If the CITY determines that operating conditions at existing locations or any new Public Toilets installed under this Agreement require Attendant Services and provided that the then-current Annual Service Fee has not been fully used for the given Contract Year, CITY shall request such services from CONTRACTOR. CONTRACTOR shall implement the CITY's request for additional services within 30 days. If CONTRACTOR requests Attendants at existing location(s) and provided that the then current Annual Service Fee has not been fully used for the given Contract Year, CONTRACTOR will use the hours available and inform the CITY accordingly.
- C. In the event that CITY and CONTRACTOR agree that additional monitoring services beyond what is required under this Agreement and as specified in this Section 5.12 are required, the CITY shall pay for the cost of providing such additional monitoring services.
- D. If during the Term, the cost for Attendant Services decreases such that the cost of providing forty-eight thousand, one hundred eighty (48,180) hours of Attendant Services decreases from two million, one-hundred fifty thousand dollars (\$2,150,000) or increases such that the cost of providing forty-eight thousand, one hundred eighty (48,180) hours of Attendant Services exceeds the two million, one-hundred fifty thousand dollars (\$2,150,000), adjusted by CPI as specified in Section 1.8, the CONTRACTOR and CITY shall review the cost of services and mutually agree to adjustments. Under no circumstances shall CONTRACTOR have an obligation to provide Attendance Services above the Annual Service Fee (adjusted by CPI as specified in Section 1.8)
- E. The Attendants shall be sourced by local community organizations, as determined by the CONTRACTOR, with the approval of the CITY, which approval shall not unreasonably be withheld and which may include the CONTRACTOR, such that there may always be enough individuals to provide the Attendant Services at the Public Toilets in accordance with this Agreement and subject to Section 5.12F below.
- F. It is the intention of the Parties that the Attendant Services be staffed by individuals sourced by local community organization/s, however, in the event that, after reasonable efforts, CONTRACTOR is unable to source enough individuals to meet its total Contract Year hours of Attendant Services

from individuals sourced by local community organizations, CONTRACTOR shall inform the CITY and use its own employees to staff the Public Toilets on the same terms and conditions specified herein for a Third Party providing Attendant Services. Notwithstanding, in the event that CONTRACTOR employees are staffing Public Toilets the CONTRACTOR shall continue to make efforts to source individuals from local community organization/s and the Parties shall meet to discuss the Attendant Services sourcing.

- G. The local community organizations shall be responsible for sourcing individuals who are ready, willing and able to work as Attendants and tracking the hours of the Attendants.
- H. Attendants shall be responsible for monitoring the Public Toilets and informing CONTRACTOR if cleaning services are required, providing information to the pedestrian traffic including, but not limited to, tourist information, wayfinding information, information about the use of the Public Toilets and community event or local landmark information and for confirming that the Public Toilets are not being misused by the public.
- I. CONTRACTOR shall provide Attendants with (a) training, which shall include safe collection of needles, protocols for addressing on-site issues (including when to revert to a supervisor employed by the CONTRACTOR), environmental literacy, work and life skills, the CITY Ambassadors program, social services training to increase sensitivity to community issues, be fluid and comfortable in dealing with the local homeless population and to be able to provide referral resources to the public, (b) detailed job descriptions specifying the monitoring tasks, (c) uniforms, (d) tools and supplies, (e) monitoring and coaching from management, supervisors (who shall be employed by the local community organizations) and cleaning staff peers.
- J. The local team of the CONTRACTOR shall communicate regularly with the local community organizations as well as the Attendants to support the attendant program and confirm that participants have the information and training to undertake their duties and that the Attendants are meeting the standards communicated by JCDecaux to the Attendants and to the local community organizations.
- K. In selection of the local community organizations tasked with sourcing attendants, CONTRACTOR must consider the extent to which a local community organization can assure "Labor Harmony" in its operations to minimize the possibility of disruption of Attendant Services. This agreement construes "Labor Harmony" broadly, and does not require Contractor and selected local community organization to adopt any particular method of assuring labor harmony, but requires the Contractor to provide documentation as part of the approval process detailed in Section 5.12E indicating the extent to which the selected local community partner is committed to ensuring labor harmony in performing Attendant Services.

5.13 Technology for Public Service Kiosks and Public Toilets

- A. The CONTRACTOR shall have the right, in its sole discretion, alone or in participation with Third Parties to incorporate and install technology facilitating Wi Fi connection, which technology may include small cell installations, and which technology may generate Non-Advertising Revenue to be shared with the CITY. Should the CONTRACTOR allow third parties to place small cell node installations, it shall charge third parties no less than \$4,000 as an annual fee per installation unless

prohibited by law. The CONTRACTOR shall house CITY technology devices and power connections at such locations when technically feasible at no cost.

- B. The CITY and the CONTRACTOR acknowledge that during the Term new technology and technological innovations shall occur which are unknowable at the Signing Date but that could improve, upgrade and/or innovate the services offered under the program described under this Agreement. The Parties agree that the CONTRACTOR shall have the right alone or in participation with Third Parties with which it shall choose to work, to incorporate and install such technology, subject to the approval of the Director, which approval may not be unreasonably withheld.

6.0 Accessibility Requirements

6.1 Accessibility

All Public Toilets and Public Service Kiosks shall be universally accessible.

6.2 Accessible Design, Construction, and Operation

Design, construction, and operation of Public Toilets shall comply with all applicable federal, state and local laws and regulations for non-discrimination and barrier-free design, including but not limited to the applicable provisions of:

- A. The Americans with Disabilities Act of 1990 (ADA), the 2010 Americans with Disabilities Act Standards for Accessible Design, including the revised Title II ADA Regulations at CFR, Part 35 as amended September 15, 2010, and the 2004 ADA Accessibility Guidelines (ADAAG) at 36 CFR part 1191, Appendices B and D. In the few places where the requirements between the Title II regulations and the 2004 ADAAG differ, the requirements of the Title II regulations shall prevail;
- B. The California Code of Regulations, Title 24, Part 2; the California State Building Code;
- C. The California Government Code, Section 4450 et. seq.; and
- D. All other applicable federal, state and local regulations.

In the event of conflict between applicable laws and regulations, the laws and regulations that provide the higher degree of accessibility shall apply.

6.3 Path of Travel

Location of Public Toilets and Public Service Kiosks shall not obstruct the path of travel for persons with disabilities. CONTRACTOR shall comply with CITY's specific clearance requirements.

7.0 Termination of Agreement

7.1 Relocation and Termination: Waiver of Rights

- A. CONTRACTOR acknowledges that this agreement includes provisions granting to CITY, subject to certain terms and conditions, the right to order the removal and relocation of a limited number of Public Service Kiosks and, subject to certain terms and conditions, the right to terminate the

agreement, and upon such termination to order the removal of all Public Service Kiosks and Public Toilets.

- B. CONTRACTOR fully waives, releases, and relinquishes forever any and all claims, demands, rights, and causes of action that it may have against the CITY under the Outdoor Advertising Act (Business and Professions Code, Section 5300 *et seq.*), any amendments thereto or other future allows, for any compensation from CITY not otherwise provided for herein, including the payment of just compensation, as defined in the Eminent Domain Law (Title 7, commencing with Section 1230.010, of Part 3 of the Code of Civil Procedure), in the event the CITY lawfully exercises any such rights in accordance with the provisions of this Agreement.

7.2 Termination of Agreement

- A. Termination Upon Expiration. This Agreement shall terminate at one minute after midnight (Pacific Coast time) on the Expiration Date, unless terminated earlier as provided in this Section.
- B. Removal of Public Toilets and Public Service Kiosks Upon Termination. Upon termination of this Agreement, CITY may direct CONTRACTOR to remove its Public Toilets and Public Service Kiosks and restore the respective sidewalks and curbs if necessary, at CONTRACTOR's own cost and expense, and CONTRACTOR shall promptly thereafter file applications for the necessary permits to do so. CONTRACTOR shall complete such removal and restoration within one hundred twenty (120) days of the issuance of such permits. If CONTRACTOR fails to complete such removal and restoration within said one hundred twenty (120) day period, CITY, without further notice and at CONTRACTOR's cost and expense, may remove the Public Toilets and Public Service Kiosks and restore the sidewalks and curbs as needed. The CITY shall promptly issue permits for removal of Public Toilets and/or Public Service Kiosks whenever such removal is required hereunder.
- C. Termination for Default. In the event of any uncured default by either party to this Agreement, the non-breaching party shall have the option to terminate the Agreement as provided therein.
- D. Change in Laws and/or Conduct of Municipal Affairs. If CITY, the State of California, the federal government or any other governmental agency should adopt a change in laws or regulations, including Department of Public Works Orders, and/or if there are changes in the conduct of the CITY's municipal affairs, that are applicable to the Public Toilets, Public Service Kiosks or the use of the Public Service Kiosks for advertising, which significantly affects CONTRACTOR's ability to sell advertising, significantly restricts the areas in which the Public Service Kiosks (including the advertising to be placed thereon) are permitted, or significantly increases the cost of operation, including the cost of manufacture or installation of new Public Toilets or Public Service Kiosks, but excluding any tax or change in business regulation of general applicability, then at the request of CONTRACTOR, CITY and CONTRACTOR shall negotiate in good faith possible modifications to this Agreement to compensate for the effect of such change. In no event shall CITY be required to agree to any particular modification of this Agreement. If no modification of the Agreement satisfactory to CONTRACTOR is agreed upon after one hundred twenty (120) days, CONTRACTOR may, at its option, elect to terminate this Agreement upon ninety (90) days' notice to CITY.

7.3 Event of Default; Remedies

- A. **Default of CONTRACTOR.** In the event that CONTRACTOR shall fail to comply with or carry out any material term, covenant, condition, or promise herein set forth, CITY may elect to serve upon CONTRACTOR a First Notice of Default. If CONTRACTOR fails to cure such default within thirty (30) days after receipt of said notice, or, if such default cannot be cured within such period, if CONTRACTOR does not commence to cure within such thirty (30) days and thereafter diligently pursue such cure to completion, then CITY may elect to terminate this Agreement. Termination shall be effective after ten (10) days written notice to CONTRACTOR. CONTRACTOR shall undertake no new work after the date of receipt of any notice of termination or five (5) days after the date of the notice, whichever date is earlier.
- B. **Bankruptcy or Reorganization Proceedings.** CONTRACTOR shall be deemed to be in default of this Agreement in the event that CONTRACTOR shall cease conducting business in the normal course, become insolvent, make a general assignment for the benefit of creditors, suffer or permit the appointment of a receiver for its business or assets or shall avail itself of, or become subject to, any proceeding under any chapter of the U.S. Bankruptcy Code or any other statute of any state of these United States or any other foreign country relating to the insolvency or the protection of rights of creditors, then at the option of the other party, this Agreement shall terminate and be of no further force and effect, and any property or rights of such other party, tangible or intangible, shall forthwith be returned to it. Upon the occurrence of any of the foregoing events, the CITY shall have the right to terminate this Agreement forthwith and CONTRACTOR or its successor in interest by operation of law or otherwise shall thereafter have no rights in or to this Agreement or to any of the privileges herein conferred.
- C. **Option to Demand Payment on Letter of Credit; Performance Bond.** In the event of a default by CONTRACTOR under this Agreement which causes CITY to suffer any loss or damage, whether or not said default is timely cured, CITY shall be entitled to demand the immediate payment of the full amount of the letter of credit from which the CITY may be compensated for said loss or damages incurred as a result of CONTRACTOR's failure to comply with the Agreement, including but not limited to the CITY's costs of operating and maintaining the Public Toilets and Public Service Kiosks in the event of CONTRACTOR's default. If CONTRACTOR has not fulfilled its obligations to install any Public Toilets at the time of said default, the CITY shall also be entitled to make a demand on CONTRACTOR's performance bond or other guarantee of performance in addition to any other remedies available in law or equity.
- D. **Default of CITY.** In the event that CITY shall fail to comply with or carry out any material term, covenant, condition, or promise herein set forth, CONTRACTOR may elect to serve upon CITY a Notice of Default. If the CITY fails to cure such default within thirty (30) days after receipt of said notice, or, if such default cannot be cured within such period, if CITY does not commence to cure within such thirty (30) days and thereafter diligently pursue such cure to completion, then CONTRACTOR may elect to serve upon CITY a Second Notice of Default. If CITY fails to cure such default within twenty (20) days after receipt of said Second Notice of Default, or, if such default cannot be cured within such period, CITY does not commence to cure such default and thereafter diligently pursue such cure to completion; then CONTRACTOR may elect to terminate this Agreement. Termination shall be effective after ten (10) days written notice to the CITY.

CONTRACTOR shall then be entitled to the return of its letter of credit and any performance bond, in addition to any other remedies available in law or equity.

- E. Actual Damages. In the event that either Party serves a Notice of Default on the other and such default is subsequently cured, the non-defaulting party shall nevertheless be entitled to recover from the defaulting party any loss or damage which the non-defaulting party may have incurred by reason of such default. Each Party shall have available to it the remedies provided for in this Section 7.3 as well as all remedies available in law and equity, to resolve its claim for loss or damage.
- F. Rights of Parties Accrued Prior to Termination. Termination of this Agreement shall not in any way affect the rights and obligations of the Parties with respect to damages or amounts payable to the other party which have accrued prior to such termination.
- G. Other Remedies. The exercise of the remedies provided for in this Section 7.3 shall be cumulative and shall in no way affect any other remedy the Parties may have available in law or equity. The exercise by either Party of any of the options set forth in this paragraph by commencement of legal proceedings, audit, or otherwise, shall not be deemed a waiver of its right to exercise any other option provided herein.
- H. Force Majeure. The CONTRACTOR shall be granted an extension of the Term or any other events that are tied to a time schedule, including the payment of the Annual Service Fee, which extension shall be on a day-by-day basis, for any delays that occur due to a Force Majeure event.

7.4 No Waiver of Subsequent Breaches or Defaults

The failure of either Party to insist upon a strict performance of any of the terms, conditions and covenants herein by the other party shall not be deemed a waiver of any subsequent breach or default in the terms, conditions and covenants herein contained.

8.0 Miscellaneous Contract Provisions

8.1 San Francisco Office

CONTRACTOR shall maintain a fully staffed business office within the City and County of San Francisco in order to facilitate coordination between CITY and CONTRACTOR.

8.2 Regulatory Compliance; Conflicts of Interest

- A. CONTRACTOR shall comply with all laws applicable in any manner affecting the performance of this Agreement, including but not limited to: local and state planning, public works, electrical, plumbing and other applicable codes, the CITY'S Charter, Municipal Codes, and regulations, and all other state, and federal legal requirements, and shall at all times comply with such codes as they may be adopted or amended during the term of this Agreement. Citation of specific laws sections in this Agreement shall not exonerate CONTRACTOR from its obligation of compliance with the aforementioned. Without limiting the foregoing, CONTRACTOR shall comply with all ordinances and CITY policies restricting advertising on City property as those laws may be adopted or amended during the term of this Agreement.

- B. By executing this Agreement, CONTRACTOR certifies that it does not know of any fact which constitutes a violation of Section 15.103 of the CITY'S Charter; Article III, Chapter 2 of CITY'S Campaign and Governmental Conduct Code; Title 9, Chapter 7 of the California Government Code (Section 87100 *et seq.*), or Title 1, Division 4, Chapter 1, Article 4 of the California Government Code (Section 1090 *et seq.*), and further agrees promptly to notify the CITY if it becomes aware of any such fact during the term of this Agreement.
- C. Limitations on Contributions. By executing this Agreement, CONTRACTOR acknowledges its obligations under section 1.126 of the CITY'S Campaign and Governmental Conduct Code, which prohibits any person who contracts with, or is seeking a contract with, any department of the CITY for the rendition of personal services, for the furnishing of any material, supplies or equipment, for the sale or lease of any land or building, for a grant, loan or loan guarantee, or for a development agreement, from making any campaign contribution to (i) a CITY elected official if the contract must be approved by that official, a board on which that official serves, or the board of a state agency on which an appointee of that official serves, (ii) a candidate for that CITY elective office, or (iii) a committee controlled by such elected official or a candidate for that office, at any time from the submission of a proposal for the contract until the later of either the termination of negotiations for such contract or twelve (12) months after the date the CITY approves the contract. The prohibition on contributions applies to each prospective party to the contract; each member of CONTRACTOR'S board of directors; CONTRACTOR'S chairperson, chief executive officer, chief financial officer and chief operating officer; any person with an ownership interest of more than ten percent (10%) in CONTRACTOR; any subcontractor listed in the bid or contract; and any committee that is sponsored or controlled by CONTRACTOR. CONTRACTOR certifies that it has informed each such person of the limitation on contributions imposed by Section 1.126 by the time it submitted a proposal for the contract and has provided the names of the persons required to be informed to the CITY department with which it is contracting.

8.3 Other Agreements between CITY and CONTRACTOR

CONTRACTOR agrees that, to the best of its knowledge and belief, neither it nor any of its employees has any interest, however remote, in any other agreement with CITY, whether or not such agreement is with CONTRACTOR's firm, affiliate firms under common ownership, or through separate employment. Failure to disclose such information may result in termination of this Agreement pursuant to Section 7.3 "Event of Default; Remedies", herein.

8.4 Assignment

This Agreement and the rights granted therein may not be assigned by CONTRACTOR without the prior written consent of CITY; provided, however, that any corporate reorganization of CONTRACTOR that results in the CONTRACTOR being owned in substantially the same proportions by the persons who own the CONTRACTOR immediately before such transaction shall not be deemed an assignment and shall not require the prior written consent of CITY.

8.5 Binding Effect of Agreement

This Agreement shall bind and inure to the benefit of all the successors or assigns of the Parties hereto.

8.6 Taxes

A. Without limiting the effect of Section 1.11, CONTRACTOR acknowledges and agrees that during the entire term of this Agreement, CONTRACTOR shall pay prior to delinquency, all lawful taxes and assessments, including, but not limited to, possessory interest taxes and California Sales and Use Taxes, assessed, imposed or levied upon this Agreement, the transaction, CONTRACTOR's interest under this Agreement, any of CONTRACTOR's property or the CITY's property which is the subject of this Agreement or the services delivered pursuant hereto to the full extent of installments or amounts payable arising during the term of this Agreement and existing on the date hereof. Without limiting from conditions in this paragraph, CONTRACTOR agrees as follows:

1. CONTRACTOR, on behalf of itself and any permitted successors, assigns and subcontractors, recognizes and understands that this Agreement may create a possessory interest subject to property taxation and CONTRACTOR, and any permitted successor assign, or subcontractor may be subject to the payment of such taxes.
2. CONTRACTOR, on behalf of itself and any permitted successors, assigns and subcontractors, further recognizes and understands that any subcontract or assignment permitted hereunder and any exercise of any option to renew or other extension of this Agreement may constitute a change in ownership within the meaning of the California Revenue and Taxation Code and therefore may result in a reassessment of any possessory interest created hereunder in accordance with applicable laws. CONTRACTOR shall report any subcontract, assignment or other transfer of any interest in this Agreement or any renewal or extension thereof to the County Assessor within sixty (60) days after such assignment, transfer, renewal or extension.
3. Notwithstanding any requirement to pay any all taxes existing on the date hereof, should any existing taxes be structured and assessed materially differently or new taxes be levied and become due and payable by the CONTRACTOR to any government authority or subdivision, after the date hereof, CONTRACTOR shall pay such taxes and the CONTRACTOR, with the agreement of the Director, shall be permitted to deduct the amount paid to relevant taxing authority from any annual payment to the CITY at such time. Should there be such material change, CONTRACTOR shall present documentation of such change and the financial impact to the Director, who may permit CONTRACTOR to make the aforementioned deduction. Such permission shall not be unreasonably withheld.
4. San Francisco Administrative Code Section 23.38 requires the CITY to report certain information relating to this Agreement and the creation, renewal, extension, assignment or the transfer of any interest granted hereunder to the County Assessor within sixty (60) days after any such transaction and within thirty (30) days following the date of any transaction that is subject to reporting requirements. CONTRACTOR shall provide such information as may be requested by the CITY to enable the CITY to comply with any reporting requirements under applicable law with respect to possessory interests.
5. CONTRACTOR shall pay or reimburse CITY, as the case may be, for any fine, penalty, interest or costs which may be added by the collecting authority to late payment or any

nonpayment of any tax or other imposition required to be paid by CONTRACTOR under this Agreement.

6. Within a reasonable time following the CITY's written request, given from time to time, CONTRACTOR shall deliver to CITY copies of official receipts of the appropriate taxing authorities, or other proof reasonably satisfactory to CITY, evidencing the timely payment of such taxes.
7. All taxes and impositions for the tax years after the Start Date occurs or during the tax year in which this Agreement terminates shall be apportioned and prorated between CITY and CONTRACTOR on the basis of the number of days occurring in such period.

8.7 Legal Relationship

The Parties hereby declare that it is not their intention by this Agreement or any of the terms thereof to create a partnership, joint venture or agency relationship between them.

8.8 Independent Contractor

- A. For the purposes of this Section 8.8, "Contractor" shall be deemed to include not only CONTRACTOR, but also any agent or employee of CONTRACTOR. Contractor acknowledges and agrees that Contractor or any agent or employee of Contractor shall be deemed at all times to be an independent contractor and is wholly responsible for the manner in which it performs the services and work requested by CITY under this Agreement. Contractor, its agents, and employees will not represent or hold themselves out to be employees of the CITY at any time. Contractor or any agent or employee of Contractor shall not have employee status with CITY, nor be entitled to participate in any plans, arrangements, or distributions by CITY pertaining to or in connection with any retirement, health or other benefits that CITY may offer its employees.
- B. Contractor or any agent or employee of Contractor is liable for the acts and omissions of itself, its employees and its agents. Contractor shall be responsible for all obligations and payments, whether imposed by federal, state or local law, including, but not limited to, FICA, income tax withholdings, unemployment compensation, insurance, and other similar responsibilities related to Contractor's performing services and work, or any agent or employee of Contractor providing same. Nothing in this Agreement shall be construed as creating an employment or agency relationship between CITY and Contractor or any agent or employee of Contractor.
- C. Any terms in this Agreement referring to direction from CITY shall be construed as providing for direction as to policy and the result of Contractor's work only, and not as to the means by which such a result is obtained. CITY does not retain the right to control the means or the method by which Contractor performs work under this Agreement. Contractor agrees to maintain and make available to CITY, upon request and during regular business hours, accurate books and accounting records demonstrating Contractor's compliance with this Section.
- D. Should CITY determine that Contractor, or any agent or employee of Contractor, is not performing in accordance with the requirements of this Agreement, CITY shall provide Contractor with written notice of such failure. Within ten (10) business days of Contractor's receipt of such notice, and in accordance with Contractor policy and procedure, Contractor shall

remedy the deficiency. Notwithstanding, if CITY believes that an action of Contractor, or any agent or employee of Contractor, warrants immediate remedial action by Contractor, CITY shall contact Contractor and provide Contractor in writing with the reason for requesting such immediate action.

8.9 Payment of Employment Taxes and Other Expenses

- A. Should CITY, in its discretion, or a relevant taxing authority such as the Internal Revenue Service or the State Employment Development Division, or both, determine that CONTRACTOR is an employee for purposes of collection of any employment taxes, the amounts payable under this Agreement shall be reduced by amounts equal to both the employee and employer portions of the tax due (and offsetting any credits for amounts already paid by CONTRACTOR which can be applied against this liability). CITY shall then forward those amounts to the relevant taxing authority.
- B. Should a relevant taxing authority determine a liability for past services performed by CONTRACTOR for CITY, upon notification of such fact by CITY, CONTRACTOR shall promptly remit such amount due or arrange with CITY to have the amount due withheld from future payments to CONTRACTOR under this Agreement (again, offsetting any amounts already paid by CONTRACTOR which can be applied as a credit against such liability).
- C. A determination of employment status pursuant to the preceding two paragraphs shall be solely for the purposes of the particular tax in question, and for all other purposes of this Agreement, CONTRACTOR shall not be considered an employee of CITY. Notwithstanding the foregoing, CONTRACTOR agrees to indemnify and save harmless CITY and its officers, agents and employees from, and, if requested, shall defend them against any and all claims, losses, costs, damages, and expenses, including attorneys' fees, arising from this section.

8.10 Qualified Personnel and Regulatory Compliance

Work under this Agreement shall be performed only by competent personnel under the supervision of and in the employment of CONTRACTOR. CONTRACTOR will conform to the CITY's reasonable requests regarding assignment of personnel, but all personnel, including those assigned at CITY's request, shall be supervised by CONTRACTOR.

8.11 Local Business Enterprise Utilization

CONTRACTOR shall make good faith efforts to use the services of Local Business Enterprises (LBEs) in the service agencies, suppliers, contractors and subcontractors used in the performance of this Agreement. The term "Local Business Enterprise" shall have the meanings set forth in Section 14B of the San Francisco Administrative Code as of the date hereof, the provisions of which are incorporated herein by reference and made a part of this Agreement as though fully set forth. If a Local Business Enterprise ("LBE") subcontractor is selected to perform work, is unable to do so successfully and needs to be replaced; CONTRACTOR will notify the CITY promptly and make good faith efforts to replace the original LBE subcontractor with another LBE subcontractor.

8.12 Nondiscrimination; Penalties

- A. CONTRACTOR Shall Not Discriminate. In the performance of this Agreement, CONTRACTOR agrees not to discriminate on the basis of the fact or perception of a person's race, color, creed, religion, national origin, ancestry, age, sex, sexual orientation, gender identity, domestic partner status, marital status, disability or Acquired Immune Deficiency Syndrome or HIV status (AIDS/HIV status) against any employee of, any CITY employee working with, or applicant for employment with CONTRACTOR, in any of CONTRACTOR's operations within the United States, or against any person seeking accommodations, advantages, facilities, privileges, services, or membership in all business, social, or other establishments or organizations operated by CONTRACTOR.
- B. Subcontracts. CONTRACTOR shall incorporate by reference in all subcontracts the provisions of Sections 12B.2(a), 12B.2(c)-(k), and 12C.3 of the San Francisco Administrative Code (copies of which are available from CITY) and shall require all subcontractors to comply with such provisions. CONTRACTOR's failure to comply with the obligations in this subsection shall constitute a material breach of this Agreement.
- C. Non-Discrimination in Benefits. CONTRACTOR does not as of the date of this Agreement and will not during the term of this Agreement, in any of its operations in San Francisco or where the work is being performed for the CITY or elsewhere within the United States, discriminate in the provision of bereavement leave, family medical leave, health benefits, membership or membership discounts, moving expenses, pension and retirement benefits or travel benefits, as well as any benefits other than the benefits specified above, between employees with domestic partners and employees with spouses, and/or between the domestic partners and spouses of such employees, where the domestic partnership has been registered with a governmental entity pursuant to state or local law authorizing such registration; subject to the conditions set forth in Section 12B.2(b) of the San Francisco Administrative Code.
- D. Condition to Contract. As a condition to this Agreement, CONTRACTOR shall execute the "Chapter 12B Declaration: Nondiscrimination in Contracts and Benefits" form (Form CMD-12B-101) with supporting documentation and secure the approval of the form by the San Francisco Contract Monitoring Division.
- E. Incorporation of Administrative Code Provisions by Reference. The provisions of Chapters 12B and 12C of the San Francisco Administrative Code are incorporated in this Section by reference and made a part of this Agreement as though fully set forth herein. CONTRACTOR shall comply fully with and be bound by all of the provisions that apply to this Agreement under such Chapters of the Administrative Code, including but not limited to the remedies provided in such Chapters.

8.13 Tropical Hardwood and Virgin Redwood Ban

The CITY urges contractors not to import, purchase, obtain, or use for any purpose, any tropical hardwood, tropical hardwood products, virgin redwood or virgin redwood products.

8.14 Resource Conservation

Reports required to be submitted under this Agreement shall be on recycled paper and printed on double-sided pages to the maximum extent possible.

8.15 Sunshine Ordinance

CONTRACTOR acknowledges that this Agreement and all public records related to its formation, CONTRACTOR's performance of Services, and City's payment are subject to the California Public Records Act, (California Government Code §6250 et. seq.), and the San Francisco Sunshine Ordinance, (San Francisco Administrative Code Chapter 67). Such records are subject to public inspection and copying unless exempt from disclosure under federal, state or local law.

8.16 Advertising Rights

CONTRACTOR acknowledges that this Agreement is specifically subject to San Francisco Administrative Code 67.29.-3, though CONTRACTOR is both a provider and the advertiser.

8.17 Cooperative Drafting; Cooperation

This Agreement has been drafted through a cooperative effort of CITY and CONTRACTOR, and both Parties have had an opportunity to have the Agreement reviewed and revised by legal counsel. No Party shall be considered the drafter of this Agreement, and no presumption or rule that an ambiguity shall be construed against the Party drafting the clause shall apply to the interpretation or enforcement of this Agreement.

The Parties agree cooperate with each other to achieve the purpose of the Agreement and shall take such further action, including the provision of documentation reasonably requested, as may be related to the program governed under this Agreement and to work together in good faith to resolve any disputes that arise between the Parties.

8.18 Non-Waiver of Rights

The omission by either party at any time to enforce any default or right reserved to it, or to require performance of any of the terms, covenants, or provisions hereof by the other party at the time designated, shall not be a waiver of any such default or right to which the party is entitled, nor shall it in any way affect the right of the party to enforce such provisions thereafter.

8.19 Modification and Amendment of Agreement

This Agreement may be modified or amended only by a written instrument signed by both CITY and CONTRACTOR, nor may compliance with any of its terms be waived, except by written instrument executed and approved in the same manner as this Agreement.

8.20 Section Headings

The section headings contained herein are for convenience in reference and are not intended to define or limit the scope of any provision hereof.

8.21 Agreement Made in California; Venue

The formation, interpretation and performance of this Agreement shall be governed by the laws of the State of California, excluding its conflict of laws rules, Venue for all litigation relative to the formation, interpretation and performance of this Agreement shall be in San Francisco.

8.22 Construction

All paragraph captions are for reference only and shall not be considered in construing this Agreement.

8.23 Entire Agreement

This Agreement, including all Appendices hereto, sets forth the entire Agreement between the Parties, and supersedes all other oral or written provisions. In the event of a conflict between any term or condition included in the Proposal and this Agreement, this Agreement shall control. This Agreement may be modified only as provided in Section 8.19, "Modification and Amendment of Agreement".

8.24 MacBride Principles - Northern Ireland

The CITY urges companies doing business in Northern Ireland to move towards resolving employment inequities and encourages such companies to abide by the MacBride Principles. By signing below, the persons executing this Agreement on behalf of the CONTRACTOR acknowledge and agree that they have read and understood this section.

IN WITNESS WHEREOF, the parties hereto have executed this Agreement on the day first mentioned above.

CITY

Recommended by:

CONTRACTOR

JCDecaux San Francisco LLC

Signature

Julia Dawson
Deputy Director

Signature

Name: _____
Title: _____

Signature

Name: _____
Title: _____

Approved as to Form:
Dennis J. Herrera
City Attorney

City vendor number:

By: _____
Gus Guibert
Deputy City Attorney

Approved:

Mohammed Nuru, Director of Public Works

Appendix A
Location of Approved and Existing Public Toilets

Toilet ID #	ADDRESS	LOCATION	CROSS STREET
1	910 MARKET STREET	MARKET STREET	POWELL STREET
2	600 UNION STREET	UNION STREET	COLUMUS STREET
3	2399 MARKET STREET	MARKET STREET	CASTRO STREET
4	110 MARKET STREET	MARKET STREET	SPEAR STREET
5	499 BAY STREET	BAY STREET	TAYLOR STREET
6	1134 MARKET STREET	MARKET STREET	7TH STREET
7	50 CHRISTMAS TREE POINT RD.	TWIN PEAKS	TWIN PEAKS
8	60 GROVE STREET	GROVE STREET	LARKIN STREET
9	3309 24TH STREET	24TH STREET	MISSION STREET
10	3013 16TH STREET	16TH STREET	MISSION STREET
11	550 PINE STREET	PINE STREET	QUINCY STREET
12	1 STEUART STREET	STEUART STREET	MARKET
13	401 THE EMBARCADERO (PIER 22 1/2)	EMBARCADERO	HARRISON
14	290 EDDY STREET	EDDY STREET	JONES STREET
15	813 LARKIN STREET	LARKIN STREET	MYRTLE STREET
16	Pier 7	EMBARCADERO	PIER 7
17	2 JEFFERSON STREET	JEFFERSON STREET	POWELL STREET
18	Pier 43	EMBARCADERO	POWELL STREET
19	747 STANYAN STREET	STANYAN STREET	WALLER STREET
20	250 GEARY STREET	GEARY STREET	UNION STREET
21	50 CHRISTMAS TREE POINT RD.	TWIN PEAKS	TWIN PEAKS
22	1540 S. VAN NESS AVENUE	S. VAN NESS AVENUE	CEASAR CHAVEZ STREET
23	2042 MARKET STREET	MARKET STREET	CHURCH STREET
24	1 TELEGRAPH HILL BLVD (COIT TOWER)	PIONEER PARK	PIONEER PARK
25	204 DRUMM STREET	DRUMM STREET	CLAY STREET

Appendix B
Location of Licensed Public Service Kiosks

Kiosk ID	Address	Street	Cross Street
SFO0001SF	2 BAY STREET	BAY STREET	EMBARCADERO
SFO0002SF	13 EMBARCADERO	EMBARCADERO	FERRY BUILDING
SFO0003SF	19 MARKET STREET	MARKET STREET	STEUART STREET
SFO0004SF	1 MARKET STREET	MARKET STREET	SPEAR STREET
SFO0005SF	208 DRUMM STREET	DRUMM STREET	MARKET STREET
SFO0006SF	245 MARKET STREET	MARKET STREET	MAIN STREET
SFO0007SF	234 MARKET STREET	MARKET STREET	DAVIS STREET
SFO0008SF	333 MARKET STREET	MARKET STREET	BEALE STREET
SFO0009SF	388 MARKET STREET	MARKET STREET	PINE STREET
SFO0010SF	427 MARKET STREET	MARKET STREET	FREMONT STREET
SFO0011SF	400 MARKET STREET	FRONT STREET	MARKET STREET
SFO0012SF	101 CALIFORNIA STREET	CALIFORNIA STREET	DAVIS STREET
SFO0013SF	309 SANSOME STREET	SANSOME STREET	CALIFORNIA STREET
SFO0014SF	398 SACRAMENTO STREET	SACRAMENTO STREET	BATTERY STREET
SFO0015SF	315 CALIFORNIA STREET	CALIFORNIA STREET	BATTERY STREET
SFO0016SF	22 BATTERY STREET	BATTERY STREET	BUSH STREET
SFO0017SF	525 MARKET STREET	MARKET STREET	FIRST STREET
SFO0018SF	98 FIRST STREET	FIRST STREET	MISSION STREET
SFO0019SF	198 FIRST STREET	FIRST STREET	HOWARD STREET
SFO0020SF	524 MARKET STREET	MARKET STREET	BATTERY STREET
SFO0021SF	575 MARKET STREET	MARKET STREET	1ST-2ND MID BLOCK
SFO0022SF	595 MARKET STREET	MARKET STREET	2ND STREET
SFO0023SF	544 MARKET STREET	MARKET STREET	SUTTER STREET
SFO0024SF	1 SANSOME STREET	SANSOME STREET	BET. SUTTER & BUSH STREET
SFO0025SF	225 BUSH STREET	BUSH STREET	SANSOME STREET
SFO0026SF	301 PINE STREET	PINE STREET	SANSOME STREET
SFO0027SF	401 CALIFORNIA STREET	CALIFORNIA STREET	SANSOME STREET
SFO0028SF	295 BROADWAY STREET	BROADWAY STREET	SANSOME STREET
SFO0029SF	600 MONTGOMERY STREET	MONTGOMERY STREET	CLAY STREET
SFO0030SF	498 CALIFORNIA STREET	CALIFORNIA STREET	MONTGOMERY STREET
SFO0031SF	300 MONTGOMERY STREET	MONTGOMERY STREET	PINE STREET
SFO0032SF	180 MONTGOMERY STREET	MONTGOMERY STREET	BUSH STREET
SFO0033SF	544 MARKET STREET	MARKET STREET	MONTGOMERY STREET
SFO0034SF	625 MARKET STREET	MARKET STREET	NEW MONTGOMERY STREET
SFO0035SF	643 MARKET STREET	MARKET STREET	NEW MONTGOMERY STREET
SFO0036SF	644 MARKET STREET	MARKET STREET	POST STREET
SFO0037SF	5 THIRD STREET	THIRD STREET	MARKET STREET
SFO0038SF	701 HOWARD STREET	HOWARD STREET	THIRD STREET
SFO0039SF	199 FOURTH STREET	FOURTH STREET	HOWARD STREET
SFO0040SF	2400 MARKET STREET	MARKET STREET	CASTRO STREET
SFO0041SF	57 POST STREET	POST STREET	MID. KEARNY/MONTGOMERY ST.
SFO0042SF	222 KEARNY STREET	KEARNY STREET	SUTTER STREET
SFO0043SF	308 KEARNY STREET	KEARNY STREET	BUSH STREET
SFO0044SF	580 CALIFORNIA STREET	CALIFORNIA STREET	KEARNY STREET
SFO0045SF	600 GREEN STREET	GREEN STREET	COLUMBUS AVENUE
SFO0046SF	10 GEARY STREET	GEARY STREET	KEARNY STREET
SFO0047SF	700 MARKET STREET	MARKET STREET	GEARY STREET
SFO0048SF	744 MARKET STREET	MARKET STREET	GRANT AVENUE
SFO0049SF	767 MARKET STREET	MARKET STREET	BTW. 3RD-4TH
SFO0050SF	141 GRANT STREET	GRANT STREET	MAIDEN LANE
SFO0051SF	330 SUTTER STREET	SUTTER STREET	MID GRANT/STOCKTON STREET
SFO0052SF	88 SUTTER STREET	SUTTER STREET	MONTGOMERY STREET

Kiosk ID	Address	Street	Cross Street
SFO0053SF	268 STOCKTON STREET	STOCKTON STREET	POST STREET
SFO0054SF	172 GEARY STREET.	GEARY STREET	STOCKTON STREET
SFO0055SF	55 STOCKTON STREET	STOCKTON STREET	O'FARRELL STREET
SFO0056SF	17 STOCKTON STREET	STOCKTON STREET	ELLIS STREET
SFO0057SF	798 MARKET STREET	MARKET STREET	STOCKTON STREET
SFO0058SF	799 MARKET STREET	MARKET STREET	FOURTH STREET
SFO0059SF	99 FOURTH STREET	FOURTH STREET	MISSION STREET
SFO0060SF	800 MARKET STREET	MARKET STREET	ELLIS STREET
SFO0061SF	870 MARKET STREET	MARKET STREET	POWELL STREET
SFO0062SF	35 POWELL STREET	POWELL STREET	EDDY STREET
SFO0063SF	184 O'FARRELL STREET	O'FARRELL STREET	POWELL STREET
SFO0064SF	323 GEARY STREET	GEARY STREET	POWELL STREET
SFO0065SF	320 POST STREET	POST STREET	STOCKTON STREET
SFO0066SF	401 POWELL STREET	POWELL STREET	POST STREET
SFO0067SF	386 GEARY STREET	GEARY STREET	MASON STREET
SFO0068SF	1 CYRIL MAGNIN STREET	CYRIL MAGNIN STREET	MARKET STREET
SFO0069SF	899 MARKET STREET	MARKET STREET	FIFTH STREET
SFO0070SF	80 FIFTH STREET	FIFTH STREET	JESSIE STREET
SFO0071SF	894 MISSION STREET	MISSION STREET	FIFTH STREET
SFO0072SF	989 MARKET STREET	MARKET STREET	SIXTH STREET
SFO0073SF	1095 MARKET STREET	MARKET STREET	SEVENTH AVENUE
SFO0074SF	1135 MARKET STREET MID BLOCK	MARKET STREET	UN PLAZA
SFO0075SF	1200 MARKET STREET	MARKET STREET	GROVE STREET
SFO0076SF	255 POST STREET	POST STREET	BET. STOCKTON ST & GRANT ST.
SFO0077SF	1 POLK STREET	POLK STREET	FELL STREET
SFO0078SF	26 VAN NESS AVENUE	VAN NESS AVENUE	MARKET STREET
SFO0079SF	91 SPEAR STREET	SPEAR STREET	MISSION STREET
SFO0080SF	201 SACRAMENTO STREET	SACRAMENTO STREET	DAVIS STREET
SFO0081SF	72 THE EMBARCADERO	EMBARCADERO	POWELL STREET
SFO0082SF	2 JEFFERSON STREET	JEFFERSON STREET	POWELL STREET
SFO0083SF	95 JEFFERSON STREET	JEFFERSON STREET	MASON STREET
SFO0084SF	2899 TAYLOR STREET	TAYLOR STREET	JEFFERSON STREET
SFO0085SF	2800 HYDE STREET	HYDE STREET	BEACH STREET
SFO0086SF	496 JEFFERSON STREET	JEFFERSON STREET	HYDE STREET
SFO0087SF	359 GRANT STREET	GRANT STREET	BUSH STREET
SFO0088SF	16 BATTERY STREET	BATTERY STREET	BUSH STREET
SFO0089SF	120 KEARNY STREET	KEARNY STREET	VERMEHR LANE
SFO0090SF	195 PINE STREET	PINE STREET	BATTERY STREET
SFO0091SF	12 S. VAN NESS AVENUE	S. VAN NESS AVENUE	MISSION STREET
SFO0092SF	1 S. VAN NESS AVENUE	S. VAN NESS AVENUE	MARKET STREET
SFO0093SF	1266 GEARY BLVD	GEARY BLVD	GOUGH STREET
SFO0094SF	2390 MARKET STREET	MARKET STREET	CASTRO STREET
SFO0095SF	708 FOLSOM STREET	FOLSOM STREET	THIRD STREET
SFO0096SF	104 FOURTH STREET	FOURTH STREET	MISSION STREET
SFO0097SF	2397 MARKET STREET	MARKET STREET	CASTRO STREET
SFO0098SF	201 FOURTH STREET	FOURTH STREET	HOWARD STREET
SFO0099SF	1600 MARKET STREET	MARKET STREET	FRANKLIN STREET
SFO0100SF	90 NEW MONTGOMERY STREET	NEW MONTGOMERY ST.	MISSION STREET
SFO0101SF	182 NEW MONTGOMERY STREET	NEW MONTGOMERY ST.	HOWARD STREET
SFO0102SF	210 KING STREET	KING STREET	THIRD STREET

Kiosk ID	Address	Street	Cross Street
SFO0103SF	124 BAY STREET	BAY STREET	STOCKTON STREET
SFO0104SF	519 POWELL STREET	POWELL STREET	SUTTER STREET
SFO0105SF	99 HAYES STREET	HAYES STREET	POLK STREET
SFO0106SF	1699 MARKET STREET	MARKET STREET	VALENCIA STREET
SFO0107SF	1010 KEARNY STREET	KEARNY STREET	PACIFIC STREET
SFO0108SF	601 CALIFORNIA STREET	CALIFORNIA STREET	KEARNY STREET
SFO0109SF	202 MISSION STREET	MISSION STREET	MAIN STREET
SFO0110SF	494 EMBARCADERO	EMBARCADERO	BRYANT STREET
SFO0111SF	150 EMBARCADERO	EMBARCADERO	BTW HOWARD & MISSION
SFO0112SF	1790 MARKET STEET	MARKET STREET	OCTAVIA STREET
SFO0113SF	1818 THE EMBARCADERO	EMBARCADERO	IFO FERRY BUILDING
SFO0114SF	210 MARKET STREET	MARKET STREET	CHURCH STREET

Appendix C
Approved Design

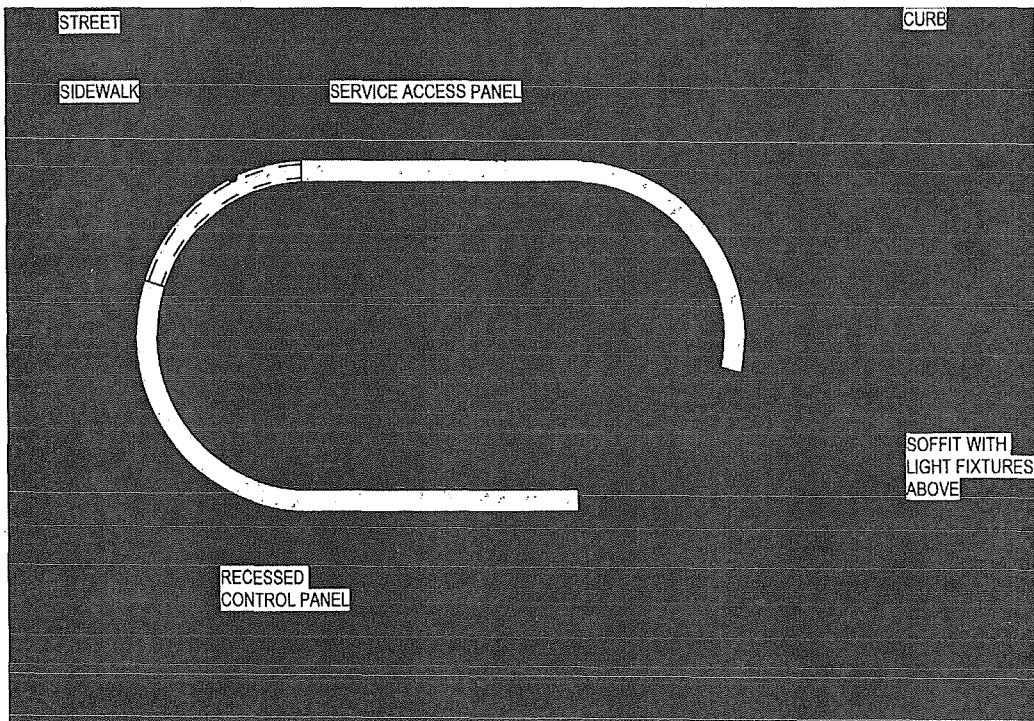

The graphics depict designs that may be revised when engineered and manufactured.

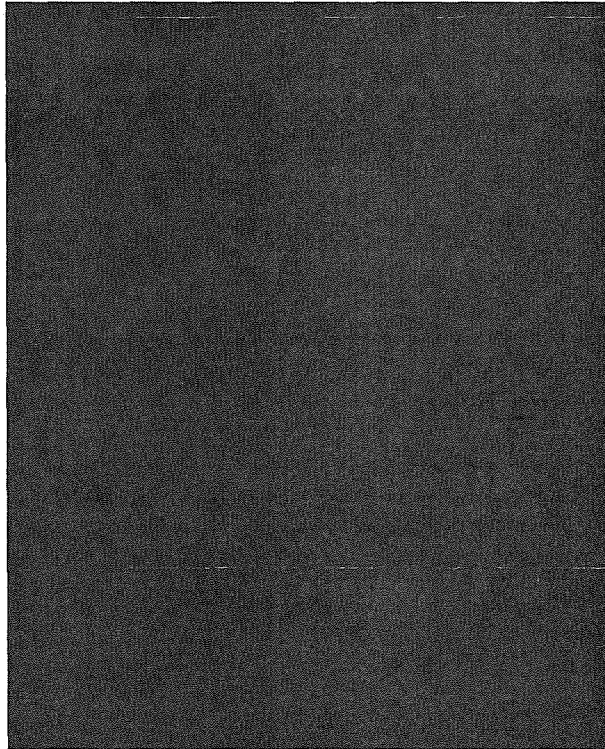
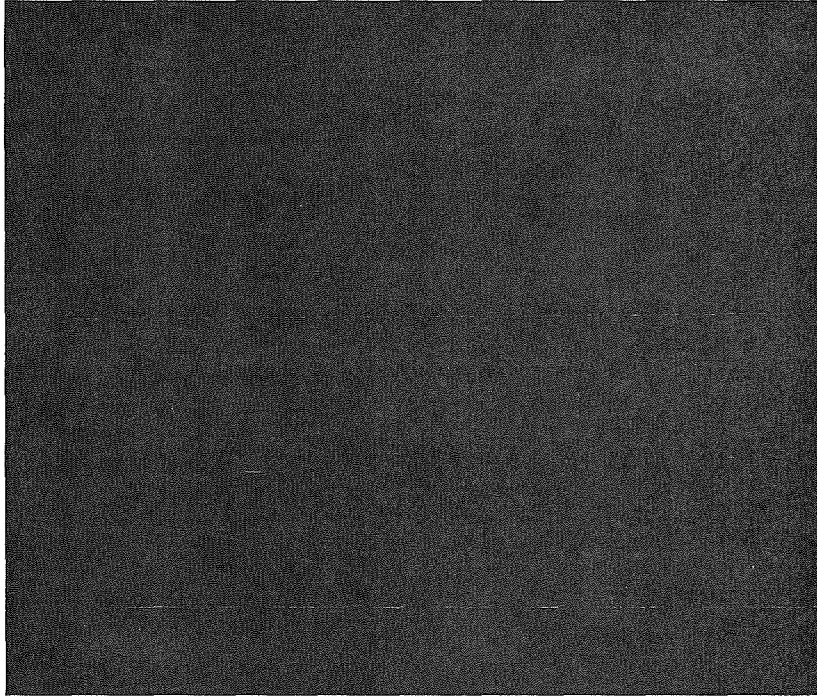

The graphics depict designs that may be revised when engineered and manufactured.

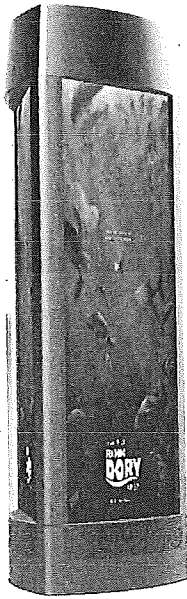

Small 3-Sided Panel Kiosk

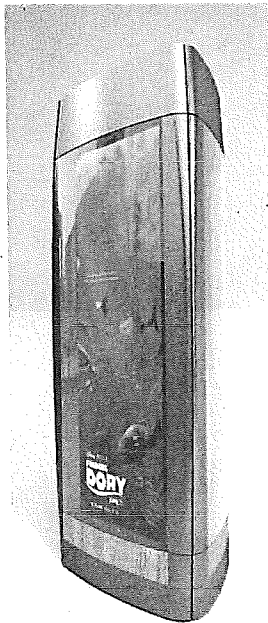
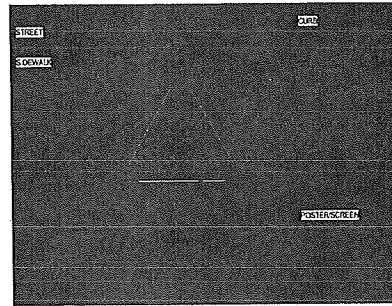
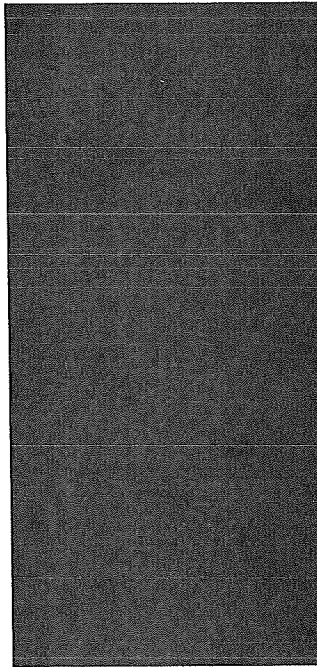

Market St. 3-Sided Panel Kiosk

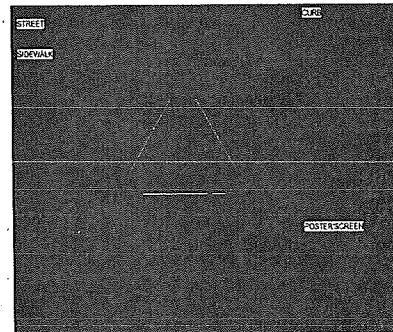
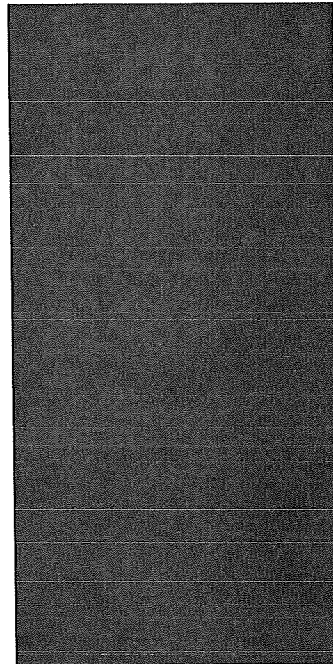

The graphics depict designs that may be revised when engineered and manufactured.



Interactive Kiosk

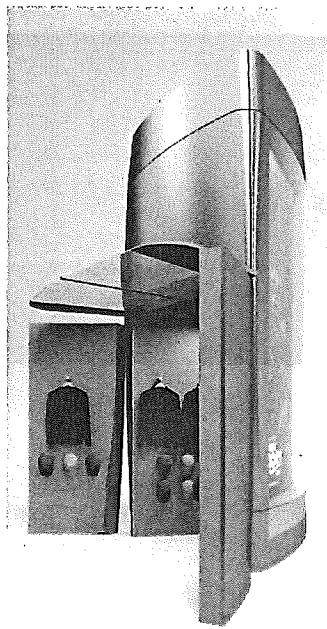
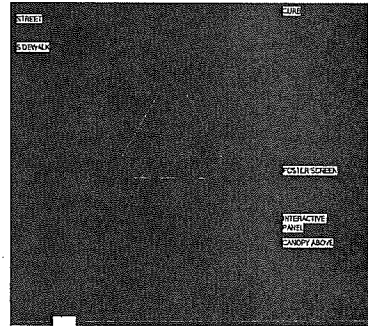
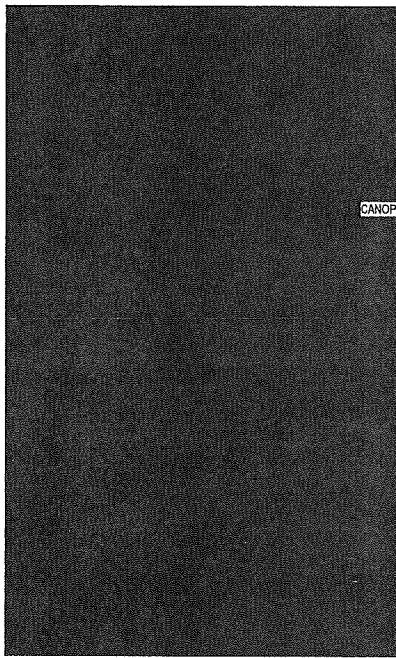

Multi-Function / Retail Kiosk

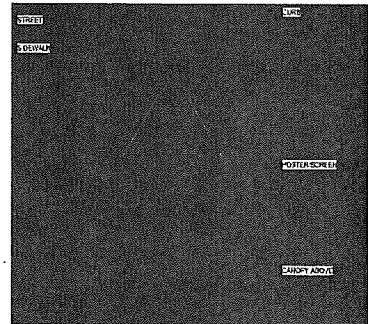
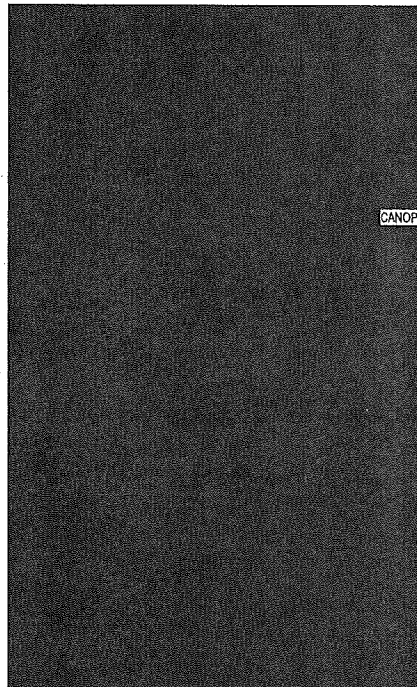

The graphics depict designs that may be revised when engineered and manufactured.

Appendix D
Form of Guaranty of JCDecaux North America, Inc.

THIS GUARANTY (the "Guaranty") is given as of the ___ April, 2019 by JCDecaux North America, Inc., a Delaware corporation ("Guarantor"), to the City and County of San Francisco, (hereinafter together referred to as "City"). Capitalized terms not otherwise defined herein shall have the meaning given in the Agreement (as defined in Recital B below) and the form of which is attached hereto as Exhibit A.

RECITALS

- A. Guarantor is the one-hundred percent (100%) owner of JCDecaux San Francisco, LLC, a California limited liability company ("Affiliate").
- B. Affiliate and City are, simultaneously with the execution of this Guaranty, entering into that Public Toilet and Public Service Kiosk Agreement (the "Agreement"), dated as of _____, 2019.
- C. It is in the best interest of the Guarantor to execute this Guaranty because Guarantor will derive substantial direct benefits from the Agreement and the Guarantor has, therefore, agreed to provide this Guaranty as a material inducement to the City's execution of the Agreement.

NOW, THEREFORE, in consideration of the foregoing, and for other good and valuable consideration, the receipt and adequacy of which are hereby acknowledged, and as a material inducement to City to enter into the Agreement, Guarantor agrees as follows:

AGREEMENTS

1. Incorporation of Recitals. The above recitals are incorporated herein by reference and constitute a material part of this Guaranty.
2. Guaranty of Payment and Performance. Guarantor hereby irrevocably and unconditionally guarantees to the City
 - A. the complete and timely payment by the Affiliate to City of
 - (1) as and when payable from time to time, the Annual Administrative Fee (as defined in the Agreement), and
 - (2) as and when payable from time to time, the Annual Service Fee (as defined in the Agreement), and
 - (3) a one-time payment of one million, five hundred thousand dollars (\$1,500,000),

(each such payment obligation separately, a "Payment Obligation", and collectively, the "Guaranteed Payment Obligations"), and

- B. the complete and timely performance of the Affiliate to install twenty-five (25) Public Toilets ("Toilet Installation"), as such performance is required in the Agreement, (the "Guaranteed Performance Obligation", and together with the Guaranteed Payment Obligations, the "Guaranteed Obligations").

At such time that the Contractor has completed the any Payment Obligation and the Toilet Installation pursuant to the Agreement or such requirement or at such time that any portion of such requirement has terminated for any reason, then Guarantor shall have no obligation under this Guaranty with regard to such completed or terminated portion and the Guaranty related to such portion of the Guaranteed Obligations shall automatically terminate.

For purpose of the Guaranteed Obligations and this Guaranty, the Affiliate shall be deemed to have completed the Toilet Installations of each Public Toilet, and this Guaranty shall automatically terminate with regard to such Public Toilet, at the time such Public Toilet is available for use to the public.

Without any limitation on the generality of the foregoing, in no event shall the Guarantor be responsible or liable for any obligation of the Affiliate under the Agreement, including but not limited to Section 1.18 of the Agreement, except as specified in this Guaranty.

In the event that Affiliate fails to perform the Guaranteed Obligations, as the same may become required under the terms and conditions of the Agreement (unless relieved from the timing of the performance or any part or all of the performance under the terms and conditions of the Agreement, under any statute or by the decision of a court or tribunal of competent jurisdiction), the Guarantor will promptly and fully act to perform such outstanding Guaranteed Obligations in the place of Affiliate until such time as the Guarantor completed all outstanding Guaranteed Obligations.

Except as set forth above, nothing contained herein shall be construed as obligating Guarantor to perform any obligations of Affiliate.

3. Guarantor's Guarantees Are Absolute. This Guaranty is an absolute, irrevocable and unconditional guaranty of performance (as to performance of the Guaranteed Obligations only) and is not a guaranty of collection. Guarantor shall be liable for the performance of the Guaranteed Obligations as set forth in this Guaranty, as a primary obligor. This Guaranty shall be effective as a waiver of, and Guarantor hereby expressly waives, any and all rights to which Guarantor may otherwise have been entitled under any warranty, suretyship or letter of credit laws in effect from time to time; including any right or privilege, whether existing under statute, at law or in equity, to require City to take prior recourse or proceedings against any warranty,

collateral, security or person whatsoever.

Guarantor hereby agrees that in the event of

- A. an Event of Default by Affiliate under the Agreement (provided that any cure period permitted by the Agreement has passed and the Event of Default has not been cured);
- B. the dissolution or insolvency of Affiliate; or
- C. the institution of any proceeding by or against Affiliate in bankruptcy or for a reorganization or an arrangement with creditors, or for the appointment of a receiver, trustee or custodian for Affiliate or for any of its properties (provided if such proceeding is instituted against Affiliate, then such proceeding shall not cause the Guaranteed Obligations to be immediately due and payable if such proceeding is dismissed within one hundred twenty (120) days of filing);

then in any such event, the Guaranteed Obligations, for purposes of this Guaranty, shall be deemed immediately due, at the election of City. Provided however, the City shall give written notice to the Affiliate and to the Guarantor that the Guaranty is immediately due.

It shall not be necessary for City, in order to enforce performance by Guarantor of its obligations under this Guaranty, first to institute suit or pursue or exhaust any rights or remedies against Affiliate, or any Other Obligated Party (as hereafter defined) with respect to the Guaranteed Obligations, or to institute suit or pursue or exhaust any rights or remedies against Affiliate, or any other guarantor, surety, warrantor, service contractor, letter of credit issuer or other party obligated with respect to the Guaranteed Obligations or having obligations with respect to the performance of the Guaranteed Obligations (each and all such other parties, an "Other Obligated Party"), or to enforce any rights against any security that shall ever have been given to secure the Guaranteed Obligations, or to join Affiliate, or any Other Obligated Party in any action to enforce this Guaranty, or to resort to any other means of obtaining payment of the Guaranteed Obligations. Suit may be brought or demand may be made against the Guarantor, and any Other Obligated Party, without impairing the rights of City against Guarantor or any Other Obligated Party under any contract.

No right or action shall accrue under this Guaranty to any party other than the City.

- 4. Waivers. Except to the extent the Guaranteed Obligations have been satisfied, Guarantor hereby agrees that neither City's rights or remedies nor Guarantor's obligations under the terms of this Guaranty shall be released, diminished, impaired, reduced or affected by anyone or more of the following events, actions, facts, or circumstances, and the liability of Guarantor under this Guaranty shall be absolute and

unconditional irrespective of:

- A. any claim or defense that this Guaranty was made without consideration or is not supported by adequate consideration;
- B. the taking or accepting of any other security, guaranty, bond, warranty, service contract, letter of credit or right of recourse ("Other Security Documents") with respect to any or all of the Guaranteed Obligations or the performance of any work required under the Agreement;
- C. the availability to Guarantor of any exemption or defense under applicable law or at equity;
- D. any release, surrender, abandonment, exchange, alteration, sale or other disposition, subordination, deterioration, waste, failure to protect or preserve, impairment, or loss of, or any failure to create or perfect any lien or security interest with respect to, or any other dealings with, any collateral or security at any time existing or purported, believed or expected to exist in connection with any or all of the Guaranteed Obligations required under the Agreement, including any impairment of Guarantor's recourse against any person or collateral;
- E. whether express or by operation of law, any partial release of the liability of Guarantor hereunder, or if one or more other guaranty, are now or hereafter obtained by City from any Other Obligated Party covering all or any part of the Guaranteed Obligations or the work required under the Agreement, any complete or partial release of any Other Obligated Party under any Other Security Documents, or any complete or partial release of or settlement with Affiliate;
- F. the insolvency, bankruptcy, dissolution, liquidation, termination, receivership, reorganization, merger, consolidation, change of form, structure or ownership, sale of all assets, or lack of corporate, partnership or other power of Affiliate or any Other Obligated Party at any time liable for the payment of any or all of the Guaranteed Obligations or the performance of the work required under the Agreement;
- G. either with or without notice to or consent of Guarantor: any renewal, extension, modification or rearrangement of the terms of any or all of the Guaranteed Obligations and/or the work required under the Agreement, or any waiver, termination, or release of, or consent to departure from, the Agreement or any other guaranty of any or all of the Guaranteed Obligations, or any adjustment, indulgence, forbearance, or compromise that may be granted from time to time by City to Affiliate, Guarantor, and/or any Other Obligated Party

liable for all or any portion of the Guaranteed Obligations or the performance of the work required under the Agreement;

- H. any neglect, lack of diligence, delay, omission, forbearance, failure, or refusal of City to take or prosecute (or in taking or prosecuting) any action for the collection or enforcement of any of the Guaranteed Obligations, or to take or prosecute any action upon any security therefor, or to exercise (or in exercising) any other right or power with respect to any security therefor, or to take or prosecute (or in taking or prosecuting) any action in connection with the Agreement, or any failure to sell or otherwise dispose of in a commercially reasonable manner any collateral securing any or all of the Guaranteed Obligations;
- I. any order, ruling or plan of reorganization emanating from proceedings under Title 11 of the United States Code with respect to Affiliate, or any other person, including any extension, reduction, composition, or other alteration of the Guaranteed Obligations, whether or not consented to City; or
- J. any partial performance of the Guaranteed Obligations, except that to the extent the Affiliate has performed part of the Guaranteed Obligations as required under the Agreement, in which case the Guarantor's obligations shall be reduced by the amount of such partial performance.

Guarantor hereby waives

- A. notice of acceptance of this Guaranty;
- B. notice of any advances made by City in connection with the Agreement;
- C. notice of any waiver, amendment, modification, postponement, release, renewal, extension, accrual or termination of any of the Guaranteed Obligations or the work required under the Agreement;
- D. notice of the reliance of City upon this Guaranty;
- E. notice of the occurrence, existence or continuance of any event of default, or failure of payment or performance under the Agreement;
- F. demand for payment, diligence, presentment, filing of claims with a court in the event of receivership or bankruptcy of the Affiliate, protest or notice with respect to the Guaranteed Obligations or the work required under the Agreement, and all demands whatsoever; and
- G. any other notice, demand, protest or formality which would otherwise be legally required to charge Guarantor with liability hereunder; and Guarantor covenants

and agrees that this Guaranty will not be discharged, except by complete performance of the Guaranteed Obligations.

It is the intent of Guarantor and City that the obligations and liabilities of Guarantor hereunder are absolute and unconditional under any and all circumstances and that until the Guaranteed Obligations are fully and finally performed, the obligations and liabilities of Guarantor hereunder shall not be discharged or released, in whole or in part, by any act or occurrence that might, but for the provisions of this Guaranty, be deemed a legal or equitable discharge or release of Guarantor.

5. Term. This Guaranty, provided in connection with the terms and conditions of the Agreement, shall continue in full force and effect until
- A. the Guaranteed Obligations have been fully performed, or otherwise discharged by Affiliate, or Guarantor, as applicable, or
 - B. the Agreement has terminated or expired by its terms.

whichever event occurs first.

6. Representations, Warranties and Covenants of Guarantor. Guarantor hereby represents, warrants and covenants
- A. The Affiliate is one-hundred percent (100%) owned by the Guarantor and the Guarantor will derive a material and substantial benefit, directly and indirectly, from the execution of the Agreement by Affiliate and the making of this Guaranty by Guarantor;
 - B. this Guaranty has been duly authorized pursuant to resolutions duly adopted by its Board of Directors, and is binding upon and enforceable against Guarantor;
 - C. Guarantor is not, and the execution, delivery and performance by Guarantor of this Guaranty will not, cause Guarantor to be, in violation of or in default with respect to any law or in default (or at risk of acceleration of indebtedness) under any document, indenture, agreement or restriction by which Guarantor is bound or affected;
 - D. Guarantor is duly organized and is validly existing and in good standing under the laws of Delaware and has full power and authority to enter into and perform this Guaranty;
 - E. after giving effect to this Guaranty, Guarantor is solvent, is not engaged or about to engage in business or a transaction for which the properties of Guarantor constitute an unreasonably small capital, and do not intend to incur or believe

that they will incur debts that will be beyond its ability to pay as such debts mature;

- F. Guarantor acknowledges and agrees that Guarantor may be required to perform the Guaranteed Obligations in full without assistance or support from Affiliate or any other person; and
- G. Guarantor has read and fully understand the provisions contained in the Agreement.

Guarantor's representations, warranties and covenants are a material inducement to City to enter into the Agreement and shall survive the execution thereof and any bankruptcy, foreclosure, transfer of security or other event affecting Affiliate, Guarantor or any other party.

- 7. Attorney Fees. In addition to the amounts guaranteed under this Guaranty, Guarantor agrees to pay actual reasonable attorney's fees and all other reasonable costs and expenses incurred by the City in any action or proceeding arising out of or relating to this Guaranty, including any action instituted to determine the respective rights and obligations of the parties hereunder and any action to enforce a judgment relating to this Guaranty (regardless of the venue of such action), whether or not suit is filed thereon, or whether in connection with bankruptcy, insolvency or appeal, provided, that and to the extent that the City is the prevailing party in such action or proceeding.
- 8. Governing Law. This Guaranty is and shall be deemed to be a contract entered into in and pursuant to the laws of the State of California and shall be governed and construed in accordance with the laws of California without regard to its conflicts of laws rules for all purposes, including, but not limited to, matters of construction, validity and performance. Guarantor hereby irrevocably submits generally and unconditionally for itself and in respect of its property to the jurisdiction of any United States federal court, sitting in the State of California, over any suit, action or proceeding arising out of or relating to this Guaranty or the Guaranteed Obligations.

The registered office of Guarantor in the State of California shall be care of JCDecaux San Francisco, LLC, 81 Dorman Avenue, Suite B, San Francisco, California 94124, attention Chief Operating Officer with a copy by email to Francois.nion@decaux.com and the registered agent for service of process on Guarantor at the registered office shall be [INSERT NAME AND ADDRESS OF REGISTERED AGENT]. Guarantor will immediately notify the City of a replacement agent to be located in California, in the event that Guarantor changes its agent for service of process. Guarantor hereby irrevocably waives to the fullest extent permitted by law, any objection that Guarantor may now or hereafter have to the laying of venue in any such court and any claim that any such court is an inconvenient forum. Guarantor hereby agrees and consents that, in addition to any methods of service of process provided under applicable law, all service

of process in any such suit, action or proceeding may be made by certified or registered mail, return receipt requested, directed, at City's election, either (x) to Guarantor's registered agent at the address specified above or (y) to Guarantor at the address set forth in Section 13, or at a subsequent address in the continental United States of which City received actual notice from Guarantor in accordance with Section 13, and service so made shall be complete five (5) days after the same shall have been so mailed, whether or not such service has been accepted or refused. Nothing herein shall affect the right of City to serve process in any manner permitted by law or limit the right of City to bring proceedings against Guarantor in any other court or jurisdiction.

9. Severability. If any portion of this Guaranty is held to be invalid or unenforceable, such invalidity shall have no effect upon the remaining portions of this Guaranty, which shall be severable and continue in full force and effect to the maximum extent permitted by law or equity.
10. Binding on Successors. This Guaranty shall inure to the benefit of the City and its successors and assigns. The Guarantor may not transfer, convey or assign this Guaranty, or any interest therein, without the prior written consent of the City. The Guaranty shall be binding upon Guarantor and its successors and permitted assigns, including transferee(s) of substantially all of its assets and its shareholder(s) in the event of its dissolution or insolvency. Guarantor waives notice by the City of any transfer or assignment of rights to the Guaranteed Obligations, or any part thereof, and Guarantor agrees that failure to give notice will not affect the liabilities of Guarantor hereunder.
11. Authority. Guarantor represents and warrants that it has the power and authority to give this Guaranty, that its execution of this Guaranty has been authorized by all necessary action under its organizational documents and applicable law, and that the person or persons signing this Guaranty on its behalf have the authority to do so.
12. Subordination. Any claims Guarantor may have against Affiliate are hereby subordinated to any and all claims of the City against Affiliate until such time as the obligations of Affiliate to the City are fully satisfied and discharged.
13. Notices. Notice shall be given in writing, deposited in the U.S. mail, registered or certified, first class postage prepaid, addressed as follows:

To the Guarantor: JCDecaux North America, Inc.
350 Fifth Avenue
73rd Floor
New York, New York 10118

Attn: Co-Chief Executive Officer and
Legal Department

To CITY: Public Works

Contract Administration
1155 Market Street, 4th Floor
San Francisco, California 94103
Attention: Contracts Manager

With a copy by email to contractadmin.staff@sfdpw.org

Nothing in this Guaranty shall preclude or waive any notices to Affiliate for breach or default and opportunity to cure any breach or default which are required to be given pursuant to the Agreement, and copies of any such notices given to Affiliate for breach or default shall be copied to Guarantor at the address provided above.

14. Cumulative Rights. The exercise by City of any right or remedy hereunder or under the Agreement, or at law or in equity, shall not preclude the concurrent or subsequent exercise of any other right or remedy. City shall have all rights, remedies and recourses afforded to City by reason of this Guaranty or the Agreement or by law or equity or otherwise, and the same (a) shall be cumulative and concurrent, (b) may be pursued separately, successively or concurrently against Guarantor, or any Other Obligated Party, or Affiliate, or against any one or more of them, or against any security or otherwise, at the sole discretion of City, (c) may be exercised as often as occasion therefor shall arise, it being agreed by Guarantor that the exercise of, discontinuance of the exercise of or failure to exercise any of such rights, remedies, or recourses shall in no event be construed as a waiver or release thereof or of any other right, remedy or recourse, and (d) are intended to be, and shall be, nonexclusive. No waiver of any default on the part of Guarantor or of any breach of any of the provisions of this Guaranty shall be considered a waiver of any other or subsequent default or breach, and no delay or omission in exercising or enforcing the rights and powers granted herein or in any other document shall be construed as a waiver of such rights and powers, and no exercise or enforcement of any rights or powers hereunder or under any other document shall be held to exhaust such rights and powers, and every such right and power may be exercised from time to time. The granting of any consent, approval or waiver by City shall be limited to the specific instance and purpose therefor and shall not constitute consent or approval in any other instance or for any other purpose. No notice to or demand on Guarantor in any case shall in and of itself entitle Guarantor to any other or further notice or demand in similar or other circumstances. No provision of this Guaranty or any right, remedy or recourse of City with respect hereto, or any default or breach, can be waived, nor can this Guaranty or Guarantor be released or discharged in any way or to any extent, except specifically in each case by a writing intended for that purpose (and which refers specifically to this Guaranty) executed, and delivered to Guarantor, by City.
15. Entire Agreement. This Guaranty embodies the entire agreement between City and Guarantor with respect to the guaranty by Guarantor of the Guaranteed Obligations. This Guaranty supersedes all prior agreements and understandings, if any, with respect

to guaranty by Guarantor of the Guaranteed Obligations. No condition or conditions precedent to the effectiveness of this Guaranty exist. This Guaranty shall be effective upon execution by Guarantor and delivery to City. This Guaranty may not be modified, amended or superseded except in a writing signed by City and Guarantor referencing this Guaranty by its date and specifically identifying the portions hereof that are to be modified, amended or superseded.

Notwithstanding the above paragraph, in the event that, under the terms of the Agreement, the obligations regarding the Guaranteed Obligations are reduced, this Guaranty shall automatically be reduced accordingly, and this Guaranty shall be modified without any additional action required to such reduced terms.

16. WAIVER OF JURY TRIAL. GUARANTOR HEREBY WAIVES TRIAL BY JURY IN ANY ACTION OR PROCEEDING TO WHICH GUARANTOR OR CITY MAY BE PARTIES ARISING OUT OF, IN CONNECTION WITH, OR IN ANY WAY PERTAINING TO, THIS GUARANTY OR THE AGREEMENT. IT IS AGREED AND UNDERSTOOD THAT THIS WAIVER CONSTITUTES A WAIVER OF TRIAL BY JURY OF ALL CLAIMS AGAINST ALL PARTIES TO SUCH ACTIONS OR PROCEEDINGS, INCLUDING CLAIMS AGAINST PARTIES WHO ARE NOT PARTIES TO THIS GUARANTY. THIS WAIVER IS KNOWINGLY, WILLINGLY AND VOLUNTARILY MADE BY GUARANTOR, AND GUARANTOR HEREBY REPRESENTS THAT NO REPRESENTATIONS OF FACT OR OPINION HAVE BEEN MADE BY ANY INDIVIDUAL TO INDUCE THIS WAIVER OF TRIAL BY JURY OR TO IN ANY WAY MODIFY OR NULLIFY ITS EFFECT. GUARANTOR FURTHER REPRESENTS AND WARRANTS THAT IT HAS BEEN REPRESENTED IN THE SIGNING OF THIS GUARANTY AND IN THE MAKING OF THIS WAIVER BY INDEPENDENT LEGAL COUNSEL, AND THAT IT HAS HAD THE OPPORTUNITY TO DISCUSS THIS WAIVER WITH COUNSEL.

17. Consent to Jurisdiction. Guarantor irrevocably submits generally and unconditionally for itself and in respect of its property to the nonexclusive jurisdiction of the courts specified in Section 8 hereof. Final, non-appealable judgment in any suit, action or proceeding brought in any such Court shall be conclusive and binding upon Guarantor and may be enforced in any court within or outside the United States of America, in which Guarantor is subject to jurisdiction, by a suit upon such judgment provided that service of process is effected upon Guarantor as permitted herein or by applicable law. Guarantor hereby releases, to the extent permitted by applicable law, all errors and all rights of exemption, appeal, stay of execution, inquisition, and other rights to which the Guarantor may otherwise be entitled under the laws of the United States of America or any state, possession or territory of the United States of America, now in force or which may hereinafter be enacted. The authority and power to appear for and enter judgment against the Guarantor shall not be exhausted by one or more exercises thereof or by any imperfect exercise thereof and shall not be extinguished by any judgment entered pursuant thereto. Such authority may be exercised on one or more occasions or from time to time in the same or different jurisdiction as often as City shall deem necessary and desirable, for all of which this Guaranty shall be sufficient warrant.

IN WITNESS WHEREOF, Guarantor has executed this Guaranty as of the day and year first above written.

JCDecaux North America, Inc.,
a Delaware corporation

By: _____
Name: Jean-Luc Decaux
Title: Co-Chief Executive Officer

By: _____
Name: Bernard Parisot
Title: Co-Chief Executive Officer

STATE OF NEW YORK)

) SS.

COUNTY OF NEW YORK)

I, the undersigned, a Notary Public in and for said County, in the State aforesaid, do hereby certify that each of Bernard Parisot and Jean-Luc Decaux, in each of their capacity as a Co-Chief Executive Officer of JCDecaux North America, Inc., a Delaware company (the "Company"), personally known to me to be the same person whose name is subscribed to the foregoing instrument, appeared before me this day in person, and being first duly sworn by me, acknowledged that as said Co-Chief Executive Officer, each of Bernard Parisot and Jean-Luc Decaux signed and delivered the foregoing instrument pursuant to authority given the Company, as his free and voluntary act, and as the free and voluntary act and deed of said Company, for the uses and purposes therein set forth.

Given under my hand and notarial seal on _____, 2019.

Notary Public

EXHIBIT A to the Guaranty

Form of
Public Toilet and Public Service Kiosk Agreement (the "Agreement"), dated as of _____, 2019,
between the City and County of San Francisco and JCDecaux San Francisco



SAN FRANCISCO PLANNING DEPARTMENT

Addendum to Negative Declaration

Date of Publication of Addendum: October 5, 2018
Date of Publication of Final MND: December 16, 1993
Case No.: 2017-009220ENV
Project Title: Public Works - JCDeCaux Kiosk & Automatic Toilet Replacement Project
Block/Lot: N/A
Project Sponsor: Lisa Zhou, Department of Public Works
 lisa.zhuo@sfdpw.org
 (415) 557-4699

Lead Agency: San Francisco Planning Department
Staff Contact: Chelsea Fordham – (415) 575-9071
 Chelsea.Fordham@sfgov.org

1650 Mission St.
 Suite 400
 San Francisco,
 CA 94103-2479

Reception:
415.558.6378

Fax:
415.558.6409

Planning
 Information:
415.558.6377

REMARKS

Background

A final negative declaration (case number 93.504E) for the San Francisco public toilet and advertising kiosk program was adopted and issued on December 16, 1993. The project analyzed in the final negative declaration (FND) was for the initial installment of approximately 27 freestanding public toilets and about 120 freestanding advertising/public service kiosks concentrated in the downtown financial and retail shopping areas, and along Market Street to Upper Market; with fewer toilets and kiosks in the Civic Center area and along Van Ness Avenue; along Columbus Avenue; in the Fisherman's Wharf/Pier 39 area; and several neighborhood locations. The 1993 FND also analyzed up to an additional 23 toilets and 105 kiosks to be provided in future installations throughout San Francisco, totaling about 50 toilets and 225 kiosks, respectively. A private company (JCDeCaux) under contract to the city provided and maintained the toilet facilities and kiosks in exchange for kiosk advertising revenues. All facilities were located on sidewalks and other public properties.

The existing public toilets are self-cleaning, handicapped accessible, and connected directly to city sewer, water and electrical lines. The existing toilets are 10 feet in height, and 12 feet by 7 feet in floor area. The advertising/public service kiosks are cylindrical in shape, about 14 to 17 feet in height (depending on the roof design), about 5 to 6 feet in diameter, and have three illuminated vertical panels about 12 feet tall. Approximately 65 of the kiosks open to contain newsstands and replaced existing sidewalk newsstand structures. Following approval of the project, 25 toilets and 114 kiosks were installed throughout the city. Sixty-nine of the constructed kiosks were designed to contain newsstands. Additionally, the analyzed future installation of 23 toilets and 105 kiosks did not occur.

Proposed Revisions to Project

Subsequent to the issuance of the FND, the proposed project has been modified to involve the proposed removal and replacement of the existing 25 toilets and 114 kiosks with new facilities with a modern design. The proposed public toilets would use the existing utility connections to city sewer, water, and electrical lines constructed when the original toilets were installed.

The modified project would replace the kiosks and toilets in the same locations as the existing facilities (with the exception of three locations), and these toilets and kiosks would generally be similar configuration. Of the 25 existing toilets, 12 proposed replacements would be expanded from single-stall toilets to double-stall toilets. The specific locations of the double-stall toilets are provided in Appendix A. The proposed single toilets would be approximately 14 feet in height, and 13 feet by 9 feet in floor area. The proposed double toilets would be approximately 14 feet in height, and 18 feet by 9 feet in floor area. The proposed kiosks would range from 14 to 17 feet in height and would have a diameter of five-to-six feet.

The proposed new toilets would be installed in the existing locations of the original facilities with the exception of three locations that would be slightly adjusted as follows. The existing toilet located at the intersection of Embarcadero and Harrison Street would be moved from its current location to a new location no more than 40 feet south of the existing location on the Embarcadero seawall in order to provide access to the proposed new fireboat station at Pier 22-1/2. The existing toilet at Larkin and Myrtle Streets near a bulbout at Sgt. Macaulay Park would be replaced by a new toilet near the new fence of the playground. Finally, the toilet at Civic Center Plaza at Grove and Larkin Streets would be replaced by a new one about 20 feet from the existing toilet location to accommodate the new café kiosk. On these three relocated facilities, a new foundation and utility connections would be required. Other than these three, the replacements facilities would remain in their existing locations.

The proposed new kiosks and toilets would be curved and sculptural structures (see Appendix A). The toilets would be roughly a rounded hour-glass shape in plan, and the kiosks, a rounded triangle. In elevation, they would be wider at the middle and taper towards the top and bottom. Both would have either a sculptural, polished concrete base or a painted cast-iron base. A glass surface would cover the advertising panels on the kiosks and would connect with the adjoining surfaces. The toilets would feature a durable concrete base and formed textured stainless steel panels for the walls and door with a fiberglass roof that includes a skylight. The exterior shell of the kiosks would consist of glazed poster/display space and formed textured stainless steel panels for the walls and door with a fiberglass cap.

The proposed kiosks would have three illuminated vertical panels about 12 feet tall to contain general advertising. On 70 of the new 114 kiosks, there would be up to two changeable electronic displays. Approximately 20 of the existing 69 newsstand kiosks would be replaced by new multi-function kiosks, which would provide a variety of service and retail uses, such as wayfinding assistance, ATMs or vending of coffee, magazines, or other retail uses. The other remaining kiosks would be standard advertising kiosks. All images displayed on these kiosks would be silent (no audio) and static, with no

video/animation as required by Article 6 of the San Francisco Planning Code. Blocks of time on the advertising displays would be sold in 8-10 second increments; these images would move every 8-10 seconds at the maximum interval.

Table 1 includes a comparison of the existing and proposed toilet and kiosks. Attachment A shows the locations of the proposed kiosks and toilets, and provides tables listing the locations of the modified toilets and kiosks. Attachment A also includes a table with the proposed double toilet locations. Attachment B shows the plans and renderings of the proposed kiosks and toilets.

Table 1 – Comparison of Original and Modified Toilets and Kiosks

Toilet and Kiosks Characteristics	Existing (Original Toilets and Kiosks)	Proposed (Modified Toilets and Kiosks)
Footprint – single toilets	Flattened oval – 12.5' X 7.5'	Rounded rectangle -- Single module (one ADA-accessible toilet): 14.0' x 9'
Footprint – double toilets	N/A – No existing double toilets	Rounded hour-glass shape Two module (one ADA accessible, one non-accessible toilet): 18.0' X 9'
Footprint – kiosks	Circular 5' diameter	Triangular 5-6' diameter
Height - toilets	10 feet	14 feet
Height - kiosks	14 to 17 feet in height	14 to 17 feet in height
Exterior aesthetic	"Faux Victorian", with fluting, gilding, and decorative top knobs and turrets	Contemporary, sleek, with minimalist detailing
Exterior materials	Green enamel finish over metal, with gold accents	Matte metal, glass and neutral-colored accents
Advertising signage	Lighted panels	Changeable electronic displays ¹
Kiosk usage	Designed for use as staffed newsstand	"Multi-function" kiosks: Variety of service and retail uses, such as wayfinding assistance, ATMs, or vending of coffee, magazines, and/or retail uses
Notes:		
1. 70 of the 114 proposed new kiosks would have two changeable electronic displays.		

Comparing the existing and proposed facilities, the proposed single toilet would be slightly larger and taller than the existing toilet resulting in an increase of 2 feet in width and length, and 3.5 feet in height. The proposed double-stall toilets would be approximately 4 feet longer. The proposed kiosks would have similar heights and widths, with a potential increase in width of one-foot.

Construction Activities and Schedule

The existing toilets and kiosks are bolted to existing foundations, which are concrete pads with utility connections (water, sewer and electrical for toilets; electrical for kiosks). Construction of the proposed project would involve detaching the existing toilets and kiosks from their existing foundations, and returning them to JCDecaux. Existing foundations would be repaired and adjusted as necessary, to conform to the footprint of the replacement toilets and kiosks. Additionally, the existing foundations would be extended (up to 4.5 feet in additional length) for the proposed double-toilets. The maximum depth of excavation would be 3 feet for the expansion or creation of new foundations and utility connections. New kiosks and toilets would then be placed on the foundations and connected to the existing utilities. Sidewalk repair, as needed, would match existing sidewalk surfaces and would restore any sidewalk features such as distinctive scoring. Construction of the three relocated toilets would involve construction of a new foundation and utilities connections. Depth of excavation would be approximately three feet for all work.

Construction of these new facilities would involve small amounts of additional ground disturbance. The maximum depth of excavation associated with the project work is three feet, with the majority of impacts occurring at the surface and within the first 1-2 feet. The deeper excavation would be for utility conduit installation and tie-in.

Construction would require sawcutting and jackhammering for foundation work, and hand-held tools such as saws and nail guns for the construction of forms for modifications to foundations. Each kiosk and toilet would require removal of the existing facility and replacement with a new one, which would take from two to five days at each location. Work crews would consist of up to five members per day at each location. Multiple crews could be operating at different locations at the same time. The construction contractor would be responsible for identifying staging locations, which would take place on city streets. Equipment, materials and work crew members would temporarily occupy on-street parking spaces next to work locations during the delivery and removal of toilets and kiosks, for concrete pumping, and for similar construction activities. Where no parking lanes are available, partial (single-lane) road closures during work times, which would be generally between 7:00 AM and 5:00 PM, Monday through Friday, would be required. At least one lane of traffic would be maintained along the streets during construction and a flag person would be on duty to maintain traffic flow when necessary. Access to residences and businesses would be maintained at all times. Public Works and the project construction contractor would coordinate with SFMTA to minimize disruption and delay of traffic movement and transit service on the project streets. Portable toilets would be provided at public parks/open space toilet-replacement locations operated and maintained by the Recreation and Park Department during construction.

The project would be initiated upon completion of the environmental review process and approval of the renewed contract with JCDecaux. The proposed project would be completed in approximately six months, and start in fall, 2020. Construction activities would primarily be conducted between 7:00 am to 5:00 p.m. Monday through Friday; however, evening and weekend work may be required.

PROJECT APPROVALS

Board of Supervisors

- Approval of contract with JCDeCaux

Historic Preservation Commission

- Certificate of Appropriateness and Permit to Alter from the Historic Preservation Commission for the replacement of 6 existing non-historic public toilets and 34 kiosks located within the boundaries of Article 10 and Article 11 landmarks, landmark districts, and conservation districts including: Coit Tower (City Landmark No. 165), Washington Square Park (City Landmark No. 226), Civic Center Landmark District, Jackson Square Landmark District, Kearny- Market-Mason-Sutter Conservation District, New Montgomery-Mission-Second Street Conservation District, Kearny-Belden Conservation District, and Pine-Sansome Conservation District.

San Francisco Port Commission

- Building Permit
- Encroachment permit

Recreation and Park Commission

- Encroachment permit

Public Works

- Excavation Permit
- Surface-Mounted Facilities Permit (relocations only)

Actions by Other Government Agencies

- San Francisco Bay Conservation and Development Commission (BCDC): Administrative Permit

PUBLIC WORKS STANDARD CONSTRUCTION MEASURES

The Department of Public Works (Public Works) has established standard construction measures for all projects that would be implemented as part of the proposed project.¹ The main objectives of these measures are to:

- Reduce impacts on existing resources to the extent feasible;
- Include activities such as early identification of sensitive environmental resources in the project area; and
- Notify businesses, owners, and residents of adjacent areas potentially affected by the projects about the nature, extent, and duration of construction activities.

¹ San Francisco Department of Public Works, Standard Construction Measures, July 1 2015.

Public Works would ensure that the proposed project's contract specifications contain uniform minimum provisions to address these issues.

CHANGES TO APPROACH TO ANALYSIS

Analysis of Potential Environmental Effects

Section 31.19(c)(1) of the San Francisco Administrative Code states that a modified project must be reevaluated and that, "If, on the basis of such reevaluation, the Environmental Review Officer determines, based on the requirements of CEQA, that no additional environmental review is necessary, this determination and the reasons therefor shall be noted in writing in the case record, and no further evaluation shall be required by this Chapter."

The FND found that the project would not result in any significant impacts. As described above, the modified project proposes replacement of the existing 25 toilets and 114 kiosks with a new modern design, relocation of three toilets, and expanding some of the existing toilets to double-stall toilets. Taking into account these changes, the modified project would have similar effects as the original project.

As described further below, the modified project would not result in new, different, or substantially greater environmental impacts, nor would it require new mitigation measures. No new information has emerged that would materially change the analyses or conclusions set forth in the FND for the original project. Therefore, the modified project would not change the analysis or conclusions reached in the FND.

Land Use

The FND found that the original project would not result in substantial changes in land use given the toilet and kiosks relatively small scale and diffused distribution. The FND stated that the project could not disrupt or divide established land use patterns from the placement of freestanding toilets and kiosks on sidewalks and other public properties. The modified project would replace the existing toilets and kiosk at the same locations as the existing facilities with the exception of three locations that would be moved slightly to ensure they would not disrupt the existing path of travel; therefore, the modified project would similarly result in less-than-significant impacts to land use and land use planning.

Aesthetics

The FND found that the original project would not result in substantial changes to aesthetics, scenic vistas, or light and glare. This was because the vast majority of proposed locations were in the dense downtown area, or in commercial districts and along boulevards characterized by the diversity and high density of built urban features, including a variety of street furniture and signage. As an addition of a limited number of prominent but relatively small-scale urban features to an existing dense and diverse urban setting, the original project added structures and advertising signage that some persons may find objectionable, but which could not have significant adverse impacts on the aesthetic character of the city, and would not be substantially incompatible or inconsistent with the existing urban pattern. The FND stated that a more detailed assessment of the design and placement of these features would be conducted by public hearing of the San Francisco Arts Commission's Civic Design Review Committee, which would evaluate the proposal and make recommendations based in part on aesthetic considerations (such as

architectural treatment) beyond the scope of this environmental review. Like other similar features typical of urban streetscapes, such as street trees, street furniture and newsstands, the proposed toilets and kiosks would partially obstruct some existing scenic views from public streets and spaces in the immediate proximity, such as view corridors along city sidewalks. This effect would be limited and localized where it would occur, and therefore would result in a less-than-significant impact. Additionally, the FND states the small-scale effects of specific facilities on particularly sensitive view locations (such as along the waterfront or in a public park space) would be one of the issues considered on a case-by-case basis during the approval process by various city agencies, such as the Port Commission, the Recreation and Park Commission, the Department of Public Works and the San Francisco Arts Commission's Civic Design Review Committee. The FND stated that kiosks and public toilets would be illuminated during the nighttime hours, and would introduce light in the immediate area. Being located in areas along major boulevards, these increases in light would represent marginal incremental increases in light sources, and thus would not have substantial impacts due to increases in light.

As with the original project, the modified project would not result in a significant impact to public views and aesthetics, or light and glare. The modified project would replace the existing toilets and kiosks within the same locations as the existing facilities (with the exception of the three locations identified above) and would therefore have similar less-than-significant impacts to scenic resources and aesthetics. The modified project would have up to three 12-foot-tall panels of illuminated vertical advertising. On 70 of the proposed 114 kiosks, there would be up to two changeable electronic display panels. As such, the modified project would result in limited additional lighting in the immediate surroundings of the kiosks. The increase in light and glare resulting from the modified project would be a marginal incremental increase from the original project. Therefore, the modified project would not result in substantial increase in light and glare from the original project.

Similar to the original project, the proposed new toilets and kiosks would be considered on a case-by-case basis during the approval process by various City agencies, such as the Port Commission, the Recreation and Park Commission, the San Francisco Arts Commission's Civic Design Review Committee, and the Historic Preservation Commission. Therefore, the modified project would similarly result in less-than-significant impacts to aesthetics, scenic vistas, or light and glare.

Archeological Resources

The FND determined that the original project would result in less-than-significant impacts to archeological resources. The installation of facilities proposed by the original project required shallow excavation as needed to connect the toilets to city utilities. The FND stated this would affect only highly disturbed fill material just below the pavement surface which could not contain any significant archaeological resources that might be destroyed or disrupted by the project.

Since that time, the Planning Department's guidance for analysis of archeological resources has been updated. Therefore, the Planning Department prepared a Preliminary Archeological Review (PAR) for

the modified project.² The site history and soil formations vary widely because the project locations are distributed throughout the eastern part of the City. The sites closest to the San Francisco Bay are located on bay fill and generally are not expected to be archaeologically sensitive at the expected excavation depths for the modified project. Archaeological resources tend to be closer to the surface in the Mission District and potentially in the central part of the Market Street corridor. Review of all archaeological records indicates that there are no previously documented resources at any of the project locations. A number of the locations are very close to known or suspected prehistoric, maritime or Hispanic period archaeological resources, and/or are within generally archaeologically sensitive areas identified by the city archaeologist based on archival research.

Suspected buried prehistoric and maritime resources would be expected to occur within the modified project areas; however, because the anticipated maximum depth of excavation for the modified project would be 3 feet, it is unlikely that these resources would be encountered in project excavations. However, there is a potential for Hispanic-period resources to be present within the anticipated zone of disturbance at two work sites at Market/Church streets (both a proposed toilet and kiosks), and at the South Van Ness/Cesar Chavez (proposed toilet) site. The former is a location where a Hispanic period acequia (water conveyance feature) may have crossed Market Street. The latter is a potential location of Bernal's stone wall.³ Archaeological evidence for such features, if present, is likely to be very subtle. Therefore, an archaeological monitor should be present during excavations at these sites, consistent with Public Works Standard Construction Archeological Measure II - Archeological Monitoring (SCM II). Implementation of Public Works Standard Construction Archeological Measures I - Accidental Discovery (SCM I) is required for all of the other sites. With implementation of Public Works Standard Construction Measures I and II, the modified project would similarly result in less-than-significant impacts to archaeological resources.

Historic Architectural Resources

The FND found that the original project would not result in substantial changes to cultural resources, including to preservation of buildings subject to the provisions of Article 10 or Article 11 of the San Francisco Planning Code.

The modified project would replace the existing non-historic public toilets and kiosks in the same locations (except for three toilets that would be slightly moved). The modified project would include a total of 25 public toilets and 114 kiosks spread throughout the City of San Francisco. Of the total proposed toilets and kiosks, 10 of those toilets and 38 kiosks would be located within Local, California, and National historic districts and individual local landmarks listed below. The Planning Department preservation team reviewed the proposed project to determine whether it would cause a significant adverse impact to these historic districts and individual landmarks. The results of this review were summarized in a Preservation Team Review Form, which determined that the proposed project would

² San Francisco Planning Department, Environmental Planning Preliminary Archeological Review, Toilets and Kiosks Replacement, August 29, 2017. This document is on file and available for review at the San Francisco Planning Department as part of Case File 2017-009220ENV.

³ The Bernal's stone wall was built in the approximate area of Army Street (now Cesar Chavez) that separated the Spanish land grant of Potrero Hill from the Bernal Heights Ranch. When the Spanish ranches were broken into smaller plots of land, private citizens carried away the stones and used them in their homes or for walls surrounding their property. Portions of this wall may still remain near the South Van Ness/Cesar Chavez proposed toilet site.

not cause a significant adverse impact on the historic districts or the individual landmarks.⁴ The Planning Department determined that the proposal to replace the existing non-historic public toilets and kiosks with new redesigned toilets and kiosks is consistent with the Secretary of the Interior Standards (Secretary's Standards) and would not impair the character defining features of the identified historic districts.⁵ The following describes the historic districts and individual landmarks where the modified toilets and kiosks would be located. Following is a list of the proposed toilet and kiosk locations within historic districts and individual landmarks and their historical registers.

Historic District and Individual Landmark Toilet Locations:

- 1 toilet at Coit Tower, Individual Local Landmark No. 165
- 1 toilet at Washington Square Park, Individual Local Landmark No. 226 and Washington Square Historic District (California Register)
- 2 toilets within Civic Center Historic District (Article 10, California and National Register)
- 2 toilets within Kearny-Market-Mason-Sutter Conservation District (Article 11 and California Register)
- 2 toilets within Uptown Tenderloin Historic District (California and National Register)
- 1 toilet within Port of San Francisco Embarcadero Historic District (California and National Register)
- 1 toilet within Golden Gate Park Historic District (California and National Register)

Historic District and Individual Landmark Kiosk Locations:

- 2 kiosks within Civic Center Historic District (Article 10, California and National Register)
- 1 kiosk within Jackson Square Historic District (Article 10, California and National Register)
- 1 kiosk within Kearny-Belden Conversation District (Article 11 and California Register)
- 23 kiosks within Kearny-Market-Mason-Sutter Conservation District (Article 11 and California Register)
- 6 kiosks within New Montgomery-Mission-2nd St Conservation District (Article 11 and California Register)
- 1 kiosk within Pine-Sansome Conservation District (Article 11 and California Register)
- 1 kiosk within Upper Market Street Commercial Historic District (California Register)
- 1 kiosk within Sixth Street Lodging House Historic District (California Register)
- 1 kiosk within Market Street Theatre and Loft Historic District (California and National Register)
- 1 kiosk within Aquatic Park Historic District (California and National Register)

The existing public toilets and kiosks were designed in a turn of the 20th century style and installed in 1995 and are therefore non-historic and non-contributing to the landmarks, landmark districts, conservation districts, and historic districts in which they are located. The existing design included fluted and modeled fascia, domes, brass knobs, and a green with gold trim color scheme. The existing public toilets feature a single-stall, measure approximately 12'-3" in length by 7'-1" in width and 9'-10" in height, and have a rounded footprint and shape. The existing kiosks include two types and sizes, both measure approximately 5'-5" in diameter and are either 14'-4" or 17'-5" tall, and feature a circular

⁴ San Francisco Planning Department Preservation Team Review Form, September 6, 2018. This document is on file and available for review at the San Francisco Planning Department as part of Case File 2017-009220ENV.

⁵ San Francisco Planning Department Preservation Team Review Form, September 6, 2018. Ibid

footprint and shape. Some of the kiosks were designed to contain newsstands and the rest function as non-functional advertising kiosks with one advertising panel dedicated to city/public service uses and two panels dedicated for advertising purposes.

The modified project would consist of a contemporary design for the replacement toilets and kiosks, a departure from the existing structures which convey a historic aesthetic. The proposed design is intended to reference the aesthetic of new city street furniture such as Market Street subway entrances, bus shelters, the Civic Center kiosk, etc. The kiosks and toilets in the new design are curved, abstract, sculptural structures: the toilets would be roughly a rounded hourglass shape in plan, and the kiosks, a rounded triangle. In elevation, they are wider at the middle and taper towards the top and bottom. Both would have a sculptural, polished concrete base. A bowed glass surface would cover the advertising panels on the kiosks and would connect with the adjoining sculpted surfaces. The public toilets would feature a durable concrete base and formed textured stainless steel panels for the walls and door with a fiberglass roof that includes a skylight. The exterior shell of the kiosks would consist of glazed poster/display space and formed textured stainless steel panels for the walls and door with a fiberglass cap hiding antennas.

The proposed public toilets would come in two sizes, including single- and double-stall toilets. The proposed single toilet would be slightly larger and taller than the existing, measuring 14 feet in length, 9 feet in width, and 13.5 feet in height, resulting in an increase of 2 feet in width and length, and 3.5 feet in height. The proposed double-stall toilets would be approximately 4 feet longer.

The proposed replacement kiosks would either be designed as multi-service kiosks, intended to serve micro-businesses, way-finding and neighborhood services, or as standard advertising kiosks. The proposed replacement kiosks would have similar dimensions to the existing, ranging from 14 to 17 feet tall, 5 to 6 feet in diameter, with three illuminated vertical panels approximately 12 feet tall. On 70 of the proposed 114 kiosks, there would be up to two changeable electronic display panels.

Based on the requirements of Article 10 and 11 of the Planning Code and the Secretary of Interior's Standards, Planning Department staff has determined that the proposed work is compatible with, and would not adversely affect the surrounding historic resources.⁶ Specifically, the existing structures falsely evoke a historic aesthetic and their removal would not result in the loss of any historic fabric. The proposed design of the structures would be sufficiently differentiated from the historic buildings through the use of contemporary materials while maintaining a compatible appearance through the small scale, rounded form, and shaped massing of the structures. The curved shape further reduces the perception of the volume and allows the structures to recede as subordinate elements of their site.

The replacement structures would be located within or near the existing locations. The number of toilets and kiosks would not increase from the existing 25 toilets and 114 kiosks, and would continue to be free-standing structures located in the public right-of-way or on lots operated by the Port or the Recreation and Park Department. The existing structures are not attached to any existing buildings and the proposed new facilities would not remove or alter any character-defining features. If removed in the future, the

⁶ San Francisco Planning Department Preservation Team Review Form, September 6, 2018. This document is on file and available for review at the San Francisco Planning Department as part of Case File 2017-009220ENV.

essential form and integrity of the historic districts and their surroundings would be unimpaired. Due to the scale, sculptural design, and relative location of the proposed replacement kiosks and toilets, the proposed project would not materially impair the character defining features of any of the historic districts or surroundings resources in which they would be located. Additionally, as discussed above individual installations would be required to obtain a Certificate of Appropriateness and Permit to Alter from the Historic Preservation Commission for the proposed installation of the toilet and kiosk structures within Article 10 and 11 districts. Therefore, the modified project would have similar impacts to cultural resources as the original project, and the impact would remain less-than-significant.

Transportation and Circulation

The FND determined that the transportation and circulation impacts, including construction impacts and pedestrian impacts from operation of the project would be less-than-significant. The FND determined that there may be short-term impacts on vehicle traffic circulation, pedestrian circulation and parking in the immediate proximity of proposed toilet and kiosk sites during installation, due to the presence of construction vehicles, equipment and materials. These effects would be temporary in duration, and therefore not significant.

The FND determined that the original project would result in less-than-significant pedestrian impacts from operation of the project. The modified project would replace these existing facilities on sidewalks largely in the downtown area where pedestrian volumes are highest. Therefore, project has the potential to adversely affect pedestrian circulation. Project facilities would be sited in accordance with guidelines established and implemented by the Department of Public Works, the provisions of which include minimum circulation spaces between all street furniture, between street furnishings and structures, and minimum distances from corner cross walks, handicapped access ramps and fire escapes. The original project represented a small incremental increase in overall pedestrian obstructions in the downtown area, which would not be significant. Some individual sites already experiencing pedestrian congestion may become further restricted; however, this impact would occur only for very short periods of time (weekday peak commute and lunch hours) in very limited locations (mostly downtown financial district areas), and therefore would not be significant overall. Pedestrian traffic flows for individual locations would be evaluated on a case-by-case basis during the siting and approval process by the Department of Public Works.

The modified project would result in similar construction impacts as with the original project. Construction impacts would result from short-term impacts (over 2-5 days) on traffic circulation, pedestrian circulation, and parking in the immediate proximity of proposed toilet and kiosk sites during installation due to the presence of construction vehicles, construction workers, equipment, and materials. As described above, these activities are anticipated to take two-to-five days at each location and would primarily be staged in on-street parking spaces. Where adjacent on-street parking is not available, at least one lane of traffic would be maintained along the streets during construction and a flag person would be on duty to maintain traffic flow when necessary. Therefore, the modified project would similarly result in less-than-significant impacts from construction as the original project.

The modified project would be replace the existing toilets and kiosk within the same locations as the existing facilities with the exception of three locations that would be moved slightly to ensure they would

not disrupt the path of travel; therefore, the modified project would similarly result in less-than-significant impacts to transportation and circulation impacts.

Odors

The FND determined that the original toilet facilities would be connected directly to city sewer lines, and are designed to flush, self-clean and disinfect automatically after each use, and equipped with ventilation systems and therefore installation of 25 toilets citywide would not have the potential to create significant objectionable odors either cumulatively or in the immediate vicinity of each facility. The modified project would replace the 25 existing toilets in the same locations, except for 3 locations which would be moved a minimal distance. These new facilities would also connect directly to city sewer lines and thus would have no greater direct or cumulative odor effects as the original project. Therefore, the modified project would have similar impacts relating to odors as the original project discussed in the FND and this impact would be less-than-significant.

Other Environmental Topics

When compared to the original project, the modified project would represent no change from the less-than-significant impacts related to population and housing, noise, air quality, wind and shadow, recreation, utilities and service systems, public services, biological resources, geology and soils, hazards and hazardous materials, hydrology and water quality, mineral/energy resources, and agricultural and forest resources discussed in the FND. The modified project would neither increase the severity of the impacts associated with the project or result in new or substantially different environmental effects.

Conclusion

Based on the foregoing, it is concluded that the analyses conducted and the conclusions reached in the final negative declaration adopted and issued on September 23, 1993 for the original project remain valid and that no supplemental environmental review is required. The proposed revisions to the project would not cause new significant impacts not identified in the final negative declaration, or result in substantially more severe impacts and no new mitigation measures would be necessary to reduce significant impacts. No changes have occurred with respect to circumstances surrounding the proposed project that would cause significant environmental impacts to which the project would contribute considerably, and no new information has become available that shows that the project would cause significant environmental impacts. Therefore, no supplemental environmental review is required beyond this addendum.

I do hereby certify that the above determination has been made pursuant to State and Local requirements.

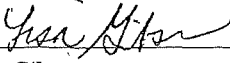

Lisa Gibson
Environmental Review Officer

October 5, 2018

Date

Addendum to Negative Declaration
October 5, 2018

CASE NO. 2017-009220ENV
JCDeCaux Kiosk & Automatic Toilet Replacement Project

Date of Determination

cc: Oliver Iberien, Public Works
Natalia Kwiatkowska, Preservation Planner
Distribution List
Virna Byrd, Master Decision File/Bulletin Board

Attachment A – Locations of the Proposed Toilets and Kiosks

Table 1 - Double-Lavatory Locations

Name	Address
Twin Peaks - A	Twin Peaks
Twin Peaks - B	Twin Peaks
Civic Center	Grove Street & Larkin St.
Fisherman's Wharf - A	Jefferson Street & Powell St
Fisherman's Wharf - B	Jefferson Street & Powell St
U.N. Plaza	Market Street & 7 th St
Hallidie Plaza	Market & Powell St
Market & Castro	Market & Castro
Cesar Chavez & S. Van Ness	Cesar Chavez & S. Van Ness
Pier 7	Pier 7
Embarcadero & Harrison	Embarcadero & Harrison
Embarcadero Plaza	Embarcadero Plaza (formerly Justin Herman Plaza)

Table 2 Proposed toilet Locations

Name	Address
Sue Bierman Park	Clay Street & Drumm St
Coit Tower	Coit Tower
Eddy Street & Jones St	Eddy Street & Jones St
Union Square	Geary Blvd & Powell St
Civic Center	Grove Street & Larkin St
Fisherman's Wharf -A	Jefferson Street & Powell St
Fisherman's Wharf - B	Jefferson Street & Powell St
Embarcadero Plaza	Embarcadero Plaza (formerly Justin Herman Plaza)
Sgt. Macaulay Park	Larkin Street & Myrtle St
Market Street & Spear St	Market Street & Spear St
Market Street & Castro St	Market Street & Castro St
Market Street & Church St	Market Street & Church St
Hallidie Plaza	Market Street & Powell St
U.N. Plaza	Market Street & 7 th St
Mission Street & 16th St	Mission Street & 16th St
Mission Street & 24th St	Mission Street & 24th St
Pier 7	Pier 7
Saint Mary's Square	Pine Street & Quincy St
South Van Ness Ave & Cesar Chavez St	South Van Ness Ave & Cesar Chavez St
Golden Gate Park	Stanyan Street & Waller St
Taylor Street & Bay St	Taylor Street & Bay St
The Embarcadero & Harrison St	The Embarcadero & Harrison St
Twin Peaks - A	Twin Peaks
Twin Peaks - B	Twin Peaks
Washington Square Park	Union Street & Columbus Ave

Table 3 Proposed Kiosk Locations

Kiosk Number	Address	Type
SFO0001SF	Bay Street & The Embarcadero	
SFO0002SF	148 The Embarcadero	
SFO0003SF	Market Street & Steuart St	Newsstand
SFO0004SF	Market Street & Spear St	Newsstand
SFO0005SF	Drumm Street & Market St	Newsstand
SFO0006SF	Market Street & Main St	Newsstand
SFO0007SF	Market Street & Davis St	Newsstand
SFO0008SF	Market Street & Beale St	Newsstand
SFO0009SF	Market Street & Pine St	Newsstand
SFO0010SF	Market Street & Fremont St	Newsstand
SFO0011SF	Market Street & Front St	
SFO0012SF	California Street & Davis St	Newsstand
SFO0013SF	California Street & Sansome St	Newsstand
SFO0014SF	Sacramento Street & Battery St	
SFO0015SF	California Street & Battery St	Newsstand
SFO0016SF	Battery Street & Bush St	Newsstand
SFO0017SF	Market Street & 1st St	Newsstand
SFO0018SF	1st Street & Mission St	Newsstand
SFO0019SF	1st Street & Mission St	Newsstand
SFO0020SF	Market Street & Battery St	Newsstand
SFO0021SF	549 Market St	Newsstand
SFO0022SF	Market Street & 2nd St	Newsstand
SFO0023SF	Market Street & Sutter St	Newsstand
SFO0024SF	49 Sansome St	Newsstand
SFO0025SF	Bush Street & Sansome St	Newsstand
SFO0026SF	Pine Street & Sansome St	Newsstand
SFO0027SF	California Street & Sansome St	Newsstand
SFO0028SF	Sansome Street & Broadway	
SFO0029SF	Montgomery Street & Clay St	Newsstand
SFO0030SF	California Street & Montgomery St	Newsstand
SFO0031SF	Montgomery Street & Pine St	Newsstand
SFO0032SF	Montgomery Street & Bush St	Newsstand
SFO0033SF	Market Street & Montgomery St	Newsstand
SFO0034SF	Market Street & New Montgomery St	Newsstand
SFO0035SF	Market Street & New Montgomery St	Newsstand
SFO0036SF	Montgomery Street & Post St	Newsstand
SFO0037SF	3rd Street & Market St	Newsstand
SFO0038SF	Howard Street & 3rd St	
SFO0039SF	Howard Street & 4th St	

Kiosk Number	Address	Type
SFO0040SF	Market Street & Castro St	Newsstand
SFO0041SF	49 Post St	Newsstand
SFO0042SF	Kearny Street & Sutter St	Newsstand
SFO0043SF	Kearny Street & Bush St	Newsstand
SFO0044SF	California Street & Kearny St	Newsstand
SFO0045SF	Green Street & Columbus Ave	Newsstand
SFO0046SF	Geary Blvd & Kearny St	Newsstand
SFO0047SF	Market Street & Geary Blvd	Newsstand
SFO0048SF	Market Street & Grant Ave	
SFO0049SF	749 Market St	
SFO0050SF	Grant Ave & Maiden Ln	Newsstand
SFO0051SF	349 Sutter St	Newsstand
SFO0052SF	Sutter Street & Montgomery St	Newsstand
SFO0053SF	Stockton Street & Post St	Newsstand
SFO0054SF	149 Geary Blvd	Newsstand
SFO0055SF	Stockton Street & O'Farrell St	
SFO0056SF	Stockton Street & Ellis St	
SFO0057SF	Market Street & Stockton St	
SFO0058SF	Market Street & 4th St	Newsstand
SFO0059SF	4th Street & Mission St	Newsstand
SFO0060SF	Market Street & Ellis St	Newsstand
SFO0061SF	Market Street & Powell St	Newsstand
SFO0062SF	Powell Street & Eddy St	Newsstand
SFO0063SF	O'Farrell Street & Powell St	Newsstand
SFO0064SF	Geary Blvd & Powell St	Newsstand
SFO0065SF	Post Street & Stockton St	Newsstand
SFO0066SF	Powell Street & Post St	Newsstand
SFO0067SF	Geary Blvd & Mason St	Newsstand
SFO0068SF	Cyril Magnin Street & Market St	
SFO0069SF	Market Street & 5th St	Newsstand
SFO0070SF	5th Street & Jessie St	Newsstand
SFO0071SF	Mission Street & 5th St	Newsstand
SFO0072SF	Mission Street & 6th St	Newsstand
SFO0073SF	Market Street & 7th St	Newsstand
SFO0074SF	1140 Market St	
SFO0075SF	Market Street & Grove St	Newsstand
SFO0076SF	249 Post St	Newsstand
SFO0077SF	Polk Street & Fell St	
SFO0078SF	Van Ness Ave & Market St	Newsstand
SFO0079SF	Spear Street & Mission St	Newsstand

Kiosk Number	Address	Type
SFO0080SF	Sacramento Street & Davis St	
SFO0081SF	The Embarcadero & Powell St	
SFO0082SF	Jefferson Street & Powell St	
SFO0083SF	Jefferson Street & Mason St	
SFO0084SF	Taylor Street & Jefferson St	
SFO0085SF	Hyde Street & Beach St	
SFO0086SF	Jefferson Street & Hyde St	
SFO0087SF	Grant Ave & Bush St	Newsstand
SFO0088SF	Battery Street & Bush St	
SFO0089SF	Kearny Street & VerMehr Pl	Newsstand
SFO0090SF	Pine Street & Battery St	
SFO0091SF	South Van Ness Ave & Mission St	
SFO0092SF	South Van Ness Ave & Market St	
SFO0093SF	Geary Blvd & Gough St	
SFO0094SF	Market Street & Castro St	
SFO0095SF	Folsom Street & 3rd St	
SFO0096SF	4th Street & Mission St	
SFO0097SF	Market Street & Castro St	Newsstand
SFO0098SF	4th Street & Howard St	
SFO0099SF	Market Street & Franklin St	
SFO0100SF	New Montgomery Street & Mission St	
SFO0101SF	New Montgomery Street & Howard St	
SFO0102SF	Fremont Street & Mission St	
SFO0103SF	Bay Street & Stockton St	
SFO0104SF	Powell Street & Sutter St	
SFO0105SF	Hayes Street & Polk St	
SFO0106SF	Market Street & Valencia St	
SFO0107SF	Kearny Street & Pacific Ave	
SFO0108SF	California Street & Kearny St	
SFO0109SF	Mission Street & Main St	
SFO0110SF	The Embarcadero & Bryant St	
SFO0111SF	79 The Embarcadero	
SFO0112SF	Market Street & Octavia St	
SFO0113SF	148 The Embarcadero	Newsstand
SFO0114SF	Market Street & Church St	Newsstand

DeCaux Kiosks and Toilets

- Decaux toilets
- ▲ Kiosks



0 3,750 7,500 15,000 Feet

Attachment B - Plans and Renderings of the of the Proposed Toilets and Kiosks

ADA Single
Public Toilet

Double Public Toilet
(1 of 2 stalls is
ADA Accessible)

Interactive Kiosk

Public Service Announcement Kiosk

Multi-Function Kiosk/
Vending*

Market St.

Small

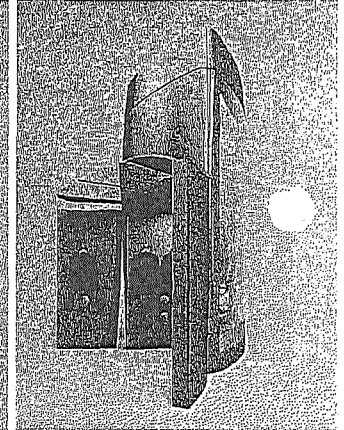
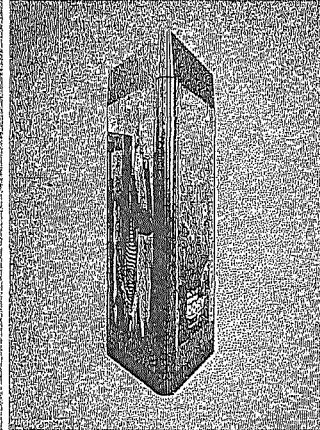
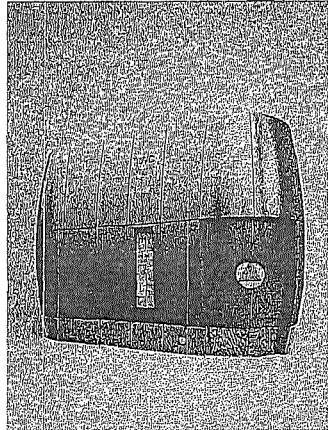
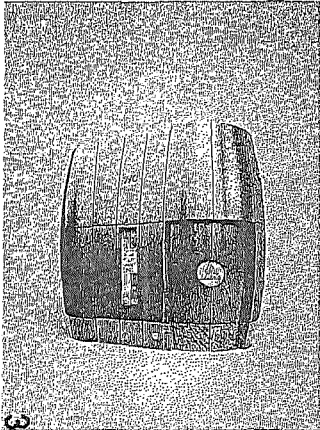

Union Square
Coit Tower
Washington Square Park

Grove St & Larkin St
(Civic Center)
Market St & 7th St
(UN Plaza)
Market St & Powell St
(Hallidie Plaza)

Market St & Montgomery St
Market St & Stockton St

Market St & 5th St
Market St & Ellis St
Market St & 3rd Street
Market St & Grant Ave
Market St & Grove St
1140 Market St

149 Geary St
249 Post St
Geary St & Kearny St
Kearny St & Sutter St
O'Farrell St & Powell St
Pine St & Sansome St
Powell St & Post St
New Montgomery St & Howard St
New Montgomery St & Mission St
Powell St & Sutter St
Kearny St & Pacific Ave
Cyril Magnin St & Market St
Stockton St & Ellis
Stockton St & O'Farrell St
Powell St & Eddy St
Stockton St & Post St
Grant Ave & Maiden Lane
Geary St & Mason St
Geary St & Powell St
Grant Ave & Bush St

Market St & 4th St
Market St & Geary St
Market St & New
Montgomery St
Market St & Powell St

Single Public Toilet Dimensions

3257

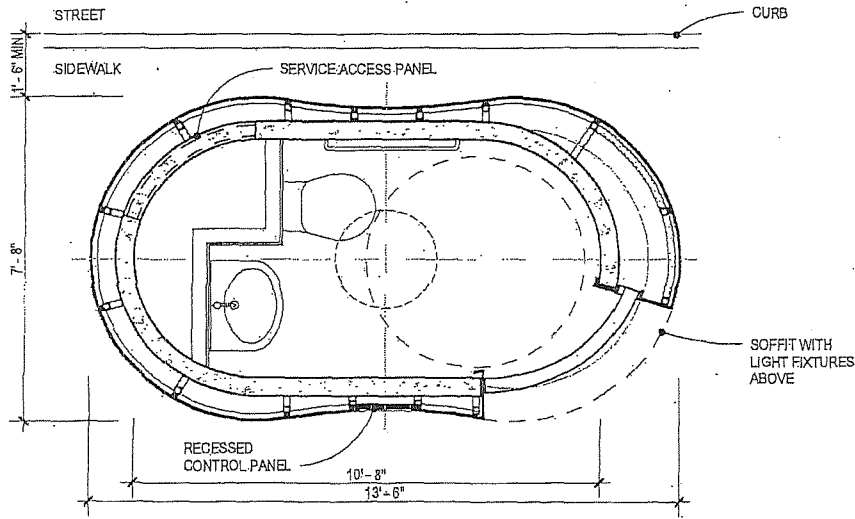

FOOTPRINT OVERLAY EXISTING & PROPOSED - ADA SINGLE TOILET

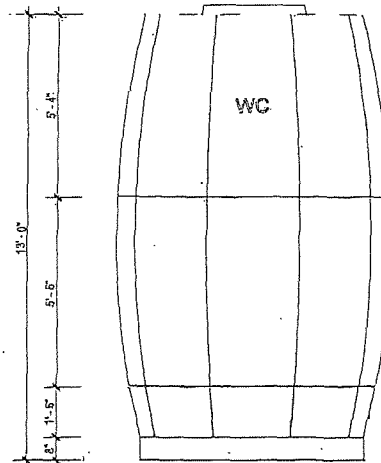
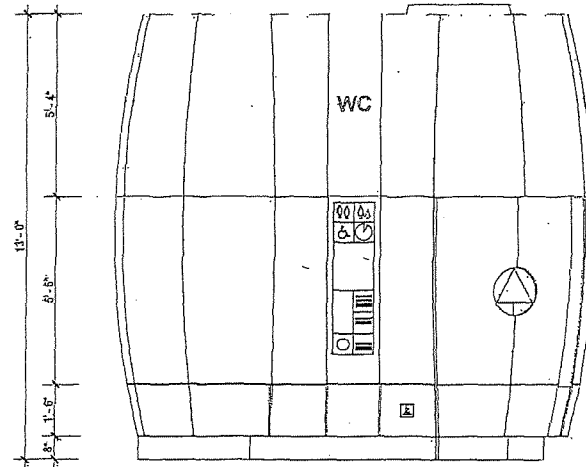
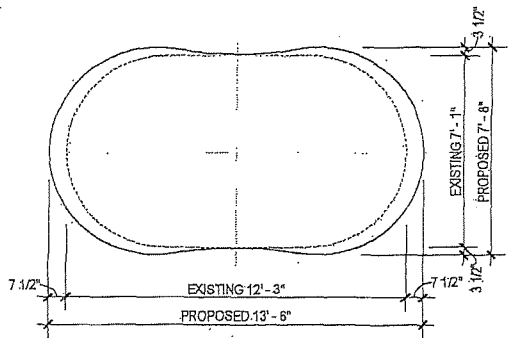

The proposed designs need to be fully developed and engineered over the next few months to confirm that all codes are met and for structural and constructability requirements

Double Public Toilet Dimensions

3258

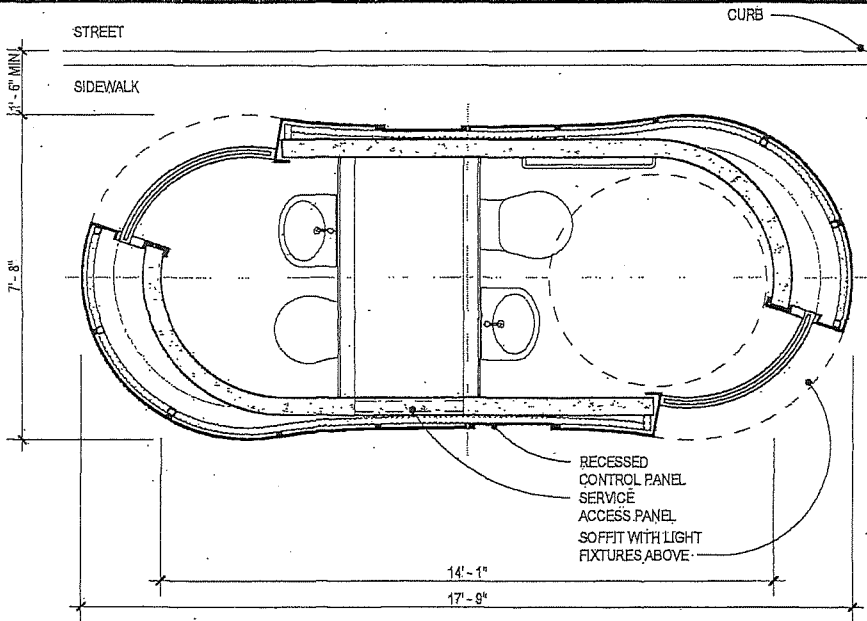

FOOTPRINT OVERLAY EXISTING & PROPOSED - DOUBLE TOILET

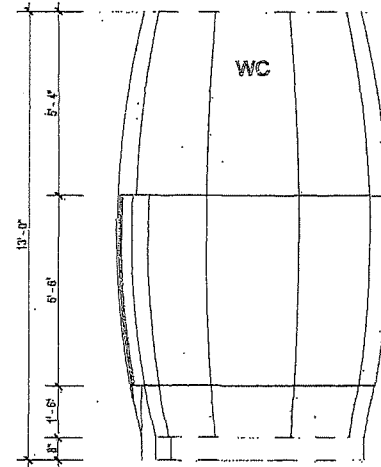
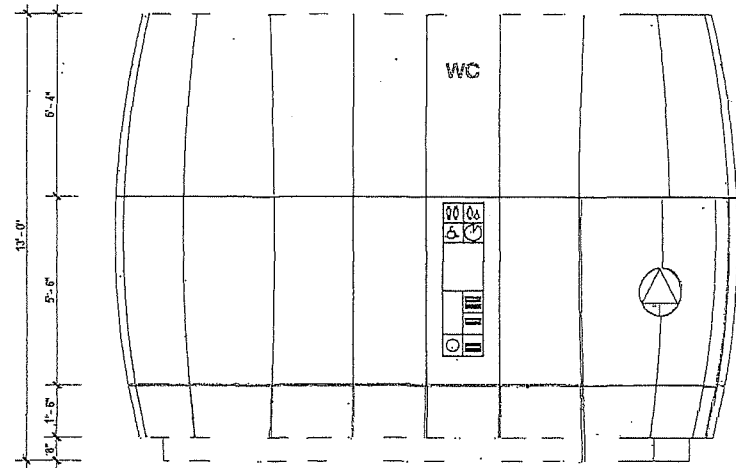
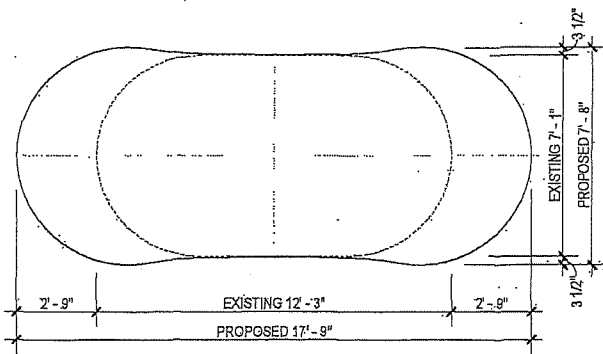

The proposed designs need to be fully developed and engineered over the next few months to confirm that all codes are met and for structural and constructability requirements

Single Public Toilet Design

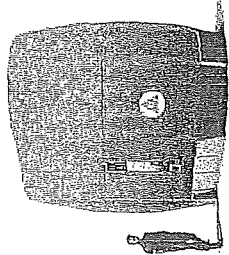

Perspective - Front-Left

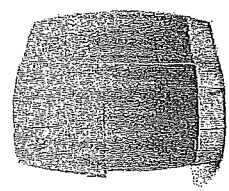

Perspective - Front-Right

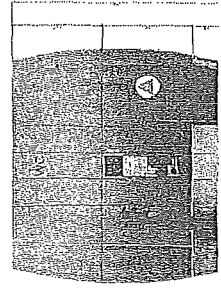

Elevation - Front

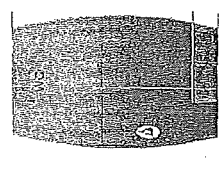

Elevation - Side

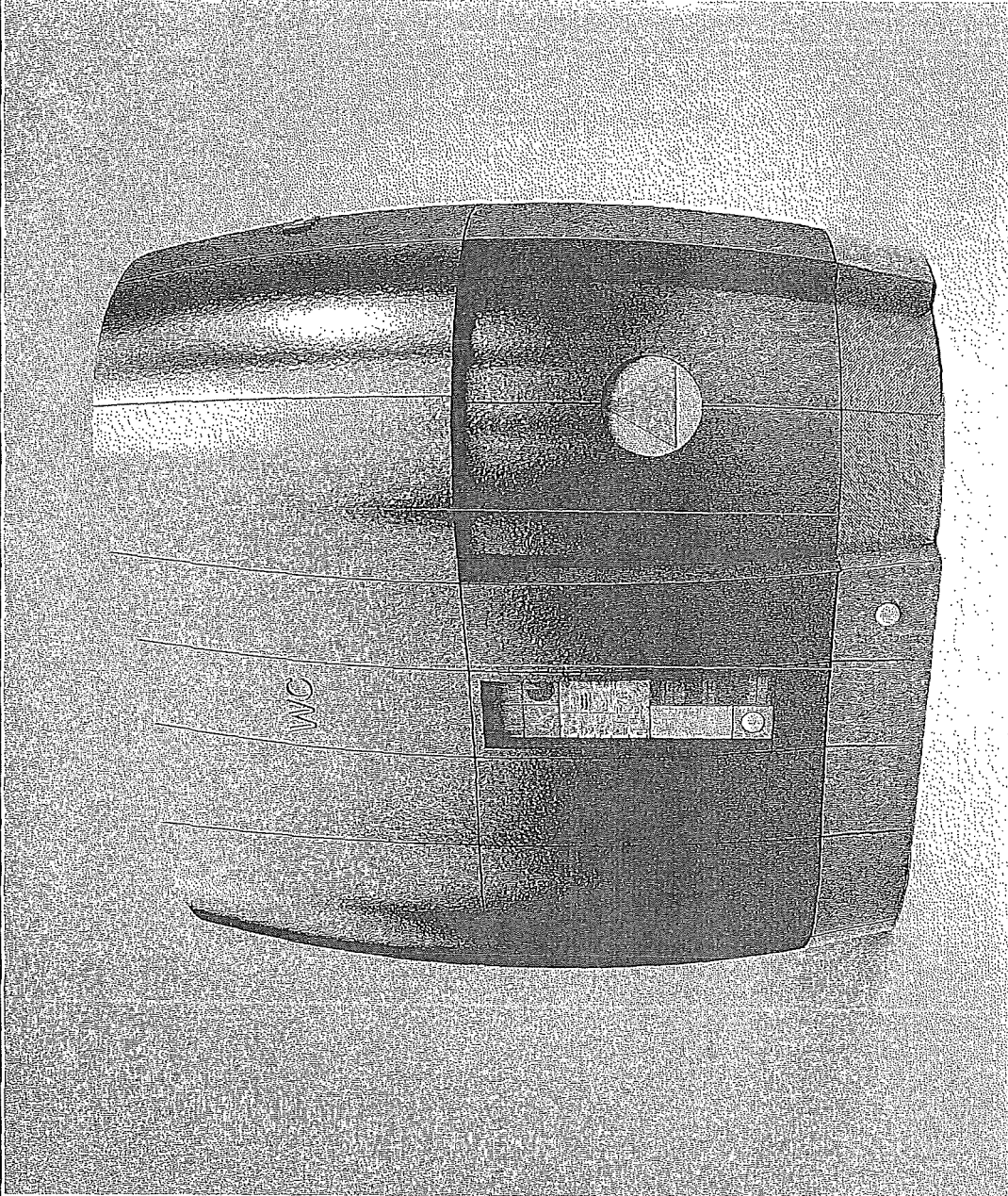
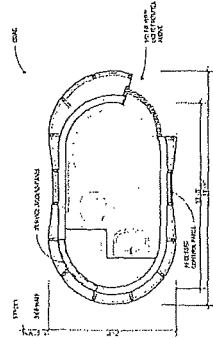

Double Public Toilet Design

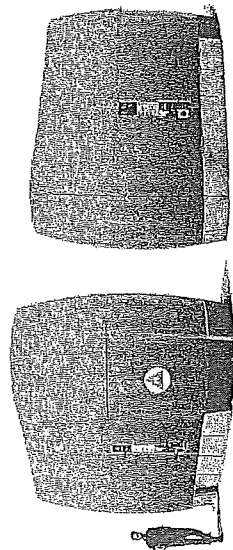

Perspective - From Street

Perspective - From Street

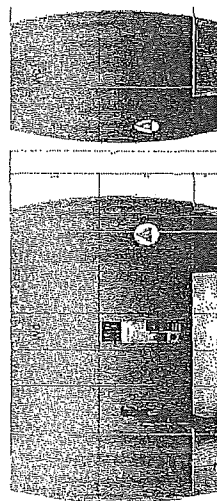

Elevation - From Street

Elevation - Side

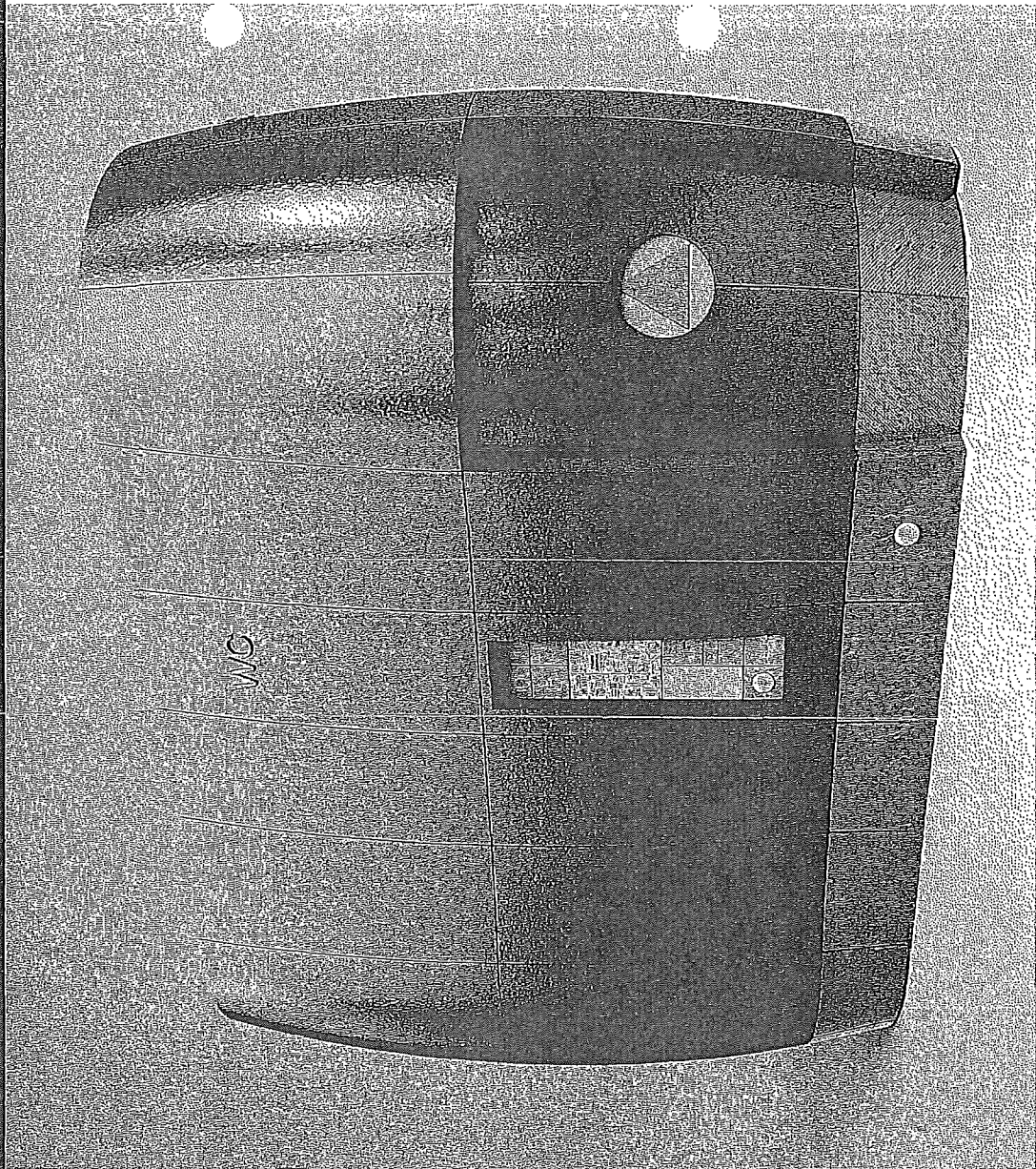
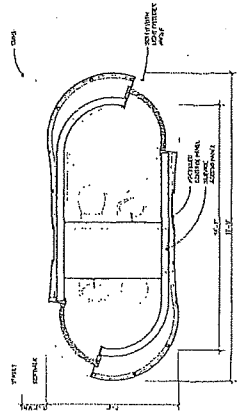

Kiosk Design Details and Dimensions

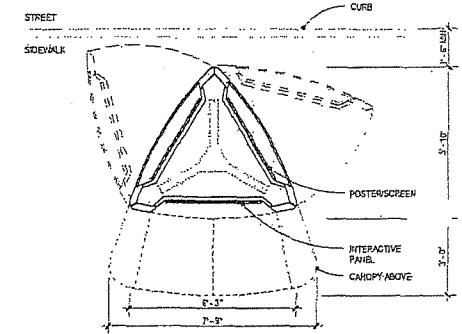
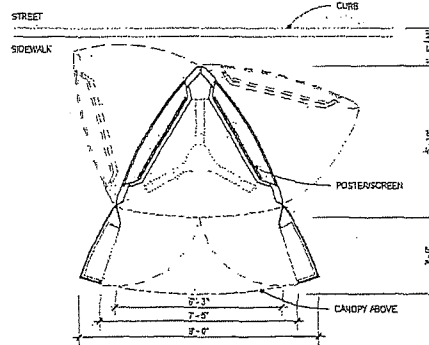
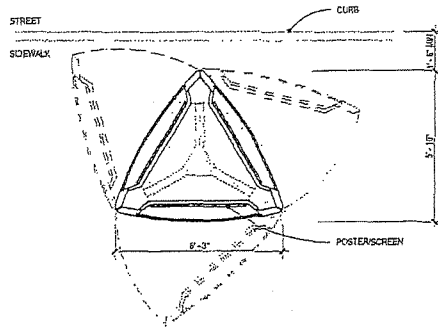
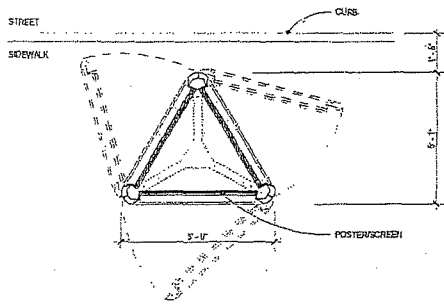

3261

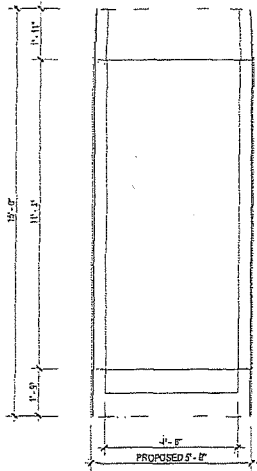

Small

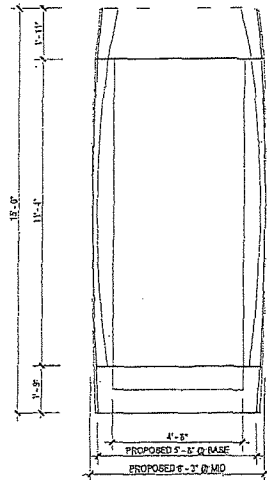

Market Street

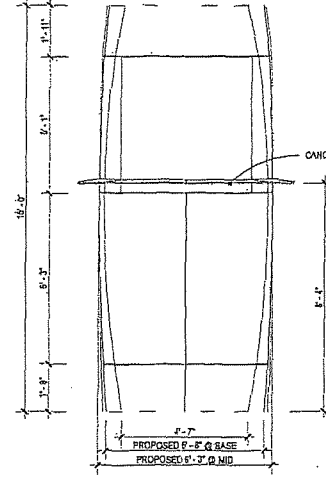

Multi-Function / Retail Kiosk

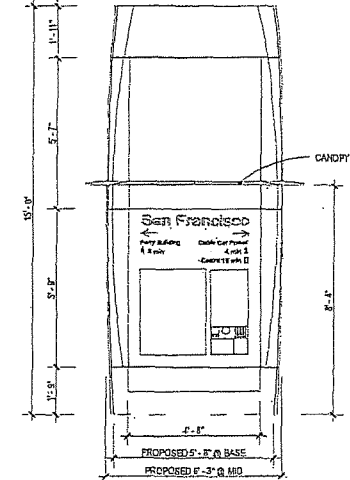

Interactive / Info Kiosk

3 Sided Panel Kiosk

The City panel is a full length poster space for a public service announcement including the Market Street Art Commission poster program.

The service side is a vending area. The service side is divided in 2 sections. Lower section has 2 French doors that swing open underneath an awning. The upper section above the awning is a space reserved for a public service announcements poster or digital clock.

The service side has 2 sections. The lower section underneath a small awning has information/ map and an interactive digital screen. The upper section above the awning is reserved for a public service announcement poster.

The proposed designs need to be fully developed and engineered over the next few months to confirm that all codes are met and for structural and constructability requirements

Kiosk Design Dimensions

3262

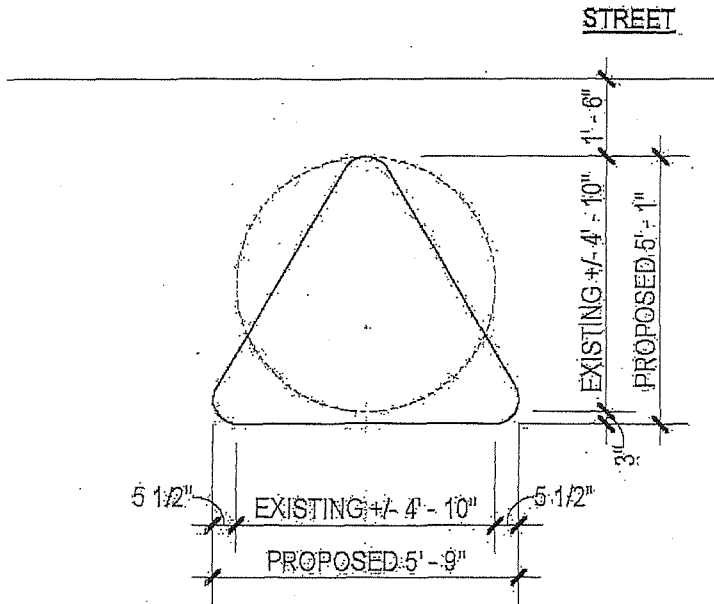

Small 3 Sided Kiosk

Small 3-sided kiosk requires minimal (3") additional sidewalk encroachment.

Required for narrow sidewalk conditions.

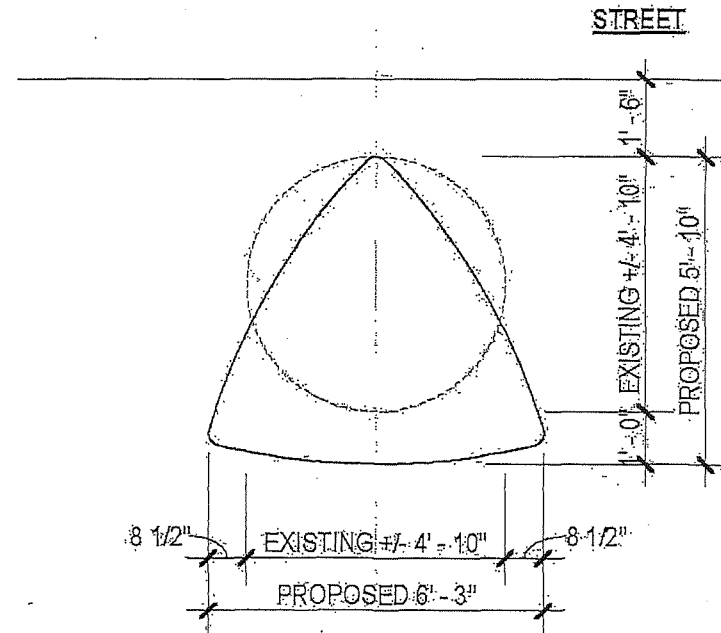

Market Street 3-sided, interactive & Multi-Function

Market St. 3-sided kiosk 'pillows' and 'bows' on all faces. Requires 1'-0" additional sidewalk encroachment.

Feasible on Market St., Embarcadero, Park & Rec locations with no clearance issues.

The proposed designs need to be fully developed and engineered over the next few months to confirm that all codes are met and for structural and constructability requirements

Kiosk Design Dimensions

ELEVATIONS OVERLAY EXISTING & PROPOSED - KIOSK

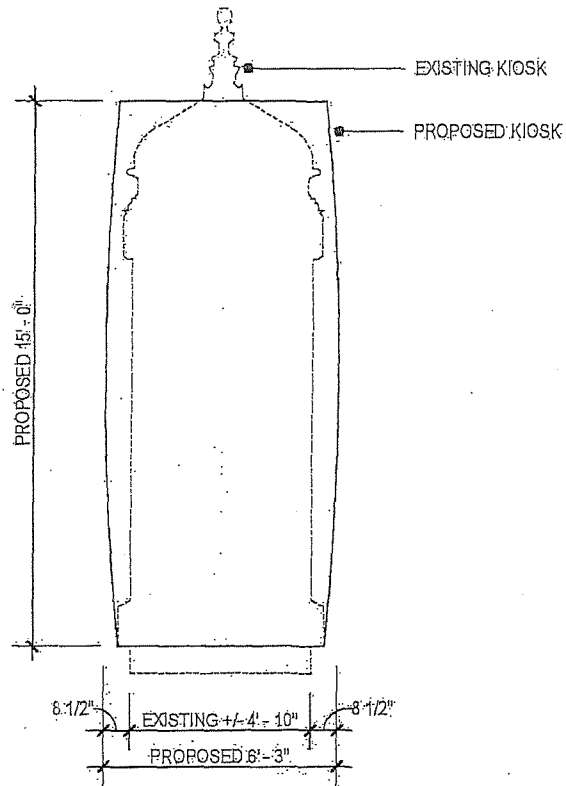

Types of Kiosks and Programming

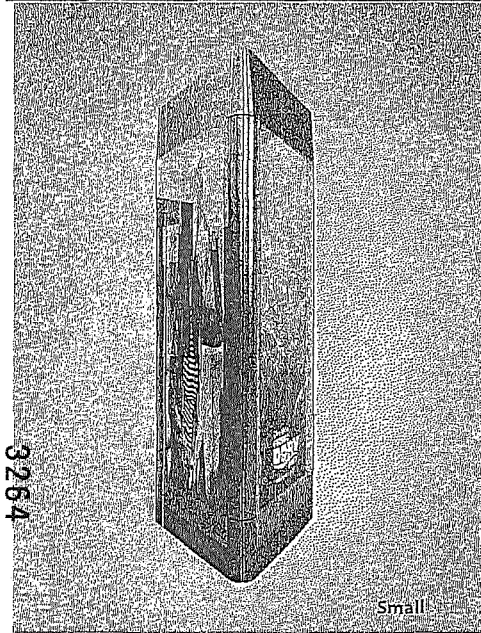

Small



Market Street

3 Sided Panel Kiosk

The City panel is a full length poster space for a public service announcement including the Market Street Art Commission poster program.

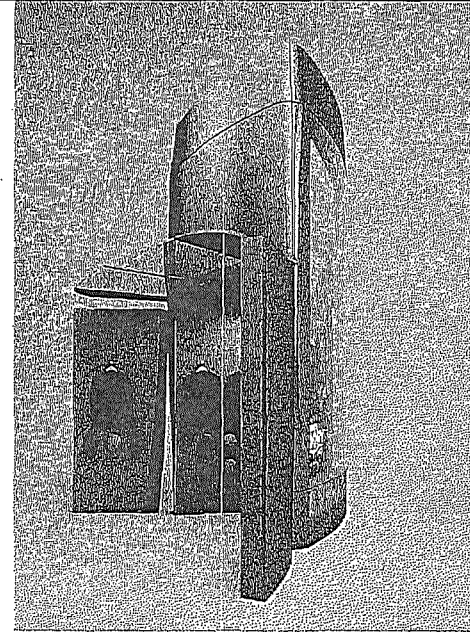

Multi-Function / Retail Kiosk

The service side is a vending area. The service side is divided in 2 sections. Lower section has 2 French doors that swing open underneath an awning. The upper section above the awning is a space reserved for a public service announcements poster or digital clock.



Interactive / Info Kiosk

The service side has 2 sections. The lower section underneath a small awning has information/ map and an interactive digital screen. The upper section above the awning is reserved for a public service announcement poster.

Please note that in every case, existing kiosk will be replaced with the similar one in terms of functionality.

Multi-function kiosks will have the ability to provide a variety of service and retail uses, such as wayfinding assistance, ATMs or vending of coffee, magazines, and/or sundries. Only select locations will have vending doors open where path of travel requirements are met.

Kiosk Materials, Colors and Shaping

3265

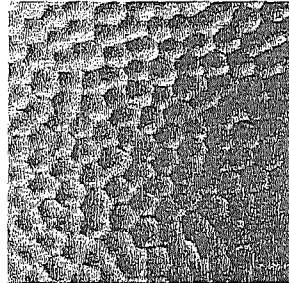

Textured
Stainless
Steel and
matching
fiberglass cap

option 1

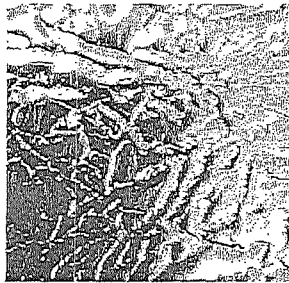

option 2
Perforated
Stainless
Steel (at
ventilated
base)

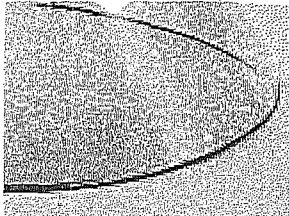
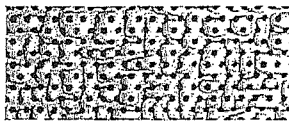

Glazing

Design Approach

Simplicity in its Kit of Parts

The furnishings are designed as a kit of parts for ease in buildability and maintenance. The kiosk's unique sculptural shape displays a sense of complexity, yet, the kit of parts assembly is simple. The exterior shell consists of glazed poster/display space and formed texture Stainless Steel panels for the walls and door. Cap is made of matching fiberglass hiding antennas behind.

Maintainability

State of the Art engineering to deliver ruggedized furniture for everyday useage. They are designed to keep the challenges of structures in an urban context. This includes climate, graffiti, and pedestrian activity.

Introduction Form

By a Member of the Board of Supervisors or Mayor

BOARD OF SUPERVISORS
SANTA CLARA COUNTY

2019 MAY 21

Time stamp
or meeting date

I hereby submit the following item for introduction (select only one):

- 1. For reference to Committee. (An Ordinance, Resolution, Motion or Charter Amendment).
- 2. Request for next printed agenda Without Reference to Committee.
- 3. Request for hearing on a subject matter at Committee.
- 4. Request for letter beginning : "Supervisor [] inquiries"
- 5. City Attorney Request.
- 6. Call File No. [] from Committee.
- 7. Budget Analyst request (attached written motion).
- 8. Substitute Legislation File No. []
- 9. Reactivate File No. []
- 10. Topic submitted for Mayoral Appearance before the BOS on []

Please check the appropriate boxes. The proposed legislation should be forwarded to the following:

- Small Business Commission
- Youth Commission
- Ethics Commission
- Planning Commission
- Building Inspection Commission

Note: For the Imperative Agenda (a resolution not on the printed agenda), use the Imperative Form.

Sponsor(s):

Supervisor Peskin

Subject:

[Revenue Agreement - JC Decaux San Francisco, LLC. - Public Toilets and Public Service Kiosk Agreement - \$12,950,000]

The text is listed:

Resolution approving a Revenue Agreement between Public Works and JC Decaux San Francisco, LLC, for an Automatic Public Toilet and Public Service Kiosk Program with anticipated revenues of over \$12,950,000 and a term of 21.5 years commencing on July 1, 2019; and affirming the Planning Department's determination under the California Environmental Quality Act.

Signature of Sponsoring Supervisor: []

For Clerk's Use Only

File # 190517
Received 7/17/19
Committee

JCDecaux Revenue Agreement 2019

Public Toilet and Public Service Kiosk Program

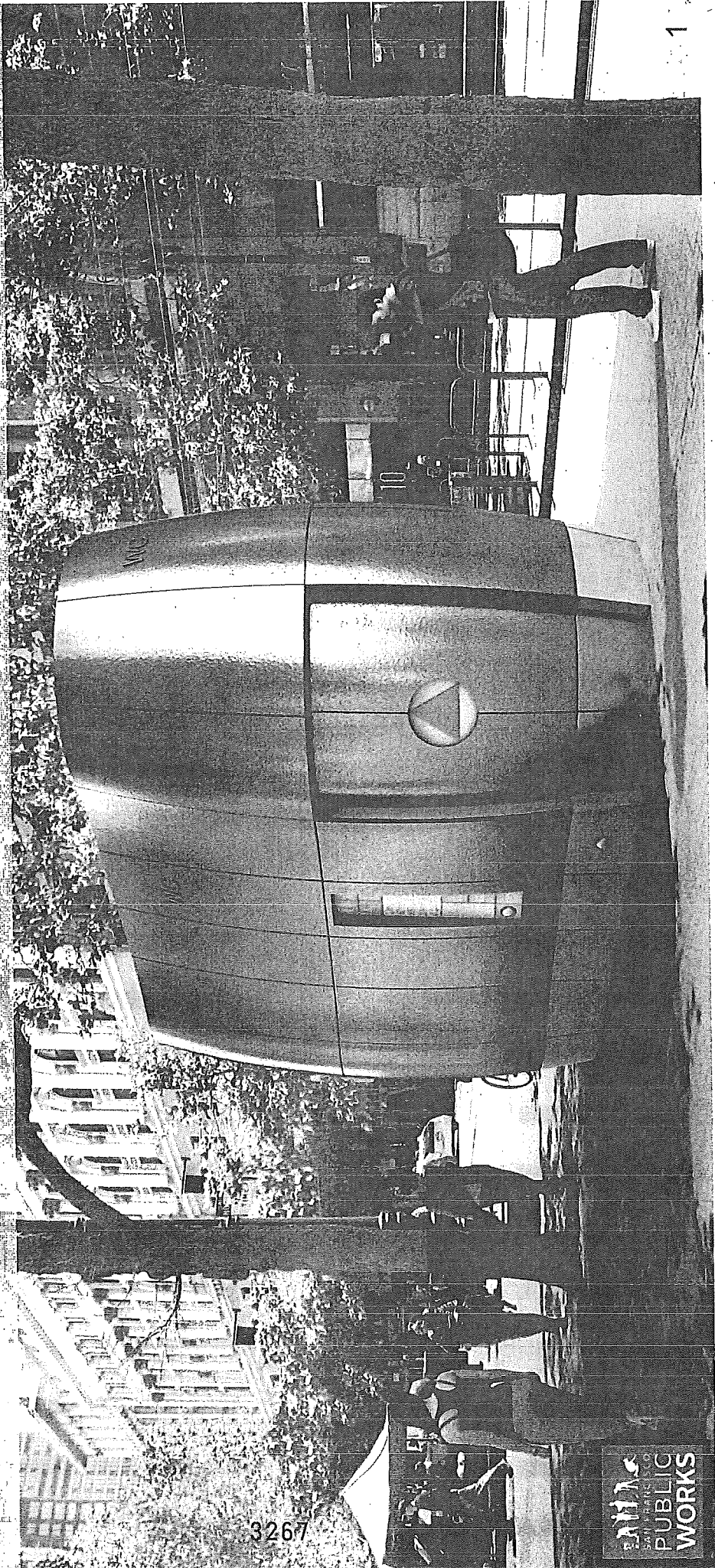

3267

EAHHC
SANTA FE PUBLIC WORKS

Existing Program

- Contract signed in 1998
- 25 self-cleaning, ADA accessible single stall public toilets
- 114 total kiosks
 - 45 advertising
 - 69 newsstand
- **13.5 million** flushes since the program started
- **826,087** flushes last year
- No cost to the City



Program Years: 13.5 Million Flushes

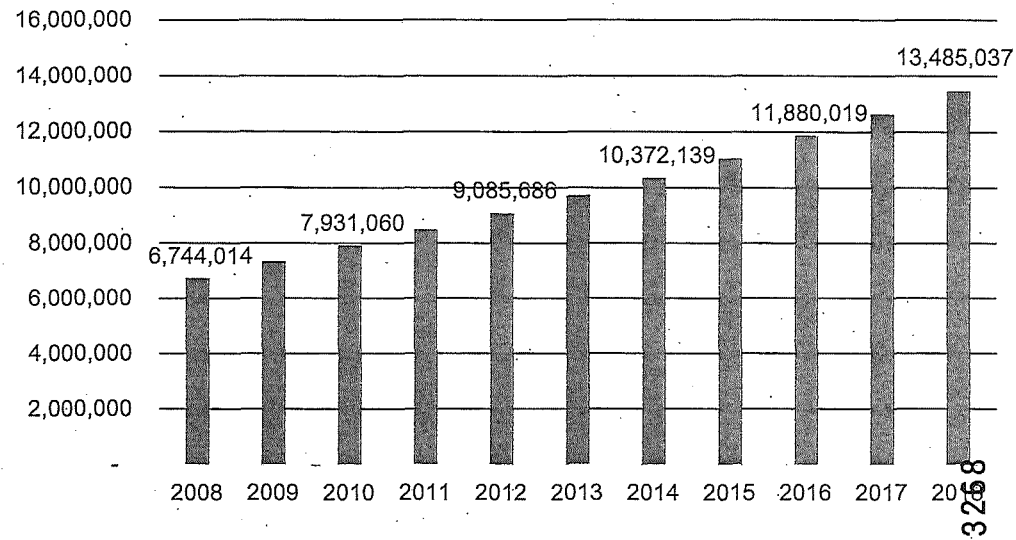

2018 Monthly Number of Flushes

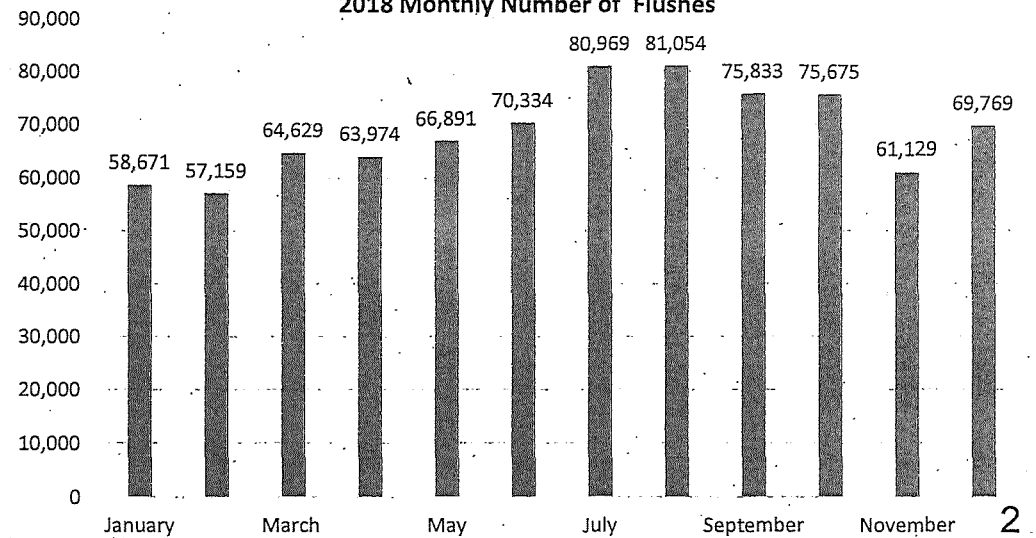

New Agreement

Overview

- Replace toilets and kiosks with up-to-date technology and a more contemporary, curated design
- Existing, aging infrastructure has growing maintenance challenges
- Continue to provide safe, attractive and easy-to-use public amenities
- JCDecaux to assume Pit Stop staffing at 11 locations
- City can purchase additional toilets at cost

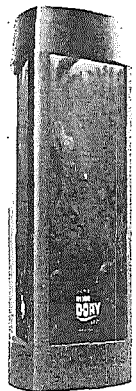
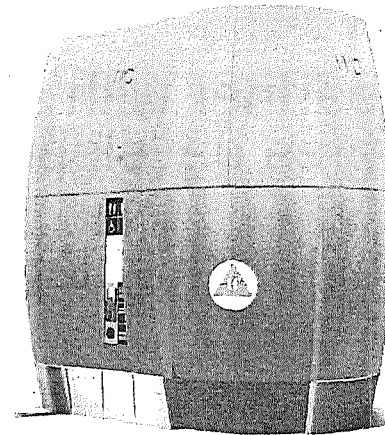
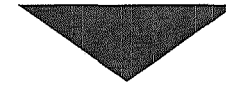
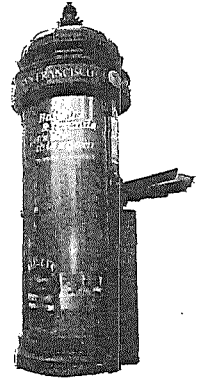

New Agreement

Highlights - Staffing

- JC Decaux will assume Pit Stop staffing at 11 toilets
- Attendants are crucial at certain locations
- Keeps the units safe, attractive and easy to use and improves the surrounding area
- Will continue to partner with a non-profit as a workforce development program
- Available as a cash equivalent at \$2.15 million per year

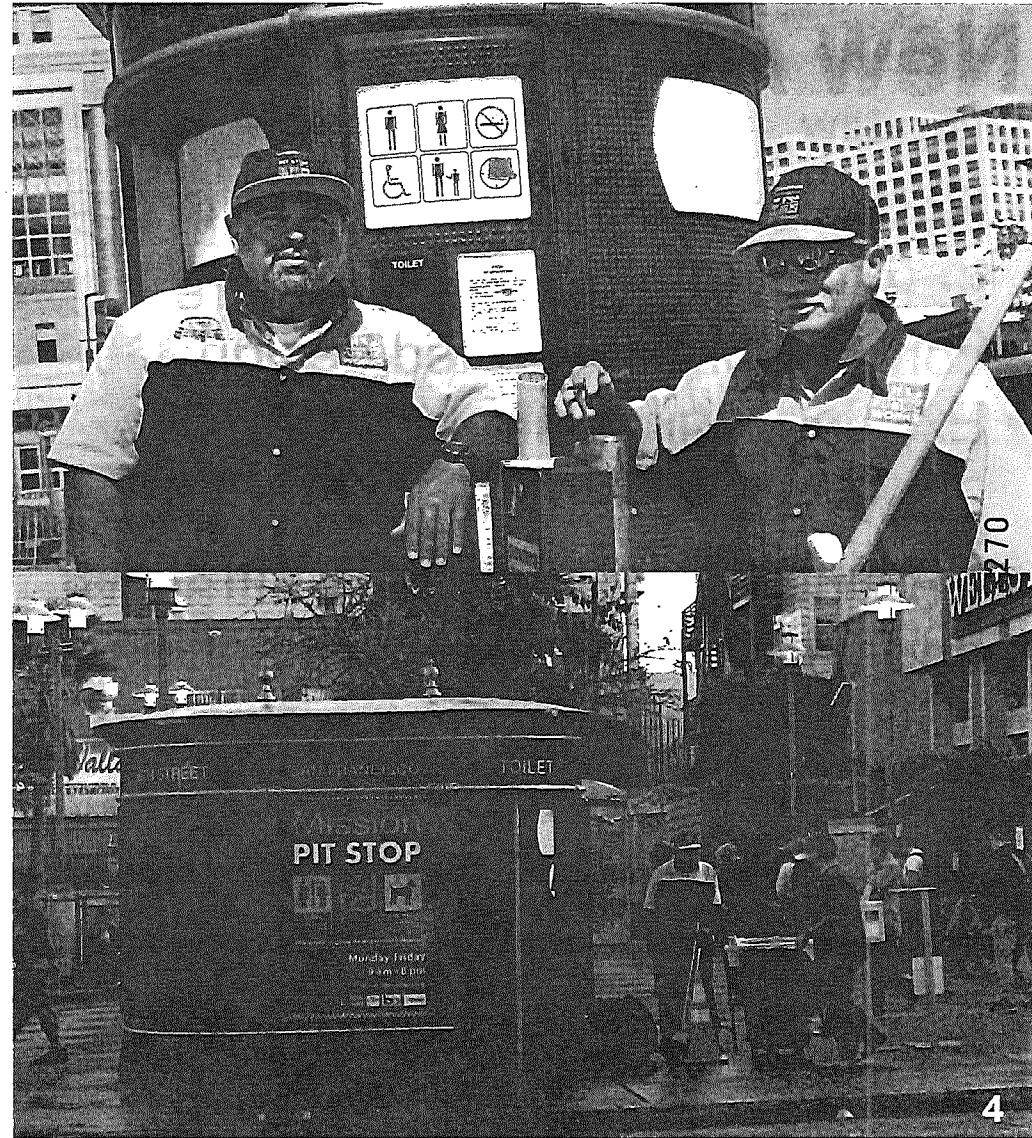

New Agreement

Highlights - Staffing

Castro

- 1) Market and Castro streets – daily – 9am to 8pm
- 2) Market and Church streets – daily – 9am to 8pm

Civic Center

- 3) Grove and Larkin streets - daily - 7am to 8pm

The Embarcadero

- 4) Embarcadero Plaza - daily - 9am to 8pm

Haight

- 5) Stanyan and Waller streets – daily – 9am to 8pm

Mid-Market

- 6) Hallidie Plaza – daily – 7am to 8pm
- 7) U.N. Plaza – daily – 9am to 8pm

Mission

- 8) 16th and Mission streets – daily – 9am to 8pm
- 9) 24th and Mission streets – daily – 9am to 8pm

North Beach

- 10) Washington Square at Union St. – daily – 9am to 8pm

Tenderloin

- 11) Eddy St. and Jones St. – daily – 7am to 8pm

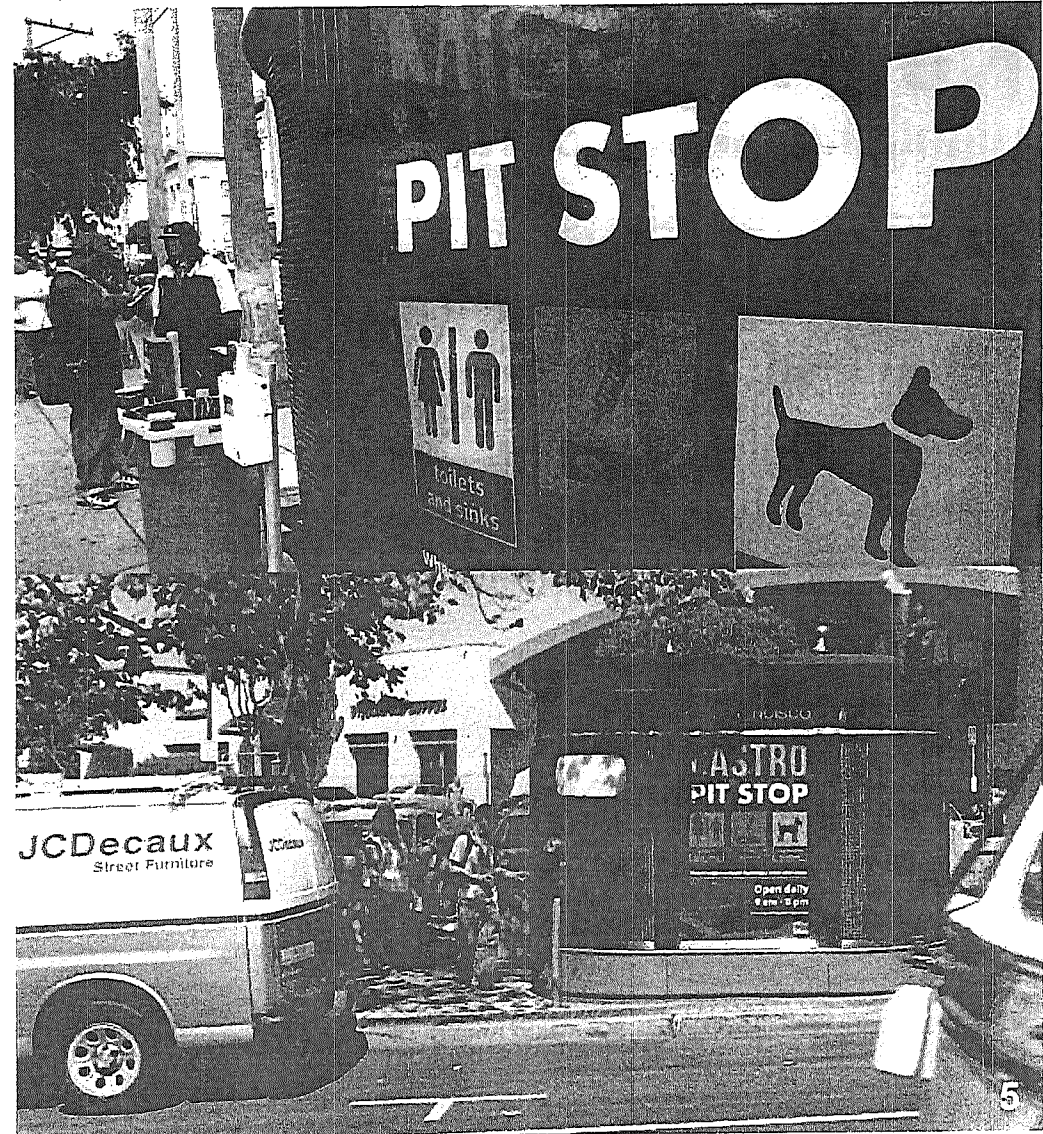

New Agreement

Highlights - New Toilets

- Additional toilets can be purchased by the City at cost (est. \$400K)
- City would need to allocate funding for this purpose through the budget process
- City also would need to pay for infrastructure installation and additional maintenance

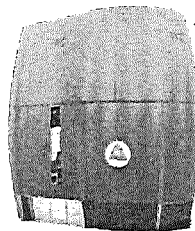

Kiosks

- 44 static kiosks
- 70 digital kiosks
- One of every eight digital ad spots are reserved for public purposes
- Interactive kiosks can be used for wayfinding and City PSAs
- Vending kiosks can be used for small local businesses, SFMade, etc.
- Public Works will develop a policy to govern the public digital displays and interactive and vending kiosks and return the Board

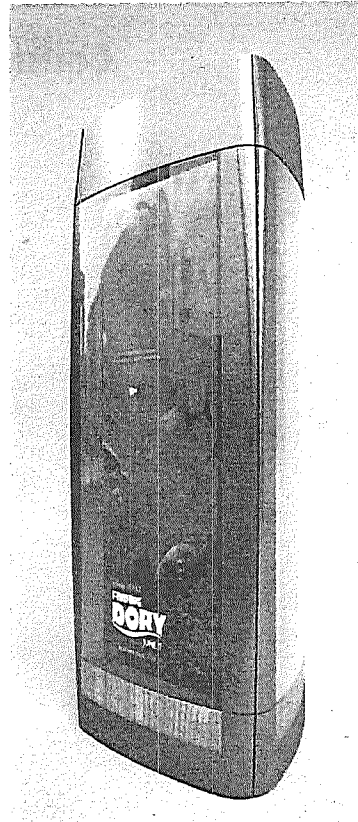

94 three-sided panel kiosks



15 interactive kiosks

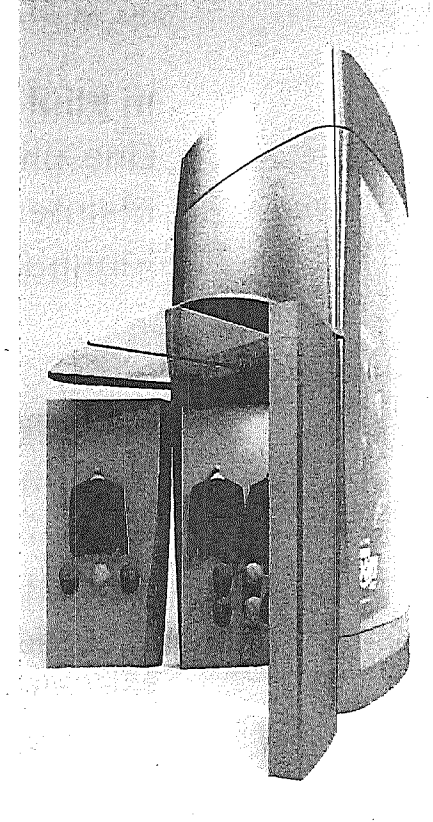

20 vending kiosks



Financial Benefits to the City

Contract Term (in millions)

In Kind Benefits

One-time capital investment	\$28.30
Maintenance services	\$63.71
Monitoring Services	<u>\$59.64</u>
Total In Kind	\$151.65

Cash Benefits

One-time payment	\$1.50
Administrative fee	\$7.91
Advertising gross revenue share - 50% share above \$16 million	\$3.55
Miscellaneous revenue share - 50% share	<u>\$0.52</u>
Total Cash	\$13.48

Grand Total **\$165.13**



Design Process

Goals

- Timeless
- Modern
- Ambitious

Competition

- 12 Local design firms
- Panel of experts
- Three finalists

Public Engagement

- Board of Supervisors
- Media outlets
- Online
- Main Library
- UN Plaza
- More than 200 responses

New Design

- Unanimously approved by Civic Design Review, Arts Commission and Historic Preservation Commission



New Design

Toilet- Option 01.A.1

Single Occupancy

Toilet- Option 01.A.1

Single Occupancy

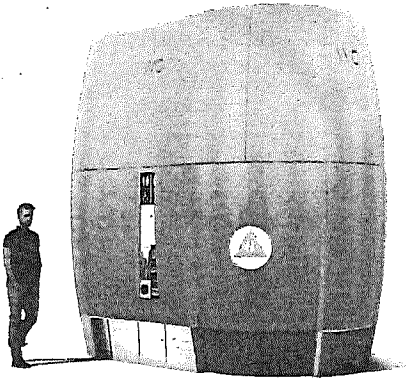

Perspective - From Sidewalk

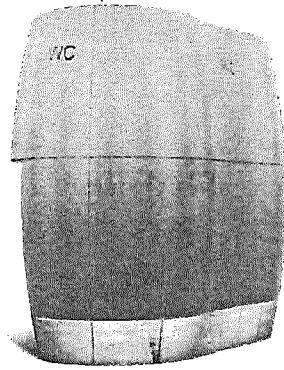

Perspective - From Street

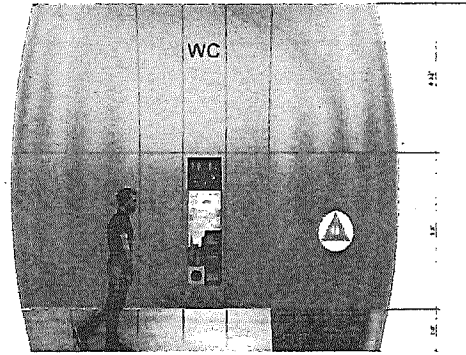

Elevation - From Sidewalk

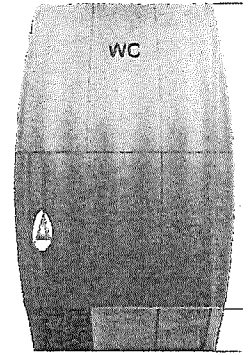

Elevation - Side

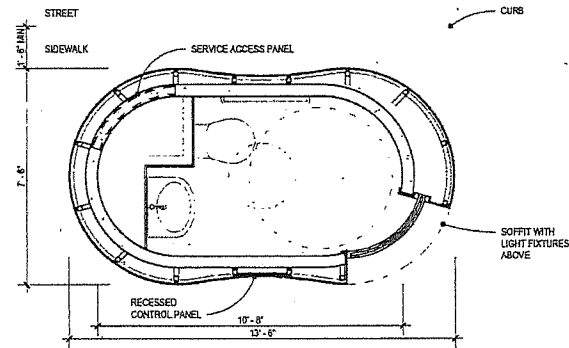

SMITHGROUP

3276

New Design

3277

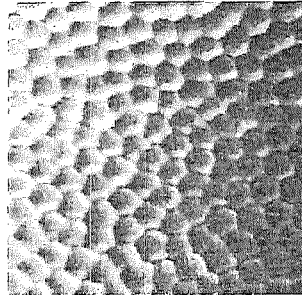
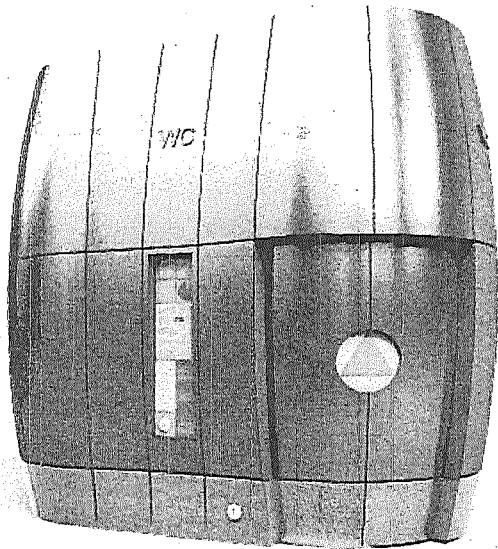

Textured
Stainless Steel



Perforated
Stainless Steel
(base of door)



Durable
Concrete base

Design Approach

Simplicity in its Kit of Parts

The furnishings are designed as a kit of parts for ease in buildability and maintenance. The toilet's unique sculptural shape displays a sense of complexity, yet, the kit of parts assembly is simple having been composed of repeated and rotated panels. The exterior shell consists of a durable concrete base and formed texture stainless steel panels for the walls and door. A fiberglass roof includes a skylight for daylight illumination inside.

Maintainability

State of the Art engineering to deliver ruggedized furniture for everyday useage. They are designed to keep the challenges of structures in an urban context. This includes climate, graffiti, and pedestrian activity.

Safety

Illumination of the toilet using LED lighting for enhanced perception of safety and ease of use. Lighting is located around door frame and in seam between concrete base and SS panels



SMITHGROUP

New Design

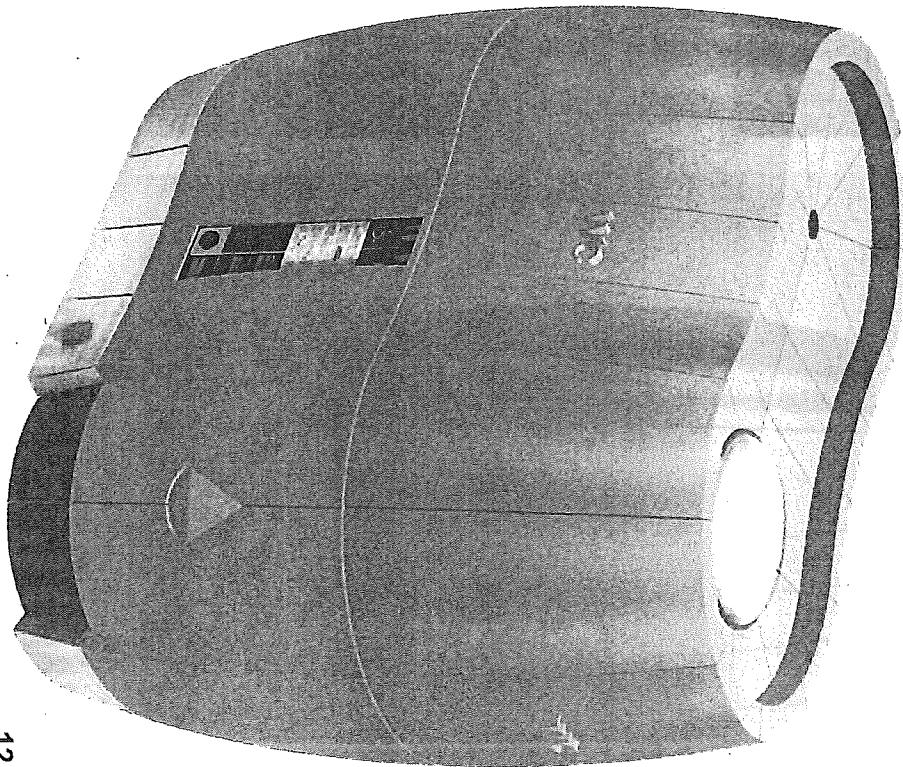
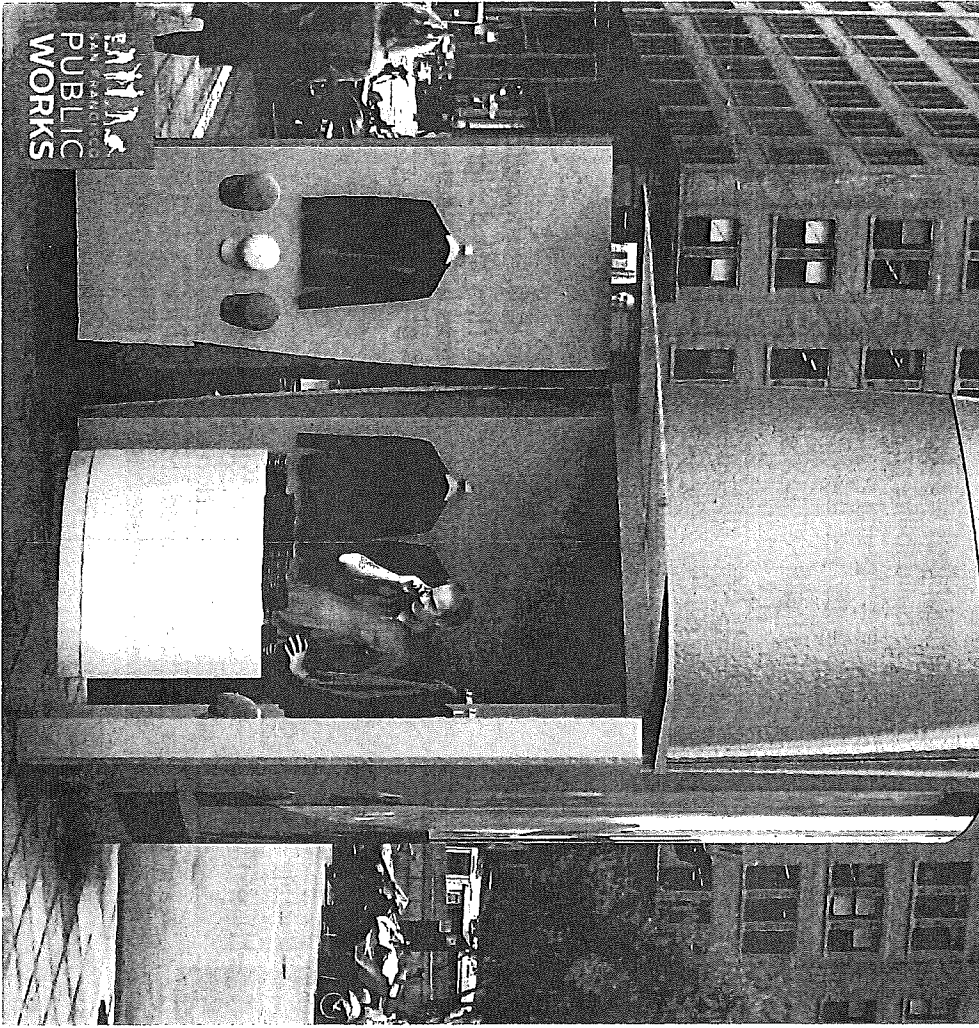

Questions?

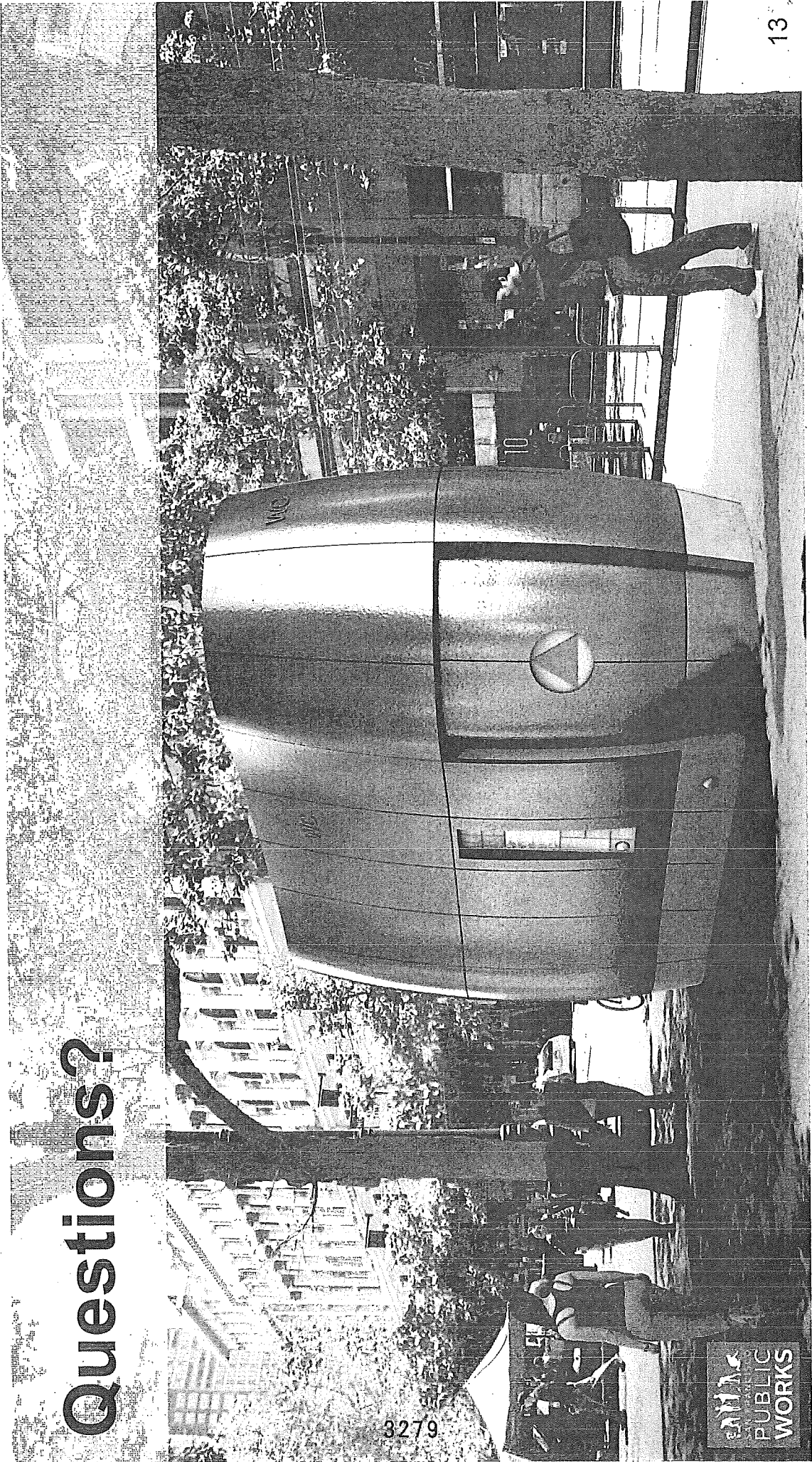

3279

Earth & Water
PUBLIC
WORKS

