

1 [2011 Airport Lease and Use Agreement - Air Pacific Limited dba Fiji Airways]

2
3 **Resolution approving the terms of 2011 Lease and Use Agreement No. 17-0184**
4 **between the City and County of San Francisco, acting by and through its Airport**
5 **Commission, and Air Pacific Limited dba Fiji Airways to conduct flight operations at**
6 **San Francisco International Airport, for the lease term to commence following Board**
7 **approval through June 30, 2021.**

8
9 WHEREAS, Air Pacific Limited dba Fiji Airways ("Fiji Airways") currently conducts flight
10 operations at San Francisco International Airport (the "Airport") pursuant to Airline Operating
11 and Space Permit No. 4504; and

12 WHEREAS, The City and County of San Francisco, acting by and through its Airport
13 Commission ("City"), has entered into a 2011 Lease and Use Agreement ("2011 Lease")
14 with 52 airlines effective July 1, 2011, for a term of ten years, to provide for the continuation
15 of flight operations and terminal rental by such airlines at the Airport; and

16 WHEREAS, Fiji Airways now desires to become a signatory to the 2011 Lease, which
17 grants it the right to conduct flight operations with City under the same terms and conditions
18 as other signatory airlines, except that the term will be approximately three years and seven
19 months to commence on the first day of the month following full approval by City; and

20 WHEREAS, Fiji Airways does not rent any exclusive space but will use the
21 International Terminal Joint Use Spaces and support facilities, as summarized on
22 Attachment A; and

23 WHEREAS, On July 25, 2017, the Airport Commission adopted Resolution
24 No. 17-0184 approving a 2011 Lease with Fiji Airways; and

1 WHEREAS, A copy of the 2011 Lease is on file with the Clerk of the Board of
2 Supervisors in File No. 171080, which is hereby declared to be a part of this resolution as if
3 set forth fully herein; now, therefore, be it

4 RESOLVED, That this Board of Supervisors approves 2011 Lease No. 17-0184 with
5 Air Pacific Limited dba Fiji Airways; and, be it

6 FURTHER RESOLVED, That this Board of Supervisors authorizes the Airport Director
7 to enter into non-material modifications to the Lease, including changes to the demised
8 premises of not to exceed ten percent (10%) of the lease square footage, that the
9 Commission, in consultation with the City Attorney, determines are in the best interest of the
10 Commission and necessary to effectuate the purposes of the 2011 Lease and are in
11 compliance with all applicable laws, including the City's Charter; and, be it

12 FURTHER RESOLVED, That within 30 days of the 2011 Lease being fully executed by
13 all parties, the Airport Commission shall provide a copy of the final 2011 Lease to the Clerk of
14 the Board for inclusion into the official file.

ATTACHMENT A

JOINT USE SPACE (in square feet)

| JOINT USE | CATEGORIES OF RENT | | | | | TOTAL |
|------------------------|---------------------------|-----------|------------|-----------|----------|----------------|
| | I | II | III | IV | V | |
| International Terminal | 133,794 | 214,307 | 12,025 | 265,400 | 1,888 | 627,414 |

LEASE AND USE AGREEMENT

SAN FRANCISCO INTERNATIONAL AIRPORT

by and between the
AIRPORT COMMISSION OF THE
CITY AND COUNTY OF SAN FRANCISCO

and

AIR PACIFIC LIMITED D/B/A FIJI AIRWAYS,
a Limited Liability Company Duly Registered Under the Laws of
the Republic of Fiji

Mayor Edwin M. Lee

AIRPORT COMMISSION
Hon. Larry Mazzola, President
Hon. Linda S. Crayton, Vice President
Hon. Eleanor Johns
Hon. Richard J. Guggenlime
Hon. Peter A. Stern

Ivar C. Satero
Airport Director

Lease No. 17-0184

| | |
|--|---|
| Items 9 and 10 Files 17-1080 and 17-1081 | Department: San Francisco International Airport (Airport) |
| EXECUTIVE SUMMARY | |
| Legislative Objectives | |
| <ul style="list-style-type: none"> The proposed resolutions approve the terms of San Francisco International Airport's (Airport) 2011 Lease and Use Agreement between the City, acting through the Airport Commission, and (i) Air Pacific Limited (Fiji Airways) (File 17-1080) and (ii) Air India Limited (Air India) (File 17-1081) to conduct flight operations at the Airport for a term of approximately four years and seven months through June 30, 2021. | |
| Key Points | |
| <ul style="list-style-type: none"> In 2011, the Airport negotiated a new Lease and Use Agreement (2011 Lease) with its domestic and international airlines. The 2011 Lease allows airlines to provide flight operations and rent terminal space at the Airport with a common set of provisions, including rent and landing fees, permitted uses, and use of common facilities. The 2011 Lease will expire June 30, 2021. Air India and Fiji Airways began conducting flight operations at the Airport under Operating and Use Permits executed in December 2015 and June 2016, respectively. Both airlines now wish to sign onto to 2011 Lease. International Terminal Joint Use Space rent is determined annually by formula, with 20 percent of total rent divided equally between all airlines, and 80 percent assessed proportionally based on the number of passengers traveling on each airline each year. Landing Fees are determined annually as part of the Airport Rates and Charges. The current fees for FY 17-18 are \$5.24 per 1,000 pounds for airlines that have signed the 2011 Lease, and \$6.55 per 1,000 pounds for airlines that have not. Fiji Airways and Air India would receive a 20 percent fee reduction after signing the lease. | |
| Fiscal Impact | |
| <ul style="list-style-type: none"> In FY 17-18, the Airport expects to receive approximately \$1,450,513 in Joint Use Space rent and \$234,000 in Landing Fees from Fiji Airways, and approximately \$1,869,766 in Joint Use Space rent and \$470,000 in Landing Fees from Air India. As there are many variables that affect the Joint Use Space rent and Landing Fees, it is difficult for the Airport to project revenues in future years. | |
| Recommendation | |
| <ul style="list-style-type: none"> Approve the proposed resolutions. | |

MANDATE STATEMENT

City Charter Section 9.118(a) states that contracts entered into by a department, board, or commission that (i) have anticipated revenues of \$1 million or more, or (ii) have anticipated revenues of \$1 million or more and require modifications, are subject to Board of Supervisors approval.

BACKGROUND

In 2011, the San Francisco International Airport (Airport) negotiated a new Lease and Use Agreement (2011 Lease) with its domestic and international airlines. The 2011 Lease allows airlines to provide flight operations and rent terminal space at the Airport and provides a common set of lease provisions that are used for these airlines. Such provisions include rent and landing fees paid by the airlines to the Airport, permitted uses of the premises, use of common facilities, and numerous other provisions. The 2011 Lease will expire on June 30, 2021.

Air India Limited (Air India) and Air Pacific Limited (Fiji Airways) commenced flight operations at the Airport under Operating and Space Permits executed in December 2015 and June 2016, respectively. Both airlines now wish to sign onto the 2011 Lease. By signing the 2011 Lease, the airlines will continue paying the same Shared Use Fees, but will receive a 20 percent discount on Landing Fees. The Airport Commission approved the 2011 Lease with Air India and Fiji Airways on July 25, 2017.

DETAILS OF PROPOSED LEGISLATION

The proposed resolutions would approve two leases of approximately three years and seven months, from December 1, 2017 through June 30, 2021 between the Airport as landlord and (i) Fiji Airways (File 17-1080) and (ii) Air India (File 17-1081) as tenants to conduct flight operations at the Airport. The key provisions of the 2011 Lease for the two airlines are summarized in Table 1 below.

Table 1: Key Provisions of 2011 Lease for Air India and Fiji Airways**Lease Terms – Air India and Fiji Airways**

| | |
|--|---|
| Term | Approximately three years and seven months, from the first day of the month following full City approval through June 30, 2021 |
| International Terminal Joint Use Space | 627,414 square feet |
| International Terminal Joint Use Space Rent | Determined annually by formula: 20% divided equally between all airlines, 80% assessed proportionally based on number of airline passengers |
| Landing Fees | Determined annually by Airport Rates and Charges; currently \$5.24 per 1,000 pounds for FY 17-18 |
| Deposit | Two months of Terminal Area Rentals, Landing Fees, usage fees per rates and charges |

FISCAL IMPACT

Under the 2011 Lease, Fiji Airways and Air India will rent Joint Use Space in the International Terminal. Joint Use Space rent is determined annually by a formula, with 20 percent of the total rent assessed equally to all airlines, and 80 percent assessed proportionally based on the number of inbound and outbound passengers traveling on each airline each year. The Joint Use Space Formula is used to determine rent for all airlines in service at the Airport, regardless of whether or not the airline has signed onto the 2011 Lease. According to Mr. Dan Ravina, Airport Senior Property Manager, in FY 2017-18 Fiji Airways is currently expected to pay approximately \$1,450,513 in Joint Use Space rent, and Air India is expected to pay approximately \$1,869,766. However, the charges will be recalculated in November 2017, as two other airlines are terminating their operations at the Airport.

In addition to Joint Use Space rent, airlines also pay Landing Fees to the Airport, which are set annually as part of the Airport Rates and Charges. The current Landing Fee for FY 2017-18 is \$5.24 per 1,000 pounds for airlines that have signed the 2011 Lease, and \$6.55 per 1,000 pounds for airlines that have not signed the 2011 Lease. By signing onto the 2011 Lease, Fiji Airways and Air India would receive an approximate 20 percent cost reduction on Landing Fees. According to Mr. Sean Murphy, Airport Senior Administrative Analyst, Fiji Airways is expected to pay approximately \$234,000 and Air India is expected to pay \$470,000¹ in Landing Fees in FY 17-18.

A summary of projected rent and fees paid by Fiji Airways and Air India is shown in Table 2 below. As there are many variables that affect these rates, it is difficult for the Airport to confidently project revenues in future years.

¹ Air India currently participates in the Air Carrier Incentive Program (ACIP), which waives landing fees for up to two years for carriers that provide service to new international destinations. Air India, which provides service to Delhi, India, is eligible to participate in ACIP through November 30, 2017.

Table 2: Anticipated Rent and Fees Paid by Fiji Airways and Air India in FY 17-18

| Airline | Joint Use Space Rent | Landing Fees | Total |
|-----------------------------|-----------------------------|---------------------|--------------------|
| Fiji Airways (File 17-1080) | \$1,450,513 | \$234,000 | \$1,684,513 |
| Air India (File 17-1081) | 1,869,766 | 470,000 | 2,339,766 |
| Total | \$3,320,279 | \$704,000 | \$4,024,279 |

RECOMMENDATION

Approve the proposed resolutions.

TABLE OF CONTENTS
LEASE AND USE AGREEMENT

RECITALS.....1

ARTICLE 1. DEFINITIONS1

Section 101 Definitions.....1

Section 102 Time Conventions..... 11

ARTICLE 2. PREMISES; USE11

Section 201 Lease of Demised Premises.....11

Section 202 Permitted Uses.....12

Section 203 Prohibited Uses, Exclusions and Reservations.....14

Section 204 Space Classifications.....16

Section 205 Rights of Way.....18

Section 206 Ingress and Egress.....18

Section 207 Accommodation of Other Air Carriers in Airline’s Exclusive Use Space.....19

Section 208 Environmental Sustainability Measures.....19

Section 209 Equipment, Maintenance and Operating Agreements.....20

Section 210 Relocation of Operations.....21

Section 211 [Reserved].....21

Section 212 Termination.....21

Section 213 Recapture of Exclusive Use Space Following Involuntary Reduction in Number of Preferential Use Gates.....22

Section 214 Recapture of Exclusive Use Space Following Rejection of Preferential Use Gates by Airline.....22

Section 215 Airline-Owned Equipment in Demised Premises.....23

Section 216 Affiliate Airlines.....24

ARTICLE 3. ASSIGNMENT AND USE OF COMMON USE FACILITIES AND PREFERENTIAL USE GATES.....24

Section 301 No Exclusive Use Gates.....24

Section 302 Resource Management Advisory Committee.....24

Section 303 Annual Determination by the City of the Total Number of Common Use Gates.....25

Section 304 Annual Determination of the Number and Locations of Preferential Use Gates to be offered to the Signatory Airlines.....25

Section 305 City Scheduling Rights at Preferential Use Gates.....27

Section 306 Charges for Use of Preferential Use Gate by Another Air Carrier.....28

Section 307 Gate Accommodation Conditions.....28

Section 308 City’s Control of Common Use Gates, Ticket Counters and Support Facilities.....28

| | | |
|-------------------|---|-----------|
| Section 309 | <i>Initial Determination by City of Common Use Ticket Counters and Support Facilities</i> | 28 |
| Section 310 | <i>Charges for Common Use Gates, Ticket Counters and Support Facilities</i> | 28 |
| Section 311 | <i>Shared Use Equipment</i> | 28 |
| Section 312 | <i>Self-Service Devices</i> | 29 |
| ARTICLE 4. | RENTALS AND FEES | 29 |
| Section 401 | <i>Reports and Payments</i> | 29 |
| Section 402 | <i>Rent and Usage Fees</i> | 30 |
| Section 403 | <i>Landing Fees</i> | 31 |
| Section 404 | <i>Payment for Utilities</i> | 31 |
| Section 405 | <i>Other Fees</i> | 32 |
| Section 406 | <i>Payment Details</i> | 33 |
| Section 407 | <i>Prepayment of Terminal Area Rentals/Landing Fees</i> | 33 |
| Section 408 | <i>Accounting</i> | 33 |
| ARTICLE 5. | ADJUSTMENT OF AIRLINE RATES AND CHARGES | 33 |
| Section 501 | <i>Periodic Review</i> | 33 |
| Section 502 | <i>Method of Adjusting Terminal Area Rentals</i> | 33 |
| Section 503 | <i>Method of Adjusting Landing Fees</i> | 36 |
| Section 504 | <i>Review of Adjusted Rentals and Fees</i> | 37 |
| Section 505 | <i>Reconciliation of Airline Rates and Charges and Application of Prior Period Deficits (Surpluses)</i> | 38 |
| ARTICLE 6. | CAPITAL IMPROVEMENTS | 38 |
| Section 601 | <i>Financing of Capital Improvements</i> | 38 |
| Section 602 | <i>Review of Capital Improvements</i> | 39 |
| Section 603 | <i>Development of West of Bayshore Area</i> | 40 |
| ARTICLE 7. | MISCELLANEOUS COVENANTS OF CITY | 41 |
| Section 701 | <i>Prudent Operation</i> | 41 |
| Section 702 | <i>Revenues From Non-Airline Sources</i> | 41 |
| Section 703 | <i>Airfield Area Users</i> | 41 |
| ARTICLE 8. | PIPELINES AND UTILITIES | 41 |
| Section 801 | <i>Reservations by City</i> | 41 |
| Section 802 | <i>Relocation of Pipelines</i> | 41 |
| Section 803 | <i>Information and Communications Technology; Utilities</i> | 42 |
| ARTICLE 9. | DEVELOPMENT, MAINTENANCE, AND OPERATION OF AIRPORT | 42 |
| Section 901 | <i>Operation of Airport</i> | 42 |
| Section 902 | <i>Condition of Demised Premises and Janitorial Services</i> | 42 |

| | | |
|--------------------|---|-----------|
| Section 903 | <i>Airline Improvements</i> | 43 |
| Section 904 | <i>Maintenance and Repair; Operator Training</i> | 44 |
| Section 905 | <i>Inspections; Audit of Operations</i> | 45 |
| Section 906 | <i>Trespass and Security</i> | 45 |
| Section 907 | <i>Compliance with Code Requirements</i> | 46 |
| Section 908 | <i>Trash Removal</i> | 46 |
| Section 909 | <i>Taxes</i> | 46 |
| Section 910 | <i>Other Liens</i> | 46 |
| Section 911 | <i>Damage and Destruction</i> | 47 |
| Section 912 | <i>Condemnation/Eminent Domain</i> | 49 |
| ARTICLE 10. | RULES AND REGULATIONS | 49 |
| Section 1001 | <i>Rules and Regulations</i> | 49 |
| ARTICLE 11. | NO OTHER CHARGES, QUIET ENJOYMENT | 50 |
| Section 1101 | <i>No Other Charges</i> | 50 |
| Section 1102 | <i>Quiet Enjoyment</i> | 50 |
| ARTICLE 12. | LIMITED OBLIGATIONS, INDEMNITY, WAIVER AND INSURANCE | 50 |
| Section 1201 | <i>Limited Obligations of City</i> | 50 |
| Section 1202 | <i>Indemnity, Waiver</i> | 50 |
| Section 1203 | <i>Public Liability and Property Damage Insurance</i> | 52 |
| ARTICLE 13. | SECURITY DEPOSIT | 54 |
| Section 1301 | <i>Security for Faithful Performance</i> | 54 |
| Section 1302 | <i>Deposit/Faithful Performance Bond</i> | 55 |
| ARTICLE 14. | ASSIGNMENT AND SUBLETTING | 56 |
| Section 1401 | <i>No Transfer</i> | 56 |
| Section 1402 | <i>Changes in Airline</i> | 56 |
| Section 1403 | <i>No Release</i> | 57 |
| ARTICLE 15. | TERMINATION OR SUSPENSION OF LEASE PROVISIONS | 57 |
| Section 1501 | <i>Airline Events of Defaults and City Remedies</i> | 57 |
| Section 1502 | <i>Remedies</i> | 58 |
| Section 1503 | <i>City's Right to Perform</i> | 60 |
| Section 1504 | <i>Rights Related to Termination</i> | 60 |
| Section 1505 | <i>Cumulative Rights</i> | 60 |
| Section 1506 | <i>Prepayment</i> | 60 |
| Section 1507 | <i>Fines</i> | 61 |
| Section 1508 | <i>[Reserved]</i> | 61 |

| | | |
|--------------------|---|-----------|
| Section 1509 | <i>Waiver of Notice</i> | 61 |
| Section 1510 | <i>Annual Service Payments and City's Right to Suspend Part of Agreement</i> | 61 |
| Section 1511 | <i>Airline's Right to Terminate</i> | 64 |
| ARTICLE 16. | SURRENDER OF POSSESSION OF DEMISED PREMISES | 65 |
| Section 1601 | <i>Surrender</i> | 65 |
| ARTICLE 17. | HOLDING OVER | 65 |
| Section 1701 | <i>Month to Month</i> | 65 |
| ARTICLE 18. | CITY CONTRACTING PROVISIONS | 66 |
| Section 1801 | <i>Nondiscrimination Ordinance</i> | 66 |
| Section 1802 | <i>Conflict of Interest</i> | 67 |
| Section 1803 | <i>Tropical Hardwoods and Virgin Redwoods</i> | 67 |
| Section 1804 | <i>Drug-Free Workplace Policy</i> | 67 |
| Section 1805 | <i>Compliance with Americans with Disabilities Act and Air Carrier Access Act</i> | 67 |
| Section 1806 | <i>Pesticide Prohibition</i> | 68 |
| Section 1807 | <i>MacBride Principles - Northern Ireland</i> | 68 |
| Section 1808 | <i>No Advertising or Promotions; Prohibition of Tobacco Advertising</i> | 68 |
| Section 1809 | <i>First Source Hiring Ordinance</i> | 68 |
| Section 1810 | <i>[Reserved]</i> | 69 |
| Section 1811 | <i>Sunshine Ordinance</i> | 69 |
| Section 1812 | <i>Charter Provisions</i> | 69 |
| Section 1813 | <i>Requiring Health Benefits for Covered Employees</i> | 69 |
| Section 1814 | <i>Requiring Minimum Compensation for Covered Employees</i> | 71 |
| Section 1815 | <i>Notification of Limitations on Contributions</i> | 72 |
| Section 1816 | <i>Compliance with Laws</i> | 72 |
| Section 1817 | <i>Airport Intellectual Property</i> | 72 |
| Section 1818 | <i>Food Service Waste Reduction</i> | 72 |
| Section 1819 | <i>Labor Disputes</i> | 73 |
| Section 1820 | <i>Preservative-Treated Wood Containing Arsenic</i> | 73 |
| ARTICLE 19. | MISCELLANEOUS PROVISIONS | 73 |
| Section 1901 | <i>No Individual Liability</i> | 73 |
| Section 1902 | <i>Agreements With Governments</i> | 73 |
| Section 1903 | <i>Governing Law</i> | 74 |
| Section 1904 | <i>Notices</i> | 74 |
| Section 1905 | <i>No Implied Waiver</i> | 74 |
| Section 1906 | <i>Federal Grant Agreement Covenants</i> | 74 |

| | |
|--|-----------|
| <i>Section 1907 Contracting on More Favorable Terms</i> | 77 |
| <i>Section 1908 Force Majeure</i> | 77 |
| <i>Section 1909 Invalid Provisions and Severability</i> | 77 |
| <i>Section 1910 Headings</i> | 78 |
| <i>Section 1911 Exclusiveness of Airline's Rights</i> | 78 |
| <i>Section 1912 Withholding Required Approvals</i> | 78 |
| <i>Section 1913 Majority-in-Interest Decisions</i> | 78 |
| <i>Section 1914 Declaration Regarding Airport Private Roads</i> | 78 |
| <i>Section 1915 Subordination of Agreement</i> | 78 |
| <i>Section 1916 Inspection of Records</i> | 79 |
| <i>Section 1917 Successors and Assigns</i> | 79 |
| <i>Section 1918 Taxes, Assessments and Liens</i> | 79 |
| <i>Section 1919 Appendices, Exhibits and Schedules</i> | 80 |
| <i>Section 1920 Entire Agreement</i> | 80 |
| <i>Section 1921 Approvals</i> | 80 |
| <i>Section 1922 Amendments</i> | 80 |
| <i>Section 1923 Interpretation of Agreement</i> | 81 |
| <i>Section 1924 Duty Free Merchandise and International Travel Merchandise</i> | 81 |
| <i>Section 1925 No Third-Party Beneficiaries</i> | 82 |
| <i>Section 1926 No Joint Venture</i> | 82 |
| <i>Section 1927 Nature of Agreement</i> | 82 |
| <i>Section 1928 Required Approvals</i> | 82 |
| <i>Section 1929 Airline Operations Information and Planning</i> | 83 |
| <i>Section 1930 Waiver of Visual Artists Rights</i> | 83 |
| <i>Section 1931 Airport Functions</i> | 83 |
| ARTICLE 20. HAZARDOUS MATERIALS | 84 |
| <i>Section 2001 Definitions</i> | 84 |
| <i>Section 2002 Airline's Covenants</i> | 85 |
| <i>Section 2003 Access for Environmental Inspection</i> | 86 |
| <i>Section 2004 Liability</i> | 86 |
| <i>Section 2005 Environmental Indemnity</i> | 86 |
| <i>Section 2006 Environmental Audit</i> | 86 |
| <i>Section 2007 Notice by Airline</i> | 86 |
| <i>Section 2008 Stormwater</i> | 87 |
| <i>Section 2009 Airline Obligations Upon Termination</i> | 88 |
| <i>Section 2010 Cumulative Remedies</i> | 88 |

Section 2011 Prior Agreements 88
Signature Page 90

LEASE AND USE AGREEMENT

SUMMARY OF MAJOR TERMS

For the convenience of Airline and City (as such terms are defined below), this Summary of Major Terms (the "Summary") summarizes certain terms of this Agreement (as defined below). The Summary is not intended to be a detailed or complete description of this Agreement and reference must be made to the Sections below for the particulars of this Agreement. In the event of any inconsistency between the terms of the Summary and any other provision of this Agreement, such other provision shall prevail. Capitalized terms used elsewhere in this Agreement and not defined elsewhere shall have the meanings given them in the Summary.

| | |
|---|--|
| Reference Date: | _____ |
| Airline: | Air Pacific Limited d/b/a/ Fiji Airways, a limited liability company duly registered under the laws of the Republic of Fiji and having its registered office at The Hangar, Maintenance and Administration Office, Nasoso Road, Nadi, Fiji |
| Lease No. | <u>17-0184</u> |
| Airline's Notice Address: (§§ 101, 1904) | 5777 W. Century Blvd., #1610 Los Angeles, CA 90045 U.S.A. Attention: Ms. Kim Royal Title: Manager Ground Operations – N. America Phone: (310) 628-7005 Email: Kim.Royal@fijiairways.com |
| Airline's Property Manager Address: (§ 1202(K)) | The Hangar Maintenance and Administration Office Nasoso Road Nadi, Fiji Attention: Mr. Vishal Chandra Phone: (679) 673-7425 Fax: (679) 672-0512 Email: Vishal.Chandra@fijiairways.com |
| City: | The City and County of San Francisco, a municipal corporation, acting by and through its Airport Commission. |

| | |
|--|---|
| City's Notice Address: (§§ 101, 1904) | San Francisco International Airport Administrative Offices P.O. Box 8097 San Francisco, CA 94128 Attention: Airport Director Phone: (650) 821-5000 Fax: (650) 821-5005 |
| Demised Premises: (§ 201) Exclusive Use Space: Joint Use Space: Preferential Use Space: | Not Applicable. Approximately 627,414 square feet of Joint Use Space in the International Terminal, including: Category I: 133,794 square feet Category II: 214,307 square feet Category III: 12,025 square feet Category IV: 265,400 square feet Category V: 1,888 square feet All as more particularly described in Exhibit D hereto. Initially as described in Exhibit D hereto, as reallocated annually in accordance with Article 3. |
| Term: | Approximately three (3) years and eleven (11) months, commencing on the Effective Date and continuing through the Expiration Date. |
| Effective Date: | _____ |
| Expiration Date: (§ 211) | June 30, 2021, unless terminated earlier as provided herein. |
| Deposit Amount: (§ 1301) | Two (2) months of Terminal Area Rentals, Landing Fees, usage fees, per rates and charges. |
| Commission Resolution: (§ 101) | Number <u>17-0184</u> , approved by the Airport Commission on <u>July 25, 2017</u> . |
| Board Resolution: (§ 101) | Number _____, approved by the City's Board of Supervisors on _____ and signed by the Mayor on _____. |

LEASE AND USE AGREEMENT

THIS LEASE AND USE AGREEMENT (the "Agreement") is made and entered into as of the Reference Date by and between the CITY AND COUNTY OF SAN FRANCISCO (the "City"), a municipal corporation acting by and through its AIRPORT COMMISSION (the "Commission"), and the AIRLINE identified in the foregoing Summary.

RECITALS

A. The City, acting by and through its Commission, owns and operates the San Francisco International Airport, which is located in the County of San Mateo, State of California.

B. Under the City Charter, Commission is charged with the management, supervision, operation, use, maintenance, extension, construction, and control of the Airport and is authorized to enter into all contracts, leases, permits, and agreements relating to matters within its jurisdiction and properties.

C. Airline desires to enter into this Agreement in order to operate at the Airport, and to lease and use certain space in one or more Terminals.

D. Pursuant to the Commission resolution identified in the Summary, Commission has determined that entering into this Agreement is in the best interest of City and has authorized the execution of this Agreement. Pursuant to the Board resolution identified in the Summary, the Board and the Mayor, each acting in their sole and absolute discretion, have determined that entering into this Agreement is in the best interest of City and have authorized the execution of this Agreement.

NOW THEREFORE, in consideration of the foregoing and of the mutual covenants set forth herein, and other good and valuable consideration, receipt of which is hereby acknowledged, the parties do mutually agree as follows:

ARTICLE 1. DEFINITIONS

Section 101 Definitions. The following words, terms, and phrases, wherever used in this Agreement, including this Section, shall for the purpose of this Agreement have the meanings respectively ascribed to them in this Section.

"ACAA" means the Air Carrier Access Act, 49 U.S.C. Section 41705, as amended and supplemented.

"Activity Report" means a monthly air traffic activity report submitted in accordance with Section 401(C) in substantially the form attached hereto as Exhibit P, as modified from time to time.

"ADA" means, collectively, the Americans with Disabilities Act, 42 U.S.C. Sections 12101 et seq. and Title 24 of the California Code of Regulations, as amended and supplemented.

“Affiliate Airline” means a non-Signatory Airline that is operating at the Airport under an Operating Permit with City and either (i) is a wholly owned subsidiary of a Signatory Airline, (ii) is a subsidiary of the same corporate parent of the Signatory Airline or (iii) shares flight codes with a Signatory Airline at the Airport, or (iv) operates cargo feeder flights at the Airport under the direction and control of a Signatory Airline. Further, notwithstanding that a non-Signatory Airline may satisfy any of the criteria above, if such non-Signatory Airline is able to sell its own seats for flights at the Airport, it shall not be classified as an Affiliate Airline of any Signatory Airline.

“Agreement” means this Lease and Use Agreement.

“Air Carrier” means a legal entity certified by the Secretary of Transportation and engaged in the business of scheduled or non-scheduled commercial transportation by air of persons, property, mail, parcels and/or cargo.

“Airfield Area” means the Cost Center that includes all runways, taxiways, ramps, aprons, landing areas, adjacent infield areas, and related support facilities (e.g., perimeter dike, drainage pumping stations, field lighting, navigational aides, ARFF support facilities, fire and rescue watercraft, boathouses and related support facilities, and cart roads).

“Airfield Area Net Expense” has the meaning given such term in Section 503(A).

“Airline” means the Air Carrier that is a party to this Agreement.

“Airline Entity” means Airline’s officers, contractors, employees, agents, representatives, licensees and/or invitees, and their successors and assigns; provided, however, that Airline Entity shall not include passengers.

“Airline Leased Space” means the Joint Use Space, Exclusive Use Space, and Preferential Use Space in the Terminal Area leased to any Signatory Airline.

“Airline’s Notice Address” means the address set forth in the Summary, or such other address as Airline may designate in writing to City.

“Airline Rates and Charges” means all Landing Fees and Terminal Area Rentals, inclusive of rentals for Exclusive Use, Joint Use, and Preferential Use Space, paid by Signatory Airlines and Affiliate Airlines.

“Airline Representative” means a representative of Airline who is authorized to act on behalf of Airline, as specified in writing by Airline to City. The initial Airline Representative is identified in the Summary.

“Airport” means the San Francisco International Airport.

“Airport Cost Accounting System” means the system for collection, allocation, and reporting of revenues, expenses and debt service associated with the operation of the Airport in such a manner that will ensure the availability of proper data to support the calculation of Airline

Rates and Charges required under this Agreement. The Airport Cost Accounting System for reporting revenues, expenses and debt service utilized by City will preserve the basic Cost Centers and shall be in accord with Exhibit O which is incorporated herein by this reference.

“Airport Revenue Bonds” means taxable and tax-exempt obligations authorized and issued, or to be issued, by City or for the benefit of Airport, including bonds, refunding bonds, notes, bond anticipation notes, commercial paper, lease or installment purchase agreements or certificates of participation therein, and other evidences of indebtedness, irrespective of priority of payment, the principal of, premium, if any, and interest on which are payable directly or indirectly from or secured in whole or substantial part by Revenues. Airport Revenue Bonds do not include Special Revenue Bonds.

“Airport Rules” means the reasonable and not unjustly discriminatory rules and regulations as are now or may hereinafter be prescribed by City as provided in Section 1001.

“Airport Support Area” means the Cost Center that includes all areas and facilities which support airline functions (e.g., hangars, aircraft maintenance facilities, cargo facilities, fuel farms, flight kitchens), Airport support, and City/State/federal installations, fixed base operators, airline offices outside the Terminal Area, airline employee parking, Airport-maintained employee parking, Airport support facilities with related parking, sewage/waste treatment plants, detention ponds, Coast Guard, FAA, FBI, Post Office and other related facilities, and all unleased land not included in another Cost Center.

“Airport TI Guide” means the Airport’s Airline Tenant Improvement Guide, as amended from time to time.

“Alterations” means the improvements installed by Airline at its expense in accordance with Section 903, including fixtures, furnishings, carpeting, decorations, finishings, equipment and all other improvements which Airline deems necessary for the use of the Demised Premises and which are not supplied by City.

“Annual Service Payment” means a payment to City’s General Fund in accordance with Sections 502(B) and 1510, or the equivalent amount determined in accordance with Section 1510(C) and (E).

“AO&M Expense” has the meaning given such term in Exhibit O.

“Basic Rate” has the meaning given such term in Exhibit O.

“Basic Rental Adjustment” has the meaning given such term in Section 502(C)(v).

“Billing and Operational Information” means any information that may be requested by City for the purposes of providing timely and accurate billing to Airline and improving Airport operations.

“Board” means City’s Board of Supervisors.

“Capital Improvement” means a single Airport addition or improvement, including equipment, which is purchased, leased or constructed at a cost of the Charge Trigger Amount or more, and has a useful life in excess of three (3) years.

“Charge Trigger Amount” means \$626,257 in Fiscal Year 2008/2009 dollars, as adjusted by the Index.

“City” means the City and County of San Francisco, a municipal corporation, acting by and through the Commission.

“City Entity” means City, Commission, its members, or any officers, agents, and employees of each of them, and their successors and assigns.

“City Charter” means that certain document, as amended from time to time, that grants City the legal authority to make and enforce all ordinances and regulations in respect to municipal affairs, subject only to the restrictions and limitations provided in that document.

“City’s Notice Address” means the address set forth in the Summary, or such other address as may be designated by City from time to time.

“Code Requirements” means, collectively, all fire sprinklers, seismic retrofit, and other building code requirements.

“Commission” means the Airport Commission of the City.

“Common Use” means the use of facilities or equipment made available by the City for use in common by one or more Air Carriers, each for a limited, designated period subject to payment of the applicable fees for such use.

“Common Use Gates” means the Gates as designated, both in number and location, from time to time by the Director in accordance with Article 3.

“Common Use Support Facilities” means the Support Facilities in the Terminals associated with the Common Use Gates or Common Use Ticket Counters as such Support Facilities are designated, both in number and location, from time to time by the Director in accordance with Article 3.

“Common Use Ticket Counters” means the ticket counters as designated, both in number and location, from time to time by the Director in accordance with Article 3.

“Concession Revenues” means (1) the fees and rentals collected by Commission acting on behalf of City for the right to provide and operate restaurants, bars, newsstands, gift shops, specialty shops, advertising displays, insurance, public telephones and other merchandising concessions and consumer services in the Terminal Area; (2) the fees and rentals collected by Commission acting on behalf of City for the right to provide and operate courtesy vehicles, ground transportation services, car rental services, hotels, service stations and other concessions and services in the Groundside Area; and (3) the fees and rentals collected by Commission acting

on behalf of City for other activities and services in the Groundside Area such as public automobile parking and traffic fines.

“Contingency Account” means the account of that name established pursuant to the Master Bond Documents, funded with Revenues and other City moneys, the balance in which serves to satisfy a portion of the debt service coverage requirements under the Master Bond Documents.

“Cost Centers” means the functional areas of the Airport used to indicate the general geographic location of facilities and in accounting for revenues, expenses and debt service, consisting of the “Airfield Area,” “Airport Support Area,” “Terminal Area,” “Groundside Area,” “Utilities Area,” and “West of Bayshore Area,” as further described in the definition of each Cost Center and illustrated in Exhibit O.

“Demised Premises” means the space leased by City to Airline on an Exclusive Use, Preferential Use, or Joint Use basis, all as more particularly described in the Summary and Exhibit D.

“Deposit” means Airline’s security deposit delivered in accordance with Article 13.

“Deposit Amount” means two (2) months of Terminal Area Rentals, Landing Fees, usage fees, rates and charges, in the amount set forth in the Summary as required under Article 13.

“Director” means the Airport Director, the Chief Executive Officer of the Airport.

“DT” or **“Domestic Terminals”** means Domestic Terminals T1, T2 and T3.

“DT Gate Management Protocols” means the protocols set forth in Exhibit J, as the same may be amended from time to time.

“DT Ticket Counter Management Protocols” means the protocols set forth in Exhibit I, as the same may be amended from time to time.

“Effective Date” means the date on which this Agreement becomes effective, namely, the later of July 1, 2011 or the date on which the following conditions have been satisfied: (a) each party shall have executed two duplicate originals of this Agreement and provided the other party with a fully-executed original of the same; (b) the Commission, the Board and the Mayor, each acting in their sole and absolute discretion, shall have approved this Agreement and Airline shall have received evidence of the same; (c) Airline shall have obtained all necessary and appropriate corporate authorizations of this Agreement, and City shall have received evidence of the same; and (d) Airline shall have delivered the Deposit in accordance with Article 13. The actual Effective Date is set forth in the Summary.

“Environmental Laws” has the meaning given such term in Section 2001.

“Event of Default” means each event listed in Section 1501.

“Exclusive Use Space” means space in a Terminal leased or permitted to a single Air Carrier for its exclusive use.

“Expiration Date” means June 30, 2021, unless terminated earlier as provided herein.

“FAA” means the Federal Aviation Administration or any successor agency.

“Fiscal Year” means the twelve (12) month period commencing on July 1 and expiring on June 30 of each year.

“Gate” means those portions of a Terminal individually comprised of a passenger holdroom, together with any or all of the following equipment if owned by City: a passenger loading bridge, a 400 MHz power unit, a pre-conditioned air unit, and related equipment. The related ramp (apron) is not included in the Gate, but is retained by City and used by the Air Carrier using the related Gate.

“Gate Management Protocols” means, with respect to the IT, the IT Gate Management Protocols, and with respect to the DT, the DT Gate Management Protocols.

“Groundside Area” means the Cost Center that includes all roadways and parkways, courtyards, fences, walks, bridges and culverts, public parking lots, garages, hotels, service stations, shuttle bus service (non-airline), consolidated rental car facility, AirTrain system including pedestrian bridges to Terminals, leased commercial unimproved areas, paved areas, buildings and structures other than Terminals and Airport/government installations.

“Gross Terminal Space” means every square foot of interior space in the Terminal Area.

“Hazardous Materials” has the meaning given such term in Section 2001(B).

“Information and Communications Technology” means the information and communications technology (ICT) utilities, devices and displays provided by the Airport under Section 803 including, but not limited to, telephone, guided wire, wireless radio communications (both cellular and Wi-Fi), satellite communications including television, and over-the-air commercial high-definition television (HDTV).

“Index” means the Implicit Price Deflator Index for Gross Domestic Product published by the U.S. Department of Commerce, Bureau of Economic Analysis, or its successor or replacement. The specific dollar cost figures throughout this Agreement are based upon Fiscal Year 2008/2009 dollars and shall be increased or decreased annually in proportion to changes in the Index using as a base the figure for the second quarter of 2008 (ending in June), which was 121.890 (index numbers, 2005=100; seasonally adjusted; and last updated on October 30, 2008.)

“Integrated Pest Management” or **“IPM”** has the meaning given such term in Section 1806(A).

"IT" or **"International Terminal"** means the portion of the Terminal Area, together with its connecting concourses, piers, boarding areas including extensions thereof, and satellite buildings, known individually as the International Terminal.

"IT Domestic Turn Fee" means the fee collected for use of Gates in the IT by domestic Air Carriers, as provided in Section 405.

"IT Gate Management Protocols" means the protocols set forth in Exhibit H, as the same may be amended from time to time.

"IT Ticket Counter Management Protocols" means the IT Ticket Counter and Other Joint Use Resources Management Protocols set forth in Exhibit G, as the same may be amended from time to time.

"Joint Use Formula" means the billing method applied to a specific area of Joint Use Space. The Joint Use Formula(s) applicable to Airline, if any, are attached as Exhibit E.

"Joint Use Space" means space in a Terminal that is leased or permitted for use by more than one Air Carrier with payments by the Air Carriers utilizing such space calculated using the Joint Use Formula applicable to such space.

"Joint Use Gate" means a Gate that is leased or permitted for use by more than one Air Carrier in accordance with the terms of Section 204(A)(iv), with charges to the Air Carriers utilizing such Gate calculated using the applicable Joint Use Formula.

"Landing Fee Rate" means the cents per thousand pounds of Maximum Landing Weight computed as provided in this Agreement, including Articles 4 and 5.

"Landing Fees" means the fees payable by the Signatory Airlines and their Affiliate Airlines as provided in this Agreement, including Articles 4 and 5.

"Lease and Use Agreement" means a Lease and Use Agreement substantially identical to this Agreement which is executed by a Signatory Airline.

"Majority-in-Interest" means more than fifty percent (50%) in number of the Signatory Airlines who, on the date in question, account for more than fifty percent (50%) of the aggregate weight for Revenue Aircraft Arrivals by the Signatory Airlines (including their respective Affiliate Airlines) at the Airport during the immediately preceding Fiscal Year.

"Master Bond Documents" means each resolution, ordinance, trust indenture or other document authorizing the issuance of Airport Revenue Bonds and prescribing the covenants and conditions attendant upon such issuance, including (a) Resolution No. 91-0210 adopted by the Commission on December 3, 1991, and (b) Resolution No. 97-0146 adopted by the Commission on May 20, 1997, each as amended and supplemented from time to time, or such successor resolutions not inconsistent with the provisions of this Agreement.

“Maximum Landing Weight” means the maximum weight in thousand pound units that an aircraft is authorized by the FAA to land at the Airport, as recited in the flight manual governing such aircraft.

“Non-Airline Revenues” means revenues of the Commission from sources other than Airline Rates and Charges, as illustrated in Exhibit O.

“Operating Permit” means a thirty-day (30) revocable permit issued by City to an Air Carrier who is not a party to a Lease and Use Agreement, to use, together with others so authorized, the runways, taxiways, navigational aids, and other general use landing air facilities, for its aircraft landing and takeoffs required in connection with its operations to and from the Airport.

“Passenger Facility Charge” or **“PFC”** means the fees authorized by 49 U.S.C. Section 40117 and regulated by 14 CFR Part 158 as such statute and regulations currently exist or as they may be amended during the Term of this Agreement.

“Period of Use” means (a) with respect to the use by a Signatory Airline (or its Affiliate Airline) of its Preferential Use Gate, the period of time with respect to a Scheduled Operation that such Signatory Airline is to use such Gate for a scheduled arrival and/or departure pursuant to the applicable Gate Management Protocols, (b) with respect to an Air Carrier’s use of a Gate that is not its Preferential Use Gate, the period of time that such Air Carrier is authorized to use such Gate for an aircraft arrival and/or departure pursuant to the applicable Gate Management Protocols, and (c) with respect to ticket counters and/or Support Facilities, the period of time that an Air Carrier is authorized to use such ticket counters and/or Support Facilities pursuant to the applicable Ticket Counter Management Protocols.

“Pesticide Ordinance” has the meaning given such term in Section 1806(A).

“Pre-Existing Condition” has the meaning given such term in Section 2001(D).

“Preferential Use” means with respect to a Gate, the scheduling preference over similar operations by another Air Carrier given to a Signatory Airline for the use of a Gate during applicable Periods of Use for such Signatory Airline’s Scheduled Operations.

“Preferential Use Gate” means a Gate assigned to a Signatory Airline for its Preferential Use in accordance with Article 3.

“Preferential Use Space” means the Terminal Area space leased by City to a Signatory Airline on a Preferential Use basis as provided in Article 3, and with respect to the Demised Premises leased to Airline, as described in Exhibit D.

“Public Space” means all Terminal Area space other than Airline Leased Space, including without limitation the space comprising Common Use facilities.

“Release” has the meaning given such term in Section 2001(C).

“Rental Surcharge” has the meaning given such term in Section 502(C)(iv).

“Requesting Airline” means an Air Carrier without adequate Gate access desirous of operating at the Airport.

“Revenue Aircraft Arrival” means each aircraft arrival at the Airport for which the applicable Air Carrier has received or made a monetary fee or charge, including flights which are diverted to the Airport because of mechanical, meteorological or other precautionary reasons; provided, however, that flights departing from the Airport and required to return to the Airport for such reasons shall not be considered Revenue Aircraft Arrivals.

“Revenues” has the meaning given such term in the Master Bond Documents.

“RMAC” means the Resource Management Advisory Committee established under Section 302.

“Scheduled Operation” means an Air Carrier’s operation (arrival or departure) that occurs pursuant to a published schedule.

“Scheduled Seats” means the average daily number of departing seats on the Scheduled Operations of a Signatory Airline (including its Affiliate Airlines) to destinations in the United States or Canada and on international flights allowed by City to operate from a DT, for the month of August immediately preceding the Fiscal Year for which the determination under Section 304 is being made, which is computed by dividing total departing seats for the Scheduled Operations of a Signatory Airline (including its Affiliate Airlines) for the month of August by thirty-one (31).

“Scheduled Seats Percentage” has the meaning given such term in Section 304(A).

“Settlement Agreement” means the Settlement Agreement dated July 1, 1981, between City and certain Air Carriers.

“SFAAAC” means the San Francisco Airline-Airport Affairs Committee.

“Shared Use Equipment” means common use technology such as CUPPS, CUSS, iMUSE, CUTE, and other similar passenger processing equipment.

“Signatory Airline” means an Air Carrier, including Airline, that signs a Lease and Use Agreement.

“Space Category(ies)” shall mean the classification of the square footage attributable to the Airline Leased Space for the purpose of establishing Terminal Rental Rates, as set forth in Section 502(D) hereof.

“Space Change Summary Notice” means a notice in the form of Exhibit L. Each Space Change Summary Notice shall be deemed to form a part of this Agreement when executed by the parties and shall not require or constitute a formal amendment to this Agreement.

“Special Revenue Bonds” means taxable and tax-exempt obligations issued by City or on behalf of Airport, including bonds, refunding bonds, notes, bond anticipation notes, commercial paper, lease or installment purchase agreements or certificates of participation therein and other evidences of indebtedness, the principal of, premium, if any, and interest on which are payable from or secured in whole or substantial part by revenues other than Revenues.

“State” means the State of California.

“Summary” means the Summary of Major Terms set forth at the beginning of this Agreement.

“Support Facilities” means ticket office, outbound baggage makeup, inbound baggage makeup, baggage claim, and/or other support space.

“Surcharge Rate” has the meaning given such term in Exhibit O.

“T1” means the portion of the Terminal Area, together with its connecting concourses, piers, boarding areas including extensions thereof, and satellite buildings, known individually as Domestic Terminal 1.

“T2” means the portion of the Terminal Area, together with its connecting concourses, piers, boarding areas including extensions thereof, and satellite buildings, known individually as Domestic Terminal 2.

“T3” means the portion of the Terminal Area, together with its connecting concourses, piers, boarding areas including extensions thereof, and satellite buildings, known individually as Domestic Terminal 3.

“Term” means the period of time during which Airline’s activities at the Airport shall be governed by this Agreement, as set forth in the Summary. Said Term shall begin on the Effective Date and, except as otherwise set forth herein, shall terminate on the Expiration Date.

“Terminal” means, individually or collectively, as the case may be, T1, T2, T3 and the IT.

“Terminal Area” means the Cost Center that includes all areas within the Terminals, including concourses, boarding areas, pedestrian bridges, tunnel lobbies to garages, mechanical/utility areas, lobbies, offices, Commission facilities, baggage facilities and storage areas.

“Terminal Area Expenses” has the meaning given such term in Section 502(A).

“Terminal Area Rental(s)” has the meaning given such term in Section 502(D).

“Terminal Area Rental Rate(s)” shall mean the rental rates established for Airline Leased Space classified according to Space Category by location and function, as calculated in accordance with Section 502(D).

“Terminal Area Space” means those categories of space used in the calculation of Terminal Area Rentals for the Signatory Airlines as more particularly defined under “Gross Terminal Space,” “Airline Leased Space,” and “Public Space.”

“Terminal Company” means an entity designated by Signatory Airlines and/or representing Signatory and non-Signatory Airlines for the purposes set forth herein, including in Sections 204(A), 209 and 1921 and Exhibit G.

“Ticket Counter Management Protocols” means, with respect to the IT, the IT Ticket Counter Management Protocols, and with respect to the DT, the DT Ticket Counter Management Protocols.

“Transfer” means any assignment, encumbrance, subletting or other transfer, whether voluntary or involuntary or by operation of law.

“TSA” means the Transportation Security Administration, or any successor agency.

“Utilities Area” means the Cost Center that includes the facilities for water, gas, electricity, telecommunication and information systems, including distribution systems.

“West of Bayshore Area” means the Cost Center that includes all of the property located west of U.S. Highway 101 currently under the jurisdiction of the Commission as indicated on the map attached hereto as Exhibit A.

Section 102 Time Conventions. Every use of the term "day" shall refer to a calendar day unless otherwise specified. Any reference to a time of day shall refer to the time of day at the Airport unless otherwise specified.

ARTICLE 2. PREMISES; USE

Section 201 Lease of Demised Premises.

A. City, as owner and operator of the Airport, shall and does hereby demise and let to Airline, and Airline shall and does hereby hire and take from City for the uses and purposes herein enumerated, the Demised Premises for use from and after the Effective Date on the terms and conditions set forth herein.

B. Following reasonable notice to Airline, Director may cause City to conduct a space audit pursuant to which City re-measures the Demised Premises using the Airport's then-current measurement specifications, which space audit, shall only be conducted at reasonable times. Following such measurement and notice to Airline, the Demised Premises description and the rent shall be deemed adjusted per such measurement. Airport measurement specifications as of the Effective Date are set forth in Exhibit N, attached hereto.

C. Airline acknowledges and agrees that (a) City shall have the right at all times to change, alter, expand, and contract the Airport; (b) City has made no representations, warranties, or covenants to Airline regarding the design, construction, pedestrian traffic, or views

of the Airport or the Demised Premises; provided, however, that all such changes, alterations, expansions, and contractions, shall be subject to any consultation or approval requirements as may be described elsewhere in this Agreement. Without limiting the generality of the foregoing, Airline acknowledges and agrees that the Airport (i) is currently undergoing, and may from time to time hereafter undergo renovation, construction, and other Airport modifications; and (ii) may from time to time adopt Airport Rules relating to security and other operational concerns that may affect Airline's business.

Section 202 Permitted Uses. Airline may use the Airport for all such operations and functions as are incidental, necessary or proper to the conduct of its air transportation business, including, but not limited to, the rights set forth below, provided the same are conducted in accordance with the conditions set forth in this Agreement and the Airport Rules; provided, however, that such rights shall not be construed as authorizing the conduct of a separate business by Airline, but shall permit Airline to perform such functions as are incidental to the conduct of air transportation:

- A. The use, with others so authorized, of the Airport and appurtenances, including the Terminal Area, the Groundside Area and the Airfield Area.
- B. The operation of an air transportation business for the carriage of persons, property, baggage, cargo, express and mail, including, but without limiting the generality hereof, revenue, courtesy, test, training, inspection, emergency, charter and sightseeing flights.
- C. The repairing, maintaining, conditioning, servicing, testing, parking or storage of aircraft or other equipment operated by Airline or other Air Carriers.
- D. The hiring and training on the Airport of personnel in the employ of or to be employed by Airline, its contractors or other Air Carriers.
- E. The sale, disposal, or exchange of Airline's aircraft, engines, accessories, gasoline, fuel, or other propellants, oils, greases, lubricants, and other equipment or supplies, to permit Airline to perform such functions as are incidental to the conduct of its air transportation business, and specifically, but without limitation, to permit the sale or disposal of any article or goods used by, or bought for use by Airline in connection with its operation of an air transportation business; provided, however, that Airline may not sell gasoline, fuel, or other propellants, oils, greases, and other lubricants, to anyone other than a subsidiary, an affiliated company, other Signatory Airlines, other Air Carriers, or others for use in aircraft being used in connection with operations of Airline unless a particular grade is desired by others and is not otherwise available from concessionaires at the Airport.
- F. The servicing by Airline, or others, of Airline's aircraft and other equipment by truck or otherwise, with gasoline, fuel or other propellants, oils, greases, lubricants, or other supplies including foods and beverages required by Airline. Notwithstanding anything to the contrary herein, (i) Airline acknowledges that City has granted, or may in the future grant, to one or more parties the sole and exclusive right to operate a fuel storage and delivery system serving the Airport; and (ii) Airline acknowledges and agrees that, to the extent it desires to receive

distribution of jet fuel on Airport premises, it must receive such distribution from such party or parties, on the terms and conditions established by such party or parties. In no event will Airline have any right to operate a fuel storage and delivery system at the Airport.

G. The landing, taking off, flying, taxiing, towing, parking, loading or unloading of Airline's aircraft, or the aircraft of any other Air Carrier.

H. The loading and unloading of property, cargo, express, mail and carriage of employees, in properly designated facilities, by such motor vehicles or other manner of conveyance as Airline may desire or require in the operation of an air transportation business, with the right to designate the Air Carrier(s) who shall regularly transport Airline's employees, property, cargo, express and mail to and from the Airport, subject to Subsection (O).

I. The use, alone or in conjunction with other Air Carriers as provided herein, of the Airport's Common Use facilities and the Demised Premises for any and all purposes in connection with and incidental to the operation of an air transportation business, including, without limiting the generality hereof, the handling of reservations, the handling, ticketing, billing and manifesting of passengers, baggage, express, cargo, property and mail, and the installation, maintenance and operation of radio and other communications equipment and facilities, meteorological and navigational equipment and facilities (subject to coordination with the Airport's radio service). In addition, Airline or any subsidiary of Airline, may, within the confines of the Demised Premises leased to Airline hereunder and subject to the Director's approval, operate passenger clubs and lounges in the Terminal Area, and to the extent permitted by law serve food and beverages in such passenger clubs and lounges.

J. The preparation by Airline, or a subsidiary of Airline, of food and beverage service to be used in connection with the furnishing of air transportation by Airline or to provide in-flight food and beverage services for other Air Carriers and to engage in any activities related thereto.

K. The installation, maintenance and operation, by Airline alone, or in conjunction with other Air Carriers, without cost to City, of a reasonable amount of suitable airplane air conditioning equipment, auxiliary power, start-up and other miscellaneous support equipment, which equipment shall be subject to the approval of Director and shall be installed, maintained and operated in accordance with the Airport TI Guide and the Airport Rules.

L. The installation and operation, at Airline's expense, of signs identifying the business of Airline, which signs shall be substantially uniform in size, type and location with those of other Air Carriers, the number, general type, size, design and location of such signs to conform to the Airport TI Guide and the Airport Rules, and which signs shall be subject to the approval of Director, such approval not to be unreasonably withheld

M. The use of all public areas inside and outside the Terminal Area, which use shall be nonexclusive.

N. The purchase or other acquisition of services or personal property of any nature, including, but not limited to, gasoline, fuel, propellants, lubricating oil, greases, food,

beverages and other materials, equipments and supplies deemed by Airline to be required by, or incidental to, Airline's operations, its exercise of the rights herein granted or its discharge of the obligations herein imposed, from any person, partnership, firm, association, or corporation it may choose pursuant to licensing requirements established consistent with Section 1001 hereof and subject to Subsections (F) and (O).

O. City retains the right to regulate ground handlers and other service providers used by Airline. Airline is entitled to engage in its operations only those third-party ground handlers and service providers that are licensed or permitted by City to operate at the Airport. In the event Airline agrees to ground handle any portion of the operations of another Air Carrier, Airline shall provide City advance written notice of such proposed activities, including a description of the type and extent of services to be provided. Notwithstanding the foregoing, Airline shall not ground handle any Air Carrier which does not have the consent of City to operate at the Airport.

Section 203 Prohibited Uses, Exclusions and Reservations.

A. Airline shall not use the Airport or cause or permit its employees or others to use the Airport for any other purpose than specified under the terms and conditions of this Agreement. Without limiting the generality of the foregoing, Airline shall not do, cause or permit anything to be done in or about the Airport, or bring or keep anything thereon which will in any way:

- (i) increase the rate of fire insurance upon the Terminal Area or any of its contents; or
- (ii) subject to Section 1001 hereof, conflict with any law, ordinance, rule or regulation now in effect or which may hereafter be enacted or promulgated by any public authority having jurisdiction; or
- (iii) create a nuisance; or
- (iv) obstruct or interfere with the rights of other tenants in the Terminal Area; or
- (v) commit or suffer to be committed any waste; or
- (vi) place any loads upon the floor, walls, or ceiling which endanger the structure; or
- (vii) obstruct the sidewalk or passageways or stairways or escalators; or
- (viii) be unlawful.

B. Airline shall not knowingly interfere or permit interference with the use, operation, or maintenance of the Airport, including, but not limited to, the effectiveness or

accessibility of the drainage, sewerage, water, communications, fire protection, utility, electrical or other systems installed or located from time to time at the Airport.

C. As soon as possible after release from proper authorities, Airline shall remove any of its disabled aircraft from the airfield or aprons, shall place any such disabled aircraft only in such storage areas as may be reasonably designated by the Director, and shall store such disabled aircraft only upon such terms and conditions as may be reasonably established by City. In the event Airline shall fail to remove any of its disabled aircraft as expeditiously as possible, City may, after at least two (2) days written notice, but shall not be obligated to, cause the removal of such disabled aircraft. Airline shall pay to City, upon receipt of an invoice, the costs incurred for such removal plus fifteen percent (15%).

D. Airline shall not do or permit to be done anything, either by act or failure to act, that shall cause the cancellation or violation of the provisions, or any part thereof, of any policy of insurance for the Airport or that shall cause a hazardous condition so as to increase the risks normally attendant upon operations permitted by this Agreement. If Airline shall do or permit to be done any act not permitted under this Agreement, or fail to do any act required under this Agreement, regardless of whether such act shall constitute a breach of this Agreement, which act or failure, in and of itself, causes an increase in City's insurance premiums, Airline shall immediately remedy such actions upon notice from City to do so.

E. City may install or cause to be installed advertising and revenue generating devices, including vending machines, in Joint Use Space and Preferential Use Space in the Demised Premises; provided, however, that City shall not install or cause to be installed advertising for Airline's direct competitors in Airline's Preferential Use Space. Airline shall purchase all advertising for any product or service other than air service arriving at or departing from the Airport from the Airport's advertising concessionaire. Any revenue generated by advertising installed on Airline-owned equipment shall be shared by City and Airline as shall be mutually agreed. City may also, at its sole option, install Information and Communications Technology in any part of the Terminals excluding Airline's clubs and lounges. City shall be entitled to reasonable access to the Demised Premises so as to install or service such Information and Communications Technology. Income generated by such Information and Communications Technology shall be accounted for in the same manner as other Non-Airline Revenues of the Airport.

F. Except as permitted or authorized by applicable Environmental Laws or discharge requirements issued by the Airport or included in the Airport Rules, Airline shall not dispose of nor permit any other person to dispose of any waste material into the sanitary or storm sewers at the Airport or elsewhere (whether liquid or solid) unless such waste materials or products are first properly treated. Nothing herein shall prohibit Airline from disposing of human waste taken from its aircraft in proper designated sanitary sewer facilities.

G. Airline shall not disturb any asbestos at the Airport without first obtaining all permits and approvals as required by applicable Environmental Laws or by City. City shall make available to Tenant upon request any surveys, reports, plans, or other documentation regarding the presence or management of asbestos at the Airport.

H. Any and all rights and privileges not specifically granted to Airline for its use of and operations at the Airport pursuant to this Agreement are hereby reserved for and to City.

Section 204 Space Classifications. For purposes of rent allocations and billing, all space is either deemed Joint Use Space, Exclusive Use Space, Preferential Use Space, or Public Space.

A. Joint Use Space. All space designated as Joint Use Space has the following characteristics:

(i) Airline shall be entitled to use the Joint Use Space included in the Demised Premises with others so authorized, subject to the provisions of Subsections 204(A)(iii), (iv) and (v) below.

(ii) Rent on Airline's Joint Use Space shall be based on the Joint Use Formula applicable to such area of Joint Use Space.

(iii) If the Demised Premises include ticket counters and other resources used by more than one Air Carrier within Joint Use Space in the IT, Airline shall be entitled to use the same with others so authorized. Such ticket counters and resources shall be assigned to Airline for priority use as determined by a Terminal Company, based on the IT Ticket Counter Management Protocols, which assignments are subject to City's approval, not to be unreasonably withheld. In determining Airline's need, the Terminal Company shall include the needs of Air Carriers being handled at such ticket counters and resources by Airline. When Airline is not using the assigned ticket counters and resources, other Air Carriers may use some or all of the same, in accordance with the IT Ticket Counter Management Protocols. The Terminal Company shall be responsible for arranging such use, based on the IT Ticket Counter Management Protocols, and shall inform City of such arrangements with such frequencies as the parties shall determine. Although City does not intend to review or approve each such arrangement, City shall have the right to oversee and reasonably object to such arrangements or practices. In such event, the Terminal Company shall revise its practices to satisfy City's objection. City shall manage the ticket counters and resources within the IT Joint Use Space in accordance with the IT Ticket Counter Management Protocols during any period of time when there is no Terminal Company under contract to provide such services.

(iv) If the Demised Premises include Gates within Joint Use Space in the IT, Airline shall be entitled to use such Joint Use Gates with others so authorized. Such Gates shall be assigned to Airline for priority use as determined by a Terminal Company, based on the IT Gate Management Protocols, which assignments are subject to City's approval, not to be unreasonably withheld. In determining Airline's need, the Terminal Company shall include the needs of Air Carriers being handled at such Gates by Airline. When Airline is not using the assigned Gates, other Air Carriers may use some or all such Gates, in accordance with the IT Gate Management Protocols. The Terminal Company shall be responsible for arranging such use, based on the IT Gate Management Protocols, and shall inform City of such arrangements with such frequencies as the parties shall determine. Although City does not intend to have daily approvals over each such arrangement, City shall have the right to oversee and reasonably object to such arrangements or practices. In such event, the Terminal Company shall revise its

practices to satisfy City's objection. City shall manage the Gates within the IT Joint Use Space in accordance with the IT Gate Management Protocols during any period of time when there is no Terminal Company under contract to provide such services.

(v) Other Joint Use Space in the Terminals may be managed by City or by one or more Terminal Companies in accordance with management protocols, including the Ticket Counter Management Protocols and Gate Management Protocols, as applicable. If Director elects to treat an area in the Terminals as Joint Use Space, City may establish or designate the necessary management protocols and Joint Use Formulas in consultation with the Air Carriers that will use such Joint Use Space and any Terminal Company that will manage such Joint Use Space.

B. Exclusive Use Space. All space designated as Exclusive Use Space shall be space with the following characteristics:

(i) Airline shall have the exclusive right to occupy and use all Exclusive Use Space included in the Demised Premises.

(ii) Rent for all Exclusive Use Space shall be based on City's rates and charges, as calculated pursuant to this Agreement.

C. Preferential Use Space. All space designated as Preferential Use Space shall be space with the following characteristics:

(i) Airline shall be entitled to use Preferential Use Space included in the Demised Premises with others authorized in accordance with the provisions of Article 3.

(ii) Rent for all Preferential Use Space shall be based on City's rates and charges, as calculated pursuant to this Agreement.

D. Public Space. All space designated as Public Space shall be space with the following characteristics:

(i) Airline shall be entitled to use Public Space (other than space leased or permitted to, or used by, other tenants or parties) within the Terminal Area with others so authorized in accordance with the provisions of this Agreement and the Airport Rules.

(ii) City will periodically designate portions of the Public Space for use as Common Use Gates, Common Use Ticket Counters and Common Use Support Facilities.

(iii) Airline's use of a Common Use Gate, a Common Use Ticket Counter or Common Use Support Facilities shall be as provided by Article 3 hereof and the applicable Gate Management Protocols and Ticket Counter Management Protocols.

(iv) Fees for the use of Common Use facilities shall be established by City in accordance with this Agreement.

Section 205 Rights of Way. Airline shall have the use and enjoyment of suitable rights of way in the Terminal(s) where the Demised Premises are located to install and maintain facilities necessary to Airline's air transportation operations, except that Airline shall not be entitled to any such rights of way for any function provided or available to Airline through City or a Terminal Company. Airline shall have the use and enjoyment of suitable rights of way over, under and upon the apron areas adjacent to the Demised Premises for the purpose of enabling Airline, at its own expense, to install and maintain underground conduits, ducts, pipes, wires and incidental pumps, motors, tanks, filters and other equipment which are or may be necessary or convenient in connection with the supply of power, airstart, and other services to Airline's aircraft, provided that such right(s) of way shall not be in competition with the exclusive fuel system described in Section 202(F) of this Agreement. The location or locations of said rights of way and installations therein shall be subject to the prior written approval of Director. The use and enjoyment of said rights of way shall not be subject to any charge whatsoever by City to Airline. Notwithstanding anything to the contrary herein, Airline shall have no such right(s) of way for any telecommunications systems, except and to the extent the same is consistent with the Airport's telecommunications policies and programs, including the Communications Master Plan and the Telecommunications Infrastructure Policy, as the same may be amended from time to time.

Section 206 Ingress and Egress. Subject to Airport Rules and applicable federal security regulations, City hereby grants to Airline the following rights and privileges of ingress and egress at the Airport:

A. For Airline, its agents, employees, contractors and subcontractors: to the public areas of the Airport and to those areas and facilities designated herein for use by Airline. This right shall extend to aircraft, vehicles, machinery and equipment used by or for the benefit of Airline in its air transportation business.

B. For Airline's passengers, guests and invitees: to areas leased exclusively, jointly or preferentially to Airline and to public areas and public facilities. This privilege shall extend to vehicles of such passengers, guests and invitees.

C. For Airline's vendors, suppliers of materials and furnishers of service: to the public areas of the Airport and to areas and facilities leased to or designated herein for use by Airline. This privilege shall extend to vehicles, machinery and equipment of such vendors, suppliers and furnishers of services used in their business of furnishing such supplies and services to Airline; provided, however, that Commission may impose a charge upon Airline's suppliers or furnishers of service in an amount sufficient to recover the costs incurred in the reasonable regulation by Commission of such suppliers or furnishers of service in the exercise by them of the foregoing right of ingress and egress.

The full and free right of ingress and egress provided for above shall not be used, enjoyed or extended for any purpose or use in contravention of the provisions of Section 202 hereof unless expressly authorized by Director. When reasonably required for reasons of safety or security, Director may limit access to any area within the Airport.

Section 207 Accommodation of Other Air Carriers in Airline's Exclusive Use Space.

A. To facilitate the entry of new Air Carriers and to maximize the utilization of facilities at the Airport, City shall first attempt to accommodate Air Carriers with space needs with Preferential Use Gates as provided in Article 3, Common Use facilities, Joint Use Space, or uncommitted space available in the applicable Terminal.

B. If the Common Use facilities or Joint Use Space cannot adequately accommodate the requesting Air Carrier needs, City shall have the right to require accommodation of a requesting Air Carrier in Airline's Exclusive Use Space as follows: Airline agrees, upon request by City, to make all reasonable efforts to facilitate the temporary accommodation of an Air Carrier's operations, including use of space for a ticket counter area, use of Airline's baggage facilities and the rendering of customary ground services, if (1) Airline has adequate capabilities, capacity, facilities and personnel therefor, after taking into account Airline's own requirements and contractual obligations, the compatibility of said Air Carrier's proposed operations with those of Airline, and (2) said Air Carrier enters into a written agreement with Airline therefore and agrees to (a) pay Airline its established rates and charges for such services, (b) indemnify and hold harmless Airline and Airline Entities to the same extent as Airline is required to indemnify the City hereunder for claims or liability (including fines and penalties arising out of or in connection with such Air Carrier's acts or omissions or use of the Demised Premises), and (c) carry insurance in the amounts and of the type(s) as may be reasonably requested by Airline, not to exceed the insurance required of Airline under this Agreement. Any accommodation of an Air Carrier under the procedures hereof may be pursuant to a sublease, handling agreement, or a combination thereof, mutually agreed upon by the parties and subject to the Director's approval.

C. Nothing contained in this Agreement nor the rights conferred herein shall prevent or prohibit the entering into of inter-airline agreements between Airline and other Air Carriers authorized to operate into and out of the Airport; provided, however, that any agreements between Airline and another Air Carrier providing for the shared use of any of the facilities in the Exclusive Use Space leased to Airline shall be approved in writing by the Director.

D. During any use of Airline's facilities by another Air Carrier at City's request pursuant to this Section, Airline shall thereupon be relieved of any obligation under this Agreement to indemnify and save harmless City and City Entities with regard to any claim for damages or personal injury arising out of or in connection with said accommodated Air Carrier's use of the Demised Premises unless proximately caused by the sole negligence of Airline or any Airline Entity that has come upon the Demised Premises in connection with Airline's occupancy hereunder. The City shall, however, require such indemnification from such other Air Carrier.

Section 208 Environmental Sustainability Measures. From time to time, City may adopt certain environmental sustainability measures to minimize the environmental footprint of Airport operations. Air Carriers operating at the Airport may also pursue various sustainability measures. City encourages such initiatives and from time to time may call upon Airline to cooperate with City where practicable in implementing sustainability measures that impact

Airline operations such as tenant improvements to Leadership in Energy and Environmental Design (LEED) Silver or better standards, energy and water conservation, solid waste reduction and recycling, electrification of ground services equipment, maximizing the use of preconditioned air, or single engine taxiing, provided that such sustainability measures are lawful. Airline shall agree to implement sustainability measures as required to meet City, State and federal regulations.

Section 209 Equipment, Maintenance and Operating Agreements.

A. Domestic Terminals.

(i) City-owned passenger loading bridges and baggage handling systems.

Airline will be responsible for equipment maintenance functions on City-owned baggage handling systems, including high-tech maintenance, and passenger loading bridges at Preferential Use Gates either directly through Airline's employees or through one or more Terminal Companies. City will be responsible for equipment maintenance functions on City-owned passenger loading bridges at Common Use Gates.

(ii) Other City-owned equipment and systems. City will be responsible for equipment maintenance functions on certain other City-owned equipment and systems utilized by Airline, including but not limited to, centralized baggage handling system monitoring and control systems related to explosive detection equipment, preconditioned air, and 400Hz ground power.

B. International Terminal.

(i) City-owned passenger loading bridges and baggage handling systems.

Airline will be responsible for equipment maintenance functions on City-owned passenger loading bridges and baggage handling systems either directly through Airline's employees or through one or more Terminal Companies. Airline will not be responsible for equipment maintenance functions on City-owned equipment described in Subsection (ii) below unless otherwise agreed to by the parties.

(ii) Other City-owned equipment and systems. Unless otherwise agreed to by the parties, City will be responsible for equipment maintenance functions on certain other City-owned equipment and systems utilized by Airline, including centralized baggage handling system monitoring and control systems related to explosive detection equipment, preconditioned air, 400Hz ground power, and other equipment owned by City as of the Effective Date. City shall have sole discretion to retain or assign maintenance functions with respect to new equipment acquired by City after the Effective Date upon consultation with the applicable Terminal Company or the Signatory Airlines operating from the IT.

C. Maintenance Standards. All equipment maintenance functions will be subject to audit and oversight by City, and will be conducted in accordance with maintenance schedules, record-keeping, reporting and quality standards established by City. Airline will submit for City's approval a maintenance plan to meet City's requirements. City reserves the right to assume equipment maintenance functions for City-owned passenger loading bridges and baggage

handling systems following notice to Airline in the event, at City's sole determination, Airline fails to comply with maintenance standards established by City and to cure such failure within ninety (90) days' of City's notice.

Section 210 Relocation of Operations. From time to time during the Term of this Agreement, part or all of the Demised Premises may be required (1) for implementation of improvements at the Airport; (2) for accommodation of the traveling public; or (3) in order to maximize the use of the Terminals and related facilities by Air Carriers (including Airline) and other tenants, lessees, permittees, and users thereof. In said event, City shall provide at least sixty (60) days advance written notice of the Director's decision to reallocate space in the Terminals and of the schedule for implementation of such reallocation. Director and Airline may agree to reasonable extensions of time necessary to accommodate said reallocation. Airline hereby agrees to comply with any reallocation requirements. In any such reallocation, the actual, reasonable requirements of Airline for Terminal space to accommodate its operations at the Airport shall be given consideration. All reasonable moving costs resulting from relocation of Airline in a City-imposed temporary reallocation of space shall be funded by City, subject to rate recovery under Articles 4 and 5; provided, however, that if removal of all or a portion of Airline's trade fixtures and other movable property from the existing premises and reinstallation of the same at Airline's new premises is possible and not unreasonable, Airline shall not be entitled to a replacement of such fixtures or property. Notwithstanding any provision of this Section to the contrary, Airline shall not be entitled to reimbursement for relocation of or within (a) Joint Use Space, or (b) Preferential Use Space resulting from the annual reallocation, acceptance or rejection of Gates in accordance with Article 3.

Section 211 [Reserved].

Section 212 Termination.

A. Termination for Cessation of Use. Without limiting the generality of Section 1501 of this Agreement, City shall have the right to terminate this Agreement if Airline ceases all Revenue Aircraft Arrivals at the Airport and such cessation continues for more than thirty (30) consecutive days. To exercise such right of termination, City shall give a termination notice to Airline. In such event, this Agreement shall terminate on the date specified in the notice. City shall not have the foregoing right to terminate for such cessation if such cessation is caused by a force majeure event described in Section 1908.

B. Mid-Term Optional Termination. Airline shall have the option to request termination of its use of up to twenty percent (20%) of its Exclusive Use Space prior to the expiration of this Agreement; provided, however, that such a request may only be submitted during the period commencing July 1, 2015 through February 1, 2016. To exercise this option, Airline shall give City ninety (90) days written notice requesting the City's consent to such termination, effective July 1, 2016. If, in the City's sole determination, the Exclusive Use Space Airline intends to vacate has independent physical access and is otherwise functional and useable by other Air Carriers or tenants, the City shall not unreasonably withhold approval of Airline's request under this Section. In case of a termination hereunder, City shall issue to Airline a Space

Change Summary Notice documenting the termination of any portion of Airline's Exclusive Use Space under this Section.

C. Other Termination Rights. Airline may terminate this Agreement as provided in Sections 911, 912, 1510 and 1511.

D. Surrender of Demised Premises. All Demised Premises surrendered by Airline under this Section shall be subject to the provisions of Section 1601.

Section 213 Recapture of Exclusive Use Space Following Involuntary Reduction in Number of Preferential Use Gates. If the number of Preferential Use Gates assigned to Airline is reduced during the Term of this Agreement for any reason, City may at any time thereafter and from time to time, after taking into account any recommendations of the RMAC, at City's sole discretion and upon thirty (30) days written notice to Airline, terminate Airline's rights to use all or a portion of Airline's Exclusive Use Space, including, but not limited to, ticket counters and Support Facilities, that is reasonably required to support the operations of other Air Carriers using the Preferential Use Gates no longer assigned to Airline; provided, however, that City shall not so terminate rights to Exclusive Use Space that, in the Director's reasonable discretion, are required to support Airline's operations at Airline's remaining Preferential Use Gate(s), if any. In case of recapture hereunder, City shall issue to Airline a Space Change Summary Notice documenting the recapture of any portion of Airline's Exclusive Use Space under this Section. Airline's surrender of Exclusive Use Space pursuant to this Section or surrender of Preferential Use Gates shall be subject to the terms of Section 1601 of this Agreement.

Section 214 Recapture of Exclusive Use Space Following Rejection of Preferential Use Gates by Airline. Whenever Airline declines to accept a Preferential Use Gate following allocation of Gates pursuant to Section 304, City may at any time thereafter and from time to time, after taking into account any recommendations of the RMAC, at City's sole discretion and upon sixty (60) days written notice to Airline, reclaim all or a portion of Airline's Exclusive Use Space associated with the rejected Preferential Use Gate, including, but not limited to, ticket counters and Support Facilities, in accordance with the following procedure:

A. If there is another Signatory Airline that is willing to lease the reclaimed space, Airline and the other Signatory Airline shall attempt to negotiate an agreement as to any changes to the condition or layout of the space, any required sharing of Support Facilities such as hallways and baggage areas, any associated costs, and any other provisions required to permit the other Signatory Airline to use the reclaimed space for its intended purpose.

B. If Airline and the other Signatory Airline cannot reach agreement on the items listed above, City shall join the negotiations and attempt to mediate an agreement.

C. If City is unable to mediate an agreement on the items listed above, the Airport Director shall develop a reasonable solution and notify both Airline and the other Signatory Airline of the decision.

D. Any changes to Airline's Demised Premises and the other Signatory Airline's leased space as a result of Subsections (A) through (C) above shall be documented by City issuing a Space Change Summary Notice to Airline and the other Signatory Airline.

E. Airline shall be responsible for the cost of removing its furniture, fixtures, and equipment from the reclaimed space and returning the reclaimed space to a tenantable condition in accordance with the provisions of Section 1601 of this Agreement, and such reclaimed space shall revert to the possession and control of City and may thereafter be made available by City on a Common Use basis to other Air Carriers, or leased on an Exclusive Use or Preferential Use basis to other Signatory Airlines or Airport tenants.

F. Under no circumstances shall Airline be responsible for any costs greater than those required to vacate its furniture, fixtures, and equipment, including communications and utility lines, from the reclaimed space and to return the reclaimed space in the condition provided in Section 214(E) above. Airline will not be responsible for any costs of extending utilities to make the reclaimed space tenantable.

Section 215 Airline-Owned Equipment in Demised Premises.

A. If Airline leased space in one or more of the Domestic Terminals prior to the Effective Date of this Agreement, any equipment or trade fixtures (including without limitation passenger loading bridges and baggage handling systems) owned by Airline located in such space shall be treated as follows:

(i) If the previously leased space where such equipment or trade fixtures are located remains in the Demised Premises under this Agreement, City and Airline agree that such equipment or trade fixtures may remain in the Demised Premises under Airline ownership subject to the provisions of this Agreement. With respect to such equipment or trade fixtures located at or associated with a Preferential Use Gate, Airline hereby grants City and/or any other Air Carrier using such Gate the right to use the Airline-owned equipment or trade fixtures located at or associated with such Preferential Use Gate in accordance with the terms of this Agreement.

(ii) If the previously leased space where such equipment or trade fixtures are located is not included in the Demised Premises under this Agreement, the treatment of such equipment or trade fixtures prior to the Effective Date shall be determined in accordance with the terms of the prior lease or permit for such space, unless City and Airline shall have made alternate arrangements.

B. If a Preferential Use Gate previously assigned to Airline is no longer assigned to Airline (either because Airline declines to accept such Gate during the annual allocation process under Section 304 or for any other reason), and Airline-owned equipment or trade fixtures are located at or associated with such Preferential Use Gate, Airline shall remove such equipment or trade fixtures in accordance with Section 1601 prior to surrendering such Preferential Use Gate unless City and Airline shall have made alternate arrangements.

Section 216 Affiliate Airlines. A Signatory Airline may designate one or more Affiliate Airlines by submitting documentation sufficient to demonstrate to the satisfaction of the Director that the conditions of this Section have been met. Each Affiliate Airline shall execute an agreement with City substantially in the form of an Operating Permit prior to operating at the Airport. Airline shall provide City with thirty (30) days prior written notice before designating an Affiliate Airline. This Agreement and such written notice shall constitute an agreement by Airline to guarantee and be responsible for performing all obligations hereunder on behalf of its Affiliate Airline(s), including, without limitation, all reporting obligations, and paying all amounts to be due to City from Affiliate Airline under this Agreement. If an Air Carrier is an Affiliate Airline of more than one Signatory Airline, the guaranty of each such Signatory Airline shall include only the payment and reporting obligations in connection with the flight operations of the Affiliate Airline related to such Signatory Airline. Airline's designation of any Affiliate Airline shall be subject to City's approval, which approval shall not be unreasonably withheld provided that Airline has notified City in the manner required above. Airline shall provide City with thirty (30) days prior written notice before the cancellation or modification of any designation of an Affiliate Airline. Regardless of the timing of any such written notice, an Affiliate Airline's status shall terminate automatically at such time as the Affiliate Airline ceases to satisfy the criteria that allowed it to qualify as an Affiliate Airline hereunder. An Affiliate Airline shall have no Majority-in-Interest voting rights, but shall be included with its Signatory Airline's Revenue Aircraft Arrivals for purposes of determining a Majority-in-Interest.

ARTICLE 3. ASSIGNMENT AND USE OF COMMON USE FACILITIES AND PREFERENTIAL USE GATES

Section 301 No Exclusive Use Gates. Gates will be leased to Signatory Airlines as Preferential Use Gates or Joint Use Gates, or will be made available by City for use by an Air Carrier, including a Signatory Airline, as a Common Use Gate. No Gates will be leased or permitted to any Air Carrier on an Exclusive Use basis. Use of any Gate shall, at all times, be subject to the Gate Management Protocols applicable to such Gate. As of July 1, 2011, all Gates in the DT are Preferential Use Gates or Common Use Gates, and all Gates in the IT are Joint Use Gates and/or Common Use Gates. City reserves the right to remove Gates from active use, following consultation with the RMAC and SFAAAC.

Section 302 Resource Management Advisory Committee. The Director shall establish a committee composed of three (3) representatives designated by City and three (3) representatives of the Signatory Airlines designated by the SFAAAC (the "Resource Management Advisory Committee" or "RMAC") to review and make recommendations to City about the numbers of Gates to be reserved for use as Common Use Gates during any Fiscal Year and about the locations within the Terminals of Common Use Gates and Preferential Use Gates. The RMAC shall consider both the operational efficiency from the perspectives of City, the Signatory Airlines and any non-Signatory Airlines, and the customer service implications of its recommendations. The final recommendations of the RMAC shall be advisory only, and all final determinations shall be made by the Director in the Director's sole discretion.

Section 303 Annual Determination by the City of the Total Number of Common Use Gates.

A. No later than October 1, 2010 and October 1 of each year thereafter, City shall present to the RMAC for review and discussion a preliminary plan indicating the number of Gates in each Terminal proposed to be reserved for use as Common Use Gates in the following Fiscal Year. The Director shall have sole discretion, after taking into consideration any recommendations by the RMAC, to determine the total number of Gates to be reserved as Common Use Gates effective July 1, 2011 and July 1 of each Fiscal Year thereafter during the Term. Gates other than Joint Use Gates remaining available for use after such determination shall be offered by City to Signatory Airlines for use as Preferential Use Gates to be allocated in accordance with Section 304. City shall notify in writing all Signatory Airlines, including Airline, of its determination with respect to Common Use Gates no later than December 1, 2010 and December 1 of each Fiscal Year thereafter during the Term. Any Gate first becoming available for use after July 1 of each Fiscal Year shall be reserved for use as a Common Use Gate for the remainder of that Fiscal Year unless, after taking into consideration any recommendation of the RMAC, the Director, in the Director's sole discretion, designates the Gate as a Joint Use Gate or assigns it to a Signatory Airline as a Preferential Use Gate.

B. Notwithstanding Section 303(A) above, the Director's initial determination of the number of Common Use Gates in all DT under Section 303(A) shall not exceed ten percent (10%) of the total number of DT Gates. This limitation shall not prevent the Director from designating additional Gates for Common Use in accordance with the last sentence of Section 303(A), or following rejection of such Gates by all eligible Signatory Airlines under Section 304(F).

C. If at any time the Director determines that a certain number of Gates in the IT are to be reserved for use as Common Use Gates, the Director may designate specific Gates for such use or may make the determination without reference to specific Gates, thereby allowing greater flexibility in the daily utilization of IT Gates in accordance with the IT Gate Management Protocols.

Section 304 Annual Determination of the Number and Locations of Preferential Use Gates to be offered to the Signatory Airlines. After determination by City of the total number of Common Use Gates pursuant to Section 303, City shall apply the following methodology (as illustrated in Exhibit J-2) to determine the total number of Preferential Use Gates that will be offered to each Signatory Airline, including Airline, during each Fiscal Year, effective July 1, 2011 and July 1 of each Fiscal Year thereafter:

A. The City shall first divide the number of Scheduled Seats for Airline, including its Affiliate Airline(s), by the total number of Scheduled Seats for all Signatory Airlines to determine Airline's percentage share of all Scheduled Seats ("Scheduled Seats Percentage").

B. The City shall calculate the number of Preferential Use Gates to be offered to Airline by multiplying Airline's Scheduled Seats Percentage by the total number of Gates to be

made available for Preferential Use, rounding the product to the nearest whole number; provided, however, that a product less than 0.5 shall not be eligible for rounding under this Subsection.

C. If as a result of rounding, the total number of Preferential Use Gates to be offered to all Signatory Airlines as computed in Section 304(B) is less than the total number of Gates available for Preferential Use as determined under Section 303, City shall allocate such remaining Preferential Use Gates to Signatory Airlines based on the unrounded results of the computations under Section 304(B). The remaining Preferential Use Gates shall be allocated in priority order by first increasing by one (1) the number of Preferential Use Gates to be offered to the Signatory Airline whose unrounded product is nearest to 0.5 without equaling or exceeding 0.5 and next proceeding to increase by one (1) the number of Preferential Use Gates to be offered to the Signatory Airline whose unrounded product is second nearest to 0.5 without equaling or exceeding 0.5 and so on until the total number of Preferential Use Gates to be made available to all Signatory Airlines by City is reached.

D. If as a result of rounding, the total number of Preferential Use Gates to be offered to all Signatory Airlines as computed in Section 304(B) exceeds the total number of Preferential Use Gates as determined under Section 303, City shall reduce the number of calculated Preferential Use Gates to be offered to Signatory Airlines based on the unrounded results of the computations under Section 304(B). The number of over-allocated Preferential Use Gates shall be reduced in priority order by first reducing by one (1) the number of allocated Preferential Use Gates to the Signatory Airline whose unrounded Section 304(B) product is nearest to 0.5 without being less than 0.5 and next proceeding to reduce by one (1) the number of Preferential Use Gates to be offered to the Signatory Airline whose unrounded Section 304(B) product is second nearest 0.5 without being less than 0.5 and so on until the total number of Preferential Use Gates to be made available to all Signatory Airlines by City is reached.

E. No later than December 1, 2010 and December 1 of each Fiscal Year thereafter during the Term, City shall provide written notice to all Signatory Airlines, including Airline, of its annual determination of Preferential Use Gates under this Section and shall offer each Signatory Airline the opportunity to be allocated the number of Preferential Use Gates indicated by these calculations. Each Signatory Airline shall provide written notice to City no later than February 1 of each Fiscal Year during the Term either accepting or rejecting any or all of the Gates offered to it by City for Preferential Use. The following provisions shall apply to rejected Gates:

(i) If a Signatory Airline does not accept the allocation of a Preferential Use Gate by February 1 of each Fiscal Year, the Signatory Airline rejecting such Gate may request the City to allocate such Preferential Use Gate to another Signatory Airline if, within the acceptance period, the following two conditions are met: (a) the Signatory Airline rejecting the Preferential Use Gate has a written handling agreement with the Signatory Airline accepting allocation of the rejected Preferential Use Gate, and (b) the Signatory Airline accepting allocation of the rejected Preferential Use Gate demonstrates to the City's satisfaction that it needs the rejected Preferential Use Gate reasonably to accommodate the rejecting Signatory Airline's flights, in which case the Gate shall be allocated to that other Signatory Airline as a Preferential Use Gate. Alternatively, if any Signatory Airline does not accept the allocation of a

Preferential Use Gate, City may elect to reallocate such Gate to another Signatory Airline if City determines the number of Common Use Gates determined in Section 303 is adequate to accommodate all Air Carrier operations needing to use Gates at the Airport. The City may reallocate such Gates until all Gates available for use as Preferential Use Gates are allocated to Signatory Airlines or rejected for use as Preferential Use Gates.

F. Any Gate rejected for allocation during a Fiscal Year as a Preferential Use Gate by all eligible Signatory Airlines may be deactivated or used during such Fiscal Year as City sees fit, including, without limitation, as a Common Use Gate. Only Gates leased to a Signatory Airline as a Preferential Use Gate or Joint Use Gate in such Fiscal Year and included as part of its Demised Premises for such Fiscal Year are included in the determination of Airline Leased Space for the Fiscal Year.

G. The City shall, in its sole discretion, determine the locations of any Preferential Use Gates to be offered to a Signatory Airline, after taking into consideration the compatibility of such Signatory Airline's aircraft with the Gate being assigned and the desirability of assigning contiguous Gates within the same Terminal for Preferential Use by any given Signatory Airline and minimizing the frequency of changes in the locations of Preferential Use Gates as well as any recommendations by the RMAC. By March 1, 2011 and March 1 of each Fiscal Year thereafter during the Term, City shall provide Signatory Airlines, including Airline, notice of the assignments of Preferential Use Gates and the locations of Common Use Gates, to be effective July 1, 2011 and July 1 of each Fiscal Year thereafter. Such notice shall be deemed to update Exhibit D hereto without the need for an amendment of this Agreement.

Section 305 City Scheduling Rights at Preferential Use Gates.

A. The City shall have the right, upon reasonable notice to Airline, to schedule arrivals and departures by a Requesting Airline at a Preferential Use Gate at all periods of time other than Airline's Periods of Use of that assigned Preferential Use Gate. In accommodating City in its right to schedule such operations at a Preferential Use Gate, Airline shall allow and provide for use of its facilities or equipment (not including ground service equipment) at the Preferential Use Gate or permitted use of City equipment and podiums as may be required for the efficient use of the Preferential Use Gate by a Requesting Airline. The City shall first, whenever it is practical to do so, consider the availability of Common Use Gates and any recommendations by the RMAC before scheduling Requesting Airline arrivals and departures at any Preferential Use Gate. Notwithstanding the foregoing and any other provision of this Article 3, City shall have the right, upon reasonable notice to Airline, to accommodate arrivals and departures by a Requesting Airline at a Preferential Use Gate during Airline's Periods of Use of that Preferential Use Gate if Airline is not utilizing the Preferential Use Gate during the Period of Use for a Scheduled Operation. If an arrival or departure of Airline that would have utilized one of Airline's Preferential Use Gates is early or late and Airline is prevented from utilizing any of its Preferential Use Gates because they are already being utilized by Requesting Airlines, City shall, whenever possible, accommodate Airline's arrival or departure on a Common Use Gate at no additional charge to Airline for its use of the Common Use Gate, and Airline shall continue to be entitled to the credit referenced in Section 306.

B. Airline shall have no scheduling preference during a Period of Use at its Preferential Use Gates under this Article 3 for any operation other than a Scheduled Operation.

Section 306 Charges for Use of Preferential Use Gate by Another Air Carrier. Any Requesting Airline that is accommodated at any of Airline's Preferential Use Gates shall be required to pay City the same charges for use of the Preferential Use Gate that it would have been required to pay for use of a Common Use Gate. The City shall provide a credit to Airline for one-half of the amount of any such Gate-use payment.

Section 307 Gate Accommodation Conditions. As a condition of accommodation on any of Airline's Preferential Use Gates, the Requesting Airline shall have executed an agreement with City that is substantially in the form of the Lease and Use Agreement or an Operating Permit, as applicable, through which the Requesting Airline is bound by insurance and indemnification obligations that are substantially similar to the obligations set forth herein. These insurance and indemnification obligations shall inure to the benefit of the Airline as a third-party beneficiary for any period of accommodation, and Airline shall not be required to accommodate a Requesting Airline at its Preferential Use Gates if the Requesting Airline's insurance and indemnification obligations are not satisfied.

Section 308 City's Control of Common Use Gates, Ticket Counters and Support Facilities. The City shall retain exclusive control of the use of all Common Use Gates, Common Use Ticket Counters and Common Use Support Facilities, provided that Common Use facilities in the IT shall be managed and scheduled by the applicable Terminal Company in accordance with the applicable Gate and Ticket Counter Management Protocols.

Section 309 Initial Determination by City of Common Use Ticket Counters and Support Facilities.

A. Airline acknowledges that as of the Effective Date, City has identified the ticket counters and Support Facilities to be designated for Common Use described on the attached Exhibit B.

B. During the Term, if in the Director's reasonable discretion an adjustment to the location or number of Common Use Ticket Counters and Common Use Support Facilities would be desirable, the Director may designate for Common Use additional ticket counters and Support Facilities. The Director may also change ticket counters and Support Facilities from Common Use to Joint Use or Exclusive Use for lease to Signatory Airlines.

Section 310 Charges for Common Use Gates, Ticket Counters and Support Facilities. City shall determine the fees for the use of Common Use Gates, Common Use Ticket Counters and Common Use Support Facilities as part of its annual determination of Airport fees.

Section 311 Shared Use Equipment. The City reserves the right to install Shared Use Equipment at all Common Use and Joint Use Gates and Ticket Counters on a position-by-position basis. Airline shall remove any of its computer equipment installed at a Common Use or Joint Use Gate or Ticket Counter upon thirty (30) days written notice from Director. Any

such removal of computer equipment installed by Airline during the Term of this Agreement shall be subject to the provisions of Section 1601.

Section 312 Self-Service Devices. Airline may only install proprietary self-service devices for passenger processing at ticket counters within Airline's Exclusive Use Space, which installation shall be subject to the Director's approval. Airline shall remove any proprietary self-service devices built within such ticket counters when those counter spaces are later surrendered by Airline or reclaimed by City in accordance with Sections 212, 213 or 214. Any removal of self-service devices installed during the Term of this Agreement shall be subject to the provisions of Section 1601 hereof. All freestanding self-service devices will be considered on a case by case basis, at the Director's sole discretion, including requests to install proprietary freestanding self-service devices in a Domestic Terminal adjacent to Exclusive Use Space or at a Preferential Use Gate. Requests by a domestic Air Carrier to install proprietary freestanding self-service devices in the IT at dedicated check-in positions in a dedicated ticket aisle (i.e. operated solely by such Air Carrier) will be considered on a case by case basis, at the Director's sole discretion.

ARTICLE 4. RENTALS AND FEES

Section 401 Reports and Payments. Airline and City shall deliver the reports and notices regarding Airline Rates and Charges as set forth below, and Airline shall pay to City, without demand or notice other than any invoices provided by City hereunder, and without deductions or set-off, for the use of all premises and facilities, easements, rights, licenses and privileges granted hereunder, the following rentals, fees and charges during the Term hereof:

A. Notice of Rates and Charges. Not later than sixty (60) days prior to the beginning of each Fiscal Year on July 1, City shall transmit to Airline a notice of the proposed rates and charges for said Fiscal Year. Within ten (10) days following the Commission's approval of the final rates and charges for the Fiscal Year, City shall transmit to Airline a notice of such final rates and charges for the ensuing Fiscal Year.

B. Payment of Rentals. Airline shall render payment of Terminal Area Rentals not later than the first day of each month for which they are due or shall be due, without demand or invoice.

C. Monthly Activity Reports; Payment of Landing and Other Fees.

(i) Airline shall, within fifteen (15) days following the end of each calendar month, transmit to City separate Activity Reports for itself and each of its Affiliate Airlines certifying for said month (1) the data necessary, including actual Revenue Aircraft Arrivals by type of equipment, to calculate the amount of Landing Fees incurred by Airline and its Affiliate Airlines during such month, (2) the number of enplaned and deplaned revenue and non-revenue passengers for Airline and its Affiliate Airlines, (3) the data on actual enplaned and deplaned cargo by cargo type for Airline and its Affiliate Airlines, (4) the data necessary on actual jet bridge usage activity to calculate the amount of jet bridge usage fees incurred by Airline and its Affiliate Airlines, (5) any other information required by the Joint Use Formulas applicable to Airline and its Affiliate Airlines, (6) other required Billing and Operational Information, and (7)

data required to calculate the projection of Non-Airline Revenues necessary for determining airline required revenue, the analysis and forecasting of air traffic, and Airport performance metrics.

(ii) In accordance with Sections 403 and 503, Airline shall calculate such Landing Fees incurred during said month and shall pay such amount on behalf of itself and its Affiliate Airlines within fifteen (15) days after the end of each calendar month, without demand or invoice from City, at the same time it submits the Activity Report. The acceptance by City of any such payment shall not preclude City from questioning the accuracy of Airline's Activity Report submitted to City as provided herein and upon which the Landing Fees are based.

D. Failure to Transmit Activity Report. In the event that Airline fails to transmit to City the Activity Report with data necessary to calculate the amount of Landing Fees incurred by Airline and its Affiliate Airlines during said month, City shall compute and bill Landing Fees based upon data available as though the Revenue Aircraft Arrivals and other data were the same as during the highest month in the immediately preceding Fiscal Year or in the current Fiscal Year, whichever is higher. After receipt of the delinquent Activity Report from Airline, City shall recalculate Landing Fees for the month in question based upon the Activity Report. If the actual Landing Fees are higher than the Landing Fees paid by Airline, the deficiency shall be billed by City to Airline, as applicable. If the actual Landing Fees are less than the Landing Fees paid by Airline, the excess shall be credited by City to Airline. In the event that Airline fails to deliver the Activity Report when due, Airline's proportionate share of fees and charges, where applicable under this Agreement, may be determined at the option of City as though the number of passengers or level of usage were the same as during the highest month during the immediately preceding Fiscal Year or in the current Fiscal Year, whichever is higher.

E. Electronic Reporting, Billing and Payment Systems. City may elect to implement one or more electronic reporting, billing and/or payment systems to collect Airport activity information, disseminate billing information and process payments as an alternative to the methods described above. If City elects to utilize any such systems during the Term of this Agreement, Airline shall make every reasonable effort to comply with the requirements applicable thereto. Airline shall continue to provide Activity Reports and payments as described above until such time as Airline commences use of any such electronic systems as implemented by City.

Section 402 Rent and Usage Fees.

A. As to all Exclusive Use Space and Preferential Use Space, from and after the Effective Date, Airline shall pay to City on a monthly basis as rental for such space, the product of the number of square feet comprising such space and the rate in effect from time to time for the Space Category comprising such space, as designated in Section 502(D). With respect to rent for Preferential Use Gates (i.e. holdrooms), please see Section 402(C) below.

B. Airline's Space Categories and square footage designated as "I", "II", "III", "IV" and "V" are assigned relative weighting values as described in Section 502(D) and are shown on Exhibit D.

C. The square footage of Preferential Use Gate space shall be based on an average square footage for Preferential Use Gates derived from the total demised square footage of Preferential Use Gates accepted by Signatory Airlines in each boarding area divided by the total number of Preferential Use Gates accepted by Signatory Airlines in each boarding area. Airline's Preferential Use Gate square footage for purposes of rental payments under Section 402(A) shall be based on the product of the Preferential Use Gate average square footage for each boarding area and the number of Preferential Use Gates accepted by Airline in each such boarding areas under Article 3. The Preferential Use Gate average square footage for each boarding area and Airline's Preferential Use Gate square footage shall be reviewed and, if required, adjusted each Fiscal Year in accordance with Gate assignments under Article 3.

D. Airline acknowledges and agrees that the rental rate for all Demised Premises is subject to adjustment from time to time based on changes to the Airport's rates and charges. For illustrative purposes, the attached Exhibit K describes the rent amounts applicable to Airline's Exclusive Use Space, Joint Use Space and Preferential Use Space as of the execution date of this Agreement.

E. As to all Joint Use Space, Airline shall pay to City on a monthly basis as rental for such space its proportionate share according to the applicable Joint Use Formula of the category rent applicable to such area.

F. Should Airline be allowed by City to make use of a Common Use Gate, a Common Use Ticket Counter, or Common Use Support Facilities, Airline shall pay to City, when invoiced by City for such use, the applicable use charges in effect at the time of such use, as determined by the City in accordance with Exhibit F. City reserves the right to modify the calculation of Common Use fees from time to time following consultation with the Signatory Airlines.

Section 403 Landing Fees. From and after the Effective Date, with respect to each month, Airline shall pay the sum of the Landing Fees applicable to each Revenue Aircraft Arrival of Airline and its Affiliate Airlines that occurred in such month. With respect to each Revenue Aircraft Arrival, the Landing Fees shall equal the higher of (i) the product of the Maximum Landing Weight for a Revenue Aircraft Arrival and the Landing Fee Rate; or (ii) the minimum landing fee for a Revenue Aircraft Arrival established by City from time to time.

Section 404 Payment for Utilities.

A. Until July 1, 2013, charges to Airline for direct use electric power shall be calculated in accordance with the terms and provisions of the Stipulated Judgment entered into by and between Trans World Airlines, Inc., American Airlines, Inc., United Airlines, Inc. and City dated as of September 14, 1982, in Civil Action Nos. C-76-1386 RPA, C-76-1387 RPA and C-76-1388 RPA, United States District Court for the Northern District of California, which is incorporated herein by this reference. Such terms and provisions shall govern such calculations notwithstanding any portion of said Stipulated Judgment that might be construed to the contrary. On July 2, 2013, following the expiration of the Stipulated Judgment referenced above, the City

reserves the right to continue providing electricity to Airline and other Airport tenants, and to charge legally established rates for such service.

B. City reserves the right to continue providing Airline and other Airport tenants with utility services, including gas, water, sewer, Information and Communications Technology, Shared Use Equipment, rubbish removal and other utilities and services, including, but not limited to, new technology-related services as provided in Section 803, and to charge Airline and other Airport tenants legally established rates for such utilities and services.

Section 405 Other Fees. City reserves the right to establish, modify and assess from time to time, and Airline agrees to pay, reasonable charges for the use of additional City-provided facilities, equipment and services including, but not limited to:

A. Use of Common Use Gates, Ticket Counters and Support Facilities calculated as described below and illustrated in Exhibit F:

(i) The Common Use fee and any fees determined under Subsection (A)(iii) for any Air Carrier shall be recalculated as provided in Section 310.

(ii) Narrow-body aircraft shall be charged 100% of the Common Use fee and wide-body aircraft shall be charged 115% of the Common Use fee.

(iii) Common Use fee revenue resulting from use of Common Use Gates in the IT shall be applied equally between Joint Use Space in the IT and any Terminal Company providing services in the IT, or as otherwise agreed between City and such Terminal Company. If no Terminal Company is providing services in the IT, such revenues shall be applied entirely to Joint Use Space in the IT.

B. Use of City-owned loading bridges and related equipment not being charged for through Common Use Gate fees, if applicable.

C. Use of other specialized Terminal Area equipment.

D. Use of designated aircraft parking sites.

E. Use of designated employee parking facilities by Airline's employees at rates established from time to time by City.

F. Terminal Area cleaning and other specialized services requested by Airline or permitted under this Agreement.

G. Security and personnel identification badges for Airline's personnel.

H. Office services, such as facsimile, photocopying, or telephone provided by City. Charges for these services shall be at the rates that City customarily charges for such services.

Section 406 Payment Details. All payments hereunder shall be paid at the office of Director, or at such other place as Director may from time to time designate in writing. All amounts shall be paid in lawful money of the United States, free from all claims, demands, set-offs, or counterclaims of any kind. Any amounts not paid when due shall be subject to a service charge equal to the lesser of the rate of one and one half percent (1.5%) per month and the maximum rate permitted by law. Acceptance of any service charge shall not constitute a waiver of Airline's default on the overdue amount or prevent City from exercising any of the other rights and remedies available to City.

Section 407 Prepayment of Terminal Area Rentals/Landing Fees. Notwithstanding anything to the contrary herein, in the event Airline shall fail to pay any amount, including Terminal Area Rentals and Landing Fees when due hereunder (whether for itself or its Affiliate Airlines), Director shall have the right to require Airline to pay estimated Terminal Area Rentals, Landing Fees, and all other amounts due hereunder in advance of the month during which the same shall accrue. For Landing Fees and other fees based on usage, prepayment shall be based on the highest previous fees charged to Airline in the previous 12 months. The Director may exercise such right by giving written notice to Airline at any time after such default by Airline, regardless of whether the same is cured by Airline.

Section 408 Accounting. Airline shall maintain separate and accurate daily records of Airline's operations hereunder for a period of five (5) years, or, in the event of a claim by City, until such claim of City for payments hereunder shall have been fully ascertained, fixed and paid. All such books and records shall be kept in accordance with generally accepted accounting principles, consistently applied, showing in detail all business done or transacted in, on, about or from or pertaining to the Airport. Upon Director's written request, Airline shall make available immediately to City and/or its auditors any and all books, records and accounts pertaining to its operations under this Agreement.

ARTICLE 5. ADJUSTMENT OF AIRLINE RATES AND CHARGES

Section 501 Periodic Review. The Terminal Area Rentals and Landing Fees set forth in Article 4 shall be re-examined and re-adjusted annually in accordance with the provisions of this Article 5.

Section 502 Method of Adjusting Terminal Area Rentals. Not less than ninety (90) days before the end of the then-current Fiscal Year, Airline shall submit to City in writing any proposed additions to its Demised Premises for the ensuing Fiscal Year. Likewise, not less than ninety (90) days before the end of the then-current Fiscal Year, City shall submit in writing to the Signatory Airlines its budgetary forecast for the Terminal Area, Groundside Area and Utilities Area for the ensuing Fiscal Year. From such data and consistent with the Airport Cost Accounting System, City shall calculate the proposed Terminal Area Rentals for each Space Category for the ensuing Fiscal Year and shall forward such proposed Terminal Area Rental calculations to the Signatory Airlines not less than sixty (60) days before the end of the then-current Fiscal Year. City and Airline agree that in calculating Terminal Area Rentals for each Space Category, City shall comply with the following basic methods:

A. Calculation of Annual Basic Rentals:

(i) City shall calculate the estimated total annual Terminal Area costs (the "Terminal Area Expenses") in accordance with the Airport Cost Accounting System illustrated in Exhibit O, including the estimated Annual Service Payment derived in accordance with Section 502(B).

(ii) If City estimates a deficit or surplus in Section 505, City shall include the allocable portion of that deficit or surplus as an addition to Terminal Area Expenses for the ensuing Fiscal Year.

(iii) City shall divide the estimated total Terminal Area Expenses, as calculated in Subsections (A)(i) through (A)(ii), by the Gross Terminal Space in the Terminal Area to arrive at City's estimated Basic Rate per square foot for all Terminal Area Space.

(iv) City shall determine the aggregate Basic Rentals payable by the Signatory Airlines, including Airline, for Exclusive Use Space, Joint Use Space, or Preferential Use Space by multiplying City's estimated Basic Rate for all Terminal Area Space by the Airline Leased Space.

B. Calculation of Annual Service Payment:

(i) In each Fiscal Year during the Term of this Agreement, City shall include, as an item of expense in the budgetary forecast of Terminal Area Expenses, an amount equal to fifteen percent (15%) of forecasted Concession Revenues to fully compensate City for all indirect services, management and facilities provided by City in the operation of the Airport.

(ii) In the event that fifteen percent (15%) of Concession Revenues does not generate five million dollars (\$5,000,000) in any Fiscal Year, the Signatory Airlines, including Airline, agree that City may include, as an item of expense in the budgetary forecast of Terminal Area Expenses for the ensuing Fiscal Year, an amount equal to the difference between fifteen percent (15%) of Concession Revenues and five million dollars (\$5,000,000).

C. Calculation of Rental Surcharge (Basic Rental Adjustment):

(i) City shall determine its cost of the Public Space by multiplying the Basic Rate per square foot, arrived at in Subsection (A)(iii) of this Section, by the amount of Public Space in the Terminal Area.

(ii) City shall compute revenues from all sources in the Terminal Area, other than the Basic Rentals to be paid by the Signatory Airlines, including Airline, pursuant to Subsection (A)(iv) of this Section, in accordance with the Airport Cost Accounting System illustrated in Exhibit O.

(iii) City shall also calculate any excess of revenues over expenses or any excess of expenses over revenues forecasted to result from its operation of the Groundside Area. Any net expense forecasted from operation of the Groundside Area shall be included in a

surcharge calculation under Subsection(C). Any net revenues forecasted from operation of the Groundside Area shall be applied to the calculation of the Landing Fees as specified in Subsections of Section 503. In calculating net revenues or net expenses in the Groundside Area, revenues from parking facilities shall be applied to pay the following in the order specified: (1) parking facility expenses; (2) debt service allocable to parking facilities; (3) other Groundside Area expenses; (4) other Groundside Area debt service; and (5) the Annual Service Payment.

(iv) To the extent that the expenses in Subsection (C)(i) exceed the revenues in Subsection (C)(ii), a surcharge (the "Rental Surcharge") will result. The Signatory Airlines, including Airline, shall pay fifty percent (50%) of the Rental Surcharge in the form of a "Terminal Area Rental Surcharge." The remaining fifty percent (50%) of the Rental Surcharge shall be paid by the Signatory Airlines, including Airline, as a "Landing Fee Surcharge" during the ensuing Fiscal Year.

(v) If the net revenues in Subsection (C)(ii) exceed the expenses in Subsection (C)(i), a "Basic Rental Adjustment" will result. The Basic Rental Adjustment will be credited 100% to the Signatory Airlines, including Airline, as a reduction of their Basic Rentals as calculated in Subsections (A)(i) through (iv), above.

D. The sum of the Basic Rentals and the Terminal Area Rental Surcharge (or the Basic Rental Adjustment), hereinafter referred to as "Terminal Area Rentals," paid by all Signatory Airlines for Airline Leased Space, shall be converted to specific "Terminal Rental Rates" for the five (5) Space Categories as shown below:

| <u>Category</u> | <u>Function</u> | <u>Relative Value</u> |
|-----------------|--|-----------------------|
| I | Ticket Counters Holdrooms Service Counters and Kiosks | 1.00 |
| II | VIP Clubs and Lounges Baggage Claim Lobbies Baggage Service Offices Curbside Check-in Other Enclosed Space Departure Level and above | .75 |
| III | Other Enclosed Space Arrivals Level and below Non-Public Offices and Other Enclosed Areas Arrivals Level and below | .50 |
| IV | Inbound/Outbound Baggage Equipment Rooms | .25 |
| V | Other Unenclosed space Covered Area – Ramp Level | .10 |

For any given Fiscal Year, the Terminal Rental Rates for the Airline Leased Space square footage shall be calculated as illustrated in Exhibit O.

E. Notwithstanding any other provision hereof, if, at any time during any Fiscal Year, the actual expenses (including debt service) in the Terminal Area and Groundside Area are projected by City to exceed by ten percent (10%) or more, for such Fiscal Year, the actual revenues in the Terminal Area and Groundside Area, Commission may increase the Terminal Area Rentals, after using commercially reasonable efforts to reduce expenses and upon sixty (60) days' notice to, and in consultation with, the Signatory Airlines, including Airline. The Signatory Airlines, including Airline, shall pay such additional rentals or such lesser amounts which shall equal such projected deficiency for the remaining months of the then-current Fiscal Year.

Section 503 Method of Adjusting Landing Fees. Not less than ninety (90) days before the end of the then-current Fiscal Year, each Signatory Airline (including its Affiliate Airlines) shall submit to City in writing its landed weight forecast for the ensuing Fiscal Year. Not less than ninety (90) days prior to the end of the then-current Fiscal Year, City shall submit in writing to the Signatory Airlines its budgetary forecast for the Airfield Area, Airport Support Area, Groundside Area, Terminal Area, Utilities Area and West of Bayshore Area (as provided in Article 6 hereof) for the ensuing Fiscal Year. From such data and consistent with the Airport Cost Accounting System, City shall compute the Landing Fee Rate for the ensuing Fiscal Year and shall forward such computations to the Signatory Airlines not less than sixty (60) days before the end of the then-current Fiscal Year. City and Airline agree that the Landing Fee Rate shall be computed in accordance with the following basic methods:

A. City shall compute the revenues forecast to be received from all sources other than the Signatory Airlines under this Agreement from the Airfield Area, and the total expenses to be incurred in the Airfield Area. The excess, if any, of such expenses over such revenues ("Airfield Area Net Expense") shall be the basic cost element in the determination of Basic Landing Fees to be paid by the Signatory Airlines, including Airline, in the ensuing Fiscal Year.

B. City shall compute the projected revenues to be received and expenses to be incurred in the Airport Support Area in the ensuing Fiscal Year. The excess of such expenses over such revenues or any excess of such revenues over such expenses shall be included in the computations as an addition to or reduction of Airfield Area Net Expense.

C. If City estimates a deficit or surplus in Section 505, City shall include the allocable portion of deficit or surplus as an addition to Airfield Area Net Expense for the ensuing Fiscal Year.

D. After calculating Airfield Area Net Expense pursuant to the foregoing Subsections of this Section, City shall divide the resulting forecast of Airfield Area Net Expense by the composite landed weight forecast to arrive at the Basic Rate for the ensuing Fiscal Year.

E. Any net revenue forecasted from operation of the Groundside Area pursuant to Section 502(C)(iii) shall be applied to the Landing Fee Surcharge in Subsection (F).

F. If a Rental Surcharge is calculated in Subsection 502(C)(iii), then fifty percent (50%) of such Rental Surcharge shall be collected as a Landing Fee Surcharge during the ensuing Fiscal Year.

G. City shall divide the resulting forecast of Landing Fee Surcharge by the composite landed weight forecast provided by City based on information obtained from the Signatory Airlines, including Airline, to arrive at the Surcharge Rate for the ensuing Fiscal Year.

H. The sum of the Basic Rate and the Surcharge Rate shall equal the Landing Fee Rate for the ensuing Fiscal Year.

I. The sum of the Basic Landing Fees and the Landing Fee Surcharge shall equal the Landing Fees for the ensuing Fiscal Year.

J. Notwithstanding any other provision hereof, if at any time during any Fiscal Year, the actual expenses (including debt service) in the Airfield Area and Airport Support Area are projected by City to exceed by ten percent (10%) or more, for such Fiscal Year, the actual revenues in the Airfield Area and Airport Support Area, Commission may increase the Landing Fees, after using commercially reasonable efforts to reduce expenses and upon sixty (60) days' notice to, and in consultation with the Signatory Airlines, including Airline. The Signatory Airlines, including Airline, shall pay such additional Landing Fees or such lesser amounts that shall equal such projected deficiency for the remaining months of the then-current Fiscal Year.

K. City shall charge non-Signatory Airlines (excluding Affiliate Airlines which shall pay the Landing Fees available to Signatory Airlines) a twenty-five percent (25%) premium on Landing Fees.

Section 504 Review of Adjusted Rentals and Fees.

A. Unless otherwise requested by a Majority-in-Interest, Director shall call a meeting with the Signatory Airlines to be held not less than fifteen (15) nor more than thirty (30) days after forwarding, pursuant to Sections 502 and 503, the Terminal Area Rentals and Landing Fee Rate proposed for the ensuing Fiscal Year for the purpose of reviewing such rentals and fees with the Signatory Airlines. City understands and agrees that, in advance of the said meetings, it shall make available to the Signatory Airlines any additional information reasonably requested by them regarding the budgetary forecasts forwarded pursuant to Sections 502 and 503. The City shall give due regard to any comments offered by the Signatory Airlines on the proposed calculations of the Terminal Area Rentals and Landing Fee Rate for the ensuing Fiscal Year. Within thirty (30) days after the meeting, or the forwarding of the rentals and fees to the Signatory Airlines if no meeting shall be held, the rentals and fees, as calculated by City in accordance with this Agreement and the Master Bond Documents, shall become effective.

B. Airline and City agree that the time periods for notices, meetings, exchanges of information and for the establishment of the Terminal Area Rental Rates and the Landing Fee Rate as provided for in this Article 5 may be altered by the Commission if deemed by the Commission to be necessary to meet the time requirements of City's annual budgetary process; provided, that the number of days allocated for Signatory Airline review of data submitted by

City shall not, without good cause, be reduced; and, provided further, that the Commission and the City shall use commercially reasonable efforts to establish Terminal Area Rental Rates and Landing Fee Rate for any Fiscal Year within one hundred twenty (120) days following the commencement of the Fiscal Year for which rates are being developed, and, when so finally determined, such rentals and fees shall be made retroactive to the first day of such Fiscal Year.

Section 505 Reconciliation of Airline Rates and Charges and Application of Prior Period Deficits (Surpluses).

A. As part of City's preparation of its annual audited financial statements, City shall calculate any deficit or surplus in Airline Rates and Charges using actual expenses (including the amount, if any, required to meet the Rate Covenant in the Master Bond Documents for such Fiscal Year) and Non-Airline Revenues to determine any deficit or surplus in the amount of Airline Rates and Charges. Any such deficit or surplus would be recorded as part of that Fiscal Year's financial data and would result in an adjustment to the amount carried on the balance sheet as the Deferred Aviation Revenue liability (or receivable, if appropriate).

B. The Deferred Aviation Revenue liability (or receivable, if appropriate) balance shown at the end of the preceding Fiscal Year, together with any deficit or surplus estimated in the budgetary forecast for Airline Rates and Charges during the then-current Fiscal Year, would constitute the amount of deficit or surplus available to be applied in the ensuing Fiscal Year.

C. If the determination referenced in Subsection (B) above results in an estimated deficit for the then-current Fiscal Year and this deficit exceeds or will exceed the total budgetary forecast by five percent (5%), then the Signatory Airlines must be advised in writing at the time that City becomes aware of the aforementioned deficit.

D. The amount of deficit or surplus determined by City to be applied to the calculation of the ensuing Fiscal Year's Airline Rates and Charges will be allocated between adjusted Terminal Area Expense and Airfield Area Net Expense in proportion, respectively, to Terminal Area Rentals and Landing Fees to total Airline Rates and Charges.

ARTICLE 6. CAPITAL IMPROVEMENTS

Section 601 Financing of Capital Improvements.

A. Except as provided in Subsection (B) hereof, City agrees to use commercially reasonable efforts to finance Capital Improvements through the use of grants, TSA funding and PFCs, and through the issuance of Airport Revenue Bonds. City may, in its discretion, finance through the issuance of Airport Revenue Bonds: (i) Capital Improvements with a useful life of less than three (3) years but more than one (1) year or a cost of less than the Charge Trigger Amount, and (ii) maintenance or operating expenses or other expenses.

B. During the Term of this Agreement, no Capital Improvement provided for in this Section or Section 602 shall be financed from current revenues; provided, however, the Commission may appropriate from current revenues up to four million two hundred thousand

dollars (\$4,200,000) in Fiscal Year 2008/2009 dollars, as adjusted by the Index, in any Fiscal Year, for use pursuant to Sections 16.104(b)(5) and (6) of the City Charter (or any successor legislation) or such additional amounts as may be approved by a Majority-in-Interest.

Section 602 Review of Capital Improvements.

A. Any Capital Improvement, which would result in a charge to Airline in the Terminal Area Rentals or Landing Fees, having a cost in excess of the Charge Trigger Amount, excluding any capital improvements made in the development of the West of Bayshore Area, are subject to the provisions of paragraph B and C of this Section unless:

(i) The Capital Improvement is required by a federal or State agency having jurisdiction over Airport operations;

(ii) The Capital Improvement is financed by the issuance of Special Revenue Bonds; or

(iii) The Capital Improvement is of an emergency nature, which, if not made, would result in the closing of the Airport within forty-eight (48) hours.

The cost of each Capital Improvement shall include the cost of planning and design, if any.

B. Unless the Capital Improvement meets one of the conditions set forth in Subsections (A)(i), (A)(ii) or (A)(iii) of this Section, the Signatory Airlines shall be notified in writing of the proposed Capital Improvement and the decision of a Majority-in-Interest whether or not to object to the Capital Improvement shall be forwarded to City within forty-five (45) days of the Airport providing full information to Signatory Airlines on the proposed project in substantially the form set forth in Exhibit Q (as such form may be revised by City from time to time). The Director, at his or her sole discretion, may extend the forty-five (45) day period for the Majority-In-Interest to file objection. Airline covenants that, in the exercise of its discretion regarding objections to Capital Improvements, it will base its decision upon prudent judgment and sound airport management policies.

C. City shall not proceed with any Capital Improvement that has been objected to by a Majority-in-Interest for a period or periods specified by the Signatory Airlines not to exceed six (6) months in the aggregate from the date of the Signatory Airlines' notice of objection to said Capital Improvement proposal. During such time, the Signatory Airlines may develop and present their opposition to said Capital Improvement to the Commission at a public hearing, or otherwise. At the end of such six (6) months period, City may proceed with the Capital Improvements notwithstanding objection by a Majority-in-Interest.

D. City may pledge Revenues as further security for Special Revenue Bonds, or issue Airport Revenue Bonds to refund Special Revenue Bonds, if (i) the Signatory Airlines are notified in writing of the proposed pledge or issuance, and (ii) the Majority-in-Interest approves the pledge or issuance within forty-five (45) days of the mailing to Signatory Airlines of the

notification. City shall not proceed with any such pledge or issuance that is not so approved by a Majority-in-Interest.

Section 603 Development of West of Bayshore Area.

A. The Signatory Airlines shall have no responsibility for and shall not bear, directly or indirectly, any costs involved in developing the West of Bayshore Area, such costs to include expenses associated with any architectural, engineering and other consultant studies, and evaluations or reports related to potential development projects. The Signatory Airlines recognize, however, that the maintenance costs of the property in its current undeveloped state will be attributed to the Airport and that such costs are included in calculations to determine Landing Fee Rates. It is understood and agreed that maintenance costs for the whole or portions of the West of Bayshore Area shall continue to be attributed to the Airport only until the commencement of development (as evidenced by physical work performed in the West of Bayshore Area) of the West of Bayshore Area or such portion(s) thereof or its lease, sale or other transfer to any other department of City or any other entity.

B. After the commencement of development of the West of Bayshore Area or portions thereof or its lease, sale or other transfer, said West of Bayshore Area or portions thereof shall be developed, operated and maintained solely with non-Airport revenues, and without Airport revenues being pledged directly or serving indirectly as security for debt incurred for such purposes. Except as otherwise provided in this paragraph, the Signatory Airlines will have no claim to any revenues generated by the West of Bayshore Area as a result of its development, nor any control or claim as to the manner in which City uses, transfers, diverts or disposes of such revenues, nor any right to approve or challenge the development, transfer, sale, leasing or other disposition of the West of Bayshore Area or any part thereof. Claims to the benefits of development in the West of Bayshore Area or requirements of approval or support by any persons or authorities other than the Signatory Airlines are the sole responsibility and risk of City.

C. The Commission, the Board and the City agree that any development of the West of Bayshore Area shall be in a manner consistent with maintaining the integrity of the Cost Centers and Airport revenues attributable thereto, as provided in this Agreement. The Commission and the City agree not to relocate present Airport businesses or concession operators to the West of Bayshore Area or induce prospective businesses or concession operators to locate within the West of Bayshore Area rather than the Airport to the detriment of Airport revenues or the Signatory Airlines and further agree that any lease, sale or other transfer of the property will contain these covenants.

D. Notwithstanding the foregoing, it is agreed that City may develop a hotel, office complex, shopping center, or warehousing in the West of Bayshore Area and may locate any other business facility or concession in the West of Bayshore Area that City has made a good faith effort to locate or accommodate on the Airport and which cannot be physically so located or accommodated. Parking facilities, if any, shall not be made available to the public at rates below those in effect, from time to time, at Airport remote parking lots.

ARTICLE 7. MISCELLANEOUS COVENANTS OF CITY

Section 701 Prudent Operation. City covenants that it will efficiently manage and operate the Airport on the basis of sound business and airport management principles in effect at airports of comparable size in the continental United States and with efficient and prudent control of all capital and operating expenses.

Section 702 Revenues From Non-Airline Sources. Consistent with the provisions of Section 701, City agrees that it will use commercially reasonable efforts to operate the Airport in a manner consistent with its strategic marketing and public relations plans in order to maximize revenues from concessionaires, lessees and other non-airline users; provided, however, that City will not permit the installation of concession facilities in such a manner or at such locations in the Terminal Area as will materially obstruct traffic or impede Airline's ability to perform the functions enumerated in Section 202.

Section 703 Airfield Area Users. City agrees that it shall require all users of the Airfield Area to pay for their use thereof. The portion of Airfield Area expenses payable through fees to be charged to other than Signatory Airlines and their Affiliate Airlines may be based on some collection method other than a per-thousand-pounds landing fee rate, but whatever the method of payment, whether it be by aviation fuel through-put charges paid to City or by minimum flat-rate landing fees or other means, the amounts so paid to City shall be credited to the Airfield Area or to the Airport Support Area, as appropriate, so as to reduce the amount of Airfield Area Net Expense to be collected from the Signatory Airlines and their Affiliate Airlines through Landing Fees. City agrees that it will adjust such fees charged to users of the Airfield Area other than the Signatory Airlines and their Affiliate Airlines from time to time to reflect its changing costs due to inflation, improvements, betterments or increased demands placed upon the Airfield Area facilities.

ARTICLE 8. PIPELINES AND UTILITIES

Section 801 Reservations by City. It is understood and agreed that Commission acting on behalf of City reserves and retains the right, with reasonable advance notice to Airline, to construct, reconstruct, install, repair, remove, renew, operate and use pipelines, utility lines, roadways, or structures for Airport purposes across, over, or under any of Airline's rights of way or Demised Premises, but Airline's enjoyment of its rights of way or Demised Premises shall not be unnecessarily interfered with.

Section 802 Relocation of Pipelines. In the event that any pipeline, utility line or appurtenance installed by Airline be so located that it shall be necessary to change, alter, relocate or reconstruct same in order to allow City to install sewer or drain lines, such change, alteration, relocation or reconstruction of said pipeline shall be made as requested by Commission. The cost of such change, alteration, relocation or reconstruction of said pipelines shall be borne by Commission as an Airport expense.

Section 803 Information and Communications Technology; Utilities.

A. City has provided or shall provide in or in the vicinity of the Demised Premises the following utility services: water, electricity, Information and Communications Technology, Shared Use Equipment, sewage outlets, heating, ventilation, and air conditioning of the Demised Premises as indicated in the plans and specification thereof. Airline shall ascertain from City, and City shall make available, the information as to the points at or near the Demised Premises where such services will be brought by City at the cost and expense of the Commission as an Airport expense. All extensions of the facilities requested by Airline for said utility services from said points shall be at the sole cost and expense of Airline, unless other arrangements are made therefor. In the event of any change desired by Airline as to said points of supply by City, the expense of making such changes shall be at the sole cost of Airline. Except as otherwise provided herein, and consistent with Section 404 of this Agreement, Airline shall pay the whole cost at legally established rates for all utility services and for such other special services which it may require in the Demised Premises. Airline shall not be charged for the supply of heating, ventilation, and air conditioning of the Demised Premises.

B. City agrees that supply points for utility services shall be generally equal for all Signatory Airlines, including Airline.

ARTICLE 9. DEVELOPMENT, MAINTENANCE, AND OPERATION OF AIRPORT

Section 901 Operation of Airport. City agrees that it will develop and improve and at all times maintain and operate with adequate and efficient personnel and keep in good repair the Airport (other than the Demised Premises which Airline is required to maintain and repair in accordance with Section 902) and the appurtenances, facilities, and services now or hereafter connected therewith, and that it will keep the Airport and its approaches free from obstruction, and will maintain and operate the Airport so as to entitle it to the approved certification and rating by the FAA and all other appropriate regulatory authorities in respect to all present operations of Airline. It is expressly understood that City will keep the Public Space in the Terminal Area in a clean, neat, safe and sanitary condition and attractively furnished and shall be responsible for and shall furnish in the Public Space and the Demised Premises the services and maintenance indicated on Exhibit C. It is likewise expressly understood that Airline will perform its responsibilities as indicated on Exhibit C in a diligent manner conducive to the best operation of the Airport.

Section 902 Condition of Demised Premises and Janitorial Services. Except as otherwise set forth in Section 901 and Exhibit C, Airline agrees to repair and maintain the Demised Premises, including the fixtures and equipment which are a part thereof, in a clean, neat, safe and sanitary condition, and in good order, at all times, except for damages or loss due to reasonable wear and tear, fire or other casualty or other cause beyond Airline's control. All waste matter shall be stored in compliance with applicable Environmental Laws and Airport Rules, and Airline agrees to arrange for the daily disposal, at its expense, of all waste material, except in the case of special agreement with Director. All lawful requirements of the County or State Board of Health, relating to health or sanitary regulation adopted by any legal authority with jurisdiction, shall be fully met by Airline, and Airline upon request shall give access for inspection purposes to any

duly authorized representative of said legal authority or of City. Except as otherwise set forth in Exhibit C (which provides that, subject to Section 701, City shall furnish the janitorial services, window washing, and cleaning, maintenance, replacement and repair of carpets and seating (but not equipment) in holdrooms and baggage claim lobbies), janitorial services, carpet cleaning, maintenance and repair and window washing on the Demised Premises will be furnished by Airline. Airline expressly waives all rights to make repairs at the expense of City, to vacate the Demised Premises, or to terminate this Agreement for failure by City to keep the Demised Premises in good order, condition or repair as provided for in Sections 1941 and 1942 of the California Civil Code.

Section 903 Airline Improvements.

A. Airline shall, at its sole expense, install all Alterations which Airline deems necessary for the use of the Demised Premises and which are not supplied by City. Airline shall not make or suffer to be made any Alterations without Director's prior written consent. Airline shall cause all such Alterations to be performed in a workmanlike manner, in compliance with the requirements of the Airport TI Guide, Section 907, and, to the extent applicable, the Local Hiring Requirements outlined in Section 1821. Without limiting the generality of the foregoing, all Alterations shall conform to Commission's established architectural design scheme for the Airport, and may require the approval of the Airport's Design Review Committee. Prior to the construction of any Alterations, Airline shall submit detailed plans and specifications to the Director for approval. Airline shall include with its plans and specifications schematic renderings of the common area, materials, and a color board. Director's approval rights will extend to and include architectural and aesthetic matters and City reserves the right to reject any designs submitted and to require Airline to resubmit designs until they meet Director's approval. In the event of disapproval by City of any portion of the plans and specifications, Airline will promptly submit necessary modifications and revisions thereof. No changes or alterations will be made in said plans or specifications after approval by Director. City agrees to act within a reasonable period of time upon such plans and specifications and upon requests for approval of changes or alterations in said plans or specifications. One copy of plans for all proposed Alterations will, within fifteen (15) days after approval thereof by Director, be signed by Airline and deposited with City as an official record thereof. All Alterations shall be effected through the use of contractors approved by Director who shall furnish to Director upon demand such completion bonds and labor and material bonds as Director may require so as to assure completion of the Alterations on a lien-free basis. Without limiting the requirements set forth above, Airline acknowledges and agrees that Airline may be required to obtain approvals for any desired Alterations from the Airport's Building Inspection and Code Enforcement Section.

B. Airline shall obtain and pay all fees for building, mechanical, electrical and plumbing permits and like permits required by any legal authority having competent jurisdiction for any improvements or additions requiring construction in the Demised Premises. Airline shall, upon request of Director, exhibit to City all certificates and permits required by the laws of any legal authority having jurisdiction. Airline agrees to give City advance written notice, which, except in the case of emergency repairs, shall be given at least three (3) days before commencing any construction, alteration or repairs on the Demised Premises in order that City may post appropriate notices of non-responsibility. Airline agrees that such notices may remain

posted on the Demised Premises until completion and acceptance of such work. Airline shall also conduct a pre-construction conference with City before commencing any Alterations in the Demised Premises.

C. Except as provided in Section 1601 below, any Alterations of the Demised Premises, except movable furniture and trade fixtures, shall at once become a part of the realty and belong to City and shall be surrendered with the Demised Premises at the expiration of the Term hereof or any extension thereof, or upon earlier termination as provided for herein. Upon surrender of the Demised Premises, Airline shall provide City with current as-built drawings of the Demised Premises, or shall reimburse City for the cost of creating such as-built drawings.

D. If and to the extent that Airline's activities or proposed Alterations trigger an obligation or requirement on the part of City to make changes to the Airport premises (including ADA and ACAA requirements), Airline shall indemnify, defend, and hold harmless City from and against any and all losses, costs, claims and liabilities arising out of such activities or Alterations.

Section 904 Maintenance and Repair; Operator Training.

A. AIRLINE SPECIFICALLY ACKNOWLEDGES AND AGREES THAT ANY SPACE LEASED TO OR USED BY AIRLINE IS ON AN "AS IS WITH ALL FAULTS" BASIS AND THAT AIRLINE IS NOT RELYING ON ANY REPRESENTATIONS OR WARRANTIES OF ANY KIND WHATSOEVER, EXPRESS OR IMPLIED, FROM CITY OR ANY CITY ENTITY, AS TO ANY MATTERS CONCERNING SUCH SPACE.

B. As to all Exclusive Use Space, Preferential Use Space and other Demised Premises (including Joint Use Space) (other than holdrooms and baggage claim lobbies) if and to the extent Airline is responsible for such Demised Premises pursuant to Section 902 and Exhibit C, Airline shall, at its own expense, (i) keep the Demised Premises in good repair and neat and clean condition at all times; and (ii) redecorate and paint the interior of the Demised Premises and replace electric light bulbs, worn carpeting or other floor coverings, curtains, draperies, blinds or other furnishings and equipment as their conditions may require.

C. Commission acting on behalf of City agrees, if and to the extent City is responsible pursuant to Exhibit C, to keep, operate and maintain the facilities and space described below in good condition and repair, and in a neat, clean and operating condition, including replacing all worn-out fixtures, furnishings, carpeting and other floor coverings, machinery and equipment as may be required:

(i) the Terminal Area, including, but not limited to, its foundation, structure, outside walls, roof and utility systems;

(ii) the Public Space and Common Use Space in the Terminal Area, including, but not limited to, the lobby, waiting rooms, passageways, nonexclusive baggage handling space (except for baggage conveyor systems owned by Signatory Airlines), public restrooms, elevators and escalators, together with all fixtures, furnishings, and carpeting or other floor coverings located therein; and

(iii) the holdrooms and baggage claim lobbies in the Demised Premises.

D. City shall determine the training responsibility for any passenger loading bridges, baggage handling systems and other equipment owned by City and used or maintained by Airline or Airline Entity. When Airline is responsible for such training, City reserves the right to approve training content and to audit training records. Airline shall not permit any untrained personnel to operate or maintain any City-owned passenger loading bridges, baggage handling systems or equipment.

Section 905 Inspections; Audit of Operations.

A. Director may cause the Demised Premises and Airline's operations therein to be inspected at any time and from time to time in the presence of Airline or Airline Entity, to confirm that such operations comply with the requirements set forth herein. Airline shall cooperate with such inspection. In the event such inspection shows that Airline is not complying with such requirements, without limiting City's ability to call an Event of Default hereunder, City may require that Airline reimburse City for the costs of such inspection. Airline shall promptly remedy any noncompliance shown in any such inspection.

B. Director may cause the Airline's operations hereunder to be audited at any time and from time to time, with reasonable advance written notice and at a mutually agreeable time, and in the presence of Airline or its representative, to confirm that such operations comply with the requirements set forth herein. Airline shall cooperate with such audit. Airline shall be provided the opportunity to review and comment on the findings of such audit prior to finalization. In the event such audit shows that Airline is not complying with such requirements, without limiting City's ability to call an Event of Default hereunder, City may require that Airline reimburse City for the costs of such audit. Airline shall promptly remedy any noncompliance shown in any such audit.

C. This Section 905 shall not govern inspections or audits for compliance with Environmental Laws. Such inspections and audits are subject to the provisions set forth in Sections 2003 and 2006, respectively.

Section 906 Trespass and Security. Airline shall use reasonable precautions to prevent unauthorized persons from gaining access to restricted flight and public aircraft operational areas and all other nonpublic areas of the Airport. Further, Airline, its officers, employees, agents, and those under its control, shall comply with security measures (a) required of Airline by the FAA, TSA or City in accordance with applicable requirements of the FAA or the TSA or the City or their authorized successors, or (b) contained in any Airport master security plan approved by the FAA, TSA or City or their authorized successors. If Airline or any Airline Entity shall fail or refuse to comply with said measures and such non-compliance results in a monetary penalty being assessed against City, Airline shall be responsible for and shall reimburse City in the full amount of any such monetary penalty or other damages, in addition to other penalties or remedies available to City under this Agreement.

Section 907 Compliance with Code Requirements. Airline shall promptly, at its sole expense, cause Airline's use of the Airport and operations therein to comply at all times with all applicable present and future federal, State and local laws, as the same may be amended from time to time, including all applicable laws relating to (a) health and safety, (b) disabled access, including the ADA and the ACAA, (c) the Code Requirements, and (d) the Airport Rules. (Airline's obligation to comply with Environmental Laws is set forth in Article 20.) Airline shall also promptly, at its sole expense, cause the Demised Premises and related equipment to comply with all applicable Code Requirements and Airport Rules to the extent such portions of the Demised Premises and/or equipment are deemed an Airline responsibility pursuant to Exhibit C attached hereto. The parties acknowledge and agree that such obligations are a material part of the bargained for consideration under this Agreement. Any work or installations made or performed by or on behalf of Airline or any person or entity claiming through or under Airline on the Demised Premises shall be subject to and performed in compliance with the provisions of this Agreement, including this Section. Airline shall keep current all licenses and permits, whether municipal, county, Airport, State or federal, required for conduct of its operations at Airport, and pay all fees promptly when due. Airline shall promptly upon reasonable request provide City with evidence of its compliance with any of the obligations required under this Section.

Section 908 Trash Removal. Airline shall at all times cause the Demised Premises and the areas around the Demised Premises to be clean, sightly and free from trash. Airline shall not store nor allow accumulation of trash or debris on the Demised Premises, nor use City's trash containers without Director's prior consent. Airline shall provide its own trash containers for its use. As provided in Section 1503, in the event that Airline fails to perform the aforementioned obligations, the Airport shall have the right to do so, at Airline's expense.

Section 909 Taxes. Airline recognizes and understands that this Agreement may create a possessory interest subject to property taxation and that Airline may be subject to the payment of property taxes levied on such interest. Airline further recognizes and understands that any Transfer permitted under this Agreement and any exercise of any option to renew or other extension of this Agreement may constitute a change in ownership for purposes of property taxation and therefore may result in a revaluation of any possessory interest created hereunder. Airline shall pay all taxes of any kind, including possessory interest taxes, that may be lawfully assessed on the real property interest hereby created and pay all other taxes, excises, licenses, permit charges and assessments based on Airline's usage of the Demised Premises, all of which shall be paid when the same become due and payable and before delinquency.

Airline shall report any Transfer, or any renewal or extension hereof, to the County of San Mateo Assessor within sixty (60) days after such Transfer, renewal or extension. Airline further agrees to provide such other information as may be requested by the City within sixty (60) days of said request to enable the City to comply with any reporting requirements under applicable law with respect to possessory interests.

Section 910 Other Liens. Airline shall not permit or suffer any liens to be imposed upon the Airport or any part thereof, including without limitation, mechanics, materialmen's and tax liens, as a result of its activities without promptly discharging the same. Notwithstanding the

foregoing, Airline may in good faith contest any such lien if Airline provides a bond in an amount and form acceptable to City in order to clear the record of any such liens. Airline shall assume the defense of and indemnify and hold City harmless against any and all liens and charges of any and every nature and kind which may at any time be imposed upon the Airport or any part thereof as a consequence of any act or omission of Airline or as a consequence of the existence of Airline's interest under this Agreement.

Section 911 Damage and Destruction.

A. Partial Damage. If any part of the Demised Premises shall be partially damaged by fire or other casualty, but these circumstances do not render the Demised Premises untenable as reasonably determined by City, the same shall be repaired, constructed or renovated to usable condition with due diligence by the parties as provided in Section 911(D) below.

B. Substantial Damage. If any part of the Demised Premises shall be so extensively damaged by fire or other casualty as to render any portion of the Demised Premises untenable, but capable of being repaired, as reasonably determined by City, the same shall be repaired to usable condition with due diligence by the parties as provided in Section 911(D). City shall use commercially reasonable efforts to provide Airline with comparable temporary alternative facilities sufficient to allow Airline to continue its operations while repairs are being completed, at a rental rate applicable to such alternative facilities; provided, however, that Airline shall not be required to lease more alternative space than was rendered untenable in accordance with this Section.

C. Destruction.

(i) If any part of the Demised Premises shall be damaged by fire or other casualty, and is so extensively damaged as to render any portion of the Demised Premises untenable and not economically feasible to repair, as reasonably determined by City, City shall notify Airline within a period of forty-five (45) days after the date of such damage of its decision whether said space should be reconstructed or replaced; provided, however, City shall be under no obligation to reconstruct or replace such premises.

(ii) If City elects to replace or reconstruct the affected Demised Premises, the same shall be replaced or reconstructed to usable condition with due diligence by the parties as provided in Section 911(D), and City shall use commercially reasonable efforts to provide Airline with comparable temporary alternative facilities sufficient to allow Airline to continue its operations while reconstruction or replacement facilities are being completed; provided, however, that Airline shall not be required to occupy and pay for more alternative space than was rendered untenable in accordance with this Section.

(iii) If City elects to not reconstruct or replace the damaged Demised Premises, City shall either relocate Airline pursuant to Section 210 above, or if no premises are available to accomplish such relocation, amend this Agreement to remove the damaged facilities. City agrees to amend this Agreement effective as of the date of damage or destruction to reflect

such changes, additions and deletions to the Demised Premises. If Airline is not relocated and, after amendment of this Agreement as to the damaged facilities, the remaining tenantable portion of the Demised Premises is not sufficient to maintain operations at the Airport, Airline may terminate this entire Agreement upon at least thirty (30) days advance notice given within sixty (60) days after receipt by Airline of notice of amendment of this Agreement as to the damaged facilities.

D. Allocation of Responsibility for Reconstruction.

(i) In the event any Alterations in the Exclusive Use Space or Preferential Use Space included in the Demised Premises are to be reconstructed or repaired following damage by any casualty described in Sections 911(A), (B) or (C) above. Airline shall repair such damage to its Alterations, at its sole cost and expense, and this Agreement shall continue in full force and effect. In the event such damage occurs to Alterations in Exclusive Use Space or Preferential Use Space that is open or available to the public, Airline shall use commercially reasonable efforts to cause such repair to be performed within ninety (90) days. If the damage occurs to Alterations in Exclusive Use Space or Preferential Use Space that is not open or available to the public, Airline shall use commercially reasonable efforts to cause such repair to be performed within one hundred and eighty (180) days.

(ii) In the event any improvements in the Joint Use Space included in the Demised Premises are to be reconstructed or repaired following damage by any casualty described in Sections 911(A), (B) or (C) above, such damage shall be repaired as follows: all Joint Use Space which is an Air Carrier's responsibility pursuant to Exhibit C hereof shall be repaired by the Air Carriers operating in such Joint Use Space, at their sole cost and expense; and all Joint Use Space which is City's responsibility pursuant to Exhibit C hereof shall be repaired by City.

(iii) Any replacement, repair or reconstruction not described in Section 911(D)(i) or (ii) shall be completed by City.

E. No Abatement of Rent; Airline's Remedies. If the Demised Premises is wholly or partially destroyed or damaged, Airline shall have no claim against City for any damage suffered by reason of any such damage, destruction, repair or restoration. Airline waives California Civil Code Sections 1932(2) and 1933(4) providing for termination of hiring upon destruction of the thing hired. In no event will Airline be entitled to an abatement of rent resulting from any damage, destruction, repair, or restoration described herein; provided, however, that Airline shall not be charged rent for both untenable Demised Premises and temporary alternative facilities.

F. Reporting of Damage to Airport Property. Neither Airline nor any Airline Entity shall destroy or cause to be destroyed, injure, deface, or disturb in any way, property of any nature on the Airport, nor willfully abandon any personal property on the Airport. If Airline or Airline Entity is aware of any injury, destruction, damage or disturbance of property on the Airport (regardless of responsibility therefor), Airline shall file a written report with City describing the incident and damage within twenty four (24) hours after discovery, and, if such

damage was caused by Airline or any Airline Entity, upon demand by the Director, shall reimburse the City for the full amount of such damage within sixty (60) days. Failure to file any written reports required by this Section shall constitute an Event of Default under this Agreement and a violation of Airport Rules subject to fines under Section 1507, as applicable.

Section 912 Condemnation/Eminent Domain.

A. If all or a substantial part of the Demised Premises shall be taken or condemned by any competent authority through exercise of its power of eminent domain or other authority justifying such taking, Airline may terminate this Agreement upon thirty (30) days' notice, and the rents, fees and charges in respect of the Demised Premises shall cease as of the date possession is taken by the taking authority, if City does not notify Airline in writing within sixty (60) days before the date of taking that it will provide Airline with mutually acceptable substitute facilities.

B. If a portion of the Demised Premises shall be so taken, Airline shall have the right, exercisable at its sole discretion, to request City to amend this Agreement to remove the Demised Premises so taken upon thirty (30) days' notice, if City does not notify Airline in writing within sixty (60) days before the date of taking that it will provide Airline with mutually acceptable substitute facilities.

C. City shall be entitled to all damages payable by reason of a taking, (including, but not limited to, any portion of such damages made for the value of the leasehold estate created by this Agreement and any Alterations), and Airline shall have no claim against City for the value of any unexpired term of this Agreement, provided that Airline may make a separate claim for compensation, and Airline shall receive any damages made specifically to Airline, for Airline's relocation expenses or the interruption of or damage to Airline's business or damage to Airline's movable personal property.

ARTICLE 10. RULES AND REGULATIONS

Section 1001 Rules and Regulations. The use by Airline of the areas and facilities described herein and the rights and privileges granted Airline pursuant to this Agreement shall at all times be subject to any and all reasonable rules, regulations, and laws, including, but not limited to, the Airport TI Guide, Airport Rules and Regulations, Airport Operation Bulletins and Airport Directives (collectively "Airport Rules"), as may be established by City, as the same may be amended from time to time, and to the provisions of this Agreement; provided that (a) Airport Rules must be reasonable, not unjustly discriminatory, and not in conflict with any federal, state or local laws or regulations, and (b) in the event that any Airport Rules conflicts with any term or provision of this Agreement, the Agreement shall prevail. Airline covenants and agrees that it will not violate or permit any Airline Entity to violate any such rules, regulations and laws. City may prescribe civil penalties and injunctive remedies for violations thereof, and the same may be applied to Airline for violations by Airline or any Airline Entity. Nothing herein contained shall be deemed to prevent Airline from contesting in good faith any federal, State or local code, law, regulation, ordinance or rule, Airport Rules or any other rule or regulation of the City or

Commission without being considered in breach of this Agreement so long as such contest is diligently commenced and prosecuted by Airline.

ARTICLE 11. NO OTHER CHARGES, QUIET ENJOYMENT

Section 1101 No Other Charges.

A. Except as otherwise specifically provided herein or as the parties hereto may subsequently agree in writing, no charges, fees or tolls of any nature, direct or indirect (including, but not limited to, fuel flowage charges), shall be charged by Commission, directly or indirectly, against Airline or its passengers, employees, furnishers of services, or suppliers, for any of the premises, facilities, rights, licenses and privileges granted in this Agreement, or for the privilege of purchasing, selling, using, storing, withdrawing, handling, consuming, loading, unloading, or delivering any such personal property of Airline or its suppliers or for the privilege of transporting such personal property or persons to, from, or on the Airport.

B. Nothing in this Agreement shall preclude the Commission from imposing and using a PFC. Airline agrees to collect and remit PFCs to City as required by applicable law. Such PFC shall not be credited in any way to the West of Bayshore Cost Center.

Section 1102 Quiet Enjoyment. City represents that it has the right to lease said Demised Premises together with all the premises and facilities, easements, rights, licenses, and privileges herein granted, and has full power and authority to enter into this Agreement in respect thereof; and City further covenants that Airline shall peaceably have and enjoy said Demised Premises and the premises and facilities, easements, rights, licenses and privileges for the Term of this Agreement.

ARTICLE 12. LIMITED OBLIGATIONS, INDEMNITY, WAIVER AND INSURANCE

Section 1201 Limited Obligations of City. Any obligation or liability of City created by or arising out of this Agreement shall be payable solely out of the Revenues and other lawfully available moneys of the Airport, and shall not constitute a general obligation of City or a charge upon its general fund. This Agreement shall not obligate City to make any appropriation from its general fund for any payment due hereunder. No breach by City hereunder shall impose any pecuniary liability upon City, other than from Revenues, or be payable from or constitute a charge upon the general credit or against the taxing power of City.

Section 1202 Indemnity, Waiver.

A. Airline agrees to protect, defend, reimburse, indemnify and hold and save City and each City Entity, free and harmless at all times from and against any and all claims, liability, expenses, losses, costs, fines and damages (including actually incurred reasonable attorney's fees) and causes of action of every kind and character, whether or not meritorious, against or incurred by City by reason of any damage to property or bodily injury (including death) incurred or sustained by any party hereto, any agent or employee of any party hereto, and any third or other party whomsoever or any governmental agency, arising out of or incident to or in

connection with the performance, non-performance or purported performance of Airline or any Airline Entity under this Agreement, or any breach of the terms of this Agreement by Airline or any Airline Entity; Airline's or any Airline Entity's use or occupancy of the Demised Premises; or Airline's or any Airline Entity's negligent acts, omissions or operations hereunder; provided, however, that Airline shall not be so obligated to protect, defend, reimburse, indemnify and hold City free and harmless if the applicable claim, liability, expense, loss, cost, fine, damage or cause of action is caused (i) solely by the negligence or the willful misconduct of the City or any City Entity; (ii) by the existence of Hazardous Materials on the Demised Premises caused exclusively by a third party other than an Airline Entity; or (iii) by a Pre-Existing Condition provided that Airline demonstrates to City's reasonable satisfaction both that the Hazardous Materials constitute a Pre-Existing Condition and that Airline or other Airline Entity did not exacerbate the Pre-Existing Condition. Upon the filing by anyone of a claim with City for damages arising out of incidents for which Airline is obligated herein to indemnify and hold City harmless, City shall promptly notify Airline of such claim and, in the event that Airline does not settle or compromise such claim, Airline shall undertake the legal defense of such claim both on behalf of Airline and on behalf of City. It is specifically agreed, however, that City, at its option and at its own expense, may participate in the legal defense of such claim. Any final judgment against City from which no appeals remain for any cause for which Airline or Airline Entity is liable hereunder shall be conclusive against Airline or Airline Entity as to liability and amount upon the expiration of the time for appeal therefrom. Airline recognizes the broad nature of this indemnification and hold harmless clause and voluntarily makes this covenant and expressly acknowledges that the terms and conditions of this Agreement constitute good and valuable consideration provided by City in support of this indemnification in accordance with laws of the State.

B. Airline, as a material part of the consideration to be rendered to City under this Agreement, hereby waives all claims or causes of action against City, its officers, or employees which it may have for damages to any property on, about, or related to the Airport, and for injuries or death to persons on, about, or related to the Airport, from any cause or causes arising during the term of this Agreement. By way of example and not limitation, Airline hereby waives any and all claims or causes of action which it may hereafter have against City, its officers, or employees (a) for loss, injury, or damage sustained by reason of any deficiency, impairment, and interruption of any water, electrical, gas, plumbing, air conditioning, ventilation, Information and Communications Technology, Shared Use Equipment or sewer service or system serving any portion of the Airport, or failure or interruption of any public or passenger conveniences; (b) for any loss, injury, or damage arising or resulting from any act or neglect or omission of any other tenant, subtenant, permittee, concessionaire, or occupant of the Airport, or any person who uses the Airport with authorization or permission of the City (City agrees to use commercially reasonable efforts to control tenants, subtenants, permittees, concessionaires, occupants, or Airport users to prevent loss, injury, or damage); and (c) for any loss or damage to the property of, or injury or damage to Airline, its officers, employees, agents, contractors, or any other person whomsoever, from any cause or causes arising at any time because of Airline's use or occupancy of the Demised Premises or of the Airport, or its operations thereon (City will use commercially reasonable efforts to control the activities of other users); and (d) for loss, injury, or damage sustained by reason of any act of terrorism. Nothing in this Section shall relieve City from liability to Airline caused solely and directly by the negligence or willful

misconduct of City or a City Entity, but City shall not be liable under any circumstances for any consequential, incidental or punitive damages.

C. The parties hereto expressly agree that no provision of this Section shall in any way limit, modify, diminish, or otherwise affect the rights, claims, suits, judgments, or causes of action that either party may at any time have (or have had) against the other party (whether for contribution, indemnity, or otherwise) arising out of, resulting from, or related to Airline's noise, smoke, or vibration.

D. This Section shall survive the termination of this Agreement as to claims arising during the Term thereof. Compliance with the insurance requirements of this Article 12 shall not relieve Airline of its liability or obligation to indemnify City as set forth in this Article 12.

Section 1203 Public Liability and Property Damage Insurance.

A. Airline, at its sole cost and expense, and for the full Term of this Agreement or any renewal thereof, shall obtain and maintain all of the following minimum insurance:

(i) An Aircraft Liability policy, with coverage of at least \$500 million combined single limit for bodily injury and property damage, which shall include but not necessarily be limited to all of the following coverages: Aircraft Liability, including General Liability, Aircraft Products and Completed Operations, Liquor Liability, Premises Liability, Products & Completed Operations, Contractual Liability, Hangarkeepers Liability, Motor Vehicle Liability within the secured side of the Airport, Cargo Legal Liability and Fueling and Refueling, if such operations are conducted by Airline.

(ii) At least \$100 million War and Named Perils coverage for bodily injury and property damage, each occurrence and annual aggregate, or the U.S. Government equivalent.

(iii) A Workers' Compensation and Employers' Liability policy written in accordance with the laws of the State providing coverage for any and all employees of Airline and providing coverage as follows:

- (a) Workers' Compensation (Coverage A);
- (b) \$2 million in Employers' Liability (Coverage B);
- (c) Broad Form All States Endorsement;
- (d) Voluntary Compensation Endorsement; and
- (e) Waiver of Subrogation in favor of City.

(iv) A Commercial Business Auto policy with a minimum limit of not less than \$2 million combined single limit for bodily injury and property damage providing that coverages shall be applicable to any and all leased, owned, hired or non-owned vehicles used in pursuit of any of the activities associated with this Agreement. Any and all mobile equipment, including cranes, which is not covered under the Comprehensive Business Auto policy shall have said coverage provided for under the Comprehensive General Liability policy required above.

(v) Property Insurance in an amount equal to "Value of Airline Improvements and Betterments" during the course of construction and after completion. Coverage shall include Replacement Value, covering Airline improvements and betterments, for Fire & Extended Coverage, including Sprinkler Leakage, Vandalism & Malicious Mischief, and Debris Removal.

B. Any deductibles or self-insured retentions must be disclosed to the City.

C. Except for U.S. government equivalent War and Named Perils coverage, Workers Compensation/Employer's Liability Insurance and Property Coverage, the insurance policies shall contain, or be endorsed to contain, the following provisions:

(i) City and its officials, employees, agents and contractors shall be covered as additional insureds to the extent of Airline's indemnity obligations under this Agreement. The coverage shall contain no special limitations on the scope of protection afforded to City, its officials, employees, agents and contractors.

(ii) Airline's insurance coverage shall be primary insurance with respect to City, its officials, employees, agents and contractors. Any insurance or self-insurance maintained by City, its officials, employees, agents or contractors, shall be excess of Airline's insurance and shall not contribute with it.

D. Any failure to comply with reporting provisions of the policies shall not affect coverage provided to City, its officials, employees, agents or contractors.

E. Coverage shall state that Airline's insurance shall apply separately to each insured against whom claim is made or suit is brought, except at the limits of the insurer's liability.

F. City shall retain the right at any time to review the coverage, form, and amount of the insurance required hereby. If, in the opinion of City, the insurance provisions in this Agreement do not provide adequate protection for City and/or for members of the public, City may require Airline to obtain insurance sufficient in coverage, form, and amount to provide adequate protection. City's requirements shall be commercially reasonable but shall be designed to assure protection from and against the kind and extent of risk which exists at the time a change in insurance is required (provided such protection is available on commercially reasonable terms), and Airline agrees to provide same within thirty (30) days of receiving notice from City.

G. Provisions of this paragraph as to maintenance of insurance shall not be construed as limiting in any way the extent to which Airline may be held responsible for the payment of damages to persons or property resulting from its activities or of any person or persons for which it is otherwise responsible.

H. Each insurance policy required by this Section shall be endorsed to state that coverage shall not be suspended, voided, canceled, or reduced in limits except after thirty (30) days' prior written notice has been given to City (notwithstanding the foregoing, the notice period for War Risks and Named Allied Perils insurance may be seven (7) days or such lesser

period as may be customarily available, and the notice period for cancellations due to non-payment of premium for the Property, Worker's Compensation/Employers Liability, and Commercial Business Auto policies shall be ten (10) days).

I. Insurance is to be placed with insurers reasonably acceptable to City's Risk Manager.

J. Airline shall furnish City with certificates of insurance, and "Additional Insured" endorsements where appropriate, as required by this clause. The certificates for each insurance policy shall be signed by a person authorized by that insurer to bind coverage on its behalf.

K. Proof of insurance shall be mailed to the following address or any subsequent address as may be directed in writing by the Airport Risk Manager, with a copy to Airline's Property Manager at the address set forth in the Summary:

Airport Risk Manager
San Francisco International Airport
PO Box 8097
San Francisco, CA 94128
Fax: 650-821-5554

L. Airline shall either self-insure (by establishing reserves in accordance with accepted accounting practices) or procure and keep in force fire and extended coverage insurance upon its leasehold improvements located at the Airport, to the full replacement cost, insurable value thereof and shall furnish City, upon execution of this Agreement, with evidence that such self-insurance reserves have been established or such coverage has been procured and is being maintained in full force and effect. Said evidence of insurance shall be endorsed to require thirty (30) days written notice to City of cancellation or material change and to provide that any insurance carried by City be excess insurance only.

M. City and Airline agree to have all property insurance carried with respect to the Airport, the Demised Premises or any property therein endorsed with a clause that waives all rights of subrogation that the insurer of one party may have against the other party hereto. To that effect, City and Airline will respectively employ diligent efforts to cause their insurance companies to endorse the affected property insurance policies with a waiver of subrogation clause as required herein.

ARTICLE 13. SECURITY DEPOSIT

Section 1301 Security for Faithful Performance.

A. Security. The full and faithful performance of the Lease and Use Agreement by each Signatory Airline, including this Agreement by Airline, including, but not limited to, the payment of all Terminal Area Rentals, Landing Fees, usage fees, rates and charges now or in the future payable to City hereunder, and the compensation for any loss or damages the City may

suffer by a default hereunder or breach or rejection hereof, shall be secured by the Deposit provided in accordance with Section 1302 by such Signatory Airline, including Airline.

B. Other Agreements. From time to time, Signatory Airlines, including Airline, have entered or may enter into other agreements with City under which Signatory Airlines, including Airline, may provide additional security deposits in accordance with such agreements.

Section 1302 Deposit/Faithful Performance Bond.

A. Applicability. The provisions of this Section shall be applicable to all Signatory Airlines, including Airline.

B. Nature of Deposit. Prior to the Effective Date, Airline will deliver to Director the Deposit in the Deposit Amount. Such Deposit shall be in the form of (a) a surety bond payable to City, naming City as obligee, and otherwise in form satisfactory to City's City Attorney, and issued by a surety company satisfactory to Director, or (b) a letter of credit naming City as beneficiary, and otherwise in form satisfactory to City's City Attorney, issued by a bank satisfactory to Director. Such bond or letter of credit shall be renewed annually at Airline's cost, and shall be kept in full force and effect at all times to ensure the faithful performance by Airline of all covenants, terms, and conditions of this Agreement between City and Airline, including payment of rent and Landing Fees. Airline shall cause the surety company or bank issuing such bond or letter of credit to give Director notice in writing by registered mail at least forty-five (45) days prior to the expiration date or termination of such bond or letter of credit of its intention not to renew said bond or letter of credit or to terminate said bond or letter of credit.

C. Draws upon Deposit. If Airline fails to pay any Terminal Area Rentals, Landing Fees, usage fees, rates and charges now or in the future payable to City hereunder, or otherwise defaults with respect to any provision of this Agreement, City may use, apply or retain all or any portion of the Deposit for the payment of such amounts, or for the payment of any other sum to which City may become obligated by reason of Airline's default or to compensate City for any loss or damages which City may suffer thereby. If City so uses or applies all or any portion of the Deposit, Airline, within ten (10) days after demand therefor, shall deposit other security acceptable to Director with City in an amount sufficient to restore the Deposit to the full amount thereof. In the event the surety company or bank declines to renew or elects to cancel the bond or letter of credit comprising the Deposit, Airline shall, at least fifteen (15) days prior to the expiration or cancellation date thereof, replace such bond or letter of credit with another bond or letter of credit. If Airline fails to do so, City may, without notice to Airline, draw on the entirety of the Deposit and hold the proceeds thereof as security hereunder. City shall not be required to keep the Deposit separate from its general accounts. If Airline performs all of Airline's obligations hereunder, the Deposit, or so much thereof as has not theretofore been applied by City, shall be returned, without payment of interest or other increment for its use, to Airline (or, at City's option, to the last assignee, if any, of Airline's interest hereunder) upon the revocation or termination of this Agreement and following Airline's cessation of use of the Demised Premises and Common Use facilities. No trust relationship is created herein between City and Airline with respect to the Deposit.

ARTICLE 14. ASSIGNMENT AND SUBLETTING

Section 1401 No Transfer. Except as expressly provided herein, Airline shall not Transfer the Demised Premises, this Agreement, or any right hereunder without Director's prior written consent, which consent shall not be unreasonably withheld. Without limiting the generality of the foregoing reasonableness standard, the parties agree that it would be reasonable for Director to deny consent for any Transfer if the proposed transferee does not have adequate financial or operational capacity to perform the assumed obligations under this Agreement. In no event will Director be obligated to consent to any Transfer where the transferor earns a profit or bonus rent. Director's consent to one Transfer shall not be deemed a consent to subsequent Transfers. Any Transfer made without Director's consent shall constitute an Event of Default hereunder and shall be voidable at Director's election.

Section 1402 Changes in Airline.

A. The merger of Airline with any other entity or the transfer of any controlling ownership interest in Airline, or the assignment or transfer of a substantial portion of the assets of Airline, whether or not located on the Demised Premises shall constitute a Transfer to which the consent requirements in Section 1401 are applicable. Without limiting the generality of the foregoing, if Airline is a partnership, a withdrawal or change, voluntary, involuntary or by operation of law, of the partner or partners owning fifty-one percent (51%) or more of the partnership, or the dissolution of the partnership, or the sale or transfer of at least fifty-one percent (51%) of the value of the assets of the partnership shall be deemed a Transfer to which the consent requirements in Section 1401 are applicable. If Airline is a corporation or limited liability company, any dissolution, merger, consolidation or other reorganization of Airline, or the sale or other transfer of a controlling percentage of the capital stock or membership interests of Airline, or the sale or transfer of at least fifty-one percent (51%) of the value of the assets of Airline, shall be deemed a Transfer to which the consent requirements in Section 1401 are applicable. The phrase "controlling percentage" means the ownership of, and the right to vote, stock or interests possessing at least fifty-one percent (51%) of the total combined voting power of all classes of Airline's capital stock or interests issued, outstanding and entitled to vote for the election of directors. Without limiting the restrictions on asset transfers, this paragraph shall not apply to stock or limited liability company interest transfers of corporations or limited liability companies the stock or interests of which are traded through an exchange or over the counter. Airline's entering into any operating agreement, license or other agreement where a third party, other than a subsidiary, Affiliate Airline, or code share partner of Airline, is given rights or privileges to utilize portions of the Demised Premises shall be considered an attempted Transfer to which the consent requirements in Section 1401 are applicable.

B. Notwithstanding anything set forth herein to the contrary, Airline shall have the right, without first obtaining City's written consent, to assign or transfer this Agreement and Airline's rights and obligations hereunder, to (i) an entity controlling, controlled by or under common control with Airline, or (ii) a successor by merger, consolidation or acquisition to all or substantially all of the assets of Airline, if such entity or successor conducts an air transportation business at the Airport and assumes all rights and obligations hereunder. Written notice of such

assumption shall be provided by such entity or successor thirty (30) days prior to the effective day of such assignment.

C. Notwithstanding anything set forth herein to the contrary, Airline shall have the right, without first obtaining City's written consent, to grant a no-fee license to use a portion of the Demised Premises to a ground handler or other service provider as part of a ground handling or services agreement; provided that (i) such ground handler or service provider shall be licensed or permitted by City to operate at the Airport in accordance with Section 202(O), (ii) such ground handler or service provider shall acquire no interest or rights in this Agreement or the Demised Premises, and (iii) Airline shall provide City with notice of the license thirty (30) days prior to the effective date thereof.

Section 1403 No Release. In no event will Director's consent to a Transfer be deemed to be a release of Airline as primary obligor hereunder.

ARTICLE 15. TERMINATION OR SUSPENSION OF LEASE PROVISIONS

Section 1501 Airline Events of Defaults and City Remedies.

A. The occurrence of any one or more of the following events shall constitute a breach of this Agreement and an "Event of Default" hereunder:

(i) Airline shall fail duly and punctually to pay rent, Landing Fees, or to make any other payment required hereunder, when due to City, and such failure shall continue beyond the date specified in a written notice of such breach or default from Director, which date shall be no earlier than the tenth (10th) day after the effective date of such notice.

Notwithstanding the foregoing, in the event there occurs two (2) defaults in the payment of rent, Landing Fees, or other payment under this Agreement, thereafter Airline shall not be entitled to, and City shall have no obligation to give, notice of any further defaults in the payment of rent, Landing Fees, or other payment. In such event, there shall be deemed to occur an "Event of Default" immediately upon Airline's failure to duly and punctually pay rent, Landing Fees or other payment hereunder; or

(ii) Airline shall become insolvent, or shall take the benefit of any present or future insolvency statute, or shall make a general assignment for the benefit of creditors, or file a voluntary petition in bankruptcy, or a petition or answer seeking an arrangement for its reorganization, or the readjustment of its indebtedness under the federal bankruptcy laws, or under any other law or statute of the United States or of any state thereof, or consent to the appointment of a receiver, trustee, or liquidator of any or substantially all of its property; or

(iii) A petition under any part of the federal bankruptcy laws, or an action under any present or future insolvency law or statute, shall be filed against Airline and shall not be dismissed within thirty (30) days after the filing thereof; or

(iv) There shall occur a Transfer (other than in accordance with Section 1402(B) or (C)) without the prior approval of the City, and such Transfer shall not be voided or rescinded within ten (10) days after receipt of notice from City to Airline; or

(v) Airline shall abandon, desert, or vacate the Demised Premises; or

(vi) Any lien shall be filed against the Demised Premises as a result of an act or omission of Airline, and shall not be discharged or contested by Airline in good faith by proper legal proceedings within thirty (30) days after receipt of notice by Airline; or

(vii) Airline shall fail to provide the Deposit when required hereunder or shall fail to maintain in full such Deposit at all times thereafter, and such failure shall continue for a period of more than three (3) days after delivery by Director of written notice of such failure; or

(viii) Airline shall fail to obtain and maintain the insurance or self-insured reserves required hereunder, or provide copies of the policies or certificates to City as required herein; or

(ix) Airline shall fail to keep, perform and observe each and every other promise, covenant and agreement set forth in this Agreement, and such failure shall continue for a period of more than ten (10) days after delivery by Director of a written notice of such failure (the "First Notice"); or if satisfaction of such obligation requires activity over a period of time, if Airline fails to commence the cure of such failure within ten (10) days after receipt of the First Notice, or thereafter fails to diligently prosecute such cure, or fails to actually cause such cure within one hundred twenty (120) days after the giving of the First Notice;

(x) There shall occur a default under any other agreement between Airline and City, if any, and such default is not cured as may be provided in such agreement; provided, however, that nothing herein shall be deemed to imply that Airline shall be entitled to additional notice or cure rights at such default other than as may be provided in such other agreement; or

(xi) Airline shall fail duly and timely to remit to City any PFCs collected by Airline from its passengers in accordance with 49 U.S.C. § 40117 and applicable implementing regulations adopted by the FAA, 14 CFR Pt. 158, as they may be amended from time to time.

Section 1502 Remedies. Upon the occurrence and during the continuance of an Event of Default, City shall have the following rights and remedies in addition to all other rights and remedies available to City at law or in equity:

A. City shall have the rights and remedies provided by California Civil Code Section 1951.2 (damages on termination for breach), including the right to terminate Airline's right to use the Demised Premises upon written notice to Airline. Airline expressly acknowledges that in the absence of such written notice from City, no other act of City, including, but not limited to, its re-entry into the Demised Premises, its efforts to relet the Demised Premises, its reletting of the Demised Premises for Airline's account, its storage of Airline's personal property and trade fixtures, its acceptance of keys to the Demised Premises from Airline, its appointment of a receiver, or its exercise of any other rights and remedies under this Section or otherwise at law shall constitute an acceptance of Airline's surrender of the Demised Premises or constitute a termination of this Agreement or of Airline's right to possession of the Demised Premises.

B. Upon any termination in writing of Airline's right to possession of the Demised Premises, this Agreement shall terminate and City shall be entitled to recover damages from Airline as provided in California Civil Code Section 1951.2 or any other applicable existing or future laws providing for recovery of damages for such breach, including, but not limited to, the following:

- (i) The reasonable cost of recovering the Demised Premises; plus
- (ii) The reasonable cost of removing Airline's Alterations, trade fixtures and improvements; plus
- (iii) All unpaid rent due or earned hereunder prior to the date of termination, less the proceeds of any reletting or any rental received from subtenants prior to the date of termination applied as provided below, together with interest at the Interest Rate, on such sums from the date such rent is due and payable until the date of the award of damages; plus
- (iv) The amount by which the rent which would be payable by Airline hereunder, as reasonably estimated by City, from the date of termination until the date of the award of damages, exceeds the amount of such rental loss as Airline proves could have been reasonably avoided, together with the interest rate on such sums from the date such rent is due and payable until the date of the award of damages; plus
- (v) The amount by which the rent which would be payable by Airline hereunder, as reasonably estimated by City, for the remainder of the then Term after the date of the award of damages exceeds the amount such rental loss as Airline proves could have been reasonably avoided, discounted at the discount rate published by the Federal Reserve bank of San Francisco for member banks at the time of the award plus one percent (1%); plus
- (vi) Any other amount necessary to compensate City for all the detriment proximately caused by Airline's failure to perform its obligations under this Agreement or which in the ordinary course of things would be likely to result therefrom.

For purposes of the foregoing, the amounts referred to in clauses (iii) and (iv) above are computed by allowing interest at the lower of eighteen 18% per annum and the highest rate legally permitted under applicable law. For purposes of the foregoing, the term "rent" shall mean all rent, Landing Fees, and other amounts payable by Airline hereunder. Notwithstanding any other provisions hereof, any efforts by City to mitigate damages caused by Airline's breach of this Agreement shall not constitute a waiver of City's right to recover damages hereunder and shall not affect the right of City to indemnification pursuant to the provisions of Article 12 hereof. Airline agrees that Airline's obligations under this Agreement, including the payment of rent, are independent covenants and are not conditioned on the covenants or warranties of City.

C. City shall have the right and remedy described in California Civil Code Section 1951.4. City may elect not to terminate this Agreement and let this Agreement continue, in which case City may enforce all its rights and remedies under this Agreement, including the right to recover rent as it becomes due under this Agreement. Acts of maintenance or preservation or efforts to relet the Demised Premises or the appointment of a receiver upon the

initiative of City to protect City's interest under this Agreement shall not constitute a termination of Airline's right to possession.

D. City shall have the right to have a receiver appointed upon application by City to take possession of the Demised Premises and to collect the rents or profits therefrom and to exercise all other rights and remedies pursuant to this Section.

E. City shall have the right to enjoin, and any other remedy or right now or hereafter available to a landlord against a defaulting tenant under the laws of the State or the equitable powers of its courts, and not otherwise specifically reserved herein.

F. City may elect to terminate any other agreement between Airline and City.

Section 1503 City's Right to Perform. All agreements and provisions to be performed by Airline under any of the terms of this Agreement shall be at its sole cost and expense and without any abatement of rent or Landing Fees. If Airline shall fail to make any payment or perform any act on its part to be performed hereunder and such failure shall continue for three (3) days (as to any emergency), or thirty (30) days (as to any non-emergency), after notice thereof by City, City may, but shall not be obligated to do so, and without waiving or releasing Airline from any obligations of Airline, make any such payment or perform any such other act on Airline's part to be made or performed as provided in this Agreement. All sums so paid by City and all necessary incidental costs shall be deemed additional rent hereunder and shall be payable to City on demand, and City shall have (in addition to any other right or remedy of City) the same rights and remedies in the event of the nonpayment thereof by Airline as in the case of default by Airline in the payment of rent or Landing Fees.

Section 1504 Rights Related to Termination. In the event of any termination based on any breach of the covenants, terms and conditions contained in this Agreement, City shall have the option at once and without further notice to Airline to enter upon the Demised Premises and take exclusive possession of same. City may remove or store any personal property located therein, at the sole cost and expense of Airline without City being liable to Airline for damages or loss thereby sustained by Airline. Upon such termination by City, all rights, powers and privileges of Airline hereunder shall cease, and Airline shall immediately vacate any space occupied by it under this Agreement, and Airline shall have no claim of any kind whatsoever against City or any City Entity by reason of such termination, or by reason of any act by City or any City Entity incidental or related thereto. In the event of the exercise by City of such option to terminate, Airline shall have no right to or claim upon any improvements or the value thereof, which may have been previously installed by Airline in or on the Demised Premises.

Section 1505 Cumulative Rights. The exercise by City of any remedy provided in this Agreement shall be cumulative and shall in no way affect any other remedy available to City under law or equity.

Section 1506 Prepayment. As provided in Section 407, if Airline defaults in the payment of rent, Landing Fees, or any other amounts due hereunder, City may require prepayment thereof.

Such right shall be in addition to and not in lieu of any and all other rights hereunder, or at law or in equity.

Section 1507 Fines. City reserves the right to impose and collect from Airline the fines set forth in the Airport Rules as established and updated from time to time by the Director for violations of Airport Rules or the terms of this Agreement by any Airline Entity.

Director's right to impose fines pursuant to this Agreement shall be in addition to and not in lieu of any and all other rights hereunder, in the Airport Rules, at law or in equity. City shall have no obligation to Airline to impose fines on or otherwise take action against any other tenant at the Airport. THE PARTIES HAVE AGREED THAT THE VIOLATIONS SET FORTH IN THE AIRPORT RULES SHALL RESULT IN CITY INCURRING DAMAGES WHICH ARE IMPRACTICAL OR IMPOSSIBLE TO DETERMINE. THE PARTIES HAVE AGREED THAT THE FINES FOR SUCH VIOLATIONS SET FORTH IN THE AIRPORT RULES ARE A REASONABLE APPROXIMATION OF SUCH DAMAGES. Such fines shall constitute "additional rent."

City reserves the right to impose and collect from Airline reimbursement for any fines for violations of any federal, state or local laws or regulations by any Airline Entity.

Section 1508 [Reserved].

Section 1509 Waiver of Notice. Except as otherwise expressly provided in this Article 15, Airline hereby expressly waives, so far as permitted by law, the service of any notice of intention to enter or re-enter provided for in any statute, or of the institution of legal proceedings to that end, and Airline, for and on behalf of itself and all persons claiming through or under Airline, also waives any right of redemption or relief from forfeiture under California Code of Civil Procedure Sections 1174 or 1179, or under any other present or future law, if Airline is evicted or City takes possession of the Demised Premises by reason of any default by Airline hereunder.

Section 1510 Annual Service Payments and City's Right to Suspend Part of Agreement.

A. An Annual Service Payment will be paid from the Airport Revenue Fund into the General Fund of the City for each Fiscal Year during the Term of this Agreement beginning with Fiscal Year 2011/2012. In each such Fiscal Year, the Annual Service Payment shall equal the greater of (a) fifteen percent (15%) of Concession Revenues or (b) five million dollars (\$5,000,000).

In each Fiscal Year, payment of the Annual Service Payment from the Airport Revenue Fund to the City's General Fund shall be made in installments on September 30, December 31, March 31 and June 30. Each of the installments payable on these dates shall be in an amount equal to twenty-five percent (25%) of the budgeted Annual Service Payment for such Fiscal Year. As part of each Fiscal Year audit, the Annual Service Payment shall be recalculated based on actual Concession Revenues and the payment submitted to the City shall be adjusted to reflect the recalculation.

During the Term of this Agreement, the Commission will not make any payments to the City's General Fund other than the Annual Service Payments, to reimburse the City for the costs of any and all indirect services provided by the City to the Commission during any Fiscal Year in which Annual Service Payments calculated as provided above are paid. The Commission shall not make any additional payments to the City's General Fund for indirect services provided by the City to the Airport during any such Fiscal Year. The Commission may, in addition to making Annual Service Payments, continue to reimburse the City's General Fund for the actual, verifiable and reasonable costs of direct services provided by the City to the Airport.

B. If Airline was a signatory to the Settlement Agreement or received from the City and the Commission a Release in the form attached as Exhibit C to the Settlement Agreement, Airline hereby waives and forever releases whatever rights, if any, Airline may have, either (a) under the Settlement Agreement or (b) by reason of such Release to challenge Annual Service Payments made after June 30, 2011.

C. In the event that the Annual Service Payment provided for above cannot be made for any reason, other than Airport's own inaction or action not in conformance with this Agreement, including, but not limited to, supervening legislation or court decision, City may elect to suspend uniformly as to all Signatory Airlines all or some of the following provisions of this Agreement:

| <u>Article</u> | <u>Section</u> | |
|----------------|----------------|--|
| 4 | 403 | Landing Fees |
| 5 | 503(A)-(K) | Method of Adjusting Landing Fees |
| 5 | 504(A) | Review of Adjusted Rentals and Fees (only to the extent it pertains to adjustment of Landing Fees "in accordance with this Agreement") |
| 6 | 601(B) | Capital Improvements |
| 6 | 602(A) | Other Capital Improvements |
| 6 | 602(C) | Other Capital Improvements |
| 7 | 703 | Airfield Area Users |
| 17 | 1701 | Holding Over |

In addition or alternatively, in such event City may: (1) appropriate an amount equal to the Annual Service Payment then payable hereunder in any Fiscal Year for Capital Improvements included in City's then-current Five Year Capital Program pursuant to Sections 16.104(b)(5) and (6) of the City Charter (or any successor legislation) and any such appropriation shall not be

subject to Section 602; and (2) during any period of suspension of Sections 403, and 503(A) through (K), pursuant to this Section, adjust the level of Terminal Area Rental Rates, observing in the calculations of such adjusted rental rates the Cost Centers and procedures for allocation of revenues, expenses, and debt service to such Cost Centers as illustrated in Exhibit O, and maintaining the relationships between rental rates for each Space Category of Demised Premises; provided, however, Airline reserves its rights to contest such adjusted rental rates through legal processes to determine whether any such adjusted rental rates are reasonable or are otherwise in accordance with applicable law.

D. The right of City to elect to suspend the above-referenced provisions, or any of them, shall not be effective unless and until:

(i) The payment of the Annual Service Payment is interrupted for any cause other than City's own inaction or action not in conformance with this Agreement;

(ii) City has given written notice to Airline of such interruptions in payment;

(iii) Within twelve (12) months after the date of the notice of interruption in payment, the City has failed to achieve the resumption of such Annual Service Payment or to have received sums equal to the then-current Annual Service Payment obligation for its General Fund in lieu thereof; and

(iv) After expiration of such twelve (12) month period, City shall have given Airline thirty (30) days written notice of its election to exercise such right to suspend, which notice shall specify which of the above-referenced provisions of this Agreement are suspended. Following receipt of such notice and until Section 1510(F)(iv) shall be applicable, Airline may elect to terminate this Agreement upon thirty (30) days written notice to City.

E. During the period commencing with any such interruption of Annual Service Payments and continuing thereafter until such payments are resumed or sums equal to the then-current Annual Service Payment obligation are received by City's General Fund, in lieu thereof, Section 502(B) shall remain in effect, and amounts equal to the Annual Service Payment shall be segregated as accumulated in an identifiable, interest-bearing subaccount of the Airport Revenue Fund by City. Monies in such subaccount may be applied to any lawful purpose of the Commission; provided, however, that to the extent such monies are so applied the Annual Service Payment shall be deemed satisfied, pro tanto.

F. During any period of any interruptions of the Annual Service Payment to City, City shall use commercially reasonable efforts to achieve the resumption of such Annual Service Payment or receipt in the General Fund of a sum equivalent to the then-current Annual Service Payment obligation in lieu thereof. Upon resumption of the Annual Service Payment or receipt of sums equivalent to the then-current Annual Service Payment obligation by City's General Fund in lieu thereof:

(i) The right of Commission to suspend or continue suspension of the provisions referred to in this Section shall terminate;

(ii) Commission shall release from the Airport Revenue Fund subaccount all funds therein, plus accrued interest, to the Airport Revenue Fund to be available for customary budgeting disposition;

(iii) As soon as practicable thereafter, Commission shall make any necessary adjustments to the Terminal Area Rentals and Landing Fees; and

(iv) Airline's right to terminate this Agreement as provided in Section 1510(D)(iv) shall terminate.

G. During any period of suspension of some or all of the above-referenced provisions pursuant to this Section, City may take such other actions as may be permitted by law which are designed to provide City with substitute monies in lieu of the Annual Service Payment provided for in Section 502(B); provided, however, Airline reserves its rights to challenge the reasonableness or contest the legality of any such actions and nothing in this Agreement shall operate as a waiver of, or estoppel or other bar to, any such challenge or contest.

H. No action properly taken by City in exercise of its rights under this Article 15 shall be deemed a breach of any other provision of this Agreement.

Section 1511 Airline's Right to Terminate. If Airline is not then in default in the payment of any amount due from it to City hereunder, Airline, in addition to any other rights given to it herein or to which it may be entitled by law, may terminate this Agreement in its entirety by giving City ninety (90) days advance written notice upon or after the occurrence and during the continuance of any one or more of the following events:

A. The issuance of a permanent injunction by any court of competent jurisdiction substantially restraining or preventing Airline from using all or major portions of the Airport for airport purposes and its remaining in force for one hundred and eighty (180) days;

B. Any action of any governmental authority, board, agency or officer having jurisdiction thereof preventing Airline from conducting its air transportation business in its entirety at the Airport;

C. The involuntary termination by any governmental authority, board, agency or officer having jurisdiction, of Airline's right to serve San Francisco, California; or

D. The default by City in the performance of any material covenant or agreement required to be performed by City herein, which default materially and adversely limits or prohibits Airline's operations at the Airport, and the failure by City to remedy such default after written notice thereof has been delivered to City, unless (i) City takes prompt action to remedy such default within a period of sixty (60) days after receipt from Airline of such notice, or (ii) in the case of any such failure which cannot with due diligence be cured within such sixty (60) day period, City takes corrective action within the sixty (60) day period and diligently pursues such action until the failure is cured.

ARTICLE 16. SURRENDER OF POSSESSION OF DEMISED PREMISES

Section 1601 Surrender. At the termination of this Agreement by expiration or otherwise, or of any renewal or extension hereof, or upon partial surrender of the Demised Premises, including as provided in Section 212, or upon Airline's rejection of Preferential Gates as provided in Section 304, Airline shall peaceably quit and surrender to City the Demised Premises together with the improvements and all Alterations approved by City in good order and condition, except for normal wear and tear after Airline having made the last necessary repair required on its part under this Agreement, and further except for any portion of the Demised Premises condemned and any damage and destruction for which Airline is not responsible hereunder.

Immediately before the Expiration Date or other termination of this Agreement, Airline shall remove all personal property and trade fixtures, and repair any damage resulting from the removal; provided, City in its sole discretion shall have the right to reserve ownership of any telecommunications equipment, wire, cabling and/or conduit installed in the Demised Premises by or on behalf of Airline. If such removal is not completed at the expiration or other termination of this Agreement, City may remove the same at Airline's expense. In such event, Airport shall not be responsible for any losses related to such personal property, at City's option, be deemed abandoned and disposed of in accordance with Section 1980 et seq. of the California Civil Code or in any other manner allowed by law. Notwithstanding anything to the contrary in this Agreement, City can elect at any time prior to the Expiration Date or within five (5) days after termination of this Agreement, to require Airline to remove, at Airline's sole expense, all or part of the improvements, Alterations, trade fixtures or equipment constructed or installed by or at the expense of Airline including, but not limited to, any passenger loading bridges, baggage handling systems, telecommunications equipment, wires, cabling and/or conduit installed in the Demised Premises by or on behalf of Airline. Airline shall promptly remove such items and shall repair, at no cost to the City, any damage to the Demised Premises resulting from such removal, or if Airline fails to repair, City may do so, at Airline's expense. Airline's obligations under this Section shall survive the Expiration Date or other termination of this Agreement.

ARTICLE 17. HOLDING OVER

Section 1701 Month to Month. If Airline shall, with the concurrence of Commission, hold over after the expiration or sooner termination of the Term of this Agreement, the resulting tenancy shall, unless otherwise mutually agreed, be on a month-to-month basis, and may be terminated by Airline or Commission at any time on thirty (30) days written notice to the other party. During such month-to-month tenancy, Airline shall pay to Commission the same rate of rentals and Landing Fees as are set forth herein, unless different rates shall be agreed upon, and the parties shall be bound by all of the provisions of this Agreement, insofar as they may be pertinent, unless different terms and conditions shall be agreed upon. If Airline shall, without the written consent of the Commission, hold over after the expiration or sooner termination of the Term of this Agreement, Airline shall pay to Commission on a month-to-month basis the rentals and the Non-Signatory Premium on Landing Fees as provided in Section 503(J) for any such holdover period and shall otherwise be subject to the terms and conditions of this Agreement beyond the end of the term hereof. Any holding over without Commission's consent shall constitute a default by Airline and entitle Commission to exercise any or all remedies as

provided herein, notwithstanding that Commission may elect to accept one or more payments of Terminal Area Rentals, and whether or not such amounts are at the holdover rate specified above or the rate at the end of the term of this Agreement.

ARTICLE 18. CITY CONTRACTING PROVISIONS

Section 1801 Nondiscrimination Ordinance. Airline shall comply with the following:

A. Airline Shall Not Discriminate. In the performance of this Agreement, Airline agrees not to discriminate against any employee, City employee working with Airline, applicant for employment with Airline, or against any person seeking accommodations, advantages, facilities, privileges, services, or membership in all business, social, or other establishments or organizations, on the basis of the fact or perception of a person's race, color, creed, religion, national origin, ancestry, age, height, weight, sex, sexual orientation, gender identity, domestic partner status, marital status, disability or Acquired Immune Deficiency Syndrome or HIV status (AIDS/HIV status), or association with members of such protected classes, or in retaliation for opposition to discrimination against such classes.

B. Subleases and Other Subcontracts. Airline shall include in all subleases and other subcontracts relating to the Demised Premises a non-discrimination clause applicable to such subtenant or other subcontractor in substantially the form of Subsection (A) above. In addition, Airline shall incorporate by reference in all subleases and other subcontracts the provisions of Sections 12B.2(a), 12B.2(c)-(k), and 12C.3 of the San Francisco Administrative Code and shall require all subtenants and other subcontractors to comply with such provisions. Tenant's failure to comply with the obligations in this Subsection shall constitute a material breach of this Agreement.

C. Non-Discrimination in Benefits. Airline does not as of the date of this Agreement and will not during the Term, in any of its operations in San Francisco on real property owned by City, or where work is being performed for City elsewhere in the United States, discriminate in the provision of bereavement leave, family medical leave, health benefits, membership or membership discounts, moving expenses, pension and retirement benefits or travel benefits, as well as any benefits other than the benefits specified above, between employees with domestic partners and employees with spouses, and/or between the domestic partners and spouses of such employees, where the domestic partnership has been registered with a governmental entity pursuant to state or local law authorizing such registration, subject to the conditions set forth in Section 12B.2(b) of the San Francisco Administrative Code.

D. Conditions to Contract. As a condition to this Agreement, Airline shall execute the "Chapter 12B Declaration: Nondiscrimination in Contracts and Benefits" form (Form HRC-12B-101) with supporting documentation and secure the approval of the form by the San Francisco Human Rights Commission. Airline hereby represents that prior to execution of this Agreement, (i) Airline executed and submitted to the HRC Form HRC-12B-101 with supporting documentation, and (ii) the HRC approved such form.

E. Incorporation of Administrative Code Provisions by Reference. The provisions of Chapters 12B and 12C of the San Francisco Administrative Code relating to non-discrimination by parties contracting for the lease of City property are incorporated in this Section by reference and made a part of this Agreement as though fully set forth herein. Airline shall comply fully with and be bound by all of the provisions that apply to this Agreement under such Chapters of the Administrative Code, including, but not limited to, the remedies provided in such Chapters. Without limiting the foregoing, Airline understands that pursuant to Sections 12B.2(h), 12C.3(g) of the San Francisco Administrative Code, a penalty of fifty dollars (\$50) for each person for each calendar day during which such person was discriminated against in violation of the provisions of this Agreement may be assessed against Airline and/or deducted from any payments due Airline.

Section 1802 Conflict of Interest. Through its execution of this Agreement, Airline acknowledges that it is familiar with the provision of Section 15.103 of the City's Charter, Article III, Chapter 2 of City's Campaign and Governmental Conduct Code, and Section 87100 et seq. and Section 1090 et seq. of the Government Code of the State, and certifies that it does not know of any facts which constitutes a violation of said provisions and agrees that it will immediately notify the City if it becomes aware of any such fact during the term of this Agreement.

Section 1803 Tropical Hardwoods and Virgin Redwoods. The City urges companies not to import, purchase, obtain or use for any purpose any tropical hardwood, tropical hardwood wood product, virgin redwood or virgin redwood wood product. Except as expressly permitted by the application of Sections 802(B) and 803(B) of the San Francisco Environment Code, Airline shall not provide any items to the construction of Airline tenant improvements or the Alterations, or otherwise in the performance of this Agreement, which are tropical hardwoods, tropical hardwood wood products, virgin redwood, or virgin redwood wood products. In the event Airline fails to comply in good faith with any of the provisions of Chapter 8 of the San Francisco Environment Code, Airline shall be liable for liquidated damages for each violation in any amount equal to Airline's net profit on the contract, or five percent (5%) of the total amount of the contract dollars, whichever is greater.

Section 1804 Drug-Free Workplace Policy. Airline acknowledges that pursuant to the Federal Drug-Free Workplace Act of 1989, the unlawful manufacture, distribution, dispensation, possession or use of a controlled substance is prohibited on City premises. Airline agrees that any violation of this prohibition by Airline, its employees, agents or assigns shall be deemed a material breach of this Agreement.

Section 1805 Compliance with Americans with Disabilities Act and Air Carrier Access Act. Airline acknowledges that, pursuant to the ADA and the ACAA, to the extent applicable to Airline, programs, services and other activities provided by a public entity to the public, whether directly or through a contractor, must be accessible to the disabled public. To the extent the ADA or the ACAA is so applicable: (a) Airline shall provide the services specified in this Agreement in a manner that complies with the ADA or the ACAA, as applicable, and any and all other applicable federal, State and local disability rights legislation; (b) Airline agrees not to discriminate against disabled persons in the provision of services, benefits or activities provided

under this Agreement; and (c) Airline further agrees that any violation of this prohibition on the part of Airline, its employees, agents or assigns shall constitute a material breach of this Agreement.

Section 1806 Pesticide Prohibition.

A. Airline shall comply with the provisions of Section 308 of Chapter 3 of the San Francisco Environment Code (the "Pesticide Ordinance") which (i) prohibit the use of certain pesticides on City property, (ii) require the posting of certain notices and the maintenance of certain records regarding pesticide usage, and (iii) require Airline to submit to the Airport an integrated pest management ("IPM") plan that (a) lists, to the extent reasonably possible, the types and estimated quantities of pesticides that Airline may need to apply to the Demised Premises during the terms of this Agreement, (b) describes the steps Airline will take to meet the City's IPM Policy described in Section 300 of the Pesticide Ordinance, and (c) identifies, by name, title, address, and telephone number, an individual to act as the Airline's primary IPM contact person with the City. In addition, Airline shall comply with the requirements of Sections 303(a) and 303(b) of the Pesticide Ordinance.

B. Nothing herein shall prevent Airline, through the Director, from seeking a determination from the Commission on the Environment that it is exempt from complying with certain portions of the Pesticide Ordinance as provided in Section 307 thereof.

Section 1807 MacBride Principles - Northern Ireland. The City urges companies doing business in Northern Ireland to move toward resolving employment inequities and encourages them to abide by the MacBride Principles as expressed in San Francisco Administrative Code Section 12F.1 et seq. The City also urges San Francisco companies to do business with corporations that abide by the MacBride Principles. Airline acknowledges that it has read and understands the above statement of the City concerning doing business in Northern Ireland.

Section 1808 No Advertising or Promotions; Prohibition of Tobacco Advertising. Airline shall have no right to conduct any advertising or promotional activities on the Airport. Airline acknowledges and agrees that no advertising of cigarettes or tobacco products is allowed on any real property owned by or under the control of the City, including the Demised Premises and the Airport. This prohibition includes the placement of the name of a company producing, selling or distributing cigarettes or tobacco products or the name of any cigarette or tobacco product in any promotion of any event or product. This prohibition does not apply to any advertisement sponsored by a state, local or nonprofit entity designed to communicate the health hazards of cigarettes and tobacco products or to encourage people not to smoke or to stop smoking.

Section 1809 First Source Hiring Ordinance. The City has adopted a First Source Hiring Ordinance (Board of Supervisors Ordinance No. 264 -98) which establishes specific requirements, procedures and monitoring for first source hiring of qualified, economically disadvantaged individuals for entry level positions. Within thirty (30) days after the Real Estate Division of the Department of Administrative Services adopts a First Source Hiring Implementation and Monitoring Plan in accordance with the First Source Hiring Ordinance,

Airline shall enter into a First Source Hiring Agreement that meets the applicable requirements of Section 83.9 of the First Source Hiring Ordinance.

Section 1810 [Reserved]

Section 1811 Sunshine Ordinance. In accordance with Section 67.24(e) of the San Francisco Administrative Code, contracts, contractors' bids, leases, agreements, responses to Requests for Solicitations, and all other records of communications between City and persons or firms seeking contracts will be open to inspection immediately after a contract has been awarded. Nothing in this provision requires the disclosure of a private person's or organization's net worth or other proprietary financial data submitted for qualification for a contract, lease, agreement or other benefit until and unless that person or organization is awarded the contract, lease, agreement or benefit. Information provided which is covered by this Section will be made available to the public upon request.

Section 1812 Charter Provisions. This Agreement is governed by and subject to the provisions of the City Charter.

Section 1813 Requiring Health Benefits for Covered Employees.

A. Unless exempt, Airline agrees to comply fully with and be bound by all of the provisions of the Health Care Accountability Ordinance (HCAO), as set forth in San Francisco Administrative Code Chapter 12Q, including the remedies provided, and implementing regulations, as the same may be amended from time to time. The provisions of Chapter 12Q are incorporated herein by reference and made a part of this Agreement as though fully set forth. The text of the HCAO is available on the web at <http://www.sfgov.org/olse>. Capitalized terms used in this Section and not defined in this Agreement shall have the meanings assigned to such terms in Chapter 12Q.

B. For each Covered Employee, Airline shall provide the appropriate health benefit set forth in Section 12Q.3 of the HCAO. If Airline chooses to offer the health plan option, such health plan shall meet the minimum standards set forth by the San Francisco Health Commission.

C. Notwithstanding the above, if the Airline is a small business as defined in Section 12Q.3(d) of the HCAO, it shall have no obligation to comply with Subsection (A) above.

D. Airline's failure to comply with the HCAO shall constitute a material breach of this Agreement. City shall notify Airline if such a breach has occurred. If, within thirty (30) days after receiving City's written notice of a breach of this Agreement for violating the HCAO, Airline fails to cure such breach or, if such breach cannot reasonably be cured within such period of thirty (30) days, Airline fails to commence efforts to cure within such period, or thereafter fails diligently to pursue such cure to completion, City shall have the right to pursue the remedies set forth in Sections 12Q.5.1, 12Q.5(f)(1-6). Each of these remedies shall be exercisable individually or in combination with any other rights or remedies available to City.

E. Any Subcontract entered into by Airline shall require the Subcontractor to comply with the requirements of the HCAO and shall contain contractual obligations substantially the same as those set forth in this Section. Airline shall notify City's Purchasing Department when it enters into such a Subcontract and shall certify to the Purchasing Department that it has notified the Subcontractor of the obligations under the HCAO and has imposed the requirements of the HCAO on Subcontractor through the Subcontract. Airline shall be responsible for its Subcontractors' compliance with this Chapter. If a Subcontractor fails to comply, the City may pursue the remedies set forth in this Section against Airline based on the Subcontractor's failure to comply, provided that City has first provided Airline with notice and an opportunity to obtain a cure of the violation.

F. Airline shall not discharge, reduce in compensation, or otherwise discriminate against any employee for notifying City with regard to Airline's compliance or anticipated compliance with the requirements of the HCAO, for opposing any practice proscribed by the HCAO, for participating in proceedings related to the HCAO, or for seeking to assert or enforce any rights under the HCAO by any lawful means.

G. Airline represents and warrants that it is not an entity that was set up, or is being used, for the purpose of evading the intent of the HCAO.

H. Airline shall maintain employee and payroll records in compliance with California Labor Code and Industrial Welfare Commission orders.

I. Airline shall keep itself informed of the current requirements of the HCAO.

J. Airline shall provide reports to the City in accordance with any reporting standards promulgated by the City under the HCAO, including reports on Subcontractors and Subtenants, as applicable.

K. Airline shall provide City with access to records pertaining to compliance with HCAO after receiving a written request from City to do so and being provided at least ten (10) business days to respond.

L. Airline shall allow City to inspect Airline's Demised Premises and to have access to Airline's employees in order to monitor and determine compliance with HCAO.

M. City may conduct random audits of Airline to ascertain its compliance with HCAO. Airline agrees to cooperate with City when it conducts such audits.

N. If Airline is exempt from the HCAO when this Agreement is executed because its amount is less than twenty-five thousand dollars (\$25,000), but Airline later enters into an agreement or agreements that cause Airline's aggregate amount of all agreements with City to reach seventy-five thousand dollars (\$75,000), all the agreements shall be thereafter subject to the HCAO. This obligation arises on the effective date of the agreement that causes the cumulative amount of agreements between Airline and the Contracting Department to be equal to or greater than seventy-five thousand dollars (\$75,000) in the Fiscal Year.

Section 1814 Requiring Minimum Compensation for Covered Employees.

A. Airline agrees to comply fully with and be bound by all of the provisions of the Minimum Compensation Ordinance (MCO), as set forth in San Francisco Administrative Code Chapter 12P (Chapter 12P), including the remedies provided, and implementing guidelines and rules. The provisions of Chapter 12P are incorporated herein by reference and made a part of this Agreement as though fully set forth. The text of the MCO is available on the web at www.sfgov.org/olse/mco. A partial listing of some of Airline's obligations under the MCO is set forth in this Section. Airline is required to comply with all the provisions of the MCO, irrespective of the listing of obligations in this Section.

B. The MCO requires Airline to pay Airline's employees a minimum hourly gross compensation wage rate and to provide minimum compensated and uncompensated time off. The minimum wage rate may change from year to year and Airline is obligated to keep informed of the then-current requirements. Any sublease entered into by Airline shall require the subtenant to comply with the requirements of the MCO and shall contain contractual obligations substantially the same as those set forth in this Section. It is Airline's obligation to ensure that any subtenants of any tier under this Agreement comply with the requirements of the MCO. If any subtenant under this Agreement fails to comply, City may pursue any of the remedies set forth in this Section against Airline.

C. Airline shall not take adverse action or otherwise discriminate against an employee or other person for the exercise or attempted exercise of rights under the MCO. Such actions, if taken within ninety (90) days of the exercise or attempted exercise of such rights, will be rebuttably presumed to be retaliation prohibited by the MCO.

D. Airline shall maintain employee and payroll records as required by the MCO. If Airline fails to do so, it shall be presumed that the Airline paid no more than the minimum wage required under State law.

E. The City is authorized to inspect Airline's job sites and conduct interviews with employees and conduct audits of Airline.

F. Airline's commitment to provide the Minimum Compensation is a material element of the City's consideration for this Agreement. The City in its sole discretion shall determine whether such a breach has occurred. The City and the public will suffer actual damage that will be impractical or extremely difficult to determine if the Airline fails to comply with these requirements. Airline agrees that the sums set forth in Section 12P.6.1 of the MCO as liquidated damages are not a penalty, but are reasonable estimates of the loss that the City and the public will incur for Airline's noncompliance. The procedures governing the assessment of liquidated damages shall be those set forth in Section 12P.6.2 of Chapter 12P.

G. Airline understands and agrees that if it fails to comply with the requirements of the MCO, the City shall have the right to pursue any rights or remedies available under Chapter 12P (including liquidated damages), under the terms of the contract, and under applicable law. If, within 30 days after receiving written notice of a breach of this Agreement

for violating the MCO, Airline fails to cure such breach or, if such breach cannot reasonably be cured within such period of 30 days, Airline fails to commence efforts to cure within such period, or thereafter fails diligently to pursue such cure to completion, the City shall have the right to pursue any rights or remedies available under applicable law, including those set forth in Section 12P.6(c) of Chapter 12P. Each of these remedies shall be exercisable individually or in combination with any other rights or remedies available to the City.

H. Airline represents and warrants that it is not an entity that was set up, or is being used, for the purpose of evading the intent of the MCO.

I. If Airline is exempt from the MCO when this Agreement is executed because the cumulative amount of agreements with this department for the Fiscal Year is less than \$25,000, but Airline later enters into an agreement or agreements that cause contractor to exceed that amount in a Fiscal Year, Airline shall thereafter be required to comply with the MCO under this Agreement. This obligation arises on the effective date of the agreement that causes the cumulative amount of agreements between Airline and Commission to exceed \$25,000 in the Fiscal Year.

Section 1815 Notification of Limitations on Contributions. Through its execution of this Agreement, Airline acknowledges that it is familiar with Section 1.126 of the San Francisco Campaign and Governmental Conduct Code, which prohibits any person who contracts with the City for the selling or leasing any land or building to or from the City whenever such transaction would require approval by a City elective officer or the board on which that City elective officer serves, from making any campaign contribution to the officer at any time from the commencement of negotiations for such contract until the termination of negotiations for such contract or three (3) months has elapsed from the date the contract is approved by the City elective officer, or the board on which that City elective officer serves.

Section 1816 Compliance with Laws. Airline shall keep itself fully informed of the City Charter, codes, ordinances and regulations of the City and of all State, and federal laws in any manner applicable to the performance of this Agreement, and must at all times comply with such applicable local codes, ordinances, and regulations and all applicable laws as they may be amended from time to time.

Section 1817 Airport Intellectual Property. Pursuant to Resolution No. 01-0118, adopted by the Airport Commission on April 18, 2001, the Airport Commission affirmed that it will not tolerate the unauthorized use of its intellectual property, including the SFO logo, CADD designs, and copyrighted publications. All proposers, bidders, contractors, tenants, permittees, and others doing business with or at the Airport (including subcontractors and subtenants) may not use the Airport intellectual property, or any intellectual property confusingly similar to the Airport intellectual property, without the Airport Director's prior consent.

Section 1818 Food Service Waste Reduction. If and to the extent applicable, the Airline agrees to comply fully with and be bound by all of the applicable provisions of the Food Service Waste Reduction Ordinance, as set forth in the San Francisco Environment Code, Chapter 16, including the remedies provided therein, and implementing guidelines and rules. The provisions of

Chapter 16 are incorporated herein by reference and made a part of this Agreement as though fully set forth herein. Accordingly, Airline acknowledges that City contractors and lessees may not use Disposable Food Service Ware that contains Polystyrene Foam in City Facilities and while performing under a City contract or lease, and shall instead use suitable Biodegradable/Compostable or Recyclable Disposable Food Service Ware. This provision is a material term of this Agreement. By entering into this agreement, Airline agrees that if it breaches this provision, City will suffer actual damages that will be impractical or extremely difficult to determine; further, Airline agrees that the sum of one hundred dollars (\$100.00) liquidated damages for the first breach, two hundred dollars (\$200.00) liquidated damages for the second breach in the same year, and five hundred dollars (\$500.00) liquidated damages for subsequent breaches in the same year is a reasonable estimate of the damage that City will incur based on the violation, established in light of the circumstances existing at the time this agreement was made. Such amounts shall not be considered a penalty, but rather agreed monetary damages sustained by City because of Airline's failure to comply with this provision.

Section 1819 Labor Disputes. Airline agrees to use commercially reasonable efforts to avoid disruption to City, other Air Carriers, Airport tenants, or members of the public arising from labor disputes involving Airline, and in the event of a strike, picketing, demonstration or other labor difficulty involving Airline, to use commercially reasonable efforts, including the utilization of available legal remedies, to minimize or eliminate any disruption to City, other Air Carriers, Airport tenants, or members of the public, arising from such strike, picketing, demonstration or other labor difficulty.

Section 1820 Preservative-Treated Wood Containing Arsenic. As of July 1, 2003, Airline may not purchase preservative-treated wood products containing arsenic in the performance of this Agreement unless an exemption from the requirements of Environment Code Chapter 13 is obtained from the Department of Environment under Section 1304 of the Environment Code. The term "preservative-treated wood containing arsenic" shall mean wood treated with a preservative that contains arsenic, elemental arsenic, or an arsenic copper combination, including, but not limited to, chromated copper arsenate preservative, ammoniac copper zinc arsenate preservative, or ammoniacal copper arsenate preservative. Airline may purchase preservative-treated wood products on the list of environmentally preferable alternatives prepared and adopted by the Department of Environment. This provision does not preclude Airline from purchasing preservative-treated wood containing arsenic for saltwater immersion. The term "saltwater immersion" shall mean a pressure-treated wood that is used for construction purposes or facilities that are partially or totally immersed in saltwater.

ARTICLE 19. MISCELLANEOUS PROVISIONS

Section 1901 No Individual Liability. No Commissioner, director, officer, agent or employee of either party shall be charged personally or held contractually liable by or to the other party under any term or provision of this Agreement or because of any breach thereof or because of its or their execution or attempted execution.

Section 1902 Agreements With Governments. Except for the payment of rentals and fees provided for herein, this Agreement is subject and subordinate to the provisions of any

agreement and amendments thereto heretofore made between City and the United States, relative to the operation or maintenance of the Airport, the execution of which has been required as a condition precedent to the transfer of federal rights or property to City for Airport purposes, or to the expenditure of federal funds for the extension, expansion, or development of the Airport, including the expenditure of federal funds for the development of the Airport in accordance with the provisions of the Federal Aviation Act of 1958, as it has been amended from time to time.

Section 1903 Governing Law. This Agreement shall be deemed to have been made in, and be construed in accordance with, the laws of the State and the City Charter.

Section 1904 Notices. Any notice given under this Agreement shall be effective only if in writing and given by delivering the notice in person or by sending it first-class mail or certified mail with a return receipt requested or by overnight courier, return receipt requested, with postage prepaid, to: (a) Airline, (i) at Airline's address set forth in the Airline's Address Notice, or (ii) at any place where Airline or any agent of Airline may be found if sent subsequent to Airline's vacating, abandoning or surrendering the Demised Premises; or (b) City, at City's address set forth in the City's Notice Address; or (c) to such other address as either City or Airline may designate as its new address for such purpose by notice given to the other in accordance with the provisions of this Section at least ten (10) days prior to the effective date of such change. Any notice hereunder shall be deemed to have been given two (2) days after the date when it is mailed if sent by first class or certified mail, one day after the date it is made if sent by overnight courier, or upon the date personal delivery is made. For convenience of the parties, copies of notices may also be given by facsimile to the telephone number set forth in the City's Notice Address and the Airline's Notice Address or such other number as may be provided from time to time; however, neither party may give official or binding notice by facsimile. Airline shall promptly provide City with copies of any and all notices received regarding any alleged violation of laws or insurance requirements or any alleged unsafe condition or practice related to Airline's use of, or its operations at, the Airport. Any provision herein that one party shall notify the other of some matter is to be construed as a requirement that notice is to be given in accordance with the provisions of this Section.

Section 1905 No Implied Waiver. No failure by City to insist upon the strict performance of any obligation of Airline under this Agreement or to exercise any right, power or remedy arising out of a breach thereof, irrespective of the length of time for which such failure continues, prior to the expiration of the Term by any City, shall constitute a waiver of such breach or of City's right to demand strict compliance with such term, covenant or condition or operate as a surrender of this Agreement. No express written waiver of any default or the performance of any provision hereof shall affect any other default or performance, or cover any other period of time, other than the default, performance or period of time specified in such express waiver. One or more written waivers of a default or the performance of any provision hereof shall not be deemed to be a waiver of a subsequent default or performance. Any consent by City hereunder shall not relieve Airline of any obligation to secure the consent of City in any other or future instance under the terms of this Agreement.

Section 1906 Federal Grant Agreement Covenants. Airline acknowledges that City is subject to Federal Grant Agreement obligations as a condition precedent to granting of funds for

improvement of the Airport, and, accordingly, agrees to be bound by the following covenants provided by the FAA, as they may apply to Airline.

A. Airline for itself, its personal representatives, successors in interest, and assigns, as part of the consideration hereof, does hereby covenant and agree that in the event facilities are constructed, maintained, or otherwise operated at the Airport for a purpose for which a DOT program or activity is extended, or for another purpose involving the provision of similar services or benefits, Airline shall maintain and operate such facilities and services in compliance with all other requirements imposed pursuant to Title 49, Code of Federal Regulations, DOT, Sub-title A, Office of the Secretary, Part 21, Nondiscrimination in Federally-Assisted Programs of the Department of Transportation-Effectuation of Title VI of the Civil Rights Act of 1964, and as said regulations may be amended.

B. Airline for itself, its personal representatives, successors in interest, and assigns, as part of the consideration hereof, does hereby covenant and agree that (1) no person on the grounds of race, color, or national origin shall be excluded from participation, denied the benefits of, or be otherwise subjected to discrimination in the use of said facilities, (2) that in the construction of any improvements on, over, or under the Airport and the furnishing of services thereon, no person on the grounds of race, color, or national origin shall be excluded from participation or denied the benefits of, or otherwise be subjected to discrimination, (3) that Airline shall use all City premises in compliance with all other requirements imposed by or pursuant to Title 49, Code of Federal Regulations, DOT, Sub-title A, Office of the Secretary, Part 21, Nondiscrimination in Federally-Assisted Programs of the Department of Transportation-Effectuation of Title VI of the Civil Rights Act of 1964, and as said Regulations may be amended.

C. That in the event of breach of any of the above nondiscrimination covenants, City shall have the right to terminate this Agreement, to re-enter and repossess any of said Airport premises and the facilities thereon, and to hold the same as if this Agreement had never been made or issued. This provision shall not become effective until the procedures of 49 CFR Part 21 are followed and completed including expiration of appeal rights.

D. Airline shall furnish its accommodations and/or services on a fair, equal and not unjustly discriminatory basis to all users thereof and it shall charge fair, reasonable and not unjustly discriminatory prices for each unit or service; provided, that Airline may be allowed to make reasonable and nondiscriminatory discounts, rebates or other similar types of price reductions to volume purchasers.

E. Non-compliance with Subsection (D) above shall constitute a material breach of this Agreement and in the event of such non-compliance City shall have the right to terminate this Agreement and any estate hereby created without liability therefor or, at the election of City or the United States, either or both said governments shall have the right to judicially enforce Subsections (A), (B), (C), and (D) of this Section.

F. Airline agrees that it shall insert or incorporate by reference the provisions in Subsections (A)-(E) of this Section in any agreement by which Airline grants a right or privilege

to any person, firm or corporation to render accommodations and/or services to the public at the Airport.

G. Airline assures that it will comply with pertinent statutes, executive orders and such rules as are promulgated to assure that no person shall, on the grounds of race, creed, color, national origin, sex, age, or handicap, be excluded from participating in any activity conducted with or benefiting from federal assistance. This paragraph obligates Airline or its transferee for the period during which federal assistance is extended to the airport program, except where federal assistance is to provide, or is in the form of, personal property or real property or interests therein or structures or improvements thereon. In these cases, this paragraph obligates the party or any transferee for the longer of the following periods: (i) the period during which the property is used by the sponsor or any transferee for a purpose for which federal assistance is extended, or for another purpose involving the provision of similar services or benefits; or (ii) the period during which the airport sponsor or any transferee retains ownership or possession of the property. In the case of contractors, this paragraph binds the contractors from the bid solicitation period through the completion of the contract.

H. Notwithstanding anything set forth herein to the contrary, to the extent required: (a) under the Master Bond Documents; or (b) by the FAA, the DOT, the TSA or a similar governmental authority, other than City, having jurisdiction over the Airport, City reserves the right to further develop or improve the landing area of the Airport as required, regardless of the desires or views of Airline and without interference or hindrance.

I. This Agreement shall be subordinate to the provisions and requirements of any existing or future agreement between City and the United States relative to the development, operation or maintenance of the Airport.

J. Airline agrees to comply with the notification and review requirements covered in Part 77 of the Federal Aviation Regulations in the event any future structure or building is planned for the Airport premises or in the event of any planned modification or alteration of any present or future building or structure situated on the permitted premises.

K. Airline, by accepting this Agreement, agrees for itself and its successors and assigns that it will not make use of the Airport premises in any manner which might interfere with the landing and taking off of aircraft from the Airport or otherwise constitute a hazard. In the event the aforesaid covenant is breached, City reserves the right to enter upon the Airport premises and cause the abatement of such interference at the expense of Airline.

L. Airline, by accepting this Agreement, expressly agrees for itself and its successors and assigns that it will not erect nor permit the erection of any structure or object, nor permit the growth of any tree on the Airport premises, above the main sea level elevation that would exceed FAR Part 77 standards or elevations affecting the Airport navigable airspace. In the event the aforesaid covenants are breached, City reserves the right to enter upon the permitted premises and to remove the offending structure or object and cut the offending tree, all of which shall be at the expense of Airline.

Section 1907 Contracting on More Favorable Terms.

A. City covenants and agrees that in the event it enters into any lease, contract or any other agreement with any other Air Carrier containing more favorable terms than this Agreement, or grants to any Air Carrier rights, privileges, or concessions at the Airport which are not accorded Airline hereunder, it shall advise Airline of such action and this Agreement shall, at Airline's option, be amended to incorporate such rights, terms, privileges and concessions, or any of them, as part of this Agreement; provided, however, that this covenant shall not extend to any intrastate Air Carrier operating only aircraft of less than 30,000 pounds maximum gross weight nor shall it require City to permit international flights from any Domestic Terminal.

B. In the event that any Air Carrier shall undertake any operations at the Airport for the carriage of passengers, cargo or mail by air, City shall require, to the extent legally permissible, such Air Carrier to execute and deliver an agreement, lease, permit or contract with City providing for:

(i) the payment of Landing Fees at rates not less than those rates then in effect for the Signatory Airlines, and on such other terms and conditions that are not more favorable than those terms and conditions then in effect for the Signatory Airlines; and

(ii) the payment of (a) rentals, for any space leased from City in the Terminal Area at rates not less than those rates then payable by the Signatory Airlines for similar space; provided, however, that if space has been constructed by City for such Air Carrier and the rental rates then payable by the Signatory Airlines for similar space would not fairly compensate City for the cost of providing, maintaining, operating and administering such space over the term of its agreement with such Air Carrier, then at rental rates that will fairly compensate City; or (b) terminal operations charges, if such Air Carrier does not lease, sublease or hold space pursuant to a permit in the Terminal Area, which charge shall be payable for each aircraft arrival in the Terminal Area in an amount that will fairly compensate City; and

(iii) the payment of fees (including those described in Section 405) for use by such Air Carrier of Common Use areas, including operating costs of all baggage handling, public address, porter service or other passenger service systems, calculated and billed to such Air Carrier as in the case of the Signatory Airlines.

Section 1908 Force Majeure. Neither City nor Airline shall be deemed in violation of this Agreement if it is prevented from performing any of its obligations hereunder by reason of strikes, boycotts, labor disputes, embargoes, shortages of material, acts of terrorism, riots, rebellion, sabotage or any other casualty which is not within its control; provided, however, that these provisions shall not excuse Airline from payment of the Terminal Area Rentals and Landing Fees specified in Articles 4 and 5 hereinabove, and other fees, rates, and charges specified in this Agreement.

Section 1909 Invalid Provisions and Severability. In the event any covenant, condition or provision herein contained is held to be invalid or unenforceable by a court of competent jurisdiction, the invalidity or unenforceability of any such covenant, condition or provision shall

in no way affect any other covenant, condition or provision herein contained, provided the invalidity or unenforceability of any such covenant, condition or provision does not materially prejudice either City or Airline in their respective rights and obligations contained in the valid covenants, conditions and provisions of this Agreement.

Section 1910 Headings. The headings of the several Sections of this Agreement are inserted only as a matter of convenience and for reference and in no way define, limit or describe the scope or intent of any provisions of this Agreement, and shall not be construed to affect in any manner the term and provisions hereof or the interpretation or construction thereof.

Section 1911 Exclusiveness of Airline's Rights. Nothing herein contained shall be deemed to grant to Airline any exclusive right or privilege within the meaning of 49 U.S.C. Section 40103(e) or 49 U.S.C. Section 47107(a)(4) for activity on the Airport, except that, subject to the terms and provisions hereof, Airline shall have the right to exclusive possession of the Exclusive Use Space leased to Airline under the provisions of this Agreement.

Section 1912 Withholding Required Approvals. Whenever the approval of the Director, Commission, City or Airline is required herein, no such approval shall be unreasonably refused, withheld or delayed.

Section 1913 Majority-in-Interest Decisions. Whenever decisions of a Majority-in-Interest are required hereunder, such decisions may be evidenced by a letter mailed pursuant to the provisions of Section 1904 from the then-current Chairman of the SFAAAC to Director, or his successor or designee.

Section 1914 Declaration Regarding Airport Private Roads. Airline hereby acknowledges and agrees that all roads existing at the date of execution hereof within the boundaries of the Airport, as shown on Exhibits A and B, attached hereto, are the private property and private roads of City, with the exception of that portion of the Old Bayshore Highway which runs through the southern limits of the City of South San Francisco and through the northern portion of the Airport to the intersection with the North Airport Road, and with the exception of that portion of the North Airport Road which runs from the off- and on-ramps of the State Bayshore Freeway to the intersection with said Old Bayshore Highway. It further acknowledges that any and all roads hereafter constructed or opened by City within the Airport boundaries will be the private property and roads of City, unless otherwise designated by appropriate action.

Section 1915 Subordination of Agreement.

A. Subject to the provisions of Section 1510, this Agreement and all rights of Airline and City hereunder are expressly subject to the lien of any pledge, transfer, hypothecation or assignment made at any time by City to secure Airport Revenue Bonds and to the terms and conditions of the Master Bond Documents. Airline acknowledges that any failure by Airline to make payments under this Agreement as and when such payments are due may result in a default by City on such Airport Revenue Bonds and related agreements.

B. With respect to property leased by City to Airline hereunder which was or is to be acquired by City with proceeds of Airport Revenue Bonds, the interest on which is, or is

intended to be, excludable from the gross income of the holders of such Airport Revenue Bonds for federal income tax purposes, the parties hereby covenant not to take or fail to take any action that would impair the tax-exempt status of such Airport Revenue Bonds. In particular, Airline shall make an irrevocable election not to claim depreciation or an investment credit with respect to any property leased to Airline hereunder.

C. Airline agrees to execute all instruments, certificates, or other documents reasonably requested by City to assist City and bond counsel in determining and assuring that Airport Revenue Bonds are issued in compliance with applicable rules and regulations of the Internal Revenue Service and the Securities and Exchange Commission, and Airline shall provide whatever additional relevant information is reasonably requested by City initially or on an ongoing basis in connection with complying with any of those rules and regulations.

Section 1916 Inspection of Records. Airline and City, each at its own expense and upon reasonable notice, shall have the right to inspect the books, records and other data of the other party relating to the provisions and requirements hereof, provided such inspection is made during regular business hours. City agrees to provide Airline with a copy of the report of the annual audit covering the Airport.

Section 1917 Successors and Assigns. All of the terms, provisions, covenants, stipulations, conditions and considerations in this Agreement shall extend to and bind the legal representatives, successors, sublessees (except as to the rentals, fees and other charges), and assigns of the respective parties hereto.

Section 1918 Taxes, Assessments and Liens.

A. Airline shall pay all taxes, assessments and charges of a like nature, if any (including any possessory interest tax), which at any time during the term of this Agreement may be levied against Airline or become a lien by virtue of any levy, assessment or charge against Airline by the federal government, the State, San Mateo County or any governmental successor in authority to the foregoing, or any other tax- or assessment-levying bodies, in whole or in part, upon or in respect to (a) the Demised Premises or such facilities of the Airport as are made available for use by Airline hereunder or (b) any personal property belonging to Airline situated on or in the Demised Premises. The property interest of Airline, if any, created by this Agreement may be subject to property taxation, and Airline may be subject to the payment of property tax levied on such interest. Payment of such additional charges for all such taxes, assessments and charges, when and if levied or assessed, shall be made by Airline directly to the taxing or assessing authority charged with collection thereof, in which event Airline shall be responsible for obtaining bills for all of said taxes, assessments and charges and promptly providing City with evidence of payment therefor.

B. Airline may, at its expense, contest the amount or validity of any tax or assessment or the inclusion of the Demised Premises as taxable or assessable property directly against the taxing or assessing authority. Airline shall indemnify City from all taxes, penalties, costs, expenses, and attorneys' fees incurred by City resulting directly or indirectly from all such tax contests other than contests of City-imposed taxes.

C. Upon any termination of this Agreement, all lawful taxes then levied or a lien upon any of such property or taxable interest therein shall be paid in full by Airline forthwith or as soon as a statement thereof has been issued by the tax collector if termination occurs during the interval between the attachment of the lien and the issuance of the statement.

Section 1919 Appendices, Exhibits and Schedules. All exhibits referred to herein and all exhibits and schedules referred to in any appendices, and any appendices, exhibits or schedules which may, from time to time, be referred to in any duly executed amendment hereto are (and including future amendments, shall be) by such reference incorporated herein and shall be deemed a part of this Agreement as fully as if set forth herein. In the event of any inconsistency between an exhibit or schedule and any provision of this Agreement, such provision shall prevail.

Section 1920 Entire Agreement. The parties intend that this Agreement (including all of the attached exhibits, which are made a part of this Agreement) shall be the final expression of their agreement concerning the subject matter hereof and may not be contradicted by evidence of any prior or contemporaneous written or oral agreements or understandings. The parties further intend that this Agreement shall constitute the complete and exclusive statement of its terms and that no extrinsic evidence whatsoever (including prior drafts hereof and changes therefrom) may be introduced in any judicial, administrative or other legal proceeding involving this Agreement. Airline hereby acknowledges that neither City nor City's agents have made any representations or warranties concerning the Demised Premises or this Agreement except as expressly set forth herein, and no rights, easements or licenses are or shall be acquired by Airline by implication or otherwise unless expressly set forth herein.

Section 1921 Approvals. All approvals, consents, waivers, and determinations to be made by City or Commission hereunder can be given, withheld, or made by Director, unless otherwise provided or required. All approvals, consents, waivers, and determinations to be made by Airline can be made by the Airline Representative, unless otherwise provided or required. Without limiting the generality of the foregoing, if a Terminal Company of which Airline is a member is representing Airline for certain limited purposes under this Agreement and such representation is consistent with the organizational documents of such Terminal Company, City may rely on an approval, consent, waiver, or determination of such corporation or committee for such purposes. In no event shall a Terminal Company be authorized to amend or modify this Agreement on behalf of Airline.

Section 1922 Amendments. Neither this Agreement nor any terms or provisions hereof may be changed, waived, discharged or terminated, except by a written instrument signed by the party against which the enforcement of the change, waiver, discharge or termination is sought. Whenever this Agreement requires or permits the giving by City of its consent or approval, the Director, or his or her designee shall be authorized to provide such approval, except as otherwise provided by applicable law, including the Charter. Any amendments or modifications to this Agreement, including, without limitation, amendments to or modifications to the exhibits to this Agreement, shall be subject to the mutual written agreement of City and Airline, and City's agreement may be made upon the sole approval of the Director, or his or her designee; provided, however, material amendments or modifications to this Agreement (i) increasing the Term, (ii)

increasing the rental payments required and payable by Airline by more than ten percent (10%) under this Agreement, (iii) changing the general use of the Demised Premises from the uses authorized in Section 202, and (iv) any other amendment or modification which materially increases the City's liabilities or financial obligations under this Agreement shall additionally require the approval of the Commission and the Board.

Notwithstanding anything to the contrary:

A. To the extent Airline's Demised Premises in any Terminal are reduced or relocated pursuant to this Agreement, such reduction/relocation shall be memorialized by City's issuance of a Space Change Summary Notice and shall not require or constitute a formal amendment to this Agreement; and

B. To the extent the Preferential Use Gates assigned to Airline are changed in accordance with Article 3, such annual reallocation shall be memorialized by City's issuance of the annual Preferential Use Gate allocation notice which shall be deemed to form a part of this Agreement and shall not require or constitute a formal amendment to this Agreement.

Section 1923 Interpretation of Agreement. As amended hereby, each and every of the terms, conditions, and covenants in this Agreement shall remain in full force and effect. The captions preceding the articles and sections of this Agreement and in the table of contents have been inserted for convenience of reference only and such captions shall in no way define or limit the scope or intent of any provision of this Agreement. This Agreement has been negotiated at arm's length and between persons sophisticated and knowledgeable in the matters dealt with herein and shall be interpreted to achieve the intents and purposes of the parties, without any presumption against the party responsible for drafting any part of this Agreement. Provisions in this Agreement relating to number of days shall be calendar days, unless otherwise specified; provided, however, that if the last day of any period to give notice, reply to a notice or to undertake any other action occurs on a Saturday, Sunday or a bank or City holiday, the last day for undertaking the action or giving or replying to the notice shall be the next succeeding business day. Use of the word "including" or similar words shall not be construed to limit any general term, statement or other matter in this Agreement, whether or not language of non-limitation, such as "without limitation" or similar words, are used.

Section 1924 Duty Free Merchandise and International Travel Merchandise. Airline shall not sell, take orders, deliver, or transport duty free merchandise and/or international travel merchandise ("ITM") as such terms are defined by the United States Department of the Treasury/U.S. Customs Service, and its applicable regulations and directives, on any flight into or out of the Airport under a program in which Airline solicits or accepts orders for purchase by passengers of, or delivers, ITM at any time prior to the departure of Airline's aircraft on the outbound flight from the Airport. The foregoing restriction shall apply to Airline and its Affiliate Airlines, and their respective officers, employees, affiliates, agents, and assigns. In the event City grants any other Air Carrier permission to conduct such activity, City shall offer no less favorable rights to Airline relating to ITM.

Section 1925 No Third-Party Beneficiaries. Except as expressly stated herein, there are no third-party beneficiaries to this Agreement.

Section 1926 No Joint Venture. It is expressly agreed that City is not, in any way or for any purpose, a partner of Airline in the conduct of Airline business or a member of a joint enterprise with Airline, and does not assume any responsibility for Airline's conduct or performance of this Agreement.

Section 1927 Nature of Agreement. Under no circumstances will City be expected or required to make any payment of any kind for Airline's use or occupancy of the Demised Premises, except as may be otherwise expressly set forth herein. Except as otherwise expressly provided herein, this Agreement shall continue in full force and effect, and the obligations of Airline hereunder shall not be released, discharged or otherwise affected, by reason of: (a) any bankruptcy, insolvency, reorganization, composition, adjustment, dissolution, liquidation or other proceeding relating to City, Airline or any constituent partner of Airline or any sublessee, licensee or concessionaire or any action taken under this Agreement by a trustee or receiver, or by any court, in any proceeding; (b) any claim that Airline or any other person has or might have against City; (c) any failure on the part of City to perform or comply with any of the terms hereof or of any other agreement with Airline or any other person; (d) any failure on the part of any sublessee, licensee, concessionaire, or other person to perform or comply with any of the terms of any sublease or other agreement between Airline and any such person; (e) any termination of any sublease, license or concession, whether voluntary or by operation of law; or (f) any other occurrence whatsoever, whether similar or dissimilar to the foregoing in each case whether or not Airline shall have notice or knowledge of any of the foregoing. The obligations of Airline hereunder shall be separate and independent covenants and agreements. Except as otherwise provided for in this Agreement, Airline hereby waives to the full extent permitted by applicable law, all rights now or hereafter conferred by statute, including without limitation the provisions of Civil Code Sections 1932 and 1933, to quit, terminate or surrender this Agreement or the Demised Premises or any part thereof, or to any abatement, suspension, deferment, diminution or reduction of any rent hereunder.

Section 1928 Required Approvals. NOTWITHSTANDING ANYTHING TO THE CONTRARY CONTAINED IN THIS AGREEMENT, AIRLINE ACKNOWLEDGES AND AGREES THAT NO OFFICER OR EMPLOYEE OF CITY HAS AUTHORITY TO COMMIT CITY TO THIS AGREEMENT UNLESS AND UNTIL CITY'S BOARD OF SUPERVISORS SHALL HAVE DULY ADOPTED A RESOLUTION APPROVING THIS AGREEMENT AND AUTHORIZING THE TRANSACTIONS CONTEMPLATED HEREBY AND THE MAYOR SIGNS THE RELATED RESOLUTION. THEREFORE, ANY OBLIGATIONS OR LIABILITIES OF CITY HEREUNDER ARE CONTINGENT UPON ADOPTION OF SUCH A RESOLUTION, AND THIS AGREEMENT SHALL BE NULL AND VOID IF CITY'S MAYOR AND THE BOARD OF SUPERVISORS DO NOT APPROVE THIS AGREEMENT, EACH ACTING IN THEIR RESPECTIVE SOLE DISCRETION. APPROVAL OF THIS AGREEMENT BY THE AIRPORT OR THE AIRPORT COMMISSION OR AGENCY OF CITY SHALL NOT BE DEEMED TO IMPLY THAT SUCH RESOLUTION WILL BE ENACTED, NOR WILL ANY SUCH APPROVAL CREATE ANY BINDING OBLIGATIONS ON CITY.

Section 1929 Airline Operations Information and Planning. For planning purposes, Airline shall upon request cooperate to the greatest extent possible to furnish to City any and all pertinent information regarding Airline's current and future operations (including forecasts) at Airport. City will not disclose such information unless required to by law without first having Airline's consent, unless disclosure of such information is, in the Director's sole discretion, required for the sale of bonds or other indebtedness. Notwithstanding the foregoing, City shall be entitled, from time to time, to release consolidated statistics for all Air Carriers operating at the Airport.

Section 1930 Waiver of Visual Artists Rights. Airline shall not install any object in the Demised Premises that constitutes a work of visual art under the Visual Artists Rights Act of 1990 ("VARA") unless and until Airline has (a) obtained the prior written approval of the Director and (b) provided City with a written waiver from the author of such work of visual art, in form and substance reasonably satisfactory to City, which waiver shall identify specifically the work of visual art and the uses of that work to which the waiver applies in accordance with 17 U.S.C. § 106A(e)(1). Airline shall also provide City with a similar written waiver that is effective to bar any claim by an artist for a work of fine art under the California Art Preservation Act, Cal. Civ. Code §§ 987-989.

Section 1931 Airport Functions. All Airport-related functions provided as of July 1, 2009, by City employees assigned to the Commission and working under the direct authority and control of the Director, including but not limited to Airport operations, custodial cleaning and facilities maintenance, planning, development, construction, financial management and accounting, information technology and telephony, parking management and operations, human resources, marketing, public relations and other administrative and governmental functions, shall continue to be provided by employees assigned to the Commission and may only be transferred to other City departments in accordance with the following procedure:

A. City shall give Signatory Airlines sixty (60) days' notice of any proposed transfer of functions from Commission employees to other City departments.

B. Signatory Airlines shall forward any comments, questions or objections to the proposed transfer of functions in writing to the Director within sixty (60) days of receipt of such notice.

C. City shall consider and respond to such comments, questions or objections within forty-five (45) days of receipt thereof, following which the City may implement the proposed transfer.

D. Any City department head whose department receives work relating to the Airport in such transfer of functions shall coordinate and consult with the Director at least annually to ensure that the work is performed in a manner that is efficient, meets the needs of the Airport and conforms to sound business and airport management principles. Furthermore, such work (including work orders and billings) and any payments therefor shall be properly documented to comply with interdepartmental memoranda of understanding and billing procedures established from time to time by the Commission, and FAA rules and regulations.

ARTICLE 20. HAZARDOUS MATERIALS

Section 2001 Definitions. As used herein, the following terms shall have the meanings hereinafter set forth:

A. **“Environmental Laws”** shall mean any federal, State, local or administrative law, rule, regulation, order, or requirement relating to industrial hygiene, protection of human health and safety, environmental conditions or Hazardous Materials, whether now in effect or hereafter adopted or amended from time to time, including without limitation the Comprehensive Environmental Response, Compensation and Liability Act of 1980, as amended (42 U.S.C. Sections 9601, et seq.), the Resources Conservation and Recovery Act of 1976 (42 U.S.C. Section 9601, et seq.), the Clean Water Act (33 U.S.C. Section 1251, et seq.), the Safe Drinking Water Act (14 U.S.C. Section 401, et seq.), the Hazardous Materials Transportation Act (49 U.S.C. Section 1801, et seq.), the Toxic Substance Control Act (15 U.S.C. Section 2601, et seq.), the California Hazardous Waste Control Law (California Health and Safety Code Section 25100, et seq.), the Porter-Cologne Water Quality Control Act (California Water Code Section 13000, et seq.), and the Safe Drinking Water and Toxic Enforcement Act of 1986 (California Health and Safety Code Section 25249.5, et seq.); and applicable and controlling federal or state court decisions.

B. **“Hazardous Materials”** shall mean (a) any material that, because of its quantity, concentration or physical or chemical characteristics, is deemed by any federal, State or local governmental authority to pose a present or potential hazard to human health or safety or to the air, water, soil or environment; and (b) any materials, substances, products, by products, waste, or other materials of any nature or kind whatsoever whose presence in and of itself or in combination with other materials, substances, products, by products, or waste may give rise to liability under any Environmental Laws or permits. "Hazardous Material" includes any material or substance identified, listed, or defined as a "hazardous waste" "hazardous substance," or "pollutant" or "contaminant" or term of similar import, or is otherwise regulated pursuant to Environmental Laws; any asbestos and asbestos- containing materials; petroleum, including crude oil or any fraction thereof, natural gas or natural gas liquids.

C. **“Release”** when used for Hazardous Materials shall include any actual spilling, leaking, pumping, pouring, emitting, emptying, discharging, injecting, escaping, leaching, dumping, or disposing into or on any property or the environment, and includes any threat of Release to the extent regulated under Environmental Laws.

D. **“Pre-Existing Condition”** means the existence of any Hazardous Materials on the Demised Premises immediately prior to the Effective Date, including, without limitation, those conditions described in the reports listed in Exhibit M attached hereto that are applicable to the Demised Premises. A "Pre-Existing Condition" shall not include the existence of any Hazardous Materials caused or contributed to by the act or omission of Airline or any Airline Entity at any time.

Section 2002 Airline's Covenants. Airline covenants the following:

A. Airline and any Airline Entity shall at all times and in all respects comply with all Environmental Laws and permits applicable to Airline's operations on the Airport. The Release of Hazardous Materials is strictly prohibited, except in compliance with applicable Environmental Laws or permits issued pursuant to applicable Environmental Laws.

B. Neither Airline nor any Airline Entity shall cause any Hazardous Material to be brought upon, kept, used, stored, generated, treated, managed, or disposed of in, on or about the Airport, or transported to or from or within the Airport, except to the extent that such Hazardous Material, in kind and quantity, is normally necessary or useful to Airline's conduct of the Permitted Uses under Section 202 and will be used, kept, and stored in a manner that complies with all applicable Environmental Laws, the Airport Rules, and all other applicable laws. At all times, Airline shall ensure and certify that to the extent Airline is required to decontaminate the Demised Premises and/or dispose of Hazardous Materials under this Agreement or applicable law, including Environmental Laws, that such decontamination of the Demised Premises and/or disposal of Hazardous Materials shall be performed in compliance with the foregoing and any relevant permits. Any reuse of contaminated soil by Airline at the Airport shall be subject to: (a) this Section and considered a Release of Hazardous Materials caused by Airline and not a Pre-Existing Condition, and (b) Director's approval in writing to the reuse of contaminated soil.

C. Airline, at Airline's sole cost and expense, shall promptly investigate and remediate, in accordance with requirements of all applicable Environmental Laws and permits, any Release of Hazardous Materials on the Airport, including, but not limited to, any Release into soil or groundwater, which was caused or results in whole or in part from the activities of Airline or any Airline Entity, but excluding: (a) the disposal of Hazardous Materials through the Airport's sewage system so long as such disposal complies with all applicable Environmental Laws and any predischARGE treatment requirements issued by the Airport; or (b) the portions of said Release that the Airline demonstrates to the reasonable satisfaction of the City was caused exclusively by the City or City Entity.

In addition to any remedy provided in this Agreement, City, in its discretion, may after reasonable written notice to Airline (except that notice is not required for any Release that poses an imminent harm to the environment or other emergency situation), pay to have such Release investigated and remediated as required by applicable Environmental Laws, and Airline shall reimburse City for its share of the documented costs within thirty (30) days of City's demand for payment if: (a) Airline does not promptly commence investigation of any such Release; (b) Airline does not diligently pursue appropriate remedial activities as required by applicable Environmental Laws and permits; or (c) City determines that its performance of the investigation and/or remediation is needed to achieve the City's operational needs or construction objectives. The failure to commence investigation and provide City with a preliminary schedule for diligent pursuit of any required remediation within thirty (30) business days after (a) Airline's discovery of such Release or (b) notice of such Release shall constitute prima facie evidence of failure to promptly commence investigation and remediation.

D. Airline shall provide Director with a copy of any application for a permit, if required, for use or storage of Hazardous Materials on the Airport from any regulatory agency responsible for enforcement of applicable Environmental Laws and shall also provide a copy of any permit received from such agency.

Section 2003 Access for Environmental Inspection. City shall have reasonable access to the Demised Premises to inspect the same in order to confirm that Airline is using the Demised Premises in accordance with all applicable Environmental Laws or permits. City will, where practical, give Airline the opportunity to have an Airline representative present during the inspection. Airline shall cooperate fully with any such inspections provided that such inspections shall not unreasonably interfere with Airline's operations.

Section 2004 Liability. In addition to any remedy provided in this Agreement, Airline shall be solely and fully responsible and liable for costs, including without limitation costs of clean-up or other remedial activities, fines or penalties assessed directly against the Airport, attributable to (a) storage, use or disposal of Hazardous Materials on the Airport by Airline or any Airline Entity; or (b) any Hazardous Material release or discharge which is caused or results from the activities of Airline or any Airline Entity.

Section 2005 Environmental Indemnity. Airline shall indemnify, defend, and hold harmless City from and against any and all losses resulting or arising from: (a) a breach by Airline of its obligations contained in Section 2002; (b) any Release of Hazardous Material from, in, on or about the Airport caused by the act or omission of Airline or any Airline Entity or otherwise arising from Airline's operations hereunder; or (c) the existence of any Hazardous Materials on the Demised Premises, except to the extent that (i) Airline can demonstrate to the reasonable satisfaction of City that such Hazardous Materials constitutes a Pre-Existing Condition and Airline or Airline Entity did not exacerbate such Pre-Existing Condition, or (ii) such Hazardous Material was exclusively caused by City or a third party other than an Airline Entity. Nothing herein shall constitute a release of Airline for any losses arising out of any Pre-Existing Conditions to the extent Airline is responsible therefore pursuant to any other agreement or under applicable law.

Section 2006 Environmental Audit. Upon reasonable written notice, Director shall have the right but not the obligation to conduct or cause to be conducted by a firm acceptable to Director, an environmental audit of the Demised Premises and Airline's operations, equipment and fixtures thereon for the purpose of assessing Airline's compliance with Environmental Laws and permits. City will give Airline an opportunity to have an Airline representative present during the audit. Airline shall pay all reasonable costs associated with said audit, but only to the extent City's actions are consistent with Section 2002(C), in the event such audit shall disclose any Hazardous Materials contamination as to which Airline is liable hereunder. Airline shall be provided the opportunity to review and comment on the report of the audit results prior to finalization. Airline will promptly correct any deficiencies associated with its compliance with this Lease or Environmental Laws or permits as identified in the final audit report.

Section 2007 Notice by Airline. Airline shall give City verbal and written notice of any unauthorized Release of any Hazardous Material, except for Releases considered to be de

minimis under Environmental Laws, known to Airline. Such report shall be made in conformance with those procedures established in the Airport Rules. In addition, to the extent known to Airline, Airline shall notify City in writing, to the extent related to the Airport, of: (a) a pre-existing condition of contamination other than such conditions previously disclosed to the Airline by City; (b) any enforcement, clean-up, removal or other government or regulatory action instituted, completed or threatened against Airline or the Airport pursuant to any Environmental Laws; (c) any claim made or threatened by any person against Airline or the Airport relating to damage, contribution, cost recovery compensation, loss or injury resulting from or claimed to result from any Hazardous Materials on or about the Demised Premises; and (d) any reports made by Airline to any environmental agency arising out of or in connection with any Hazardous Materials or pursuant to any Environmental Laws or permits on or about the Demised Premises. Airline shall also supply to City as promptly as possible, and in any event within ten (10) business days after Airline first receives or sends the same, with copies of all claims, reports, complaints, notices or warnings of, and any other communications related to asserted violations of Environmental Laws or permits by Airline relating in any way to the Demised Premises or Airline's use thereof.

Section 2008 Stormwater. Notwithstanding any other provisions or terms of this Agreement, Airline acknowledges that certain properties within the Airport are subject to federal and State stormwater rules and regulations. Airline agrees to observe and abide by such stormwater rules and regulations as may be applicable to City's property and Airline's use thereof.

A. City and Airline both acknowledge that cooperation is necessary to ensure compliance with any stormwater discharge permit terms and conditions, as well as to ensure safety and to minimize cost of compliance. Airline acknowledges further that it may be necessary to undertake such actions to minimize the exposure of stormwater to "significant materials" generated, stored, handled or otherwise used by Airline, as such term may be defined by applicable stormwater rules and regulations, by implementing and maintaining "best management practices" as that term may be defined in applicable stormwater rules and regulations.

B. City will provide Airline with written notice of any stormwater discharge permit requirements applicable to Airline and with which Airline may be obligated to comply from time-to-time, including, but not limited to: certification of non-stormwater discharges; collection of stormwater samples if required by law; preparation of stormwater pollution prevention or similar plans; implementation of best management practices; and maintenance of necessary records. Such written notice shall include applicable deadlines. Airline shall agree that within thirty (30) days of receipt of such written notice it shall notify City in writing if it disputes any of the stormwater permit requirements it is directed to undertake. If Airline does not provide such timely notice, Airline will be deemed to assent to undertake such stormwater permit requirements applicable to Airline's operations. In that event, Airline agrees to undertake, at its sole expense, unless otherwise agreed to in writing between City and Airline, those stormwater permit requirements applicable to Airline's operations for which it has received written notice from City, and Airline agrees that it will hold harmless and indemnify City for any violations or non-compliance with any such permit requirements. Additionally, City will endeavor, where practical, to notify Airline in advance of negotiations with federal or state

regulators concerning new or revised stormwater permit conditions that directly affect the Airline.

Section 2009 Airline Obligations Upon Termination. Prior to vacating the Demised Premises, and in addition to all other requirements under this Agreement and without limiting Airline's indemnification obligations herein, Airline shall:

A. Remove any Hazardous Materials on the Demised Premises except (i) to the extent Airline demonstrates to the reasonable satisfaction of City that said Hazardous Material constitutes a Pre-Existing Condition and Airline or Airline Entity did not exacerbate said Pre-Existing Contamination; (ii) to the extent the Airline can demonstrate to the reasonable satisfaction of City that said Hazardous Material was exclusively caused by City or a third party other than an Airline Entity; or (iii) said Hazardous Material is addressed pursuant to Section 2009(B). Moreover, Airline shall demonstrate to City's reasonable satisfaction that such removal is in compliance with all applicable Environmental Laws and permits, including without limitation conducting any environmental audits and/or site investigations as may be reasonably required by City to demonstrate such removal has been completed according to the terms of this Agreement. This removal and demonstration shall be a condition precedent to City's return of the Deposit, if any, to Airline upon termination or expiration of this Agreement.

B. With respect to any Release of Hazardous Materials on the Demised Premises not removed pursuant to Section 2009(A) above and not subject to the exceptions therein, Airline shall promptly investigate and remediate it in accordance with the requirements of all applicable Environmental Laws and permits ("Airline's remediation"). If Airline's remediation will leave Hazardous Materials at the Airport (including but not limited to in the soil or groundwater), prior to completion of the remediation, the Airline shall: (i) obtain the City's written determination that such Hazardous Materials will not interfere with any reuse of the Demised Premises reasonably contemplated or anticipated by the City; (ii) provide the City with a plan for long-term care and surveillance of any such Hazardous Material and (iii) provide the City with a written acknowledgement of responsibility and indemnification for any and all losses or disruption associated with such contamination. The Airline's full compliance with this Section 2009 shall be a condition precedent to the City's return of the Deposit, if any, to Airline upon termination or expiration of this Agreement.

Section 2010. Cumulative Remedies. All remedies of the City as provided herein with regard to Hazardous Materials or any actual or threatened violations of any Environmental Laws and permits are deemed to be cumulative in nature. The City's right to indemnification as provided in this Section shall survive the expiration or early termination of this Agreement with respect to occurrences during the Term of this Agreement.

Section 2011 Prior Agreements. Notwithstanding any provisions in this Agreement, nothing herein shall affect the terms and conditions of any prior settlement agreements reached between City and Airline relating to Hazardous Materials at the Airport, including the civil action captioned City and County of San Francisco v. Atlantic Richfield et al (N.D. Cal. Case No. C97-2965), and nothing herein shall be construed in any way to limit the releases granted by the parties in those prior agreements.

///

IN WITNESS WHEREOF, the parties hereto have executed this Agreement in duplicate by their duly authorized officers the day and year first hereinabove written.

AIRLINE: AIR PACIFIC LIMITED D/B/A/ FIJI AIRWAYS,
a limited liability company duly registered under the laws of the Republic of Fiji

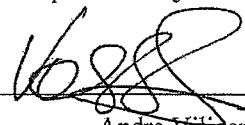
By: 
Name: Andre Vijden
Title: Managing Director and Chief Executive Officer

By: 
Name: Peter Seares
Title: Company Secretary

CITY: CITY AND COUNTY OF SAN FRANCISCO,
a municipal corporation,
acting by and through its Airport Commission

Ivar C. Satero
Airport Director



AUTHORIZED BY AIRPORT COMMISSION

Resolution No. 17-0184

Adopted: July 25, 2017

Attest: _____

Secretary
Airport Commission

APPROVED AS TO FORM:
DENNIS J. HERRERA, City Attorney

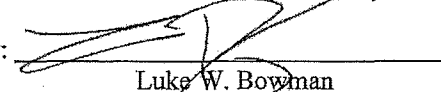
By: 
Luke W. Bowman
Deputy City Attorney

05.09.17
X:\TENANTS\AIRLINES\LEASES\2011 Lease and Use Agreement\Fiji 2011 Lease and Use Agreement.doc

List of Exhibits

- Exhibit A: Map of Airport
- Exhibit B: Location of Common Use Ticket Counters and Support Facilities
- Exhibit C: Maintenance and Operations Responsibilities
- Exhibit D: Description of Demised Premises and Space Drawings
- Exhibit E: Joint Use Formula(s) applicable to Airline, if any
 - E-1: IT Joint Use Formulas
 - E-2: Other Joint Use Formulas
- Exhibit F: Calculation of Fees for Common Use Facilities
- Exhibit G: Management Protocols - IT Ticket Counter and Other Joint Use Resources
- Exhibit H: Management Protocols - IT Gate Resources
- Exhibit I: Management Protocols - DT Ticket Counter Resources
- Exhibit J: DT Gates
 - J-1: Management Protocols - DT Gate Resources
 - J-2: Illustration of Domestic Terminals Preferential Use Gate Assignment Formula
- Exhibit K: Rents for Airline's Demised Premises
- Exhibit L: Form of Space Change Summary Notice
- Exhibit M: List of Baseline Environmental Reports
- Exhibit N: Airport Measurement Specifications
- Exhibit O: Calculation of Rates and Charges
- Exhibit P: Form of Activity Report
- Exhibit Q: Form of Capital Project Review Form

EXHIBIT A
MAP OF AIRPORT

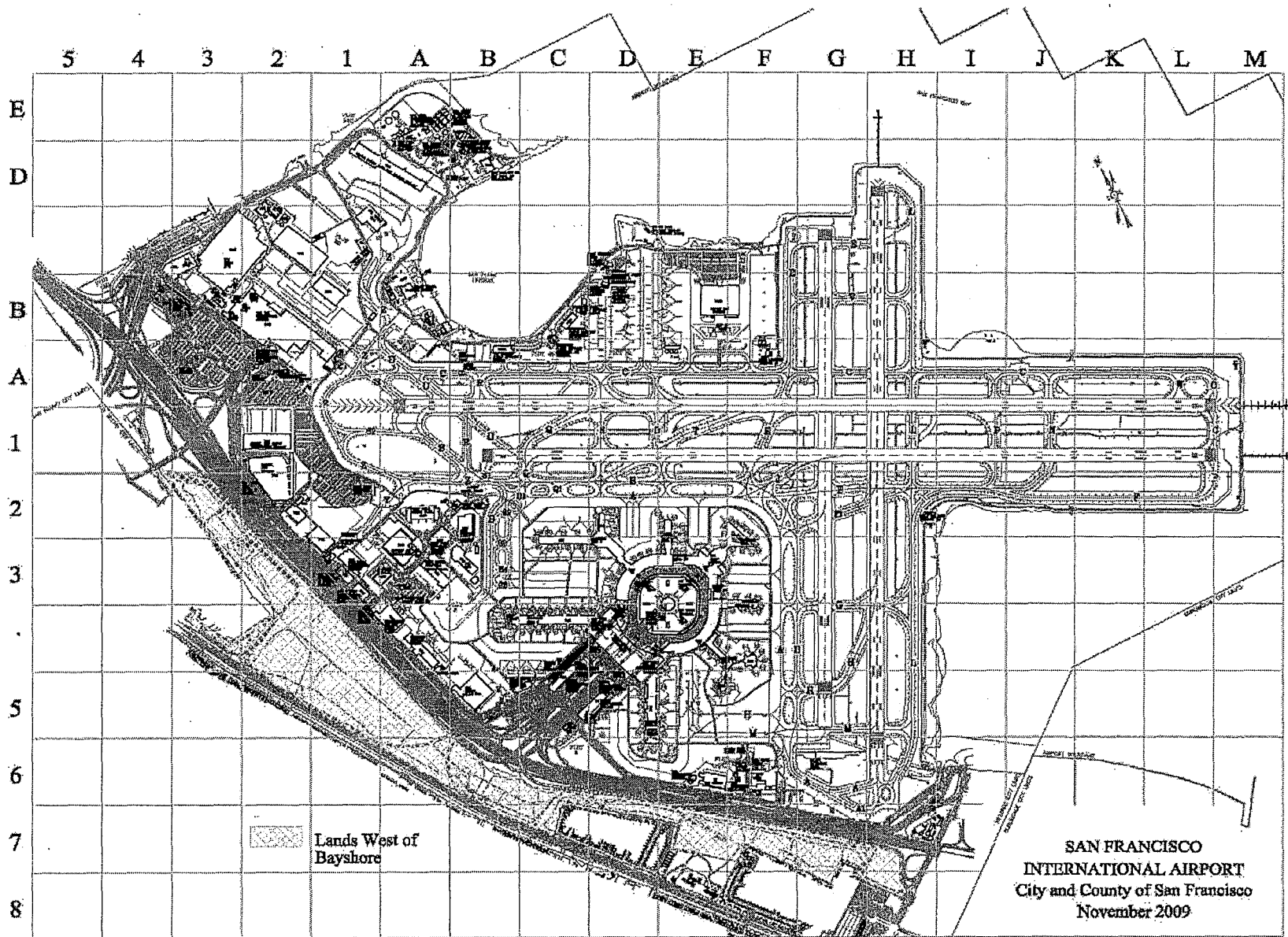

Exhibit A, Page 1

EXHIBIT B

**LOCATION OF COMMON USE
TICKET COUNTERS AND SUPPORT FACILITIES**

The following Ticket Counters and Support Facilities have been designated for Common Use by the Director as of the Effective Date, subject to annual change in designation as provided in Section 309.

[INSERT AS OF EFFECTIVE DATE]

EXHIBIT C
MAINTENANCE AND OPERATIONS RESPONSIBILITIES

| | | | | | | | Key: A-Airline/ C-City/ T-Non-Airline Tenant | | | |
|--|---|---|--------------------------------|------------------------|--------------|-----------------|--|----------------|------------------|----------------|
| TERMINAL BUILDINGS | | | | | | | LANDING AREAS | | | |
| | Leased | | | | | | Runways | Taxiways | Parking Ramps | Cart Roads |
| | Space - Full Public Exposure ¹ | Leased Space Unexposed ² | Airline Leaseable Vacant | Common Use Space | FIS Space | Public Space | | | | |
| HVAC -- Central Heating and Cooling to Premises | C | C | C | C | C | C | --- | --- | --- | --- |
| -- Heating of Premises | C | A | C | C | C | C | --- | --- | --- | --- |
| -- Cooling of Premises | C | A | C | C | C | C | --- | --- | --- | --- |
| Water and Sewerage | --- | A ³ | C | C | C | C | --- | --- | --- | --- |
| Water Supply to Premises ⁴ | C | C | C | --- | C | C | C | C | C | C |
| Lighting ⁵ | C | A | C | C | C | C | C | C | C | C |
| Cleaning ⁶ | C | A | C | C | C | C | C | C | A | C |
| Trash Removal | C | A | C | C | C | C | C | C | A | C |
| Window Washing - Interior | C | A | C | C | C | C | --- | --- | --- | --- |
| - Exterior | C | C | C | C | C | C | --- | --- | --- | --- |
| Decorative/Maintenance/Replacement/Repair: Walls, Doors, Furniture, Fixture, Windows, Ceilings, Carpets, Floors | C | A | C | C | C | C | --- | --- | --- | --- |
| Plumbing and Fixtures | --- | A | C | C | C | C | --- | --- | --- | --- |
| Building: - Structural | C | C | C | C | C | C | --- | --- | --- | --- |
| - Interior | C | A | C | C | C | C | --- | --- | --- | --- |
| - Exterior | C | C | C | C | C | C | --- | --- | --- | --- |
| Paving - Repair and Replacement | C | C | C | C | C | C | C | C | C | C |
| Baggage: - Claim Devices | A ⁷ | A ⁷ | --- | C | A | C | --- | --- | --- | --- |
| - Conveyors | A ⁷ | A ⁷ | --- | C | A | C | --- | --- | --- | A |
| Passenger Loading Bridges Maint. | A | A | --- | C | --- | --- | --- | --- | --- | A |
| Keys and Locks | A | A | C | C | T | C | --- | --- | --- | --- |
| Security Doors | C | C | C | C | C | C | --- | --- | --- | --- |
| Fuel Lines | --- | --- | --- | --- | --- | --- | --- | A ⁸ | A ⁸ | A ⁸ |
| Other: - 400HZ Power | IT and T2: City; all others: Airlines | | | | | | | | | |
| - Preconditioned Air | City responsible through the building and loading bridges. Airlines responsible for all hoses from loading bridges to aircraft. | | | | | | | | | |

¹ Includes Ticket Counters, Holdrooms, Baggage Claim Areas.

² Includes Offices, VIP Clubs/Lounges, Baggage Operations, Storage/Equipment Rooms.

³ Airport will inspect and maintain potable water backflow devices.

⁴ Usage of all power shall be estimated, or measured by meter. Meters to be installed at Airline's expense.

⁵ Lighting shall mean general illumination and shall include relamping and replacement of the Airport's standard starters, ballasts, switches and outlets but shall not include special airline installations or requirements.

⁶ Excludes Ticket Counters and passenger loading bridge interiors.

⁷ May be performed through SFOTEC.

⁸ Terminal 2 maintenance of baggage handling equipment will be provided by City for two years following opening of Terminal 2.

EXHIBIT D

DESCRIPTION OF DEMISED PREMISES AND SPACE DRAWINGS

The Demised Premises consist of the following:

EXCLUSIVE USE SPACE, as more particularly described on Airport Drawings Numbers specified on the List of Drawings attached hereto.

| Type | Terminal | Category | Square Feet |
|--|----------|----------|-------------|
| Ticket Counters | | I | |
| Other Category I | | I | |
| Airline Ticket Office (ATO) | | II | |
| VIP Clubs and Lounges | | II | |
| Other Enclosed Space Departure Level and above | | II | |
| Baggage Claim Lobbies | | II | |
| Baggage Service Offices | | II | |
| Curbside Check-in | | II | |
| Other Enclosed Space, Arrivals Level and below | | III | |
| Inbound/Outbound Baggage Handling Areas and Baggage Transfer Areas | | IV | |
| Equipment Rooms | | IV | |
| Unenclosed or Covered Area - Ramp Level | | V | |

JOINT USE SPACE, as more particularly described on Airport Drawings Numbers specified on the List of Drawings attached hereto.

| Type | Terminal | Category* (J/U type) | Square Feet |
|--|----------|-------------------------|-------------|
| Ticket Counter | | I (e) | 18,769 |
| Holdroom | | I (e) | 115,025 |
| Other Common Use, Level 1 & 3+ | | II (d) | 544 |
| Baggage Claim/FIS | | II (d) | 205,711 |
| Domestic Baggage Claim | | II (t) | 8,052 |
| Other Enclosed Common Use, Level 2 and below | | III (t) | 12,025 |
| Outbound Baggage Makeup | | IV (d) | 138,826 |
| Inbound Baggage Makeup | | IV (e) | 126,574 |
| Other Unenclosed Space | | V (t) | 1,888 |

* The Category references are utilized in the Joint Use Formulas, as follows: (e): enplaned / (d): deplaned / (t): total.

PREFERENTIAL USE GATES, as more particularly described on Airport Drawing Numbers specified on the List of Drawings attached hereto.

Exhibit D, Page 1

The Gates are allocated to Airline on a Preferential Use basis as of the Effective Date, subject to annual reallocation as provided in Article 3.

LIST OF DRAWINGS

EXCLUSIVE USE SPACE **Drawing No.** **Dated**

Not Applicable

JOINT USE SPACE **Drawing No.** **Dated**

| | | |
|--|---------|--------------|
| International Terminal, 1 st Floor | IT1JT | July 1, 2011 |
| International Terminal, 2 nd Floor | IT2JT | July 1, 2011 |
| International Terminal, 3 rd Floor | IT3JT | July 1, 2011 |
| Boarding Area A, 1 st Floor | BAA1JT | July 1, 2011 |
| Boarding Area A, 2 nd Floor | BAA2JT | July 1, 2011 |
| Boarding Area A, 2 nd Floor Mezzanine | BAA2MJT | July 1, 2011 |
| Boarding Area A, 3 rd Floor | BAA3JT | July 1, 2011 |
| Boarding Area G, 1 st Floor | BAG1JT | July 1, 2011 |
| Boarding Area G, 2 nd Floor | BAG2JT | July 1, 2011 |
| Boarding Area G, 3 rd Floor | BAG3JT | July 1, 2016 |

PREFERENTIAL USE SPACE

For future determination.

I:\AutoCad\LEASE\newitb\aviation\joint\IT1JT.dwg, 2/2/2010 5:22:52 PM

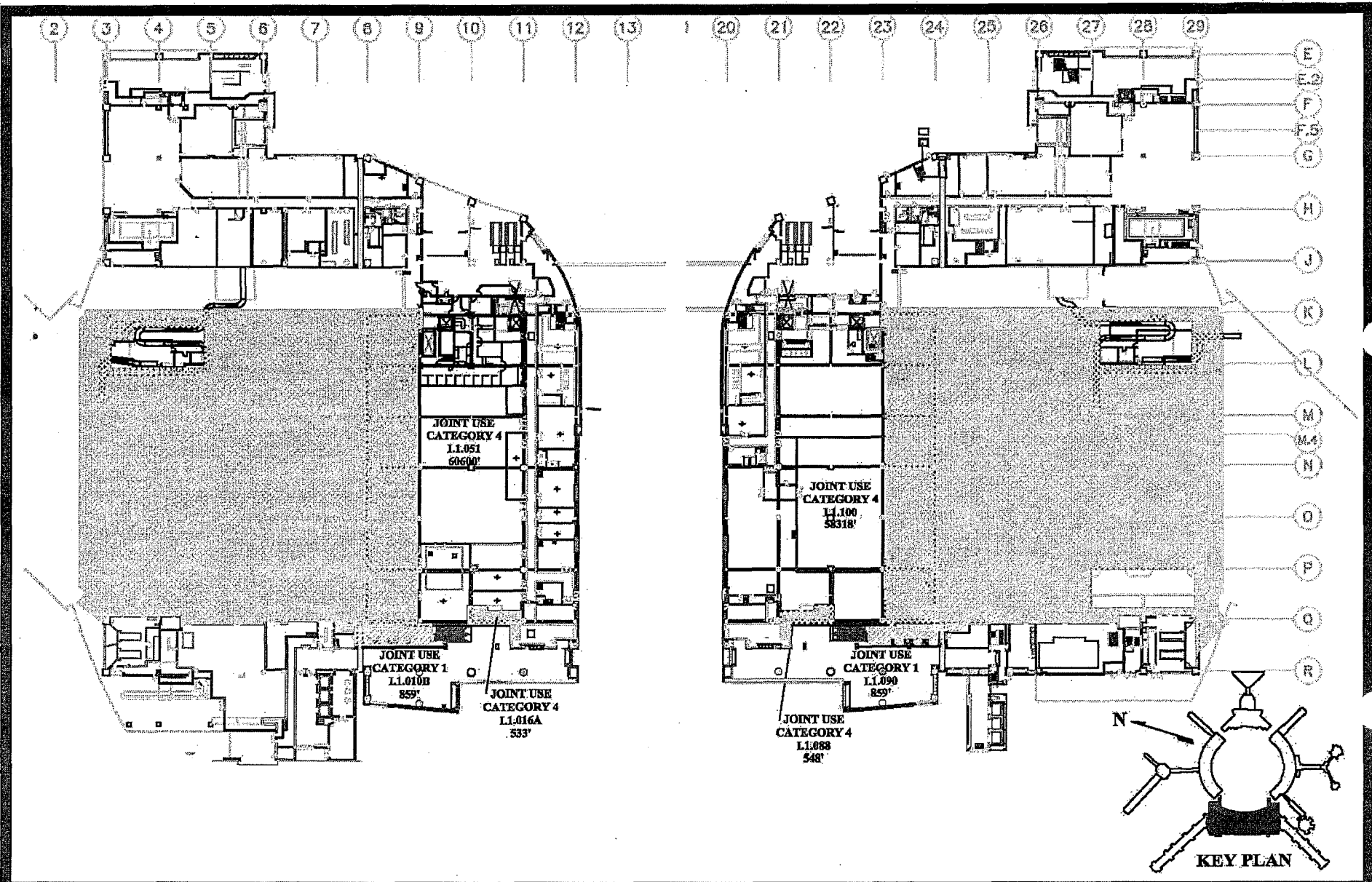

| TENANT LOCATION LEASE DRAWING | | LOCATION | TENANT | CAT | AREA | CONTRACT | EFF DATE |
|---|-------------------|----------|-----------|-----|---------|----------|----------|
| LOCATION: INTERNATIONAL TERMINAL, 1ST FLOOR | | | JOINT USE | 1 | 1718' | | |
| ALL INTERNATIONAL AIRLINES | | | JOINT USE | 4 | 119999' | | |
| CITY & COUNTY OF SAN FRANCISCO | DWG: IT1JT | | | | | | |
| AIRPORTS COMMISSION | SCALE: 1/8"=1'-0" | | | | | | |
| SAN FRANCISCO INTERNATIONAL AIRPORT | DATE: 07/01/2011 | | | | | | |

I:\AutoCad\LEASE(newwithblaviation)\joint\IT2JT.dwg, 2/2/2010 1:55:19 PM

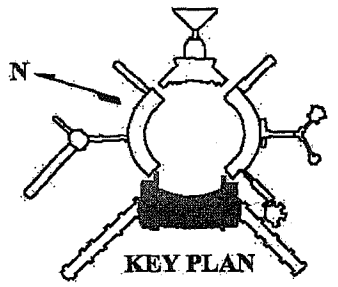
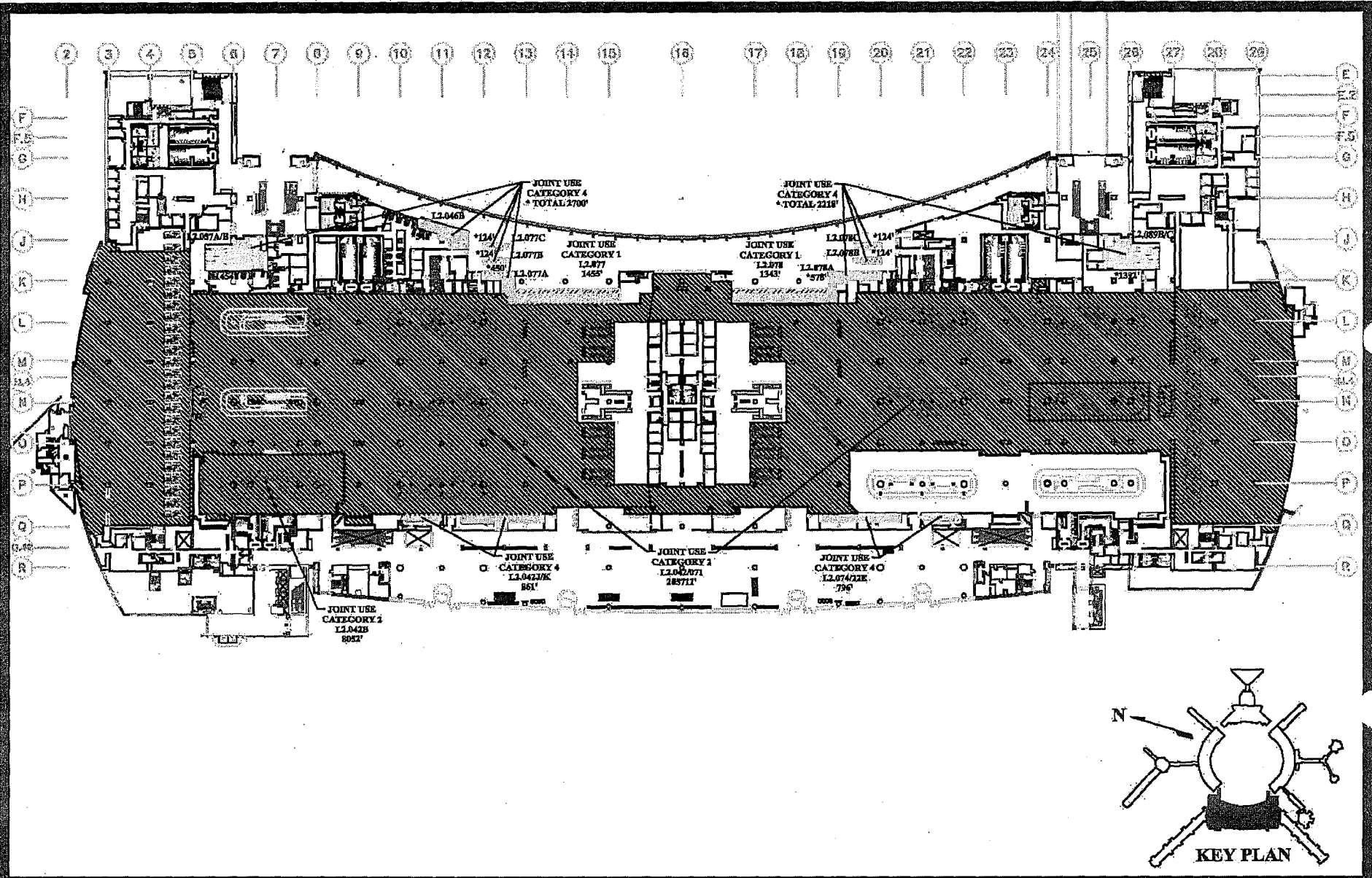

| TENANT LOCATION LEASE DRAWING | | LOCATION | TENANT | CAT | AREA | CONTRACT | EFF DATE |
|---|-------------------|----------|-----------|-----|---------|----------|----------|
| LOCATION: INTERNATIONAL TERMINAL, 2ND FLOOR, CENTER | | | JOINT USE | 1 | 2798' | | |
| ALL INTERNATIONAL AIRLINES | | | JOINT USE | 2 | 213763' | | |
| CITY & COUNTY OF SAN FRANCISCO | DWG: IT2JT | | JOINT USE | 4 | 6575' | | |
| AIRPORTS COMMISSION | SCALE: 1"=100'-0" | | | | | | |
| SAN FRANCISCO INTERNATIONAL AIRPORT | DATE: 07/01/2011 | | | | | | |

I:\AutoCad\LEASE\newwith\aviation\joint\IT3JT.dwg, 2/2/2010 2:07:12 PM

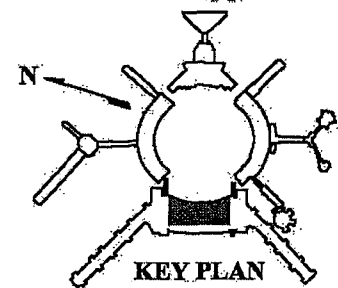
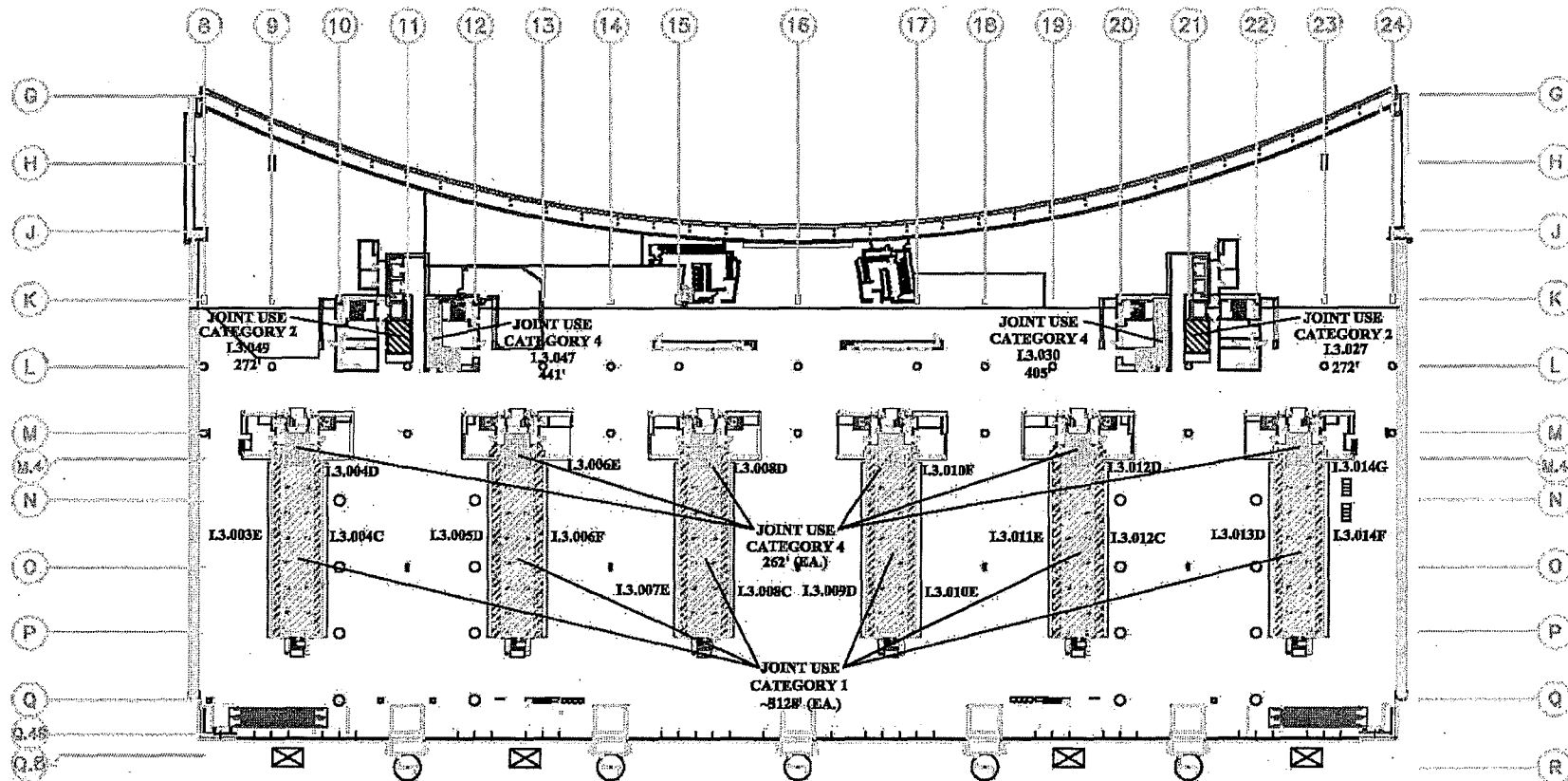

| TENANT LOCATION LEASE DRAWING | | LOCATION | TENANT | CAT | AREA | CONTRACT | EFF DATE |
|--|-------------------|----------|-----------|-----|--------|----------|----------|
| LOCATION: INTERNATIONAL TERMINAL, 3RD FLOOR CENTER | | | JOINT USE | 1 | 18769' | | |
| ALL INTERNATIONAL AIRLINES | | | JOINT USE | 2 | 544' | | |
| CITY & COUNTY OF SAN FRANCISCO | DWG: IT3JT | | JOINT USE | 4 | 2418' | | |
| AIRPORTS COMMISSION | SCALE: 1/8"=1'-0" | | | | | | |
| SAN FRANCISCO INTERNATIONAL AIRPORT | DATE: 07/01/2011 | | | | | | |

I:\AutoCad\LEASE\newitb\aviation\joint\BAA1JT.dwg, 2/2/2010 5:07:40 PM

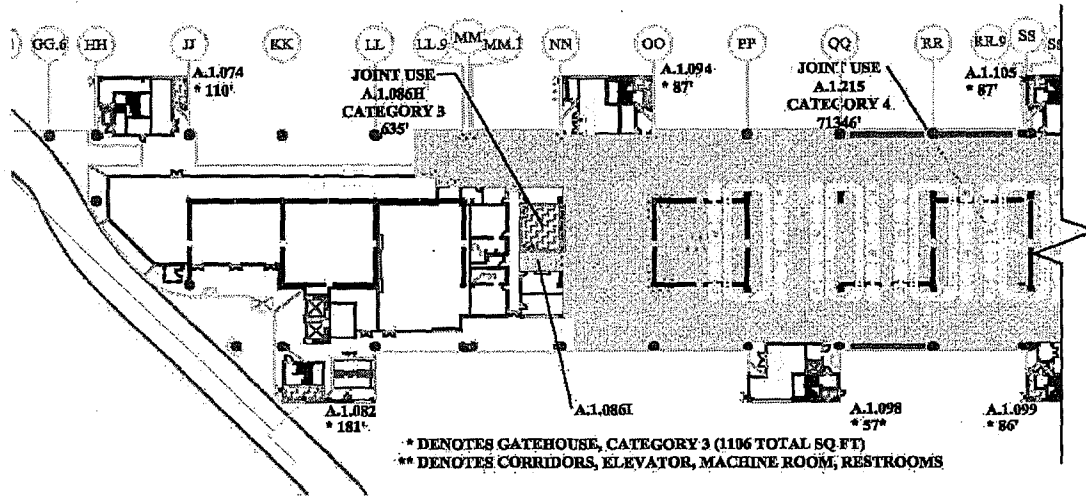

* DENOTES GATEHOUSE, CATEGORY 3 (1106 TOTAL SQ FT)
 ** DENOTES CORRIDORS, ELEVATOR, MACHINE ROOM, RESTROOMS

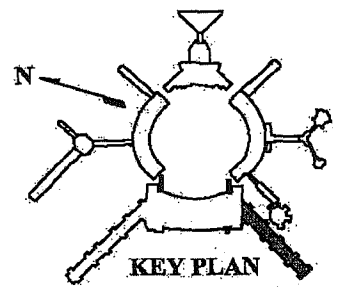
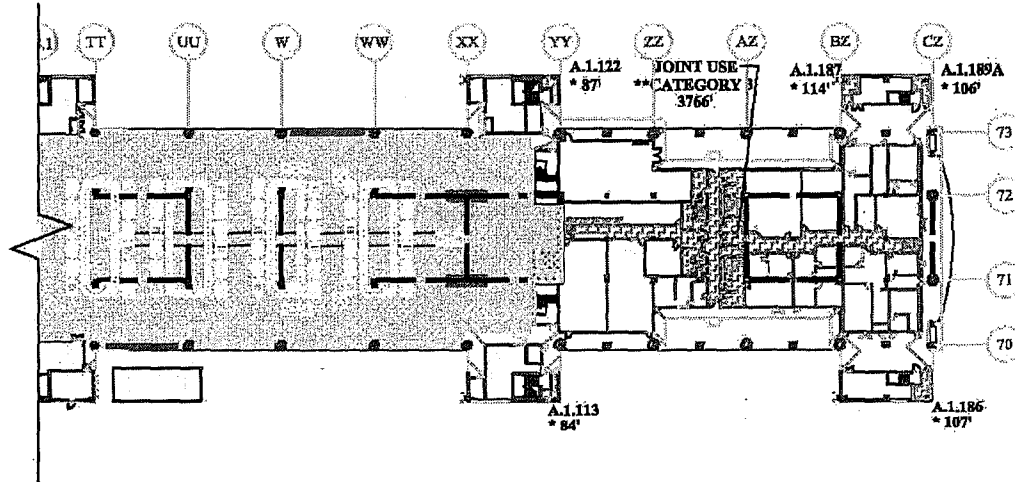

| TENANT LOCATION LEASE DRAWING | | LOCATION | TENANT | CAT | AREA | CONTRACT | EFF DATE |
|--------------------------------------|--------------------|----------|-------------|-----|--------|----------|----------|
| LOCATION: BOARDING AREA A, 1ST FLOOR | | | JT CORRIDOR | 3 | 4401' | | |
| ALL INTERNATIONAL AIRLINES | | | JT GATEHSE | 3 | 1106' | | |
| CITY & COUNTY OF SAN FRANCISCO | DWG: BAA1JT | | JOINT USE | 4 | 71346' | | |
| AIRPORTS COMMISSION | SCALE: 1/8"=10'-0" | | | | | | |
| SAN FRANCISCO INTERNATIONAL AIRPORT | DATE: 07/01/2011 | | | | | | |

I:\AutoCad\LEASE\new\with\aviation\joint\BAA2JT.dwg, 2/2/2010 11:48:12 AM

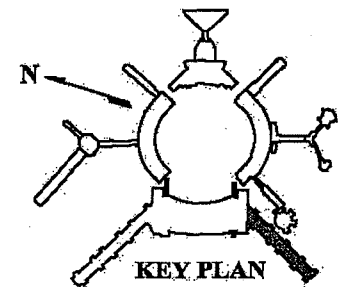
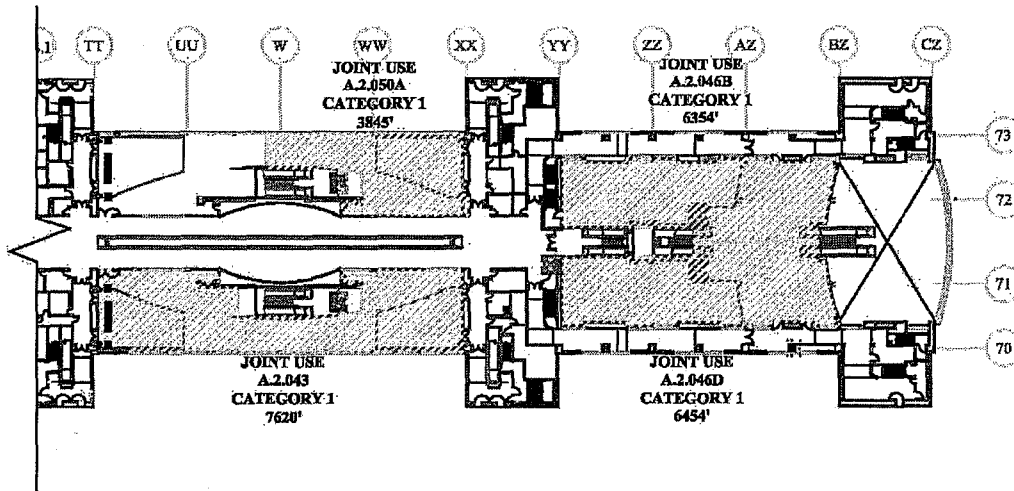
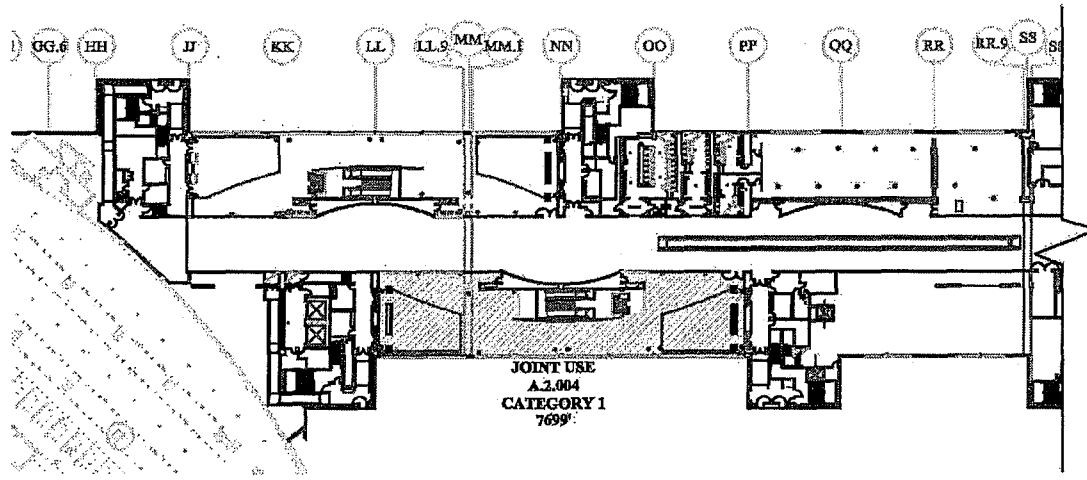

| TENANT LOCATION LEASE DRAWING | | LOCATION | TENANT | CAT | AREA | CONTRACT | EFF DATE |
|--------------------------------------|-------------------|----------|-----------|-----|--------|----------|----------|
| LOCATION: BOARDING AREA A, 2ND FLOOR | | | JOINT USE | 1 | 31972' | | |
| ALL INTERNATIONAL AIRLINES | | | | | | | |
| CITY & COUNTY OF SAN FRANCISCO | DWG: BAA2JT | | | | | | |
| AIRPORTS COMMISSION | SCALE: 1/8"=1'-0" | | | | | | |
| SAN FRANCISCO INTERNATIONAL AIRPORT | DATE: 07/01/2011 | | | | | | |

I:\AutoCad\LEASE\newwith\aviation\joint\BAA2MJT.dwg, 2/2/2010 1:09:05 PM

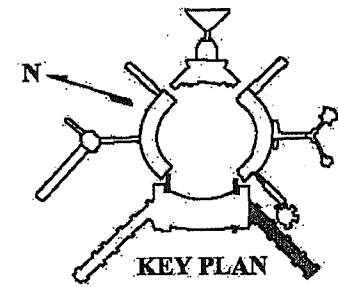
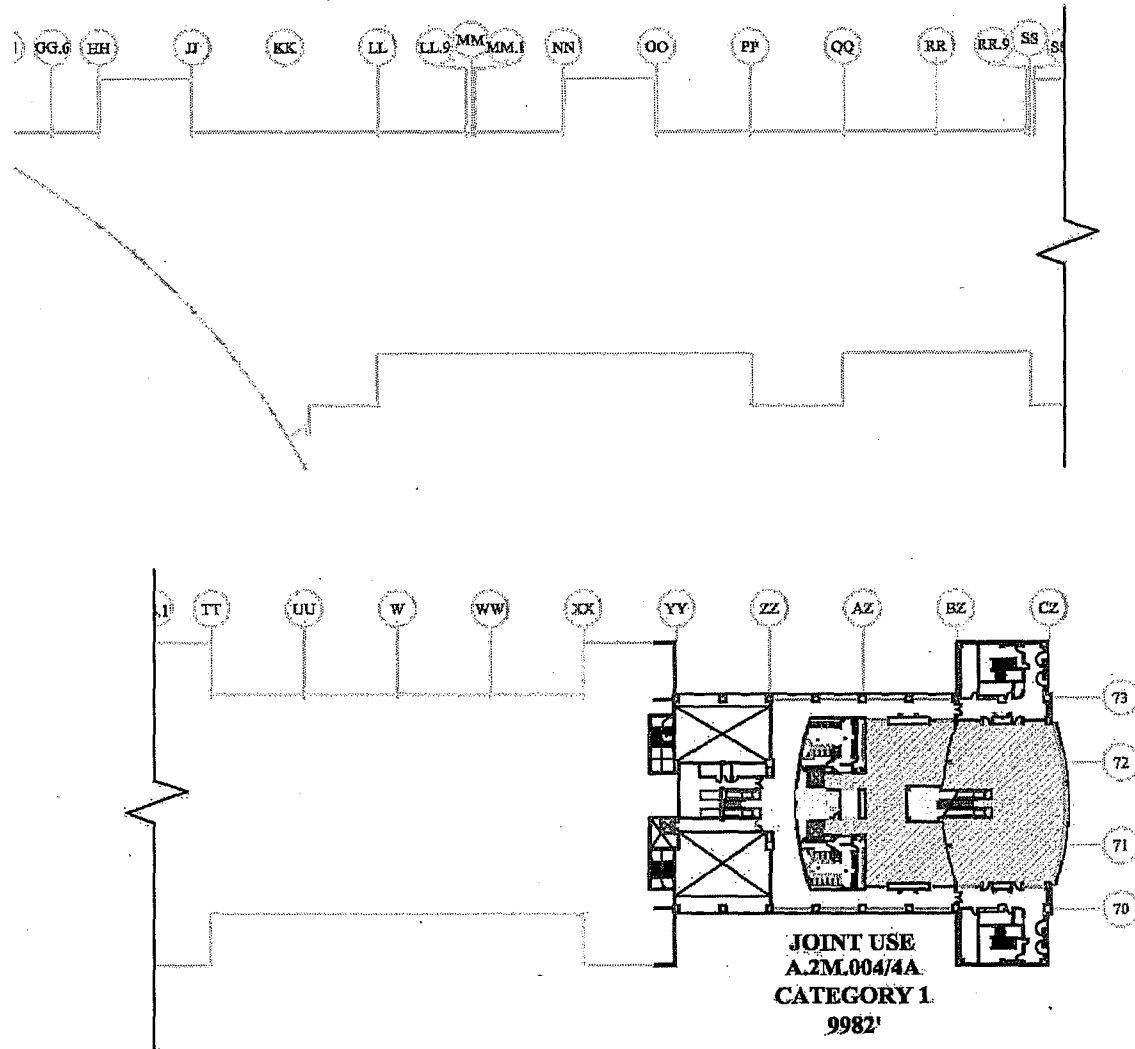

| TENANT LOCATION LEASE DRAWING | | LOCATION | TENANT | CAT | AREA | CONTRACT | EFF DATE |
|--|-------------------|----------|-----------|-----|-------|----------|----------|
| LOCATION: BOARDING AREA A, 2ND FLOOR MEZZANINE | | | JOINT USE | 1 | 9982' | | |
| ALL INTERNATIONAL AIRLINES | | | | | | | |
| CITY & COUNTY OF SAN FRANCISCO | DWG: BAA2MJT | | | | | | |
| AIRPORTS COMMISSION | SCALE: 1/8"=1'-0" | | | | | | |
| SAN FRANCISCO INTERNATIONAL AIRPORT | DATE: 07/01/2011 | | | | | | |

I:\AutoCad\LEASE(newitb\aviation)\joint\BAA3JT.dwg, 2/2/2010 12:17:14 PM

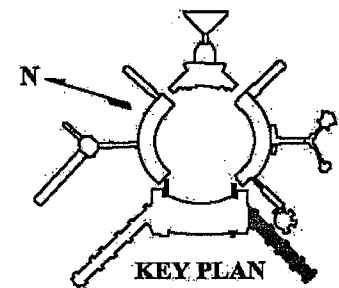
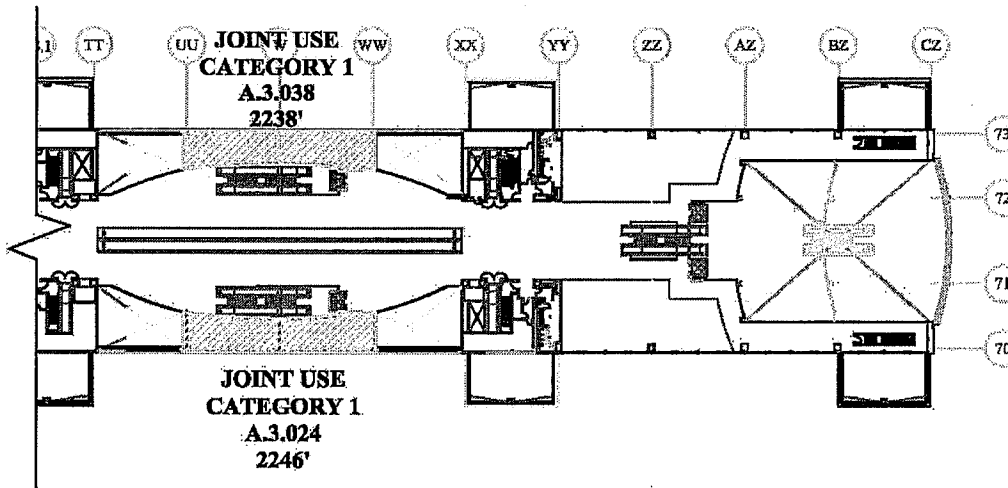
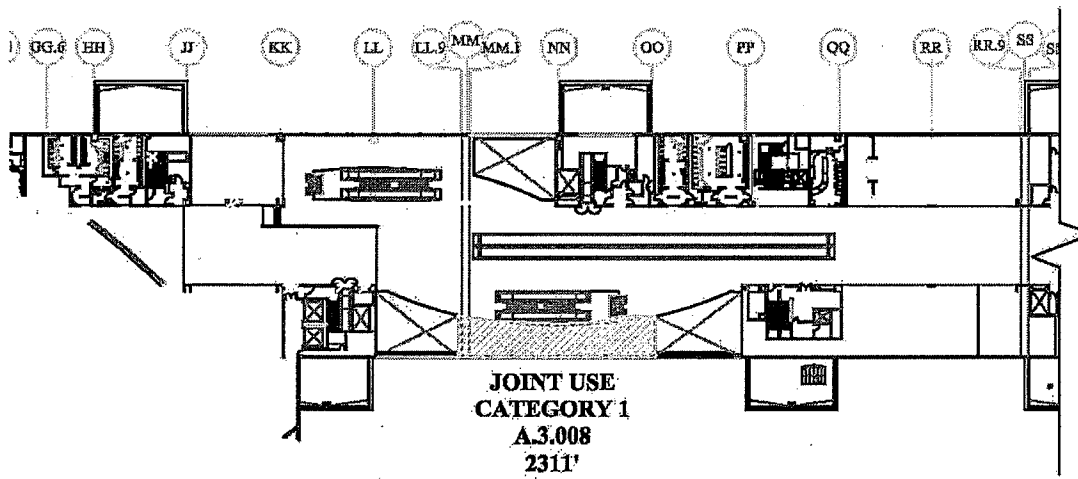

| TENANT LOCATION LEASE DRAWING | | LOCATION | TENANT | CAT | AREA | CONTRACT | EFF DATE |
|--------------------------------------|-------------------|----------|-----------|-----|-------|----------|----------|
| LOCATION: BOARDING AREA A, 3RD FLOOR | | | JOINT USE | 1 | 6795' | | |
| ALL INTERNATIONAL AIRLINES | | | | | | | |
| CITY & COUNTY OF SAN FRANCISCO | DWG: BAA3JT | | | | | | |
| AIRPORTS COMMISSION | SCALE: 1/8"=1'-0" | | | | | | |
| SAN FRANCISCO INTERNATIONAL AIRPORT | DATE: 07/01/2011 | | | | | | |

I:\AutoCad\LEASE\new\ib\aviation\joint\BAG1JT.dwg, 2/3/2010 8:51:20 AM

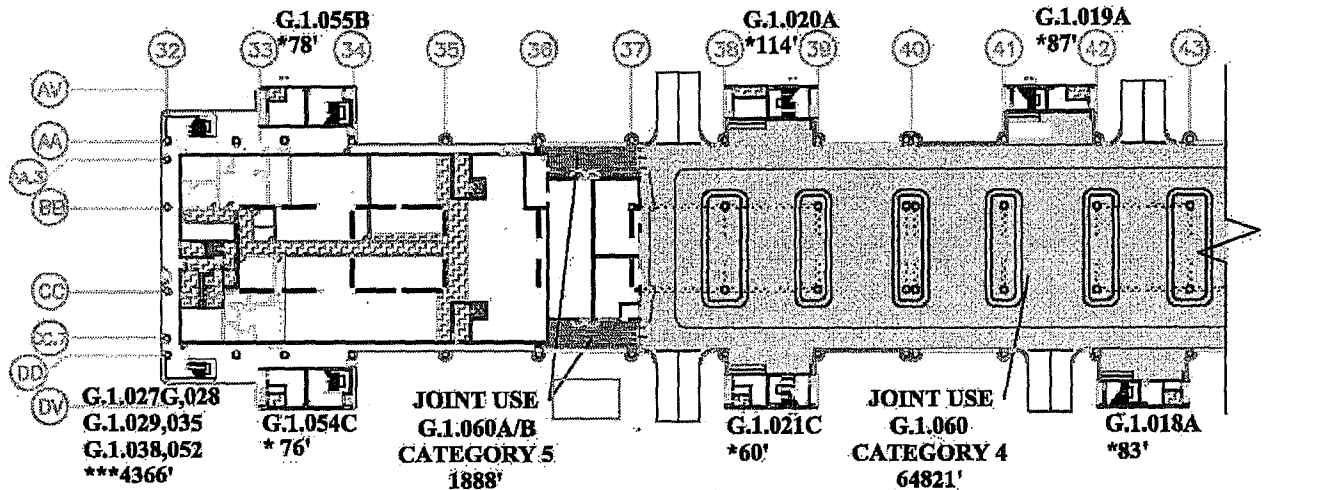

* DENOTES JOINT GATEHOUSE CATEGORY 3 (TOTAL 893' SQ FT)
 *** DENOTES OFFICE/CORRIDOR CATEGORY 3 (TOTAL 5625' SQ FT)

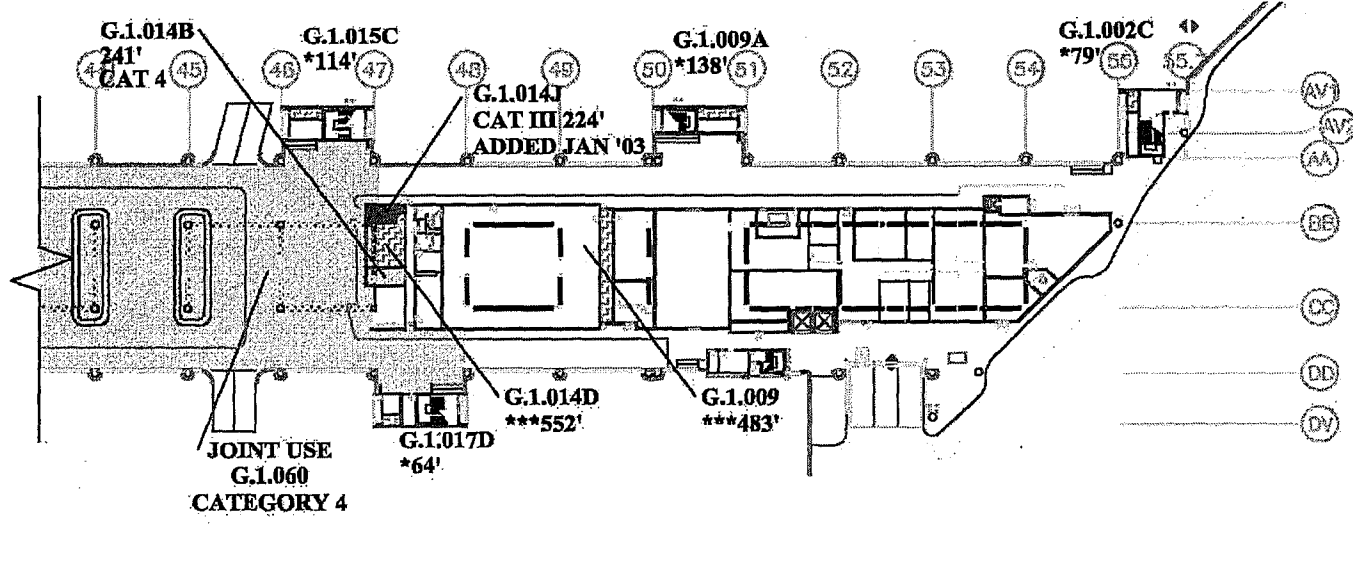

TENANT LOCATION LEASE DRAWING

| LOCATION | TENANT | CAT | AREA | CONTRACT | EFF DATE |
|----------|--------------|-----|--------|----------|----------|
| | JT GATEHOUSE | 3 | 893' | | |
| | OFFICE/COR | 3 | 5625' | | |
| | JOINT USE | 4 | 65062' | | |
| | JOINT USE | 5 | 1888' | | |

LOCATION: BOARDING AREA G, 1ST FLOOR

ALL INTERNATIONAL AIRLINES

CITY & COUNTY OF SAN FRANCISCO

AIRPORTS COMMISSION

SAN FRANCISCO INTERNATIONAL AIRPORT

DWG: BAG1JT

SCALE: 1"=10'-0"

DATE: 07/01/2011

I:\AutoCad\LEASE\newitb\aviation\BAG2JT.dwg, 1/14/2010 2:44:43 PM

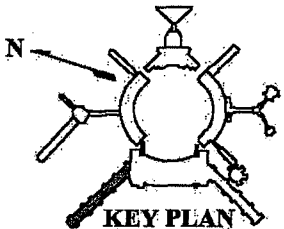
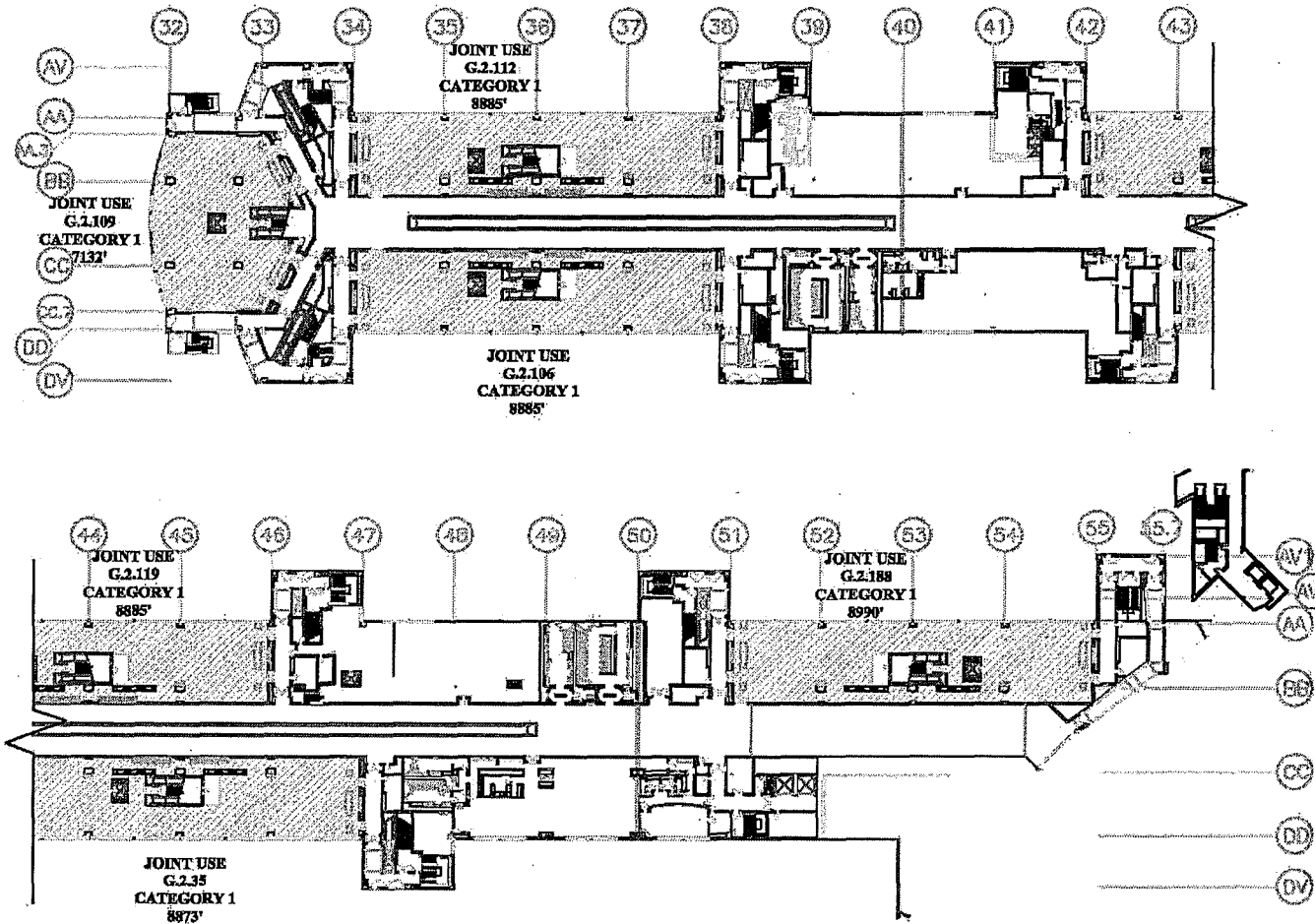

| TENANT LOCATION LEASE DRAWING | | LOCATION | TENANT | CAT. | AREA | CONTRACT | EFF DATE |
|--------------------------------------|--------------------|----------|-----------|------|--------|----------|----------|
| LOCATION: BOARDING AREA G, 2ND FLOOR | | | JOINT USE | 1 | 51650' | | |
| ALL INTERNATIONAL AIRLINES | | | | | | | |
| CITY & COUNTY OF SAN FRANCISCO | DWG: BAG2JT | | | | | | |
| AIRPORTS COMMISSION | SCALE: 1/8"=10'-0" | | | | | | |
| SAN FRANCISCO INTERNATIONAL AIRPORT | DATE: 07/01/2011 | | | | | | |

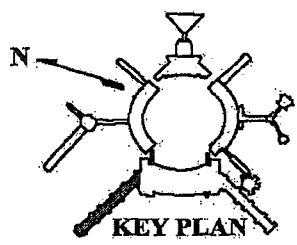
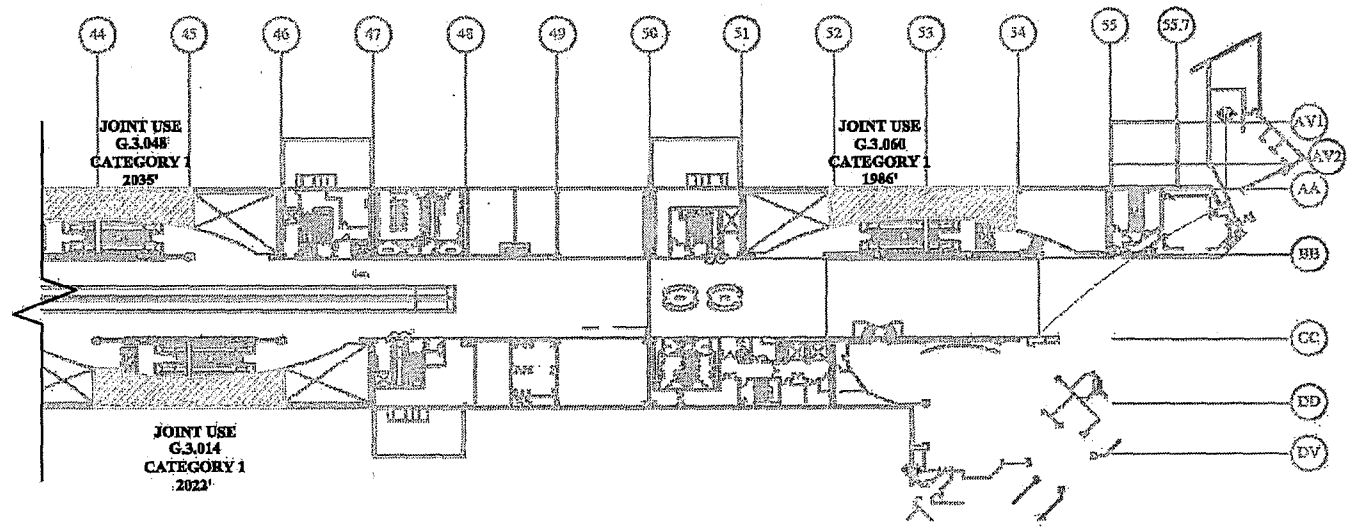
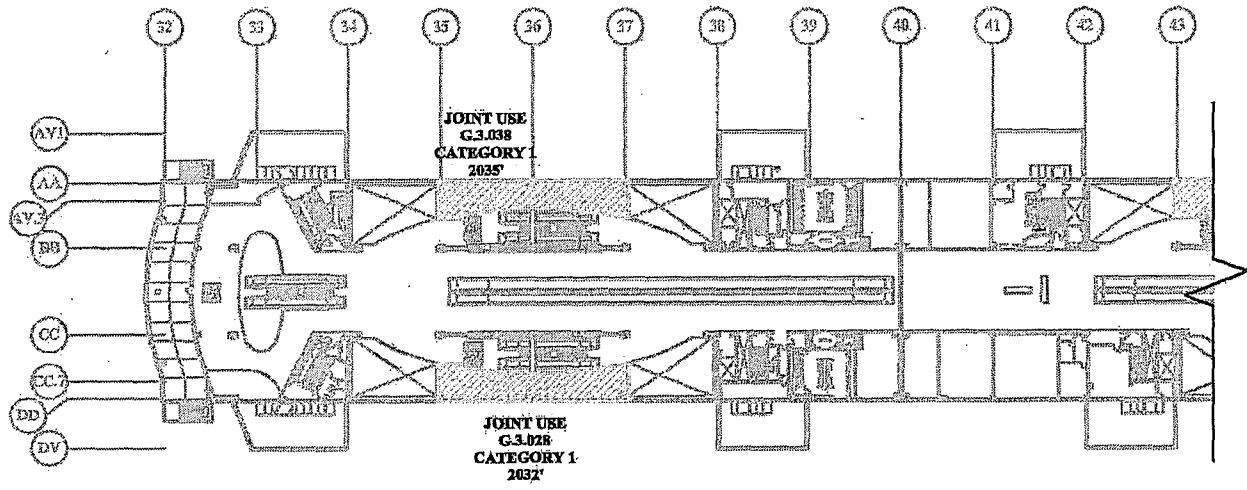

I:\AutoCad\LEASER\AIRLINE\JOINT USE\BAG3JT.dwg, 3/17/2016, 10:31:41 AM

| TENANT LOCATION LEASE DRAWING | | LOCATION | TENANT | CAT | AREA | CONTRACT | EFF DATE |
|--------------------------------------|------------------|----------|-----------|-----|--------|----------|------------|
| | | | JOINT USE | 1 | 10110' | | 07/01/2016 |
| LOCATION: BOARDING AREA G, 3RD FLOOR | | | | | | | |
| ALL INTERNATIONAL AIRLINES | | | | | | | |
| CITY & COUNTY OF SAN FRANCISCO | DWG: BAG3JT | | | | | | |
| AIRPORTS COMMISSION | SCALE: NTS | | | | | | |
| SAN FRANCISCO INTERNATIONAL AIRPORT | DATE: 07/01/2016 | | | | | | |

EXHIBIT E-1

JOINT USE FORMULA(S) APPLICABLE TO AIRLINE, IF ANY

IT JOINT USE FORMULAS

The IT Joint Use Formulas are used to calculate the appropriate charges to be levied on each of the Signatory Airlines leasing IT Joint Use Space. IT Joint Use Space does not include Gates in the IT that have been designated by the Director as domestic Common Use Gates and for the use of which Air Carriers pay an IT Domestic Turn Fee in accordance with Section 405 of the Lease and Use Agreement.

The total charges for each room comprising Joint Use Space (as described in Exhibit D) shall be divided among the Signatory Airlines using such space and the services related to such use as follows:

- Twenty percent (20%) shall be divided equally among all Signatory Airlines (excluding Affiliate Airlines) using each such Joint Use Space.
- Eighty percent (80%) shall be divided so that each Signatory Airline using the Joint Use Space pays that proportion of said eighty percent (80%) which the number of its passengers enplaning and/or deplaning (as specified below for each category and J/U Type of space) at the IT (including its Affiliate Airlines) bears to the total number of enplaning and/or deplaning passengers of those Signatory Airlines (including their respective Affiliate Airlines) using the Joint Use Space or the related services at the IT during the prior Fiscal Year. If for any reason the passengers enplaning or deplaning in the prior Fiscal Year for any of the Signatory Airlines using the Joint Use Space constitute an inappropriate basis for forecasting that Signatory Airline's passenger volume for the year in which the charges are levied, City may make appropriate adjustments in order to equitably apportion the total costs among all of the Signatory Airlines using such Joint Use Space.
- Subject to the provisions above, the eighty percent (80%) shares for each Space Category and Joint Use type shall be allocated as follows:

| Space Category/Joint Use Type | Allocation Basis |
|--|---|
| I Holdroom/Ticket Counter | IT enplaned passengers |
| II Bag Claim/FIS | IT deplaned passengers |
| II Other 3 rd floor and above, and 1 st floor passenger access | IT total enplaned and deplaned passengers |
| III Other Enclosed, 2 nd floor and below | IT total enplaned and deplaned passengers |
| IV Inbound Baggage Makeup | IT deplaned passengers |
| IV Outbound Baggage Makeup | IT enplaned passengers |
| V Other Unenclosed | IT total enplaned and deplaned passengers |

EXHIBIT E-2

**OTHER JOINT USE FORMULAS (IF ANY)
APPLICABLE TO AIRLINE**

[None as of the Effective Date. Any Joint Use formula that becomes applicable to Airline after the Effective Date shall be added to this Exhibit as provided in Section 1922 of the Agreement.]

EXHIBIT F

CALCULATION OF FEE FOR USE OF COMMON USE GATES

Fees for use of Common Use facilities are currently calculated as set forth below. City reserves the right to modify the calculation methodology and/or add new fees as necessary to accommodate changing circumstances.

COMMON USE GATES

Usage Fee for Departure

- [A] 50% of Category I square footage rate
x Square footage of Common Use hold rooms
- [B] 50% of AO&M Expenses – for Common Use jet bridges, ramp area, and hold rooms
- [C] Amortization of the net cost of necessary equipment and finishes, if applicable

The total of [A+B+C] is divided by the average* number of departures. A per departure fee is assessed to the user.

Usage Fee for Arrival

- [A] 50% Category I square footage rate
x Square footage of Common Use hold rooms
- [B] 50% AO&M Expenses – for Common Use jet bridges, ramp area, and hold rooms
- [C] Amortization of the net cost of necessary equipment and finishes, if applicable

The total of [A+B+C] is divided by the average* number of arrivals. A per arrival fee is assessed to the user.

*The average is calculated by assuming that aircraft with 30 seats or less are counted as one third of an aircraft.

COMMON USE BAGGAGE CLAIM FEE

[A] 100% Category II square footage rate
x Square footage of Common Use baggage claim area

[B] 100% AO&M Expenses – for Common Use baggage claim devices and inbound conveyors

The total of [A+B] is divided by the average* number of arrivals. A per arrival fee is assessed to the user.

COMMON USE TICKET COUNTERS

Usage Charge for Ticket Counter

[A] Category I square footage rate
x Square footage of Common Use ticket counters

[B] AO&M Expenses – for Common Use ticket counters and equipment

[C] Amortization of the net cost of necessary equipment and finishes, if applicable

[D] Category III square footage rate
x Square footage of common baggage makeup area

[E] AO&M Expenses – for baggage makeup and outbound conveyor systems

The total of [A+B+C+D+E] is divided by the average* number of departures. A ticket counter usage charge is assessed to the user.

*The average is calculated by assuming that aircraft with 30 seats or less are counted as one third of an aircraft.

EXHIBIT G

MANAGEMENT PROTOCOLS IT TICKET COUNTER AND OTHER JOINT USE RESOURCES

(1) Purpose

- (a) The IT Ticket Counter and Other Shared Use Resources Management Protocols provide the framework for the efficient, systematic and equitable management of the ticket counters and other Joint Use resources in the International Terminal at the San Francisco International Airport (“SFO” or the “Airport”), including, but not limited to, the inbound and outbound baggage equipment and systems, the pre-conditioned air and 400mhz systems, and the Joint Use passenger boarding bridges. These Protocols are developed by the Airport Director in accordance with the Lease and Use Agreement effective on and after July 1, 2011 (the “Agreement”) between the Airport Commission of the City and County of San Francisco and the Signatory Airlines. These Protocols are subject to change by the Director from time to time. All capitalized terms used but not defined in these Protocols have the meanings provided in the Agreement.
- (b) The Protocols deal with the allocation and management of the resources only. Standards, rules, regulations and requirements concerning the use and operation of the equipment and facilities are found in Airport Rules and Regulations, Operations Bulletins and other publications the Airport may issue and revise from time to time.

(2) Scope

- (a) A Terminal Company shall be granted responsibility for managing and allocating use of the IT ticket counters and other IT Joint Use resources based upon these protocols. The Terminal Company may, as it deems necessary, develop and apply additional policies and procedures to facilitate the proper and effective management of the resources. The protocols should be focused on the assurance of staffing and maintenance to ensure efficient operation of the IT and service to the traveling public. Such policies and procedures shall be subject to approval by the Airport Director.

(3) Resource Assignment Responsibilities

- (a) Shared Use Resources.
 - (i) The Terminal Company shall manage the IT ticket counters and other Joint Use resources, and controls and assigns their use.
 - (ii) Only ticket counters and other support resources in the IT, including Boarding Areas A and G, are designated as Joint Use.
 - (iii) Joint Use ticket counters and other resources are established through specific provisions of this Agreement and are not subject to annual allocation.
- (b) Common Use Resources.
 - (i) Certain ticket counters and/or other resources within the IT may be designated by the Airport Director for Common Use pursuant to the terms of this Agreement.

- (ii) Responsibility for management and allocation of ticket counters and/or other resources in the IT that are designated for Common Use shall be managed by the Terminal Company.
- (iii) Management and allocation of ticket counters and/or other resources in the IT that are designated for Common Use may be in accordance with either the Domestic Terminals Ticket Counter Management Protocols, or the IT Ticket Counter and Other Resource Protocols at the Airport Director's sole discretion.

(4) Management of Shared Use Ticket Counters and Other Resources

(a) Equipment and Facilities Provided.

- (i) Assignment of a Joint Use ticket counter includes the use of the following facilities and equipment associated with that ticket counter.
 - (1) Counter or equivalent millwork.
 - (2) Baggage Scale.
 - (3) Common Use passenger processing electronics.
 - (a) Equipment sufficient to conduct passenger processing to the current industry standard, as may change with technology available and industry trends.
 - (b) The Air Carrier must provide necessary connectivity to their host system and accomplish any necessary integration of their applications with the platform provided.
 - (4) Sign(s) identifying the Air Carrier using the counter and the function being performed at the counter.
 - (5) Baggage handling system (outbound).
 - (6) In-line explosive detection system.
 - (7) Baggage make-up area, including lateral or carousel type make up device(s) serviced by the assigned counter(s).
 - (8) Capability to transport odd-sized baggage from the counter area to an area accessible to screening and loading processes.

(b) Requesting and Allocation of Shared Use Ticket Counters and Other Resources.

- (i) Ticket counters and other resources requested for processing international flights are assigned contingent upon requesting Air Carrier being granted an operating (gate) slot through the IATA scheduling process or other processes as may be specified by the Airport Director.
 - (1) The Terminal Company will administer the slot and subsequent ticket counter and other resources allocation processes. Related policies and procedures developed by the Terminal Company or other designated entity to facilitate these process (with the exception of the IATA Scheduling Guidelines) are subject to approval by the Airport Director.

- (2) Requests for domestic flights, or international flights not subject to the IATA scheduling process will be managed by the Terminal Company.
- (ii) Slot approval assumes use of all facilities and equipment necessary to operate a flight unless specific exceptions are agreed to by the Terminal Company, requesting Air Carrier, and City.
- (iii) Ticket counters and other resources will be assigned based upon times and durations relative to the allocated slot time and aircraft type as described in Section (4)(c)(i) following.

(c) Periods of Use.

- (i) In order to maximize utilization of the IT ticket counters and other Joint Use resources, the following maximum Periods of Use will be applied. Requests for deviation may be granted dependent upon conditions at the time of operation.

| Type of Operation | Wide Body | Narrow Body | Regional/Commuter |
|-------------------|---|---|---|
| Ticket Counter | -4 Hours to +.5 Hours | -2 Hours to +.25 Hours | -1.5 Hours to +.25 Hours |
| Baggage Make-up | -4.5 Hours to 0:00 | -2.5 Hours to 0:00 | -2.0 Hours to 0:00 |
| Baggage Claim | Actual Time of Flight Arrival +60 minutes | Actual Time of Flight Arrival +40 minutes | Actual Time of Flight Arrival +30 minutes |

Wide Body = Seats >225 and/or ADG IV, V or VI

Narrow Body Seats >100 and <225 and/or ADG III

Regional/Commuter Seats <100

“-” (minus) refers to prior to scheduled time of departure or arrival

“0:00” refers to scheduled time of departure or arrival

“+” (plus) refers to after scheduled time of departure or arrival

- (ii) City or the Terminal Company will establish minimum and/or maximum Periods of Use when ticket counters and other resources are not used in conjunction with Gate use.
 - (1) Deviations from minimum and/or maximum Periods of Use may be granted based upon operational conditions
 - (2) Usage will be assigned and measured in 15 minute increments.
- (iii) Air Carriers must adhere to the established Periods of Use. Failure to do so may result in a fine or penalty under Section 1507 of the Agreement.

- (iv) Air Carriers are required to advise the Terminal Company or other designated entity of any cancellations or other deviations from scheduled or last-updated Estimated Time of Arrival (ETA) and/or Estimated Time of Departure (ETD) or other factors that may result in changes to their needs, or their ability to adhere to their assigned period of use in a timely manner. Failure to do so may result in a penalty equal to 50% (fifty percent) of the basic fee assessed for the operation. This penalty may be applied for every increment of 15 (fifteen) minutes beyond the expiration of the assigned Period of Use that the Air Carrier occupies the ticket counter or other resource.
- (d) Conditions of Use.
- (i) In order to establish and maintain acceptable levels of customer service, City may, in consultation with the Terminal Company, or other designated entity, establish regulations requiring minimum quantities in terms of time of use and/or numbers of ticket counters or other resources that must be operated to service a particular flight or group of flights. These quantities will be approved by the Airport Director and may be changed from time to time.
 - (ii) The Terminal Company will be required to provide the required minimum resources for each Air Carrier operation unless specific exceptions are approved by the Airport Director.
- (e) Resolution of Conflicts.
- (i) Basic priorities to be applied to resolve conflicting requests for use of IT ticket counters and associated resources are, in descending order:
 - (1) International flights operating within slots (time and equipment type) granted through the IATA scheduling process.
 - (2) International flights not operating within slots (time and equipment type) granted through the IATA scheduling process.
 - (3) Domestic flights operating within slots (time and equipment type) granted through the scheduling process established by the Terminal Company.
 - (4) Domestic flights not operating within slots (time and equipment type) granted through the scheduling process established by the Terminal Company.
 - (5) Levels of priority within the above categories may be established by the Terminal Company subject to the approval of the Airport Director.

EXHIBIT H

MANAGEMENT PROTOCOLS IT GATE RESOURCES

(1) Purpose

- (a) The IT Gate Management Protocols provide the framework for the efficient, systematic and equitable management of the gates in the International Terminal at the San Francisco International Airport (“SFO” or the “Airport”). These Protocols are developed by the Airport Director in accordance with the Lease and Use Agreement effective on and after July 1, 2011 (the “Agreement”) between the Airport Commission of the City and County of San Francisco and the Signatory Airlines. These Protocols are subject to change by the Director from time to time. All capitalized terms used but not defined in these Protocols have the meanings provided in the Agreement.
- (b) The Protocols deal with the allocation and management of the gate resources only. Standards, rules, regulations and requirements concerning the use and operation of the equipment and facilities are found in Airport Rules and Regulations, Operations Bulletins and other publications the Airport may issue and revise from time to time.

(2) Scope

- (a) A Terminal Company shall have responsibility for managing and allocating use of the IT gates based upon these protocols. The Terminal Company may, as it deems necessary, develop and apply additional policies and procedures to facilitate the proper and effective management of the gate resources. The protocols should be focused on the assurance of efficient operation of the IT and service to the traveling public. Such policies and procedures shall be subject to approval by the Airport Director.

(3) Gate Resource Assignment Responsibilities

- (a) Joint Use Gate Resources.
 - (i) The Terminal Company manages the IT gates and controls and assigns their use.
 - (ii) Only gates in the IT, including Boarding Areas A and G, are designated as Joint Use.
 - (iii) Joint Use gates are established through specific provisions of this Agreement and are not subject to annual allocation.
- (b) Common Use Gate Resources.
 - (i) Certain gates within the IT may be designated by the Airport Director for Common Use pursuant to the terms of this Agreement.

- (ii) Responsibility for management and allocation of gates in the IT that are designated for Common Use shall be delegated to the Terminal Company responsible for management of the Joint Use gate resources.
- (iii) Management and allocation of gate resources in the IT that are designated for Common Use may be in accordance with either the Domestic Terminals Gate Management Protocols, or the IT Gate Management Protocols at the Airport Director's sole discretion.

(4) Management of IT Gate Resources

(a) Equipment and Facilities Provided.

- (i) IT gates includes the following facilities and equipment:
 - (1) Ramp parking space approved for the assigned aircraft.
 - (2) Passenger Boarding Bridge(s).
 - (3) 400 Hz ground power sufficient for the assigned aircraft.
 - (4) Pre-conditioned air (PCA) sufficient for the assigned aircraft.
 - (5) Potable water servicing capability.
- (ii) Gates may be assigned and used with certain equipment inoperative subject to the Terminal Company policy and procedures.
 - (1) Operators must comply with Airport Rules and Regulations regarding operation of aircraft and aircraft systems on gates.
 - (2) Responsibility for maintenance and repair of equipment is defined elsewhere in this agreement.
- (iii) City will establish and maintain a listing of aircraft types compatible with each gate.
 - (1) Aircraft types not listed for a gate shall not be assigned to that gate.
 - (2) Modifications to, or deviations from, the aircraft/gate compatibility listing must be approved by City.

(b) Requesting and Allocation of IT Gates.

- (i) Gates requested for processing international flights are assigned contingent upon requesting Air Carrier being granted an operating (gate) slot through the IATA scheduling process or other processes as may be specified by the Airport Director.

- (1) The Terminal Company will administer the slot and subsequent allocation processes. Related policies and procedures developed by the Terminal Company to facilitate these processes (with the exception of the IATA Scheduling Guidelines) are subject to approval by the Airport Director.
- (2) Requests for domestic flights or international flights not subject to the IATA scheduling process will be managed by the Terminal.
- (ii) Slot approval assumes use of all facilities and equipment necessary to operate a flight unless specific exceptions are agreed to by the Terminal Company, requesting Air Carrier, and City.
- (iii) Gates will be assigned based upon times and durations relative to the allocated slot time and aircraft type as described in Section (4)(c)(i) following.

(c) Periods of Use

- (i) In order to maximize utilization of the IT gate resources, the following maximum Periods of Use will be applied:

| Type of Operation | Wide Body | Narrow Body | Regional/Commuter |
|-------------------|-------------|-------------|-------------------|
| Arrival | 60 minutes | 45 minutes | 45 minutes |
| Departure | 75 minutes | 60 minutes | 45 minutes |
| Turnaround | 135 minutes | 105 minutes | 90 minutes |

Wide Body = Seats >225 and/or ADG IV, V or VI

Narrow Body Seats >100 and <225 and/or ADG III

Regional/Commuter Seats <100

“-” (minus) refers to prior to scheduled time of departure or arrival

“0:00” refers to scheduled time of departure or arrival

“+” (plus) refers to after scheduled time of departure or arrival

- (ii) City or the Terminal Company will establish minimum and/or maximum Periods of Use when gates are used for aircraft parking (e.g. RON) only.
 - (1) Deviations from minimum and/or maximum Periods of Use may be granted based upon operational conditions
 - (2) Usage will be assigned and measured in 15 minute increments.

- (iii) Air Carriers must adhere to the established Periods of Use. Failure to do so may result in monetary or other penalties as established by the Terminal Company or other designated entity, and approved by the Airport Director.
 - (iv) Air Carriers are required to advise the Terminal Company of any cancellations or other deviations from scheduled or last-updated Estimated Time of Arrival (ETA) and/or Estimated Time of Departure (ETD) or other factors that may result in changes to their needs, or their ability to adhere to their assigned period of use in a timely manner. Failure to do so may result in monetary or other penalties as established by the Terminal Company, and approved by the Airport Director.
- (d) Conditions of use.
- (i) In order to establish and maintain acceptable levels of customer service, City will, in consultation with the Terminal Company establish the IATA activity level, capacity and coordination parameters to be used in the IATA scheduling process used by City to allocate IT gate resources. City will also designate the IATA Scheduling Coordinator to represent City in the process as defined by IATA's Scheduling Guidelines.
 - (ii) The Terminal Company will be required to follow and abide by the IATA Scheduling Guidelines, and the designated Schedule Coordinator's rulings, unless specific exceptions are approved by the Airport Director.
- (e) Resolution of Conflicts.
- (i) Basic priorities to be applied to resolve conflicting requests for use of IT gates are, in descending order:
 - (1) International flights operating within slots (time and equipment type) granted through the IATA scheduling process.
 - (2) International flights not operating within slots (time and equipment type) granted through the IATA scheduling process.
 - (3) Domestic flights operating within slots (time and equipment type) granted through the scheduling process established by the Terminal Company.
 - (4) Domestic flights not operating within slots (time and equipment type) granted through the scheduling process established by the Terminal Company.
 - (5) Levels of priority within the above categories may be established by the Terminal Company.

EXHIBIT I

DOMESTIC TERMINALS (DT) MANAGEMENT PROTOCOLS TICKET COUNTER RESOURCES

1) Purpose and Scope

- a) These DT Ticket Counter Management Protocols (the "Protocols") provide the framework for the efficient and equitable management of ticket counters and Support Facilities in the Domestic Terminals (collectively, "resources") at the San Francisco International Airport ("SFO" or the "Airport"). These Protocols are developed by the Airport Director in consultation with the Signatory Airlines through the Resource Management Advisory Committee (RMAC) in accordance with the Lease and Use Agreement effective on and after July 1, 2011 (the "Agreement") between the Airport Commission of the City and County of San Francisco and the Signatory Airlines. All capitalized terms used but not defined in these Protocols have the meanings provided in the Agreement. The Protocols are subject to change by the Director from time to time.
- b) The Protocols deal with the allocation and management of the ticket counters and Support Facilities in the DT only. Standards, rules, regulations and requirements concerning the use and operation of the equipment and facilities are found in the Airport Rules, operations bulletins, and other publications the Airport may issue and revise from time to time.

2) Resource - Assignment Responsibilities

a) **Exclusive Use Resources**

- i) The Signatory Airline leasing the resources manages their assignment.
- ii) The Signatory Airline may also manage the assignment and use of their leased resources on behalf of others as provided in the Agreement (e.g. handled Air Carriers, Affiliate Airlines, subleases, if approved).

b) **Common Use Resources**

- i) Common Use resources are assigned and managed by SFO Gate Control.
- ii) Common Use resources are identified by SFO annually in accordance with Article 3 of the Agreement.
- iii) Assignments are effective July 1 of each year.
- iv) Any Air Carrier may request and use Common Use resources.
- v) Fees for use of Common Use resources are assessed by SFO.

- vi) Common Use resources are requested and assigned either in conjunction with the use of a Common Use Gate or independent of Gate use.
 - (1) When requested in conjunction with a Gate request, either on a slot or ad-hoc basis, the allocations of Common Use Gates, Common Use Ticket Counters, and Common Use Support Facilities is combined, and use of the full complement of Gates and Common Use resources required to handle a flight (turn, originating or terminating) is considered.
 - (a) The Air Carrier indicates on the Gate request form which resources will be required.
 - (b) Fees for the use of Common Use Ticket Counters and Common Use Support Facilities will be assessed according to the fees described in Exhibit F attached to the Agreement.
 - (2) Air Carriers may request use of Common Use Ticket Counters and Common Use Support Facilities without requesting use of a Common Use Gate.
 - (a) Priority will be given to requests associated with Gate usage.
 - (3) SFO Airport Operations may request ad-hoc use of Common Use resources for operations of an emergency nature, VIP or other Airport-involved operations.
 - (4) SFO may establish minimum quantities in terms of time and/or numbers of Common Use Ticket Counters or Common Use Support Facilities that may be requested. These quantities may be changed from time to time.

c) Joint Use Resources

- i) The SFOTEC airline consortium or a successor Terminal Company manages the use of Joint Use Space in the IT including ticket counters and other Support Facilities and controls and assigns their use.
- ii) Currently, only ticket counters and other support resources in the IT are designated as Joint Use facilities. Certain baggage handling facilities in Domestic Terminal 1 have also been designated as Joint Use facilities.
- iii) For purposes of managing and assigning the ticket counters and other resources, the relationship of SFOTEC or a successor Terminal Company to the IT Joint Use ticket counters and resources is essentially the same as the relationship of an individual Signatory Airline to the ticket counters and resources they lease in the Domestic Terminals.
- iv) Joint Use ticket counters and other Support Facilities are designated by the Director in accordance with the Agreement and are not subject to the annual allocation process applicable to Preferential Use Gates. Joint Use ticket counters and other

Joint Use Space are managed in accordance with the IT Ticket Counter Management Protocols attached as Exhibit G to the Agreement unless otherwise determined by the Director.

3) Management of Common Use Resources

a) **Equipment and Facilities Provided.**

- i) Assignment of a Common Use Ticket Counter may include the use of the following Common Use Support Facilities associated with that counter.
 - (1) Counter or equivalent millwork.
 - (2) Baggage Scale
 - (3) Common Use passenger processing electronics.
 - (a) Equipment sufficient to conduct passenger processing to the current industry standard, as may change with technology available and industry trends.
 - (b) Air Carrier must provide necessary connectivity to their host system and accomplish any necessary integration of their application with SFO's system.
 - (c) Should SFO provide access to a local boarding application (LBA), SFO may, at its sole discretion, assess an additional fee for Air Carrier's use of this resource.
 - (4) Sign(s) identifying the Air Carrier using the counter and if necessary the function being performed at the counter.
 - (5) Baggage handling system (outbound).
 - (6) In-line explosive detection system.
 - (7) Baggage make-up area, including lateral or carousel type make up device serviced by the assigned counter(s).
 - (8) Odd-size baggage capability.
 - (a) Capability to transport odd-size baggage from the counter area to an area accessible to screening and loading processes.
 - (b) No porter service or equipment is provided.

- ii) SFO may not fully equip each Airport-controlled Common Use Ticket Counter, or group of Common Use Ticket Counters due to forecast demand or other considerations.
 - (1) The association of outbound baggage handling systems and ticket counters may also cause similar conditions to exist at fully equipped counters (e.g. a ticket counter is available, but the associated baggage system is in use by others).
 - (2) Upon the request or agreement of the Air Carrier, these counters may be assigned in their "as is" condition.
- iii) Inbound baggage claim devices and associated feed belts may be requested on a per flight or Period of Use basis.
 - (1) Assignment includes right of way to all associated feed belts and use of odd-size baggage claim facilities.
 - (2) Porter service is not provided.

b) Requesting and Allocation of Common Use Resources

- i) Air Carrier/operator representatives may request use of Common Use Ticket Counters or Common Use Support Facilities by contacting SFO Gate Control by phone, facsimile, or email.
 - (1) Requests in association with a Gate use request are submitted and processed in conjunction with the Gate use request (see the DT Gate Management Protocols attached as Exhibit J to the Agreement).
 - (2) Requests not in conjunction with a Gate use request will be submitted by means separate from the Gate request procedures and processed as follows:
 - (a) Requests will be granted in order of receipt.
 - (b) Requests will not be evaluated until a maximum of 30 days' prior to the requested date of use.
 - (c) Requests will be given priority after requests made in conjunction with Gate use.
 - (d) Up until 7 days prior to the date of requested use, the assignment may be rescinded if a request made in conjunction with Gate use conflicts.

c) Periods of Use

- i) In order to maximize utilization of Common Use Ticket Counters and Common Use Support Facilities, the following maximum Periods of Use may be applied.

Requests for deviation may be granted dependent upon conditions at the time of operation.

| Type of Operation | Wide Body | Narrow Body | Regional/Commuter |
|--------------------|---|---|---|
| Aircraft Size/Type | Seats >225 and/or ADG IV, V or VI | Seats >100 and <225 and/or ADG III | Seats <100 |
| Period of Use | | | |
| Ticket Counter | -3 Hours to +.5 Hours | -2 Hours to +.25 Hours | -1.5 Hours to +.15 Hours |
| Baggage Make-up | -3.5 Hours to 0:00 | -2.5 Hours to 0:00 | -2.0 Hours to 0:00 |
| Baggage Claim | Actual Time of Flight Arrival +60 minutes | Actual Time of Flight Arrival +40 minutes | Actual Time of Flight Arrival +30 minutes |

“-” (minus) refers to prior to scheduled time of departure or arrival

“0:00” refers to scheduled time of departure or arrival

“+” (plus) refers to after scheduled time of departure or arrival

- ii) SFO will establish minimum and/or maximum Periods of Use when Common Use Ticket Counters and Common Use Support Facilities are not used in conjunction with Gate use.
 - (1) Deviations from minimum and/or maximum Periods of Use may be granted based upon operational conditions.
 - (2) Usage will be assigned and measured in 15 minute increments
- iii) Air Carriers must adhere to the established Periods of Use. Failure to do so may result in a fine or penalty under Section 1507 of the Agreement.
- iv) Air Carriers are required to advise SFO Gate Control of any cancellations or other deviations from scheduled or last-updated Estimated Time of Arrival (ETA) and/or Estimated Time of Departure (ETD) or other factors that may result in changes to their needs, or their ability to adhere to their assigned period of use in a timely manner. Failure to do so may result in a fine or penalty under Section 1507 of the Agreement.

EXHIBIT J-1

MANAGEMENT PROTOCOLS DOMESTIC TERMINALS (DT) GATE RESOURCES

(1) Purpose and Scope

- (a) These DT Gate Management Protocols (the "Protocols") provide the framework for the efficient and equitable management of the Gate resources in the Domestic Terminals at the San Francisco International Airport ("SFO" or the "Airport"). These Protocols are developed by the Airport Director in consultation with the Signatory Airlines through the Resource Management Advisory Committee (RMAC) in accordance with the Lease and Use Agreement effective on and after July 1, 2011 (the "Agreement") between the Airport Commission of the City and County of San Francisco and the Signatory Airlines. These Protocols apply to the management of Common Use, Joint Use, and Preferential Use Gates and are subject to change by the Director from time to time. All capitalized terms used but not defined in these Protocols have the meanings provided in the Agreement.
- (b) In Terminal 2 upon opening and in all Terminals after July 1, 2011, there will be no exclusive use Gates at SFO. Space leases and permits issued prior to July 1, 2011 will be replaced effective July 1, 2011 with leases or permits providing for Preferential Use or Common Use of Gates. The process for allocating Preferential Use and Common Use Gates is described in Article 3 of the Agreement.

(2) Gate Control and Assignment Responsibilities

- (a) Preferential Use Gates
- (i) The Signatory Airline granted Preferential Use of a Gate (the "Preference Holder") manages the assignment of flights at that Gate.
- (ii) Air Carriers with mutual handling agreements and regional or "express/connection" Affiliate Airlines may be considered the same as the Preference Holder's flights for purposes of managing and assigning Preferential Use Gates.
- (iii) Preferential Use Gates are allocated annually through a process specified in Article 3 of the Agreement. Assignments are effective July 1 of each year.
- (iv) Preferential Use Gates may be assigned to another Air Carrier for ad-hoc use if that Air Carrier has requested a Gate from SFO and cannot be accommodated on a Common Use Gate but could be accommodated on the open Preferential Use Gate without impact to the Preference Holder's flight operations.
- (1) The Airport's Gate control agency (SFO Gate Control) initiates arrangements for use of Preferential Use Gates if Common Use Gates are not available to accommodate demand.

- (2) The Preference Holder is compensated for use of their Preferential Use Gate(s) by the using Air Carrier as specified in Section 305 of the Agreement.
- (b) Common Use Gates
- (i) Common Use Gates are assigned and managed by SFO Gate Control.
 - (ii) Common Use Gates are identified by SFO annually as provided in Article 3 of the Agreement.
 - (iii) Assignments are effective July 1 of each year.
 - (iv) Any Air Carrier may request and use a Common Use Gate.
 - (v) Fees for use of Common Use Gates are assessed by SFO.
 - (vi) Common use Gates are requested and assigned on either a slot use basis or an ad-hoc flight basis.
 - (1) Slot use applies to recurring, pre-planned use during the same time of day (Period of Use) over a specified period of time and generally requested with weeks or months of advance notice.
 - (a) The user may be a Signatory Airline not offered or declining a Preferential Use Gate.
 - (b) The user may be a seasonal or new entrant Air Carrier at SFO.
 - (c) The user may be a Signatory Airline with a recurring, pre-planned Gate requirement that cannot be accommodated using their Preferential Use Gate(s).
 - (2) Ad-hoc use is a one-time event which may or not be pre-planned and is generally requested with notice ranging from weeks to an immediate need.
 - (a) The user may be a one-time operation, i.e. a charter flight by a resident or itinerant Air Carrier.
 - (b) The user may be a Signatory Airline with an operational necessity due to irregular operations (delays, diversions, etc.) that cannot be accommodated within the Signatory Airline's Preferential Use Gate availability.
 - (c) SFO Airport Operations may request ad-hoc use of a Common Use Gate for operations of an emergency nature (e.g. medical diversions, etc.), VIP or other Airport-involved operations, or in the event of extreme irregular operations with the potential for significant passenger disservice (e.g. stranded aircraft).

(c) Joint Use Gates

- (i) Terminal Company manages the use of the IT Gates and controls and assigns flights to Joint Use Gates in accordance with the IT Gate Management Protocols (Exhibit H to the Agreement).
- (ii) Currently, only Gates in the International Terminal (IT), Boarding Areas A and G are designated as Joint Use Gates.
- (iii) The Commission reserves the right to have the Director designate Joint Use Gates in the DT from time to time in accordance with the Agreement, to be managed in accordance with the IT Gate Management Protocols or other protocols designated by the Director. Such Gates are not subject to the annual allocation process applicable to Preferential Use Gates.

(3) Management of Common Use Gates

(a) Equipment and Facilities Provided.

- (i) Assignment of a Common Use Gate includes the use of the following facilities and equipment associated with that Gate (if installed):
 - (1) Passenger Boarding Bridge (PBB).
 - (2) 400 Hz aircraft ground power.
 - (3) Pre-conditioned air supply.
 - (4) Potable water supply.
 - (5) Associated Gate holdroom and Common Use passenger processing equipment (for turnaround and departure operations only).
 - (6) Hydrant fueling is available, however arrangements must be made directly with the fuel supplier by the Air Carrier/operator.
- (ii) Gates may be offered for assignment with certain equipment or facilities unavailable, or equipment may fail during period(s) of use.
 - (1) The Air Carrier/operator representative may request assignment to another Gate, if available, at no additional charge (considered a single Gate use).
 - (2) The Air Carrier/operator representative may elect to accept/continue use of the Gate with the understanding that obtaining and operating alternative equipment or facilities is their responsibility and at their expense.

(b) Requesting and Allocation of Gates

- (i) Air Carrier/operator representatives may request use of a Common Use Gate by contacting SFO Gate Control by phone, facsimile, or email.
- (ii) Recurring slot requests are subject to rules and procedures in Appendix A of these Protocols.

- (iii) Ad-hoc allocations are by flight (arrival, departure, or both) and the associated Period of Use.
- (iv) Recurring slot allocations are for single Periods of Use during a day and for a specified number of days.
- (v) Requests for use of a Common Use Gate will be responded to with an “approved” or “not approved-reason” notification to the requesting Air Carrier.
- (vi) Requests for ad-hoc use of a Gate will be responded to by SFO Gate Control within 24 (twenty-four) hours of receipt.
- (vii) Requests for ad-hoc use of a Common Use Gate with less than forty-eight (48) hours’ notice must be made by phone and will be responded to by SFO Gate Control as soon as possible.
- (viii) Requests for recurring slots will be responded to within the guidelines specified in Appendix A of this section.
- (ix) A minimum 15 minute Gate rest (Gate not occupied by aircraft) period will be planned between consecutive operations at a Gate in order to allow for aircraft movement on/off, transition between operators, positioning of equipment, etc.
- (x) Requests for specific Gates will be accommodated only if optimal utilization of Gate resources is not compromised.
- (xi) Requests for Remain Over Night (RON) will be accommodated if Gate availability permits.
 - (1) Request may be RON “turns”, combinations of live in/out and RON or RON only.
 - (2) RON fees set by the Commission as provided in the Agreement will apply in addition to standard Gate use fees.
- (xii) In order to maximize utilization of Gate resources, the following maximum Periods of Use (Gate times) will be applied as needed. Air Carriers/operators will be notified of planned on/off Gate times as part of the request approval process.

| Type of Operation | Wide Body | Narrow Body | Regional/Commuter |
|----------------------|-----------------------------------|------------------------------------|-------------------|
| Aircraft Size/Type | Seats >225 and/or ADG IV, V or VI | Seats >100 and <225 and/or ADG III | Seats <100 |
| Period of Use | | | |
| Arrival | 45 minutes | 30 minutes | 20 minutes |
| Departure | 60 minutes | 40 minutes | 30 minutes |
| Turnaround | 80 minutes | 50 minutes | 40 minutes |

- (c) **Priorities Applied to Resolve Competing Requests**
- (i) **Recurring Gate slot requests – apply in descending order.**
 - (1) Date of first recurring operation of this slot.
 - (2) Chronological order of request (first requestor is first allocated a Gate). Applied only for requests after the annual allocation request process (annual allocation period) for Preferential Use Gates has closed.
 - (3) Signatory Airline not offered Preferential Use Gate(s) during current allocation year.
 - (4) Signatory Airline offered and accepted Preferential Use Gate(s) during current allocation year.
 - (5) Signatory Airline offered and declined Preferential Use Gate(s) during current allocation year.
 - (6) Aircraft type – wide body given first priority, narrow body second priority followed by regional/commuter.
 - (ii) **Ad-Hoc Flights Requests – Apply in descending order.**
 - (1) Emergency or other priority operation (classified such by the Airport Director or designee).
 - (2) Chronological order of request (first requestor is first allocated a Gate).
 - (3) Aircraft type – wide body given first priority, narrow body second priority followed by regional/commuter.
- (d) **Management of Gate Resources During Irregular Operations**
- (i) SFO Gate Control is authorized to manage the Gate resources as necessary to maximize the safety and efficiency of the overall Airport operation and to provide the highest possible level of customer service.
 - (ii) SFO Gate Control will be responsible for the resolution of conflicting Gate assignments.
 - (iii) To the greatest extent possible, given operational conditions, Gate allocations will be honored as originally granted.
 - (iv) As necessary to maximize utilization of Gate resources, the maximum Period of Use (Gate times) allowances set forth in the table above will be applied. Note that these Gate times will be applied if operationally required regardless of preliminary, pre-operational plans.
 - (v) **Priorities applied to resolve Gate conflicts – apply in descending order.**
 - (1) Emergency or other priority operation (classified such by the Airport Director or designee).
 - (2) Recurring slot – within allocated time of use (+/- 15 minutes).

- (3) Ad-hoc flight – on schedule (within +/- 15 minutes).
 - (4) Recurring slot – outside of allocated Period of Use (> +/- 15 minutes).
 - (5) Ad-hoc flight – off schedule (> +/- 15 minutes from schedule).
 - (6) Flights on request but no Gate confirmed (unplanned flights).
 - (7) Flights with no passenger impact (not applied to “ferry in-live out situations where outbound passengers are waiting).
- (vi) At its discretion, and if Gate(s) are available, SFO Gate Control may invoke the Airport’s authority to use Signatory Airlines’ Preferential Use Gates to accommodate flights that cannot be accommodated on Common Use Gates.
- (vii) Air Carriers will be provided as much advance notice as possible to prepare for moving aircraft on/off Gates but in all cases must adhere to the established Periods of Use. Failure to do so may result in a fine or penalty under Section 1507 of the Agreement.
- (viii) Air Carriers are required to advise SFO Gate Control of any cancellations or other deviations from scheduled or last-updated Estimated Time of Arrival (ETA) and/or Estimated Time of Departure (ETD) or changes to the scheduled or last revised aircraft type in a timely manner. Failure to do so may result in a fine or penalty under Section 1507 of the Agreement.

APPENDIX A to DT GATE MANAGEMENT PROTOCOLS
Common Use Gate Slot Allocation

(1) Purpose and Concept

- (a) Advance requesting and Gate planning of recurring needs for Common Use Gates allows the Air Carrier(s) to plan their future schedules and operations with assurance that a Gate will be available for them at the time when they need it. It also provides SFO Gate Control with the ability to better pre-plan and maximize Gate utilization to maximize utilization and best meet customer (Air Carrier and public) needs.
- (b) Gate Slots are defined as a period of time (Period of Use) for a specified aircraft type or FAA design group of aircraft (e.g. A320 or aircraft design group III) on a single Gate recurring for a given period of time (days/weeks/months/year).
- (c) Gate Slots provide allocation of Gates based upon Periods of Use rather than specific flights in order to provide operational flexibility for the Air Carrier(s).
- (d) Periods of Use are limited based upon aircraft type (see Section 4-C below).
- (e) Based upon Gate availability and other operational conditions, Periods of Use may be extended solely at the discretion of SFO Gate Control.
- (f) Gate Slots are requested and assigned for specified days of the week and for a specified duration (e.g. Mondays Aug. 4 through Sept. 8 or daily Dec. 1 through Jan. 15, etc.)

(2) Request and Allocation Process

- (a) Requests for Gate Slots are valid for one Fiscal Year (July 1 to June 30) or period thereof or for the duration requested, whichever is less.
- (b) The annual request process is timed to coincide with the Airport-wide allocation of Preferential Use Gates.
- (c) Requests are processed and Gate assignments confirmed soon after the annual assignment of Preferential Use Gates is finalized.
- (d) Approximate timeline – actual dates will be established and communicated to the Air Carriers annually.
 - (i) Oct. 1 – SFO announces number and location of Common Use Gates planned for the next year (effective July 1)
 - (ii) Nov. 15 – Signatory Airlines deadline to submit notice of rejection of Preferential Use Gates offered.
 - (iii) Mar. 31 – SFO announces assignments of Preferential Use Gates for the next year (effective July 1).
 - (iv) 1 Apr. to Apr. 14 – SFO accepts and processes requests for slots (annual request period).

- (v) Apr. 15 – SFO announces assignments of Gate Slots.
- (vi) July 1 – Annual Gate allocations and Gate Slot assignments are effective.
- (e) Both new requests and requests for renewal of assignments granted during the previous year are accepted during the annual request period.
- (f) Renewal requests will be afforded priority (may be referred to as historical precedence) over new requests provided the following conditions are met; and if they are not, the request will be handled as if new.
 - (i) The slot for which renewal is requested was used as requested (i.e. Gate occupied during requested Periods of Use by requested aircraft type/category) a minimum of 80% of the Periods of Use requested during the preceding year.
 - (ii) The renewal request is for the same hours (e.g. 1300-1350) +/- fifteen minutes as requested during the preceding year and the Gate capability requested (i.e. type(s) of aircraft that can be accommodated) is unchanged from the preceding year.
- (g) Priority among renewal requests is based upon the following criteria, applied in descending order.
 - (i) Requesting Air Carriers with the longest duration (length of time in years/months/days) of continuous recurring use meeting above requirements (historical precedence).
 - (ii) Requesting Signatory Airlines not initially offered Preferential Use Gates for the year being allocated due to seats available for previous year below threshold for a Preferential Use Gate offer.
 - (iii) Requesting Signatory Airlines that did not reject initially offered Preferential Use Gate(s) for the year being allocated.
 - (iv) Remaining conflicts will be resolved by a lottery system designed by Airport staff in consultation with the RMAC.
- (h) Priority among new requests is based upon the following criteria, applied in descending order.
 - (i) Requests received no later than 1700 hours on the final day of the annual request period.
 - (ii) Requesting Signatory Airlines not initially offered Preferential Use Gates for the year being allocated due to seats available for previous year below threshold for Preferential Use Gate offer.
 - (iii) Requesting Signatory Airlines that did not reject initially offered Preferential Use Gate(s) for the year being allocated/planned.
 - (iv) Remaining conflicts will be resolved by a lottery system designed by Airport staff in consultation with the RMAC.

- (i) Requests received after 1701 hours on the final day of the annual request period will be prioritized based upon earliest time of receipt.
- (j) Request must indicate it is for a Gate Slot and must provide complete information including duration, i.e. start-end dates, day(s) of week required, Period of Use (i.e. start-end times), and aircraft type.
- (k) SFO Gate Control will provide the necessary forms and communication channels required to request Gate Slots.
- (l) Separate requests must be submitted for each Gate Slot requested.
- (m) Gate Slot requests may include RON.
 - (i) Approved RON requests are subject to cancellation due to Gate availability at time of operation.
 - (ii) RON charges will apply if a RON on Gate is accommodated through this process.
- (n) Gate Slots are not transferable between Air Carriers.
- (o) Flight operated by Air Carriers with mutual handling agreements and regional or "express/connection" Affiliate Airlines are considered the same as the slot holder's flight.
- (p) Gate Slot holders may not sub-assign slots to others.
- (q) Unused Gate Slots revert to Airport control.
- (r) Air Carriers are to advise SFO Gate Control as soon as possible if an assigned Gate Slot will not be used (see IV- E of this Section).
- (s) Gate Slots are revocable if not used.
 - (i) Gate Slots not utilized (i.e., Gate occupied during requested Periods of Use by requested aircraft type/category) a minimum of 80% of the Periods of Use requested during the preceding month may be revoked.
 - (ii) Airlines must submit a new request to reinstate a revoked Gate Slot or submit ad-hoc request for needed Gates.
 - (iii) Revoked Gate Slots cannot accrue historical precedence.

EXHIBIT J-2

ILLUSTRATION OF DOMESTIC TERMINALS PREFERENTIAL USE GATE ASSIGNMENT FORMULA

Preferential Use Gates will be offered to each Signatory Airline to commence each Fiscal Year (July 1st) as provided in Article 3. The City shall first determine the actual number of Scheduled Seats in the preceding month of August for each Signatory Airline, including its Affiliate Airline(s). This actual number of Scheduled Seats shall be divided by the total number of Scheduled Seats for all Signatory Airlines to determine each Signatory Airline's percentage share of all Scheduled Seats. Each Signatory Airline's Scheduled Seats Percentage shall be multiplied by the total number of Gates made available for Preferential Use. Certain rounding conventions apply.

An example of the formula worksheet is shown below:

| | Preferential Use Gates | Common Use Gates |
|------------|---------------------------|---------------------|
| Terminal 1 | 23 | 3 |
| Terminal 2 | 14 | 1 |
| Terminal 3 | <u>30</u> | <u>1</u> |
| Total | 67 | 5 |



| Airline | Carrier | Terminal | Gates | AUGUST 20xx Actual* | | | No. of Gates | |
|------------------|---------------------------------|----------|-------|---------------------|---------------|---------------|--------------|-----------|
| | | | | Seats | Seats | % of | Calc. | Rounded |
| | | | | /Mth | /Day | Total | | |
| Air Canada | | 3 | 2 | 45,000 | 1,452 | 2.4% | 1.63 | 2 |
| Alaska | | 1 | 3 | 94,000 | 3,032 | 5.1% | 3.40 | 3 |
| | Alaska-Mainline | | | 87,700 | 2,829 | 4.7% | 3.17 | 3 |
| | Alaska-Horizon Air | | | 6,300 | 203 | 0.3% | 0.23 | 0 |
| American | | 3 | 7 | 191,800 | 6,187 | 10.4% | 6.94 | 7 |
| | American-Mainline | | | 183,800 | 5,929 | 9.9% | 6.65 | 7 |
| | American Eagle | | | 8,000 | 258 | 0.4% | 0.29 | 0 |
| Continental | | 1 | 5 | 102,000 | 3,290 | 5.5% | 3.69 | 4 |
| Delta | | 1 | 5 | 178,000 | 5,742 | 9.6% | 6.44 | 6 |
| | Delta-Mainline | | | 167,350 | 5,398 | 9.0% | 6.05 | 6 |
| | Delta Express, Delta Connection | | | 10,650 | 344 | 0.6% | 0.39 | 0 |
| Frontier | | 1 | 1 | 22,400 | 723 | 1.2% | 0.81 | 1 |
| Future Signatory | | - | - | 23,750 | 766 | 1.3% | 0.86 | 1 |
| Future Signatory | | - | - | 22,000 | 710 | 1.2% | 0.80 | 1 |
| JetBlue | | IT | | 32,000 | 1,032 | 1.7% | 1.16 | 1 |
| Southwest | | 1 | 4 | 182,000 | 5,871 | 9.8% | 6.58 | 7 |
| United Airlines | | 3 | | 725,000 | 23,387 | 39.1% | 26.23 | 26 |
| | United-Mainline | | | 579,000 | 18,677 | 31.3% | 20.94 | 21 |
| | United Express | | | 146,000 | 4,710 | 7.9% | 5.28 | 5 |
| US Airways | | 1 | 5 | 98,000 | 3,161 | 5.3% | 3.54 | 4 |
| Virgin America | | IT | | 160,000 | 5,161 | 8.6% | 5.79 | 6 |
| Total | | | | 1,852,200 | 59,748 | 100.0% | | 67 |

Sources:

* Reported landings from Airline MATAR times aircraft seat capacity from OAG

This exhibit is intended to illustrate the formula for allocating Preferential Use Gates among Signatory Airlines in accordance with Article 3 of the Agreement. In the event of any conflict between this exhibit and the Agreement, the Agreement shall prevail. The presentation and format of the calculations illustrated on this exhibit is subject to change.

EXHIBIT K

RENTS FOR AIRLINE'S DEMISED PREMISES

| Category Rate | Rate Per Square Foot Per Year FY 2016/17 |
|----------------------|---|
| I | \$282.96 |
| II | \$212.22 |
| III | \$141.48 |
| IV | \$70.74 |
| V | \$28.30 |

EXHIBIT L

FORM OF SPACE CHANGE SUMMARY NOTICE

Statement of change(s) in [IT/T1/T2/T3] Exclusive Use Space leased by _____ pursuant to the provisions of Section 1922 of Lease and Use Agreement No. _____

Effective Date: _____

| Type [modify as needed for specific Terminal/space] | CAT | Original Space | | | Sq. Ft. Change | | Space Following Change | | |
|--|-----|-------------------|----------|-------------|----------------|-------|------------------------|----------|-------------|
| | | Exh. D Sheet Nos. | Location | Sq. Footage | Surrendered | Added | Exh. D Sheet Nos. | Location | Sq. Footage |
| Ticket Counter | I | | | | | | | | |
| Airline Ticket Office (ATO) | II | | | | | | | | |
| Inbound/Outbound Baggage System | II | | | | | | | | |
| | | | | | | | | | |

CITY:
CITY AND COUNTY OF SAN FRANCISCO,
a municipal corporation,
acting by and through its Airport Commission

APPROVED AS TO FORM:
DENNIS J. HERRERA, City Attorney

AIRLINE:

a _____

Ivar C. Satero
Airport Director

By _____
Deputy City Attorney

By: _____
Name: _____
Title: _____

EXHIBIT M

LIST OF BASELINE ENVIRONMENTAL REPORTS

| REPORT NO. | TITLE | CATEGORY | LOCATION | DATE OF REPORT |
|------------|--|------------------------------|--------------------------------|----------------|
| 10 | Task 2 Fuel Hydrant Line Investigation, Boarding Area A, Volume 1 | Fuel Line Investigation | Boarding Area A | 01-Aug-95 |
| 11 | Task 2 Fuel Hydrant Line Investigation, Boarding Area A, Volume 2 | Fuel Line Investigation | Boarding Area A | 01-Aug-95 |
| 15 | Revised Draft Work Plan and Site Safety Plan for the Phase 1, Task 3 Site Investigations | Site Investigation Work Plan | Boarding Areas A & B | 25-Mar-94 |
| 16 | Summary of Findings Environmental Site Assessment, Boarding Areas A & B | Investigation Report | Boarding Areas A & B | 05-May-94 |
| 18 | Phase 1 Site Assessment Workplan | Site Investigation Work Plan | Boarding Areas A & B | 28-Mar-94 |
| 20 | 1996 First Quarter Monitoring Report, Delta Air Lines | Quarterly Monitoring Report | Boarding Areas B & C | 10-Apr-96 |
| 21 | Fuel Hydrant System Investigation: Boarding Area E & Lease Hold Plot 9, Task 2 | Fuel Line Investigation | Boarding Area E & Plot 9 | 15-Jan-96 |
| 22 | Task 2 North Terminal Fuel Hydrant Line Investigation, Volume 1 | Fuel Line Investigation | Boarding Area F North Terminal | 01-Oct-95 |
| 23 | Task 2 North Terminal Fuel Hydrant Line Investigation, Volume 2 | Fuel Line Investigation | Boarding Area F North Terminal | 01-Oct-95 |
| 24 | Task 2 North Terminal Fuel Hydrant Line Investigation, Volume 3 | Fuel Line Investigation | Boarding Area F North Terminal | 01-Oct-95 |
| 25 | Remedial Concept Plan for the Boarding Area G Site | Site Investigation Work Plan | Boarding Area G | 01-Apr-94 |
| 26 | Boarding Area C to Boarding Area D (Gate 50) Chevron Fuel Hydrant Interconnect Project | Fuel Line Investigation | Boarding Area D, IT | 13-Dec-95 |
| 81 | Task 2 Fuel Transmission Line and Fuel Hydrant Line Investigation, B/A "A" and Plot 1 | Fuel Line Investigation | Boarding Area A & Plot 1 | 01-Oct-95 |
| 114 | Site Characterization Report- Task 3, Boarding Areas A & B, Volume 1 | Investigation Report | Boarding Areas A & B | 08-Nov-94 |
| 115 | Site Characterization Report- Task 3, Boarding Areas A & B, Volume 2 | Investigation Report | Boarding Areas A & B | 08-Nov-94 |
| 266 | Soil Vapor Contaminant Assessment Report of Investigation, Gates 68-69, North Terminal, SFIA | Investigation Report | Boarding Area F North Terminal | 12-Apr-88 |

| REPORT NO. | TITLE | CATEGORY | LOCATION | DATE OF REPORT |
|------------|---|---------------------------------|--------------------------------|----------------|
| 269 | Report of Investigation, Soil Vapor Contaminant Assessment, North Terminal, SFIA | Investigation Report | Boarding Area F North Terminal | 02-Jun-88 |
| 286 | Results of the Geophysical Survey of Selected Areas Around Boarding Areas A & B, SFIA (Draft) | Investigation Report | Boarding Areas A & B | 17-Mar-94 |
| 287 | Request for Airport Access Fuel Hydrant Investigation, Delta Airlines, Boarding Area B and C | Fuel Line Investigation | Boarding Areas B & C | 01-Jun-95 |
| 295 | Site Assessment of TWA Gates 26-31 | Investigation Report | Boarding Area B, Gates 26-31 | 01-Apr-94 |
| 299 | TWA Gate 21 and Cargo/Freight Areas - Quarterly Groundwater Monitoring Program Final Report | Quarterly Monitoring Report | Boarding Area B, TWA Gate 21 | 01-Sep-92 |
| 324 | Results of the Geophysical Survey of Selected Areas Around Boarding Areas A & B, SFIA (Final) | Site Investigation Report | Boarding Areas A & B | 17-Mar-94 |
| 325 | 1996 Second Quarter Monitoring Report, Delta Airlines, Inc., Boarding Area B and C | Quarterly Monitoring Report | Boarding Areas B & C | 18-Jul-96 |
| 337 | Task 5 - Feasibility Study/Remedial Action Plan, Boarding Areas B and C, SFIA San Francisco, California | Site Investigation Report | Boarding Areas B & C | 31-Jan-96 |
| 360 | Boarding Area "A" Fuel Line Removal and Remediation, Volume 1 | Fuel Hydrant Line Investigation | Boarding Area A | 01-Dec-96 |
| 361 | Boarding Area "A" Fuel Line Removal and Remediation, Volume 2 | Fuel Hydrant Line Investigation | Boarding Area A | 01-Dec-96 |
| 362 | Boarding Area "A" Fuel Line Removal and Remediation, Volume 3 | Fuel Hydrant Line Investigation | Boarding Area A | 01-Dec-96 |
| 373 | 1997 First Quarter Monitoring Report, Delta Airlines, Inc., Boarding Area B and C | Quarterly Monitoring Report | Boarding Areas B & C | 08-May-97 |
| 376 | First Quarter 1997, Quarterly Groundwater Monitoring Report, Trans World Airlines, Inc. Boarding Area B | Quarterly Monitoring Report | Boarding Area B | 12-Feb-97 |
| 399 | United Airlines SFIA Boarding Area G, Project Documents & Technical Specifications for Site Remediation Project, Volume 2 | Site Investigation Report | Boarding Area G | 01-Dec-95 |

| REPORT NO. | TITLE | CATEGORY | LOCATION | DATE OF REPORT |
|------------|---|---------------------------------|--------------------------------|----------------|
| 401 | Specifications Existing 24" Pipeline Disconnection Boarding Area "A" and "F" and appurtenant work | Project Specifications | Boarding Areas A & F | 28-Sep-95 |
| 405 | Remedial Action Plan for the Boarding Area A site | Remedial Action Plan | Boarding Area A | 01-Nov-95 |
| 419 | Technical Specifications Monitoring Well Drilling, Installation and Development Exhibit 1, Delta Air Lines | Site Investigation Work Plan | Boarding Area B | 26-Aug-97 |
| 421 | Work Plan for Remediation Services-Delta Airlines-Boarding Area B | Site Investigation Work Plan | Boarding Area B | 07-Aug-97 |
| 434 | First Quarter 1995, Groundwater Sampling Results and Four Quarter Summary Boarding Area B-South Terminal | Quarterly Monitoring Report | Boarding Area B | 31-May-95 |
| 441 | Boarding Area "A" Fuel Pipeline Removal Project, Project Documents and Technical Specifications for Pipeline Removal Project | Project Specifications | Boarding Area A | 01-Jan-96 |
| 443 | 1996 Fourth Quarter Monitoring Report, Delta Airlines, Inc., Boarding Area B and C | Quarterly Monitoring Report | Boarding Areas B & C | 24-Feb-97 |
| 447 | 1996 Third Quarter Monitoring Report, Delta Air Lines, Boarding Areas B and C | Quarterly Monitoring Report | Boarding Areas B & C | 04-Nov-96 |
| 459 | Work Plan for the Site Characterization of United Airlines Gates 58, 84, and 86 | Site Investigation Work Plan | Boarding Area F North Terminal | 01-Jan-92 |
| 464 | Second Quarter 1995 Quarterly Groundwater Report for Boarding Area B, South Terminal at SFIA | Quarterly Monitoring Report | Boarding Area B | 01-Jun-95 |
| 511 | 1997 Third Quarter Monitoring Report Delta Air Lines, Inc. Boarding Area B SFIA San Mateo County, CA Law Engineering and Environmental. Service., Project | Quarterly Monitoring Report | Boarding Area B | 03-Nov-97 |
| 547 | Boarding Area "A" Hydrant System (AF16) at SFIA | Fuel Hydrant Line Investigation | BAA Hydrant System IT | 24-Oct-97 |
| 553 | Report: Hazardous Materials Survey SFIA, Tunnel 'D' | Site Investigation Report | Boarding Area D | 01-Oct-96 |
| 565 | Third Quarter 1994 Quarterly Groundwater Report for Gates 26-31, South Terminal | Quarterly Monitoring Report | Boarding Area B, Gates 26-31 | 01-Oct-94 |

| REPORT NO. | TITLE | CATEGORY | LOCATION | DATE OF REPORT |
|------------|--|-------------------------------|--------------------------------|----------------|
| 566 | Fourth Quarter 1994, Quarterly Groundwater Reports for Gates 26-31 at SFIA | Quarterly Monitoring Report | Boarding Area B, Gates 26-31 | 01-Jan-95 |
| 577 | TWA-SFIA Gate 21 Pipeline Leak: Progress Report No. 1 | Site Investigation Report | Boarding Area B | 12-Apr-90 |
| 594 | 1997 Third Quarter Groundwater Report for Boarding Area B - South Terminal, Plot 3 | Quarterly Monitoring Report | Boarding Area B | 24-Oct-97 |
| 624 | California Regional Water Quality Control Board Order No. 95-136, Task 2 Work Plan - Phase 2 Fuel Hydrant System Investigation | Regional Board Correspondence | Boarding Areas E & Plot 9 | 23-May-96 |
| 641 | Boarding Area 'G', Phase 1 and Phase 2 Remediation, SFIA, Volume 1 | Site Investigation Report | Boarding Area G | 01-Nov-97 |
| 642 | Boarding Area 'G', Phase 1 and Phase 2 Remediation, SFIA, Volume 2 | Site Investigation Report | Boarding Area G | 01-Nov-97 |
| 643 | Boarding Area 'G', Phase 1 and Phase 2 Remediation, SFIA, Volume 3 | Site Investigation Report | Boarding Area G | 01-Nov-97 |
| 644 | Boarding Area 'G', Phase 1 and Phase 2 Remediation, SFIA, Volume 4 | Site Investigation Report | Boarding Area G | 01-Nov-97 |
| 645 | Boarding Area 'G', Phase 1 and Phase 2 Remediation, SFIA, Volume 5 | Site Investigation Report | Boarding Area G | 01-Nov-97 |
| 646 | Boarding Area 'G', Phase 1 and Phase 2 Remediation, SFIA, Volume 6 | Site Investigation Report | Boarding Area G | 01-Nov-97 |
| 649 | Work Plan for Fuel Pipeline Leak Detection Testing at Boarding Area E and the Air Cargo Facility | Site Investigation Work Plan | Boarding Area E & Plot 9 | 03-Dec-97 |
| 661 | Results of Subsurface Investigation at United Airlines Gate 58, 84, and 86, SFIA | Site Investigation Report | Boarding Area F North Terminal | 07-Apr-93 |
| 710 | Analysis of Effects of Hazardous Materials Remediation Plans on Proposed Structures for Boarding Area G, SFIA | Site Investigation Report | Boarding Area G | 01-May-95 |
| 738 | Summary Report: Hazardous Materials Survey, Terminal E and F | Site Investigation Report | Boarding Areas E & F | 01-Mar-97 |

| REPORT NO. | TITLE | CATEGORY | LOCATION | DATE OF REPORT |
|------------|--|------------------------------|----------------------------|----------------|
| 821 | Task 2B-Fuel Hydrant Investigation, Delta Boarding Area B & C, Delta Air Lines, Inc. | Site Investigation Report | Boarding Areas B & C | 14-Dec-95 |
| 824 | Fourth Quarter 1995, Quarterly Groundwater Report For Boarding Area B-South Terminal & Cargo/Freight Area-Plot 3 | Quarterly Monitoring Report | Boarding Area B | 01-Dec-95 |
| 872 | Request for Proposal for Remediation Services at Boarding Area B | Site Investigation Work Plan | Boarding Area B | 25-Feb-97 |
| 889 | First Phase Results, Delta Air Lines, Task 2B-Fuel Hydrant System Investigation, SFIA | Site Investigation Report | Boarding Areas B & C | 01-Nov-95 |
| 894 | Third Quarter 1995 Quarterly Groundwater Reports for Boarding Area B-South Terminal at SFIA | Quarterly Monitoring Report | Boarding Area B | 26-Aug-95 |
| 905 | Tenant Improvement United Airlines, Aboveground Fuel Tank Removal, Boarding Area G | Site Investigation Report | Boarding Area G | 09-Jun-96 |
| 906 | Workplan Aboveground Fuel Tank Storage Removal | Site Investigation Work Plan | Boarding Area G | 01-May-96 |
| 938 | Remedial Action Plan Addendum, Delta Air Line Remedial Action Plan, Boarding Area B | Remedial Action Plan | Boarding Area B | 12-Dec-96 |
| 997 | Remedial Action Plan, Boarding Area G Fuel Line Removal Project, SFIA | Remedial Action Plan | Boarding Area G | 01-Mar-98 |
| 999 | United Airlines, SFIA, Boarding Area G Fuel Line Removal Project, Project Documents & Specifications | Site Investigation Report | Boarding Area G | 01-Mar-98 |
| 1021 | 1997 Fourth Quarter Groundwater Monitoring Report Conducted by Delta Air Lines at Boarding Areas B and C at SFIA | Quarterly Monitoring Report | Boarding Areas B & C | 20-Apr-98 |
| 1076 | Phase 3 - Subsurface Information Report, B/A A, B/A B to F Connector (Phase 3), and B/A G | Site Investigation Report | B/A A, B/A B to F, & B/A G | 01-Oct-97 |
| 1142 | Fuel Line Removal at Boarding Area "A"; Airport Storm Drain Installation Project | Site Investigation Report | Boarding Area "A" | 12-May-99 |
| 1150 | Remedial Concept Plan for the Boarding Area "G" Site | Remedial Action Plan | Boarding Area G | 01-Apr-95 |
| 1153 | Letter Report: Remediation Services at Boarding Area B for Delta Air Lines | Site Investigation Report | Boarding Area B | 23-Jun-98 |

| REPORT NO. | TITLE | CATEGORY | LOCATION | DATE OF REPORT |
|------------|--|---|-------------------------------------|----------------|
| 1154 | Fuel Line Removal and Remediation, Boarding Area G | Site Investigation Report | Boarding Area G | 23-Apr-98 |
| 1169 | Minor Modifications to Soil and Groundwater Remediation Project Being Implemented by Delta Airlines, Inc. at Boarding Area B | Site Investigation Report | Boarding Area B | 29-Jun-99 |
| 1171 | 1999 First Quarter Groundwater Monitoring and System Operations Report, Delta Air Line, Inc., Boarding Area B, SFIA | Quarterly Monitoring Report | Boarding Area B | 30-Jun-99 |
| 1174 | Tentative Order for the Adoption of Revised Site Cleanup Requirements at SFIA; Designation of Additional Primary Dischargers | Regional Water Quality Control Board Report | Boarding Area E and Superbay Hangar | 09-Jul-99 |
| 1180 | First Semi-Annual Groundwater Report for Boarding Area B and Plot 3 | Quarterly Monitoring Report | Boarding Area B and Plot 3 | 01-Jul-99 |
| 1185 | Task 2 Fuel Hydrant Line Investigation, International Terminal Fuel Subcommittee, Boarding Area D - SFIA | Site Investigation Report | Boarding Area D | 08-Sep-95 |
| 1187 | 1999 Second Quarter Groundwater Monitoring and System Operations Report, Delta Air Lines, Inc., Boarding Area B, SFIA, Law Engineering and Environmental Project | Quarterly Monitoring Report | Boarding Area B | 09-Aug-99 |
| 1203 | Additional Information Request Re Naming Responsible Parties at the Superbay Hangar and Boarding Area E at SFIA | Site Investigation Report | Boarding Area E and Superbay Hangar | 20-Sep-99 |
| 1211 | Investigation of Diesel Fuel Line American Airlines Baggage Handling Area Boarding Area E | Site Investigation Report | Boarding Area E | 01-Apr-99 |
| 1230 | 1998 Third and Fourth Quarter Groundwater Monitoring and Systems Operations Report, Delta Airlines, Boarding Area B, SFIA | Quarterly Monitoring Report | Boarding Area B | 30-Jun-99 |
| 1239 | Letter RE Storm Drain Installation and Concrete Removal in Boarding Area F, Ramp Area | Regional Water Quality Control Board Report | Boarding Area F | 28-Oct-99 |
| 1253 | Fuel Hydrant System Investigation: Boarding Area E, SFIA, Volume 1 of 3 (Text, Tables, Figures) | Site Investigation Report | Boarding Area E | 01-Nov-99 |
| 1254 | Fuel Hydrant System Investigation: Boarding Area E, SFIA, Volume 2 of 3 (Analytical Reports) | Site Investigation Report | Boarding Area E | 01-Nov-99 |
| 1255 | Fuel Hydrant System Investigation: Boarding Area E, SFIA, Volume 3 of 3 (Analytical Reports) | Site Investigation Report | Boarding Area E | 01-Nov-99 |

| REPORT NO. | TITLE | CATEGORY | LOCATION | DATE OF REPORT |
|------------|--|---|---|----------------|
| 1257 | Naming Responsible Parties at the Superbay Hangar (TWA and United) and Boarding Area E (United) at SFIA (Order No. 99-045) | Regional Water Quality Control Board Report | Boarding Area E and Plot 40 | 10-Dec-99 |
| 1258 | Comments on American Airlines November 1, 1999, Submittal to the RWQCB on Plot 40 Superbay Hangar and Boarding Area E | Regional Water Quality Control Board Report | Boarding Area E and Plot 40 | 10-Dec-99 |
| 1260 | Request for Additional Information Regarding Naming of Responsible Parties at the Superbay Hangar and Boarding Area E, SFIA | Site Investigation Report | Boarding Area E and Plot 40 | 20-Sep-99 |
| 1261 | Task 2 Boarding Area "D" Fuel Hydrant Line Investigation SFIA Volume I | Site Investigation Report | Boarding Area D | 01-Dec-99 |
| 1262 | Task 2 Boarding Area "D" Fuel Hydrant Line Investigation SFIA Volume II (Appendix D - Lab Reports) | Site Investigation Report | Boarding Area D | 01-Dec-99 |
| 1263 | Task 2 Boarding Area "D" Fuel Hydrant Line Investigation SFIA Volume III (Lab Reports) | Site Investigation Report | Boarding Area D | 01-Dec-99 |
| 1277 | Subsurface Investigation in the Vicinity of Gate 56, Boarding Area "D", to Document Extent of Fuel Line Release | Site Investigation Report | Boarding Area D | 23-Nov-99 |
| 1278 | 1999 Third Quarter Groundwater Monitoring and System Operations Report, Delta Air Lines, Inc. Boarding Area B | Quarterly Monitoring Report | Boarding Area B | 26-Nov-99 |
| 1281 | Second Semi-Annual 1999 Groundwater Monitoring Report for TWA Boarding Area B - South Terminal and Cargo/Freight Area-Plot 3, SFIA | Quarterly Monitoring Report | Boarding Area B-South Terminal and Plot 3 | 01-Dec-99 |
| 1284 | Boarding Area "G" Fuel Line Closure, SFIA, for United Airlines | Site Investigation Report | Boarding Area G | 01-Feb-00 |
| 1291 | Planned Work for Fuel Vault at B/AG Drainage (Response to letter of October 13, 1999) | Site Investigation Work Plan | Boarding Area G | 08-Feb-00 |
| 1300 | Work Plan Remediation Services Expansion, Boarding Area B, SFIA | Site Investigation Work Plan | Boarding Area B | 01-Jan-00 |
| 1302 | Technical Specifications Bioventing Well and Monitoring Point Drilling and Installation, Boarding Area B, SFIA | Site Investigation Report | Boarding Area B | 01-Jan-00 |
| 1307 | Biovent Pilot Test Results for Delta Air Lines, Boarding Area B, SFIA | Site Investigation Report | Boarding Area B | 31-Mar-00 |

| REPORT NO. | TITLE | CATEGORY | LOCATION | DATE OF REPORT |
|------------|---|------------------------------|-------------------------------------|----------------|
| 1354 | 2000 First Quarter Groundwater Monitoring and System Operations Report: Delta Airlines, Inc., Boarding Areas B and C | Quarterly Monitoring Report | Boarding Areas B and C | 06-Jul-00 |
| 1361 | Progress Report on Connection of Sanitary Sewer Line at Boarding Area B | Site Investigation Report | Boarding Area B | 26-Jul-00 |
| 1364 | Request for Variance from Tier 1 Cleanup Requirement, Boarding Area D Fuel Hydrant System | Site Investigation Report | Boarding Area D | 23-May-00 |
| 1367 | Revised Work Plan, Soil and Groundwater Investigation, Boarding Area C, Plot 3E, Plot 50 and Pipe No. 11 | Site Investigation Work Plan | BAC, Plot 3E, P50, and Pipe No. 11 | 20-Mar-00 |
| 1373 | First Semi-Annual 2000 Groundwater Monitoring Report for TWA Boarding Area B-South Terminal and Cargo/Freight Area - Plot 3 | Quarterly Monitoring Report | Boarding Areas B & Plot 3 | 01-Jul-00 |
| 1374 | Supplemental Phase II Investigation Boarding Area E/Former Pier B, SFIA | Site Investigation Report | Boarding Area E/ Former Pier B | 01-Sep-00 |
| 1393 | 2000 Second Quarter Groundwater Monitoring and System Operations Report, Delta Airline, Boarding Areas B and C, SFIA | Quarterly Monitoring Report | Boarding Areas B & C | 26-Sep-00 |
| 1400 | Second Semi-Annual 2000 Groundwater Monitoring Report for TWA at Boarding Area B - South Terminal, SFIA | Quarterly Monitoring Report | Boarding Area B | 01-Dec-00 |
| 1418 | Approval of Proposed Work Plans for Additional Investigation at Boarding Area E, Board Order No. 99-045 | Site Investigation Work Plan | Boarding Area E | 05-Jun-00 |
| 1443 | Letter Report, Soil and Groundwater Investigation, Boarding Area C, Plot 3E, and Pipe No. 11, SFIA, for ARCO | Site Investigation Report | BAC, Plot 3E | 25-Oct-00 |
| 1451 | Observation of Fuel Product Sheen in Storm Drain Manhole at Boarding Area D | Site Investigation Report | Boarding Area D | 24-May-01 |
| 1452 | Monitoring Well Cover Specifications, Boarding Area D Remedial Action Plan | Remedial Action Plan | Boarding Area D | 17-May-01 |
| 1456 | Analytical Results of a Water Sample Collected on January 12, 2001 from the Storm Water Wet Well Located in the BAD Underpass | Site Investigation Report | Boarding Area D Underpass | 25-Jan-01 |
| 1457 | Remedial Action Plan Boarding Area "D" and Former Pier "C" Fuel Hydrant Systems, SFIA | Remedial Action Plan | Boarding Area D and Historic Pier C | 31-May-01 |

| REPORT NO. | TITLE | CATEGORY | LOCATION | DATE OF REPORT |
|------------|--|---------------------------------------|---|----------------|
| 1460 | Storm Water Pollution Prevention Plan SFO Fuel System Expansion: Boarding Area D Transmission Line | Storm Water Pollution Prevention Plan | Boarding Area D | 31-May-01 |
| 1462 | 2000 Third Quarter Groundwater Monitoring and System Operations Report, Delta Air Lines, Inc., Boarding Area B | Quarterly Monitoring Report | Boarding Area B | 27-Feb-01 |
| 1463 | 2000 Fourth Quarter Groundwater Monitoring and System Operations Report, Delta Airlines, Inc., Boarding Area B | Quarterly Monitoring Report | Boarding Area B | 12-Jun-01 |
| 1467 | Boarding Area D Apron Rehabilitation Demolition Plan | Project Specifications | Boarding Area D | 04-Jun-01 |
| 1477 | Supplemental Phase II Investigation, Boarding Area E / Former Pier B | Site Investigation Report | BAE - Terminal & Gates | 08-Sep-00 |
| 1479 | Work Plan: Boarding Area C Investigation, SFIA | Site Investigation Work Plan | Boarding Area C | 30-May-01 |
| 1516 | Status Report for the Remedial Action Plan | Remedial Action Plan | Boarding Area D | 05-Sep-01 |
| 1523 | Final Subsurface Investigation Workplan Former Pier "D" Fuel Hydrant System | Site Investigation Work Plan | Boarding Area D, Former Pier D Hydrant System | 11-Oct-01 |
| 1527 | Additional Investigation of the Boarding Area 'G' Footprint United Airlines Service Center, Plots 4, 5 & 6 | Site Investigation Report | Boarding Area G Footprint, UAL Service Center | 01-Apr-96 |
| 1541 | Remedial Action Plan Boarding Area D and Former Pier C Fuel Hydrant Systems, SFIA | Remedial Action Plan | Boarding Area 'D' - Former Pier 'C' | 31-May-01 |
| 1572 | 2001 First Quarter GW Monitoring and System Operations Report, Delta Air Lines, BAB | Quarterly Monitoring Report | BAB | 29-Nov-01 |
| 1576 | 1998 First Quarter GW Report for BAB and Plot 3 | Quarterly Monitoring Report | BAB | 15-May-98 |
| 1577 | Soil and GW Investigation for Delta Air Lines and Northwest Airlines at BAC | Site Investigation Report | BAC | 21-Jan-02 |
| 1593 | Notice re: Additional Monitoring Wells and Soil Borings by UAL | Site Investigation Report | BAF - Terminal & Gates | 18-Apr-02 |
| 1596 | Boarding Area E Technical Oversight Committee, Interim Remedial Action Plan, Boarding Area E | Site Investigation Report | BAE | 28-Sep-01 |

| REPORT NO. | TITLE | CATEGORY | LOCATION | DATE OF REPORT |
|------------|---|------------------------------|-------------------------------|----------------|
| 1597 | Report of Results of Product Analyses (age dating) Performed During SFO Boarding Area C Investigation by Delta Air Lines and Northwest Airlines | Site Investigation Report | BAC | 04-Mar-02 |
| 1627 | Interim Remedial Action Program Implementation, Boarding Area E, SFIA | Site Investigation Report | BAE - Terminal & Gates | 20-Mar-02 |
| 1630 | Interim Remedial Action Plan, Boarding Area E | Remedial Action Plan | BAE - Terminal & Gates | 28-Sep-01 |
| 1632 | Work Plan for Remediation Services Expansion, Boarding Area B, Gate 32 | Site Investigation Work Plan | B/A B | 14-Jun-02 |
| 1641 | 2001 Third Quarter Groundwater Monitoring and System Operations Report | Quarterly Monitoring Report | BAB, BAC | 12-Sep-01 |
| 1660 | Free-Product Removal Feasibility Study and Interim Remedial Action Plan, Boarding Area E | | BAE - Terminal & Gates | 30-Sep-02 |
| 1670 | 2001 Second Quarter Groundwater Monitoring and System Operations Report, Delta Air Lines, Inc., Boarding Area B, SFIA | | BAB, BAC | 01-Jul-02 |
| 1678 | 2001 Fourth Quarter groundwater Monitoring and System Operating Report | | BAB, BAC | |
| 1687 | SFIA United Airlines North Terminal Feasibility Study/Remedial Action Plan | | BAF - Terminal & Gates | 30-Apr-03 |
| 1689 | Expansion of Remediation Services at Gate 32, Boarding Area B Delta Air Lines | | BAB - Terminal, Gates & Apron | 26-Jun-03 |
| 1692 | Monitoring Well Abandonment Boarding Area D SFIA | Ground Water Monitoring | Boarding Area D | 21-Jul-03 |
| 1693 | Boarding Area F Remedial Action Program Implementation BAF, SFIA | Remedial Action Plan | BAF - Terminal & Gates | 16-Jul-03 |
| 1694 | Health and Safety Plan Remedial Action Program BAF, SFIA | | BAF - Terminal & Gates | 16-Jul-03 |
| 1695 | Storm Water Pollution Prevention Plan (SWPPP) Remedial Action Program BAF, SFIA | | BAF - Terminal & Gates | 16-Jul-03 |
| 1699 | 2002 First Semi-Annual Groundwater Monitoring and System Operations Report Delta Air Lines, Inc., Boarding Area B and C SFIA | | BAB, BAC | 30-Jun-03 |

| REPORT NO. | TITLE | CATEGORY | LOCATION | DATE OF REPORT |
|------------|---|--------------------------------|-----------------------------------|----------------|
| 1701 | Second Quarter 2003 Ground Water Monitoring Report, Boarding Area F, SFIA | | BAF - Terminal & Gates | 13-Aug-03 |
| 1710 | Phase 1 Remedial Action Program Progress Report, BAE, SFIA | | BAE - Terminal & Gates | 06-Nov-03 |
| 1717 | 2002 Second Semi-Annual Groundwater Monitoring and System Operations Report Delta Air Lines, Inc., Boarding areas B and C | | BAB, BAC | 08-Dec-03 |
| 1722 | Boarding Area F - Monitoring Well Installation and 4th Quarter 2003 Groundwater Monitoring Report | | Boarding Area F | 29-Jan-04 |
| 1726 | 2003 First Semi-Annual Groundwater Monitoring & System Operations Report, Delta Airlines, Boarding Areas B & C | | BAB & BAC | 20-Apr-04 |
| 1728 | First Quarter Groundwater Monitoring Report, BAF, SFIA | | BAF | 16-Apr-04 |
| 1733 | Final Supplemental Phase II Investigation Report | | BAE/Former Pier B | 31-Jan-01 |
| 1742 | Boarding Area D Remedial Action Plan | Remedial Action Plan | Boarding Area D | 12-Feb-03 |
| 1754 | Boarding Area F Remedial Action Program Progress Report # 1 | Monitoring Report | Boarding Area F | 12-Sep-04 |
| 1764 | Boarding Area E Phase 2 Interim Remedial Action Plan Progress Report | Remediation /Monitoring Report | Boarding Area E | 08-Apr-05 |
| 1768 | Descaling Operations at Gates 20, 22, and 33, San Francisco International Airport | Remediation | Boarding Area B | 03-Dec-04 |
| 1769 | 2004 First Semi-Annual Groundwater Monitoring and System Operations Report - Boarding Areas B & C | Monitoring | Boarding Areas B & C | 15-Dec-04 |
| 1770 | 2003 Second Semi-Annual Groundwater Monitoring and System Operations Report - Boarding Areas B & C | Monitoring | Boarding Areas B & C | 26-Jul-04 |
| 1788 | Final Report: Emergency Clean-up, Asbestos Removal & Encapsulation Project, Rotunda A, South Terminal | Asbestos Abatement Report | Boarding Area A | 01-Apr-90 |
| 1792 | Monitoring Well Installation Boarding Area "D" | Investigation | Boarding Area "D" | 20-Sep-05 |
| 1796 | Boarding Area F Remediation Action Program, Progress Report No. 2, San Francisco International Airport | Remediation Report | Boarding Area F | 02-Aug-05 |
| 1797 | PS Trading Inc. Temporary Closure Fuel System, San Francisco International Airport | Closure Report | Boarding Area A - Boarding Area C | 11-Aug-05 |

| REPORT NO. | TITLE | CATEGORY | LOCATION | DATE OF REPORT |
|------------|--|-------------------------------|----------------------|----------------|
| 1799 | Descaling Operations at Gates 20, 22, and 33 San Francisco International Airport | Remediation Report | Boarding Area B | 03-Dec-04 |
| 1811 | Boarding Area E Phase 3 Interim Remedial Action Plan Progress Report, San Francisco International Airport | Remedial action Report | Boarding Area E | 18-Nov-05 |
| 1812 | Groundwater Monitoring Report, Boarding Area D, January 2006 Semi-Annual Report | Monitoring Report | Boarding Area D | 22-Mar-06 |
| 1823 | SFO Fuel Hydrant Pit Repairs, Boarding Area G, San Francisco International Airport | Report & Specifications | Boarding Area G | 13-Jun-06 |
| 1829 | Boarding Area F Remediation Action Program, Progress Report No. 3 | Remediation Report | Boarding Area F | 13-Sep-06 |
| 1834 | Boarding Area E Work Plan to Investigate Free product in Well MW-1 | Investigation Work Plan | Boarding Area E | 13-Mar-07 |
| 1838 | Boarding Area D Monitoring Well Installation, SFO Fuel Company, LLC. | Well Installation | Boarding Area D | 08-Mar-05 |
| 1843 | Boarding Area E Phase 4 Interim Remedial Action Plan 2006 Progress Report | Remedial Action Report | Boarding Area E | 22-Dec-06 |
| 1844 | Boarding Area D October 2006 Semi-Annual Groundwater Monitoring Report | Monitoring Report | Boarding Area D | 30-Nov-06 |
| 1848 | 2005 First Semi-Annual Groundwater Monitoring, System Operations, and Soil Vapor Monitoring Report, Boarding Areas B and C | Monitoring Report | Boarding Areas B & C | 17-Aug-06 |
| 1854 | Boarding Area F Workplan for Soil and Ground Water Investigation | Investigation Workplan | B/A F | 16-Apr-07 |
| 1858 | Field Sampling Workplan for Boarding Area A Fuel System Expansion Baseline Soil Investigation | Sampling Workplan | B/A A | 30-Apr-07 |
| 1860 | March 2007 Semi-Annual Groundwater Monitoring Report Boarding Area D, San Francisco International Airport | Monitoring Report | B/A D | 22-Jun-07 |
| 1865 | Boarding Area F Remedial Action Plan, Progress Report #4 | Remediation Monitoring Report | Boarding Area F | 12-Sep-07 |
| 1866 | Semi-Annual Groundwater Monitoring Report Boarding Area D, San Francisco International Airport | Monitoring Report | Boarding Area D | 05-Dec-07 |
| 1868 | February 2008 Semi-Annual Groundwater Monitoring Report, Boarding Area D, San Francisco International Airport | Monitoring Report | Boarding Area D | 07-May-08 |
| 1869 | Boarding Area A Baseline Soil Investigation Report | Investigation Report | Boarding Area A | 04-Dec-07 |

| REPORT NO. | TITLE | CATEGORY | LOCATION | DATE OF REPORT |
|------------|--|---------------------------------|-----------------|----------------|
| 1877 | Work Plan for Mobile High-Vacuum Extraction, Former TWA Operations Area, Boarding Area B | Remediation Work Plan | Boarding Area B | 30-Jul-08 |
| 1881 | November 2008 Semi-Annual Groundwater Monitoring Report, Boarding Area D | Monitoring Report | Boarding Area D | 17-Dec-08 |
| 1883 | Boarding Area B Remediation Progress Report # 1 | Remediation Report | Boarding Area B | 13-Feb-09 |
| 1886 | Boarding Area F Progress Report # 5, United Airlines | Remediation / Monitoring Report | Boarding Area F | 28-Jan-09 |

EXHIBIT N

AIRPORT MEASUREMENT SPECIFICATIONS

1. Leasable revenue space adjacent to leasable revenue space is measured from the center line of the wall. When wall thickness is indeterminate assume a 6" wall and 3" to center line.
2. Non-revenue space adjacent to non-revenue space is measured from the center line of the wall. When wall thickness is indeterminate assume a 6" wall and 3" to center line.
3. Leasable revenue space sharing a wall with non-revenue space is measured to the inside face of wall on revenue side.
4. Storefronts locations relative to the lease area calculation are established on a case by case basis. This type of Lease line is typically established at the plumb line of a header fascia or floor finish transition to public space. This is used when walls are unclear, otherwise it is typical to measure to the tenant side face of wall or glass, whichever is greatest.
5. All exterior walls are measured to the inside face of wall.
6. If any wall, being measured to, is made up of glass area greater than 50% of wall area, take measurement from face of glass.
7. Structural columns, structural braces and projections necessary to the building are typically included in area calculation for a given space. Exceptions considered are rooms where these intrusions represent a disproportionately large area of the room outside the normal demising walls.
8. Escalators/elevators and stairs within the lease area included in the area calculation of one floor only. Additional levels may be included by agreement.
9. Telephone services, for revenue purposes, are measured by the shelf size or seat size whichever is larger.
10. Mechanical chases are non-revenue, non-leasable spaces.
11. Fire stairs are non-leasable space.

EXHIBIT O

CALCULATION OF RATES AND CHARGES

This Exhibit provides additional support for the calculation of Airline Rates and Charges described in Articles 4 and 5 of the Agreement. This Exhibit also provides an illustration of the calculations of Terminal Area Rentals and Landing Fees.

In each Fiscal Year, Airline Rates and Charges are calculated so that they recover the difference between Commission expenses and Commission Non-Airline Revenues. The expenses and Non-Airline Revenues of the Commission are described in more detail below.

Airline Rates and Charges are calculated to be effective on the first day of each Fiscal Year based on the budgetary forecast of expenses and Non-Airline Revenues, which are allocated to Cost Centers according to the Airport Cost Accounting System for the purpose of calculating the Landing Fee Rate and the Terminal Area Rental Rate(s) in accordance with Article 5. These calculations are illustrated below.

As part of the City's preparation of its annual audited financial statements, the actual amount of expenses and Non-Airline Revenues is used to calculate the actual amount of Airline Rates and Charges for the Fiscal Year in accordance with Article 5. This calculation of surplus or deficit is illustrated below.

Capitalized terms not otherwise defined in this Agreement shall have the meaning given in the Master Bond Documents.

EXPENSES

The expenses of the Commission include the following:

1. AO&M Expenses
 - a. All expenses of the Commission incurred for the operation and maintenance of the Airport including, for example, salaries and mandatory fringe benefits, contractual services, materials and supplies, direct services provided by other City departments (e.g., legal and utilities), and the recurrent maintenance expenses referred to as Facilities Maintenance expenses in the budget of the Commission;
 - b. The payment of pension charges and proportionate payments to such compensation and other insurance or outside reserve funds as the Commission may establish or the Board of Supervisors may require with respect to employees of the Commission, as now provided in Section 6.408 of the Charter; and
 - c. Such other expenses, if any, required to be paid from the Operations and Maintenance Account or to be treated as Operations and Maintenance Expenses under the Master Bond Documents.

2. Equipment and Small Capital Outlay:
 - a. Items of Equipment consisting of assets whose individual cost is more than \$5,000 (or such other threshold amount as used in the Commission's financial statements) and less than \$1,000,000 (in 2008 dollars), as increased or decreased annually by the Index; and
 - b. Small Capital Outlays consisting of assets whose individual cost is more than \$1,000,000 (in 2008 dollars) and less than \$4,790,000 (in 2008 dollars), as increased or decreased annually by the Index.
3. Debt Service Requirements:
 - a. Amounts required for deposits to the Revenue Bond Account and for deposits and payments to the General Obligation Bond Account and to the General Purpose Account or to funds and accounts hereafter created under the Master Bond Documents to secure Airport Revenue Bonds;
 - b. Amounts required for deposits and payments to funds and accounts created to secure Special Revenue Bonds, but only to the extent payable from Revenues and authorized by the Majority-In-Interest;
 - c. Amounts required to fund or replenish funds in the Contingency Account;
 - d. Amounts, if any, required pursuant to Section 505 of the Lease and Use Agreement to insure compliance with the Rate Covenant;
 - e. Amounts, if any, of rental credits against tenant invoices to reimburse such tenants for their cost to finance improvements to the Airport pursuant to a formal agreement with the Commission.
 - f. Amounts, if any, required to make payments under credit and liquidity facilities, interest rates swaps, investment agreements, and other agreements entered into in connection with Airport debt; and
 - g. Amounts required to pay fees and expenses of bond trustees, fiscal agents, tender agents, remarketing agents and other similar parties in connection with Airport debt.
4. The Annual Service Payment calculated pursuant to Section 502(B),

NON-AIRLINE REVENUES

The Non-Airline Revenues of the Commission are generally classified as follows:

1. Concession Revenues pursuant to Article 1.
2. Revenues from other sales and fees. This generally includes revenues from the sale of electricity, water and sewage resale, commissions of the UAL Cogeneration facility, fees for security services, Air Train trip fees, telecommunications fees, license and permit fees, itinerant and general aviation landing fees, non-Signatory Airline landing fee premiums, jet bridge fees, and fixed-base operator aircraft parking and fuel sales.
3. Revenues from all fixed or cost-recovery based rentals. This generally includes revenues from charges for Common Use facilities, reimbursement of custodial fees from the Terminal Company, rentals from government agencies, rental car facility fees, the BART rental payment, cargo and hangar space and customs fees and rentals; ground lease rentals; fixed base operator hangar rentals; tank farm rentals; and airline support services.
4. Interest income. This generally includes interest earnings from monies on deposit in the Airport Revenue Fund, the various debt service funds, the various debt service reserve funds, the Contingency Account, and interest attributable to loans, if any, to other parties.
5. PFC revenues designated as Revenues. In accordance with the Master Bond Documents, PFC revenues are excluded from Revenues and can only be included if the Commission designates them as Revenues. Non-Airline Revenue includes PFC revenues in a Fiscal Year only to the extent that the Commission designates an amount of PFC revenues as Revenue for such Fiscal Year.

RECONCILIATION OF EXPENSES AND NON-AIRLINE REVENUES

As part of the City's preparation of its annual audited financial statements, the actual amount of expenses and Non-Airline Revenues is used to calculate the actual amount of Airline Rates and Charges required for the Fiscal Year in accordance with Article 5. The resulting deficit or surplus is recorded as part of that Fiscal Year's financial activity. This reconciliation process, which is described in Section 505, is illustrated in the table below with Fiscal Year 2009 data.

CALCULATION OF DEFICIT (SURPLUS) - AIRLINE
RATES AND CHARGES
Fiscal Year 2008
(in thousands)

| | Audited 2008 |
|---|-----------------|
| Total Airport Expenses | |
| AO&M Expense | \$ 309,368 |
| Facilities Maintenance | 5,919 |
| Equipment and Small Capital Outlays | 1,507 |
| Annual Service Payment | 25,942 |
| Debt Service Requirements | 290,684 |
| | \$ 633,419 |
| Less: revenues from sources other than Airline Rates and Charges | 392,482 |
| Net revenue required | \$ 240,937 |
| Actual Airline Rate and Charges | 247,525 |
| Deficit (surplus) | \$ (6,588) |

BUDGETARY FORECAST OF EXPENSES AND NON-AIRLINE REVENUES

Airline Rates and Charges are calculated to be effective on the first day of each Fiscal Year based on the budgetary forecast of expenses and Non-Airline Revenues for the Fiscal Year. In addition to the expenses of the Commission previously described, the budgetary forecast of expenses also includes the deficit (surplus) of prior years consisting of:

1. The amount of the actual accumulated deficit (or surplus) from prior periods applied pursuant to Section 505(A) and 505(D); and
2. The estimated current period deficit (or surplus) pursuant to Section 505(B) and 505(D).

The term "current period" refers to the Fiscal Year next preceding the Fiscal Year for which the Airline Rates and Charges are being calculated.

ALLOCATION OF EXPENSES AND NON-AIRLINE REVENUES

The budgetary forecast of expenses and Non-Airline Revenues of the Commission are allocated to the Cost Centers. The total expenses of the Airfield Area, Airport Support Area, Terminal Area, and Groundside Area includes the re-allocation of the net expenses and Non-Airline Revenues of the Utilities Area.

AO&M Expenses

The City's current accounting system is the "Financial Accounting and Management Information System" (FAMIS) developed by Peat Marwick. In FAMIS, AO&M expenses are budgeted and tracked within the Airport by "index codes." Table 1 summarizes each of the Airport's current index codes and the "organization" titles. These "organization" titles were originally established in 1981 for the purpose of allocating AO&M expenses by Cost Center. The Cost Center allocation of the "organization" titles were based on a review of Airport and industry experience.

Since 1981, the Airport has continued to utilize these "organization" titles to allocate AO&M expenses by Cost Center. As facilities, like the new international terminal, additional garages, and the AirTrain, have been built and additional Airport "organizations" have been added, the allocation percentages by Cost Center have been reviewed and updated, as necessary. Table 2 summarizes the Cost Center allocation for each "organization" at the Airport as of FY 2009.

These Cost Center allocations will continue to be reviewed throughout the term of the Agreement and will be adjusted for changes in the Airport's organizational structure, in staffing levels, and in physical facilities. The City may someday replace FAMIS, which may cause the structure and organization of the budgetary accounts depicted on the following pages to change.

Equipment and Small Capital Outlays

Equipment and Small Capital Outlay expenses are budgeted by index and allocated by Cost Center in accordance with the percentages set forth in Table 2.

Debt Service Requirements

Debt Service Requirements previously described as "Expenses 3.a. and 3.b." above (except commercial paper) are allocated to Cost Centers based on the use of bond proceeds by Cost Center, either on a series by series basis or in the aggregate for all series of Airport Revenue Bonds and Special Revenue Bonds, if any. Table 3 summarizes annual debt service Cost Center allocation percentages by issue with data for FY 2009.

Debt Service Requirements on outstanding commercial paper or other short-term financing are also allocated based on the use of proceeds. However, to the extent there is no outstanding commercial paper or other short-term financings, then commercial paper and short-term financing fees and expenses, if any, are allocated to one or more Cost Centers based on considerations deemed appropriate by the City.

Debt Service Requirements previously described as "Expenses 3.c., 3.d., 3.e., 3.f., and 3.g." above are allocated to one or more Cost Centers based on considerations deemed appropriate by the City.

Table 1

**FAMIS INDEX CODES BY AIRPORT OPERATING DIVISION AND "ORGANIZATION"
San Francisco International Airport**

| Division | Index code | "Organization" |
|--|---------------------------|---|
| Operations & Security | AirDeputyopn | Office of the Deputy Director - Operations |
| | AirRescue 315017 | ARFF |
| | AirSFPDPROG 38Airp | Police |
| | AirAvSec | Airport Security |
| | AirFieldOpn | Operations Services |
| | AirDispatch | Airport Dispatch |
| | AirPermit | License and Permit Bureau |
| | AirControl | Emergency Planning Services |
| | AirLndside | Landside |
| | AirBartOe | BART |
| | AirGTU | Ground Transportation |
| | AirInfobooth | Airport Transit Booth |
| | AirTransit | Transportation Systems Management |
| | AirOpnmgt | Terminal Management |
| | AirNoiseCOS | Noise Monitoring |
| AirITMgt | Aviation Security Systems | |
| Planning, Design & Construction | AirPlan | Bureau of Planning |
| | AirBDC | Design & Construction |
| | AirTrainOpn | Airport Train Operations |
| Facilities Maintenance | | <i>TECHNICAL SERVICES & MAINTENANCE</i> |
| | AirDeputyFom | Office of the Deputy Director |
| | AirDeputyFom | Light, Heat, Power |
| | AirDeputyFom | Water |
| | AirSignshop | Sign Shop |
| | AirSchedind | Scheduling and Control |
| | AirConstind | Construction Support |
| | AirQtyind | Quality Control |
| | AirEngineer | Technical Services |
| | AirTrafEng | |
| | AirTechsvcs | |
| | AirGIS | Geographic Information System |
| | AirPurchaser | Purchasing |
| | AirPurchaser | Fuel |
| | AirPurchaser | Office Supplies |
| | | <i>BUILDING, GROUNDS, & VEHICLE MAINTENANCE</i> |
| | AirMainsuper | Maintenance Supervision |
| | AirAutoshop | Auto Shop |
| AirCustodian | Custodial | |
| AirPavements | Pavement/Grounds | |
| AirLandscape | Landscaping | |

Table 1 (concluded)

FAMIS INDEX CODES BY AIRPORT OPERATING DIVISION AND "ORGANIZATION"
San Francisco International Airport

| Division | Index code | "Organization" |
|---|----------------------------|-------------------------------|
| Facilities Maintenance (concluded) | AirPainting | Painting |
| | AirWaterind | Water Quality Control |
| | AirCarpenter | Carpentry |
| | AirLocksmith | |
| | AirMechind | Mechanical |
| | AirMechind | Terminal Maintenance |
| | | UTILITIES MAINTENANCE |
| | AirEnvind | Environmental Control |
| | AirSteamfitr | Steamfitting |
| | AirPlumbing | Plumbing |
| AirElectric | Electrical | |
| AirMetalshop | Sheet Metal Shop | |
| Administration | AirAdmin | Administration Division |
| | AirITT | |
| | AirMailRepro | |
| | AirPersonnel | |
| | AirSafety | |
| | AirECP | Employment Development |
| Business & Finance | AirAcctng | Finance Division |
| | AirAcctng | Taxes |
| | AirFinancial | Finance Division |
| | AirConcess | Business Division |
| | AirDepbus | |
| | AirProperty | |
| | AirProperty | Rental of Property |
| AirOutreach | Minority Business Outreach | |
| AirParkMgt | Garage | |
| Communications & Marketing | AirCommktg | Communications & Marketing |
| | AirCustserv | |
| | AirPAffairs | |
| | AirCombureau | Community Affairs |
| Chief Operating Officer | AirCOO | Office of the Director |
| | AirExhibit | Exhibition Operations |
| Director's Office | AirDirector | Office of the Director |
| | AirEEO | Administration Division |
| | AirLegislate | Bureau of Legislative Affairs |
| | AirLegal | Legal Expenses Program |
| | AirSecretary | Secretary to Commission |

Table 2

ALLOCATION OF ADMINISTRATIVE, OPERATING, AND MAINTENANCE EXPENSES
San Francisco International Airport

| | Airfield Area | Airport Support Area | Terminal Area | Groundside Area | Utilities Area |
|---|------------------|----------------------------|------------------|--------------------|-------------------|
| OPERATIONS | | | | | |
| Office of the Deputy Director | 20% | 10% | 50% | 20% | 0% |
| ARFF | 55% | 5% | 25% | 15% | 0% |
| Police | 2% | 10% | 65% | 23% | 0% |
| Airport Security | 10% | 15% | 60% | 15% | 0% |
| Operations Services | 73% | 13% | 10% | 3% | 1% |
| Airport Dispatch | 16% | 2% | 68% | 14% | 0% |
| License and Permit Bureau | 20% | 30% | 39% | 11% | 0% |
| Emergency Planning Services | 15% | 0% | 80% | 5% | 0% |
| Landside | 0% | 3% | 0% | 97% | 0% |
| BART | 0% | 0% | 0% | 100% | 0% |
| Ground Transportation | 0% | 0% | 0% | 100% | 0% |
| Airport Transit Booth | 0% | 0% | 50% | 50% | 0% |
| Transportation Systems Management | 0% | 0% | 0% | 100% | 0% |
| Terminal Management | 3% | 3% | 74% | 20% | 0% |
| Noise Monitoring | 70% | 0% | 30% | 0% | 0% |
| Aviation Security Systems | 5% | 5% | 85% | 5% | 0% |
| PLANNING, DESIGN & CONSTRUCTION | | | | | |
| Bureau of Planning | 10% | 20% | 20% | 50% | 0% |
| Design & Construction | 0% | 2% | 50% | 45% | 3% |
| Air Train Operations | 0% | 0% | 0% | 100% | 0% |
| TECHNICAL SERVICES & MAINTENANCE | | | | | |
| Office of the Deputy Director | 10% | 15% | 35% | 25% | 15% |
| Sign Shop | 0% | 15% | 40% | 45% | 0% |
| Scheduling and Control | 10% | 15% | 55% | 15% | 5% |
| Construction Support | 10% | 30% | 28% | 20% | 12% |
| Quality Control | 5% | 10% | 65% | 5% | 15% |
| Technical Services | 5% | 15% | 25% | 30% | 25% |
| Geographic Information System | 5% | 15% | 25% | 25% | 30% |
| Purchasing | 5% | 5% | 80% | 10% | 0% |
| Fuel | 1% | 0% | 1% | 98% | 0% |
| Office Supplies | 5% | 5% | 80% | 10% | 0% |
| BUILDING, GROUNDS, & VEHICLE MAINTENANCE | | | | | |
| Maintenance Supervision | 20% | 15% | 30% | 25% | 10% |
| Auto Shop | 25% | 15% | 35% | 23% | 2% |
| Custodial | 0% | 1% | 96% | 3% | 0% |
| Pavement/Grounds | 25% | 20% | 16% | 29% | 10% |
| Landscaping | 5% | 10% | 30% | 55% | 0% |
| Painting | 10% | 18% | 38% | 30% | 4% |
| Water Quality Control | 0% | 40% | 53% | 2% | 5% |
| Carpentry | 1% | 30% | 50% | 19% | 0% |
| Mechanical | 5% | 5% | 70% | 5% | 15% |
| Terminal Maintenance | 0% | 0% | 100% | 0% | 0% |

Table 2 (concluded)

ALLOCATION OF ADMINISTRATIVE, OPERATING, AND MAINTENANCE EXPENSES
San Francisco International Airport

| | Airfield Area | Airport Support Area | Terminal Area | Groundside Area | Utilities Area |
|------------------------------------|------------------|----------------------------|------------------|--------------------|-------------------|
| UTILITIES MAINTENANCE | | | | | |
| Environmental Control | 8% | 29% | 29% | 2% | 32% |
| Steamfitting | 0% | 25% | 50% | 5% | 20% |
| Plumbing | 5% | 10% | 50% | 20% | 15% |
| Electrical | 10% | 10% | 40% | 34% | 6% |
| Sheet Metal Shop | 0% | 20% | 50% | 7% | 23% |
| ADMINISTRATION | | | | | |
| Office of the Director | | | | | |
| Director's Office | 15% | 10% | 45% | 25% | 5% |
| International Aviation Development | 0% | 50% | 50% | 0% | 0% |
| Safety Program | 5% | 10% | 52% | 20% | 13% |
| Exhibition Operations | 0% | 0% | 100% | 0% | 0% |
| Legal Expenses Program | 10% | 20% | 50% | 15% | 5% |
| Secretary to Commission | 10% | 10% | 45% | 30% | 5% |
| Community Affairs | 20% | 15% | 40% | 20% | 5% |
| Bureau of Legislative Affairs | 15% | 10% | 45% | 25% | 5% |
| Communications & Marketing | 10% | 10% | 50% | 29% | 1% |
| Minority Business Outreach | 5% | 25% | 59% | 10% | 1% |
| Business Division | 5% | 15% | 50% | 25% | 5% |
| Finance Division | 10% | 10% | 50% | 25% | 5% |
| Administration Division | 0% | 10% | 80% | 10% | 0% |
| Human Resources | 5% | 5% | 65% | 20% | 5% |
| Employment Development | 10% | 20% | 40% | 25% | 5% |
| Medical Clinic | 10% | 10% | 50% | 25% | 5% |
| Garage | 0% | 15% | 0% | 83% | 2% |
| OTHER COSTS | | | | | |
| Health Service Subsidy | 15% | 5% | 50% | 26% | 4% |
| Negotiated Labor Increases | 5% | 10% | 45% | 25% | 15% |
| Water | 0% | 0% | 0% | 0% | 100% |
| Taxes | 14% | 7% | 47% | 25% | 7% |
| Rental of Property | 0% | 100% | 0% | 0% | 0% |
| Light, Heat, Power | 0% | 0% | 0% | 0% | 100% |

Annual Service Payment

The Annual Service Payment (the ASP) is allocated 100% to the Terminal Area Cost Center.

Prior Years Deficits (Surpluses)

The deficits (surpluses) of prior years are allocated between the Terminal Area and the Airfield Area in proportion to the amount of Terminal Area Rentals and Landing Fees, respectively, to total Airline Rate and Charges.

Non-Airline Revenues

Non-Airline Revenues are budgeted and tracked within FAMIS by sub-object code. For the most part, each sub-object code of Non-Airline Revenue is 100% allocable to one of the five Cost Centers. Periodically, sub-object codes are updated as necessary to account for changes in "revenue" sources. Table 4 lists all Non-Airline Revenues by Cost Center and by sub-object. The following Non-Airline Revenues require allocation to the Airport Cost Centers:

- Interest income – Interest income attributable to the Airport Revenue Fund is allocated by Cost Center based on the allocation of AO&M expenses. Loan payments from other parties, if any, is allocable to one or more Cost Centers based on considerations deemed appropriate by the City. Interest income on the Debt Service Fund, the Debt Service Reserve Fund, and the Contingency Fund are allocated by Cost Center based on the allocation of Debt Service Requirements by Cost Center.
- PFC revenues designated as Revenues – PFC revenues are allocated by Cost Center based on the approved projects. The Cost Center allocation each year will depend on how much PFC revenue is designated as Revenues for such Fiscal Year the amount being applied to Airline Rates and Charges for each approved project.

Reallocation of Utilities Area

The net expenses (revenues) of the Utilities Area are reallocated to the other Cost Centers. The reallocation of the Utilities Area is reviewed periodically and is based on the estimated usage (benefit derived) by each of the other Cost Centers. In the FY 2009 Airline Rates and Charges, the Utilities Area net expense was reallocated, as follows:

| Direct Cost Centers | Allocation percentage |
|----------------------|-----------------------|
| Airfield Area | 8% |
| Airport Support Area | 8 |
| Terminal Area | 69 |
| Groundside Area | <u>16</u> |
| Total | 100% |

Table 4

SUMMARY OF NON-AIRLINE REVENUES BY SUB-OBJECT CODE
San Francisco International Airport

| AIRFIELD | |
|-----------------------------|--------------------------------------|
| 67121 | ITINERANT AIRCRAFT LANDING FEES |
| 67131 | FBO/GENERAL AVIATION LANDING FEES |
| 67161 | NON SIGNATORY LANDING FEE PREMIUM |
| AIRPORT SUPPORT AREA | |
| 67215 | CUSTOMS CARGO FACILITY FEE |
| 67311 | RENTAL-AIRLINE CARGO SPACE |
| 67321 | RENTAL-AIRLINE GROUND LEASES |
| 67329 | RENTAL-AIRLINE OTHERS |
| 67411 | RENTAL-AIRCRAFT PARKING |
| 67421 | RENTAL-AIRLINE, SUPERBAY HANGAR |
| 67511 | AIRLINE SUPPORT SERVICES |
| 67611 | RENTAL TANK FARM AREA |
| 67651 | FBO SERVICES |
| 67711 | PARKING – EMPLOYEES |
| 77111 | COMMISSION-COGENERATION FACILITY-UAL |
| 77511 | MEDICAL SERVICES |
| 77911 | LICENSES & PERMITS |
| 77921 | COLLECTION CHARGES |
| 77951 | RENT-GOVERNMENTAL AGENCY |
| 77999 | MISC AIRPORT REVENUE |
| TERMINAL AREA | |
| 37211 | RENTAL-INTL TERMINAL(NON-AIRLINE) |
| 37212 | RENTAL-CENTRAL TERMINAL(NON-AIRLINE) |
| 37213 | RENTAL-NORTH TERMINAL(NON-AIRLINE) |
| 37214 | RENTAL-SOUTH TERMINAL(NON-AIRLINE) |
| 37216 | RENTAL-NON-AIRLINE, ITB |
| 37421 | CONCESSION REV-TELEPHONE |

Table 4 (concluded)

SUMMARY OF NON-AIRLINE REVENUES BY SUB-OBJECT CODE
San Francisco International Airport

| TERMINAL AREA (Continued) | |
|----------------------------------|--|
| 37441 | CONCESSIONS-ADVERTISING |
| 37499 | CONCESSION OTHERS |
| 37501 | CONCESSION-OTHERS-ITB |
| 37511 | CONCESSION REV-DUTY FREE IN BOND |
| 37512 | CONCESSION REV-DUTY FREE IN BOND-ITB |
| 37521 | CONCESSION REV-GIFTS & MERCHANDISE |
| 37522 | CONCESSION REV-GIFTS & MERCHANDISE-ITB |
| 37611 | CONCESSION REV-CAR RENTAL |
| 37711 | CONCESSION REV-FOOD & BEVERAGE |
| 37712 | CONCESSION REV-FOOD & BEVERAGE-ITB |
| 67141 | JET BRIDGE FEES |
| 77411 | SECURITY SERVICES |
| 77421 | TSA (TRANSP SECURITY ADMIN) RECOVERY FEE |
| 77931 | REFUSE DISPOSAL |
| 77932 | REFUSE DISPOSAL-ITB |
| 77933 | MISCELLANEOUS TERMINAL FEES |
| 77942 | REIMBURSEMENT FROM SFOTEC |
| GROUND SIDE AREA | |
| 25150 | AIRPORT TRAFFIC FINES |
| 25920 | PENALTIES |
| 35271 | SFIA-PARKING(GARAGE, LOTS & PERMITS) |
| 37217 | RENTAL-BART |
| 37219 | RENTAL-OTHER BUILDINGS(NON-AIRLINE) |
| 37311 | RENTAL-UNIMPROVD AREA(NON-AIRLINE) |
| 37321 | RENTAL CAR FACILITY FEE |
| 37411 | CONCESSION REV-GROUND SIDE |
| 37621 | OFF AIRPORT PRIVILEGE FEE |
| 37911 | TAXICABS |
| 37921 | GROUND TRANS TRIP FEES |
| 38011 | AIRPORT HOTEL LEASE |
| 38111 | SERVICE STATION |
| 67521 | TRANSPORTATION AND FACILITIES FEES |
| 77941 | REIMBURSEMENT OF TAXES |

CALCULATION OF AIRLINE RATES AND CHARGES

Terminal Area Rental Rate(s) and Landing Fee Rates are calculated pursuant to Section 502 and Section 503, respectively, using the budgetary forecast of expenses and Non-Airline Revenues allocated to Cost Centers as previously described.

ILLUSTRATION OF THE AIRLINE RATES AND CHARGES CALCULATION

The calculation of Terminal Area Rental Rate(s) and Landing Fee Rate(s) are illustrated below through Figure 1, descriptive narrative of procedures using some additional terms that are unique to this description (and designated by quotes), and a series tables using data for Fiscal Year 2009.

Figure 1 illustrates the basic flow of allocated Expenses and Non-Airline Revenues through the Airline Rates and Charges calculations.

Under the terms of the Agreement, the Signatory Airlines will be obligated to pay Terminal Area Rentals and Landing Fees in amounts that, when included with all Non-Airline Revenues, will be sufficient to cover all annual Airport Expenses. This type of calculation is sometimes referred to as a residual calculation because the Signatory Airlines are required to pay for the remaining amount of expenses not recovered from Non-Airline Revenues. The Agreement also provides that surpluses or deficits are to be carried forward in the calculation of Airline Rates and Charges in subsequent years.

Terminal Area Rentals. Terminal Area Rentals are derived by combining (1) the annual budgeted "Basic Rentals" and (2) the Terminal Area's share of either the estimated Rental Surcharge or the "Basic Rental Adjustment."

"Adjusted Terminal Area Expenses," the basis for calculating "Basic Rentals," are derived by combining the following:

1. Allocating budgeted Airport expenses by Cost Center to derive the total amount of budgeted Terminal Area Expenses,
2. Adding the amount of the Annual Service Payment, and
3. Adding or subtracting any prior period deficit or surplus in Airline Rates and Charges available for application in the ensuing Fiscal Year.

In computing "Basic Rentals", total budgeted Terminal Area Expenses, as calculated above, are divided by the Gross Terminal Space to compute a "Basic Rate" per square foot. This "Basic Rate" is then multiplied by Airline Leased Space to derive the total amount of rentals payable by the Signatory Airlines, referred to as "Basic Rentals."

The Rental Surcharge (or the Basic Rental Adjustment) is computed by:

1. Multiplying the "Basic Rate" times the Public Space to derive the cost of Public Space,
2. Subtracting the budgeted amount of Terminal Area revenues from sources other than "Basic Rentals" and,
3. Further adding net expenses in the Groundside Area. (Net revenues from this cost center are applied to the Landing Fees calculation.)

If the cost of the items above exceeds the revenues, then a Rental Surcharge will result. One-half of this Rental Surcharge will be recoverable through Terminal Area Rentals as a Terminal Area Rental Surcharge and one-half will be recoverable through Landing Fees as a "Landing Fee Surcharge."

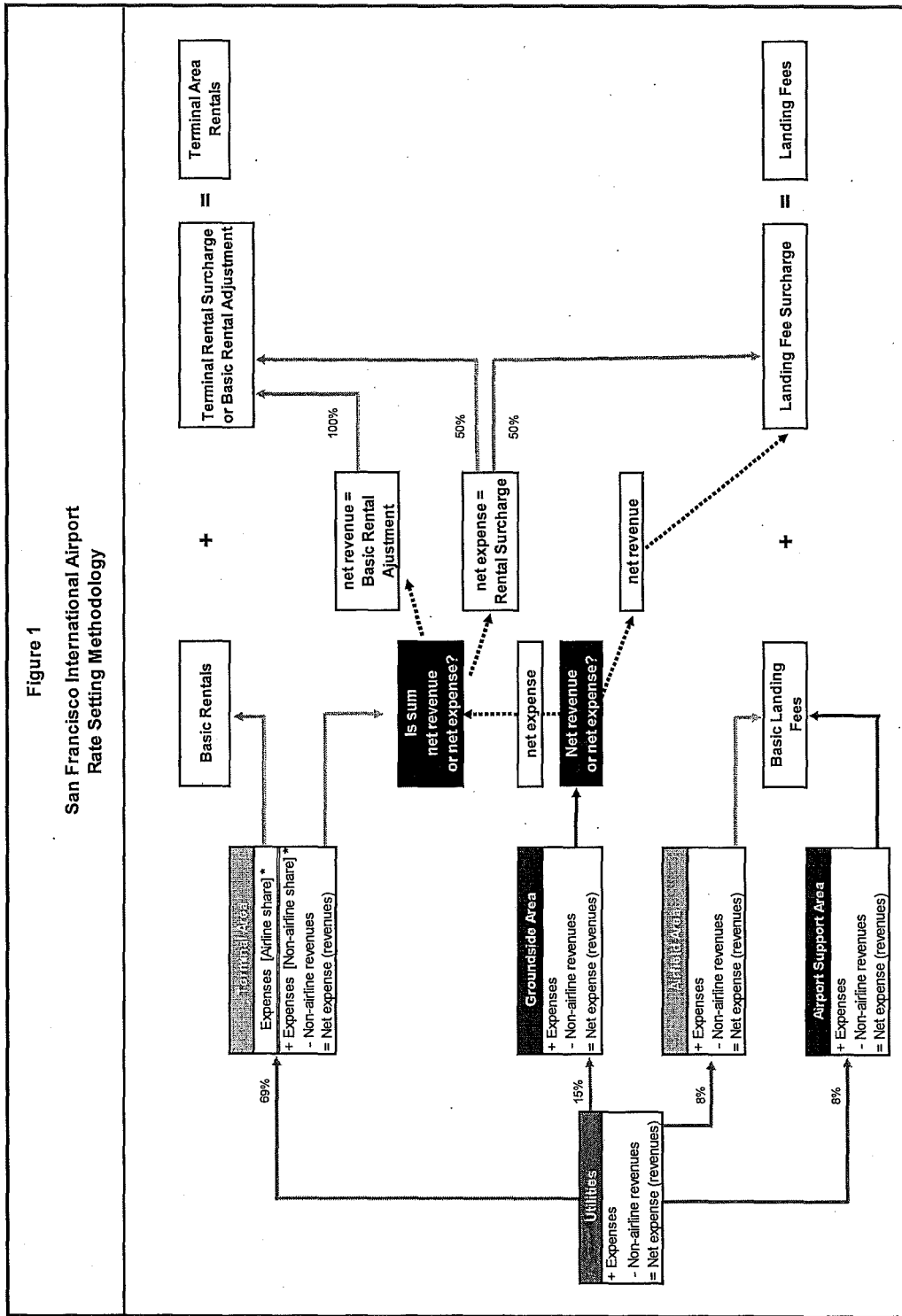

* Terminal Area Expenses are used to derive both the Basic Rentals and the Rental Surcharge (or Basic Rental Adjustment) based on the distribution of Gross Terminal Space between Airline Leased Space and Public Space, respectively.

If the revenues of the items above exceed the cost, then a “Basic Rental Adjustment” will result. All of the Basic Rental Adjustment will be used to reduce the “Basic Rentals” of the Terminal Area.

The resulting Terminal Area Rentals will be converted to Terminal Rental Rate(s) for each Space Category as described below and as illustrated on Exhibit F-2 of this Exhibit.

1. Classify all Airline Leased Space by the five (5) Space Categories of space defined in Section 502(D) of the Agreement;
2. Multiply the total square footage of each Space Category of Airline Leased Space by the relative value of each Space Category to determine the weighted equivalent square footage;
3. Sum the weighted equivalent square footage for each Space Category of Airline Leased Space to determine total weighted equivalent square footage;
4. Divide the Terminal Area Rentals by the total weighted equivalent square footage to establish the “Category I” Terminal Area Rental Rate; and
5. Multiply the “Category I” Terminal Area Rental Rate by the relative value for Categories II, III, IV and V to determine the Terminal Area Rental Rates for each of the remaining Space Categories.

Landing Fees. Landing Fees are derived by combining “Basic Landing Fees” and the “Landing Fee Surcharge.” “Basic Landing Fees” are derived, as follows:

1. Allocating budgeted Airport expenses by Cost Center to derive the total amount of budgeted Airfield Area expenses,
2. Subtracting the budgeted amount of Non-Airline Revenues from the Airfield Area,
3. Subtracting (adding) the budgeted residual amount of Non-Airline Revenues over Expenses from the Airport Support Area, and
4. Adding or subtracting an amount of prior period deficit or surplus, respectively, available for application in the calculation.

The resultant amount is referred to as the budgeted Airfield Area Net Expense. The Airfield Area Net Expense is then divided by the forecast Signatory Airline landed weight in 1,000 pound-units to derive the “Basic Rate.”

The “Landing Fee Surcharge,” which is equal to one-half of the Rental Surcharge, if any, offset by any net revenues from the Groundside Area, will also be divided by the forecast Signatory Airline landed weight in 1,000 pound-units to derive the “Surcharge Rate.” The “Basic Rate” plus the “Surcharge Rate” becomes the effective Landing Fee Rate payable for the ensuing Fiscal Year. The calculation of the Landing Fee Rate is shown on Exhibit G of this Exhibit.

The following pages provide an illustrative presentation of the calculation of Airline Rates and Charges using FY 2009 data for the purpose of the illustration.

Exhibit A

SUMMARY OF OPERATING BUDGET AND COST CENTER ALLOCATIONS (a)
BY FUNCTIONAL ACTIVITY
SAN FRANCISCO INTERNATIONAL AIRPORT
Fiscal Year 2008/09
 (in thousands)

| | COST CENTERS | | | | | |
|---|--|--------------------------|-------------------------------------|--------------------------|----------------------------|---------------------------|
| | Proposed budget FY 2009 | Airfield Area | Airport Support Area | Terminal Area | Groundside Area | Utilities Area |
| Administrative, Operating, & Maintenance (A, O & M) Expense Allocation (b) | | | | | | |
| Operations | \$ 92,178 | \$ 16,192 | \$ 6,994 | \$ 39,409 | \$ 29,532 | \$ 51 |
| Planning, Design and Construction | 16,966 | 404 | 848 | 1,838 | 13,814 | 62 |
| Technical Services and Maintenance | 6,625 | 403 | 896 | 2,995 | 1,417 | 914 |
| Building, Grounds, and Vehicle Maintenance | 65,659 | 3,598 | 5,964 | 46,862 | 6,993 | 2,242 |
| Utilities Systems Maintenance | 16,722 | 1,104 | 2,187 | 7,404 | 4,023 | 2,004 |
| Administration | 89,992 | 3,595 | 10,800 | 47,074 | 26,468 | 2,055 |
| Utilities and Other Costs | 42,798 | 91 | 6,362 | 305 | 162 | 35,877 |
| Facilities Maintenance (c) | 7,000 | 829 | 1,555 | 2,586 | 100 | 1,930 |
| Total A, O, & M Expenses | \$ 337,940 | \$ 26,216.50 | \$ 35,607 | \$ 148,473 | \$ 82,509 | \$ 45,136 |
| Equipment (d) | 2,884 | 487 | 389 | 1,388 | 556 | 64 |
| Total A, O, & M Expenses and Equipment | \$ 340,824 | \$ 26,704 | \$ 35,996 | \$ 149,861 | \$ 83,065 | \$ 45,200 |

- (a) Includes all budgetary categories of expenditures except Capital Projects, Debt Service, and the Annual Service Payments.
 (b) Exhibit A-2.
 (c) Exhibit A-3.
 (d) Exhibit A-4.

Exhibit A-1

SUMMARY OF BUDGET BY CATEGORY OF EXPENDITURE
SAN FRANCISCO INTERNATIONAL AIRPORT

| | Proposed Budget FY 2008/09 |
|---|----------------------------------|
| Administrative, Operating, & Maintenance (A, O & M) Expense Allocation | |
| Personnel Costs | \$ 132,976,178 |
| Contractual Services | 84,949,667 |
| Utilities | 32,733,394 |
| Materials and Supplies | 12,519,589 |
| Services of Other Departments (includes Police and Fire Direct Charge) | 67,762,113 |
| Facilities Maintenance | <u>7,000,000</u> |
| Total A,O, & M Expenses | \$ 337,940,941 |
| Equipment | <u>2,883,713</u> |
| Total "Operating Budget" | \$340,824,654 |
| Small Capital Outlays | 500,000 |
| Debt Service | 285,361,000 |
| Transfers to the City: | |
| Annual Service Payment | <u>25,933,000</u> |
| Total | <u>\$ 652,618,654</u> |

Exhibit A-2

DETAIL OF ADMINISTRATIVE, OPERATING, AND MAINTENANCE EXPENSES (a)
SAN FRANCISCO INTERNATIONAL AIRPORT

Fiscal Year 2008/09

(in thousands)

| | Allocation By Cost Center | | | | | | Total |
|--|---------------------------|------------------|----------------------------|------------------|--------------------|-------------------|------------------|
| | Budget 2009 | Airfield Area | Airport Support Area | Terminal Area | Groundside Area | Utilities Area | |
| OPERATIONS | | | | | | | |
| Office of the Deputy Director - Operations | \$ 673 | \$ 135 | \$ 67 | \$ 337 | \$ 134 | \$ - | \$ 673 |
| ARFF | 16,178 | 8,897 | 809 | 4,045 | 2,427 | - | 16,178 |
| Police | 38,278 | 766 | 3,828 | 24,881 | 8,803 | - | 38,278 |
| Airport Security | 2,637 | 264 | 396 | 1,581 | 396 | - | 2,637 |
| Operations Services | 5,101 | 3,723 | 663 | 511 | 153 | 51 | 5,101 |
| Airport Dispatch | 5,458 | 873 | 109 | 3,712 | 764 | - | 5,458 |
| License and Permit Bureau | 1,788 | 358 | 536 | 697 | 197 | - | 1,788 |
| Emergency Planning Services | 557 | 84 | - | 445 | 28 | - | 557 |
| Landside | 15,032 | - | 451 | - | 14,581 | - | 15,032 |
| BART | 269 | - | - | - | 269 | - | 269 |
| Ground Transportation | 1,276 | - | - | - | 1,276 | - | 1,276 |
| Airport Transit Booth | - | - | - | - | - | - | - |
| Transportation Systems Management | - | - | - | - | - | - | - |
| Terminal Management | 2,168 | 65 | 65 | 1,604 | 434 | - | 2,168 |
| Noise Monitoring | 1,368 | 957 | - | 411 | - | - | 1,368 |
| Aviation Security Systems | 1,395 | 70 | 70 | 1,185 | 70 | - | 1,395 |
| Total Operations | \$ 92,178 | \$ 16,192 | \$ 6,994 | \$ 39,409 | \$ 29,532 | \$ 51 | \$ 92,178 |
| PLANNING, DESIGN & CONSTRUCTION | | | | | | | |
| Bureau of Planning | \$ 4,036 | \$ 404 | \$ 807 | \$ 807 | \$ 2,018 | \$ - | \$ 4,036 |
| Design & Construction | 2,061 | - | 41 | 1,031 | 927 | 62 | 2,061 |
| Airport Train Operations | 10,869 | - | - | - | 10,869 | - | 10,869 |
| Total Planning, Design & Construction | \$ 16,966 | \$ 404 | \$ 848 | \$ 1,838 | \$ 13,814 | \$ 62 | \$ 16,966 |

Exhibit A-2 (Page 2 of 4)

DETAIL OF ADMINISTRATIVE, OPERATING, AND MAINTENANCE EXPENSES
 SAN FRANCISCO INTERNATIONAL AIRPORT
 Fiscal Year 2008/09
 (in thousands)

| | Allocation By Cost Center | | | | | | Total |
|--|---------------------------|-----------------|----------------------|------------------|-----------------|-----------------|------------------|
| | Budget 2009 | Airfield Area | Airport Support Area | Terminal Area | Groundside Area | Utilities Area | |
| TECHNICAL SERVICES & MAINTENANCE | | | | | | | |
| Office of the Deputy Director | 1,179 | 117 | 177 | 413 | 295 | 177 | 1,179 |
| Sign Shop | 573 | - | 86 | 229 | 258 | - | 573 |
| Scheduling and Control | 485 | 49 | 72 | 267 | 73 | 24 | 485 |
| Construction Support | 345 | 35 | 103 | 97 | 69 | 41 | 345 |
| Quality Control | 1,309 | 65 | 131 | 851 | 65 | 197 | 1,309 |
| Technical Services | 1,899 | 95 | 285 | 475 | 569 | 475 | 1,899 |
| Geographic Information System | - | - | - | - | - | - | - |
| Purchasing | 654 | 33 | 33 | 523 | 65 | - | 654 |
| Fuel | 5 | - | - | - | 5 | - | 5 |
| Office Supplies | 176 | 9 | 9 | 140 | 18 | - | 176 |
| Total Technical Services & Maintenance | \$ 6,625 | \$ 403 | \$ 896 | \$ 2,995 | \$ 1,417 | \$ 914 | \$ 6,625 |
| BUILDING, GROUNDS, & VEHICLE MAINTENANCE | | | | | | | |
| Maintenance Supervision | \$ 654 | \$ 131 | \$ 98 | \$ 196 | \$ 164 | \$ 65 | \$ 654 |
| Auto Shop | 3,501 | 875 | 526 | 1,225 | 805 | 70 | 3,501 |
| Custodial | 30,322 | - | 303 | 29,109 | 910 | - | 30,322 |
| Pavement/Grounds | 6,975 | 1,743 | 1,395 | 1,116 | 2,023 | 698 | 6,975 |
| Landscaping | 1,810 | 91 | 181 | 543 | 995 | - | 1,810 |
| Painting | 3,758 | 376 | 676 | 1,428 | 1,127 | 150 | 3,757 |
| Water Quality Control | 3,961 | - | 1,584 | 2,099 | 79 | 198 | 3,960 |
| Carpentry | 2,823 | 28 | 847 | 1,412 | 536 | - | 2,823 |
| Mechanical | 7,071 | 354 | 354 | 4,950 | 354 | 1,061 | 7,073 |
| Terminal Maintenance | 4,784 | - | - | 4,784 | - | - | 4,784 |
| Total Building, Grounds, & Vehicle Maint. | \$ 65,659 | \$ 3,598 | \$ 5,964 | \$ 46,862 | \$ 6,993 | \$ 2,242 | \$ 65,659 |

Exhibit A-2 (Page 3 of 4)

DETAIL OF ADMINISTRATIVE, OPERATING, AND MAINTENANCE EXPENSES
 SAN FRANCISCO INTERNATIONAL AIRPORT
 Fiscal Year 2008/09
 (in thousands)

| | Allocation By Cost Center | | | | | | |
|------------------------------------|---------------------------|------------------|----------------------------|------------------|--------------------|-------------------|-------------------|
| | Budget 2009 | Airfield Area | Airport Support Area | Terminal Area | Groundside Area | Utilities Area | Total |
| UTILITIES MAINTENANCE | | | | | | | |
| Environmental Control | \$ 293 | \$ 23 | \$ 85 | \$ 85 | \$ 6 | \$ 94 | \$ 293 |
| Steamfitting | 1,643 | - | 411 | 822 | 82 | 328 | 1,643 |
| Plumbing | 3,705 | 185 | 371 | 1,852 | 741 | 556 | 3,705 |
| Electrical | 8,955 | 896 | 895 | 3,582 | 3,045 | 537 | 8,955 |
| Sheet Metal Shop | 2,126 | - | 425 | 1,063 | 149 | 489 | 2,126 |
| Total Utilities Maintenance | \$ 16,722 | \$ 1,104 | \$ 2,187 | \$ 7,404 | \$ 4,023 | \$ 2,004 | \$ 16,722 |
| Total Direct Expenses | \$ 198,150 | \$ 21,701 | \$ 16,889 | \$ 98,508 | \$ 55,779 | \$ 5,273 | \$ 198,150 |
| ADMINISTRATION | | | | | | | |
| Office of the Director | | | | | | | |
| Director's Office | \$ 2,512 | \$ 377 | \$ 251 | \$ 1,130 | \$ 628 | \$ 126 | \$ 2,512 |
| International Aviation Department | - | - | - | - | - | - | - |
| Safety Program | - | - | - | - | - | - | - |
| Exhibition Operations | 2,834 | - | - | 2,834 | - | - | 2,834 |
| Legal Expenses Program | 5,610 | 561 | 1,122 | 2,805 | 841 | 281 | 5,610 |
| Secretary to Commission | 464 | 46 | 47 | 209 | 139 | 23 | 464 |
| Community Affairs | 415 | 83 | 62 | 166 | 83 | 21 | 415 |
| Bureau of Legislative Affairs | - | - | - | - | - | - | - |
| Communications & Marketing | 4,171 | 417 | 416 | 2,086 | 1,210 | 42 | 4,171 |
| Minority Business Outreach | 1,241 | 62 | 311 | 732 | 124 | 12 | 1,241 |
| Business Division | 7,288 | 364 | 1,094 | 3,644 | 1,822 | 364 | 7,288 |
| Finance Division | 15,921 | 1,592 | 1,592 | 7,961 | 3,980 | 796 | 15,921 |
| Administration Division | 31,421 | - | 3,142 | 25,137 | 3,142 | - | 31,421 |
| Human Resources | - | - | - | - | - | - | - |
| Employment Development | 926 | 93 | 185 | 370 | 232 | 46 | 926 |
| Medical Clinic | - | - | - | - | - | - | - |
| Garage | 17,189 | - | 2,578 | - | 14,267 | 344 | 17,189 |
| Total Administration | \$ 89,992 | \$ 3,595 | \$ 10,800 | \$ 47,074 | \$ 26,468 | \$ 2,055 | \$ 89,992 |

Exhibit A-2 (Page 4 of 4)

DETAIL OF ADMINISTRATIVE, OPERATING, AND MAINTENANCE EXPENSES
SAN FRANCISCO INTERNATIONAL AIRPORT
Fiscal Year 2008/09
 (in thousands)

| | Allocation By Cost Center | | | | | | |
|---|---------------------------|------------------|----------------------------|-------------------|--------------------|-------------------|-------------------|
| | Budget 2009 | Airfield Area | Airport Support Area | Terminal Area | Groundside Area | Utilities Area | Total |
| OTHER COSTS | | | | | | | |
| Health Service Subsidy | \$ - | \$ - | \$ - | \$ - | \$ - | \$ - | \$ - |
| Negotiated Labor Increases | - | - | - | - | - | - | - |
| Water | 3,099 | - | - | - | - | 3,099 | 3,099 |
| Taxes | 649 | 91 | 45 | 305 | 162 | 46 | 649 |
| Rental of Property | 6,317 | - | 6,317 | - | - | - | 6,317 |
| Light, Heat, Power | 32,733 | - | - | - | - | 32,733 | 32,733 |
| Total Other Costs | \$ 42,798 | \$ 91 | \$ 6,362 | \$ 305 | \$ 162 | \$ 35,878 | \$ 42,798 |
| Subtotal Administrative, Operating, & Maintenance Expense Allocation | \$ 330,940 | \$ 25,387 | \$ 34,051 | \$ 145,887 | \$ 82,409 | \$ 43,206 | \$ 330,940 |
| Facilities Maintenance | 7,000 | 829 | 1,555 | 2,586 | 100 | 1,930 | 7,000 |
| TOTAL Administrative, Operating, & Maintenance Expense | \$ 337,940 | \$ 26,216 | \$ 35,606 | \$ 148,473 | \$ 82,509 | \$ 45,136 | \$ 337,940 |

- (a) Programs that show zero were combined, consolidated, or eliminated.
 (b) Calculated based on Cost Center percentages shown on Exhibit A-5.

Exhibit A-3

DETAIL OF FACILITIES MAINTENANCE
SAN FRANCISCO INTERNATIONAL AIRPORT
Fiscal Year 2008/09
(in thousands)

| | Budget 2009 |
|--|----------------|
| Facilities Maintenance Projects | \$ 7,000 |
| Allocation by Cost Center | |
| Airfield Area | \$ 829 |
| Airport Support Area | 1,555 |
| Terminal Area | 2,586 |
| Groundside Area | 100 |
| Utilities | 1,930 |
| | \$ 7,000 |
| | \$ 7,000 |

Exhibit A-4

**DETAIL OF EQUIPMENT AND SMALL CAPITAL OUTLAYS
SAN FRANCISCO INTERNATIONAL AIRPORT
Fiscal Year 2008/09
(in thousands)**

| | Budget 2009 |
|----------------------------------|------------------------|
| Equipment | |
| Operations | \$ 344 |
| Maintenance | 1,948 |
| Utilities | - |
| Administration | 592 |
| | \$ 2,884 |
| Allocation by Cost Center | |
| Airfield Area | \$ 487 |
| Airport Support Area | 389 |
| Terminal Area | 1,388 |
| Groundside Area | 556 |
| Utilities | 64 |
| | \$ 2,884 |
| Small Capital Outlays | |
| Operations | \$ - |
| Maintenance | 500 |
| Utilities | - |
| Administration | - |
| | \$ 500 |
| Allocation by Cost Center | |
| Airfield Area | \$ - |
| Airport Support Area | - |
| Terminal Area | 500 |
| Groundside Area | - |
| Utilities | - |
| | \$ 500 |

Exhibit A-5

ALLOCATION OF ADMINISTRATIVE, OPERATING, AND MAINTENANCE EXPENSES
San Francisco International Airport

| | Airfield Area | Airport Support Area | Terminal Area | Groundside Area | Utilities Area |
|---|------------------|----------------------------|------------------|--------------------|-------------------|
| OPERATIONS | | | | | |
| Office of the Deputy Director | 20% | 10% | 50% | 20% | 0% |
| ARFF | 55% | 5% | 25% | 15% | 0% |
| Police | 2% | 10% | 65% | 23% | 0% |
| Airport Security | 10% | 15% | 60% | 15% | 0% |
| Operations Services | 73% | 13% | 10% | 3% | 1% |
| Airport Dispatch | 16% | 2% | 68% | 14% | 0% |
| License and Permit Bureau | 20% | 30% | 39% | 11% | 0% |
| Emergency Planning Services | 15% | 0% | 80% | 5% | 0% |
| Landside | 0% | 3% | 0% | 97% | 0% |
| BART | 0% | 0% | 0% | 100% | 0% |
| Ground Transportation | 0% | 0% | 0% | 100% | 0% |
| Airport Transit Booth | 0% | 0% | 50% | 50% | 0% |
| Transportation Systems Management | 0% | 0% | 0% | 100% | 0% |
| Terminal Management | 3% | 3% | 74% | 20% | 0% |
| Noise Monitoring | 70% | 0% | 30% | 0% | 0% |
| Aviation Security Systems | 5% | 5% | 85% | 5% | 0% |
| PLANNING, DESIGN & CONSTRUCTION | | | | | |
| Bureau of Planning | 10% | 20% | 20% | 50% | 0% |
| Design & Construction | 0% | 2% | 50% | 45% | 3% |
| Air Train Operations | 0% | 0% | 0% | 100% | 0% |
| TECHNICAL SERVICES & MAINTENANCE | | | | | |
| Office of the Deputy Director | 10% | 15% | 35% | 25% | 15% |
| Sign Shop | 0% | 15% | 40% | 45% | 0% |
| Scheduling and Control | 10% | 15% | 55% | 15% | 5% |
| Construction Support | 10% | 30% | 28% | 20% | 12% |
| Quality Control | 5% | 10% | 65% | 5% | 15% |
| Technical Services | 5% | 15% | 25% | 30% | 25% |
| Geographic Information System | 5% | 15% | 25% | 25% | 30% |
| Purchasing | 5% | 5% | 80% | 10% | 0% |
| Fuel | 1% | 0% | 1% | 98% | 0% |
| Office Supplies | 5% | 5% | 80% | 10% | 0% |
| BUILDING, GROUNDS, & VEHICLE MAINTENANCE | | | | | |
| Maintenance Supervision | 20% | 15% | 30% | 25% | 10% |
| Auto Shop | 25% | 15% | 35% | 23% | 2% |
| Custodial | 0% | 1% | 96% | 3% | 0% |
| Pavement/Grounds | 25% | 20% | 16% | 29% | 10% |
| Landscaping | 5% | 10% | 30% | 55% | 0% |
| Painting | 10% | 18% | 38% | 30% | 4% |
| Water Quality Control | 0% | 40% | 53% | 2% | 5% |
| Carpentry | 1% | 30% | 50% | 19% | 0% |
| Mechanical | 5% | 5% | 70% | 5% | 15% |
| Terminal Maintenance | 0% | 0% | 100% | 0% | 0% |

Exhibit A-5 (concluded)

ALLOCATION OF ADMINISTRATIVE, OPERATING, AND MAINTENANCE EXPENSES
San Francisco International Airport

| | Airfield Area | Airport Support Area | Terminal Area | Groundside Area | Utilities Area |
|------------------------------------|------------------|----------------------------|------------------|--------------------|-------------------|
| UTILITIES MAINTENANCE | | | | | |
| Environmental Control | 8% | 29% | 29% | 2% | 32% |
| Steamfitting | 0% | 25% | 50% | 5% | 20% |
| Plumbing | 5% | 10% | 50% | 20% | 15% |
| Electrical | 10% | 10% | 40% | 34% | 6% |
| Sheet Metal Shop | 0% | 20% | 50% | 7% | 23% |
| ADMINISTRATION | | | | | |
| Office of the Director | | | | | |
| Director's Office | 15% | 10% | 45% | 25% | 5% |
| International Aviation Development | 0% | 50% | 50% | 0% | 0% |
| Safety Program | 5% | 10% | 52% | 20% | 13% |
| Exhibition Operations | 0% | 0% | 100% | 0% | 0% |
| Legal Expenses Program | 10% | 20% | 50% | 15% | 5% |
| Secretary to Commission | 10% | 10% | 45% | 30% | 5% |
| Community Affairs | 20% | 15% | 40% | 20% | 5% |
| Bureau of Legislative Affairs | 15% | 10% | 45% | 25% | 5% |
| Communications & Marketing | 10% | 10% | 50% | 29% | 1% |
| Minority Business Outreach | 5% | 25% | 59% | 10% | 1% |
| Business Division | 5% | 15% | 50% | 25% | 5% |
| Finance Division | 10% | 10% | 50% | 25% | 5% |
| Administration Division | 0% | 10% | 80% | 10% | 0% |
| Human Resources | 5% | 5% | 65% | 20% | 5% |
| Employment Development | 10% | 20% | 40% | 25% | 5% |
| Medical Clinic | 10% | 10% | 50% | 25% | 5% |
| Garage | 0% | 15% | 0% | 83% | 2% |
| OTHER COSTS | | | | | |
| Health Service Subsidy | 15% | 5% | 50% | 26% | 4% |
| Negotiated Labor Increases | 5% | 10% | 45% | 25% | 15% |
| Water | 0% | 0% | 0% | 0% | 100% |
| Taxes | 14% | 7% | 47% | 25% | 7% |
| Rental of Property | 0% | 100% | 0% | 0% | 0% |
| Light, Heat, Power | 0% | 0% | 0% | 0% | 100% |

Exhibit B

**ANNUAL DEBT SERVICE REQUIREMENTS BY COST CENTER
SAN FRANCISCO INTERNATIONAL AIRPORT**

Fiscal Year 2008/09
(in thousands)

| | Budget 2009 |
|--|----------------|
| ANNUAL DEBT SERVICE - DEPOSIT BASIS | |
| Existing and refundings | |
| Issue 15 | \$ 16,202 |
| Issue 16 | 1,197 |
| Issue 17 | 511 |
| Issue 18 | 2,072 |
| Issue 19 | - |
| Issue 20 | 24,404 |
| Issue 21 | 4,865 |
| Issue 22 | 5,118 |
| Issue 23 | 13,821 |
| Issue 24 | 8,212 |
| Issue 25 | 8,399 |
| Issue 26 | 14,650 |
| Issue 27 | 33,729 |
| Issue 28 | 25,778 |
| Issue 29 | 15,120 |
| Issue 30 | 1,659 |
| Issue 31F | 10,125 |
| Issue 32F/G/H | 31,822 |
| Issue 34A/B | 7,142 |
| Issue 34C | 5,062 |
| Issue 34D | 4,216 |
| Issue 34E | 19,044 |
| Issue 34F | 832 |
| Issue 36 | 8,442 |
| Issue 37 | 16,662 |
| New Money | |
| Issue 2009 | 592 |
| | \$ 279,678 |
| Allocation by Cost Center | |
| Airfield Area | \$ 45,050 |
| Airport Support Area | 13,501 |
| Terminal Area | 117,469 |
| Groundside Area | 88,960 |
| Utilities | 14,698 |
| | \$ 279,678 |
| COMMERCIAL PAPER | |
| Interest Expense | \$ 5,683 |
| Allocation by Cost Center | |
| Airfield Area | \$ 215 |
| Airport Support Area | 364 |
| Terminal Area | 4,436 |
| Groundside Area | 268 |
| Utilities | 400 |
| | \$ 5,683 |
| Annual Debt Service | \$ 285,361 |

Exhibit C

**SUMMARY OF BUDGETED "NON-AIRLINE REVENUE"
BY COST CENTER
SAN FRANCISCO INTERNATIONAL AIRPORT
Fiscal Year 2008/09
(in thousands)**

| | Budget 2009 |
|--|------------------------|
| Airfield Area | |
| <hr/> | |
| General aviation & nonscheduled airline fees | \$ - |
| Interest income | 2,104 |
| PFC Revenues | 2,500 |
| | <hr/> |
| | \$ 4,604 |
| | |
| Airport Support Area | |
| <hr/> | |
| Ground Rentals | |
| Ground leases | \$ 15,743 |
| Other airline support | 16,441 |
| Airline cargo buildings | 13,045 |
| Superbay hangar | 6,386 |
| | <hr/> |
| | \$ 51,615 |
| | |
| Tank farm, SFO Fuel, LLC | 1,240 |
| Government agencies | 3,076 |
| Fuel/Energy commissions | 136 |
| Fixed base operator | 12,021 |
| Custom Fees - Cargo | 951 |
| Miscellaneous revenues | 841 |
| Interest income | 893 |
| | <hr/> |
| | \$ 70,773 |
| | |
| Terminal Area | |
| <hr/> | |
| Concession fees | |
| Gifts, merchandise, and services | \$ 26,864 |
| Car rentals | 30,684 |
| Food and beverage | 11,394 |
| Duty free, in-bond | 26,400 |
| | <hr/> |
| | \$ 95,342 |
| | |
| Other revenue | |
| Refuse collection | \$ 402 |
| Miscellaneous terminal fees | 1,205 |
| Nonairline space rentals | 1,062 |
| Security fees | 2,897 |
| Other airline fees | 472 |
| Custodial Reimbursement | 1,511 |
| Common use terminal equipment charges | - |
| Interest income | 6,308 |
| PFC Revenues | 48,500 |
| | <hr/> |
| | \$ 62,357 |
| | <hr/> |
| | \$ 157,699 |

Exhibit C (concluded)

**SUMMARY OF BUDGETED "NON-AIRLINE REVENUE"
BY COST CENTER
SAN FRANCISCO INTERNATIONAL AIRPORT
Fiscal Year 2008/09
(in thousands)**

| | Budget 2009 |
|---|-------------------------------|
| Groundside Area | |
| <hr/> | |
| Concession fees | |
| Auto parking - Public | \$ 62,539 |
| Taxi | 4,553 |
| Hotel | - |
| Other ground transportation | 6,155 |
| Off-Airport rental cars | 352 |
| | <hr/> |
| | \$ 73,599 |
| | |
| Ground and Building Rentals | \$ 2,366 |
| Rental car facility fees | 11,646 |
| Transportation and Facilities Fees (Rental car contract fees) | 25,974 |
| BART payments | 3,242 |
| Other revenue | |
| Reimbursement of taxes & grants | - |
| Traffic fines & forfeitures | 520 |
| Penalties & other | - |
| Interest income | 4,470 |
| | <hr/> |
| | \$ 48,218 |
| | <hr/> |
| | \$ 121,817 |
| | |
| Utilities Area | |
| <hr/> | |
| Electricity sales | \$ 16,454 |
| Water and sewer sales | 5,320 |
| Natural gas sales | 375 |
| Telecommunications access fee | 1,665 |
| Interest income | 1,031 |
| | <hr/> |
| | \$ 24,845 |
| | |
| Total "non-airline revenue" | <hr/> \$ 379,738 <hr/> |

EXHIBIT D

**CALCULATION OF THE ANNUAL SERVICE PAYMENT
SAN FRANCISCO INTERNATIONAL AIRPORT
Fiscal Years 2007/08 through 2008/09**

| | <u>Budget 2009</u> |
|---|------------------------|
| Terminal Area | |
| Concession fees (a) | |
| Gifts, merchandise, and services | \$ 26,864 |
| Car rentals | 30,684 |
| Food and beverage | 11,394 |
| Duty free, in-bond | 26,400 |
| Concession space rentals [a] | 1,062 |
| Terminal Area concession revenues | \$ 96,404 |
| Groundside Area | |
| Concession fees (a) | |
| Auto parking - Public | \$ 62,539 |
| Taxi | 4,553 |
| Hotel | - |
| Other ground transportation | 6,155 |
| Off-Airport rental cars | 352 |
| Ground and building rentals | 2,366 |
| Traffic fines and forfeitures | 520 |
| Groundside Area concession revenues | \$ 76,485 |
| Total concession revenues | \$ 172,889 |
| x 15% | 15% |
| Percentage based | \$ 25,933 |
| Minimum Payment | 5,000 |
| Total Annual Service Payment | |
| (greater of percentage based or minimum payment) | \$ 25,933 |

(a) Exhibit C.

(b) Terminal space rentals from concessions and passenger service firms.
Excludes rentals from government agencies.

Exhibit E

CALCULATION OF NET EXPENSE (REVENUE) BY COST CENTER
SAN FRANCISCO INTERNATIONAL AIRPORT

Fiscal Year 2008/09
(in thousands)

| | | COST CENTERS | | | | |
|---|-------------|------------------|----------------------------|------------------|--------------------|------------------|
| | | Airfield Area | Airport Support Area | Terminal Area | Groundside Area | Utilties Area |
| "Non-airline revenues" (a) | [A] | \$ 4,604 | \$ 70,773 | \$ 157,699 | \$ 121,817 | \$ 24,845 |
| Expenses | | | | | | |
| AO&M expenses (b) | | \$ 25,387 | \$ 34,051 | \$ 145,887 | \$ 82,409 | \$ 43,206 |
| Facilities Maintenance (b) | | 829 | 1,555 | 2,586 | 100 | 1,930 |
| Annual Debt Service (c0) | | | | | | |
| Revenue Bonds | | 45,050 | 13,501 | 117,469 | 88,960 | 14,698 |
| Commerical Paper | | 215 | 364 | 4,436 | 268 | 400 |
| Small Capital Outlays (d) | | - | - | 500 | - | - |
| Equipment (d) | | 487 | 389 | 1,388 | 556 | 64 |
| Annual Service Payment (e) | | | | 25,933 | | |
| | [B] | \$ 71,968 | \$ 49,860 | \$ 298,199 | \$ 172,293 | \$ 60,298 |
| <i>Utilties Area net expenses (revenue)</i> | [B - A] | | | | | \$ 35,453 |
| Reallocation of Utilties Area net expense (f) | [C] | 2,836 | 2,836 | 24,463 | 5,318 | (35,453) |
| | | 8% | 8% | 69% | 15% | |
| Total "expenses" | [B + C = D] | \$ 74,804 | \$ 52,696 | \$ 322,662 | \$ 177,611 | |
| Net expense (revenue) | [D - A] | \$ 70,200 | \$ (18,077) | \$ 164,963 | \$ 55,794 | |

EXHIBIT F

**CALCULATION OF TERMINAL AREA RENTALS
SAN FRANCISCO INTERNATIONAL AIRPORT
Fiscal Year 2008/09**

| | Exhibit Reference | Budget 2009 |
|---|----------------------|------------------------|
| Basic Rentals | | |
| Terminal Area Expenses | E | \$ 322,662 |
| Deficit (surplus) from prior fiscal years | | (11,340) |
| | | <u>\$ 311,322</u> |
| + Gross Terminal Space (square feet) | Schedule A-1 | <u>4,592</u> |
| = Basic Rate (per square foot) | | \$67.79 |
| x Airline Leased Space (square feet) | Schedule A-2 | <u>1,690</u> |
| Basic Rentals | | \$ 114,565 |
| Terminal Area Rental Surcharge | F-1 | <u>47,426</u> |
| Terminal Areal Rentals | | <u>\$ 161,991</u> |
| + Airline Leased Space (square feet) | | <u>1,690</u> |
| Effective average rental rate | | \$ 95.85 |

EXHIBIT F-1

**CALCULATION OF RENTAL SURCHARGE
(BASIC RENTAL ADJUSTMENT)
SAN FRANCISCO INTERNATIONAL AIRPORT
Fiscal Year 2008/09**

| | <u>Exhibit Reference</u> | Budget 2009 |
|---|------------------------------|------------------------|
| Rental Surcharge (Basic Rental Adjustment) | | |
| Basic Rate | | \$67.79 |
| x Public Space (square feet) | Schedule A-1 | <u>2,902</u> |
| = cost of Public Space | | \$ 196,757 |
| - "Non-airline" Terminal Area revenues | C | (157,699) |
| - Surplus (deficit) in Groundside Area cost center | E | <u>55,794</u> |
| = Amount of Rental Surcharge (Basic Rental Adjustment) | | \$ 94,852 |
| Allocation of Rental Surcharge (Basic Rental Adjustment) | | |
| Terminal Area Rental Surcharge | | \$ 47,426 |
| Landing Fee Surcharge | | <u>47,426</u> |
| | | \$ 94,852 |

EXHIBIT F-2

**DERIVATION OF REQUIRED TERMINAL RENTAL RATES
SAN FRANCISCO INTERNATIONAL AIRPORT
Fiscal Year 2008/09**

| | | |
|--|----------|------------------------|
| | | Budget 2009 |
| Airline Leased Space (square feet) (a) | | |
| Category I | | 288 |
| Category II | | 573 |
| Category III | | 195 |
| Category IV | | 595 |
| Category V | | 39 |
| | | <hr/> |
| | | 1,690 |
| | Relative | |
| | Value | |
| Equivalent Category I Space(square feet) | | |
| Category I | 1.00 | 288 |
| Category II | 0.75 | 430 |
| Category III | 0.50 | 98 |
| Category IV | 0.25 | 149 |
| Category V | 0.10 | 4 |
| | | <hr/> |
| | | 968 |
| Required Category I | | |
| Terminal Area Rentals (b) | | \$161,991 |
| Divided by Equivalent Category I space (square feet) | | <hr/> 968 |
| "Category I" Terminal Rental Rate | | \$167.32 |

| Terminal Rental Rates | Relative Value | |
|-----------------------|-------------------|----------|
| Category I | 1.00 | \$167.32 |
| Category II | 0.75 | 125.49 |
| Category III | 0.50 | 83.66 |
| Category IV | 0.25 | 41.83 |
| Category V | 0.10 | 16.73 |

- (a) Schedule A-2.
(b) Exhibit F.

EXHIBIT G

**CALCULATION OF LANDING FEES AND LANDING FEE RATE
SAN FRANCISCO INTERNATIONAL AIRPORT
Fiscal Year 2008/09**

| | Exhibit Reference | Budget 2009 |
|--|----------------------|-------------------|
| Basic Rate | | |
| Airfield Area Expenses | E | \$ 74,804 |
| Deficit (surplus) from prior fiscal years | | (6,660) |
| - Airfield area revenues from sources other than landing fees paid by the Scheduled Airlines | C | 4,604 |
| Airfield Area Net Expense | | <u>\$ 72,748</u> |
| Surplus(deficit) in Airport Support Area | E | <u>(18,077)</u> |
| = Basic Landing Fees | | \$ 54,671 |
| + Composite landed weight forecast (in 1,000 pound units) | Schedule B | <u>30,982</u> |
| = Basic Rate (per 1,000 lbs.) | | \$1.77 |
| Landing Fee Surcharge | F-1 | \$ 47,426 |
| + Composite landed weight forecast (in 1,000 pound units) | Schedule B | <u>30,982</u> |
| = Landing Fee Surcharge rate (per 1,000 lbs.) | | \$1.53 |
| Landing Fee Rate | | |
| Basic Rate | | \$1.77 |
| Surcharge Rate | | 1.53 |
| | | <u>\$ 3.30</u> |
| Landing Fees | | |
| Basic Landing Fees | | \$ 54,671 |
| Landing Fee Surcharge | | 47,426 |
| | | <u>\$ 102,097</u> |

Schedule A-1

**SUMMARY OF TERMINAL AREA SPACE
SAN FRANCISCO INTERNATIONAL AIRPORT
(SQUARE FEET)**

| |
|------------------------|
| Budget 2009 |
|------------------------|

Terminal 1

| | |
|------------------|----------------|
| Terminal 1 | 468,292 |
| Boarding Area A | - |
| Boarding Area B | 190,528 |
| Boarding Area C | 139,691 |
| Total Terminal 1 | <u>798,511</u> |

Terminal 2

| | |
|--------------------------|---------------|
| Terminal 2 (Floors 1-2) | - |
| Terminal 2 (Floors 3-11) | 94,671 |
| Boarding Area D | - |
| Connectors | - |
| Total Terminal 2 | <u>94,671</u> |

Terminal 3

| | |
|------------------|------------------|
| Terminal 3 | 597,025 |
| Boarding Area E | 93,644 |
| Boarding Area F | 475,309 |
| Total Terminal 3 | <u>1,165,978</u> |

International Terminal

| | |
|------------------------------|------------------|
| International Terminal | 1,666,778 |
| Boarding Area A | 407,982 |
| Boarding Area G | 458,436 |
| Total International Terminal | <u>2,533,196</u> |

| | |
|----------------------------------|-------------------------|
| Gross Terminal Space | 4,592,356 |
| Less Airline Leased Space | <u>1,689,963</u> |

| | |
|---------------------|------------------|
| Public Space | 2,902,393 |
|---------------------|------------------|

Schedule A-2

**SUMMARY OF AIRLINE LEASED SPACE (Square Feet)
SAN FRANCISCO INTERNATIONAL AIRPORT
FY 2008/09**

| | CATEGORY[a] (SQUARE FEET) | | | | | TOTAL AREA |
|-------------------------------------|---------------------------|----------------|---------------|----------------|---------------|----------------|
| | I | II | III | IV | V | |
| TERMINAL 3 | | | | | | |
| Exclusive Use | | | | | | |
| Air Canada | - | 1,746 | - | - | - | 1,746 |
| American Airlines | 23,909 | 31,017 | 38,204 | 42,328 | - | 135,458 |
| United Airlines | 70,634 | 123,989 | 61,207 | 220,547 | 23,052 | 499,429 |
| Joint Use | - | - | - | - | - | - |
| Total Terminal 3 | 94,543 | 156,752 | 99,411 | 262,875 | 23,052 | 636,633 |
| INTERNATIONAL TERMINAL | | | | | | |
| Exclusive Use | | | | | | |
| Air China | - | 409 | 916 | - | - | 1,325 |
| Air France | - | 4,673 | 537 | 158 | - | 5,368 |
| Air New Zealand | - | 297 | - | - | - | 297 |
| Alitalia | - | 1,285 | - | - | - | 1,285 |
| All Nippon | - | 1,777 | - | - | - | 1,777 |
| Asiana Airlines | - | 1,789 | - | - | - | 1,789 |
| British Airways | - | 10,768 | 1,236 | - | - | 12,004 |
| Cathay Pacific | - | 2,604 | 856 | - | - | 3,460 |
| China Airlines | - | 4,449 | 574 | - | - | 5,023 |
| EVA Airlines | - | 5,312 | 1,183 | - | - | 6,495 |
| Japan Airlines | - | 9,037 | 889 | - | - | 9,926 |
| Jet Airways | - | 829 | - | - | - | 829 |
| JetBlue | - | 744 | - | - | 100 | 844 |
| KLM | - | 607 | - | - | - | 607 |
| Korean Airlines | - | 1,534 | 421 | - | - | 1,955 |
| LACSA | - | 1,317 | - | - | - | 1,317 |
| Lufthansa German Airlines | - | 5,678 | 1,023 | - | - | 6,701 |
| Mexicana Airlines | - | 2,205 | 1,158 | - | - | 3,363 |
| Northwest Airlines | - | 7,441 | 1,311 | - | - | 8,752 |
| Philippine Airlines | - | 4,192 | - | - | - | 4,192 |
| Ryan International Airlines | - | 683 | 337 | - | - | 1,020 |
| Singapore Airlines | - | 6,026 | 588 | - | - | 6,614 |
| United Airlines | - | 36,537 | 16,508 | 600 | - | 53,645 |
| Virgin Atlantic Airways | - | 6,661 | 425 | - | - | 7,086 |
| Virgin USA | - | 2,578 | 310 | - | - | 2,888 |
| Joint Use | 137,603 | 227,164 | 14,255 | 273,523 | 1,888 | 654,433 |
| Total International Terminal | 137,603 | 346,596 | 42,527 | 274,281 | 1,988 | 802,995 |

Schedule A-2 (concluded)

**SUMMARY OF AIRLINE LEASED SPACE (Square Feet)
SAN FRANCISCO INTERNATIONAL AIRPORT
FY 2008/09**

| | CATEGORY[a] (SQUARE FEET) | | | | | TOTAL AREA |
|-------------------------------|---------------------------|----------------|----------------|----------------|---------------|------------------|
| | I | II | III | IV | V | |
| TERMINAL 1 | | | | | | |
| Exclusive Use | | | | | | |
| Air Canada | | | | | | - |
| Alaska Airlines | 4,794 | 6,908 | 5,398 | 6,917 | 1,917 | 25,934 |
| America West Airlines | 11,748 | 7,298 | 4,121 | 5,728 | 7,178 | 36,073 |
| Continental Airlines | 9,116 | 16,730 | 13,846 | 11,107 | 4,949 | 55,748 |
| Delta Airlines | 13,228 | 20,051 | 17,304 | 12,221 | - | 62,804 |
| Frontier | 3,268 | 3,695 | - | 5,849 | - | 12,812 |
| Northwest Airlines | 6,753 | 5,443 | 5,720 | - | - | 17,916 |
| Southwest | 7,423 | 9,199 | 6,900 | 14,735 | - | 38,257 |
| Joint Use | - | - | - | 791 | - | 791 |
| Estimated adjusment | | | | | | |
| Total Terminal 1 | 56,330 | 69,324 | 53,289 | 57,348 | 14,044 | 250,335 |
| SUMMARY | | | | | | |
| Exclusive Use | | | | | | |
| Terminal 3 | 94,543 | 156,752 | 99,411 | 262,875 | 23,052 | 636,633 |
| International Terminal | - | 119,432 | 28,272 | 758 | 100 | 148,562 |
| Terminal 1 | 56,330 | 69,324 | 53,289 | 56,557 | 14,044 | 249,544 |
| Subtotal Exclusive Use | 150,873 | 345,508 | 180,972 | 320,190 | 37,196 | 1,034,739 |
| Joint Use | | | | | | |
| Terminal 3 | - | - | - | - | - | - |
| International Terminal | 137,603 | 227,164 | 14,255 | 273,523 | 1,888 | 654,433 |
| Terminal 1 | - | - | - | 791 | - | 791 |
| Subtotal Joint Use | 137,603 | 227,164 | 14,255 | 274,314 | 1,888 | 655,224 |
| Total All Terminals | 288,476 | 572,672 | 195,227 | 594,504 | 39,084 | 1,689,963 |

[a]Categories:

- I. Ticket counters, holdrooms, and service counters and kiosks.
- II. VIP clubs and lounges, baggage claim lobbies, baggage service offices, curbside check-in, and other enclosed space Departure Level and above.
- III. Other enclosed space Arrivals Level and below and non-public offices and other enclosed areas Arrivals Level and below.
- IV. Inbound/outbound baggage handling areas, baggage transfer areas, and equipment rooms.
- V. Other unenclosed space and covered area at ramp level.

Schedule B

AIRLINE TRAFFIC FORECAST
SAN FRANCISCO INTERNATIONAL AIRPORT
FOR FISCAL YEARS ENDING JUNE 30
(in thousands)

Budget
2009

| | |
|---|---------------|
| ENPLANED PASSENGERS ⁽¹⁾ | |
| DOMESTIC | 14,395 |
| INTERNATIONAL | 4,920 |
| TOTAL | 19,315 |

| | |
|---|---------------|
| COMPOSITE LANDED WEIGHT FORECAST | |
| DOMESTIC | 19,712 |
| INTERNATIONAL | 9,770 |
| CARGO | 1,500 |
| TOTAL | 30,982 |

⁽¹⁾ Combined Jacobs Consultancy and Airport Management forecast (February 2008).

EXHIBIT P
FORM OF ACTIVITY REPORT

San Francisco International Airport - Monthly Air Traffic Activity Report (MATAR)

| | |
|---------------|-------------------------|
| Month/Yr | |
| Air Carrier | Example Airlines |
| Operating for | Example Airlines |
| Category | [See Description Sheet] |
| Lease/Permit | [Lease/Permit No.] |

Revenue and Non-Revenue Passenger Data Summary

| Geographic Region | Passenger Category | Terminal 1 | | | International Terminal | | | Total |
|-------------------|--------------------|-----------------|----------------|------------------|------------------------|----------------|------------------|-------------|
| | | Boarding Area C | | | Boarding Area A | | | |
| | | Enplaned Count | Deplaned Count | In-Transit Count | Enplaned Count | Deplaned Count | In-Transit Count | Total Count |
| US Domestic | Revenue | | | | | | | |
| | Non-Revenue | | | | | | | |
| | Total | | | | | | | |
| Asia | Revenue | | | | | | | |
| | Non-Revenue | | | | | | | |
| | Total | | | | | | | |
| GRAND TOTAL | Revenue | | | | | | | |
| | Non-Revenue | | | | | | | |
| | Total | | | | | | | |

Cargo Data Summary

| Geographic Region | Type of Cargo | Pax Aircraft | | Freighter Aircraft | | Combi Aircraft | | Total | | |
|-------------------|---------------|---------------------|--------------------|---------------------|--------------------|---------------------|--------------------|---------------------|--------------------|--------------------|
| | | Enplaned (Outbound) | Deplaned (Inbound) | Enplaned (Outbound) | Deplaned (Inbound) | Enplaned (Outbound) | Deplaned (Inbound) | Enplaned (Outbound) | Deplaned (Inbound) | Total Weight (lbs) |
| | | Weight (lbs) | Weight (lbs) | Weight (lbs) | Weight (lbs) | Weight (lbs) | Weight (lbs) | Weight (lbs) | Weight (lbs) | Weight (lbs) |
| US Domestic | Mail | | | | | | | | | |
| | Express | | | | | | | | | |
| | Freight | | | | | | | | | |
| | Total | | | | | | | | | |
| Asia | Mail | | | | | | | | | |
| | Express | | | | | | | | | |
| | Freight | | | | | | | | | |
| | Total | | | | | | | | | |
| GRAND TOTAL | Mail | | | | | | | | | |
| | Express | | | | | | | | | |
| | Freight | | | | | | | | | |
| | Total | | | | | | | | | |

Revenue Landing Activity Summary

| | | | | | | | | | | |
|----------------------------------|--|---|---|---|---|---|---|---|---|-------|
| A/C Model | | | | | | | | | | |
| A/C Type | ▼ | ▼ | ▼ | ▼ | ▼ | ▼ | ▼ | ▼ | ▼ | ▼ |
| Max. Landing Wt. (lbs) | | | | | | | | | | |
| Geographic Region | No. of Landings by Corresponding A/C Model (above) | | | | | | | | | Total |
| US Domestic | | | | | | | | | | |
| Asia | | | | | | | | | | |
| GRAND TOTAL | | | | | | | | | | |
| Total Domestic Landing Wt. (lbs) | | | | | | | | | | |
| Total Int'l Landing Wt. (lbs) | | | | | | | | | | |
| GRAND TOTAL Landing Wt. (lbs) | | | | | | | | | | |

Non-Revenue Landings

Total

Completed by:
 Email
 Certified Correct
 (Name, Title, Telephone)

| |
|--|
| |
| |
| |

Jet Bridge Usage Activity (if required to report)

| Gate # | Usage | Total |
|--------|-------|-------|
| | | |
| | | |

SUBMIT REPORT BY THE 10TH OF EACH MONTH
 TO >>> MATAR@fivso.com

TELEPHONE >>> **650-821-2879**

EXHIBIT Q

FORM OF CAPITAL PROJECT REVIEW FORM

| SAN FRANCISCO INTERNATIONAL AIRPORT | | | | | | | |
|---|---|-------------------------|----------------------|----------------------|--|-----------------------------|------------------------|
| CAPITAL PROJECT REQUEST AND REVIEW FORM - FY2010/11 | | | | | | | |
| Project Title: [Project Title] | | Proj. Mgr: [PM Name] | | | | | |
| FAMIS No. | Select FAMIS Project | SFO Project No: | [Airport Project No] | Primary Contract No: | [Enter Primary Contract Number] | Phone No: | [Phone Number] |
| Division: | Select Division | Section: | [Enter Section] | Date: | [Enter Date] | Deputy Approval: | Select Deputy Director |
| PROJECT DESCRIPTION | | | | | | | |
| [Provide a brief paragraph describing the purpose of the project, location of the project, and the significance of the project's benefits relative to the Airport.] | | | | | | | |
| EVALUATION CRITERIA (to be completed by CPRC) | | | | | | PROJECT STATUS | |
| Project Rank: | | In Capital Plan? | | | | Yes | |
| Project Score: | | | | | | No | |
| | | | | | | Total Project Cost: | \$ - |
| | | | | | | Capital Plan Funded Amount: | \$ - |
| | | | | | | Unfunded Balance: | \$ - |
| BUSINESS CASE | | | | | | | |
| A. Project justification: | [Provide reasons why the Airport should undertake this project] | | | | | | |
| B. Consequences if project not done: | [Provide information about what will happen if the project is not undertaken] | | | | | | |
| C. Project alternatives: | [Provide workable alternatives that might be undertaken in lieu of the project] | | | | | | |
| D. Reason for increase in cost from current approval: | [Provide reasons why the project cost has increased] | | | | | | |
| G. Useful Life (Yrs): | [Estimate the useful life of the asset once it is completed and/or activated] | | | | | | |
| PROJECT EXPENDITURES | | | | | | | |
| Contract No. and Title | FY10/11 | FY11/12 | FY12/13 | FY13/14 | FY14/15 | YEARS 6-10 | TOTAL PROJECT COST |
| Contract No & Title | \$ - | \$ - | \$ - | \$ - | \$ - | \$ - | \$ - |
| Contract No & Title | \$ - | \$ - | \$ - | \$ - | \$ - | \$ - | \$ - |
| Contract No & Title | \$ - | \$ - | \$ - | \$ - | \$ - | \$ - | \$ - |
| Contract No & Title | \$ - | \$ - | \$ - | \$ - | \$ - | \$ - | \$ - |
| Contract No & Title | \$ - | \$ - | \$ - | \$ - | \$ - | \$ - | \$ - |
| Total Amount | \$ - | \$ - | \$ - | \$ - | \$ - | \$ - | \$ - |
| PROJECT SCHEDULE | | | | | | | |
| | Start | | Finish | | SOURCES OF FUNDS | | |
| | Estimated | Actual | Estimated | Actual | Bond Funds: | \$ - | |
| Planning & Design | [Month - Year] | [Month - Year] | [Month - Year] | [Month - Year] | Passenger Facility Charge (PFC) Funds: | \$ - | |
| Construction | [Month - Year] | [Month - Year] | [Month - Year] | [Month - Year] | Operating Funds (including FM): | \$ - | |
| Project In Service Date | [Month - Year] | [Month - Year] | [Month - Year] | [Month - Year] | Grant Funds: | \$ - | |
| | | | | | Other: | \$ - | |
| | | | | | Total: | \$ - | |
| USES OF FUNDS | | | | | | | |
| | Previously Budgeted | Requested Appropriation | Requested Yr 1-5 | Requested Yr 6-10 | Grand Total | | |
| External Costs | | | | | | | |
| 10 Construction | \$ - | \$ - | \$ - | \$ - | \$ - | | |
| 55 Professional Services | \$ - | \$ - | \$ - | \$ - | \$ - | | |
| Subtotal | \$ - | \$ - | \$ - | \$ - | \$ - | | |
| Internal Costs | | | | | | | |
| 11 Reprographics | \$ - | \$ - | \$ - | \$ - | \$ - | | |
| 15 Equipment | \$ - | \$ - | \$ - | \$ - | \$ - | | |
| 16 ITT | \$ - | \$ - | \$ - | \$ - | \$ - | | |
| 25 AE&I Design | \$ - | \$ - | \$ - | \$ - | \$ - | | |
| 35 AE&I Inspection | \$ - | \$ - | \$ - | \$ - | \$ - | | |
| 40 Maintenance | \$ - | \$ - | \$ - | \$ - | \$ - | | |
| 65 Interdepartmental Work Order | \$ - | \$ - | \$ - | \$ - | \$ - | | |
| 75 Airfield Escorts | \$ - | \$ - | \$ - | \$ - | \$ - | | |
| AE Art Enrichment | \$ - | \$ - | \$ - | \$ - | \$ - | | |
| OH Overhead | \$ - | \$ - | \$ - | \$ - | \$ - | | |
| Subtotal | \$ - | \$ - | \$ - | \$ - | \$ - | | |
| Total Project Cost | \$ - | \$ - | \$ - | \$ - | \$ - | | |
| CASH FLOW PROJECTIONS AND FISCAL IMPACT | | | | | | | |
| | FY 10/11 | FY 11/12 | FY 12/13 | FY 13/14 | FY 14/15 | Years 6-10 | TOTAL PROJECT COST |
| Cash Requirements (-) | \$ - | \$ - | \$ - | \$ - | \$ - | \$ - | \$ - |
| Grant Collections (+) | \$ - | \$ - | \$ - | \$ - | \$ - | \$ - | \$ - |
| Incr (-) or Decr (+) In O&M Costs | \$ - | \$ - | \$ - | \$ - | \$ - | \$ - | \$ - |
| Revenue Increase (+) | \$ - | \$ - | \$ - | \$ - | \$ - | \$ - | \$ - |
| Net Cash Flow | \$ - | \$ - | \$ - | \$ - | \$ - | \$ - | \$ - |
| Net Present Value | | | | | | | |

AIRPORT COMMISSION

CITY AND COUNTY OF SAN FRANCISCO

RESOLUTION NO. 17-0184

APPROVAL OF A 2011 LEASE AND USE AGREEMENT WITH AIR PACIFIC LIMITED DBA FIJI AIR FOR OPERATING RIGHTS AT SAN FRANCISCO INTERNATIONAL AIRPORT, AND DIRECTING THE COMMISSION SECRETARY TO FORWARD THE LEASE TO THE BOARD OF SUPERVISORS FOR APPROVAL

WHEREAS, Air Pacific Limited dba Fiji Air ("Fiji Air") conducts flight operations at San Francisco International Airport ("Airport") pursuant to Airline Operating and Space Permit No. 4504; and

WHEREAS, Fiji Air wishes to become a signatory airline at the Airport pursuant to a 2011 Lease and Use Agreement ("2011 Lease"), a lease comparable to the 2011 Leases previously approved for 52 other airlines; and

WHEREAS, as initially approved in March 2010, the 2011 Lease has a term of 10 years, expiring on June 30, 2021, and provides for terminal rent and landing fees in accordance with the Airport's Rates and Charges; and

WHEREAS, the Airport Commission of the City and County of San Francisco ("City") and Fiji Air now desires to enter into a 2011 Lease under the same terms and conditions, except that the term will be approximately three years and six months, with the exact term dependent upon full approval of the 2011 Lease by the City; and

WHEREAS, in order to facilitate the implementation of the 2011 Lease and the placement in service of new facilities, the Commission desires to authorize the Airport Director to enter into non-material modifications to the 2011 Lease, including changes to the demised premises not to exceed 10% of leased square footage, that the Airport Director determines, in consultation with the City Attorney, are in the best interests of the Commission, do not otherwise materially increase the obligations or liabilities of the Commission, are necessary or advisable to effectuate the purposes of the 2011 Lease or this Resolution, and are in compliance with all applicable laws, including City's Charter; now, therefore, be it

RESOLVED, that this Commission approves the 2011 Lease between Fiji Air and the City consistent with the terms of the attached memorandum, subject to Air India's compliance with Chapter 12B of the City's Administrative Code and other City contracting requirements or obtaining the appropriate waivers thereto, as applicable; and, be it further

RESOLVED, that this Commission authorizes the Airport Director to execute said 2011 Lease and to enter into any non-material modifications thereto, including changes to the demised premises of not to exceed 10% of leased square footage, as described above; and, be it further

RESOLVED, that the Commission Secretary is hereby directed to request Board of Supervisors' approval of said 2011 Lease with Air Pacific Limited dba Fiji Air pursuant to City Charter Section 9.118.

I hereby certify that the foregoing resolution was adopted by the Airport Commission

at its meeting of

≡ JUL 25 2017

Secretary



San Francisco International Airport

MEMORANDUM

July 25, 2017

TO: AIRPORT COMMISSION
Hon. Larry Mazzola, President
Hon. Linda S. Crayton, Vice President
Hon. Eleanor Johns
Hon. Richard J. Guggenheim
Hon. Peter A. Stern

FROM: Airport Director

SUBJECT: Approval of 2011 Lease and Use Agreements with Air India Limited and Air Pacific Limited dba Fiji Air

DIRECTOR'S RECOMMENDATION: APPROVE 2011 LEASE AND USE AGREEMENTS WITH AIR INDIA LIMITED AND AIR PACIFIC LIMITED DBA FIJI AIR AT SAN FRANCISCO INTERNATIONAL AIRPORT, AND DIRECT THE COMMISSION SECRETARY TO FORWARD THE LEASES TO THE BOARD OF SUPERVISORS FOR APPROVAL.

Executive Summary

Air India Limited ("Air India") and Air Pacific Limited dba Fiji Air ("Fiji Air") commenced operations at San Francisco International Airport ("SFO" or the "Airport") under Airline Operating and Space Permit Nos. 4488 and 4504, respectively. These airlines wish to become signatory airlines pursuant to a 2011 Lease and Use Agreement ("2011 Lease"). The 2011 Lease has a term of 10 years, which expires on June 30, 2021, continues the current residual rate-setting methodology for terminal rental rates and landing fees based on the Airport's Rates and Charges, and continues the Annual Service Payment to the City's General Fund. Staff now seeks approval of separate 2011 Leases with Air India and Fiji Air under the same terms, except that the length of the lease term will be approximately three years and six months commencing on the first day of the month following full City approval.

Background

Effective July 1, 2011, the Airport entered into the 2011 Lease with a majority of the airlines operating at the Airport, which will expire on June 30, 2021. Of the 61 airlines currently operating at the Airport, approximately 85% are signatories to the 2011 Lease (see Attachment A). The major business terms of the 2011 Lease are summarized on Attachment B.

THIS PRINT COVERS CALENDAR ITEM NO. 10

AIRPORT COMMISSION CITY AND COUNTY OF SAN FRANCISCO

| | | | | | | |
|-----------------------|----------------------------|------------------------------------|---------------|-----------------------|----------------|-----------------------------------|
| EDWIN M. LEE MAYOR | LARRY MAZZOLA PRESIDENT | LINDA S. CRAYTON VICE PRESIDENT | ELEANOR JOHNS | RICHARD J. GÜGGENHIME | PETER A. STERN | IVAR C. SATEO AIRPORT DIRECTOR |
|-----------------------|----------------------------|------------------------------------|---------------|-----------------------|----------------|-----------------------------------|

Proposal

The Airport continues to offer the 2011 Lease to airlines that wish to obtain signatory status at the Airport. Air India and Fiji Air have executed and returned the 2011 Lease containing the same terms and conditions as the 2011 Lease executed by other airlines, except that the term of these 2011 Leases will be approximately three years and six months, becoming effective on the first day of the month following full City approval and expiring on June 30, 2021.

Air India and Fiji Air do not rent any exclusive spaces but will use the International Terminal Joint Use Spaces and support facilities, as summarized on Attachment C. These spaces are subject to the Airport's Rates and Charges. Staff is now seeking Commission approval of separate 2011 Leases with Air India and Fiji Air, contingent upon approval of the Board of Supervisors.

Recommendation

I recommend that this Commission adopts the attached resolutions approving 2011 Leases with Air India and Fiji Air, and directing the Commission Secretary to request Board of Supervisors' approval of such 2011 Leases, in accordance with City Charter Section 9.118.

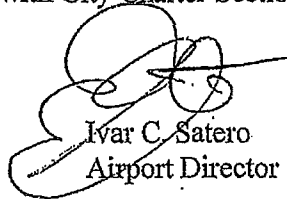

Ivar C. Satero
Airport Director

Prepared by: Leo Fermin
Chief Business and Finance Officer

Attachment

ATTACHMENT A

Signatories to the 2011 Lease and Use Agreements

| Airline | Lease No. | Airline | Lease No. |
|------------------------|-----------------------|---|-----------------------|
| ABX Air | L11-0005 | Japan Airlines | L10-0088 |
| Aer Lingus | L16-0298 | JetBlue Airways | L12-0027 |
| Air Berlin | L11-0006 | Kalitta Air | L10-0277 |
| Air Canada | L11-0007 | KLM Royal Dutch Airlines | L10-0089 |
| Air Cargo Carriers | L11-0008 | Korean Airlines | L10-0090 |
| Air China | L10-0075 | LAN Peru | L11-0012 |
| Air France | L10-0076 | Lufthansa German Airlines | L10-0091 |
| Air New Zealand | L11-0009 | Mexicana Airlines | L10-0092 ¹ |
| Alaska Airlines | L10-0274 | MN Airlines, LLC dba Sun Country Airlines | L12-0015 |
| All Nippon Airways | L10-0077 | Nippon Cargo Airlines | L10-0278 |
| American Airlines | L10-0078 | Philippine Airlines | L10-0093 |
| Ameriflight | L11-0010 | Qantas Airways | L15-0275 |
| Asiana Airlines | L10-0079 | Redding Aero Enterprises | L16-0326 |
| British Airways | L10-0080 | Scandinavian Airlines | L13-0066 |
| Cathay Pacific Airways | L10-0081 | Singapore Airlines | L10-0094 |
| China Airlines | L10-0082 | Southern Air | L10-0279 |
| China Eastern | L13-0065 | Southwest Airlines | L10-0095 |
| China Southern | L15-0253 | Swiss International Air Lines | L11-0182 |
| Continental Airlines | L10-0275 ² | TACA | L10-0096 |
| COPA Airlines | L10-0166 | Turkish Airlines | L16-0301 |
| Delta Air Lines | L10-0083 | United Airlines ³ | L10-0097 |
| Emirates | L10-0084 | U.S. Airways | L10-0276 ⁴ |
| EVA Airways | L10-0085 | Virgin America | L10-0098 |
| Federal Express | L10-0086 | Virgin Atlantic | L10-0099 |
| Frontier Airlines | L10-0087 | WestJet | L11-0239 |
| Hawaiian Airlines | L11-0011 | World Airways | L12-0014 |

¹ Obtained full City approval but Tenant did not consummate the Lease.

² Terminated pursuant to Airport Commission Resolution No. 14-0018 and Board of Supervisors Resolution No. 191-47 due to merger with United Air Lines, Inc.

³ Lease originally signed as United Air Lines. Merger with Continental Airlines resulted in new entity known as United Airlines, Inc.

⁴ Terminated pursuant to Airport Commission Resolution No. 15-0274 and Board of Supervisors Resolution No. 131-16 due to merger with American Airlines.

ATTACHMENT B

Basic Provisions of 2011 Lease & Use Agreement

The 2011 Lease continues many of the provisions of the 1981 Lease and Use Agreement and the 1999 Lease and Operating Agreement, with some important improvements and updates, as summarized below:

TERM

- Ten years, effective July 1, 2011 through June 30, 2021.
- Leases may be terminated by airlines upon certain extraordinary events, such as destruction of the leased space or closure of the Airport.

ANNUAL SERVICE PAYMENT

The 2011 Lease continues the Airport Commission's payment of the Annual Service Payment to the City's General Fund calculated at 15% of concession revenues.

TYPES OF SPACE

Space shall be leased in the following five categories:

| Type | Category |
|--|----------|
| Ticket Counters, Gate Holdrooms | I |
| Airline Ticket Office (ATO) | II |
| VIP Clubs and Lounges | II |
| Other Enclosed Space, Departure Level and above | II |
| Baggage Claim Lobbies | II |
| Baggage Service Offices | II |
| Curbside Check-in | II |
| Other Enclosed Space, Arrivals Level and below | III |
| Inbound/Outbound Baggage Handling Areas and Baggage Transfer Areas | IV |
| Equipment Rooms | IV |
| Unenclosed or Covered Area - Ramp Level | V |

A. Exclusive Use Space – International Terminal

- Each 2011 Lease may include Exclusive Use Space consisting of ATO, baggage service office, ramp operations office, administrative office, VIP clubroom, and/or other support space.

B. Exclusive Use Space – Domestic Terminals

- Each 2011 Lease may include Exclusive Use Space consisting of ticket counters, ATO, baggage service office, ramp operations office, administrative office, VIP clubroom, and/or other support space.

ATTACHMENT B

Basic Provisions of 2011 Lease & Use Agreement

- The 2011 Leases will no longer allow gate holdrooms to be leased on an exclusive use basis to airlines. All gate holdrooms in the domestic terminals will be used by airlines on a preferential or common use basis as further described below, thus allowing for the more efficient utilization of Airport resources and the accommodation of new entrants.

C. Joint Use Space

- Each 2011 Lease for space in the International Terminal will continue the current Joint Use structure for all airline-shared operational space, including ticket counters, holdrooms, baggage claim and FIS space, and baggage handling related areas.
- Scheduling of Joint Use Space in the International Terminal will continue to be managed by an airline consortium, in accordance with established protocols, with Airport oversight.
- Ticket counter check-in positions in the International Terminal assigned to each airline will be based on flight activity, in accordance with current Ticket Counter Management Protocols, and be managed by an airline consortium, with Airport oversight.
- Certain 2011 Leases may include a Joint Use structure for designated airline shared operational space in the Airport's Domestic Terminals.

D. Preferential Use Space – Domestic Terminals

- Domestic Terminal gate holdrooms will convert from Exclusive Use Space, under the prior leases, to a Preferential Use Gate system that will be leased to signatory airlines.
- Preferential Use Gates will be assigned annually to signatory airlines for domestic operations based upon their share of all scheduled seats in the previous month of August.
- The 2011 Lease allows the Airport to permit any airline to use a Preferential Use Gate when it is not actively being used by the signatory airline to which it is assigned, thus promoting the efficient utilization of Airport resources and the accommodation of new entrants.

E. Common-Use Gates – All Terminals

- The 2011 Lease will provide the Airport an annual opportunity to designate Common Use Gates for domestic operations in both the Domestic and International Terminals to maintain flexibility. In no event may the number of designated Common Use Gates in Domestic Terminals exceed 10% of the total number of Domestic Terminal gates.

SECURITY DEPOSIT

The 2011 Lease provides for a standardized security deposit requirement of two months of terminal rent and landing fees, instead of the security deposits under prior leases which vary from two to six months.

RENTALS AND FEES

All airlines will pay terminal rent based on square footage for Exclusive Use Space and Preferential Use Space, including ticket counters, gates and support facilities, as well as landing

ATTACHMENT B

Basic Provisions of 2011 Lease & Use Agreement

fees in accordance with the Airport's Rates and Charges, as adjusted from fiscal year to fiscal year.

Terminal rent for Joint Use Space will continue to be charged on the basis of the current Joint Use Formula, with 20% of the charges divided equally among all airlines using each Joint Use Space, and 80% of the charges allocated based on each airline's number of passengers compared to the total number of passengers of all airlines using the Joint Use Space facilities.

Terminal rent for Preferential Use Space will be charged on the basis of the average gate holdroom square footage in the respective boarding area.

Airlines will pay per-use fees for use of Common Use space, such as ticket counters, gates and support facilities. These fees will be reviewed annually in accordance with the Airport's Rates and Charges.

JANITORIAL RESPONSIBILITY

In order to ensure a consistent appearance and uniform level of cleanliness in all public areas, the Airport will assume janitorial responsibility in the Domestic Terminals for all areas in full public view, including gate holdrooms, baggage claim, and Common Use areas. Individual airlines will be relieved of carpet replacement costs in the gate holdrooms and baggage claim areas.

The Airport will continue to provide janitorial service in the International Terminal and cease the "special charge" to the airline consortium as of FY11/12. All costs related to these services will be included within the Airport's Rates and Charges.

NON-SIGNATORY AIRLINES

Any airline that does not sign the 2011 Lease will be considered a non-signatory airline and will be issued the appropriate Operating Permit and/or Space Permit, and be subject to the following impacts:

- A security deposit requirement equal to six months of terminal rental and landing fees.
- A 25% premium on Landing Fees. Non-signatory airlines that are "Affiliate Airlines" of signatory airlines, as defined in the 2011 Lease, will pay the same Landing Fees as signatory airlines.
- Charges for use of terminal space to support passenger operations will be applied in accordance with Common Use fees, as established in the Airport's Rates and Charges.
- Non-signatory airlines will not be eligible to lease Preferential Gates in Domestic Terminals but may be accommodated at such gates if not actively in use by the applicable signatory airline, if Common Use gates are not available.

ATTACHMENT C

Premises

**JOINT USE SPACE IN THE INTERNATIONAL TERMINAL
(in square feet)**

| | CATEGORIES OF RENT | | | | | TOTAL |
|------------------------|--------------------|---------|--------|---------|-------|---------|
| | I | II | III | IV | V | |
| International Terminal | 133,794 | 214,307 | 12,025 | 265,400 | 1,888 | 627,414 |



San Francisco International Airport

BOARD OF SUPERVISORS
SAN FRANCISCO

2017 SEP 28 PM 1:48

October 2, 2017

Ms. Angela Calvillo
Clerk of the Board
Board of Supervisors
City Hall
1 Dr. Carlton B. Goodlett Place, Room 244
San Francisco, CA 94102-4689

Subject: Approval of New Lease and Use Agreements between Various Airlines that Conduct Flight Operations at San Francisco International Airport, and the City and County of San Francisco, acting by and through its Airport Commission .

Dear Ms. Calvillo:

Pursuant to Section 9.118 of the City Charter, I am forwarding for the Board of Supervisors' approval two new 2011 Lease and Use Agreements (the "2011 Leases") between the City and County of San Francisco, acting by and through its Airport Commission, and 1) Air India Limited ("Air India"), and 2) Air Pacific Limited dba Fiji Airways ("Fiji Airways"), which grant operating rights for flight operations and terminal rental at San Francisco International Airport. The 2011 Leases shall be effective on the first day of the month following full City approval.

The Airport Commission approved the 2011 Leases by Resolution No. 17-0183 and Resolution No. 17-0184 for Air India and Fiji Airways, respectively. The term of these 2011 Leases is approximately three years and seven months, commencing on the first day of the month following full approval of the Board of Supervisors.

Following is a list of accompanying documents (three sets):

- Board of Supervisors Resolution for approval of a 2011 Lease with Air India;
- Board of Supervisors Resolution for approval of a 2011 Lease with Fiji Airways;
- Airport Commission Resolution No. 17-0183 approving a 2011 Lease with Air India;
- Airport Commission Resolution No. 17-0184 approving a 2011 Lease with Fiji Airways;
- Director's Memorandum accompanying Airport Commission Resolution Nos. 17-0183 and 17-0184;
- SFEC-126 (Board of Supervisors and Mayor's Office) for Air India;
- SFEC-126 (Board of Supervisors and Mayor's Office) for Fiji Airways;

AIRPORT COMMISSION CITY AND COUNTY OF SAN FRANCISCO

EDWIN M. LEE
MAYOR

LARRY MAZZOLA
PRESIDENT

LINDA S. CRAYTON
VICE PRESIDENT

ELEANOR JOHNS

RICHARD J. GUGGENHIME

PETER A. STERN

IVAR C. SATERO
AIRPORT DIRECTOR

October 2, 2017

- 2011 Lease and Use Agreement No. 17-0183 with Air India approved as to form by the City Attorney's Office; and
- 2011 Lease and Use Agreement No. 17-0184 with Fiji Airways approved as to form by the City Attorney's Office.

You may contact Dan Ravina of Airport Aviation Management at (650) 821-4525 regarding this matter.

Very truly yours,

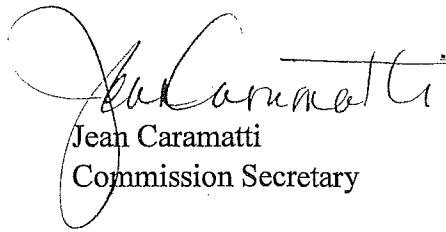

Jean Caramatti
Commission Secretary

Enclosures

cc: Dan Ravina, Aviation Management
Cathy Widener, Governmental Affairs

**FORM SFEC-126:
NOTIFICATION OF CONTRACT APPROVAL
(S.F. Campaign and Governmental Conduct Code § 1.126)**

| | |
|--|---|
| City Elective Officer Information <i>(Please print clearly.)</i> | |
| Name of City elective officer(s): Members, SF Board of Supervisors | City elective office(s) held: Members, SF Board of Supervisors |
| Contractor Information <i>(Please print clearly.)</i> | |
| Name of contractor: AIR PACIFIC LIMITED DBA FIJI AIRWAYS | |
| Please list the names of (1) members of the contractor's board of directors; (2) the contractor's chief executive officer, chief financial officer and chief operating officer; (3) any person who has an ownership of 20 percent or more in the contractor; (4) any subcontractor listed in the bid or contract; and (5) any political committee sponsored or controlled by the contractor. Use additional pages as necessary. <i>See Attachment A</i> | |
| Contractor address: 5777 W. Century Boulevard, Suite 1610, Los Angeles, CA 90045 | |
| Date that contract was approved: July 25, 2017 | Amount of contract: Per formula |
| Describe the nature of the contract that was approved: 2011 Lease approved by Airport Commission Resolution No. 17-0184 | |
| Comments: | |

This contract was approved by (check applicable):

- the City elective officer(s) identified on this form
- a board on which the City elective officer(s) serves San Francisco Board of Supervisors
Print Name of Board
- the board of a state agency (Health Authority, Housing Authority Commission, Industrial Development Authority Board, Parking Authority, Redevelopment Agency Commission, Relocation Appeals Board, Treasure Island Development Authority) on which an appointee of the City elective officer(s) identified on this form sits

Print Name of Board

| | |
|---|---|
| Filer Information <i>(Please print clearly.)</i> | |
| Name of filer: Angela Calvillo, Clerk of the Board | Contact telephone number: (415) 554-5184 |
| Address: City Hall, Room 244, 1 Dr. Carlton B. Goodlett Pl., San Francisco, CA 94102 | E-mail: Board.of.Supervisors@sfgov.org |

Signature of City Elective Officer (if submitted by City elective officer) Date Signed

Signature of Board Secretary or Clerk (if submitted by Board Secretary or Clerk) Date Signed

Attachment A to Form SFEC-126

Contractor Information (Please print clearly.)

Name of contractor:

AIR PACIFIC LIMITED DBA FIJI AIRWAYS

Please list the names of (1) members of the contractor's board of directors; (2) the contractor's chief executive officer, chief financial officer and chief operating officer; (3) any person who has an ownership of 20 percent or more in the contractor; (4) any subcontractor listed in the bid or contract; and (5) any political committee sponsored or controlled by the contractor. Use additional pages as necessary.

(1) Names of Directors:

- Rajesh Punja
- Sharvada Sharma
- Shaheen Ali
- Neil Palmer
- Andre Vilijoen

(2) Andre Vilijoen, MD/CEO

Nicholas Caine, CFO

No COO

(3) Person with an ownership of 20% or more in the Contractor:

- Government of Fiji = 51%
- Qantas Airways = 46.32%

(4) No subcontractor

(5) No political committees sponsored or controlled by the Contractor