



SFMTA
Municipal
Transportation
Agency

March 3, 2014

Karen Schkolnick, District Grant Programs Manager
Strategic Incentives Division
Bay Area Air Quality Management District
939 Ellis Street, San Francisco, CA 941 09

Subject: SFMTA Request for TFCA Regional Funding

Dear Ms. Schkolnick:

Enclosed please find the San Francisco Municipal Transportation Agency's (SFMTA) revised application for TFCA Regional funding for the Electronic Bicycle Lockers Program. We originally submitted our application on December 24, 2013 but are revising it to request more funding in line with the recent increase in the allowable amount.

The SFMTA confirms that the proposal submitted for the Electronic Bicycle Lockers Program will be carried out as described in the application. If our project is selected, we will provide the required matching funds to cover all costs in excess of the grant amount. We will also provide funds for the maintenance of the lockers for a minimum of 10 years.

If you have any questions, please call Joel Goldberg at (415) 701-4499 or email him at Joel.goldberg@sfmta.com.

Thank you for your consideration of the Municipal Transportation Agency's TFCA application.

Sincerely,

A handwritten signature in black ink, appearing to read "Sonali Bose", with a long horizontal line extending to the right.

Sonali Bose
Chief Financial Officer

Summary Information: Complete areas shaded in yellow below.

Date of Grant Application:	March 3, 2014
Legal Name of Applicant Organization:	San Francisco Municipal Transportation Agency
Mailing Address:	
Street Address	1 South Van Ness, 7th Fl
P.O. Box	
City	San Francisco
County	San Francisco
State	CA
Zip	94103
Primary Project Contact Info (serves as single point of contact for day-to-day communications):	
Name	Matt Lasky
Position / Title	Senior Planner
Email Address	Matt.lasky@sfmta.com
Phone Number	415.701.5228
Fax Number	
Person Authorized to Sign Application and Execute Grant Agreement:	
Name	Sonali Bose
Position / Title	Chief Financial Officer
Email Address	sonali.bose@sfmta.com
Phone Number	415.701.9999
Fax Number	
Person who Completed Application:	
Name	Matt Lasky
Position / Title	Senior Planner
Email Address	Matt.lasky@sfmta.com
Phone Number	415.701.5228
Fax Number	
Name of Project (may be modified by the Air District):	Electronic Bicycle Lockers
Total Project Cost:	
Amount of TFCA Regional Funding Requested:	\$ 70,000.00
How did you hear about this grant opportunity?	
Email from the Air District (YES/NO)	Yes
Air District Website (YES/NO)	Yes
Post card / Mailer (YES/NO)	No
Newsletter (please specify)	
Association (please specify)	
Other (please specify)	
Did you or anyone associated with this application attend an Application Workshop, a meeting, or other event where information was presented about BAAQMD grant programs? (YES/NO)	Yes
If yes, provide the event name and date of the event:	Webinar 11/21/2013

PROPOSED IMPLEMENTATION SCHEDULE:

Complete areas shaded in yellow below. Include key interim milestone dates (i.e., project start date, completion of construction/installation/service date(s), Final Report date). All projects must commence in calendar year 2014.

Activity or Milestone	Date
Project Start	June 1, 2014
Project Completion	February 1, 2016
Final Report	within three months from date of project completion
Complete Environmental Review (if applicable)	
other milestones, if any	
other milestones, if any	
other milestones, if any	

Proposed Budget: Complete areas shaded in yellow below.

Provide a project budget in the yellow-shaded areas, broken out by capital purchase and installation costs. Any other costs should be excluded from the project budget. **If match funding is derived from more than a single source, specify each funding source and the amount of match funds on a separate line.**

Name of Project: Electronic Bicycle Lockers

TFCA Regional Funds Line Item
(if necessary, add additional lines)

Estimated Cost

Electronic Bicycle Lockers	\$ 70,000.00	TFCA Regional Funds
	\$ -	TFCA Regional Funds
	\$ -	TFCA Regional Funds
	\$ -	TFCA Regional Funds
	\$ -	TFCA Regional Funds
Total TFCA Regional Funds	\$ 70,000.00	

Costs for maintenance, repairs, upgrades, rehabilitation, operations, and project administration are not eligible for TFCA funding.

Matching Funds Line Item*
(if necessary, add additional lines)

Estimated Cost

Electronic Bicycle Lockers	\$ 8,000.00	
0	\$ -	
0	\$ -	
0	\$ -	
0	\$ -	
Total Matching Funds	\$ 8,000.00	

** Matching Funds: List only line items and estimated costs that will be cost-shared with TFCA Regional Funds. Project sponsors must provide a minimum of 10% matching funds from non-TFCA sources. TFCA County Program Manager funds may NOT be used towards fulfilling this requirement. Administrative costs may be considered matching funds for electronic bicycle lockers. Costs for maintenance, repairs, upgrades, rehabilitation, and operations are not considered matching funds.*

Total Project Cost (Matching Funds) \$ 78,000.00
+ TFCA Regional Funds)

Summary of Funding Sources: Complete yellow-shaded areas below.

Funding Sources	Amount of Funds	Status (Secured, Approval Pending, etc.)
TFCA Regional Funds requested	\$ 70,000.00	Application submitted 12/24/13 & revised 2/28/14.
TFCA County Program Manager Funds	\$ -	
Matching Funds 1:	\$ 8,000.00	Local Sales Tax Revenue (Prop K)
Matching Funds 2:	\$ -	
Matching Funds 3:	\$ -	
Total Project Cost	\$ 78,000.00	

Hard copies of applications must include documentation to support availability of all matching funds (i.e. resolutions, adopted budgets, letters of funding commitment, contracts.) **Documentation must be provided before applications can be evaluated.**

Name of Applicant: SFMTA
Name of Project: Electronic Bicycle Lockers

To determine maximum grant amount based on number of bicycles accomodated

Number of bicycles accomodated	Funding per bicycle accomodated (TFCA Policy# 30)	Maximum grant amount
28	\$2,500	\$70,000



NAME OF PROJECT: ELECTRONIC BICYCLE LOCKERS **NAME OF APPLICANT AGENCY:** SFMTA

PART 3. PROJECT INFORMATION

A. Provide the following information for the proposed electronic bicycle locker project:

1. Type and number of electronic bicycle lockers to be purchased (including name of the vendor, if known)
 Type BikeLink eLockers Quantity 28 Vendor ELock Technologies, LLC
2. Manufacturer's warrantee for electronic bicycle lockers: 3 Years (Note: Regardless of warranty duration, grantees are responsible for maintaining equipment purchased with TFCA funds in service for a minimum of 10 years).
3. Please attach a copy of the manufacturer's specifications for the proposed equipment.

B. Bicycle Plan: Is a description of the availability of bicycle parking contained in an adopted countywide bicycle plan, Congestion Management Program (CMP), or the Metropolitan Transportation Commission's Regional Bicycle Plan? Language regarding bicycle parking will suffice if exact locations for lockers are not stated in the Plan or Program.

YES (Attach documentation) NO If no, explain: _____

C. Location of Locker(s) and Proximity to Activity Center: Provide a map showing where the locker(s) would be installed that also indicates the nearest major activity center(s). Major activity centers are locations that attract significant vehicle travel for utilitarian purposes, such as work/school commuting, shopping, etc.

Complete the following information for each proposed distinct location. If needed, submit the information below in a spreadsheet format.

Location	Street Address	City	Activity Center(s)
#1	SFMTA Parking Lot 174 West Portal Avenue	San Francisco	West Portal Transit Station West Portal Commercial Corridor
#2	SFMTA Parking Lot 1340 7 th Avenue	San Francisco	9 th Avenue/Irving Transit Station Irving Street Commercial Corridor
#3	SFMTA Moscone Garage 255 3 rd Street	San Francisco	Yerba Buena Gardens Moscone Convention Center SF MOMA Contemporary Jewish Museum Archstone Condominium Development
#4	SFMTA Golden Gateway Garage 250 Clay Street	San Francisco	Embarcadero Center Transamerica Pyramid San Francisco Ferry Building Sue Bierman Park San Francisco Financial District

D. Describe the anticipated demand and why lockers are needed at each of the project locations:

This project will install and maintain a total of 28 electronic bicycle lockers at four SFMTA off-street parking facilities. Provision of secure long-term bicycle parking is a key strategy for supporting and promoting bicycle transportation. Electronic bicycle lockers combine high security with modern technology to increase service: five to seven more people can be served with e-lockers versus traditional lock-and-key lockers. Survey results from the SFMTA's Long Term Bicycle Parking Strategy indicate that increasing the supply of attractive, secure and flexible bicycle parking by adding 28 e-lockers in San Francisco will result in higher rates of bicycling. The SFMTA's Strategy for Long-Term Bicycle Parking also recommends expansion of electronic bicycle lockers to existing SFMTA parking garages and near high-demand transit stations. San Francisco Bicycle Strategy Goal 2, Objective 2.3 seeks to increase convenience for bicycle trips by increasing the supply of adequate long-term bicycle parking, including a target of expanding electronic bicycle lockers available in the city. Below is a summary of the four proposed locations for the electronic bicycle lockers funded by this grant.

174 West Portal Avenue: Electronic bicycle lockers in the SFMTA West Portal parking lot, near the West Portal MUNI station and adjacent to the West Portal Avenue commercial corridor is planned for several reasons. The MUNI station is a major destination for people accessing transit and the surrounding hilly topography between this area and downtown San Francisco is considered a major barrier to bicycling. Placement of electronic bicycle lockers near the MUNI station will help alleviate this issue by providing people who ride bikes a secure place to park when transferring to transit. Additionally, this parking lot location serves the West Portal Avenue commercial corridor, offering consumers and employees in the area a safe and secure bicycle parking option.

1340 7th Avenue: The SFMTA also plans electronic bicycle lockers at the 7th Avenue parking lot since it is in close proximity to a major MUNI station and a popular commercial corridor. MUNI does not permit non-folding bicycles onboard light rail vehicles, so providing electronic lockers near the 9th/Irving MUNI station will help facilitate the bike/transit modal transfer. People riding bikes can park a bicycle in an electronic locker and then transfer to MUNI light rail. In addition to being a popular MUNI station, the Irving Corridor is a high-density commercial corridor where there is high visitor and employee demand for electronic bicycle lockers.

Moscone Garage, 255 3rd Street: Moscone Garage is in a high-density area of downtown San Francisco with large employers, regional destinations and high-density housing all within a one-block radius. Electronic bicycle lockers at this garage will serve employees, visitors and residents in the area. Attractors/generators in the area include Moscone Convention Center, San Francisco Museum of Modern Art, the Contemporary Jewish Museum, Yerba Buena Gardens and the Archstone Condominium complex. The electronic lockers will be placed outside at the street level, adjacent to the parking garage.

Golden Gateway Garage, 250 Clay Street: Golden Gateway Garage is in the Financial District of San Francisco, a high-density office area in downtown. There is an extremely high density of jobs in this area and electronic bicycle lockers in this location will service employees and commuters needing safe and secure bicycle parking. This garage is also relatively close to the San Francisco Ferry Plaza and will provide secure bicycle parking for commuters making the ferry transit connection. Compared to other SFMTA garages, Golden Gateway has the highest existing demand for bicycle parking.

NAME OF PROJECT: ELECTRONIC BICYCLE LOCKERS **NAME OF APPLICANT AGENCY:** SFMTA

PART 4. CLEAN AIR POLICIES AND PROGRAMS

Indicate which of the following Mobile Source and Transportation Control Measures (MSMs and TCMs, respectively) included in the Air Districts 2010 Clean Air Plan are implemented by your agency.

A complete description of MSMs and TCMs can be found in Volume 2, Sections B and C of the 2010 CAP: http://www.baaqmd.gov/~media/Files/Planning%20and%20Research/Plans/2010%20Clean%20Air%20Plan/CAP%20Volume%20II_Sections%20A-F.ashx.

<u>Specific Mobile Source or Transportation Control Measure</u>	Implemented by Your Agency? Y/N
MSM A-1 – Promote Clean, Fuel-Efficient Light and Medium-Duty Vehicles (pg. B-1)	Y
MSM A-2 – Zero Emission Vehicles (ZEV) and Plug-in Hybrids (pg. B-6)	Y

MSM A-3 – Green Fleets (pg. B-10)	Y
MSM A-4 – Replacement or Repair of High-Emission Vehicles (pg. B-14)	N
MSM B-1 – Fleet Modernization for Medium-and Heavy-Duty On-Road Vehicles (pg. B-20)	N
MSM B-2 – Low NO _x Retrofits in Heavy-Duty On-Road Vehicles (pg. B-23)	Y
MSM B-3 – Efficient Drive Trains	Y
MSM C-1 – Construction and Farming Equipment (pg.B-30)	N
MSM C-2 – Reduce Emissions from Lawn and Garden Equipment (pg.B-34)	N
TCM A-1 – Local and Area-wide Bus Service Improvements (pg. C-1)	Y
TCM A-2 - Local and Regional Rail Service Improvements (pg. C-7)	Y
TCM B-1 - Freeway and Arterial Operations Strategies (pg. C-12)	Y
TCM B-2 - Transit Efficiency and Use Strategies (pg. C-17)	Y
TCM B-3 - Bay Area Express Lane Network (pg. C-22)	N
TCM C-1 - Voluntary Employer-Based Trip Reduction Programs (pg. C-33)	Y
TCM C-2 - Safe Routes to Schools and Safe Routes to Transit Programs (pg. #C-39)	Y
TCM C-3 - Ridesharing Services and Incentives (pg. C-44)	Y
TCM C-4 - Conduct Public Outreach & Education (pg. C-49)	Y
TCM C-5 - Smart Driving (pg.C-53)	N
TCM D-1 - Bicycle Access and Facilities Improvements (pg. C-58)	Y
TCM D-2 - Pedestrian Access and Facilities Improvements (pg. C-64)	Y
TCM D-3 - Local Land Use Strategies (pg. C-69)	Y
TCM E-1 - Value Pricing Strategies (pg. C-75)	N
TCM E-2 - Promote Parking Policies to Reduce Motor Vehicle Travel (pg. C-79)	Y
TCM E-3 - Implement Transportation Pricing Reform (pg. C-86)	Y

For each applicable MSM and TCM implemented by your agency, provide a brief paragraph (not to exceed 100 words) describing:

1. The policies and actions that your agency has adopted in order to implement the MSM or TCM; and
2. Current progress in implementing those policies and actions.

Additional documentation is not required at the time of submittal - Air District staff will notify you if supporting documentation is required.

NAME OF PROJECT: ELECTRONIC BICYCLE LOCKERS NAME OF APPLICANT AGENCY: SFMTA

PART 5. ATTACHMENTS

The following attachments must be included with the application:

- Either (1) a signed letter of commitment from an individual with authority to enter into a financial commitment and carry out the Project, or (2) a copy of a signed resolution from the governing body authorizing the submittal of the application and identifying the individual authorized to submit the application and carry out the Project. Letter/Resolution must also address matching funds and maintenance of equipment for 10 years.
- A copy of the manufacturer's specifications for the proposed equipment including warranty information.
- Bicycle Plan: Documentation that bicycle parking is contained in an adopted countywide bicycle plan, Congestion Management Program, or the Metropolitan Transportation Commission's *Regional Bicycle Plan* (please submit copies only of the pages pertaining to the project and highlight the project-specific information).
- Map of Project location(s); must indicate the distance to the nearest major activity center(s).
- Clean Air Policies and Programs Descriptions.
- Copy of vendor quote for purchase, installation and maintenance of equipment.

PART 6. CERTIFICATION AND SURVEY

Applicant must read and initial each item below to indicate understanding and agreement:

I understand that this application is for evaluation purposes only and does not guarantee project funding.

Initial: SB

I certify that the proposed project and the emission reductions that would be realized from it are not required by any federal, state or local regulation, judicial order, agreement, memorandum of understanding, contract, mitigation requirement, or other binding obligation that requires the project applicant to implement any portion of the project.

Initial: SB

I certify that my agency is responsible for providing matching funds to cover all costs that exceed the amount of the grant and that these funds will be from non-TFCA derived funding sources.

Initial: SB

I certify that to the best of my knowledge, the information contained in this application and in any documentation accompanying this application or submitted in furtherance of this application is true and accurate and I understand that any misstatements or omissions of material facts may disqualify this grant application and any monies awarded based on it.

Initial: SB

I understand and agree that no costs funded by this program can be incurred until after the notice of award **and** after a funding agreement is executed between the project sponsor (grantee) and the Air District.

Initial: SB

I certify that I have the legal authority to apply for funding on behalf of the applicant entity and that I am authorized to sign this application on behalf of applicant.

Signed:  Date: 3/3/14
 (Authorized Representative of Applicant)

Name (Please Print): Sonali Bose Title: Chief Financial Officer

Survey Question: Was this application easy to follow? **Yes** **No** Please share your suggestions for improving the application process:

What is BikeLink?

BikeLink™ is an integrated management and multi-platform software system designed to facilitate both on-demand secure bike parking and deployment of rental bikes. BikeLink™ integrates smart microelectronics, wireless mesh networking, cellular technology, and relational databases with administrative procedures and access control systems. BikeLink™ can be used as an operating system for eLockers™, eCages™, eRacks™, or with eLock retrofit kits for existing mechanically keyed bike lockers.



The BikeLink™ Card

The BikeLink™ Card acts as both a debit device and access key. It is smart and it never expires. It stores rental information which can help a user if they forget where they parked, and deters several types of system abuses by preventing multiple simultaneous rentals.

As indicated on its back, use of the BikeLink™ Card invokes the BikeLink™ Cardholder Agreement, which can be viewed at www.bikelink.org.

The Benefits of BikeLink™

Operational Flexibility

- Easily switch between parking and vending modes.
- Use with lockers, racks, or cage enclosures.
- All components run on AC power or batteries.
- Works with and without a network.
- Membership-based access control is not required.

Ease of Use

- Clear, intuitive user interface.
- Faster to use than a mechanical bike lock or locker.

Interoperability

- Cardholder can access a national network of facilities.
- System supports a variety of card types.

Low Operating Cost

- The BikeLink system has been continuously refined to minimize administration, service, cleaning, power, and communications costs.

Serves More Cyclists

- Usage data indicates BikeLink serves 5-7 times as many cyclists in a year compared to non-shared systems.

How On-Demand Bike Parking Works:



Get a BikeLink™ card

The BikeLink™ Card is sold online at www.bikelink.org, by local facility owners, nearby businesses, or vending machines.



Insert card

The screen guides you through a very quick process to start your rental. It's like using a parking meter.



Park your bike

Once there's time on the meter, the door opens. Put your bike inside, close the door, and walk away. Your bike remains secure even if the meter expires.



End rental

Insert your card, get your bike, and get your refund! Unlike a parking meter, any time you don't use is refunded. If your meter expires you are simply charged for the extra time at a higher rate.

How Automated Bike Rental Works:



Get a BikeLink™ card

To facilitate insurance or security deposit requirements, the bike fleet owner may require your card be tagged with an extra electronic access code. You can get a code for your card over the phone, on the web, or by purchasing your card directly from the bike fleet owner.



Insert card

The screen guides you through a very quick process to select a bike and start your rental.



Remove rental bike

When you start your rental, if you're using an eLocker the door opens. If you're using an eRack, your selected bike is released.



End rental

You can return your bike to a different location from where you rented it. If you're using an eLocker, insert your card, view and accept your receipt, replace bike and attach docking device. If you're using an eRack, just dock your bike at any slot and then insert your card to view your receipt and close out the transaction.

eLocker™ Product Specifications

General Specifications

- BikeLink™ operating system pre-installed.
- Designed for operation under a wide range of environmental conditions.
- Modular design and replaceable components for ease of maintenance, lower lifecycle costs, and ability to upgrade.
- High quality materials, design, and attention to aesthetics.

Frame & Door

- Heavy gage all steel locker frame.
- Frame finish: G90 Galvanized, Stainless steel or Superdurable TGIC powdercoat over specially prepared hot-dip galvanized steel.
- Wide range of frame color options.
- No externally exposed fasteners.
- Stainless steel fully perforated door permits view of contents.
- Door recessed and extra thick for pry resistance.
- Door braced for security & stiffness to ensure consistent latching.
- Debris skirts & door flaps prevent intrusion and entrapment of wind-blown debris.
- FRP roofs meet stringent Transit Agency fire resistance specifications, have high impact, UV, and cutting resistance, yet let light in so locker contents remain visible at a distance. Sloped to shed rain and deter repose.
- FRP or perforated stainless steel end panels.

Divider Panels

- Galvanized 1/2" #16 expanded steel interior divider panels have proven security characteristics yet permit light and visibility.
- Stainless steel 18 gage 1/4" on 3/8" perforated exterior panels.

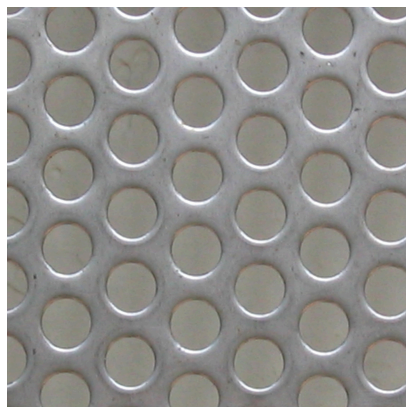

1/4" ON 3/8" STAGGERED PERFORATED STAINLESS STEEL
Excellent corrosion resistance, small hole size results in excellent security properties. 42% Open Area

Electronics Housing

- 300 series 16 gage stainless steel.
- Easily removable electronics for ease of maintenance and battery replacement.
- Housing held in place by high-security mechanical lock.

Locking & Latching System

- Patented "always locked" logic means door is secured even when locker is empty and available for parking or bike return. This deters misuse as shelter or for storage of inappropriate items.
- Motor-driven latch release mechanism for low power consumption and reliable operation even when batteries are low.
- 3000 lb pull-out test automotive grade latch mechanism.
- Latch can be released from inside locker.

Access System

- Smart Card ISO-7816 compliant on-demand access: any BikeLink cardholder can initiate rental.
- 3rd party ISO-7816 or 14443 compliant upgrade capable. Upgrade configuration & cost depend on specifications of 3rd party card to be used.
- Parking meter style interface. Access cards distributed via bikelink.org or local vendors. For rental rates over 10 cents per hour, facility-specific revenue is reimbursed to facility owner.

User Interface Display

- High contrast, wide temperature 128x64 graphic LCD.
- Backlight for nighttime operation.



1/2" #16 HOT-DIP GALVANIZED FLATTENED EXPANDED STEEL
Proven security characteristics. 52% Open Area

Power Source Options

- Battery or AC power -- see power supply options spec sheet.

Local Administration

- Smart Manager Card provides access to rental settings, date & time setting, battery levels, rental history, ability to switch between pay-for-parking and automated bike rental modes, and other features.
- Mechanical Manager Key for maintenance and battery replacement, as well as latch override.
- Firmware updates via handheld "paddle" programming device.
- Public information screens are accessible to any person requiring up-to-date information about the system, where to get a card, emergency contact phone numbers, rentals rates. No card needed to access these screens.

Remote Administration

- See BikeLink wireless network spec sheet for optional network features.

Installation and Relocation

- Concrete slab with less than 1.5% slope and installation by eLock technicians is recommended.
- Wheel-jack connections are built in to frame for easy relocation.

Support & Maintenance

- eLock provides free cardholder and facility owner technical support.
- Electromechanical components are not Owner servicable.
- Annual check-ups and tune-ups are recommended. Guaranteed on-site service contracts and extended warranties are available.



16 GAGE STAINLESS STEEL CONTROLLER HOUSING.
Pry-resistant mounting, yet easily removable using high-security mechanical lock.

eLocker™ Representative Installations

Copyright © 2011 eLock Technologies, LLC



**COMMUTER PARKING
SORRENTO VALLEY COASTER STATION
SAN DIEGO CALIFORNIA**



**DOWNTOWN PARKING AT CITY HALL
FRANK OGAWA PLAZA
OAKLAND CALIFORNIA**



**TREK BIKES AVAILABLE FOR CHECK-OUT
BUR-MIL PARK
GREENSBORO NORTH CAROLINA**



**COMMUTER & RECREATIONAL PARKING
OHLONE GREENWAY/PLAZA BART STATION
EL CERRITO CALIFORNIA**

eLocker™ Power Supply Options

Each eLocker™ controller is powered from two sources to ensure maximum reliability. For new construction, we recommend running eLockers™ with our field-proven power supply as the primary source, and a single refillable alkaline battery pack at each controller as a back-up. When running conduits for AC line power is not practical, you can run eLockers™ off two refillable alkaline packs. Each pack lasts over 12 months, so there is plenty of time to replace the cells in the primary pack before the backup pack runs out.

EM-PS04 Power Supply

The EM-PS04 is a power supply option that allows you to connect to an AC power source. This option eliminates the need to monitor and replace batteries at each controller and is recommended for all new construction installations.

The EM-PS04 protects itself and the components it powers from surges, faults, and outages with an integrated GFCI, auto-reset overload protector.

EM-PS04 Features

- Designed for operation under a wide range of environmental conditions.
- Easy mounting using built-in mount points on all eLocker Quads and Doubles.
- Enclosure cover fully gasketed and locked down with security screws to prevent tampering.

- Automatic resetting “fuseless” overload protection resets when short or overload is removed.
- 8A output can power 10 controllers (up to 20 locker spaces) driving latches simultaneously.
- Alternate models available for 120, 240 or 277VAC supply.
- Visual AC & DC power indicator LEDs.
- 1/2” knockout at bottom of enclosure for easy connection to conduit and line-level power.

EM-PS04 Specifications

- Stainless Steel IP64 enclosure.
- Input: 120, 240, or 277VAC @ 50/60Hz.
- Voltage Output: 12VDC.
- Current Output: 5A continuous, 8A peak.
- Auto-reset “fuseless” overload protector.



EM-PS04

Refillable Battery Pack

EM-BP08

The eLock EM-BP08 is a refillable battery pack that contains six standard “D” size alkaline cells. Each pack powers an eLocker™ controller unit for approximately one year. The EM-BP08 is designed to be installed in pairs to take advantage of eLock’s proprietary power management software. This software automatically switches between battery units to maximize battery life and minimize maintenance costs by simplifying battery replacement scheduling.

EM-BP08 Features

- Easily refillable with standard “D” cell alkaline batteries.
- Automatic active battery pack switching.

EM-BP08 Specifications

- 9VDC output.
- 20.5AH per pack.
- Takes 6 standard “D” alkaline cells.
- High-pressure gold-plated friction locking connector for reliable connection to eLock controller.



EM-BP08

Shown without protective cover.

Overview

Distributed Intelligence

The BikeLink system is designed so that communication disruptions will never disrupt basic reliability.

Because lock controllers do not depend on network communications to control access, an unreliable network connection will never result in a user getting stranded, unable to retrieve their bike, or return a rental bike.

Distributed intelligence also improves security and robustness. For example, when a bike is rented, the bike, the renting card, the lock controller, and the central network all record the transaction. Thus scamming the system is more difficult, and reconstructing a corrupted or suspect transaction trail is easier.

Low Power Consumption

Like all eLock products, our wireless components are optimized for very low power consumption.

Network Capabilities

1) Basic "Sneakernet"

BikeLink delivers surprisingly sophisticated capabilities without any network connections except those provided by a person physically carrying the read/write memory contained in a smart card or bike ID device with them when they move between lock controllers. These features include:

- Ability to prevent multiple concurrent rentals.
- "Always locked" logic (for lockers) to deter inappropriate uses.
- Transaction data downloading.
- Lost-card user support without having to meet the cardholder.
- Limited card or bike use tracking.

2) Local Area Network

A local area network (LAN) is established by simply plugging in a small low-cost wireless module into each lock controller. The network is self-forming and additional system management capabilities are available immediately. These include:

- Ability to propagate settings or information screens to an entire group of controllers in one operation.
- Ability to update software for an entire group of controllers in one operation.
- Ability to autosynchronize date and time settings.

3) Internet Connection

An internet connection is established by plugging a small gateway module into one controller at a location. Cellular service costs apply, however annual service costs are low because we manage the entire network in a way that minimizes bandwidth requirements.

Service Benefits:

The addition of an internet connection significantly reduces the need for on-site visits for many service, troubleshooting, data collection and support activities.

Benefits for the cyclist:

- Check status of a facility remotely.
- Reserve in advance via the web.
- Check personal system usage history.

Benefits for the Facility Owner:

- Real-time usage reporting online.
- Real-time revenue tracking.
- Remotely change emergency contact information, card vendor information, rental rates, special notices displays, and even animated advertising or sponsor displays on the controller's graphic LCD screen.

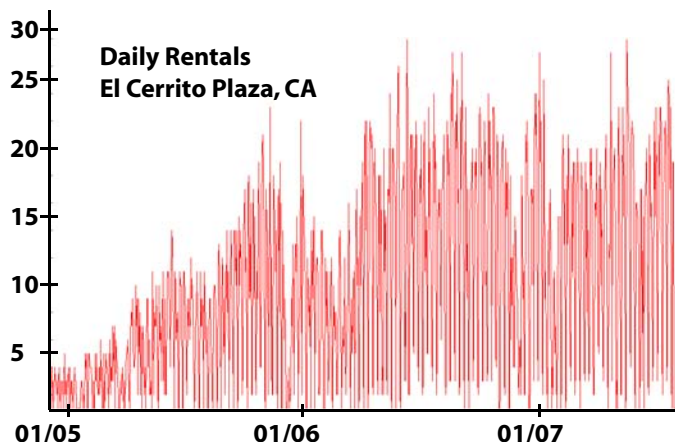

Usage reports available online to facility owners include automatically generated and dynamically updated plots.

Cardholder proximity to BikeLink facility

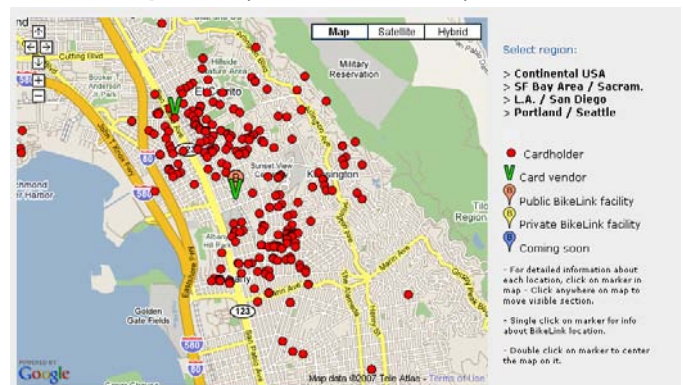

Cardholder addresses are automatically geocoded and mapped. This supports planning assessment for facility relocation or expansion.

eLocker™ Configuration Options

RECTANGULAR

2 SPACES, 2 ELECTRONIC CONTROLLERS
BEST FOR LIMITED CLEARANCE SITUATIONS

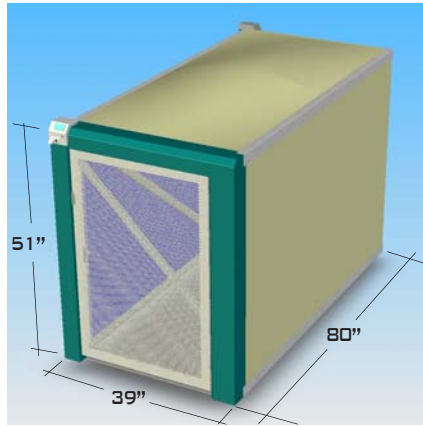
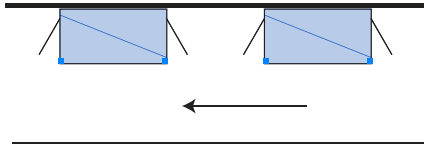

BOTH DOORS HINGE FROM SAME SIDE TO MAKE GETTING YOUR BIKE IN AND OUT EASIER WHEN LOCKER IS PLACED AGAINST A WALL. NOT DESIGNED FOR GROUPING; USE ONLY AS STANDALONE OR ON ONE END OF A GROUP OF QUADS.

QUAD

4 SPACES, 2 ELECTRONIC CONTROLLERS
LOWEST COST PER SPACE

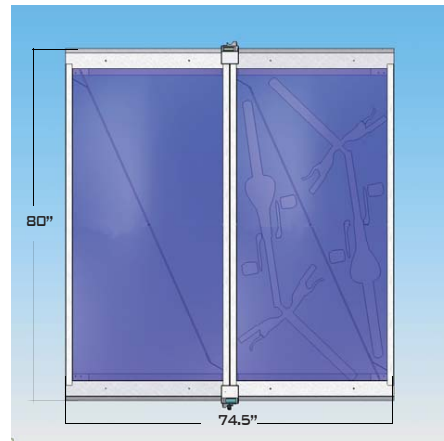
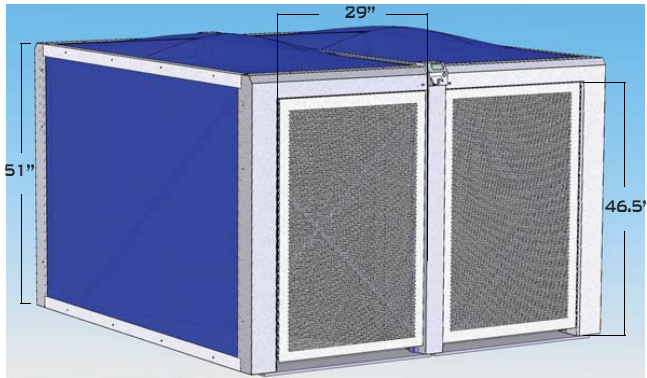

SAVE COSTS & SIMPLIFY DIRECT POWER SUPPLY BY GROUPING QUADS.

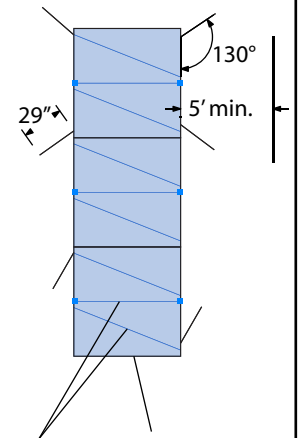

DIVIDER PANELS

END PANEL

WEDGE

EACH WEDGE HAS 2 SPACES SERVED BY 1 ELECTRONIC CONTROLLER
USE WHEN OPEN VISIBILITY AND FREE TRAFFIC FLOW ARE CRITICAL

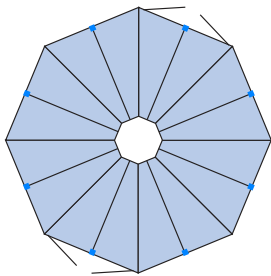

WEDGE UNITS ARE DESIGNED TO BE PLACED AGAINST A WALL, IN A CORNER, OR ARRANGED AS A FULL CIRCLE.

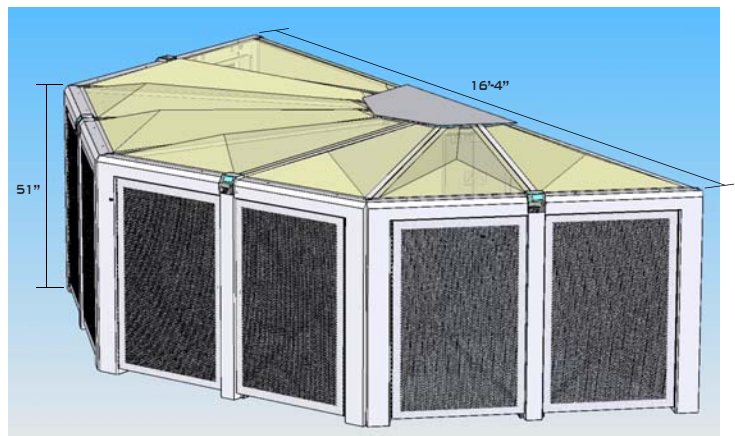
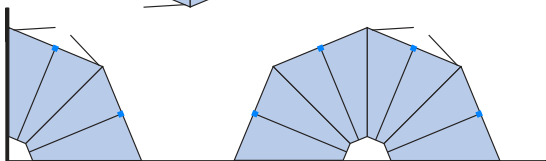

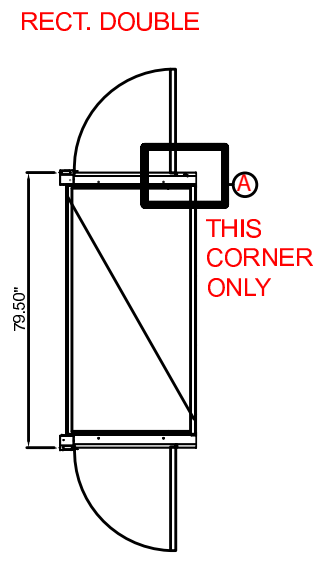
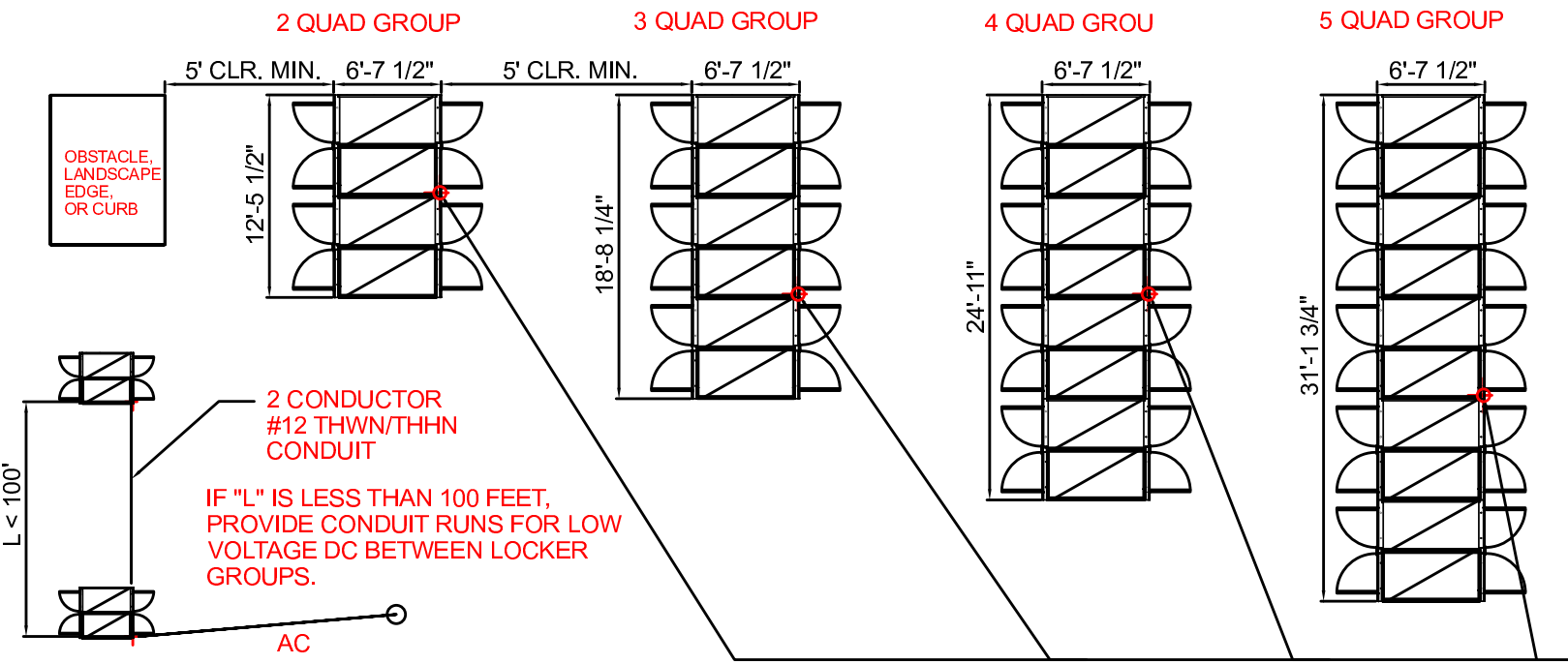

LOCATE CONDUIT STUB-OUT IN QUAD NEAR CENTER OF GROUP. SEE DETAIL FOR EXACT CONDUIT STUB-OUT LOCATION RELATIVE TO QUAD FRAME.

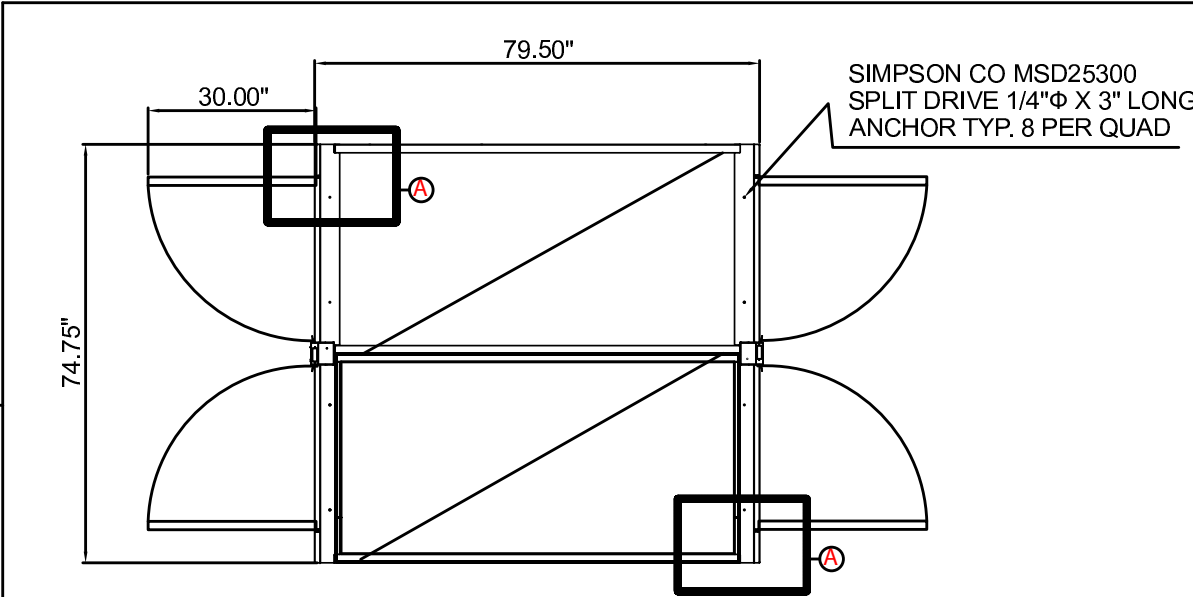
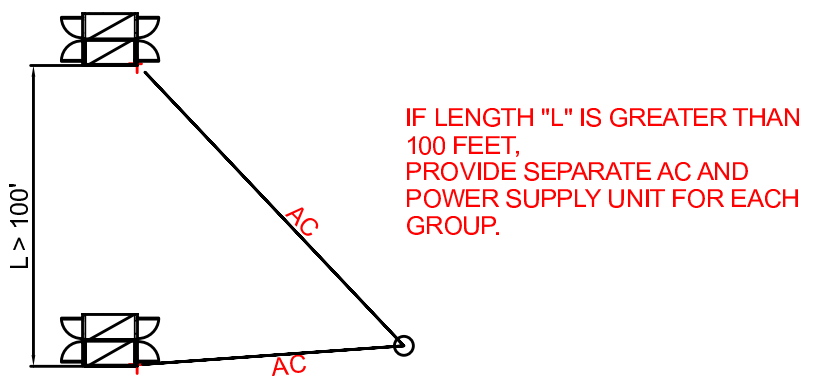

NOTE: WE RECOMMEND THAT YOU PROVIDE A COPY OF YOUR SITE PLAN FOR OUR REVIEW DURING DESIGN. OUR REVIEW IS FREE OF CHARGE AND MAY HELP AVOID ISSUES.

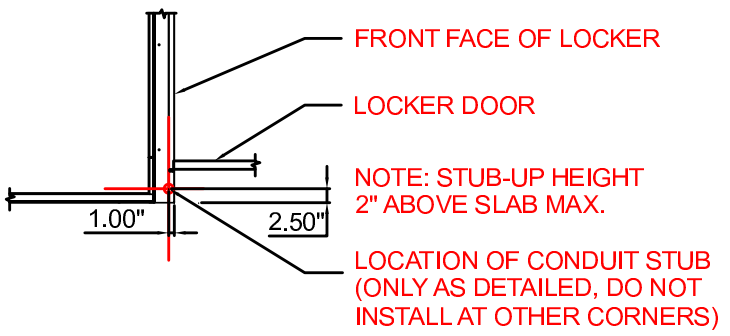



LOCATION OF CONDUIT STUB (ONLY AS DETAILED, DO NOT INSTALL AT OTHER CORNERS)

MATERIAL	UNLESS OTHERWISE SPECIFIED:	NAME	DATE	800 HEINZ AVENUE SUITE 11 BERKELEY CA 94710 USA TEL: (510) 549-2853 FAX: (510) 549-9157 info@elocktech.com
THICKNESS	DIMENSIONS ARE IN INCHES	DRAWN		
FINISH	TOLERANCES IN INCHES XX ±.1 XXX ±.01 XXXX ±.005	CHECKED		
WEIGHT	ANGLES X° ±.3° XX ±1.0° XXX ±.5° HOLES FOR PEM FSTNRS: +.0031-.0004	ENG APPR.		
SURFACE AREA		MFG APPR.		
		SPECIAL INSTRUCTIONS		DESCRIPTION
				LOCKER STUB LAYOUT
				SIZE PART NO. REV
				A

BikeLink™ G5 eLocker™ Technical Features & Specifications

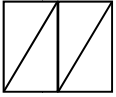
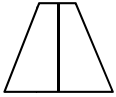
Locker Types

 <p>Quad eLocker 4 spaces, 2 Controllers <i>Most popular and cost effective.</i></p>	 <p>Wedge eLocker 2 spaces, 1 Controller <i>For corners and to maximize visibility and traffic flow.</i></p>	 <p>Double eLocker 2 spaces, 2 Controllers <i>For sites with limited clearance. Cannot be grouped.</i></p>
--	--	--

Standard eLocker Configurations

- Modular design and replaceable components for ease of maintenance, lower lifecycle costs, and upgradability.
- High quality materials, design, and attention to aesthetics.
- Three year limited Warranty. Service & Operations Plan options.
- 304 stainless steel exterior frame and perforated 304 stainless steel doors and side panels with bike graphic perforation pattern.
- Ultra-low power electronic controllers with ISO-7816 compliant smart card readers (ready for ISO-14443 contactless RFID/NFC card reader, magnetic stripe card reader, and LAN/WAN wireless networking upgrades).
- Motor-driven 3000 lb test latch system.
- Translucent blue FRP roof.
- On-site post-installation orientation.
- BikeLink™ software license.
- Free technical support for the life of the product.



Details

Electronic Controller Housing



- 304 series 16 gage stainless steel.
- ¼" thick UV and abrasion protected polycarbonate windows.
- No exposed edges to pry against.
- Removable for maintenance and battery or latch assembly replacement.
- Housing held in place by recessed high-security mechanical lock.
- High contrast, wide temperature 128x64 graphic LCD user interface display with backlight for nighttime operation.

Exterior Frame & Doors



- Exterior Frame and doors: Stainless steel with #4 finish (standard, other finishes available)
- Interior Frame Components: 16 and 18 gage G90 galvanized steel.
- No externally removable screw fasteners.
- ¼" on 3/8" perforation pattern provides exceptional security resistance and for visibility of contents for security monitoring and rental rules enforcement.
- Door recessed and extra thick for pry resistance.
- Full length pry guard / door handle.
- Door braced for additional security and out-of-plane stiffness to ensure consistent latching.
- Lockers designed to be installed plumb and level for consistent automatic door opening action.
- Debris skirts & door flaps prevent intrusion and entrapment of wind-blown debris.
- FRP roofs meet stringent Transit Agency fire resistance requirements, resist very high impact, UV and cutting, yet let light in so locker contents remain visible at a distance.
- Roof sloped to shed rain and deter repose.

Exterior Side Panels



- Standard Exterior Panels are 18 gage 304 stainless steel with 1/4" on 3/8" staggered round hole perforation pattern with bike graphic.
- Custom exterior panel options are available, such as bike images created with perforation patterns, or clear polycarbonate for advertising.
- Visibility of contents for security and enforcement. Also makes it easy to see which spaces are available.

Interior Divider Panels

- 3/8" on 1/2" round hole perforated interior divider panels.
- Proven security characteristics and excellent visibility for security and rules enforcement.



Locking & Latching System

- Patented "always locked" logic means door is secured even when locker is empty and available for parking or bike return. This deters misuse as shelter or for storage of inappropriate items.
- Motor-driven latch release mechanism for low power consumption and reliable operation even if batteries are low.
- 3000 lb pull-out test automotive grade latch mechanism.
- Latch can be released from inside locker without using a card or key ("panic release").

Optional Vehicle Presence Sensing (VPS) Hardware (for Bike Share operating mode)

- Optional low profile self-adhesive metal-mount 900MHz passive tag mounts on bicycle frame and can be read within locker, but not outside of locker by optional VPS reader that mounts on interior divider panels.

Power Supply

- Each controller is individually powered, so any power supply failure affects a maximum of two parking spaces.
- Power management logic is designed to work with both a "primary" and "backup" power source to maximize reliability and optimize battery replacement field service operations.
- Three power supply options: 1) Solar/low self-discharge NiMH with alkaline backup, 2) Alkaline with alkaline backup, or 3) AC power with low self-discharge NiMH battery backup. Lithium backup battery option for locations requiring operation below -18 C.

User Access and Interface



- In Parking mode, pre-pay parking interface shows how long a user intends to park and reinforces the user's understanding of the lockers as a shared resource.
- Park, retrieve or rent a bike in 15 seconds or less.
- Contact-type (ISO-7816 compliant) on-demand smart card access.
- Electronic controller/reader is upgradable to read contactless (ISO-14443A/B compliant) devices with AES encryption.
- Electronic controller/reader is upgradable to read magnetic stripe cards.
- User access devices distributed via bikelink.org (888) 540-0546 24/7 and local retail vendors.
- Online or telephone purchase of add value.
- No card needed to access user information screens describing rentals rates and policies, how to get access, how to use the system, emergency contact phone numbers, etc.
- Electronic controller/reader is upgradable to provide 128-bit AES-encrypted local area network (LAN) communication, and SSL-secured wide area network (WAN) communication with the internet (via cellular, wifi, or direct wired connection). LAN/WAN upgrade provides many valuable administrative, user, and owner benefits.

BikeLink System General

- BikeLink™ system administration services, owner and user web tools, 24/7 user and owner telephone support are all included with Software License (these services are covered by card sales revenue, no ongoing cost to owner).
- BikeLink is an inter-owner open-access system; cardholders can access any BikeLink™ facility.

User Web Resources

- Purchase, activate, or add value to card.
- Login to update contact information.
- FAQs.
- Facility locations and card retail vendor search tool.
- Location-sensing map with option to show nearby bike paths and amenities.
- How-to videos.
- Cardholder Agreement.

User Telephone Support Resources

- Operators can sell, activate, or add value to card.
- Operators answer questions about the system, including how/where to get access.
- On-call technicians are available to support our call center staff 24/7 to help with difficult questions, malfunctions, remote release of bike for lost cards, etc.

On-site Administration Tools

- Smart Manager Card provides access to rental settings, date & time setting, battery levels, rental history, ability to switch between pay-for-parking and automated bike rental modes, start or end rentals, open doors, and other features.
- Mechanical Service Key for general maintenance, battery replacement, and mechanical latch override.

Resources & Software Tools for Facility Owners

- Individual controllers or locations may be access-restricted at any time so that an owner-controlled access code is required to access designated lockers.³
- Web-based customizable usage data plotting and downloading tools.
- Cardholder address geocoding and mapping.
- Outreach flier samples and templates in .ai format.
- BikeLink equipment product manuals.
- Promotional program sales tracking tools.
- Cardholder information search by card number or name.
- Deployed equipment records by location.

BikeLink System Administration Web Tools

- Call Center operator scripts.
- Comprehensive problem report and resolution tracking system.
- Service-in-progress and service records tracking system with ability to link service reports to problem reports facilitates coordination of eLock engineers and regional field technicians.
- Cardholder information database tools.
- Email and snail mail address verification tools.
- Card vendor inventory and order tracking tools.
- Detailed deployed equipment records by location.
- Detailed transaction history by user or controller.
- “Paddle” administration device for efficient firmware release management, data collection and uploading, settings and information screen changes. PC and web software for both tethered and un-tethered paddle modes.

Installation and Relocation

- Installation by eLock technicians is strongly recommended. Installation by others requires training or supervision by eLock technicians to ensure proper mechanical, electronic, and software operation.
- Adjacent units can be tightly connected to each other.
- Concrete slab recommended. Contact eLock if you are considering installing on asphalt.
- Individual Quad, Wedge, or Double locker units can accommodate up to 2.5% slope while remaining plumb and level to provide for reliable and user-friendly door operation. Optional steep-slope base for slopes up to 5.2%.
- Full-perimeter wind-driven debris blocking system conforms to ground slope even when lockers are set plumb and level.
- Wheel-jack connections are built into locker frame for easy relocation.

Equipment Maintenance

- Electromechanical components are not Owner serviceable.
- Installations that are distant from our home office are not a problem. We have a very successful training, oversight, and support system for local field technicians.
- Our proactive service, enforcement, and extended warranty plans are recommended to minimize lifecycle costs and ensure maximum level of service for cyclists.

³ Access restriction feature permits up to 4 restricted zones accessible to only a subset of cardholders. This feature is best deployed after cards are distributed and need for restriction is verified.
Contact us at (510) 549-2853 or sales@elocktech.com

Sample On-Demand Electronic Bike Locker Specifications

High Level Locker Functions:

- Lockers shall provide access for one bike per point of entry into locker.
- Lockers shall be of adequate size to hold an adult-sized standard or mountain-style bike, as well as accessories such as a helmet or cycling shoes.
- Lockers shall be capable of storing a bike up to 50 pounds in weight without damage or failure due to bike leaning against the locker from the inside.
- Lockers shall be structurally sufficient to withstand abuses such as kicking, hitting, and being stood or jumped upon.
- Lockers shall have modular subassemblies and be repairable without replacing an entire locker should an accident or vandalism incident occur.
- Lockers shall provide stored contents shelter from debris and rain.
- Lockers shall be capable of withstanding exterior weather for the approximate 25-year life-cycle of the locker enclosure.
- Lockers shall minimize costs of power supply replacement and maintenance.
- Lockers shall provide flexibility by having electronics ready to accommodate alternative access technologies, including but not limited to phone, text/SMS, mag stripe credit cards, NFC cell phones, contactless regional transit cards, or other access devices.
- Lockers shall be capable of completely stand-alone functionality for normal rental transaction functions without any wired or wireless communication or power supply connections.
- Lockers shall provide high durability and vandalism resistance, and minimum maintenance of electronic interface hardware and components.

High Level Software and Electronics System Functions:

- The System shall enable 24-hour on-demand user access to secure bicycle parking and rental.
- The System shall log all rental transactions, and link access device transactions to a specific user and facility Owner.
- The System shall enable multiple location secure bicycle parking and rental, such that a single smartcard access device can be used at multiple locations and multiple facility owners.
- The System shall enable System Administrators to permanently disable a renting smartcard access device when that device's rental is in violation of the terms of service.
- The System shall be capable of upgrade to enable System Administrators to remotely monitor and manage Lockers via the internet.
- The Parking mode shall restrict access for each space to only one user at a time. When Locker space is occupied by a user, only the same user or a System Administrator shall be able to open the locker to retrieve its contents.
- The System shall permit rental of one bike or parking space at a time per access device.
- The Bike Share mode shall verify the specific bike rented is returned and secured before closing the rental transaction and releasing credit card deposit.
- The Bike Share mode shall permit return of a bike to a different locker or location from which it was rented.
- The System shall be capable of upgrade to wireless internet connectivity to allow users to check current parking space or rental bike availability online, make reservations, and find out where they are currently parked.
- The System shall provide a secured web-based central repository for usage, service, and monitoring records, as well as usage data plotting and analysis and user support tools.
- The System shall provide 24/7 email and telephone user support including daytime technical support, and round-the-clock basic and emergency support for registered users.
- The System shall provide 24/7 phone and web-based smartcard access device and add-value vending.
- The System shall provide universal User Agreement coverage to all system Owners.
- The System shall provide for access restriction so that Owners are able to limit access to their facilities to a subset of smartcard access device holders.
- The system shall be capable different rental rates by time of day, day of week, or holidays, as well as dynamic bike share pricing to facilitate redistribution of bicycles.

General:

- 4-space "Quad" rectangular locker configuration: Each locker shall provide individual storage for 4 bicycles in separate locked compartments.

- 2-space "Wedge" locker configuration: Each locker shall provide individual storage for 2 bicycles in separate locked compartments and shall be capable of being a stand-alone unit, or arranged adjacent to other Quad, Double, or Wedge units to achieve desired grouped configurations, including a full "round" comprising 16 individual spaces.
- 2-space "Double" rectangular locker configuration: Each locker shall provide individual storage for 2 bicycles in separate locked compartments.
- Each locker shall have at least one smart card reader per pair of adjacent doors.
- Each smart card reader shall have a dynamic display of real time rental status and usage rules.
- Lockers shall be of a modular design that allows for easy replacement of components such as doors, top and side panels, electronic controllers, and latching mechanisms.
- Locker battery power supplies shall use dual redundant battery packs, and advanced battery selection logic to allow run times over one year per pack under normal conditions. Packs shall utilize readily available Alkaline, Lithium, or NiMh cells that are easily replaced and cost-effective to maintain.
- Alternate power supply configurations shall include [hard-wired 120VAC with alkaline battery backup] [hard-wired 277VAC with alkaline battery backup] [hard-wired 12VDC with alkaline battery backup] [dual redundant alkaline battery packs with advanced pack selection logic to deplete the primary pack before switching to the reserve pack, warn users of a depleted pack, and refuse rentals when both packs have been depleted], or [Solar power with rechargeable low self-discharge NiMh and alkaline battery backup].
- Lockers shall be capable of operation in temperatures ranging from 0-110°F.
- Lockers shall be capable of operating in exposed conditions and in coastal marine environments.
- Lockers shall restrict the entry of wind-blown debris around their full perimeter.
- Lockers shall have adjustable system for anchoring and leveling on site with adjustment range of up to 3.0% slope.
- Lockers shall provide access for easy removal or cut-off of installed anchors, to facilitate Locker relocation.
- Four-space Lockers shall be of an aspect ratio which resists lifting and tipping, and shall be capable of operating when unanchored.
- Lockers shall be capable of being installed on concrete substrates.
- Lockers shall provide standard externally mounted number plates made of a durable, weather resistant material, and shall include electronically coded controller, location, and Owner ID numbers which are logged on every transaction.
- Lockers shall have no exposed fasteners that would enable locker disassembly from the outside.
- Locker shall have external finishes which facilitate the removal of graffiti.

Locker Materials:

- Locker doors shall be fabricated from 16-gage 304 stainless steel fully perforated with a ¼-inch on 3/8-inch staggered, round-hole pattern. Doors shall have interior reinforcement to reduce warping increase out-of-plane stiffness. Doors shall be at least 1.5" thick to resist prying attacks.
- No portion of door shall displace more than 0.4" when subjected to prying at any location on the door using a 30 lb force on a 36" pry bar with a 1" fulcrum.
- Exterior Locker frame components shall be precision manufactured sheet steel of no less than 16-gage 304 stainless steel.
- Locker roofs shall be high-durability FRP with additives for fire resistance, and shall use a UV-resistant resin. Locker roofs shall have at least 20% translucency to aid in visibility of contents.
- Locker roofs shall be crowned to enable proper water run-off, and roof system shall be capable of resisting the dropping of a 200lb load from 12 inches without any permanent buckling, cracking, or deformation of the roof or other locker components.
- Locker sides and doors shall be capable of resisting the impact of a 100lb pendulum swinging from a height of 5 inches above the impact point without any permanent buckling, cracking, or deformation of the doors, side panels, or other locker components.
- The latching device shall be capable of resisting a 3000lb pull-out force, such as during an attempt to pry the door open.
- Locker interior divider panels shall be G90 hot-dipped galvanized material with 50-70% open area.
- Locker exterior side panels shall be ¼-inch on 3/8-inch staggered, round-hole, fully perforated panels of no less than 18-gauge 304 stainless steel.
- Locker materials shall allow maximum visual transparency for ease of locker inspection.
- User interface display and solar windows shall be protected by 1/4" thick polycarbonate with abrasion and UV resistance properties, "Makrolon 15" or equal.

Finish:

- External locker hardware (such as nuts, bolts, and latches) shall be 18-8 stainless steel, or better.

- Internal locker hardware (such as nuts, bolts, and latches) shall be zinc plated steel, or better.
- The door hinge shall be a full height piano style hinge made from 304 stainless steel.
- Exterior Locker frame components shall be #4 finish 304 stainless steel. Alternate finish options shall include [Tiger Drylac Series 38 super-durable TGIC polyester powdercoat, prepared and applied per manufacturer's specifications for maximum performance] [G90 base with Tnemec Epoxyline Primer and EnduraShield II Topcoat].
- Interior Locker components shall be G90 hot-dipped galvanized steel or better.

Parking and Bike Share User Interface:

- Locker electronic controllers shall be equipped with an easily read, tamper-resistant user interface that provides users with vital locker information such as current rental state, rates, and where to obtain an access device.
- Provide authorized user access to bicycle or parking space within 15 seconds from initiation of transaction.
- User interface display shall be graphic LCD type, capable of operating in wide temperature range (-20°C/-4°F to 70°C/158°F).
- User interface display shall be readable in bright sunlight, and have a backlight for low light and full darkness readability.
- Locker electronic controllers shall be capable of displaying user-specific information such as value remaining on access device, access device rental state, and if an access device has been blocked.
- Interface shall include on-screen instructions, and in-context warnings.
- In bike share mode, presence of bike shall be confirmed using vehicle presence sensing hardware before rental transaction may be closed out.
- In bike share mode, user shall be able to flag bike for repair.

Locking System and Smartcard Access:

- Lockers shall be equipped with electronic latch and controller systems. Locker controllers shall be ISO-7816 smartcard accessible, and ISO 14443 smart card, and/or magnetic stripe card upgradable. A clearly defined reader and web system upgrade path for integration with regional ISO-14443 compliant transit cards shall be provided.
- Any available locker space must be accessible by a valid smartcard.
- Locker spaces must remain secure while in the 'available' mode, meaning the locker is closed and cannot be opened by anyone except a holder of a valid smartcard.
- Locker spaces must remain dedicated while in a 'secured' mode, meaning the locker is closed, secure, and cannot be opened by any user except the authorized user who initially engaged the latch in the 'secured' mode.
- Smart cards shall be electronically tagged with their current renting status, and shall not be capable of renting more than one locker space or bicycle at the same time.
- Lockers shall be capable of being opened at any time, while in any mode, by a System Administrator.
- Lockers shall be capable of being field serviced and electronic components shall be easily removed by maintenance staff, with a mechanical key, from the outside of the locker without damaging the locker components, locker, or internal wiring.
- Locker shall be accessible to service personnel regardless of whether or not the locker has power or functioning electronics.
- The system shall be capable of being manually opened from the outside of the locker by maintenance staff should power be cut to the locker, or should the electronic system malfunction for any reason.
- Each locker space shall have a secure internal panic release which can be operated by an individual locked inside.

BikeLink Gen5 eLocker Limited Product Warranty

Bicycle storage locker, electronic controller with software and latching mechanism (the "Product").

The following limited warranties provided by eLock Technologies LLC ("ELOCK") extend to the original facility owner ("OWNER") of the Product and are assignable or transferable to a subsequent Owner.

- 1) **Commencement.** This Limited Product Warranty commences upon OWNER acceptance of product installation.
- 2) **Electronics.** ELOCK warrants that the locker controller, cables, latch assembly, and battery power supply system including electronic components and battery holder will, under normal use, be free from defects in materials and workmanship and will perform substantially in compliance with the product documentation in the BikeLink Gen 5 eLocker Product Manual relating to the electronics for a period of three (3) years from the date of Commencement.
- 3) **Locker.** ELOCK warrants that locker frame, door and roof of new lockers will, under normal use, be free from defects in materials and workmanship and will perform substantially in compliance with the product documentation in the Product Manual for a period of three (3) years from the date of Commencement.
- 4) **Locker Frame Exterior Finishes.** ELOCK warrants that locker frame, electronics housings, roof and panel materials will not deteriorate or corrode beyond normal weathering under normal use for a period of three (3) years from the date of Commencement. Normal weathering for 304 stainless steel components includes small rust deposits that form when ferrous dust impurities in the air adhere to the surface. Normal weathering for galvanized components includes build-up of "white rust" deposits as well as rust that forms along and remains limited to cut or punched edges. Normal weathering for the FRP roof(s) includes a gradual reduction in glossiness and accumulation of oxidation. The roofs will become less shiny and more matte over time. Normal weathering may be substantially decelerated by adhering to care and cleaning recommendations in the BikeLink Gen5 eLocker Product Manual.
- 5) **Remedies.** ELOCK'S sole obligation for a breach of the warranties set forth in paragraphs 2 through 5 above is, in ELOCK'S sole discretion, either (a) a refund of the purchase price paid for the defective component, excluding installation costs, or (b) repair or replacement with new or remanufactured component. Any replacement component will be warranted against defects in materials or workmanship for the remainder of the original warranty period or thirty (30) days, whichever is longer.
- 6) **Warranty Procedures.** If a defect arises during the limited warranty period, OWNER shall provide written notification to ELOCK via certified mail and may also contact ELOCK via email at support@elocktech.com or at the phone number at the top of this page. ELOCK will respond to service inquiries between 10:00 a.m. and 5:00 p.m. Pacific Time, excluding weekends and holidays. ELOCK represents and warrants that such response will not be unreasonably withheld or delayed. Service will be via a mailed exchange of parts.
 - a) Field service may be provided at OWNER'S request, however travel time and component replacement labor billed on an hourly basis plus travel expenses, including parking, directly associated with field service, are not covered in this limited warranty and must be requested in advance by OWNER.
 - b) In lieu of mailed exchange of parts, ELOCK may, at its sole discretion, elect to perform on-site service to replace a defective part and no charges for labor or travel expenses will be due to ELOCK.
 - c) In order to expedite a repair, ELOCK may choose to send a replacement component prior to receiving an original defective part. ELOCK will ship the replacement component to OWNER at the address provided by OWNER at ELOCK'S expense. For Products shipped within the United States of

- America, ELOCK will use reasonable efforts to ensure delivery within ten (10) business days. Expedited service is available at additional cost to OWNER.
- d) OWNER shall ship the product taken out of service, including cables and attachment hardware where applicable, to the address below, freight or postage prepaid and insured by OWNER.
 - e) If ELOCK determines that the defect is not eligible for warranty service (e.g. defects due to vandalism or power-washing), Out-of-Warranty service is available at OWNER's request.
 - f) When a product or part is exchanged, any replacement item becomes OWNER's property and the replaced item becomes ELOCK's property.
- 7) **Out of Warranty Service.** Out of warranty service, replacement, and repair is available on a time and materials basis. Please contact ELOCK for current Out-of-Warranty repair rates and to request service.
- 8) **Limitations.**
- a) ELOCK is not responsible for damage arising from failure to follow instructions in the BikeLink Gen 5 eLocker Product Manual relating to the product's use.
 - b) OWNER shall have no coverage or benefits under this Limited Product Warranty if the Product has been subject to abnormal use, abnormal conditions, improper storage, improper cleaning or maintenance, unauthorized modifications, disassembly, repair or alteration by any person other than ELOCK or a party authorized by ELOCK, misuse, neglect, abuse, accident, use on improper power supply, improper installation, installation of any third-party software, or other acts which are not within the control of ELOCK, including acts of nature and damage caused during shipping components for warranty service.
 - c) This Limited Product Warranty does not cover normal wear of parts or any use contrary to written operating instructions.
 - d) Because battery cells may be replaced by the OWNER, this Limited Product Warranty does not cover a defect of the device caused by leaking or otherwise defective battery cells.
 - e) Incorrect service attempts made by technicians other than ELOCK-authorized technicians will void this Limited Product Warranty. Service only by ELOCK technicians is strongly recommended due to the potential for security issues, disabling of user access devices, unintended environmental exposure of electronic components, or damage to electronics resulting from service by non-ELOCK technicians.
 - f) OWNER ACKNOWLEDGES THAT THIS LIMITED WARRANTY SETS FORTH ITS COMPLETE REMEDY WITH RESPECT TO THE PRODUCTS AND SOFTWARE AND THAT ELOCK'S LIABILITY FOR A WARRANTY CLAIM IS LIMITED TO THE REMEDIES SET FORTH IN PARAGRAPH 6 ABOVE. IN NO EVENT SHALL ELOCK BE LIABLE FOR ANY INDIRECT, SPECIAL, INCIDENTAL OR CONSEQUENTIAL DAMAGES, WHETHER BASED ON BREACH OF CONTRACT, TORT (INCLUDING NEGLIGENCE) OR OTHERWISE, WHETHER OR NOT OWNER HAS BEEN ADVISED OF THE POSSIBILITY OF SUCH DAMAGES.
 - g) Except as noted in paragraph 5 above, this Limited Product Warranty does not cover defects in appearance of cosmetic, decorative or structural items, including framing, finishes, and any non-operative parts. ELOCK's limit of liability under the limited warranty shall be the actual cash value of the product at the time ELOCK receives written notice of a defect from the OWNER, determined by the price paid for the product less a reasonable amount for usage. ELOCK shall not be liable for any other losses or damages.
 - h) ELOCK provides no warranty for damage caused by third parties, such as graffiti or scratches, software hacking, software viruses, vandalism, neglect or abuse of the equipment.

- i) ELOCK provides no warranty for damage caused by conditions beyond its control including but not limited to flooding, earthquakes, or other acts of God.
 - j) ELOCK provides no warranty for performance of existing locker components for lockers that are retrofitted with retrofit or upgrade products supplied by ELOCK.
 - k) Any OWNER requested modifications to the software will void the warranty on software provided in paragraph 3 above.
 - l) THIS LIMITED WARRANTY IS THE ONLY WARRANTY ELOCK MAKES FOR THE PRODUCT AND SOFTWARE. TO THE EXTENT ALLOWED BY LAW, NO OTHER WARRANTY APPLIES, WHETHER EXPRESS, IMPLIED OR STATUTORY, INCLUDING ANY WARRANTY OF MERCHANTABILITY OR FITNESS FOR A PARTICULAR PURPOSE.
- 9) **Exclusions:**
- a) Post-installation service.
 - b) Post-installation maintenance.
 - c) Battery cells.
 - d) eLocker Administrative and Access Devices.
 - e) Replacement or repair of components damaged by vandalism, including but not limited to finishes, electronic, software, and locker components.
 - f) Replacement or repair of components damaged by actions of OWNER or its agents, including but not limited to power-washing.
 - g) Custom software or modifications.
 - h) Service of non-ELOCK components or replacement of non-ELOCK parts on existing lockers which have been retrofitted to use the eLocker electronic controller.
- 10) **Jurisdiction.** This Limited Warranty will be covered by and construed in accordance with the laws of the State of California, United States (excluding conflicts of laws rules), and shall inure to the benefit of ELOCK and its successor, assignees and legal representatives.
- 11) **Severability.** If any provision of this Limited Warranty is held by a court of competent jurisdiction to be invalid or unenforceable to any extent under applicable law, that provision will be enforced to the maximum extent permissible and the remaining provisions of this Limited Warranty will remain in full force and effect.
- 12) **Entire Agreement.** This Limited Product Warranty contains the entire agreement of the parties with respect to the matters set forth herein.
- 13) **Notices.** Any notices or other communications to be sent to ELOCK must be mailed by certified mail to the following address:

eLock Technologies, LLC
800 Heinz Avenue, Suite 11
Berkeley, CA 94710
U.S.A.



SFMTA
Municipal
Transportation
Agency

BICYCLE PARKING & BICYCLE PLANS

Strategy for Long-Term Bicycle Parking in San Francisco

November 8, 2013

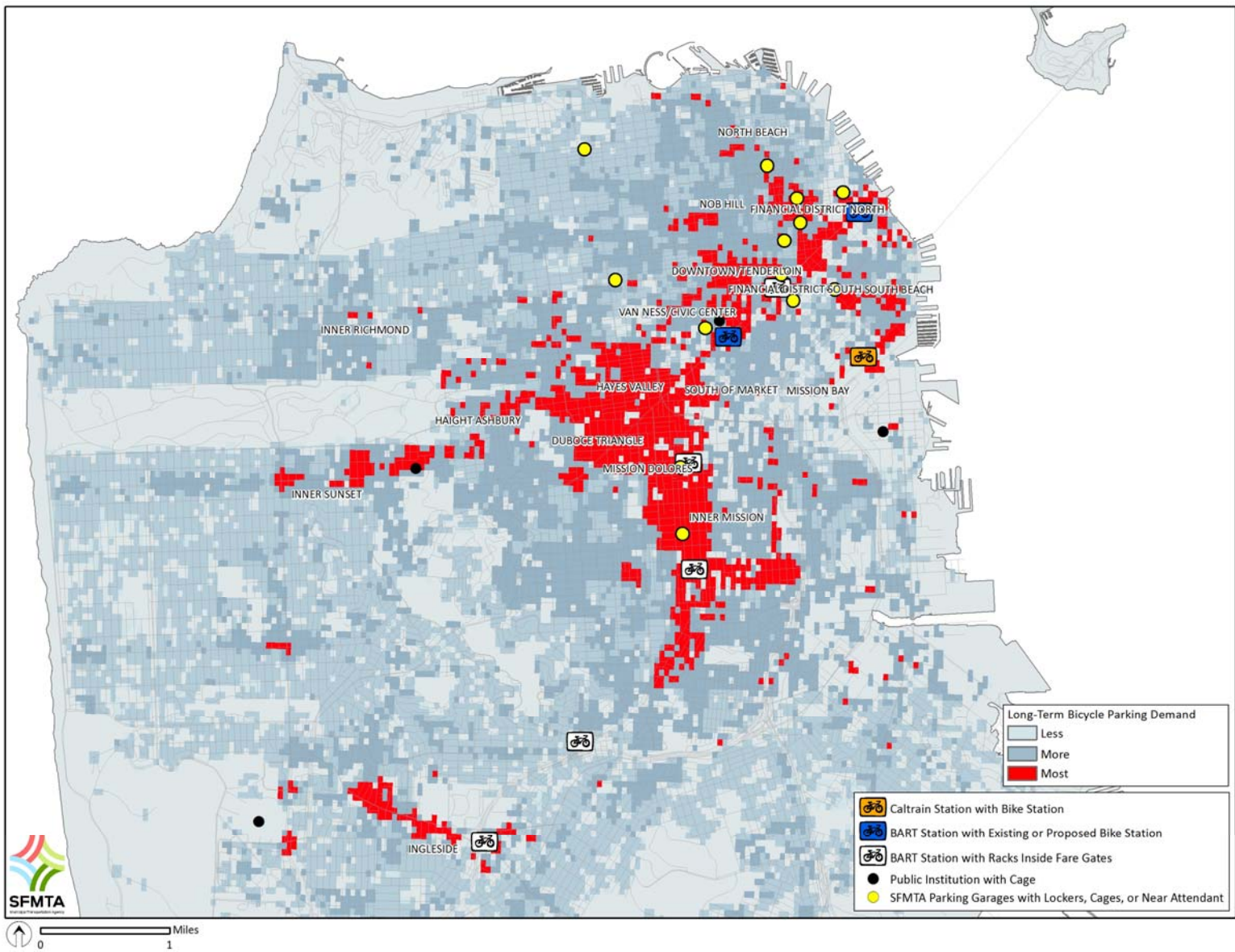

Figure 3 Long-Term Bicycle Parking *High* Demand Results

7. Recommendations for Long-Term Bicycle Parking

This chapter provides recommendations for expanding the supply of unattended and attended long-term bicycle parking in San Francisco. Recommendations are for two phases: a near-term priority phase during which the SFMTA can pilot and evaluate bicycle parking facilities and a future phase with an expansion of long-term bicycle parking facilities throughout San Francisco. The priority phase allows the testing of different facilities, especially those that are new to San Francisco and provides opportunities to test demand at specific locations. Based on bicycle parking use at new facilities and implementation during the priority phase, the SFMTA will respond to the demonstrated need with planned future implementation.

7.1. Locations in San Francisco

Building on the analysis presented in the needs assessment (Chapter 6), this Strategy recommends additional or new long-term bicycle parking facilities where there is the greatest existing and future demand. The maps included in Chapter 6 show that the greatest demand is in downtown San Francisco, in and around the Mission District, the Inner Sunset, Duboce Triangle, Hayes Valley, north of downtown including Nob Hill and North Beach, Ingleside near Balboa Park BART Station and City College of San Francisco, and near the West Portal MUNI Station. This Strategy recommends that new long-term bicycle parking facilities be concentrated in these areas for the following reasons.

1. Bicycle on Transit Restrictions (downtown San Francisco, the Mission District, Ingleside, West Portal) –bicycles are not currently allowed on MUNI light rail vehicles at all hours. Therefore people need to leave bicycles in these locations when transferring from bicycle to rail or vice versa.
2. High Bicycle Volumes (downtown San Francisco, the Mission District) – based on SFMTA count information and the long-term bicycle parking survey, the greatest demand for long-term bicycle parking is in downtown San Francisco (given the highest density of jobs, transit, bikeways, etc.) and the Mission District. Large numbers of bicyclists require large numbers of bicycle parking spaces.
3. Topographic and Geographic Constraints (Ingleside, Inner Sunset, West Portal) – bicycling around the hills of San Francisco is possible but is challenging in some areas. These neighborhoods have the greatest challenge of topography and geography and bicyclists tend to ride locally and connect to transit accessing downtown San Francisco. Bicyclists need places to leave bikes when making the modal transfer
4. High Population Density (Mission District, Duboce Triangle, Hayes Valley, North Beach, Nob Hill) – as suggested by the long-term bicycle parking survey results, the most populous areas of the city have great demand for bicycle storage given that many of these apartments and condominiums do not have secure bicycle parking available for residents.

7.2. Types of Facilities

This section provides recommendations for improving and implementing the three broad categories of bicycle parking (bicycle lockers, unattended, and attended bicycle parking) in San Francisco including amounts, locations and capital and operating cost estimates.

7.2.1. Bicycle Lockers

The Strategy for Long-Term Bicycle Parking recommends on-demand bicycle lockers in a number of locations. In the future, if parking demand exceeds locker capacity, then the recommendation is for the SFMTA to consider adding additional lockers or, if possible given space and operating constraints, adding an unattended bicycle room or area. Unattended facilities offer less security but more capacity than lockers.

Locations

SFMTA Parking Garages

This Strategy recommends implementation of on-demand bicycle lockers in San Francisco given the success of these facilities at Bay Area BART Stations. As stated in Chapter 4 and listed in Table 10, there are 52 existing bicycle lockers in SFMTA parking garages with the traditional lock-and-key design. Some of these existing facilities are broken or misused for non-bicycle storage, and SFMTA is currently seeking funds to replace them with e-lockers. The SFMTA should work with the parking garage operators to verify that the lockers are placed in the most appropriate locations, increasing their likelihood of use and turnover. For example, in some garages there are two sections for vehicle parking: one section for hourly parking and one section for monthly parking. At some garages the hourly parking section is closed during late-night hours. In this situation, *if operationally feasible*, the lockers should be placed in the monthly section of the garage and people parking bicycles should have 24 hour access. Once in place, the SFMTA should monitor use of the lockers to confirm that there is demand. In low-demand locations, the SFMTA should consider moving the lockers to other garages or surface parking lots with demonstrated or strong potential for demand.



Table 10 SFMTA Garages with Existing Lockers

Garage Name	Address	Bicycle Lockers
Ellis O'Farrell	123 O'Farrell St	8
Fifth & Mission	833 Mission St	16
Golden Gateway	250 Clay St	8
Saint Mary's Square	433 Kearny St	6
16th & Hoff	42 Hoff St	6
Sutter Stockton	444 Stockton St	8
Total		52

Transit Connections

Secure bicycle parking near the 16th Street, 24th Street and Balboa Street BART Stations will increase the number of transit riders bicycling to the stations and then transferring to the regional rail system. There is long-term bicycle parking demand in these locations but there is limited space to provide larger long-term bicycle parking facilities at the stations. BART is researching opportunities to develop unattended long-term bicycle parking on the concourse levels of the Mission Street stations and the SFMTA recommends additional facilities where there are existing nearby SFMTA surface lots or where other opportunities arise such as in publicly owned public spaces near transit stations and stops. These additional SFMTA facilities will provide long-term bicycle parking options for BART users as well as residents in the area. Priority opportunities for on-demand lockers near these BART stations are at the Lilac Street lot in the Mission District, located one and a half blocks from the 24th Street BART Station and the San Jose Avenue lot in Ingleside, adjacent to the Balboa Park BART Station.

The SFMTA also recommends on-demand bicycle lockers near high-use MUNI rail stops. MUNI does not permit non-folding bicycles onboard light rail vehicles, so providing secure bicycle parking nearby will help facilitate this modal transfer. One priority location is near 9th Avenue and Irving Street where commercial land uses, high MUNI rail use and demand for long-term bicycle parking all converge.

Other opportunities for bicycle lockers are at regional vanpool and carpool drop-off and pick-up locations in San Francisco. Given the volumes of private bus lines traveling to and from Silicon Valley and vanpools to the East Bay and North Bay, the SFMTA should consider installation of on-demand bicycle lockers at these connections.

The short-term recommendation is a minimum of four (one single quad) of lockers at 16th Street, 24th Street and Balboa Street BART Stations and 9th Avenue and Irving Street MUNI stop.

Market Street, POPOS, and Private Garages

This Strategy also recommends on-demand bicycle lockers where space allows along Market Street. Given the wide sidewalks, there may be opportunities to place bicycle lockers on the sidewalk that should be considered with future implementation of the Better Market Street Plan. The City of Oakland has placed e-lockers on wide sidewalks proximate to BART entrances in downtown at Frank Ogawa Plaza and at 19th Street and Broadway. Alternatively, installation of bicycle lockers could occur on privately owned public open spaces (POPOS) along Market Street and in the Financial District of San Francisco where there is limited sidewalk space.

The SFMTA should work with the City Planning Department to confirm that bicycle lockers can fit into the existing City Planning requirements for POPOS and the agencies should develop an incentive program for property owners to place long-term bicycle parking, such as on-demand lockers in POPOS and private garages. Property managers and owners may consider the overall aesthetics of bicycle lockers and may wish to implement facilities with better design than the traditional bicycle lockers.

Residential Areas

A pilot program for residential collective bicycle lockers positioned in the parking lane or where space allows on the sidewalk for long-term bicycle storage in residential areas should be pursued. Such facilities would be new to San Francisco and perhaps to the United States and the initial phase should be the installation of two to four facilities followed by an evaluation of their use and benefit. This Strategy recommends that these facilities operate with an electronic, on-demand system, at least initially, to allow turnover and use to be optimized and to help ensure that the lockers are used to permanently store bikes. Use would be restricted to residents living only in buildings neighboring the lockers. As recommended by the CROW Design Manual, testing of these residential long-term bicycle parking facilities should occur in the older, higher-density residential areas with the most long-term bicycle parking demand and where there is higher than average bicycle thefts.⁴² Given these criteria and a preliminary subjective review of information, the Mission District, the Inner Sunset, Duboce Triangle, Hayes Valley and north of downtown in Nob Hill and North Beach may provide the best locations due to high long-term bicycle parking demand. These collective facilities are relatively portable so evaluating different locations is possible.



Examples of residential collective bicycle lockers in London (top) and Rotterdam (bottom)

If collective lockers prove successful, the SFMTA should develop an application process for future implementation of collective bicycle lockers similar to the existing bicycle corral application process. Interested property owners could apply to have a collective bicycle locker located in front of their property and agree to maintain the area free of debris. The SFMTA would then establish criteria and score locations to determine the most appropriate placement. The SFMTA could also work with the Department of Public Works and private properties interested in purchasing these facilities and placing them in the public right-of-way.

Costs & Operations

On-demand bicycle lockers vary in price depending on the power source, access keys, and overall design of the locker. Table 11 lists estimates for capital costs for bicycle lockers. Lockers for use at SFMTA Parking Garages and Surface Lots would most likely come in groups of four lockers. The Market Street lockers would be more expensive assuming that property managers and owners would want better looking facilities than the standard lockers recommended for SFMTA garages and transit connections. The residential or collective lockers are made in different, larger designs and are more costly.

⁴² CROW, *Design Manual for Bicycle Traffic*.

Table 11 SFMTA Capital Costs for Priority Bicycle Lockers*

Location	Cost	Initial Phase		Secondary Phase	
		Number	Total Cost	Number	Total Cost
SFMTA Parking Garages	\$3,000	52	\$156,000	-	-
Transit Connections	\$3,000	12	\$36,000	-	-
Market Street ⁴³	\$4,200	-	-	10	\$42,000
Residential Neighborhoods	\$8,400	4	\$33,600	8	\$67,200

*Conceptual level estimate includes 20% contingency

Like the existing BikeLink lockers at BART stations, the SFMTA bicycle lockers should have a nominal cost per hour charged to users (approximately \$0.05 per hour). This will ensure that there is turnover between users, aiding in long-term operations. The nominal fee can also be used to offset costs of operations and the software license. The operating costs of bicycle lockers, as listed in Table 12, are lower than the operating costs for other long-term bicycle parking facilities.

Table 12 Annual Operating Costs for Priority Bicycle Lockers

Location	Annual Cost	Initial Phase		Secondary Phase	
		Number	Annual Cost	Number	Annual Cost
SFMTA Parking Garages	\$200	52	\$10,400	-	-
Transit Connections	\$200	12	\$2,400	-	-
Market Street ⁴⁴	\$200	-	-	10	\$2,000
Residential Neighborhoods	\$400	4	\$1,600	8	\$3,200

7.2.2. Unattended Bicycle Parking

The San Francisco Planning Code sets requirements for secure long-term bicycle parking for buildings, including offices, retail properties, apartment and condominium buildings and schools. The type of parking most commonly required is an unattended bicycle area. Beyond the code requirements, this Strategy recommends unattended bicycle areas or rooms near transit stations with high volumes of bicyclists and transit riders and in locations with a high density of housing and few existing long-term bicycle parking opportunities. Alternatives to on-demand unattended bicycle facilities are recommended where users arrive at one time during commute hours. If each user has to use a keycard and wait until the door has closed from the previous entry before entering themselves, then queuing and significant delays can result, causing people to miss transit connections.

⁴³ Privately funded.

⁴⁴ Ibid.



SFMTA Bicycle Strategy

April 2013



Goal 2

Increase convenience for trips made by bicycle



The small footprint of a bicycle makes it a convenient and flexible way to travel. Good parking facilities are vital for reducing bicycle theft. Bicycle sharing encourages spontaneous bicycle trips. Both bicycle parking and bicycle sharing extend public transit's reach and improve its performance.

Objective 2.1: Increase the supply of short-term bicycle parking.

Objective 2.2: Increase the supply of adequate long-term bicycle parking

Objective 2.3: Expand bicycle sharing in core bicycle areas.

The performance indicators listed below are the key measures that will indicate how the SFMTA is performing with respect to increasing bicycle convenience.

PROPOSED KEY PERFORMANCE INDICATORS	PROPOSED TARGETS		
	FY 2014	FY 2016	FY 2018
OBJECTIVE 2.1: Short-term bicycle parking spaces and coverage	Establish short-term bicycle parking baseline of 1 rack on each neighborhood commercial block.	Provide additional short-term bicycle parking in areas identified via user survey or online crowd sourcing.	
OBJECTIVE 2.2: Long-term bicycle parking space and coverage	Establish one new attended and one new unattended secure bicycle parking station.	Establish a second new attended and second new unattended secure bicycle parking station.	Establish a third new attended and third new unattended secure bicycle parking station.
	Replace 100% of existing SFMTA bicycle lockers with e-lockers	Incorporate e-lockers into secure bicycle parking facilities.	Incorporate e-lockers into secure bicycle parking facilities.
	Install four residential collective bicycle lockers	Install four additional residential collective bicycle lockers	Install four additional residential collective bicycle lockers
OBJECTIVE 2.3: Bicycle sharing system coverage.	Implement Phases I and II of the bicycle sharing system. (1000 bikes) Explore opportunities to incorporate diverse vehicle types, including e-bicycles and pedalecs.	Implement Phase III of the bicycle sharing system (2,750 bikes, 25% of City)	Expand the bicycle sharing system to include key satellite service areas.









SFMTA Strategic Plan

Fiscal Year 2013 - Fiscal Year 2018

SFMTA

Municipal Transportation Agency

KEY ISSUES AND OPPORTUNITIES FOR OUR SYSTEM, CITY AND REGION

Focus Area	Issues	Opportunities
	<p>Projected 25% increase in jobs and 15% increase in population by 2035; more seniors, fewer families with children</p> <p>Funding, particularly federal and state, is declining</p> <p>Local and regional funding becomes more important to finance our capital and operational needs</p> <p>Insufficient resources to operate and maintain the transportation system and to address state-of-good-repair and expansion needs</p> <p>Different modes are not integrated, systems are hard to navigate and require separate payment</p> <p>Mixed traffic, circling, and double parking slows down transit, taxis, and deliveries</p> <p>Electric vehicle parking demand impacts public garages</p>	<p>Better linkages between transportation and smart land uses can create efficiencies in future development</p> <p>New funding sources and new funding partnerships can help meet growing needs</p> <p>New technology and good planning will allow integration of all modes, customer information, and payments</p> <p>Dedicating lanes and spaces for shared mobility can be effective</p> <p>City is positioned to have a greater voice in regional, state, and federal forums</p> <p>Transportation system can benefit from zero- and low-emission vehicles</p>
	<p>Population aging</p> <p>Demand for walking is increasing</p> <p>Most collisions are preventable</p> <p>Traffic speeds not compatible with land uses in key locations</p>	<p>Public support to implement best practices in street design and the Mayor's Directive on Pedestrian Safety</p> <p>Technology applications for speed enforcement and education</p> <p>Infrastructure support for walking is cost-effective</p>
	<p>Transit system safety</p> <p>Transit speeds lowest in the nation; vehicles are operating mostly in mixed traffic</p> <p>Peak crush loads mean people shifting back to auto, with some switching to bicycle and walking</p> <p>State-of-good-repair and major maintenance needs</p> <p>Existing vehicle fleet is difficult for families to use and needs major overhaul</p> <p>Many stops not fully accessible</p>	<p>New technology and educational opportunities to improve system safety</p> <p>Ability to speed transit and increase reliability through cost-effective measures like dedicated transit lanes, all-door boarding, stop spacing, and signal priority tools</p> <p>Upcoming fleet replacement cycle</p> <p>Public support to prioritize the funding of mission-critical assets to ensure the preservation of a safe and reliable system</p> <p>Capital and operations funding through development agreements</p>
	<p>Interest in bicycling is growing; mode share expected to double in next five years</p> <p>Bicycle network connectivity is fragmented</p> <p>Limited bicycle parking supply</p>	<p>Expanding bicycle infrastructure is cost-effective: lanes, parking facilities, signals, and marketing yield high returns</p> <p>Bike sharing provides cost-effective access for inner-urban trips</p> <p>Business community is open to bicycle parking as prudent customer strategy</p>
	<p>Parking is not efficiently used and creates congestion through double parking and circling; results in slower transit speeds</p> <p>Residential parking is not consistent across city</p> <p>Disabled placard abuse is compromising access to parking spaces for the disabled community</p> <p>Demand for parking for family vehicles is increasing</p> <p>State Vehicle Code limits best practices in parking management</p>	<p>New technologies make it easier to find and pay for parking</p> <p>Demand-responsive parking pricing</p> <p>Parking maximums and California's Parking Cash-Out Law provide incentives for <i>Transit First</i> modes</p> <p>Growing support to amend the State Vehicle Code to allow flexibility in local parking management and better parking management strategies across the state</p>
	<p>Demand for taxis not being met</p> <p>Improved collaboration is needed for carshare/vehicleshare growth</p> <p>Shuttle and ridesharing providers need expanded coordination and partnerships with city</p>	<p>Public support to identify the number of taxis needed in the city and improve taxi services</p> <p>Growth of carshare and vehicleshare usage leads to the reduction of single occupant automobile trips</p> <p>Ridesharing and regional shuttles can mitigate regional traffic coming to the city</p>

Metropolitan Transportation Commission

Regional Bicycle Plan for the San Francisco Bay Area 2009 Update

March 2009



Prepared by:

Eisen | Letunic
Transportation, Environmental and Urban Planning
www.eisenletunic.com



In association with:
Fehr & Peers transportation consultants

- 4.4 Offer training sessions on “best practices” bicycle facility design and safe cycling practices.

Goal 5.0: Multimodal integration

Work toward developing seamless transfers between bicycling and public transportation.

Policies

- 5.1 Encourage transit agencies to provide, maintain and promote convenient and secure bicycle parking at transit stops, stations and terminals, including racks, bike lockers, in-station bike storage and staffed and automated bicycle parking facilities.
- 5.2 Ensure that bicycles are accommodated on all forms of public transit whenever possible, including on local and regional systems.
- 5.3 Foster collaboration between local jurisdictions and regional transit agencies to improve bicycle access to transit stations in the last mile

surrounding each station. Improvements to ease, speed, convenience and safety of bicycle access, including by means of signage and bikeways, should be considered.

Goal 6.0: Comprehensive support facilities & mechanisms

Encourage the development of facilities and institutions that contribute to a bicycle-friendly environment.

Policies

- 6.1 Encourage development of facilities at transit stations that provide long-term bicycle storage, bicycle repair and bicycle rental.
- 6.2 Encourage local jurisdictions to adopt ordinances requiring bicycle parking and storage and to offer incentives to employers that provide enclosed, sheltered bicycle parking for their employees and, when feasible, their customers.
- 6.3 Encourage local jurisdictions to provide shower and locker facilities, or to make arrangements for access

to local health clubs, for all new developments and major redevelopments.

- 6.4 Continue to require cities and counties to form and maintain bicycle advisory committees, and to develop and update comprehensive bicycle plans, as a condition for receiving Transportation Development Act (TDA) funds.

Goal 7.0: Funding

Develop an equitable and effective regional funding and implementation process.

Policies

- 7.1 Continue to fund bicycle projects to complete the RBN.
- 7.2 Consider the benefits of bicycling improvements in the allocation of all transportation funding and in developing performance measures, including vehicle trip and greenhouse gas reduction, public health and community livability.
- 7.3 Pursue additional fund sources to continue MTC's Safe Routes to Transit program once Regional

MAP OF PROJECT LOCATIONS

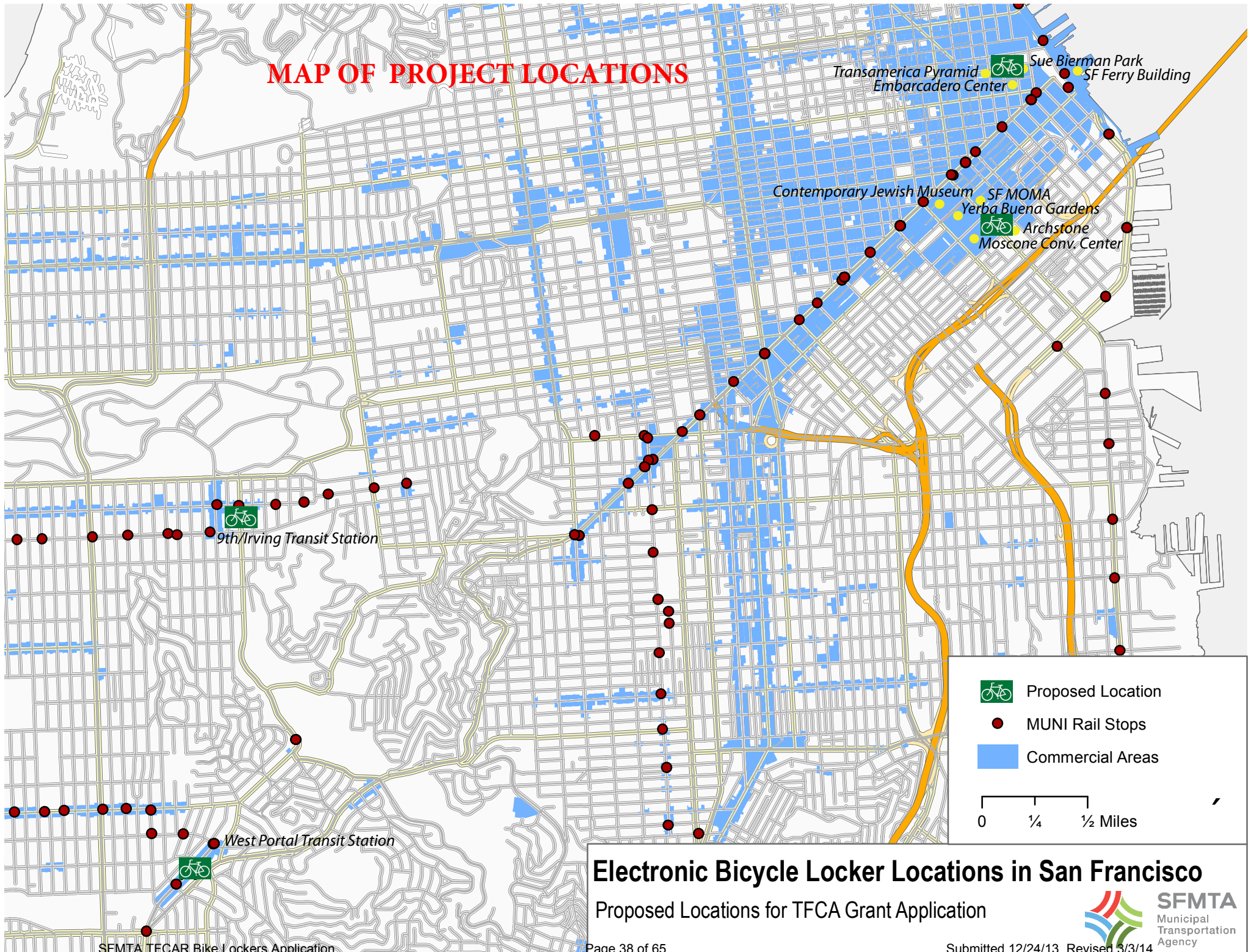

Electronic Bicycle Locker Locations in San Francisco

Proposed Locations for TFCA Grant Application





PART 4. CLEAN AIR POLICIES AND PROGRAMS

MSM A-1 – Promote Clean, Fuel-Efficient Light and Medium-Duty Vehicles (pg. B-1)

MSM A-2 – Zero Emission Vehicles (ZEV) and Plug-in Hybrids (pg. B-6)

Policies and Actions:

- A) Agency non-revenue passenger vehicles: The SFMTA has a green purchasing policy for the Agency's non-revenue vehicle fleet, based on the City's Healthy Air and Clean Transportation Ordinance (HACTO). The HACTO requires an overall fleet size reduction of 20 percent by 2015, and the retirement of all vehicles older than 12 years. Further, the SFMTA purchases replacement vehicles only after obtaining SF Environment approval, indicating that the vehicle is electric, or else the cleanest available, in most cases powered with alternative/renewable fuels.
- B) Parking Control Officer (PCO) vehicles: This category of vehicle is unique. EVs are beginning to challenge the sole manufacturer (Go-4) of three-wheeled, gasoline parking control vehicles.
- C) Taxis: The SFMTA manages the City's taxi fleets, including requirements for fleet greening.

Current Progress:

- a) All SFMTA diesel vehicles are fueled with B20 (a 20% biodiesel blend with conventional diesel) produced from San Francisco restaurant grease. Non-Revenue Biodiesel Pilot
- b) The SFMTA is testing the leading alternatives with the goal of fleet greening as EVs become available in large enough numbers and the ability to handle San Francisco duty cycle requirements.
- c) All 1,500 taxis in San Francisco are either CNG or hybrids. Fifty ZEVs (25 Better Place, and 25 Nissan Leafs) have been ordered and are expected to join the taxi fleets in 2013.

MSM A-3 – Green Fleets (pg. B-10)

The following is in addition to the Policies and Actions, and Current Progress, listed for MSM A-1 and MSM A-2:

Policies and Actions:

- A) Transit bus fleets: The SFMTA policy for transit fleet greening is outlined in the Agency's Clean Air Plan - Zero Emissions 2020. The policy calls for a conversion from conventional diesel buses to electric-drive buses, consistent with the Agency's existing electric trolley bus fleet. While evaluating the viability of ZEBs prior to full conversion, the Agency will use interim, or "bridge" electric-drive and sustainable fuel technologies in the form of hybrid buses fueled biodiesel.

Current Progress:

- d) SFMTA buses produce the lowest average passenger emissions of any transit agency in California. Fifty-nine percent of SFMTA's 1,100 vehicle transit fleet are zero emission, while 38 percent of the Agency's 819 buses are zero emission. Additionally, the SFMTA operates 86 electric-drive hybrid buses. All SFMTA diesel buses are fueled with B20 produced from San Francisco restaurant grease.

MSM A-4 – Replacement or Repair of High-Emission Vehicles (pg. B-14)

Not applicable.

MSM B-1 – Fleet Modernization for Medium-and Heavy-Duty On-Road Vehicles (pg. B-20)

Not applicable.

MSM B-2 – Low NOx Retrofits in Heavy-Duty On-Road Vehicles (pg. B-23)

Policies and Actions:

Cleaire Longview PM and NOx reduction devices are installed on all SFMTA conventional diesel buses.

Current Progress:

The SFMTA has had Level-1 NOx reduction devices installed on 426 buses since 2007.

MSM B-3 – Efficient Drive Trains

See Policies and Actions, and Current Progress, for MSM A-3, above.

MSM C-1 – Construction and Farming Equipment (pg.B-30)

Not applicable.

MSM C-2 – Reduce Emissions from Lawn and Garden Equipment (pg.B-34)

Not applicable.

TCM A-1 – Local and Area-wide Bus Service Improvements

SFMTA is currently in the process of improving its bus service through two innovative projects: Van Ness Bus Rapid Transit, which will create a priority bus lane and speed travel times along the Van Ness travel corridor; and the Transit Effectiveness Project, a series of projects and initiatives that will strengthen the agency's ability to respond to current travel needs, provide a blueprint for future service, apply best practices of service delivery, and promote the SFMTA's long-term financial stability. SFMTA is also soliciting funds for fleet procurement which will replace diesel buses with hybrid buses.

TCM A-2 - Local and Regional Rail Service Improvements (pg. C-7)

Construction of the Third Street Light-Rail Central Subway is currently underway. The Central Subway Project will construct a modern, efficient light-rail line that will improve public transportation in San Francisco. This new 1.7-mile extension of Muni's T Third Line will provide direct connections to major retail, sporting and cultural venues while efficiently transporting people to jobs, educational opportunities and other amenities throughout the city.

TCM B-1 - Freeway and Arterial Operations Strategies (pg. C-12)

The SFMTA is responsible for designing, directing and managing all traffic engineering functions within San Francisco, including placement of signs, signals, traffic striping, and curb markings to promote the safe and efficient movement of people and goods throughout the City. The SFMTA's SFgo program uses the latest signal technology to design, time and operate the city's traffic signals, message signs and cameras to improve the safety and operation of the city's signal system.

TCM B-2 - Transit Efficiency and Use Strategies (pg. C-17)

SFMTA has been a key partner in the implementation of Clipper. New faregates accepting Clipper have replaced the old turnstiles in all Muni Metro stations, and transit vehicles have been outfitted with Clipper readers at all doors (to facilitate rear-door boarding.)

TCM B-3 – Bay Area Express Lane Network (pg. C-22)

Not applicable.

TCM C-1 - Voluntary Employer-Based Trip Reduction Programs (pg. C-33)

The SFMTA participates in the citywide Sustainable Commuting Program encouraging staff to use non-private auto transportation modes. All new staff members are given the opportunity to participate in the Commuter Benefits program and given information about the regional rideshare program run by the San Francisco Department of the Environment. The SFMTA also provides a pool of hybrid or CNG cars for bicycles for trips taken during work hours.

TCM C-2 - Safe Routes to Schools and Safe Routes to Transit Programs (pg. C-39)

The SFMTA's School Area Safety Program strives to make streets near San Francisco's public and private schools safer for walking, bicycling and public transportation. The School Area Safety Program coordinates with other city departments and the San Francisco Unified School District (SFUSD) to provide adult crossing guards, traffic enforcement, school crosswalks, school warning signage, and school bus and passenger loading zones. The School Area Safety Program also leverages regional, state and federal Safe Routes to School grant funds to make safety-focused infrastructure improvements near schools such as curb extensions, pedestrian refuge islands, and traffic signals.

TCM C-3 - Ridesharing Services and Incentives (pg. C-44)

In addition to encouraging staff members to participate in the city and regional commute programs, the SFMTA is currently studying the effects of regional commute shuttles on the transportation system in San Francisco and developing and overall transportation demand management and vehicle sharing strategies for the city.

TCM C-4 - Conduct Public Outreach & Education (pg. C-49)

The SFMTA regularly runs bicycle and pedestrian campaigns to increase awareness and improve safety. Recent efforts include giveaways of bicycle bells and lights and a print media campaign to encourage walking your bike on the sidewalk. The SFMTA is also a key partner in the Bike-to-Work Day, Bike-to-School Day and Walk-to-School Day programs in San Francisco encouraging and educating residents, commuters and children on transportation mode choice and options. Additionally, the SFMTA partners with other city agencies to produce and distribute travel information related major events like the America's Cup, Fleet Week and the World Series.

TCM C-5 - Smart Driving (pg.C-53)

Not applicable.

TCM D-1 - Bicycle Access and Facilities Improvements (pg. C-58)

SFMTA continues to plan and implement a variety of bicycle projects including expanding bike parking, planning for a regional bike sharing network and constructing new bike lanes. Since the lifting of the bicycle plan injunction in August 2010, SFMTA has completed several projects including the 19th Avenue mixed-use path, JFK Drive cycle track, Cargo Way separated bike lanes, Market Street bicycle lanes (between 17th and Octavia), and more. A variety of projects are also scheduled for implementation in 2013.

TCM D-2 - Pedestrian Access and Facilities Improvements (pg. C-64)

Working from previous and ongoing pedestrian safety and walkability efforts along with direction from the mayoral directive calling for a reduction of severe and fatal injuries of 50% by 2021, the SFMTA is working with the SF Department of Public Health, the Pedestrian Strategy identifies a number of capital improvements and supportive programs, policies and institutional reforms to meet the city's goals.

TCM D-3 – Local Land Use Strategies (pg. 69)

The SFMTA works as an active partner with SF Department of City Planning and the Mayor's Office of Workforce and Economic Development to develop the transportation elements of large-scale new developments. In project areas like Treasure Island, Hunter's Point Shipyard and Park Merced, the SFMTA has coordinated expansions and enhancements to the transit, bicycle and pedestrian networks in order to reduce the need for a private automobile for residents and visitors to those new communities.

TCM E-1 – Value Pricing Strategies (pg. C-75)

Not applicable.

TCM E-2 - Promote Parking Policies to Reduce Motor Vehicle Travel (pg. C-79)

In November 2008, the SFMTA Board of Directors approved legislation that enabled the SFpark pilot project. It defined the SFpark pilot areas and specified, as required by city law, the ranges and limits for rates and time limits, as well as parking availability targets. The SFMTA installed new parking meters and parking sensors in pilot areas across the City through the end of 2010. In April 2011, real-time parking data was made publicly available at SFpark.org. Since then, the SFMTA has implemented demand-responsive pricing in SFpark pilot areas. It continues to monitor the project closely.

TCM E-3 - Implement Transportation Pricing Reform (pg. C-86)

SFMTA is currently participating in a Statewide Transportation Needs Assessment led by the California Transportation Commission to identify and estimate new revenue sources for transportation improvements. SFMTA has been an active member of the working group and submitted policy proposals and revenue estimates to the report, which will be finalized and submitted to the CTC in the coming months.



VENDOR QUOTE

eLock Technologies, LLC

PROPOSAL

Date: 2/24/2014
Proposal # 2013-031B

Proposal For:
SFMTA
1 South Van Ness Avenue
7th Floor
San Francisco, CA
ATTN: Matt Lasky
SFMTA Sustainable
Streets Division
Matt.Lasky@sfmta.com
415.701.4762

Notes:

eLocker Equipment for SFMTA

1 Moscone Walkway (Moscone Garage)						
	Product/ Options	Quantity	Spaces	Unit Price	Extended	
Unit	Double eLocker	4	8	\$7,595.00	\$30,380.00	
Finish	Standard: Stainless Steel	4		\$0.00	\$0.00	
Roof	Standard: Blue	4		\$0.00	\$0.00	
Side Panels	Standard: Bike Perf Panel	8		\$0.00	\$0.00	
Power Supply	Standard: Solar / Alk Back	8		\$50.00	\$400.00	
2 Golden Gateway Garage						
	Product/ Options	Quantity	Spaces	Unit Price	Extended	
Unit	Quad eLocker	3	12	\$9,750.00	\$29,250.00	
Finish	Standard: Stainless Steel	3		\$0.00	\$0.00	
Roof	Standard: Blue	6		\$0.00	\$0.00	
Side Panels	Standard: Bike Perf Panel	6		\$0.00	\$0.00	
Power Supply	Option: AC Power	6		\$50.00	\$300.00	
	120VAC Power Supply	1		\$800.00	\$800.00	
<p>Note: One power supply required for each physical group of lockers. For multiple freestanding units to be connected to a common power supply, they must each have stub-outs for in-slab conduits or raceways which will house low voltage wires. Low voltage wires must not run more than 100 feet from the power supply. For distances between units greater than 100 feet, multiple power supplies may be needed.</p>						
3 West Portal Lot						
	Product/ Options	Quantity	Spaces	Unit Price	Extended	
Unit	Quad eLocker	1	4	\$9,750.00	\$9,750.00	
Finish	Standard: Stainless Steel	1		\$0.00	\$0.00	
Roof	Standard: Blue	2		\$0.00	\$0.00	
Side Panels	Standard: Bike Perf Panel	2		\$0.00	\$0.00	
Power Supply	Standard: Solar / Alk Back	2		\$50.00	\$100.00	
4 7th & Irving Lot						
	Product/ Options	Quantity	Spaces	Unit Price	Extended	
Unit	Quad eLocker	1	4	\$9,750.00	\$9,750.00	
Finish	Standard: Stainless Steel	1		\$0.00	\$0.00	
Roof	Standard: Blue	2		\$0.00	\$0.00	
Side Panels	Standard: Bike Perf Panel	2		\$0.00	\$0.00	
Power Supply	Standard: Solar / Alk Back	2		\$50.00	\$100.00	

CONTINUED BELOW

Software				
		Quantity	Unit Price	Extended
Initial License	Initial BikeLink™ Software License (per controller)	18	\$1,000.00	\$18,000.00

Transportation and Install				
		Quantity	Unit Price	Extended
Transportation & Install	Transport and install at four San Francisco locations (per space)	28	\$200.00	\$5,600.00

Access Devices				
		Quantity	Unit Price	Extended
User Cards	\$20 BikeLink Cards for for end users	0	\$16.00	\$0.00
Electronic Master Card	Manager Card	0	\$50.00	\$0.00
Access Key	Service Access Key	0	\$20.00	\$0.00

Note: 2 ea. Service Access Key and Manager Card standard provision one time-per Customer. SFMTA will already have key and card from existing installation.

eLocker Equipment TOTAL \$111,704.70

Service and Operations Plan

		Years	Spaces	Unit Price	Total
Service Plan	Annual Service and Operations Plan	5	28	\$120.00	\$16,800.00
	Includes: preventative maintenance, parts replacement, software license renewal. See Service and Operations agreement for more details				
Discount	Adjustment for BAAQMD 2013 discounted pricing (if conditions are met)	1	28	-\$120.00	-\$3,360.00
				Service & Operations Plan TOTAL	\$13,440.00

eLocker Equipment and Service & Operations Plan TOTAL \$125,144.70

eLocker™ Purchasing & Delivery Terms and Conditions

General Terms and Conditions

I. GENERAL CONDITIONS

This agreement shall be governed by the Uniform Commercial Code as adopted in the State of California. There are no understandings, terms or conditions not fully expressed herein, and no terms and conditions in lieu of or in addition to the terms and conditions hereof shall be binding unless made in writing and signed by eLock. Failure of either party to enforce any of these conditions or to exercise any right shall not affect such party's rights nor shall any failure act as a waiver in respect of other or further occurrences.

II. TERMS OF PAYMENT

Payment is due as described in this Proposal and Acceptance. In the event Customer fails to make payments as agreed, Customer agrees to pay eLock interest on such unpaid amount at the rate of 1.5% per month. In such event eLock may also, at its option defer further shipments until all payments are made or terminate this agreement. Additionally, eLock shall be entitled to costs of collection, including reasonable legal fees in any legal proceedings commenced to enforce payment.

III. WARRANTIES

See document attached, entitled Limited Product Warranty.

IV. TAXES

Prices quoted herein may include sales, use or other taxes imposed upon or in connection with the sale, transfer, transportation or storage of the materials or work covered by this proposal. To the extent that such taxes are included in the price quoted, only such taxes as are presently imposed upon eLock are included, and should there be any other such taxes imposed or any imposition, withdrawal, or change in rate of any such taxes applicable to this Agreement or to materials furnished hereunder, then the prices stated herein shall be adjusted accordingly.

V. SHIPPING SCHEDULE

eLock will establish shipping schedule as closely in accordance with Customer's requested delivery date as practicable. eLock will use its best efforts to ship within the time(s) scheduled, but eLock does not guarantee to do so and eLock assumes no liability for loss, general damages or special or consequential damages due to delays or failure to deliver. eLock may during any periods of shortage due to causes beyond the control of eLock or its suppliers, prorate its supply among all of its Customers in such manner as may be deemed equitable in the sole judgment of eLock.

eLock shall not incur any liability to Customer because of any proration hereunder. eLock reserves the rights to make shipment in lots, and to ship in advance of any Customer's estimated delivery schedule, except those dates stipulated not before. Should shipment be held beyond scheduled date for the convenience of the Customer, eLock reserves the right to charge Customer for all expenses incident to such delay and to charge Customer a reasonable amount for storage of such items whose shipment has been delayed.

VI. CUSTOMER DELAYS

Notwithstanding any rights eLock may have to take other action, eLock shall not be held responsible for, nor deem to be in default on account of delays in the performance of this Agreement by Customer including, by way of example, the failure of Customer to deliver any designs, schematics, data or information required under this Agreement, or to respond in a prompt manner to any reasonable request for such material made by eLock. Any such delays by Customer resulting in additional expenses or increased costs of production incurred by such delay, shall be chargeable to Customer.

eLocker™ Purchasing & Delivery Terms and Conditions

VII. MANUFACTURE AND SPECIFICATION

Unless otherwise expressly agreed in writing, the products sold hereunder shall be subject to the eLock's standard manufacturing variations, tolerances, and classifications. All inspections or tests made by or on behalf of Customer to determine compliance with specifications shall be made at eLock's plant prior to shipment unless Customer secures eLock's written consent to make such tests at another location. All charges incident to such inspection or tests, wherever made, shall be paid for by Customer. eLock shall not be responsible for the suitability, performance, adequacy or accuracy of designs, engineering or specifications provided by the Customer for use in manufacturing the products sold hereunder.

VIII. TRANSPORTATION

Prepaid freight charges, if quoted herein, are based on delivery from eLock's plant to the Delivery Location shown in Proposal. eLock reserves the right to designate the common carrier and to ship in the manner it deems most economical. Added costs due to special routing requested by Customer shall be charged to Customer. Added costs due to special packing for Customer-arranged pick-up or transportation shall be charged to Customer. If after the date hereof and on or prior to dates of shipment there shall be any increase or decrease in the tariff freight rates used in determining prices, such increase or decrease on all unshipped goods shall be charged to Customer.

IX. NON-ASSIGNABILITY

This contract may not be assigned without eLock's prior written consent.

X. LIMITATION OF LIABILITY

The remedies of the Customer set forth herein are exclusive. The liability of eLock for any claims, damages, or losses arising out of or related to its performance under this Agreement or the products supplied hereunder shall not exceed the price of the products on which such liability is based. In no event shall eLock be liable for special, indirect, consequential or incidental damages regardless of cause and whether founded upon negligence, breach of express or implied warranty, other tort or breach of contract, or otherwise.

XI. TERMINATION

In the event that Customer terminates all or any portion of this order, eLock shall have the right to charge Customer for all costs already incurred by eLock including the price of any goods or services required to fill this order already committed to by eLock and a reasonable allowance for overhead and profit.

XII. DISPUTE

Any controversy or claim arising out of or relating to a contract or purchase order executed by eLock and Customer for goods and/or services that are a subject of this proposal shall be settled by: a) Mediation. If mediation is unsuccessful; b) Arbitration. Mediation and arbitration proceedings shall be held in San Francisco, California and shall be administered by the American Arbitration Association under its Commercial Mediation or Arbitration Rules.

XIII. SEVERABILITY

If any provision in this Agreement is found to be invalid, illegal or otherwise unenforceable by any court or arbitral tribunal, that determination will not affect any other provision of this Agreement. The invalid provision will be severed from this Agreement and all remaining provisions will continue to be enforceable by its terms and of full force and effect.

Specific Terms and Conditions

XIV. PROJECT LOCATION

As specified in Proposal.

eLocker™ Purchasing & Delivery Terms and Conditions

XV. DELIVERY SITE REQUIREMENTS:

- Level concrete slab (Customer will incur a relocation surcharge if slab is sloped more than 2.5%).
- If direct power is specified, 120VAC connection with accessible breaker, hookup by customer after locker Delivery.
- Truck and trailer access & free parking.
- Restroom access during Delivery.

XVI. MATERIALS/PROCESS/FINISH

eLock reserves the right to substitute superior materials, processes, and/or finishes if specified materials, processes, and/or finishes become unavailable during production.

XVII. ESTIMATED SCHEDULE

1. Estimated schedule based on workload at the time of Proposal. Actual schedule may vary.
2. This product is fabricated for each order, starting when both purchase order and down payment are received.

XVIII. COMPLETION OF DELIVERY, ACCEPTANCE OF PRODUCT

1. Before the start of Delivery, eLock will communicate to Customer the estimated date of Completion of Delivery. At the end of Delivery, eLock will notify Customer of Substantial Completion. Customer will make all reasonable efforts to visit the Delivery while eLock Delivery crew is still on-site, at a time mutually agreeable to Customer and eLock. If Customer cannot visit Delivery site at time mutually agreeable to Customer and eLock, eLock will send Customer a Notice of Substantial Completion of Delivery via email.
2. During this Delivery site visit or review of Notice of Substantial Completion of Delivery, Customer will assess the completion status of the Delivery and, if necessary, create a written Punch List of items requiring further attention, including documentation of what will constitute Clearance of each item on such a Punch List. Punch List will be dated as of the day of the visit or review.
3. If eLock is not notified within 3 business days that a Punch List will be sent, or if a Punch List is not received by eLock within 10 business days of Notice of Substantial Completion, then the Delivery is classified as Complete, Customer has Accepted Delivery, Customer waives all rights to dispute Delivery classification as Complete, and Customer will remit 100% of unpaid portion of Grand Total within 10 business days.
4. If a Punch List is created, eLock will make all reasonable efforts to clear all items on Punch List within 10 business days. Customer will withhold no more than 10% of Grand Total until clearance of all items on Punch List. Customer will remit payment of 100% of the balance due within 10 business days of clearing of all Punch List items.

XIX. INSURANCE:

eLock carries the following insurance coverage. Additional coverage required may result in additional expense, to be added to the contract price.

General Aggregate Liability	\$2,000,000
Products and Completed Operations Aggregate	\$2,000,000
Each Occurrence	\$1,000,000
Auto Coverage	\$1,000,000
Workers Compensation	\$1,000,000
Umbrella	\$1,000,000

eLocker™ Purchasing & Delivery Terms and Conditions

XX. EXCLUSIONS

1. Post-Delivery On-Site Service unless specifically included.
2. Post-Delivery Maintenance unless specifically included.
3. Replacement Battery Packs, unless specifically included.
4. Replacement of Management Devices or Access Devices.
5. Replacement or repair of components damaged by vandalism, neglect, misuse, natural disasters or other conditions beyond eLock's control.
6. Replacement or repair of components damaged by actions of Customer or its agents in violation of written service procedures as documented in Owner's Manual, including but not limited to powerwashing.
7. Custom software or modifications written to Customer's specifications, unless specifically included.

XXI. CONTINGENCIES

1. Contingent on mutually agreed upon terms, conditions and schedules.
2. Contingent upon current labor & material costs.
3. Contingent on approval of samples, if any.
4. eLock shall not be liable for any delay in the performance of or failure to perform under this agreement for any cause not reasonably within the control of eLock (including without limitation acts of God, fire, accidents to or breakdowns or mechanical failures of machinery or equipment, however caused, failure of delivery of materials from normal sources, strikes, lockouts or other labor troubles). In the event of eLock's inability to complete its work under this Agreement by reason of any such cause, eLock may cancel and terminate this Agreement in whole or delay performance hereunder for such reasonable period as may be necessary to permit eLock to complete its performance under this Agreement.

BikeLink™ Software License

SFMTA

1. Overview

This License grants OWNER the right to use only the following programmable instructions for the duration of the term defined in section 3:

- a. Programmable instructions loaded on BikeLink™ equipment listed in section 4;
- b. Programmable instructions loaded on BikeLink™ equipment listed in section 4;
- c. Web-based software accessed with a facility owner login at bikelink.org;

The included components above will hereafter be referred to as “Software.” The features and functionality provided by the Software are described in the Product Manual for Gen 5 eLocker with BikeLink Software 5.01. Services associated with this BikeLink Software License are described in sections 6, 7, and 8 below.

By using the BikeLink™ Software, OWNER understands and agrees that OWNER is joining the BikeLink™ inter-agency facility network, and is subject to the operational terms and conditions outlined herein which are designed to ensure continuing interoperability and access by USERS throughout the network.

This BikeLink™ Software License, provided by eLock Technologies LLC (“ELOCK”) extends to the original purchaser (“OWNER”) or agency with jurisdiction over a BikeLink™ facility or equipment. Rights and responsibilities are automatically transferred to any subsequent Owner or agency with jurisdiction over a BikeLink™ facility or equipment.

2. Definitions

“ELOCK” is the company eLock Technologies LLC, with principal place of business at 800 Heinz Avenue #11 Berkeley CA 94710. ELOCK also does business as “BikeLink™.”

“BikeLink™” is the name of the bike parking and bike sharing system created by eLock Technologies LLC.

“OWNER” is the original purchaser and/or entity with jurisdiction over a BikeLink™ facility.

“ACCESS DEVICE” is any uniquely assigned ID and/or debit device, such as the BikeLink™ Smart Card, issued to a particular USER and registered in the BikeLink™ central database.

“USER” is an individual who has obtained one or more BikeLink™ access devices and is registered in the BikeLink™ database.

“ELOCKER” is a multi-SPACE electronically controlled enclosure.

KIOSK is an electronic control and user interface device that controls access to group parking facilities.

“SPACE” is an enclosure or docking device within an ELOCKER capable of securing one bicycle or other small vehicle.

“CONTROLLER” is an electronic control and user interface device that controls access to one or more SPACES.

“GATEWAY” is a device enabling remote communications with a group of CONTROLLERS at a specific location.

“ADMINISTRATIVE DEVICE” is a device which enables updating software, collection or viewing of CONTROLLER status, settings and data, modification of CONTROLLER settings or states, and ability to gain entry into a SPACE.

3. Term of License

This license agreement shall remain in effect as long as the equipment remains in operation and any software license renewal fees agreed to in the original purchase contract are paid in full, unless terminated by mutual agreement.

4. Equipment

This License is for use of BikeLink Software loaded on equipment listed below, as noted in purchase agreement dated:

Location Name	Quantity	Product	Spaces	Controllers
Moscone Walkway (Moscone Garage)	4	Double eLocker	8	8
Golden Gateway Garage	3	Quad eLocker	12	6
West Portal Lot	1	Quad eLocker	4	2
7th & Irving Lot	1	Quad eLocker	4	2
			TOTAL	18

5. Terms and Conditions

By taking ownership or jurisdiction of equipment using the BikeLink™ system, you (the OWNER, or entity with jurisdiction) agree to the following terms and conditions:

5.01 Scope.

This License is grants OWNER the right to use the Software installed on individual BikeLink™ controllers or Kiosks; it is not a general site license. This license covers only software installed on equipment specifically named in section 4, BikeLink™ access devices, and web-based software accessed with a facility owner login at bikelink.org.

5.02 Cardholder and User Agreement.

OWNER agrees to support and uphold the terms and conditions of the universal BikeLink™ Cardholder and User Agreement, including the privacy policy regarding user information.

5.03 Inter-Agency Facility Network.

OWNER agrees to support the BikeLink™ inter-agency facility network. Specifically, you agree to permit ELOCK dba BikeLink™ to:

- a. Sell ACCESS DEVICES directly to users for BikeLink™ equipment you have purchased,
- b. Provide information and assistance directly to users,
- c. Maintain a complete USER information database which allows any BikeLink™ System Facility Owner to look up an individual USER's information,
- d. Maintain the universal User Agreement on behalf of all Facility Owners,
- e. Track usage at your facility and report, or publish it in an aggregated form,
- f. Attach to each locker a small sign, sticker, label or other similar item, displaying eLock's name, address, BikeLink™ logo, contact information, and product information such as model number,
- g. Attach a sign at each location approximately 18" x 24" in size displaying the BikeLink™ logo and information about how to use the BikeLink™ system.

5.04 Administrative Devices.

OWNER agrees to carefully safeguard BikeLink™ ADMINISTRATIVE DEVICES, and to report their loss to ELOCK immediately.

5.05 Access Restriction.

OWNER may restrict access to a BikeLink™ facility under OWNER's control, by setting up restrictive access zones. To permit access, OWNER obtains from ELOCK a unique access code, associated with each individual user's standard BikeLink™ access device to whom OWNER wishes to grant access. A nominal fee is charged for each access code generated by ELOCK. The access code permanently adds permissions for the specified access zone to the user's BikeLink™ access device.

Information collected upon issuing an access code, beyond the standard information requested from every BikeLink™ user upon access device activation, need not be shared with other facility owners via the BikeLink™ database. However, neither restricting access to OWNER's BikeLink™ Facility by implementing access zones, nor issuing access codes to vetted users, releases OWNER from obligations to the BikeLink™ inter-agency facility network as described above.

USERS who have been issued access codes for a specific BikeLink™ facility retain the ability to access other unrestricted BikeLink™ facilities. Therefore, to protect the interests of other Facility Owners, all USERS' information must be included in the BikeLink™ database even if the USER's primary BikeLink location is one with restricted access.

5.06 Revenue and Rental Rates.

The BikeLink system relies on rental charges accruing in proportion with actual rental time in order to encourage turnover and effectively deter monopolization of the resource by some users. OWNER agrees that the base rental rate of its ELOCKERS will remain set at between \$0.05 and \$0.10 per hour and that the expired rental rate charged whenever a user allows their meter to expire will be set at least two times the base rental rate. OWNER agrees that the system-wide base rental rate may be periodically adjusted in accordance with changes in the U.S. Consumer Price Index. To compensate ELOCK for the services described in section 6, which are provided for as long as the BikeLink™ facility is in operation, OWNER agrees that all revenue up to \$0.10 per hour and 10% of revenue above \$0.10 per hour will be retained by eLock, and that any remaining revenue will be transferred to OWNER on an annual basis. Alternatively, if the base rental rate is set below \$0.05 per hour, OWNER agrees to compensate ELOCK for the difference between the actual rental rate and \$0.10 per hour.

5.07 Primary Contact.

To facilitate ELOCK's provision of the services described in section 6, ELOCK shall be the primary contact for USERS. ELOCK's (dba "BikeLink") contact information shall be displayed prominently at BikeLink™ locations so USERS know who to contact for assistance.

5.08 Use of Facility-Specific Usage Data.

For research and marketing purposes, ELOCK retains the right to collect and publish facility-specific usage data. ELOCK shall report usage data only in aggregate and shall not publicly disclose any user-specific details.

5.09 Transferability.

Upon transfer of ownership or jurisdiction of BikeLink™ equipment by OWNER to another entity, OWNER agrees to provide a copy of this License to that entity and the new owner or entity shall be bound by the terms herein.

5.10 Limitations on Transferability.

The Software may only be used in connection with the BikeLink™ facility or equipment as provided under applicable quote and purchase order or in fulfillment of the specified contract. OWNER may not use, copy or transfer the Software except as permitted herein. OWNER may not sublicense, rent, lease, assign or transfer the Software; provided, however that this License may be transferred to a third party who acquires the BikeLink™ facility or equipment and who agrees to be bound by the terms of this License.

5.11 Exclusions.

This License does not cover custom software that may in the past or future be developed for OWNER or other customers of ELOCK.

5.12 Copyright.

The Software is protected by copyright laws and international copyright treaties. OWNER may NOT: remove, decompile, reverse engineer, disassemble, modify, adapt, translate, overwrite, reprogram, or create derivative works based upon the Software or any part thereof.

5.13 Unauthorized Removal.

Any unauthorized removal of the Software, or the installation of any third-party software to be used in conjunction with the Software, shall void the Limited Product Warranty, and result in termination of this License.

5.14 Limited Product Warranty.

The Limited Product Warranty, incorporated herein by reference, contains the complete and exclusive warranty with respect to the Software licensed hereunder.

5.15 Intellectual Property.

The Software is the property and pre-existing work product of ELOCK. OWNER shall not acquire any rights, including intellectual property rights of any kind or nature, in the Software other than the license set forth herein. This provision extends to new software or software improvements that may be created after this license takes effect.

5.16 Confidentiality.

The Software is the proprietary information of ELOCK and constitutes the confidential information and trade secrets of ELOCK, and may not be disclosed by OWNER to any person.

5.17 Jurisdiction.

This License will be governed by and construed in accordance with the laws of the State of California, United States (excluding conflicts of laws), and shall inure to the benefit of ELOCK and its successors and assigns. If any provision of this License is held by a court of competent jurisdiction to be invalid or unenforceable to any extent under applicable law, that provision will be enforced to the maximum extent permissible and the remaining provisions of this License will remain in full force and effect. Any notices or other communications to be sent to ELOCK must be mailed by certified mail to the following address:

eLock Technologies, LLC
800 Heinz Avenue
Suite 11
Berkeley, CA 94710
U.S.A.
(510) 549-2853

6. Ongoing Services Covered by Rental Revenue

6.01 Access Device Production & Programming.

ELOCK shall produce and program ACCESS DEVICES that are compatible with the current version of BikeLink™ Software.

6.02 Access Device Distribution & Activation.

ELOCK shall maintain an inventory of access devices, and shall provide the following related services:

- Distribution of ACCESS DEVICES to retail vendors.
- 24-hour web and telephone sales and distribution of ACCESS DEVICES and add value codes to USERS.
- 24-hour web and telephone ACCESS DEVICE activation.
- Web-based FAQs and other instructional information.

Note: OWNER may elect to act as a vendor of ACCESS DEVICES. OWNER understands and agrees that ACCESS DEVICES it may choose to sell shall not be different from those sold by other vendors, that such ACCESS DEVICES are subject to the universal BikeLink™ USER Agreement, that they may be used at any BikeLink™ facility, and that USER information associated with all BikeLink™ ACCESS DEVICES must be stored in the BikeLink™ database and available to all BikeLink™ facility owners.

6.03 USER Agreement.

ELOCK shall maintain and periodically update USER Agreement, also known as the “BikeLink™ System Cardholder and User Agreement.” ELOCK shall inform OWNERS and USERS of changes to USER Agreement in accordance with notification obligations defined in USER Agreement.

ELOCK shall maintain USER Agreement link at www.bikelink.org, and take reasonable measures to ensure USERS are informed of USER Agreement before using the BikeLink™ system.

6.04 Remote USER Support.

Upon receiving a query or problem report from a USER, ELOCK shall reply promptly with accurate information to all reasonable inquiries. Upon receiving a technical assistance request from a USER, ELOCK shall create an online problem report, and provide troubleshooting and telephone or email-based problem resolution during normal business hours.

ELOCK shall maintain the following additional remote USER support benefits and services:

- 24-hour telephone support for USERS to report problems, request a free taxi ride, or to request single use access device in cases where USER has lost his or her ACCESS DEVICE.
- Reimbursement of taxi ride costs from BikeLink™ facility up to \$20 in case USER is unable to retrieve bicycle due to an equipment malfunction.
- One-time use cards and ID-verification for lost cards and similar situations.

6.05 USER Database Maintenance.

ELOCK shall maintain a web-based database of USER information and provide OWNER with access to information stored on this database. ELOCK shall maintain an up-to-date off-site database backup.

6.06 Rental Transaction Data.

ELOCK shall maintain rental transaction data that has been uploaded to the BikeLink™ web-based database. ELOCK shall maintain an up-to-date off-site rental transaction data backup. ELOCK shall provide online rental transaction data plotting and data download tools.

6.07 Signage.

ELOCK shall install one sign at each location approximately 18" x 24" in size displaying the BikeLink™ logo and information about the BikeLink™ system. Additional signs may be requested by OWNER for an additional fee.

7. Ongoing Services Covered by User Fees

7.01 ID Check at Group-Access Facilities.

Use of group-access facilities requires an additional vetting step for USERS, referred to as the "ID Check." This ID Check may be performed by ELOCK and may include making a photographic record of a USER's face and current photo ID such as a driver license upon their first use of the group-access facility. ELOCK shall not be obligated to ensure legibility of this photograph. ELOCK may, at its sole discretion, change the requirements and procedures for the ID Check. Once an ID Check has been performed successfully, a unique Access Code is generated for the USER's access device, and automatically loaded onto it by the group-access facility's CONTROLLER. The nominal fee for this Access Code shall be deducted from the balance on the USER's access device and retained by ELOCK.

7.02 On-site User Assistance.

In the event a USER requests on-site assistance in lieu of remote assistance to resolve a problem caused by an ACCESS DEVICE or equipment malfunction, ELOCK reserves the right to charge a reasonable fee directly to the USER for this service.

8. Ongoing Services Covered by Annual Software License Fee

8.01 Software Maintenance for System Interoperability.

To maintain interoperability for BikeLink™ users throughout the BikeLink™ network of facilities, as well as compatibility with evolving changes in USER Access Device technologies, technology security standards, communications networks technologies, and point of sale technologies, ELOCK shall release ongoing Software improvements including:

- Software upgrades
- Security patches
- Ongoing web-based software maintenance

8.02 On-call Network and Web Application Technicians.

ELOCK shall provide specialized technical support services as required to troubleshoot and resolve technical issues that may arise.

8.03 Facility Owner Web Page.

ELOCK shall provide password-protected OWNER's web page customized for OWNER's locations with up-to-date location information, ability to search USER database, ability to generate access codes, geo-coded cardholder location mapping, outreach materials, promotional program tools, access to rental transaction data, and equipment documentation. ELOCK shall provide training to OWNER on use of system at time of initial installation.

8.04 Limitations on USER Database Access by OWNER.

To help ensure the USER information privacy, OWNER access to database may be limited to individual queries, USERS in vicinity of OWNER's facilities, and/or USERS who have previously accessed OWNER's facilities.

8.05 User Support Reporting.

Problem reports prepared by ELOCK shall be available for review by OWNER upon request on a case-by-case basis. USER queries and associated responses prepared by ELOCK shall be available for review by OWNER upon request on a case-by-case basis.

8.06 Service Records.

Service records for any service performed by ELOCK shall be maintained by ELOCK. Service records shall be available for review by OWNER upon request, on a case-by-case basis.

8.07 Exclusions.

- a) Testing, troubleshooting, upgrade, repair, or other services which require an on-site field technician;
- b) Hardware upgrades;
- c) Out-of-Warranty service or replacement for malfunctioning parts;
- d) Repairs needed due to damage caused by conditions beyond ELOCK's control including but not limited to flooding, earthquakes, or other acts of God.

Payment: Any software license renewal fees agreed to in the original purchase contract are payable annually upon the date of OWNER acceptance of product installation. If payment is not received within 60 days of the annual renewal date, services described in section 8 may be suspended.

BikeLink™ Service and Operations Plan

SFMTA

Overview

This document provides notice of the Operating Terms and Conditions for the BikeLink™ System. Please read it carefully.

If optional services are selected, then sections 3, 5, 14, and signature blocks should be filled out accordingly, based on quotations provided by ELOCK.

Operating Terms & Conditions and Supplemental Operating Services Agreement is made and entered into

by and between eLock Technologies LLC, a California limited liability company,
and

SFMTA

hereinafter referred to as “OWNER.”

1. Definitions

“ELOCK” is the company eLock Technologies LLC, with principal place of business at 800 Heinz Avenue #11 Berkeley CA 94710. ELOCK also does business as “BikeLink™”.

“BikeLink™” is the name of the bike parking and bike sharing system created by eLock Technologies LLC.

“OWNER” is the original purchaser and/or entity with jurisdiction over a BikeLink™ facility.

“ACCESS DEVICE” is any uniquely assigned ID and/or debit device, such as the BikeLink™ Smart Card, issued to a particular USER and registered in the BikeLink™ central database.

“USER” is an individual who has obtained one or more BikeLink™ access devices and is registered in the BikeLink™ database.

“ELOCKER” is a multi-SPACE electronically controlled enclosure, including group-access enclosures typically referred to as bicycle parking stations.

KIOSK is an electronic control and user interface device that controls access to group parking facilities.

“SPACE” is an enclosure or docking device within an ELOCKER capable of securing one bicycle or other small vehicle.

“CONTROLLER” is an electronic control and user interface device that controls access to one or more SPACES.

“GATEWAY” is a device enabling remote communications with a group of CONTROLLERS at a specific location.

“ADMINISTRATIVE DEVICE” is a device which enables updating software, collection or viewing of CONTROLLER status, settings and data, modification of CONTROLLER settings or states, and ability to gain entry into a SPACE.

2. Locations Covered

Location Name	Quantity	Product	Spaces	Controllers
Moscone Walkway (Moscone Garage)	4	Double eLocker	8	8
Golden Gateway Garage	3	Quad eLocker	12	6
West Portal Lot	1	Quad eLocker	4	2
7th & Irving Lot	1	Quad eLocker	4	2
			0	
			TOTAL	18

3. Plan and Duration

Plan selected:

	Term (years)	Spaces	Unit Price	Total
Annual Service and Operations Plan	5 years	28	\$120.00	\$13,440.00

First year free

Coverage starts on date this agreement is executed.

After end of the initial 5 year period, renews automatically on an annual basis unless either party provides written notice 60 days in advance of renewal date.

Start Date		Renewal Date
------------	--	--------------

4. Term of Agreement

Elective portions of this agreement are subject to renewal as defined above. The remaining services, benefits, terms and conditions remain in effect as long as the equipment is installed and operational. In the event that OWNER terminates the elective portions of this agreement prior to expiration of annual term, no refund of payments will be made.

Plan Details: Benefits & Services, Service & Operations, Parts Replacement

5. Standard BikeLink™ Benefits & Services

5.01 Access Distribution & Related Services

ELOCK shall maintain an inventory of access devices, and shall provide the following related services:

- ACCESS DEVICE vendor support.
- 24-hour web and telephone sales of ACCESS DEVICES and add value codes.
- 24-hour web and telephone ACCESS DEVICE activation.
- Web-based FAQs and other instructional information.

OWNER may elect to act as a vendor of ACCESS DEVICES. OWNER understands that ACCESS DEVICES it may choose to sell are not different from those sold by other vendors, that they are subject to the universal BikeLink™ USER Agreement, that they may be used at any BikeLink™ facility, and that USER information associated with all BikeLink™ ACCESS DEVICES must be stored in the BikeLink™ database and available to all BikeLink™ facility owners.

5.02 USER Database

ELOCK shall maintain a web-based database of USER information and provide OWNER with access to information stored on this database. To help ensure the USER information privacy policy, OWNER access to database may be limited to individual queries, USERS in vicinity of OWNER's facilities, and/or USERS who have previously accessed OWNER's facilities. ELOCK shall maintain an up-to-date off-site database backup.

5.03 USER Agreement

ELOCK shall maintain and periodically update USER Agreement, also known generally as the "BikeLink™ System Cardholder and User Agreement." ELOCK shall inform OWNERS and USERS of changes to USER Agreement in accordance with notification obligations defined in USER Agreement.

ELOCK shall maintain USER Agreement link at www.bikelink.org, and take reasonable measures to ensure USERS are informed of USER Agreement before using the BikeLink™ system.

OWNER shall carefully review and comply with terms of USER Agreement, including information privacy policy.

5.04 Remote USER Support

Upon receiving a query from a USER, ELOCK shall reply promptly to all reasonable inquiries. Upon receiving a technical assistance request from a USER, ELOCK shall create an online trouble ticket, and provide troubleshooting and telephone or email-based problem resolution during normal business hours.

ELOCK shall maintain the following additional remote USER support benefits and services:

- 24-hour free taxi ride from BikeLink™ facility up to \$20 in case USER is unable to retrieve bicycle due to equipment malfunction.
- 24-hour telephone support for USERS to report problems, free taxi ride, or to request single use access device in cases where USER has lost his or her access device.

5.05 Supplemental Access Restriction

If OWNER desires to restrict access to a BikeLink™ facility, OWNER may implement BikeLink™ Access Zones feature as described below.

Using ACCESS DEVICE, OWNER turns on Access Zone feature at CONTROLLERS for which access restriction is desired and sets Access Zone desired for each CONTROLLER. To permit access, OWNER obtains from ELOCK, via bikelink.org, a unique access code, associated with the individual user's standard BikeLink™ ACCESS DEVICE for which access will be granted. OWNER is charged a nominal fee for each access code generated. The access code permanently adds permissions for the specified access zone, and only for the OWNER's BikeLink facility, to the user's BikeLink™ ACCESS DEVICE.

Information collected by OWNER upon issuing an access code, beyond the standard information required from every BikeLink™ USER upon ACCESS DEVICE registration, need not be shared with other facility owners via the BikeLink™ database.

USERS who have been issued access codes for a specific BikeLink™ facility retain the ability to access other unrestricted BikeLink™ facilities.

5.06 User Support Reporting

Trouble tickets prepared by ELOCK shall be available for review by OWNER upon request.

USER queries and associated responses prepared by ELOCK shall be available for review by OWNER upon request.

5.07 Facility Owner Support

ELOCK shall provide password-protected OWNER's web page customized for OWNER's locations with up-to-date location information, ability to search USER database, ability to generate access codes, geo-coded cardholder location mapping, outreach materials, promotional program tools, access to monitoring sheets and reporting data, trouble tickets and service records, and equipment documentation.

ELOCK shall provide training to OWNER on use of system at time of initial installation.

5.08 Revenue and Minimum Rental Rate

To compensate ELOCK for standard benefits and services provided to OWNER and USERS, unless otherwise indicated in the Options Selected section of this document, OWNER agrees that rental rate of its ELOCKERS will remain set at or above \$0.05 per hour (and, at group-parking facilities, at or above \$0.02 per hour nights and weekends), and that revenue will be retained by ELOCK.

5.09 Primary Contact

To facilitate ELOCK's provision of standard benefits and services to USERS, ELOCK shall be the primary contact for USERS. ELOCK's (dba "BikeLink") contact information shall be displayed prominently at BikeLink™ locations so USERS know who to contact for assistance.

5.10 Facility-Specific Usage Data.

For research and marketing purposes, ELOCK retains the right to collect and publish facility-specific usage data. ELOCK shall report usage data only in aggregate and shall not publicly disclose any user-specific details.

6. Service & Operations

6.01 Facility Status

ELOCK shall review problem reports by USERS, monitoring information if available, and shall inspect OWNER's BikeLink™ facilities for mechanical, electronic, software, cleaning, and enforcement issues on a regular basis (approximately twice per year.)

eLock shall contact OWNER if graffiti, ELOCKER damage due to vandalism, or items requiring impounding are discovered.

6.02 Preventative Maintenance & Repair

If ELOCK learns that more than 10% of controllers within a thousand foot radius are out of service due to malfunction, low batteries, abandoned rentals or other types of USER violations (see Rental Policy Enforcement section below), ELOCK will provide field service within one week to attempt to restore the facility to 100% of its originally installed functionality.

If ELOCK technicians are unable to restore the facility to at least 90% of originally installed functionality during initial field service visit, ELOCK shall expedite acquisition of replacement parts and materials and shall provide temporary replacement of functionality using alternate parts or systems if possible.

All reasonable measures shall be taken to avoid data loss when CONTROLLER replacement is required.

The following services and materials are specifically included:

- Routine CONTROLLER firmware upgrades, such as for security or bug fixes.
- Replacement battery cells for battery-powered BikeLink™ installations.
- Critical mechanical security improvements.

Note: OWNER may elect to act as a vendor of ACCESS DEVICES. OWNER understands and agrees that ACCESS DEVICES it may choose to sell shall not be different from those sold by other vendors, that such ACCESS DEVICES are subject to the universal BikeLink™ USER Agreement, that they may be used at any BikeLink™ facility, and that USER information associated with all BikeLink™ ACCESS DEVICES must be stored in the BikeLink™ database and available to all BikeLink™ facility owners.

ELOCK shall provide labor, transportation, tools, and equipment necessary to perform the above preventative maintenance and repairs. Service not covered by this Proactive Service and Operation Plan shall be invoiced as "Additional Services and Materials" in accordance with Section 10 below and payable to ELOCK. "Additional Services and Materials" shall be pre-approved by OWNER, except under the following situations where preapproval shall not be required:

- Repair is due to vandalism and can be performed during regular service visit in less than 1 additional hour.
- Repair is due to vandalism and is required to correct an urgent security, safety, or stranded USER issue.

6.03 Auditing & Rental Policy Enforcement

ELOCK shall contact USERS by email or telephone to assist in the enforcement of BikeLink™ rental policies adopted by OWNER. For example, ELOCK will attempt to contact the USER indicated and when rental is expired but SPACE is empty, rental is abandoned, ELOCKER contains inappropriate materials, or when apparent user confusion is noted during inspections or by MONITORS.

Upon receiving a query or problem report from a USER, ELOCK shall reply promptly with accurate information to all reasonable inquiries. Upon receiving a technical assistance request from a USER, ELOCK shall create an online problem report, and provide troubleshooting and telephone or email-based problem resolution during normal business hours.

ELOCK shall contact USERS by email or telephone to assist in the enforcement of BikeLink™ rental policies.

Whenever possible, ELOCK shall resolve enforcement problems by working directly with USERS. When ELOCK is unable to resolve issues with abandoned bicycles or inappropriate storage situations by working with USER, ELOCK shall contact OWNER to arrange for impounding.

ELOCK does not guarantee USER compliance with BikeLink™ rental policies. ELOCK shall not be responsible for enforcement of supplemental laws or policies adopted by OWNER except as described in the standard BikeLink™ Cardholder & User Agreement.

6.04 Service Records

ELOCK shall generate trouble tickets and maintenance records for all on-site service and repair. These documents shall be available electronically for review by OWNER upon request.

6.05 Signs and Promotional Outreach Materials

ELOCK shall provide one (1) standard "BIKE PARKING" sign per installation at no additional cost. Sign is 14"x20", and are customizable with logos requested by OWNER. ELOCK shall install sign on ELOCKER door or side panel. ELOCK can, at the request of OWNER, provide and customize a flyer for outreach purposes.

6.06 Usage Monitoring and Reports

Usage reports are available on www.bikelink.org with a facility owner login, a component of the software included in the BikeLink™ Software License.

eLocker usage data includes rentals by time, market size, UI nodes reporting and rental duration.

Kiosk usage data includes camera images, transaction data, door entry events, and user ID check photos.

6.08 Cleaning

Cleaning shall be performed during a scheduled service visit and shall include the following tasks:

- Sweep/remove trash or debris found inside of ELOCKER spaces
- Clean up urine, grime, grease and other contaminants or stains on internal electronic ELOCKER components.

6.09 Exclusions

This Comprehensive Proactive Service and Operation Plan does not include:

- Repair of any damage or malfunction caused by vandalism.
- Repair of any damage or malfunction caused by abnormal use, abnormal conditions, improper storage, improper cleaning or maintenance such as powerwashing, unauthorized modifications, disassembly, repair or alteration by any person other than ELOCK or a party authorized by ELOCK, misuse, neglect, abuse, accident, use on improper power supply, improper installation, installation of any third-party software, or other acts which are not the fault of ELOCK, including acts of nature and damage caused by shipping.
- Repair of damage caused by battery leakage.
- Cleaning of exterior of BikeLink™ equipment including frames, doors, and rooftops.
- Removal of graffiti.
- Removal of scratches from roof or signage.
- Usage Monitoring & Reports on more frequent than annual basis.

- Regular monitoring and audits for group-access facilities.
- Replacement parts.
- Emergency response, including staffing group-access facilities to enable bicycle retrieval if the CONTROLLER has been damaged due to vandalism.
- Impounding bicycles or other stored items.
- Custom software or custom features.
- Repair or replacement parts for ELOCKER components manufactured by others (for ELOCKERS retrofitted with an ELOCK retrofit kit).

7. Limited Parts Replacement Coverage

7.01 Parts Repair, Upgrade, or Replacement

If a component is determined by ELOCK to be functionally defective, ELOCK, at its sole discretion, will repair, replace, or upgrade the defective component with a refurbished or new component. ELOCK shall not be obligated to replace worn components with new ones to bring appearance or function to originally installed condition unless basic rental and security functions are disabled.

7.02 Limitations

OWNER shall have no coverage or benefits under this Parts Replacement Plan if the product has been subject to abnormal use, abnormal conditions, use contrary to operating instructions, improper storage, improper cleaning or maintenance, unauthorized modifications, disassembly, repair or alteration by any person other than ELOCK or a party authorized by ELOCK, misuse, neglect, abuse, accident, use on improper power supply, improper installation, installation of any third-party software, or other acts which are not the fault of ELOCK, including acts of nature and damage caused by shipping.

Unauthorized or incorrect service attempts by OWNER may void the parts replacement coverage provided by this plan.

This Parts Replacement Plan does not cover defects in appearance of cosmetic, decorative or structural items, including framing, and any non-operative parts.

This plan must be initiated while still under warranty, and may not lapse. Unless specifically indicated, this parts replacement plan is not extendable beyond five years from original installation date.

In the event a USER requests on-site assistance in lieu of remote assistance to resolve a problem caused by an ACCESS DEVICE or equipment malfunction, ELOCK reserves the right to charge a reasonable fee directly to the USER for this service.

8. Software & Intellectual Property

Please see Software License Agreement.

9. Exclusions

This Comprehensive Proactive Service and Operation Plan does not include:

- Repair of any damage or malfunction caused by vandalism.
- Repair of any damage or malfunction caused by abnormal use, abnormal conditions, improper storage, improper cleaning or maintenance such as powerwashing, unauthorized modifications, disassembly, repair or alteration by any person other than ELOCK or a party authorized by ELOCK, misuse, neglect, abuse, accident, use on improper power supply, improper installation, installation of any third-party software, or other acts which are not the fault of ELOCK, including acts of nature and damage caused by shipping.
- Replacement or repair of components damaged by actions of Owner or its agents, including but not limited to power-washing.

- Replacement or repair of components originally supplied by OWNER as a part of group-access facility installation, including but not limited to electric strikes and, power supplies.

BikeLink™ Service and Operations Plan v1.3
 Copyright 2014 eLock Technologies, LLC

- Repair of damage caused by battery leakage.
- Cleaning of exterior of BikeLink™ equipment including frames, doors, and rooftops.
- Removal of graffiti.
- Removal of scratches from roof or signage.
- Usage Monitoring & Reports on more frequent than annual basis.
- Regular monitoring and audits for group-access facilities.
- Emergency response, including staffing group-access facilities to enable bicycle retrieval if the CONTROLLER has been damaged due to vandalism.
- Impounding bicycles or other stored items.
- Repair or replacement parts for ELOCKER components manufactured by others (for ELOCKERS retrofitted with an ELOCK retrofit kit).
- Custom software or custom features.
- Shipping costs for owner return of apparently defective components.
- Shipping costs for replacement components.
- Immediate or next-day On-site User Support.
- Emergency response, including staffing group-access facilities to enable bicycle retrieval if the CONTROLLER has been damaged due to vandalism.
- Impounding bicycles or other stored items.

10. Costs for Parts and Labor for Additional Services

For additional services not otherwise provided for in this agreement, services will be rendered on a time and materials basis in accordance with the following schedule. Costs provided below are for budget planning purposes. This schedule is not comprehensive, and costs are subject to change without prior notice.

Mileage: Current standard business mileage rate allowed by IRS

Overhead markup for direct expenses:	15%
Monitoring (includes usage reports):	\$10 per controller per visit
Next-day on-site user support:	\$85 per hour
Retrofit, Double, Quad, or Wedge ELOCKER Replacement Parts:	
Controller:	\$450.00
Latch Assembly:	\$150.00
D- Cell Batteries:	\$2.00
LCD Screen:	\$20.00
LCD Window:	\$15.00
Cardslot Assembly:	\$375.00
UI Board:	\$95.00
Ui Button:	\$15.00

11. Miscellaneous

This document will be covered by and construed in accordance with the laws of the State of California, and the laws of the United States (excluding conflicts of laws rules), and shall inure to the benefit of ELOCK and its successor, assignees and legal representatives. If any provision of this document is held by a court of competent jurisdiction to be invalid or unenforceable to any extent under applicable law, that provision will be enforced to the maximum extent permissible and the remaining provisions will remain in full force and effect.

ELOCK is not liable for incidental or consequential damages of any nature arising from use or inability of use of the equipment.

Upon transfer of ownership or jurisdiction of a BikeLink facility to another entity, OWNER agrees to provide a copy of this document to that entity.

Any modifications to this Agreement must be in writing and signed by both parties.

Any notices or other communications shall be sent by certified mail,

if to ELOCK, at :

eLock Technologies LLC
800 Heinz Avenue, Suite 11
Berkeley, CA 94710
USA

if to OWNER, at the following address:

SFMTA
1 South Van Ness Avenue
7th Floor
San Francisco, CA

The parties agree to the foregoing and have executed the BikeLink Service and Operations Plan on the date indicated below:

eLock Technologies LLC

1 South Van Ness Avenue

By: _____
Steven Grover, President
Date: _____

By: _____
Date: _____

BikeLink™ System Cardholder and User Agreement

This Agreement with eLock Technologies, LLC (also referred to as “eLock”) and Facility Owner (as defined below) allows You to use a BikeLink™ access device to obtain share time in a BikeLink™ facility. Your use of the Access Device constitutes your acknowledgment and consent to this Agreement – READ IT CAREFULLY.

1. Definitions

- 1.1. The “Access Device” is any uniquely assigned ID and/or debit device, including the BikeLink™ Smart Card, issued to a particular user and registered in the BikeLink™ user database.
- 1.2. The “Card” or “Smart Card” is the BikeLink™ Smart Card issued to the Cardholder.
- 1.3. The “Cardholder” or “User” (“You”) is the bearer of the Access Device.
- 1.4. A “Locker” or “eLocker” is a Bicycle Locker with compatible Access Device reader made or licensed by eLock Technologies LLC.
- 1.5. “BikeLink™” is an inter-agency network of shared, on-demand parking and vending facilities for bicycles and other small vehicles, and an administrative system for issuing and distributing Access Devices for use in BikeLink™ Facilities.
- 1.6. “Inter-agency network” means that a user who has obtained a BikeLink™ Access Device and who agrees to and complies with the terms of this Agreement could access any BikeLink™ facility. Some BikeLink™ facilities may require additional access codes.
- 1.7. An “Administrative Device” is a device which enables system administrators to update, modify, unlock, or access a BikeLink™ Facility.
- 1.8. “Card Issuers” or “Vendors” are agencies or entities which sell or distribute Access Devices.
- 1.9. “Rental” is the result of securing a unit of a BikeLink™ facility, such as an on-demand locker, or bicycle share, for the sole use of a specific access device.
- 1.10. “Available” is the state in which any authorized Access Device may initiate a Rental of a unit of a BikeLink™ facility.
- 1.11. “Rented” is the state in which a particular unit of a BikeLink™ facility is assigned for exclusive use by a particular User.
- 1.12. “Expired” is the state resulting when a Rental is not terminated before its scheduled ending date and time.
- 1.13. “Held” or “Reserved” is the state in which a particular unit of a BikeLink™ facility is preemptively assigned for exclusive use by a particular User or set of Users.
- 1.14. “Abandoned” is the state in which a particular unit of a BikeLink™ facility has been left in an “Expired” state long enough to be in violation of rental duration terms indicated on screens or signage at the Facility.
- 1.15. A “Facility Owner” or “Owner” is the agency with ownership of a particular BikeLink™ facility, or the agency with jurisdiction over a particular BikeLink™ facility.

2. Rental Transactions

- 2.1. Rental terms may vary by location and are displayed on information screens or signage.
- 2.2. Only the renting Access Device or an authorized Administrative Device can unlock a Rented, or Expired unit of a BikeLink™ facility.
- 2.3. Only the renting Access Device or Administrative Device can terminate a Rental.

3. Vehicle Storage Facility: Usage & Contents

- 3.1. Initiation of a Rental at a BikeLink™ storage facility entitles the User to access a storage space for immediate or future use. User may store their vehicle for the duration until the Rental is terminated or the Locker becomes Expired. BikeLink™ storage facilities shall be used only for the purpose of storing a vehicle and related equipment (such as helmet, pump, or lock). The storage facility shall not be used in, or in connection with, any activity prohibited by law, or set by Facility Owner. Non-compliance of any of the above conditions shall constitute a default by the User in the terms of this agreement.
- 3.2. After a time period the Facility Owner deems excessive, an Expired Rental shall be considered Abandoned. Abandoned Rentals constitute a default by the User in the terms of this agreement.

- 3.3. Upon default, the Facility Owner and the Facility Owner’s agent(s) have the right to empty the storage space of any property stored therein, and dispose of such contents as it sees fit. If the User has registered his or her correct and up to date contact information with BikeLink™ (at the time of Access Device purchase or by contacting BikeLink™), the Facility Owner shall promptly notify the User in writing, by email, and/or by phone before disposing of property.

- 3.4. As a condition for using a BikeLink™ facility for the restricted purposes mentioned above, the User waives any claim to the right to privacy and expressly consents to allow the Facility Owner and the Facility Owner’s agent(s):

- to open and inspect the storage space and inspect or relocate the contents thereof at any time without prior notice;
- in an emergency, to determine whether a health or safety hazard exists;
- to maintain the storage space, its door, or locking mechanism; or
- to determine whether any term of the Agreement is being violated.

- 3.5. You will be monetarily responsible for damages beyond normal wear and tear to the facility or adjacent structures caused by your misuse of the storage space.

4. Issue of Access Devices

- 4.1. The Access Device is available for purchase through BikeLink™, and authorized Vendors.
- 4.2. Vendor Location information is provided at www.bikelink.org, by calling (888) 540-0546, or on information screens, and signage at a BikeLink facility.

5. Access Device Value

- 5.1. The Access Device is not a charge, credit, or debit card.
- 5.2. The value the Access Device holds is neither cash nor the equivalent of cash. At a BikeLink™ Facility which charges for use, You can exchange value on the Access Device for share time of the facility or item; the Access Device value has no other use or worth.

6. Access Device Loss and Damage

- 6.1. You shall take all reasonable care of the Access Device to prevent it from damage, defacement, destruction, or loss of any kind.
- 6.2. You shall not alter or interfere with any graphic or Access Device Data and shall take all reasonable measures and care to ensure that any graphic and Access Device Data are not interfered or tampered with.
- 6.3. No refund for lost or damaged Access Devices will be provided except at the absolute discretion of eLock.
- 6.4. You shall report any lost, stolen, or irreparably damaged Access Devices to eLock in a timely manner; unless You report your lost or stolen Access Device, You may be held liable for its misuse.

7. Conditions for Services and Facilities

- 7.1. While using the services and/or facilities of a Facility Owner, You shall observe, perform, and comply with the terms and conditions, by-laws, rules, and regulations, including rental settings such as maximum rental duration and hourly rate, selected by that Facility Owner in relation to such services and/or facilities.
- 7.2. At the behest of a Facility Owner, authorized agents of eLock or the Facility Owner may electronically access, unlock, move or remove stored contents, and/or modify a facility owned by the Facility Owner, regardless of the facility’s state or the state of any affected Access Device, and neither eLock nor the Facility Owner shall be liable for any loss or damage resulting therefrom.
- 7.3. A Facility Owner may deny access to, replace, or remove any facilities it owns at any time for any reason, and neither eLock nor the Facility Owner shall be liable for any loss or damage resulting therefrom.
- 7.4. Neither eLock nor the Facility Owner are responsible for fire, theft, loss, or damage to any article left in a facility. The User shall indemnify eLock and the Facility Owner and their directors, officers, agents, representatives, and employees from any liability of any nature arising out of the User’s use of a facility.

8. Reservation

- 8.1. eLock does not warrant that any particular service and/or facility will be provided by any Facility Owner at any time or place.
- 8.2. You may rent in advance, within the limits set by the Facility Owner, to reserve use of a facility until a future time.

- 8.3. Where available, you may rent in advance using the on-line reservation system, within the limits set by eLock and the Facility Owner, to reserve use of a facility at a future time.
- 8.4. A reservation which has Expired constitutes a default by the User in the terms of this agreement, and may be terminated by the Facility Owner pursuant to section 3.3.
- 8.5. Neither eLock nor the Facility Owner warrant that any particular facility will function as expected at any time or place, nor shall eLock nor the Facility Owner be liable for any loss or damage therefrom.
- 8.6. No warranty is given that operation of the Access Device or BikeLink™ will be available with any Facility Owner at any time or place, and neither eLock nor the Facility Owner shall be liable for any loss or damage resulting therefrom.
- 8.7. Authorized agents of eLock and the Facility Owner shall have the right to inspect any Access Device and the Data therein at any time.
- 8.8. eLock reserves the right to:
 - 8.8.1. Recover any cost, expenses, loss, and damages incurred or suffered by eLock as a result of the User altering or interfering with the Access Device Data.
 - 8.8.2. Waive these Conditions or any part thereof against any person.

9. Termination

- 9.1. eLock may terminate this agreement at any time and for any reason. If eLock requests or if You wish to terminate this Agreement, you must return your Access Device in proper working condition to BikeLink. No refund will be provided except at the absolute discretion of eLock.

10. Changes to this Agreement

- 10.1. eLock reserves the right to change the terms of this Agreement and any associated policies at any time by providing written notice on the BikeLink™ website at www.bikelink.org. You will be deemed to have received such notice thirty (30) days after posting of that notice on the BikeLink™ web site. You agree to all changes when You use your Access Device after that date.

11. Release and Indemnity

- 11.1. You hereby release eLock and the Facility Owner from all loss, damage, or injury whatsoever, known or unknown, arising out of or in any manner connected with the use or performance of the Access Device issued to You. Neither eLock, its officers, employees, nor its agents, nor the Facility Owner, will have any obligation or liability with respect to your use or the performance of the Access Device. Your sole and exclusive recourse from eLock and the Facility Owner will be the replacement of any defective Access Device(s) by eLock. You agree to indemnify, protect, and hold harmless the Facility Owner, eLock, their officers, employees, and their agents from any and all liability for any loss, damage, or injury to persons or property arising from or related to the Access Device.
- 11.2. For and in consideration of permitting You to rent Facility Owner's property, You hereby voluntarily release, discharge, waive and relinquish any and all actions or causes of action for personal injury, property damage or wrongful death occurring to You arising as a result of your use of or the performance of the Access Device issued to You, any BikeLink facility, or any activities incidental thereto, wherever or however the same may occur, and You do for yourself, your heirs, executors, administrators and assigns hereby release, waive, discharge and relinquish any action or causes of action aforesaid, which may hereafter arise for yourself or for your estates and agree that under no circumstances will You or your heirs, executors, administrators and assigns prosecute, present any claim for personal injury, property damage or wrongful death against eLock or the Facility Owner or any of its officers, agents, servants or employees for any of said causes of action whether the same shall arise by the negligence of any of said persons or otherwise. It is your intention by this instrument to exempt and relieve eLock and the Facility Owner from liability for personal injury, property damage or wrongful death, whether or not the same is caused by negligence.
- 11.3. You further agree to indemnify and hold harmless eLock and the Facility Owner, its officers, agents, servants and employees from any liability or claim or action for damages which in any way arises out of your use of or the performance of the Access Device or BikeLink facility, even though that liability may arise out of the negligence or carelessness on the part of the Facility Owner or eLock, their officers, agents or employees. Notwithstanding anything stated in the

foregoing paragraphs, nothing in this document shall apply to exempt any person or entity from responsibility for his, her, or its own fraud, or willful injury to the person or property of another, or violation of law whether willful or negligent.

12. Failure to Comply

- 12.1. Failure to comply with any portion of this agreement may result in eLock's blocking the use of the Access Device. No refund will be provided except at the absolute discretion of eLock.

13. Entire Agreement

- 13.1. This document represents the entire and integrated agreement between eLock and the User, and the entire and integrated agreement between the Facility Owner and the User. This document supersedes all prior negotiations, representation, or agreements, either written or oral. All provisions of this agreement are expressly made conditions.

14. Communications

Please address all questions, notifications, and communications related to the bicycle parking facility to the Facility Owner using the contact information provided on the information screens.

Please address all questions, notifications, and communications related to the BikeLink™ Access Device to: info@bikelink.org

15. Privacy

- 15.1. All information and data relating to the User collected by BikeLink™ shall be used by eLock and the Facility Owner for the purposes of the operation and management of BikeLink™ facilities, and shall serve as a source of information and data for transit and/or related services in general but shall otherwise be dealt with in a confidential manner by eLock unless:
 - a) the express written consent of the User has been obtained; and / or
 - b) there is a legal requirement to the contrary.
- 15.2. You retain the right to review all personal information pertaining to your Access Device, whether stored electronically or on paper. Any inquiry or request to obtain information, in accordance with the above provisions, should be directed in writing to BikeLink™. eLock may adopt procedures for your review of such information, including but not limited to charging a fee for processing requests for access to personal information.
- 15.3. When you provide information to eLock, eLock will not share this information with other entities except to conduct regular business, to comply with legal requirements, and to protect against fraud. eLock will not sell, lease, rent, loan, or trade lists of physical or email addresses or phone numbers. eLock's web server and rental devices collect information that details the traffic on our site and rental usage patterns. eLock may analyze this information and use aggregate statistics to improve the content and navigation on websites, and to improve the usefulness of products.
- 15.4. Your Address, Email and Other Contact Information. When you obtain a BikeLink™ Access Device you are required to provide accurate personal identifying, address, and contact information. That information will not be released to third parties, except as follows: it is available on demand to BikeLink™ facility owners and law enforcement officials so that in the event that your BikeLink™ Access Device is lost while you are storing a vehicle, your identity may be verified before releasing that vehicle to You. Unless and until you return your Access Device to eLock Your information may also be used to contact You if your Access Device's rental transactions do not conform with the terms of this agreement, or in the event of an emergency affecting your property, or to provide information about changes in BikeLink terms or features, facility status, or stored property status.
- 15.5. Usage Data. eLock may provide aggregate statistics and usage reports to our customers or researchers, to assist them in assessing the BikeLink™ system or in applying for funding to install new facilities. These statistics and usage reports shall not contain personally identifiable information.
- 15.6. Website Statistics. eLock makes no attempt to link website statistics to the individuals who browse our site. eLock does not share server statistics with third parties.
- 15.7. Information Requests. If you request information from us, any information you supply will be used only to satisfy your request. eLock will not share this information with third parties unless it has prior approval from you.
- 15.8. Exceptions. The above policies may be superseded by requirements or obligations imposed by statute, regulation, or legal process.