

File No. 191253 Committee Item No. 2  
 Board Item No. 30

**COMMITTEE/BOARD OF SUPERVISORS**  
 AGENDA PACKET CONTENTS LIST

Committee: Land Use and Transportation Committee Date February 3, 2020

Board of Supervisors Meeting Date Mar 01 3, 2020

**Cmte Board**

- |                                     |                                     |  |
|-------------------------------------|-------------------------------------|--|
| <input type="checkbox"/>            | <input type="checkbox"/>            | Motion                                       |
| <input type="checkbox"/>            | <input type="checkbox"/>            | Resolution                                   |
| <input checked="" type="checkbox"/> | <input checked="" type="checkbox"/> | Ordinance                                    |
| <input checked="" type="checkbox"/> | <input checked="" type="checkbox"/> | Legislative Digest                           |
| <input type="checkbox"/>            | <input type="checkbox"/>            | Budget and Legislative Analyst Report        |
| <input type="checkbox"/>            | <input type="checkbox"/>            | Youth Commission Report                      |
| <input type="checkbox"/>            | <input type="checkbox"/>            | Introduction Form                            |
| <input type="checkbox"/>            | <input type="checkbox"/>            | Department/Agency Cover Letter and/or Report |
| <input type="checkbox"/>            | <input type="checkbox"/>            | MOU  |
| <input type="checkbox"/>            | <input type="checkbox"/>            | Grant Information Form                       |
| <input type="checkbox"/>            | <input type="checkbox"/>            | Grant Budget                                 |
| <input type="checkbox"/>            | <input type="checkbox"/>            | Subcontract Budget                           |
| <input type="checkbox"/>            | <input type="checkbox"/>            | Contract/Agreement                           |
| <input type="checkbox"/>            | <input type="checkbox"/>            | Form 126 – Ethics Commission                 |
| <input type="checkbox"/>            | <input type="checkbox"/>            | Award Letter                                 |
| <input type="checkbox"/>            | <input type="checkbox"/>            | Application                                  |
| <input type="checkbox"/>            | <input type="checkbox"/>            | Public Correspondence                        |

**OTHER (Use back side if additional space is needed)**

- |                                     |                                     |   |
|-------------------------------------|-------------------------------------|---|
| <input checked="" type="checkbox"/> | <input checked="" type="checkbox"/> | <u>DRAFT SUR Map</u>                              |
| <input checked="" type="checkbox"/> | <input checked="" type="checkbox"/> | <u>FMND 122719</u>                                |
| <input checked="" type="checkbox"/> | <input checked="" type="checkbox"/> | <u>GP Referral 122719.</u>                        |
| <input checked="" type="checkbox"/> | <input checked="" type="checkbox"/> | <u>Transbay Trust Exchange Agmt 121919</u>        |
| <input checked="" type="checkbox"/> | <input checked="" type="checkbox"/> | <u>Map Trust Termination Streets</u>              |
| <input checked="" type="checkbox"/> | <input checked="" type="checkbox"/> | <u>Port Memo 011020 &amp; Port Reso No. 20-01</u> |
| <input checked="" type="checkbox"/> | <input checked="" type="checkbox"/> | <u>Map Trust Addition Streets</u>                 |
| <input type="checkbox"/>            | <input type="checkbox"/>            | <u> </u>  |
| <input type="checkbox"/>            | <input type="checkbox"/>            | <u> </u>  |
| <input type="checkbox"/>            | <input type="checkbox"/>            | <u> </u>  |
| <input type="checkbox"/>            | <input type="checkbox"/>            | <u> </u>  |
| <input type="checkbox"/>            | <input type="checkbox"/>            | <u> </u>  |

Completed by: Erica Major Date January 30, 2020  
 Completed by: Erica Major Date 02/05/2020

1 [Street Vacation - Millennium Tower 301 Mission Perimeter Pile Upgrade Project]  
2

3 Ordinance ordering the vacation of the sidewalk portion of streets on the south side of  
4 Mission Street at the intersection of Mission and Fremont Streets and on the east side  
5 of Fremont Street at the same intersection to allow a structural upgrade of the 301  
6 Mission Street high-rise building known as Millennium Tower, subject to certain  
7 conditions; rededicating the area subject to the street vacation to public use for street  
8 and right-of-way purposes after the City's issuance of an easement for the  
9 abovementioned structural upgrade; adopting environmental findings under the  
10 California Environmental Quality Act; adopting findings that the vacation and  
11 rededication of the street area are consistent with the General Plan, and the eight  
12 priority policies of Planning Code, Section 101.1; and authorizing actions in  
13 furtherance of this Ordinance.

14 NOTE: **Unchanged Code text and uncodified text** are in plain Arial font:  
15 **Additions to Codes** are in single-underline italics Times New Roman font.  
16 **Deletions to Codes** are in ~~strikethrough italics Times New Roman font~~.  
17 **Board amendment additions** are in double-underlined Arial font.  
18 **Board amendment deletions** are in ~~strikethrough Arial font~~.  
19 **Asterisks (\* \* \* \*)** indicate the omission of unchanged Code  
20 subsections or parts of tables.

21 Be it ordained by the People of the City and County of San Francisco:

22 Section 1. Environmental and General Plan Findings.

23 (a) On November 20, 2019, the Planning Department published a Preliminary  
24 Mitigated Negative Declaration ("PMND") for the 301 Mission Street, Millennium Tower  
25 Perimeter Pile Upgrade Project (the "Project"). The PMND found that although the Project  
could have potentially significant impacts on the environment, such impacts will be reduced to

1 a less than significant level because Millennium Tower Association (the "Project Sponsor") will  
2 implement all mitigation measures identified in the PMND. The Planning Department  
3 prepared and publicized the PMND in compliance with the provisions of the California  
4 Environmental Quality Act (California Public Resources Code Sections 21000 et seq.,  
5 "CEQA"), the State CEQA Guidelines (California Code of Regulations Title 14 Sections 15000  
6 et seq.), and Chapter 31 of the San Francisco Administrative Code ("Chapter 31").

7 (b) On December 27, 2019, following the required notice and appeal period, the  
8 Planning Department published a Final Mitigated Negative Declaration ("FMND"), a copy of  
9 which is on file with the Clerk of the Board of Supervisors in File No. 191253 and incorporated  
10 herein by reference.

11 (c) In a letter dated December 27, 2019 (the "General Plan Referral Letter"), the  
12 Planning Department determined that the street vacation and rededication of the area subject  
13 to the street vacation as public use for street and right-of-way purposes are, on balance,  
14 consistent with the General Plan and with the eight priority policies of Planning Code Section  
15 101.1. A copy of said letter is on file with the Clerk of the Board of Supervisors in File No.  
16 191253 and is incorporated herein by reference. The Board of Supervisors adopts as its own  
17 the consistency findings of the General Plan Referral Letter for purposes of this ordinance.

18 (d) As part of its determination on the General Plan, the Planning Department  
19 reviewed and considered the FMND. As part of the General Plan Referral Letter, the Planning  
20 Department adopted CEQA Findings and the proposed mitigation monitoring and reporting  
21 program (collectively, "CEQA Findings") as required by State and local law. The Board of  
22 Supervisors hereby adopts and incorporates by reference the CEQA Findings. In so doing,  
23 the Board of Supervisors approves and endorses the mitigation monitoring and reporting  
24 program for implementation by other City departments. A copy of the CEQA Findings and the  
25

1 mitigation monitoring and reporting program is on file with the Clerk of the Board of  
2 Supervisors in File No. 191253 and is incorporated herein by reference.

3 (e) The Board of Supervisors finds that the actions taken in this ordinance are within  
4 the scope of the Project analyzed in the FMND and subject to the CEQA Findings. The Board  
5 of Supervisors further finds that (1) no substantial changes are proposed in the Project and no  
6 substantial changes have occurred with respect to the circumstances under which this Project  
7 will be undertaken that would cause new significant environmental effects or a substantial  
8 increase in the severity of previously identified effects and (2) there is no new information of  
9 substantial importance showing that the Project would have any significant effects not  
10 discussed in the FMND, that significant effects would be substantially more severe, or that  
11 new or different mitigation measures or alternatives would substantially reduce one or more  
12 significant effects of the Project.

13  
14 Section 2. Background and General Findings.

15 (a) The Project is associated with the 50,500-square-foot (1.16-acre) parcel  
16 (Assessor's Parcel Block No. 3719, Lots 020-440) at 301 Mission Street located on the south  
17 side of Mission Street between Fremont and Beale streets within San Francisco's Financial  
18 District (the "Property"). The existing high-rise on the 301 Mission Street parcel is called the  
19 Millennium Tower. The Tower building covers a footprint of approximately 32,960 square feet  
20 and its foundation system consists of a 10-foot-thick reinforced concrete mat foundation.

21 (b) In accordance with information provided by the Project Sponsor, since completion  
22 of construction of the Tower in 2009, the area around the Tower and Property has  
23 experienced differential settlement due to consolidation and compression of the soil layer  
24 beneath the Colma Sand, which is known as Old Bay Clay, and tilting to the northwest near  
25 the corner of Mission and Fremont Streets.

1 (c) The Project consists of a structural upgrade of the Tower building foundation that  
2 includes installation of a horizontal extension of the existing mat foundation for the Tower  
3 building within an approximately 8-foot-wide zone beneath the public right-of-way sidewalk  
4 area and immediately adjacent to the Tower along Fremont and Mission Streets, supported by  
5 52 new piles extending to bedrock. The 52 new piles are referred to as "perimeter piles" and  
6 the extended mat foundation is referred to as the "collar foundation." In addition to preventing  
7 further settlement in the northwest corner of the Tower's existing foundation, the Project  
8 Sponsor has stated that this effort may allow for gradual tilt correction of the Tower building  
9 over time.

10 (d) The Project Sponsor will stage construction activities adjacent to the Property  
11 along Fremont, Mission, and Beale Streets, requiring the closure of one travel lane and  
12 sidewalks along Fremont and Mission Streets and restricting pedestrian access on the  
13 sidewalk along Beale Street during portions of construction. There would be limited or no  
14 pedestrian access along the Fremont and Mission Streets sides of the Tower during the  
15 entirety of construction, because the structural upgrade construction would occur in the  
16 sidewalk area; however, after completion of the structural upgrade, the Project Sponsor would  
17 restore the site and sidewalk area to pre-construction conditions.

18 (e) The permanently installed perimeter piles and collar foundation would occupy a  
19 portion of current public right-of-way on Mission and Fremont Streets that is subject to the  
20 public trust doctrine, which designation would be removed by a State Trust exchange  
21 agreement approved by the California State Lands Commission, the San Francisco Port  
22 Commission, and this Board of Supervisors ("Public Trust Exchange"). The Public Trust  
23 Exchange is addressed in a companion ordinance that is on file with the Clerk of the Board of  
24 Supervisors in File No. 191286. The vacation of the Vacation Area authorized by this  
25 ordinance is conditioned upon the Public Trust Exchange being final and effective.

1 (f) The street vacation proceeding associated with the Project is for the sidewalk  
2 portions of Mission Street and Fremont Street near the Mission and Fremont Streets  
3 intersection (collectively, the "Vacation Area") and identified more particularly on the Public  
4 Works ("PW") SUR Map No. 2019-006, dated January 8, 2020 (the "SUR Map"). A copy of  
5 the SUR Map is on file with the Clerk of the Board of Supervisors in File No. 191253 and  
6 incorporated herein by reference. The Assessor's Office has assigned Assessor's Parcel  
7 Block No. 3719, Lot 519, to the Mission Street portion and Assessor's Parcel Block No. 3719,  
8 Lot 520, to the Fremont Street portion of the Vacation Area.

9 (g) The street vacation would allow a portion of the Vacation Area to be permanently  
10 occupied by the Project in accordance with the terms of an easement that the City and County  
11 of San Francisco proposes to grant to the Project Sponsor (the "301 Mission Street  
12 Easement" or "Easement").

13 (h) The Board of Supervisors will consider the grant of the 301 Mission Street  
14 Easement in a yet to be introduced companion legislation ~~resolution on file with the Clerk of~~  
15 ~~the Board of Supervisors in File No. \_\_\_\_\_.~~

16 (i) The City is prohibited from granting a non-revocable permit or easement over the  
17 public right-of-way unless the subject area is vacated in accordance with the California Streets  
18 and Highways Code Sections 8300 et seq. and Public Works Code Section 787.  
19 Consequently, in order to accommodate the Project and grant the 301 Mission Street  
20 Easement, the City will need to temporarily vacate the Vacation Area prior to granting such  
21 Easement. Once the street vacation occurs and the Board of Supervisors approves the  
22 Easement legislation and said Easement is granted and recorded, the City intends to restore  
23 the street status on the Vacation Area so it will continue in its current form as a dedicated  
24 public right-of-way. Therefore, when the 301 Mission Street Easement is effective and  
25 recorded, the Vacation Area will be rededicated to public use for street and right-of-way

1 purposes subject to the Easement.

2 (j) The Board of Supervisors also will consider the settlement of litigation related to 301  
3 Mission Street that comprised of all complaints and associated cross-claims and cross-  
4 complaints coordinated and/or consolidated under the case entitled, *Laura S. Lehman v.*  
5 *Transbay Joint Powers Authority, et al.*, Case Number CGC-16-553758 in the Superior Court  
6 of San Francisco in a companion ordinance (the "Settlement Ordinance"). But for this  
7 settlement, the Board of Supervisors would not undertake this street vacation or the  
8 companion resolution for the 301 Mission Street Easement. Consequently, the street vacation  
9 ordinance will not be operative unless and until the Board of Supervisors approves the yet to  
10 be introduced Settlement Ordinance and said Ordinance is final and effective. The Settlement  
11 on file with the Clerk of the Board of Supervisors in File No. \_\_\_\_\_.

12 (k) The Public Works ("PW") Director has prepared PW Order No. 202465, dated ,  
13 dated January 8, 2020, in regard to the vacation and other actions contemplated herein and  
14 has made the following determinations: (1) the Vacation Area shown in SUR Map 2019-006  
15 will no longer be necessary for the City's present or prospective future public street, sidewalk,  
16 and public service easement purposes on a temporary basis until the City approves the grant  
17 of the 301 Mission Street Easement to the Project Sponsor for the Project and said easement  
18 is recorded; (2) concurrent with recordation of the 301 Mission Street Easement, the Vacation  
19 Area should be rededicated to public use for street and right-of-way purposes subject to the  
20 Easement in order to restore the existing street use status to the Vacation Area; (3) in  
21 accordance with California Streets and Highways Code Section 892, the Vacation Area will  
22 not be useful as a nonmotorized transportation facility, as defined in Streets and Highways  
23 Code Section 887, because the entire Vacation Area is below grade; (4) the public interest,  
24 convenience, and necessity require that the street vacation occur as contemplated to protect  
25 the public safety and allow for the Project to be implemented; and (5) it is a policy matter for

1 the Board of Supervisors to grant the 301 Mission Street Easement over the City's interest in  
2 the Vacation Area to the Project Sponsor. A copy of the PW Order is on file with the Clerk of  
3 the Board of Supervisors in File No. 191253 and is incorporated herein by reference.

4 (l) In addition, the PW Director, in PW Order No. 202465, recommended: (1) that the  
5 Board of Supervisors adopt the legislation to vacate the Vacation Area; (2) that the Board of  
6 Supervisors authorize the Mayor, Clerk of the Board of Supervisors, Director of Property,  
7 County Surveyor, and PW Director to take any and all actions which they or the City Attorney  
8 may deem necessary or advisable in order to effectuate the purpose and intent of this  
9 ordinance; and (3) that the operative date of the street vacation be conditioned upon the  
10 following: (i) the Public Trust Exchange being final and effective and (ii) the Settlement  
11 Ordinance being final and effective.

12 (m) On March 3, 2020, the Board of Supervisors adopted Resolution No. 034-20 (the  
13 "Resolution of Intent"), which declared the intention of the Board to conditionally vacate the  
14 Vacation Area. A copy of this resolution is on file with the Clerk of the Board of Supervisors in  
15 File No. 191252 and incorporated herein by reference.

16 (n) The Clerk of the Board of Supervisors published the Resolution of Intent in the  
17 manner required by law and transmitted to the PW Director a certified copy of the Resolution  
18 of Intent, and the PW Director posted the Resolution of Intent in the manner required by law.

19 (o) The vacation actions contemplated by this ordinance are conducted under the  
20 general vacation procedures of the Public Streets, Highways and Service Easements  
21 Vacation Law (California Streets and Highways Code Sections 8300 et seq.) and Public  
22 Works Code Section 787(a).

23 ///

24 Section 3. Street Vacation and Conditions.  
25



1 (a) Except as set forth in subsection (d), the Board of Supervisors hereby adopts the  
2 findings, determinations, and recommendations of PW Order No. 202465 and temporarily  
3 vacates the Vacation Area, as shown on the SUR Map No. 2019-006, in the manner  
4 described in Section (2)(k) and (l) of this ordinance, upon satisfaction of the conditions  
5 described in this ordinance and pursuant to California Streets and Highways Code Sections  
6 8300 et seq. and San Francisco Public Works Code Section 787(a).

7 (b) For reference purposes, the Vacation Area also shall be identified as Assessor's  
8 Parcel Block No. 3719, Lot 519, for the Mission Street portion and Assessor's Parcel Block  
9 No. 3719, Lot 520, for the Fremont Street portion of the Vacation Area.

10 (c) The Board of Supervisors hereby finds that the Vacation Area is unnecessary for  
11 present or prospective public use, subject to the conditions described in this ordinance.

12 (d) The Board finds that the public interest, convenience, and necessity require that  
13 the Street Vacation be done as declared in this ordinance.

14 (e) The Street Vacation shall be operative as to all of the Vacation Area when: (1) the  
15 Public Trust Exchange becomes final and effective and (2) the Settlement Ordinance  
16 becomes final and effective.

17 (f) No existing easements or other rights are reserved for any public utility facilities that  
18 are in place in the Vacation Area during the term of the vacation, and any rights based upon  
19 any such public utility facilities shall be temporarily extinguished upon the effectiveness of the  
20 vacation hereunder and until the Vacation Area is rededicated to public use as set forth in  
21 Section 4 of this ordinance.

22  
23 Section 4. Rededication of the Vacation Area to Public Use for Street and Right-of-  
24 Way Purposes.  
25

1 (a) The vacation of the Vacation Area is temporary and will be operative as set forth in  
2 this ordinance.

3 (b) The Board of Supervisors hereby declares that concurrent with recordation of the  
4 301 Mission Street Easement, the Vacation Area shall be rededicated to public use for street  
5 and right-of-way purposes subject to the Easement.  
6

7 Section 5. The Board of Supervisors hereby directs the Clerk of the Board of  
8 Supervisors to transmit to the PW Director certified copies of this ordinance, and the Board of  
9 Supervisors hereby urges the PW Director to proceed in the manner required by law. The  
10 Clerk of the Board of Supervisors also is hereby directed to transmit to the PW Director  
11 certified copies of this ordinance so that this ordinance may be recorded together with any  
12 other documents necessary to effectuate the ordinance.  
13

14 Section 6. The Mayor, Clerk of the Board of Supervisors, Director of Property, and PW  
15 Director are hereby authorized and directed to take any and all actions which they or the City  
16 Attorney may deem necessary or advisable in order to effectuate the purpose and intent of  
17 this ordinance (including, without limitation, the filing of the ordinance in the Official Records of  
18 the City and County of San Francisco).  
19

20 Section 7. Effective and Operative Dates.

21 (a) This ordinance shall become effective 30 days after enactment. Enactment occurs  
22 when the Mayor signs the ordinance, the Mayor returns the ordinance unsigned or does not  
23 sign the ordinance within ten days of receiving it, or the Board of Supervisors overrides the  
24 Mayor's veto of the ordinance.  
25

///

1  
2  
3  
4  
5  
6  
7  
8  
9  
10  
11  
12  
13  
14  
15  
16  
17  
18  
19  
20  
21  
22  
23  
24  
25

(b) This ordinance shall become operative when both of the following have occurred:  
(1) the Public Trust Exchange becomes final and effective and (2) the Settlement Ordinance becomes final and effective.

APPROVED AS TO FORM:  
DENNIS J. HERRERA, City Attorney

By:   
JOHN D. MALAMUT  
Deputy City Attorney  
n:\land01\as2019\2000225\01420314.docx

**REVISED LEGISLATIVE DIGEST**  
(Amended in Committee, 2/3/2020)

[Street Vacation - Millennium Tower 301 Mission Perimeter Pile Upgrade Project]

**Ordinance ordering the vacation of the sidewalk portion of streets on the south side of Mission Street at the intersection of Mission and Fremont Streets and on the east side of Fremont Street at the same intersection to allow a structural upgrade of the 301 Mission Street high-rise building known as Millennium Tower, subject to certain conditions; rededicating the area subject to the street vacation to public use for street and right-of-way purposes after the City's issuance of an easement for the abovementioned structural upgrade; adopting environmental findings under the California Environmental Quality Act; adopting findings that the vacation and rededication of the street area are consistent with the General Plan, and the eight priority policies of Planning Code, Section 101.1; and authorizing actions in furtherance of this Ordinance.**

Existing Law

San Francisco processes the vacation of streets in accordance with California Streets and Highways Code Sections 8300 et seq. and Public Works Code Section 787.

Amendments to Current Law

This ordinance would vacate the sidewalk portions of the Mission and Fremont Street frontages of 301 Mission Street, also referred to as Millennium Tower, to allow for the City to grant an easement to Millennium Tower Associates for purposes of installing and maintaining a structural upgrade to the high-rise building on this property. The legislation would restore the street use status of the vacated area after the easement is recorded. The ordinance would adopt various findings associated with these actions, including environmental findings and General Plan and Planning Code Section 101.1 findings. The ordinance would become operative when both of the following have occurred: (a) a State Public Trust Exchange removing the Trust from the street vacation area becomes final and effective and (b) a Board of Supervisors settlement ordinance associated with litigation concerning 301 Mission Street becomes final and effective.

n:\leganas2019\2000225\01412335.docx

1525



# 301 Mission Trust Exchange and Street Vacation

Land Use and Transportation Committee  
February 3, 2020



RECEIVED  
 1/13/20  
 1/13/20  
 1/13/20  
 1/13/20

1526

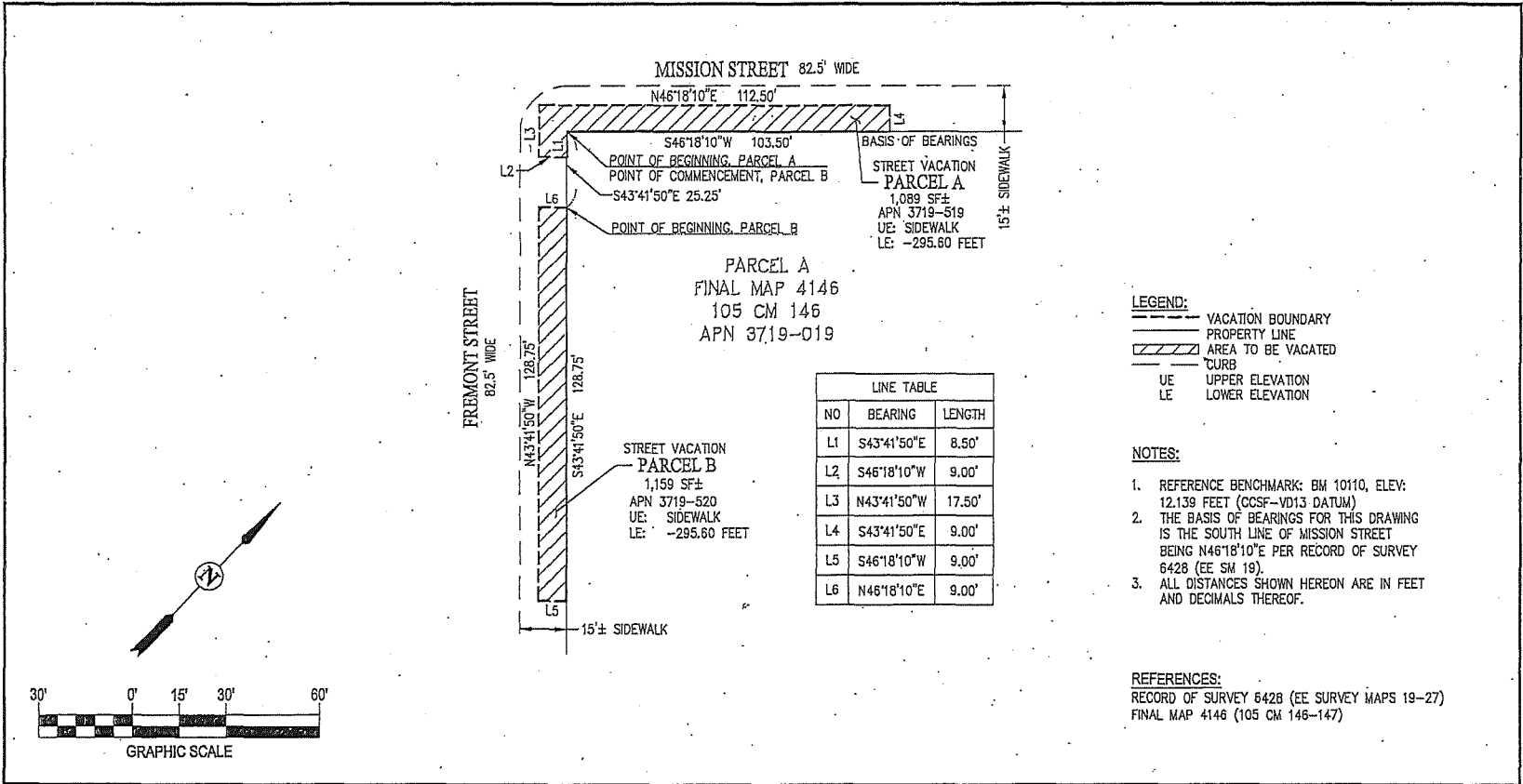

	APPROVED: BRUCE R. STORRS CITY & COUNTY SURVEYOR	DATE: 1/21/2020	<b>CITY AND COUNTY OF SAN FRANCISCO PUBLIC WORKS</b> SUBDIVISION AND MAPPING			
	STREET VACATION OF PORTIONS OF MISSION ST. AND FREMONT ST., FRONTING APN 3719-019			FILE: SUR 2019-006	SHEET 1 OF 3	SCALE: 1"=30'



1527

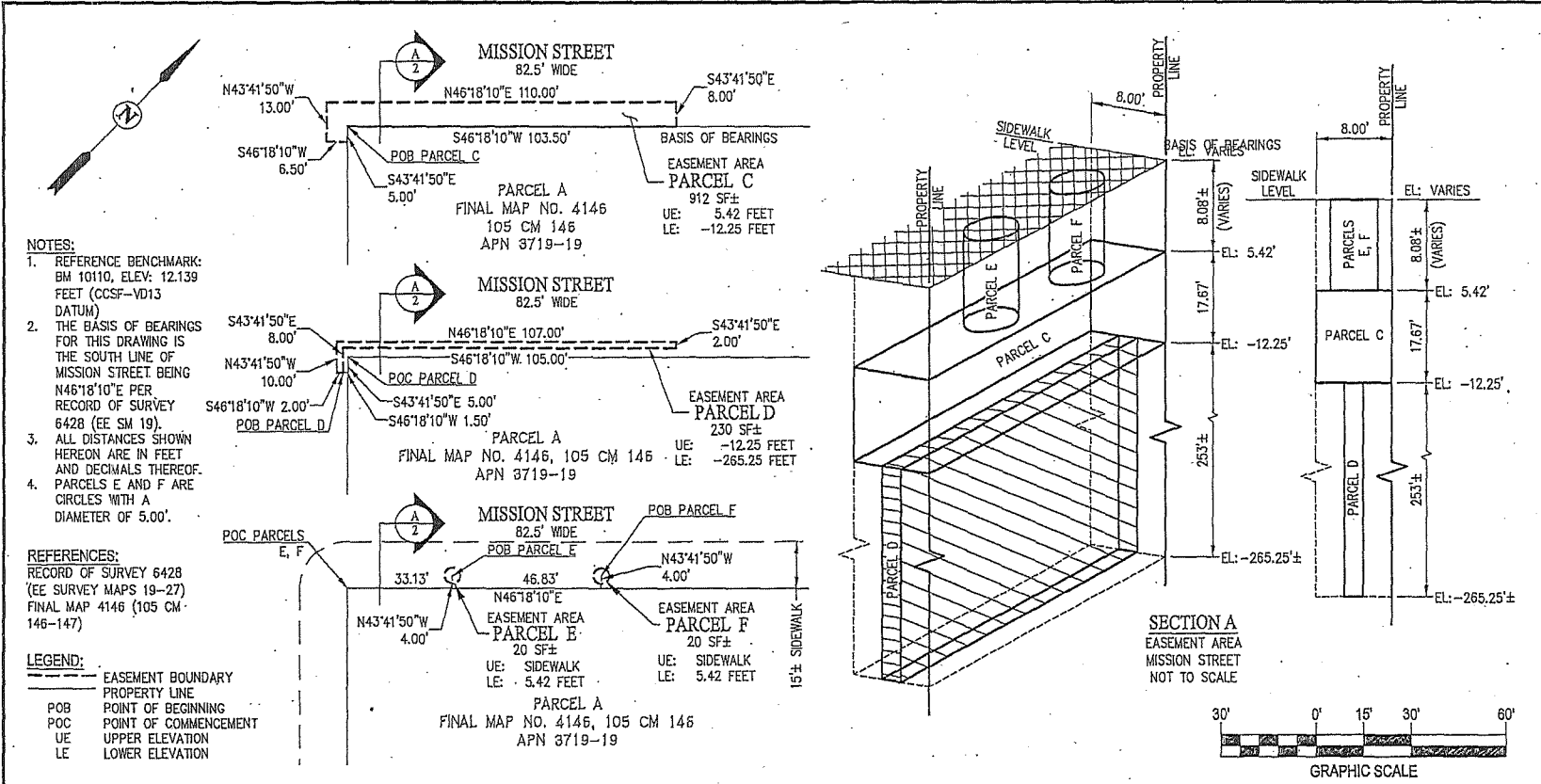

- NOTES:**
- REFERENCE BENCHMARK:  
BM 10110, ELEV: 12.139  
FEET (CCSF--VD13  
DATUM)
  - THE BASIS OF BEARINGS  
FOR THIS DRAWING IS  
THE SOUTH LINE OF  
MISSION STREET BEING  
N46°18'10"E PER  
RECORD OF SURVEY  
6428 (EE SM 19).
  - ALL DISTANCES SHOWN  
HEREON ARE IN FEET  
AND DECIMALS THEREOF.
  - PARCELS E AND F ARE  
CIRCLES WITH A  
DIAMETER OF 5.00'.

**REFERENCES:**  
RECORD OF SURVEY 6428  
(EE SURVEY MAPS 19-27)  
FINAL MAP 4146 (105 CM-  
146-147)

- LEGEND:**
- EASEMENT BOUNDARY
  - PROPERTY LINE
  - POB POINT OF BEGINNING
  - POC POINT OF COMMENCEMENT
  - UE UPPER ELEVATION
  - LE LOWER ELEVATION



APPROVED: *Bruce R. Storrs*  
BRUCE R. STORRS  
CITY & COUNTY SURVEYOR

1/8/2020  
DATE

**CITY AND COUNTY OF SAN FRANCISCO PUBLIC WORKS**  
SUBDIVISION AND MAPPING

STREET VACATION OF PORTIONS OF MISSION ST. AND FREMONT ST., FRONTING APN 3719-019

FILE: SUR 2019-006	SHEET 2 OF 3	SCALE: 1"=30'	REVISION
--------------------	--------------	---------------	----------



1528

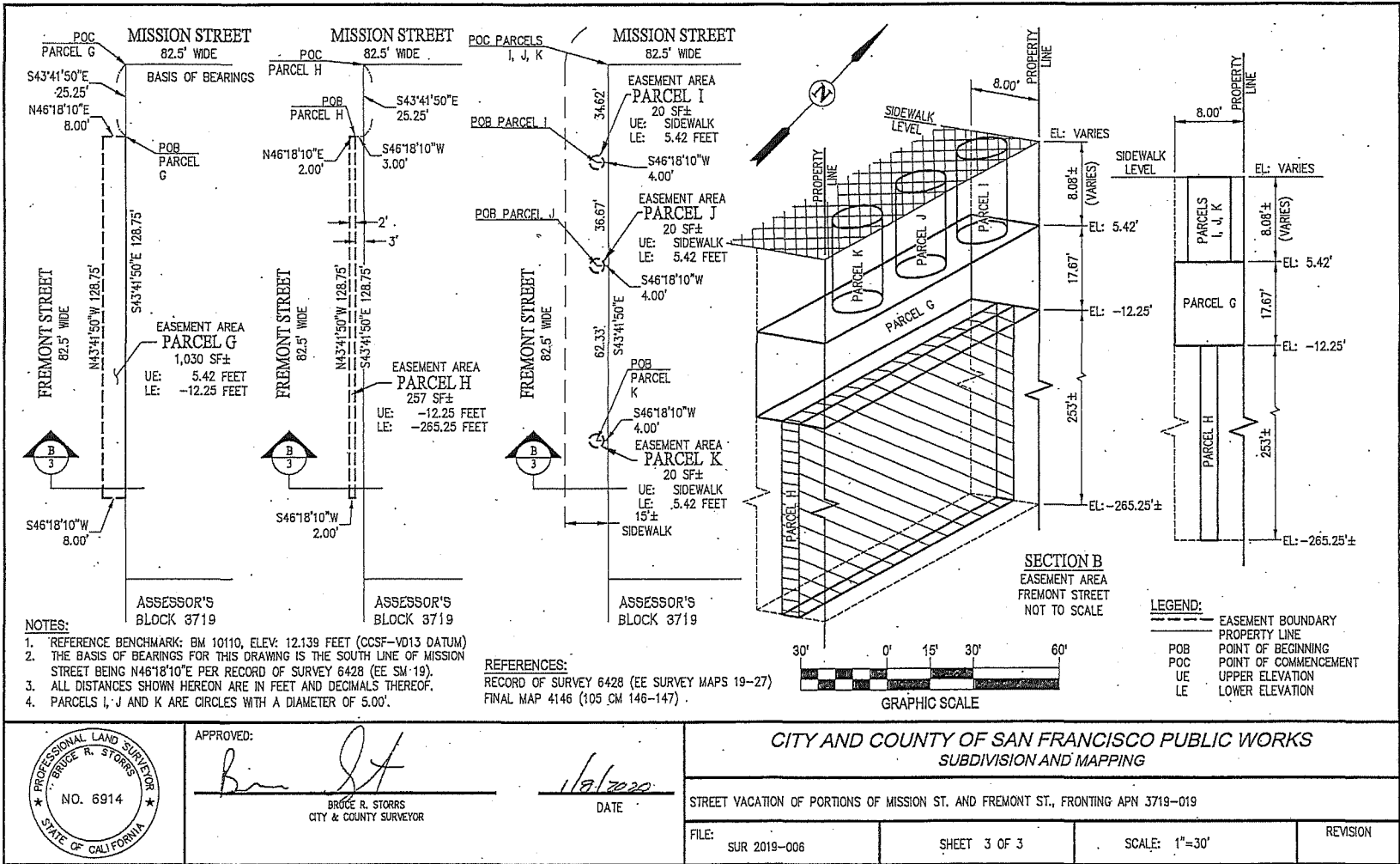

APPROVED:  
 \_\_\_\_\_  
 BRUCE R. STORRS  
 CITY & COUNTY SURVEYOR

DATE  
 1/6/2020

**CITY AND COUNTY OF SAN FRANCISCO PUBLIC WORKS**  
 SUBDIVISION AND MAPPING

STREET VACATION OF PORTIONS OF MISSION ST. AND FREMONT ST., FRONTING APN 3719-019			
FILE:	SUR 2019-006	SHEET 3 OF 3	SCALE: 1"=30'
			REVISION





1529

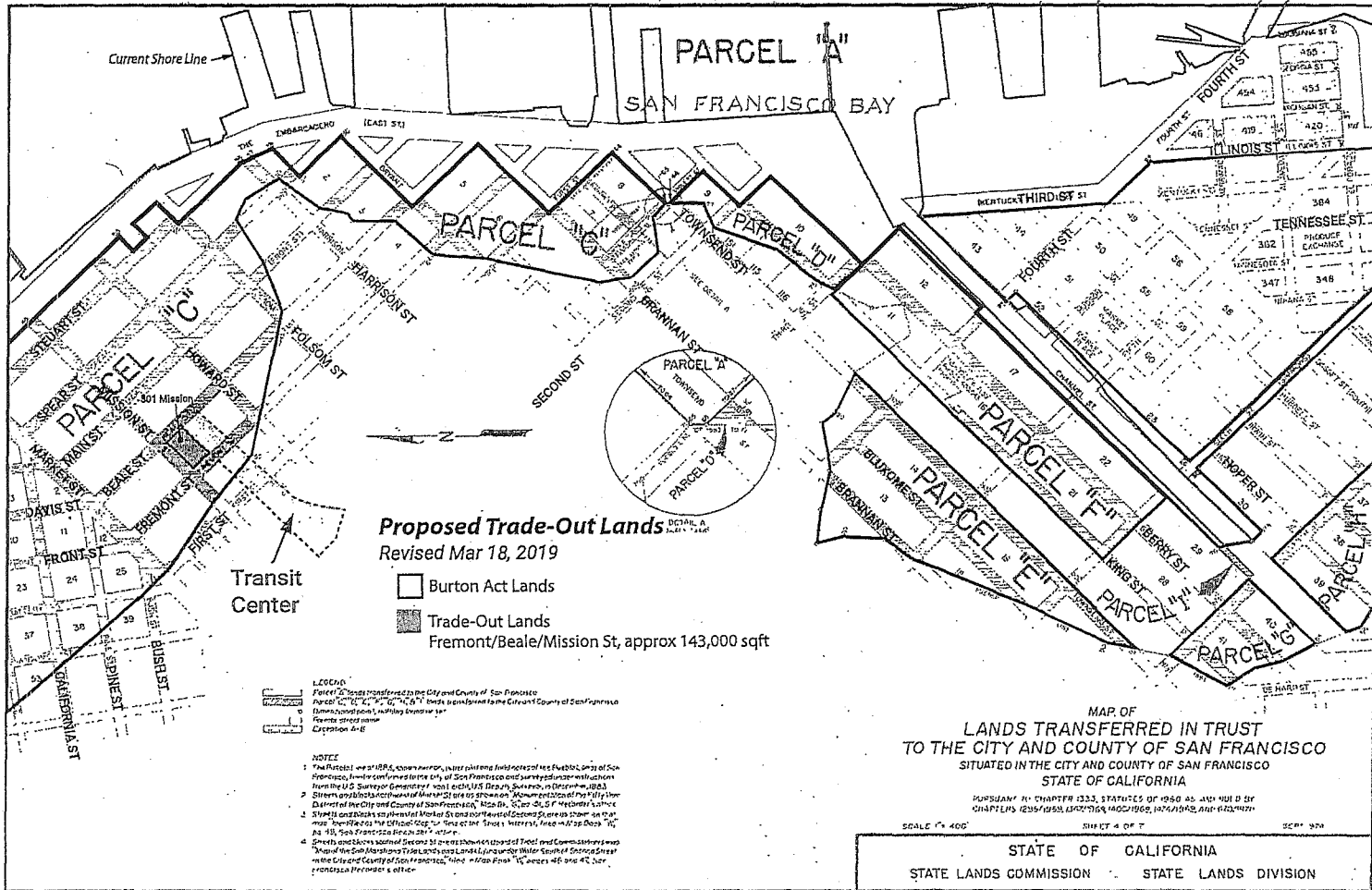

**Proposed Trade-Out Lands**  
 Revised Mar 18, 2019

Burton Act Lands  
 Trade-Out Lands  
 Fremont/Beale/Mission St, approx 143,000 sqft

**LEGEND**

- 1 Parcel C lands transferred to the City and County of San Francisco
- 2 Parcel C lands transferred to the City and County of San Francisco
- 3 Parcel C lands transferred to the City and County of San Francisco
- 4 Parcel C lands transferred to the City and County of San Francisco
- 5 Parcel C lands transferred to the City and County of San Francisco
- 6 Parcel C lands transferred to the City and County of San Francisco
- 7 Parcel C lands transferred to the City and County of San Francisco
- 8 Parcel C lands transferred to the City and County of San Francisco
- 9 Parcel C lands transferred to the City and County of San Francisco
- 10 Parcel C lands transferred to the City and County of San Francisco
- 11 Parcel C lands transferred to the City and County of San Francisco
- 12 Parcel C lands transferred to the City and County of San Francisco
- 13 Parcel C lands transferred to the City and County of San Francisco
- 14 Parcel C lands transferred to the City and County of San Francisco
- 15 Parcel C lands transferred to the City and County of San Francisco
- 16 Parcel C lands transferred to the City and County of San Francisco
- 17 Parcel C lands transferred to the City and County of San Francisco
- 18 Parcel C lands transferred to the City and County of San Francisco
- 19 Parcel C lands transferred to the City and County of San Francisco
- 20 Parcel C lands transferred to the City and County of San Francisco
- 21 Parcel C lands transferred to the City and County of San Francisco
- 22 Parcel C lands transferred to the City and County of San Francisco
- 23 Parcel C lands transferred to the City and County of San Francisco
- 24 Parcel C lands transferred to the City and County of San Francisco
- 25 Parcel C lands transferred to the City and County of San Francisco
- 26 Parcel C lands transferred to the City and County of San Francisco
- 27 Parcel C lands transferred to the City and County of San Francisco
- 28 Parcel C lands transferred to the City and County of San Francisco
- 29 Parcel C lands transferred to the City and County of San Francisco
- 30 Parcel C lands transferred to the City and County of San Francisco
- 31 Parcel C lands transferred to the City and County of San Francisco
- 32 Parcel C lands transferred to the City and County of San Francisco
- 33 Parcel C lands transferred to the City and County of San Francisco
- 34 Parcel C lands transferred to the City and County of San Francisco
- 35 Parcel C lands transferred to the City and County of San Francisco
- 36 Parcel C lands transferred to the City and County of San Francisco
- 37 Parcel C lands transferred to the City and County of San Francisco
- 38 Parcel C lands transferred to the City and County of San Francisco
- 39 Parcel C lands transferred to the City and County of San Francisco
- 40 Parcel C lands transferred to the City and County of San Francisco
- 41 Parcel C lands transferred to the City and County of San Francisco
- 42 Parcel C lands transferred to the City and County of San Francisco
- 43 Parcel C lands transferred to the City and County of San Francisco
- 44 Parcel C lands transferred to the City and County of San Francisco
- 45 Parcel C lands transferred to the City and County of San Francisco
- 46 Parcel C lands transferred to the City and County of San Francisco
- 47 Parcel C lands transferred to the City and County of San Francisco
- 48 Parcel C lands transferred to the City and County of San Francisco
- 49 Parcel C lands transferred to the City and County of San Francisco
- 50 Parcel C lands transferred to the City and County of San Francisco
- 51 Parcel C lands transferred to the City and County of San Francisco
- 52 Parcel C lands transferred to the City and County of San Francisco
- 53 Parcel C lands transferred to the City and County of San Francisco
- 54 Parcel C lands transferred to the City and County of San Francisco
- 55 Parcel C lands transferred to the City and County of San Francisco
- 56 Parcel C lands transferred to the City and County of San Francisco
- 57 Parcel C lands transferred to the City and County of San Francisco
- 58 Parcel C lands transferred to the City and County of San Francisco
- 59 Parcel C lands transferred to the City and County of San Francisco
- 60 Parcel C lands transferred to the City and County of San Francisco
- 61 Parcel C lands transferred to the City and County of San Francisco
- 62 Parcel C lands transferred to the City and County of San Francisco
- 63 Parcel C lands transferred to the City and County of San Francisco
- 64 Parcel C lands transferred to the City and County of San Francisco
- 65 Parcel C lands transferred to the City and County of San Francisco
- 66 Parcel C lands transferred to the City and County of San Francisco
- 67 Parcel C lands transferred to the City and County of San Francisco
- 68 Parcel C lands transferred to the City and County of San Francisco
- 69 Parcel C lands transferred to the City and County of San Francisco
- 70 Parcel C lands transferred to the City and County of San Francisco
- 71 Parcel C lands transferred to the City and County of San Francisco
- 72 Parcel C lands transferred to the City and County of San Francisco
- 73 Parcel C lands transferred to the City and County of San Francisco
- 74 Parcel C lands transferred to the City and County of San Francisco
- 75 Parcel C lands transferred to the City and County of San Francisco
- 76 Parcel C lands transferred to the City and County of San Francisco
- 77 Parcel C lands transferred to the City and County of San Francisco
- 78 Parcel C lands transferred to the City and County of San Francisco
- 79 Parcel C lands transferred to the City and County of San Francisco
- 80 Parcel C lands transferred to the City and County of San Francisco
- 81 Parcel C lands transferred to the City and County of San Francisco
- 82 Parcel C lands transferred to the City and County of San Francisco
- 83 Parcel C lands transferred to the City and County of San Francisco
- 84 Parcel C lands transferred to the City and County of San Francisco
- 85 Parcel C lands transferred to the City and County of San Francisco
- 86 Parcel C lands transferred to the City and County of San Francisco
- 87 Parcel C lands transferred to the City and County of San Francisco
- 88 Parcel C lands transferred to the City and County of San Francisco
- 89 Parcel C lands transferred to the City and County of San Francisco
- 90 Parcel C lands transferred to the City and County of San Francisco
- 91 Parcel C lands transferred to the City and County of San Francisco
- 92 Parcel C lands transferred to the City and County of San Francisco
- 93 Parcel C lands transferred to the City and County of San Francisco
- 94 Parcel C lands transferred to the City and County of San Francisco
- 95 Parcel C lands transferred to the City and County of San Francisco
- 96 Parcel C lands transferred to the City and County of San Francisco
- 97 Parcel C lands transferred to the City and County of San Francisco
- 98 Parcel C lands transferred to the City and County of San Francisco
- 99 Parcel C lands transferred to the City and County of San Francisco
- 100 Parcel C lands transferred to the City and County of San Francisco

**NOTE**

1. The title to the lands shown on this map is subject to the provisions of the San Francisco Ordinance No. 100,000, which provides for the sale of lands owned by the City and County of San Francisco.
2. The title to the lands shown on this map is subject to the provisions of the San Francisco Ordinance No. 100,000, which provides for the sale of lands owned by the City and County of San Francisco.
3. The title to the lands shown on this map is subject to the provisions of the San Francisco Ordinance No. 100,000, which provides for the sale of lands owned by the City and County of San Francisco.
4. The title to the lands shown on this map is subject to the provisions of the San Francisco Ordinance No. 100,000, which provides for the sale of lands owned by the City and County of San Francisco.

MAP OF  
**LANDS TRANSFERRED IN TRUST**  
 TO THE CITY AND COUNTY OF SAN FRANCISCO  
 SITUATED IN THE CITY AND COUNTY OF SAN FRANCISCO  
 STATE OF CALIFORNIA

PURSUANT TO CHAPTER 2333, STATUTES OF 1946 AS AMENDED BY  
 CHAPTERS 425, 426, 427, 428, 429, 430, 431, 432, 433, 434, 435, 436, 437, 438, 439, 440, 441, 442, 443, 444, 445, 446, 447, 448, 449, 450, 451, 452, 453, 454, 455, 456, 457, 458, 459, 460, 461, 462, 463, 464, 465, 466, 467, 468, 469, 470, 471, 472, 473, 474, 475, 476, 477, 478, 479, 480, 481, 482, 483, 484, 485, 486, 487, 488, 489, 490, 491, 492, 493, 494, 495, 496, 497, 498, 499, 500, 501, 502, 503, 504, 505, 506, 507, 508, 509, 510, 511, 512, 513, 514, 515, 516, 517, 518, 519, 520, 521, 522, 523, 524, 525, 526, 527, 528, 529, 530, 531, 532, 533, 534, 535, 536, 537, 538, 539, 540, 541, 542, 543, 544, 545, 546, 547, 548, 549, 550, 551, 552, 553, 554, 555, 556, 557, 558, 559, 560, 561, 562, 563, 564, 565, 566, 567, 568, 569, 570, 571, 572, 573, 574, 575, 576, 577, 578, 579, 580, 581, 582, 583, 584, 585, 586, 587, 588, 589, 590, 591, 592, 593, 594, 595, 596, 597, 598, 599, 600, 601, 602, 603, 604, 605, 606, 607, 608, 609, 610, 611, 612, 613, 614, 615, 616, 617, 618, 619, 620, 621, 622, 623, 624, 625, 626, 627, 628, 629, 630, 631, 632, 633, 634, 635, 636, 637, 638, 639, 640, 641, 642, 643, 644, 645, 646, 647, 648, 649, 650, 651, 652, 653, 654, 655, 656, 657, 658, 659, 660, 661, 662, 663, 664, 665, 666, 667, 668, 669, 670, 671, 672, 673, 674, 675, 676, 677, 678, 679, 680, 681, 682, 683, 684, 685, 686, 687, 688, 689, 690, 691, 692, 693, 694, 695, 696, 697, 698, 699, 700, 701, 702, 703, 704, 705, 706, 707, 708, 709, 710, 711, 712, 713, 714, 715, 716, 717, 718, 719, 720, 721, 722, 723, 724, 725, 726, 727, 728, 729, 730, 731, 732, 733, 734, 735, 736, 737, 738, 739, 740, 741, 742, 743, 744, 745, 746, 747, 748, 749, 750, 751, 752, 753, 754, 755, 756, 757, 758, 759, 760, 761, 762, 763, 764, 765, 766, 767, 768, 769, 770, 771, 772, 773, 774, 775, 776, 777, 778, 779, 780, 781, 782, 783, 784, 785, 786, 787, 788, 789, 790, 791, 792, 793, 794, 795, 796, 797, 798, 799, 800, 801, 802, 803, 804, 805, 806, 807, 808, 809, 810, 811, 812, 813, 814, 815, 816, 817, 818, 819, 820, 821, 822, 823, 824, 825, 826, 827, 828, 829, 830, 831, 832, 833, 834, 835, 836, 837, 838, 839, 840, 841, 842, 843, 844, 845, 846, 847, 848, 849, 850, 851, 852, 853, 854, 855, 856, 857, 858, 859, 860, 861, 862, 863, 864, 865, 866, 867, 868, 869, 870, 871, 872, 873, 874, 875, 876, 877, 878, 879, 880, 881, 882, 883, 884, 885, 886, 887, 888, 889, 890, 891, 892, 893, 894, 895, 896, 897, 898, 899, 900, 901, 902, 903, 904, 905, 906, 907, 908, 909, 910, 911, 912, 913, 914, 915, 916, 917, 918, 919, 920, 921, 922, 923, 924, 925, 926, 927, 928, 929, 930, 931, 932, 933, 934, 935, 936, 937, 938, 939, 940, 941, 942, 943, 944, 945, 946, 947, 948, 949, 950, 951, 952, 953, 954, 955, 956, 957, 958, 959, 960, 961, 962, 963, 964, 965, 966, 967, 968, 969, 970, 971, 972, 973, 974, 975, 976, 977, 978, 979, 980, 981, 982, 983, 984, 985, 986, 987, 988, 989, 990, 991, 992, 993, 994, 995, 996, 997, 998, 999, 1000.

SCALE 1" = 400' SHEET 4 OF 7 SEP 1978  
 STATE OF CALIFORNIA  
 STATE LANDS COMMISSION STATE LANDS DIVISION

PREPARED UNDER W6414 Will Spargur wspargur@transbaycenter.org  
 StreetVocallon|Burton Act|Burton Act Map|Trade-Out Lands for Transbay Trust Exchange 20190311.ai



1530

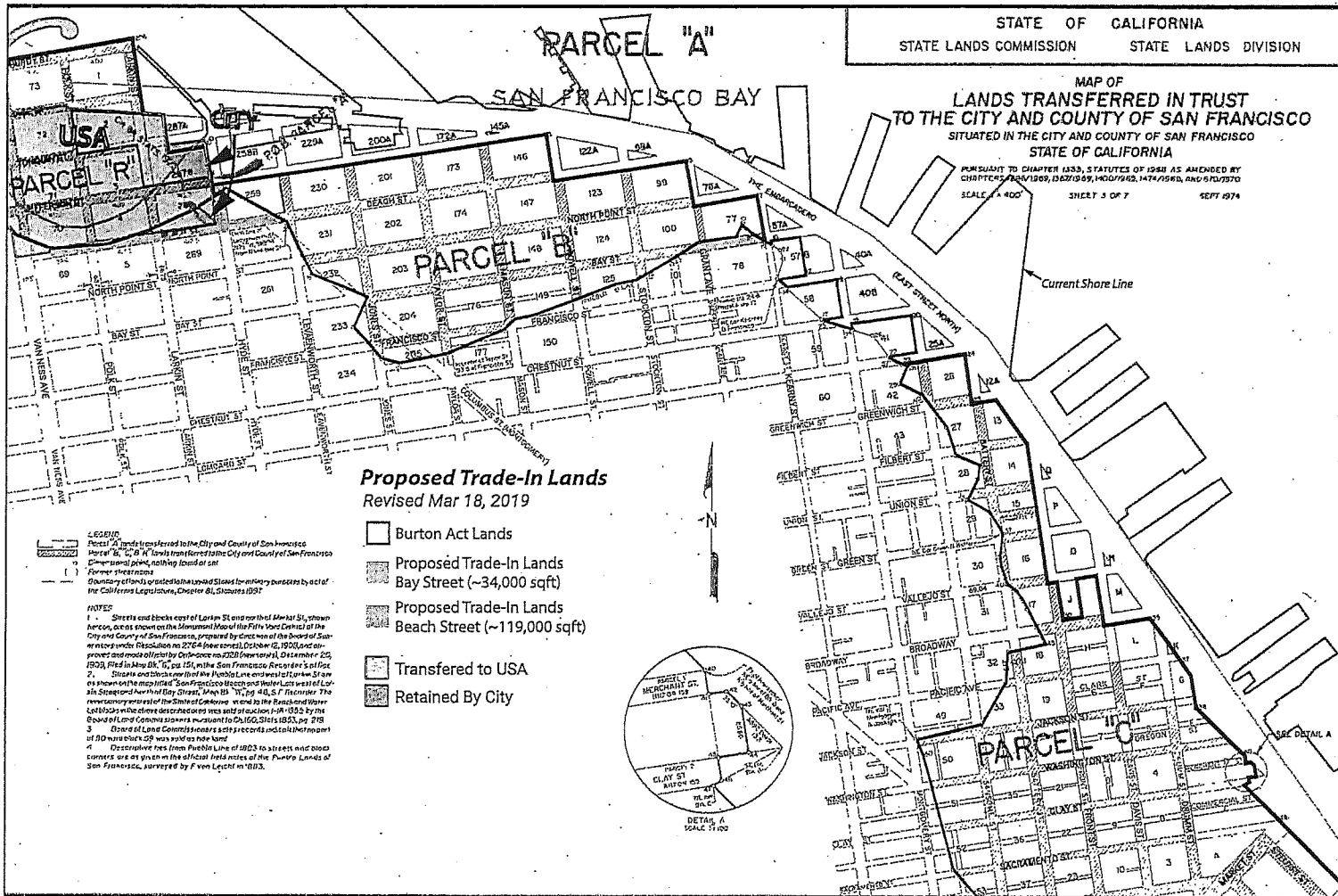

Will Spatzgur wspatzgur@transbaycenter.org  
StreetVacation\Burton Act\Burton Act Map\Trade-In Lands for Transbay Trust Exchange v2 210918



**MEMORANDUM**

January 10, 2020

**TO:** MEMBERS, PORT COMMISSION  
Hon. Kimberly Brandon, President  
Hon. Willie Adams, Vice President  
Hon. Gail Gilman  
Hon. Victor Makras  
Hon. Doreen Woo Ho

**FROM:** Elaine Forbes  
Executive Director

**SUBJECT:** Request approval of a Trust Exchange Agreement with the California State Lands Commission that would remove the public trust from certain Transbay Streets and impress the public trust on certain Fisherman's Wharf Streets; adopting environmental findings and findings of consistency with the General Plan and the eight Priority Policies of City Planning Code Section 101.1; and authorizing the Port's Executive Director to execute documents, make certain modifications and take certain actions in furtherance of this Resolution.

**DIRECTOR'S RECOMMENDATION:** Approve Attached Resolution No. 20-01

---

**SUMMARY**

The purpose of the memorandum is to provide the Port Commission and the public with information and analysis regarding Port staff's recommendation to approve the trust exchange between the Port, City, and the State Lands Commission for Transbay and Fisherman's Wharf streets. Staff recommends approval of a trust exchange to facilitate consolidation of the Transbay Transit Center site and implementation of a plan to strengthen the substructure of the Millennium Tower residential development at 301 Mission Street.

The new Transbay Transit Center encroaches in part in the airspace over Fremont and Beale Streets. The City seeks to acquire from the Port the air and subsurface rights in

**THIS PRINT COVERS CALENDAR ITEM NO. 10A**

the streets occupied by the Transit Center structure and trainbox, including the occupied portions of Fremont and Beale Streets, for the purpose of creating a single legal parcel for the entire Transit Center site. The City also seeks to convey a permanent easement in the surface and subsurface of a portion of Mission Street in addition to portions of Beale and Fremont Streets to permit the construction and maintenance of a retrofit for the Millennium Tower residential development at 301 Mission Street.

Those portions of Mission Street, Fremont Street and Beale Street in the vicinity of the Transit Center are among the former State-owned tide and submerged lands granted to the City and County of San Francisco by the State in trust under the Burton Act. The Burton Act prohibits the City from conveying a permanent interest in the granted lands. Accordingly, for the City to convey permanent air and subsurface rights in the Mission, Fremont and Beale Streets, the public trust and Burton Act restrictions must be lifted from portions of these streets with the approval of the State Lands Commission.

The City is requesting the Port Commission approve the exchange. If approved, the exchange agreement would be considered by the Board of Supervisors.

### **BACKGROUND**

In 2001, the Transbay Joint Powers Authority (TJPA) was formed as a joint powers agency consisting of the City, AC Transit, and the Peninsula Corridor Joint Powers Board (Caltrain) for the purpose of constructing a new Transbay Transit Center. In 2002, the California State Legislature added Section 5027.1 to the Public Resources Code, authorizing the construction of a replacement of the old transit terminal at the same location to serve Caltrain, bus lines, and high-speed rail.

Caltrans conveyed the former terminal property to the TJPA in 2010. That conveyance, however, did not include any air or subsurface rights in any streets. In 2011, the Board of Supervisors approved an ordinance vacating the public street easement in the airspace and subsurface of streets occupied by the new Transbay Transit Center, and authorized the City to quitclaim its interest in those areas to the TJPA (Ordinance No. 43-11). With the completion of the Transit Center in 2018 and a legal description defining the area occupied by the Transit Center, the City and the TJPA are finally prepared to proceed with the conveyance of the easements. This has raised the issue of whether the City has the legal authority to convey its interests in Fremont, Mission and Beale Streets to the TJPA and the proponents of Millennium Tower Association.

A proposed structural upgrade for the Millennium Tower at 301 Mission Street, if approved, may occupy a portion of the surface and subsurface of the same streets that are under the Transit Center and adjacent to the Tower, and the City may wish to convey a permanent easement in the occupied areas to the owners of the Tower to provide for the installation of and occupation related to the structural upgrade.

### Burton Act

The new Transbay Transit Center encroaches in part in the airspace over Fremont and Beale Streets. The Transbay Transit Center is built on what was once Yerba Buena Cove. When California became a state in 1850, it took title to all the tide and submerged lands in the State – including Yerba Buena Cove. The TJPA seeks to acquire from the City the air and subsurface rights in the streets occupied by the Transit Center structure and trainbox, including the occupied portions of Fremont and Beale Streets, for the purpose of creating a single legal parcel for the entire Transit Center site. The City also seeks to convey a permanent easement in the surface and subsurface of a portion of Mission Street in addition to portions of Beale and Fremont Streets to the neighboring property “owner” Millennium Tower Association to permit the construction and maintenance of a retrofit for the tower foundation to prevent and potentially correct the subsidence and leaning of the Millennium Tower.

Those portions of Mission Street, Fremont Street and Beale Street in the vicinity of the Transit Center are among the former State owned tide and submerged lands granted to the City and County of San Francisco in trust under Chapter 1333 of the Statutes of 1968 (“Burton Act”). Staff concludes that these streets are impressed with the Public Trust because of the original formation of the shoreline and Yerba Buena Cove.

The Burton Act prohibits the City from conveying a permanent interest in the granted lands; at most it could convey a 66-year lease or easement. Accordingly, for the City to convey permanent air and subsurface rights in the Mission, Fremont and Beale Streets, the public trust and Burton Act restrictions must be lifted from portions of these streets.

### Public Trust Exchange

The State Lands Commission (“State Lands Commission”) has authority to approve the public trust exchanges of Port property (the (“Trust Exchange”) pursuant to Section 5 of Chapter 310, Statutes of 1987 (“Chapter 310”). Under Chapter 310, the City has the authority, subject to State Lands Commission approval, to exchange City property subject to the Public Trust with public or private entities for property not subject to the Public Trust if the City and State Lands Commission make certain findings. The findings are further discussed in the “Public Trust Analysis” section below.

### Public Trust Analysis

As mentioned above, the Project must include a proposed Trust Exchange for portions of Beale, Fremont and Mission Streets that provides significant benefits to the Public Trust. Under Chapter 310, the City has the authority, subject to State Lands Commission approval, to exchange City property subject to the Public Trust with public or private entities for property not subject to the Public Trust if the City and State Lands Commission determine that the land to be exchanged out of the Public Trust (1) has been filled and reclaimed; (2) is cut off from access to the waters of the Bay; (3) represents a relatively small portion of the granted tide and submerged lands; (4) is

no longer needed or required for the promotion of the Trust; and (5) can be removed from the Public Trust without causing any substantial interference with Public Trust uses and purposes. In addition, the Trust Addition Streets must have value equal to or greater than the value of the Trust Termination Streets that is useful for the particular trust purposes authorized by the Burton Act.

- 1. The Trust Termination Streets have been filled and reclaimed. The Trust Termination Streets are located in the Transbay Area, which was filled as part of the Port's program of reclaiming lands between the new seawall and the previously existing City front, for the purpose of generating revenues used to support the improvement of the harbor.*
- 2. The Trust Termination streets are cut off from access to the waters of the Bay. All of the Trust Termination Streets are located on filled land, located on the landside of the 100 foot wide Embarcadero Roadway, which consists of 6 traffic lanes and the MUNI light-rail corridor. No immediate access to the waters of San Francisco Bay exists from any portion of the Trust Termination Streets.*
- 3. The Trust Termination Streets are a very small portion of the Port's trust grant. The total area of the Trust Termination Streets is approximately 143,000 square feet (approximately 3.28 acre). The total amount of granted tide and submerged lands held by the Port is approximately 725 acres, of which the Trust Terminal Parcel represents 0.45%.*
- 4. The Trust Termination Streets are no longer needed or required for the promotion of the Public Trust. The Streets comprising the Trust Termination Streets are physically cut-off from the water, serve no purpose in furthering maritime commerce, navigation or fisheries, and are no longer needed or required for the promotion of the Trust. As public streets, the Trust Termination Streets do not allow for the feasible development of uses that would further Trust goals such as useable or desirable open space or park use of Trust-consistent commercial use, such as hotel or retail. The primary use of the Trust Termination Streets is public access, but the streets are distant from the waterfront and are not required to provide access to the water.*
- 5. The Trust Termination Streets can be removed from the Trust without causing substantial interference with Trust uses and purposes. The use of Trust Termination Streets for non-Trust purposes would not impede any Trust use on the granted lands or otherwise interfere with any Trust purpose. In addition, in exchange for the lifting of the Trust from the Trust Termination Streets, the Port will receive streets into the Trust that have a greater square footage and linear footage than the Trust Termination Streets, and have substantial utility to the Trust.*

The Trust Addition Streets consist of a portion of Beach Street between Van Ness Avenue and Leavenworth Street, a portion of Hyde Street between Beach Street and Jefferson Street, and a portion of Bay Street between Stockton Street and Kearny Street. These streets, located near Fisherman's Wharf area, provide public access along and to the water and the City's waterfront and service important Trust purposes.

- 1. The Beach Street segment of the Trust Addition Streets runs along Aquatic Park, generally parallel to the beach, and provides views of the beach and the San Francisco Bay. A fragment of Beach Street (near Polk Street) is waterward of the historic shoreline and is already in the Trust. The Beach Street segment is also lined with historic waterfront buildings such as the Cannery and Ghirardelli Square, waterfront hotels, and the Maritime Museum. The remainder of Beach Street, from Leavenworth Street to The Embarcadero, is already in the Trust.*
- 2. The Hyde Street segment runs from Beach Street to the waterfront, providing public access to Aquatic Park, the Dolphin Swim and Boat Club, the South End Rowing Club, and the historic Hyde Street Pier ships at the San Francisco Maritime National Historical Park.*
- 3. The Bay Street segment is two blocks south of Pier 39 and one block west of Alcatraz Landing at Pier 33 and the Port's secondary cruise terminal at Pier 35. The street segments abutting the Bay Street segment on three sides (Grant Street north from Bay Street to the Embarcadero, Bay Street to Jones Street on the west, and to The Embarcadero on the east) are already in the Trust.*

Attachment A shows the Trust Termination Streets and Attachment B shows the Trust Addition Streets, including their respective square footages. The Trust Addition Streets to be impressed with the Public Trust has a preliminary appraised value at least equal to the value of the Trust Termination Streets to be conveyed out of the Public Trust, confirming the value of the land to be exchanged into the Public Trust equals or exceeds the value of the land to be exchanged out of the Public Trust. The appraiser will complete the analysis for the State Lands Commission. Staff recommends this trust exchange because the Trust Termination Streets of 143,000 square feet is smaller than the proposed Trade-in Lands of 153,000 square feet and these streets are adjacent to Port property.

For reasons set forth above, the Trust Exchange meets the requirements of Chapter 310.

### **California Environmental Quality Act ("CEQA") Findings**

On December 27, 2019, following the required notice and appeal period, the Planning Department published a Final Mitigation Negative Declaration ("FMND") for the 301 Mission Street, Millennium Tower Perimeter Pile Upgrade Project (the "Project"),

including the permanent easement required for the Project. The FMND found that although the Project could have potentially significant impacts on the environment, such impacts will be reduced to less than significant level because Millennium Tower Association (the "Project Sponsor") will implement all mitigation measures identified in the PMND.

In a letter dated December 27, 2019 (the "General Plan Referral Letter"), the City Planning Department determined that the Trust Exchange is, on balance, consistent with the General Plan and with the Eight Priority Policies of City Planning Code Section 101.1. As part of its determination on the General Plan, the Planning Department reviewed and considered the FMND, including the proposed mitigation monitoring and reporting program, and adopted CEQA Findings and the proposed mitigation monitoring and reporting program (collectively, "CEQA Findings") as required by State and local law. The Board of Supervisors adopted and incorporated by reference the CEQA Findings; and, in so doing, the Board of Supervisors approved and endorsed the Mitigation Monitoring and Reporting Program for implementation by other City departments. Copies of the General Plan Referral Letter, FMND, CEQA Findings, and the Mitigation Monitoring and Reporting Program are on file with the Secretary of the Port Commission and incorporated herein by reference. The Board of Supervisors found that the actions proposed are within the scope of the Project analyzed in the FMND and subject to the CEQA Findings.

The Board of Supervisors further found that (1) no substantial changes are proposed in the Project and no substantial changes have occurred with respect to the circumstances under which this Project will be undertaken that would cause new significant environmental effects or a substantial increase in the severity of previously identified effects and (2) there is no new information of substantial importance showing that the Project would have any significant effects not discussed in the FMND, that significant effects would be substantially more severe, or that new or different mitigation measures of alternatives would substantially reduce one or more significant effects of the Project. For copies of CEQA documents in the San Francisco Planning Department's file for CEQA Case including the Draft Environmental Impact Report ("EIR") and Comments, please see the Planning Department's Environmental Planning Division website. Copies of these documents are also filed with the Port Commission Secretary ("CEQA Findings").

### **Recommendation**

The City is eager to complete this transaction to support the Millennium Tower settlement agreement negotiations and to provide a single Transit Center site to the TJPA. The City is requesting the Port Commission approve the exchange at its January 14, 2020. If approved, the exchange agreement would be considered by the Board of Supervisors Land Use Committee January 27<sup>th</sup>, and before the full board on February 4<sup>th</sup>. The State Lands Commission would consider the exchange in February although a date has not been set yet.



Accordingly, Staff request the following:

- Authorization to execute a Trust Exchange Agreement between the City and the Port and the State Lands Commission

Prepared by: Byron A. Rhett  
Chief Operating Officer

PORT COMMISSION  
CITY AND COUNTY OF SAN FRANCISCO

RESOLUTION NO. 20-01

**Resolution approving and authorizing a Trust Exchange Agreement with the California State Lands Commission that would remove the public trust from certain Transbay Streets and impress the public trust on certain Fisherman's Wharf Streets; adopting environmental findings and findings of consistency with the General Plan and the eight Priority Policies of City Planning Code Section 101.1; and authorizing the Port's Executive Director execute documents, make certain modifications and take certain actions in furtherance of this Resolution.**

WHEREAS, Pursuant to Chapter 1333 of the Statutes of 1968 (The "Burton Act"), the State of California granted to the City and County of San Francisco ("City") certain current and former tide and submerged lands, including a number of public streets, to be held under the jurisdiction of the San Francisco Port (the "Port") subject the public trust for commerce navigation and fisheries ("Public Trust"); and

WHEREAS, The granted lands include (i) a portion of Beale Street, bounded by Mission Street and Howard Street; (ii) a portion of Mission Street, bounded by Beale Street and First Street; and (iii) a portion of Fremont Street, bounded by Mission Street and Howard Street (collectively, the "Trust Termination Streets"); and

WHEREAS, The Trust Termination Streets are situated in the vicinity of the Salesforce Transit Center ("Transit Center"), are distant from the City's present waterfront, are not needed to ensure public access to the water, and are longer needed to serve the purposes of the Public Trust or the Burton Act (collectively, the "Trust"); and

WHEREAS, The recently completed Transit Center occupies the airspace and subsurface of a portion of the Trust Termination Streets, and the City has previously agreed to convey title to the occupied areas to the Transbay Joint Powers Authority, which owns and operates the Transit Center pursuant to Ordinance No. 43-11 adopted by the Board of Supervisors on March 8, 2011, on file with the Clerk of the Board of Supervisors in File No. 110019; and

WHEREAS, A proposed structural upgrade for the Millennium Tower located at 301 Mission Street, if approved, may occupy a portion of the surface and subsurface of the Trust Termination Streets adjacent to the building, and the City may wish to convey a permanent easement in the occupied areas

to the owners of the building to provide for the installation of and occupation of infrastructure related to the structural upgrade; and

WHEREAS, The City is not permitted to convey any permanent easement or title in the Trust Termination Streets unless the Trust is terminated therein; and

WHEREAS, Certain public streets owned by the City in or near Fisherman's Wharf are landward of the historic shoreline and are not presently within the Port's jurisdiction or subject to the Trust, but are near the water and have high value for the Trust; and

WHEREAS, These streets include (i) a portion of Beach Street bounded by Leavenworth Street and Van Ness Avenue; (ii) a portion of Hyde Street bounded by Beach Street and Jefferson Street; and (iii) a portion of Bay Street, bounded by Kearney Street and Stockton Street (collectively, the "Trust Addition Streets"); and

WHEREAS, The Trust Addition Streets serve important Trust purposes by providing public access along and to the water and the City's waterfront, including access to Aquatic Park, the Maritime Museum, Hyde Street Pier and Maritime National Historic Park, historic waterfront buildings such as the Cannery and Ghirardelli Square, and The Embarcadero waterfront from Pier 39 to Pier 35; and

WHEREAS, The City seeks to enter into an agreement with the Port and the California State Lands Commission ("State Lands") authorizing a Trust exchange (the "Trust Exchange") pursuant to Section 5 of Chapter 310, Statutes of 1987 ("Chapter 310") whereby the Trust will be lifted from the Trust Termination Streets in exchange for impressing the Trust on the Trust Addition Streets, all as depicted and described on documents on file with the Secretary of this Port Commission; and

WHEREAS, Port and City staff have negotiated with State Lands staff an exchange agreement (the "Trust Exchange Agreement") that will authorize the conveyances necessary to effectuate the Trust Exchange; and

WHEREAS, On November 20, 2019, the Planning Department published a Preliminary Mitigated Negative Declaration ("PMND") for the 301 Mission Street, Millennium Tower Perimeter Pile Upgrade Project (the "Project"). The PMND found that although the Project could have potentially significant impacts on the environment, such impacts will be reduced to a less than significant level because Millennium Tower Association (the "Project Sponsor") will implement all mitigation measures identified in the PMND; and

WHEREAS, The Planning Department prepared and publicized the PMND in compliance with the provisions of the California Environmental Quality Act

(California Public Resources Code Sections 21000 et seq., "CEQA"), the State CEQA Guidelines (California Code of Regulations Title 14 Sections 15000 et seq.), and Chapter 31 of the San Francisco Administrative Code ("Chapter 31"); and

WHEREAS, On December 27, 2019, following the required notice and appeal period, the Planning Department published a Final Mitigated Negative Declaration ("FMND"); and

WHEREAS, In a letter dated December 27, 2019 (the "General Plan Referral Letter"), the City Planning Department determined that the Trust Exchange is, on balance, consistent with the General Plan and with the Eight Priority Policies of City Planning Code Section 101.1; and

WHEREAS, As part of its determination on the General Plan, the Planning Department reviewed and considered the FMND, including the proposed mitigation monitoring and reporting program; and

WHEREAS, As part of the General Plan Referral Letter, the Planning Department adopted CEQA Findings and the proposed mitigation monitoring and reporting program (collectively, "CEQA Findings") as required by State and local law; and

WHEREAS, The Port Commission hereby adopts and incorporates by reference the CEQA Findings; and, in so doing, the Port Commission approves and endorses the Mitigation Monitoring and Reporting Program for implementation by other City departments; and

WHEREAS, Copies of the General Plan Referral Letter, FMND, CEQA Findings, and the Mitigation Monitoring and Reporting Program are on file with the Secretary of this Port Commission and are incorporated herein by reference; and

WHEREAS, The Port Commission finds that the actions proposed herein are within the scope of the project ("Project") analyzed in the FMND and subject to the CEQA Findings; and

WHEREAS, The Port Commission further finds that (1) no substantial changes are proposed in the Project and no substantial changes have occurred with respect to the circumstances under which this Project will be undertaken that would cause new significant environmental effects or a substantial increase in the severity of previously identified effects and (2) there is no new information of substantial importance showing that the Project would have any significant effects not discussed in the FMND, that significant effects would be substantially more severe, or that new or different mitigation measures or alternatives would substantially reduce one or more significant effects of the Project; and

WHEREAS, As required by Chapter 310, the Port Commission makes the following findings with respect to the Trust Termination Streets:

1. The Trust Termination Streets have been filled and reclaimed.
2. The Trust Termination Streets are cut off from access to the waters of the San Francisco Bay. The Trust Termination Streets consist of City streets in the Transbay area that are several blocks from the waterfront. No immediate access to the waters of San Francisco Bay exists from the Trust Termination Streets.
3. The Trust Termination Streets comprise a relatively small portion of the Port's trust grant. The total area of the Trust Termination Streets is approximately 143,000 square feet (approximately 3.28 acres). The total amount of granted lands (exclusive of lands presently submerged) held by the Port is approximately 725 acres, of which the Trust Termination Streets represents 0.45%.
4. The Trust Termination Streets are no longer needed or required for the promotion of the Trust. The streets comprising the Trust Termination Streets are physically cut-off from the water, serve no purpose in furthering maritime commerce, navigation or fisheries, and are no longer needed or required for the promotion of the Trust. As public streets, the Trust Termination Streets do not allow for the feasible development of uses that would further Trust goals such as useable or desirable open space or park use or Trust-consistent commercial use, such as hotel or retail. The primary use of the Trust Termination Streets is public access, but the streets are distant from the waterfront and are not required to provide access to the water.
5. The Trust Termination Streets can be removed from the Trust without causing substantial interference with Trust uses and purposes. The use of Trust Termination Streets for non-Trust purposes would not impede any Trust use on the granted lands or otherwise interfere with any Trust purpose. In addition, in exchange for the lifting of the Trust from the Trust Termination Streets, the Port will receive streets into the Trust that have a greater square footage and linear footage than the Trust Termination Streets, and have substantial utility to the Trust; and

WHEREAS, The City's Director of Property ("Director of Property") has determined based on an independent MAI appraisal that the Trust Addition Streets have an appraised value that is equal to or greater than the value of the Trust Termination Streets; and

WHEREAS, In order to accomplish the proposed Trust Exchange, the Board of Supervisors must approve the Trust Exchange and related CEQA findings

substantially the form of the Trust Exchange Agreement which is on file with the Secretary of this Commission and incorporated herein by reference; and

WHEREAS, The Trust Exchange Agreement conforms to all local laws and regulations and is not prohibited by the City's Charter; now, therefore, be it

RESOLVED, That the Trust Exchange is in conformance with the Burton Act and Chapter 310, subject to approval by State Lands; and be it further

RESOLVED, That for reasons set forth herein, the Port Commission finds that the Trust Termination Streets (i) have been filled and reclaimed, and are cut off from access to the waters of the Bay, (ii) comprise a relatively small portion of the Port's trust grant, (iii) are no longer needed or required for the promotion of the Trust, (iv) can be removed from the Trust without causing substantial interference with Trust uses and purposes; and be it further

RESOLVED, That the Trust Addition Streets have a value that is equal to or greater than the value of the Trust Termination Streets, and are useful for the particular trust purposes specifically authorized by the Burton Act; and be it further

RESOLVED, That the Port Commission hereby approves the Trust Exchange and the Trust Exchange Agreement including all attachments and exhibits thereto, and the transactions which such agreement contemplates, materially on the terms and conditions set forth in the Port Commission Memorandum and in such final form as is approved by the City Attorney; and be it further

RESOLVED, That the Port Commission authorizes and directs the Port's Executive Director ("Executive Director") to execute the Trust Exchange Agreement in substantially the form presented to this Commission, and in such final form as if approved by the Executive Director in consultation with the City Attorney; and be it further

RESOLVED, That the Executive Director is hereby authorized and urged, in the name and on behalf of the City and the Port, to (i) execute and deliver any and all conveyance deeds and instruments, and (ii) to take any and all steps (including, but not limited to, the execution and delivery of any and all certificates, agreements, notices, consents, escrow instructions, closing documents and other instruments or documents) as they deem necessary or appropriate in order to implement the Trust Exchange in accordance with the terms of the Trust Exchange Agreement, or to otherwise effectuate the purpose and intent of this resolution, such determination to be conclusively evidenced by the execution and delivery by the Executive Director of any such documents subject to the approval of the Board of Supervisors; and be it further

RESOLVED, That the Executive Director is hereby authorized and urged, in the name and on behalf of the City and the Port, to (i) execute and deliver the deeds to the Trust Termination Streets and the Trust Addition Streets to the State, (ii) accept from the State a Trust patent for the Trust Addition Streets (iii) accept from the State a Trust termination patent for the Trust Termination Streets, and (iv) to take any and all steps (including, but not limited to, the execution and delivery of any and all certificates, agreements, notices, consents, escrow instructions, closing documents and other instruments or documents) as they deem necessary or appropriate in order to consummate the conveyances authorized in the Trust Exchange Agreement, or to otherwise effectuate the purpose and intent of this resolution, such determination to be conclusively evidenced by the execution and delivery by the Director of Property and Executive Director of any such documents; and be it further

RESOLVED, That the Port Commission authorizes the Executive Director and any other appropriate officers, agents or employees of the Port to take any and all steps (including the execution and delivery of any and all certificates, agreements, notices, consents, escrow instructions, closing documents and other instruments or documents) as they or any of them deems necessary or appropriate, in consultation with the City Attorney, in order to consummate the transactions contemplated by the Trust Exchange Agreement, in accordance with this resolution, or to otherwise effectuate the purpose and intent of this Resolution, such determination to be conclusively evidenced by the execution and delivery by any such person or persons of any such documents.

*I hereby certify that the foregoing resolution was adopted by the San Francisco Port Commission at its meeting of January 14, 2020.*

*A. Quesada*

---

Secretary

MAP OF  
LANDS TRANSFERRED IN TRUST  
TO THE CITY AND COUNTY OF SAN FRANCISCO  
SITUATED IN THE CITY AND COUNTY OF SAN FRANCISCO  
STATE OF CALIFORNIA

PURSUANT TO CHAPTER 1333, STATUTES OF 1968 AS AMENDED BY  
CHAPTERS 1206/1969, 1367/1969, 1400/1969, 1474/1969, AND 670/1970  
SCALE: 1" = 400' SHEET 3 OF 7 SEP 1 1974

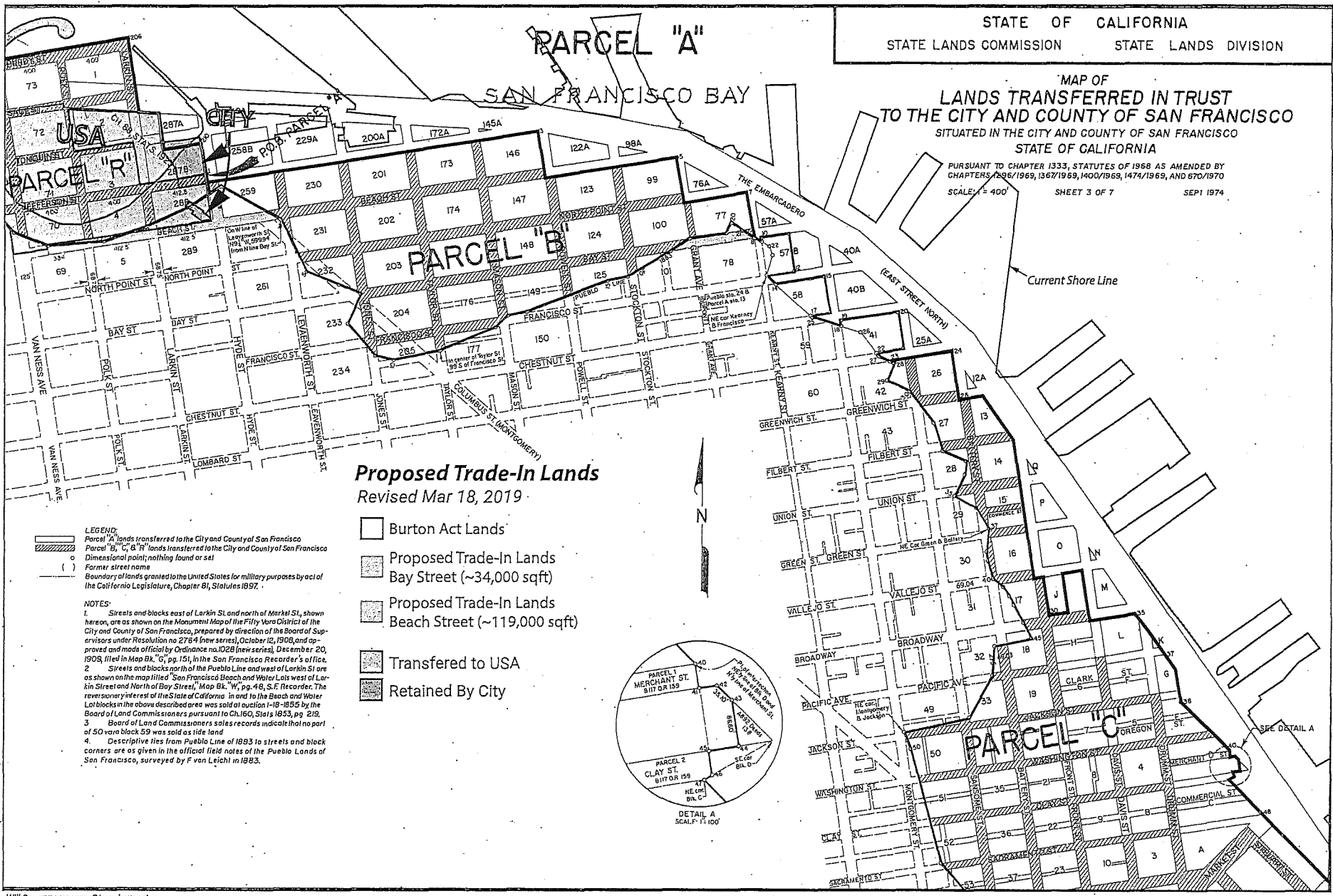

**Proposed Trade-In Lands**  
Revised Mar 18, 2019

- Burton Act Lands
- Proposed Trade-In Lands Bay Street (~34,000 sqft)
- Proposed Trade-In Lands Beach Street (~119,000 sqft)
- Transferred to USA
- Retained By City

**LEGEND:**  
Parcel "A" lands transferred to the City and County of San Francisco  
Parcel "B", "C", & "H" lands transferred to the City and County of San Francisco  
○ Dimensional point; nothing found or set  
( ) Former street name  
--- Boundary of lands granted to the United States for military purposes by act of the California Legislature, Chapter 81, Statutes 1897.

**NOTES:**  
1. Streets and blocks east of Larkin St. and north of Market St., shown hereon, are as shown on the Monument Map of the Fifty Vara District of the City and County of San Francisco, prepared by direction of the Board of Supervisors under Resolution no 2784 (new series), October 12, 1908, and approved and made official by Ordinance no. 1028 (new series), December 20, 1908, filed in Map Bk. "C", pg. 151, in the San Francisco Recorder's office.  
2. Streets and blocks north of the Pueblo Line and west of Larkin St. are as shown on the map title of "San Francisco Beach and Water Lots west of Larkin Street and North of Bay Street," Map Bk. "W", pg. 4-B, S.F. Recorder. The reversionary interest of the State of California in and to the Beach and Water Lot blocks in the above described area was sold at auction 1-B-1855 by the Board of Land Commissioners pursuant to Ch. 160, Stats 1853, pg. 219.  
3. Board of Land Commissioners sales records indicate that no part of 50 vara block 59 was sold as tide land.  
4. Descriptive ties from Pueblo Line of 1893 to streets and block corners are as given in the official field notes of the Pueblo Lands of San Francisco, surveyed by F. van Leitch in 1893.

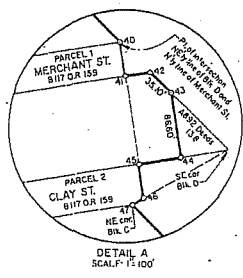

1544



DRAFT 12/19/19

**Recorded at the Request of and  
When Recorded Mail to:**

Andrew Kershen  
Legal Department  
California State Lands Commission  
100 Howe Avenue, Suite 100-South  
Sacramento, California 95825-8202

STATE OF CALIFORNIA  
OFFICIAL BUSINESS:  
Document entitled to free  
Recordation Pursuant to  
Government Code Section 27383  
NO TAX DUE

---

[Space Above for Recorder's Use]

SLC File No.: \_\_\_\_\_  
APNs: \_\_\_\_\_

**PUBLIC TRUST EXCHANGE AGREEMENT FOR TRANSBAY AND FISHERMAN'S  
WHARF STREETS**

This PUBLIC TRUST EXCHANGE AGREEMENT FOR TRANSBAY AND FISHERMAN'S WHARF STREETS (**Agreement**) is dated for reference as of \_\_\_\_\_, 2020. The parties to this Agreement are the STATE OF CALIFORNIA, acting by and through the STATE LANDS COMMISSION (**Commission**), the CITY AND COUNTY OF SAN FRANCISCO, a charter City (**City**), and the CITY AND COUNTY OF SAN FRANCISCO, acting by and through the SAN FRANCISCO PORT COMMISSION (**Port**), as a trustee under Chapter 1333 of the Statutes of 1968 (as amended, **Burton Act**). The Commission, City and Port are each a "Party" and are referred to together as the "Parties." This Agreement is entered into pursuant to Section 5 of Chapter 310 of the Statutes of 1987 (**Chapter 310**).

RECITALS

A. This Agreement concerns lands comprising portions of public streets owned by the City, illustrated on Exhibit A. Certain of the streets (**Trust Termination Streets**), more particularly described in Exhibit B, are situated in the area commonly known as the Transbay District. The other streets (**Trust Addition Streets**), more particularly described in Exhibit C, are situated in the area commonly known as Fisherman's Wharf. The purpose of this Agreement is to effectuate an exchange that will terminate the public trust for commerce, navigation, and fisheries (**Public Trust**) and the statutory trust imposed by the Burton Act (**Burton Act Trust**) in the Trust Termination Streets, and impress the Public Trust and Burton Act Trust on the Trust Addition Streets, through the conveyances provided for in this Agreement, subject to the terms and conditions of this Agreement. The Trust Addition Streets and Trust Termination Streets are referred to together as the "**Exchange Lands**."

**DRAFT 12/19/19**

B. Upon its admission to the Union on September 9, 1850, the State of California (**State**), by virtue of its sovereignty, received all right, title, and interest in the tide and submerged lands (collectively, **tidelands**) within its boundaries up to the ordinary high water mark, subject to the Public Trust.

C. The Trust Termination Streets consist of a portion of Mission Street (between Beale Street and First Street), a portion of Beale Street (between Mission Street and Howard Street), and a portion of Fremont Street (between Mission Street and Howard Street), that were historically tidelands within the shallow waterbody known as Yerba Buena Cove. During the California Gold Rush, Yerba Buena Cove was largely filled and reclaimed. The resulting filled lands were mapped into streets and blocks and the State Legislature authorized the sale of the blocks into private ownership, free of the Public Trust but retained State ownership of the streets. The State eventually granted ownership of the lands to the City in 1969 pursuant to the Burton Act, to be held by the Port subject to the Public Trust and the Burton Act Trust.

D. As a result of extensive fill and development of the former Yerba Buena Cove, the Trust Termination Streets are now far removed from the City's waterfront, and are located in what has become the center of downtown San Francisco. Some of San Francisco's largest and most recognizable buildings constructed in recent years, including the Millennium Tower and the City's tallest building, the Salesforce Tower, front on the portion of Mission Street included in the Trust Termination Streets, which are four or more city blocks from the current waterfront at the Embarcadero.

E. The Trust Termination Streets are also partly located on the site of the Salesforce Transit Center (**Transit Center**) at the center of the Transbay District. The site became a transit hub in the late 1930s when the State constructed the Transbay Transit Terminal to serve as the terminus for rail commuter lines using the Bay Bridge. The Transbay Transit Terminal was later converted to serve bus lines under the control of the California Department of Transportation (**Caltrans**). Following the decline and deterioration of the terminal, the Transbay Joint Powers Authority (**TJPA**) was formed in 2001 as a joint powers agency to plan and construct a replacement transit center to serve Caltrain, high speed rail, and local and regional bus lines. The State Legislature gave TJPA exclusive control over the new Transit Center (Public Resources Code section 5027.1), and in 2010 Caltrans conveyed the property comprising the Transbay Transit Terminal to the TJPA. The new Transit Center was completed in 2018. Both the Transbay Transit Terminal and the Transit Center were constructed in part in the airspace above and subsurface below portions of the Trust Termination Streets, both structures spanning Fremont Street to allow traffic to pass underneath, and both including basement or train box structures under Fremont and Beale Streets.

F. The City seeks to convey to the TJPA title to the airspace and subsurface area within the Trust Termination Streets that are occupied by the Transit Center, so that the entire Transit Center structure can be placed under single legal ownership. In addition, a proposed retrofit for the Millennium Tower, if approved by the City, may occupy a portion of the surface and subsurface of the Trust Termination Streets adjacent to the tower, and the City may wish to convey a permanent easement in the occupied areas to the owners of the tower. The proposed conveyances of permanent rights in the Trust Termination Streets are in the public interest, but

**DRAFT 12/19/19**

are not presently allowed under constitutional and statutory restrictions on the alienation of lands subject to the Public Trust.

G. The Trust Termination Streets are no longer needed to serve the purposes of the Public Trust or the Burton Act Trust (collectively, the **Trust**). The streets are distant from the City's present waterfront and are not needed to ensure public access to the water.

H. The Trust Addition Streets consist of a portion of Beach Street between Van Ness Avenue and Leavenworth Street, a portion of Hyde Street between Beach Street and Jefferson Street, and a portion of Bay Street between Stockton Street and Kearney Street. These streets, located near the Fisherman's Wharf area, provide public access along and to the water and the City's waterfront and serve important Trust purposes.

1. The Beach Street segment of the Trust Addition Streets runs along Aquatic Park, generally parallel to the beach, and provides views of the beach and the San Francisco Bay. A fragment of Beach Street (near Polk Street) is waterward of the historic shoreline and is already in the Trust. The Beach Street segment is also lined with historic waterfront buildings such as the Cannery and Ghirardelli Square, waterfront hotels, and the Maritime Museum. The remainder of Beach Street, from Leavenworth Street to The Embarcadero, is already in the Trust.

2. The Hyde Street segment runs from Beach Street to the waterfront, providing public access to Aquatic Park, the Dolphin Swim and Boat Club, the South End Rowing Club, and the historic Hyde Street Pier ships at the San Francisco Maritime National Historical Park.

3. The Bay Street segment is two blocks south of Pier 39 and one block west of Alcatraz Landing at Pier 33 and the Port's secondary cruise terminal at Pier 35. The street segments abutting the Bay Street segment on three sides (Grant Street north from Bay Street to the Embarcadero, Bay Street to Jones Street on the west, and to The Embarcadero on the east) are already in the Trust.

I. Chapter 310 authorizes the City, subject to Commission approval, to exchange City property that is currently subject to the Trust for other property not currently subject to the Trust if the City and the Commission determine that the land to be exchanged out of the Trust: (1) has been filled and reclaimed; (2) is cut off from access to the waters of the Bay; (3) represents a relatively small portion of the granted tide and submerged lands; (4) is no longer needed or required for the promotion of the Trust; and (5) can be removed from the Trust without causing any substantial interference with Trust uses and purposes. In addition, the land to be exchanged into the Trust must have an economic value equal to or greater than the economic value of land to be exchanged out of the Trust.

J. This Agreement sets forth the procedures and conditions for exchanging the Trust from the Trust Termination Streets to the Trust Addition Streets pursuant to Chapter 310. The findings made in support of this Agreement are in accordance with Chapter 310. The exchange will place the Trust Addition Streets (approximately 3.51 acres) into the Trust, and will remove the Trust Termination Streets (approximately 3.28 acres) from the Trust.

**DRAFT 12/19/19**

K. The Commission has reviewed an appraisal and other information prepared to analyze monetary value of the Trust Termination Streets and the Trust Addition Streets and has reached an independent conclusion regarding the economic value of these properties. The monetary value of land or interests in land to be received as Trust Addition Streets is equal to or greater than the monetary value of the land or interests in land to be given in the Trust Termination Streets.

L. The land title transfers provided for in this Agreement will be accomplished through the following recorded conveyances, subject to the conditions of closing and other terms and conditions of this Agreement:

1. City will convey to the Commission all of its right, title and interest in the Exchange Lands by quitclaim deed;
2. After accepting the above conveyance, the Commission will convey to the City of its right title and interest in the Trust Addition Streets, to be held by the Port subject to the Trust; and
3. After accepting the above conveyance, the Commission will convey by patent the Trust Termination Streets to the City, free of the Trust.

M. The San Francisco Board of Supervisors, by Ordinance \_\_\_\_\_, adopted on \_\_\_\_\_, approved this Agreement and authorized the Port's Executive Director ("**Port Director**") and the Director of the City's Real Estate Division ("**Director of Property**") to enter into this Agreement on behalf of the City. The San Francisco Port Commission approved this Agreement by Resolution \_\_\_\_\_ adopted on \_\_\_\_\_. The Commission approved this Agreement at its meeting of \_\_\_\_\_.

**AGREEMENT**

In consideration of the foregoing recitals and the following conveyances and terms, the Parties hereby agree as follows:

1. Conveyances to Effectuate Exchange. Subject to the conditions of closing and other terms and conditions of this Agreement, the Parties shall make the following conveyances of property:
  - a. City Conveyance to State. City shall convey, remise, release, and forever quitclaim to the Commission all of City's right, title, and interest, including any right, title and interest held by the Port in trust pursuant to the Burton Act, in the Exchange Lands. The conveyance shall be by Quitclaim Deed in the form of Exhibit D (Form of City Quitclaim Deed).
  - b. State Conveyance of Trust Addition Streets to City. Upon accepting the Trust Addition Streets, the Commission shall convey, remise, release, and forever quitclaim, in trust, to the City all of the State's right, title, and interest (including any right, title, and interest existing by virtue of its sovereignty) in the Trust Addition Streets, which conveyance shall be by Patent in the form of Exhibit E (Form of Public Trust Patent), and the lands conveyed shall be held by Port as sovereign lands subject to the Trust.

c. State Conveyance of Trust Termination Streets to City. Upon accepting the Trust Termination Streets, the Commission shall convey, remise, release, and forever quitclaim to City all of the State's right, title, and interest (including any right, title, and interest existing by virtue of its sovereignty) in the Trust Termination Streets, which conveyance shall be by patent in the form of Exhibit F (Form of Trust Termination Patent), and shall specifically release and terminate any Trust interest in the lands conveyed, and these lands shall be held by the City free of the Trust.

2. State Minerals Reservation. The Commission excepts from the conveyances of the Trust Addition Streets made by the Commission pursuant to this Agreement and reserves unto the State, its successors and assigns, forever, any and all minerals and any and all mineral rights in the lands of every kind and character now known to exist or hereafter discovered in the Trust Addition Streets hereafter conveyed to the City pursuant to this Agreement. Such mineral rights shall include, but are not limited to, oil and gas rights, together with the sole, exclusive, and perpetual right to explore for, remove, and dispose of those minerals by any means or methods suitable to the State or to its successors and assigns, except that, this reservation shall not include the right of the State or its successors or assigns in connection with any mineral reservation, removal, or disposal activity, to do either of the following: (1) enter upon, use or damage the surface of the lands or interfere with the use of the surface by the City, the Port, or the Port's successor, assigns, or lessees; or (2) conduct any mining activities of any nature whatsoever above a plane located five hundred (500) feet below the surface of the lands without written permission of the Port or its successors or assigns.

3. Commission Findings. The Commission, effective upon recordation of this Agreement, makes the following findings as required by Chapter 310 and in accordance with Article X section 3 of the California Constitution:

a. The Trust Termination Streets have been filled and reclaimed and are cut off from access to the waters of San Francisco Bay.

b. The lands or interests in lands in which the Trust will be terminated constitute a relatively small portion of the lands granted to the City and County of San Francisco and are no longer needed or required for the promotion of the Trust.

c. No substantial interference with Trust uses and purposes will ensue by virtue of the exchange.

d. The lands or interests in lands to be impressed with the Trust have an economic value equal to or greater than that of the lands or interests in lands removed from the Trust.

4. Additional Findings. The City has also completed a Mitigated Negative Declaration, which was certified by the San Francisco Planning Commission on \_\_\_\_\_ (Planning Department Case No. \_\_\_\_\_; State Clearinghouse No. \_\_\_\_\_). The Commission has made findings that [CEQA findings].

5. Closing. "Closing" or "Closing Date" shall mean the date that this Agreement (if not previously recorded) and the conveyances described in Section 1 above have

been recorded in the official records of the City and County of San Francisco (**Official Records**). The Closing shall be consummated through the offices of [ \_\_\_\_\_; address] (**Title Company**), Escrow No. [ \_\_\_\_\_], attention [ \_\_\_\_\_]. Within \_\_\_\_\_ days of the Effective Date, the City shall establish an escrow with the Title Company and City shall provide written notice to the Executive Officer of the Commission (**Closing Notice**). The Closing Notice shall include a list of all documents required to close escrow with required signatories indicated, and drafts of all deeds, instruments, certificates of acceptance, title commitments, and other documents that are required for the Closing and are within City's responsibility and control. The Parties shall use commercially reasonable efforts to close within \_\_\_\_\_ days of receipt of the notice so long as no additional Commission approval is necessary.

6. Conditions Precedent to Closing.

a. Legal Descriptions. It is a condition precedent to a Party's obligation to close escrow for the conveyance or acceptance of real property that the Party has approved the final legal description for the real property, if any modifications are made to the legal descriptions attached hereto, which approval shall not be unreasonably withheld. For the Commission, the Executive Officer may grant such approval; for the City, the Director of Property may grant such approval; and for the Port, the Port Director may grant such approval.

b. Commission's Closing Conditions. As a condition precedent to the Commission's obligation to close escrow, the Executive Officer shall have approved:

i. The condition of title and the form of a CLTA title insurance policy to be issued by the Title Company, in the amount of coverage reasonably requested, for the Trust Addition Streets; provided, however, that the exceptions reflected in that preliminary title report prepared by Title Company dated \_\_\_\_\_ shall be deemed acceptable.

ii. The physical condition of the Trust Addition Streets.

iii. The Record of Survey described in Section \_\_\_ of this Agreement.

7. Deposits into Escrow.

a. Commission Deposits. At least two (2) business days prior to the Closing, the Commission shall deposit the following documents into escrow:

i. A certified copy of the Minute Item for Staff Report No. \_\_\_\_\_, the Commission public hearing on \_\_\_\_\_, showing the Commission's approval of this Agreement;

ii. The Executive Officer's written approval of (A) the condition of title to the Trust Addition Streets as shown in pro forma title commitments in coverage amounts acceptable to the Executive Officer, (B) the form of title insurance to be issued, and (C) the physical condition of the Trust Addition Streets;

iii. A duly signed and attested patent in the form of Exhibit F, transferring to the City the Trust Termination Streets, free of the Trust; and

iv. A duly signed and attested patent in the form of Exhibit E transferring to the City the Trust Addition Streets, to be held by the Port subject to the Trust.

b. City Deposits. At least two (2) business days prior to the Closing, City shall deposit the following documents into escrow:

i. Certified copies of Board of Supervisors [**Ordinance/Reso**] \_\_\_\_\_ adopted on \_\_\_\_\_, 2020, and Port Commission Resolution \_\_\_\_\_ adopted on \_\_\_\_\_, 2020, each authorizing this Agreement; and

ii. A duly signed and acknowledged quitclaim deed from City in the form of Exhibit D, transferring to the Commission all of City's right, title and interest in the Exchange Lands, including any interest held by the City as trustee under the Burton Act.

iii. Pro forma CLTA title insurance commitments for the Trust Addition Streets, in a form and with coverage amounts approved by the Commission.

c. Each patent and quitclaim deed to be deposited into escrow shall include a certificate of acceptance duly executed by the grantee (which certificate may be deposited into escrow separately by the grantee), the appropriate attestations or acknowledgments, and any ancillary documents required by state law or the City's Assessor-Recorder, such as executed Transfer Tax Affidavits and executed Preliminary Change of Ownership Reports.

d. The Parties shall submit to the escrow agent joint escrow instructions substantially conforming to the foregoing, together with any supplemental instructions necessary to effectuate the intent of this Agreement as may be agreed to in writing by the Parties.

8. Close of Escrow and Recordation. The joint escrow instructions shall direct the escrow agent to notify the Parties, upon the agent's receipt of all documents listed and described in the escrow instructions, of its intention to close escrow and to record this Agreement, if not already recorded, and the deed and patents deposited into escrow, in the manner specified in, and subject to the requirements of, the escrow instructions.

9. Records of Survey. Within 30 days following the Closing, City shall record (or cause to be recorded) in the Official Records a record of survey, reviewed and approved by the Parties and based on field surveys, showing the boundaries of the Trust Addition Streets and Trust Termination Streets. Each record of survey shall establish the physical location of boundaries and shall define same with sufficient controlling monuments appropriately placed. The Commission's approval of the survey may be given by its Executive Officer.

10. Impacts of Sea Level Rise.

a. The exchange authorized by this Agreement is intended to establish with certainty the boundary between lands free of the Trust and lands subject to the Trust within the boundaries of the Exchange Lands, which boundary is intended to be fixed and not subject to change by erosion, accretion, reliction, or submergence, whether due to natural or artificial causes. However, if the Trust Termination Streets should later become submerged or subject to the ebb and flow of the tide below the elevation of mean high water, whether due to erosion or

sea level rise (**Inundation**), those lands, for so long as the condition of Inundation exists, shall be subject to an easement in favor of the Public Trust (**Public Trust Easement**); provided, however, that the Public Trust Easement shall not attach until Inundation has existed continuously for five years. Prior to the attachment of the Public Trust Easement, neither the Easement nor the Commission shall prevent the right of the City, as owner of the inundated lands, to reclaim or otherwise restore the lands to their pre-Inundation condition so long as the City has begun activities to exercise this right within one year after Inundation. The City's submittal of an application for any permit required for reclamation or restoration and reasonable efforts to complete the permitting process is sufficient, but not necessary, evidence that the City has begun to exercise the right to reclamation or restoration provided herein. The Commission may delay the attachment of the Public Trust Easement for a specified period by resolution based upon its finding that reclamation or restoration could not be completed within the five-year period of Inundation specified herein.

b. Nothing in this Agreement obligates the Commission to protect or cause to be protected any publicly or privately held uplands, including, but not limited to, constructing or causing to be constructed any protective structures that benefit any privately held uplands.

c. Nothing in this Section is intended to limit (a) rights the City may have under applicable law to take actions to preserve the boundaries established by this Agreement, including without limitation the rights of the City to undertake measures to protect its property, including lands freed from the Trust at the locations established pursuant to this Agreement, or to file an action within the applicable limitations period to preserve the title interests of such lands established by this Agreement, or (b) rights the public has under applicable law to navigate, fish, or otherwise use navigable waters on Inundated lands, including but not limited to any rights arising under *Bohn v. Albertson* (1951) 107 Cal.App.2d 738 and *People ex rel Baker v. Mack* (1971) 19 Cal.App.3d 1040.

11. Judicial Confirmation of Validity of Agreement. The City may choose to submit this Agreement or any of the conveyances or instruments authorized herein to a court of competent jurisdiction to confirm the validity thereof by court judgment pursuant to Code of Civil Procedure sections 760.010 through 764.080, inclusive. The Commission shall cooperate with the City in obtaining such a confirmatory judgment. Upon entry of a judgment confirming the validity of the Agreement, conveyance, or instrument, each Party shall be deemed to have waived any right to appeal from such judgment. Except as the parties may otherwise agree, City shall be responsible for all costs incurred by the Commission associated with its participation in a judicial action initiated by City pursuant to this section, including without limitation reasonable attorneys' fees and costs.

12. Effect of a Judicial Finding of Invalidity. A judicial determination that any portion of this Agreement is invalid shall not invalidate the remainder. If any term, provision, covenant or condition of this Agreement is held by a court of competent jurisdiction to be invalid, void or unenforceable, the Parties shall amend this Agreement or take other action necessary to achieve the intent of this Agreement in a manner consistent with the ruling of the court.

13. Indemnification and Defense of Claims.



DRAFT 12/19/19

a. City shall indemnify, defend and hold harmless the Commission and its respective officers, agencies, commissions, and employees from and against any and all Claims, including third party Claims and Claims by any governmental agency, relating to any Hazardous Substances that as of the date of Closing are located at, on, over, under, or flowing through any portion of the Exchange Lands, except to the extent caused by the actions of the State.

b. The Parties agree to use reasonable efforts to defend this Agreement, any deed, patent, agreement, or other instrument executed pursuant thereto, and any decision made by a Party to approve the foregoing, including the approval of any required findings related thereto, in any legal action challenging the validity or legality thereof. In any such action, City shall reimburse the Commission for all reasonable costs incurred in connection with such action, including but not limited to reasonable staff time and attorneys' fees incurred by the Commission, and including but not limited to any award of attorneys' fees made by a court of competent jurisdiction against the Commission, on such reasonable terms and conditions as the Parties may establish by separate agreement. Nothing in this Section limits the discretion of the Commission to conduct its own defense or take the lead in its own defense.

14. Execution Before a Notary Public. All signatures of the Parties to this Agreement and all deeds and other instruments of conveyance executed pursuant to this Agreement shall be acknowledged before a Notary Public and a certificate of acknowledgment shall be attached to the executed Agreement and other documents to allow them to be recorded in the Official Records. The Governor's signature shall be attested to by the Secretary of State.

15. No Determination of Trust Consistency. Nothing in this Agreement shall be construed as a determination by the Commission regarding the Public Trust consistency of any current or proposed use of the Trust Addition Streets.

16. Agreement Not to Encumber. Except to the extent consistent with the purposes of this Agreement, or as otherwise provided herein, the City shall not sell, transfer, assign, mortgage, pledge, or hypothecate, whether by operation of law or otherwise, any of their respective rights, title, or interests in the Trust Addition Streets prior to the Closing without the prior written consent of the Commission.

17. Further Assurances. So long as authorized by applicable laws to do so, the Parties will perform such other acts, and execute, acknowledge and deliver all further conveyances and other instruments that may be necessary to fully assure to the other Parties all of the respective properties, rights, titles, interests, remedies, powers and privileges to be conveyed or provided for by this Agreement.

18. Allocation of Costs and Expenses. City shall pay the expenses and fees of the escrow agent, including those costs associated with document preparation and recordation of this Agreement, its deeds and patents, and any associated documents. City shall also pay all closing costs, including without limitation all expenses and fees associated with any title insurance policy.

19. No Admission or Effect if Agreement Not Made Effective. If this Agreement does not become effective, or becomes effective but is declared by a final non-appealable judgment of a court of competent jurisdiction to be invalid, nothing in it shall

**DRAFT 12/19/19**

constitute, or be construed as, an admission by any Party hereto or evidence concerning the boundaries, physical character, or character of title or interest in the Exchange Lands.

20. No Effect on Other Lands. The provisions of this Agreement do not constitute, nor are they to be construed as, an admission by any Party or evidence concerning the boundaries, physical character, or character of title to or interest in any lands outside the Exchange Lands.

21. No Damages. No party shall have any remedy for monetary damages against another party for breach of this Agreement, excepting recovery of attorneys' fees to the extent provided by this Agreement, and excepting any indemnification required by this Agreement.

22. Notice: Any notice required pursuant to this Agreement shall be in writing and given by delivering the notice in person, by commercial courier, or by sending it by registered or certified mail, or overnight mail, return receipt requested, with postage to the addresses shown below or to such other address as the applicable Party may provide. For the convenience of the Parties, notice also may be given by electronic mail in addition to one of the above methods, at the numbers listed below:

**Commission:**

State Lands Commission  
100 Howe Avenue, Suite 100 South  
Sacramento, CA 95825-8202  
Attn: Mark Meier, Chief Counsel  
Email: Mark.Meier@slc.ca.gov

**With copies to:**

Office of the Attorney General  
[Address]  
Attn: \_\_\_\_\_  
Email: \_\_\_\_\_

**City:**

Port of San Francisco  
Pier 1, The Embarcadero  
San Francisco, CA 94111  
Attn: Elaine Forbes, Executive Director  
Email: elaine.forbes@sfport.com

**With copies to:**

City and County of San Francisco  
Real Estate Division  
25 Van Ness Avenue, Suite 400  
Attn: Andrico Penick, Director of Property

DRAFT 12/19/19

andrico.penick@sfgov.org

Port of San Francisco  
Pier 1, The Embarcadero  
San Francisco, CA 94111  
Attn: Michelle Sexton, Port General Counsel  
Michelle.Sexton@sfcityatty.org

San Francisco City Attorney's Office  
City Hall, Rm. 234  
1 Dr. Goodlett Place  
San Francisco, CA 94102  
Attn: Charles Sullivan, Deputy City Attorney  
charles.sullivan@sfcityatty.org

23. Acceptance of Conveyances and Consent to Recording. By their execution of this Agreement, the Parties each agree to accept the conveyance of rights, titles, and interests in land referred to in this Agreement and consent to the recording of this Agreement and other documents executed pursuant to this Agreement.

24. Approvals and Consents. Unless otherwise provided in this Agreement, whenever an approval, consent or satisfaction is required of a Party, the approval, consent or satisfaction shall be given on behalf of the Party by the representative(s) listed below.

a. If the Party is the Commission: by the Commission, as may be evidenced by appropriate document executed by the Executive Officer of the Commission.

b. If the Party is City: by the Port Director and the Director of Property .

c. Correction of Technical Errors. If by reason of inadvertence, and contrary to the intention of the Parties, errors are made in this Agreement, in a legal description or the reference to or within any exhibit with respect to a legal description, in the boundaries of any parcel in any map or drawing which is an exhibit, or in the typing of this Agreement or any of its exhibits, the Parties affected by the error by mutual agreement may correct such error by memorandum reflecting the intent of the Parties concerning the relevant exhibits, legal descriptions, or other provisions at the time of approval and execution of this Agreement. The Executive Officer of the Commission, the Port Director and the Director of Property may approve and execute such a "**Memorandum of Correction**" without the necessity of amendment of this Agreement.

25. Agreement Binding on Successors. All the terms, provisions, and condition of this Agreement shall be binding upon and inure to the benefit of the respective heirs, administrators, executors, successors, and assigns of the Parties.

26. Modification. No modification, amendment, or alteration of this Agreement shall be valid unless in writing and signed by the Parties to this Agreement.

DRAFT 12/19/19

27. No Effect on Other Government Jurisdiction. This Agreement has no effect whatsoever on the regulatory, environmental or other jurisdiction of any federal, state, local, or other government entity not a party to this Agreement.

28. Headings. The title headings of the Sections of this Agreement are inserted for convenience only and shall not be considered in construing this Agreement.

29. Effective Date. This Agreement shall become effective upon execution by all Parties and the Governor. For purposes of bringing a validation action under Section 11, this Agreement shall be deemed entered into upon execution by the Executive Officer of the Commission, who shall be the last to sign prior to the signature of the Governor.

30. Termination. If the Closing has not occurred by the date that is one (1) year from the Effective Date hereof, this Agreement shall terminate and be of no further force and effect unless extended in writing by both the City and the Commission, each in their sole and absolute discretion.

31. Exhibits A through F. Exhibits A through F, inclusive, are attached to this Agreement and are incorporated by reference as parts of it.

To witness this Agreement, a duly authorized officer of each Party has executed it below on the date opposite each signature.

[SIGNATURES BEGIN ON FOLLOWING PAGE]

DRAFT 12/19/19

STATE OF CALIFORNIA  
STATE LANDS COMMISSION

DATED: \_\_\_\_\_

By: \_\_\_\_\_  
Jennifer Lucchesi  
Executive Officer

Approved as to form:

Xavier Becerra  
Attorney General of the  
State of California

DATED: \_\_\_\_\_

By: \_\_\_\_\_  
Deputy Attorney General

[SIGNATURES CONTINUE ON FOLLOWING PAGE]

DRAFT 12/19/19

DATED: \_\_\_\_\_

CITY AND COUNTY OF SAN FRANCISCO, a municipal corporation

By: \_\_\_\_\_  
Andrico Penick, Director of Property

DATED: \_\_\_\_\_

CITY AND COUNTY OF SAN FRANCISCO, acting by and through the SAN FRANCISCO PORT COMMISSION as a trustee under Chapter 1333 of the Statutes of 1968

By: \_\_\_\_\_  
Elaine Forbes, Executive Director

Approved as to form:  
Dennis Herrera  
San Francisco City Attorney

DATED: \_\_\_\_\_

By: \_\_\_\_\_  
Michelle Sexton  
Port General Counsel

**DRAFT 12/19/19**

IN APPROVAL WHEREOF, I, GAVIN NEWSOM, Governor of the State of California, have set my hand and caused the Seal of the State of California to be hereunto affixed pursuant to section 6107 of the Public Resources Code of the State of California. Given under my hand at the City of Sacramento this \_\_\_\_\_, 2020.

\_\_\_\_\_  
GAVIN NEWSOM  
Governor, State of California

Attest:  
SECRETARY OF STATE

By: \_\_\_\_\_  
Alex Padilla  
Secretary of State

LIST OF EXHIBITS

<u>Exhibit</u>	<u>Name/Description</u>
A.	Illustrative plat of Exchange Lands
B.	Legal Description Trust Termination Streets
C.	Legal Description Trust Addition Streets
D.	Form of City Quitclaim Deed
E.	Form of Public Trust Patent
F.	Form of Trust Termination Patent



1561

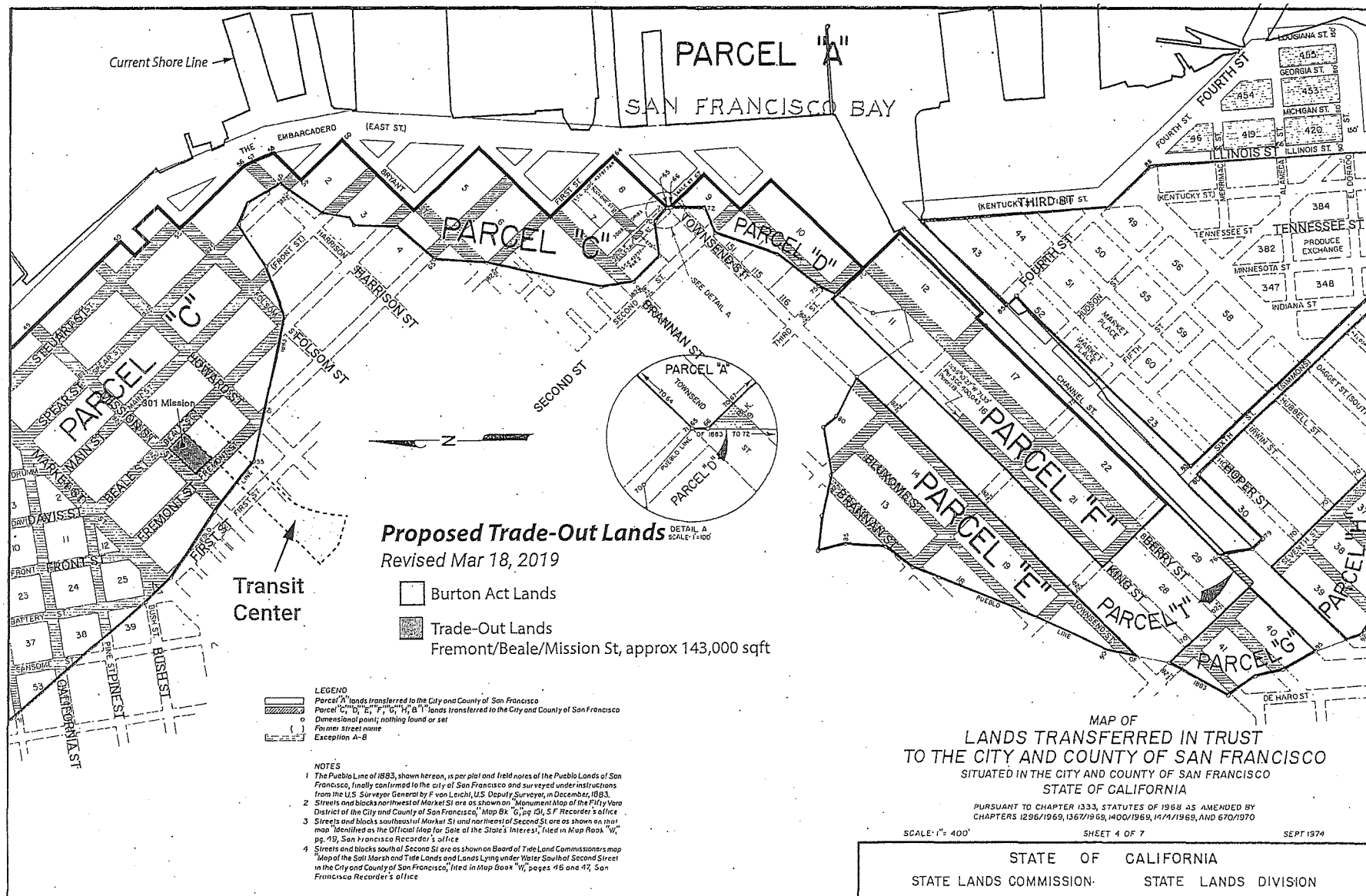

**Proposed Trade-Out Lands**  
 Revised Mar 18, 2019

Burton Act Lands  
 Trade-Out Lands  
 Fremont/Beale/Mission St, approx 143,000 sqft

**LEGEND**

[Hatched Box] Parcel 'A' lands transferred to the City and County of San Francisco  
 [Dotted Box] Parcel 'C', 'D', 'E', 'F', 'G', 'H', 'I' lands transferred to the City and County of San Francisco  
 [Circle with dot] Dimensional point; nothing found or set  
 [Line with dots] Former street name  
 [Line with dashes] Exception A-B

**NOTES**

- 1 The Public Line of 1883, shown hereon, is pericial and field notes of the Public Lands of San Francisco, finally confirmed to the city of San Francisco and surveyed under instructions from the U.S. Surveyor General by F. von Leich, U.S. Deputy Surveyor, in December, 1883.
- 2 Streets and blocks northwest of Market St are as shown on "Monument Map of the Fifty Year District of the City and County of San Francisco," Map Bk. C, page 151, S.F. Recorder's office
- 3 Streets and blocks southeast of Market St and northeast of Second St are as shown on that map identified as the Official Map for Sale of the State's Interest, filed in Map Book "W", page 49, San Francisco Recorder's office
- 4 Streets and blocks south of Second St are as shown on Board of Tide Land Commissioners' map "Map of the Salt Marsh and Tide Lands Lying under Water South of Second Street in the City and County of San Francisco," filed in Map Book "W", pages 4B and 47, San Francisco Recorder's office

MAP OF  
**LANDS TRANSFERRED IN TRUST  
 TO THE CITY AND COUNTY OF SAN FRANCISCO**  
 SITUATED IN THE CITY AND COUNTY OF SAN FRANCISCO  
 STATE OF CALIFORNIA

PURSUANT TO CHAPTER 1333, STATUTES OF 1968 AS AMENDED BY  
 CHAPTERS 1296/1969, 1367/1969, 1400/1969, 1471/1969, AND 670/1970

SCALE: 1" = 400' SHEET 4 OF 7 SEPT 1974

STATE OF CALIFORNIA  
 STATE LANDS COMMISSION STATE LANDS DIVISION

City and County of San Francisco

San Francisco Public Works



London N. Breed, Mayor  
Mohammed Nuru, Director

GENERAL - DIRECTOR'S OFFICE  
City Hall, Room 348  
1 Dr. Carlton B. Goodlett Place, S.F., CA 94102  
(415) 554-6920 [www.SFPublicWorks.org](http://www.SFPublicWorks.org)



**Public Works Order No: 202465**

**Determination to recommend the street vacation of the south side of Mission Street and on the east side of Fremont Street, fronting Assessor's Block Number 3719, Lots 020-440, in connection with the Millennium Tower 301 Mission Perimeter Pile Upgrade Project pursuant to California Streets and Highways Code Sections 8300 *et seq.* and Public Works Code Section 787.**

WHEREAS, Most public streets and sidewalks are owned by the City and County of San Francisco as a public right-of-way; and

WHEREAS, The area to be vacated (the "Vacation Area") is the sidewalk portion of the south side of Mission Street and the east side of Fremont Street, fronting Assessor's Block Number 3719, Lots 020-440, also known as the Millennium Tower at 301 Mission Street, and is specifically shown on SUR Map 2019 - 006, dated January 8, 2020; and

WHEREAS, For reference purposes, the Vacation Area also shall be identified as Assessor's Parcel Block No. 3719, Lot 519, for the Mission Street portion and Assessor's Parcel Block No. 3719, Lot 520, for the Fremont Street portion of the Vacation Area; and

WHEREAS, In accordance with information provided by the Project Sponsor, since completion of construction of the Tower in 2009, the area around the Tower and Property has experienced differential settlement due to consolidation and compression of the soil layer beneath the Colma Sand, which is known as Old Bay Clay. The existing mat foundation has settled near the northwest corner of the Tower and that corner of the Tower is tilting; and

WHEREAS, The 301 Mission Perimeter Pile Upgrade Project ("the Project") consists of a structural upgrade of the Tower building foundation that includes installation of a horizontal extension of the existing mat foundation for the Tower building within an approximately 8-foot-wide zone beneath public right of way sidewalk area immediately adjacent to the Tower along Fremont and Mission Streets, supported by 52 new piles extending to bedrock. The 52 new piles are referred to as "perimeter piles" and the extended mat foundation is referred to as the "collar foundation." In addition to preventing further settlement in the northwest corner of the Tower's existing foundation, the Project Sponsor has stated that this effort may allow for gradual tilt correction of the Tower building over time. The Project sponsor will need an easement to permanently occupy the City sidewalk portion of the public right-of-way (the "301 Mission Street Easement"); and

WHEREAS, The City is prohibited from granting a non-revocable permit or easement over public right-of-way unless the subject area is vacated in accordance with the Streets and Highways Code Sections 8300 *et seq.* and Public Works Code Section 787. Consequently, in order to accommodate the Project



San Francisco Public Works  
Making San Francisco a beautiful, livable, vibrant, and sustainable city.

and grant the 301 Mission Street Easement, the City will need to temporarily vacate the Vacation Area prior to granting such Easement; and

WHEREAS, Under these circumstances, Public Works finds that the Vacation Area is no longer necessary for the City's present or prospective future public street, sidewalk, and public service easement purposes on a temporary basis to allow for the grant of the 301 Mission Street Easement; and

WHEREAS, Once the street vacation occurs and the Easement is granted and recorded, the City intends to restore the street status on the Vacation Area so it will continue in its current form as a dedicated public right-of-way. Therefore, when the 301 Mission Street Easement is recorded, Public Works recommends that the Vacation Area be rededicated to public use for street and right-of-way purposes subject to the Easement; and

WHEREAS, Concurrent with recordation of the 301 Mission Street Easement, the Vacation Area should be rededicated to public use for street and right-of-way purposes subject to the Easement in order to restore the existing street use status to the Vacation Area; and

WHEREAS, The permanently installed perimeter piles and collar foundation will occupy a portion of current public right of way on Mission and Fremont Streets that is subject to the public trust doctrine, which designation will be removed by a State Trust exchange agreement approved by the State Lands Commission, the San Francisco Port Commission, and this Board of Supervisors ("Public Trust Exchange") prior to the street vacation being operative and 301 Mission Street Easement being recorded; and

WHEREAS, The vacation of the Vacation Area is conditioned upon the State Lands Commission Public Trust Exchange being final and effective; and

WHEREAS, Related to the street vacation action, the City also will consider the settlement of litigation related to 301 Mission Street that is comprised of all complaints and associated cross-claims and cross-complaints coordinated and/or consolidated under the case entitled, *Laura S. Lehman v. Transbay Joint Powers Authority, et al.*, Case Number CGC-16-553758 in the Superior Court of San Francisco in a companion ordinance (the "Settlement Ordinance"). But for this settlement, the City would not undertake this street vacation or the companion legislation for the 301 Mission Street Easement. Consequently, Public Works recommends that the street vacation ordinance not be operative until the Settlement Ordinance is final and effective.

WHEREAS, On November 20, 2019, the Planning Department published a Preliminary Mitigated Negative Declaration ("PMND") for the 301 Mission Street, Millennium Tower Perimeter Pile Upgrade Project (the "Project"). The PMND found that although the Project could have potentially significant impacts on the environment, such impacts will be reduced to a less than significant level because Millennium Tower Association (the "Project Sponsor") will implement all mitigation measures identified in the PMND; and

WHEREAS, Prior to the Board of Supervisor's acting on the Street Vacation, the Planning Department will finalize CEQA documents and will issue a General Plan determination related to the street vacation; and

WHEREAS, In accordance with California Streets and Highways Code Sections 892 and 8300 et seq., the right-of-way and parts thereof proposed for vacation are no longer useful as a non-motorized transportation facility, as defined in Streets and Highways Code Section 887, because the subject area is underground; and

WHEREAS, The vacation is being carried out pursuant to San Francisco Public Works Code Section 787; and

WHEREAS, Pursuant to the California Streets and Highway Code, the Department of Public Works, Bureau of Street Use and Mapping (the "Department") has initiated the process to vacate the Vacation Area; and

WHEREAS, The Department sent notice of the proposed street vacation, draft SUR drawing, a copy of the petition letter, and a DPW referral letter to the Department of City Planning, the Department of Technology, San Francisco Municipal Transportation Agency, AT&T, CenturyLink, Comcast, ExteNet, Point to Point communications, Verizon/MCI, XO-Communications, Sprint, San Francisco Fire Department, San Francisco Water Department, Pacific Gas and Electric ("PG&E"), Bureau of Engineering, Department of Parking and Traffic, Utility Engineering Bureau, and the San Francisco Public Utility Commission ("PUC"). No utility company or agency objected to the proposed vacation; and

WHEREAS, On December 6, 2019, the Municipal Transportation Agency determined that the proposed vacation did not have to be presented to the Transportation Advisory Staff Committee (TASC); and WHEREAS, The public interest, convenience, and necessity require that the street vacation occur as contemplated to protect the public safety and allow for the Project to be implemented; and

WHEREAS, It is a policy matter for the Board of Supervisors to grant the 301 Mission Street Easement over the City's interest in the Vacation Area to the Project Sponsor;

**NOW THEREFORE BE IT ORDERED THAT,**

The Director approves the following documents either attached hereto or referenced herein:

1. Ordinance to vacate the Vacation Area
2. Vacation Area SUR Map No. 2019-006

The Director recommends that the Board of Supervisors move forward with the legislation to vacate said Vacation Area.

The Director recommends that the Board of Supervisors approve all actions set forth herein with respect to this vacation and, after recordation of the 301 Mission Street Easement, rededicate the Vacation Area to street use for public right-of-way purposes subject to the Easement. The Director further recommends the Board of Supervisors authorize the Mayor, Clerk of the Board, Director of Property, County Surveyor, and Director of Public Works to take any and all actions which they or the City Attorney may deem necessary or advisable in order to effectuate the purpose and intent of this Ordinance.

X

DocuSigned by:

*Bruce Storrs*

Storrs, Bruce 97ABC41607B0494...

County Surveyor

X

DocuSigned by:

*Nuru, Mohammed*

Nuru, Mohammed 45AB17F474FA...

Director

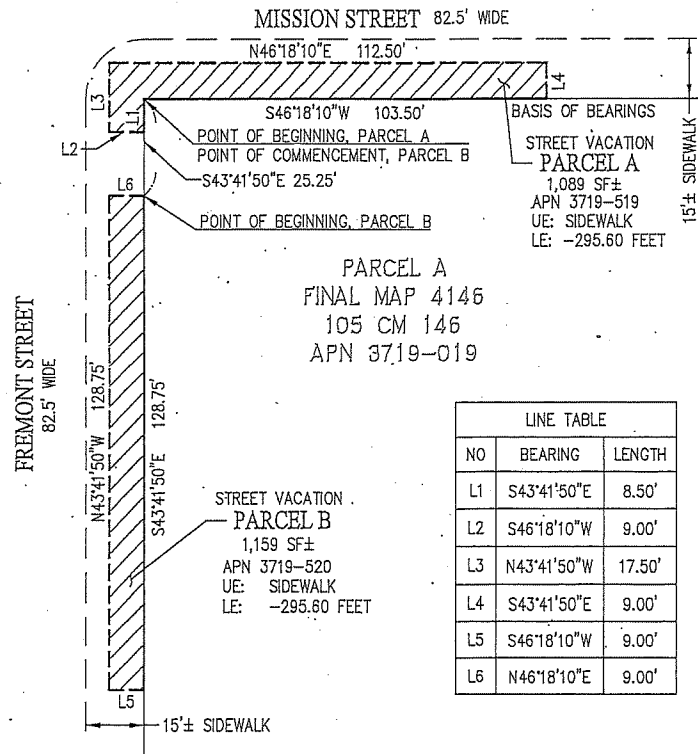

PARCEL A  
FINAL MAP 4146  
105 CM 146  
APN 3719-019

STREET VACATION  
PARCEL B  
1,159 SF±  
APN 3719-520  
UE: SIDEWALK  
LE: -295.60 FEET

LINE TABLE		
NO	BEARING	LENGTH
L1	S43°41'50"E	8.50'
L2	S46°18'10"W	9.00'
L3	N43°41'50"W	17.50'
L4	S43°41'50"E	9.00'
L5	S46°18'10"W	9.00'
L6	N46°18'10"E	9.00'

**LEGEND:**

- VACATION BOUNDARY
- PROPERTY LINE
- AREA TO BE VACATED
- CURB
- UE UPPER ELEVATION
- LE LOWER ELEVATION

**NOTES:**

1. REFERENCE BENCHMARK: BM 10110, ELEV: 12.139 FEET (CCSF-VD13 DATUM)
2. THE BASIS OF BEARINGS FOR THIS DRAWING IS THE SOUTH LINE OF MISSION STREET BEING N46°18'10"E PER RECORD OF SURVEY 6428 (EE SM 19).
3. ALL DISTANCES SHOWN HEREON ARE IN FEET AND DECIMALS THEREOF.

**REFERENCES:**

RECORD OF SURVEY 6428 (EE SURVEY MAPS 19-27)  
FINAL MAP 4146 (105 CM 146-147)

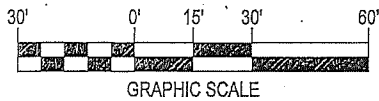

GRAPHIC SCALE

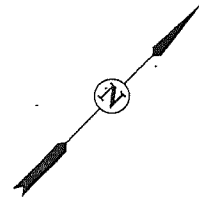

APPROVED:  
  
BRUCE R. STORRS  
CITY & COUNTY SURVEYOR

1/21/2020  
DATE

**CITY AND COUNTY OF SAN FRANCISCO PUBLIC WORKS  
SUBDIVISION AND MAPPING**

STREET VACATION OF PORTIONS OF MISSION ST. AND FREMONT ST., FRONTING APN 3719-019

FILE: SUR 2019-006	SHEET 1 OF 3	SCALE: 1"=30'	REVISION
-----------------------	--------------	---------------	----------

1567

FIG 49 0000 SURVEY MAPS/PLATS/PLATS/PLATS/STREET VACATION SUR MAP.DWG

NOTES:

1. REFERENCE BENCHMARK: BM 10110, ELEV: 12.139 FEET (CCSF-VD13 DATUM)
2. THE BASIS OF BEARINGS FOR THIS DRAWING IS THE SOUTH LINE OF MISSION STREET BEING N46°18'10"E PER RECORD OF SURVEY 6428 (EE SM 19).
3. ALL DISTANCES SHOWN HEREON ARE IN FEET AND DECIMALS THEREOF.
4. PARCELS E AND F ARE CIRCLES WITH A DIAMETER OF 5.00'.

REFERENCES:  
 RECORD OF SURVEY 6428  
 (EE SURVEY MAPS 19-27)  
 FINAL MAP 4146 (105 CM  
 146-147)

LEGEND:

- EASEMENT BOUNDARY
- PROPERTY LINE
- POB POINT OF BEGINNING
- POC POINT OF COMMENCEMENT
- UE UPPER ELEVATION
- LE LOWER ELEVATION

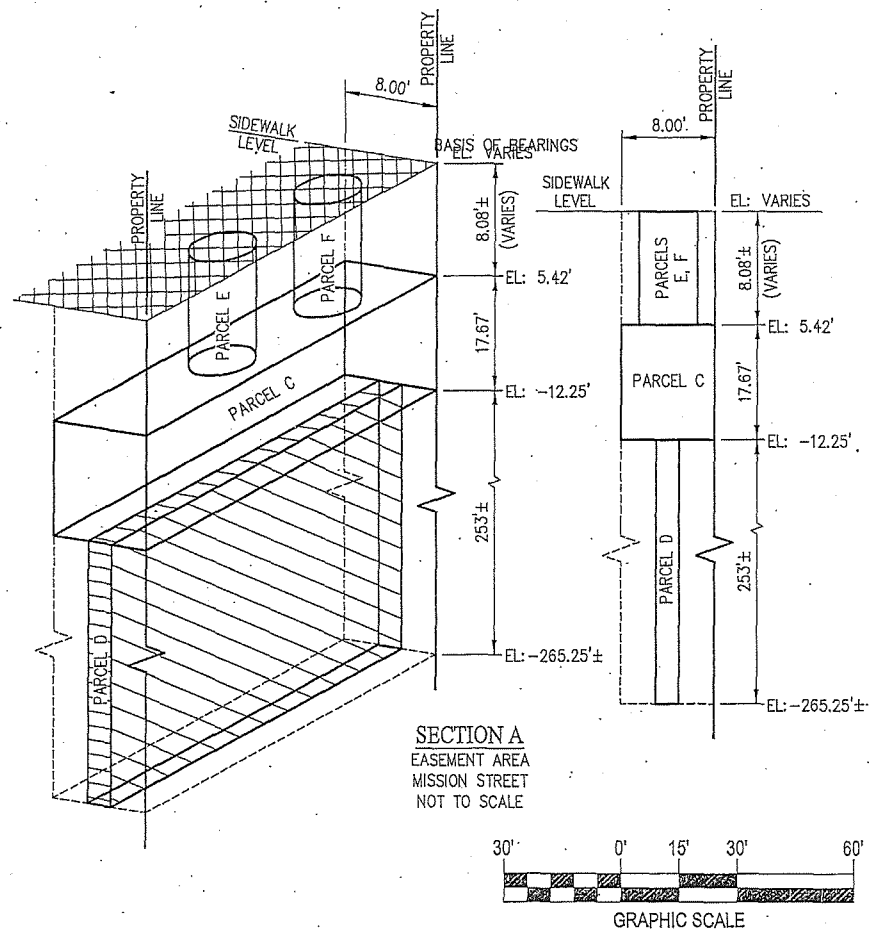
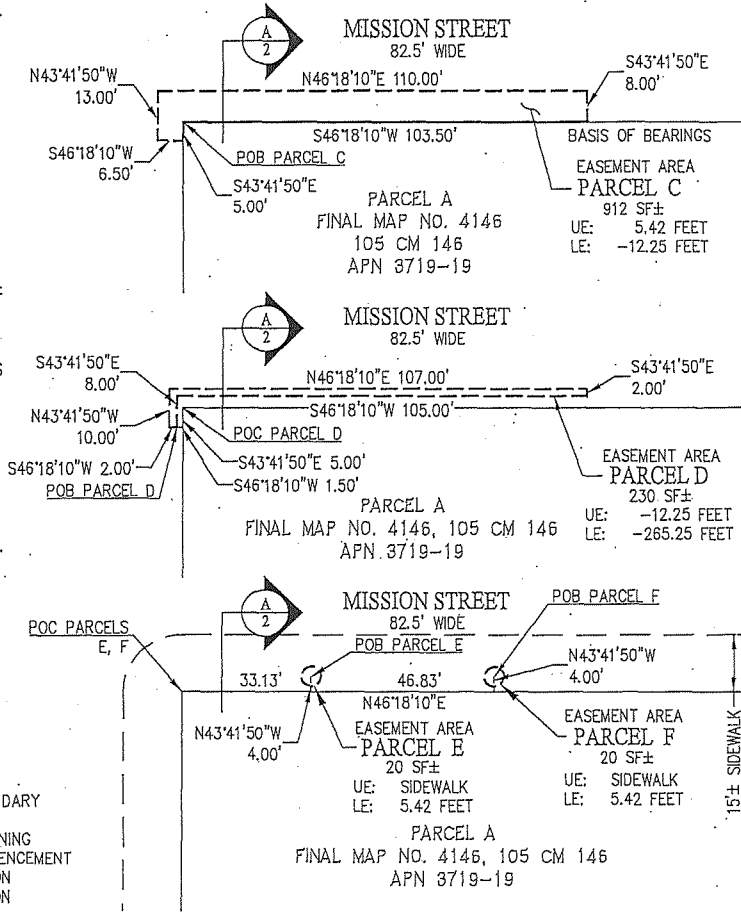

APPROVED: *Bruce R. Storrs*  
 BRUCE R. STORRS  
 CITY & COUNTY SURVEYOR

DATE: 1/8/2020

<b>CITY AND COUNTY OF SAN FRANCISCO PUBLIC WORKS</b> SUBDIVISION AND MAPPING			
STREET VACATION OF PORTIONS OF MISSION ST. AND FREMONT ST., FRONTING APN 3719-019			
FILE: SUR 2019-006	SHEET 2 OF 3	SCALE: 1"=30'	REVISION

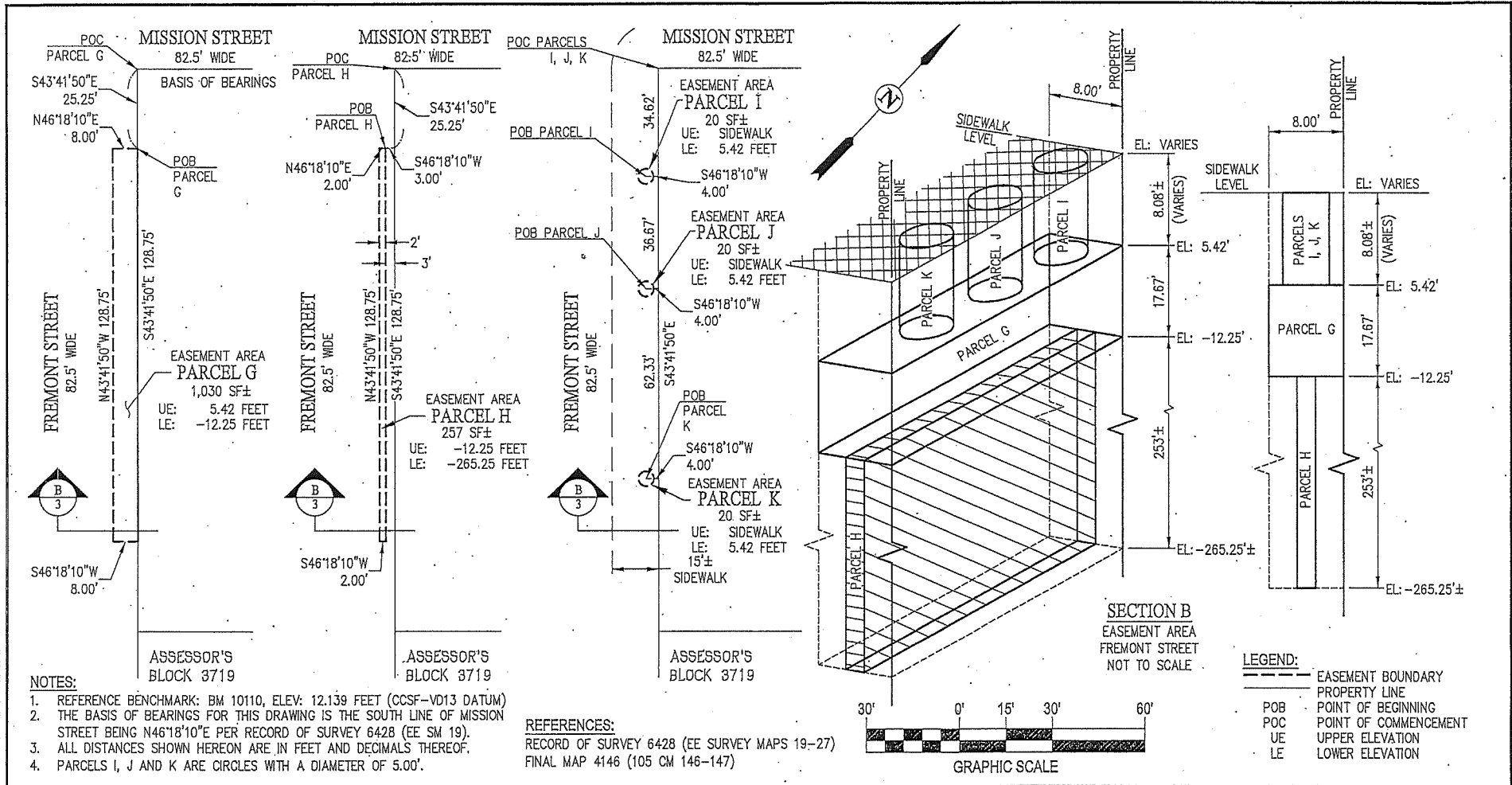

APPROVED: *Bruce R. Storrs*  
 \_\_\_\_\_  
 BRUCE R. STORRS  
 CITY & COUNTY SURVEYOR

*1/9/2020*  
 \_\_\_\_\_  
 DATE

**CITY AND COUNTY OF SAN FRANCISCO PUBLIC WORKS**  
**SUBDIVISION AND MAPPING**

STREET VACATION OF PORTIONS OF MISSION ST. AND FREMONT ST., FRONTING APN 3719-019

FILE: SUR 2019-006	SHEET 3 OF 3	SCALE: 1"=30'	REVISION
-----------------------	--------------	---------------	----------





# SAN FRANCISCO PLANNING DEPARTMENT

## General Plan Referral

*Date:* December 27, 2019  
*Case No.* 2018-016691GPR  
 301 Mission Street

*Block/Lot No:* 3719/020 through 440

*Project Sponsors:* Howard Dickstein  
 Millennium Tower Association  
 301 Mission Street  
 San Francisco, CA 94105

*Applicant:* Same as Above

*Staff Contact:* Paolo Ikezoe – (415) 575-9137  
 paolo.ikezoe@sfgov.org

*Recommendation:* Finding the project, on balance, is in conformity with the General Plan

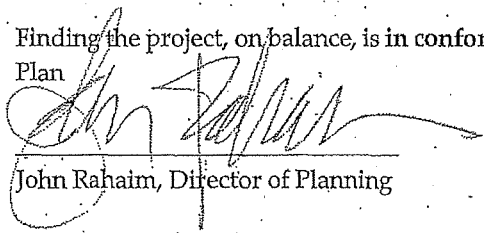
*Recommended By:*   
 John Rahaim, Director of Planning

1650 Mission St.  
 Suite 400  
 San Francisco,  
 CA 94103-2479

Reception:  
 415.558.6378

Fax:  
 415.558.6409

Planning  
 Information:  
 415.558.6377

### PROJECT DESCRIPTION

On December 4, 2018, the Planning Department (herein "the Department") received a request from the Millennium Tower Association to consider the street vacation of portions of the sidewalk along Mission and Fremont Streets, as well as a permanent easement for a portion of the street vacation area. The street vacation and easement are necessary to enable structural upgrades to the existing residential tower located at 301 Mission Street. The upgrade involves the installation of approximately 52 piles underneath the sidewalks along Mission and Fremont Streets, which will extend into bedrock approximately 235 feet beneath the sidewalk. The piles and mat foundation extension would be located approximately 15 feet beneath the sidewalk, with a vault above located approximately 12 feet beneath the sidewalk that will allow access to the upgrade for monitoring and analysis. When the easement is recorded, the City will restore the street use status on the street vacation area through a rededication of the area for street and public right-of-way purposes subject to the easement.

A condition precedent to the street vacation is termination of the Public Trust through a Trust Exchange with the State Lands Commission on portions of Mission, Fremont, and Beale Streets. The Trust Exchange will allow the City to grant the easement to the Project Sponsor for the purposes described above as well

as allow the Transbay Joint Powers Authority to consolidate its ownership of above and below grade portions of Fremont and Beale Street that the Salesforce Transit Center currently occupies. The streets where the Trust is terminated ("Trust Termination Streets") consist of a portion of Mission Street (between Beale Street and First Street), a portion of Beale Street (between Mission Street and Howard Street), and a portion of Fremont Street (between Mission Street and Howard Street), that were historically tidelands within the shallow waterbody known as Yerba Buena Cove. The streets proposed to be added to the Trust ("Trust Addition Streets") consist of a portion of Beach Street between Van Ness Avenue and Leavenworth Street, a portion of Hyde Street between Beach Street and Jefferson Street, and a portion of Bay Street between Stockton Street and Kearney Street. These streets, located near the Fisherman's Wharf area, provide public access along and to the water and the City's waterfront and serve important Trust purposes. The area of the Trust Addition Streets comprises approximately 153,000 square feet in comparison to the total area of the Trust Termination Streets that is approximately 143,000 square feet. The General Plan Referral applies to all the aforementioned issues including the street vacation, grant of permanent easement, rededication of street use, and the Trust Exchange.

In determining to issue this General Plan Referral, the Planning Department adopts findings under the California Environmental Quality Act, California Public Resources Code Sections 21000 et seq. ("CEQA"), particularly Sections 21081 and 21081.5, the Guidelines for Implementation of CEQA, California Code of Regulations, Title 14, Sections 15000 et seq. ("CEQA Guidelines"), particularly Sections 15091 through 15093, and Chapter 31 of the San Francisco Administration Code ("Chapter 31"). The CEQA Findings are contained in Attachment A to this General Plan Referral. In addition to the CEQA Findings, the Planning Department adopts a Mitigation Monitoring and Reporting Program ("MMRP") attached hereto as Attachment B.

## ENVIRONMENTAL REVIEW

On November 20, 2019, the Planning Department published a Preliminary Mitigated Negative Declaration ("PMND") for the Project, finding that, although the Project could have a significant effect on the environment, there will not be a significant effect in this case because the Project Sponsor has agreed to implement all mitigation measures as identified in the MMRP, which is included as Attachment B to this document. The Planning Department prepared and publicized the PMND in compliance with the provisions of CEQA, the CEQA Guidelines and Chapter 31.

On December 27, 2019, following a 30-day public comment period, and finding that no member of the public filed an appeal of the PMND to the Planning Commission, the Planning Department published a Final Mitigated Negative Declaration ("FMND"). This General Plan Referral determination is within the scope of the FMND and the Department relies on the FMND as the CEQA basis for its determination.

## GENERAL PLAN COMPLIANCE AND BASIS FOR RECOMMENDATION

As described below, the Project is consistent with the Eight Priority Policies of Planning Code Section 101.1 and is, on balance, **in-conformity** with the following Objectives and Policies of the General Plan:

**Note:** General Plan Objectives and Policies are in **bold font**; General Plan text is in regular font. Staff comments are in *italic font*.

### Community Safety Element

#### OBJECTIVE 1

**REDUCE STRUCTURAL AND NON-STRUCTURAL HAZARDS TO LIFE SAFETY AND MINIMIZE PROPERTY DAMAGE RESULTING FROM FUTURE DISASTERS.**

#### POLICY 1.3

**Assure that new construction meets current structural and life safety standards.**

#### POLICY 1.13

**Reduce the risks presented by the City's most vulnerable structures, particularly privately owned buildings and provide assistance to reduce those risks.**

*The proposed project is necessary to enable a structural upgrade to an existing residential building, ensuring it meets current structural and life safety standards.*

### Housing Element

#### POLICY 2.4

**Promote improvements and continued maintenance to existing units to ensure long term habitation and safety.**

#### POLICY 2.5

**Encourage and support the seismic retrofitting of the existing housing stock.**

*The proposed project is necessary to enable a structural upgrade to an existing residential building, ensuring long term habitation, safety, and structural soundness.*

### Eight Priority Policies Findings

The subject project is found to be consistent with the Eight Priority Policies of Planning Code Section 101.1 in that:

1. That existing neighborhood-serving retail uses be preserved and enhanced and future opportunities for resident employment in and ownership of such businesses enhanced.

*The Project would have no adverse effect on neighborhood serving retail uses or opportunities for employment in or ownership of such businesses.*

2. That existing housing and neighborhood character be conserved and protected in order to preserve the cultural and economic diversity of our neighborhoods.

*The Project would have no adverse effect on the City's housing stock or on neighborhood character. The existing housing and neighborhood character will be not be negatively affected.*

3. That the City's supply of affordable housing be preserved and enhanced.

*The Project would have no adverse effect on the City's supply of affordable housing.*

4. That commuter traffic not impede Muni transit service or overburden our streets or neighborhood parking.

*The Project will not result in commuter traffic impeding Muni's transit service, overburdening the streets or altering current neighborhood parking.*

5. That a diverse economic base be maintained by protecting our industrial and service sectors from displacement due to commercial office development, and that future opportunities for residential employment and ownership in these sectors be enhanced.

*The Project would not affect the existing economic base in this area.*

6. That the City achieve the greatest possible preparedness to protect against injury and loss of life in an earthquake.

*The Project proposes a structural upgrade to the residential tower at 301 Mission Street,*

7. That landmarks and historic buildings be preserved.

*The Project will not involve any changes to landmarks or historic buildings.*

8. That our parks and open space and their access to sunlight and vistas be protected from development.

*The Project will not affect City parks or open spaces, or their access to sunlight and vistas.*

<b>RECOMMENDATION:</b>	<b>Finding the Project, on balance, in-conformity with the General Plan</b>
------------------------	---

Attachment A: 301 Mission Street CEQA Findings

Attachment B: Mitigation Monitoring and Reporting Program for 301 Mission Street

# ATTACHMENT A GENERAL PLAN REFERRAL 301 MISSION STREET

## California Environmental Quality Act Findings

### PREAMBLE

In determining to approve the project described in Section I, Project Description below, the San Francisco Department of City Planning (“DCP” or “Planning Department”) makes and adopts the following findings of fact and decisions, prepared by the Planning Department, based on substantial evidence in the whole record of this proceeding and under the California Environmental Quality Act, California Public Resources Code Sections 21000 et seq. (“CEQA”), particularly Sections 21081 and 21081.5, the Guidelines for Implementation of CEQA, California Code of Regulations, Title 14, Sections 15000 et seq. (“CEQA Guidelines”), particularly Sections 15091 through 15093, and Chapter 31 of the San Francisco Administration Code. DCP adopts these findings in conjunction with the Approval Actions described in Section I(c), below, as required by CEQA.

These findings are organized as follows:

**Section I** provides a description of the project (the “Proposed Project”) as analyzed in the Final Mitigated Negative Declaration for the Project (“Final MND” or “FMND”), the environmental review process for the Project, and the approval actions to be taken and the location of records;

**Section II** identifies the impacts found not to be significant that do not require mitigation;

**Section III** identifies potentially significant impacts that can be avoided or reduced to less-than significant levels through mitigation and describes the mitigation measures;

The Mitigation Monitoring and Reporting Program (“MMRP”) for the mitigation measures that have been proposed for adoption is attached with these findings as **Attachment B to the General Plan Referral for 301 Mission Street**. The MMRP is required by CEQA Section 21081.6 and CEQA Guidelines Section 15074. Attachment B provides a table setting forth each mitigation measure listed in the FMND that is required to avoid a significant adverse impact. Attachment B also specifies the agency responsible for implementation of each measure and establishes monitoring actions and a monitoring schedule. The full text of the mitigation measures is set forth in Attachment B. These findings are based upon substantial evidence in

the entire record before DCP. The references set forth in these findings to certain pages or sections of the FMND are for ease of reference and are not intended to provide an exhaustive list of the evidence relied upon for these findings.

## I. PROJECT DESCRIPTION AND PROCEDURAL BACKGROUND

### A. Project Description

The 301 Mission Street, Millennium Tower Perimeter Pile Upgrade Project (the "Project") is associated with the 50,500-square-foot (1.16-acre) parcel (Assessor's Block 3719, Lots 020-440) at 301 Mission Street located on the south side of Mission Street between Fremont and Beale streets within San Francisco's Financial District (the "Property"). The existing high-rise on the 301 Mission Street parcel is called the Millennium Tower. The Tower building covers a footprint of approximately 32,960 square feet and its foundation system consists of a 10-foot-thick reinforced concrete mat foundation. In accordance with information provided by the Project Sponsor, Millennium Tower Association, since completion of construction of the Tower in 2009, the area around the Tower and Property has experienced differential settlement due to consolidation and compression of the soil layer beneath the Colma Sand, which is known as Old Bay Clay. As of the release of the FMND, at its lowest point, the existing mat foundation has settled approximately 17.6 inches near the northwest corner of the Tower, such that the top of the Tower tilts approximately 17.1 inches to the northwest near the corner of Mission and Fremont Streets.

The Project consists of a structural upgrade of the Tower building foundation that includes installation of a structural extension of the existing mat foundation for the Tower building within an approximately 8-foot-wide zone beneath public right of way sidewalk area immediately adjacent to the Tower along Fremont and Mission streets, supported by 52 new piles extending to bedrock. The 52 new piles are referred to a "perimeter piles" and the extended mat foundation is referred to as the "collar foundation." In addition to preventing further settlement in the northwest corner of the Tower's existing foundation, the Project Sponsor has stated that this effort may allow for gradual tilt correction of the Tower building over time. Project construction activities would be staged adjacent to the Property along Fremont, Mission and Beale Streets, requiring the closure of one travel lane and sidewalks along Fremont and Mission Streets and restricting pedestrian access on the sidewalk along Beale Street during portions of construction. There would be no pedestrian access along the Fremont and Mission Streets sides of the Tower during the entirety of construction, because the structural upgrade construction would occur in the sidewalk area; however, after completion of the structural upgrade, the Project would restore the site to pre-construction conditions.

### B. Project Approvals

The Project requires the following Board of Supervisors approvals:

- Review and approval of an ordinance authorizing a street vacation and a resolution for an easement permitting the permanent installation of the perimeter piles and collar foundation;
- Approval of a State public trust exchange to remove public trust from the public right-of-way on Mission, Fremont, and Beale Streets and replace it on other public streets;
- Approval of the settlement of an ongoing lawsuit related to the Tower;

- Adopting CEQA findings and a MMRP.

The Project requires the following San Francisco Port Commission approvals:

- Approval of a state public trust exchange to remove public trust from the public right-of-way on Mission, Fremont, and Beale Streets and replace it on other public streets;
- Adopting CEQA findings and a MMRP.

### *Actions by Other City Departments and State Agencies*

- State Lands Commission
  - Approval of a state public trust exchange to remove public trust from the public right-of-way on Mission, Fremont, and Beale Streets and replace it on other public streets
- San Francisco Planning Department
  - General Plan Referral related to Project, street vacation, and other related actions
- San Francisco Department of Public Works
  - Various permits and approvals related to street demolition and restoration plans, including tree removal and replanting
- San Francisco Department of Building Inspection
  - Building permits required to construction the structural upgrade
- San Francisco Municipal Transportation Agency
  - Various permits and approvals related to temporary street closures and temporary relocation of overhead wires for Muni trolley coach services
- San Francisco Department of Public Health
  - Various approvals related to the Maher Ordinance and work site safety
- San Francisco Public Utilities Commission
  - Review and approval of a batch waste discharge permit
  - Review and approval of erosion and sediment control plan

### **C. Environmental Review**

DCP commenced environmental review of the Project following submission of complete environmental evaluation materials from the Project Sponsor on December 19, 2018. Following completion of technical study scoping, on June 14, 2019, the Planning Department circulated a Notification of Project Receiving Environmental Review ("Neighborhood Notice"). The Neighborhood Notice was sent to community organizations, occupants of the Property, and those persons who own property within 300 feet of the project site. In addition, the Neighborhood Notice was sent to people who had requested to receive notice regarding the Property.

On November 20, 2019, the Planning Department published a Preliminary Mitigated Negative Declaration ("PMND") for the Project, finding that, although the Project could have a significant effect on the environment, there will not be a significant effect in this case because the Project Sponsor has agreed to implement all mitigation measures as identified in the MMRP, Attachment B. DCP prepared and publicized the PMND in compliance with the provisions of the California Environmental Quality Act (California Public Resources Code Sections 21000 et seq., "CEQA"), the State CEQA Guidelines (California Code of Regulations Title 14 Sections 15000 et seq.), and Chapter 31 of the San Francisco Administrative Code ("Chapter 31").

On December 27, 2019, following a 30-day public comment period and finding that no member of the public filed an appeal of the PMND to the Planning Commission, DCP published a Final MND.

Prior to considering approval of the Project, DCP must determine that the Project proposed for approval has been sufficiently assessed under CEQA.

#### **D. Content and Location of Record**

The record upon which all findings and determinations related to the adoption of the proposed Project are based include the following:

- The FMND; and all documents referenced in or relied upon by the FMND;
- All information (including written evidence and testimony) provided by City staff to DCP relating to the FMND, the proposed approvals and entitlements, the Project;
- All information (including written evidence and testimony) presented to DCP by the environmental consultant and subconsultants who prepared the FMND, or incorporated into reports presented to DCP;
- All information (including written evidence and testimony) presented to the City from other public agencies relating to the Project or FMND;
- All applications, letters, testimony, and presentations presented to the City by the Project Sponsor and its consultants in connection with the Project;
- All information (including written evidence and testimony) presented at any public hearing related to the FMND;
- The MMRP; and,
- All other documents comprising the record pursuant to Public Resources Code Section 21167.6(e).

The public hearing transcripts and audio files, a copy of all letters regarding the FMND received during the public review period, the administrative record, and background documentation for the FMND are located at the Planning Department, 1650 Mission Street, 4th Floor, San Francisco. The Planning Department, Jonas P. Ionin, is the custodian of these documents and materials.



## **E. Findings About Significant Environmental Impacts of the Project and Mitigation Measures**

The following Sections II and III set forth DCP's findings about the FMND and the mitigation measures proposed such that potentially significant impacts can be avoided or reduced to less-than significant levels. These findings provide the written analysis and conclusions of DCP regarding the environmental impacts of the Project and the mitigation measures included as part of the FMND and adopted by DCP as part of the Project. To avoid duplication and redundancy, and because DCP agrees with, and hereby adopts, the conclusions in the FMND, these findings will not repeat the analysis and conclusions in the FMND, but instead incorporates them by reference herein and relies upon them as substantial evidence supporting these findings.

In making these findings, DCP has considered the opinions of Planning Department and other City staff and experts, other agencies, and members of the public. DCP finds that: the determination of significance thresholds is a judgment decision within the discretion of the City and County of San Francisco; the significance thresholds used in the FMND are supported by substantial evidence in the record, including the expert opinion of the FMND preparers and City staff; and the significance thresholds used in the FMND provide reasonable and appropriate means of assessing the significance of the adverse environmental effects of the Project.

These findings do not attempt to describe the full analysis of each environmental impact contained in the FMND. Instead, a full explanation of these environmental findings and conclusions can be found in the FMND and these findings hereby incorporate by reference the discussion and analysis in the FMND supporting the determination regarding the Project impacts and mitigation measures designed to address those impacts. In making these findings, DCP ratifies, adopts and incorporates in these findings the determinations and conclusions of the FMND relating to environmental impacts and mitigation measures, except to the extent any such determinations and conclusions are specifically and expressly modified by these findings.

As set forth below, DCP adopts and incorporates the mitigation measures set forth in the FMND and the attached MMRP to avoid the potentially significant and significant impacts of the Project. DCP intends to adopt the mitigation measures proposed in the FMND. Accordingly, in the event a mitigation measure recommended in the FMND has inadvertently been omitted in these findings or the MMRP, such mitigation measure is hereby adopted and incorporated in the findings below by reference. In addition, in the event the language describing a mitigation measure set forth in these findings or the MMRP fails to accurately reflect the mitigation measures in the FMND, due to a clerical error, the language of the policies and implementation measures as set forth in the FMND, shall control. The impact numbers and mitigation measure numbers used in these findings reflect the information contained in the FMND.

In the Sections II and III below, the same findings are made for a category of environmental impacts and mitigation measures. Rather than repeat the identical finding dozens of times to address each and every significant effect and mitigation measure, the initial finding obviates the need for such repetition because in no instance is DCP rejecting the conclusions of the FMND or the mitigation measures recommended in the FMND for the Project.

## **II. IMPACTS OF THE PROJECT FOUND NOT TO BE SIGNIFICANT AND THUS DO NOT REQUIRE MITIGATION**

Under CEQA, no mitigation measures are required for impacts that are less than significant (Pub. Resources Code, § 21002; CEQA Guidelines, §§ 15126.4, subd. (a)(3), 15091.). Based on the evidence in the whole record of this proceeding, DCP finds that, the Project described in the FMND will not result in any significant impacts in the below areas and that these impact areas therefore do not require mitigation.

**Land Use**

- **Impact LU-1:** The proposed project would not physically divide an established community.
- **Impact LU-2:** The proposed project would not cause a significant physical environmental impact due to a conflict with any land use plan, policy, or regulation adopted for the purpose of avoiding or mitigating an environmental effect?
- **Impact C-LU-1:** The proposed project, in combination with reasonably foreseeable future projects, would not result in a cumulative land use impact.

**Aesthetics**

- **Impact AE-1:** The proposed project would not result in a substantial adverse effect on a scenic vista.
- **Impact AE-2:** The proposed project would not damage scenic resources, including, but not limited to, tree, rock outcroppings, and other features of the built or natural environment which contribute to a scenic public setting.
- **Impact AE-3:** The proposed project would not create a new source of substantial light or glare which would adversely affect daytime or nighttime views in the area
- **Impact C-AE-1:** The proposed project, in combination with reasonably foreseeable projects in the vicinity of the project site, would not result in cumulatively significant impacts related to aesthetics.

**Population, Housing, and Employment**

- **Impact PH-1:** The proposed project would not induce substantial population growth in an area, either directly or indirectly.
- **Impact PH-2:** The proposed project would not displace substantial numbers of existing people or housing units, necessitating the construction of replacement housing.
- **Impact C-PH-1:** The proposed project, in combination with reasonably foreseeable future projects in the vicinity, would not result in a cumulative impact on population and housing.

**Cultural and Paleontological Resources**

- **Impact CR-1:** The project would not cause a substantial adverse change in the significance of a historical resource as defined in CEQA Guidelines section 15064.5, including those resources listed in article 10 or article 11 of the planning code.
- **Impact C-CR-1:** The proposed project, in combination with reasonably foreseeable future projects, would not result in significant cumulative impacts to cultural resources.

**Tribal Cultural Resources**

- **Impact C-TC-1:** The proposed project, in combination with reasonably foreseeable future projects, would not result in significant cumulative impacts to tribal cultural resources

**Transportation and Circulation**

- **Impact TR-1:** Construction of the project would require an intense activity but would not create potentially hazardous conditions for people walking, bicycling, or driving or public transit operations; or interfere with accessibility for people walking or bicycling; or substantially delay public transit, including due to loading activities.

- **Impact TR-2:** Operation of the project would not result in significant transportation impacts.
- **Impact C-TR-1:** Construction of the proposed project, in combination with reasonably foreseeable projects, would not contribute considerably significant construction-related transportation impacts.
- **Impact C-TR-2:** Operation of the project, in combination with reasonably foreseeable future projects, would not result in significant transportation impacts.

#### Noise

- **Impact NO-3:** Operation of the proposed project would not generate noise levels in excess of standards established in the local general plan or noise ordinance or result in a substantial permanent increase in ambient noise levels in the project vicinity.
- **Impact C-NO-1:** Implementation of the proposed project, in combination with reasonably foreseeable projects would not result in a significant cumulative noise or vibration impacts.

#### Air Quality

- **Impact AQ-3:** During project operations, the proposed project would not result in emissions of criteria air pollutants or toxic air contaminants.
- **Impact AQ-4:** The proposed project would not conflict with, or obstruct implementation of the 2017 Clean Air Plan.
- **Impact AQ-5:** The proposed project would not result in other emissions (such as those leading to odors) that would adversely affect a substantial number of people.

#### Greenhouse Gas Emissions

- **Impact C-GG-1:** The proposed project would generate greenhouse gas emissions, but not at levels that would result in a significant impact on the environment or conflict with any policy, plan, or regulation adopted for the purpose of reducing greenhouse gas emissions.

#### Wind and Shadow

- These topics are not applicable to the proposed project, because there would be no substantial change to the above-ground structures on the Property

#### Recreation

- **Impact UT-1:** The proposed project would not require or result in the relocation or construction of new or expanded water, wastewater treatment, or stormwater drainage, electric power, natural gas, or telecommunications facilities.
- **Impact UT-2:** The proposed project would have sufficient water supply available and would not require new or expanded water supply resources or entitlements.
- **Impact UT-3:** The proposed project would not exceed the capacity of the wastewater treatment provider that would serve the project.
- **Impact UT-4:** The proposed project would be served by a landfill with sufficient permitted capacity to accommodate the project's solid waste disposal needs and would comply with all applicable statutes and regulations related to solid waste.
- **Impact C-UT-1:** The proposed project, in combination with reasonably foreseeable projects, would not result in a cumulative impact on utilities and service systems.

#### Utilities and Service Systems

- **Impact UT-1:** The proposed project would not require or result in the relocation or construction of new or expanded water, wastewater treatment, or stormwater drainage, electric power, natural gas, or telecommunications facilities.

- **Impact UT-2:** The proposed project would have sufficient water supply available and would not require new or expanded water supply resources or entitlements.
- **Impact UT-3:** The proposed project would not exceed the capacity of the wastewater treatment provider that would serve the project.
- **Impact UT-4:** The proposed project would be served by a landfill with sufficient permitted capacity to accommodate the project's solid waste disposal needs and would comply with all applicable statutes and regulations related to solid waste.
- **Impact C-UT-1:** The proposed project, in combination with reasonably foreseeable projects, would not result in a cumulative impact on utilities and service systems.

#### Public Services

- **Impact PS-1:** The proposed project would not increase demand for police and fire protection services and would not require construction of new or physically altered facilities, associated with the provision of such services, that could cause significant environmental impacts.
- **Impact C-PS-1:** The proposed project, in combination with other past, present, or reasonably foreseeable projects, would not have a significant cumulative impact on public services.

#### Biological Resources

- **Impact BI-1:** The proposed project would not have a substantial adverse effect, either directly or through habitat modifications, on any special-status species.
- **Impact BI-2:** The proposed project would not interfere with the movement of any native resident or wildlife species or with established native resident or migratory wildlife corridors.
- **Impact BI-3:** The proposed project would not conflict with any local policies or ordinances protecting biological resources, such as a tree preservation policy or ordinance.
- **Impact C-BI-1:** The proposed project, in combination with reasonably foreseeable future projects in the vicinity of the site, would not have a significant cumulative impact on biological resources.

#### Geology and Soil

- **Impact GE-1:** The proposed project would not directly or indirectly cause potential substantial adverse effects, including the risk of loss, injury, or death involving rupture of a known earthquake fault, strong seismic ground shaking, seismic-related ground failure, or landslides.
- **Impact GE-2:** The proposed project would not result in substantial loss of topsoil or erosion.
- **Impact GE-3:** The proposed project would not be located on a geologic unit or soil that is unstable, or that could become unstable as a result of the project, resulting in an onsite or offsite landslide, lateral spreading, subsidence, liquefaction or collapse.
- **Impact GE-4:** The proposed project would not create substantial risks to life or property as a result of being located on expansive soil.
- **Impact C-GE-1:** The proposed project, in combination with reasonably foreseeable future projects would not result in a significant cumulative impact related to geology, soils, seismicity, and paleontological resources.

As a result of the analysis leading to the findings above and the DCP's Environmental Planning division review of the Project, the FMND includes a recommended improvement measure related to implementation of monitoring and reporting already included as part of the project. The Project Sponsor has agreed to follow this improvement measure and the Department of Building Inspection has indicated it will adopt the recommended improvement measure as part of its approvals related to the Project.

#### Hydrology and Water Quality

- **Impact HY-1:** The project would not violate any water quality standards or waste discharge requirements or otherwise substantially degrade surface or groundwater quality.

- **Impact HY-2:** The proposed project would not substantially decrease groundwater supplies or interfere substantially with groundwater recharge such that the project may impede sustainable groundwater management of the basin.
- **Impact HY-3:** The proposed project would not result in altered drainage patterns that would cause substantial erosion and siltation or flooding on- or off-site, or contribute runoff water which would exceed the capacity of existing or planned stormwater drainage systems or provide substantial additional sources of polluted runoff, or impede or redirect flood flows.
- **Impact HY-4:** The project would not conflict with or obstruct implementation of a water quality control plan or sustainable groundwater management plan.
- **Impact C-HY-1:** The proposed project, in combination with reasonably foreseeable future projects in the site vicinity, would not have a significant cumulative impact on hydrology and water quality.

#### **Hazards and Hazardous Materials**

- **Impact HZ-1:** Construction of the proposed project would not create a significant hazard through the routine transport, use, or disposal of hazardous materials.
- **Impact HZ-2:** The proposed project would not create a significant hazard to the public or the environment through reasonably foreseeable upset and accident conditions involving the release of hazardous materials into the environment.
- **Impact HZ-3:** The proposed project would not impair implementation of or physically interfere with an adopted emergency response plan or emergency evacuation plan.
- **Impact C-HZ-1:** The proposed project, in combination with reasonably foreseeable future projects in the site vicinity, would result in less than significant impacts related to hazards and hazardous materials.

#### **Mineral Resources**

- Because no sites in San Francisco are designated areas of significant mineral deposits, this topic is not applicable to the proposed project.

#### **Energy Resources**

- **Impact EN-1:** The proposed project would not encourage activities which would result in wasteful, inefficient, or unnecessary consumption of energy resources.
- **Impact EN-2:** The proposed project would not conflict with or obstruct a state or local plan for renewable energy or energy efficiency.
- **Impact C-EN-1:** The proposed project, in combination with reasonably foreseeable future project in the site vicinity, would not result in significant cumulative impacts on energy resources.

#### **Agriculture and Forest Resources**

- The proposed project will have no impact on agricultural or forest resources.

#### **Wildfire**

- Because San Francisco does not contain any state responsibility areas for fire prevention or lands classified as very high fire hazard severity zones, this topic is not applicable to the proposed project.

### **III. FINDINGS OF POTENTIALLY SIGNIFICANT IMPACTS THAT CAN BE AVOIDED OR REDUCED TO A LESS-THAN-SIGNIFICANT LEVEL THROUGH MITIGATION**

CEQA requires agencies to adopt mitigation measures that would avoid or substantially lessen a project's identified significant impacts or potential significant impacts if such measures are feasible (unless mitigation to such levels is achieved through adoption of a project alternative). The findings in this Section

III concern mitigation measures set forth in the FMND. These findings discuss mitigation measures identified in the FMND to mitigate the potentially significant impacts of the proposed project. The full text of the mitigation measures is contained in the FMND and in the MMRP, Attachment B. DCP finds that the impacts of the Project identified in this Section III would be reduced to a less-than-significant level through implementation of the mitigation measures contained in the FMND for the reasons specified therein, and imposed as conditions of approval as set forth in Attachment B.

DCP recognizes that some of the mitigation measures are partially within the jurisdiction of other agencies. DCP urges these agencies to assist in implementing these mitigation measures, and finds that these agencies can and should participate in implementing these mitigation measures.

**Impact CR-2: The proposed project could cause a substantial adverse change in the significance of an archeological resource pursuant to CEQA Guidelines section 15064.5.**

**Impact CR-3: The proposed project could disturb human remains, including those interred outside of formal cemeteries**

Because the Project involves ground-disturbing activities, which could affect human remains and archaeological resources, the FMND proposes Mitigation Measure M-CR-2 requiring the development of a testing, monitoring and data recovery program, as well as procedures for the treatment of human remains discovered during ground-disturbing activity.

*Mitigation Measure M-CR-2: Archaeological Testing*

**Impact TC-1: The proposed project could result in a substantial adverse change in the significance of a tribal cultural resource as defined in Public Resources Code section 21074.**

Because the Project involves ground-disturbing activities, which could affect tribal cultural resources, the FMND proposes Mitigation Measure M-TC-1 requiring the development of a tribal cultural resources interpretive program in the event the Environmental Review Officer determines that a significant archeological resource is present and, in consultation with affiliated Native American tribal representatives, determines that the resource constitutes a tribal cultural resource and that the resource could be adversely affected by the proposed project.

*Mitigation Measure M-TC-1: Tribal Cultural Resources Interpretive Program*

**Impact NO-1: Construction of the proposed project would generate substantial temporary or periodic increases in ambient noise levels.**

Because construction of the Project would cause a temporary increase in noise levels at the project site and within the project vicinity area, the FMND proposes Mitigation Measure M-NO-1a requiring general construction noise control measures to ensure that project noise from construction activities is minimized to the maximum extent feasible. The FMND also proposes Mitigation Measure M-NO-1b to reduce nighttime construction delivery noise during Stages 3 and 4.

*Mitigation Measure M-NO-1a*

*Mitigation Measure M-NO-1b*

**Impact NO-2:** During project construction, the proposed project could generate excessive groundborne vibration or groundborne noise levels.

Because construction activities involve impact activities and compaction that could produce detectable vibration at nearby sensitive buildings and sensitive receptors, the FMND propose Mitigation Measure M-NO-2 which requires contractors to use limit the use of vibratory rollers.

*Mitigation Measure M-NO-2*

**Impact AQ-1:** The proposed project's construction activities would generate fugitive dust and criteria air pollutants. Construction exhaust emissions would result in a cumulatively considerable net increase in regional non-attainment criteria air pollutants.

**Impact AQ-2:** The proposed project's construction activities would generate toxic air contaminants, including diesel particulate matter that would expose sensitive receptors to substantial pollutant concentrations.

**Impact C-AQ-1:** Construction of the proposed project, in combination with past, present, and reasonably foreseeable future development in the project area would result in significant cumulative air quality impacts.

Because construction activity would generate fugitive dust and criteria air pollutants and toxic air contaminants that would expose sensitive receptors to substantial pollutant concentrations, the FMND proposes Mitigation Measure M-AQ-1, which requires engines meet higher emission standards on certain types of construction equipment in order to reduce NO<sub>x</sub> construction emissions, cancer risk and PM<sub>2.5</sub> to less-than-significant levels. Implementation of Mitigation Measure M-AQ-1 would also bring the cumulative air quality impacts of the construction activities to a less than significant level.

*Mitigation Measure M-AQ-1*

**Impact GE-5:** The proposed project could directly or indirectly destroy a unique paleontological resource or site or unique geological feature.

Because construction activities could directly or indirectly destroy a paleontological resource, the FMND proposes Mitigation Measure M-GE-5a, b, c, & d, requiring the project sponsor or its contractor to retain a qualified paleontologist to train workers, monitor installation of the 36-inch-diameter casings anticipated to return Colma Sands and Old Bay Clay and salvage and prepare any find deemed significant.

*Mitigation Measure M-GE-5a, b, c, & d*

**Mandatory findings of significance**

The proposed project would not substantially reduce the habitat of a fish or wildlife species, cause a fish or wildlife population to drop below self-sustaining levels, threaten to eliminate a plant or animal community, or reduce the number or restrict the range of a rare or endangered plant or animal.

As described above, construction activities associated with the proposed project could result in potential impacts on unknown archeological resources, human remains, and tribal cultural resources. These impacts would be less than significant with implementation of Mitigation Measures M-CR-2, Archeological Testing and Archeological Monitoring, and M-TC-1, Tribal Cultural Resources Interpretive Program.

Also as described above, construction activities associated with the proposed project could result in potential impacts on paleontological resources. These impacts would be less than significant with implementation of Mitigation Measures M-GE-5a through M-GE-5d. Therefore, the proposed project would not result in a significant impact through the elimination of important examples of major periods of California history or prehistory.

Section E of the initial study has addressed cumulative impacts under each environmental topic and determined that the proposed project, in combination with reasonably foreseeable projects, would not result in significant cumulative impacts.

As described above, the proposed project would result in substantial temporary noise level increases in excess of established standards and groundborne vibration impacts on sensitive receptors at the 301 Mission Street. These impacts would be less than significant with implementation of Mitigation Measures M-NO-1a, General Construction Noise Control Measures, M-NO-1b, Noise Reduction Techniques for Equipment Used in Nighttime Delivery Activity, and M-NO-2, Limited Use of Vibratory Rollers.

Also as described above, the proposed project would result in potentially significant impacts related to criteria air pollutants and health risk. These impacts would be less than significant with implementation of Mitigation Measures M-AQ-1, Construction Air Quality. Therefore, the proposed project would not cause substantial adverse effects on human beings, either directly or indirectly, with the implementation of the mitigation measures.



**ATTACHMENT B: MITIGATION MONITORING AND REPORTING PROGRAM (MMRP) FOR THE 301 MISSION STREET  
PERIMETER PILE UPGRADE PROJECT**

MITIGATION MONITORING AND REPORTING PROGRAM FOR THE 301 MISSION STREET PERIMETER PILE UPGRADE PROJECT

Measures Adopted as Conditions of Approval	Implementation Responsibility	Mitigation Schedule	Monitoring/Reporting Responsibility	Monitoring Actions/Schedule and Verification of Compliance
<b>MITIGATION MEASURES FOR THE 301 MISSION STREET PERIMETER PILE UPGRADE PROJECT</b>				
<b>Cultural Resources Mitigation Measures</b>				
<p><b>Mitigation Measure M-CR-2: Archeological Testing and Monitoring.</b>                      Based on a reasonable presumption that archeological resources may be present within the project site, the following measures shall be undertaken to avoid any potentially significant adverse effect from the proposed project on buried or submerged historical resources. The project sponsor shall retain the services of an archeological consultant from the rotational Department Qualified Archeological Consultants List (QACL) maintained by the Planning Department archeologist. The project sponsor shall contact the Department archeologist to obtain the names and contact information for the next three archeological consultants on the QACL, with specialized expertise in geoarcheology and historical archeology. The archeological consultant shall undertake an archeological testing and monitoring program as specified herein. In addition, the consultant shall be available to conduct a data recovery program if required pursuant to this measure. The archeological consultant's work shall be conducted in accordance with this measure at the direction of the Environmental Review Officer (ERO). All plans and reports prepared by the consultant as specified herein shall be submitted first and directly to the ERO for review and comment, and shall be considered draft reports subject to revision until final approval by the ERO. Archeological data recovery programs required by this measure could suspend construction of the project for up to a maximum of four weeks. At the direction of the ERO, the suspension of construction can be extended beyond four weeks only if such a suspension is the only feasible means to reduce to a less-than-significant level potential effects on a significant archeological resource as defined in CEQA Guidelines section 15064.5(a) and (c).</p>	<p>Project sponsor to retain qualified professional archeological consultant.</p>	<p>Upon publication of the draft CEQA document.</p>	<p>The archeological consultant shall undertake an archeological testing and monitoring program as specified herein. (See below regarding archeological consultant's reports).</p>	<p>Considered complete when project sponsor retains a qualified professional archeological consultant and scope of ATP/AMP has been approved by the ERO</p>
<p><b>Consultation with Descendant Communities.</b> On discovery of an archeological site associated with descendant Native Americans, the Overseas Chinese, or other potentially interested descendant group, an appropriate representative of the descendant group and the ERO shall be contacted. The representative of the descendant group shall be given the opportunity to monitor archeological field investigations of the site and to offer recommendations to the ERO regarding appropriate archeological treatment of the site, or recovered data from the site, and, if applicable, any interpretative treatment of the associated archeological site. A copy of the Final Archeological Resources Report shall be provided to the representative of the descendant group.</p>	<p>Qualified archeologist to identify descendant monitor; Project sponsor to retain monitor.</p>	<p>Upon discovery of an archeological site associated with descendant groups, and for the duration of any archeological investigation of the associated site.</p>	<p>Project sponsor/archeological consultant shall contact the ERO and appropriate descendant group representative upon discovery of an archeological site.</p>	<p>Considered complete upon submittal of Final Archeological Resources Report.</p>
<p><b>Archeological Testing and Monitoring Program.</b> The archeological consultant shall prepare and submit to the ERO for review and approval an archeological testing plan and archeological monitoring plan (ATP/AMP). The ATP/AMP shall identify the property types of the expected archeological resource(s) that potentially could be adversely affected by the proposed project, the testing method to be used, and the locations recommended for testing and monitoring. The purpose of the archeological testing and monitoring program will be to determine to the extent possible the presence or absence of archeological resources or strata with potential to include archeological resources and to identify and to evaluate whether any archeological resource encountered on the site constitutes an historical resource under CEQA.</p>	<p>Archeological consultant to prepare in consultation with ERO</p>	<p>Prior to any excavation, site preparation or, geotechnical drilling, submit ATP/AMP to the ERO for approval.</p>	<p>ERO to review and approve ATP/AMP.</p>	<p>Considered complete upon ERO approval of ATP/AMP</p>
<p>The archeological testing and monitoring program shall be conducted in accordance with the approved ATP/AMP, as follows:                      Archeological testing shall consist of geoarcheological coring prior to the beginning of project excavations and/or in concert with post-approval geotechnical testing, and shall, at minimum, include sampling of the uppermost five feet of the Young Bay Mud and the uppermost five feet of the Colma Sands Formation, or of the Old Bay Clay, where this stratum directly underlies the Young Bay Mud stratum. At the completion of the archeological testing program, the archeological consultant shall submit a written report of the findings to the ERO. If based on the archeological testing program the archeological consultant finds that significant archeological resources may be present, the ERO in consultation with the archeological consultant shall determine if additional measures are warranted. Additional measures that may be undertaken include additional archeological testing, modifications to the archeological monitoring program; and/or implementation of an archeological data recovery program, as detailed below. No archeological data recovery shall be undertaken without the prior approval of the ERO or the Planning Department archeologist.</p>	<p>Project sponsor and archeological consultant to implement ATP/AMP in consultation with the ERO.</p>	<p>Testing to be completed concurrent with geotechnical drilling.                       Upon completion of the archeological testing program.</p>	<p>Archeological consultant to implement approved ATP/AMP in consultation with ERO. Archeological consultant and project sponsor to submit results of testing and consult with ERO on subsequent tasks.</p>	<p>Considered complete upon ERO approval of consultant's initial report of archeological testing results and ERO approval of scope of any subsequent monitoring and/or data recovery.</p>
<p>Archeological monitoring shall be conducted in accordance with the approved AMP. It is anticipated that at a minimum, this shall include at least intermittent monitoring of excavations within bay fill and the upper portion of the Young Bay Mud stratum, and selective monitoring of the installation of the 36-inch-diameter outer casings. The archeological consultant, project sponsor, and ERO shall meet and consult on any adjustments needed in the scope of archeological monitoring based on the results of geoarcheological testing and the judgment of the project archeologist, reasonably prior to the commencement of mass excavation and casing installations. Whether or not significant archeological resources are encountered, the archeological consultant shall submit a written report of the findings of the monitoring program to the ERO. If no potential archeological resources are identified, the final report shall consist of an Archeological Testing Results Report/ Archeological Monitoring Results Report (AMRR/ATTR). If significant resources are identified, the consultant shall prepare a Final Archeological Resources Report (FARR), the contents of which are detailed below.</p>	<p>Project sponsor, archeological consultant, archeological monitor, and project sponsor's contractors shall implement the applicable provisions of the AMP, if required by the ERO</p>	<p>Upon conclusion of archeological testing, and prior to the commencement of post-coring soil-disturbing activities.</p>	<p>Project sponsor and archeological consultant in consultation with the ERO</p>	<p>Considered complete on ERO approval of Archeological Monitoring Results Report and/or Final Archeological Resources Report</p>
<p>In addition:</p> <ul style="list-style-type: none"> <li>Prior to the beginning of construction soil disturbance, the archeological consultant shall advise all project contractors to be on the</li> </ul>				

1586

MITIGATION MONITORING AND REPORTING PROGRAM FOR THE 301 MISSION STREET PERIMETER PILE UPGRADE PROJECT

Measures Adopted as Conditions of Approval	Implementation Responsibility	Mitigation Schedule	Monitoring/Reporting Responsibility	Monitoring Actions/Schedule and Verification of Compliance
<p>alert for evidence of the presence of the expected resource(s), of how to identify the evidence of the expected resource(s), and of the appropriate protocol in the event of apparent discovery of an archeological resource;</p> <ul style="list-style-type: none"> <li>The archeological monitor(s) shall be present on the project site according to a schedule agreed upon by the archeological consultant and the ERO until the ERO has, in consultation with the project archeological consultant, determined that project construction activities could have no effects on significant archeological deposits;</li> <li>The archeological monitor shall record and be authorized to collect soil samples and artifactual/ecofactual material as warranted for analysis;</li> <li>If an intact archeological deposit is encountered, all soils-disturbing activities in the vicinity of the deposit shall cease. The archeological monitor shall be empowered to temporarily redirect demolition/excavation/pile installation/construction activities and equipment until the deposit is evaluated. If in the case of pile installation or deep foundation activities (foundation, shoring, etc.), the archeological monitor has cause to believe that the pile installation or deep foundation activities may affect an archeological resource, the pile installation or deep foundation activities shall be terminated until an appropriate evaluation of the resource has been made in consultation with the ERO. The archeological consultant shall immediately notify the ERO of the encountered archeological deposit. The archeological consultant shall make a reasonable effort to assess the identity, integrity, and significance of the encountered archeological deposit, and present the findings of this assessment to the ERO.</li> </ul> <p><i>Archeological Data Recovery Program.</i> The archeological data recovery program, when required through the process set forth above, shall be conducted in accord with an archeological data recovery plan (ADRP). The archeological consultant, project sponsor, and ERO shall meet and consult on the scope of the ADRP prior to preparation of a draft ADRP. The archeological consultant shall submit a draft ADRP to the ERO. The ADRP shall identify how the proposed data recovery program will preserve the significant information the archeological resource is expected to contain. That is, the ADRP will identify what scientific/historical research questions are applicable to the expected resource, what data classes the resource is expected to possess, and how the expected data classes would address the applicable research questions. Data recovery, in general, should be limited to the portions of the historical resource that could be adversely affected by the proposed project. Destructive data recovery methods shall not be applied to portions of the archeological resources if nondestructive methods are practical.</p> <p>The scope of the ADRP shall include the following elements:</p> <ul style="list-style-type: none"> <li>Field Methods and Procedures – Descriptions of proposed field strategies, procedures, and operations</li> <li>Cataloguing and Laboratory Analysis – Description of selected cataloguing system and artifact analysis procedures</li> <li>Discard and Deaccession Policy – Description of and rationale for field and post-field discard and deaccession policies</li> <li>Interpretive Program – Consideration of an on-site/off-site public interpretive program based on the results of the archeological data recovery program</li> <li>Security Measures – Recommended security measures to protect the archeological resource from vandalism, looting, and non-intentionally damaging activities</li> <li>Final Report – Description of proposed report format and distribution of results</li> <li>Curation – Description of the procedures and recommendations for the curation of any recovered data having potential research value, identification of appropriate curation facilities, and a summary of the accession policies of the curation facilities.</li> </ul>	<p>Project sponsor and archeological consultant in consultation with the ERO.</p>	<p>ADRP to be prepared by consultant upon determination by the ERO that an ADRP is required. Archeological data recovery to be implemented prior to or during construction, as determined by provisions of approved ADRP.</p>	<p>If required, archeological consultant to prepare and implement an ADRP in consultation with the ERO</p>	<p>Considered complete upon review and approval of the ADRP by the ERO and upon notification of the ERO, by the consultant, that data recovery is complete.</p>
<p><i>Human Remains, Associated or Unassociated Funerary Objects.</i> The treatment of human remains and of associated or unassociated funerary objects discovered during any soils disturbing activity shall comply with applicable State and federal laws. This shall include immediate notification of the Medical Examiner of the City and County of San Francisco and, in the event of the Medical Examiner's determination that the human remains are Native American remains, notification of the California State Native American Heritage Commission, which will appoint a Most Likely Descendant (MLD). The MLD will complete his or her inspection of the remains and make recommendations or preferences for treatment within 48 hours of being granted access to the site (Public Resources Code section 5097.98). The ERO also shall be notified immediately upon the discovery of human remains.</p> <p>The project sponsor and ERO shall make all reasonable efforts to develop a Burial Agreement ("Agreement") with the MLD, as expeditiously as possible, for the treatment and disposition, with appropriate dignity, of human remains and associated or unassociated funerary objects (as detailed in CEQA Guidelines section 15064.5(d)). The Agreement shall take into consideration the appropriate excavation, removal, recordation, scientific analysis, custodianship, curation, and final disposition of the human remains and associated or unassociated funerary objects. If the MLD agrees to scientific analyses of the remains and/or associated or unassociated funerary objects, the archeological consultant shall retain possession of the remains and associated or unassociated funerary objects until completion of any such analyses, after which the remains and associated or unassociated funerary objects shall be reinterred or curated as specified in the Agreement.</p> <p>Nothing in existing State regulations, or in this mitigation measure compels the project sponsor and the ERO to accept treatment</p>	<p>Project sponsor and archeological consultant shall notify the San Francisco Medical Examiner and if applicable, Native American Heritage Commission who will appoint a Most Likely Descendant. Project sponsor, ERO, and the Most Likely Descendant shall make all reasonable efforts to develop a burial agreement.</p>	<p>Upon discovery of human remains and as required by PRC 5097.98</p>	<p>Archeological consultant and project sponsor to report discovery and notification of ME to ERO</p>	<p>Considered complete on completion of burial agreement and/or analysis and/or legal disposition of the remains and associated funerary materials.</p>

1587

MITIGATION MONITORING AND REPORTING PROGRAM FOR THE 301 MISSION STREET PERIMETER PILE UPGRADE PROJECT

Measures Adopted as Conditions of Approval	Implementation Responsibility	Mitigation Schedule	Monitoring/Reporting Responsibility	Monitoring Actions/Schedule and Verification of Compliance
<p>recommendations of the MLD. However, if the ERO, project sponsor and MLD are unable to reach an Agreement on scientific treatment of the remains and associated or unassociated funerary objects, the ERO, with cooperation of the project sponsor, shall ensure that the remains and/or mortuary materials are stored securely and respectfully until they can be reinterred on the property, with appropriate dignity, in a location not subject to further or future subsurface disturbance.</p> <p>Treatment of historic-period human remains and of associated or unassociated funerary objects discovered during any soil-disturbing activity, additionally, shall follow protocols laid out in the project's archeological treatment documents, and in any related agreement established between the project sponsor, Medical Examiner and the ERO.</p> <p><i>Final Archeological Resources Report.</i> The archeological consultant shall submit a Draft Final Archeological Resources Report (FARR) to the ERO that evaluates the historical significance of any discovered archeological resource and describes the archeological and historical research methods employed in the archeological testing/monitoring/data recovery program(s) undertaken. The Draft FARR shall also include an Interpretation Plan for public interpretation of all significant archeological features.</p> <p>Once approved by the ERO, copies of the FARR shall be distributed as follows: California Historical Resources Information Center Northwest Information Center (NWIC) shall receive one (1) copy and the ERO shall receive a copy of the transmittal of the FARR to the NWIC. The Environmental Planning division of the Planning Department shall receive one bound, one unbound and one unlocked, searchable PDF copy on CD of the FARR along with copies of any formal site recordation forms (CA DPR 523 series) and/or documentation for nomination to the National Register of Historic Places/California Register of Historical Resources. In instances of high public interest in or the high interpretive value of the resource, the ERO may require a different final report content, format, and distribution than that presented above.</p>	<p>Project sponsor and archaeological consultant in consultation with the ERO if the project results in archeological discoveries.</p>	<p>After completion of archeological testing, monitoring, data recovery, analysis and interpretation, as applicable.</p>	<p>If applicable, archeological consultant to submit a FARR to ERO for approval; distribute FARR and provide written certification of distribution to ERO</p>	<p>Considered complete upon approval of FARR by ERO and distribution of FARR as directed by ERO.</p>
<b>Tribal Cultural Resources Mitigation Measure</b>				
<p><b>Mitigation Measure M-TC-1: Tribal Cultural Resources Interpretive Program.</b></p> <p>If the Environmental Review Officer (ERO) determines that a significant archeological resource is present, and if in consultation with the affiliated Native American tribal representatives, the ERO determines that the resource constitutes a tribal cultural resource and that the resource could be adversely affected by the proposed project, the proposed project shall be redesigned so as to avoid any adverse effect on the significant tribal cultural resource, if feasible.</p>	<p>Project sponsor, tribal representative and ERO to consult on feasibility of preservation in place.</p>	<p>Prior to further soil disturbing activities that could affect the resource</p>	<p>Archeological consultant shall contact the ERO and appropriate Native American tribe representative upon discovery of an archeological resource that may constitute a tribal cultural resource.</p>	<p>Upon agreement between ERO and project sponsor that preservation plan shall be prepared and implemented.</p>
<p>If the ERO determines that preservation-in-place of the tribal cultural resource is both feasible and effective, then the archeological consultant shall prepare an archeological resource preservation plan (ARPP). Implementation of the approved ARPP by the project sponsor and the archeological consultant shall be required when feasible.</p>	<p>Project sponsor and archeological consultant</p>	<p>Preservation Plan to be prepared on agreement that preservation in place is feasible and implemented prior to further activities that could affect the resources</p>	<p>Project sponsor and archeological consultant in consultation with the ERO</p>	<p>Archeological consultant submits preservation plan; ERO reviews and approves; project sponsor verifies to ERO that plan has been implemented.</p>
<p>If the ERO, in consultation with the affiliated Native American tribal representatives and the project sponsor, determines that preservation-in-place of the tribal cultural resources is not a sufficient or feasible option, the project sponsor shall implement an interpretive program of the tribal cultural resource in consultation with affiliated tribal representatives. An interpretive plan produced in consultation with the ERO and affiliated tribal representatives, at a minimum, and approved by the ERO would be required to guide the interpretive program. The plan shall identify, as appropriate, proposed locations for installations or displays, the proposed content and materials of those displays or installation, the producers or artists of the displays or installation, and a long-term maintenance program. The interpretive program may include artist installations, preferably by local Native American artists, oral histories with local Native Americans, artifacts displays and interpretation, and educational panels or other informational displays.</p>	<p>Project sponsor in consultation with the ERO and tribal representatives.</p>	<p>Prior to issuance of final certificate of occupancy.</p>	<p>The ERO to approve final interpretive program.</p>	<p>Considered complete upon installation of approved interpretive program, if required. Project sponsor to provide verification to ERO that approved interpretation program has been implemented</p>
<b>Noise Mitigation Measures</b>				
<p><b>Mitigation Measure M-NO-1a: General Construction Noise Control Measures.</b></p> <p>To ensure that project noise from construction activities is minimized to the maximum extent feasible, the project sponsor shall undertake the following:</p> <ul style="list-style-type: none"> <li>The project sponsor shall require the general contractor to ensure that equipment and trucks used for project construction utilize the best available noise control techniques (e.g., improved mufflers, equipment redesign, use of intake silencers, ducts, engine enclosures and acoustically-attenuating shields or shrouds, wherever feasible).</li> <li>The project sponsor shall require the general contractor to locate stationary noise sources (such as compressors) as far from adjacent or nearby sensitive receptors as possible, to muffle such noise sources, and to construct barriers around such sources and/or the</li> </ul>	<p>Project sponsor and contractor shall prepare a construction noise management plan</p>	<p>Draft construction noise management plan to be submitted to Planning Department and DBI prior to issuance of the first permit.</p>	<p>Prior to the issuance of any building permit, San Francisco Department of Building Inspection and Planning Department shall review and approve Construction Noise Management Plan. Project sponsor, qualified consultant, and/or construction</p>	<p>Considered complete at the completion of construction and submittal of final noise monitoring reports for all construction stages.</p>

1588

MITIGATION MONITORING AND REPORTING PROGRAM FOR THE 301 MISSION STREET PERIMETER PILE UPGRADE PROJECT

Measures Adopted as Conditions of Approval	Implementation Responsibility	Mitigation Schedule	Monitoring/Reporting Responsibility	Monitoring Actions/Schedule and Verification of Compliance
<p>construction site, which could reduce construction noise by as much as 5 dBA. To further reduce noise, the contractor shall locate stationary equipment in pit areas or excavated areas, if feasible.</p> <ul style="list-style-type: none"> <li>The project sponsor shall require the general contractor to use impact tools (e.g., jack hammers, pavement breakers, and rock drills) that are hydraulically or electrically powered wherever possible to avoid noise associated with compressed air exhaust from pneumatically powered tools. Where use of pneumatic tools is unavoidable, an exhaust muffler on the compressed air exhaust shall be used, along with external noise jackets on the tools, which could reduce noise levels by as much as 10 dBA.</li> <li>The project sponsor shall include noise control requirements in specifications provided to construction contractors. Such requirements could include, but not be limited to, performing all work in a manner that minimizes noise to the extent feasible; use of equipment with effective mufflers; undertaking the most noisy activities during times of least disturbance to surrounding residents and occupants, as feasible; and selecting haul routes that avoid residential buildings inasmuch as such routes are otherwise feasible.</li> <li>Prior to the issuance of the building permit, the project sponsor shall submit to the planning department and Department of Building Inspection (building department) a Construction Noise Management Plan identifying all measures to be implemented and identifying a contact person and phone number to respond to and track complaints pertaining to construction noise. These measures shall include (1) a procedure and phone numbers for notifying the building department, the Department of Public Health (health department), and the Police Department (during regular construction hours and off-hours); (2) a sign posted on-site describing noise complaint procedures and a complaint hotline number that shall be answered at all times during construction; (3) designation of an on-site construction complaint and enforcement manager for the project; and (4) notification of neighboring residents and non-residential building managers within 300 feet of the project construction area at least 30 days in advance of commencement of construction activities.</li> <li>The general contractor or other designated person(s) shall prepare a weekly noise monitoring log report that shall be made available to the planning department upon request. The log shall include any noise complaints received, whether in connection with an exceedance or not, as well as any noise complaints received through calls to 311 or DBI if the contractor is made aware of them (for example, via a building department notice, inspection, or investigation). Any weekly report that includes an exceedance or for a period during which a complaint is received shall be submitted to the planning department within three business days following the week in which the exceedance or complaint occurred. A report shall be submitted to the planning department at the completion of construction. The report shall document noise levels, exceedances of standards, if reported, and corrective action(s) taken.</li> </ul>			<p>contractor(s) to prepare a weekly noise monitoring log which shall be made available to the Planning Department when requested. Any weekly report that includes an exceedance or for a period during which a complaint is received shall be submitted to the development performance coordinator within 3 business days following the week in which the exceedance or complaint occurred.</p> <p>Project sponsor, qualified consultant, and/or construction contractor(s) to submit final noise monitoring report to the Planning Department development performance coordinator at the completion of each construction stage.</p>	
<p><b>Mitigation Measure M-NO-1b: Noise Reduction Techniques for Equipment Used in Nighttime Delivery Activity.</b></p> <p>The project sponsor shall notify the Planning Department Development Performance Coordinator of any night noise permit application filed with the Department of Building Inspection on the day of filing and any emergency/unanticipated activity with the potential to exceed standard as soon as possible. The project sponsor shall implement all of the following noise reduction techniques to reduce nighttime construction delivery noise during Stages 3 and 4:</p> <ul style="list-style-type: none"> <li>The crane used for nighttime deliveries shall be directionally positioned such that the exhaust faces away from the building at 301 Mission Street. This measure would be expected to reduce noise levels by 2 to 3 dBA.</li> <li>Provide acoustically-rated shielding around crane engine. This measure would be expected to reduce noise levels by 5 to 12 dBA depending on the proximity of shielding to the crane engine.</li> <li>The crane shall be operated in ECO silent mode during nighttime hours. This measure would be expected to reduce noise levels by 3 to 5 dBA.</li> <li>Forklifts shall employ self-adjusting directional backup alarms. Such alarms constantly measure the background noise and can reduce their sound level by 20 dBA or more.</li> </ul>	Project sponsor and contractor	During nighttime delivery activity in Stages 3 and 4 of construction	Planning Department and project contractor.	Considered complete at the completion of construction and submittal of final noise monitoring reports.
<p><b>Mitigation Measure M-NO-2: Limited Use of Vibratory Rollers.</b></p> <p>The project sponsor shall require that the contractors use non vibratory excavator mounted compaction wheels and small, smooth drum rollers for final compaction of any asphalt base and asphalt concrete. If needed to meet compaction requirements, smaller vibratory rollers shall be used to minimize vibration levels during repaving activities where needed to meet vibration standards.</p>	Project sponsor and contractor	During construction	San Francisco Department of Building Inspection (DBI)	Considered complete at the completion of construction and submittal of final noise monitoring reports.
<b>Air Quality Mitigation Measure</b>				
<p><b>Mitigation Measure M-AQ-1: Construction Air Quality.</b></p> <p>The project sponsor or contractor shall provide the Planning Department with a certification statement that the sponsor or contractor agrees to fully comply with the following requirements which shall be included in contract specifications:</p> <ul style="list-style-type: none"> <li>All construction equipment shall be maintained and properly tuned in accordance with the manufacturer's specifications. All equipment shall be checked by a certified mechanic and determined to be running in proper condition prior to operation.</li> <li>Idling times shall be minimized either by shutting equipment off when not in use or reducing the maximum idling time to two minutes.</li> <li>The project construction contractor shall not use diesel generators for construction purposes where feasible alternative sources of power are available.</li> <li>All construction equipment, diesel trucks, and generators shall be equipped with Best Available Control Technology for emission</li> </ul>	Project sponsor and contractor	Implement during construction activities	Planning Department Environmental Review Officer (ERO).	Considered complete upon Planning Department review and approval of documentation and completion of construction.

1589

MITIGATION MONITORING AND REPORTING PROGRAM FOR THE 301 MISSION STREET PERIMETER PILE UPGRADE PROJECT

Measures Adopted as Conditions of Approval	Implementation Responsibility	Mitigation Schedule	Monitoring/Reporting Responsibility	Monitoring Actions/Schedule and Verification of Compliance
<p>reductions of NOx and Particulate Matter, including Tier 4 Interim or Final or alternative fuel engines where such equipment is available and feasible for use.</p> <ul style="list-style-type: none"> <li>- The following equipment shall have Tier 4 final engines: air compressors, bore/drill rigs, compactor, concrete pump, crawler tractors, excavator, generator sets/power pack, pavers, rollers, rough terrain forklifts, rubber tired loaders, skid steer loaders, and track drill.</li> <li>- The following equipment shall have Tier 4 Interim or final engines: backhoes.</li> <li>- The following equipment shall have Tier 1 or newer engines: truck mount drills.</li> </ul> <p>• Should any deviations in the construction equipment list or tier levels be required, the project sponsor shall present documentation to the satisfaction of the ERO that any such deviation would not result in an exceedance of the average daily NOx significance threshold or any health risk threshold.</p>				
<b>Biological Resource Mitigation Measure</b>				
<p><b>Mitigation Measure M-BI-2: Preconstruction Nesting Bird Surveys and Buffer Areas</b></p> <p>Nesting birds and their nests shall be protected during construction by implementation of the following measures for each construction phase:</p> <ol style="list-style-type: none"> <li>a. To the extent feasible, conduct initial activities including, but not limited to, vegetation removal, tree trimming or removal, ground disturbance, building demolition, site grading, and other construction activities which may compromise breeding birds or the success of their nests outside of the nesting season (January 15 through August 15).</li> <li>b. If construction during the bird nesting season cannot be fully avoided, a qualified wildlife biologist* shall conduct pre-construction nesting surveys within 14 days prior to the start of construction or demolition at areas that have not been previously disturbed by project activities or after any construction breaks of 14 days or more. Surveys shall be performed for suitable habitat within 250 feet of the project site in order to locate any active nests of common bird species and within 500 feet of the project site to locate any active raptor (birds of prey) nests.</li> <li>c. If active nests are located during the preconstruction nesting bird surveys, a qualified biologist shall evaluate if the schedule of construction activities could affect the active nests and if so, the following measures would apply:                     <ol style="list-style-type: none"> <li>i. If construction is not likely to affect the active nest, construction may proceed without restriction; however, a qualified biologist shall regularly monitor the nest at a frequency determined appropriate for the surrounding construction activity to confirm there is no adverse effect. Spot-check monitoring frequency would be determined on a nest-by-nest basis considering the particular construction activity, duration, proximity to the nest, and physical barriers which may screen activity from the nest. The qualified biologist may revise his/her determination at any time during the nesting season in coordination with the Planning Department.</li> <li>ii. If it is determined that construction may affect the active nest, the qualified biologist shall establish a no-disturbance buffer around the nest(s) and all project work shall halt within the buffer until a qualified biologist determines the nest is no longer in use. Typically, these buffer distances are 250 feet for passerines and 500 feet for raptors; however, the buffers may be adjusted if an obstruction, such as a building, is within line-of-sight between the nest and construction.</li> <li>iii. Modifying nest buffer distances, allowing certain construction activities within the buffer, and/or modifying construction methods in proximity to active nests shall be done at the discretion of the qualified biologist and in coordination with the Planning Department, who would notify CDFW. Necessary actions to remove or relocate an active nest(s) shall be coordinated with the Planning Department and approved by CDFW.</li> <li>iv. Any work that must occur within established no-disturbance buffers around active nests shall be monitored by a qualified biologist. If adverse effects in response to project work within the buffer are observed and could compromise the nest, work within the no disturbance buffer(s) shall halt until the nest occupants have fledged.</li> <li>v. Any birds that begin nesting within the project area and survey buffers amid construction activities are assumed to be habituated to construction-related or similar noise and disturbance levels, so exclusion zones around nests may be reduced or eliminated in these cases as determined by the qualified biologist in coordination with the Planning Department, who would notify CDFW. Work may proceed around these active nests as long as the nests and their occupants are not directly impacted.</li> </ol> </li> <li>d. In the event inactive nests are observed within or adjacent to the project site at any time throughout the year, any removal or relocation of the inactive nests shall be at the discretion of the qualified biologist in coordination with the Planning Department, who would notify and seek approval from the CDFW, as appropriate. Work may proceed around these inactive nests.</li> </ol> <p>* Typical experience requirements for a "qualified biologist" include a minimum of four years of academic training and professional experience in biological sciences and related resource management activities, and a minimum of two years of experience conducting surveys for each species that may be present within the project area.</p>	<p>Project sponsor and construction contractor</p>	<p>Implement during construction activities</p>	<p>Planning Department Environmental Review Officer (ERO).</p>	<p>Considered complete upon Planning Department review and approval of documentation and completion of construction.</p>
<b>Geology and Soils Mitigation Measures</b>				
<p><b>Mitigation Measure GE-4a: Project Paleontologist</b></p> <p>The project sponsor or its contractor shall retain a qualified professional paleontologist (qualified paleontologist) prior to the approval of</p>	<p>Project sponsor to retain qualified professional paleontologist.</p>	<p>Prior to approval of demolition or grading permits.</p>	<p>ERO to approve selection of professional paleontologist.</p>	<p>Considered complete when project sponsor retains a</p>

1590

MITIGATION MONITORING AND REPORTING PROGRAM FOR THE 301 MISSION STREET PERIMETER PILE UPGRADE PROJECT

Measures Adopted as Conditions of Approval	Implementation Responsibility	Mitigation Schedule	Monitoring/Reporting Responsibility	Monitoring Actions/Schedule and Verification of Compliance
<p>demolition or grading permits. The qualified paleontologist shall attend the project kick-off meeting and project progress meetings on an as-needed basis, shall report to the project site for drilling activities associated with installation of the outer casings for the perimeter piles that are anticipated to return Colma Sands or Old Bay Clay materials, and shall implement the duties outlined in Mitigation Measures M-GE-4b through M-GE-4d.</p>				<p>qualified professional paleontologist.</p>
<p><b>Mitigation Measure GE-4b: Worker Training</b>                      Prior to the start of ground-disturbing activity related to the installation of the outer casings for the perimeter piles, which is anticipated to return Colma Sands or Old Bay Clay materials, the qualified paleontologist shall prepare paleontological resources sensitivity training materials for use during Project-wide Worker Environmental Awareness Training (or equivalent). The paleontological resources sensitivity training shall be conducted by a qualified environmental trainer working under the supervision of the qualified paleontologist. In the event construction crews are phased, additional trainings shall be conducted for new construction personnel. The training session shall focus on the recognition of the types of paleontological resources that could be encountered within the project site and the procedures to be followed if they are found, as outlined in the approved Paleontological Resources Monitoring and Mitigation Plan in Mitigation Measure M-GE-4c. The project sponsor and/or its contractor shall retain documentation demonstrating that all construction personnel attended the training prior to the start of work on the site, and shall provide the documentation to the City Planning Department Project Manager upon request.</p>	<p>Paleontologist to conduct training.</p>	<p>Prior to any excavation, site preparation or geotechnical drilling.</p>	<p>ERO to verify that training has been conducted.</p>	<p>Considered complete after qualified professional paleontologist conducts training.</p>
<p><b>Mitigation Measure M-GE-4c: Paleontological Monitoring</b>                      The qualified paleontologist shall prepare, and the project sponsor and/or its contractors shall implement, a Paleontological Resources Monitoring and Mitigation Plan (PRMMP). The project sponsor shall submit the plan to the planning department for review and approval at least 30 days prior to the start of construction. This plan shall address specifics of monitoring and mitigation and comply with the City requirements, as follows.</p> <ul style="list-style-type: none"> <li>• The qualified paleontologist shall identify, and the project sponsor or its contractor(s) shall retain, qualified paleontological resource monitors (qualified monitors).</li> <li>• The qualified paleontologist and/or the qualified monitors under the direction of the qualified paleontologist shall conduct full-time paleontological resources monitoring of the installation of the 36-inch-diameter outer casings for all ground-disturbing activities anticipated to return Colma Sands or Old Bay Clay materials.</li> <li>• Monitors shall have the authority to temporarily halt or divert work away from exposed fossils in order to evaluate and recover the fossil specimens.</li> <li>• If construction or other project personnel discover any potential paleontological resources during construction, regardless of the depth of work or location and regardless of whether the site is being monitored, work at the discovery location shall cease until the qualified paleontologist, project sponsor, and ERO shall meet and consult on the appropriate course of action at the 36-inch-diameter outer casing locations, based on the nature of the recovered paleontological resource and the judgment of the qualified paleontologist, reasonably provided prior to continuing with the installation of outer casings. The qualified paleontologist shall determine the significance of any paleontological resources discovered, and shall determine the appropriate treatment for significant paleontological resources in accordance with City standards. Whether or not a significant paleontological resource has been encountered, the qualified paleontologist shall assess the discovery, make recommendations as to the appropriate treatment, and submit a written report of the findings of the monitoring program to the ERO. Mitigation Measure M-GE-4d regarding significant fossil treatment is described further below.</li> <li>• Monitors shall prepare daily logs detailing the types of activities and soils observed, and any discoveries. The qualified paleontologist shall prepare a final monitoring and mitigation report to document the results of the monitoring effort and any curation of fossils. The project sponsor shall provide the daily logs to the City Planning Department upon request, and shall provide the final report to the City Planning Department upon completion.</li> </ul>	<p>Paleontologist to prepare in consultation with ERO.</p>	<p>Prior to any excavation, site preparation or geotechnical drilling, submit PRMMP to the ERO for approval.</p>	<p>ERO to review and approve PRMMP.</p>	<p>Considered complete upon ERO approval of PRMMP.</p>
<p><b>Mitigation Measure M-GE-4d: Significant Fossil Treatment</b>                      If any find is deemed significant following the process outlined in Mitigation Measure M-GE-4c, the qualified paleontologist shall salvage and prepare the fossil for permanent curation with a certified repository with retrievable storage.</p>	<p>Project sponsor and paleontologist in consultation with the ERO.</p>	<p>Upon discovery of fossil.</p>	<p>ERO to verify recovery of fossil.</p>	<p>Considered complete when fossil has been salvaged and prepared for curation.</p>

1591

IMPROVEMENT MEASURES FOR THE 301 MISSION STREET PERIMETER PILE UPGRADE PROJECT

	Implementation Responsibility	Mitigation Schedule	Monitoring/Reporting Responsibility	Monitoring Actions/Schedule and Verification of Compliance
<i>Geology &amp; Soils Improvement Measure</i>				
Improvement Measure I-GE-1: Sponsor Reimbursement for Engineering Design Review Team Review of Construction and Post-Construction Monitoring Data. The project sponsor should cooperate with the Department of Building Inspection (building department) in its engagement of the Engineering Design Review Team (peer review team) convened during review and evaluation of the monitoring data collected for the project during and post construction. The project sponsor should reimburse the building department for the costs of the monitoring data review and evaluation by the peer review team.	Department of Building Inspection (building department) to invoice the project sponsor for reimbursement of the cost for each of the Engineering Design Review Team's (peer review team's) review and evaluation of the construction and post-construction monitoring data for the project. The project sponsor shall pay the invoice within 60 days of receipt of the peer review team's findings for a particular review and the invoice for such review from the building department.	For the duration of the 10-year monitoring program.	Department of Building Inspection to invoice project sponsor for the cost of each of the peer review team's review and evaluation of construction and post-construction monitoring data and project sponsor to provide timely reimbursement to the city.	Considered complete upon payment by the project sponsor to the Department of Building Inspection Director or designee of the final invoice for the final data review letter from the peer review team with its findings at the conclusion of the post-construction monitoring program.





# SAN FRANCISCO PLANNING DEPARTMENT

## Mitigated Negative Declaration

1650 Mission St.  
Suite 400  
San Francisco,  
CA 94103-2479

Reception:  
415.558.6378

Fax:  
415.558.6409

Planning  
Information:  
415.558.6377

*Date:* November 20, 2019; amended on December 27, 2019 (amendments to the PMND are shown as deletions in ~~strikethrough~~; additions in double underline)

*Case No.:* 2018-016691ENV

*Project Title:* 301 Mission Street, Millennium Tower Perimeter Pile Upgrade Project

*BPA Nos.:* 201812047402, 201812077819, and 201812077828

*Zoning:* C-3-O(SD) – Downtown-Office (Special Development) Zoning District  
Transit Center C-3-O(SD) Commercial Special Use District  
Transbay C-3 Special Use District  
450-S and 700-S-2 Height and Bulk Districts

*Associated*

*Block/Lots:* 3719 / Lots 020–440

*Associated*

*Lot Size:* 50,500 square feet (1.16 acres)

*Project Sponsor:* James Abrams – 415.999.4402, on behalf of the Millennium Tower Homeowners Association  
jabrams@jabramslaw.com

*Lead Agency:* San Francisco Planning Department

*Staff Contact:* Kei Zushi – 415.575.9038  
CPC.301missionCEQA@sfgov.org

### PROJECT DESCRIPTION

The proposed project is associated with the 50,500-square-foot (1.16-acre) parcel (Assessor's Block 3719, Lots 020–440) at 301 Mission Street located on the south side of Mission Street between Fremont and Beale streets within San Francisco's Financial District. The existing high-rise on the 301 Mission Street parcel is called the Millennium Tower. The project site includes portions of the public right-of-way on Fremont, Beale, and Mission streets adjacent to the 301 Mission Street parcel as well as limited portions of the 301 Mission Street parcel itself as described in more detail below. It is on the block bounded by Mission Street to the north, Fremont Street to the west, Beale Street to the east, and the Transit Center to the south. The area of soil disturbance associated with the project would be located primarily in the public right-of-way.

Assessor's Block 3719; Lots 020–440 are occupied by two buildings constructed as part of a single development project beginning in 2006 and completed in 2009. The multiple lots on the parcel reflect that the dwelling units are condominium units. The development project's environment impacts were analyzed in an Environmental Impact Report (EIR), San Francisco Planning Department (planning department) Case No. 2001.0792E. As constructed, the parcel includes: (1) the 58-story, 645-foot-tall Millennium Tower (Tower building) on the western portion of the 301 Mission Street parcel; and (2) a 12-story, 125-foot-tall midrise structure and atrium (collectively called the Podium building) on the eastern portion of the site.

The Tower and Podium buildings include approximately 551,000 square feet of residential space (419 dwelling units), 9,400 square feet of ground level retail/commercial space (bank and restaurant), and 24,365 square feet of open space, including an approximately 2,961-square-foot privately owned, publicly accessible atrium open space on the ground floor of the Podium building. A total of 339 parking spaces are provided in four basement levels under the Podium building. There is one level under the Tower building, which is used for maintenance and management office and storage.

The Tower building covers a footprint of approximately 32,960 square feet and its foundation system consists of a 10-foot-thick reinforced concrete mat foundation that is supported by 942, 14-inch-square precast pre-stressed concrete piles. The piles were driven through the two uppermost soil layers (artificial fill underlain by Young Bay Mud) and extend approximately 75 to 85 feet below ground surface (bgs) to the Colma Sands soil layer. The existing piles do not extend to the Franciscan Complex bedrock that underlies the site at varying depths ranging from approximately 220 to 250 feet bgs. In accordance with information that the project sponsor has provided, since completion of the Tower in 2009, the project site has experienced differential settlement due to consolidation and compression of the soil layer beneath the Colma Sands, which is known as Old Bay Clay. At its lowest point, the existing mat foundation has settled approximately 17.6 inches near the northwest corner of the Tower building, such that the top of the building tilts approximately 17.1 inches to the northwest near the corner of Mission and Fremont streets. The building has been assessed and determined to be structurally sound.<sup>1</sup>

The project site, where construction activities and staging for the proposed improvements would occur, consists of an approximately 13,900 sf area within the existing Mission, Beale, and Fremont streets public right-of-way, including sidewalks and sub-sidewalks, vehicular lanes, and parking, adjacent to the Tower and Podium buildings. The proposed project consists of a structural upgrade of the Tower building foundation that includes installation of a structural extension of the existing mat foundation for the Tower building along its north and west sides, supported by 52 new piles extending to bedrock (the project sponsor refers to the new piles as "perimeter piles"). This extended mat foundation is also referred to as "the collar foundation." In addition to preventing further settlement in the northwest corner of the Tower's existing foundation, the project sponsor's geotechnical engineer has stated that this effort may allow for gradual tilt correction of the Tower building over time. The structural upgrade would involve the installation of 52 cast-in-place reinforced concrete piles beneath the sidewalk areas, within an approximately 8-foot-wide zone along the Mission (north) and Fremont (west) street sides of the Tower building. Each of the piles would have a diameter of 36 inches (outer casings) through the Young Bay Mud and Colma Sands to a depth of approximately 70 to 90 feet, a diameter of 24 inches (shaft liners) to the Franciscan Complex bedrock at approximately 220 to 250 feet bgs, and a diameter of 20 inches (rock sockets) by 30- to 50-foot-long extension into the bedrock. Once pile placement is complete, an 8-foot-wide, 10-foot-thick reinforced concrete extension of the existing concrete mat foundation would be constructed outward in the direction of the new piles. Once completed, the area of the mat extension that would connect to the new piles would total approximately 2,130 square feet. The new piles would be connected to the extended mat via a jack system that would transfer load from the existing foundation to the new piles.<sup>2</sup>

<sup>1</sup> Simpson Gumpertz & Heger, *301 Mission St Perimeter Pile Upgrade Calculations Vols 2 - Gravity and 3 - Lateral- Revision 5*, June 7, 2019.

<sup>2</sup> All actual soils/bedrock depths would be confirmed in the field.

During the site preparation and mobilization stage, and prior to excavation and construction, implementation of an indicator pile beneath the sidewalk near the corner of Fremont and Mission streets near the northwest corner of the Tower building would be required. The purpose of the indicator pile is to assess the geological strength of the bedrock underneath the Tower building and to determine the required depth of extension of the piles into the rock to achieve design strength.

Approximately 4,380 cubic yards of soil under the affected sidewalk areas would be excavated in order to perform the pile installation: 1,880 cubic yards would be excavated to depths of approximately 5 to 25 feet bgs for the extended mat foundation; and 2,500 cubic yards would be excavated to depths of 300 feet bgs for the outer casings, shaft liners, and rock sockets installation. Approximately 400 cubic yards of construction debris would be generated from the sidewalk demolition along Fremont and Mission streets. Approximately 1,000 cubic yards of soil/fill would be imported in Stage 6.

The total duration for construction is anticipated to be 22 months. Construction activities would be staged along the perimeter of Fremont, Mission, and Beale streets, requiring the closure of one travel lane and sidewalks along Fremont and Mission streets and restricting pedestrian access on the sidewalk along Beale Street during portions of the construction period. The existing bank at the northwest corner of the Tower's ground floor would vacate the northwestern corner of floor space it currently occupies, and modify portions of the space to accommodate a smaller bank operation during construction. The existing restaurant on the northeast corner of the Tower building would remain open during construction. Approximately 4-foot-wide pedestrian walkways with overhead and side protection would be provided along a portion of the site's Mission Street frontage and the entirety of the Beale Street frontage to maintain access to the Tower and Podium buildings and allow a through path of travel for pedestrians along Beale Street. There would be no pedestrian access along the Fremont and Mission streets sides of the Tower building during the entirety of construction, because the structural upgrade construction activities would occur in the sidewalk area.

As specified in the design drawings, the Engineer of Record has proposed a system of monitoring the mat settlement, pile forces, and building movement during jacking of the new piles and continuing for 10 years after completion of construction. Components of the monitoring program are summarized in Section A, Project Description in the initial study checklist.

A project-specific construction transportation management plan would be implemented as part of the project, and is summarized in Section A, Project Description in the initial study checklist and the detailed transportation plan is included as Appendix A to the initial study. The transportation management plan would address temporary, construction period changes to circulation in and around the project site. Potential impacts resulting from project construction on existing and future Muni transit service routes in the project area are analyzed as part of the environmental review.

## FINDING

This project could not have a significant effect on the environment. This finding is based upon the criteria of the Guidelines of the State Secretary for Resources, sections 15064 (Determining Significant Effect), 15065 (Mandatory Findings of Significance), and 15070 (Decision to Prepare a Negative Declaration), and the

Finding

following reasons as documented in the initial study for the project, which is attached. Mitigation measures are included in this project to avoid potentially significant effects. See page 169.

In the independent judgment of the Planning Department, there is no substantial evidence that the project could have a significant effect on the environment.



12-27-2019

fov

Lisa Gibson  
Environmental Review Officer

Date of Adoption of Final Mitigated  
Negative Declaration

cc: James Abrams, on behalf of Project Sponsor Millennium Tower Homeowners Association  
Commenter  
Supervisor Matt Haney, District 6  
Erica Major, Clerk of the Board  
Byron Rhett, Port of San Francisco  
Gary Ho, Department of Building Inspection  
Debra Lutske, San Francisco Public Works  
Reid Boggiano, State Lands Commission  
Claudine Asbagh, Current Planning Division, Planning Department  
Paolo Ikezoe, Citywide Division, Planning Department

## Initial Study Table of Contents

### 301 Mission Street Millennium Tower Perimeter Pile Upgrade Project

	<u>Page</u>
A. Project Description .....	1
B. Project Setting.....	38
C. Compatibility with Existing Zoning and Plans.....	41
D. Summary of Environmental Effects .....	44
E. Evaluation of Environmental Effects .....	44
1. Land Use and Planning.....	44
2. Aesthetics.....	46
3. Population and Housing.....	48
4. Cultural Resources.....	50
5. Tribal Cultural Resources.....	61
6. Transportation and Circulation.....	63
7. Noise.....	91
8. Air Quality.....	106
9. Greenhouse Gas Emissions.....	122
10. Wind.....	124
11. Shadow.....	125
12. Recreation.....	125
13. Utilities and Service Systems.....	126
14. Public Services.....	129
15. Biological Resources.....	131
16. Geology and Soils.....	135
17. Hydrology and Water Quality.....	154
18. Hazards and Hazardous Materials.....	158
19. Mineral Resources.....	165
20. Energy.....	165
21. Agriculture and Forestry Resources.....	167
22. Wildfire.....	168
23. Mandatory Findings of Significance.....	168
F. Mitigation Measures and Improvement Measures.....	169
G1. Public Notice and Comment.....	179
G2. <u>Notification of Intent to Adopt A Mitigated Negative Declaration</u> .....	179
H. Determination .....	181
I. Initial Study Preparers .....	182

**APPENDICES**

Appendix A:	Construction Transportation Management Plan
Appendix B:	Transportation Technical Appendix
	Attachment B.1: Existing and Baseline Roadway Geometry
	Attachment B.2: Vehicle Turning Movement, Pedestrian, and Loading Counts
	Attachment B.3: Existing and Baseline Volumes Summary
	Attachment B.4: Project Volumes Summary
	Attachment B.5: Auto Turn Analysis

**FIGURES**

Figure 1	Project Location .....	2
Figure 2	Project Site Existing Conditions .....	4
Figure 3	Existing Project Site and Subsurface Profile .....	7
Figure 4	Current and Proposed Foundation System (Looking Southeast) .....	9
Figure 5	Proposed Piles and Mat Extension – Plan View .....	10
Figure 6	Stage 1: Site Preparation and Construction Work Area .....	14
Figure 7	Stage 1: Mobilization and Indicator Pile .....	17
Figure 8	Stage 2: Demolition and Shoring .....	18
Figure 9	Stage 2: Demolition and Shoring (Section View) .....	19
Figure 10	Stage 3: Installation of Outer Casings on Mission and Fremont Streets, Piles on Fremont Street .....	21
Figure 11	Stages 3 and 4: Backfill and Perimeter Pile Installation (Section View) .....	22
Figure 12	Stages 3 and 4: Jet Grout Plug Installation (Section View) .....	24
Figure 13	Stage 4: Piles on Mission Street and Construction of Mat Slab Extension on Fremont Street .....	25
Figure 14	Stage 4: Excavation (Section View) .....	26
Figure 15	Stages 4 and 5: Mat Slab Extension (Section View) .....	27
Figure 16	Stage 5: Mat Slab Extension on Mission Street .....	29
Figure 17	Stage 6: Jacking, Vault Construction, Backfill, and Site Restoration .....	30
Figure 18	Stage 6: Mat Slab Extension, Jack Pile System, and Vault (Section View) .....	31
Figure 19	Cumulative Projects .....	40
Figure 20	Transportation Study Area and Study Intersections .....	66
Figure 21	Existing Walking Network .....	67
Figure 22	Existing Bicycling Network .....	69
Figure 23	Existing Transit Service .....	70
Figure 24	Construction Truck Routes .....	77
Figure 25	Construction Staging during Stages 1 through 5 .....	78
Figure 26	Construction Staging during Stage 6 .....	79

**TABLES**

Table 1	Approximate Construction Schedule and Work Force .....	11
Table 2	Construction Equipment .....	11
Table 3	Truck Load Estimates .....	12
Table 4	Summary of Transportation Management Strategies .....	34
Table 5	Existing Transit Volumes .....	71

Table 6	Vehicular Volumes under Baseline Condition.....	73
Table 7	Pedestrian Volumes under Baseline Condition.....	74
Table 8	Transit Volumes under Baseline Condition.....	75
Table 9	Vehicular Volumes under Project Condition.....	80
Table 10	Pedestrian Volumes under Project Condition.....	80
Table 11	Transit Service under Project Condition.....	81
Table 12	Construction Travel Demand by Stage.....	82
Table 13	Transit Service under Cumulative Condition.....	89
Table 14	Summary of Long-Term and Short-Term Ambient Noise Level Data on the Project Site and Vicinity.....	93
Table 15	Caltrans Vibration Damage Potential Threshold Criteria.....	96
Table 16	Caltrans Vibration Annoyance Potential Criteria.....	96
Table 17	Maximum Noise Levels from Construction Equipment.....	97
Table 18	Daytime Noise Levels from Indicator Pile, Piles on Fremont, and Piles on Mission Construction (Stages 1, 3, and 4).....	99
Table 19	Nighttime Noise Levels from Stage 3 and 4 Overnight Deliveries.....	101
Table 20	Vibration Levels from Construction Equipment.....	104
Table 21	Construction Criteria Air Pollutants Significance Thresholds.....	107
Table 22	Health Risk Significance Thresholds.....	112
Table 23	Average Daily Project Construction Emissions.....	115
Table 24	Lifetime Cancer Risk and PM <sub>2.5</sub> Concentration at the Maximally Exposed Individual Sensitive Receptors.....	119

[THIS PAGE INTENTIONALLY BLANK]



## ACRONYMS AND ABBREVIATIONS

Acronym/ Abbreviation	Definition
$\mu\text{g}/\text{m}^3$	Microgram per cubic meter
AC Transit	Alameda-Contra Costa Transit
ADA	Americans with Disabilities Act
ADRP	archeological data recovery plan
AERMOD	American Meteorological Society/Environmental Protection Agency regulatory air dispersion model
ATP	archeological testing plan
AMP	archeological monitoring program
ARPP	archeological resource preservation plan
ASC	Anthropological Studies Center
AWSS	Auxiliary Water Supply System
BART	Bay Area Rapid Transit
bgs	below ground surface
Cal/EPA	California Environmental Protection Agency
Cal/OSHA	State of California Division of Occupational Safety and Health
CAM	California Administrative Manual
CalEEMod	California Emissions Estimator Model
CEQA	California Environmental Quality Act
CFGC	California Fish and Game Code
CFR	Code of Federal Regulations
classification system	Potential Fossil Yield Classification system
CMP	Congestion Management Program
CO	carbon monoxide
Cr6	hexavalent chromium
CWTR	Construction Worker Trip Reduction
EIR	environmental impact report
ERO	Environmental Review Officer
ESL	environmental screening level
FARR	Final Archeological Resources Report
FTA	Federal Transit Administration
g	g-force
GHG	greenhouse gases
HRA	health risk assessment
MBTA	Migratory Bird Treaty Act
MLD	Most Likely Descendant
MRZ	Mineral Resource Zone
MTHA	Millennium Tower Homeowner's Association
MTS	Metropolitan Transportation System
Muni	San Francisco Municipal Railway

Acronym/ Abbreviation	Definition
NESHAP	National Emissions Standards for Hazardous Air Pollutants
NO <sub>2</sub>	nitrogen dioxide
NO <sub>x</sub>	oxides of nitrogen
NPDES	National Pollutant Discharge Elimination System
NWIC	Northwest Information Center
OEHHA	Office of Environmental Health Hazard Assessment's
OSHA	Occupational Safety and Health Administration
PCB	polychlorinated biphenyls
PAH	polyaromatic hydrocarbons
PAR	preliminary archeological review
peer review team	Engineering Design Review Team
PM <sub>2.5</sub>	particulate matter less than 2.5 microns in diameter
PM <sub>10</sub>	particulate matter less than 10 microns in diameter
PNA	polynuclear aromatics
PPV	peak particle velocity
QAACL	Qualified Archeological Consultants List
ROG	reactive organic gases
SamTrans	San Mateo County Transit
SD	Special Development
SFMTA	City and County of San Francisco Municipal Transportation Agency
SFPUC	San Francisco Public Utilities Commission
SO <sub>2</sub>	sulfur dioxide
SVOC	semivolatile organic compounds
TACs	toxic air contaminants
TNC	transportation network company
TPH-d	Total petroleum hydrocarbons as diesel
TPH-g	Total petroleum hydrocarbons as gasoline
TPH-mo	Total petroleum hydrocarbons as motor oil
USEPA	United States Environmental Protection Agency
VOC	volatile organic compounds

## GLOSSARY

**Auxiliary Water Supply System (AWSS):** the AWSS is a high pressure fire protection water supply system independent from the city's municipal potable water system built for exclusive use by the San Francisco Fire Department

**Baker tank:** a steel tank that stores turbid water for the purpose of retention and settlement

**Class 2 bikeways:** bike lanes striped within the paved areas of roadways and established for the preferential use of bicycles

**Class 3 bikeways:** signed bike routes that allow bicycles to share travel lanes with vehicles, and often marked with shared lane markings called sharrows

**Conex:** a shipping container that is used for storing tools and other supplies

**fire department water connections:** the water connections are located on the exterior of a building and are where the fire department can pump supplemental water into the building's sprinkler system, standpipe, or other system, furnishing water for fire extinguishment to supplement existing water supplies

**g, or g-force:** the acceleration due to Earth's gravity

**geofencing:** Transportation Network Companies implement geofencing to direct drivers and passengers to pick-up and drop-off zones or blackout certain areas to prohibit loading activities

**jet grout plug:** a soil-cement mixture intended to seal the bottom of the excavation to minimize flow of water into the excavation during construction

**k-rails:** concrete barriers placed around a construction site

**lithic debitage:** stone tool fragments

**Leq:** the equivalent steady state sound level that in a stated period of time would contain the same acoustical energy

**Lmax:** the maximum sound level measured during the measurement period

**loading dock levelers:** loading docks equipped to level to the height of the truck being loaded/unloaded

**manifold control:** the manifold (a pipe that branches into several openings) connects to the hydraulic power source and branches to each of the piles; the control system involves a series of valves that enable branches to be opened or closed to control pressure to the individual jacks

**outer casings:** the 36-inch-diameter outer casings would be installed as a first step in the pile installation process to provide separation between the 24-inch-diameter pile that would ultimately carry the Tower building's weight to bedrock and the surrounding soils in the upper 70 to 90 feet

**pre-stressed concrete piles:** the most common variety of driven concrete pile. Pre-stressing simply means that they are pre-loaded through the use of internal bonded strands in a way that makes them more robust, in order to sustain the hammering experienced during of the driving process

**prisms:** reflective elements attached to the building, at which surveyors can aim their lasers, in order to accurately measure a location in three dimensions

**rock socket:** bottom portion of the pile that is socketed into the bedrock

**shaft liners:** pile casings that extend the full depth to the bedrock and fabricated with friction-reducing coating along its full length

**sheet refuse:** a layer or scatter of artifacts deposited on the surface (rather than a hollow filled feature such as a privy pit or well)

**soldier pile:** a common retaining wall strategy in which H-shaped steel beams (“piles”) are installed into the earth at regular intervals—usually 6 to 12 feet apart to brace excavation shoring

# Initial Study

## 301 Mission Street Millennium Tower Perimeter Pile Upgrade Planning Department Case No. 2018-016691ENV

### A. PROJECT DESCRIPTION

#### A.1 Project Location and Site Characteristics

The proposed project is associated with the 50,500-square-foot (1.16-acre) site (Assessor's Block 3719, Lots 020–440) at 301 Mission Street (also known as the Millennium Tower or Tower building) located on the south side of Mission Street between Fremont and Beale streets within San Francisco's Financial District. The project site and staging areas include approximately 13,860 square feet of the public right-of-way on Fremont, Beale, and Mission streets adjacent to the parcel as well as limited portions of the 301 Mission Street parcel, where the existing mat foundation below the Tower building would be extended to connect to the new piles for the foundation upgrade. Once constructed, the area of the mat extension where the mat connects to the new piles would total 2,130 square feet. The project site is on the block bounded by Mission Street to the north, Fremont Street to the west, Beale Street to the east, and the Transit Center<sup>3</sup> to the south (**Figure 1, Project Location**). The associated 301 Mission Street parcel is located within a C-3-O(SD) (Downtown–Office (Special Development) zoning district, Transit Center C-3-O(SD) Commercial Special Use District, Transbay C-3 Special Use District, and 450-S and 700-S-2 height and bulk districts.<sup>4</sup> The project consists of a structural upgrade of the Tower building foundation that includes installation of a structural extension of the existing mat foundation for the Tower building along its north and west sides, supported by 52 new piles extending to bedrock (the project sponsor refers to the new piles as "perimeter piles"). This structure is also referred to as "the collar foundation." Construction activities would primarily be conducted within the public right-of-way (sidewalk and roadway).

Assessor's Block 3719, Lots 020–440 are occupied by two buildings constructed as part of a single development project beginning in 2006 and completed in 2009. The multiple lots on the parcel reflect that the dwelling units are condominium units. The environmental impacts of the Millennium Tower development project were analyzed in an EIR, Planning Department Case No. 2001.0792E. As constructed, the parcel includes: (1) the 58-story, 645-foot-tall Tower building on the western portion of the 301 Mission Street parcel; and (2) a 12-story, 125-foot-tall Podium building on the eastern portion of the parcel. The Tower and Podium buildings include 551,000 square feet of residential space (419 dwelling units), 9,400 square feet of ground-level retail/commercial space (bank and restaurant), and 24,365 square feet of open space, including an approximately 2,960-square-foot privately owned, publicly accessible atrium open space on the ground floor of the Podium building. A total of 339 parking spaces are provided in four basement levels under the Podium building. There is one level under the Tower building, which is used for maintenance and management office and storage.

<sup>3</sup> The Salesforce Transit Center (Transit Center) replaced the Transbay Terminal located on Mission Street between Fremont and First streets, providing access to regional and local transit services. Information on the Transit Center is available at <https://www.sfmta.com/projects/salesforce-transit-center>.

<sup>4</sup> Typically zoning district designations do not apply to the public right-of-way.

1606

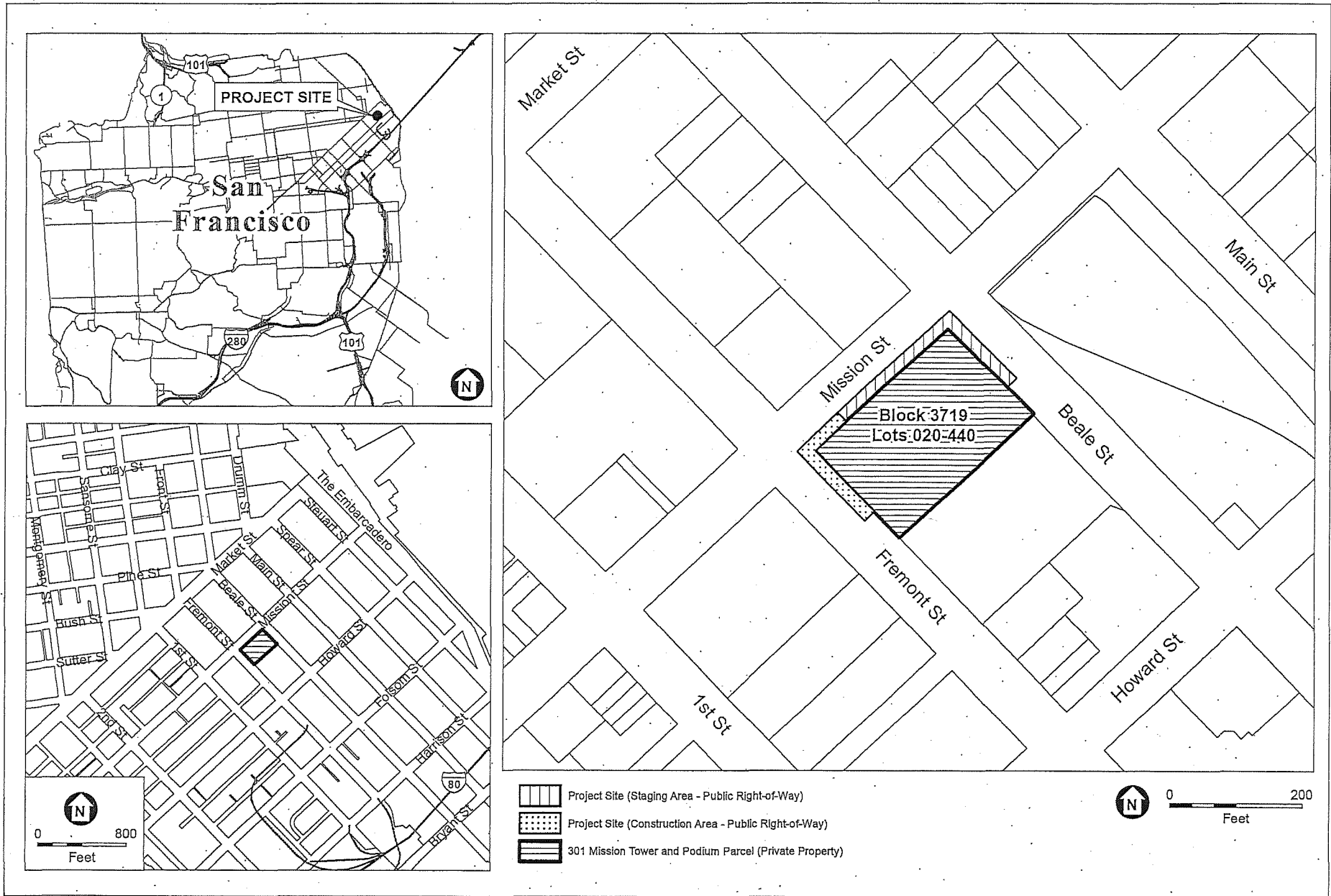

SOURCE: ESA, 2019; San Francisco Planning Department

2018-016691ENV: 301 Mission Street Perimeter Pile Upgrade Project

Figure 1  
Project Location

The Tower and Podium buildings include approximately 275 feet of frontage on Mission Street, and approximately 185 feet of frontage on Fremont and Beale streets. The project site is primarily adjacent to the parcel occupied by the Tower and Podium buildings and includes an approximately 13,900-sf area within the existing Mission, Beale, and Fremont streets public right-of-way, including sidewalks and sub-sidewalks, vehicular lanes, and parking.

## A.2 Existing Circulation, Loading, and Parking

Direct vehicular ingress/egress to the project site is provided via curb cuts and driveways from Fremont Street at the southwest corner of the site and from Beale Street at the southeast corner of the site (see Figure 2, Project Site Existing Conditions). The driveways are 30 feet wide and 27 feet wide on Fremont and Beale streets, respectively, and both connect to an internal two-way, drive-through (porte cochere) running the length of the south side of the site. The porte cochere serves the residential lobbies from the south side of the site, including off-street passenger loading. A ramp entrance to the parking garage is located centrally off of the porte cochere and leads down to the subsurface levels. A total of 339 parking spaces are provided in four basement levels under the Podium building. In addition, there are three off-street loading docks at the southeast corner of the Podium building: two are equipped with loading dock levelers<sup>5</sup> and may be reserved in 4-hour increments on weekdays only; and the third is used for faster drop off items such as food delivery, mail, and package delivery.

As stated, the project construction activities would occur within the public right-of-way. Therefore, the existing conditions for the right-of-way are presented here.

Mission Street is an east-west street on the north side of the project site with two lanes in each travel direction. The outermost travel lanes are bus-only lanes. Fremont street is a north-south street that operates one-way (northbound) within the vicinity of the project site with two through lanes and a left-turn lane and a right-turn lane at the Mission Street intersection. Beale Street is a north-south street that operates one way (southbound) with three through lanes within the vicinity of the project site.

An approximately 170-foot-long on-street passenger loading/unloading zone and 20-foot-long on-street commercial loading/unloading zone are located immediately adjacent to the Podium building frontage on Mission Street. There are no vehicle curb cuts along the Mission Street frontage. There is no on-street parking on Fremont and Beale streets adjacent to the associated parcel. There are no existing bicycle facilities on Fremont, Mission, or Beale streets.

There are multiple transit services provided in the immediate project vicinity. The following San Francisco Municipal Railway (Muni) bus routes travel along the Fremont, Mission, and Beale street frontages of the 301 Mission Street parcel: the 5 Fulton, 5R Fulton Rapid, 7 Haight/Noriega, 38 Geary, and 38R Geary Rapid (outbound). The following additional Muni bus routes travel along Mission Street adjacent to the project: 14 Mission, 14X Mission, 14R Mission Rapid, and 2 Sutter/Clement (inbound). Additional Muni bus routes that travel along the Beale Street side of the project frontage include: 30X Marina Express, 41 Union, 81X Caltrain Express, and 82X Levi Plaza (inbound).

<sup>5</sup> Loading dock is equipped to level to the height of the truck being loaded/unloaded.

1608

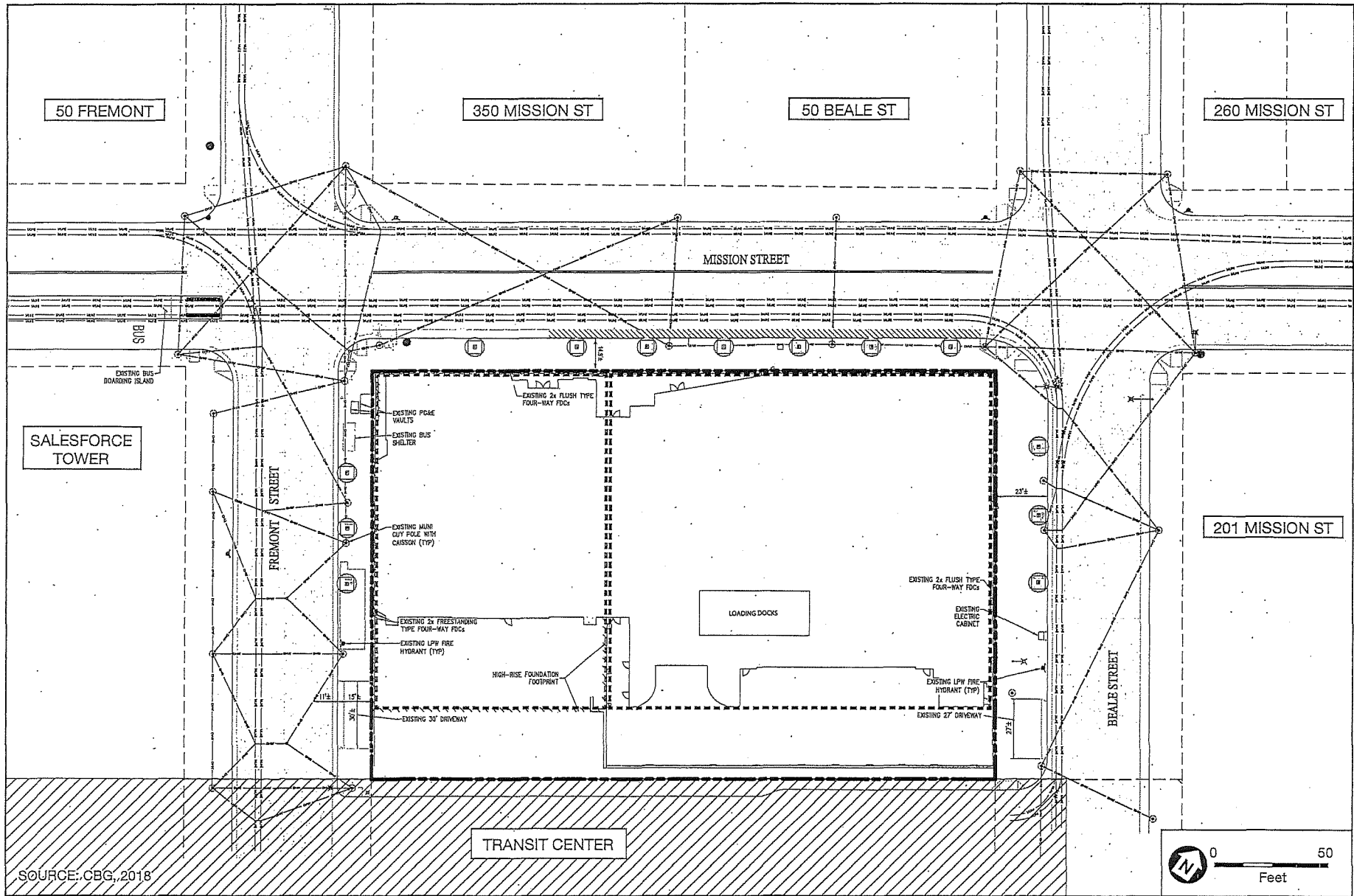

- |                                     |   |                           |
|-------------------------------------|---|---------------------------|
| □ Existing Electric Box/Vault       | ⊙ Existing MUNI OCS Guy Pole with Caisson | ▨ Commercial Loading Zone |
| ▲ Existing LPW Fire Hydrant         | — Existing MUNI Overhead Cable System     | ▩ Passenger Loading Zone  |
| ● Existing AWSS Fire Hydrant        | — Existing MUNI Overhead Guy Wires        |                           |
| ⊗ Existing Street Light/Signal Pole | — Property Boundary                       |                           |
| ⊕ Existing Tree Well                | — Tower                                   |                           |
|                                     | — Podium                                  |                           |

2018-016691ENV: 301 Mission Street Perimeter Pile Upgrade Project

Figure 2  
Project Site Existing Conditions



In addition to Muni operations, the following regional transit services operate within San Francisco and are accessible from the project site via Muni or other modes of travel: Bay Area Rapid Transit (BART), Golden Gate Transit, Alameda-Contra Costa County Transit District (AC Transit), and San Mateo County Transit District (SamTrans). The Embarcadero BART station is located approximately a quarter mile from the project site. The Golden Gate Transit buses that travel along the Fremont, Mission, and Beale street frontages of the 301 Mission Street parcel are Routes 30, 70, 101, and 101X with stops along Mission Street, and on Fremont Street near the southeast corner of Fremont and Mission streets.

AC Transit operates out of the Transit Center but does not travel along any of the roadways adjacent to the 301 Mission Street parcel. SamTrans routes serving Downtown San Francisco include route 292 with stops along Mission Street.

Overhead wires for Muni trolley coach service are supported by guy poles located within the sidewalks adjacent to the Tower and Podium buildings. As shown in Figure 2, there are a total of eleven poles along the project parcel frontages, including four overhead wire-support poles each on the Mission and Fremont streets sidewalks, and three support poles on the Beale Street sidewalk along the project frontage.

The sidewalks adjacent to the site parcel are 15 feet wide along Fremont and Mission streets, and 23 feet wide along Beale Street. Pedestrian access to the existing ground-floor bank in the Tower building is from Mission Street near the Fremont Street intersection. Pedestrian access to the existing restaurant is from Mission Street through the Podium building. Pedestrian access to the residences in the Tower and Podium buildings are available from the porte cochere and Mission and Beale streets.

### A.3 Existing Infrastructure and Landscaping

On the sidewalks immediately adjacent to the project parcel, there are a total of three fire hydrants: one Auxiliary Water Supply System<sup>6</sup> (AWSS) high pressure fire hydrant at the Fremont and Mission streets intersection; and two low-pressure fire hydrants, one each on Fremont and Beale streets near the project site's driveways (see Figure 2). The AWSS fire hydrant was located at the Fremont and Mission streets intersection prior to the construction of the Tower and Podium buildings.<sup>7</sup> Two existing PG&E vaults are also located under the Fremont Street sidewalk near the Mission Street intersection. The project site is served by water, sanitary sewer, stormwater, electric, and natural gas lines from lines under the adjacent streets.

There are a total of 13 existing street trees along the project parcel frontages, including three existing street trees along Fremont Street, seven street trees along Mission Street, and three street trees along Beale Street.

### A.4 Project Background and Subsurface Characteristics

The project sponsor, Millennium Tower Homeowner's Association (MTHA), submitted three building permit applications (Permit Nos. 201812047402, 201812077819, and 201812077828) to the City and County of San Francisco's (city) Department of Building Inspection (building department) on December 4, 2018

<sup>6</sup> The AWSS is a high pressure fire protection water supply system independent from the city's municipal potable water system built for exclusive use by the San Francisco Fire Department.

<sup>7</sup> Roosevelt, Nick, Associate Attorney, J. Abrams Law, P.C., e-mail correspondence with Kei Zushi, Senior Planner, San Francisco Planning Department, April 16, 2019.

and December 7, 2018, for a proposed structural upgrade of the Tower building. As described in detail below, MTHA's general purpose for its proposed project is to address the settling and tilting of the Millennium Tower. The existing building has been evaluated and determined to be structurally sound.<sup>8</sup> The proposed project is designed to meet the requirements of section 403.9, Voluntary Seismic Improvements, of the San Francisco Existing Building Code, with the intent to reduce future building settlement on the associated parcel at 301 Mission Street.<sup>9</sup>

As described above, construction of the buildings on the 301 Mission Street parcel was completed in 2009. The Tower building covers a footprint of approximately 32,960 square feet with 100 feet of frontage on Mission Street and approximately 150 feet of frontage on Fremont Street. The subsurface conditions on the Tower building portion of the lot consist of approximately 220 to 250 feet of various soil types overlying the Franciscan Complex bedrock (see Figure 3, Existing Project Site and Subsurface Profile). Figure 3 is for illustrative purposes only as there is variation in the depths of soil types and depth to bedrock across the project site. The artificial fill ranges from approximately 15 to 25 feet bgs. The fill is underlain by 20 to 30 feet of a soft to medium-stiff marine clay deposit known locally as Young Bay Mud, to depths between 35 and 55 feet bgs. The Young Bay Mud is generally underlain by a zone of stiff to very stiff sandy clay interbedded with medium-dense to dense clayey sand, known locally as Colma Sands, to depths of approximately 45 to 90 feet bgs, followed by a stiff to very stiff marine clay deposit, known locally as Old Bay Clay, which is approximately 120 to 160 feet thick. In some locations, interbedded layers of sand and clays, known as the Alameda formation, occur at depths of 150 to 200 feet bgs. Finally, bedrock at the site, known locally as Franciscan Complex, underlies the Old Bay Clay unit beginning at depths ranging from about 220 to 250 feet bgs.

The existing foundation system of the Tower building consists of a 10-foot-thick reinforced concrete mat foundation that is connected to and supported by 942 14-inch-square precast pre-stressed<sup>10</sup> concrete piles. The piles were driven through the two uppermost soil layers (artificial fill underlain by Young Bay Mud) and extend approximately 75 to 85 feet bgs to the Colma Sands soil layer. The piles do not extend to the Franciscan Complex bedrock. At the completion of the 10-foot-thick concrete mat foundation construction of the Tower building in 2006, the mat was monitored for vertical displacements during erection of the Tower building and construction of the adjacent Podium building.<sup>11</sup> Since April 2009, 32 settlement markers across the Tower building's footprint have been monitored, and an additional 30 settlement markers were installed in December 2016.<sup>12</sup> The north and east sides of the Tower building have also been monitored for

<sup>8</sup> Simpson Gumpertz & Heger, *301 Mission St Perimeter Pile Upgrade Calculations Vols 2 - Gravity and 3 - Lateral- Revision 5*, June 7, 2019.

<sup>9</sup> Engineering Design Review Team, letter to Tom C. Hui, S.E., C.B.O., Director and Chief Building Official, City and County of San Francisco Department of Building Inspection, August 27, 2019. This document (and all other documents cited in this report, unless otherwise noted) are available for review at the San Francisco Planning Department, 1650 Mission Street, Suite 400, as part of Case File No. 2018-016691ENV. Documents may also be accessed through the planning department's Property Information Map, planning application 2018-016691ENV, related records.

<sup>10</sup> Pre-stressed concrete piles are the most common variety of driven concrete pile. Pre-stressing simply means that they are pre-loaded through the use of internal bonded strands in a way that makes them more robust, in order to sustain the hammering experienced during of the driving process.

<sup>11</sup> John A. Egan, PE, *Geotechnical Evaluation for the Perimeter Pile Upgrade - Revision 1, Millennium Tower, City and County of San Francisco, California*, August 13, 2019, with the assistance of Slate Geotechnical Consultants.

<sup>12</sup> Ibid.

1611

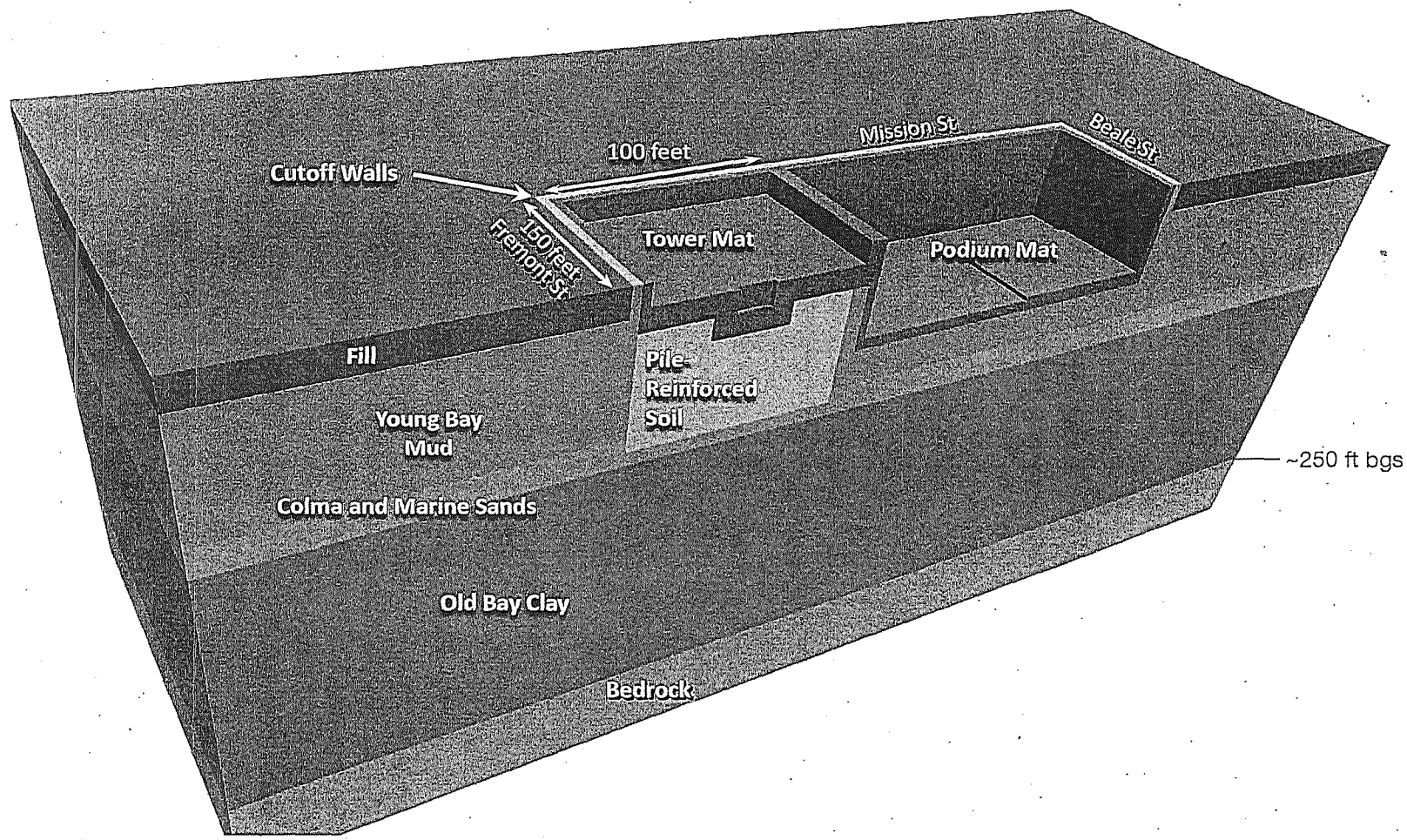

Note: Not to scale. Intended for illustrative purposes only

SOURCE: Shannon & Wilson Inc., 2018

2018-016691ENV: 301 Mission Street Perimeter Pile Upgrade Project

**Figure 3**  
Existing Project Site and Subsurface Profile

lateral deformation at floors 2, 5, 10, 20, 40, and 60 by using prisms<sup>13</sup> mounted on the exterior of the structure.<sup>14</sup> In accordance with information that the project sponsor has provided, since completion of the Tower building in 2009, the project site has experienced settlement due to consolidation and compression of the soil layer beneath the Colma Sands, which is known as Old Bay Clay. At its lowest point, the existing mat foundation has settled approximately 17.6 inches near the northwest corner of the Tower building, such that the top of the building tilts approximately 17.1 inches to the northwest near the corner of Mission and Fremont streets.<sup>15</sup>

## A.5 Proposed Project

The proposed project consists of a structural upgrade of the Tower building foundation, which includes installation of an extension of the existing mat foundation along the north and west sides of the Tower building, supported by 52 new perimeter piles extending to bedrock which is located at approximately 220 – 250 feet bgs. This structure is also referred to as “the collar foundation.” In addition to preventing further settlement in the northwest corner of the Tower building’s existing foundation, the project sponsor’s geotechnical engineer has stated that this effort may allow for gradual tilt correction of the Tower building over time. The structural upgrade would involve the installation of 52 cast-in-place reinforced concrete piles beneath the sidewalk areas within an approximately 8-foot-wide zone along the Mission (north) and Fremont (west) Street sides of the Tower building (see **Figure 4, Current and Proposed Foundation System (Looking Southeast)**, and **Figure 5, Proposed Piles and Mat Extension – Plan View**). Once pile placement is complete, an 8-foot-wide, 10-foot-thick reinforced concrete extension of the existing concrete mat foundation would be constructed outward in the direction of the new piles. The new piles would be connected to the extended mat via a jack system that would transfer load from the existing foundation to the new piles. The jack system would be located in new vaults, one along Fremont Street and the other along Mission Street, located approximately 8 feet below the sidewalk. Once constructed, the area below the sidewalk where the mat extension and new piles would be located would total approximately 2,130 square feet (see Figure 5).

The project would be implemented in six stages, Stages 1 through 6. **Table 1, Approximate Construction Schedule and Work Force**, shows the estimated construction schedule and duration by stage. Project construction would last about 22 months, and is expected to commence in early 2020. With the exception of Stages 3 and 4, construction activities at the project site would occur Monday through Friday from 7 a.m. to 8 p.m., consistent with the San Francisco Noise Ordinance. Stages 3 and 4 would require an extra shift (8 p.m. to 7 a.m. as allowed in San Francisco) to receive oversized truck deliveries for approximately five nights per week. Construction could also occur on Saturdays and Sundays (7 a.m. to 8 p.m.) when the project sponsor determines such construction is necessary. Construction on holidays is not anticipated to occur.

<sup>13</sup> Prisms are reflective elements attached to the building, at which surveyors can aim their lasers, in order to accurately measure a location in three dimensions.

<sup>14</sup> John A. Egan, PE, *Geotechnical Evaluation for the Perimeter Pile Upgrade – Revision 1, Millennium Tower, City and County of San Francisco, California*, August 13, 2019, with the assistance of Slate Geotechnical Consultants.

<sup>15</sup> Ibid.

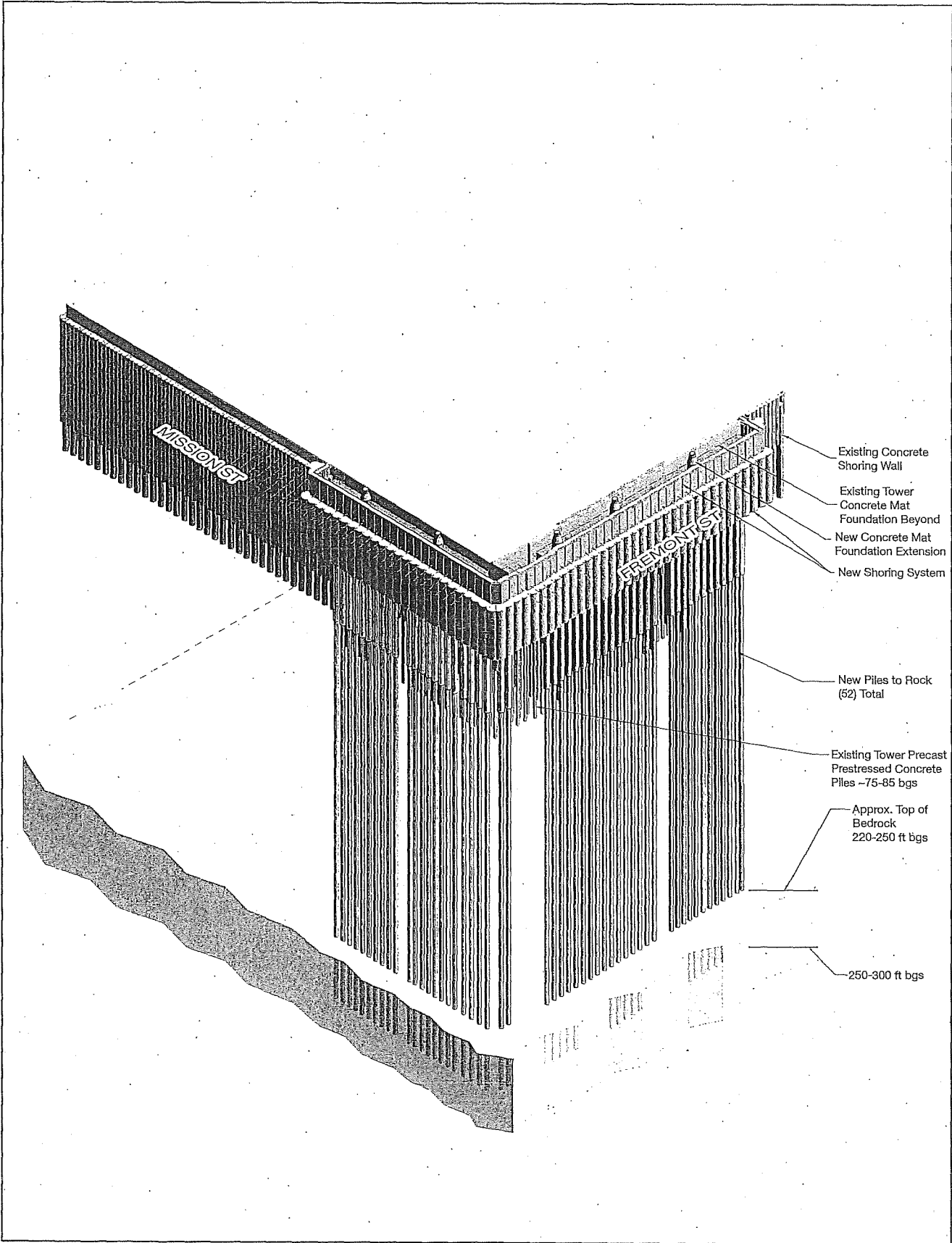

SOURCE: Simpson Gumpertz & Heger, 2019

2018-016691ENV: 301 Mission Street Perimeter Pile Upgrade Project

**Figure 4**  
 Current and Proposed Foundation System  
 (Looking Southeast)

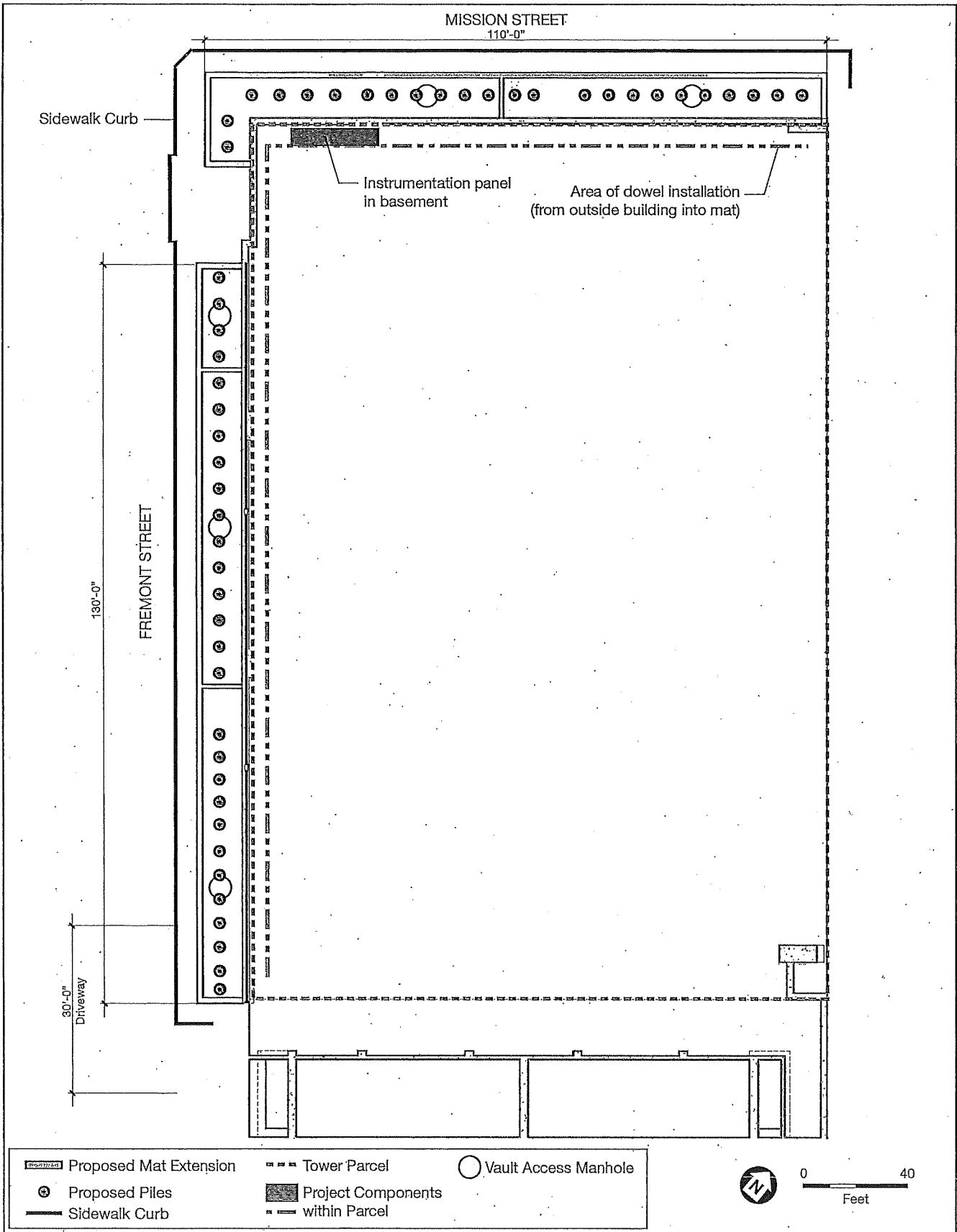

SOURCE: Simpson Gumpertz & Heger, 2019; Modified by ESA

2018-016691ENV: 301 Mission Street Perimeter Pile Upgrade Project

**Figure 5**  
Proposed Piles and Mat Extension - Plan View

**TABLE 1  
APPROXIMATE CONSTRUCTION SCHEDULE AND WORK FORCE**

Construction Stage and Activity	Start (Calendar Days)	Finish (Calendar Days)	Duration (Days/Week)	Number of Workers (Daily Avg.)
1. Site Preparation, Mobilization, and Indicator Pile	Day 1	Day 90	5	9
2. Demolition and Shoring	Day 90	Day 150	5	9
3. Installation of Outer Casings on Mission and Fremont Streets, Piles on Fremont Street	Day 150	Day 310	5	19 <sup>a</sup>
4. Piles on Mission Street and Mat Slab Extension on Fremont Street	Day 310	Day 420	5	30 <sup>b</sup>
5. Mat Slab Extension on Mission Street	Day 420	Day 510	5	9
6. Jacking, Vault Construction, Backfill, and Site Restoration	Day 510	Day 640	5	13
<b>Total Construction</b>	<b>22 months</b>			

## NOTES:

<sup>a</sup> Stage 3 would require two shifts: 9 workers on one shift, and 10 workers for the second.

<sup>b</sup> Stage 4 would require two shifts: 20 workers on one shift, and 10 workers for the second.

SOURCE: Millennium Tower Homeowner's Association, 2019.

### Work Force

As shown in Table 1, the size of the construction work force would vary over the 22-month construction period, ranging from approximately 9 to 30 workers depending on the stage. The work force would peak at 30 in Stage 4, when the perimeter piles are installed on Mission Street concurrent with the mat slab extension on Fremont Street.

### Construction Equipment and Hauling

Table 2, *Construction Equipment*, lists the types of equipment that would be used during construction.

**TABLE 2  
CONSTRUCTION EQUIPMENT**

Air Compressor	Excavator	Roller	Roller
Backhoe	Generator Sets/Power Pack	Rough Terrain Forklift	Rough Terrain Forklift
Bore/Drill Rig	Haul Truck	Rubber Tire Loader	Concrete Pump
Compactor	Paver	Signal Board	Concrete Truck
Crawler Tractor	Paving Equipment	Skid Steer Loader	

SOURCE: Millennium Tower Homeowner's Association, 2019.

Table 3, *Truck Load Estimates*, provides estimates of import/export of demolition and fill and truck loads to and from the project site. Stage 2 would include demolition of about 4,400 square feet of sidewalk within the construction area. The most extensive disturbance in terms of area, approximately 8,000 square feet, would occur as part of the excavation under Stages 3 and 4. The depths of excavation would range from 5 to 300 feet below the existing grade depending on the construction stage, with a total of 4,380 cubic yards of excavated soils generated during construction. The depths of excavation for the piles would range from 220 to 300 feet bgs. During construction approximately 1,910 cubic yards would be excavated in Stage 3, 1,610 cubic yards of soil would be excavated in Stage 4, and 860 cubic yards excavated in Stage 5. Stage 6 would include

demolition of about 1,400 square feet of sidewalk along the Podium building frontage. The sidewalk demolition under Stages 2 and 6 would generate approximately 400 cubic yards of demolition debris. In total, construction of the proposed project would require the removal of approximately 4,780 cubic yards of soil and construction debris. Approximately 1,000 cubic yards of soil/fill would be imported in Stage 6.

**TABLE 3  
TRUCK LOAD ESTIMATES**

Construction Stage and Activity	Deliveries (Loads)	Import (cubic yards)	Export (cubic yards)	Total Truck Loads
1. Site Preparation, Mobilization, and Indicator Pile	Ready Mix Concrete (61) <sup>a</sup> Drill Casing (30) <sup>b</sup> Drilled Shaft Rebar (3) <sup>c</sup> Equipment (5) <sup>d</sup> Supplier Deliveries (8) <sup>e</sup>			107 (material deliveries)
2. Demolition and Shoring	Ready Mix Concrete (61) <sup>a</sup> Equipment (5) <sup>d</sup> Supplier Deliveries (8) <sup>e</sup>		340	349 (fill export) 74 (material deliveries)
3. Installation of Outer Casings on Mission and Fremont Streets, Piles on Fremont Street	Ready Mix Concrete (61) <sup>a</sup> Drill Casing (30) <sup>b</sup> Drilled Shaft Rebar (3) <sup>c</sup> Equipment (5) <sup>d</sup> Supplier Deliveries (8) <sup>e</sup>		1,910	1919 (fill export) 107 (material deliveries)
4. Piles on Mission Street and Mat Slab Extension on Fremont Street	Ready Mix Concrete (61) <sup>a</sup> Drill Casing (30) <sup>b</sup> Drilled Shaft Rebar (3) <sup>c</sup> Equipment (5) <sup>d</sup> Supplier Deliveries (8) <sup>e</sup> Rebar (8) <sup>f</sup>		1,610	1619 (fill export) 115 (material deliveries)
5. Mat Slab Extension on Mission Street	Ready Mix Concrete (61) <sup>a</sup> Equipment (5) <sup>d</sup> Supplier Deliveries (8) <sup>e</sup> Rebar (8) <sup>f</sup>		860	869 (fill export) 82 (material deliveries)
6. Jacking, Vault Construction, Backfill, and Site Restoration	Ready Mix Concrete (61) <sup>a</sup> Equipment (5) <sup>d</sup> Supplier Deliveries (8) <sup>e</sup>	1,000	60	69 (fill export) 1009 (fill import) 74 (material deliveries)
<b>Total Construction</b>		<b>1,000</b>	<b>4,780</b>	<b>1,137</b>

## NOTES:

- a Approximately 365 loads of ready mix concrete would be delivered throughout all stages. This assumes 61 loads per stage. Numbers may not total due to rounding.
- b Approximately 90 loads of drill casing deliveries would occur in Stages 1, 3, and 4. This assumes 30 loads for each of these stages
- c Approximately 10 loads of drilled shaft rebar would occur in Stages 1, 3, and 4. This assumes 3 loads for each of these stages. Numbers may not total due to rounding.
- d Approximately 30 loads of equipment would be delivered throughout all stages. This assumes 5 loads per stage.
- e Approximately 50 loads of miscellaneous supplier deliveries would occur throughout all stages. This assumes 8 loads per stage.
- f Approximately 15 loads of rebar would be delivered in Stages 4 and 5. This assumes 8 loads per stage. Numbers may not total due to rounding.
- g Assumes a truck capacity of 10 cubic yards.

SOURCE: Millennium Tower Homeowner's Association, 2019.

### Stage 1: Site Preparation, Mobilization, and Indicator Pile

Stage 1 construction activities would last approximately 90 days and include site preparation, mobilization, the drilling of seven geotechnical borings, and implementation of an indicator pile beneath the sidewalk near the corner of Fremont and Mission streets near the northwest corner of the Tower building. The purpose of the indicator pile is to assess the geological strength of the bedrock underneath the Tower



building and determine the required depth of extension of the piles into the rock to achieve design strength. It is anticipated that the bedrock strength varies somewhat across the upgrade area. The seven geotechnical borings would provide information on the actual strength of the rock in the area of upgrade, to allow adjustment of the required length of rock socket for each pile before it is placed. After the geotechnical borings are drilled and the rock properties measured, strings of piezometer and extensometer instruments would be inserted into three of the borings to enable future monitoring of the foundation's performance.

Construction of the project would require the temporary closure of the right-turn lane on Fremont Street as it approaches Mission Street and the sidewalk along the east side of Fremont Street; the eastbound bus-only lane and sidewalk along the south side of Mission Street; and would restrict pedestrian access on the sidewalk along the west side of Beale Street to an approximately 4-foot-wide through lane, which are summarized below. Before construction can commence, the contractor would prepare the construction site to allow for staging, truck and equipment access, protection or relocation of utilities, and installation of protected pedestrian pathways (see Figure 6, Stage 1: Site Preparation and Construction Work Area). Concrete barriers (also commonly referred to as "k-rails") would be placed along the outer side of the closed lanes on Fremont and Mission streets, and along the outer edge of the sidewalk on Beale Street (see Figure 6). All construction activities would be contained inside the concrete barriers and fences. Temporary closures and changes that would affect the following public rights-of-way include:

- **Fremont Street.** Fremont Street would have one left-turn lane, one through lane, and one through and right-turn shared lane in the northbound direction. The concrete barriers and fences would be installed approximately 11 feet west of the Fremont Street east sidewalk between the northern edge of the Tower building driveway and Mission Street. This change would require a temporary closure of four elements within the public right-of-way for the entire duration of project construction from Stages 1 through 6. Those four elements would be: (1) the northbound exclusive right-turn lane approaching Mission Street, (2) the Fremont Street east sidewalk along the Tower building frontage, (3) the nearside Golden Gate Transit bus stop near the southeast corner of the Fremont Street/Mission Street intersection, and (4) south and east crosswalks at the Fremont Street/Mission Street intersection. Muni guy poles currently installed in the sidewalk (and associated overhead electric trolley wires) would be temporarily relocated in alignment with the k-rail approximately 11 feet westward of the Fremont Street east sidewalk.
- **Mission Street.** Mission Street would have two eastbound lanes and one westbound lane. Concrete barriers and fences would be installed approximately 11.6 feet north of the Mission Street existing south sidewalk between Fremont and Beale streets. This change would require a temporary closure of two elements within the public right-of-way for the entire duration of project construction from Stages 1 through 6. Those two elements would be: (1) the eastbound bus-only lane and (2) the western half of the Mission Street south sidewalk. As part of the proposed project, the existing 170-foot-long passenger loading/unloading zone and 20-foot-long commercial loading zone located adjacent to the Podium building frontage on Mission Street would be closed during construction. An approximately 4-foot-wide pedestrian walkway with overhead and side protection would be constructed along the Mission Street frontage between Beale Street and the Tower and Podium building entrance to provide access to the bank, residences, the ground floor restaurant. The ground floor bank would vacate the northwestern corner of floor space it currently occupies at the corner of Fremont and Mission streets and would modify a portion of its space to accommodate a smaller bank branch operation. The existing Mission Street entrance to the bank would be closed; however, access would be provided adjacent to the Tower and Podium building entrance. As a result of the temporary public right-of-way closures,

1618

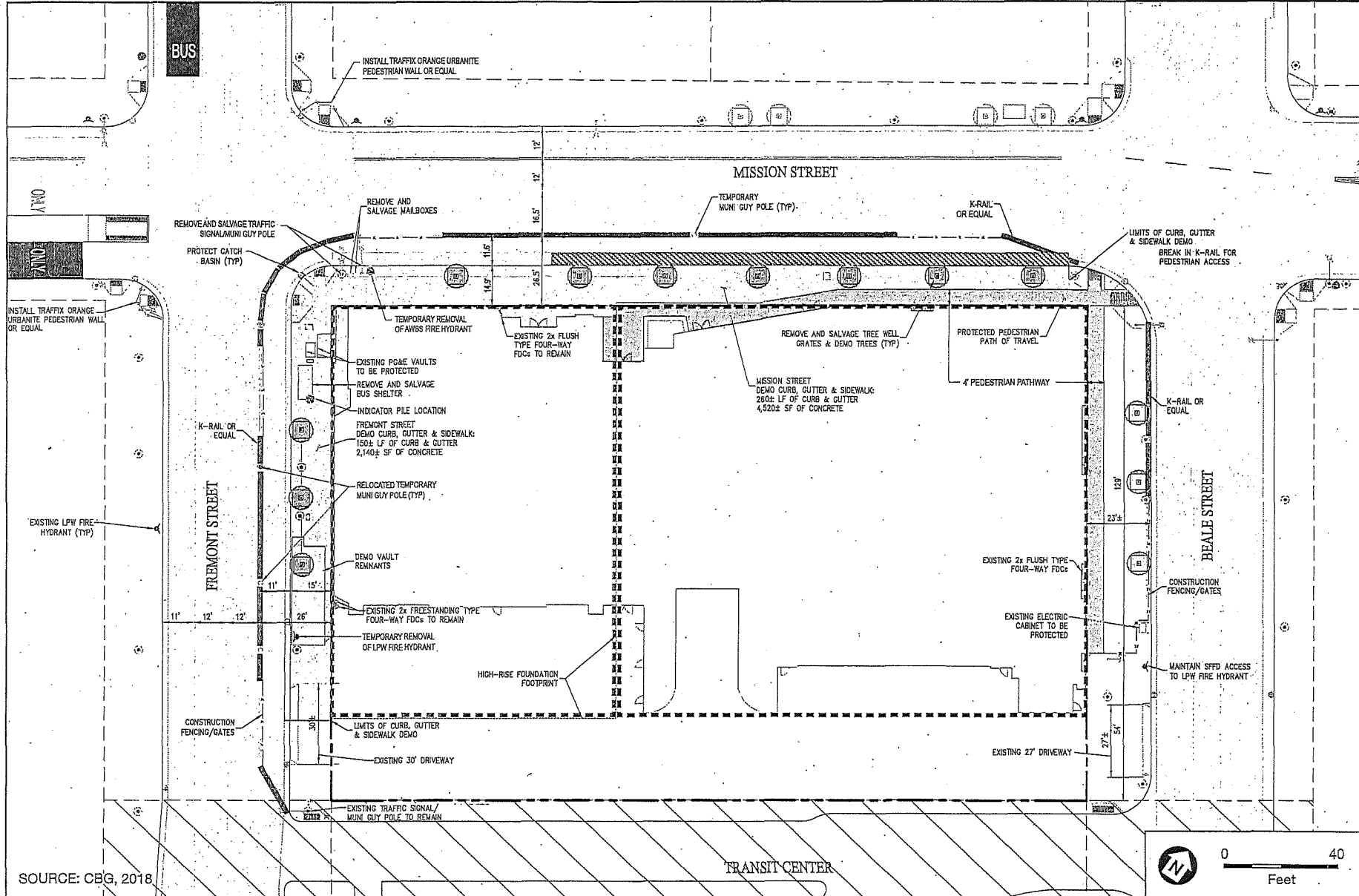

SOURCE: CBG, 2018

- |                                     |  |                         |
|-------------------------------------|--|-------------------------|
| □ Existing Electric Box/Vault       | ⊙ Existing MUNI OCS Guy Pole with Caisson  | ----- Property Boundary |
| ▣ Existing Catch Basin              | -x-x- Construction Fencing/Gates           | ----- Tower             |
| ▲ Existing LPW Fire Hydrant         | ▨ Protected Pedestrian Path of Travel      | ----- Podium            |
| ⊙ Existing AWSS Fire Hydrant        | ▨ Limits of Surface Demolition             |                         |
| ⊙ Existing Street Light/Signal Pole | ⊙ Relocated MUNI OCS Guy Pole with Caisson |                         |
| ⊙ Existing Tree Well                | ▨ Closed Loading Zones                     |                         |

2018-016691ENV: 301 Mission Street Perimeter Pile Upgrade Project

**Figure 6**  
**Stage 1:**  
**Site Preparation and Construction Work Area**

pedestrian right-of-way along the eastern half of the Mission Street south sidewalk would be reduced from 15 feet to approximately 4 feet in width. Muni guy poles currently installed in the sidewalk (and associated overhead electric trolley wires and the switch that allows trolley buses to make the right turn from eastbound Mission Street onto southbound Beale Street) would be temporarily relocated in alignment with the k-rail approximately 11.6 feet northward of the Mission Street existing south sidewalk into the temporarily closed eastbound lane in line with the concrete barrier.

- **Beale Street.** Fences would be installed along the outer edge of the Beale Street west sidewalk between the northern edge of the Podium building driveway and Mission Street. An approximately 4-foot-wide pedestrian walkway with overhead and side protection would be constructed along the Beale Street frontage. As a result, pedestrian right-of-way along the Beale Street west sidewalk would be reduced from 23 feet to approximately 4 feet in width during Stages 1 through 5. During Stage 6, the sidewalk along Beale Street frontage would be restored to full width for pedestrians. There would be no closure of existing travel lanes.

Construction fencing/gates and breaks in the barriers would be provided along the construction site perimeter to allow San Francisco Fire Department access to fire department water connections in the event of fire emergency.<sup>16</sup>

The above ground AWSS hydrant as well as the large underground concrete thrust block<sup>17</sup> at the Fremont and Mission streets intersection would be removed in order for the proposed shoring wall to have adequate space. The low-pressure fire department connections at Fremont and Beale streets near the project site's driveways would be extended from their existing locations along the building to the edge of the work zone. The extensions would be constructed with pipelines and fittings in accordance with National Fire Protection Association Code section 13 (2016 Edition). The temporary mounted fire department connections would be accessible and clearly marked in accordance with the San Francisco Fire Department requirements.

As described above, approximately 4-foot-wide pedestrian walkways with overhead and side protection would be constructed along a portion of the Mission Street frontage and the entirety of the Beale Street frontages to maintain access to the Tower and Podium buildings and to allow a through path of travel for pedestrians along Beale Street. There would be no pedestrian access along the Fremont and Mission streets sides of the Tower building during the entirety of construction because the structural upgrade construction would occur in the sidewalk area. Preparation of the sidewalk area to be demolished during Stage 2 along the Tower building perimeter would also require the removal of the mailboxes on the sidewalk at Mission and Fremont streets (see Figure 6). Construction would occur either in the sidewalk area or require the use of the sidewalk area for staging. As such, all existing 13 street trees along Fremont, Mission, and Beale streets would be removed, while the associated well grates would be salvaged to accommodate planting of replacement street trees at the completion of project construction.

<sup>16</sup> The water connections are located on the exterior of a building and are where the fire department can pump supplemental water into the building's sprinkler system, standpipe, or other system, furnishing water for fire extinguishment to supplement existing water supplies.

<sup>17</sup> Concrete thrust blocks ensure pipeline stability at critical points in a water system where the pipeline decreases or increases in diameter, changes, direction, or changes elevation. The concrete thrust block underneath the AWSS hydrant and associated pipeline provides end restraint to counteract the water pressure acting on the pipeline fitting.

Construction staging would occur within the sidewalk area of Beale Street and would not require any travel lane closures on Beale Street. Construction offices, equipment for treatment of groundwater removed during construction, and tool storage would be located on the Mission and Beale street sides of the project site (see **Figure 7, Stage 1: Mobilization and Indicator Pile**). As shown in Figure 7, the construction offices and water treatment equipment would be elevated on top of the Conex<sup>18</sup> and Baker tanks.<sup>19</sup> Groundwater removed during construction would be routed through an 18,000-gallon Baker tank (also referred to as a settlement tank) located within the sidewalk area of Beale Street prior to discharge to the combined storm sewer via water treatment equipment located within the sidewalk area of Mission Street. Prior to discharging, the San Francisco Public Utilities Commission (SFPUC) would test ground water samples to ensure compliance with SFPUC discharge standards. The project team must obtain a batch waste discharge (for construction dewatering) permit from SFPUC in compliance with federal and state requirements. During Stage 1, the construction haul trucks and deliveries would access the site at the northwest corner using the bus-only lane on Fremont Street.

### **Stage 2: Demolition and Shoring**

Stage 2 construction activities would last approximately 60 days. The proposed structural upgrade construction would occur in the sidewalk area of Fremont and Mission streets along the Tower building perimeter, requiring demolition of approximately 4,400 square feet of existing sidewalk (see **Figure 6 and Figure 8, Stage 2: Demolition and Shoring**). Demolition of the sidewalk is anticipated to take approximately two weeks and would be performed using hand held tools powered with generators or compressors. Demolition debris would be recycled to the extent feasible and in accordance with chapter 14 and section 708 of the San Francisco Environment Code. The amount of demolition debris is estimated at 340 cubic yards. About 34 total truck loads<sup>20</sup> would be needed to haul the demolition debris to appropriate sites for disposal or recycling.

After the sidewalk area is demolished, construction of a shoring system would be required at the perimeter of the excavation line to allow installation of the piles. A section view of this process is illustrated in **Figure 9, Stage 2: Demolition and Shoring (Section View)**. The shoring system would consist of soldier piles installed in drilled holes, with horizontal supports (“lagging”) at the perimeter of the excavation line. A soldier pile is a common retaining wall strategy in which H-shaped steel beams (“piles”) are installed into the earth at regular intervals— usually six to 12 feet apart. In between each vertical pile, lagging fills the gap, helping to spread the load. Soldier piles would be installed approximately 10 to 12 feet from the Mission and Fremont street faces of the Tower building to a depth of approximately 45 feet. The soldier piles would be spaced to avoid existing tie-backs (abandoned in place during the original building construction) and utilities.

To protect the existing PG&E vault on Fremont Street, the shoring would be installed around the vault, such that when excavation is conducted adjacent to the vault, the soil supporting it would not be disturbed. Supplemental structural support for conduits that exit the vault and extend across the excavation area would be provided prior to excavating beneath them. Grade-level access to the vault would be available to

<sup>18</sup> A Conex is a shipping container that is used for storing tools and other supplies.

<sup>19</sup> A Baker tank is a steel tank that stores turbid water for the purpose of retention and settlement.

<sup>20</sup> Assumes a truck capacity of 10 cubic yards

1621

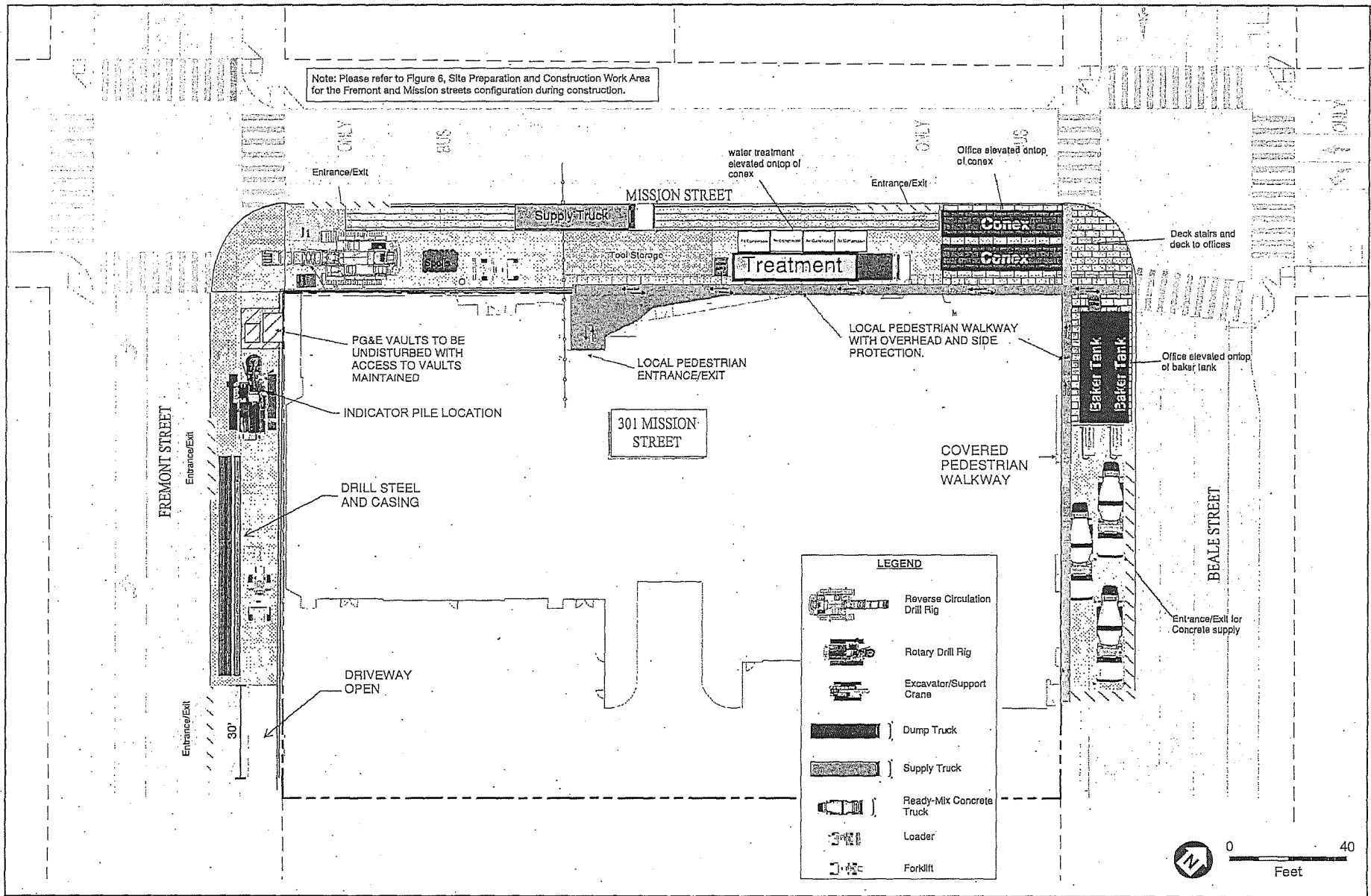

SOURCE: CBG, 2019

2018-016691ENV: 301 Mission Street Perimeter Pile Upgrade Project

Figure 7  
Stage 1: Mobilization and Indicator Pile

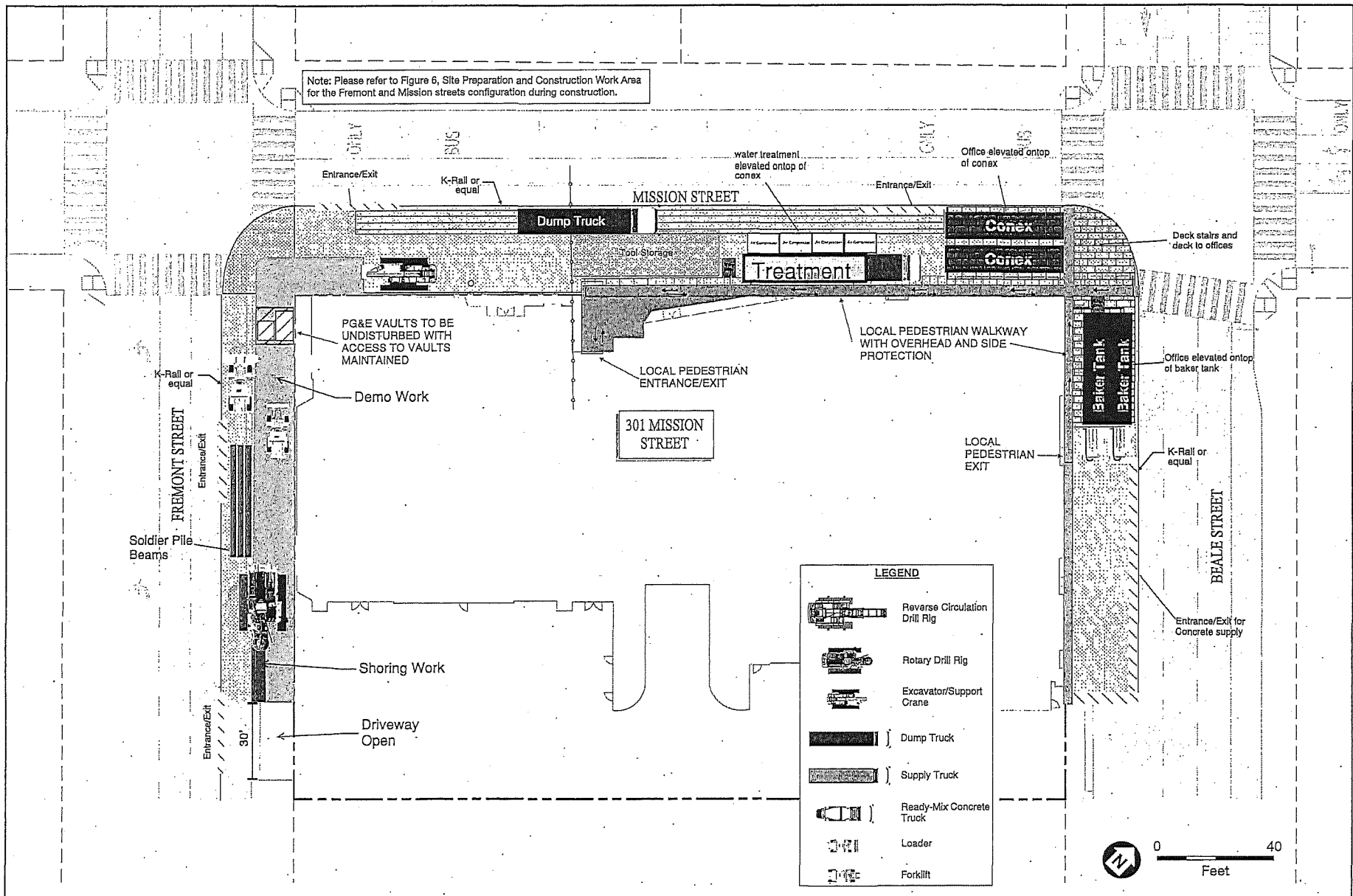

SOURCE: CBG, 2019

2018-016691ENV: 301 Mission Street Perimeter Pile Upgrade Project

**Figure 8**  
Stage 2: Demolition and Shoring

1623

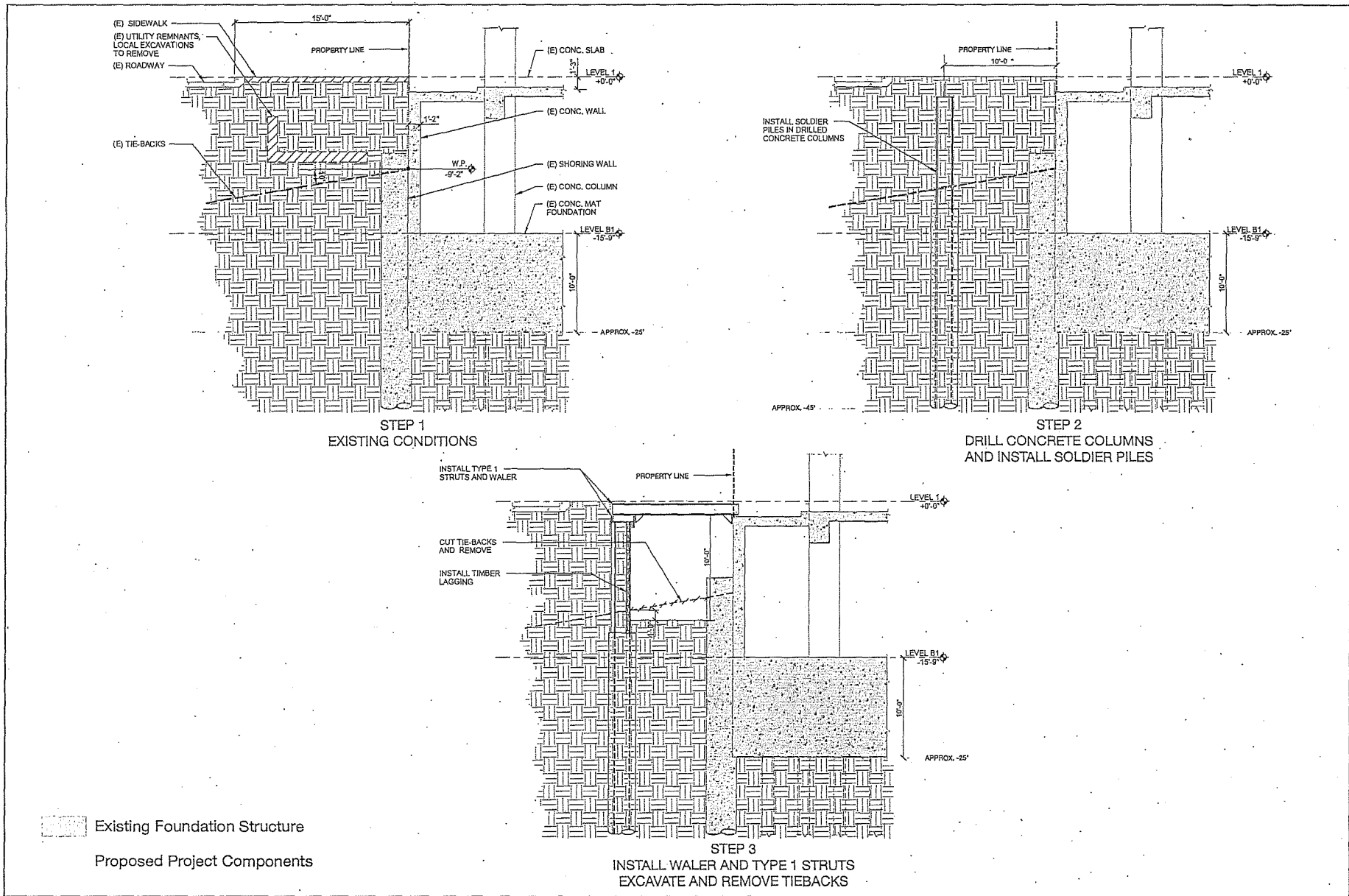

SOURCE: Simpson Gumpertz & Heger, 2019

2018-016691ENV: 301 Mission Street Perimeter Pile Upgrade Project

Figure 9  
Stage 2: Demolition and Shoring (Section View)

PG&E at all times during construction. After the shoring and structural supports are installed around the PG&E vault, the area between the soldier piles and the Tower building would then be excavated to the depth of the existing tie backs and utilities (approximately 10 feet bgs), with wood lagging placed between the soldier piles to stabilize the excavation. The existing tie backs and abandoned utilities would be removed from areas where the piles would be installed. The excavated area would be backfilled to grade to provide a working platform for purposes of equipment access and the installation of the perimeter piles.

### **Stage 3: Installation of Outer Casings on Mission and Fremont Streets, Piles on Fremont Street**

Stage 3 construction would last approximately 160 days. Installation of the perimeter piles would require the initial installation of 52, 36-inch-diameter casings (outer casings) to a depth of 70 to 90 feet bgs through the upper soil layers (see **Figure 10, Stage 3: Installation of Outer Casings on Mission and Fremont Streets, Piles on Fremont Street**). These outer casings would be installed as a first step in the pile installation process to provide separation between the 24-inch-diameter pile that would ultimately carry the Tower building's weight to bedrock and the surrounding soils in the upper 70 to 90 feet. The outer casings would be installed through a process of drilling and pressure, with soil inside the casing removed as the casing is advanced. Once the casing is installed, there would be a cased 36-inch-wide, 70- to 90-foot-deep hole, without soil, but with groundwater to the depth of the surrounding groundwater table which is anticipated to be 19 to 22 feet bgs.<sup>21</sup> A section view of this process is illustrated in **Figure 11, Stages 3 and 4: Backfill and Perimeter Pile Installation (Section View)**.

Installation of the outer casings would be followed by installation of the perimeter piles on Fremont Street. As shown in Figure 10, the drill rig would be used to install the piles from south to north on Fremont Street. Installation of the first 10 piles would require temporary closure of the Fremont Street driveway to the Tower and Podium building for approximately 40 to 50 days. During this time, two-way vehicular access to the Tower and Podium buildings would remain at the southeast corner from Beale Street. After the first 10 piles are installed, vehicular access to the project site at the southwest corner from Fremont Street would be restored.

For each pile, a 24-inch-diameter pile casing (shaft liner) would be centered within the 36-inch-diameter outer casing and drilled through the Old Bay Clay to the top of the Franciscan Complex bedrock to depths of approximately 220 to 250 feet bgs. The shaft liner would extend the full depth to the bedrock and would be fabricated with friction-reducing coating along its full length. A 20-inch-diameter rock socket<sup>22</sup> would be drilled an additional 30 to 50 feet below the shaft liner into the bedrock to form the lower portion of the pile. The exact length of rock socket required would be determined based on testing of rock samples extracted from the seven geotechnical borings installed in Stage 1. A central reinforcing bar would then be placed in the full length of the shaft liner followed by concrete filling of the rock socket and interior of the shaft liner to the depth of the mat extension (approximately 25 feet bgs).

<sup>21</sup> John A. Egan, GE, *Geotechnical Evaluation for the Perimeter Pile Upgrade—Revision 1, Millennium Tower, City and County of San Francisco, California*, August 13, 2019, with the assistance of Slate Geotechnical Consultants.

<sup>22</sup> Bottom portion of the pile that is socketed into the bedrock.





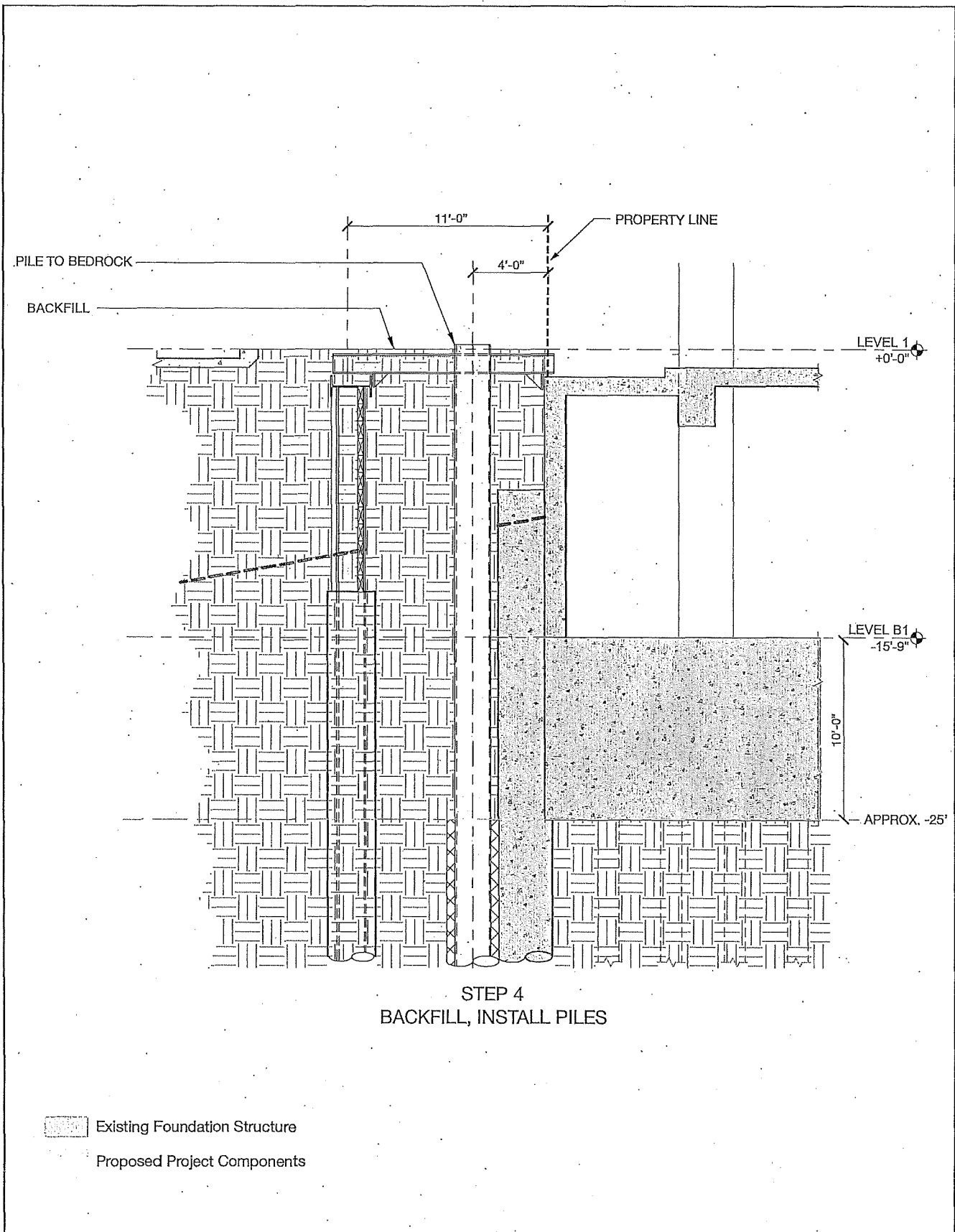

SOURCE: Simpson Gumpertz & Heger, 2019

2018-016691ENV: 301 Mission Street Perimeter Pile Upgrade Project

**Figure 11**  
Stages 3 and 4: Backfill and Perimeter  
Pile Installation (Section View)

Approximately 1,910 cubic yards of soil would be excavated from the outer casing and perimeter pile installation and hauled off site. About 191 total truck loads<sup>23</sup> would be needed to haul the excavated soil to appropriate sites for disposal. After the perimeter piles are installed, jet grout columns, which consist of a soil-cement mixture, would be installed between the soldier piles (constructed during Stage 1) to form a permanent wall to provide shoring for Stage 4 excavation that would extend to 25 feet bgs (a section view of the excavation is illustrated in Figure 14, Stage 4: Excavation (Section View), p. 26). A jet grout plug would also be installed between the new shoring wall and existing shoring wall starting at a depth of approximately 25 feet bgs and extending to 35 feet bgs (see Figure 12, Stages 3 and 4: Jet Grout Plug Installation (Section View)). The jet grout plug would seal the bottom of the excavation to minimize flow of water into the excavation during construction<sup>24</sup> and would brace the bottom of the shoring wall.

#### **Stage 4: Piles on Mission Street and Mat Slab Extension Construction on Fremont Street**

Once Stage 3 is complete, perimeter piles would be installed on Mission Street in the same method as those on Fremont Street, described above. Stage 4 construction would last approximately 110 days. The perimeter pile installation on Mission Street would be concurrent with excavation and construction of the mat slab extension on Fremont Street (see Figure 13, Stage 4: Piles on Mission Street and Construction of Mat Slab Extension on Fremont Street).

As described earlier in Section A.5, the structural upgrade would include an 8-foot-wide, 10-foot-thick reinforced extension of the existing concrete mat foundation that would connect to the 52 piles. The mat slab extension is also referred to as "the collar foundation", and is the structure that would be supported by new piles extending to bedrock. Construction of the mat slab extension would require excavation to 25 feet bgs, which is where the jet grout plug begins and is at the same level as the bottom of the Tower building's existing mat foundation. A section view of the excavation and mat extension process is illustrated in Figure 14, Stage 4: Excavation (Section View), and Figure 15, Stages 4 and 5: Mat Slab Extension (Section View). The area below the sidewalk where the mat extension and new piles would be located on Fremont and Mission streets would total approximately 2,130 square feet. Approximately 1,610 cubic yards of soil would be excavated in Stage 4 and hauled off site. About 161 total truck loads<sup>25</sup> would be needed to haul the excavated soil to appropriate sites for disposal.

As excavation advances: (1) support for utility lines to remain in place would be installed; (2) the newly installed perimeter piles founded in bedrock would be cut to 1 to 4 inches above the bottom of the mat; and (3) the existing Tower building shoring that is more than one-foot above the bottom of the mat would be cut and removed. The tops of the soldier piles would be braced to the Tower building's basement first level slab by struts as the excavation proceeds. After the excavation is extended to the bottom of the existing mat foundation at 25 feet bgs, the exposed lower edge of the mat would be chipped back to expose the existing reinforcing steel at the bottom of the mat and to create a notch to aid in load transfer. New reinforcing steel would be connected to the existing reinforcing steel using mechanical couplers. The exposed face of the existing mat would be scarified with chipping hammers to create a roughened surface. New epoxy adhesive

<sup>23</sup> Assumes a truck capacity of 10 cubic yards

<sup>24</sup> John A. Egan, PE, GE, *Geotechnical Evaluation for the Perimeter Pile Upgrade—Revision 1, Millennium Tower, City and County of San Francisco, California*, August 13, 2019, with the assistance of Slate Geotechnical Consultants.

<sup>25</sup> Assumes a truck capacity of 10 cubic yards

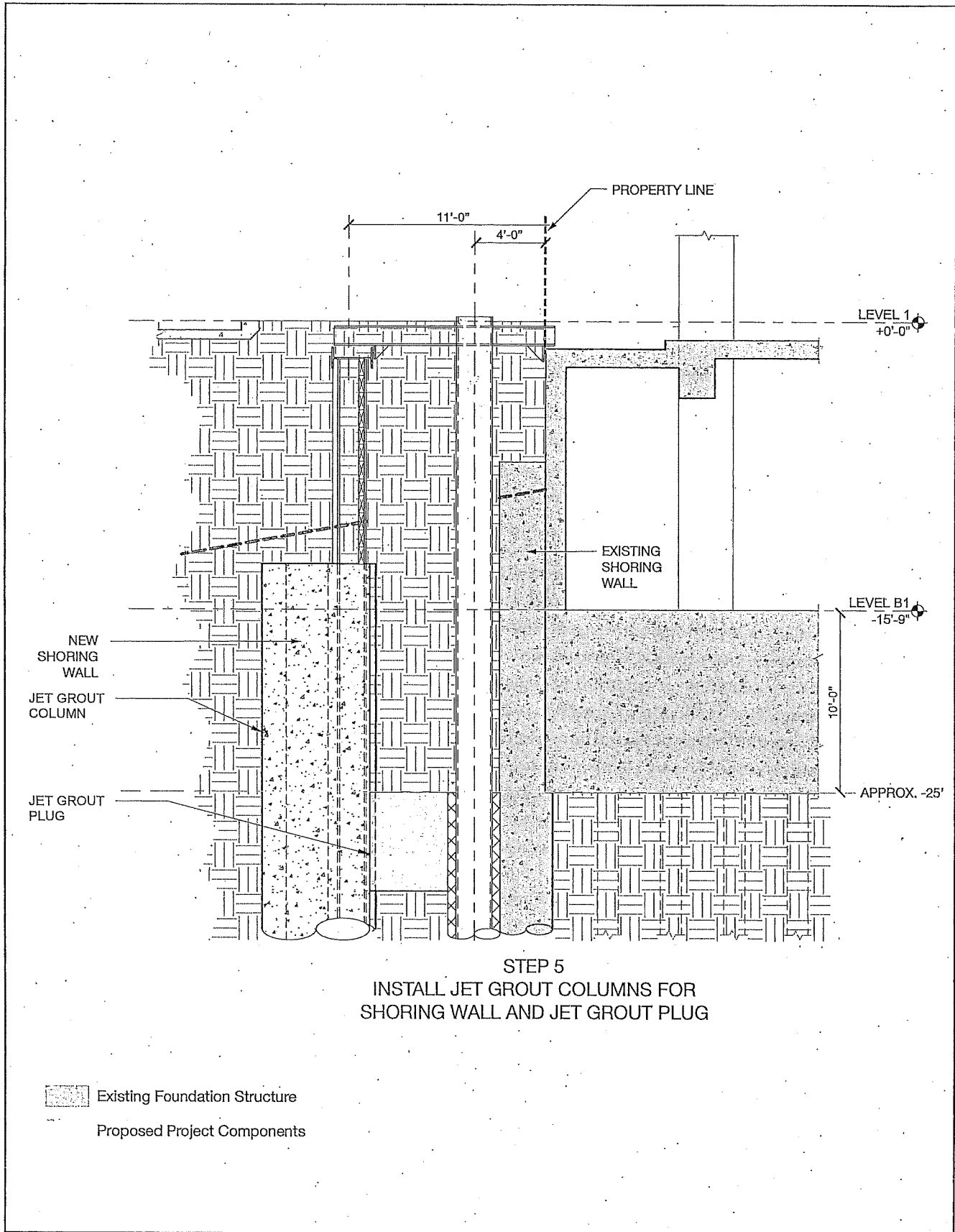

SOURCE: Simpson Gumpertz & Heger, 2019

2018-016691ENV: 301 Mission Street Perimeter Pile Upgrade Project

**Figure 12**  
Stages 3 & 4: Jet Grout Plug  
Installation (Section View)

1629

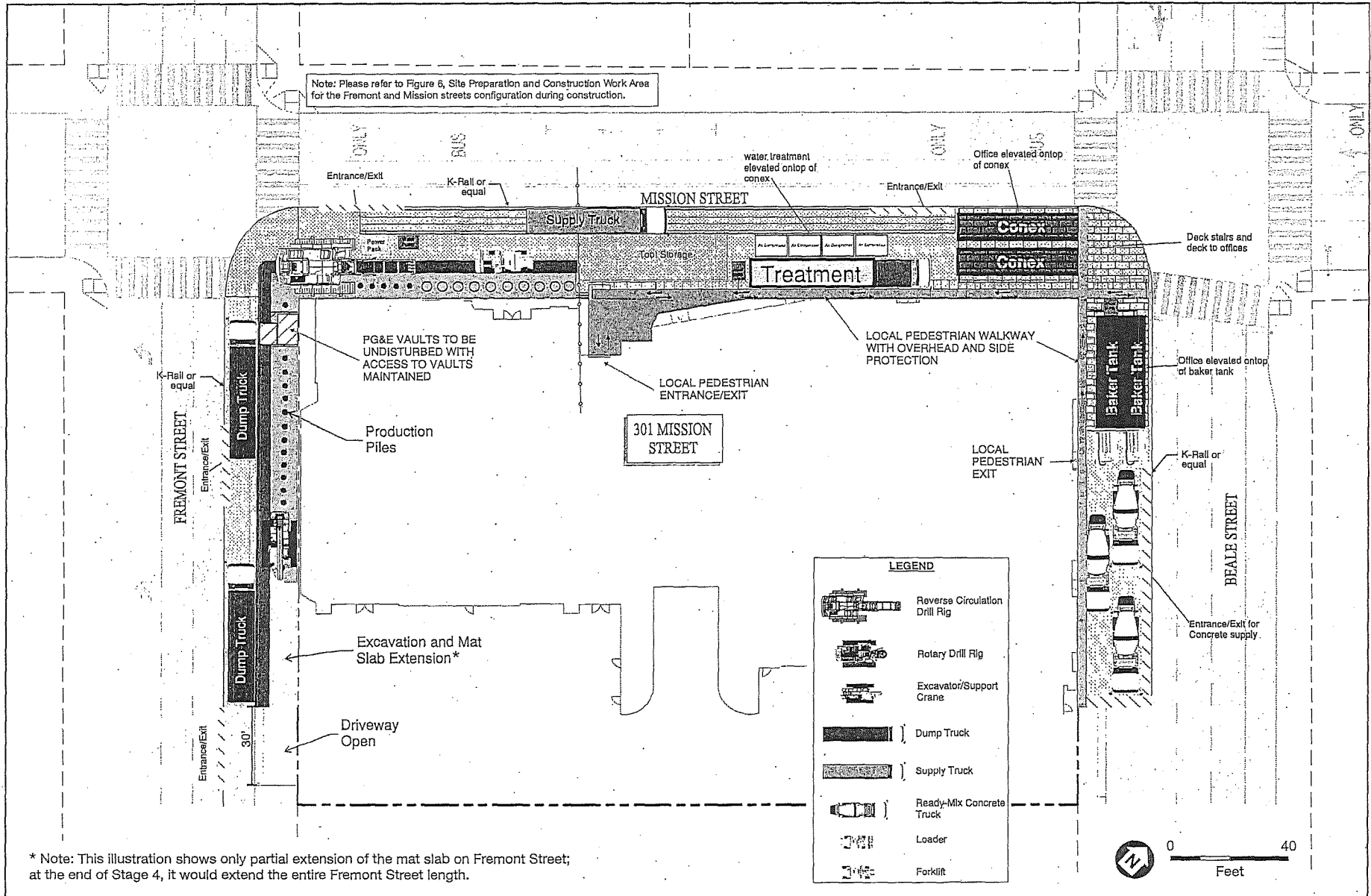

SOURCE: CBG, 2019

2018-016691ENV: 301 Mission Street Perimeter Pile Upgrade Project

**Figure 13**  
 Stage 4: Piles on Mission Street and Construction of Mat Slab Extension on Fremont Street

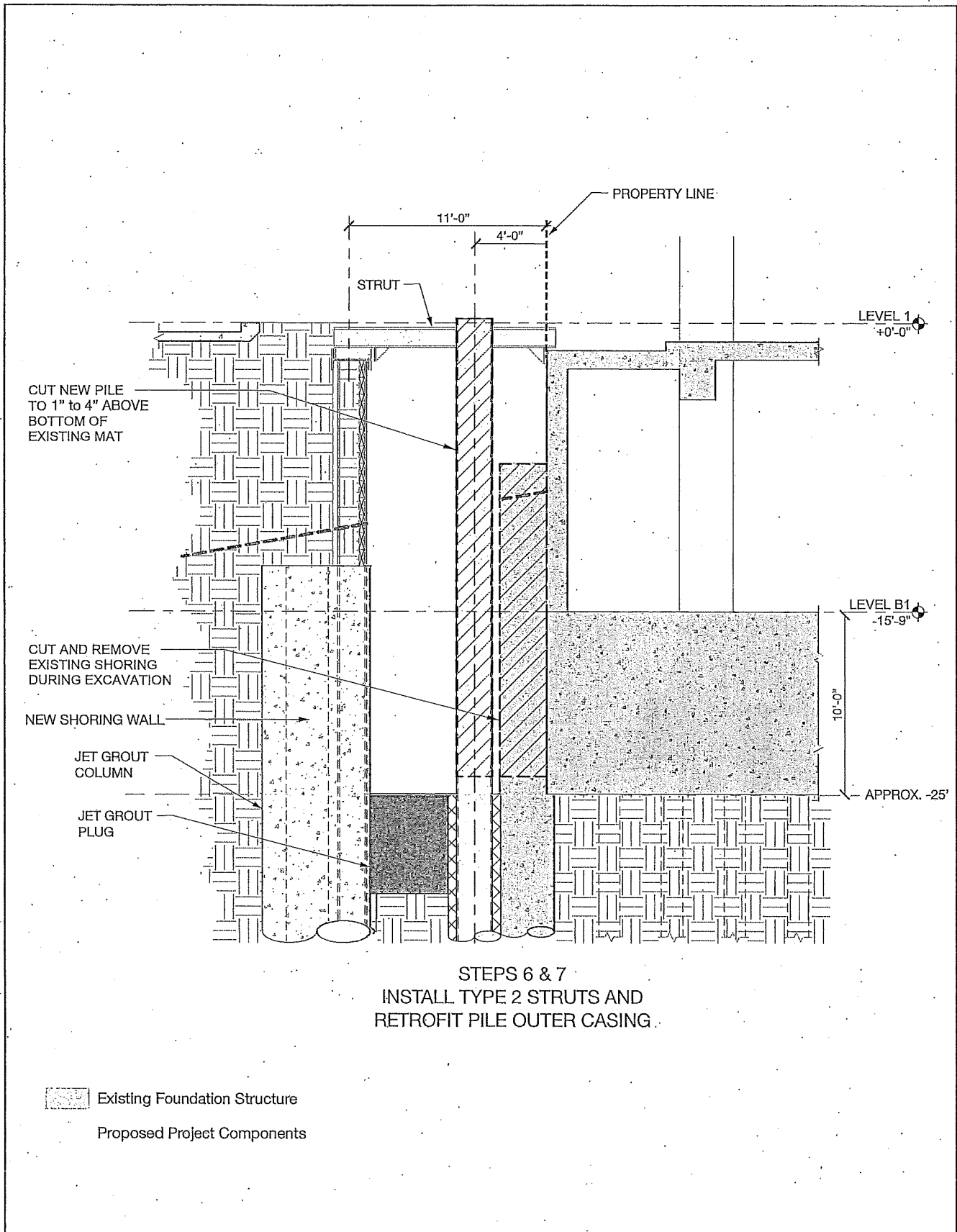

SOURCE: Simpson Gumpertz & Heger, 2019

2018-016691ENV: 301 Mission Street Perimeter Pile Upgrade Project

**Figure 14**  
Stages 3 and 4: Excavation (Section View)

1631

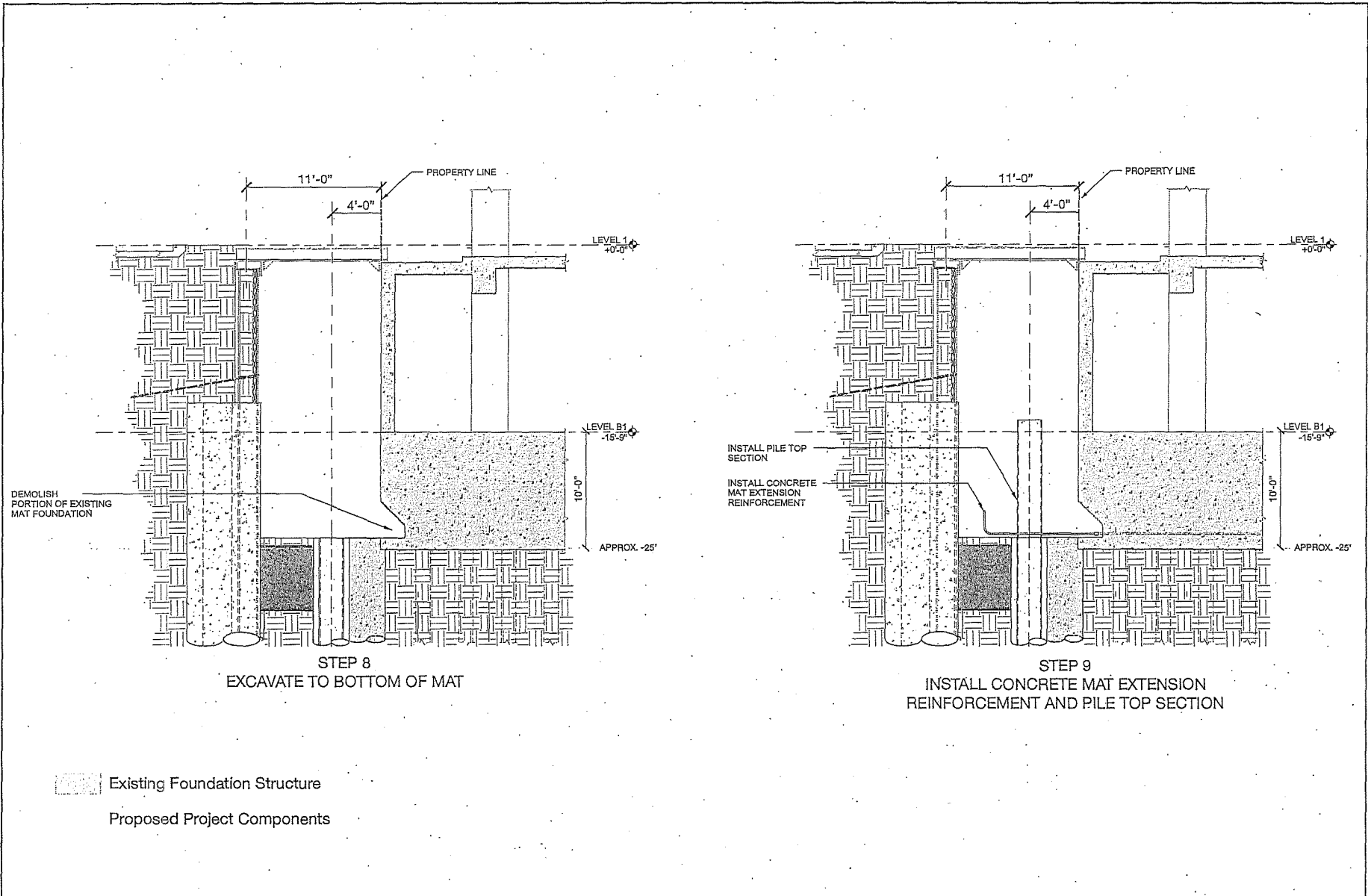

SOURCE: Simpson Gumpertz & Heger, 2019

2018-016691ENV: 301 Mission Street Perimeter Pile Upgrade Project

**Figure 15**  
Stages 4 and 5: Mat Slab Extension (Section View)

steel dowels would be drilled into the exposed face of the mat to provide additional shear reinforcement for the connection between the new mat extension and the existing mat. Additional reinforcement, consisting of conventional steel reinforcing bars in two perpendicular directions, would be placed within the new mat extension. A pile top section would be installed, and concrete would be cast against the roughened face of the existing mat, resulting in the concrete mat extension.

### **Stage 5: Mat Slab Extension on Mission Street**

Stage 5 construction would last approximately 90 days and would consist of the excavation and construction of the mat slab foundation extension on Mission Street (see **Figure 16, Stage 5: Mat Slab Extension on Mission Street**). Approximately 860 cubic yards of soil would be excavated in Stage 5 and hauled off site. About 86 total truck loads<sup>26</sup> would be needed to haul excavated soil to appropriate sites for disposal. The mat extension process would be the same as under Stage 4 and illustrated in Figure 14 and Figure 15.

### **Stage 6: Jacking, Vault Construction, Backfill, and Site Restoration**

Once the mat slab extensions on Fremont and Mission streets are completed, the pile tops would be encapsulated in the 10-foot-thick reinforced concrete mat extension. Once constructed, the top of the mat slab extension would be at the same level as the top of the Tower building's existing mat foundation (approximately 15 feet bgs). Stage 6 would last approximately 130 days and would consist of installation of the jack system, vault construction, backfill, and site restoration (see **Figure 17, Stage 6: Jacking, Vault Construction, Backfill, and Site Restoration**). The jack system would comprise an individual, closed cylinder hydraulic jack at each of the 52 piles, a steel jacking beam at each pile, four steel rods extending from the jacking beam at each pile into the new mat foundation, a manifold control,<sup>27</sup> and a single hydraulic power unit. A section view of Stage 6 is illustrated in **Figure 18, Stage 6: Mat Slab Extension, Jack Pile System, and Vault (Section View)**. The purpose of the jacking is to transfer load from the existing foundation to the new piles by jacking the piles against the jacking beam, which then transfers the load to the foundation through the steel rods. Once the new mat extension has been constructed, the jacks would be connected to the manifold and power unit and pressurized to produce the desired level of loading.

The jacks would be locked off to permanently transfer a portion of the Tower building's load to bedrock. The hydraulic system would then be depressurized and removed from the site. Once the hydraulic power unit and manifold are removed, the jacks, jacking beams and rods would remain in place.

The remaining components would be enclosed by two accessible concrete vaults to provide weather protection and allow backfill of the excavated area and reconstruction of sidewalks. One 130-foot-long vault would be along Mission Street and the other 110-foot-long vault would be along Fremont Street. The vaults would be 7 feet tall and 7 feet wide (see Figure 18). The vaults would be accessible by five access manholes located on the sidewalk (three on Fremont Street, two on Mission Street), allowing for periodic inspection (see Figure 5). Once the vaults are constructed, the area would be backfilled with approximately 1,000 cubic

---

<sup>26</sup> Assumes a truck capacity of 10 cubic yards

<sup>27</sup> The manifold (a pipe that branches into several openings) connects to the hydraulic power source and branches to each of the piles. The control system involves a series of valves that enable branches to be opened or closed to control pressure to the individual jacks.



1633

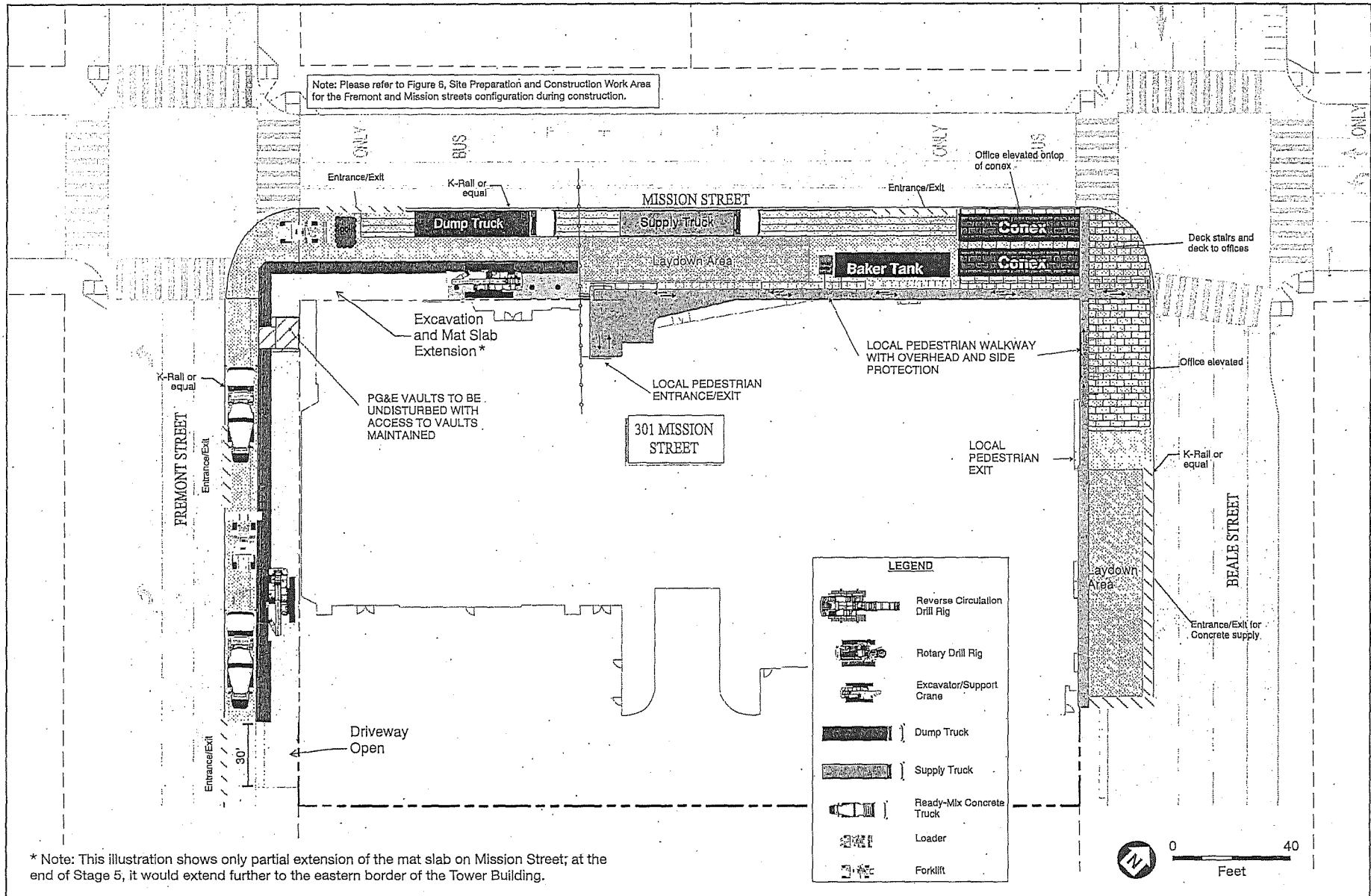

SOURCE: CBG, 2018

2018-016691ENV: 301 Mission Street Perimeter Pile Upgrade Project

Figure 16  
Stage 5: Mat Slab Extension on Mission Street

1634

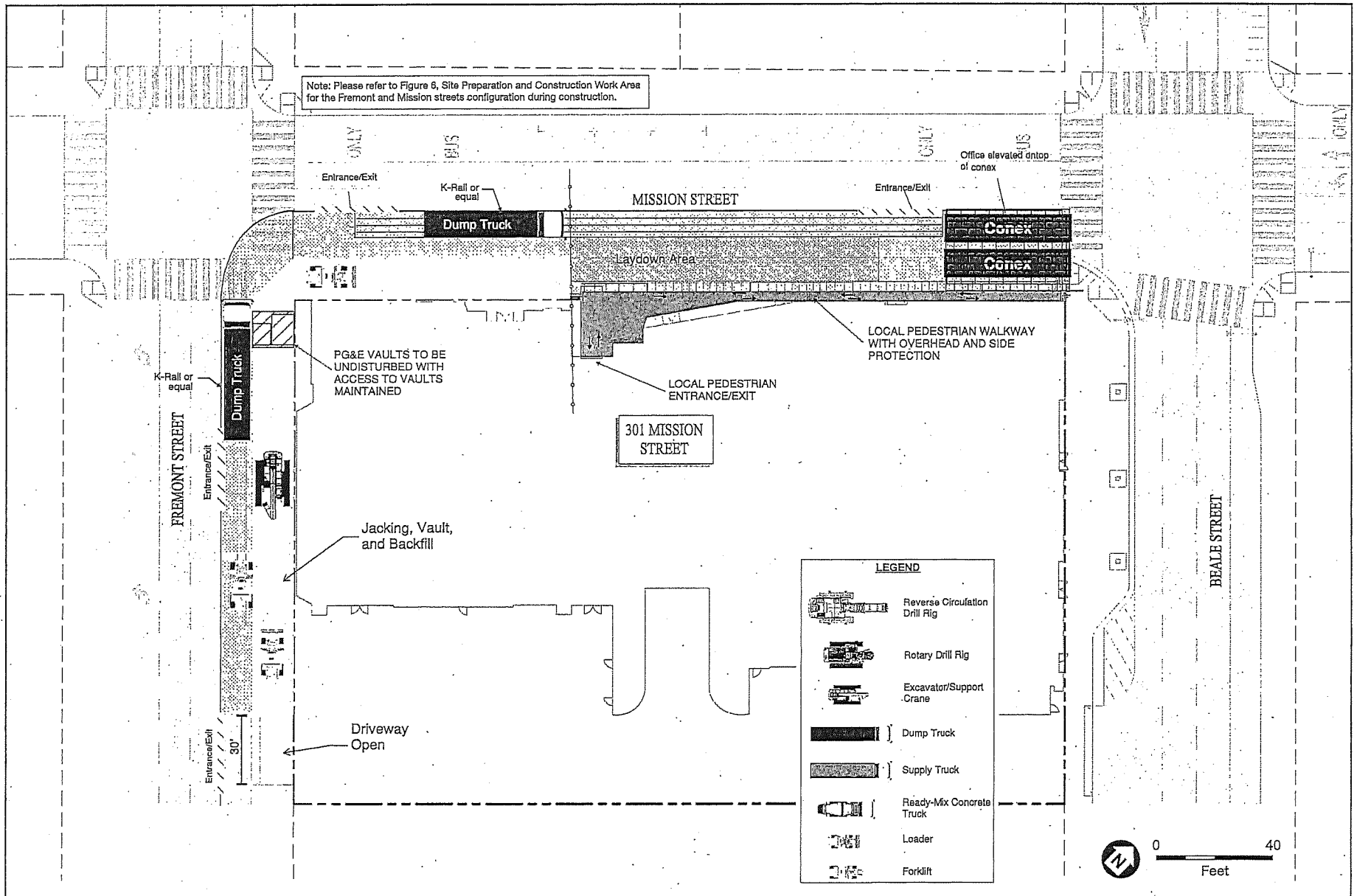

SOURCE: CBG, 2018

2018-016691ENV: 301 Mission Street Perimeter Pile Upgrade Project

**Figure 17**  
Stage 6: Jacking, Vault Construction, Backfill, and Site Restoration

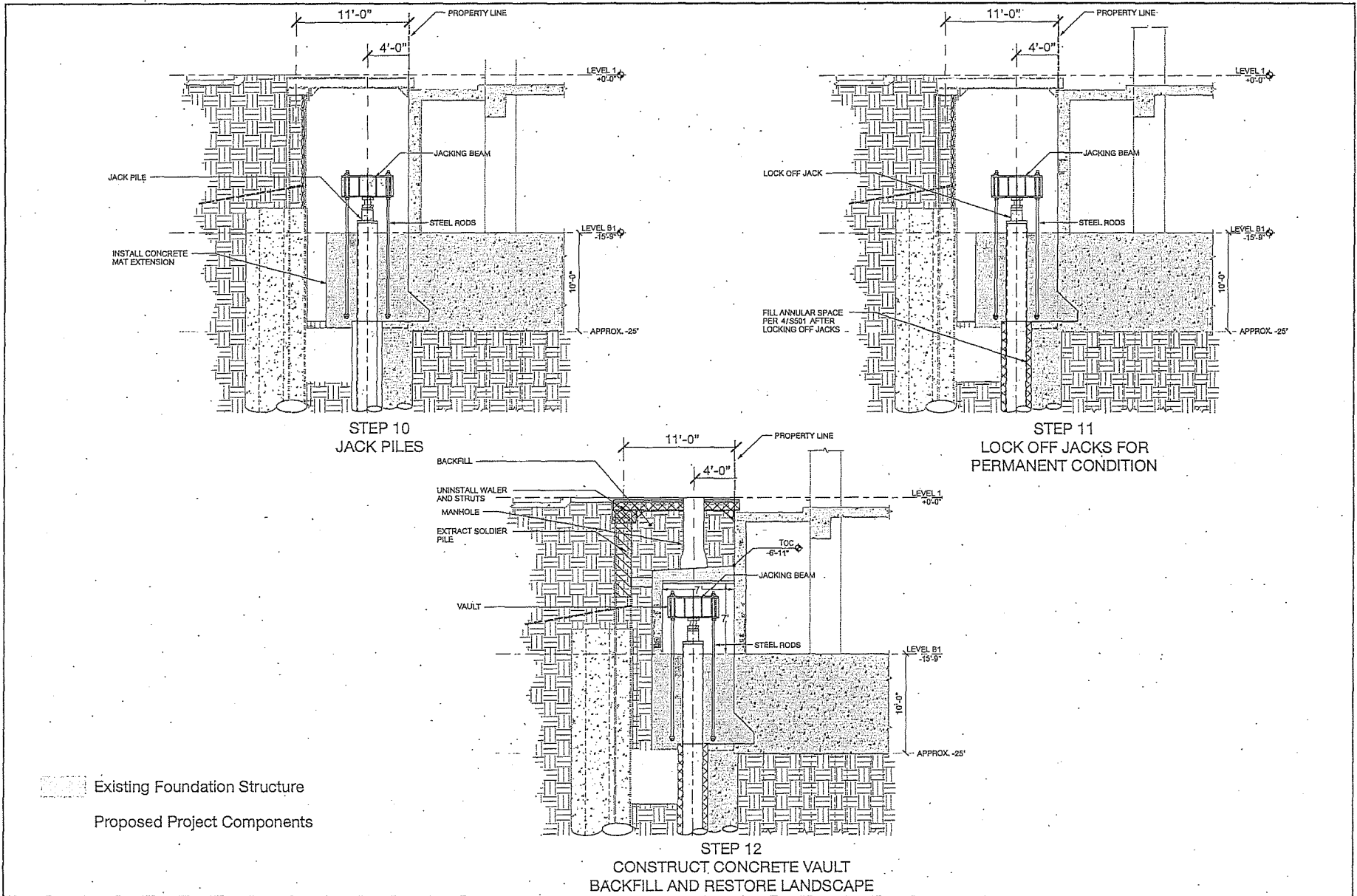

SOURCE: Simpson Gumpertz & Heger, 2019

2018-016691ENV: 301 Mission Street Perimeter Pile Upgrade Project

**Figure 18**

Stage 6: Mat Slab Extension, Jack Pile System, and Vaults (Section View)

yards of imported fill, and the construction site would be restored to pre-construction conditions. About 100 total truck loads<sup>28</sup> would be needed to import fill to the project site.

Approximately 1,400 square feet of the existing sidewalk along the Podium building frontage would be demolished and replaced during Stage 6 to: (1) address current curb and gutter drainage ponding issues and reestablish positive drainage flow; and (2) restore the areas damaged from the removal of the tree wells and Muni guy poles during construction. The amount of demolition debris is estimated at 60 cubic yards. About six truck loads would be needed to haul the demolition debris to appropriate sites for disposal or recycling. Replacement street trees would be planted, and the temporarily relocated Muni equipment (i.e., guy poles and associated overhead electric trolley wires) would be re-installed back on the sidewalks. Approximately 3,000 square feet of asphalt paving would be required to restore the project site (roadway along Fremont and Mission streets) to existing conditions. Finally, the AWSS fire hydrant would be reinstalled at its original pre-construction location after the construction is completed.

Each vault would be designed to remain dry, however, incidental surface water may enter the vaults through the manhole access openings, which are normally covered. For each vault, the floor of the vault (top of the mat extension) would be sloped to drain to a series of dry sumps within the vault. Five low horsepower, electrically operated pumps would be placed permanently in the vault sumps (two in the vault along Mission Street and three in the vault along Fremont Street), with a float switch to activate the pumps should sufficient rainwater collect to trigger it, and the pumped water would be discharged into the combined sewer system. Operation of the pumps would connect to and operate off the Tower building's permanent power supply and would be alarmed to the building management system.

## GROUNDWATER CONTROLS DURING CONSTRUCTION

Groundwater is anticipated to be encountered within the depths of the excavation at approximately 19 to 22 feet. To provide a dry and stable excavation for construction of the foundations and mat extension, a jet grout plug would be constructed at the base of the excavation to seal the bottom of the excavation to minimize flow of water into the excavation during construction. In addition, the jet grout columns installed during Stage 2 as part of the outer face of the excavation would inhibit groundwater drawdown outside the excavation.

It is anticipated that any leakage through the jet grout would be handled with the use of sumps, and discharged into the combined sewer system. As discussed above under Stage 1, groundwater removed during construction would be routed through an 18,000-gallon settlement tank and water treatment equipment prior to discharge to the combined storm sewer. Prior to discharge, groundwater samples would be tested to ensure compliance with SFPUC discharge standards.

### A.6 Monitoring Plan Summary

As stated in the report entitled "Geotechnical Evaluation For The Perimeter Pile Upgrade, Millennium Tower, 301 Mission Street, City and County of San Francisco, CA" dated August 13, 2019, additional future long-term (from 2020 to 2060) settlement of the Tower under the proposed Perimeter Pile Upgrade (the proposed project) is estimated to be in the range of less than 1 inch to approximately 3.5 inches at different

---

<sup>28</sup> Assumes a truck capacity of 10 cubic yards

locations across the footprint of the Tower mat, with the larger of these estimated settlements occurring toward the southeastern portion of the Tower footprint.

These future settlements will be monitored immediately prior to, during, and after construction of the proposed project. The Monitoring Program outlined below was submitted by the geotechnical engineer of record for the project to peer review team, who took no exception to the proposed monitoring program.<sup>29</sup> This program has been incorporated in the design drawings and specifications (see project plans Structural Plan Sheet S207<sup>30</sup>) for consideration by the building department:

- Monitoring of the basement and exterior piezometers and extensometers for two years as follows:
  - Prior to installation of the shoring soldier piles;
  - Bi-weekly for the first 26 weeks;
  - Every 6 weeks for 18 weeks; and
  - Quarterly monitoring until the completion of all subterranean work.
- Prism and basement monitoring review and analysis based on the following schedule:
  - Prior to installation of the shoring soldier piles;
  - Weekly until the completion of all subterranean work;
  - Bi-weekly for 3 months;
  - Every 6 weeks for 2 years;
  - Quarterly monitoring for 2 years; and
  - Annual monitoring for 6 years.

In accordance with building department Information Sheet No. S-18, the monitoring period will be extended to 10 years following installation of the proposed project, and settlement monitoring data with a summary of the analysis will be submitted annually to the building department.

In addition, S-18 requires immediate notification of the building department if unexpected performance conditions are experienced that may require immediate attention or additional investigation. The project sponsor proposes the following be used as triggers for notification of the building department (Notification Triggers) for the duration of the S-18 monitoring period:

1. Relaxation of proposed project's pile load by more than 25 percent of original prestress in any single pile, or by more than 10 percent for the group of piles as a whole.
2. Average settlement across the Tower footprint exceeding 1 inch during any annual monitoring period or exceeding 150 percent of the best estimate additional long-term maximum settlement of 3.5 inches at any location across the Tower footprint following installation of the proposed project.

If none of these conditions is triggered, the proposed project would be considered to be performing within expectations, and no action would be required under S-18.

<sup>29</sup> See Comment #127 of the project comment log. Engineering Design Review Team, *301 Mission Street – Voluntary Foundation Retrofit EDRT Log*, August 27, 2019.

<sup>30</sup> Simpson Gumpertz & Heger, *Perimeter Pile Upgrade, 301 Mission Street, San Francisco, CA*, August 23, 2019, Sheet S207 (Monitoring Plan).

## A.7 Construction Transportation Management Plan

The construction contractor would be required to follow the city’s *Regulations for Working in San Francisco Streets* (the Blue Book) published by the San Francisco Municipal Transportation Agency (SFMTA) and the San Francisco Public Works’ (public works) regulations during the construction period. The proposed project includes a Construction Transportation Management Plan (transportation plan) developed in consultation with staff at the SFMTA to provide a comprehensive set of approaches and strategies to minimize potential transportation-related impacts related to the construction of the project (the transportation plan is included as Appendix A to this initial study).

The transportation plan’s objectives are to maintain a safe and efficient movement of motorized vehicles, pedestrians, transit passengers, bicycle traffic and commercial traffic through and around the construction zone and to provide public awareness of potential impacts on Fremont, Mission, and Beale streets. The transportation plan lays out a set of strategies designed to manage construction impacts of the proposed project based on the understanding of transportation and circulation conditions prior to the start of construction, but some of the transportation plan’s strategies may be adjusted based on conditions at the time of construction commencement. Therefore, the proposed strategies are grouped into the following three categories to help understand the likelihood of implementing different strategies:

- Strategies that shall be implemented with certainty – Many of these strategies are required as part of the Blue Book, and San Francisco Public Works and State of California Division of Occupational Safety and Health (Cal/OSHA) regulations.
- Strategies that could be implemented based on conditions at the time of construction commencement – Adjustments or additional coordination may be needed by responsible parties depending on transportation conditions at the time of construction commencement.
- Strategies that could be explored for the purpose of the transportation plan, but may not be feasible to implement – They are recommended to improve transportation conditions but are not required as part of the project.

Table 4, *Summary of Transportation Management Strategies*, provides a summary of transportation management strategies by mode and type.

**TABLE 4**  
**SUMMARY OF TRANSPORTATION MANAGEMENT STRATEGIES**

Mode of Travel	Type <sup>a</sup>	Strategies
Public Transit	Shall Implement	<ul style="list-style-type: none"> <li>• The existing “Bus Only” signs mounted on the Mission Street north sidewalk shall be removed or covered.</li> <li>• Concrete barriers and fences including signs bordering the project site shall not encroach onto the adjacent bus-only lane on eastbound Mission Street, and the eastbound bus-only lane on Mission Street between Fremont and Beale streets shall be at least 12 feet wide during construction.</li> <li>• At least one sign shall be provided and continuously maintained at bus stops for routes that SFMTA has authorized to be closed or relocated (e.g., routes 5, 5R, 7, 14, 38, and 38R), and at the new bus stop location. The sign(s) shall indicate the routes affected, new stop location, and the start and end dates.</li> <li>• The MTHA shall work with Golden Gate Transit and the affected property owner(s) to establish extended or temporary stops for Routes 2, 4, and 27 whose stop on the southeast corner of Fremont/Mission intersection is proposed for relocation during the project construction.</li> </ul>

Mode of Travel	Typea	Strategies
		<ul style="list-style-type: none"> <li>Golden Gate Transit service changes to Routes 2, 4, and 27 shall be posted at the temporary stop location currently proposed at Fremont Street north of Mission Street.</li> <li>Trolley buses operating along Fremont Street (Routes 5 and 5R) and Mission Street (Route 14) shall reach the overhead trolley wires when going around the work area.</li> </ul>
	Could Implement	<ul style="list-style-type: none"> <li>The closest lane to the construction staging area on eastbound Mission Street could be marked "Bus and Taxi Only" or painted in red.</li> <li>The repurposed westbound travel lane on Mission Street could have the existing red paint removed.</li> <li>Golden Gate Transit could consider relocating stop for Routes 2, 4, and 27 to the following locations: the east side of Fremont Street north of Mission Street, the east side of Fremont street south of Howard Street, and the west side of Beale Street north of Mission Street.</li> <li>Golden Gate Transit and SamTrans buses could continue to use the existing eastbound Mission Street bus lane west of Fremont Street and continue to the restriped bus lane east of Fremont. Alternatively, Golden Gate Transit and SamTrans could work with SFMTA to use the existing Muni boarding island on eastbound Mission Street west of Fremont Street.</li> </ul>
	Could Explore	<ul style="list-style-type: none"> <li>The existing westbound traffic signal at the Mission Street/Beale Street intersection could be modified to include a Queue Jump Signal. Alternately, SFMTA could dispatch parking control officers (PCOs) to manually manage traffic at Beale Street/Mission Street intersection during the a.m. (7 a.m. to 9 a.m.) and p.m. (4 p.m. to 6 p.m.) peak periods.</li> </ul>
Motorized Vehicles	Shall Implement	<ul style="list-style-type: none"> <li>The third travel lane from the west curb/sidewalk on Fremont Street (south of Mission Street) shall include a shared through and right-turn arrow pavement marking.</li> <li>No project construction truck traffic shall be allowed on eastbound Mission Street during the a.m. (7 a.m. to 9 a.m.) and p.m. (4 p.m. to 6 p.m.) peak periods.</li> <li>No project construction truck traffic shall be allowed on northbound Fremont Street during the a.m. (7 a.m. to 9 a.m.) peak period.</li> <li>An Extralegal Truck Permit shall be applied for a vehicle travelling on local streets for any distance within the City and County of San Francisco if the overall dimensions and/or weight exceed 8.5 feet in width, 65 feet in length, 14 feet in height, and over 34,000 pounds in weight on any one axle.</li> <li>When trucks make egress movements at the construction entrance/exit on Fremont, Mission, or Beale Street, flaggers, a temporary stop sign, or a combination of these methods shall be used to slow approaching traffic.</li> <li>Fences shall be installed at least one foot clear from the edge of the adjacent travel lane.</li> <li>"Road Work Ahead" signs, "Right Lane Closed Ahead" signs, and illuminated Arrow Board Displays shall be posted on the south side of Mission Street west of Fremont Street, and on Fremont Street south of Howard Street.</li> <li>Advance warning signs (e.g., reverse curve sign) shall be installed on Mission Street west of Fremont Street and east of Beale Street.</li> <li>Construction Worker Trip Reduction (CWTR) program shall be implemented. CWTR program measures may include, but not limited to, providing City's Commuter Benefits Program, subsidizing public transit fares, and implementing parking cash out program in place of providing free parking.</li> </ul>
	Could Implement	<ul style="list-style-type: none"> <li>The existing westbound bus lane striping between Fremont and Beale streets could be removed.</li> <li>The existing number two eastbound bus lane on Mission Street between Fremont and Beale streets could be painted in the relocated bus lane.</li> </ul>
	Could Explore	<ul style="list-style-type: none"> <li>The existing westbound traffic signal at the Mission Street/Beale Street intersection could be modified to include a "Queue Jump Signal".</li> </ul>
Walking/ Accessibility	Shall Implement	<ul style="list-style-type: none"> <li>"Sidewalk Closed Ahead/Local Access Only/Cross Here" signs shall be posted on the south side of Mission Street east of Beale Street.</li> <li>"Sidewalk Closed /Use Other Side/Cross Here" signs shall be posted at the following locations: on the south side of Mission Street west of Fremont Street; along the east side of Fremont Street north of Mission Street, and south of Natoma Street.</li> <li>Signs shall be posted on the Minna Street sidewalks east of Fremont Street.</li> <li>Signs shall be placed on the Beale Street west sidewalk north of Mission Street and south of the project site.</li> </ul>

A. Project Description

Mode of Travel	Type <sup>a</sup>	Strategies
		<ul style="list-style-type: none"> <li>• Pedestrian barricades shall be installed at the north end of the east crosswalk and the west end of the south crosswalk at the Mission Street/Fremont Street intersection.</li> <li>• Flaggers shall be required where workers or equipment temporarily block a pedestrian walkway for access into and out of a construction area (e.g., near the intersection of Mission and Beale streets).</li> <li>• Pedestrian walkways shall maintain a minimum 4-foot width and smooth surface for wheelchair access. It shall include ADA compliant wheelchair ramps for connection to the west and the south crosswalks at the Mission Street/Beale Street intersection.</li> <li>• Pedestrian walkways shall be designed to provide a clear view of the oncoming eastbound traffic on Mission Street and southbound traffic on Beale Street for pedestrians waiting to cross the west and south crosswalks, respectively, at the Mission Street/Beale Street intersection.</li> <li>• Pedestrian walkways shall include lighting for pedestrians at all times.</li> <li>• Pedestrian walkways shall be regularly maintained and kept clear of potential construction hazards, such as holes, cracks, debris, dust, and mud.</li> <li>• Pedestrian facilities including the sidewalks and street trees shall be restored to their original condition.</li> <li>• All or a portion of the southwest corner of Mission Street/Beale Street intersection could be restored to existing condition during Stage 6, to provide a wider pedestrian right-of-way along Beale Street (i.e., wider than 4 feet) for those crossing from the northwest corner of the intersection.</li> </ul>
Bicycling	Shall Implement	<ul style="list-style-type: none"> <li>• "Bicycle Crossing/ Share the Road" signs and sharrow pavement markings shall be placed along the south side of Mission Street west of Fremont Street for eastbound bicyclists, on the north side of Mission Street east of Beale Street for westbound bicyclists, and on Fremont Street north of Howard Street for northbound bicyclists along the construction frontage.</li> <li>• "Trucks Crossing" signs, a temporary stop sign, flaggers or a combination of these methods shall be used to alert bicyclists when construction trucks are making wide turns to access in and out of the construction zone on Fremont, Mission, or Beale Street.</li> </ul>
Passenger and Commercial Loading	Shall Implement	<ul style="list-style-type: none"> <li>• "No Stopping and Tow-Away" signs shall be posted on the construction fences along Fremont, Mission, and Beale Street frontages.</li> <li>• Residents of the Tower and Podium buildings shall be notified to use the porte cochere off the two-way driveway for all passenger and commercial loading occurrences.</li> <li>• The restaurant tenant shall post on their website instructions for patron access to the site and encourage patrons to use other nearby passenger loading zones.</li> <li>• Transportation Network Companies (TNC) shall be notified to implement geofencing<sup>b</sup> along the project frontages to prohibit loading activities.</li> </ul>
	Could Implement	<ul style="list-style-type: none"> <li>• Illegal loading occurrences along the project site frontages could be enforced by PCOs during the a.m. (7 a.m. to 9 a.m.) and p.m. (4 p.m. to 6 p.m.) peak periods or using cameras installed on Muni vehicles.</li> </ul>
	Could Explore	<ul style="list-style-type: none"> <li>• The project sponsor could work with SFMTA to temporarily convert convenient on-street parking locations to passenger loading spaces to replace the passenger loading space on Mission Street between Beale and Fremont streets that would be removed during project construction.</li> </ul>
Emergency Access	Shall Implement	<ul style="list-style-type: none"> <li>• Contractors shall coordinate with administrators of the nearest emergency service providers such as police and fire stations, and notify these services in advance of the timing, location, duration of construction activities, as well as the lane closures and suggested alternative routes.</li> <li>• Breaks in the barriers shall be provided along the construction site perimeter to allow construction traffic access as well as San Francisco Fire Department access to fire department connections at all times.</li> </ul>

NOTES:

<sup>a</sup> "Shall Implement" include strategies that shall be implemented; "Could Implement" include strategies that could be implemented based on conditions at the time of construction commencement; "Could Explore" include strategies that could be explored for the purpose of transportation plan.

<sup>b</sup> Geofencing is the practice of using global positioning (GPS) or radio frequency identification (RFID) to define a geographic boundary, or a virtual barrier. TNCs implement geofencing to direct drivers and passengers to pick-up and drop-off zones or blackout certain areas to prohibit loading activities.

SOURCE: CHS Consulting Group, 2019.



## A.8 Operations

There would be no changes to the operation of the Tower and Podium buildings on the associated parcel once construction of the project is complete. Pedestrian access, transit circulation, and vehicular access would be restored to existing conditions.

Routine inspections of the vaults would not be required; however, the sponsor would perform inspections following a major earthquake producing an estimated peak ground acceleration of 0.2 g<sup>31</sup> or greater at the building site or if an abnormal condition triggers an alarm at the remote sensing location within the basement of the Tower building. Alarms that could occur would include (1) a loss (or significant reduction or increase) in load on one or more of the piles and (2) a high water alarm in the drainage sumps. In the former case, an inspector would enter the vault to observe the condition of the pile head structure, including rods, jacking beam and load cell, so as to help with diagnosis of the problem. In the latter case, entry to the vault would require evaluation of the float gauge and level of any water actually present. The vaults would be accessed by the access manholes, the use of which would not require sidewalk closure. Instead, the area immediately around the manhole would be temporarily enclosed, and pedestrians would simply pass around the manholes. In any of these instances, the inspection would require two individuals to remove the vault manhole cover, access the vaults, and visually observe the condition of the jacks, jacking beams, and rods.

## A.9 Required Approvals

The following is a preliminary list of anticipated approvals for the proposed project and is subject to change. These approvals may be reviewed in conjunction with the required environmental review, but may not be granted until after the required environmental review is completed.

### Actions by the San Francisco Board of Supervisors

- Approval of street vacation and an easement to allow occupation of the sub-sidewalk area for the perimeter pile upgrade
- Approval of a state trust exchange to remove trust from the public right-of-way on Mission and Fremont streets and replace it on other public streets

### Actions by the San Francisco Port Commission

- Approval of a state trust exchange to remove trust from the public right-of-way on Mission and Fremont streets and replace it on other public streets

### Actions by Other San Francisco Departments

- San Francisco Planning Department
  - General plan consistency and the eight priority policies of Planning Code section 101.1 findings related to street vacation in accordance with San Francisco Charter section 4.105
- San Francisco Public Works
  - Recommendation to the board of supervisors to approve street vacation, including a recommendation from the Real Estate Division for an easement to allow occupation of the sub-sidewalk area
  - Review and approval of construction-related permits for street use, including temporary shoring, and street tree removal permit

<sup>31</sup> Peak ground acceleration is expressed in terms of g (the acceleration due to Earth's gravity, equivalent to g-force).

- San Francisco Municipal Transportation Agency
  - Authorization of construction-related street use and traffic rerouting
- San Francisco Department of Building Inspection
  - Review and approval of building permits
- San Francisco Public Utilities Commission
  - Review and approval of a batch waste discharge permit in accordance with article 4.1 of the Public Works Code
  - Review and approval of erosion and sediment control plan, in accordance with article 4.2 of the Public Works Code
- San Francisco Department of Public Health
  - Review and approval of site mitigation plan, in accordance with San Francisco Health Code article 22A (Maher ordinance)
  - Review and approval of a dust control plan, in accordance with San Francisco Health Code article 22B (Construction Dust Control Ordinance)

#### **Actions by Other Government Agencies**

- State Lands Commission
  - Approval of a state trust exchange to remove trust from the public right-of-way on Mission and Fremont streets and replace it on other public streets

The approval of the building permits constitutes the Approval Action for the proposed project. The Approval Action date establishes the start of the 30-day period for the appeal of the Final Mitigated Negative Declaration to the Board of Supervisors pursuant to Section 31.04(h)(3) of the San Francisco Administrative Code.

## **B. PROJECT SETTING**

### **B.1 Project Site and Surrounding Land Uses**

As described above, the project site is located primarily within the public right-of-way as well as limited portions of the 301 Mission Street parcel itself, on the south side of Mission Street and east side of Fremont Street within a city block bounded by Fremont Street to the west, Beale Street to the east, and the Transit Center to the south. The immediate surrounding neighborhood is comprised primarily of office, commercial, retail, residential, and transportation uses. High-rise office above ground-floor retail is the predominant use in the area including: a 417-foot-tall 201 Mission Street office building with ground-floor retail across Beale Street east of the site; a 450-foot-tall office building complex at 260 Mission Street north and diagonally east of the site on Mission Street; a 328-foot-tall office building with ground-floor retail at 50 Beale Street and 374-foot-tall office building at 350 Mission Street directly north of the site on Mission Street; and a 1,070-foot-tall Salesforce office building at 415 Mission Street west of the site (see Figure 2).

The closest residences are located on the 301 Mission Street parcel in the Tower building starting on the third floor, approximately 25 feet from the project site work area. The condominiums at 181 Fremont Street, approximately 300 feet south of the project site, are the next closest residential uses to the project site.

## B.2 Cumulative Context

The cumulative context for land use development project effects is typically localized, within the immediate vicinity of the project site, or at the neighborhood level. The proposed project consists of a structural upgrade of the Tower building's foundation, and would not change the operation of the Tower and Podium buildings once construction is complete. Therefore, the cumulative projects include reasonably foreseeable development and infrastructure projects whose construction activities could potentially overlap with construction of the proposed project. The geographic boundary of the cumulative construction projects is Market Street to the north, Folsom Street to the south, First Street to the west, and Main Street to the east. The cumulative projects include the following and mapped on **Figure 19, Cumulative Projects**:

- **Transbay Block 4/200 Folsom Street/200–272 Main Street (Planning Department Case No. 2018-015785ENV).** The project would construct a 47-story, 501-foot-tall building containing a total of approximately 683 dwelling units, ground-floor-retail, and an underground garage with 327 parking spaces. The project is currently under environmental review by the planning department; its construction schedule is unknown at this time.
- **Active Beale Street.** SFMTA would implement the following elements on Beale Street in phases starting as early as spring 2020: (1) a transit-only lane on the west side Beale Street from Market Street to Natoma Street; (2) a protected, two-way cycle track on east side Beale Street from Market Street to Folsom Street; (3) an extension of the existing bus zone on west side Beale Street between Market and Mission streets; (4) wider sidewalks near Market Street and between Howard and Folsom streets; (5) protected bicycle turn boxes at the Beale Street/Howard Street intersection; (6) a loading zone on west side Beale Street between Howard and Folsom streets; and (7) a restored a casual carpool pick-up zone on west side Beale Street between Howard and Folsom streets.
- **Better Market Street Project (Planning Department Case No. 2014.0012E).** The San Francisco Public Works Department, in coordination with the planning department and SFMTA, would provide various transportation and streetscape improvements to a 2.2-mile-long Market Street corridor between Steuart Street and Octavia Boulevard. The project would include changes to the roadway configuration as well as private vehicle access, traffic signals, surface transit, bicycle facilities, pedestrian facilities, streetscapes, commercial and passenger loading, vehicular parking, and utilities. The San Francisco Planning Commission certified the environmental impact report for the project on October 10, 2019. San Francisco Public Works and the SFMTA Board of Directors approved the project on October 15, 2019. The first phase of construction would occur between 5th and 8th streets and would begin in the spring of 2020, and all or some of the Muni routes 5, 5R, 6, 7, 7X, 9, 9R, 21, 31, and F could be rerouted from Market Street to Mission Street if there are operational constraints on Market Street during construction. Construction would continue along and near the Market Street corridor up to 14 years.
- **Oceanwide Center Development Project (Planning Department Case No. 2006.1523E).** Construction has been underway since summer 2017, and it is estimated to last until spring 2026. The project site includes multiple lots within a block bounded by Mission Street to the south, First Street to the east, Stevenson Street to the north, and Second Street to the west. The project would construct two new towers comprising approximately 2.1 million square feet of mixed uses comprising office, retail, hotel, and 265 residential units. Approximately 4,900 square feet of the existing public right-of-way along Jessie Street and Elin Alley Way would be incorporated into the project. Elin Alley would be widened to provide enhanced pedestrian access. Due to the closure of Jessie Street, vehicular traffic has been rerouted onto Ecker Street, heading south, exiting onto Mission Street. A portion of the north sidewalk on Mission Street between Second and First streets has been closed due to construction staging. Construction access to the project site is provided from westbound Mission Street or eastbound Stevenson Street.

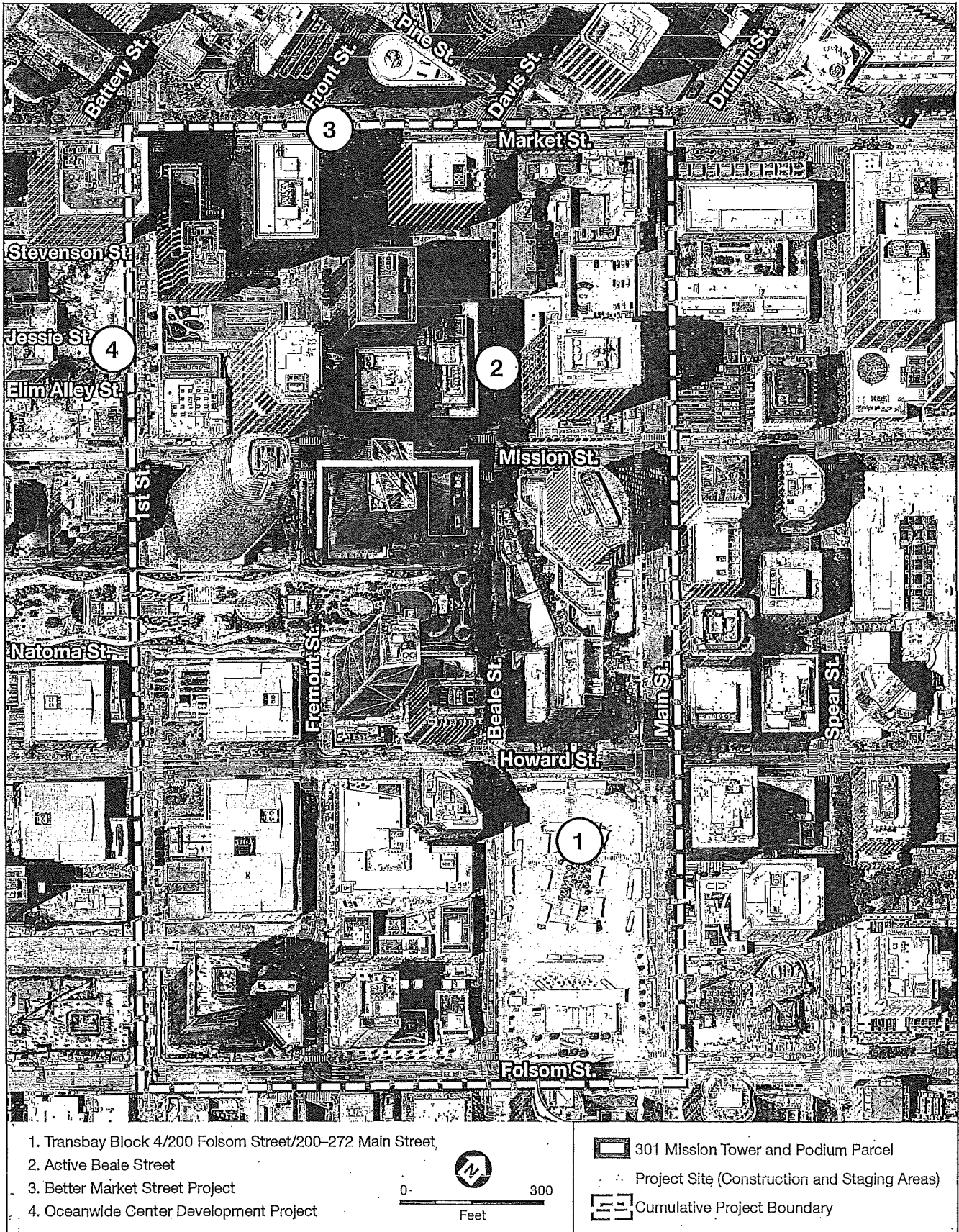

SOURCE: Google Earth, 2019; ESA, 2019

2018-016691ENV: 301 Mission Street Perimeter Pile Upgrade Project

Figure 19  
Cumulative Projects

## C. COMPATIBILITY WITH EXISTING ZONING AND PLANS

	<i>Applicable</i>	<i>Not Applicable</i>
Discuss any variances, special authorizations, or changes proposed to the planning code or zoning map, if applicable.	<input type="checkbox"/>	<input checked="" type="checkbox"/>
Discuss any conflicts with any adopted plans and goals of the City or region, if applicable.	<input checked="" type="checkbox"/>	<input type="checkbox"/>
Discuss any approvals and/or permits from city departments other than the planning department or the Department of Building Inspection, or from regional, state, or federal agencies.	<input checked="" type="checkbox"/>	<input type="checkbox"/>

No variances, special authorizations, or changes to the planning code or zoning map are proposed as part of this project; therefore, these issues are not applicable and are not discussed further.

This section provides a general description of applicable land use plans and policies and how they apply to the project. Potential inconsistencies between the project and the applicable plans are also discussed. Section A.9, Required Approvals, above, describes the anticipated permits and approvals required for project implementation. Project consistency with a particular plan is decided at the time of project approval by the agency charged with that determination. Land use plans typically contain numerous policies that emphasize differing legislative goals, and an interpretation of consistency requires decision-makers to balance the relevant policies. The board or commission that enacted a plan or policy determines the meaning of the policy as well as whether an individual project satisfies the policy at the time the board considers approval of the project.

### C.1 City and County of San Francisco Plans and Policies

#### *San Francisco General Plan*

The San Francisco General Plan (general plan) establishes policies and objectives to guide land use decisions related to the physical development of San Francisco. It is comprised of 10 elements, each of which addresses a particular topic that applies citywide: Air Quality; Arts; Commerce and Industry; Community Facilities; Community Safety; Environmental Protection; Housing; Recreation and Open Space; Transportation; and Urban Design. The proposed project would not include any substantial above-ground changes and therefore would not substantially or obviously conflict with the general plan. Any conflict between the proposed project and policies that relate to physical environmental issues are discussed in Section E, Evaluation of Environmental Effects. The compatibility of the proposed project with general plan policies that do not relate to physical environmental issues will be considered by decision-makers as part of their decision whether to approve or disapprove the proposed project.

#### *Downtown Area Plan*

The *Downtown Area Plan* of the general plan is the city's plan for the Downtown area of San Francisco, where the proposed project is located.<sup>32</sup> The plan includes objectives and policies pertaining to commerce, housing, open space, preservation, urban form, movement of goods and people, and seismic safety.

<sup>32</sup> San Francisco Planning Department, *Downtown Area Plan*, Amended on August 4, 2009, [http://www.sf-planning.org/ftp/General\\_Plan/Downtown.htm](http://www.sf-planning.org/ftp/General_Plan/Downtown.htm), accessed on November 7, 2019.

The proposed project would not involve substantial above-ground changes and therefore would not substantially or obviously conflict with the Downtown Area Plan. Any conflict between the proposed project and policies that relate to physical environmental issues are discussed in Section E, Evaluation of Environmental Effects. The compatibility of the proposed project with general plan policies that do not relate to physical environmental issues will be considered by decision-makers as part of their decision whether to approve or disapprove the proposed project.

### ***Transit Center District Plan***

The *Transit Center District Plan* is a sub-area plan of the city's Downtown Plan and builds on the Downtown Area Plan. It covers approximately 145 acres centered on the Transit Center, which is located across Fremont Street adjacent the proposed project.<sup>33</sup> The plan includes objectives and policies pertaining to land use, urban form, public realm, public open space, movement of goods and people, historic preservation, sustainability, and public improvements.

The proposed project would not involve substantial above-ground changes and therefore would not substantially or obviously conflict with the Transit Center District Plan. Any conflict between the proposed project and policies that relate to physical environmental issues are discussed in Section E, Evaluation of Environmental Effects. The compatibility of the proposed project with general plan policies that do not relate to physical environmental issues will be considered by decision-makers as part of their decision whether to approve or disapprove the proposed project.

### ***Proposition M – Accountable Planning Initiative***

In November 1986, the voters of San Francisco approved Proposition M, the Accountable Planning Initiative, which added section 101.1 to the planning code to establish eight priority policies.<sup>34</sup> These policies and applicable sections of this initial study addressing the environmental issues associated with these policies, are: (1) preservation and enhancement of neighborhood-serving retail uses; (2) protection of neighborhood character; (3) preservation and enhancement of affordable housing; (4) prevention of commuter automobiles from impeding Muni transit service or overburdening streets or neighborhood parking (Question 6a, Transportation and Circulation); (5) protection of industrial and service land uses from commercial office development and enhancement of resident employment and business ownership; (6) maximization of earthquake preparedness (Question 17a through 17d, Geology and Soils); (7) landmark and historic building preservation; and (8) protection of parks and open space and their access to sunlight and vistas.

Prior to issuing a permit for any project that requires an Initial Study under the California Environmental Quality Act (CEQA), or issuing a permit for any demolition, conversion, or change of use, and prior to taking any action that requires a finding of consistency with the general plan, the city is required to find that the project would be consistent with these priority policies. The compatibility of the proposed project with general plan objectives and policies that do not relate to physical environmental issues will be considered by decision makers as part of their decision whether to approve or disapprove the proposed

<sup>33</sup> San Francisco Planning Department, *Transit Center District Plan*, 2012, [http://generalplan.sfplanning.org/Transit\\_Center\\_District\\_Sub\\_Area\\_Plan.pdf](http://generalplan.sfplanning.org/Transit_Center_District_Sub_Area_Plan.pdf), accessed June 7, 2019.

<sup>34</sup> City and County of San Francisco, *San Francisco Planning Code*, section 101.1, [http://library.amlegal.com/nxt/gateway.dll/California/planning/planningcode?f=templates\\$fn=default.htm\\$3.0\\$vid=amlegal:sanfrancisco\\_ca\\$sync=1](http://library.amlegal.com/nxt/gateway.dll/California/planning/planningcode?f=templates$fn=default.htm$3.0$vid=amlegal:sanfrancisco_ca$sync=1), accessed November 7, 2019.

project. Any potential conflicts identified as part of that process would not alter the physical environmental effects of the proposed project.

## C.2 Regional Plans and Policies

The five principal regional planning agencies and their overarching policies and plans (noted in parentheses) that guide planning in the nine-county bay area include the Association of Bay Area Governments (*Projections 2013* and *Plan Bay Area*), the Bay Area Air Quality Management District (*2017 Bay Area Clean Air Plan*), the Metropolitan Transportation Commission (*Regional Transportation Plan – Transportation 2035*), the San Francisco Regional Water Quality Control Board (*San Francisco Basin Plan*), and the San Francisco Bay Conservation and Development Commission (*San Francisco Bay Plan*). Due to the location, size and nature of the proposed project, no anticipated conflicts with regional plans and policies would occur.

## C.3 Permits Required from City and State Agencies

The project would require permits and approvals from several city entities other than the planning and building departments. Specifically, the project would require approval from the San Francisco board of supervisors for street vacation and an easement to allow the project sponsor to occupy the sub-sidewalk area with project's structural components for the perimeter pile upgrade. The project would also require approval from the public works of construction-related permits for street use, including temporary shoring, and a street tree removal permit. Further, the project would require authorization from the San Francisco municipal transportation agency regarding construction-related street use and traffic rerouting; approval from the San Francisco Public Utilities Commission of a batch waste discharge permit and of an erosion and sediment control plan under articles 4.1 and 4.2 of the public works code; and approval from the San Francisco Department of Public Health of a site mitigation plan including a dust control plan in compliance with articles 22A (Maher ordinance) and 22B (Construction Dust Control Ordinance) of the health code.

The project would also require approval from the State Lands Commission to remove trust<sup>35</sup> from the public right-of-way on Mission and Fremont streets and replace it on other public streets. The resulting trust exchange would allow the project sponsor to install the private structural foundation elements in the sidewalk portion of the public right-of-way where the trust has been removed. The State Lands Commission represents the statewide public interest to ensure that trustees (i.e., cities and counties) operate their grants in conformance with the California constitution, applicable granting statutes, and the public trust doctrine. The removal of trust would also require approvals from the San Francisco board of supervisors and port commission.

<sup>35</sup> California acquired all right, title, and interest in tide and submerged lands and beds of navigable waterways within its borders when it became a state in 1850. These lands are sovereign, not proprietary, and have restrictions on their management and use. Unlike proprietary lands, the California Constitution, California law and the *common law Public Trust Doctrine* prohibit the sale or alienation of sovereign lands except in limited circumstances. All sovereign lands are held in trust for the benefit of the people of California. The Legislature has enacted more than 300 statutes granting sovereign public trust lands to over 80 local municipalities (referred to as grantees or trustees) to manage in trust for the people of California. More information on public trust lands is available at [https://www.slc.ca.gov/granted\\_land/](https://www.slc.ca.gov/granted_land/).

## D. SUMMARY OF ENVIRONMENTAL EFFECTS

The proposed project could potentially affect the environmental factor(s) checked below. The following pages present a more detailed checklist and discussion of each environmental factor.

- |   |  |  |
|---|--|--|
| <input type="checkbox"/> Land Use/Planning                    | <input type="checkbox"/> Greenhouse Gas Emissions        | <input type="checkbox"/> Hydrology/Water Quality                       |
| <input type="checkbox"/> Aesthetics                           | <input type="checkbox"/> Wind                            | <input type="checkbox"/> Hazards & Hazardous Materials                 |
| <input type="checkbox"/> Population and Housing               | <input type="checkbox"/> Shadow                          | <input type="checkbox"/> Mineral Resources                             |
| <input checked="" type="checkbox"/> Cultural Resources        | <input type="checkbox"/> Recreation                      | <input type="checkbox"/> Energy  |
| <input checked="" type="checkbox"/> Tribal Cultural Resources | <input type="checkbox"/> Utilities /Service Systems      | <input type="checkbox"/> Agriculture and Forestry Resources            |
| <input type="checkbox"/> Transportation and Circulation       | <input type="checkbox"/> Public Services                 | <input type="checkbox"/> Wildfire                                      |
| <input checked="" type="checkbox"/> Noise                     | <input checked="" type="checkbox"/> Biological Resources | <input checked="" type="checkbox"/> Mandatory Findings of Significance |
| <input checked="" type="checkbox"/> Air Quality               | <input checked="" type="checkbox"/> Geology/Soils        |  |

This initial study examines the proposed project to identify potential effects on the environment. For each item on the initial study checklist, the evaluation has considered the impacts of the proposed project both individually and cumulatively. All items on the initial study checklist that have been checked "Less than Significant Impact with Mitigation Incorporated," "Less than Significant Impact," "No Impact" or "Not Applicable" indicate that, upon evaluation, staff has determined that the proposed project could not have a significant adverse environmental effect relating to that issue. A discussion is included for those issues checked "Less than Significant Impact with Mitigation Incorporated" and "Less than Significant Impact" and for most items checked with "No Impact" or "Not Applicable." For items checked "No Impact" or "Not Applicable" without discussion, the conclusions regarding potential significant adverse environmental effects are based upon field observation, staff experience and expertise on similar projects, and/or standard reference material available within the planning department, such as the planning department's *Transportation Impact Analysis Guidelines for Environmental Review*. For each checklist item, the evaluation has considered the impacts of the proposed project both individually and cumulatively.

## E. EVALUATION OF ENVIRONMENTAL EFFECTS

Topics	Potentially Significant Impact	Less than Significant with Mitigation Incorporated	Less than Significant Impact	No Impact	Not Applicable
<b>1. LAND USE AND PLANNING.</b>					
<b>Would the project:</b>					
a) Physically divide an established community?	<input type="checkbox"/>	<input type="checkbox"/>	<input type="checkbox"/>	<input checked="" type="checkbox"/>	<input type="checkbox"/>
b) Cause a significant physical environmental impact due to a conflict with any land use plan, policy, or regulation adopted for the purpose of avoiding or mitigating an environmental effect?	<input type="checkbox"/>	<input type="checkbox"/>	<input checked="" type="checkbox"/>	<input type="checkbox"/>	<input type="checkbox"/>

The proposed project consists of a structural upgrade of the Tower building foundation. Following construction, the site would be restored to the existing conditions at street level and would not result in any land use changes. Therefore, the following analysis focuses on potential impacts related to land use during construction activities.



**Impact LU-1: The proposed project would not physically divide an established community. (No Impact)**

The division of an established community typically involves the construction of a physical barrier to neighborhood access, such as a new freeway, or the removal of a means of access, such as a bridge or a roadway. Implementation of the proposed project would not result in the construction of a physical barrier to neighborhood access or the removal of an existing means of access; it consists of a structural upgrade of the Tower building foundation primarily within the existing Mission, Beale, and Fremont streets public right-of-way, including sidewalks adjacent to the Tower and Podium buildings. The proposed project would not permanently alter the established street grid or permanently close any streets or sidewalks. Although portions of the sidewalk, parking lanes, and travel lanes adjacent to the project site would be closed for periods of time during project construction, these closures would be temporary in nature and access would be restored after construction. Therefore, the proposed project would not physically divide an established community and thus, would have no impact.

**Impact LU-2: The proposed project would not cause a significant physical environmental impact due to a conflict with any land use plan, policy, or regulation adopted for the purpose of avoiding or mitigating an environmental effect. (Less than Significant)**

Land use impacts would be considered significant if the proposed project would conflict with any plan, policy, or regulation adopted for the purpose of avoiding or mitigating an environmental effect. Environmental plans and policies are those that directly address environmental issues and/or contain targets or standards that must be met in order to preserve or improve characteristics of the city's physical environment. Applicable local land use plans that regulate development on the project site include the San Francisco General Plan and the San Francisco Planning Code. To the extent that substantial physical environmental impacts may result from conflicts with the general plan or planning code, this initial study discloses and analyzes these physical impacts under the relevant environmental topic sections. Moreover, the proposed project would not result in any permanent land use changes; therefore, it would not be expected to conflict with any applicable land use plan, policy, or regulation adopted for the purpose of avoiding or mitigating an environmental effect.

In addition, the proposed project would not conflict with any such adopted environmental plan or policy, including articles 10 and 11 of the city's Planning Code, the 2017 Bay Area Clean Air Plan, San Francisco's Strategies to Address Greenhouse Gas Emissions (GHG Reduction Strategy) and the city's Urban Forestry Ordinance, as discussed in Section E.4, Cultural Resources; Section E.8, Air Quality; Section E.9, Greenhouse Gas Emissions; and Section E.15, Biological Resources, respectively. Therefore, the proposed project would have a less-than-significant impact with regard to conflicts with land use plans, policies, or regulations.

**Impact C-LU-1: The proposed project, in combination with reasonably foreseeable future projects, would not result in a cumulative land use impact. (Less than Significant)**

The cumulative context for land use effects are typically localized, within the immediate vicinity of the project site, or at the neighborhood level. Cumulative construction projects in the project vicinity include Transbay Block 4/200 Folsom Street/200-272 Main Street, Oceanwide Center Development, Active Beale Street, and Better Market Street projects. The Transbay Block 4/200 Folsom Street/200-272 Main Street and

Oceanwide Center Developments would result in the intensification of uses in the project vicinity within existing city blocks; however, they would be consistent with the city's objectives for increasing the supply of housing and mix of development in the vicinity of major transit stops. The Active Beale Street and Better Market Street projects are streetscape projects that result in changes within the right-of-way, and would not result in permanent land use changes. Therefore, these projects, both individually and in combination with the proposed project, would be consistent with the city's planning efforts and would not result in the physical division of an established community, either by constructing a physical barrier to neighborhood access, removing a means of access, altering the established street grid or permanently closing any streets or sidewalks. Thus, the proposed project, in combination with reasonably foreseeable future projects, would not result in a significant cumulative land use impact.

<i>Topics</i>	<i>Potentially Significant Impact</i>	<i>Less than Significant with Mitigation Incorporated</i>	<i>Less than Significant Impact</i>	<i>No Impact</i>	<i>Not Applicable</i>
<b>2. AESTHETICS.</b>					
<b>Except as provided in Public Resources Code section 21099, would the project:</b>					
a) Have a substantial adverse effect on a scenic vista?	<input type="checkbox"/>	<input type="checkbox"/>	<input type="checkbox"/>	<input checked="" type="checkbox"/>	<input type="checkbox"/>
b) Substantially damage scenic resources, including, but not limited to, trees, rock outcroppings, and historic buildings within a state scenic highway?	<input type="checkbox"/>	<input type="checkbox"/>	<input type="checkbox"/>	<input checked="" type="checkbox"/>	<input type="checkbox"/>
c) In non-urbanized areas, substantially degrade the existing visual character or quality of public views of the site and its surroundings? (Public views are those that are experienced from publicly accessible vantage points.) If the project is in an urbanized area, would the project conflict with applicable zoning and other regulations governing scenic quality?	<input type="checkbox"/>	<input type="checkbox"/>	<input type="checkbox"/>	<input type="checkbox"/>	<input checked="" type="checkbox"/>
d) Create a new source of substantial light or glare which would adversely affect daytime or nighttime views in the area?	<input type="checkbox"/>	<input type="checkbox"/>	<input checked="" type="checkbox"/>	<input type="checkbox"/>	<input type="checkbox"/>

The project site is within an urbanized area; therefore, topic E.2(c) is not applicable. The proposed project consists of a structural upgrade of the Tower building foundation. Following construction, the site would be restored to the existing conditions and the project would not result in the construction of new permanent structures above grade. Therefore, the following analysis focuses on potential impacts related to aesthetics during construction activities.

**Impact AE-1: The proposed project would not have a substantial adverse effect on a scenic vista. (No Impact)**

A scenic vista is defined as a vantage point with a broad and expansive view of a significant landscape feature (e.g., a mountain range, lake, or coastline) or of a significant historic or architectural feature (e.g., views of a historic tower or building). A scenic vista is a location that offers a high quality, harmonious, and visually interesting view. The general plan identifies the importance of protecting major views in the city with attention to views of open space and water. Under this definition, scenic vistas in the general project area include views of the San Francisco Bay and waterfront from a publicly accessible location.

The project site is located 0.3-mile from the waterfront along the Embarcadero, is in a densely developed area of the southern Financial District of downtown San Francisco, and is surrounded by a number of high-rise buildings. Construction of the proposed project would result in short-term visual changes in the immediate area due to the presence of construction equipment and material, trailers, stockpiles, and construction-related vehicles. However, once construction is complete the site would be restored to pre-construction conditions and no new permanent structures would be introduced above grade. Due to the distance from the waterfront and highly developed nature of the area, the project site does not provide street-level scenic views of the Bay. Therefore, the proposed project would have no impact on scenic vistas.

**Impact AE-2: The proposed project would not damage scenic resources, including, but not limited to, trees, rock outcroppings, and historic buildings within a state scenic highway. (No Impact)**

Scenic resources include trees, rock outcroppings, and other landscape features that contribute to the scenic character of a public area. Scenic resources, either natural or built, are visual features that positively contribute to the scenic quality of an area. Scenic resources have a distinctive and noticeably positive effect on a viewer's impression of a site or area.

There are no state designated scenic highways in San Francisco. The closest officially designated state scenic highways are Interstate 580, approximately 6 miles east, and a segment of State Route 280 located approximately 9 miles southwest of the project site. As such, there are no scenic highways in the vicinity of the project site. Therefore, no impacts related to scenic resources within a state scenic highway corridor would occur.

Other existing features which contribute to a scenic public setting in the vicinity include the 5.4-acre public park on the roof of the Transit Center south of the project site. The project site does not contain rock outcroppings or historic buildings, but it does contain 13 street trees: three along Fremont Street, seven along Mission Street, and three along Beale Street. As described under Impact AE-1 above, the proposed project would result in short-term visual changes in the immediate area due to the presence of construction equipment. Once construction is complete the site would be restored to pre-construction conditions (including replacement of the 13 street trees) and no new permanent structures would be introduced. The proposed project would not alter views to and from the rooftop Transit Center park (also known as Salesforce Park), nor would views of or access to it be permanently blocked by the project due to the subgrade nature of the construction work. Therefore, the project would have no impact on scenic resources.

**Impact AE-3: The proposed project would not create a new source of substantial light or glare which would adversely affect day or nighttime views in the area or which would substantially impact other people or properties. (Less than Significant)**

Currently, the Tower building has exterior and interior sources of lighting typical of an urban environment. Construction would typically occur between 7 a.m. and 8 p.m. Monday through Friday. As described in Section A, Project Description, Stages 3 and 4 would require an extra shift (8 p.m. to 7 a.m.) to receive oversized truck deliveries for approximately five nights per week. During the nighttime shift, exterior lighting to accommodate the work at the project site would be temporary and short-term in nature. Nighttime lighting would be confined to the project site and directed to the delivery areas on Mission and Fremont streets and would be focused, directed, and shielded to avoid the production of glare, and

minimize up-light and light spill. As feasible, fixtures would be located, aimed, or shielded to minimize stray light to or across the construction site. The closest residences are located on the associated parcel in the Tower building starting on the third floor; no other residences are located in the immediate vicinity of the site. Nighttime lighting would not substantially interfere with nighttime views from residences adjacent to the project site during construction as the lighting would be located at least two stories below the nearest residence and directed downward. In addition, construction-related nighttime lighting would be removed once construction is complete.

There would be no substantial sources of light and glare associated with construction of the project that would adversely affect daytime views in the area. Because the proposed structural upgrade would not change the exterior of the Tower building, no new sources of light would be installed. For these reasons, impacts related to day or nighttime light and glare would be less than significant.

**Impact C-AE-1: The proposed project, in combination with reasonably foreseeable projects in the vicinity of the project site, would not result in cumulatively significant impacts related to aesthetics. (Less than Significant)**

The cumulative context for aesthetics effects are typically localized, within the immediate vicinity of the project site, or at the neighborhood level. Cumulative construction projects in the project vicinity includes the projects identified in Section B.2, Cumulative Context. The construction periods for the four cumulative projects could overlap with the proposed project. However, as described in Impacts AE-1 through AE-3, the proposed project would result in short-term visual changes during construction, and the at grade conditions at the site would be restored to pre-construction conditions once the project is completed. Therefore, the project would not combine with cumulative projects to create or contribute to a significant cumulative impact related to aesthetics.

<i>Topics</i>	<i>Potentially Significant Impact</i>	<i>Less than Significant with Mitigation Incorporated</i>	<i>Less than Significant Impact</i>	<i>No Impact</i>	<i>Not Applicable</i>
<b>3. POPULATION AND HOUSING.</b>					
<b>Would the project:</b>					
a) Induce substantial unplanned population growth in an area, either directly (for example, by proposing new homes and businesses) or indirectly (for example, through extension of roads or other infrastructure)?	<input type="checkbox"/>	<input type="checkbox"/>	<input type="checkbox"/>	<input checked="" type="checkbox"/>	<input type="checkbox"/>
b) Displace substantial numbers of existing people or housing units, necessitating the construction of replacement housing?	<input type="checkbox"/>	<input type="checkbox"/>	<input type="checkbox"/>	<input checked="" type="checkbox"/>	<input type="checkbox"/>

The proposed project consists of a structural upgrade of the Tower building foundation and would not add housing or other uses. Following construction, the surface of the project site would be restored to the existing conditions and would not result in any population or housing changes at the 301 Mission Street parcel. Therefore, the following analysis focuses on potential impacts related to population and housing during the construction period.

**Impact PH-1: The proposed project would not induce substantial unplanned population growth, either directly or indirectly. (No Impact)**

In general, a project would be considered growth-inducing if its implementation would result in substantial population increases either through the development of new homes and businesses, or through the construction of infrastructure, such as the extension of roads, that could lead to substantial new development.

The proposed project does not include new homes or businesses, nor would it extend roads or infrastructure. Therefore, the proposed project would not result in direct population growth. However, the structural upgrade of the existing Tower building's foundation would result in an increase in temporary construction employment (approximately 30 construction employees per day). It is anticipated that construction employees who are not already living in the city would commute from their residences elsewhere in the Bay Area rather than permanently relocate to San Francisco from more distant locations. Since this type of construction work is temporary, filling these jobs with existing Bay Area residents is typical for employers in various construction trades. Once construction is complete, construction workers typically seek employment at other job sites in the region that require their particular skills. Thus, construction of the proposed project would not generate a substantial population increase in the city or region.

Therefore, it is likely that no new permanent residents would reside in the city or Bay Area as a result of the proposed project, and thus, the proposed project would not induce population growth or require the construction of housing. As a result, the proposed project would have no impact with respect to growth inducement.

**Impact PH-2: The proposed project would not displace substantial numbers of existing people or housing units, necessitating the construction of replacement housing. (No Impact)**

As stated, the Millennium Tower parcel at 301 Mission Street associated with the project site includes existing residential uses and ground floor commercial uses. The proposed project consists of a structural upgrade of the existing Tower building's foundation and construction activities would primarily occur in the public right-of-way. No residents or businesses would be displaced as a result of the project. Access to the bank, restaurant, and residences in the Tower and Podium buildings would be maintained during construction. The project would not displace existing housing units or people. Therefore, the proposed project would have no impact related to housing or population displacement.

**Impact C-PH-1: The proposed project, in combination with reasonably foreseeable future projects in the vicinity, would not result in a cumulative impact on population and housing. (No Impact)**

The proposed project would have no impact with respect to population and housing. Therefore, the proposed project would not combine with the effects of other projects to create a significant cumulative impact.

Topics	Potentially Significant Impact	Less than Significant with Mitigation Incorporated	Less than Significant Impact	No Impact	Not Applicable
<b>4. CULTURAL RESOURCES.</b>					
<b>Would the project:</b>					
a) Cause a substantial adverse change in the significance of a historical resource pursuant to §15064.5, including those resources listed in article 10 or article 11 of the San Francisco Planning Code?	<input type="checkbox"/>	<input type="checkbox"/>	<input type="checkbox"/>	<input checked="" type="checkbox"/>	<input type="checkbox"/>
b) Cause a substantial adverse change in the significance of an archaeological resource pursuant to §15064.5?	<input type="checkbox"/>	<input checked="" type="checkbox"/>	<input type="checkbox"/>	<input type="checkbox"/>	<input type="checkbox"/>
c) Disturb any human remains, including those interred outside of formal cemeteries?	<input type="checkbox"/>	<input checked="" type="checkbox"/>	<input type="checkbox"/>	<input type="checkbox"/>	<input type="checkbox"/>

The proposed project consists of a structural upgrade of the existing Tower building foundation. Therefore, the following analysis focuses on potential impacts related to cultural resources during construction and ground-disturbing activities.

**Impact CR-1: The project would not cause a substantial adverse change in the significance of a historical resource as defined in CEQA Guidelines section 15064.5, including those resources listed in article 10 or article 11 of the planning code. (No Impact)**

Pursuant to CEQA Guidelines sections 15064.5(a)(1) and 15064.5(a)(2), historical resources are buildings or structures that are listed, or are eligible for listing, in the California Register of Historical Resources or are identified in a local register of historical resources, such as articles 10 and 11 of the San Francisco Planning Code, or otherwise determined by a local agency to be "historically significant."

A significant impact would occur if the project caused a substantial adverse change to historic-era architectural resources, including buildings, structures, and objects. A substantial adverse change includes the physical demolition, destruction, relocation, or alteration of the resource.

The project site includes public right-of-way on Fremont, Beale, and Mission streets adjacent to the 301 Mission Street parcel as well as limited portions of the parcel. The Tower and Podium buildings, which were constructed within the last 12 years, are the only buildings on the 301 Mission Street parcel. These buildings are not eligible for the National Register or the California Register. There are no designated landmarks or buildings designated Category I-IV under article 11 of the planning code on the project site or associated 301 Mission Street parcel. In addition, the buildings on the associated parcel are not located in a conservation district. Therefore, no buildings on the project site or the 301 Mission Street parcel are considered a historical resource pursuant to CEQA.

The buildings in the area surrounding the project site consist of mainly newer buildings (less than 45 years old). The nearest historic district is the Second and Howard Streets Historic District, which was listed in the National Register in 1999.<sup>36</sup> Located approximately 1,000 feet from the proposed project, this district contains buildings architecturally significant at the local level (National Register Criterion C) within the

<sup>36</sup> Transbay Joint Powers Authority, *Transbay Transit Center Final Supplemental EIS/EIR*, Volume 1, p. 2-242, November, 2018, [https://tjpa.org/uploads/2015/12/Vol-1-TJPA-Final-SEIS-EIR\\_11-18.pdf](https://tjpa.org/uploads/2015/12/Vol-1-TJPA-Final-SEIS-EIR_11-18.pdf), accessed June 20, 2019.

context of San Francisco's rebuilding after the 1906 earthquake and fire.<sup>37</sup> While construction activity can generate vibration that can cause structural damage to nearby buildings within 100 feet, the Second and Howard Streets Historic District is approximately 1,000 feet from the project site and, because of this distance, would not be indirectly affected by the proposed project. For a general discussion of the effects of construction vibration on nearby buildings, refer to Section E.7, Noise.

The proposed project would not directly or indirectly cause a substantial adverse change in the significance of a known eligible historical architectural resource, or any currently unevaluated age-eligible buildings. The proposed project would have no impact with respect to known historic-era architectural resources. No mitigation is required.

**Impact CR-2: The proposed project could cause a substantial adverse change in the significance of an archeological resource pursuant to CEQA Guidelines section 15064.5. (Less than Significant with Mitigation)**

This section discusses archeological resources, both as potential historical resources according to CEQA Guidelines section 15064.5, or as unique archeological resources as defined in CEQA section 21083.2(g). The planning department completed a preliminary archeological review (PAR) for the proposed project.<sup>38</sup> The PAR determined that the proposed project has the potential to cause a substantial adverse change to legally significant prehistoric and historical archeological resources. The potential for encountering archeological resources is determined based on several factors including archeological sensitivity criteria and models, local geology, site history, and the extent of potential soils disturbance or modification, as well as any documented information on known archeological resources in the vicinity.

### **Local Geology**

Prior geotechnical studies at the project site and in the immediate vicinity have indicated substantial variability from one location to another in the stratigraphy that underlies the project site. However, the subsurface conditions at the project site generally consist of approximately 250 feet of various soil types overlying Franciscan Complex bedrock.<sup>39,40</sup> Refer to Figure 3, p. 7, which is for illustrative purposes and shows the various soil types that underlie the project site. As understood based on prior geotechnical borings, artificial fill extends from the ground surface to between 15 to 25 feet bgs. The fill is underlain by 45 to 75 feet of a soft to medium stiff marine clay deposit (known locally as Young Bay Mud) interbedded with marine sands, to depths ranging from approximately 70 to 80 feet bgs. The Young Bay Mud is generally underlain by 10 to 20 feet of stiff to very stiff sandy clay interbedded with medium dense to dense clayey sands, known locally as the Colma Sands, to depths of approximately 90 to 100 feet bgs. Below the Colma Sands layer is a stiff to very stiff marine clay deposit, known locally as Old Bay Clay, which is

<sup>37</sup> Ibid.

<sup>38</sup> Morgan, Sally, *Environmental Planning Preliminary Archeological Review, 301 Mission Street* (Environmental Planning Case No. 2018-016691ENV), March 2019.

<sup>39</sup> John A. Egan, PE, *Geotechnical Evaluation for the Perimeter Pile Upgrade, Millennium Tower – Revision 1, City and County of San Francisco, California*, August 13, 2019, with the assistance of Slate Geotechnical Consultants.

<sup>40</sup> Morgan, Sally, *Environmental Planning Preliminary Archeological Review, 301 Mission Street* (Environmental Planning Case No. 2018-016691ENV), March 2019.

approximately 120 to 160 feet thick and extends to approximately 220 to 250 feet bgs. Finally, bedrock at the project site, known locally as Franciscan Complex, underlies the Old Bay Clay unit.

Pre-construction boring activities were required to understand the potential for hazardous materials in soils and groundwater underneath the project site. During pre-construction boring activities, the project sponsor conducted archeological monitoring. An archeologist was present during drilling to document soil stratigraphy and potential artifact associations.<sup>41</sup> Archeological monitoring of the borings revealed that the historic fill soil within about 2.5 feet of the margin of the 301 Mission building has been subjected to mixing related to slurry amendment of the soil at the time of Tower building construction. A modern fill layer that overlies the slurry-amended soil appears to be imported clay, placed after completion of the soil mixing process. The Tower building construction plans suggest the soil mix wall only extends approximately 2.5 feet beyond the Tower building footprint.<sup>42</sup> This implies that the historic fill layer and interface with the underlying Young Bay Mud may be intact within the current project footprint in the areas not previously subject to slurry amendment.

### **Prehistoric Archeological Sensitivity**

Several recorded prehistoric archeological resources are present within 0.25 mile of the project site, including CA-SFR-112, CA-SFR-135, CA-SFR-193/H, and CA-SFR-205. 'Recorded' means that the resources have been documented and the documentation is on file at the Northwest Information Center at Sonoma State University, Rohnert Park, California. These sites include shell midden deposits with fire-affected rock, lithic debitage (stone tool fragments), groundstone artifacts, and an isolated human burial. Midden sites were identified in and under 10 feet or more of artificial fill. The human burial was found in a stratum of Young Bay Mud or the Old Bay Clay at 55 feet bgs.<sup>43,44,45,46,47,48</sup>

Prior to the 1850s, the project site was within Yerba Buena Cove, having been inundated for several thousand years prior; accordingly, there is a low sensitivity for intact, near-surface prehistoric resources at the project site. However, artificial infilling of Yerba Buena Cove, which began in the early 1850s, used material from a

<sup>41</sup> ESA, *Draft Archeological Monitoring Results Report for Pre-Construction Maher Ordinance Drilling, 301 Mission Street Perimeter Pile Upgrade Project, San Francisco, California* (Environmental Planning Case No. 2018-016691ENV, Block 3719/Lot 020-440). Prepared for Sally Morgan, San Francisco Planning Department, Environmental Planning Division.(EP). September 2019. On file, San Francisco Planning Department. This document contains confidential information; accordingly, it is excluded from the Administrative Record.

<sup>42</sup> Roosevelt, Nick, J. Abrams Law, P.C., email correspondence with Kei Zushi, Senior Environmental Planner, San Francisco Planning Department, October 7, 2019.

<sup>43</sup> Walsh, Michael R., Department of Parks and Recreation Site Record for CA-SFR-112. On file, Northwest Information Center, Sonoma State University, Rohnert Park, CA, 1986.

<sup>44</sup> Pastron, Allen G., *Archival Cultural Resources Evaluation of the Proposed First and Howard Development Project, City and County of San Francisco, California*. Prepared by Archeo-Tec Inc., Oakland, CA, for EIP Associates, San Francisco, CA, 2005.

<sup>45</sup> William Self Associates Inc. (WSA), Department of Parks and Recreation Site Records for CA SFR-135. On file, Northwest Information Center, Sonoma State University, Rohnert Park, CA, 2001.

<sup>46</sup> WSA, *Report on Archaeological Testing Program and Data Recovery at 40 Jessie Street, San Francisco, CA*, Prepared by William Self Associates, Inc., Orinda, CA, for San Francisco City and County, Major Environmental Analysis, City Planning Department, San Francisco, CA, 2006.

<sup>47</sup> Arrigoni, Aimee, Department of Parks and Recreation Site Records for CA SFR-193/H. On file, Northwest Information Center, Sonoma State University, Rohnert Park, CA, 2013.

<sup>48</sup> WSA, Department of Parks and Recreation Site Records for CA SFR-205. On file, Northwest Information Center, Sonoma State University, Rohnert Park, CA, 2018.



variety of sources, including bayshore sand dunes. As the project site was located near the historic bay margins, and a variety of prehistoric archeological resources have been recorded in the project vicinity, there is the possibility that, beyond the perimeter of the slurry-amended belt of soil around the margin of the Tower building, the artificial fill underlying the site to between 15 to 25 feet bgs may contain redeposited prehistoric materials from nearby shoreline sites, if any were present. Redeposited prehistoric archeological materials that could occur in fill layers would be considered significant until demonstrated to the contrary.

There is little or no potential for prehistoric archeological deposits to be present in the Young Bay Mud stratum, since these sediments were deposited under water. However, as demonstrated by the presence of intact human remains in bay sediments near the project site, as discussed above, there is a potential - albeit low - for isolated features of this type to be present in the Young Bay Mud. In addition, there is the potential for pile construction to encounter prehistoric archeological deposits present in the upper layers of the Colma Sands, which immediately underlie the Young Bay Mud; these deposits would be associated with shoreline use and occupation prior to the inundation of the bay shore during Middle Holocene sea-level rise and subsequent burial by Young Bay Mud sediments as the bay filled.<sup>49,50</sup> Finally, in locations where the Colma Sands have been truncated by erosion prior to the Middle Holocene, there is the potential for isolated archeological features, including human remains, to be present in the upper layers of the Old Bay Clay, although this potential is low because of the apparent rarity of such features.

In summary, there is the potential for prehistoric archeological deposits to be present both in the artificial fill layers (outside of the belt affected by slurry amendment) and in the upper layers of the Colma Sands. There also may be the potential for isolated prehistoric archeological features to be present in Young Bay Mud and Old Bay Clay, but the presence of such features in these depositional setting is believed to be very rare and the potential for encountering them in the project's limited excavation area therefore is low.

### ***Historic Archeological Sensitivity***

As noted above, the project site was under water within Yerba Buena Cove near the Fremont Street shoreline until the early 1850s when the area was artificially filled and developed. During the early Gold Rush period, newcomers to San Francisco quickly settled the shoreline area west of Yerba Buena Cove. At the same time, infrastructure improvements in the early 1850s began to push eastward into Yerba Buena Cove as it was filled, and as wharves and city streets were extended into the Bay. Beginning about 1850 and continuing unabated for more than a decade, Yerba Buena Cove was filled with earth and debris, creating "made land" that extended eastward to today's waterfront at the Embarcadero (Front Street). By 1859, Yerba Buena Cove south of Market Street had been filled east to the Beale Street alignment, with a small lagoon remaining at Mission and Fremont streets immediately adjacent to the project site. The entire project block was fully reclaimed and developed by 1869.

<sup>49</sup> Byrd, Brian F., Philip Kajankoski, Jack Meyer, Adrian Whitaker, Rebecca Allen, Meta Bunse, and Bryan Larson, *Archaeological Research Design and Treatment Plan for the Transit Center District Plan Area, San Francisco, California*. Prepared by Far Western Anthropological Research Group, Past Forward Inc., and JRP Historical for San Francisco Planning Department, 2010.

<sup>50</sup> Kajankoski, Philip and Brian F. Byrd, *Prehistoric Archaeological Testing Report of CA-SFR-171 for the Biosolids Digester Facilities Project, Southeast Water Pollution Control Plant, San Francisco, California*. Prepared by Far Western Anthropological Research Group Inc. for the San Francisco Public Utilities Commission, 2017.

Due to the project site's location within former Yerba Buena Cove, there is a heightened sensitivity for maritime features such as ships, wharves, and piers at the interface of the artificial fill and underlying Young Bay Mud. A number of abandoned ships have been documented in the vicinity of the project site, including east of the project site near Howard Street between Main and Spear streets.<sup>51</sup> There is no archival evidence, nor has physical evidence yet been uncovered, to suggest the presence of any abandoned ships within the artificial fill beneath the project site; however, the potential for such resources still remains based on the documented near-shore setting in an area that was used as a port prior to filling.<sup>52</sup> It is also possible that undocumented waterfront infrastructure such as wharves or piers may be present in the project site that could provide valuable information about commercial life in the 1850s and 1860s.<sup>53</sup>

There also exists a heightened sensitivity for sheet refuse deposits at the interface of the artificial fill and underlying Young Bay Mud. Sheet refuse is a layer or scatter of artifacts deposited on the surface (rather than a hollow-filled feature such as a privy pit or well). During excavations for the 110 The Embarcadero/115 Steuart Street Project, researchers at the Anthropological Studies Center (ASC) encountered a sheet refuse deposit on the original Bay floor that was composed of material discarded from a historic wharf during the 1850s–1860s.<sup>54</sup> ASC investigators recovered a variety of domestic artifacts from the deposit and recommended the find was a significant archeological resource because it possessed research potential to address important questions about the way of life of stevedores and teamsters who lived and worked on the waterfront in the 1860s.

Various dwellings and industrial buildings were constructed on the Mission and Fremont street frontages throughout the nineteenth century, but all were destroyed by the 1906 earthquake and subsequent fire. Following the earthquake, the project site was razed and filled to bring the block to its modern grade, and it was redeveloped.

Subsurface hollow-filled features (such as privy or trash pits) associated with nineteenth century buildings present before the earthquake likely would have been to the rear of the structures on the project block, rather than the street frontage where the project site is located. Accordingly, there is a low sensitivity, within the artificial fill layer, for historic features or deposits associated with nineteenth century occupation following land reclamation.

### **Impacts and Mitigation**

The proposed project would install 52 24-inch-diameter perimeter piles to depths over 200 feet. Perimeter pile installation would be preceded by installation of soldier piles to a depth of approximately 45 feet and

<sup>51</sup> Byrd, Brian F., Philip Kaijankoski, Jack Meyer, Adrian Whitaker, Rebecca Allen, Meta Bunse, and Bryan Larson, *Archaeological Research Design and Treatment Plan for the Transit Center District Plan Area, San Francisco, California*. Prepared by Far Western Anthropological Research Group, Past Forward, Inc., and JRP Historical for San Francisco Planning Department, 2010.

<sup>52</sup> Delgado, James P. *Gold Rush Port: The Maritime Archaeology of San Francisco's Waterfront*. University of California Press, Berkeley, California, 2009.

<sup>53</sup> Praetzelis, Mary, and Adrian Praetzelis, *Historic-Period Research Context*. In *San Francisco-Oakland Bay Bridge, West Approach Replacement: Archaeological Research Design and Treatment Plan*, Volume 2, Edited by Grace Ziesing, pp. 146–174, Report to California Department of Transportation, Oakland, from Anthropological Studies Center, Sonoma State University, 2000.

<sup>54</sup> Praetzelis, Mary (editor), *Final Archaeological Resources Report and Data Recovery Report for 110 The Embarcadero, San Francisco, California*, Prepared for the Commonwealth Club of California, 2017.

excavation to a depth of 10 feet to clear existing tie-backs and abandoned utilities, after which the excavation area would be backfilled. Then, 36-inch-diameter outer casings would be excavated through the fill and the underlying Young Bay Mud and Colma Sands strata to a depth of 70 to 90 feet to facilitate installation of the 24-inch-diameter piles. These 24-inch-diameter piles would be drilled down inside the 36-inch-diameter outer casings, to a depths of approximately 220 to 250 feet. The installation of the 24-inch-diameter piles would displace soils along the length of the piles, which would be brought to the surface together with drilling muds that are circulated through the casings. The materials would be deposited in the Baker tanks, then disposed off-site. At the completion of piling installation, slurry walls would be constructed between the soldier piles and the entire construction footprint mass excavated to a depth of approximately 25 feet to complete the mat slab extension, install the jacking system, and construct the vaults.

Artificial fill extends to depths of 15 to 25 feet at the project site and is immediately underlain by Young Bay Mud, which represents the bay bottom prior to 1850, as discussed above. The proposed initial excavation of the entire project footprint to 10 feet in depth for utility clearing would remove fill soil, and construction of the upper 10 to 25 feet of pile casings and the subsequent mass excavation to 25 feet in depth for mat slab and pile vault construction, would remove both historic period bay fill, and Young Bay Mud sediments where the fill stratum is less than 25 feet in depth. This excavation has the potential to result in impacts to historic maritime-associated features and deposits and redeposited prehistoric archeological material that could be present in the artificial fill stratum (outside of the slurry-mixed soil belt, as discussed above), and in the upper part of the Young Bay Mud Stratum, a potentially significant impact.

The installation of 36-inch-diameter outer casings, which would take place after the uppermost 10 feet of the excavation area is backfilled subsequent to utility removal, would entail excavation through the backfill. Re-excavation of the uppermost 10 feet of backfill for pile casing installation has no potential for significant archeological impacts, as any archeological materials present in the upper part of the fill would have been destroyed by the previous excavation. However, outer casing excavation below 10 feet in depth would continue through the remainder of the unexcavated fill and the intact Young Bay Mud stratum, and would extend into the upper layers of the Colma Sands stratum, or the Old Bay Clay stratum where the Colma stratum was eroded away during the rising of the bay. The top of these strata, which are expected to be encountered at 70 to 90 feet below surface, are sensitive for the potential presence of prehistoric archeological deposits and (rare but highly significant) isolated features such as burials. The installation of outer casings therefore has the potential to result in impacts to prehistoric and historic archeological deposits and features. The archeological impact of the outer casing installation between depths of approximately 10 and 90 feet would be potentially significant, with reduced potential within the Young Bay Mud stratum at depths between approximately 30 feet and 65 feet.

The 24-inch-diameter piles would extend to 220 to 250 feet below surface. As the piles would be installed within the radius of the previously-excavated 36-inch-diameter outer casings, the installation of the 24-inch-diameter piles has no potential to result in archeological impacts between the surface and approximately 70 to 90 feet below surface or the depth of the uppermost layer of the Colma Sands, where the bottom of the outer casings would be located. There is no potential for archeological resources to be present below the uppermost layers of the Colma Sands, as their formation precedes the data of the initial human occupation of the region by many thousand years; therefore, there is no potential for archeological impacts below approximately 90 feet depth.

In summary, there is the potential for the proposed excavation and installation of the outer casings and perimeter piles to impact previously unrecorded buried or submerged historic or prehistoric archeological resources. Potential impacts to an archeological resource that is found to qualify as an historical resource per CEQA Guidelines section 15064.5 or a unique archeological resource, as defined in CEQA section 21083.2(g), should any such resource be present, would be potentially significant. Any such potentially significant impacts would be reduced to a less-than-significant level by implementing **Mitigation Measure M-CR-2: Archeological Testing and Monitoring**. As detailed below, this measure would require preparation and implementation of a pre-construction testing and monitoring plan by a qualified archeologist. Based on the information presented above, the archeological mitigation program would include geoaicheological testing in advance of excavation to a depth sufficient to assess the upper 5 feet of the Colma Sands or Old Bay Clay at a sample of the outer casings or perimeter piles locations; archeological monitoring during utility removal excavation; selective archeological monitoring of outer casing installations between the base of the excavation and the base of the outer casing installations, focused on the upper few feet of the Young Bay Mud and the upper few feet of the Colma and/or Old Bay Clay strata (depending on stratigraphic variations around the site); and mass excavation between depth of 10 and 25 feet for mat slab and pile vault installation. Any potentially significant archeological finds would be subject to further archeological assessment and treatment in consultation with the planning department Environmental Review Officer.

Testing, monitoring, and subsequent treatment of discoveries under this measure, would ensure that any prehistoric or historic archeological resources that are encountered by excavations and pile construction at the project site would be appropriately identified, documented and treated. Implementation of this measure therefore would reduce the potentially significant impact to a less-than-significant level.

**Mitigation Measure M-CR-2: Archeological Testing and Monitoring.** Based on a reasonable presumption that archeological resources may be present within the project site, the following measures shall be undertaken to avoid any potentially significant adverse effect from the proposed project on buried or submerged historical resources. The project sponsor shall retain the services of an archeological consultant from the rotational Department Qualified Archeological Consultants List (QACL) maintained by the Planning Department archeologist. The project sponsor shall contact the Department archeologist to obtain the names and contact information for the next three archeological consultants on the QACL, with specialized expertise in geoaicheology and historical archeology. The archeological consultant shall undertake an archeological testing and monitoring program as specified herein. In addition, the consultant shall be available to conduct a data recovery program if required pursuant to this measure. The archeological consultant's work shall be conducted in accordance with this measure at the direction of the Environmental Review Officer (ERO). All plans and reports prepared by the consultant as specified herein shall be submitted first and directly to the ERO for review and comment, and shall be considered draft reports subject to revision until final approval by the ERO. Archeological data recovery programs required by this measure could suspend construction of the project for up to a maximum of four weeks. At the direction of the ERO, the suspension of construction can be extended beyond four weeks only if such a suspension is the only feasible means to reduce to a less-than-significant level potential effects on a significant archeological resource as defined in CEQA Guidelines section 15064.5(a) and (c).

*Consultation with Descendant Communities.* On discovery of an archeological site associated with descendant Native Americans, the Overseas Chinese, or other potentially interested descendant

group, an appropriate representative of the descendant group and the ERO shall be contacted. The representative of the descendant group shall be given the opportunity to monitor archeological field investigations of the site and to offer recommendations to the ERO regarding appropriate archeological treatment of the site, of recovered data from the site, and, if applicable, any interpretative treatment of the associated archeological site. A copy of the Final Archeological Resources Report shall be provided to the representative of the descendant group.

*Archeological Testing and Monitoring Program.* The archeological consultant shall prepare and submit to the ERO for review and approval an archeological testing plan and archeological monitoring plan (ATP/AMP). The ATP/AMP shall identify the property types of the expected archeological resource(s) that potentially could be adversely affected by the proposed project, the testing method to be used, and the locations recommended for testing and monitoring. The purpose of the archeological testing and monitoring program will be to determine to the extent possible the presence or absence of archeological resources or strata with potential to include archeological resources and to identify and to evaluate whether any archeological resource encountered on the site constitutes an historical resource under CEQA.

The archeological testing and monitoring program shall be conducted in accordance with the approved ATP/AMP, as follows:

**Archeological testing** shall consist of geoarcheological coring prior to the beginning of project excavations and/or in concert with post-approval geotechnical testing, and shall, at minimum, include sampling of the uppermost 5 feet of the Young Bay Mud and the uppermost 5 feet of the Colma Sands Formation, or of the Old Bay Clay, where this stratum directly underlies the Young Bay Mud stratum. At the completion of the archeological testing program, the archeological consultant shall submit a written report of the findings to the ERO. If based on the archeological testing program the archeological consultant finds that significant archeological resources may be present, the ERO in consultation with the archeological consultant shall determine if additional measures are warranted. Additional measures that may be undertaken include additional archeological testing, modifications to the archeological monitoring program, and/or implementation of an archeological data recovery program, as detailed below. No archeological data recovery shall be undertaken without the prior approval of the ERO or the Planning Department archeologist.

**Archeological monitoring** shall include at least intermittent monitoring of excavations within bay fill and the upper portion of the Young Bay Mud stratum, and selective monitoring of the installation of the 36-inch-diameter outer casings. The archeological consultant, project sponsor, and ERO shall meet and consult on any adjustments needed in the scope of archeological monitoring based on the results of geoarcheological testing and the judgment of the project archeologist, reasonably prior to the commencement of mass excavation and casing installations. Whether or not significant archeological resources are encountered, the archeological consultant shall submit a written report of the findings of the monitoring program to the ERO. If no potential archeological resources are identified, the final report shall consist of an Archeological Testing Results Report/ Archeological Monitoring Results Report (AMRR/ATRR). If significant resources are identified, the consultant shall prepare a Final Archaeological Resources Report (FARR), the contents of which are detailed below.

In addition:

- Prior to the beginning of construction soil disturbance, the archeological consultant shall advise all project contractors to be on the alert for evidence of the presence of the expected resource(s), of how to identify the evidence of the expected resource(s), and of the appropriate protocol in the event of apparent discovery of an archeological resource;
- The archeological monitor(s) shall be present on the project site according to a schedule agreed upon by the archeological consultant and the ERO until the ERO has, in consultation with the project archeological consultant, determined that project construction activities could have no effects on significant archeological deposits;
- The archeological monitor shall record and be authorized to collect soil samples and artifactual/ecofactual material as warranted for analysis;
- If an intact archeological deposit is encountered, all soils-disturbing activities in the vicinity of the deposit shall cease. The archeological monitor shall be empowered to temporarily redirect demolition/excavation/pile installation/construction activities and equipment until the deposit is evaluated. If in the case of pile installation or deep foundation activities (foundation, shoring, etc.), the archeological monitor has cause to believe that the pile installation or deep foundation activities may affect an archeological resource, the pile installation or deep foundation activities shall be terminated until an appropriate evaluation of the resource has been made in consultation with the ERO. The archeological consultant shall immediately notify the ERO of the encountered archeological deposit. The archeological consultant shall make a reasonable effort to assess the identity, integrity, and significance of the encountered archeological deposit, and present the findings of this assessment to the ERO.

*Archeological Data Recovery Program.* The archeological data recovery program, when required through the process set forth above, shall be conducted in accord with an archeological data recovery plan (ADRP). The archeological consultant, project sponsor, and ERO shall meet and consult on the scope of the ADRP prior to preparation of a draft ADRP. The archeological consultant shall submit a draft ADRP to the ERO. The ADRP shall identify how the proposed data recovery program will preserve the significant information the archeological resource is expected to contain. That is, the ADRP will identify what scientific/historical research questions are applicable to the expected resource, what data classes the resource is expected to possess, and how the expected data classes would address the applicable research questions. Data recovery, in general, should be limited to the portions of the historical resource that could be adversely affected by the proposed project. Destructive data recovery methods shall not be applied to portions of the archeological resources if nondestructive methods are practical.

The scope of the ADRP shall include the following elements:

- Field Methods and Procedures – Descriptions of proposed field strategies, procedures, and operations
- Cataloguing and Laboratory Analysis – Description of selected cataloguing system and artifact analysis procedures
- Discard and Deaccession Policy – Description of and rationale for field and post-field discard and deaccession policies

- Interpretive Program – Consideration of an on-site/off-site public interpretive program based on the results of the archeological data recovery program
- Security Measures – Recommended security measures to protect the archeological resource from vandalism, looting, and non-intentionally damaging activities
- Final Report – Description of proposed report format and distribution of results
- Curation – Description of the procedures and recommendations for the curation of any recovered data having potential research value, identification of appropriate curation facilities, and a summary of the accession policies of the curation facilities

*Human Remains, Associated or Unassociated Funerary Objects.* The treatment of human remains and of associated or unassociated funerary objects discovered during any soils disturbing activity shall comply with applicable State and federal laws. This shall include immediate notification of the Medical Examiner of the City and County of San Francisco and, in the event of the Medical Examiner's determination that the human remains are Native American remains, notification of the California State Native American Heritage Commission, which will appoint a Most Likely Descendant (MLD). The MLD will complete his or her inspection of the remains and make recommendations or preferences for treatment within 48 hours of being granted access to the site (Public Resources Code section 5097.98). The ERO also shall be notified immediately upon the discovery of human remains.

The project sponsor and ERO shall make all reasonable efforts to develop a Burial Agreement ("Agreement") with the MLD, as expeditiously as possible, for the treatment and disposition, with appropriate dignity, of human remains and associated or unassociated funerary objects (as detailed in CEQA Guidelines section 15064.5(d)). The Agreement shall take into consideration the appropriate excavation, removal, recordation, scientific analysis, custodianship, curation, and final disposition of the human remains and associated or unassociated funerary objects. If the MLD agrees to scientific analyses of the remains and/or associated or unassociated funerary objects, the archeological consultant shall retain possession of the remains and associated or unassociated funerary objects until completion of any such analyses, after which the remains and associated or unassociated funerary objects shall be reinterred or curated as specified in the Agreement.

Nothing in existing State regulations or in this mitigation measure compels the project sponsor and the ERO to accept treatment recommendations of the MLD. However, if the ERO, project sponsor and MLD are unable to reach an Agreement on scientific treatment of the remains and associated or unassociated funerary objects, the ERO, with cooperation of the project sponsor, shall ensure that the remains and/or mortuary materials are stored securely and respectfully until they can be reinterred on the property, with appropriate dignity, in a location not subject to further or future subsurface disturbance.

Treatment of historic-period human remains and of associated or unassociated funerary objects discovered during any soil-disturbing activity, additionally, shall follow protocols laid out in the project's archeological treatment documents, and in any related agreement established between the project sponsor, Medical Examiner and the ERO.

*Final Archeological Resources Report.* The archeological consultant shall submit a Draft Final Archeological Resources Report (FARR) to the ERO that evaluates the historical significance of any discovered archeological resource and describes the archeological and historical research methods

employed in the archeological testing/monitoring/data recovery program(s) undertaken. The Draft FARR shall also include an Interpretation Plan for public interpretation of all significant archeological features.

Once approved by the ERO, copies of the FARR shall be distributed as follows: California Historical Resources Information Center Northwest Information Center (NWIC) shall receive one copy and the ERO shall receive a copy of the transmittal of the FARR to the NWIC. The Environmental Planning division of the Planning Department shall receive one bound, one unbound and one unlocked, searchable PDF copy on CD of the FARR along with copies of any formal site recordation forms (CA DPR 523 series) and/or documentation for nomination to the National Register of Historic Places/California Register of Historical Resources. In instances of high public interest in or the high interpretive value of the resource, the ERO may require a different final report content, format, and distribution than that presented above.

**Impact CR-3: The proposed project could disturb human remains, including those interred outside of formal cemeteries (Less than Significant with Mitigation)**

Although no human remains have been identified within the project area, the possibility that human remains are present and could be subject to inadvertent disturbance during construction of the project cannot be entirely discounted. Although unlikely, earthmoving activities associated with project construction could result in direct impacts on previously undiscovered human remains, which would be a significant impact. Implementation of **Mitigation Measure M-CR-2, Archeological Testing and Archeological Monitoring**, which includes required procedures for the treatment of human remains, during project construction would address impacts on any buried human remains and associated or unassociated funerary objects that are discovered during project construction activities by requiring the project sponsor to solicit the Most Likely Descendant's recommendations and adhere to appropriate excavation, removal, recordation, analysis, custodianship, curation, and final disposition protocols. With implementation of Mitigation Measure M-CR-2, the potential impact of project construction would be less than significant with mitigation.

**Impact C-CR-1: The proposed project, in combination with reasonably foreseeable future projects, would not result in significant cumulative impacts to cultural resources. (No Impact)**

The project would not entail installation of any permanent above ground features. No historic-era architectural resources would be directly or indirectly affected by the proposed project. Therefore, the proposed project does not have the potential to contribute to any cumulative impact on historic architectural resources.

The area for cumulative analysis of archeological resources is the project site, where excavation and pile installation would occur, and adjacent sites where construction of cumulative projects could have impacts on the same resources as would be affected by the project. None of the cumulative projects would overlap with activities at the project site, nor are there any known archaeological resources on the project site that extend outside of the project site and could be affected by nearby development. As described in Impact CR-2 and Impact CR-3 above, the proposed project would implement **Mitigation Measure M-CR-2, Archeological Testing and Monitoring**. Implementation of this measure would ensure that any potentially significant prehistoric archeological resources encountered in the project site are appropriately identified,



documented and treated, such that project-related impacts on archeological resources and human remains would be less than significant with mitigation. Because the potential impact is site-specific and generally limited to the immediate construction area, and because there are no known resources that extend outside the project site and that could be affected by adjacent development, the proposed project would not combine with other reasonably foreseeable future project's impacts to have a significant cumulative impact on archeological resources or human remains. Cumulative impacts therefore would not occur.

<u>Topics</u>	<i>Potentially Significant Impact</i>	<i>Less than Significant with Mitigation Incorporated</i>	<i>Less than Significant Impact</i>	<i>No Impact</i>	<i>Not Applicable</i>
<b>5. TRIBAL CULTURAL RESOURCES.</b>					
<b>Would the project:</b>					
a) Cause a substantial adverse change in the significance of a tribal cultural resource, defined in Public Resources Code section 21074 as either a site, feature, place, or cultural landscape that is geographically defined in terms of the size and scope of the landscape, sacred place, or object with cultural value to a California Native American tribe, and that is:					
i) Listed or eligible for listing in the California Register of Historical Resources, or in a local register of historical resources as defined in Public Resources Code section 5020.1(k), or	<input type="checkbox"/>	<input checked="" type="checkbox"/>	<input type="checkbox"/>	<input type="checkbox"/>	<input type="checkbox"/>
ii) A resource determined by the lead agency, in its discretion and supported by substantial evidence, to be significant pursuant to criteria set forth in subdivision (c) of Public Resources Code section 5024.1. In applying the criteria set forth in subdivision (c) of Public Resources Code section 5024.1, the lead agency shall consider the significance of the resource to a California Native American tribe.	<input type="checkbox"/>	<input checked="" type="checkbox"/>	<input type="checkbox"/>	<input type="checkbox"/>	<input type="checkbox"/>

The proposed project consists of a structural upgrade of the existing Tower building foundation. Therefore, the following analysis focuses on potential impacts related to potential impacts to tribal cultural resources during construction and ground-disturbing activities.

**Impact TC-1: The proposed project could result in a substantial adverse change in the significance of a tribal cultural resource as defined in Public Resources Code section 21074. (Less than Significant with Mitigation)**

CEQA section 21074.2 requires the lead agency to consider the effects of a project on tribal cultural resources. As defined in section 21074, tribal cultural resources are sites, features, places, cultural landscapes, sacred places, and objects with cultural value to a California Native American tribe that are listed, or determined to be eligible for listing, on the national, state, or local register of historical resources. Pursuant to CEQA section 21080.3.1(d), on June 24, 2019, the planning department contacted Native American individuals and organizations for the San Francisco area, providing a description of the project and requesting comments on the identification, presence, and significance of tribal cultural resources in the project vicinity. During the 30-day comment period, no Native American tribal representatives contacted the planning department to request consultation.

Based on background research and as discussed under Impact CR-2, the project site is in an archeologically sensitive area with the potential for prehistoric archeological resources to be encountered as redeposited archeological materials in the artificial fill and upper surface of the Young Bay Mud; and as deeply buried

prehistoric features, such as human remains, within the Young Bay Mud and the upper layer of the Colma Sands or Old Bay Clay that underlies the Young Bay Mud at the site (at approximately 70 to 90 feet bgs). In San Francisco, based on the results of prior tribal consultation, all prehistoric archeological resources are considered to be potential tribal cultural resources. If a prehistoric archeological site were found to be present within the project site, the site would be considered to be a potential tribal cultural resource, and construction damage to the site would be considered a significant impact. As discussed under Impact CR-2, Mitigation Measure M-CR-2: Archeological Testing and Monitoring, would be applicable to the proposed project. Prehistoric archeological resources or human remains encountered during implementation of Mitigation Measure M-CR-2, or encountered during project construction, would be assumed to be tribal cultural resources. Therefore, the potential adverse effects of the proposed project on previously unidentified archeological resources, discussed under Impact CR-2, also represent a potentially significant impact on tribal cultural resources. Implementation of **Mitigation Measure M-TC-1, Tribal Cultural Resources Interpretive Program**, would reduce potential adverse effects on tribal cultural resources to a less-than-significant level. Mitigation Measure M-TC-1 would require either preservation-in-place of the tribal cultural resources, if determined effective and feasible, or development of an interpretive program regarding the tribal cultural resources in consultation with affiliated Native American tribal representatives.

**Mitigation Measure M-TC-1: Tribal Cultural Resources Interpretive Program.** If the Environmental Review Officer (ERO) determines that a significant archeological resource is present, and if in consultation with the affiliated Native American tribal representatives, the ERO determines that the resource constitutes a tribal cultural resource and that the resource could be adversely affected by the proposed project, the proposed project shall be redesigned so as to avoid any adverse effect on the significant tribal cultural resource, if feasible.

If the ERO determines that preservation-in-place of the tribal cultural resource is both feasible and effective, then the archeological consultant shall prepare an archeological resource preservation plan (ARPP). Implementation of the approved ARPP by the project sponsor and the archeological consultant shall be required when feasible.

If the ERO, in consultation with the affiliated Native American tribal representatives and the project sponsor, determines that preservation-in-place of the tribal cultural resources is not a sufficient or feasible option, the project sponsor shall implement an interpretive program of the tribal cultural resource in consultation with affiliated tribal representatives. An interpretive plan produced in consultation with the ERO and affiliated tribal representatives, at a minimum, and approved by the ERO would be required to guide the interpretive program. The plan shall identify, as appropriate, proposed locations for installations or displays, the proposed content and materials of those displays or installation, the producers or artists of the displays or installation, and a long-term maintenance program. The interpretive program may include artist installations, preferably by local Native American artists, oral histories with local Native Americans, artifacts displays and interpretation, and educational panels or other informational displays.

**Impact C-TC-1: The proposed project, in combination with reasonably foreseeable future projects, would not result in significant cumulative impacts to tribal cultural resources. (No Impact)**

Project-related impacts on tribal cultural resources are site-specific and generally limited to a project's construction area and adjacent areas that may overlie the same resource. The construction areas of the cumulative projects do not overlap with the proposed project site, nor are there known prehistoric or tribal cultural resources on the project site that are known to extend to other adjacent project sites. Further, as described under Impact TC-1, the proposed project would be required to implement Mitigation Measure M-TC-1, which would ensure that project-related impacts on tribal cultural resources, should any be present within the construction area, would be less than significant. For these reasons, the proposed project's impact, which would be less than significant with mitigation, would not combine with other reasonably foreseeable future project's impacts to have a significant cumulative impact on tribal cultural resources. Therefore, no cumulative impact would occur.

<i>Topics</i>	<i>Potentially Significant Impact</i>	<i>Less than Significant with Mitigation Incorporated</i>	<i>Less than Significant Impact</i>	<i>No Impact</i>	<i>Not Applicable</i>
<b>6. TRANSPORTATION AND CIRCULATION.</b>					
<b>Would the project:</b>					
a) Conflict with a program, plan, ordinance, or policy addressing the circulation system, including transit, roadway, bicycle, and pedestrian facilities?	<input type="checkbox"/>	<input type="checkbox"/>	<input checked="" type="checkbox"/>	<input type="checkbox"/>	<input type="checkbox"/>
b) Conflict or be inconsistent with CEQA Guidelines section 15064.3, subdivision (b)?	<input type="checkbox"/>	<input type="checkbox"/>	<input type="checkbox"/>	<input type="checkbox"/>	<input checked="" type="checkbox"/>
c) Substantially increase hazards due to a geometric design feature (e.g., sharp curves or dangerous intersections) or incompatible uses?	<input type="checkbox"/>	<input type="checkbox"/>	<input checked="" type="checkbox"/>	<input type="checkbox"/>	<input type="checkbox"/>
d) Result in inadequate emergency access?	<input type="checkbox"/>	<input type="checkbox"/>	<input checked="" type="checkbox"/>	<input type="checkbox"/>	<input type="checkbox"/>

This section presents the existing transportation and circulation conditions and analyzes the potential impacts on transportation and circulation during construction and operation of the project. Transportation and circulation topics consist of walking, bicycling, driving hazards, transit, emergency access, vehicle miles traveled, and loading. The CEQA Guidelines section 15064.3, subdivision (b) does not apply to this project because the project is a voluntary seismic improvement to an existing building that would not change the VMT associated with the existing land uses at and near 301 Mission Street. Therefore, topic E.6(b) is not applicable to the proposed project.

The analysis in this section is based on the Construction Transportation Management Plan (transportation plan) that was developed as part of the proposed project and is included in Appendix A.<sup>55</sup> As described in Section A, Project Description, the transportation plan lays out a set of strategies (see Table 4, Summary of Transportation Management Strategies, p. 34) designed to manage construction impacts of the proposed project based on the understanding of transportation conditions at the time of construction commencement.

<sup>55</sup> CHS Consulting Group, *301 Mission Street Perimeter Pile Upgrade Project Transportation Management Plan*, Final – October, 2019, prepared for: City and County of San Francisco Planning Department.

Therefore, the proposed strategies are grouped into the following three categories to help understand the likelihood of implementing different strategies:

1. Strategies that shall be implemented with certainty – Many of these strategies are required as part of the SFMTA Regulations for Working in San Francisco Streets (commonly referred to as the Blue Book), and San Francisco Public Works (public works) and the Division of Occupational Safety and Health in State of California (CAL OSHA) regulations.
2. Strategies that could be implemented based on conditions at the time of construction commencement – Adjustments or additional coordination may be needed by responsible parties depending on transportation conditions at the time of construction commencement.
3. Strategies that could be explored for the purpose of the transportation plan but may not be feasible to implement – They are strategies recommended to improve transportation conditions but are not required.

The transportation impact analyses presented in this initial study assumes that the first two groups of transportation plan strategies (i.e., strategies that shall be implemented with certainty or could be implemented based on conditions at the time of construction commencement) would be implemented as part of the proposed project.

The transportation and circulation section generally relies on the San Francisco Planning Department's 2019 Transportation Impact Analysis Guidelines (2019 guidelines) and is organized as follows:

1. Existing Conditions: This section describes the existing roadway, walking, bicycling, public transit, emergency access, and loading conditions.<sup>56</sup>
2. Near-Term Baseline Conditions: This section describes known and funded projects that would be operational by the time the proposed project commences construction (i.e., the Transit Center<sup>57</sup>) and any changes to the existing roadway, walking, bicycling, public transit, emergency access, and loading conditions that may occur with implementation of the near-term baseline projects.
3. Cumulative Conditions: This section describes reasonably foreseeable projects that could be under construction or operational at the same time as the proposed project.
4. Impact Analysis: This section provides an analysis of near-term baseline plus project and cumulative plus project impacts.

### **Existing Conditions**

The following describes the existing transportation and circulation conditions at the time of data collection (April 2019). The transportation study area consists of those locations where the project could potentially affect transportation and circulation conditions, and is generally bounded by Market Street to the north, Fremont Street to the west, Howard Street to the south, and Beale Street to the east. The following provides a summary of existing transportation and circulation conditions. **Figure 20, Transportation Study Area**

<sup>56</sup> The description of existing conditions reflects the transportation and circulation conditions in the vicinity of the project site at the time of data collection, which occurred in April 2019.

<sup>57</sup> The Transit Center is considered as part of the near-term baseline because it was temporarily closed for structural repairs when the transportation data collection and analysis for the Initial Study was completed. The repairs have since been completed and the Transit Center is fully operational as of August 12, 2019. Refer to the Near-Term Baseline Conditions section for further information.

and Study Intersections, shows the transportation study area and study intersections. Section A.2, p. 3, provides a detailed description of the existing roadways and circulation.

## REGIONAL AND LOCAL ROADWAYS

The project site is located approximately 0.3 miles west of I-80, which provides freeway access to and from the project site via on-ramps at 1st Street (to eastbound) and 4th Street (to westbound) and off-ramps at Fremont Street (from westbound) and 4th Street (from eastbound). Local access to the project site is provided by Mission, Fremont, Beale, Market, and Howard streets. Appendix B, Attachment B.1, Existing and Baseline Roadway Geometry, includes the existing roadway geometry for Fremont, Mission, and Beale streets adjacent to the project site.

Vehicular turning movement counts were collected and vehicular conditions were observed at five intersections (Market Street/Fremont Street, Market Street/Beale Street, Mission Street/Fremont Street, Mission Street/Beale Street, and Howard Street/Fremont Street) on Tuesday, April 9, 2019 during the a.m. and p.m. peak periods. Vehicles were observed to travel at or lower than the speed limit, and no existing potentially hazardous conditions were observed related to people driving. Appendix B, Attachment B.2, Vehicle Turning Movement, Bicycle, Pedestrian, and Loading Counts, include the existing vehicle counts along these streets. Fremont Street carries the heaviest traffic volumes with approximately 1,416 a.m. peak hour trips and 1,208 p.m. peak hour trips. Beale Street carries approximately 792 a.m. peak hour trips and 885 p.m. peak hour trips. Mission Street carries approximately 852 a.m. peak hour trips and 788 p.m. peak hour trips.

## WALKING CONDITIONS

Between Fremont and Beale streets, Mission Street's south sidewalk is approximately 15 feet wide and the north sidewalk is approximately 16 feet and 6 inches wide. In the vicinity of the project site Fremont Street's east sidewalk is approximately 15 feet wide, and the west sidewalk is approximately 21 feet wide. Beale Street's west sidewalk is approximately 23 feet wide, and the east sidewalk is approximately 14 feet and 6 inches wide in the project site vicinity. All five study intersections (Market Street/Fremont Street, Market Street/Beale Street, Mission Street/Fremont Street, Mission Street/Beale Street, and Howard Street/Fremont Street) have crosswalks at all four legs of the intersections, pedestrian signal heads, and American Disability Act (ADA) compliant curb ramps with detectable warning surface (e.g., dome-shaped bumps). In the vicinity of the project site, Fremont and Market streets are designated as part of the Vision Zero's High Injury Network. Figure 21, Existing Walking Network, presents the existing pedestrian network including High Injury Network streets.

Pedestrian counts were collected and pedestrian conditions were observed at five intersections (Market Street/Fremont Street, Market Street/Beale Street, Mission Street/Fremont Street, Mission Street/Beale Street, and Howard Street/Fremont Street) on Tuesday, April 9, 2019, during the a.m. and p.m. peak periods. People walked freely without obstacles along the streets, and no existing potentially hazardous conditions were observed. Appendix B, Attachment B.2, Vehicle Turning Movement, Bicycle, Pedestrian, and Loading Counts, includes the existing pedestrian counts. In the vicinity of the project site, pedestrian volumes are generally high with approximately 3,977 a.m. peak hour and 4,562 p.m. peak hour pedestrian crossings at the Mission Street/Fremont Street intersection, and 3,336 a.m. peak hour and 3,613 p.m. peak hour pedestrian crossings at the Mission Street/Beale Street intersection.

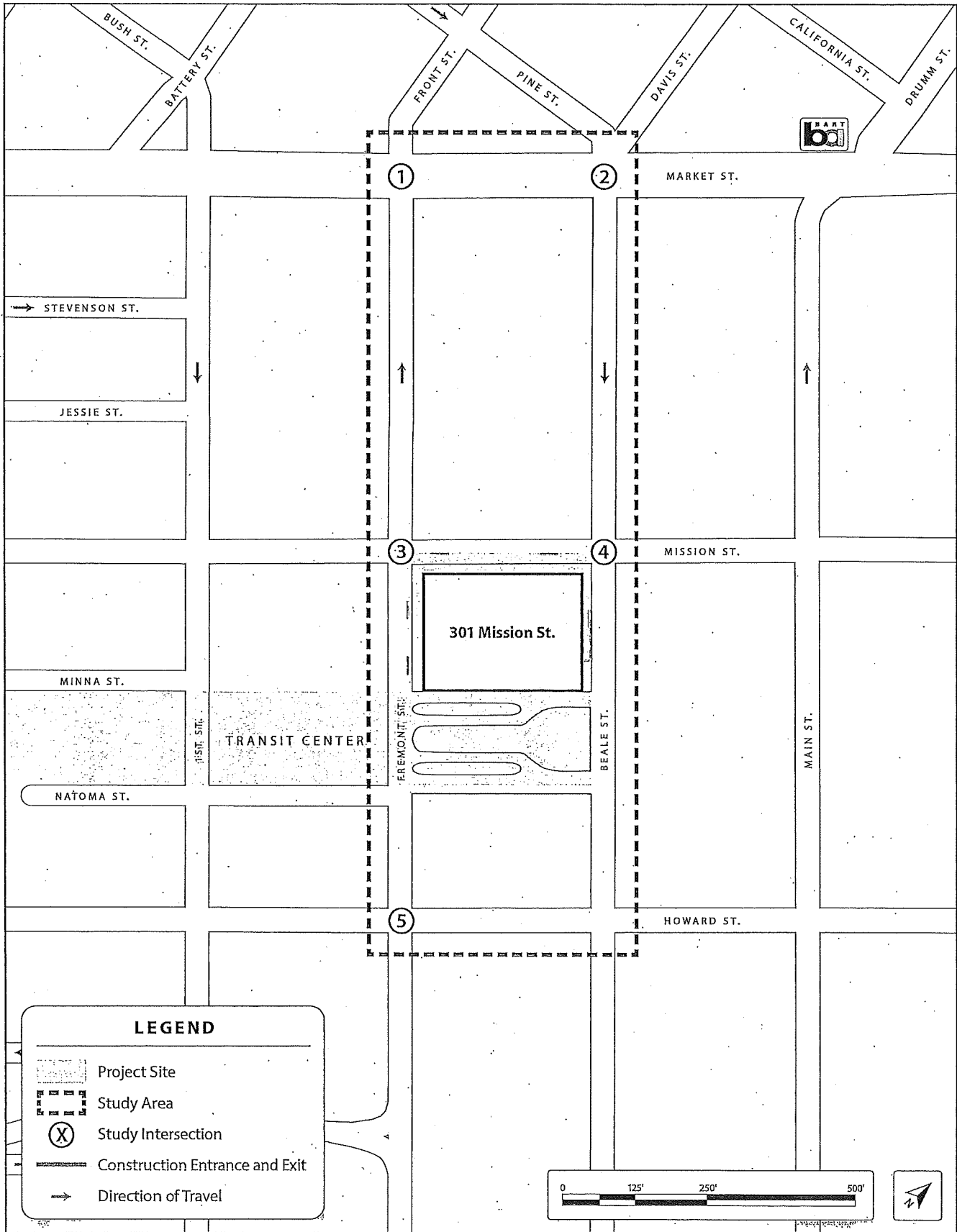

SOURCE: CHS Consulting Group, 2019

2018-016691ENV: 301 Mission Street Perimeter Pile Upgrade Project

**Figure 20**  
Transportation Study Area and Study Intersections

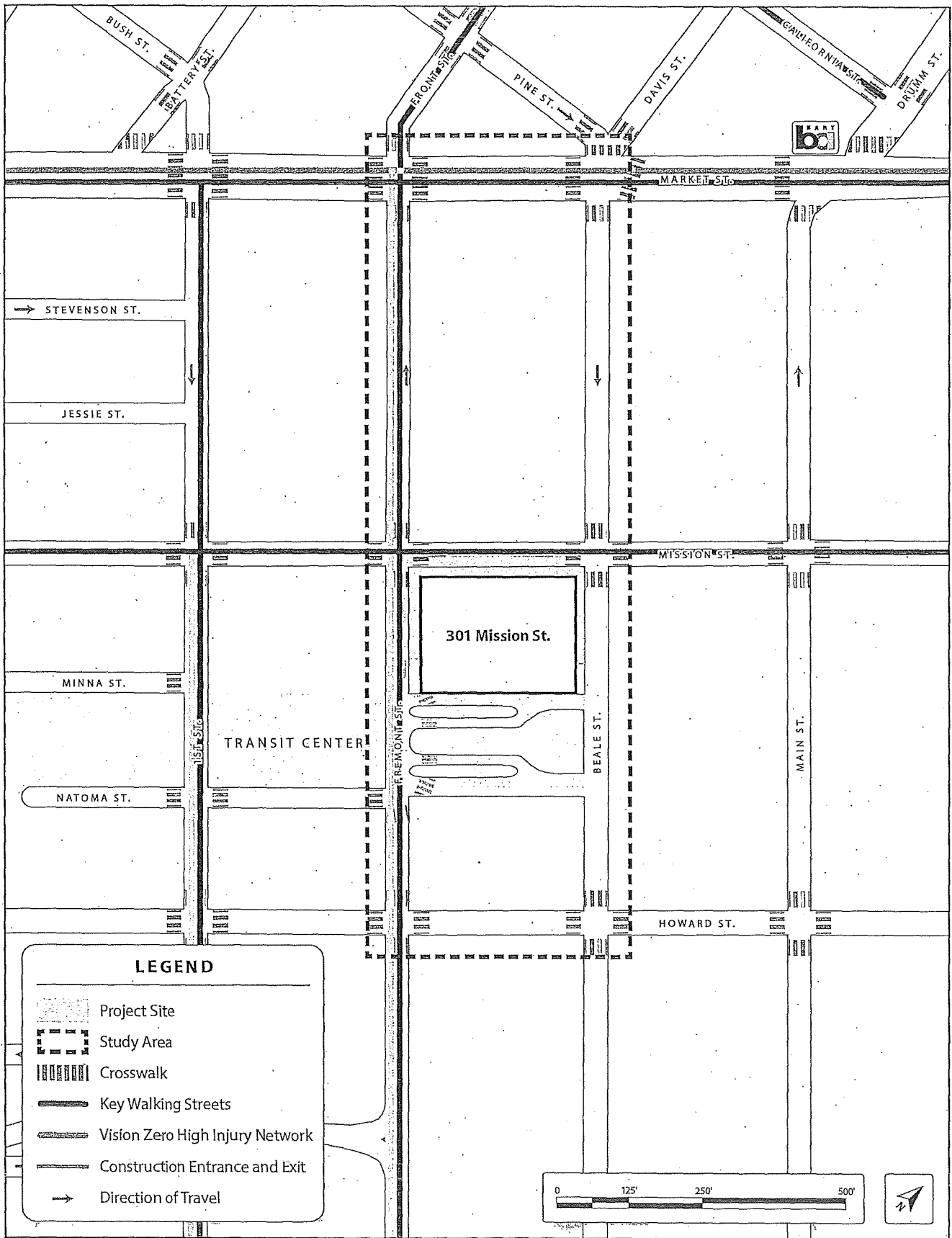

SOURCE: CHS Consulting Group, 2019

2018-016691ENV: 301 Mission Street Perimeter Pile Upgrade Project

**Figure 21**  
Existing Walking Network

## BICYCLING CONDITIONS

On-street bicycle facilities include city-designated routes that are part of the San Francisco Bicycle Network. There are no bicycle facilities along the project frontages on Fremont, Mission, or Beale streets. The nearest bicycle facilities include a Class 3 bicycle route that runs along Market Street between The Embarcadero and Eighth Street, and a Class 2 bicycle lane that runs in the westbound direction along the north side of Howard Street west of Beale Street.<sup>58</sup> **Figure 22, Existing Bicycling Network**, presents the existing bicycle network including High Injury Network streets.

Bicycle counts were collected and bicycle conditions were observed at five intersections (Market Street/Fremont Street, Market Street/Beale Street, Mission Street/Fremont Street, Mission Street/Beale Street, and Howard Street/Fremont Street) on Tuesday April 9, 2019, during the a.m. and p.m. peak periods. Appendix B, Attachment B.3, Existing and Baseline Volumes Summary Memo, includes the existing bicycle counts. Bicycle volumes are generally low (less than 50 bicyclists during the a.m. or p.m. peak hour) along the project frontages on Mission, Beale, or Fremont streets, but bicycle volumes are substantially higher along Market Street and Howard Street. No existing potentially hazardous conditions were observed during these periods.

## PUBLIC TRANSIT CONDITIONS

The following describes the local and regional public transit service in the study area, including their geographic extent; scheduled frequency; and transit stop proximity to the project site as they existed during data collection (April 2019).

Muni, Golden Gate Bridge, Highway, and Transportation District (Golden Gate Transit), and SamTrans provide bus service in the study area, and Alameda-Contra Costa Transit District (AC Transit) provide transit service to and from the Temporary Transbay Terminal<sup>59</sup> located at the intersection of Howard and Beale streets. Muni operates buses, cable cars, and light rail services within the City and County of San Francisco; Golden Gate Transit provides bus and ferry service between the North Bay (Marin and Sonoma counties) and San Francisco; SamTrans provides bus service between the Peninsula and San Francisco; AC Transit provides bus service in the western portions of Alameda and Contra Costa counties, as well as "Transbay" routes across the San Francisco Bay to San Francisco and selected areas in San Mateo and Santa Clara counties. It is noted that AC Transit buses have stops at the Temporary Transbay Terminal located at the Howard Street/Beale Street intersection, but they do not operate or have stops within the study area. **Figure 23, Existing Transit Service**, shows the existing transit network in the vicinity of the project site.

Existing transit routes that currently travel along Mission, Fremont, and Beale streets in the project vicinity are:

- Muni Routes 2, 5, 5R, 7, 9, 9R, 14, 14R, 14X, 30X, 38, 38R, 41, 81X, and 82X
- Golden Gate Transit Routes 2, 4, 8, 18, 24, 27, 30, 38, 44, 54, 56, 58, 70, 72, 74, 76, 101, and 101X
- SamTrans Routes 292 and 398

<sup>58</sup> Class 2 bikeways are bike lanes striped within the paved areas of roadways and established for the preferential use of bicycles; class 3 bikeways are signed bike routes that allow bicycles to share travel lanes with vehicle.

<sup>59</sup> At the time of data collection for the proposed project (April 2019), the Transit Center was temporarily closed for structural repairs and transit routes that would have terminated or originated at the Transit Center instead used Temporary Transbay Terminal. The repairs have since been completed and the Transit Center is fully operational as of August 12, 2019. Refer to the Near-Term Baseline Conditions section for further information.



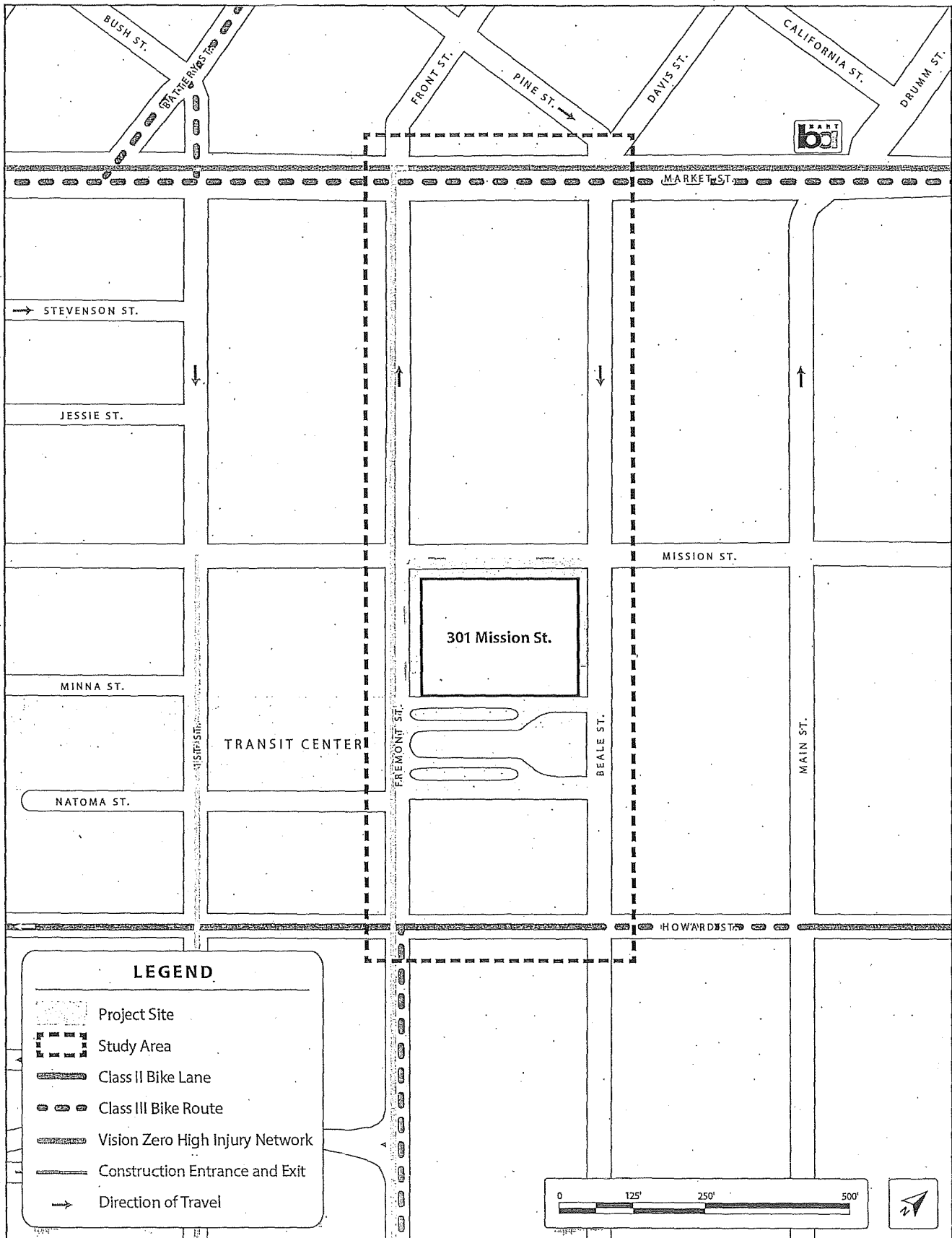

SOURCE: CHS Consulting Group, 2019

2018-016691ENV: 301 Mission Street Perimeter Pile Upgrade Project

**Figure 22**  
Existing Bicycle Network

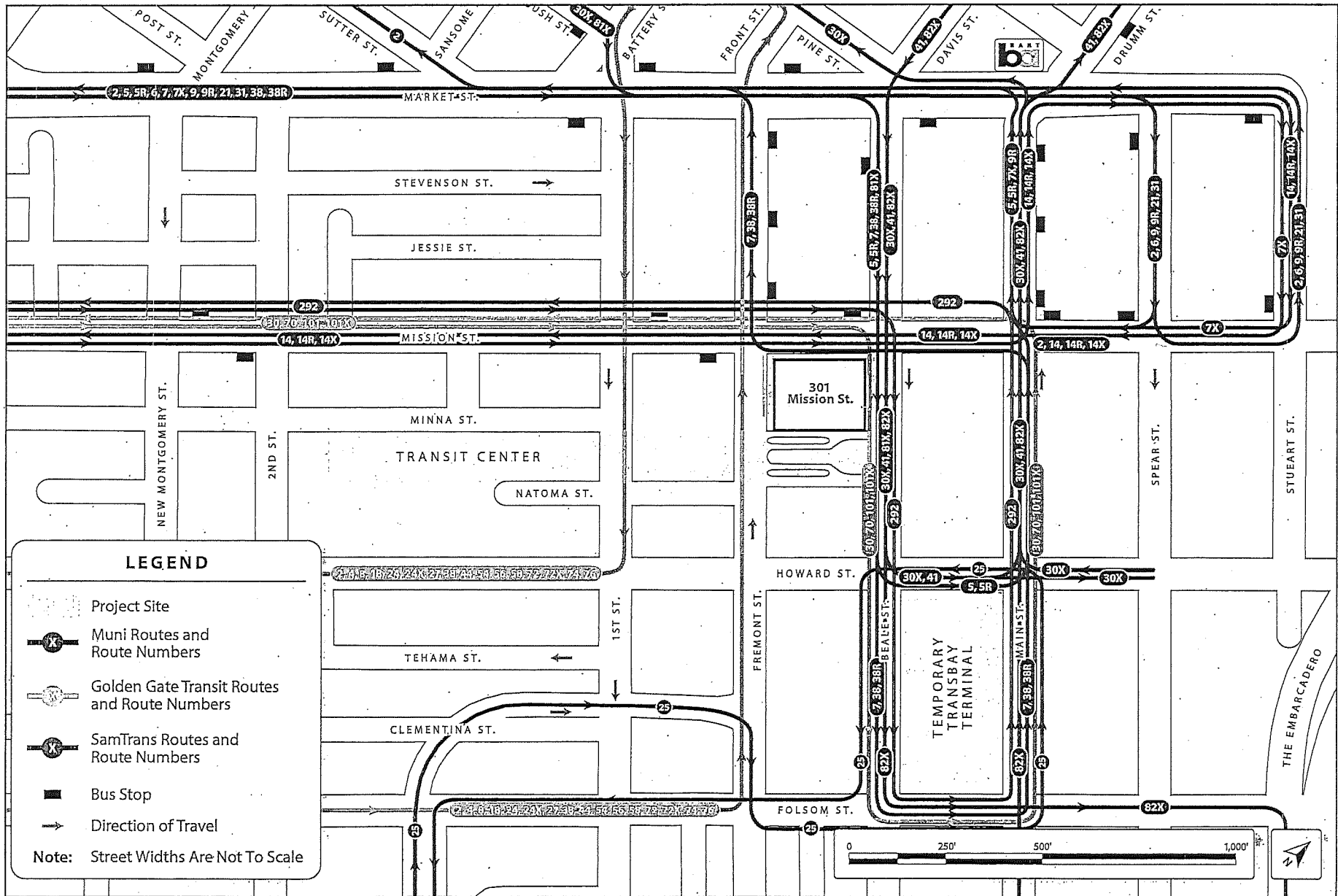

SOURCE: CHS Consulting Group, 2019

2018-016691ENV: 301 Mission Street Perimeter Pile Upgrade Project

Figure 23  
Existing Transit Service

Table 5, Existing Transit Volumes, presents the existing transit vehicle volumes compiled using Muni, Golden Gate Transit, and SamTrans transit schedules (see Appendix B, Attachment B.3) and route maps published on their websites. It shows that there are approximately 80 a.m. peak hour and 57 p.m. peak hour transit trips along the project frontage on Beale Street, approximately 31 a.m. peak hour and 20 p.m. peak hour transit trips along the project frontage on Mission Street (i.e., eastbound direction); and approximately two a.m. peak hour and 34 p.m. peak hour transit trips along the project frontage on Fremont Street.

**TABLE 5  
EXISTING TRANSIT VOLUMES**

Street	Direction (Segment)	Muni	Golden Gate Transit	SamTrans	Total
<b>A.M. Peak Hour</b>					
Mission Street	Eastbound (Fremont to Beale Street)	24	5	2	31
	Westbound (Beale to Fremont Street)	45	4	2	51
Fremont Street	Northbound (Howard to Mission Street)	0	2	0	2
Beale Street	Southbound (Mission to Howard Street)	73	5	2	80
<b>P.M. Peak Hour</b>					
Mission Street	Eastbound (Fremont to Beale Street)	15	3	2	20
	Westbound (Beale to Fremont Street)	47	4	2	53
Fremont Street	Northbound (Howard to Mission Street)	0	34	0	34
Beale Street	Southbound (Mission to Howard Street)	52	3	2	57

SOURCE: CHS Consulting Group, 2019.

## EMERGENCY ACCESS CONDITIONS

Emergency vehicle access to the project site is currently provided along Fremont, Mission, and Beale streets. The nearest San Francisco Fire Department fire stations, San Francisco Police Department stations, and hospitals include:

- Fire Station No. 35 at 399 The Embarcadero (about 0.4 miles west of the project site)
- Fire Station No. 1 at 935 Folsom Street (about one mile southwest of the project site)
- Fire Station No. 13 at 530 Sansome Street (about 0.5 miles northwest of the project site)
- SF Police Southern Station at 1251 Third Street (about 1.3 miles southeast of the project site)
- Saint Francis Memorial Hospital at 900 Hyde Street (about 1.3 miles west of the project site)
- California Pacific Medical Center at 1101 Van Ness Avenue (about 1.8 miles west of the project site)

## LOADING CONDITIONS

The following describes the absence, discontinuity, or presence of features related to people loading in the study area. The description includes an assessment of commercial and passenger on and off-street loading spaces, hour restrictions, and usage. In addition, the following identifies any potentially or observed hazardous conditions or delays to public transit because of loading activities.

There is a 170-foot-long white passenger loading zone and a 20-foot-long yellow commercial loading zone on the south side of Mission Street along the project frontage. Beale and Fremont streets fronting the project

site are No Stopping/Tow Away zones at all times. Passenger and commercial loading counts were collected along the project frontages on Fremont, Mission, and Beale streets, on Tuesday, April 9, 2019, from 8 a.m. to 6 p.m. Appendix B, Attachment B.2, Vehicle Turning Movement, Bicycle, Pedestrian, and Loading Counts, includes loading survey data. A total of 343 loading activities occurred between 8 a.m. and 6 p.m., and approximately half of the loading activities occurred illegally along red curbs or No Stopping/Tow Away zones. Illegal loading activities also included passengers being dropped off in the center travel lane. The maximum number of vehicles engaged in loading activities at any given time during the survey period was six vehicles. The peak loading period generally occurred after the peak morning commute period between 9 a.m. and 11 a.m.<sup>60</sup>

### ***Near-Term Baseline Conditions***

The Near-Term Baseline Conditions reflect that the Transit Center Structural Repair Project is completed, and the Transit Center is fully operational. The Transit Center was temporarily closed after cracks were discovered in two steel beams above the third-level bus deck in late September 2018, along a segment that crosses over First Street. While the Transit Center was closed for repairs at the time the transportation data collection and analysis was conducted for the proposed project, the repairs have since been completed and the Transit Center was reopened on August 12, 2019.

Because all transit service has resumed to and from the Transit Center since August 12, 2019, using the existing conditions data which was collected prior to reopening of the transit center for an existing plus project analysis would not accurately reflect the conditions that would exist at the time the project's impacts actually occur. An existing plus project conditions analysis could be misleading or without informative value to the public and decision makers. Therefore, the impact analysis below uses an adjusted, near-term baseline conditions for a comparison of project impacts. The near-term baseline represents that the Transit Center is reopened and fully operational with all buses that had been rerouted during the closure now serving the Transit Center. The following describes adjustments, by transportation topic, to existing conditions (described above) to reflect the reopened Transit Center. If the following does not list a particular transportation topic, the impact analysis uses the existing conditions description because the conditions under the near-term baseline have not changed from existing conditions. Detailed changes are described in Appendix B, Attachment B.3, Existing and Baseline Volumes Summary Memo.

### **REGIONAL AND LOCAL ROADWAYS**

When the Transit Center reopened on August 12, 2019, traffic volumes in the study area changed from those which existed at the time the traffic data were collected on April 9, 2019, because transit vehicles were rerouted from the Temporary Transbay Terminal to the Transit Center. Traffic volumes for the Baseline Condition were estimated by adjusting the transit vehicle volumes along Market, Mission, Fremont, Beale, and Howard streets based on changes to transit routes after the Transit Center reopened. Affected transit routes are described under *Public Transit Conditions* below. It is assumed that non-transit vehicle volumes along these streets did not substantially change when the Transit Center reopened because there was no change in street lane geometry.

<sup>60</sup> The maximum loading activities (with six vehicles in queue at the white passenger loading zone on the south side of Mission Street) occurred at 9:04 a.m., 9:44 a.m., and 10:36 a.m.

**Table 6, Vehicular Volumes under Baseline Condition**, shows the vehicle (transit included) volumes under Baseline Condition. Under the Baseline Condition, Mission Street carries approximately 570 a.m. peak hour and 480 p.m. peak hour vehicle trips in the eastbound direction (approximately 10 percent increase from the Existing Condition during a.m. and p.m. peak hours), and approximately 310 a.m. peak hour and 320 p.m. peak hour vehicle trips in the westbound direction (approximately 10 percent decrease from the Existing Condition during a.m. and p.m. peak hours). Fremont Street carries approximately 1,470 a.m. peak hour and 1,254 p.m. peak hour vehicle trips (approximately four percent increase from the Existing Condition during a.m. and p.m. peak hours). Traffic volumes on Beale Street south of Mission Street have not substantially changed because the transit vehicles traveling in the southbound through movement under the existing conditions shifted to eastbound Mission Street and make a right-turn movement on Beale Street instead.

**TABLE 6  
VEHICULAR VOLUMES UNDER BASELINE CONDITION**

Street	Direction (Segment)	A.M. Peak Hour	P.M. Peak Hour
Mission Street	Eastbound (Fremont Street to Beale Street)	566	478
	Westbound (Beale Street to Fremont Street)	306	323
Fremont Street	Northbound (Howard Street to Mission Street)	1,470	1,254
Beale Street	Southbound (Mission Street to Howard Street)	792	885
Market Street	Eastbound (Fremont Street to Beale Street)	345	332
	Westbound (Beale Street to Fremont Street)	168	230
Howard Street	Westbound (Beale Street to Fremont Street)	264	721

SOURCE: CHS Consulting Group, 2019.

## WALKING CONDITIONS

When the Transit Center reopened, pedestrian volumes generally increased along Mission and Fremont streets, because they provide direct access to the main entrance to the Transit Center, located at the southwest corner of the Mission Street/Fremont Street intersection. Pedestrian volumes for the Baseline Condition were estimated by redistributing the existing pedestrian volumes observed at the Temporary Transbay Terminal, to the Transit Center at the Mission Street/Fremont Street and Mission Street/Beale Street intersections (see Appendix B, Attachment B.3).

**Table 7, Pedestrian Volumes under Baseline Condition**, shows the pedestrian counts under Baseline Condition. Under the Baseline Condition, the pedestrian volumes continue to be high with approximately 5,130 a.m. peak hour and 5,860 p.m. peak hour pedestrian crossings at the Mission Street/Fremont Street intersection (approximately 30 percent increase from the Existing Condition during the a.m. and p.m. peak hours), and approximately 4,150 a.m. peak hour and 4,470 p.m. peak hour pedestrian crossings at the Mission Street/Beale Street intersection (approximately 23 percent increase from the Existing Condition during the a.m. and p.m. peak hours).

**TABLE 7**  
**PEDESTRIAN VOLUMES UNDER BASELINE CONDITION**

Intersection/Peak Hour	North	South	East	West	Total
<b>Mission Street/Fremont Street</b>					
A.M.	858	1,584	1,348	1,338	5,128
P.M.	1,194	2,141	1,403	1,116	5,855
<b>Mission Street/Beale Street</b>					
A.M.	878	962	575	1,730	4,145
P.M.	1,091	1,057	529	1,790	4,467

SOURCE: CHS Consulting Group, 2019.

### BICYCLING CONDITIONS

Bicycling conditions in the project vicinity would be the same under the near-term baseline as they are under existing conditions:

### PUBLIC TRANSIT CONDITIONS

When the Transit Center reopened, transit vehicles were rerouted from the Temporary Transbay Terminal to the Transit Center. Transit vehicle volumes for the Baseline Condition were estimated based on the changes to transit routes that went into effect when the Transit Center reopened on August 12, 2019. The following changes have occurred since the Transit Center reopened:<sup>61</sup>

- **Muni Routes 5 and 5R**, which traveled along southbound Beale Street (from eastbound Market Street), eastbound Howard Street (stopping by the Temporary Transbay Terminal on Howard Street) and northbound Main Street at the time of data collection, were rerouted to travel along southbound First Street, eastbound Mission Street, southbound Beale Street (stopping in the Transit Center), and northbound Fremont Street. As a result, vehicle trips on the eastbound Mission Street and northbound Fremont Street increased by 19 trips during the a.m. peak hour and 15 trips during the p.m. peak hour.
- **Muni Routes 7, 38, and 38R**, which traveled along southbound Beale Street (from eastbound Market Street), eastbound Folsom Street, northbound Main Street (stopping by the Temporary Transbay Terminal on Main Street), westbound Mission Street, and northbound Fremont Street at the time of data collection were rerouted to travel along southbound First Street, eastbound Mission Street, southbound Beale Street (stopping in the Transit Center), and northbound Fremont Street. As a result, vehicle trips on eastbound Mission Street and northbound Fremont Street increased by 29 trips during the a.m. peak hour and 25 trips during the p.m. peak hour. Likewise, vehicle trips on westbound Mission Street decreased by 29 trips during the a.m. peak hour and 25 trips during the p.m. peak hour.
- **Muni Route 2**, which traveled along southbound Spear Street (from eastbound Market Street), eastbound Mission Street and northbound Steuart Street at the time of data collection were rerouted to travel along southbound First Street, eastbound Mission Street and northbound Steuart Street. As a result, vehicle trips on the eastbound Mission Street increased by eight trips during the a.m. peak hour and four trips during the p.m. peak hour.

<sup>61</sup> After the Transit Center reopened on August 12, 2019, AC Transit service is no longer operating on surface streets as the AC Transit buses use ramps directly into and out of the Transit Center to the freeway.

- **Golden Gate Transit Routes 30, 70, 101, and 101X**, which traveled along southbound Beale Street (from eastbound Mission Street), eastbound Folsom Street, northbound Main Street (stopping by the Temporary Transbay Terminal on Main Street), and westbound Mission Street at the time of data collection, were rerouted to travel along southbound Beale Street (stopping in the Transit Center), and northbound Fremont Street. As a result, vehicle trips on northbound Fremont Street increased by four trips during the a.m. and p.m. peak hours. Likewise, vehicle trips on westbound Mission Street decreased by four trips during the a.m. and p.m. peak hours.
- **SamTrans Route 292**, which traveled along southbound Beale Street (from eastbound Market Street), eastbound Folsom Street, northbound Main Street (stopping at the Temporary Transbay Terminal on Main Street), and westbound Mission Street at the time of data collection, were rerouted to travel along southbound Beale Street, westbound Howard Street, and northbound Fremont Street, with a stop on westbound Mission Street west of Fremont Street. As a result, vehicle trips on northbound Fremont Street increased by two trips during the a.m. and p.m. peak hours. Likewise, vehicle trips on westbound Mission Street decreased by two trips during the a.m. and p.m. peak hours.

Table 8, **Transit Volumes under Baseline Condition**, shows the transit vehicle volumes under Baseline Condition. Transit vehicle trips increased along eastbound Mission and Fremont streets by 56 trips during the a.m. peak hour and 44 trips during the p.m. peak hour compared to the time of data collection. Transit vehicle trips on westbound Mission Street decreased by approximately 36 trips during the a.m. peak hour and 31 trips during the p.m. peak hour. Transit vehicle volumes on Beale Street south of Mission Street did not substantially change.

TABLE 8  
TRANSIT VOLUMES UNDER BASELINE CONDITION

Street	Direction (Segment)	Muni	Golden Gate Transit	SamTrans	Total
<b>A.M. Peak Hour</b>					
Mission Street	Eastbound (Fremont to Beale Street)	80	5	2	87
	Westbound (Beale to Fremont Street)	16	0	0	16
Fremont Street	Northbound (Howard to Mission Street)	48	6	2	56
Beale Street	Southbound (Mission to Howard Street)	73	5	2	80
<b>P.M. Peak Hour</b>					
Mission Street	Eastbound (Fremont to Beale Street)	59	3	2	64
	Westbound (Beale to Fremont Street)	22	0	0	22
Fremont Street	Northbound (Howard to Mission Street)	40	38	2	80
Beale Street	Southbound (Mission to Howard Street)	52	3	2	57

SOURCE: CHS Consulting Group, 2019.

### Cumulative Conditions

As described in Section B.2, there are four cumulative projects in the project vicinity that could potentially be under construction at the same time as the proposed project:

- **Transbay Block 4/ 200 Folsom Street/200-272 Main Street (Planning Department Case No. 2018-015785ENV)**. The project is currently under environmental review by the planning department; its construction schedule is unknown at this time.

- **Active Beale Street Project.** SFMTA would implement this project in phases starting as early as spring 2020.
- **Better Market Street Project (Planning Case No. 2014.0012E).** The San Francisco Planning Commission certified the environmental impact report for the project on October 10, 2019. San Francisco Public Works and the SFMTA Board of Directors approved the project on October 15, 2019. The first phase of construction would occur between 5th and 8th streets and would begin in the spring of 2020, and all or some of the Muni routes 5, 5R, 6, 7, 7X, 9, 9R, 21, 31, and F could be rerouted from Market Street to Mission Street if there are operational constraints on Market Street during construction.
- **Oceanwide Center Development Project (Planning Case No. 2006.1523E).**<sup>62</sup> The project is currently under construction and is therefore considered part of the existing conditions. However, construction of the Oceanwide Center Development Project is anticipated to continue through spring 2026. Thus, construction of this project could overlap with construction of the proposed project, and is therefore considered in the cumulative impacts analysis.

## ***Impact Evaluation***

### **Project Features**

The following describes the transportation-related features of the project not described in Section A, Project Description.

#### ***Construction Access Routes***

Based on the location of on- and off-ramps to the regional roadways (e.g., I-80), the majority of construction trucks are expected to approach the project site from northbound Fremont Street and enter the construction staging area through the gates/breaks provided along the construction site perimeter on Fremont, Mission, or Beale streets. When trucks enter the staging area from Beale Street, they would back into the staging area from southbound Beale Street. Exact locations of potential disposal sites are unknown at this time, but it is anticipated that they would be in the East Bay. **Figure 24, Construction Truck Routes**, presents anticipated construction truck routes to and from the project site. **Figure 25, Construction Staging during Stages 1 through 5**, presents the construction boundary for Stages 1 through 5, and **Figure 26, Construction Staging during Stage 6**, presents the construction boundary for Stage 6. The contractor would provide off-site staging areas for materials and supplies that cannot be located on site due to space constraints. The exact locations of staging areas are undetermined at this time, but it is anticipated that they would be within 5 miles of the project site. The contractor would not provide any worker parking spaces, either on site or at off-site staging areas, but workers would be paid for public transportation costs to the project site.

<sup>62</sup> The Oceanwide Center Development Project is also known as 50 1st Street project. The project underwent environmental review in Planning Department Case 2006.1523E. A community plan exemption determination pursuant to the Transit Center District Plan area plan EIR was issued on April 1, 2016.



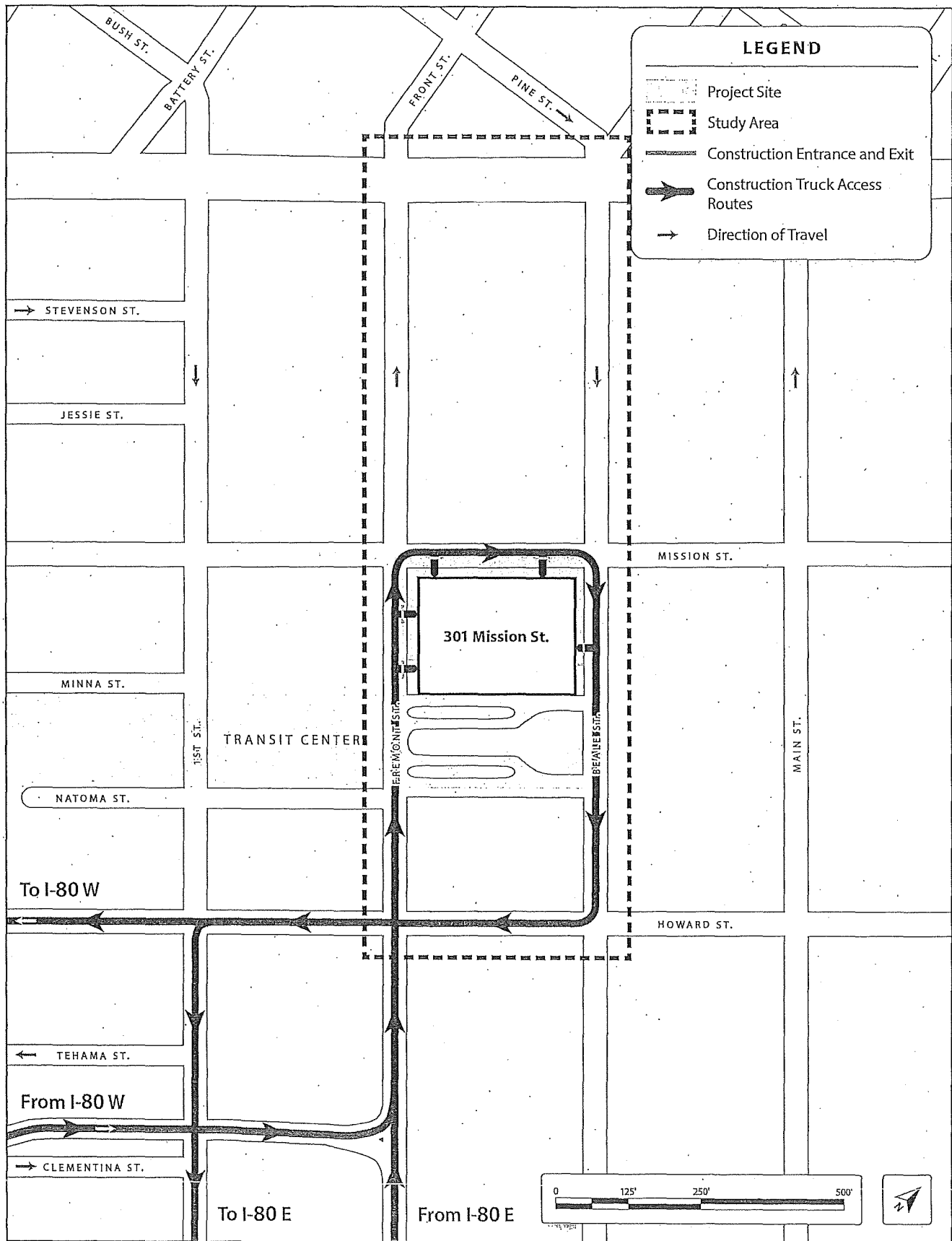

SOURCE: CHS Consulting Group, 2019

2018-016691ENV: 301 Mission Street Perimeter Pile Upgrade Project

**Figure 24**  
Construction Truck Access Routes

1682

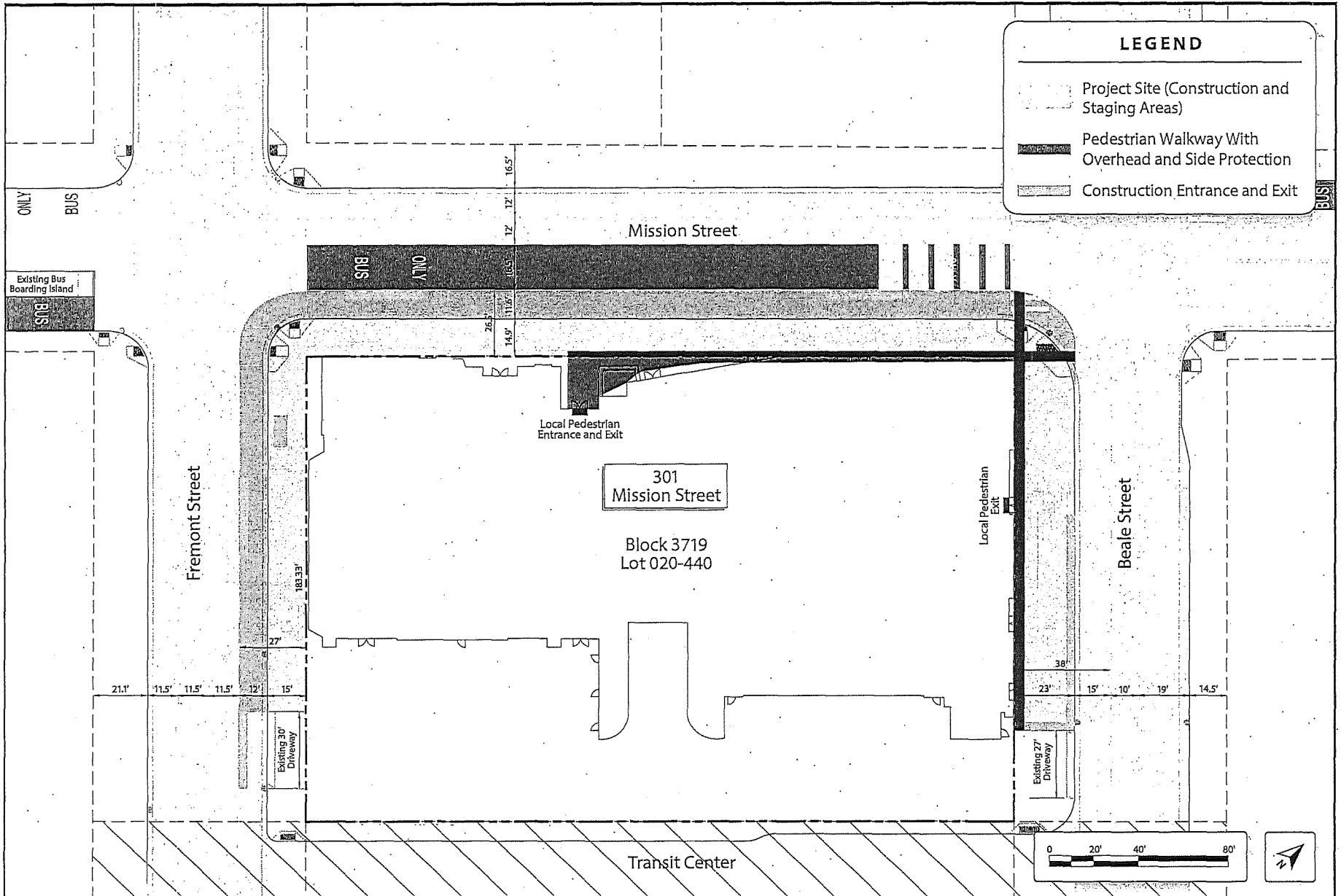

SOURCE: CHS Consulting Group, 2019

2018-016691ENV: 301 Mission Street Perimeter Pile Upgrade Project

**Figure 25**  
Construction Boundary During Stages 1 Through 5

1683

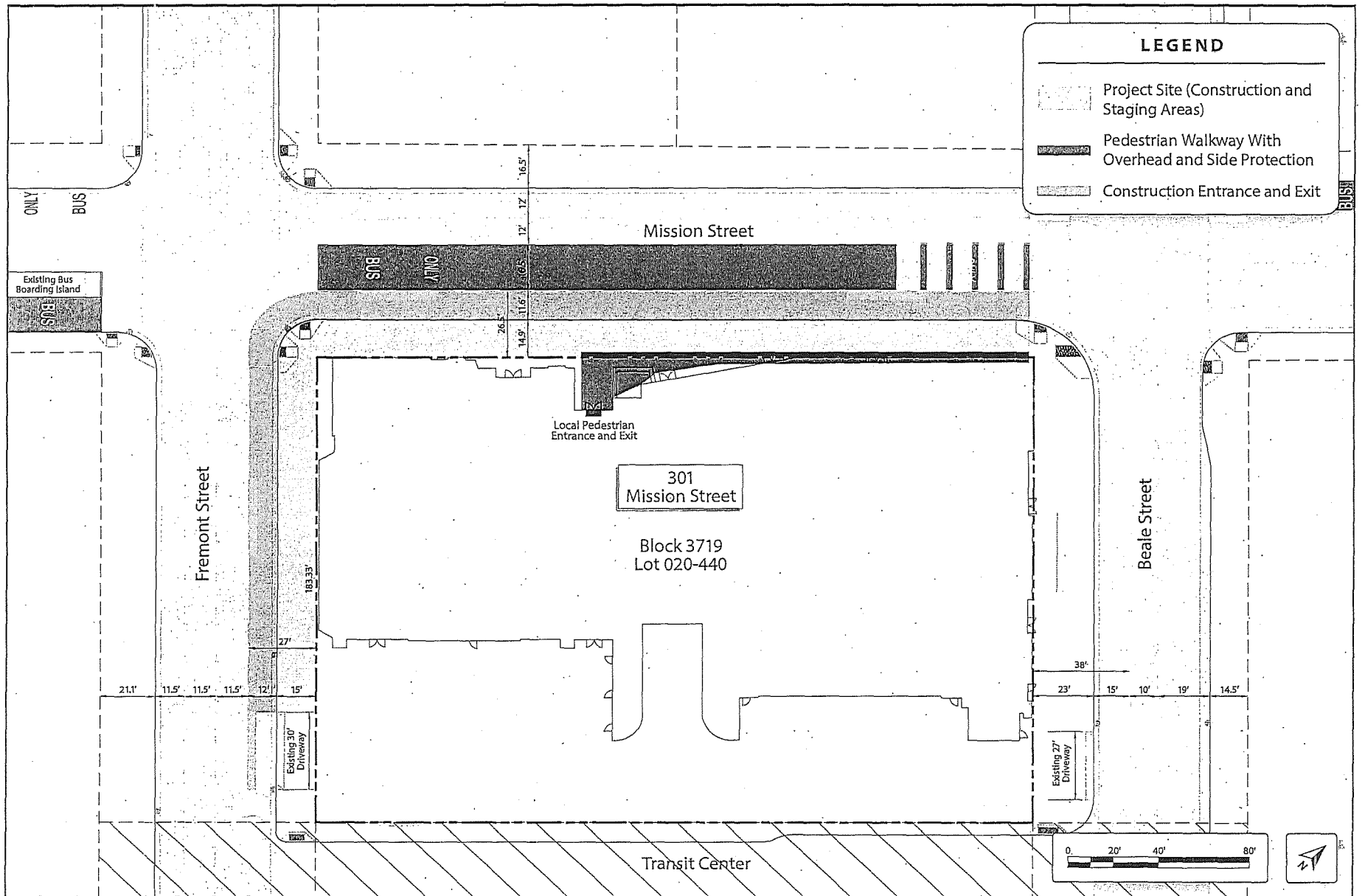

SOURCE: CHS Consulting Group, 2019

2018-016691ENV: 301 Mission Street Perimeter Pile Upgrade Project

Figure 26  
Construction Boundary During Stage 6

*Vehicular Volumes Affected during Project Construction*

During project construction, Muni Routes 5, 5R, 7, 38, and 38R, would be routed to run along eastbound Market Street and southbound Beale Street as part of the transportation plan, instead of eastbound Mission Street and southbound Beale Street. As a result, traffic volumes would be reduced on eastbound Mission Street and increased on eastbound Market Street (see Appendix B, Attachment B.4). **Table 9, Vehicular Volumes under Project Condition**, shows the estimated vehicular volumes (transit included) during project construction.

**TABLE 9**  
**VEHICULAR VOLUMES UNDER PROJECT CONDITION**

Street	Direction (Segment)	A.M. Peak Hour	P.M. Peak Hour
Mission Street	Eastbound (Fremont Street to Beale Street)	522	434
	Westbound (Beale Street to Fremont Street)	307	323
Fremont Street	Northbound (Howard Street to Mission Street)	1,470	1,254
Beale Street	Southbound (Mission Street to Howard Street)	792	885
Market Street	Eastbound (Fremont Street to Beale Street)	393	372
	Westbound (Beale Street to Fremont Street)	168	230
Howard Street	Westbound (Beale Street to Fremont Street)	264	721

SOURCE: CHS Consulting Group, 2019.

*Pedestrian Volumes Affected during Project Construction*

Pedestrians currently using the south and east crosswalks at the Mission Street/Fremont Street intersection would be diverted to the north and west crosswalks during the project construction. Similarly, pedestrians currently using the south and west crosswalks at the Mission Street/Beale Street intersection would potentially be diverted to the north and east crosswalks during Stages 1 through 5 of the project construction. Exceptions may include the residents or visitors walking to and from 301 Mission Street and those walking along the Beale Street west sidewalk to access the Transit Center from its Beale Street entrance. **Table 10, Pedestrian Volumes under Project Condition**, shows the estimated pedestrian volumes during project construction.

**TABLE 10**  
**PEDESTRIAN VOLUMES UNDER PROJECT CONDITION**

Intersection/ Peak Hour	North	South	East	West	Total
<b>Mission Street/ Fremont Street</b>					
A.M.	2,442	—	—	2,686	5,128
P.M.	3,335	—	—	2,519	5,855
<b>Mission Street/ Beale Street</b>					
A.M.	1,840	Local Only <sup>a</sup>	2,306	Local Only	4,145
P.M.	2,148	Local Only <sup>a</sup>	2,319	Local Only	4,467

## NOTE:

<sup>a</sup> Includes those walking to and from 301 Mission Street and along the Beale Street west sidewalk to the Transit Center.

SOURCE: CHS Consulting Group, 2019.

### *Bicycle Volumes Affected during Project Construction*

Bicycle volumes would generally remain the same during the project construction because the project would not affect any bicycle facilities.

### *Transit Volumes and Features Affected during Project Construction*

During project construction, Muni Routes 5, 5R, 7, 38, and 38R, would run along eastbound Market Street and southbound Beale Street as part of the transportation plan, instead of eastbound Mission Street and southbound Beale Street. **Table 11, Transit Service under Project Condition**, shows the estimated transit volumes during project construction.

**TABLE 11  
TRANSIT SERVICE UNDER PROJECT CONDITION**

Street	Direction (Segment)	Muni	Golden Gate Transit	SamTrans	Total
<b>A.M. Peak Hour</b>					
Mission Street	Eastbound (Fremont to Beale Street)	32	5	2	39
	Westbound (Beale to Fremont Street)	16	0	0	16
Fremont Street	Northbound (Howard to Mission Street)	56	6	2	56
Beale Street	Southbound (Mission to Howard Street)	80	5	2	80
<b>P.M. Peak Hour</b>					
Mission Street	Eastbound (Fremont to Beale Street)	19	3	2	24
	Westbound (Beale to Fremont Street)	22	0	0	22
Fremont Street	Northbound (Howard to Mission Street)	40	38	2	80
Beale Street	Southbound (Mission to Howard Street)	52	3	2	57

SOURCE: CHS Consulting Group, 2019.

### *Loading Features Affected during Project Construction*

During project construction, the project would temporarily remove the existing 170-foot-long white passenger loading zone and 20-foot-long yellow commercial loading zone located on the south side of Mission Street between Fremont and Beale streets. There would be no change in loading zones on Fremont and Beale streets as these two roadways have no existing passenger or commercial loading zones adjacent to the project site. As a result, any loading activities along the Fremont, Mission, and Beale street frontages would be prohibited.

### *Project Trips*

Project-generated trips are comprised of those made by construction workers traveling to and from the project site, material and equipment deliveries, and hauling truck trips associated with excavation and transport of construction materials. The number of project trips would vary on a daily basis, depending on the construction phase, planned activity, and material delivery needs.

As described in Section A, Project Description, the proposed project would be constructed in six stages, spanning over approximately 22 months (640 days) beginning in early 2020. Construction activities would occur Monday through Friday from 7 a.m. to 8 p.m. for the entire duration of project construction (Stages 1 through 6). In addition, during Stages 3 and 4, there would be a second shift on weekdays from 8 p.m. to

7 a.m., to receive oversized truck deliveries, for approximately five nights per week. As permitted within San Francisco, construction may occur on Saturdays and Sundays. This may occur when the project sponsor determines it is needed during any stage. Table 12, **Construction Travel Demand by Stage**, shows the estimated number of construction workers and truck demand generated for each construction stage. The estimated number of maximum daily workers on site during any stage would range from 11 to 32; and the estimated number of daily trucks would range from 10 during Stage 1 to 25 during Stage 6.

**TABLE 12**  
**CONSTRUCTION TRAVEL DEMAND BY STAGE**

Construction Stage	Duration (Days) <sup>a</sup>	Number of Daily Workers		Number of Truck Loads <sup>b</sup>					
				Material Delivery <sup>c</sup>			Export/ Import		
		Shift 1	Shift 2	Total	Daily	Peak Hour	Total	Daily	Peak Hour
1	90	11	—	107	10	3	0	0	0
2	60	11	—	74	10	3	34	10	3
3	160	11	10	107	10	3	191	10	5
4	110	22	10	115	10	3	161	10	5
5	90	11	—	82	10	3	86	10	5
6	130	—	—	74	10	3	106	15	5
<b>Total</b>	<b>640</b>			<b>559</b>			<b>578</b>		

## NOTES:

<sup>a</sup> Represents the overall duration from start to end dates of each stage. The actual number of work days during each stage would be shorter than the overall duration due to weekends and holidays.

<sup>b</sup> Each truck load is assumed to carry 10 cubic yards of import/export materials. Each truck load would generate two trips including one inbound trip and one outbound trip per truck load.

<sup>c</sup> Include deliveries of ready mix concrete, drill casing, drilled shaft rebar, equipment, and supplier deliveries.

SOURCE: CHS Consulting Group, 2019.

Based on the estimated travel demand for each construction stage, the highest volume period would occur during Stage 4, with 32 daily workers and 20 trucks (10 material delivery trucks and 10 hauling trucks). During this period, project construction would generate a total of 64 daily worker trips and 40 daily truck trips, assuming each construction worker and each truck generate one inbound trip and one outbound trip from the project site. Since there would be 22 workers in Shift 1 (7 a.m. to 8 p.m.) and 10 workers in Shift 2 (8 p.m. to 7 a.m.), the project would not generate any worker trips during the p.m. peak period.<sup>63</sup> Project construction would generate up to eight construction truck trips (three material and delivery trips and five hauling trips) during the peak hour, but these trips would be scheduled to occur outside of a.m. (7 a.m. to 9 a.m.) and p.m. (4 p.m. to 6 p.m.) peak periods as part of the transportation plan.

### Construction Impacts

Construction of the project would last for approximately 22 months. During this time, the project would require the temporary closure of travel lanes, sidewalks, and crosswalks in an area heavily travelled by the members of the public. The analysis for addressing project construction impacts uses preliminary project construction information and assumes implementing two groups of construction transportation management plan strategies. The evaluation addresses the staging and duration of construction activities,

<sup>63</sup> Construction workers in Shift 2 would generate approximately 10 outbound trips during the a.m. peak period.

estimated daily worker and truck trips, truck routes, roadway and/or sidewalk closures, and evaluates the effects of construction activities on people walking, bicycling, or driving and riding public transit, and emergency vehicle operators.

#### *Operational Impacts*

The analysis for addressing project operational impacts focuses on whether any temporary public right-of-way closures would be needed for routine inspections following the completion of the project construction.

**Impact TR-1: Construction of the project would require an intense activity but would not create potentially hazardous conditions for people walking, bicycling, or driving or public transit operations; or interfere with emergency access or accessibility for people walking or bicycling; or substantially delay public transit, including due to loading activities. (Less than Significant)**

The 2019 guidelines set forth screening criteria for types of construction activities that would typically not result in significant construction-related transportation effects. This project does not meet that screening criteria because it would require intense construction activities in the public right-of-way. Thus, the following assesses the potential for the project to result in significant impacts as a result of those intense activities.

#### Potentially Hazardous Conditions

##### *Walking*

The project would temporarily close the existing sidewalks on Mission, Fremont, and Beale streets fronting the 301 Mission Street parcel, and provide an approximately 4-foot-wide pedestrian walkway with overhead and side protection, along the Mission Street frontage between Beale Street and the Tower and Podium building entrance throughout the construction from Stage 1 to Stage 6. There would be pedestrian walkways along the Beale Street frontage between Mission Street and the Tower and Podium building driveway during Stages 1 through 5 only, and the west sidewalk along Beal Street would be fully open during Stage 6. The east sidewalk on Fremont Street between Mission Street and the Tower and Podium building driveway would be closed to pedestrians, and the east and south crosswalks at the Mission Street/Fremont Street intersection would be temporarily closed during Stages 1 through 6.

As part of the transportation plan, the proposed project would install signs at the Mission Street/Beale Street intersection to divert non-local (i.e., people who are not walking to 301 Mission Street) pedestrian traffic away from the south sidewalk on Mission Street. The proposed 4-foot-wide pedestrian walkway would provide a sufficient space for local pedestrian traffic (residents and tenants at 301 Mission Street) without creating potentially hazardous conditions. The walkway would have overhead and side protection and would be located along the perimeter of 301 Mission Street, away from vehicular travel lanes, and be designed to provide a clear view of oncoming traffic for pedestrians waiting to cross the Mission Street/Beale Street intersection. The walkway would be regularly maintained and kept clear of potential construction hazards to provide a safe pedestrian path. At the Mission Street/Fremont Street intersection, pedestrian barricades would be installed at the north end of the east crosswalk, and the west end of the south crosswalk, to prevent pedestrians from using the east and south crosswalks. Therefore, the proposed project would not create potentially hazardous conditions for people walking.

### *Bicycling*

The project would reduce the roadway capacity from two to one lane on westbound Mission Street, and from four to three lanes on northbound Fremont Street. Roadway capacity would remain the same on Beale Street. There are no designated bicycle facilities along these streets, and bicycle volumes are generally low (approximately 42 a.m. peak hour and 20 p.m. peak hour bicycle trips on westbound Mission Street, and approximately 25 a.m. peak hour and 17 p.m. peak hour bicycle trips on Fremont Street). The project would generate few construction truck trips (approximately eight peak hour trips) outside of the a.m. and p.m. peak commute periods only.

The majority of construction trucks are expected to approach the project site from northbound Fremont Street and enter the construction staging area through the gates/breaks provided along the construction site perimeter on Fremont, Mission, or Beale streets. As part of the transportation plan, the proposed project would use "Trucks Crossing" signs, a temporary stop sign, flaggers, or a combination of these methods, to alert bicyclists when construction trucks make wide turns in and out of the project site. For these reasons, the potential for conflicts between people bicycling and vehicles would be minimal. Therefore, the proposed project would not create potentially hazardous conditions for bicyclists.

### *Driving*

The majority of construction trucks would access the construction staging area through the gates/breaks provided along the construction site perimeter on Fremont, Mission, or Beale streets. Per the transportation plan, construction truck traffic would not be allowed on eastbound Mission Street and northbound Fremont Street during the a.m. and p.m. peak periods. Due to low traffic volumes (approximately 522 a.m. peak hour and 434 p.m. peak hour vehicle trips) on eastbound Mission Street, slow truck movements would not result in inadequate sightlines or a potentially hazardous condition for a substantial number of people driving on Mission Street. Fremont Street carries approximately 1,470 a.m. peak hour and 1,254 p.m. peak hour vehicle trips. When trucks enter the staging area from Fremont Street, they would directly enter from the curb lane which becomes a construction staging area immediately north of the Transit Center driveway. Therefore, slow truck movements would not result in inadequate sightlines. Beale Street carries approximately 792 a.m. peak hour and 885 p.m. peak hour vehicle trips. When trucks enter the staging area from Beale Street, they would stop and then back into the staging area from southbound Beale Street. As part of the transportation plan, the proposed project would use "Trucks Crossing" signs, "Road Work Ahead" and "Right Lane Closed Ahead" signs, a temporary stop sign, flaggers, or a combination of these methods, to alert drivers when construction trucks make wide turns in and out of the project site. The project would not include any design features that would constitute major hazards. Therefore, the proposed project would not create potentially hazardous conditions for people driving.

### *Public Transit Operations*

The proposed project would install concrete barriers and fences approximately 11.6 feet north of the Mission Street existing south sidewalk, between Fremont and Beale streets. This change would require relocating the existing eastbound bus- and taxi-only lane on Mission Street further north and removing the existing westbound bus- and taxi-only lane (see Figure 24 and Figure 25). Golden Gate Transit Routes 30, 70, 101, and 101X, and SamTrans Routes 292 and 398, travelling eastbound on Mission Street, currently use the curbside stop on Mission Street by Salesforce Tower to drop off passengers. These routes would be required to maneuver from the curb lane west of Fremont Street, to the restriped bus-only lane located east of Fremont



Street, and make a right-turn onto southbound Beale Street around the proposed construction staging area. The restriped bus-only lane would be at least 12 feet wide and provide adequate space for bus operations.

Auto-turn analyses were conducted at the Mission Street/Fremont Street and the Mission Street/Beale Street intersections to assess whether bus turning movements around the project construction boundary would cause a potential conflict with other vehicles. Appendix B, Attachment B.5: Auto Turn Analysis includes bus turning templates for the buses (e.g., Golden Gate Transit and SamTrans, up to 60 feet in length) operating on Mission Street and Beale Street. The auto-turn analyses shows that on Mission Street, buses would be able to maneuver from the eastbound curb lane west of Fremont Street to the restriped bus lane east of Fremont Street, without encroaching onto adjacent travel lanes or creating potential conflicts with other vehicles. At the Mission Street/Beale Street intersection, buses would temporarily encroach onto the adjacent travel lane on Beale Street as they make a right-turn from eastbound Mission Street to southbound Beale Street. Since the buses would make this turn after all vehicles approaching Mission Street are clear on Beale Street, or when there is green light for eastbound traffic, bus movements would not conflict with other vehicles.

The project would generate few construction truck trips (approximately eight peak hour trips) outside of the a.m. and p.m. peak commute periods only. In addition, as part of the transportation plan, construction traffic would be prohibited on eastbound Mission Street during the a.m. and p.m. peak periods. Construction trucks would enter the project site from the curb lanes on Fremont and Mission streets, or would back in from southbound travel lane on Beale Street. All other truck movements would be contained within the project site and they would not create potentially hazardous conditions related to transit operations. Moreover, when trucks make egress movements at the construction entrance/exit on Fremont, Mission, or Beale streets, flaggers, a temporary stop sign, or a combination of these methods, would be used to slow approaching traffic as part of the transportation plan.

Construction of the project would not create potentially hazardous conditions for people walking, bicycling, or driving, or for public transit operations.

## Accessibility

### *Walking*

During project construction, pedestrian access would be prohibited along the western half of the south sidewalk on Mission Street between Fremont and Beale streets, and the east sidewalk on Fremont Street between Mission Street and the project site driveway. In addition, the east and south crosswalks at the Mission Street/Fremont Street intersection would be closed. The project would provide an approximately 4-foot-wide pedestrian walkway with overhead and side protection, along the eastern half of the south sidewalk on Mission Street between Beale Street and the Tower and Podium building entrance throughout the construction from Stage 1 to Stage 6. The project would also provide the pedestrian walkway along the west sidewalk on Beale Street between Mission Street and the Tower and Podium building driveway during Stages 1 through 5 only; the west sidewalk along Beale Street would be fully open during Stage 6.

As part of the transportation plan, the proposed project would install signs at the Mission Street/Fremont Street and Mission Street/Beale Street intersections, directing pedestrians to use the north sidewalk on Mission Street and the west sidewalk on Fremont Street. Pedestrian access along Fremont Street would be maintained via the west sidewalk; pedestrian access along Mission Street would be maintained via the

north sidewalk; pedestrian access along Beale Street would be maintained on both sides of the street. Pedestrian access to and from the 301 Mission Street parcel would be maintained with pedestrian walkways constructed along the eastern half of Mission Street, between Beale Street and the Tower and Podium building entrance, and along the Beale Street frontage. The walkways would be maintained with the minimum width of 4 feet, and with ramps to provide ADA access at all times. During project construction pedestrian access to and from the Muni and Golden Gate Transit stop on the ground floor of the Transit Center would be provided along the west sidewalk on Fremont Street, and at crosswalks at the Fremont Street/Natoma Street intersection, with adequate signage (e.g., Sidewalk Closed/Use Other Side/Cross Here). While these temporary sidewalk/crosswalk closures would temporarily increase the travel time and distance required for some existing pedestrians using Mission, Fremont, or Beale streets, they would not interfere with pedestrian accessibility.

### *Bicycling*

The project would reduce the roadway capacity from two to one lane on westbound Mission Street, and from four to three lanes on northbound Fremont Street. Despite the reduction in roadway capacity, bicyclists would continue to be able to share the roadway with vehicular traffic along Mission, Fremont, and Beale streets. In addition, as part of the transportation plan, "Bicycle Crossing/Share the Road" signs and sharrow pavement markings would be installed along the south side of Mission Street west of Fremont Street for eastbound bicyclists, on the north side of Mission Street east of Beale Street for westbound bicyclists, and on Fremont Street north of Howard Street for northbound bicyclist along the construction frontage. Therefore, the proposed project would not interfere with bicycle accessibility.

### *Emergency Access*

No San Francisco Fire Department or San Francisco Police Department stations exist on the project block. As part of the transportation plan, the proposed project would provide openings in the barriers along the construction site perimeter to allow fire department access to the Tower and Podium buildings and their water supply connections at all times. In addition, as provided in the transportation plan, the contractor would coordinate with administrators of the nearest emergency service providers and provide advance notification of the timing, location, and duration of construction activities, including lane closures and suggested alternative routes. Therefore, the proposed project would not interfere with emergency access.

Construction of the project would not interfere with accessibility of people walking or bicycling to and from the project site, and adjoining areas, or interfere with emergency access. Therefore, the project impacts to accessibility would be less than significant.

### *Public Transit Delay*

Under baseline conditions, Muni routes 5, 5R, 38, and 38R make a right-turn from eastbound Market Street onto southbound First Street, a left-turn onto eastbound Mission Street, and a right-turn onto southbound Beale Street. During project construction, Muni Routes 5, 5R, 7, 38, and 38R would instead run eastbound on Market Street and southbound on Beale Street. Since these transit routes would make fewer turns during project construction than under baseline conditions, the proposed project would not substantially delay (e.g., cause these public transit routes to be delayed more than half a headway or more than four minutes) the affected transit routes. In addition, due to low traffic volumes on eastbound Market Street at Beale Street

(approximately 393 a.m. peak hour and 372 p.m. peak hour vehicle trips), the bus routes making turns at Market Street/Beale Street intersection would not substantially increase transit travel time.

Lane closures would temporarily reduce the roadway capacity from two to one lane on westbound Mission Street and from four to three lanes on northbound Fremont Street, but they would only affect one block segments on Fremont and Mission streets. Furthermore, the existing stop on the north side of Mission Street between Beale and Fremont streets, which serves Muni routes 14, 14R, and 14X, would be temporarily closed to prevent buses (e.g., Muni routes 7, 38, and 38R) being held up unable to maneuver around the stopped bus on the single westbound travel lane.

Golden Gate Transit could consider relocating bus stop for Routes 2, 4, and 27 to the following locations: the east side of Fremont Street north of Mission Street, the east side of Fremont Street south of Howard Street, and the west side of Beale Street north of Mission Street. These potential bus stop locations would not cause the affected bus routes to substantially deviate from the existing travel routes, and the duration of stop would not measurably change after the bus stop is relocated. Therefore, the project would not substantially increase transit travel time.

The contractor would install concrete barriers and fences approximately 11.6 feet north of the existing south sidewalk on Mission Street, between Fremont and Beale streets. This change would require a temporary closure of the existing 170-foot-long white passenger loading zone and 20-foot-long yellow commercial loading zone located adjacent to the 301 Mission Street parcel. There would be no change to loading facilities along Fremont and Beale streets as these two streets have no existing passenger or commercial loading zones near the project site.

As part of the transportation plan, the proposed project would install signs along the project frontages prohibiting any on-street loading activity and could request the SFMTA enforce illegal loading activity by dispatching Parking Control Officers or using cameras installed on Muni vehicles. The project sponsor would also notify residents and tenants to use alternate loading locations (e.g., porte cochere for residents and other nearby on-street loading zones for the restaurant and bank tenants). The project sponsor would continue to provide required residential passenger loading spaces in porte cochere. Other nearby on-street loading zones include a 90-foot-long yellow commercial loading zone on the east side of Fremont Street, between Market and Mission streets (approximately 300 feet from the project site), a 65-foot-long white zone on the west side of Beale Street between Market and Mission streets (approximately 340 feet from the project site), and a 65-foot-long white zone on the west side of Fremont Street between Market and Mission streets (approximately 350 feet from the project site). Since the majority of existing loading demand (maximum of six spaces between 9 a.m. and 11 a.m.) is associated with the residential use at 310 Mission Street, rather than the restaurant, which opens after 11:30 a.m., or the bank, which generates minimal loading demand, the majority of peak loading demand would be sufficiently accommodated at the porte cochere or other nearby on-street loading spaces as needed without substantially delaying public transit on Mission or Beale streets. Therefore, the project would not substantially delay public transit and impacts would be less than significant.

**Impact TR-2: Operation of the project would not result in significant transportation impacts. (Less than Significant)**

After project construction is completed, there would be no operational changes to the project components (i.e., structural upgrade made to the Tower building foundation within the public rights-of-way) or the Tower and Podium building operations. Pedestrian access, transit circulation, and vehicular access would be restored to existing conditions. Routine inspections would not be required, but inspections would be performed following a major earthquake. Inspections would require that the area immediately around the proposed manholes, located on the sidewalk along Fremont and Mission streets, to access the vaults be temporarily enclosed, and pedestrians would pass around the manholes. A temporary occupancy permit would be required from San Francisco Public Works for the enclosure of the area around manholes. This access would not require sidewalk closure. Therefore, the proposed project's operational transportation impacts would be less than significant.

**CUMULATIVE IMPACTS****Impact C-TR-1: Construction of the proposed project, in combination with reasonably foreseeable projects, would not contribute considerably to significant construction-related transportation impacts. (Less than Significant)**

The project construction would span over approximately 22 months (640 days) beginning in early 2020, and may overlap with the construction activities for the first phase of Better Market Street Project (starting in spring 2020), the Transbay Block 4/200 Folsom Street/200–272 Main Street (schedule unknown), and the Oceanwide Center Development Project, and the implementation of Active Beale Street (starting in spring 2020).<sup>64</sup> The first phase of Better Market Street Project would involve construction activities on Market Street between 5th and 8th streets, and the Oceanwide Center Development Project, located a block west of the project site, would require the closure of Jessie Street and Elim Alley Way and the north sidewalk on Mission Street between First and Second streets.

Cumulative projects including the proposed project would cause a substantial disruption to transit. The Better Market Street Project construction would result in a significant and unavoidable construction impacts, including to transit. During construction of the first phase of the Better Market Street project, all or some of the Muni routes 5, 5R, 6, 7, 7X, 9, 9R, 21, 31, and F could be temporarily diverted from Market Street to Mission Street if there are operational constraints on Market Street. The proposed project would temporarily (22 months) eliminate the existing westbound bus-only lane on Mission Street between Fremont and Beale streets. As a result, the diverted transit vehicles due to the Better Market Street construction could potentially travel in mixed-traffic in a single westbound lane for one block of Mission Street. The eastbound bus-only lane would remain. The Oceanwide Center Development project site does not front any transit facilities and would not cause a substantial disruption to transit.

Table 13, **Transit Service under Cumulative Condition**, shows the estimated cumulative transit volumes during project construction.

<sup>64</sup> Due to the nature of project, construction activities for the Active Beale Street are anticipated to last for a relatively short duration.

**TABLE 13  
TRANSIT SERVICE UNDER CUMULATIVE CONDITION**

Street	Direction (Segment)	Muni	Golden Gate Transit	SamTrans	Total
<b>A.M. Peak Hour</b>					
Mission Street	Eastbound (Fremont to Beale Street)	82	5	2	89
	Westbound (Beale to Fremont Street)	66	0	0	66
Fremont Street	Northbound (Howard to Mission Street)	48	6	2	56
Beale Street	Southbound (Mission to Howard Street)	73	5	2	80
<b>P.M. Peak Hour</b>					
Mission Street	Eastbound (Fremont to Beale Street)	54	3	2	59
	Westbound (Beale to Fremont Street)	67	0	0	67
Fremont Street	Northbound (Howard to Mission Street)	40	38	2	80
Beale Street	Southbound (Mission to Howard Street)	52	3	2	57
SOURCE: CHS Consulting Group, 2019.					

Overall vehicular traffic, including transit vehicular traffic, is expected to increase on the street segments adjacent to the project site under cumulative conditions. As shown on Table 13, approximately 89 eastbound and 66 westbound buses would travel on Mission Street between Beale and Fremont streets during the a.m. peak period and 59 eastbound and 67 westbound buses would travel this street segment during the p.m. peak period. However, as shown in Table 11, p. 81, the proposed project would result in approximately 16 buses on westbound Mission Street between Beale and Fremont streets during the a.m. peak period and 22 buses on this street segment during the p.m. peak period. This is a low number of transit vehicles compared to those that would be added to this street segment by the Better Market Street Project. In addition, the proposed project would temporarily close the bus stop on the north side of Mission Street between Beale and Fremont streets, which would prevent buses from being delayed due to buses stopped in the temporary single westbound travel lane so passengers can board/alight. Thus, the proposed project would not contribute considerably to the significant cumulative transit delay impact.

Furthermore, as part as part of a Better Market Street Mitigation Measure M-TR-1: Construction Management Plan – Additional Measures, private vehicles could be temporarily prohibited on Mission Street near the project site in the eastbound and/or westbound directions if public transit operational concerns arise during overlapping construction of cumulative projects (e.g., at least one travel lane is closed on Mission Street between 11th and Steuart streets resulting in only one open travel lane in either the eastbound or westbound direction). If this component of Better Market Street mitigation measure M-TR-1 is implemented, overall vehicle traffic on Mission Street in the westbound and/or eastbound would decrease due to the restriction on private vehicles thereby reducing the potential for transit delay to occur. In addition, Muni buses would be able to make the right turn from eastbound Mission Street to southbound Beale Street to access the Transit Center. The auto-turn analyses (see Appendix B, Attachment B.5, Auto Turn Analysis) shows that these buses (up to 60 feet in length) would temporarily encroach onto the adjacent travel lane on Beale Street as they make a right-turn from Mission Street to Beale Street. Since the buses would make this turn after all vehicles approaching Mission Street are clear on Beale Street, or when there is green light for eastbound traffic, bus movements would not conflict with other vehicles.

The Active Beale Street Project would install a new transit-only lane on the west side of Beale Street from Market Street to Natoma Street. The proposed project would not affect the roadway capacity on Beale Street, and all staging areas would be contained within the east sidewalk space along the Beale Street frontage. The Transbay Block 4/200 Folsom Street/200–272 Main Street project site borders Folsom, Beale (south of Howard Street) and Main streets, and the proposed project would not affect transit operation along these streets.

As stated above, as part of Better Market Street Mitigation Measure M-TR-1, Construction Management Plan – Additional Measures, private vehicles could be prohibited on Mission Street if operational concerns arise during overlapping construction of cumulative projects. As a result, traffic volumes may increase on parallel streets such as Howard and Folsom streets. Detours and diversion of vehicles to other streets would result in an increase in overall vehicle congestion throughout the South of Market neighborhood, which may lead to reduced vehicle speeds and longer peak-period queues. However, the proposed project would not generate a substantial amount of truck traffic and would not contribute considerably to the extended queues. The Oceanwide Center Development Project would require the closure of Jessie Street and rerouting vehicular traffic onto Ecker Street, heading south, exiting onto Mission Street. Jessie Street is an alleyway and carries low volume of local traffic west of First Street; therefore, it would not contribute a substantial amount of vehicle trips onto Mission Street. The Active Beale Street project would not increase vehicle trips or include any features that would obstruct sightlines for the project construction traffic on Beale Street. The Transbay Block 4/200 Folsom Street/200–272 Main Street project site borders Folsom, Beale (south of Howard Street) and Main streets, and project construction traffic would not travel along these streets.

The Better Market Street Project would cause a substantial disruption to pedestrian and bicycle travel along and near the project corridor over up to 14 years and result in significant impacts on transportation. The Oceanwide Center Development Project would temporarily close a portion of the north sidewalk on Mission Street between First and Second streets, but pedestrian right of way would be maintained through the crosswalks and the south sidewalk. The Active Beale Street Project would improve pedestrian (widened sidewalks near Market Street/Beale Street intersection) and bicycle (cycle tracks on the east side of Beale Street) facilities. The Transbay Block 4/200 Folsom Street/200–272 Main Street project site borders Folsom, Beale (south of Howard Street) and Main streets, and the proposed project would not affect pedestrian and bicycle circulation along these streets. The proposed project would not affect Market Street and would not contribute considerably to potentially hazardous conditions to pedestrians and bicyclists. The Better Market Street Project would cause periodic sidewalk, plaza, or crosswalk closures and increase emergency vehicle response times due to reduced roadway on Market Street. The Active Beale Street Project would improve pedestrian (near Market Street/Beale Street intersection), transit (new transit-only lane on the west side of Beale Street) and bicycle (new cycle tracks on the east side of Beale Street) facilities on Beale Street. Construction activities for the Transbay Block 4/200 Folsom Street/200–272 Main Street project may temporarily disrupt public rights-of-way along its borders on Folsom, Beale (south of Howard Street) and Main streets. The proposed project would provide a continuous pedestrian right-of-way on Beale Street and would not affect roadway capacity on Beale, Market, Folsom, or Howard streets.

For the reasons described above, the proposed project in combination with reasonably foreseeable projects could result in significant cumulative construction-related transportation impacts, but the project's contribution to this significant impact would be less than cumulatively considerable. In addition, Better Market Street M-TR-1, Construction Management Plan – Additional Measures, would introduce temporary

private vehicle restriction on Mission Street if public transit operational concerns arise during overlapping construction of cumulative projects. These temporary restrictions would allow public transit vehicles to operate on Mission Street without substantial delay.

**Impact C-TR-2: Operation of the project, in combination with reasonably foreseeable future projects, would not result in significant transportation impacts. (Less than Significant)**

No reasonably foreseeable future projects could combine with the project’s impacts to result in a significant cumulative transportation impact as a result of inspections of subsurface conditions that would be performed by the project sponsor following earthquakes. Therefore, the proposed project, in combination with reasonably foreseeable projects, operational transportation and circulation impacts would be less than significant.

Topics	Potentially Significant Impact	Less than Significant with Mitigation Incorporated	Less than Significant Impact	No Impact	Not Applicable
<b>7. NOISE.</b>					
<b>Would the project result in:</b>					
a) Generation of a substantial temporary or permanent increase in ambient noise levels in the vicinity of the project in excess of standards established in the local general plan or noise ordinance, or applicable standards of other agencies?	<input type="checkbox"/>	<input checked="" type="checkbox"/>	<input type="checkbox"/>	<input type="checkbox"/>	<input type="checkbox"/>
b) Generation of excessive groundborne vibration or groundborne noise levels?	<input type="checkbox"/>	<input checked="" type="checkbox"/>	<input type="checkbox"/>	<input type="checkbox"/>	<input type="checkbox"/>
c) For a project located within the vicinity of a private airstrip or an airport land use plan area, or, where such a plan has not been adopted, in an area within two miles of a public airport or public use airport, would the project expose people residing or working in the area to excessive noise levels?	<input type="checkbox"/>	<input type="checkbox"/>	<input type="checkbox"/>	<input type="checkbox"/>	<input checked="" type="checkbox"/>

The project site is not located within an airport land use plan area, within two miles of a public airport, or within the vicinity of a private airstrip. Therefore, topic E.7(c) is not applicable to the proposed project.

A Noise Technical Memorandum was prepared for the proposed project which calculated potential construction-related noise levels. The Noise Technical Memorandum provides a description of the regulatory framework and detailed calculations of construction-related noise by stage.<sup>65</sup>

**Noise**

Noise is generally defined as unwanted sound that annoys or disturbs people and potentially causes an adverse psychological or physiological effect on human health. Some land uses are more tolerant of noise than others. For example, schools, hospitals, churches, hotels, and residences are considered to be more sensitive to noise intrusion than are commercial or industrial activities. Because noise is an environmental pollutant that can interfere with human activities, evaluation of noise is necessary when considering the environmental impacts of a proposed project.

<sup>65</sup> ESA, *Noise Technical Memorandum – 301 Mission Street Perimeter Pile Upgrade Project*, November, 2019.

Sound is mechanical energy (vibration) transmitted by pressure waves over a medium such as air or water. Sound is characterized by various parameters that include the rate of oscillation of sound waves (frequency), the speed of propagation, and the pressure level or energy content (amplitude). In particular, the sound pressure level is the most common descriptor used to characterize the loudness of an ambient (existing) sound level. Although the decibel (dB) scale, a logarithmic scale, is used to quantify sound intensity, it does not accurately describe how sound intensity is perceived by human hearing. The perceived loudness of sound is dependent upon many factors, including sound pressure level and frequency content. The human ear is not equally sensitive to all frequencies in the entire spectrum, so noise measurements are weighted more heavily for frequencies to which humans are sensitive in a process called A-weighting, written as dBA and referred to as A-weighted decibels. There is a strong correlation between A-weighted sound levels and community response to noise. For this reason, the A-weighted sound level has become the standard tool of environmental noise assessment.

With respect to how humans perceive and react to changes in noise levels, a 1 dBA increase is imperceptible, a 3 dBA increase is barely perceptible, a 5 dB(A) increase is clearly noticeable, and a 10 dBA increase is subjectively perceived as approximately twice as loud. These subjective reactions to changes in noise levels were developed on the basis of test subjects' reactions to changes in the levels of steady-state pure tones or broadband noise and to changes in levels of a given noise source. These statistical indicators are thought to be most applicable to noise levels in the range of 50 to 70 dBA, as this is the usual range of voice and interior noise levels. Because decibels are logarithmic units, sound pressure levels cannot be added or subtracted through ordinary arithmetic. On the dB scale, a doubling of sound energy corresponds to a 3 dB increase. In other words, when two identical sources are each producing sound of the same loudness, their combined sound level at a given distance would be 3 dB higher than one source under the same conditions. For example, if one source produces a sound pressure level of 70 dBA, two identical sources would combine to produce 73 dBA. The combined sound level of any number of sources can be determined using decibel addition.

### ***Noise-Sensitive Receptors***

Noise sensitive receptors include residences, hotels, schools, senior care facilities, daycare facilities, and hospitals. The nearest noise-sensitive receptors to the project site are the residences of the 301 Mission Tower and Podium structures, which begin on the third story. Within 900 feet of the project site, other receptors include condominiums at 181 Fremont Street, a rooftop childcare play area at 342 Howard Street, Pacific Gas & Electric Children's Center at 77 Beale Street and Little Ohana Daycare at 50 Fremont Street. There are no existing hospitals or skilled nursing facilities within 900 feet of the project site.

### ***Vibration***

Vibration is an oscillatory motion through a solid medium in which the motion's amplitude can be described in terms of displacement, velocity, or acceleration. Several different methods are used to quantify vibration. The peak particle velocity (PPV) is defined as the maximum instantaneous peak of the vibration signal. The PPV is most frequently used to describe physical vibration impacts on buildings. Typical groundborne vibration generated by human activities attenuates rapidly with distance from the source of the vibration. Sensitive receptors to vibration include people (especially residents, the elderly, and sick people), structures (especially older masonry structures), and vibration-sensitive equipment.



Another useful vibration descriptor is known as vibration decibels or VdBs. VdBs are generally used when evaluating human response to vibration, as opposed to structural damage for which PPV is the more commonly used descriptor. Vibration decibels are established relative to a reference quantity, typically  $1 \times 10^{-6}$  inches per second.<sup>66</sup>

### Existing Vibration Sources

There are no sources of existing vibration adjacent to the project site. The nearest sources of vibration are the F-line railcars operated by Muni on Market Street, approximately 600 feet northwest of the project site. Vibration monitoring performed in North Beach in 2009 for the extension of the F-Line recorded maximum vibration levels of 81 VdB at 25 feet from the tracks.<sup>67</sup> At a distance of 600 feet vibration levels from historic streetcars would be attenuated to background levels, based on propagation curves published by FTA.<sup>68</sup>

### Ambient Noise Levels

Ambient noise levels in the project vicinity are typical of noise levels found in downtown San Francisco, which are dominated by vehicular traffic, including, cars, trucks, Muni buses, and emergency vehicles. Ambient long-term (24-hour) and short-term (15-minute) noise measurement data were collected in May 2019 in the project area, which characterize noise conditions at the nearest noise-sensitive locations. The noise measurements are summarized below in Table 14, Summary of Long-Term and Short-Term Ambient Noise Level Data on the Project Site and Vicinity.

TABLE 14  
SUMMARY OF LONG-TERM AND SHORT-TERM AMBIENT NOISE LEVEL DATA ON THE PROJECT SITE AND VICINITY

Measurement Location	Time Period <sup>a</sup>	Existing Noise Level (dBA, Leq <sup>b</sup> )
<b>Long-Term Measurements (24 hours or more)</b>		
301 Mission Street 25 feet from the project site work areas <sup>c</sup>	Daytime	64
	Nighttime	62
<b>Short-Term Measurements (15 minutes)</b>		
50 Fremont Street 140 feet north of the project site <sup>d</sup>	Daytime	64
77 Beale Street Pacific Gas & Electric Children's Center	Daytime	64
342 Howard Street 420 feet south of the project site <sup>d</sup>	Daytime	69
181 Fremont Street 300 feet south of the project site	Daytime	69
	Nighttime	62

NOTES:

- <sup>a</sup> The time period of day of monitoring reflect daytime and nighttime hours during which construction activities could occur.  
<sup>b</sup> Leq represents the constant sound level.  
<sup>c</sup> Measurement taken at the third story outdoor terrace at the same height as the lowest floor of residential uses. Exterior noise measurement does not reflect exterior-to-interior noise reduction described below and in Section 3.2 of the noise technical memorandum prepared for this project.  
<sup>d</sup> The childcare receptors at 50 Fremont Street and 342 Howard Street would not be in operation during nighttime hours. The nighttime analysis focuses on the residential receptors at 301 Mission Street and 181 Fremont Street.

SOURCE: ESA, 2019.

<sup>66</sup> U.S. Department of Transportation, Federal Transit Administration (FTA), *Transit Noise and Vibration Impact Assessment Manual*, September 2018, [https://www.transit.dot.gov/sites/fta.dot.gov/files/docs/research-innovation/118131/transit-noise-and-vibration-impact-assessment-manual-fta-report-no-0123\\_0.pdf](https://www.transit.dot.gov/sites/fta.dot.gov/files/docs/research-innovation/118131/transit-noise-and-vibration-impact-assessment-manual-fta-report-no-0123_0.pdf), accessed October 24, 2019.

<sup>67</sup> Wilson Ihrig & Associates, *Noise and Vibration Report San Francisco Muni Historic Streetcar Service to Fort Mason*, April 2009.

<sup>68</sup> U.S. Department of Transportation, Federal Transit Administration (FTA), *Transit Noise and Vibration Impact Assessment*, September 2018. Figure 6-4, p. 137, [https://www.transit.dot.gov/sites/fta.dot.gov/files/docs/research-innovation/118131/transit-noise-and-vibration-impact-assessment-manual-fta-report-no-0123\\_0.pdf](https://www.transit.dot.gov/sites/fta.dot.gov/files/docs/research-innovation/118131/transit-noise-and-vibration-impact-assessment-manual-fta-report-no-0123_0.pdf), accessed October 24, 2019.

## Analytic Methodology

### CONSTRUCTION NOISE

Article 29 of the San Francisco Police Code regulates noise. Section 2907 of article 29 provides the following limitations for construction equipment:

*“(a) Except as provided for in Subsections (b), (c), and (d) hereof, it shall be unlawful for any person to operate any powered construction equipment if the operation of such equipment emits noise at a level in excess of 80 dBA when measured at a distance of 100 feet from such equipment, or an equivalent sound level at some other convenient distance.”*

However, the police code does not specify quantitative noise limits for impact equipment or combined noise impacts from the simultaneous operation of multiple pieces of construction equipment. Therefore, the quantitative evaluation of daytime construction noise effects is based on criteria in the Federal Transit Administration (FTA) guidelines for residential land uses, which is 90 dBA Leq.<sup>69</sup> The planning department also evaluates whether construction noise would result in an increase of 10 dBA over existing noise levels (“Ambient + 10 dBA”) at sensitive receptors, which generally represents a perceived doubling of loudness.

The quantitative analysis typically evaluates the noise levels from the simultaneous operation of multiple pieces of construction equipment. The quantitative criteria above are only part of the evaluation of construction noise. The evaluation also considers the duration and intensity of any quantitative noise exceedance. In addition, nighttime construction noise is assessed to determine whether sleep disturbance would occur (if construction noise would exceed 45 dBA at residential interiors, assuming windows closed, for prolonged periods of time). The nighttime construction noise analysis also considers the frequency and duration of nighttime construction activities. All of the above factors are evaluated to determine whether a significant construction noise impact would occur.

The Federal Highway Administration Roadway Construction Noise Model (RCNM) was used to determine noise generated from construction activities for this project. The RCNM is used as the Federal Highway Administration’s national standard for predicting construction noise. The RCNM analysis includes the calculation of noise levels (L<sub>max</sub><sup>70</sup> and Leq<sup>71</sup>) at incremental distances for a variety of construction equipment. The model inputs include acoustical use factors, L<sub>max</sub> values, and Leq values at various distances depending on the receptor location analyzed.

For this project’s noise analysis, construction noise levels were calculated for each stage of construction based on the equipment list provided by the project sponsor. The estimate of construction noise levels was conducted for the purpose of this analysis based on the general assessment approach recommended by the FTA.<sup>72</sup> The FTA methodology for general assessment of construction noise entails a process for calculating

<sup>69</sup> U.S. Department of Transportation, Federal Transit Administration (FTA), *Transit Noise and Vibration Impact Assessment Manual*, September 2018, [https://www.transit.dot.gov/sites/fta.dot.gov/files/docs/research-innovation/118131/transit-noise-and-vibration-impact-assessment-manual-fta-report-no-0123\\_0.pdf](https://www.transit.dot.gov/sites/fta.dot.gov/files/docs/research-innovation/118131/transit-noise-and-vibration-impact-assessment-manual-fta-report-no-0123_0.pdf), accessed October 24, 2019.

<sup>70</sup> The maximum sound level measured during the measurement period.

<sup>71</sup> The equivalent steady state sound level that in a stated period of time would contain the same acoustical energy.

<sup>72</sup> The FTA does not publish a software noise model; as such, FHWA’s model was used and impacts assessed using FTA’s methodology for assessing impact.

the hourly dBA, Leq for each stage of construction considering (1) the reference noise emission level at 50 feet for equipment to be used for each stage of construction, (2) the usage factor for each piece of equipment, and (3) the distance between construction centerline and receptors.<sup>73</sup> This methodology entails determining the resultant noise levels for the two noisiest pieces of equipment expected to be used in each stage of construction.<sup>74</sup>

For oversized truck deliveries that are proposed to occur at night five nights per week in Stages 3 and 4 (a total duration of approximately one year), nighttime construction noise is assessed based on its potential to result in sleep disturbance at nearby residential uses (increase interior noise levels above 45 dBA per section 2909(d)).

This analysis also evaluates the potential for construction-related traffic to result in noise impacts along local access roads by determining whether noise-sensitive receptors would be located along proposed/likely construction haul routes and whether project-related peak hourly increases in construction truck traffic would be substantial. In general, traffic noise increases of less than 3 dBA are barely perceptible to people, while a 5 dBA increase is readily noticeable<sup>75</sup> and, for purposes of this analysis, considered a substantial permanent increase in ambient noise levels.

## CONSTRUCTION VIBRATION

Potential vibration levels resulting from construction of the structural upgrade of the proposed project are identified for off-site locations that are sensitive to vibration (i.e., existing residences) based on their distance from construction activities. The main concerns associated with construction-generated vibration include sleep disturbance, building damage, and interference with vibration-sensitive instruments or machinery, such as that used in research laboratories or hospitals. The potential vibration levels at off-site sensitive locations resulting from construction of the proposed project are analyzed against the vibration criteria established by Caltrans to determine whether an exceedance of allowable vibration levels would occur for structural damage and sleep disturbance. Caltrans' vibration criteria for structural damage and human annoyance (sleep disturbance) are shown in **Table 15, Caltrans Vibration Damage Potential Threshold Criteria**, and **Table 16, Caltrans Vibration Annoyance Potential Criteria**, respectively. Caltrans has identified a vibration level of 0.9 PPV to be strongly perceptible for transient construction sources which is applied in this analysis as the threshold for sleep disturbance from nighttime construction activity.

<sup>73</sup> In an urban area such as downtown San Francisco that have acoustically non-absorptive ground conditions, the ground factor is taken to be zero.

<sup>74</sup> U.S. Department of Transportation, Federal Transit Administration (FTA), *Transit Noise and Vibration Impact Assessment*, September 2018. pp. 174-179, [https://www.transit.dot.gov/sites/fta.dot.gov/files/docs/research-innovation/118131/transit-noise-and-vibration-impact-assessment-manual-fta-report-no-0123\\_0.pdf](https://www.transit.dot.gov/sites/fta.dot.gov/files/docs/research-innovation/118131/transit-noise-and-vibration-impact-assessment-manual-fta-report-no-0123_0.pdf), accessed October 24, 2019.

<sup>75</sup> Caltrans, *Technical Noise Supplement (TeNS) to the Traffic Noise Analysis Protocol*, pp. 2-44, September 2013, <http://www.dot.ca.gov/env/noise/docs/tens-sep2013.pdf>, accessed January 25, 2019.

**TABLE 15**  
**CALTRANS VIBRATION DAMAGE POTENTIAL THRESHOLD CRITERIA**

Structure and Condition	Maximum PPV (in/sec)	
	Transient Sources	Continuous/Frequent Intermittent Sources
Extremely fragile historic buildings, ruins, ancient monuments	0.12	0.08
Fragile buildings	0.2	0.1
Historic and some old buildings	0.5	0.25
Older residential structures	0.5	0.3
New residential structures	1.0	0.5
Modern industrial/commercial buildings	2.0	0.5

SOURCE: Caltrans, Transportation and Construction Vibration Guidance Manual, September 2013.

NOTES: Transient sources create a single isolated vibration event, such as blasting or drop balls. Continuous/frequent intermittent sources include impact pile drivers, pogo-stick compactors, crack and seat<sup>a</sup> equipment, vibratory pile drivers, and vibratory compaction equipment.

<sup>a</sup> Crack and seat method of pavement rehabilitation is the process of cracking concrete pavement into pieces and firmly seating the pieces into the subgrade prior to overlaying with asphalt concrete.

**TABLE 16**  
**CALTRANS VIBRATION ANNOYANCE POTENTIAL CRITERIA**

Structure and Condition	Maximum PPV (in/sec)	
	Transient Sources	Continuous/Frequent Intermittent Sources
Barely perceptible	0.04	0.01
Distinctly perceptible	0.25	0.04
Strongly perceptible	0.9	0.10
Severe	2.0	0.4

SOURCE: Caltrans, Transportation and Construction Vibration Guidance Manual, September 2013.

NOTE: Transient sources create a single isolated vibration event, such as blasting or drop balls. Continuous/frequent intermittent sources include impact pile drivers, pogo-stick compactors, crack and seat equipment, vibratory pile drivers, and vibratory compaction equipment.

## OPERATIONAL NOISE

Operational noise impacts are qualitatively discussed based on duration and perceived intensity of noise that could occur from operational adjustments to the proposed hydraulic systems.

**Impact NO-1: Construction of the proposed project would generate substantial temporary or periodic increases in ambient noise levels. (Less than Significant with Mitigation)**

### *Daytime Construction Noise*

Construction of the proposed project would cause a temporary increase in noise levels at the project site and within the project vicinity. The construction period would occur in six stages and last approximately 22 months. The proposed project construction would generally consist of excavation, installation of 52 cast-in-place reinforced concrete piles beneath the sidewalk areas, construction of a reinforced concrete extension of the existing mat foundation, installation of the hydraulic jack system, vault construction, and site restoration. The construction would temporarily increase noise in the project vicinity that could be considered an annoyance by occupants of nearby properties. The amount of construction noise generated

at any one time would fluctuate depending on the particular type, number, and duration of use of the various pieces of construction equipment.

To determine whether construction would result in a substantial temporary increase in noise levels, the estimated construction noise levels resulting from the proposed project at the nearby sensitive receptors are analyzed against three criteria to assess the magnitude of noise impact: the noise ordinance (article 29 of the San Francisco Police Code); general assessment criteria of the Federal Transit Administration (FTA); and an increase of 10 dBA over existing noise levels, which would represent a perceived doubling of loudness.

Table 17, **Maximum Noise Levels from Construction Equipment**, shows the maximum hourly noise levels ( $L_{max}$ ) produced by the various types of equipment proposed by the project sponsor at distances of 50 and 100 feet between the equipment and noise receptor.

**TABLE 17**  
**MAXIMUM NOISE LEVELS FROM CONSTRUCTION EQUIPMENT**

Construction Equipment	Noise Level at 50 Feet (dB, $L_{max}$ )	Noise Level at 100 Feet (dB, $L_{max}$ )
Air Compressors	78	72
Backhoes	78	72
Bore/Drill Rigs	84	78
Compactor	83	77
Crawler Tractor	84	78
Excavator	81	75
Generator Sets	81	75
Haul Truck	77	71
Paver	77	71
Rollers	80	74
Rough Terrain Forklifts	83	77
Front End Loaders	79	73
Concrete Pump	81	75
Concrete Truck	79	73
Truck Mount Drill	79	73

SOURCE: Federal Highway Administration, *Roadway Construction Noise Model User's Guide*, 2006.

According to section 2907 of the city's noise ordinance, it is prohibited to operate any powered construction equipment (non-impact), regardless of age or date of acquisition, if the operation of such equipment emits noise at a level in excess of 80 dBA when measured at a distance of 100 feet from such equipment. As shown in Table 17, the construction equipment would operate within the noise ordinance standards of section 2907(a). The project would have a less-than-significant impact with respect to generation of a substantial temporary increase in ambient noise levels in the vicinity of the project in excess of standards established in section 2907(a) of the noise ordinance.

Some land uses are more sensitive to noise levels than others due to the types of activities typically associated with the uses. Residences, hotels, schools, senior care facilities, daycare facilities, and hospitals are generally more sensitive to noise than commercial and industrial land uses. There are commercial, civic,

and residential uses within 900 feet<sup>76</sup> of the project site. Currently, the nearest sensitive receptors to the project site are the residences of Tower and Podium structures which begin on the third story. Within 900 feet of the project site, other sensitive receptors include condominiums at 181 Fremont Street, a rooftop childcare play area at 342 Howard Street, Pacific Gas & Electric Children's Center at 77 Beale Street, and Little Ohana Daycare (interior only) at 50 Fremont Street (see Table 14, p. 93).

The FTA methodology for general assessment of construction noise was applied for each stage of the proposed construction to determine the resultant noise levels at each of the sensitive receptors described above. Using FTA methodology for general assessment, the two noisiest pieces of equipment involved with each phase of construction were assumed to operate simultaneously. These two equipment types are the same (an augur drill rig for pile insertion and crane to maneuver heavy materials including piles) for the three stages involving drilling for pile installation which is the conservative (worst-case) scenario for daytime activities (see Section 4.2 of the Noise Technical Memorandum). **Table 18, Daytime Noise Levels from Indicator Pile, Piles on Fremont, and Piles on Mission Construction (Stages 1, 3, and 4)**, shows the predicted noise levels at each of the four nearest sensitive land uses. As shown in Table 18, construction noise from the worst-case construction stage scenarios would be below the 90 dBA daytime criterion for residential receptors which are also conservatively applied to child care facilities in this analysis. The project would have a less-than-significant impact with respect to generation of a substantial temporary increase in ambient noise levels in the vicinity of the project in excess of daytime construction criteria developed by the FTA.

For interior areas with non-opening windows, such as the residents of 301 Mission Street, section 2909(d) of the police code establishes a daytime interior noise standard of 55 dBA between the hours of 7 a.m. to 10 p.m., which is the significance threshold applied for daytime noise impacts to interior spaces. The maximum predicted exterior noise level from construction activities at the closest residential units, as shown in Table 18 would be 88 dBA. To determine the effectiveness of the exterior to interior noise reduction of exterior wall building materials at the 301 Mission Street building, short-term noise monitoring was conducted in June 2019. The noise monitoring demonstrated a 36 dBA exterior to interior sound level reduction with the existing building materials at 301 Mission Street (see Section 3.2 of the Noise Technical Memorandum). After factoring in the measured 36 dBA of exterior to interior noise reduction offered by the building's exterior wall, the maximum noise level from construction activities at the closest residential unit would be 52 dBA, which would be below the 55 dBA daytime interior noise standard established by section 2909(d). Therefore, interior noise from daytime construction would be consistent with the restrictions of the city's noise ordinance. It should also be noted that such noise levels would only be expected to occur when two noisiest pieces of equipment (an augur drill rig for pile insertion and crane to maneuver heavy materials including piles) are operating at the closest point to occupied residences. The project would have a less-than-significant impact with respect to generation of a substantial temporary increase in ambient noise levels in the vicinity of the project in excess of daytime standards established in section 2909(d) of the police code.

<sup>76</sup> This distance was selected because typical construction noise levels can affect a sensitive receptor at a distance of 900 feet if there is a direct line-of-sight between a noise source and a noise receptor (i.e., a piece of equipment generating 85 dBA would attenuate to 60 dBA over a distance of 900 feet). An exterior noise level of 60 dBA will typically attenuate to an interior noise level of 35 dBA with the windows closed and 45 dBA with the windows open.

**TABLE 18**  
**DAYTIME NOISE LEVELS FROM INDICATOR PILE, PILES ON FREMONT, AND PILES ON MISSION CONSTRUCTION**  
**(STAGES 1, 3, AND 4)**

Receptor	Existing Daytime Noise Level (dBA, Leq) <sup>a</sup>	Loudest Two Noise Sources	Usage Factor <sup>b</sup> (percent)	Distance to Receptor (feet)	Adjusted Leq Level (dBA) <sup>c</sup>	Exceed Exterior 90 dBA daytime standard?	Existing plus Construction Noise Resultant Noise Level (dBA) <sup>d</sup>	Exceed Ambient + 10 dBA standard?
301 Mission Street	64	Auger Rig Crane	20 40	25	88	No	88	Yes
50 Fremont Street	64	Auger Rig Crane	20 40	140	73	No	74	No
181 Fremont Street	69	Auger Rig Crane	20 40	200	70	No	73	No
77 Beale Street	64	Auger Rig Crane	20 40	200	70	No	71	No
342 Howard Street	69	Auger Rig Crane	20 40	420	63	No	70	No

## NOTES:

<sup>a</sup> Leq represents the constant sound level

<sup>b</sup> Usage factor is the fraction of time each piece of construction equipment is operating at full power (i.e., its loudest condition) during a construction operation.

<sup>c</sup> The Leq level is adjusted for distance and percentage of usage.

<sup>d</sup> As measured from the exterior of the building and not factoring in exterior-to-interior noise reduction discussed in Section 3.2 of the noise technical memorandum prepared for this project. Interior noise levels would be lower by 25 dBA or more for these receptors with windows closed (windows not operable for these modern office structures).

Noise exceeding threshold levels are in bold.

SOURCE: ESA, 2019.

### TEMPORARY INCREASE IN NOISE LEVELS IN THE PROJECT VICINITY

Under the city's approach to noise analysis, construction noise impacts are also assessed with respect to the overall increase in noise at a given sensitive receptor compared to existing conditions. While the city's noise ordinance establishes allowable increments in noise over existing levels for single-piece of construction equipment, the ordinance does not establish such limits for combined construction equipment. In lieu of any construction-related increment criterion within the general plan, noise ordinance or other current standards of an agency, this methodology applies a 10 dBA increase over ambient standard for sensitive receptors that would reasonably be expected in exterior areas. Such an increase represents a perceived doubling of loudness. Table 18 presents both the existing ambient noise level as well as the existing-plus-construction resultant noise level for each sensitive receptor and identifies whether the resultant noise level would exceed the ambient level by more than 10 dBA. As shown in Table 18, the resultant noise level increase would be less than 10 dBA for the receptors at 50 Fremont Street, 181 Fremont Street, 77 Beale Street and 342 Howard Street. However, the increase over ambient noise would be up to 24 dBA at the exterior of third-story residents of the Millennium Tower building. Given that construction activities would increase ambient noise levels by 10 dBA or more at receptor locations at 301 Mission Street during intermittent periods over the approximately 22-month construction period, construction noise impacts would be considered significant. Implementation of **Mitigation Measure M-NO-1a, General Construction Noise Control Measures**, would reduce construction noise levels at the 301 Mission Street receptor locations to a less-than-significant level. In addition, these residents would be within their apartments, which do not

have opening windows and would therefore receive an additional 36 dBA of sound reduction from the building and interior noise levels would remain within acceptable standards.

### **Noise Impacts of Construction Truck Traffic**

Peak truck trip activity would occur during Stage 4 with approximately 365 round truck trips.<sup>77</sup> Averaged over the estimated 110 days of this construction stage, the number of one-way truck trips during Stage 4 would be approximately 7 trips per day, which is less than one per hour. The contribution of one hourly one-way truck trip to existing roadway volumes on Fremont Street, Mission Street, and Beale Street would be negligible, given the high volumes and high transit bus percentages on these roadways and the project's construction truck traffic noise would not noticeably increase noise levels along roadways used to access the site. Temporary truck noise on local roadways would be a less than significant impact.

### **Nighttime Construction Noise**

Stages 3 and 4 of construction would require two shifts (7 a.m. to 8 p.m., and 8 p.m. to 7 a.m.), the latter of which would be to receive oversized truck deliveries five nights per week over an overall stage duration of approximately one year. For deliveries that are proposed to occur at night in Stages 3 and 4, nighttime noise is assessed based on the 80 dBA exterior noise criterion of the FTA as well as for the potential to result in sleep disturbance at nearby residential uses (increase interior noise levels above 45 dBA) as established in section 2909(d) of the city's Noise Ordinance. Because the child care receptors would not be operable during nighttime hours, the following analysis focuses on the residential receptors at 301 Mission Street and at 181 Fremont Street. For the subject building at 301 Mission Street, the measured exterior to interior noise reduction of 36 dBA was applied. For the building at 181 Fremont Street, which does not have operable windows, a standard assumption of exterior to interior noise reduction of 25 dBA with windows closed is applied.<sup>78</sup>

Delivery activities would involve the use of a crane and a forklift. Input values and calculated noise levels using FTA methodology and the Roadway Noise Construction Model for nighttime deliveries are presented in Table 19, **Nighttime Noise Levels from Stage 3 and 4 Overnight Deliveries**. Adjusted exterior noise levels at both receptors are presented and compared to the FTA criteria for nighttime construction. As shown in Table 19, nighttime delivery noise during Stages 3 and 4 would be up to 67 dBA at the receptors at 181 Fremont Street which is below the 80 dBA exterior nighttime criterion for these residential receptors. However, nighttime delivery noise during Stages 3 and 4 would be up to 89 dBA at the receptors at 301 Mission Street, which would be 9 dBA above the 80 dBA exterior nighttime criterion for residential receptors.

<sup>77</sup> Millennium Tower Homeowner's Association, 2019.

<sup>78</sup> U.S. EPA, *Information on Levels of Environmental Noise Requisite to Protect Public Health and Welfare with an Adequate Margin of Safety*, March 1974, <http://nepis.epa.gov/Exe/ZyPDF.cgi/2000L3LN.PDF?Dockey=2000L3LN.pdf>, accessed January 23, 2019.



TABLE 19  
NIGHTTIME NOISE LEVELS FROM STAGE 3 AND 4 OVERNIGHT DELIVERIES

Receptor	Existing Nighttime Noise Level (dBA, Leq) <sup>a</sup>	Noise Source	Reference Noise Level (dBA)	Distance to Receptor <sup>b</sup> (feet)	Adjusted Leq Level (dBA) <sup>c</sup>	Exceed 80 dBA Exterior Nighttime Standard?	Existing plus Construction Noise Exterior Noise Level (dBA)	Exceed 45 dBA Interior Nighttime Standard?	Existing plus Construction Noise Interior Noise Level (dBA)
301 Mission Street	62	Crane/ Forklift	84/83	25	89	Yes	89	Yes	53
181 Fremont Street	62	Crane/ Forklift	84/83	300	67	No	68	No	43

## NOTES:

Noise exceeding threshold levels are in bold.

- a Leq represents the constant sound level. Measurement does not reflect exterior-to-interior noise reduction described below and in Section 3.2 of the noise technical memorandum prepared for this project.
- b Distance between approximate location of equipment and property line of receptor.
- c The Leq level is adjusted for distance and percentage of usage.
- d As measured from the exterior of the building and not factoring in exterior-to-interior noise reduction discussed in Section 3.2 of the noise technical memorandum prepared for this project. Interior noise levels would be lower by 25 dBA or more for these receptors with windows closed (windows not operable for these modern office structures).

SOURCE: ESA, 2019.

Interior noise levels at residential receptors from nighttime deliveries would be below the 45 dBA City of San Francisco interior standard for the residential receptor at 181 Fremont Street, but 8 dBA above the interior nighttime standard at residential receptors at 301 Mission Street. This would be a substantial increase in nighttime impact and would be a significant impact. Additionally, section 2908 of the noise ordinance prohibits any person between the hours of 8 p.m. of any day and 7 a.m. of the following day from erecting, constructing, demolishing, excavating for, altering, or repairing any building or structure if the noise level created is in excess of the ambient noise level by 5 dBA at the nearest property line, unless a special permit has been applied for and granted. Therefore, the project sponsor would need to be granted a variance to the restrictions of section 2908 of the noise ordinance to conduct the proposed nighttime oversized truck delivery work.

Implementation of Mitigation Measure M-NO-1b, Noise Reduction Techniques for Equipment Used in Nighttime Delivery Activity, would reduce potentially significant nighttime delivery noise impact to a less-than-significant level. While the noise reduction potential of these measures may sum up to 20 dBA, the full realization of this cumulative reduction would only occasionally be achieved, as back-up alarms, are only active during brief periods. However, it may still be conservatively assumed that the 8 dBA attenuation necessary to reduce nighttime impacts to a less-than-significant level would be provided by the combination of the three other measures (positioning, shielding, and use of ECO silent mode) identified in Mitigation Measure M-NO-1b. The text of all of the required mitigation measures is provided below.

**Mitigation Measure M-NO-1a: General Construction Noise Control Measures.** To ensure that project noise from construction activities is minimized to the maximum extent feasible, the project sponsor shall undertake the following:

- The project sponsor shall require the general contractor to ensure that equipment and trucks used for project construction utilize the best available noise control techniques (e.g., improved mufflers, equipment redesign, use of intake silencers, ducts, engine enclosures and acoustically attenuating shields or shrouds, wherever feasible).

- The project sponsor shall require the general contractor to locate stationary noise sources (such as compressors) as far from adjacent or nearby sensitive receptors as possible, to muffle such noise sources, and to construct barriers around such sources and/or the construction site, which could reduce construction noise by as much as 5 dBA. To further reduce noise, the contractor shall locate stationary equipment in pit areas or excavated areas, if feasible.
- The project sponsor shall require the general contractor to use impact tools (e.g., jack hammers, pavement breakers, and rock drills) that are hydraulically or electrically powered wherever possible to avoid noise associated with compressed air exhaust from pneumatically powered tools. Where use of pneumatic tools is unavoidable, an exhaust muffler on the compressed air exhaust shall be used, along with external noise jackets on the tools, which could reduce noise levels by as much as 10 dBA.
- The project sponsor shall include noise control requirements in specifications provided to construction contractors. Such requirements could include, but not be limited to, performing all work in a manner that minimizes noise to the extent feasible; use of equipment with effective mufflers; undertaking the most noisy activities during times of least disturbance to surrounding residents and occupants, as feasible; and selecting haul routes that avoid residential buildings inasmuch as such routes are otherwise feasible.
- Prior to the issuance of the building permit, the project sponsor shall submit to the planning department and Department of Building Inspection (building department) a Construction Noise Management Plan identifying all measures to be implemented and identifying a contact person and phone number to respond to and track complaints pertaining to construction noise. These measures shall include (1) a procedure and phone numbers for notifying the building department, the Department of Public Health (health department), and the Police Department (during regular construction hours and off-hours); (2) a sign posted on site describing noise complaint procedures and a complaint hotline number that shall be answered at all times during construction; (3) designation of an on-site construction complaint and enforcement manager for the project; and (4) notification of neighboring residents and non-residential building managers within 300 feet of the project construction area at least 30 days in advance of commencement of construction activities.
- The general contractor or other designated person(s) shall prepare a weekly noise monitoring log report that shall be made available to the planning department upon request. The log shall include any noise complaints received, whether in connection with an exceedance or not, as well as any noise complaints received through calls to 311 or the building department if the contractor is made aware of them (for example, via a building department notice, inspection, or investigation). Any weekly report that includes an exceedance or for a period during which a complaint is received shall be submitted to the planning department within three business days following the week in which the exceedance or complaint occurred. A report shall be submitted to the planning department at the completion of construction. The report shall document noise levels, exceedances of standards, if reported, and corrective action(s) taken.

**Mitigation Measure M-NO-1b: Noise Reduction Techniques for Equipment Used in Nighttime Delivery Activity.** The project sponsor shall notify the Planning Department Development Performance Coordinator of any night noise permit application filed with the Department of Building Inspection on the day of filing and any emergency/unanticipated activity with the potential to exceed standard as soon as possible. The project sponsor shall implement all of the

following noise reduction techniques to reduce nighttime construction delivery noise during Stages 3 and 4:

- The crane used for nighttime deliveries shall be directionally positioned such that the exhaust faces away from the building at 301 Mission Street. This measure would be expected to reduce noise levels by 2 to 3 dBA.
- Provide acoustically rated shielding around crane engine. This measure would be expected to reduce noise levels by 5 to 12 dBA depending on the proximity of shielding to the crane engine.
- The crane shall be operated in ECO silent mode<sup>79</sup> during nighttime hours. This measure would be expected to reduce noise levels by 3 to 5 dBA.
- Forklifts shall employ self-adjusting directional backup alarms. Such alarms constantly measure the background noise and can reduce their sound level by 20 dBA or more.

**Impact NO-2: During project construction, the proposed project could generate excessive groundborne vibration or groundborne noise levels. (Less than Significant with Mitigation)**

Groundborne vibration from construction activities that involve impact activities, drilling and compaction, could produce detectable vibration at nearby sensitive buildings and sensitive receptors unless proper precaution is followed.

The existing residential uses located in the immediate vicinity of the project site could be exposed to the generation of some degree of groundborne vibration or groundborne noise levels related to construction activities. The results from vibration can range from no perceptible effects at the lowest vibration levels, to low rumbling sounds and perceptible vibrations at moderate levels, to structural damage at the highest levels. Site ground vibrations from construction activities rarely reach the levels that can damage structures, but they may be perceived in buildings very close to a construction site. The nearest structures to the pile locations would be the Tower building at 301 Mission Street, which is about 10 feet<sup>80</sup> from the proposed pile drilling activities. This structure was constructed in 2009 and would be considered a “new residential structure” with regard to its ability to resist vibrations.

The various PPV levels for the types of construction equipment that would operate during construction of the proposed project are identified in Table 20, **Vibration Levels from Construction Equipment**. This table presents the reference vibration level at a distance of 25 feet as published by FTA as well as at each of the four sensitive receptor locations. As shown in Table 20, vibration velocities could reach as high as approximately 0.58 in/sec PPV at 10 feet from compaction activities if a vibratory roller were to be used within 10 feet of the structure at 301 Mission Street. Vibration levels from all other equipment and at all other receptors would be below the building damage threshold of 0.5 PPV for the closest engineered structures. Implementation of **Mitigation Measure M-NO-2, Limited Use of Vibratory Rollers**, would reduce potentially significant vibration impacts at 301 Mission Street to a less-than-significant level.

<sup>79</sup> The proposed crane can operate in an “ECO silent” mode that regulates the engine speed such that it can be restricted to a predefined level, thus lowering noise emissions.

<sup>80</sup> The distance of work areas to the structure affected by vibration is closer than the distance to the residents affected by noise which are on the third story.

**TABLE 20**  
**VIBRATION LEVELS FROM CONSTRUCTION EQUIPMENT**

Equipment	Approximate PPV (in/sec)				
	10 Feet (301 Mission Street)	25 Feet (FTA Reference Level)	140 Feet (50 Fremont Street)	200 Feet (181 Fremont Street and 77 Beale Street)	420 Feet (342 Howard Street)
Vibratory Roller (daytime use)	<b>0.58</b>	0.21	0.032	0.014	0.009
Caisson Drill (daytime use)	0.24	0.089	0.013	0.006	0.004
Loaded Trucks (nighttime use)	0.21	0.076	0.011	0.005	0.003

NOTE: Vibration exceeding threshold levels are in bold.

SOURCES: FTA, 2018; ESA, 2019.

### ***Nighttime Construction Vibration***

Construction-related vibration could also result in annoyance at nearby sensitive receptors, depending on the intensity and duration. The main concern associated with construction-generated vibration resulting in annoyance is sleep disturbance during nighttime activities. With regard to annoyance, construction activities associated with the proposed project would have the potential to affect the nearest surrounding off-site sensitive receptors to the project site, which include the residents of 301 Mission Street. Caltrans has identified a vibration level of 0.9 PPV to be strongly perceptible for transient construction sources and 0.1 PPV for continuous construction sources, such as pile driving (not proposed). Delivery trucks would be the only source of vibration of concern during nighttime deliver activities and would generally occur at a distance of 25 feet from the Millennium Tower building. As shown in Table 20, the vibration velocities forecasted to occur during nighttime hours would be approximately 0.076 in/sec PPV as a result of each loaded delivery truck pass-by event. Vibration levels at the building during nighttime hours would be below the distinctly perceptible threshold of 0.25 PPV for transient construction sources such as loaded truck operation and sleep disturbance effects of nighttime deliveries would be less than significant.

The below Mitigation Measure M-NO-2 is identified to address potential impacts related to building damage at 301 Missions Street from the use of vibratory rollers in proximity to the structure.

**Mitigation Measure M-NO-2: Limited Use of Vibratory Rollers.** The project sponsor shall require that the contractors use non- vibratory excavator mounted compaction wheels and small, smooth drum rollers for final compaction of any asphalt base and asphalt concrete. If needed to meet compaction requirements, smaller vibratory rollers shall be used to minimize vibration levels during repaving activities where needed to meet vibration standards.

**Impact NO-3: Operation of the proposed project would not generate noise levels in excess of standards established in the local general plan or noise ordinance and would not result in a substantial permanent increase in ambient noise levels in the project vicinity. (Less than Significant)**

There would be no new operational noise from either stationary sources (i.e., mechanical equipment) or increases in vehicle traffic from the proposed project once construction is complete. The jack system would be located within underground vaults and, once constructed, adjustments, maintenance, and/or monitoring of the system is anticipated to result in negligible street-level noise. Because the maintenance and monitoring

trips would be occasional and generally consist of two personnel, this would not result in an increase in traffic noise on Fremont and Mission streets. Therefore, operational noise would be less than significant.

**Impact C-NO-1: Implementation of the proposed project, in combination with reasonably foreseeable projects, would not result in a significant cumulative noise or vibration impacts. (Less than Significant)**

As described in Section B.2, there are four cumulative projects in the project vicinity that could potentially be under construction at the same time as the proposed project. The Transbay Block 4/200 Folsom Street/200-272 Main Street project is located approximately 600 feet southeast of the project site and is separated from the project site by the Transit Center and two high-rise office towers. The Oceanwide Center Development project<sup>81</sup> is located approximately 400 feet northwest of the project site and is separated from the project site by the Salesforce office building and one high-rise office tower. The distance and presence of these intervening structures would effectively provide noise reduction from construction activities of the Transbay Block 4 and Oceanwide Center Development projects to contributing considerably to the noise generated by the proposed project on receptors of the project site. The Active Beale Street and Better Market Street Projects are transportation and streetscape improvements consisting of minor infrastructure upgrades such as sidewalk widening, streetscapes, and changes to lane configurations. Construction activities for the Active Beale Street project would involve minimal construction equipment and would progress linearly along Beale Street and associated noise would be of limited duration at the project site receptors and other receptors along the alignment. The Better Market Street construction activities would be located 700 feet north of the project site and separated from the site by multiple high-rise buildings. While the Better Market Street project would result in temporary diversion of bus routes from Market Street to Mission Street, this contribution to the cumulative noise environment would not be cumulatively considerable because of the relatively small number of additional trips per hour on a roadway with substantial traffic volumes. Therefore, project noise effects would not combine with the cumulative projects to result in cumulative construction noise impacts. Cumulative construction noise impacts would be less than significant.

Vibration dissipates rapidly with distance, such that vibration from vibration intensive activities such as pile-driving can be reduced to urban background levels at about 300 feet from the source for most soil types. With respect to cumulative vibration impacts, the other cumulative projects are sufficiently distant such that construction-related vibration from these projects would attenuate to background levels at the receptors. Cumulative construction vibration impacts would be less than significant.

---

<sup>81</sup> The Oceanwide Center Development Project is also known as the 50 1<sup>st</sup> Street project. This project is located on multiple lots within a block bounded by Mission Street to the south, First Street to the east, Stevenson Street to the north, and Second Street to the west.

Topics	Potentially Significant Impact	Less than Significant with Mitigation Incorporated	Less than Significant Impact	No Impact	Not Applicable
<b>8. AIR QUALITY.</b>					
<b>Would the project:</b>					
a) Conflict with or obstruct implementation of the applicable air quality plan?	<input type="checkbox"/>	<input type="checkbox"/>	<input checked="" type="checkbox"/>	<input type="checkbox"/>	<input type="checkbox"/>
b) Result in a cumulatively considerable net increase of any criteria pollutant for which the project region is non-attainment under an applicable federal, state, or regional ambient air quality standard?	<input type="checkbox"/>	<input checked="" type="checkbox"/>	<input type="checkbox"/>	<input type="checkbox"/>	<input type="checkbox"/>
c) Expose sensitive receptors to substantial pollutant concentrations?	<input type="checkbox"/>	<input checked="" type="checkbox"/>	<input type="checkbox"/>	<input type="checkbox"/>	<input type="checkbox"/>
d) Result in other emissions (such as those leading to odors) adversely affecting a substantial number of people?	<input type="checkbox"/>	<input type="checkbox"/>	<input checked="" type="checkbox"/>	<input type="checkbox"/>	<input type="checkbox"/>

The Bay Area Air Quality Management District (air district) is the regional agency with jurisdiction over the nine-county San Francisco Bay Area Air Basin (air basin), which includes: San Francisco, Alameda, Contra Costa, Marin, San Mateo, Santa Clara, and Napa Counties, and portions of Sonoma and Solano Counties. The air district is responsible for attaining and maintaining air quality in the air basin within federal and state air quality standards, as established by the federal Clean Air Act (federal clean air act) and the California Clean Air Act (clean air act), respectively. Specifically, the air district has the responsibility to monitor ambient air pollutant levels throughout the air basin and to develop and implement strategies to attain the applicable federal and state standards. The federal clean air act and the clean air act require plans to be developed for areas that do not meet air quality standards, generally.

The most recent air quality plan, the *2017 Clean Air Plan*, was adopted by the air district in April 2017. The *2017 Clean Air Plan* updates the most recent Bay Area ozone plan, the *2010 Clean Air Plan*, in accordance with the requirements of the state Clean Air Act to implement all feasible measures to reduce ozone; provide a control strategy to reduce ozone, particulate matter, air toxics, and greenhouse gases (GHGs) in a single, integrated plan; and establish emission control measures to be adopted or implemented. The *2017 Clean Air Plan* contains the following primary goals:

- Protect air quality and health at the regional and local scale: Attain all state and national air quality standards, and eliminate disparities among Bay Area communities in cancer health risk from toxic air contaminants; and
- Protect the climate: Reduce Bay Area greenhouse gas emissions to 40 percent below 1990 levels by 2030 and 80 percent below 1990 levels by 2050.

The *2017 Clean Air Plan* contains 85 measures to address the reduction of several pollutants: ozone precursors, particulate matter, air toxics, and/or GHGs. Other measures focus on potent GHGs such as methane and black carbon, or harmful fine particles that affect public health. Consistency with this plan is the basis for determining whether the proposed project would conflict with or obstruct implementation of air quality plans.

### Criteria Air Pollutants

In accordance with the state and federal clean air acts, air pollutant standards are identified for the following six criteria air pollutants: ozone, carbon monoxide (CO), particulate matter (PM), nitrogen dioxide (NO<sub>2</sub>), sulfur dioxide (SO<sub>2</sub>), and lead. These air pollutants are termed criteria air pollutants because

they are regulated by developing specific public health- and welfare-based criteria as the basis for setting permissible levels. In general, the air basin experiences low concentrations of most pollutants when compared to federal or state standards. The air basin is designated as either in attainment<sup>82</sup> or unclassified for most criteria pollutants with the exception of ozone, PM<sub>2.5</sub>, and PM<sub>10</sub>, which are designated as non-attainment for either the state or federal standards. By its very nature, regional air pollution is largely a cumulative impact in that no single project is sufficient in size to, by itself, result in non-attainment of air quality standards. Instead, a project's individual emissions contribute to existing cumulative air quality impacts. If a project's contribution to cumulative air quality impacts is "considerable," then the project's impact on air quality would be considered significant.<sup>83</sup>

Table 21, *Construction Criteria Air Pollutants Significance Thresholds*, identifies air quality significance thresholds for construction-related criteria pollutant emissions followed by a discussion of each threshold. Projects that would result in construction-related criteria air pollutant emissions below these significance thresholds would not result in a cumulatively considerable net increase in non-attainment criteria air pollutants within the air basin. Table 21 presents only the construction thresholds because operational thresholds are not applicable to this project (the project will not result in operational criteria pollutant emissions).

TABLE 21  
CONSTRUCTION CRITERIA AIR POLLUTANTS SIGNIFICANCE THRESHOLDS

Pollutant	Average Daily Emissions (lbs./day)
ROG	54
NO <sub>x</sub>	54
PM <sub>10</sub>	82 (exhaust)
PM <sub>2.5</sub>	54 (exhaust)
Fugitive Dust	Construction Dust Ordinance or other Best Management Practices

SOURCE: Bay Area Air Quality Management District, *California Environmental Quality Act Air Quality Guidelines*, May 2017

**Ozone Precursors.** As discussed previously, the air basin is currently designated as non-attainment for ozone. Ozone is a secondary air pollutant produced in the atmosphere through a complex series of photochemical reactions involving reactive organic gases (ROG) and oxides of nitrogen (NO<sub>x</sub>). The potential for a project to result in a cumulatively considerable net increase in non-attainment criteria air pollutants are based on the state and federal Clean Air Act's emissions limits for stationary sources. The federal New Source Review program was created by the federal clean air act to ensure that stationary sources of air pollution are constructed in a manner that is consistent with attainment of federal health based ambient air quality standards. Similarly, to ensure that new stationary sources do not cause or contribute to a violation of an air quality standard, air district Regulation 2, Rule 2 requires that any new source that emits criteria air pollutants above a specified emissions limit must offset those emissions. For ozone precursors ROG and NO<sub>x</sub>, the offset emissions level is an annual average of 10 tons per year (or

<sup>82</sup> "Attainment" status refers to those regions that are meeting federal and/or state standards for a specified criteria pollutant. "Non-attainment" refers to regions that do not meet federal and/or state standards for a specified criteria pollutant. "Unclassified" refers to regions where there is not enough data to determine the region's attainment status.

<sup>83</sup> Bay Area Air Quality Management District, *California Environmental Quality Act Air Quality Guidelines*, May 2017, p. 2-1.

54 pounds [lbs.] per day).<sup>84</sup> These levels represent emissions below which new sources are not anticipated to contribute considerably to non-attainment criteria air pollutants.

Although this regulation applies to new or modified stationary sources, the proposed project would result in ROG and NO<sub>x</sub> emissions during construction. Therefore, the above thresholds can be applied to the construction phase of the proposed project to determine whether the project would result in a considerable net increase in ROG and NO<sub>x</sub> emissions.

**Particulate Matter (PM<sub>10</sub> and PM<sub>2.5</sub>).** The air district has not established an offset limit for PM<sub>2.5</sub>. However, the emissions limit in the federal New Source Review for stationary sources in nonattainment areas is an appropriate significance threshold. For PM<sub>10</sub> and PM<sub>2.5</sub>, the emissions limit under New Source Review is 15 tons per year (82 lbs. per day) and 10 tons per year (54 lbs. per day), respectively. These emissions limits represent levels below which a source is not expected to have an impact on air quality.<sup>85</sup> Similar to ozone precursor thresholds identified above, the proposed project would result in increases in particulate matter emissions during construction. Therefore, the above thresholds can be applied to the construction phase of the proposed project.

**Fugitive Dust.** Fugitive dust emissions are typically generated during construction. Studies have shown that the application of best management practices at construction sites significantly controls fugitive dust.<sup>86</sup> Individual measures have been shown to reduce fugitive dust by anywhere from 30 to 90 percent.<sup>87</sup> The air district has identified a number of best management practices to control fugitive dust emissions from construction activities.<sup>88</sup> The city's Construction Dust Control Ordinance (Ordinance 176-08, effective July 30, 2008) requires a number of measures to control fugitive dust to ensure that construction projects do not result in visible dust. The best management practices employed in compliance with the city's Construction Dust Control Ordinance is an effective strategy for controlling construction-related fugitive dust. The ordinance requires that all site preparation work, demolition, or other construction activities within San Francisco that have the potential to create dust or expose or disturb more than 10 cubic yards, or 500 square feet, of soil comply with specified dust control measures, whether or not the activity requires a permit from the building department.

**Other Criteria Pollutants.** Regional concentrations of CO in the Bay Area have not exceeded the state standards in the past 11 years and SO<sub>2</sub> concentrations have never exceeded the standards. The primary source of CO emissions from development projects is vehicle traffic. Construction-related SO<sub>2</sub> emissions represent a negligible portion of the total basin-wide emissions and construction-related CO emissions represent less than five percent of the Bay Area total basin-wide CO emissions. The Bay Area is in

<sup>84</sup> Bay Area Air Quality Management District, *Revised Draft Options and Justification Report, California Environmental Quality Act Thresholds of Significance*, October 2009, page 17, <http://www.baaqmd.gov/~media/Files/Planning%20and%20Research/CEQA/Revised%20Draft%20CEQA%20Thresholds%20%20Justification%20Report%20Oct%202009.ashx?la=en>, accessed February 9, 2016.

<sup>85</sup> Bay Area Air Quality Management District, *Revised Draft Options and Justification Report, California Environmental Quality Act Thresholds of Significance*, October 2009, page 16.

<sup>86</sup> Western Regional Air Partnership. *WRAP Fugitive Dust Handbook*. September 7, 2006. Available: [http://www.wrapair.org/forums/dejffjdh/content/FDHandbook\\_Rev\\_06.pdf](http://www.wrapair.org/forums/dejffjdh/content/FDHandbook_Rev_06.pdf). Accessed February 9, 2016.

<sup>87</sup> Bay Area Air Quality Management District, *Revised Draft Options and Justification Report, California Environmental Quality Act Thresholds of Significance*, October 2009, page 27.

<sup>88</sup> Bay Area Air Quality Management District, *CEQA Air Quality Guidelines*, May 2017. Available: [http://www.baaqmd.gov/~media/files/planning-and-research/ceqa/ceqa\\_guidelines\\_may2017-pdf.pdf?la=en](http://www.baaqmd.gov/~media/files/planning-and-research/ceqa/ceqa_guidelines_may2017-pdf.pdf?la=en). Accessed December 20, 2017.



attainment for both CO and SO<sub>2</sub>. Furthermore, the air district has demonstrated, based on modeling, that in order to exceed the California ambient air quality standard of 9.0 ppm (8-hour average) or 20.0 ppm (1-hour average) for CO, project traffic in addition to existing traffic would need to exceed 44,000 vehicles per hour at affected intersections (or 24,000 vehicles per hour where vertical and/or horizontal mixing is limited). Therefore, given the Bay Area's attainment status, the proposed project would not result in a cumulatively considerable net increase in CO or SO<sub>2</sub>, and a quantitative analysis is not required.

### **Local Health Risks and Hazards**

In addition to criteria air pollutants, individual projects may emit toxic air contaminants (TACs). TACs collectively refer to a diverse group of air pollutants that are capable of causing chronic (i.e., of long-duration) and acute (i.e., severe but of short-term) adverse effects to human health, including carcinogenic effects. TACs are defined in California Health and Safety Code section 39655 as air pollutants which may cause or contribute to an increase in mortality or serious illness, or which may pose a present or potential hazard to human health. Human health effects of TACs include birth defects, neurological damage, cancer, and death. There are hundreds of different types of TACs with varying degrees of toxicity. Individual TACs vary greatly in the health risk they present; at a given level of exposure, one TAC may pose a hazard that is many times greater than another.

Unlike criteria air pollutants, TACs do not have ambient air quality standards but are regulated by the air district using a risk-based approach. This approach uses a health risk assessment to determine which sources and pollutants to control as well as the degree of control. A health risk assessment is an analysis in which human health exposure to toxic substances is estimated and considered together with information regarding the toxic potency of the substances, to provide quantitative estimates of health risks.<sup>89</sup>

Air pollution does not affect every individual in the population in the same way, and some groups are more sensitive to adverse health effects than others. Land uses such as residences, schools, children's day care centers, hospitals, and nursing and convalescent homes are considered to be the most sensitive to poor air quality because the population groups associated with these uses have increased susceptibility to respiratory distress or, as in the case of residential receptors, their exposure time is greater than for other land uses. Therefore, assessments of air pollutant exposure to residents typically result in the greatest adverse health outcomes of all population groups.

Exposures to fine particulate matter (PM<sub>2.5</sub>) are strongly associated with mortality, respiratory diseases, and lung development in children, and other endpoints such as hospitalization for cardiopulmonary disease.<sup>90</sup> In addition to PM<sub>2.5</sub>, diesel particulate matter is also of concern. The California Air Resources Board (air resources board) identified diesel particulate matter as a TAC in 1998, primarily based on

<sup>89</sup> In general, a health risk assessment is required if the air district concludes that projected emissions of a specific air toxic compound from a proposed new or modified source suggest a potential public health risk. The project applicant is then subject to a health risk assessment for the source in question. Such an assessment generally evaluates chronic, long-term effects, estimating the increased risk of cancer as a result of exposure to one or more TACs.

<sup>90</sup> San Francisco Department of Public Health, Assessment and Mitigation of Air Pollutant Health Effects from Intra-Urban Roadways: Guidance for Land Use Planning and Environmental Review, May 2008.

evidence demonstrating cancer effects in humans.<sup>91</sup> The estimated cancer risk from exposure to diesel exhaust is much higher than the risk associated with any other TAC routinely measured in the region.

In an effort to identify areas of San Francisco most adversely affected by sources of TACs, San Francisco partnered with the air district to inventory and assess air pollution and exposures from mobile, stationary, and area sources within San Francisco. Areas with poor air quality, termed the "Air Pollutant Exposure Zone," were identified based on health-protective criteria that consider estimated cancer risk, exposures to fine particulate matter, proximity to freeways, and locations with particularly vulnerable populations. The project site is located within the Air Pollutant Exposure Zone. Each of the Air Pollutant Exposure Zone criteria is discussed below.

**Excess Cancer Risk.** The 100 per one million persons (100 excess cancer risk) criterion is based on United States Environmental Protection Agency (USEPA) guidance for conducting air toxic analyses and making risk management decisions at the facility and community-scale level.<sup>92</sup> As described by the air district, the USEPA considers a cancer risk of 100 per million or less to be within the "acceptable" range of cancer risk. Furthermore, in the 1989 preamble to the benzene National Emissions Standards for Hazardous Air Pollutants (NESHAP) rulemaking,<sup>93</sup> the USEPA states that it "...strives to provide maximum feasible protection against risks to health from hazardous air pollutants by (1) protecting the greatest number of persons possible to an individual lifetime risk level no higher than approximately one in one million and (2) limiting to no higher than approximately one in ten thousand [100 in one million] the estimated risk that a person living near a plant would have if he or she were exposed to the maximum pollutant concentrations for 70 years." The 100 per one million excess cancer cases is also consistent with the ambient cancer risk in the most pristine portions of the Bay Area based on the air district regional modeling.<sup>94</sup>

**Fine Particulate Matter.** In April 2011, the USEPA published the Policy Assessment for the Particulate Matter Review of the National Ambient Air Quality Standards. In this document, USEPA staff concludes that the current federal annual PM<sub>2.5</sub> standard of 15 µg/m<sup>3</sup> should be revised to a level within the range of 13 to 11 µg/m<sup>3</sup>, with evidence strongly supporting a standard within the range of 12 to 11 µg/m<sup>3</sup>. The Air Pollutant Exposure Zone for San Francisco are based on the health protective PM<sub>2.5</sub> standard of 11 µg/m<sup>3</sup>, as supported by the USEPA's Particulate Matter Policy Assessment, although lowered to 10 µg/m<sup>3</sup> to account for error in emissions modeling programs.

**Proximity to Freeways.** According to the air resources board, studies have shown an association between the proximity of sensitive land uses to freeways and a variety of respiratory symptoms, asthma exacerbations, and decreases in lung function in children. Siting sensitive uses in proximity to freeways increases both exposure to air pollution and the potential for adverse health effects. As evidence shows that

<sup>91</sup> California Air Resources Board, Fact Sheet, "The Toxic Air Contaminant Identification Process: Toxic Air Contaminant Emissions from Diesel-fueled Engines," October 1998.

<sup>92</sup> Bay Area Air Quality Management District, *Revised Draft Options and Justification Report, California Environmental Quality Act Thresholds of Significance*, October 2009, page 67, <http://www.baaqmd.gov/~media/Files/Planning%20and%20Research/CEQA/Revised%20Draft%20CEQA%20Thresholds%20%20Justification%20Report%20Oct%202009.ashx?la=en>, accessed February 9, 2016.

<sup>93</sup> 54 Federal Register 38044, September 14, 1989.

<sup>94</sup> Bay Area Air Quality Management District, *Revised Draft Options and Justification Report, California Environmental Quality Act Thresholds of Significance*, October 2009, page 67, <http://www.baaqmd.gov/~media/Files/Planning%20and%20Research/CEQA/Revised%20Draft%20CEQA%20Thresholds%20%20Justification%20Report%20Oct%202009.ashx?la=en>, accessed February 9, 2016.

sensitive uses in an area within a 500-foot buffer of any freeway are at an increased health risk from air pollution,<sup>95</sup> lots that are within 500 feet of freeways are included in the Air Pollutant Exposure Zone.

**Health Vulnerable Locations.** Based on the air district's evaluation of health vulnerability in the Bay Area, those zip codes (94102, 94103, 94105, 94124, and 94130) in the worst quintile of Bay Area Health vulnerability scores as a result of air pollution-related causes were afforded additional protection by lowering the standards for identifying lots in the Air Pollutant Exposure Zone to: (1) an excess cancer risk greater than 90 per one million persons exposed, and/or (2) PM<sub>2.5</sub> concentrations in excess of 9 µg/m<sup>3</sup>.<sup>96</sup>

The above citywide health risk modeling was also used as the basis in approving a series of amendments to the San Francisco Building and Health Codes, generally referred to as the Enhanced Ventilation Required for Urban Infill Sensitive Use Developments or Health Code, article 38 (ordinance 224-14, effective December 8, 2014) (article 38). The purpose of article 38 is to protect the public health and welfare by establishing an Air Pollutant Exposure Zone and imposing an enhanced ventilation requirement for all urban infill sensitive use development within that zone. In addition, projects within the Air Pollutant Exposure Zone require special consideration to determine whether the project's activities would add a substantial amount of emissions to areas already adversely affected by poor air quality. The project site is located within the Air Pollutant Exposure Zone and it is also within a health vulnerable zip code: 94105.

**Health Risk Thresholds.** For projects that could result in sensitive receptor locations meeting the Air Pollutant Exposure Zone criteria that otherwise would not occur without the project, a proposed project that would emit PM<sub>2.5</sub> concentration above 0.3 µg/m<sup>3</sup> or result in an excess cancer risk greater than 10.0 per million would be considered a significant impact. The 0.3 µg/m<sup>3</sup> PM<sub>2.5</sub> concentration and the excess cancer risk of 10.0 per million persons exposed are the levels below which the air district considers new sources not to make a considerable contribution to cumulative health risks.<sup>97</sup> For projects that could affect sensitive receptor locations that already meet the Air Pollutant Exposure Zone criteria without the project, a proposed project that would emit PM<sub>2.5</sub> concentration above 0.2 µg/m<sup>3</sup> or result in an excess cancer risk greater than 7.0 per million would be considered a significant impact. The 0.2 µg/m<sup>3</sup> PM<sub>2.5</sub> concentration and the excess cancer risk of 7.0 per million persons exposed are the levels below which the city considers new sources not to make a considerable contribution to cumulative health risks.<sup>98</sup> For the proposed project, these thresholds apply to sensitive receptors that are already located in the Air Pollutant Exposure Zone. **Table 22, Health Risk Significance Thresholds**, presents the health risk thresholds that are applied to the proposed project.

<sup>95</sup> California Air Resources Board, *Air Quality and Land Use Handbook: A Community Health Perspective*, April 2005, <http://www.arb.ca.gov/ch/landuse.htm>.

<sup>96</sup> San Francisco Planning Department and San Francisco Department of Public Health, *2014 Air Pollutant Exposure Zone Map (Memo and Map)*, April 9, 2014. These documents are part of San Francisco Board of Supervisors File No. 14806, Ordinance No. 224-14 Amendment to *Health Code* article 38.

<sup>97</sup> Bay Area Air Quality Management District, *California Environmental Quality Act Air Quality Guidelines*, May 2017, p. 2-2.

<sup>98</sup> A 0.2 µg/m<sup>3</sup> increase in PM<sub>2.5</sub> would result in a 0.28 percent increase in non-injury mortality or an increase of about 21 excess deaths per 1,000,000 population per year from non-injury causes in San Francisco. This information is based on Jerrett, M., et al., *Spatial Analysis of Air Pollution and Mortality in Los Angeles*, *Epidemiology*, 16:727-736, 2005. The excess cancer risk has been proportionally reduced to result in a significance criterion of 7 per million persons exposed.

**TABLE 22**  
**HEALTH RISK SIGNIFICANCE THRESHOLDS**

Affected Sensitive Receptors	Project Significance Thresholds	
	Annual Average PM <sub>2.5</sub> Concentration (µg/m <sup>3</sup> )	Excess Cancer Risk (cases per 1 million population)
Project health risk contributions to sensitive receptor locations within the Air Pollutant Exposure Zone <sup>a</sup>	0.2	7.0
Project health risk contributions to sensitive receptor locations not within the Air Pollutant Exposure Zone but brought into the Air Pollutant Exposure Zone as a result of the project <sup>b</sup>	0.3	10.0

**NOTES:**

PM<sub>2.5</sub> = particulate matter less than or equal to 2.5 microns in diameter; µg/m<sup>3</sup> = micrograms per cubic meter

<sup>a</sup> A 0.2 µg/m<sup>3</sup> increase in PM<sub>2.5</sub> would result in a 0.28 percent increase in non-injury mortality or an increase of about 21 excess deaths per 1,000,000 population per year from non-injury causes in San Francisco. This information is based on Jerrett, M., et al., *Spatial Analysis of Air Pollution and Mortality in Los Angeles*, Epidemiology, 16:727–736, 2005. The excess cancer risk has been proportionally reduced to result in a significance criterion of 7 per million persons exposed.

<sup>b</sup> Bay Area Air Quality Management District, *California Environmental Quality Act Air Quality Guidelines*, 2017.

**SOURCES:**

1. Bay Area Air Quality Management District, *Revised Draft Options and Justification Report, California Environmental Quality Act Thresholds of Significance*, October 2009, p. 7, <http://www.baaqmd.gov/~media/files/planning-and-research/ceqa/revised-draft-ceqa-thresholds-justification-report-oct-2009.pdf?la=en>, accessed February 2019.
2. Bay Area Air Quality Management District, *California Environmental Quality Act Air Quality Guidelines*, May 2017, p. 2-2, [http://www.baaqmd.gov/~media/files/planning-and-research/ceqa/ceqa\\_guidelines\\_may2017-pdf.pdf?la=en](http://www.baaqmd.gov/~media/files/planning-and-research/ceqa/ceqa_guidelines_may2017-pdf.pdf?la=en), accessed February 2019.
3. San Francisco Department of Public Health, Environmental Health, Planning, Memorandum to File regarding 2014 Air Pollutant Exposure Zone Map, April 9, 2014.
3. Jerrett, M. et al., *Spatial Analysis of Air Pollution and Mortality in Los Angeles*, Epidemiology, 16:727–736, 2005.

### Construction Air Quality Impacts

Project-related air quality impacts fall into two categories: short-term impacts from construction and long-term impacts from project operation. The following addresses construction-related air quality impacts resulting from the proposed project.

**Impact AQ-1: The proposed project's construction activities would generate fugitive dust and criteria air pollutants. Construction exhaust emissions would result in a cumulatively considerable net increase in regional non-attainment criteria air pollutants. (Less than Significant with Mitigation)**

Construction activities (short-term) typically result in emissions of ozone precursors and particulate matter in the form of dust (fugitive dust) and exhaust (e.g., vehicle tailpipe emissions). Emissions of ozone precursors and particulate matter are primarily a result of the combustion of fuel from on-road and off-road vehicles and other construction equipment. However, ROGs are also emitted from activities that involve painting, other types of architectural coatings, or asphalt paving. During the proposed 22-month construction period, construction activities would have the potential to result in emissions of ozone precursors and particulate matter, as discussed below.

### FUGITIVE DUST

The proposed project-related trenching, drilling, and paving activities may cause wind-blown dust that could contribute particulate matter into the local atmosphere. Although there are federal standards for air pollutants and implementation of state and regional air quality control plans, air pollutants continue to have impacts on human health throughout the country. California has found that particulate matter

exposure can cause health effects at lower levels than national standards. The current health burden of particulate matter demands that, where possible, public agencies take feasible available actions to reduce sources of particulate matter exposure. According to the air resources board, reducing particulate matter PM<sub>2.5</sub> concentrations to state and federal standards of 12 µg/m<sup>3</sup> in the San Francisco Bay Area would prevent between 200 and 1,300 premature deaths.<sup>99</sup>

Dust can be an irritant causing watering eyes or irritation to the lungs, nose, and throat. Demolition, excavation, grading, and other construction activities can cause wind-blown dust that adds particulate matter to the local atmosphere. Depending on exposure, adverse health effects can occur due to this particulate matter in general and also due to specific contaminants such as lead or asbestos that may be constituents of soil. In response, the San Francisco Board of Supervisors approved amendments to the San Francisco Building and Health Codes generally referred to as the Construction Dust Control Ordinance (ordinance no. 176-08, effective August 29, 2008) with the intent of reducing the quantity of dust generated during site preparation, demolition, and construction work in order to protect the health of the general public and of on-site workers, minimize public nuisance complaints, and avoid orders to stop work by the building department.

The Construction Dust Control Ordinance requires all site preparation work, demolition, or other construction activities within San Francisco that have the potential to create dust or expose or disturb more than 10 cubic yards, or 500 square feet, of soil to comply with specified dust control measures whether or not the activity requires a permit from the building department. The director of the building department may waive this requirement for activities on sites less than one half-acre that are unlikely to result in any visible wind-blown dust.

In compliance with the Construction Dust Control Ordinance, the project sponsor and the construction contractor would be required to use the following practices to control construction dust on the site or other practices that result in equivalent dust control that are acceptable to the director. In addition, the Department of Public Health (public health department) has determined that the project must develop and implement a dust control plan in conjunction with the site mitigation plan.<sup>100</sup> Dust suppression activities may include watering all active construction areas sufficiently to prevent dust from becoming airborne; increased watering frequency may be necessary whenever wind speeds exceed 15 miles per hour. During excavation and dirt-moving activities, contractors shall wet sweep or vacuum the streets, sidewalks, paths, and intersections where work is in progress at the end of the workday. Inactive stockpiles (where no disturbance occurs for more than seven days) greater than 10 cubic yards or 500 square feet of excavated material, backfill material, import material, gravel, sand, road base, and soil shall be covered with a 10-millimeter (0.01-inch) polyethylene plastic (or equivalent) tarp, braced down, or use other equivalent soil stabilization techniques. San Francisco ordinance 175-91 restricts the use of potable water for soil compaction and dust control activities undertaken in conjunction with any construction or demolition project occurring within the boundaries of San Francisco, unless permission is obtained from the San Francisco Public Utilities Commission. Non-potable water must be used for soil compaction and dust control activities during project construction and demolition.

<sup>99</sup> ARB, *Methodology for Estimating Premature Deaths Associated with Long-term Exposure to Fine Airborne Particulate Matter in California*, Staff Report, Table 4c, October 24, 2008.

<sup>100</sup> Cushing, Stephanie, Director of Environmental Health, San Francisco Department of Public Health – Environmental Health Unit, letter to Howard Dickstein, Millennium Tower Association, September 19, 2019.

The SFPUC operates a recycled water truck-fill station at the Southeast Water Pollution Control Plant that provides recycled water for these activities at no charge.

Compliance with the regulations and procedures set forth by the Dust Control Ordinance including the implementation of a dust control plan reviewed by the health department would ensure that potential dust-related air quality impacts would be less than significant.

### CONSTRUCTION-RELATED CRITERIA AIR POLLUTANTS

As discussed above, construction activities would result in emissions of criteria air pollutants from the use of off- and on-road vehicles and equipment. Construction-related criteria air pollutants generated by the proposed project were quantified using the California Emissions Estimator Model (CalEEMod) and provided within an Air Quality Technical Report.<sup>101</sup> The model was developed, including default data (e.g., emission factors, meteorology, etc.), in collaboration with California regional air districts' staff. Default assumptions were used where project-specific information was unknown.

Construction of the proposed project would occur over an approximately 22-month period with construction activity generally occurring Monday through Friday. Stages 3 and 4 would require an extra shift to receive oversized truck deliveries for approximately five nights per week. This extra shift was incorporated into the CalEEMod emissions modeling for project construction to account for overnight activities. The off-road equipment fleet reflect the CalEEMod default for San Francisco County, which includes a composite of tiered engines for 2019-2021. Modeling was completed assuming construction would begin in year 2019, although construction work is now anticipated to begin in early 2020. Evaluating the start of construction in July 2019 provides a conservative assessment of emissions and health risks. If construction is delayed or occurs over a longer period, emissions would likely be lower than estimated here because newer and cleaner burning construction equipment would be phased into the fleet. Emissions were converted from tons/year to pounds/day using the estimated construction duration of 131 working days in 2019, 262 working days in 2020, and 69 working days in 2021, and are summarized in Table 23, **Average Daily Project Construction Emissions**. Detailed information and assumptions used to calculate construction criteria air pollutant emissions are available in the Air Quality Technical Report. As shown in Table 23, unmitigated project construction emissions would be below the threshold of significance for ROG, PM<sub>10</sub>, and PM<sub>2.5</sub>, but unmitigated project construction emissions would be above the threshold of significance for NO<sub>x</sub> in years 2019 and 2020, resulting in a significant criteria air pollutant impact.

Implementation of **Mitigation Measure M-AQ-1, Construction Air Quality**, would be required to reduce NO<sub>x</sub> construction emissions to a less-than-significant level. The mitigation measure would require engines to meet higher emission standards on certain types of construction equipment. As shown in Table 23, implementation of Mitigation Measure M-AQ-1 would reduce NO<sub>x</sub> emissions below the threshold of significance; thus, with mitigation, criteria air pollutant impacts would be less than significant.

<sup>101</sup> ESA, 301 Mission Street, Millennium Tower Perimeter Pile Upgrade Project Air Quality Technical Report, November 2019.

**TABLE 23  
AVERAGE DAILY PROJECT CONSTRUCTION EMISSIONS**

	Proposed Project Pollutant Emissions (Average Pounds per Day)			
	ROG	NOx	Exhaust PM <sub>10</sub>	Exhaust PM <sub>2.5</sub>
<i>Significance Threshold</i>	54.0	54.0	82.0	54.0
<b>2019</b>				
Unmitigated Project Emissions	9.4	<b>82.6</b>	3.4	3.3
Mitigated Project Emissions	3.2	26.5	0.6	0.6
<b>2020</b>				
Unmitigated Project Emissions	8.7	<b>75.4</b>	3.0	2.9
Mitigated Project Emissions	2.1	17.8	0.3	0.2
<b>2021</b>				
Unmitigated Project Emissions	3.6	28.9	1.5	1.4
Mitigated Project Emissions	0.9	13.0	0.1	0.1

NOTE: Emissions over threshold levels are in bold.  
SOURCES: Bay Area Air Quality Management District, 2017; ESA, 2019.

**Mitigation Measure M-AQ-1: Construction Air Quality.** The project sponsor or contractor shall provide the Planning Department with a certification statement that the sponsor or contractor agrees to fully comply with the following requirements which shall be included in contract specifications:

- All construction equipment shall be maintained and properly tuned in accordance with the manufacturer's specifications. All equipment shall be checked by a certified mechanic and determined to be running in proper condition prior to operation.
- Idling times shall be minimized either by shutting equipment off when not in use or reducing the maximum idling time to two minutes.
- The project construction contractor shall not use diesel generators for construction purposes where feasible alternative sources of power are available.
- All construction equipment, diesel trucks, and generators shall be equipped with Best Available Control Technology for emission reductions of NOx and Particulate Matter, including Tier 4 Interim or Final or alternative fuel engines where such equipment is available and feasible for use:
  - The following equipment shall have Tier 4 final engines: air compressors, bore/drill rigs, compactor, concrete pump, crawler tractors, excavator, generator sets/power pack, pavers, rollers, rough terrain forklifts, rubber tired loaders, skid steer loaders, and track drill.
  - The following equipment shall have Tier 4 interim or final engines: backhoes.
  - The following equipment shall have Tier 1 or newer engines: truck mount drills.
- Should any deviations in the construction equipment list or tier levels be required, the project sponsor shall present documentation to the satisfaction of the ERO that any such deviation would not result in an exceedance of the average daily NOx significance threshold or any health risk threshold.

**Impact AQ-2: The proposed project's construction activities would generate toxic air contaminants, including diesel particulate matter that would expose sensitive receptors to substantial pollutant concentrations. (Less than Significant with Mitigation)**

The project site is located within the Air Pollutant Exposure Zone as described above. Therefore, the existing health risks from air pollution for sensitive receptors in the vicinity of the project site are high. The closest sensitive receptors to the project site include residential units located in the Tower building itself, starting on the third floor. The nearest day care facility is the Little Ohana Daycare located approximately 40 meters northwest of the project site. The nearest school is the Chinese Education Center Elementary School at 657 Merchant Street located approximately 800 meters northwest of the project site. Most of the receptors analyzed in the Air Quality Technical Report are located within the Air Pollutant Exposure Zone.

Regarding construction emissions, off-road equipment (which includes construction-related equipment) is a large contributor to diesel particulate matter emissions in the State of California, although since 2007, the air resources board has found the emissions to be substantially lower than previously expected.<sup>102</sup> Newer and more refined emission inventories have substantially lowered the estimates of diesel particulate matter emissions from off-road equipment such that off-road equipment is, as of 2010, considered the sixth largest source of diesel particulate matter emissions in California.<sup>103</sup> This reduction in emissions is due, in part, to refined emissions estimation methodologies. For example, revised particulate matter emission estimates for the year 2010, for which diesel particulate matter is a major component of total particulate matter, have decreased by 83 percent from previous 2010 emissions estimates for the air basin.<sup>104</sup> Approximately half of the reduction in emissions can be attributed to the economic recession at that time and half to updated methodologies used to better assess construction emissions.<sup>105</sup>

Additionally, a number of federal and state regulations are mandating cleaner off-road equipment engines, ranging from Tier 1 to Tier 4. Tier 1 emission standards were phased in between 1996 and 2000 and Tier 4 Interim and Final emission standards for all new engines were phased in between 2008 and 2015. To meet the Tier 4 emission standards, engine manufacturers will be required to produce new engines with advanced emission-control technologies. Although the full benefits of these regulations will not be realized for several years, the EPA estimates that by implementing the federal Tier 4 standards, NO<sub>x</sub> and particulate matter emissions will be reduced by more than 90 percent.<sup>106</sup> Emission modeling conducted for the proposed project assumes the off-road construction fleet predicted by the air resources board for the construction years of 2019-2021, which is a composite of equipment with Tier 0 through Tier 4 Final engines.

<sup>102</sup> ARB, *Staff Report: Initial Statement of Reasons for Proposed Rulemaking, Proposed Amendments to the Regulation for In-Use Off-Road Diesel-Fueled Fleets and the Off-Road Large Spark-Ignition Fleet Requirements*, p. 1 and p. 13 (Figure 4), October 2010.

<sup>103</sup> ARB, *Staff Report: Initial Statement of Reasons for Proposed Rulemaking, Proposed Amendments to the Regulation for In-Use Off-Road Diesel-Fueled Fleets and the Off-Road Large Spark-Ignition Fleet Requirements*, October 2010.

<sup>104</sup> ARB, *In-Use Off-Road Equipment, 2011 Inventory Model*, Query accessed online, April 2, 2012, [http://www.arb.ca.gov/mseil/categories.htm#inuse\\_or\\_category](http://www.arb.ca.gov/mseil/categories.htm#inuse_or_category).

<sup>105</sup> ARB, *Staff Report: Initial Statement of Reasons for Proposed Rulemaking, Proposed Amendments to the Regulation for In-Use Off-Road Diesel-Fueled Fleets and the Off-Road Large Spark-Ignition Fleet Requirements*, October 2010.

<sup>106</sup> USEPA, *Clean Air Nonroad Diesel Rule: Fact Sheet*, May 2004.



In addition, construction activities do not lend themselves to analysis of long-term health risks because of their temporary and variable nature. As explained in the air district's CEQA Air Quality Guidelines:

*Due to the variable nature of construction activity, the generation of TAC emissions in most cases would be temporary, especially considering the short amount of time such equipment is typically within an influential distance that would result in the exposure of sensitive receptors to substantial concentrations. Concentrations of mobile-source diesel PM emissions are typically reduced by 70 percent at a distance of approximately 500 feet ... In addition, current models and methodologies for conducting health risk assessments are associated with longer-term exposure periods of 9, 40, and 70 years, which do not correlate well with the temporary and highly variable nature of construction activities. This results in difficulties with producing accurate estimates of health risk.<sup>107</sup>*

Therefore, project-level analyses of construction activities have a tendency to overestimate assessments of long-term health risks. However, within the Air Pollutant Exposure Zone, additional construction activity may adversely affect populations that are already at a higher risk for adverse long-term health risks from existing sources of air pollution.

The proposed project would require construction activities over an approximate 22-month construction period. The proposed project construction activities would result in short-term emissions of diesel particulate matter and other TACs. A health risk assessment (HRA) resulting from project construction was conducted to assess the potential impacts of diesel particulate matter and TAC emissions. The HRA conducted for the proposed project relied on conservative and worst-case assumptions to estimate potential health risks at the nearest sensitive receptor locations. This allows for a conservative (i.e., high-end) assessment of the proposed project's impacts on long-term health risk from construction activities. Consistent with the citywide health risk modeling prepared by the city in collaboration with the air district, an estimate of health risks from TACs (primarily diesel particulate matter) and annual average exhaust PM<sub>2.5</sub> concentrations at sensitive receptor locations within 1,000 meters of the proposed project's boundaries was calculated. For the proposed project, sources include emissions from off- and on-road construction equipment. The HRA was conducted following methods in the air district's Health Risk Screening Analysis Guidelines<sup>108,109</sup> and in the Office of Environmental Health Hazard Assessment's (OEHHA) Air Toxics Hot Spots Program Guidance.<sup>110</sup>

The American Meteorological Society/Environmental Protection Agency regulatory air dispersion model (AERMOD version 18081) was used to estimate concentrations of diesel particulate matter and PM<sub>2.5</sub> at sensitive receptors. AERMOD produces estimates of annual average concentrations at each receptor location for a variety of emissions sources using hourly meteorological data, obtained from the Mission Bay meteorological station. Where project-specific information is not available, default parameter sets that are designed to produce

<sup>107</sup> Bay Area Air Quality Management District, *CEQA Air Quality Guidelines*, May 2012, page 8-6.

<sup>108</sup> Bay Area Air Quality Management District, *Recommended Methods for Screening and Modeling Local Risks and Hazards*, 2012, <http://www.baaqmd.gov/~media/Files/Planning%20and%20Research/CEQA/Risk%20Modeling%20Approach%20May%202012.ashx?la=en>, accessed July 2019.

<sup>109</sup> Bay Area Air Quality Management District, *Air Toxics NSR Program Health Risk Assessment (HRA) Guidelines*, December 2016, Available at [http://www.baaqmd.gov/~media/files/planning-and-research/permit-modeling/hra\\_guidelines\\_12\\_7\\_2016\\_clean-pdf.pdf?la=en](http://www.baaqmd.gov/~media/files/planning-and-research/permit-modeling/hra_guidelines_12_7_2016_clean-pdf.pdf?la=en), accessed July 2019

<sup>110</sup> Office of Environmental Health Hazard Assessment, *Air Toxics Hot Spots Program Guidance Manual for the Preparation of Health Risk Assessments*, February 2015, [http://oehha.ca.gov/air/hot\\_spots/hotspots2015.html](http://oehha.ca.gov/air/hot_spots/hotspots2015.html), accessed March 2017.

conservative (i.e., overestimates of) air concentrations were used.<sup>111,112</sup> Detailed information and assumptions used to calculate health risks to sensitive receptors are available in the Air Quality Technical Report.

The HRA evaluated three residential exposure scenarios as follows:

- **Scenario 1** represents a child resident at a residential unit located on the third floor of the Tower building throughout construction.
- **Scenario 2** represents a child resident at a residential unit located on the third floor of the Tower building for the majority of the time; a small portion of the child's exposure (1.5 hours per day, seven days per week) occurs on the second floor of the Tower building at the on-site gym or lap pool amenities; this exposure occurs during the third trimester when the mother of the child is using the fitness facilities.
- **Scenario 3** represents an adult resident at a residential unit located on the third floor of the Tower building for the majority of the time; a small portion of the adult's exposure (1.5 hours per day, seven days per week) occurs on the second level of the Tower building at the on-site gym or lap pool amenities.

Additionally, the HRA evaluated health risks to daycare and school child sensitive receptors. However, as shown in Table 24, **Lifetime Cancer Risk and PM<sub>2.5</sub> Concentration at the Maximally Exposed Individual Sensitive Receptors**, health risks resulting from the project for daycare and school child receptor types are lower than the health risks for residential receptors in part because the exposure duration is shorter for daycare and school receptors than it is for a residential receptor. The results of the HRA are presented in Table 24, which identifies the increased cancer risk and localized PM<sub>2.5</sub> concentrations at the location where the project would result in the maximum impact for residential, daycare and school receptors, respectively. In addition, Table 24 provides the existing modeled background cancer risk and PM<sub>2.5</sub> concentration. For residential receptors located in the Tower building, results for each of the three exposure scenarios are presented. As shown in the table, the cancer risk at the Maximally Exposed Individual Sensitive Receptor (MEISR) as a result of the project would be 59.3 in one million for residential scenario 1 and 63.0 in one million for residential scenario 2, both of which exceed the significance threshold of 7 in one million for project impacts within the air pollutant exposure zone. In addition, the PM<sub>2.5</sub> concentration at the MEISR would be 0.8 µg/m<sup>3</sup>, which exceeds the significance threshold of 0.2 µg/m<sup>3</sup>. Therefore, the project's construction activities would result in significant TAC and PM<sub>2.5</sub> concentrations.

Implementation of Mitigation Measure M-AQ-1, Construction Air Quality, p. 115, would be required to reduce both cancer risk and PM<sub>2.5</sub> concentrations to a less-than-significant level. The mitigation measures would require engines to meet higher emission standards on certain types of construction equipment. As shown in Table 24, implementation of Mitigation Measure M-AQ-1 would reduce the project's cancer risk and PM<sub>2.5</sub> concentration to below the thresholds of significance (an increased cancer risk of 7 per one million persons exposed or PM<sub>2.5</sub> concentrations of 0.2 µg/m<sup>3</sup>); thus, TAC emissions impacts would be less than significant with mitigation.

<sup>111</sup> United States Environmental Protection Agency, *User's Guide for the AMS/EPA Regulatory Model – AERMOD*. December 2016, [https://www3.epa.gov/ttn/scram/models/aermod/aermod\\_userguide.pdf](https://www3.epa.gov/ttn/scram/models/aermod/aermod_userguide.pdf).

<sup>112</sup> United States Environmental Protection Agency, *AERMOD Implementation Guide*, December 2016, [https://www3.epa.gov/ttn/scram/models/aermod/aermod\\_implementation\\_guide.pdf](https://www3.epa.gov/ttn/scram/models/aermod/aermod_implementation_guide.pdf).

**TABLE 24**  
**LIFETIME CANCER RISK AND PM<sub>2.5</sub> CONCENTRATION AT THE MAXIMALLY EXPOSED INDIVIDUAL SENSITIVE RECEPTORS**

Receptor Type/Source	Unmitigated Project Risk		Mitigated Project Risk <sup>a</sup>	
	Lifetime Excess Cancer Risk (in one million)	PM <sub>2.5</sub> Concentration (µg/m <sup>3</sup> )	Lifetime Excess Cancer Risk (in one million)	PM <sub>2.5</sub> Concentration (µg/m <sup>3</sup> )
<b>Residential Receptor – Scenario 1<sup>b</sup></b>				
Background	354.7	10.7	354.7	10.7
Proposed Project Contribution	<b>59.3</b>	<b>0.8</b>	5.2	0.09
Cumulative Total	414.0	11.5	359.9	10.7
Significance Threshold for Project Contribution	7.0	0.2	7.0	0.2
Significant?	Yes	Yes	No	No
<b>Residential Receptor – Scenario 2<sup>c</sup></b>				
Background	354.7	10.7	354.7	10.7
Proposed Project Contribution	<b>63.0</b>	<b>0.8</b>	6.0	0.09
Cumulative Total	417.8	11.5	360.7	10.7
Significance Threshold for Project Contribution	7.0	0.2	7.0	0.2
Significant?	Yes	Yes	No	No
<b>Residential Receptor – Scenario 3<sup>d</sup></b>				
Background	354.7	10.7	354.7	10.7
Proposed Project Contribution	3.1	<b>0.8</b>	0.3	0.09
Cumulative Total	357.8	11.5	355.0	10.7
Significance Threshold for Project Contribution	7.0	0.2	7.0	0.2
Significant?	No	Yes	No	No
<b>Daycare Receptor</b>				
Background	231.3	10.4	231.3	10.4
Proposed Project Contribution	<b>9.6</b>	<b>0.3</b>	1.0	<0.1
Cumulative Total	240.9	10.7	232.3	10.4
Significance Threshold for Project Contribution	7.0	0.2	7.0	0.2
Significant?	Yes	Yes	No	No
<b>School Receptor</b>				
Background	98.6	8.8	98.6	8.8
Proposed Project Contribution	<0.1	<0.1	<0.1	<0.1
Cumulative Total	98.6	8.8	98.6	8.8
Significance Threshold for Project Contribution	7.0	0.2	7.0	0.2
Significant?	No	No	No	No

## NOTES:

Emissions over threshold levels are in bold.

<sup>a</sup> Mitigated Project Risk scenario assumes implementation of Mitigation Measure M-AQ-1.<sup>b</sup> Scenario 1 assumes exposure starting at the third trimester at a residential unit located on the third floor of the Tower building. PM<sub>2.5</sub> concentrations are the same for all the residential scenarios analyzed.<sup>c</sup> Scenario 2 assumes that a small portion of the third trimester exposure (1.5 hours per day, seven days per week) could occur on the second level of the Tower building at the on-site gym or lap pool amenities, when the mother of the child is using the fitness facilities and the third trimester receptor is therefore exposed to construction emissions during this activity. PM<sub>2.5</sub> concentrations are the same for all the residential scenarios analyzed.<sup>d</sup> Scenario 3 represents an off-site adult resident located on the third floor of the Tower building with a small portion of the exposure (1.5 hours per day, 7 days per week) occurring on the second level of the Tower building at the on-site gym or lap pool amenities. PM<sub>2.5</sub> concentrations are the same for all the residential scenarios analyzed.

SOURCE: ESA, 2019.

## ***Operational Air Quality Impacts***

### **Impact AQ-3: During project operations, the proposed project would not result in emissions of criteria air pollutants or toxic air contaminants. (No Impact)**

There would be no changes to the operation of the Tower and Podium buildings once construction is complete. Pedestrian access, transit circulation, and vehicular access would be restored to existing conditions. Therefore, the proposed project would not have any operational activities that would generate criteria pollutant or toxic air contaminant emissions. Thus, quantification of project-generated criteria air pollutant or toxic air contaminant emissions is not required, and the proposed project would not exceed any of the significance thresholds for criteria air pollutants or health risks, and would result in no impact with respect to operational air quality impacts.

### **Impact AQ-4: The proposed project would not conflict with, or obstruct implementation of the 2017 Clean Air Plan. (Less than Significant)**

The most recently adopted air quality plan for the air basin is the *2017 Clean Air Plan*. The *2017 Clean Air Plan* is a road map that demonstrates how the San Francisco Bay Area will achieve compliance with the state ozone standards as expeditiously as practicable and how the region will reduce the transport of ozone and ozone precursors to neighboring air basins. In determining consistency with the *2017 Clean Air Plan*, this analysis considers whether the project would: (1) support the primary goals of the plan, (2) include applicable control measures from the *2017 Clean Air Plan*, and (3) avoid disrupting or hindering implementation of control measures identified in the *2017 Clean Air Plan*.

The primary goals of the *2017 Clean Air Plan* are to: (1) reduce emissions and decrease concentrations of harmful pollutants, (2) safeguard the public health by reducing exposure to air pollutants that pose the greatest health risk, and (3) reduce greenhouse gas emissions. To meet the primary goals, the *2017 Clean Air Plan* recommends specific control measures and actions. These control measures are grouped into various categories and include stationary and area source measures, mobile source measures, transportation control measures, land use measures, and energy and climate measures. The *2017 Clean Air Plan* recognizes that to a great extent, community design dictates individual travel mode, and that a key long-term control strategy to reduce emissions of criteria pollutants, air toxics, and greenhouse gases from motor vehicles is to channel future Bay Area growth into vibrant urban communities where goods and services are close at hand, and people have a range of viable transportation options. To this end, the *2017 Clean Air Plan* contains 85 measures to reduce several pollutants: ozone precursors, particulate matter, air toxics, and GHGs in the air basin. The proposed project's impact with respect to GHGs are discussed in Section E.9, Greenhouse Gas Emissions, which demonstrates that the proposed project would comply with the applicable provisions of the city's GHG Reduction Strategy.

The measures most applicable to the proposed project are transportation control measures. The transportation measures in the *2017 Clean Air Plan* describe a comprehensive strategy to reduce emissions from medium- and heavy-duty trucks by providing incentives for the use of new trucks with advanced emissions controls, including hybrid and zero-emission trucks. The *2017 Clean Air Plan* also includes incentives to deploy electric, Tier 3, and Tier 4 off-road engines used during construction. However, these measures are not directly applicable to the proposed project as they require the air district to provide

incentives for companies to employ cleaner construction equipment. Given that the proposed project would only result in short-term construction period emissions and would not result in any air pollutant emissions upon completion of construction activities (see Impact AQ-3), the proposed project would not substantially conflict with implementation of the 2017 Clean Air Plan and this impact is less than significant.

**Impact AQ-5: The proposed project would not result in other emissions (such as those leading to odors) that would adversely affect a substantial number of people. (Less than Significant)**

Typical odor sources of concern include: wastewater treatment plants, sanitary landfills, transfer stations, composting facilities, petroleum refineries, asphalt batch plants, chemical manufacturing facilities, fiberglass manufacturing facilities, auto body shops, rendering plants, and coffee roasting facilities. During construction, diesel exhaust from construction equipment would generate some odors. However, construction-related odors would be temporary and would not persist upon project completion. Additionally, the proposed project would not introduce sources of new odors in the vicinity as no changes are proposed to the Tower and Podium building operations. Therefore, odor impacts from the proposed project would be less than significant.

***Cumulative Air Quality Impacts***

**Impact C-AQ-1: Construction of the proposed project, in combination with past, present, and reasonably foreseeable future development in the project area would result in significant cumulative air quality impacts. (Less than Significant with Mitigation)**

Regional air pollution is, by its very nature, largely a cumulative impact. Emissions from past, present and future projects contribute to the region's adverse air quality on a cumulative basis. No single project by itself would be sufficient in size to result in regional nonattainment of ambient air quality standards. Instead, a project's individual emissions contribute to existing cumulative adverse air quality impacts.<sup>113</sup> The project-level thresholds for criteria air pollutants are based on levels below which new sources are not anticipated to contribute to an air quality violation or result in a considerable net increase in criteria air pollutants. Therefore, because the proposed project's construction (Impact AQ-1) emissions would exceed the project-level thresholds for criteria air pollutants without mitigation, the proposed project would result in a cumulatively considerable contribution to regional air quality impacts. However, as discussed in Impact AQ-1, with implementation of Mitigation Measure M-AQ-1, the proposed project's construction-period criteria air pollutant emissions would be reduced to below the significance threshold for NOx. Therefore, with implementation of M-AQ-1, the proposed project would not result in a cumulatively considerable net increase in non-attainment criteria air pollutants.

As discussed above, the project site is located in an area that already experiences poor air quality. Therefore, cumulatively significant health risk impacts already exist at and near the project site. The project would add new sources of TACs (e.g., construction emissions) that exceed the project-level significance thresholds for health risks within an area already adversely affected by air quality, resulting in a considerable contribution to cumulative health risk impacts on nearby sensitive receptors. This would be a significant cumulative impact. The proposed project would be required to implement Mitigation Measure M-AQ-1,

<sup>113</sup> BAAQMD, *CEQA Air Quality Guidelines*, May 2011, page 2-1.

Construction Air Quality, p. 108, which could reduce construction period diesel particulate matter and PM<sub>2.5</sub> emissions by as much as 95 percent. Implementation of this mitigation measure would reduce the project's contribution to cumulative air quality impacts to a less-than-significant level.

Topics	Potentially Significant Impact	Less than Significant with Mitigation Incorporated	Less than Significant Impact	No Impact	Not Applicable
<b>9. GREENHOUSE GAS EMISSIONS.</b>					
<b>Would the project:</b>					
a) Generate greenhouse gas emissions, either directly or indirectly, that may have a significant impact on the environment?	<input type="checkbox"/>	<input type="checkbox"/>	<input checked="" type="checkbox"/>	<input type="checkbox"/>	<input type="checkbox"/>
b) Conflict with any applicable plan, policy or regulation adopted for the purpose of reducing the emissions of greenhouse gases?	<input type="checkbox"/>	<input type="checkbox"/>	<input checked="" type="checkbox"/>	<input type="checkbox"/>	<input type="checkbox"/>

GHG emissions and global climate change represent cumulative impacts. GHG emissions cumulatively contribute to the significant adverse environmental impacts of global climate change. No single project could generate enough GHG emissions to noticeably change the global average temperature; instead, the combination of GHG emissions from past, present, and future projects have contributed and will continue to contribute to global climate change and its associated environmental impacts.

The air district has prepared guidelines and methodologies for analyzing GHGs. These guidelines are consistent with CEQA Guidelines sections 15064.4 and 15183.5, which address the analysis and determination of significant impacts from a proposed project's GHG emissions. CEQA Guidelines section 15064.4 allows lead agencies to rely on a qualitative analysis to describe GHG emissions resulting from a project. CEQA Guidelines section 15183.5 allows for public agencies to analyze and mitigate GHG emissions as part of a larger plan for the reduction of GHGs and describes the required contents of such a plan. Accordingly, San Francisco has prepared Strategies to Address Greenhouse Gas Emissions which presents a comprehensive assessment of policies, programs, and ordinances that collectively represent San Francisco's qualified GHG reduction strategy in compliance with the CEQA Guidelines.<sup>114</sup> These GHG reduction actions have resulted in a 36 percent reduction in GHG emissions in 2015 compared to 1990 levels, exceeding the year 2020 reduction goals outlined in the air district's 2017 Clean Air Plan, Executive Order S-3-05, and Assembly Bill 32 (also known as the Global Warming Solutions Act).<sup>115,116</sup>

Given that the city has met the state and region's 2020 GHG reduction targets and San Francisco's GHG reduction goals are consistent with, or more aggressive than, the long-term goals established under order

<sup>114</sup> San Francisco Planning Department, *Strategies to Address Greenhouse Gas Emissions in San Francisco*, July 2017, <http://sf-planning.org/strategies-address-greenhouse-gas-emissions>.

<sup>115</sup> San Francisco Department of the Environment, *San Francisco's Carbon Footprint*, <https://sfenvironment.org/carbon-footprint>, accessed November 8, 2019.

<sup>116</sup> Executive Order S-3-05, Assembly Bill 32, and the air district's 2017 Clean Air Plan (continuing the trajectory set in the 2010 Clean Air Plan) set a target of reducing GHG emissions to below 1990 levels by year 2020.

S-3-05,<sup>117</sup> order B-30-15,<sup>118,119</sup> and Senate Bill 32,<sup>120,121</sup> the city's GHG reduction goals are consistent with order S-3-05, order B-30-15, Assembly Bill 32, Senate Bill 32 and the 2017 Clean Air Plan. Therefore, proposed projects that are consistent with the city's GHG reduction strategy would be consistent with the aforementioned GHG reduction goals, would not conflict with these plans or result in significant GHG emissions, and would therefore not exceed San Francisco's applicable GHG threshold of significance.

The following analysis of the proposed project's impact on climate change focuses on the project's contribution to cumulatively significant GHG emissions. Because no individual project could emit GHGs at a level that could result in a significant impact on the global climate, this analysis is in a cumulative context, and this section does not include an individual project-specific impact statement.

**Impact C-GG-1: The proposed project would generate greenhouse gas emissions, but not at levels that would result in a significant impact on the environment or conflict with any policy, plan, or regulation adopted for the purpose of reducing greenhouse gas emissions. (Less than Significant)**

Individual projects contribute to the cumulative effects of climate change by directly or indirectly emitting GHGs during construction and operational phases. Because the proposed project consists of a structural upgrade of the Tower building foundation only, the proposed project would not contribute to annual long-term increases in GHGs. Temporary GHG emissions would be limited to construction activities over the approximately 22-month construction period. In particular, the construction equipment listed in Table 2 in Section A, Project Description, would result in GHG emissions at the project site.

The proposed project would be subject to regulations adopted to reduce GHG emissions as identified in the GHG reduction strategy. Specifically, the proposed project's construction waste-related emissions would be reduced through compliance with the Construction and Demolition Debris Recovery Ordinance. This

<sup>117</sup> Office of the Governor, Executive Order S-3-05, June 1, 2005, [http://static1.squarespace.com/static/549885d4e4b0ba0bfff5dc695/1/54d7f1e0e4b0f0798cee3010/1423438304744/California+Executive+Order+S-3-05+\(June+2005\).pdf](http://static1.squarespace.com/static/549885d4e4b0ba0bfff5dc695/1/54d7f1e0e4b0f0798cee3010/1423438304744/California+Executive+Order+S-3-05+(June+2005).pdf). Executive Order S-3-05 sets forth a series of target dates by which statewide emissions of GHGs need to be progressively reduced, as follows: by 2010, reduce GHG emissions to 2000 levels (approximately 457 million metric tons of carbon dioxide equivalents [MTCO<sub>2e</sub>]); by 2020, reduce emissions to 1990 levels (approximately 427 million MTCO<sub>2e</sub>); and by 2050 reduce emissions to 80 percent below 1990 levels (approximately 85 million MTCO<sub>2e</sub>). Because of the differential heat absorption potential of various GHGs, GHG emissions are frequently measured in "carbon dioxide equivalents," which present a weighted average based on each gas's heat absorption (or "global warming") potential.

<sup>118</sup> Office of the Governor, Executive Order B-30-15, April 29, 2015, <https://www.gov.ca.gov/news.php?id=18938>, accessed March 3, 2016. Executive Order B-30-15, issued on April 29, 2015, sets forth a target of reducing GHG emissions to 40 percent below 1990 levels by 2030 (estimated at 2.9 million MTCO<sub>2e</sub>).

<sup>119</sup> San Francisco's GHG reduction goals are codified in section 902 of the Environment Code and include: (i) by 2008, determine City GHG emissions for year 1990; (ii) by 2017, reduce GHG emissions by 25 percent below 1990 levels; (iii) by 2025, reduce GHG emissions by 40 percent below 1990 levels; and (iv) by 2050, reduce GHG emissions by 80 percent below 1990 levels.

<sup>120</sup> Senate Bill 32 amends California Health and Safety Code Division 25.5 (also known as the California Global Warming Solutions Act of 2006) by adding section 38566, which directs that statewide greenhouse gas emissions to be reduced by 40 percent below 1990 levels by 2030.

<sup>121</sup> Senate Bill 32 was paired with Assembly Bill 197, which would modify the structure of the State Air Resources Board; institute requirements for the disclosure of greenhouse gas emissions criteria pollutants, and toxic air contaminants; and establish requirements for the review and adoption of rules, regulations, and measures for the reduction of greenhouse gas emissions.

regulation reduces the amount of materials sent to a landfill, reducing GHGs emitted by landfill operations. Thus, the proposed project was determined to be consistent with San Francisco’s GHG reduction strategy.<sup>122</sup>

The project sponsor is required to comply with the above regulation, which have proven effective as San Francisco’s GHG emissions have measurably decreased when compared to 1990 emissions levels, demonstrating that the city has met and exceeded Executive Order S-3-05, Assembly Bill 32, and the 2017 Clean Air Plan GHG reduction goals for the year 2020. Furthermore, the city has met its 2017 GHG reduction goal of reducing GHG emissions to 25 percent below 1990 levels by 2017. Other existing regulations, such as those implemented through Assembly Bill 32, will continue to reduce a proposed project’s contribution to climate change. In addition, San Francisco’s local GHG reduction targets are consistent with the long-term GHG reduction goals of Executive Order S-3-05, Executive Order B-30-15, Assembly Bill 32, Senate Bill 32 and the 2017 Clean Air Plan. Therefore, because the proposed project is consistent with the city’s GHG reduction strategy, it is also consistent with the GHG reduction goals of Executive Order S-3-05, Executive Order B-30-15, Assembly Bill 32, Senate Bill 32 and the 2017 Clean Air Plan, would not conflict with these plans, and would therefore not exceed San Francisco’s applicable GHG threshold of significance. As such, the proposed project would result in a less-than-significant impact with respect to GHG emissions. No mitigation measures are necessary.

Topics	Potentially Significant Impact	Less than Significant with Mitigation Incorporated	Less than Significant Impact	No Impact	Not Applicable
<b>10. WIND.</b>					
<b>Would the project:</b>					
a) Create wind hazards in publicly accessible areas of substantial pedestrian use?	<input type="checkbox"/>	<input type="checkbox"/>	<input type="checkbox"/>	<input type="checkbox"/>	<input checked="" type="checkbox"/>

The proposed project would not result in changes to the above-ground Tower and Podium buildings. Therefore, post-project conditions at the project site would be the same as existing conditions, and topic E.10(a) is not applicable to the proposed project.

<sup>122</sup> San Francisco Planning Department, *Greenhouse Gas Analysis: Compliance Checklist for 301 Mission Street, Millennium Tower Perimeter Pile Upgrade Project*, September 10, 2019.



Topics	Potentially Significant Impact	Less than Significant with Mitigation Incorporated	Less than Significant Impact	No Impact	Not Applicable
<b>11. SHADOW.</b>					
<b>Would the project:</b>					
a) Create new shadow that substantially and adversely affects the use and enjoyment of publicly accessible open spaces?	<input type="checkbox"/>	<input type="checkbox"/>	<input type="checkbox"/>	<input type="checkbox"/>	<input checked="" type="checkbox"/>

The proposed project would not result in changes to the above-ground Tower and Podium buildings. Therefore, permanent conditions at the project site would be nearly the same as existing conditions, and the proposed project would not create new shadows that would affect outdoor recreation facilities or public areas. Topic E.11(a) is not applicable to the proposed project.

Topics	Potentially Significant Impact	Less than Significant with Mitigation Incorporated	Less than Significant Impact	No Impact	Not Applicable
<b>12. RECREATION.</b>					
<b>Would the project:</b>					
a) Increase the use of existing neighborhood and regional parks or other recreational facilities such that substantial physical deterioration of the facilities would occur or be accelerated?	<input type="checkbox"/>	<input type="checkbox"/>	<input checked="" type="checkbox"/>	<input type="checkbox"/>	<input type="checkbox"/>
b) Include recreational facilities or require the construction or expansion of recreational facilities that might have an adverse physical effect on the environment?	<input type="checkbox"/>	<input type="checkbox"/>	<input checked="" type="checkbox"/>	<input type="checkbox"/>	<input type="checkbox"/>

**Impact RE-1: The proposed project would not increase the use of existing parks and recreational facilities, would not deteriorate any such facilities, and would not require the expansion of such facilities. (Less than Significant)**

The park and recreational facilities closest to the project site include the 2,961-square-foot privately owned, publicly accessible atrium open space on the ground floor of the Podium building, the 5.4-acre park on the roof of the Transit Center located to the south of the 301 Mission Street Tower building and across Fremont Street from the project site, Beale Street Plaza one block north of the project site, Spear Street Plaza two blocks east of the project site, and Mechanics Monument Plaza one block north of the project site.

The proposed project would not construct new residential or other uses that would generate a permanent increase in demand for parks or other recreational facilities. However, during the approximately 22-month construction period and depending on the construction stage, it is possible that between 9 and 30 construction workers could use nearby parks or other recreational facilities during breaks or lunch periods.

Because the use of these areas would be limited to breaks or lunch periods, this use would not be likely to result in substantial deterioration of parks or other recreational facilities. Given that a 5.4-acre park on the roof of the Transit Center and other nearby parks or other recreational facilities could accommodate the minor increase in usage from construction workers during the approximately 22-month construction period. The 9 to 30 construction workers who could use these parks would not substantially accelerate the

physical deterioration of parks or require the need for expanded parks or recreational facilities, and this impact would be less than significant.

**Impact C-RE-1: The proposed project, in combination with reasonably foreseeable future projects, would not result in cumulative recreation impacts. (Less than Significant)**

Implementation of the Active Beale Street and Better Market Street projects would not increase demand for recreational facilities and resources because these streetscape projects would not result in an increase in the city's population. However, implementation of the Transbay Block 4/200 Folsom Street/200-272 Main Street and Oceanwide Center Development projects would increase the demand for recreational facilities and resources in the project vicinity and in the city overall because future residents of the 948 dwelling units would demand recreational facilities and resources. The city has accounted for such growth as part of the Recreation and Open Space Element of the General Plan.<sup>123</sup> In addition, San Francisco voters passed two bond measures, in 2008 and 2012, to fund the acquisition, planning, and renovation of City recreational resources. For these reasons, the proposed project would not combine with reasonably foreseeable future projects in the project vicinity to create a significant cumulative impact on recreational facilities or resources.

Topics	Potentially Significant Impact	Less than Significant with Mitigation Incorporated	Less than Significant Impact	No Impact	Not Applicable
<b>13. UTILITIES AND SERVICE SYSTEMS.</b>					
<b>Would the project:</b>					
a) Require or result in the relocation or construction of new or expanded, water, wastewater treatment, or storm water drainage, electric power, natural gas, or telecommunications facilities, the construction or relocation of which could cause significant environmental effects?	<input type="checkbox"/>	<input type="checkbox"/>	<input type="checkbox"/>	<input checked="" type="checkbox"/>	<input type="checkbox"/>
b) Have sufficient water supplies available to serve the project and reasonably foreseeable future development during normal, dry, and multiple dry years?	<input type="checkbox"/>	<input type="checkbox"/>	<input checked="" type="checkbox"/>	<input type="checkbox"/>	<input type="checkbox"/>
c) Result in a determination by the wastewater treatment provider which serves or may serve the project that it has inadequate capacity to serve the project's projected demand in addition to the provider's existing commitments?	<input type="checkbox"/>	<input type="checkbox"/>	<input checked="" type="checkbox"/>	<input type="checkbox"/>	<input type="checkbox"/>
d) Generate solid waste in excess of state or local standards, or in excess of the capacity of local infrastructure, or otherwise impair the attainment of solid waste reduction goals?	<input type="checkbox"/>	<input type="checkbox"/>	<input checked="" type="checkbox"/>	<input type="checkbox"/>	<input type="checkbox"/>
e) Comply with federal, state, and local management and reduction statutes and regulations related to solid waste?	<input type="checkbox"/>	<input type="checkbox"/>	<input checked="" type="checkbox"/>	<input type="checkbox"/>	<input type="checkbox"/>

**Impact UT-1: The proposed project would not require or result in the relocation or construction of new or expanded water, wastewater treatment, or stormwater drainage, electric power, natural gas, or telecommunications facilities. (No Impact)**

The proposed project involves the foundation extension and structural upgrade of the Tower building; no new or expanded water, wastewater treatment, or stormwater drainage, electric power, natural gas, or

<sup>123</sup> San Francisco Planning Department, *San Francisco General Plan, Recreation and Open Space Element*, April 2014, pp. 20-36, [http://www.sf-planning.org/ftp/General\\_Plan/Recreation\\_OpenSpace\\_Element\\_ADOPTED.pdf](http://www.sf-planning.org/ftp/General_Plan/Recreation_OpenSpace_Element_ADOPTED.pdf), accessed July 2, 2019.

telecommunications facilities would be constructed as a result of this project. As described in Section A, Project Description, existing utility lines connecting to the Tower building would be supported in place during the 22-month construction, the existing PG&E vault in the project area would be protected by constructing shoring around the vault along with supplemental structural support for the conduits that exit the vault and extend across the excavation area. The proposed project would not require or result in the relocation of utilities.

Following installation of the perimeter piles, five low-horsepower, electrically operated pumps would be permanently placed in the vaults providing access to the jack system (two in the vault along Mission Street and three in the vault along Fremont Street), each with a float switch to activate the pump should sufficient rainwater collect to trigger it, and the pumped water would be discharged into the combined sewer system. Operation of the pumps would connect to and operate off the Tower building's permanent power supply and would be alarmed to the building management system. The electric use to power the pumps would be minimal and only operational when enough rainwater triggers it. Therefore, the proposed project would not require or result in the relocation or construction of new or expanded utilities and service facilities.

**Impact UT-2: The proposed project would have sufficient water supply available and would not require new or expanded water supply resources or entitlements. (Less than Significant)**

During construction, the proposed project would intermittently use non-potable water for dust control in accordance with article 21 of the San Francisco Public Works Code (and as otherwise permitted by law) and would use relatively small amounts of potable water for various site needs such as drinking water, on-site sanitary needs, and for cement mixing. The small increase in potable water demand would not be substantial. In addition, this water use would be temporary, terminating with the completion of construction. Water supplies for San Francisco are provided by the SFPUC, and are planned such that short-term spikes in water use can be accommodated. Therefore, project construction would not warrant construction or expansion of water treatment facilities, and this impact would be less than significant.

**Impact UT-3: The proposed project would not exceed the capacity of the wastewater treatment provider that would serve the project. (Less than Significant)**

The Tower and Podium buildings located on the 301 Mission Street parcel are currently served by SFPUC's combined sewer system, which collects both sanitary and storm drainage. All stormwater and wastewater flow from project site is currently collected and diverted to the Southeast Treatment Plant.

As described in Section A, Project Description, groundwater removed during construction would be routed through an 18,000-gallon settlement tank prior to discharge to the combined storm sewer. The project sponsor has indicated that approximately half the settling tank, or 9,000 gallons, could be discharged to the sewer system per day.<sup>124</sup> Prior to discharging, ground water samples would be tested to ensure compliance with SFPUC discharge standards. The project team would obtain a batch waste discharge (for construction dewatering) permit from SFPUC in compliance with federal and state requirements.

<sup>124</sup> Roosevelt, Nick, Associate Attorney, J. Abrams Law, P.C., e-mail correspondence with Kei Zushi, Senior Planner, San Francisco Planning Department, June 26, 2019.

Groundwater removed during construction would be conveyed to the Southeast Treatment Plant, which is owned and operated by the SFPUC and is responsible for treating flows from the Bayside of the city in addition to Daly City and Brisbane.<sup>125</sup> The Southeast Treatment Plant has the capacity to treat up to 250 million gallons per day.<sup>126</sup> Therefore, the 9,000 gallons of groundwater discharged to the sewer system per day would not exceed the capacity of the treatment plant. For this reason, the proposed project would have a less-than-significant effect related to wastewater.

**Impact UT-4: The proposed project would be served by a landfill with sufficient permitted capacity to accommodate the project's solid waste disposal needs and would comply with all applicable statutes and regulations related to solid waste. (Less than Significant)**

In September 2015, the city approved an agreement with Recology, Inc. for the transport and disposal of the city's municipal solid waste at the Recology Hay Road Landfill in Solano County. The city began disposing its municipal solid waste at Recology Hay Road Landfill in January 2016, and that practice is expected to continue for approximately nine years, with an option to renew the agreement thereafter for an additional six years. The Hay Road Landfill has a maximum permitted capacity of 37 million cubic yards; it is permitted to accept up to 2,400 tons per day and has a remaining capacity of 30.4 million cubic yards.<sup>127</sup> The Hay Road Landfill is expected to continue to receive waste approximately through the year 2077.<sup>128</sup>

The city has adopted a number of policies to promote zero-waste practices. The San Francisco Construction and Demolition Debris Recovery Ordinance (ordinance no. 27-06) requires that at least 65 percent of construction and demolition debris be recycled or diverted from landfills.<sup>129</sup>

Over the 22-month duration of the proposed project construction stages, construction and demolition activities would generate construction debris at the project site, which would require disposal. Waste materials associated with the project would consist of approximately 4,380 cubic yards of excavated material and approximately 400 cubic yards of construction debris from asphalt and concrete demolition. All waste materials would be stockpiled on site and separated according to waste characterization criteria. The materials would then be either recycled or disposed of at an off-site permitted facility in compliance with applicable regulatory standards.

The project applicant would be subject to the city's various solid waste diversion requirements, including the San Francisco Construction and Demolition Debris Recovery Ordinance. In compliance with the Construction and Demolition Debris Recovery Ordinance, the project applicant would submit a waste diversion plan and demolition debris recovery plan to the San Francisco Department of Environment, specifying that at least 65 percent of the project's nonhazardous excavated soil and construction debris would be recycled. The proposed project would recycle 65 percent (or approximately 3,110 cubic yards) of

<sup>125</sup> San Francisco Public Utilities Commission (SFPUC), San Francisco's Wastewater Treatment Facilities, 2014, <https://sfwater.org/modules/showdocument.aspx?documentid=5801>, accessed on June 25, 2019.

<sup>126</sup> Ibid.

<sup>127</sup> San Francisco Planning Department, Preliminary Negative Declaration for the Agreement for Disposal of San Francisco Municipal Solid Waste at Recology Hay Road Landfill in Solano County, Case No 2014.0653E, March 4, 2015.

<sup>128</sup> California Department of Resources Recycling and Recovery (CalRecycle), Solid Waste Information System Facility Detail, <https://www2.calrecycle.ca.gov/swfacilities/Directory/48-AA-0002/>, accessed June 24, 2019.

<sup>129</sup> City and County of San Francisco Department of the Environment, San Francisco Ordinance No. 27-06, Environment Code Chapter 14: Construction and Demolition Debris Recovery Ordinance, 2006.

excavated soil and construction demolition materials and dispose of the remaining 35 percent (or approximately 1,670 cubic yards) at the Hay Road Landfill. All mixed construction debris must be transported by a registered hauler to a registered facility to be processed for recycling, and source separated material must be taken to a facility that recycles or reuses those materials.

As described above, the Hay Road Landfill has approximately 30.4 million cubic yards of capacity remaining and is not anticipated to reach this capacity until 2077. In addition, the Hay Road Landfill can accept up to 2,400 tons of solid waste per day. Therefore, the addition of up to 4,380 cubic yards of excavated material and 400 cubic yards of construction debris as a result of the proposed project would not be in excess of the capacity of solid waste providers. In addition, through compliance with the city's Construction and Demolition Debris Recovery Ordinance, the proposed project would not impair the attainment of solid waste reduction goals in the city or the state. The proposed project would be subject to and would comply with all other applicable statutes and regulations related to solid waste. Therefore, the proposed project would have a less-than-significant impact related to solid waste.

**Impact C-UT-1: The proposed project, in combination with reasonably foreseeable projects, would not result in a cumulative impact on utilities and service systems. (Less than Significant)**

The proposed project consists of a structural upgrade related to the Tower building foundation and would not result in a permanent increase in demand for utilities and service systems in the city. Therefore, the proposed project would not contribute to planned or unplanned population growth in San Francisco. San Francisco's existing utility and service management plans are designed to accommodate the utility and service demands of anticipated growth throughout the city from new development. The proposed project would not combine with cumulative projects to create a significant cumulative impact on utilities and service systems. This impact would be less than significant, and no mitigation measures are necessary.

Topics	Potentially Significant Impact	Less than Significant with Mitigation Incorporated	Less than Significant Impact	No Impact	Not Applicable
<b>14. PUBLIC SERVICES.</b>					
<b>Would the project:</b>					
a) Result in substantial adverse physical impacts associated with the provision of new or physically altered governmental facilities, need for new or physically altered governmental facilities, the construction of which could cause significant environmental impacts, in order to maintain acceptable service ratios, response times, or other performance objectives for any of the public services such as fire protection, police protection, schools, parks, or other public facilities?	<input type="checkbox"/>	<input type="checkbox"/>	<input type="checkbox"/>	<input checked="" type="checkbox"/>	<input type="checkbox"/>

**Impact PS-1: The proposed project would not increase demand for police and fire protection services and would not require construction of new or physically altered facilities, associated with the provision of such services, that could cause significant environmental impacts. (No Impact)**

The San Francisco Police Department and San Francisco Fire Department provide emergency services in the project area. The project site is located in the Southern Police District, which covers the South of Mission,

Embarcadero, China Basin areas of San Francisco. The Southern Station is located in the Public Safety Building at 1251 Third Street, which is located about 1.2 miles south of the project site.<sup>130</sup>

The San Francisco Fire Department provides fire protection, responds to other emergency situations, including hazardous materials incidents, and provides medical aid and fire prevention and safety training. San Francisco Fire Department stations within one mile of the project site include Station No. 1 at 935 Folsom Street, Station No. 2 at 1340 Powell Street, Station No. 8 at 36 Bluxome Street, Station No. 13 at 530 Sansome Street, and Station No. 35 at Pier 22½, The Embarcadero.<sup>131</sup>

As discussed in Section E.3, Population and Housing (Impact PH-1), the proposed project would not result in the construction of residential units or add any land uses to the associated parcel. Increases in demand for public services generally occur due to a permanent increase in population in a given area. There could be a minimal increase in demand for police and fire services due to construction activities at the site; however, this would be short-term. Therefore, the proposed project would not increase the demand for public services. Construction of the project and associated travel lane closures could potentially affect police and fire service access. Please refer to Impact TR-1 regarding the project's impact to emergency access.

Project operations would not require additional maintenance personnel, except when the sponsor performs an inspection of the conditions of the jack system, jacking beams, or rods following a major earthquake as discussed in section A.5, Proposed Project. Such an inspection would require two individuals in total. Thus, the project would not increase the number of service calls or the service population in the area. Given that the proposed project is located in proximity to and already served by police and fire protection services, and would not result in population growth, there would be no impact related to the provision of new or altered public service facilities.

**Impact C-PS-1: The proposed project, in combination with other past, present, or reasonably foreseeable projects, would not have a significant cumulative impact on public services. (No Impact)**

The proposed project would have no impact related to the provision of new or altered public service facilities. Therefore, the proposed project could not contribute to a significant cumulative impact on public services.

---

<sup>130</sup> San Francisco Police Department, Police District Maps, <https://www.sanfranciscopolice.org/station-finder>, accessed November 8, 2019.

<sup>131</sup> San Francisco Fire Department, Fire Station Locations, <https://sf-fire.org/FIRE-STATION-LOCATIONS>, accessed on November 8, 2019.

Topics	Potentially Significant Impact	Less than Significant with Mitigation Incorporated	Less than Significant Impact	No Impact	Not Applicable
<b>15. BIOLOGICAL RESOURCES.</b>					
<b>Would the project:</b>					
a) Have a substantial adverse effect, either directly or through habitat modifications, on any species identified as a candidate, sensitive, or special-status species in local or regional plans, policies, or regulations, or by the California Department of Fish and Wildlife or U.S. Fish and Wildlife Service?	<input type="checkbox"/>	<input type="checkbox"/>	<input type="checkbox"/>	<input checked="" type="checkbox"/>	<input type="checkbox"/>
b) Have a substantial adverse effect on any riparian habitat or other sensitive natural community identified in local or regional plans, policies, regulations or by the California Department of Fish and Wildlife or U.S. Fish and Wildlife Service?	<input type="checkbox"/>	<input type="checkbox"/>	<input type="checkbox"/>	<input type="checkbox"/>	<input checked="" type="checkbox"/>
c) Have a substantial adverse effect on federally protected wetlands (including, but not limited to, marsh, vernal pool, coastal, etc.) through direct removal, filling, hydrological interruption, or other means?	<input type="checkbox"/>	<input type="checkbox"/>	<input type="checkbox"/>	<input type="checkbox"/>	<input checked="" type="checkbox"/>
d) Interfere substantially with the movement of any native resident or migratory fish or wildlife species or with established native resident or migratory wildlife corridors, or impede the use of native wildlife nursery sites?	<input type="checkbox"/>	<input checked="" type="checkbox"/>	<input type="checkbox"/>	<input type="checkbox"/>	<input type="checkbox"/>
e) Conflict with any local policies or ordinances protecting biological resources, such as a tree preservation policy or ordinance?	<input type="checkbox"/>	<input type="checkbox"/>	<input checked="" type="checkbox"/>	<input type="checkbox"/>	<input type="checkbox"/>
f) Conflict with the provisions of an adopted habitat conservation plan, natural community conservation plan, or other approved local, regional, or state habitat conservation plan?	<input type="checkbox"/>	<input type="checkbox"/>	<input type="checkbox"/>	<input type="checkbox"/>	<input checked="" type="checkbox"/>

The project site is not located in an area covered by an adopted habitat conservation plan, natural community conservation plan, or other approved local, regional, or state habitat conservation plan. The project site is not located within a federally protected wetland, as defined by section 404 of the Clean Water Act and does not contain riparian habitat or other sensitive natural communities. Therefore, topics E.15(b), E.15(c), and E.15(f) are not applicable to the proposed project.

**Impact BI-1: The proposed project would not have a substantial adverse effect, either directly or through habitat modifications, on any special-status species. (No Impact)**

The project site and surrounding area are in an urban environment with high levels of human activity. The project site has been developed for over 100 years and adjacent sites are currently developed; thus, any special-status species have been previously extirpated from the area. The project site is covered by impervious surfaces (i.e., existing sidewalk and paved roadway). The project site does not provide suitable habitat for any rare or endangered plant or wildlife species and only common bird species are likely to nest in the vicinity. Therefore, the proposed project would have no impact on special-status species.

**Impact BI-2: The proposed project would not interfere with the movement of any native resident or wildlife species or with established native resident or migratory wildlife corridors. (Less than Significant with Mitigation)**

As described above, the project site and surrounding area are developed in nature. As a result, the proposed project would likely not interfere with wildlife movement or impede the use of any nursery sites. No migratory birds are expected to be on the project site. The project would require the temporary removal of

13 trees along Mission, Fremont, and Beale streets. This analysis reasonably presumes that birds habituated to urban disturbance are capable of occupying the habitats that these street trees provide, and there is the potential for nesting birds to be present in these trees. Removal of the trees during the nesting season could result in potentially significant impacts to nesting birds and their nests because tree removal could result in nest abandonment, destruction, injury or mortality of nestlings, and disruption of reproductive behavior during the breeding season. The proposed project would be subject to the requirements of the Migratory Bird Treaty Act (MBTA) of 1918 (16 U.S.C. 703-711) and the California Fish and Game Code (CFG) (sections 3503 and 3503.5), both of which protect birds and their nests.

Although adult birds can escape the project site to avoid direct harm during construction, eggs or chicks associated with active nests could still be permanently affected (i.e., abandoned or killed) by project construction activities. The proposed project may result in the displacement of nesting migratory birds and/or the abandonment of active nests should construction and vegetation removal occur during the typical nesting season (January 15 through August 15). Even though the project would be required to comply with the requirements of the MBTA and CFG, which would help ensure that there would be no loss of active nests or bird mortality, the project would implement Mitigation Measure M-BI-1: Preconstruction Nesting Bird Surveys and Buffer Areas.

**Mitigation Measure M-BI-2: Preconstruction Nesting Bird Surveys and Buffer Areas.** Nesting birds and their nests shall be protected during construction by implementation of the following measures for each construction phase:

- a. To the extent feasible, conduct initial activities including but not limited to vegetation removal, tree trimming or removal, ground disturbance, building demolition, site grading, and other construction activities which may compromise breeding birds or the success of their nests outside of the nesting season (January 15 through August 15).
- b. If construction during the bird nesting season cannot be fully avoided, a qualified wildlife biologist\* shall conduct pre-construction nesting surveys within 14 days prior to the start of construction or demolition at areas that have not been previously disturbed by project activities or after any construction breaks of 14 days or more. Surveys shall be performed for suitable habitat within 250 feet of the project site in order to locate any active nests of common bird species and within 500 feet of the project site to locate any active raptor (birds of prey) nests.
- c. If active nests are located during the preconstruction nesting bird surveys, a qualified biologist shall evaluate if the schedule of construction activities could affect the active nests and if so, the following measures would apply:
  - i. If construction is not likely to affect the active nest, construction may proceed without restriction; however, a qualified biologist shall regularly monitor the nest at a frequency determined appropriate for the surrounding construction activity to confirm there is no adverse effect. Spot-check monitoring frequency would be determined on a nest-by-nest basis considering the particular construction activity, duration, proximity to the nest, and physical barriers which may screen activity from the nest. The qualified biologist may revise his/her determination at any time during the nesting season in coordination with the Planning Department.
  - ii. If it is determined that construction may affect the active nest, the qualified biologist shall establish a no-disturbance buffer around the nest(s) and all project work shall halt within the buffer until a qualified biologist determines the nest is no longer in use. Typically, these



buffer distances are 250 feet for passerines and 500 feet for raptors; however, the buffers may be adjusted if an obstruction, such as a building, is within line-of-sight between the nest and construction.

- iii. Modifying nest buffer distances, allowing certain construction activities within the buffer, and/or modifying construction methods in proximity to active nests shall be done at the discretion of the qualified biologist and in coordination with the Planning Department, who would notify CDFW. Necessary actions to remove or relocate an active nest(s) shall be coordinated with the Planning Department and approved by CDFW.
  - iv. Any work that must occur within established no-disturbance buffers around active nests shall be monitored by a qualified biologist. If adverse effects in response to project work within the buffer are observed and could compromise the nest, work within the no disturbance buffer(s) shall halt until the nest occupants have fledged.
  - v. Any birds that begin nesting within the project area and survey buffers amid construction activities are assumed to be habituated to construction-related or similar noise and disturbance levels, so exclusion zones around nests may be reduced or eliminated in these cases as determined by the qualified biologist in coordination with the Planning Department, who would notify CDFW. Work may proceed around these active nests as long as the nests and their occupants are not directly impacted.
- d. In the event inactive nests are observed within or adjacent to the project site at any time throughout the year, any removal or relocation of the inactive nests shall be at the discretion of the qualified biologist in coordination with the Planning Department, who would notify and seek approval from the CDFW, as appropriate. Work may proceed around these inactive nests.
- \* Typical experience requirements for a "qualified biologist" include a minimum of four years of academic training and professional experience in biological sciences and related resource management activities, and a minimum of two years of experience conducting surveys for each species that may be present within the project area.

Compliance with existing regulations and implementation of Mitigation Measure M-BI-2 would ensure that the proposed project would not result in any significant impacts associated with the movement of any native resident or migratory wildlife species or with established native resident or migratory wildlife corridors. This impact, therefore, would be less than significant.

**Impact BI-3: The proposed project would not conflict with any local policies or ordinances protecting biological resources, such as a tree preservation policy or ordinance. (Less than Significant)**

The city's Urban Forestry Ordinance, Public Works Code, sections 801 et seq., requires a permit from the San Francisco Public Works (public works) to remove any protected trees. Protected trees include landmark trees, significant trees, or street trees located on private property subject to location and size criteria or on public property anywhere within the territorial limits of the City and County of San Francisco. There are no landmark or significant trees along Mission, Fremont, and Beale streets.<sup>132</sup> A total of 13 street trees (seven trees along the frontage of Mission Street, three trees along Fremont Street, and three trees along Beale

<sup>132</sup> City and County of San Francisco, Significant and Landmark Trees, <https://sfpublicworks.org/services/significant-and-landmark-trees>, accessed June 7, 2019.

Street) would be temporarily removed for project construction. The proposed project would be required to comply with the Urban Forestry Ordinance, which requires a permit from public works to remove any street trees. Removal of street trees would require that the project sponsor plant an appropriate replacement tree on the project site or along the street or pay an in-lieu fee. The project sponsor would comply with the Urban Forestry Ordinance by following these requirements and replacement street trees would be planted after construction is complete. Therefore, the proposed project would not conflict with the city's local tree ordinance and impacts would be less than significant. No mitigation measures are required.

**Impact C-BI-1: The proposed project, in combination with reasonably foreseeable future projects in the vicinity of the site, would not have a significant cumulative impact on biological resources. (Less than Significant)**

The project vicinity does not currently support any candidate, sensitive, or special-status species, any riparian habitat, or any other sensitive natural community identified in local or regional plans, policies, or regulations or by the California Department of Fish and Wildlife or the U.S. Fish and Wildlife Service. As with the proposed project, nearby cumulative development projects would also be subject to federal, state, and local regulations related to biological resources. As with the proposed project, compliance with these ordinances would reduce the effects of development projects to less-than-significant levels.

The proposed project would not modify any natural habitat and would not have a substantial adverse effect on any candidate, sensitive, or special-status species, any riparian habitat, or other sensitive natural community with the implementation of Mitigation Measure M-BI-2; and/or would not conflict with any local policy or ordinance protecting biological resources or an approved conservation plan. For these reasons, the proposed project would not have the potential to combine with reasonably foreseeable future projects in the project vicinity to result in a significant cumulative impact related to biological resources. Therefore, there would be no cumulative impacts on biological resources. Therefore, cumulative impacts to biological resources would be less than significant.

Topics	Potentially Significant Impact	Less than Significant with Mitigation Incorporated	Less than Significant Impact	No Impact	Not Applicable
<b>16. GEOLOGY AND SOILS.</b>					
<b>Would the project:</b>					
a) Directly or indirectly cause potential substantial adverse effects, including the risk of loss, injury, or death involving:					
i) Rupture of a known earthquake fault, as delineated on the most recent Alquist-Priolo Earthquake Fault Zoning Map issued by the State Geologist for the area or based on other substantial evidence of a known fault? Refer to Division of Mines and Geology Special Publication 42.	<input type="checkbox"/>	<input type="checkbox"/>	<input type="checkbox"/>	<input checked="" type="checkbox"/>	<input type="checkbox"/>
ii) Strong seismic ground shaking?	<input type="checkbox"/>	<input type="checkbox"/>	<input checked="" type="checkbox"/>	<input type="checkbox"/>	<input type="checkbox"/>
iii) Seismic-related ground failure, including liquefaction?	<input type="checkbox"/>	<input type="checkbox"/>	<input checked="" type="checkbox"/>	<input type="checkbox"/>	<input type="checkbox"/>
iv) Landslides?	<input type="checkbox"/>	<input type="checkbox"/>	<input type="checkbox"/>	<input type="checkbox"/>	<input checked="" type="checkbox"/>
b) Result in substantial soil erosion or the loss of topsoil?	<input type="checkbox"/>	<input type="checkbox"/>	<input checked="" type="checkbox"/>	<input type="checkbox"/>	<input type="checkbox"/>
c) Be located on geologic unit or soil that is unstable, or that would become unstable as a result of the project, and potentially result in on- or off-site landslide, lateral spreading, subsidence, liquefaction or collapse?	<input type="checkbox"/>	<input type="checkbox"/>	<input checked="" type="checkbox"/>	<input type="checkbox"/>	<input type="checkbox"/>
d) Be located on expansive soil, as defined in Table 18-1-B of the Uniform Building Code (1994), creating substantial direct or indirect risks to life or property?	<input type="checkbox"/>	<input type="checkbox"/>	<input type="checkbox"/>	<input type="checkbox"/>	<input checked="" type="checkbox"/>
e) Have soils incapable of adequately supporting the use of septic tanks or alternative wastewater disposal systems where sewers are not available for the disposal of waste water?	<input type="checkbox"/>	<input type="checkbox"/>	<input type="checkbox"/>	<input type="checkbox"/>	<input checked="" type="checkbox"/>
f) Directly or indirectly destroy a unique paleontological resource or site or unique geologic feature?	<input type="checkbox"/>	<input checked="" type="checkbox"/>	<input type="checkbox"/>	<input type="checkbox"/>	<input type="checkbox"/>

As discussed in Section A, Project Description, the proposed project consists of a structural upgrade of the Tower building foundation that includes installation of an extension of the existing mat foundation for the Tower building, which would be supported by 52 new perimeter piles extending to bedrock and located within the public right-of-way along Mission and Fremont streets sidewalks along the north and west sides of the Tower building. The analysis in this section relies on information and recommendations provided in the geotechnical evaluation conducted for the proposed project and the findings and recommendations of the independent Engineering Design Review Team (peer review team) letter to the director of the San Francisco Department of Building Inspection (the building department) regarding the proposed upgrade.<sup>133,134</sup> Volumes 2 and 3 of the structural calculations prepared by the project's structural engineer of record and submitted to the peer review team and the building department contain detailed calculations that demonstrate settlement has not degraded the structure's strength to resist, dead, live, wind and earthquake loads to exceed the levels that trigger upgrade under the San Francisco Building Code.<sup>135,136</sup>

<sup>133</sup> John A. Egan, PE, GE, *Geotechnical Evaluation for the Perimeter Pile Upgrade, Millennium Tower – Revision 1, City and County of San Francisco, California*, August 13, 2019, with the assistance of Slate Geotechnical Consultants.

<sup>134</sup> Engineering Design Review Team, letter to Tom C. Hui, S.E., C.B.O., Director and Chief Building Official, City and County of San Francisco Department of Building Inspection, August 27, 2019.

<sup>135</sup> Simpson Gumpertz & Heger, *301 Mission St Perimeter Pile Upgrade Calculations Vols 2 - Gravity and 3 - Lateral– Revision 5*, June 7, 2019.

<sup>136</sup> Engineering Design Review Team, *301 Mission Street – Voluntary Foundation Retrofit EDRT – Log*, p. 1, August 27, 2019.

The project footprint is in an area that is entirely flat and not located in a landslide hazard area as defined in the city's General Plan Community Safety Element or in a state-identified seismic hazard zone for landslide hazard.<sup>137,138</sup> The project site is not located on expansive soil.<sup>139</sup> Instead, the project is on a variety of soil types as more fully described under the discussion of Existing Subsurface Conditions. The Tower and Podium buildings would remain connected to the combined sewer system, which is the wastewater and stormwater system for San Francisco, and would not use septic tanks or other onsite disposal systems for sanitary sewage. Therefore, topics E.16(a)(iv), E.16(d), and E.16(e) are not applicable to the proposed project.

### **Regulatory Setting**

Existing laws and regulations that stipulate a regulatory process to address seismic and geologic hazards to ensure minimum levels of safety in the construction of new or retrofitted structures are described below.

#### **FEDERAL REGULATIONS**

**Earthquake Hazard Reduction Act of 1977.** Federal laws codified in United States Code Title 42, Chapter 86, were enacted to reduce risks to life and property from earthquakes in the United States through the establishment and maintenance of an effective earthquake hazards reduction program. Implementation of these requirements are regulated, monitored, and enforced at the state and local levels. Key regulations and standards applicable to the proposed project are summarized below.

#### **CALIFORNIA REGULATIONS**

**The Alquist-Priolo Earthquake Fault Zoning Act of 1972 (Alquist-Priolo Act).** The Alquist-Priolo Act (Public Resources Code section 2621 et seq.) is intended to reduce the risk to life and property from surface fault rupture during earthquakes. The Alquist-Priolo Act prohibits the location and construction of most types of structures intended for human occupancy over active fault traces and strictly regulates construction in the corridors along active faults (i.e., earthquake fault zones).

**The Seismic Hazards Mapping Act of 1990.** The Seismic Hazards Mapping Act was passed in 1990 following the Loma Prieta earthquake to reduce threats to public health and safety and to minimize property damage caused by earthquakes (Public Resources Code section 2690 et seq.). This act requires the State Geologist to delineate various seismic hazard zones, and cities, counties, and other local permitting agencies to regulate certain development projects within these zones. For projects that would locate structures for human occupancy within designated Zones of Required Investigation, the Seismic Hazards Mapping Act requires project applicants to perform a site-specific geotechnical investigation to identify the potential site-specific seismic hazards and corrective measures, as appropriate, prior to receiving building permits. The *California Geological Survey (CGS) Guidelines for Evaluating and Mitigating Seismic Hazards*

---

<sup>137</sup> San Francisco Planning Department, *Community Safety an Element of the General Plan of the City and County of San Francisco*, October 2012.

<sup>138</sup> California Geological Survey (CGS), CGS Information Warehouse: Landslides, 2015, <http://maps.conservacion.ca.gov/cgsl/informationwarehouse/index.html?map=regulatorymaps>, accessed October 21, 2019.

<sup>139</sup> Egan, John, A., PE, GE, email correspondence with Kei Zushi, Jennifer McKellar, and Debra Dwyer, San Francisco Planning Department, November 7, 2019.

(Special Publication 117A) provides guidance for evaluating and mitigating seismic hazards.<sup>140</sup> The CGS has completed evaluating the San Francisco North Quadrangle, and has identified the project site as being located within an area that has the potential for liquefaction.<sup>141</sup>

**California Building Code.** The California Building Code is codified in Title 24 of the California Code of Regulations and consists of several parts, including Part 2, Volumes 1 and 2, the 2016 California Building Code which is referred to in this document as the building code, and Part 10, the 2016 California Existing Building Code, which contains section 403.9, Voluntary Seismic Improvements. The California Building Code provides standards that must be met to safeguard life or limb, health, property, and public welfare by regulating and controlling the design, construction, quality of materials, use and occupancy, location, and maintenance of all buildings and structures within the state. The California Building Code generally applies to all occupancies in California, with modifications adopted in some instances by state agencies or local governing bodies. Title 24 is administered by the California Building Standards Commission, which, by law, is responsible for coordinating all building standards. Under State law, all building standards must be centralized in Title 24 or they are not enforceable. The provisions of the California Building Code apply to the construction, alteration, movement, replacement, location, and demolition of every building or structure or any appurtenances connected or attached to such buildings or structures throughout California. Title 24, Part 10, the California Existing Building Code governs alteration, addition, and repair to existing buildings. It governs the requirements for upgrade of existing buildings to minimum criteria when triggered by other actions such as alteration and is described in more detail below under "San Francisco Building Code."

Specific sections of the California Building Code (Title 24, Part 2, Volume 2) relevant to this topic are as follows. Chapter 16 addresses structural design requirements governing seismically resistant construction (section 1604), including, but not limited to, factors and coefficients used to establish a seismic site class and seismic occupancy category appropriate for the soil/rock at the building location and the proposed building design (sections 1613.5 through 1613.7). Chapter 18 includes, but is not limited to, the requirements for foundation and soil investigations (section 1803); excavation, grading, and fill (section 1804); allowable load-bearing values of soils (section 1806); foundation and retaining walls, (section 1807); and foundation support systems (sections 1808 through 1810). Chapter 33 includes, but is not limited to, requirements for safeguards at work sites to ensure stable excavations and cut-or-fill slopes (section 3304) and the protection of adjacent properties including requirements for noticing (section 3307). Appendix J of the California Building Code includes, but is not limited to, grading requirements for the design of excavations and fills (sections J106 and J107) specifying maximum limits on the slope of cut and fill surfaces and other criteria, required setbacks and slope protection for cut and fill slopes (J108), and erosion control in general and regarding the provision of drainage facilities and terracing (sections J109 and J110). San Francisco has adopted Appendix J of the state building code with amendments to J103, J104, J106, and J109 as articulated in the local building code.

In addition, the project is proposed for the foundation of an existing building. As such, the California Existing Building Code (Title 24, Part 10) is also applicable. Specifically, the Existing Building Code Section 403.9, Voluntary Seismic Improvements, applies to the proposed project and is incorporated by reference

<sup>140</sup> California Geological Survey (CGS), *Special Publication 117A Guidelines for Evaluating and Mitigating Seismic Hazards in California*, 2008.

<sup>141</sup> CGS, *San Francisco North Quadrangle, Seismic Hazard Zones*, November 17, 2000.

into the San Francisco Building Code, cited below. Section 403.9 requires that alterations to existing structural elements or additions of new structural elements that are not otherwise required by Chapter 4, Prescriptive Compliance Method, and are initiated for the purpose of improving the performance of the seismic force-resisting system of an existing structure or the performance of seismic bracing or anchorage of existing non-structural elements shall be permitted, provided that an engineering analysis is submitted demonstrating the following:

1. The altered structure and the altered nonstructural elements are no less conforming to the provisions of the California Building Code with respect to earthquake design than they were prior to the alteration.
2. New structural elements are detailed as required for new construction.
3. New or relocated nonstructural elements are detailed and connected to existing or new structural elements as required for new construction.
4. The alterations do not create a structural irregularity as defined in ASCE 7 or make an existing structural irregularity more severe.

**California Division of Occupational Safety and Health Regulations.** Construction activities are subject to occupational safety standards for excavation, shoring, and trenching, as specified in Cal/OSHA regulations (Title 8).

## SAN FRANCISCO REGULATIONS

### *San Francisco Building Code*

The San Francisco Building Code consists of the California Building Code (California Code of Regulations, Title 24) with local amendments used in conjunction with the state's codes.<sup>142</sup>

To ensure that the potential for adverse effects related to geology and soils is adequately addressed, San Francisco relies on the state and local regulatory process for review and approval of building permits pursuant to the California Building Code, the California Existing Building Code, and the San Francisco Building Code and San Francisco Existing Building Code, which also includes the building department's administrative bulletins. As stated above, voluntary seismic upgrades of existing buildings are required to be conducted under the criteria of Section 403.9, Voluntary Seismic Improvements, of the San Francisco Existing Building Code.<sup>143</sup> The building department also issues information sheets to detail implementing procedures related to building department's review of projects, to clarify procedures or establish interim guidelines and procedures. The building department's Administrative Bulletins AB-082 and AB-083 described in detail below are applicable to this project. In addition, applicable information sheets for the proposed project include building department information sheets S-05 and S-18. These are also described in more detail below.

---

<sup>142</sup> The 2016 San Francisco Building Code applies to this project because this is the edition in effect when the project's permit applications were filed in December 2018.

<sup>143</sup> Note that there is no local amendment for this section. Refer to the California Existing Building Code section 403.9 for the full text of this section.

**Administrative Bulletin AB-082, Guidelines and Procedures for Structural, Geotechnical, and Seismic Hazard Engineering Design Review.** AB-082 is dated November 21, 2018, and pursuant to its title, presents guidelines and procedures for when and how structural, geotechnical, and seismic hazard engineering design review is conducted. Such review may be required by the building code, by another administrative bulletin, or at the request of the director of the building department.<sup>144</sup> This administrative bulletin is applicable to the alteration or retrofit of existing structures.<sup>145</sup> AB-082 details the purpose of the review, responsibilities of the Engineering Design Review Team (peer review team), professional qualification requirements and selection of reviewers, types of projects requiring review, scope of the review, and the review process. The scope of the review services for each discipline is described below.

- **Structural Engineering Design Review** services include review of: structural performance goals; structural basis of design and overall concept; design methodology and acceptance criteria; mathematical modeling and simulation, including input assumptions; structural calculations; interpretation of analysis results; design and detailing of members and systems; structural construction documents, including drawings, specifications, and quality control and inspection provisions.
- **Geotechnical Engineering Review** services include review of geotechnical engineering methods and assumptions and the geotechnical aspects of foundation design, as well as evaluation of the recommendations regarding geotechnical aspects of construction, which may include load testing and construction monitoring.
- **Site-Specific Seismic Hazard Review** services include the review of site-specific earthquake spectra, the methods and assumptions used in development of the spectra, and San Francisco Building Code requirements.
- **Earthquake Ground Motion Review** services include review of the motions to be used in the design, their selection, scaling to response spectra, their duration, and San Francisco Building Code requirements.

**Administrative Bulletin AB-083, Requirements and Guidelines for the Seismic Design of New Tall Buildings using Non-Prescriptive Seismic-Design Procedures.** AB-083 is dated January 1, 2014, and pursuant to its title, presents requirements and guidelines for seismic structural design and submittal documents for building permits for new tall buildings in San Francisco that use non-prescriptive seismic design procedures.<sup>146</sup> AB-083 also applies to existing buildings that are undergoing retrofitting, as required by the director of the building department. Non-prescriptive seismic design procedures are designs that take exception to one or more of the prescriptive requirements of the San Francisco Building Code and Chapter 12 of ASCE/SEI 7-05 (note: current version is ASCE/SEI 7-16) and the standards referenced therein, by invoking San Francisco Building Code, section 104A.2.8, which allows alternative materials and methods of construction as approved by the building official (the San Francisco Director of the Department of Building Inspection).

<sup>144</sup> San Francisco Department of Building Inspection, *Administrative Bulletin 082, Guidelines and Procedures for Structural, Geotechnical, and Seismic Hazard Engineering Design Review*, November 21, 2018 (Supersedes Administrative Bulletin AB-082 originally issued March 25, 2008, revised December 19, 2016), <http://sfdbi.org/sites/default/files/AB-082.pdf>, accessed July 9, 2019.

<sup>145</sup> Ibid.

<sup>146</sup> San Francisco Department of Building Inspection, *Administrative Bulletin 083, Requirements and Guidelines for the Seismic Design of New Tall Buildings using Non-Prescriptive Seismic-Design Procedures*, January 1, 2014 (Supersedes Administrative Bulletin AB-083 originally issued March 25, 2008), <http://sfdbi.org/administrative-bulletins>, accessed September 18, 2019.

AB-083 details the purpose of the requirements and guidelines, briefly discusses and references non-prescriptive seismic design procedures, describes submittal requirements, provides detail on seismic design requirements, including code-level evaluation, service-level evaluation, and maximum considered earthquake-level evaluation.

**Information Sheet S-05, Geotechnical Report Requirements.** S-05 revisions were issued on October 11, 2018 and further revised on May 7, 2019.<sup>147</sup> S-05 establishes the permit work scope which will require the submittal of a geotechnical report in conformance with building code section 1803, Geotechnical Investigations. Permit application submittals that require a geotechnical report include (but are not limited to): cut sections greater than 10 feet in vertical height; grading, excavation or fill over 5,000 cubic yards of earth material; and special foundation including but not limited to piles and piers.<sup>148</sup>

**Information Sheet S-18, Interim Guidelines and Procedures for Structural, Geotechnical, and Seismic Hazard Engineering Design Review for New Tall Buildings.** S-18 was issued on December 27, 2017 and revised on March 27, 2019.<sup>149</sup> S-18 establishes interim guidelines and procedures for structural, geotechnical, and seismic hazard engineering design review that apply to new tall buildings 240 feet or taller, located in the city's softest soils and/or liquefaction zones, or at the director of the building department's discretion.<sup>150</sup> Because administrative bulletins AB-082 (Guidelines and Procedures for Structural Design Review) and AB-083 (Requirements and Guidelines for the Seismic Design of New Tall Buildings using Non-Prescriptive Seismic-Design Procedures) are currently being reviewed by the Structural Engineers Association of Northern California, S-18 provides interim guidelines to supplement and clarify the information in AB-082, as well as AB-083. The interim guidelines specify requirements for the scope of geotechnical and structural review conducted by independent qualified geotechnical reviewers as part of an Engineering Design Review Team.<sup>151</sup> S-18 also specifies post-construction requirements for the annual monitoring of the effects of settlement on the buildings and foundations of the project for a period of ten years. The annual monitoring reports are to be submitted to the building department.

### **San Francisco Public Works Code**

**Article 4.2, Sewer System Management, Sections 146–146.11, Construction Site Runoff Control.** These sections of the public works code require that all construction sites must implement best management

<sup>147</sup> The San Francisco Department of Building Inspection applies only the building code and implementing procedures in effect at the time of building permit submission. The project sponsor complied with S-05 geotechnical report requirements as reviewed by the peer review team and the building department.

<sup>148</sup> San Francisco Department of Building Inspection, *Information Sheet No. S-05, Geotechnical Report Requirements*, May 7, 2019, <https://sfdbi.org/sites/default/files/IS%20S-05.pdf>, accessed September 19, 2019.

<sup>149</sup> The San Francisco Department of Building Inspection applies only the building code and implementing procedures in effect at the time of building permit submission. The project sponsor is compliance with Information Sheet S-18 including the March 2019 amendment.

<sup>150</sup> San Francisco Department of Building Inspection, *Information Sheet No. S-18, Interim Guidelines and Procedures for Structural, Geotechnical, and Seismic Hazard Engineering Design Review for New Tall Buildings*, March 27, 2019, <https://sfdbi.org/sites/default/files/IS%20S-18.pdf>, accessed July 9, 2019.

<sup>151</sup> A qualified geotechnical reviewer for Engineering Design Review Teams shall be a geotechnical engineer (G.E.) registered in California or a Civil Engineer (C.E.) registered in California with substantially demonstrated geotechnical experience.



practices to minimize surface runoff erosion and sedimentation.<sup>152,153</sup> In addition, if construction activities would disturb between 5,000 square feet and 1 acre of ground surface, such as the proposed project, then the project sponsor would be required to submit an erosion sediment control plan (erosion control plan) or a storm water pollution prevention plan (SWPPP), and a Construction Site Runoff Control Project Application to San Francisco Public Utilities Commission (SFPUC) for their review and approval.

An erosion control plan is a site-specific plan that details the use, location and emplacement of sediment and erosion control devices. It must include:

- The location and perimeter of the project site;
- The location of nearby storm drains and/or catch basins;
- Existing and proposed roadways and drainage pattern within the project site; and
- A drawing or diagram of the sediment and erosion control devices to be used onsite.

As stated alternately, a project may prepare and implement a storm water pollution prevention plan, as per the State Construction General Permit. Similar to the erosion control plan, the storm water pollution prevention plan would describe the BMPs a contractor will implement to prevent erosion and discharge of sediment and other pollutants in stormwater runoff, and must be submitted to SFPUC for their review and approval.

**Impact GE-1: The proposed project would not directly or indirectly cause potential substantial adverse effects, including the risk of loss, injury, or death involving rupture of a known earthquake fault, strong seismic ground shaking, seismic-related ground failure, or landslides. (Less than Significant)**

As described in Section A, Project Description, the existing Tower building on the associated parcel has experienced differential settlement due to consolidation and compression of the Old Bay Clay soil layer. The purpose of the project is to transfer some of the Tower building load from the existing foundation to 52 cast-in-place reinforced concrete piles that would be installed into the deeper, more stable Franciscan Complex bedrock. These 52 new piles would be located within the public right-of-way under the Mission and Fremont streets sidewalks along the north and west sides of the Tower building near the northwest corner of the associated parcel. The proposed project is therefore designed to meet the requirements of section 403.9, Voluntary Seismic Improvements, of the Existing Building Code, with the intent to reduce future building settlement on the associated parcel at 301 Mission Street; assure that the existing building can provide the seismic performance intended of new structures designed to the San Francisco Building Code; and improve the seismic performance of the Tower building's foundation.<sup>154</sup> The geotechnical

<sup>152</sup> San Francisco Public Works Code. Article 4.2 Section 146 et al. Construction Site Runoff Control. Online at [http://library.amlegal.com/nxt/gateway.dll/California/publicworks/publicworkscode?f=templates\\$fn=default.htm\\$3.0\\$vid=amlegal:sanfrancisco\\_ca\\$sync=1](http://library.amlegal.com/nxt/gateway.dll/California/publicworks/publicworkscode?f=templates$fn=default.htm$3.0$vid=amlegal:sanfrancisco_ca$sync=1), accessed November 7, 2019.

<sup>153</sup> San Francisco Public Utilities Commission, *Construction Site Runoff Control Program*, 2017, <http://sfwater.org/index.aspx?page=235>, accessed July 3, 2019.

<sup>154</sup> Simpson Gumpertz & Heger, *301 Mission St Perimeter Pile Upgrade Calculations Vol 1 – Design Overview – Revision 6*, August 16, 2019, p. 2.

evaluation prepared by the geotechnical engineer of record<sup>155</sup> included a review of available geologic and geotechnical data for the site vicinity, an engineering analysis of the proposed project in the context of geologic and geotechnical site conditions, subsurface exploration including soil borings, and preparation of project-specific design and construction recommendations.<sup>156</sup> Responsibility for the design in conformance with the San Francisco Building Code resides with the structural engineer of record. The geotechnical engineer of record for the project will continue to analyze the building's settlement performance during and after construction of the project.<sup>157,158</sup> The responsibility for conducting plan check resides with the Director of the building department and any plan check consultants. The responsibility for acceptance of a design and any decisions on the issuance of permits resides solely with the Director of the building department.

The building department convened under City contract an Engineering Design Review Team (peer review team) in 2018 comprised of four independent qualified professional engineers to conduct an independent review of the project in accordance with the building department's requirements of AB-082, *Guidelines and Procedures for Structural, Geotechnical, and Seismic Hazard Engineering Design Review*. The purpose of the peer review team's assessment is to provide an assurance that (1) the altered structure conforms to the provisions of the San Francisco Building Code with respect to earthquake design at the equivalent level or better than it was prior to the alteration, and (2) the alterations do not create structural irregularities. The purpose of the peer review process includes advising the Director of building department whether the design aspects in the scope of review satisfy the design intent of the San Francisco Building Code. The assessment addressed project design criteria; review of the geotechnical evaluation, data, and models; review of structural models and design calculations; design of the new piles and mat extension to meet the local building code requirements for new buildings; assessment of the existing piles, foundation mat, and superstructure to meet the requirements of Section 403.9 of the Existing Building Code; and review of engineering drawings.<sup>159</sup>

The analysis in this section relies on the information and recommendations provided in the geotechnical evaluations conducted for the proposed project by the structural and geotechnical engineers of record and the findings of the independent peer review team letter to the director of the building department.<sup>160</sup>

### ***Existing Subsurface Conditions***

The project site is underlain by approximately 250 feet of various soil types overlying the Franciscan Complex bedrock (see Figure 3, Existing Project Site and Subsurface Profile). Figure 3 is for illustrative purposes only as there is variation in the depths of soil types and depth to bedrock across the project site and associated 301 Mission Street parcel. The artificial fill ranges from approximately 15 to 25 feet below ground surface (bgs). The fill is underlain by 20 to 30 feet of a soft to medium-stiff marine clay deposit

<sup>155</sup> The geotechnical engineer of record for the project is John A. Egan, PE, GE, who has been assisted by Slate Geotechnical Consultants.

<sup>156</sup> John A. Egan, PE, GE, *Geotechnical Evaluation for the Perimeter Pile Upgrade – Revision 1, Millennium Tower, City and County of San Francisco, California*, August 13, 2019, with the assistance of Slate Geotechnical Consultants.

<sup>157</sup> San Francisco Department of Building Inspection, *Administrative Bulletin 082, Guidelines and Procedures for Structural, Geotechnical, and Seismic Hazard Engineering Design Review*, November 21, 2018.

<sup>158</sup> The Structural Engineer of Record is Ronald O. Hamburger, SE of Simpson Gumpertz & Heger, Inc., San Francisco, CA

<sup>159</sup> Engineering Design Review Team, letter to Tom C. Hui, S.E., C.B.O., Director and Chief Building Official, City and County of San Francisco Department of Building Inspection, August 27, 2019. p. 2.

<sup>160</sup> Ibid.

known locally as Upper Young Bay Mud, to depths between 35 and 55 feet bgs. The Upper Young Bay Mud is generally underlain by a zone of stiff to very stiff sandy clay (referred to as the Lower Young Bay Mud) interbedded with medium-dense to dense clayey sand and sand with clay (referred to as Upper Marine Sands and Lower Marine Sands (known locally as Colma Sands), to depths of approximately 90 to 100 feet bgs, followed by a stiff to very stiff marine clay deposit, known locally as Old Bay Clay, which is approximately 120 to 160 feet thick. Some studies refer to the lower portions of the Old Bay Clay as the Alameda Formation. Finally, bedrock at the site, known locally as Franciscan Complex, underlies the Old Bay Clay unit beginning at depths ranging from about 220 to 250 feet bgs.

In March and July 2019, eight soil borings were drilled at different locations within Mission and Fremont streets' right-of-way where the structural upgrade would take place.<sup>161</sup> The proposed depth of each boring was 30 feet bgs; however, drilling refusal<sup>162</sup> was encountered in gravel and cemented silt fill material and limited the depth of some borings to as shallow as 4 feet bgs. A March 2019 grab groundwater sample<sup>163</sup> was collected at a depth of 12 feet bgs and several July 2019 grab groundwater samples were collected at depths of 16.8 and 17.5 feet bgs. These samples informed the project design as to the anticipated depth to groundwater that would be encountered during construction and whether the groundwater has chemicals at hazardous concentrations. Based on the sampling events, groundwater could be encountered within the depths of the excavation at approximately 10 to 22 feet bgs. The depth of groundwater has been observed to vary several feet annually depending on the rainfall. As described in the project description, the project sponsor anticipates the groundwater table is currently approximately 19 to 22 feet bgs. The exact depth to groundwater would be verified during project construction.

### **Fault Rupture**

There are no known active faults intersecting the project site and the site is not within an earthquake fault zone.<sup>164</sup> Therefore, the potential of surface rupture occurring at the site is very low. As such, the proposed project would not exacerbate the potential for surface rupture and therefore, would have no impact related to fault ruptures.

### **Strong Seismic Ground Shaking**

The project site is located approximately 9.3 miles northeast of the San Andreas Fault and approximately 9.8 miles southwest of the Hayward Fault.<sup>165</sup> According to the U.S. Geological Survey, the overall probability of a magnitude 6.7 or greater earthquake to occur in the San Francisco Bay Region during the next thirty years is 72 percent.<sup>166</sup> Therefore, it is possible that a strong to very strong earthquake would affect the proposed

<sup>161</sup> AllWest Environmental, *Site Characterization Assessment Report, Millennium Tower, 301 Mission Street, San Francisco, CA 94105*, August 27, 2019.

<sup>162</sup> In soil, drilling refusal means that the drill was not able to advance further due to a subsurface obstruction, and the boring is abandoned. In other material such as rock, drilling refusal is determined by the progress of the drill in depth under a given pressure for a specified length of time.

<sup>163</sup> Grab groundwater samples are water samples collected from open boreholes for a one-time sampling effort, typically using a sampling device lowered into the open borehole. The borehole is backfilled after the samples are collected. This method is distinguished from constructing a permanent monitoring well with a well pipe and a surface seal.

<sup>164</sup> John A. Egan, PE, GE, *Geotechnical Evaluation for the Perimeter Pile Upgrade – Revision 1, Millennium Tower, City and County of San Francisco, California*, August 13, 2019, with the assistance of Slate Geotechnical Consultants.

<sup>165</sup> *Ibid.*

<sup>166</sup> U.S. Geological Survey, *Earthquake Outlook for the San Francisco Bay Region 2014–2043, Fact Sheet 2016-3020*, 2016.

project during its lifetime. The severity of the event would depend on several conditions, including; generating fault, distance to the earthquake epicenter, and magnitude and duration of the earthquake.

As described in Section A, Proposed Project, the proposed remedy for the differential settlement due to consolidation and compression of the Old Bay Clay soil layer is a structural upgrade related to the Tower building foundation that includes installation of an extension of the existing mat foundation on its north and west sides near the northwest corner of the Tower building, supported by 52 new perimeter piles located within the public right-of-way under the Mission and Fremont streets sidewalks along the north and west sides of the Tower building and extending to bedrock. The new piles would be connected to the extended mat via a jack system that would transfer load from the existing foundation to the new piles. As described above, the proposed structural upgrade is designed to meet the requirements of Section 403.9, Voluntary Seismic Improvements, of the Existing Building Code, with the intent to reduce future building settlement on the associated parcel; assure that the existing building can provide the seismic performance intended of new structures designed to the San Francisco Building Code; and improve the seismic performance of the Tower building's foundation. The proposed project would comply with the latest requirements of the state and local building codes, the building department's implementing guidance and procedures, as well as the state seismic hazards mapping act.

The proposed project has undergone independent engineering design peer review in accordance with the building department's AB-082 and AB-083 (and thereby information sheet S-18) related to structural, geotechnical, and seismic hazard design review for the alteration or retrofit of existing buildings. The peer review team was convened by and under contract with the building department. The peer review team consisted of four members, all licensed professional engineers with extensive experience in structural, geotechnical, and civil engineering including earthquake engineering. In addition to geotechnical and structural professional practitioners, the peer review team included a professor of engineering with extensive experience in structural and earthquake engineering. During its review, the peer review team assessed the project drawings, structural calculations, geotechnical investigation, written supplements and reports. The peer review team met with the project's design team consisting of the structural and geotechnical engineers of record on eleven occasions. All of the peer review team's comments on the geotechnical and structural design have been adequately addressed by the project's design team, and there are no outstanding or unresolved issues as indicated in its findings and recommendations to the building department.<sup>167</sup>

The geotechnical evaluation conducted for this project included a detailed analysis for seismically induced ground motion that complies with the San Francisco Building Code requirements.<sup>168</sup> The building department permit review process, including the assessment by the peer review team, ensures that the project's structural and foundation plans comply with applicable building code provisions. Based on the independent peer review team's review and assessment of the technical materials submitted by the geotechnical and structural engineer of record, once the structural upgrade is constructed, the existing Tower building would be expected to have performance consistent with the project's design objectives and no less conforming to the provisions of the California Building Code with respect to earthquake design

<sup>167</sup> Engineering Design Review Team, letter to Tom C. Hui, S.E., C.B.O., Director and Chief Building Official, City and County of San Francisco Department of Building Inspection, August 27, 2019.

<sup>168</sup> John A. Egan, PE, GE, *Geotechnical Evaluation for the Perimeter Pile Upgrade, Millennium Tower – Revision 1, City and County of San Francisco, California*, August 13, 2019, with the assistance of Slate Geotechnical Consultants.

than prior to construction as specified in Section of 403.9 of the Existing Building Code. The building department concurs with the findings and recommendations in the peer review team memorandum to the building department.<sup>169</sup>

Furthermore, as included in the project description, the building performance would be monitored during and upon completion of the proposed construction. The monitoring would be performed by the geotechnical engineer of record and reported to the structural engineer of record for the project in the event of unexpected or adverse findings by the geotechnical engineer. The monitoring program proposed by the project sponsor is summarized in the November 19, 2019 Summary of Monitoring Program reflected in the project description above and references the monitoring details on the Structural Plan Sheet S207, August 23, 2019 plan set. The monitoring program is consistent with the building department information sheet S-18 requirements. The details provide a well-defined schedule for data collection as well as the type and location of monitoring equipment on and around the project site.

The monitoring data and analysis would be submitted to the building department during construction and for a period of 10 years following construction to be consistent with the building department requirements. Because the proposed project would meet the seismic and geotechnical safety standards and is a voluntary seismic retrofit, the proposed project would decrease rather than exacerbate the exposure of people or structures on and adjacent to the project site to substantial adverse effects due to seismic hazards. For this reason, impacts related to seismic hazards would be considered less than significant under CEQA.

Although not required by building code requirements or the building department's implementing procedures, the independent peer review team recommended that the peer review team remain engaged to advise the City through completion of construction and the 10-year monitoring program. The building department concurs with this recommendation.<sup>170</sup>

As noted above, the project would have a less-than-significant impact related to seismic hazards. This finding would stand whether or not the building department were to engage the peer review team to participate in the post-construction monitoring. Nonetheless, in an abundance of caution, the building department intends to retain the independent peer review team to review and evaluate the monitoring data collected for the project during construction and for a period of 10 years following construction.

According to the building department<sup>171</sup>, the scope of the review services by the peer review team<sup>172</sup> will consist of the following:

- Review and evaluate monitoring data submitted to the building department by the project sponsor's geotechnical engineer of record and forwarded to the peer review team by the building department.

<sup>169</sup> Ho, Gary, San Francisco Department of Building Inspection, Building Department Permit Review, email correspondence with Kei Zushi, Jennifer McKellar, and Debra Dwyer, San Francisco Planning Department, November 7, 2019.

<sup>170</sup> Ibid.

<sup>171</sup> Personal communication between Richard Tam, San Francisco Department of Building Inspection, and Debra Dwyer, San Francisco Planning Department, November 18, 2019.

<sup>172</sup> Given the long duration of the monitoring period (ten years during construction and post-construction), it is reasonable to assume that members of the peer review team may need to be replaced over time. According to the building department, replacement member would be chosen based on Administrative Bulletin 082 (*Guidelines and Procedures for Structural, Geotechnical, and Seismic Hazard Engineering Design Review*), Section 4, Qualifications and Selection of Reviewers to have the same specialty as the qualified professional leaving the team.

- Assess the collected data to determine whether the sponsor's design team is accurately analyzing the data and reporting any unexpected performance conditions that may require immediate attention or additional investigation (notification triggers). The criteria for notification triggers will be specified in the building department's building permit approval.
- For each review and evaluation, prepare a letter that summarizes the findings of the monitoring data review and provide the reviewer's professional opinion whether any clarification is needed or additional steps are required.
- Maintain a project monitoring data review comment log should the peer review team request any clarification or follow up.
- Provide the above services annually for the first two years and thereafter every two years for the next eight years if the building department and the peer review team determine, based on close monitoring, that the data show consistently stable conditions; otherwise provide the above services annually for the entirety of the 10-year post-construction monitoring program.
- Upon completion of monitoring program, provide a final report to the building and planning departments for inclusion in the administrative record and permit record.

The building department will be responsible for contracting with and paying the members of the peer review team for their services. The building department has indicated a desire to have the project sponsor reimburse the city for the cost of the peer review team's monitoring data review and assessment both during and post construction. This financial arrangement is reflected below in Improvement Measure I-GE-1, Sponsor Reimbursement for Engineering Design Review Team Review of Construction and Post-Construction Monitoring Data.

**Improvement Measure I-GE-1: Sponsor Reimbursement for Engineering Design Review Team Review of Construction and Post-Construction Monitoring Data.** The project sponsor should cooperate with the Department of Building Inspection (building department) in its engagement of the Engineering Design Review Team (peer review team) convened during review and evaluation of the monitoring data collected for the project during and post construction. The project sponsor should reimburse the building department for the costs of the monitoring data review and evaluation by the peer review team.

### ***Liquefaction and Lateral Spreading***

Liquefaction and lateral spreading of soils can occur when ground shaking causes saturated soils to lose strength due to an increase in pore pressure. The project site is in a mapped liquefaction hazard zone.<sup>173</sup> The geotechnical evaluation included a liquefaction hazard evaluation for the proposed project due to the shallow groundwater table and loose to dense clayey sandy gravel with varying amounts of sand and clay, brick, concrete, glass, and wood debris fill encountered at the project site. The analysis indicated that fill encountered beneath the groundwater is susceptible to soil liquefaction during a major earthquake from nearby faults. Observations of liquefaction and liquefaction-related phenomena have been reported for the vicinity. The potentially liquefiable layer is the 15- to 25-foot-thick surface fill.

However, the base of the existing Tower building foundation mat was constructed to a depth of 25 feet bgs and the base of the Podium building was constructed to a depth of about 60 feet bgs. Therefore, the

---

<sup>173</sup> Ibid.

excavations for these structures removed the fill materials within the footprints of the structures and, thereby, reduced potential liquefaction-related effects that may have been associated with the fill materials.

The Young Bay Mud that underlies the fill is still present beneath the Tower building; however, it was removed within the area of the Podium building by its excavation. The Young Bay Mud is known to contain occasional lenses<sup>174</sup> of loose to medium dense sands that are susceptible to liquefaction during strong ground shaking. However, the geotechnical evaluation concluded that the sands within these lenses would likely have been compressed by the installation of the dense configuration of driven prestressed precast concrete piles that currently support the Tower building. The spacing of the existing piles driven to support the Tower building is 4 feet 8 inches for most of the mat piles and 3 feet 6 inches beneath the central area beneath the building, center-to-center. The geotechnical evaluation stated that this spacing is considered close enough that densification associated with pile driving is expected to have increased the density of the medium dense pockets of clayey sand. This densification would have substantially increased the resistance of the sands to potential liquefaction, likely to the extent that liquefaction hazard associated with these pockets of clayey sand has been reduced to an acceptable level by the installation of the driven piles.

If sand lenses remain that are susceptible to liquefaction and liquefaction occurs during strong ground shaking, the geotechnical evaluation concluded that the strength in these lenses would be similar to the strength of the surrounding Young Bay Mud, which would be unlikely to be susceptible to liquefaction as discussed above.

Finally, at depths greater than about 60 feet bgs and extending to the Old Bay Clay strata, the sands encountered are dense to very dense and are not considered to be susceptible to liquefaction and related effects.<sup>175</sup>

The proposed project would install 52 perimeter piles within the public right-of-way adjacent to and not directly beneath the existing buildings. As previously discussed, the piles would be installed into the bedrock of the underlying Franciscan Complex, which is not susceptible to liquefaction or lateral spreading, thus bypassing the susceptible geologic units.

In summary, the current conditions beneath the existing buildings are not considered to be susceptible to liquefaction or lateral spreading and the 52 perimeter piles would not exacerbate the potential for liquefaction and lateral spreading because they would bypass susceptible units and be installed in bedrock. Therefore, impacts related to liquefaction and lateral spreading would be considered less than significant under CEQA.

<sup>174</sup> In geology, a lens is a body of rock or ore that is thick in the middle and thinner toward the edges, similar in shape to a biconvex lens. In this context, there may be areas (lenses) of loose to medium dense sands within the Young Bay Mud layer.

<sup>175</sup> *Ibid*, p. 8.

**Impact GE-2: The proposed project would not result in substantial loss of topsoil or erosion. (Less than Significant)**

The project site, which consists primarily of the public right-of-way with a limited part of the associated 301 Mission Street parcel, is developed, and the construction area is covered with streets and sidewalks; therefore, the site does not contain any topsoil.

The proposed project would involve the installation of 52 cast-in-place reinforced concrete piles beneath the sidewalk areas within an approximately 8-foot-wide zone along the Mission (north) and Fremont (west) Street sides of the Tower building. The most extensive disturbance in terms of area, approximately 8,000 square feet, would occur as part of the excavation during Stages 3 and 4. The proposed project would involve excavation of approximately 4,380 cubic yards of soil to a depth of up to 300 feet bgs depending on the construction stage. The structural upgrade would include an 8-foot-wide, 10-foot thick reinforced concrete extension of the existing concrete mat foundation that would connect to the 52 new piles. In addition, the project would include soldier pile lagging shoring, and a jet grout plug between the new shoring wall and existing shoring wall to minimize flow of water into the excavation area during construction.

Grading and excavation would expose soil onsite and could result in erosion. However, the proposed project would be required to comply with the requirements of public works code article 4.2, sections 146-146.11, Construction Site Runoff Control described above and implemented through the Construction Site Runoff Control Program ensures that all construction sites implement best management practices to control construction site runoff. In particular, since the project would disturb more than 5,000 square feet of ground surface, the project sponsor would be required to submit an erosion control plan or storm water pollution prevention plan prior to commencing construction and implement the measures during construction. Compliance with these regulatory safeguards would ensure that impacts relative to erosion by the proposed project would be less than significant. The proposed project would not result in substantial loss of topsoil or erosion, and no mitigation measures are required.

**Impact GE-3: The proposed project would not be located on a geologic unit or soil that is unstable, or that could become unstable as a result of the project, resulting in an onsite or offsite landslide, lateral spreading, subsidence, liquefaction or collapse. (Less than Significant)**

As previously noted, the project site is flat and would not be susceptible to landslides. Liquefaction and lateral spreading were analyzed above in Impact GE-1, which concluded that the project would result in less-than-significant impacts. Collapse is associated with subsurface voids that lead to ground failure. Poorly compacted and undocumented fill can result in conditions susceptible to collapse. However, as discussed above under Impact GE-1, the subsurface fill materials beneath the associated parcel were all removed during the construction of the 301 Mission Street buildings; all materials with potential voids were removed, eliminating the potential for collapse; and the 52 perimeter piles to be installed adjacent to the existing buildings would bypass non-bedrock units and be installed in the bedrock of the Franciscan Complex.

As described in Section A, Project Description, the project site has experienced differential settlement due to consolidation and compression of the Old Bay Clay soil layer. The purpose of the project is to transfer some of the Tower building load from the existing foundation to 52 cast-in-place reinforced concrete piles that



would be installed in the deeper, more stable Franciscan Complex bedrock. The 52 perimeter piles would be installed within the right-of-way along the Mission and Fremont streets sides of the associated parcel.

As described above under Impact GE-1, the proposed structural upgrade is designed to meet the requirements of section 403.9, Voluntary Seismic Improvements, of the local Existing Building Code, with the intent to reduce future building settlement; assure that the existing building can provide the seismic performance no less conforming to the provisions of the California Building Code with respect to earthquake design than prior to construction; and improve the seismic performance of the Tower building's foundation. The proposed project would comply with the requirements of the state and local building codes, and the building department's implementing guidance and procedures. The proposed project has undergone review in accordance with the building department's administrative bulletin AB-082 and instruction sheet S-18 related to structural, geotechnical, and seismic hazard design review. In particular, the building department convened an independent engineering design review team to assess the structural, geotechnical, and seismic hazard design for the proposed project. As discussed above, the peer review team reviewed and commented on the plans and information provided by the structural and geotechnical engineers of record. In the process of assessing and verifying compliance with building code, the peer review team issued comments and questions to the structural and geotechnical engineers of record. These comments and responses are summarized in a comment log available as part of the project's administrative record. The structural and geotechnical engineers of record responded to all comments satisfactorily as reflected in the final geotechnical report and project plans.<sup>176, 177</sup>

The independent peer review team found that once the structural upgrade is constructed, the building would be expected to have performance consistent with the design objectives and section 403.9 of the local building ordinance as described above.<sup>178</sup> The building department concurred with the findings and recommendations in the peer review team memorandum to the building department.<sup>179</sup>

Furthermore, as included in the project description, the building's performance would be subject to monitoring during and upon completion of the proposed construction. The monitoring would be performed by the geotechnical engineer of record and reported to the structural engineer of record for the project in the event of unexpected or adverse findings by the geotechnical engineer. The monitoring data and analysis would be submitted to the building department for a period of 10 years consistent with the building code requirements and the building department's implementing procedures. As noted on the project plans<sup>180</sup> submitted for the building permits for the project, the geotechnical engineer of record would implement a system of monitoring the foundation mat settlement, pile forces, and building movement during jacking of the new piles and continuing for 10 years after completion of construction. With the proposed structural upgrade, 10 years of monitoring as required by the building code and the building department's implementing procedures which include the findings of the independent peer review team and any necessary

<sup>176</sup> Engineering Design Review Team, letter to Tom C. Hui, S.E., C.B.O., Director and Chief Building Official, City and County of San Francisco Department of Building Inspection, August 27, 2019.

<sup>177</sup> Engineering Design Review Team, *301 Mission Street – Voluntary Foundation Retrofit EDRT Log*, August 27, 2019.

<sup>178</sup> Engineering Design Review Team, letter to Tom C. Hui, S.E., C.B.O., Director and Chief Building Official, City and County of San Francisco Department of Building Inspection, August 27, 2019.

<sup>179</sup> Ho, Gary, San Francisco Department of Building Inspection, Building Department Permit Review, email correspondence with Kei Zushi, Jennifer McKellar, and Debra Dwyer, San Francisco Planning Department, November 7, 2019.

<sup>180</sup> Simpson Gumpertz & Heger, *Perimeter Pile Upgrade, 301 Mission Street, San Francisco, CA*, August 23, 2019, Sheet S207 (Monitoring Plan).

design adjustments based on monitoring data, the proposed project would decrease rather than exacerbate the exposure of people or structures on and adjacent to the project site to substantial adverse effects due to subsidence hazards. For this reason, impacts related to the building becoming unstable due to subsidence would be considered less than significant under CEQA. No mitigation measures are required.

Although not required by building code requirements or the building department's implementing procedures, as stated above the independent peer review team recommended that the peer review team remain engaged to advise the City through completion of construction and the 10-year monitoring program. The building department concurs with this recommendation. Also as noted above, the project would have a less-than-significant impact related to the building becoming unstable due to subsidence. This finding would stand whether or not the building department were to engage the peer review team to participate in the post-construction monitoring. Nonetheless, in an abundance of caution, the building department intends to retain the independent peer review team to review and evaluate the monitoring data collected for the project during construction and for a period of 10 years following construction. This is reflected in the Impact GE-1 discussion above. The project sponsor would reimburse the city as in Improvement Measure I-GE-1.

**Impact GE-4: The proposed project could directly or indirectly destroy a unique paleontological resource or site or unique geological feature. (Less than Significant with Mitigation)**

### ***Unique Geological Feature***

A unique geologic or physical feature embodies distinctive characteristics of any regional or local geologic principles, provides a key piece of information important to geologic history, contains minerals not known to occur elsewhere in the county, and/or is used as a teaching tool. No unique geologic features exist at the project site; therefore, no impacts on unique geological features would occur.

### ***Paleontological Potential Criteria***

Paleontological resources, or fossils, are the remains, imprints, or traces of mammals, plants, and invertebrates from a previous geological period.<sup>181</sup> Such fossil remains as well as the geological formations that contain them are considered a paleontological resource. Together, they can represent a limited, non-renewable scientific and educational resource. The potential to affect fossils varies with the geologic unit, depth of disturbance, construction activities, and previous disturbance.

In determining potential impacts to paleontological resources, the planning department uses guidance issued by the U.S. Bureau of Land Management (the bureau) regarding assessment of the potential for discovery of significant paleontological resources during project construction.<sup>182</sup> In particular, the bureau uses the Potential Fossil Yield Classification system (classification system) for evaluating paleontological resources.<sup>183</sup> The -classification system is a predictive resource-management tool founded on two basic facts of

<sup>181</sup> Society of Vertebrate Paleontology (SVP), *Standard Procedures for the Assessment and Mitigation of Adverse Impacts to Paleontological Resources*, 2010

<sup>182</sup> Dwyer, Debra, Principal Planner, San Francisco Planning Department, Email to Michael Burns, ESA, October 18, 2019.

<sup>183</sup> U.S. Bureau of Land Management, Potential Fossil Yield Classification (PFYC) System for Paleontological Resources on Public Lands, 2007, 2016, <https://www.blm.gov/policy/im-2016-124>, accessed October 23, 2019.

paleontology: occurrences of paleontological resources are closely tied to the geologic units (i.e., formations, members, or beds) that contain them, and the likelihood of the presence of fossils can be broadly predicted from the distribution of geologic units at or near the surface. Therefore, geologic mapping, as the documentation of geologic unit distribution, is a reliable method for assessing the potential of geologic units to preserve fossils.

The classification system classifies geologic units on the relative abundance of scientifically significant vertebrate, invertebrate, or plant fossils and their sensitivity to adverse impacts, with a higher classification number indicating a higher potential for fossil occurrences. Among paleontologists, it is understood that this classification is preferably applied to the geologic formation, member, or other distinguishable unit at the most detailed mappable level. Although significant localities may occasionally occur in a geologic unit, the existence of a few important fossils or localities widely scattered over a large area does not necessarily indicate a higher classification for the unit. The relative abundance of significant localities is intended to serve as the major determinant for the class assignment. The classification system is intended to provide baseline guidance for predicting, assessing, and mitigating impacts on paleontological resources.

### ***Local Geology, Impacts, and Mitigation***

The project site is underlain by fill, then Holocene<sup>184</sup> to Pleistocene<sup>185</sup> geologic deposits (Young Bay Mud, Colma Sands, and Old Bay Clay), and then the Franciscan Complex. The proposed project would drill 52 cast-in-place reinforced concrete piles through fill and underlying geologic units to the Franciscan Complex at approximately 220 to 250 feet bgs, where sockets for the bottom of the piles would be drilled 30 to 50 feet deeper into the Franciscan Complex to about 300 feet bgs. The fill materials would not contain paleontological resources.

A Paleontological Sensitivity Map for geologic units encountered within the city has been prepared for the planning department by qualified paleontologists.<sup>186</sup> Based on the mapping and classification system, the Young Bay Mud has a low potential to yield significant paleontological resources, largely due to the recent and common nature of the fossils within the unit. The Colma Sands and Old Bay Clay are older and have a moderate potential for significant paleontological resources. The Franciscan Complex has low potential to contain fossils and is heavily deformed and metamorphosed in most locations.

The Colma Sands layer at the project site is approximately 45 to 90 feet bgs. Below the Colma Sands layer is Old Bay Clay, which is approximately 120 to 160 feet thick and extends to approximately 220 to 250 feet bgs. The installation of the outer casings for the perimeter piles would extend to about 70 to 90 feet bgs into the Colma Sands and possibly Old Bay Clay stratum; below this depth, the drilling method would not return any materials in a form where data recovery would be possible. Although the drilling of the boreholes for the piles would result in disturbing the geologic units with a moderate potential for paleontological resources, it is possible that some paleontological resources may be recovered in the drill cuttings for the outer casings of the piles through the Colma Sands and possibly Old Bay Clay layers, if any are present. Therefore, the installation of the outer casings of the piles could potentially impact unique

<sup>184</sup> 11,000 years before present

<sup>185</sup> 11,000 years to 1.6 million years before present

<sup>186</sup> Paleo Solutions, 2018, CityofSanFrancisco\_geology\_PFYC.KMZ, spatial data file developed based on surface geology map from U.S. Geological Survey and PFCY – City of San Francisco 2018.

paleontological resources, and the impact would be significant. **Mitigation Measures M-GE-4a through M-GE-4c** would require the project sponsor or its contractor to retain a qualified paleontologist, conduct worker training, and prepare and implement a monitoring plan during the installation of the outer casings. **Mitigation Measure M-GE-4d**, would ensure that any potentially significant paleontological finds would be salvaged and prepared for permanent curation.

Implementation of Mitigation Measures M-GE-4a through M-GE-4d would reduce potentially significant impacts to a less-than-significant level.

**Mitigation Measure M-GE-4a: Project Paleontologist.** The project sponsor or its contractor shall retain a qualified professional paleontologist (qualified paleontologist) prior to the approval of demolition or grading permits. The qualified paleontologist shall attend the project kick-off meeting and project progress meetings on an as-needed basis, shall report to the project site for drilling activities associated with installation of the outer casings for the perimeter piles that are anticipated to return Colma Sands or Old Bay Clay materials, and shall implement the duties outlined in Mitigation Measures M-GE-4b through M-GE-4d.

**Mitigation Measure M-GE-4b: Worker Training.** Prior to the start of ground-disturbing activity related to the installation of the outer casings for the perimeter piles, which is anticipated to return Colma Sands or Old Bay Clay materials, the qualified paleontologist shall prepare paleontological resources sensitivity training materials for use during Project-wide Worker Environmental Awareness Training (or equivalent). The paleontological resources sensitivity training shall be conducted by a qualified environmental trainer working under the supervision of the qualified paleontologist. In the event construction crews are phased, additional trainings shall be conducted for new construction personnel. The training session shall focus on the recognition of the types of paleontological resources that could be encountered within the project site and the procedures to be followed if they are found, as outlined in the approved Paleontological Resources Monitoring and Mitigation Plan in Mitigation Measure M-GE-4c. The project sponsor and/or its contractor shall retain documentation demonstrating that all construction personnel attended the training prior to the start of work on the site, and shall provide the documentation to the Planning Department Project Manager upon request.

**Mitigation Measure M-GE-4c: Paleontological Monitoring.** The qualified paleontologist shall prepare, and the project sponsor and/or its contractors shall implement, a Paleontological Resources Monitoring and Mitigation Plan (PRMMP). The project sponsor shall submit the plan to the planning department for review and approval at least 30 days prior to the start of construction. This plan shall address specifics of monitoring and mitigation and comply with the City requirements, as follows:

- The qualified paleontologist shall identify, and the project sponsor or its contractor(s) shall retain, qualified paleontological resource monitors (qualified monitors).
- The qualified paleontologist and/or the qualified monitors under the direction of the qualified paleontologist shall conduct full-time paleontological resources monitoring of the installation of the 36-inch-diameter outer casings for all ground-disturbing activities anticipated to return Colma Sands or Old Bay Clay materials.
- Monitors shall have the authority to temporarily halt or divert work away from exposed fossils in order to evaluate and recover the fossil specimens.

- If construction or other project personnel discover any potential fossils during construction, regardless of the depth of work or location and regardless of whether the site is being monitored, work at the discovery location shall cease until the qualified paleontologist, project sponsor, and ERO shall meet and consult on the appropriate course of action at the 36-inch-diameter outer casing locations, based on the nature of the recovered paleontological resource and the judgment of the qualified paleontologist, reasonably provided prior to continuing with the installation of outer casings. The qualified paleontologist shall determine the significance of any paleontological resources discovered, and shall determine the appropriate treatment for significant paleontological resources in accordance with City standards. Whether or not a significant paleontological resource has been encountered, the qualified paleontologist shall assess the discovery, make recommendations as to the appropriate treatment, and submit a written report of the findings of the monitoring program to the ERO. Mitigation Measure M-GE-4d regarding significant fossil treatment is described further below.
- Monitors shall prepare daily logs detailing the types of activities and soils observed, and any discoveries. The qualified paleontologist shall prepare a final monitoring and mitigation report to document the results of the monitoring effort and any curation of fossils. The project sponsor shall provide the daily logs to the City Planning Department upon request, and shall provide the final report to the City Planning Department upon completion.

**Mitigation Measure M-GE-4d: Significant Fossil Treatment.** If any find is deemed significant following the process outlined in Mitigation Measure M-GE-4c, the qualified paleontologist shall salvage and prepare the fossil for permanent curation with a certified repository with retrievable storage.

**Impact C-GE-1: The proposed project, in combination with reasonably foreseeable future projects would not result in a significant cumulative impact related to geology, soils, seismicity, and paleontological resources. (Less than Significant)**

Geology, soils, seismicity, and paleontological impacts are generally site-specific and highly localized. Therefore, the potential for the proposed project to combine with reasonably foreseeable future projects and create a cumulative impact related to geology, soils, and seismicity would be low. There are four cumulative projects listed in Section B.2, Cumulative Context. Two of the cumulative projects would include the construction of buildings: the Transbay Block 4/200 Folsom Street/200–272 Main Street and the Oceanwide Center Development Project. Two of the cumulative projects would consist of streetscape and roadway improvements: Active Beale Street and Better Market Street Project.

The cumulative development projects would also be subject to the same building department requirements for geotechnical review and required to comply with the state and local building codes. Compliance with the seismic and unstable geologic unit safety standards and design review procedures would ensure that the effects from nearby cumulative projects would not be significant. Therefore, the proposed project would not combine with cumulative development projects to create or contribute to a significant cumulative impact related to seismic hazards and unstable geologic units, and cumulative impacts would be less than significant.

None of the cumulative projects would overlap with activities at the project site, nor are there any known paleontological resources on the project site that extend outside of the project site and could be affected by nearby development. As discussed above in Impact GE-4, the proposed project would be required to implement Mitigation Measures M-GE-4a through M-GE-4d to reduce potentially significant impacts to a

less-than-significant level. Implementation of these measures would ensure that any potentially significant paleontological resources are appropriately identified and treated such that project-related impacts on paleontological resources would be less than significant with mitigation. Because the potential impact is site-specific and generally limited to the immediate construction area, and because there are no known resources that extend outside the project site and that could be affected by adjacent development, the proposed project would not combine with cumulative development projects to create or contribute to a significant cumulative impact related to paleontological or unique geologic resources.

Topics	Potentially Significant Impact	Less than Significant with Mitigation Incorporated	Less than Significant Impact	No Impact	Not Applicable
<b>17. HYDROLOGY AND WATER QUALITY.</b>					
<b>Would the project:</b>					
a) Violate any water quality standards or waste discharge requirements or otherwise substantially degrade surface or groundwater quality?	<input type="checkbox"/>	<input type="checkbox"/>	<input checked="" type="checkbox"/>	<input type="checkbox"/>	<input type="checkbox"/>
b) Substantially decrease groundwater supplies or interfere substantially with groundwater recharge such that the project may impede sustainable groundwater management of the basin?	<input type="checkbox"/>	<input type="checkbox"/>	<input checked="" type="checkbox"/>	<input type="checkbox"/>	<input type="checkbox"/>
c) Substantially alter the existing drainage pattern of the site or area, including through the alteration of the course of a stream or river or through the addition of impervious surfaces, in a manner that would:	<input type="checkbox"/>	<input type="checkbox"/>	<input type="checkbox"/>	<input checked="" type="checkbox"/>	<input type="checkbox"/>
i) Result in substantial erosion or siltation on- or offsite;	<input type="checkbox"/>	<input type="checkbox"/>	<input type="checkbox"/>	<input checked="" type="checkbox"/>	<input type="checkbox"/>
ii) Substantially increase the rate or amount of surface runoff in a manner which would result in flooding on or offsite;	<input type="checkbox"/>	<input type="checkbox"/>	<input type="checkbox"/>	<input checked="" type="checkbox"/>	<input type="checkbox"/>
iii) Create or contribute runoff water which would exceed the capacity of existing or planned stormwater drainage systems or provide substantial additional sources of polluted runoff; or	<input type="checkbox"/>	<input type="checkbox"/>	<input type="checkbox"/>	<input checked="" type="checkbox"/>	<input type="checkbox"/>
iv) Impede or redirect flood flows?	<input type="checkbox"/>	<input type="checkbox"/>	<input type="checkbox"/>	<input checked="" type="checkbox"/>	<input type="checkbox"/>
d) In flood hazard, tsunami, or seiche zones, risk release of pollutants due to project inundation?	<input type="checkbox"/>	<input type="checkbox"/>	<input type="checkbox"/>	<input type="checkbox"/>	<input checked="" type="checkbox"/>
e) Conflict with or obstruct implementation of a water quality control plan or sustainable groundwater management plan?	<input type="checkbox"/>	<input type="checkbox"/>	<input type="checkbox"/>	<input checked="" type="checkbox"/>	<input type="checkbox"/>

The project site is not located within a 100-year flood risk zone identified by the SFPUC.<sup>187</sup> In addition, the project site is not within a dam failure area,<sup>188</sup> or a tsunami hazard area.<sup>189</sup> For these reasons, topic E.17(d) is not applicable to the proposed project.

The proposed project consists of a structural upgrade related to the Tower building foundation. Ground disturbing activities would be limited to the 22-month construction period. Following construction, surface conditions at the site would be restored to the existing conditions and would not result in any operational changes within the Tower building. Therefore, the following analysis focuses on potential impacts related to hydrology and water quality during construction activities and also the pumping of rainwater from the vaults.

<sup>187</sup> San Francisco Public Utilities Commission, 100-Year Storm Flood Risk Map, <https://www.sfwater.org/index.aspx?page=1229>, accessed November 13, 2019.

<sup>188</sup> San Francisco Planning Department, San Francisco General Plan, Community Safety Element, Map 6, October 2012, <http://generalplan.sfplanning.org/index.htm>, accessed June 7, 2019.

<sup>189</sup> Ibid., Map 5.

**Impact HY-1: The project would not violate any water quality standards or waste discharge requirements or otherwise substantially degrade surface or groundwater quality. (Less than Significant)**

### ***Construction-Related Stormwater Discharge***

Construction activities such as excavation, grading, drilling, and backfill would expose soil and could result in erosion and excess sediments being carried in stormwater runoff to the combined sewer system. In addition, stormwater runoff from temporary on-site use and storage of vehicles, fuels, waste, and other hazardous materials could carry pollutants to the combined sewer system if proper handling methods are not implemented. The project site is approximately 13,900 square feet of public right-of-way (including staging areas), of which approximately 8,000 square feet would be disturbed for the structural upgrade of the Tower building foundation. Because more than 5,000 square feet of ground surface would be disturbed, construction activities at the project site would be subject to the requirements of public works code article 4.2 section 146 et seq. (Construction Site Runoff Control). The purpose of the city's construction site runoff control program is to protect water quality by controlling the discharge of sediment or other pollutants from construction sites and preventing erosion and sedimentation due to construction activities. Accordingly, the project sponsor must prepare and implement an erosion and sediment control plan during project construction. The erosion and sediment control plan must include best management practices designed to prevent discharge of sediment and other pollutants from the site, and is subject to review and approval by the SFPUC. Compliance with the ordinance would reduce the potential for sediments and other pollutants to enter the combined sewer system. In addition, the proposed project would be required to comply with the Maher Ordinance (article 22A of the San Francisco Health Code), which requires further site management and reporting requirements for potential hazardous soils (see Impact HZ-1 in Section E.18, Hazards and Hazardous Materials for a discussion of the Maher Ordinance). The construction contractor would be required to conduct daily inspections and maintenance of all erosion and sediment controls and must provide inspection and maintenance information to the city as the administering agency. Compliance with construction site runoff control requirements would ensure that the project would not violate any water quality standards or degrade water quality due to discharge of construction-related stormwater runoff.

### ***Construction-Related Groundwater***

As discussed in Section E.16, Geology and Soils, groundwater is anticipated at depths of approximately 19-22 feet bgs. As described in Section A.5, Proposed Project, to provide a dry and stable excavation for construction of the foundations and mat extension a jet grout plug would be constructed at the base of the excavation to seal the bottom of the excavation to minimize flow of water into the excavation area during construction. It is anticipated that any leakage through the jet grout would be handled with the use of sumps, and discharged into the combined sewer system; however, no lowering of the water table would be required. Because groundwater may seep into the excavated area, removal of this water could be required, and the proposed project would be required to obtain a batch wastewater discharge permit from the SFPUC. Therefore, the proposed project's excavation activities could encounter groundwater, resulting in a potential water quality impact if groundwater were to contain contaminants related to past site activities. Prior to discharge, groundwater samples would be tested to ensure compliance with SFPUC discharge standards. The construction groundwater discharges to the combined sewer system would be subject to the requirements of

section 146, article 4.1 public works code<sup>190</sup> (supplemented by Department of Public Works Order No. 158170), which incorporates and implements San Francisco's National Pollutant Discharge Elimination System (NPDES) permit, and the Combined Sewer Overflow Control Policy. Article 4.1 contains construction requirements to protect water quality. Any groundwater encountered during construction of the proposed project would also be subject to requirements of the Sewer Use Ordinance (Ordinance Number 19-92, amended 116-97), as supplemented by Public Works Order No. 158170, requiring a permit from the Wastewater Enterprise Collection System Division of the SFPUC, which may issue a permit only if an effective pretreatment system is maintained and operated. Each permit for such discharge must contain specified water quality standards and may require the project sponsor to install and maintain meters to measure the volume of the discharge to the combined sewer system. These measures would ensure protection of water quality from discharge of groundwater during construction of the proposed project.

Therefore, the proposed project would not substantially degrade water quality and would not violate water quality standards or waste discharge requirements. Thus, the proposed project would have a less-than-significant impact on water quality.

**Impact HY-2: The proposed project would not substantially decrease groundwater supplies or interfere substantially with groundwater recharge such that the project may impede sustainable groundwater management of the basin. (Less than Significant)**

The project site and staging areas include an approximately 13,900-sf area within the existing Mission, Beale, and Fremont streets public right-of-way, including sidewalks, sub-sidewalk area, vehicular lanes, and parking, adjacent to the Tower and Podium buildings. Thus, the project site is covered with impervious surfaces (i.e., existing sidewalk and paved roadway) that drain to existing stormwater facilities discussed below. Impervious surfaces greatly limit the amount of surface water that can infiltrate a site to recharge the groundwater. The project construction is not anticipated to lower the water table as discussed in Impact HY-1. As described in Section A.6, Monitoring Plan Summary, monitoring would be carried out during construction. In addition, the proposed project would not require long-term, continuous dewatering following construction.

The proposed project would not interfere with groundwater recharge because no new impervious surfaces would be created. After the project construction is completed, the project site would be covered with an amount of impervious surfaces substantially similar to that under existing conditions, including existing stormwater facilities. Project operation would not result in the use of groundwater, and the project would not otherwise be expected to adversely affect groundwater supplies or quality. For these reasons, impacts related to the depletion of groundwater resources and interference with groundwater recharge would be less than significant.

---

<sup>190</sup> City and County of San Francisco, Ordinance No. 260-13 Control of Construction Site Runoff Ordinance, Public Works Code article 4.2, sections 146-146.11, October 17, 2013.



**Impact HY-3: The proposed project would not result in altered drainage patterns that would cause substantial erosion and siltation or flooding on- or off-site, or contribute runoff water which would exceed the capacity of existing or planned stormwater drainage systems or provide substantial additional sources of polluted runoff, or impede or redirect flood flows. (No Impact)**

The project site is currently covered with impervious surfaces (i.e., existing sidewalk and paved roadway) and does not contain any streams or water courses. Construction activities would require excavation below ground. During construction, incidental surface water may enter the excavated area below ground through manhole access openings, which are normally covered. Incidental surface water that enters the excavated areas during construction would be handled with the use of sumps, and discharged into the combined sewer system.

The floor of the excavated (top of the mat extension) area would be sloped to drain to a series of dry sumps within the vaults. Five low horsepower, electrically operated pumps would be placed permanently in the sumps of the vaults (two in the vault along Mission Street and three in the vault along Fremont Street), with a float switch to activate the pumps should sufficient rainwater collect to trigger this, and would be discharged into the combined sewer system. Following construction, the surface conditions at the site would be restored to consist of impervious surfaces, as it does currently. The overall amount of runoff water would therefore be unchanged because the proposed project would not increase the amount of impervious surfaces. Surface water runoff from the project site would continue to be directed to the combined sewer system, and, after construction, the ground surface would remain substantially unchanged from existing conditions.

Construction activities would have the potential to result in erosion and transportation of soil particles off site through excavation and grading activities. However, as discussed previously under Impact HY-1, the project sponsor or its construction contractor would be required to prepare and implement an erosion control plan during project construction in compliance with section 146 of the public works code. The erosion control plan would include best management practices to minimize construction site runoff. In addition, the proposed project would not add substantial additional sources of polluted runoff, or impede or redirect flood flows. As a result, the proposed project would have no impact with respect to surface drainage patterns, erosion and siltation, flooding on- or off-site, or discharge to stormwater drainage systems.

**Impact HY-4: The project would not conflict with or obstruct implementation of a water quality control plan or sustainable groundwater management plan. (No Impact)**

As discussed under Impact HY-1 above, construction activities at the project site would be subject to construction site runoff requirements of article 4.2 of the public works code section 146. In addition, construction dewatering discharges to the combined sewer system would be subject to the requirements of article 4.1 of the public works code (supplemented by Public Works Order No. 158170). For these reasons, the proposed project would not conflict with or obstruct implementation of a water quality control plan or sustainable groundwater management plan.

**Impact C-HY-1: The proposed project, in combination with reasonably foreseeable future projects in the site vicinity, would not have a significant cumulative impact on hydrology and water quality. (Less than Significant)**

The proposed project would have no impact with respect to the following topics and therefore would not have the potential to contribute to any cumulative impacts for those resource areas: altered drainage patterns and conflicts with a water quality control plan or sustainable groundwater management plan. As discussed in the beginning of Section E.17, Hydrology and Water Quality, the project would not result in a release of pollutants due to project inundation. The proposed project and cumulative projects would be required to comply with the water quality and drainage control requirements discussed above that apply to all land use development projects within the city. Specifically, the cumulative projects would be required to comply with the same drainage, groundwater discharge, and water quality regulations as the proposed project during construction. As a result, cumulative effects related to hydrology and water quality would be less than significant.

Topics	Potentially Significant Impact	Less than Significant with Mitigation Incorporated	Less than Significant Impact	No Impact	Not Applicable
<b>18. HAZARDS AND HAZARDOUS MATERIALS.</b>					
<b>Would the project:</b>					
a) Create a significant hazard to the public or the environment through the routine transport, use, or disposal of hazardous materials?	<input type="checkbox"/>	<input type="checkbox"/>	<input checked="" type="checkbox"/>	<input type="checkbox"/>	<input type="checkbox"/>
b) Create a significant hazard to the public or the environment through reasonably foreseeable upset and accident conditions involving the release of hazardous materials into the environment?	<input type="checkbox"/>	<input type="checkbox"/>	<input checked="" type="checkbox"/>	<input type="checkbox"/>	<input type="checkbox"/>
c) Emit hazardous emissions or handle hazardous or acutely hazardous materials, substances, or waste within one-quarter mile of an existing or proposed school?	<input type="checkbox"/>	<input type="checkbox"/>	<input checked="" type="checkbox"/>	<input type="checkbox"/>	<input type="checkbox"/>
d) Be located on a site which is included on a list of hazardous materials sites compiled pursuant to Government Code section 65962.5 and, as a result, would it create a significant hazard to the public or the environment?	<input type="checkbox"/>	<input type="checkbox"/>	<input type="checkbox"/>	<input type="checkbox"/>	<input checked="" type="checkbox"/>
e) For a project located within an airport land use plan or, where such a plan has not been adopted, within two miles of a public airport or public use airport, would the project result in a safety hazard or excessive noise for people residing or working in the project area?	<input type="checkbox"/>	<input type="checkbox"/>	<input type="checkbox"/>	<input type="checkbox"/>	<input checked="" type="checkbox"/>
f) Impair implementation of or physically interfere with an adopted emergency response plan or emergency evacuation plan?	<input type="checkbox"/>	<input type="checkbox"/>	<input checked="" type="checkbox"/>	<input type="checkbox"/>	<input type="checkbox"/>
g) Expose people or structures, either directly or indirectly, to a significant risk of loss, injury or death involving wildland fires?	<input type="checkbox"/>	<input type="checkbox"/>	<input type="checkbox"/>	<input type="checkbox"/>	<input checked="" type="checkbox"/>

The project site is not located on a list of hazardous materials sites compiled pursuant to Government Code section 65932.5; therefore, topic E.18(d) is not applicable. The nearest public use airport to the project site is San Francisco International Airport, which is approximately 12 miles to the south. The project site is not located within an airport land use plan area; therefore, topic E.18(e) is not applicable. In addition, the project site is not located within or adjacent to a wildland area; as a result, topic E.18(g) is not applicable.

The proposed project consists of a structural upgrade related to the Tower building foundation. Ground disturbing activities would be limited to the 22-month construction period. Following construction, the site

would be restored to the existing conditions and would not result in any operational changes. Therefore, the following analysis focuses on potential impacts related to hazards and hazardous materials during construction and ground-disturbing activities.

**Impact HZ-1: Construction of the proposed project would not create a significant hazard through the routine transport, use, or disposal of hazardous materials. (Less than Significant)**

Project construction would require the routine use of hazardous materials such as fuels, lubricants, paints, and solvents for construction vehicles and equipment. The proposed project would be required to comply with a number of federal, state, and local laws and regulations regarding the storage, use, transport, and disposal of hazardous materials. The construction contractor would be required to comply with the federal Occupational Safety and Health Administration (OSHA), Title 29 of the Code of Federal Regulations (CFR), section 1910. The contractor would also be required to comply with the California Occupational Safety and Health Administration (Cal/OSHA) under CCR Title 8, which specifies requirements for employee training, availability of safety equipment, accident prevention programs, and hazardous substance exposure warnings. Cal/OSHA requirements include safety training, availability of safety equipment, accident and illness prevention programs, hazardous substance exposure warnings, and emergency action and fire prevention plan preparation. CCR Title 8 also includes hazard communication program regulations that contain worker safety training and hazard information requirements, procedures for identifying and labeling hazardous substances, communicating hazard information related to hazardous substances and their handling, and preparing health and safety plans to protect workers.

Hazardous wastes that may be generated during project construction could include but are not limited to: (1) excavated soil that is considered hazardous under federal and state regulations, (2) spent and unspent hazardous materials use from construction. (Note: Handling, and disposal of potential contaminated soil is addressed below in Impact HZ-2. Handling, and disposal of potential contaminated groundwater generated from dewatering operation are addressed in Section E.17, Hydrology and Water Quality). The management, transport, and disposal of these hazardous wastes would be conducted in compliance with all applicable federal, state, and local regulations to ensure: (1) proper excavation and dust control procedures, (2) compliance with air emissions standards, as described in Section E.8, Air Quality, (3) compliance with worker protection and safety, and (4) proper waste storage, management, transportation, and disposal of hazardous wastes. With implementation of the protocols on the proper use, transport, and disposal of the hazardous materials in accordance with above-mentioned regulatory requirements, the project would result in a less-than-significant impact with respect to the transport, use, and disposal of the hazardous materials.

**Impact HZ-2: The proposed project would not create a significant hazard to the public or the environment through reasonably foreseeable upset and accident conditions involving the release of hazardous materials into the environment. (Less than Significant)**

***Hazardous Soil and Groundwater***

The project site is located in the Maher zone, which is an area that the health department, as set forth in San Francisco Building Code section 106A.3.2.4, has identified as likely containing hazardous substances in the

soil or groundwater. The proposed project would excavate approximately 4,380 cubic yards<sup>191</sup> of soil to depths of approximately 300 feet bgs depending on the construction stage.

During construction, particularly during excavation and grading, construction workers and nearby residents could be exposed to chemicals in the soil through inhalation of airborne dust or vapors if proper precautions are not implemented. Therefore, prior to obtaining a building permit, the project sponsor must comply with the requirements of article 22A of the San Francisco Health Code, which the health department administers. Under article 22A (commonly called "the Maher program"), the project sponsor must retain the services of a qualified professional to prepare a site history report (commonly referred to as a phase I environmental site assessment). The site assessment must determine whether hazardous substances may be present on the site at levels that exceed health risk levels or other applicable standards established by California Environmental Protection Agencies, the Regional Water Quality Control Board, and the Department of Toxics Substances Control (Cal/EPA). If so, the project sponsor is required to conduct soil and/or groundwater sampling and analysis under a work plan approved by the health department.

The sampling analysis must provide an accurate assessment of hazardous substances present at the site that may be disturbed, or may cause a public health or safety hazard, given the intended use of the site. Where such analysis reveals the presence of hazardous substances that exceed Cal/EPA public health risk levels given the intended use, the project sponsor must submit a site mitigation plan to the health department. The plan must identify the measures that the project sponsor will take to assure that the intended use will not result in public health or safety hazards in excess of the acceptable public health risk levels established by Cal/EPA or other applicable regulatory standards. The plan also must identify any soil and/or groundwater sampling and analysis that it recommends the project sponsor conduct following completion of the measures to verify that remediation is complete. If the project sponsor chooses to reduce public health or safety hazards from hazardous substances through land use or activity restrictions, the project sponsor must record a deed restriction specifying the land use restrictions or other controls that will assure protection of public health or safety from hazards substances remaining on the site.

To comply with various regulatory requirements, the health department will require a site mitigation plan to contain measures to reduce potential risks to the environment and to protect construction workers, nearby residents, workers, and/or pedestrians from potential exposure to hazardous substances and underground structures during soil excavation and grading activities. The plan must also contain procedures for initial response to unanticipated conditions such as discovery of underground storage tanks (USTs), sumps, or pipelines during excavation activities. Specified construction procedures at a minimum must comply with local building code section 106A.3.2.6.3 related to construction dust control; and public works code section 146 et seq. concerning construction site runoff control. Additional measures would typically include notification, field screening, and worker health and safety measures to comply with Cal/OSHA requirements. The health department would require discovered underground storage tanks to be closed pursuant to article 21 of the health code and comply with applicable provisions of chapters 6.7 and 6.75 of the California Health and Safety Code (commencing with section 25280) and its implementing regulations. The closure of any UST must also be conducted in accordance with a permit from the San Francisco Fire Department.

<sup>191</sup> Approximately 4,380 cubic yards of soil under the affected sidewalk areas would be excavated in order to perform the pile installation: 1,880 cubic yards would be excavated to depths of approximately 5 to 25 feet bgs for the extended mat foundation; and 2,500 cubic yards would be excavated to depths of 300 feet bgs for the outer casings, shaft liners, and rock sockets installation.

If remediation is required, it would typically be achieved through one of several methods that include off-haul and disposal of contaminated soils, on-site treatment of soil or groundwater, or a vapor barrier installation. Compliance with health code article 22A and the related regulations identified above would ensure that project activities that disturb or release of hazardous substances that may be present at the project site would not expose people in the project vicinity to unacceptable risk levels.

In compliance with health code article 22A, the project sponsor has enrolled in the Maher program through a Maher Application in December 2018 to the health department.<sup>192</sup> The 2001 Environmental Site Characterization report for development of the associated 301 Mission Street parcel was included with the December 2018 application, which assessed the potential for site contamination.<sup>193</sup> The 2001 report summarized the results of their previous phase I assessment, which identified the site's previous uses that included various industries and businesses that would have used hazardous materials such as fuels, oils, paints, solvents, and metals. The 2001 environmental site characterization conducted a soil investigation that sampled and analyzed soil samples for various chemicals. The analytical results detected various concentrations of petroleum hydrocarbons in the range of gasoline, diesel, and motor, and lead. The report concluded that fill would likely require disposal at a class I hazardous waste landfill or at a class II designated waste landfill. The underlying soil did not contain chemical concentrations that would require class I or II disposal.

To further evaluate soil conditions in the proposed excavation and pile areas along Mission and Fremont street frontages, the project sponsor submitted a site characterization assessment work plan to the health department dated January 30, 2019.<sup>194</sup> The scope of work included the drilling of six borings, and the collection of soil and grab groundwater samples.<sup>195</sup> The health department issued a letter dated May 4, 2019, acknowledging receipt of the above-summarized reports and other geotechnical reports, summarized the findings, and requested that two of the boring locations be located further away from the Tower building footprint.<sup>196</sup>

The work plan proposed that soil and groundwater samples be analyzed for total petroleum hydrocarbons as gasoline, diesel, and motor oil (TPH-g, TPH-d, and TPH-mo); volatile organic compounds (VOCs); semivolatile organic compounds (SVOCs) including polynuclear aromatics (PNAs) and polyaromatic hydrocarbons (PAHs); polychlorinated biphenyls (PCBs); California Administrative Manual (CAM)-17 metals;<sup>197</sup> hexavalent chromium (Cr6); total cyanides; and pH. Soil samples were also analyzed for asbestos, and groundwater samples were analyzed for methane, ethane, and ethane. Subsurface investigations were conducted on March 27, 2019, and July 10, 11, and 12, 2019, to characterize fill material, native soil, and

<sup>192</sup> Millennium Tower Association, Maher Ordinance Application, December 6, 2018.

<sup>193</sup> Treadwell & Rollo (T&R), *Environmental Site Characterization, 301 Mission Street, San Francisco*, August 2001.

<sup>194</sup> AllWest Environmental, *Site Characterization Assessment Work Plan, Millennium Tower, 301 Mission Street, San Francisco, CA 94105*, January 30, 2019.

<sup>195</sup> Grab groundwater samples are water samples collected from open boreholes for a one-time sampling effort, typically using a sampling device lowered into the open borehole. The borehole is backfilled after the samples are collected. This is as opposed to constructing a permanent monitoring well with a well pipe and a surface seal.

<sup>196</sup> Cushing, Stephanie, Director of Environmental Health, San Francisco Department of Public Health – Environmental Health Unit, letter to Howard Dickstein, Millennium Tower Association, May 4, 2019.

<sup>197</sup> CAM 17 metals include antimony, arsenic, barium, beryllium, cadmium, chromium, cobalt, copper, lead, mercury, molybdenum, nickel, selenium, silver, thallium, vanadium, and zinc.

groundwater. Eight cores<sup>198</sup> were taken on the Fremont and Mission street frontages of the Tower were taken, each approximately 4 inches in diameter, to depths between 2.5 and 30 feet.

On August 27, 2019, the project sponsor submitted a site characterization assessment report.<sup>199</sup> Fifteen soil samples were taken from the borings, and an additional 13 soil samples were analyzed for lead. The results from the soil samples indicated that the samples contained low concentrations of various metals, TPH-d, TPH-mo, VOCs, SVOCs, PAHs/PNAs, PCBs, and cyanides that were mostly below the Regional Water Quality Control Board's Tier 1 and Tier 2 residential, commercial, and construction worker Environmental Screening Levels (ESLs).<sup>200</sup> Although arsenic, lead, nickel, and vanadium concentrations exceeded various applicable environmental screening levels, the concentrations were within typical regional background levels.<sup>201</sup>

Two of the three groundwater samples were analyzed in accordance with article 22A. The results from the groundwater samples indicated that TPH-d, TPH-mo, and various VOCs, SVOCs/PAHs/PNAs, metals and cyanides were detected. The results indicated that SVOCs/PAHs/PNAs and metals exceeded aquatic habitat environmental screening levels. However, aquatic habitats would not be affected by groundwater at this location due to the distance of the site from such habitats.

None of the soil and groundwater samples exceed California Title 22 Total Threshold Limit Concentration or Soluble Threshold Limit Concentration hazardous waste levels.<sup>202</sup> This means that excavated fill and soil could be disposed of as non-hazardous waste. The August 27, 2019, site characterization assessment report provided the following summary conclusions:

- Since the basement and ground floor of the subject property building are commercial land use, very little on-site vegetation is present, site groundwater is not a potential drinking water resource, and there are no surface water bodies within 1,600 feet of the subject site, the several samples with certain chemical concentrations that exceeded ESLs are not a substantial human health or environmental concern. (Note: Once construction is complete, none of the fill or native materials would be accessible to the public, building maintenance workers, or the environment.)
- Since none of the detected chemical concentrations exceed California Title 22 hazardous waste levels,<sup>203</sup> excavated soils should be acceptable for disposal at a class II non-hazardous facility.
- No further subsurface investigation is needed at the site because an adequate number of soil and groundwater samples were collected and analyzed over a sufficient lateral and vertical extent to ensure representative site characterization for compliance with Maher Ordinance article 22A and profiling for excavated soil disposal.

<sup>198</sup> The scope included six borings, however additional borings were taken adjacent to previous borings due to limited access to a rig to achieve the planned boring depth and/or due to encountering drilling refusal by dense soils. The boring locations are indicated by B-[Number] (e.g., B-1). Additional boring samples taken adjacent to previous borings are indicated as B-[Number]A (e.g., B-1A).

<sup>199</sup> AllWest Environmental, *Site Characterization Assessment Report, Millennium Tower, 301 Mission Street, San Francisco, CA 94105*, City of San Francisco Department of Public Health, EHB-SAM Case Number: SMED 640, August 27, 2019.

<sup>200</sup> *Ibid*, p. 4 and 20.

<sup>201</sup> *Ibid*, p. 4 and 20.

<sup>202</sup> *Ibid*, p. 20.

<sup>203</sup> California Title 22 hazardous waste regulatory levels are the regulatory waste acceptance criteria at California disposal facilities, such as landfills.

The health department reviewed the results of the site characterization work conducted to date, as summarized above, and provided a conclusions and recommendations letter dated September 19, 2019.<sup>204</sup> The health department stated that the work conducted to date meets the requirements of articles 22A and 22B of the health code. In addition, and in compliance with articles 22A and 22B, the project sponsor or their contractor(s) shall be required to prepare a site mitigation plan with a dust control plan to be implemented during the project's construction activities. The site mitigation plan shall include contingency measures to address the handling of soil and groundwater at the project site. The site mitigation plan shall be submitted to the health department two weeks prior to the commencement of work. Thus, with compliance with existing regulations, including the requirement for a site mitigation plan, the proposed project would not result in a significant hazard to the public, construction workers, or the environment from the disturbance or release of contaminated soil (and/or) groundwater and the proposed project would result in a less than significant impact.

**Impact HZ-3: The proposed project would not emit hazardous emissions or handle hazardous or acutely hazardous materials, substances, or waste within one-quarter mile of an existing or proposed school. (*Less than Significant*)**

Several schools and daycare centers are located within a quarter mile of the project site. These schools and daycare centers include: The Youth Chance High School, a private high school serving at risk youth ages 16 to 21 is located at 169 Steuart Street; daycare and preschools operated by Bright Horizons are located at 77 Beale Street, 221 Main Street, and 220 Spear Street; Little Ohana Daycare is at 50 Fremont Street; and a pre-kindergarten school operated by Marin Day Schools - Fremont Campus is located at 342 Howard Street.

As stated above, the proposed project involves construction of a structural upgrade for the Tower building foundation. Ground-disturbing activities would be limited to the 22-month construction period. The proposed project would require the handling and transport of hazardous wastes, as described in Impacts HZ-1 and HZ-2. The project sponsor would be required to comply with regulations described in Impacts HZ-1 and HZ-2, which would ensure that hazardous materials are handled safely and would not be released within one-quarter mile of schools. In particular, as discussed above in Impact HZ-2, a site mitigation plan including a construction dust control plan would be prepared and reviewed by the health department to minimize hazardous emissions during construction. In addition, as discussed in HZ-1 and under Section E.17, Hydrology and Water Quality, the project would comply with requirements for the handling and disposal of contaminated groundwater. Therefore, there would be limited potential for such materials to affect schools in the vicinity, and the proposed project would have a less than significant impact with respect to the handling of hazardous materials within one-quarter mile radius of an existing or proposed school. No mitigation measures are required. Impacts related to emissions from construction vehicles are discussed in Section E.8, Air Quality.

<sup>204</sup> Cushing, Stephanie, Director of Environmental Health, San Francisco Department of Public Health – Environmental Health Unit, letter to Howard Dickstein, Millennium Tower Association, September 19, 2019.

**Impact HZ-4: The proposed project would not impair implementation of or physically interfere with an adopted emergency response plan or emergency evacuation plan. (Less than Significant)**

Although not adopted by legislative action, the city has a published Emergency Response Plan, prepared by the Department of Emergency Management as part of the city's Emergency Management Program, which includes plans for hazard mitigation and disaster preparedness and recovery. The Emergency Response Plan includes 16 annexes (similar to appendices) that cover a number of emergency topics. The Transportation Annex includes operations concepts for evacuation of people in an emergency, including the process for designating evacuation routes during an emergency. Mission Street is considered a primary emergency priority route in the Plan.<sup>205</sup> Construction of the proposed project is not anticipated to interfere with the San Francisco Emergency Response Plan, because it would not permanently alter or impede access to existing roads in the area. However, the project would be considered to have a significant impact on implementation of emergency response or emergency evacuation if construction activities were to interfere with emergency response vehicle travel or if they were to restrict access to critical facilities such as hospitals or fire stations.

As described in Section A.5, Proposed Project, construction would require the temporary closure of the right-turn lane along Fremont Street and the westbound bus-only lane along Mission Street. These closures would reduce the roadway capacity from two to one lane on westbound Mission Street, and from four to three on Fremont Street. However, the streets in the project vicinity would not be entirely closed and through traffic would be maintained on both streets. A transportation plan, provided in Appendix A of this initial study, would be implemented as part of the project which would specify the circulation and detour plans during construction and would require the contractor to notify the police and emergency responders of any lane closure and traffic control measures to be implemented. The San Francisco Police Department and San Francisco Fire Department would have access to the Tower and Podium buildings through breaks in the concrete barriers and fences around the project site.

Implementation of the transportation plan and compliance with the requirements of SFMTA and public works permits would provide adequate access such that project construction would not interfere with emergency response or evacuation activities. As a result, this impact would be less than significant.

**Impact C-HZ-1: The proposed project, in combination with reasonably foreseeable future projects in the site vicinity, would result in less than significant impacts related to hazards and hazardous materials. (Less than Significant)**

Impacts from hazards and hazardous materials are generally site-specific. Nearby cumulative projects would be subject to the same city, regional, state, and federal regulations designed to protect the public and the environment from risks associated with hazards and hazardous materials, and to ensure that emergency access routes are maintained. Any future development in the project vicinity would be subject to these same laws and regulations. For these reasons, the proposed project would not combine with past,

<sup>205</sup> City and County of San Francisco, *City and County of San Francisco Emergency Response Plan, an Element of the CCSE Emergency Management Program, ESF #1: Transportation Annex*, May 2017, <https://sfdem.org/sites/default/files/FileCenter/Documents/838-ESF%201%20-%20Transportation%20Annex.pdf>.



present, and reasonably foreseeable future projects in the project vicinity to create a significant cumulative impact related to hazards and hazardous materials.

Topics	Potentially Significant Impact	Less than Significant with Mitigation Incorporated	Less than Significant Impact	No Impact	Not Applicable
<b>19. MINERAL RESOURCES.</b>					
Would the project:					
a) Result in the loss of availability of a known mineral resource that would be of value to the region and the residents of the state?	<input type="checkbox"/>	<input type="checkbox"/>	<input type="checkbox"/>	<input type="checkbox"/>	<input checked="" type="checkbox"/>
b) Result in the loss of availability of a locally important mineral resource recovery site delineated on a local general plan, specific plan or other land use plan?	<input type="checkbox"/>	<input type="checkbox"/>	<input type="checkbox"/>	<input type="checkbox"/>	<input checked="" type="checkbox"/>

Pursuant to the Surface Mining and Reclamation Act of 1975, the California Division of Mines and Geology has designated all land in San Francisco, including the project site, as Mineral Resource Zone 4 (MRZ-4).<sup>206</sup> This designation indicates that inadequate information is available to assign the site to any other MRZ, and thus the project site is not a designated area of significant mineral deposits. No sites in San Francisco, including the project site, are designated areas of significant mineral deposits. Therefore, topics E.19(a) and 19(b) are not applicable to the proposed project.

Topics	Potentially Significant Impact	Less than Significant with Mitigation Incorporated	Less than Significant Impact	No Impact	Not Applicable
<b>20. ENERGY.</b>					
Would the project:					
a) Result in potentially significant environmental impact due to wasteful, inefficient, or unnecessary consumption of energy resources, during project construction or operation?	<input type="checkbox"/>	<input type="checkbox"/>	<input checked="" type="checkbox"/>	<input type="checkbox"/>	<input type="checkbox"/>
b) Conflict with or obstruct a state or local plan for renewable energy or energy efficiency?	<input type="checkbox"/>	<input type="checkbox"/>	<input type="checkbox"/>	<input checked="" type="checkbox"/>	<input type="checkbox"/>

**Impact EN-1: The proposed project would not encourage activities which would result in wasteful, inefficient, or unnecessary consumption of energy resources. (Less than Significant)**

Construction of the proposed project would require the use of fuels (primarily gas and diesel) for a variety of construction activities, including demolition, excavation, backfill, construction, and vehicle travel. The precise amount of fuel required for project construction is uncertain; however, it is expected that gasoline and diesel for construction equipment and worker and haul vehicles would be comparable to quantities used for similar construction projects, and that this consumption would not have a measurable effect on local and regional energy supplies. Fuel use for construction workers commute trips would be minor in comparison to the fuel used by construction equipment and for hauling. Fuels would not be used

<sup>206</sup> California Department of Conservation, Division of Mines and Geology, *Update on Mineral Land Classification: Aggregate Materials in the South San Francisco Bay Production-Consumption Region*. DMG Open-File Report 96-03, 1996.

wastefully during construction because doing so would not be economically sustainable for contractors. Therefore, the proposed project would have a less-than-significant impact in terms of the wasteful, inefficient, or unnecessary consumption of energy resources.

**Impact EN-2: The proposed project would not conflict with or obstruct a state or local plan for renewable energy or energy efficiency. (No Impact)**

The proposed project would not result in any substantial above ground long-term changes at the project site, or result in any additional long-term energy demand. As described in Section E.9, Greenhouse Gas Emissions, the proposed project was determined to be consistent with San Francisco's GHG reduction strategy.<sup>207</sup> The city's GHG reduction strategy is consistent with the long-term GHG reduction goals of Executive Order S-3-05, Executive Order B-30-15, Assembly Bill 32, Senate Bill 32 and the 2017 Clean Air Plan. Therefore, because the proposed project is consistent with the city's GHG reduction strategy, it is also consistent with the GHG reduction goals of Executive Order S-3-05, Executive Order B-30-15, Assembly Bill 32, Senate Bill 32 and the 2017 Clean Air Plan, and would not conflict with these plans. For these reasons, the proposed project would not conflict with or obstruct a state or local plan for renewable energy or energy efficiency.

**Impact C-EN-1: The proposed project, in combination with reasonably foreseeable future project in the site vicinity, would not result in significant cumulative impacts on energy resources. (Less than Significant)**

The demand for fuel, energy, and water created by the proposed project would be insubstantial and limited to the 22-month construction duration in the cumulative context of citywide demand and would not require an expansion of power facilities. All development projects in San Francisco, including those listed in Section B.2, Cumulative Context, would be required to comply with the city's Green Building Ordinance and title 24 of the California Code of Regulations, both of which are enforced by the building department. Thus, cumulative projects would be required to adhere to all applicable rules and regulations associated with energy use during construction and operations and implement the latest energy conservation measures that discourage activities which result in the use of large amounts of fuel, water, or energy, or use these in a wasteful manner. As a result, the proposed project, in combination with cumulative projects would not result in a cumulative impact related to energy resources and impacts would be less than significant.

---

<sup>207</sup> San Francisco Planning Department, *Greenhouse Gas Analysis: Compliance Checklist for 301 Mission Street, Millennium Tower Perimeter Pile Upgrade Project*, September 10, 2019.

Topics	Potentially Significant Impact	Less than Significant with Mitigation Incorporated	Less than Significant Impact	No Impact	Not Applicable
<b>21. AGRICULTURE AND FORESTRY RESOURCES.</b>					
<p>In determining whether impacts to agricultural resources are significant environmental effects, lead agencies may refer to the California Agricultural Land Evaluation and Site Assessment Model (1997) prepared by the California Department of Conservation as an optional model to use in assessing impacts on agriculture and farmland. In determining whether impacts to forest resources, including timberland, are significant environmental effects, lead agencies may refer to information compiled by the California Department of Forestry and Fire Protection regarding the state's inventory of forest land, including the Forest and Range Assessment Project and the Forest Legacy Assessment project; and forest carbon measurement methodology provided in Forest Protocols adopted by the California Air Resources Board. <b>Would the project:</b></p>					
a) Convert Prime Farmland, Unique Farmland, or Farmland of Statewide Importance, as shown on the maps prepared pursuant to the Farmland Mapping and Monitoring Program of the California Resources Agency, to non-agricultural use?	<input type="checkbox"/>	<input type="checkbox"/>	<input type="checkbox"/>	<input type="checkbox"/>	<input checked="" type="checkbox"/>
b) Conflict with existing zoning for agricultural use, or a Williamson Act contract?	<input type="checkbox"/>	<input type="checkbox"/>	<input type="checkbox"/>	<input type="checkbox"/>	<input checked="" type="checkbox"/>
c) Conflict with existing zoning for, or cause rezoning of, forest land (as defined in Public Resources Code section 12220(g)), timberland (as defined by Public Resources Code section 4526), or timberland zoned Timberland Production (as defined by Government Code section 51104(g))?	<input type="checkbox"/>	<input type="checkbox"/>	<input type="checkbox"/>	<input type="checkbox"/>	<input checked="" type="checkbox"/>
d) Result in the loss of forest land or conversion of forest land to non-forest use?	<input type="checkbox"/>	<input type="checkbox"/>	<input type="checkbox"/>	<input type="checkbox"/>	<input checked="" type="checkbox"/>
e) Involve other changes in the existing environment which, due to their location or nature, could result in conversion of farmland to non-agricultural use or forest land to non-forest use?	<input type="checkbox"/>	<input type="checkbox"/>	<input type="checkbox"/>	<input type="checkbox"/>	<input checked="" type="checkbox"/>

The project site is located in an urban area in San Francisco. The California Department of Conservation's Farmland Mapping and Monitoring Program identifies the site as Urban and Built-Up Land, which is defined as "... land [that] is used for residential, industrial, commercial, institutional, public administrative purposes, railroad and other transportation yards, cemeteries, airports, golf courses, sanitary landfills, sewage treatment, water control structures, and other developed purposes." In addition, no land within the city is zoned for forest uses. Because the project site does not contain agricultural or forest uses and is not zoned for such uses, the proposed project would not: convert any Prime Farmland, Unique Farmland, or Farmland of Statewide Importance to non-agricultural uses; conflict with existing zoning for agricultural land or a Williamson Act contract; or involve any changes to the environment that could result in the conversion of farmland to non-agricultural use or forest land to non-forest use. Therefore, topics E.21(a), E.21(b), E.21(c), E.21(d), and E.21(e) are not applicable to the proposed project.

Topics	Potentially Significant Impact	Less than Significant with Mitigation Incorporated	Less than Significant Impact	No Impact	Not Applicable
<b>22. WILDFIRE.</b>					
<b>If located in or near state responsibility areas or lands classified as very high fire hazard severity zones, would the project:</b>					
a) Substantially impair an adopted emergency response plan or emergency evacuation plans?	<input type="checkbox"/>	<input type="checkbox"/>	<input type="checkbox"/>	<input type="checkbox"/>	<input checked="" type="checkbox"/>
b) Due to slope, prevailing winds, and other factors, exacerbate wildfire risks, and thereby expose project occupants to, pollutant concentrations from a wildfire or the uncontrolled spread of a wildfire?	<input type="checkbox"/>	<input type="checkbox"/>	<input type="checkbox"/>	<input type="checkbox"/>	<input checked="" type="checkbox"/>
c) Require the installation or maintenance of associated infrastructure (such as roads, fuel breaks, emergency water sources, power lines or other utilities) that may exacerbate fire risk or that may result in temporary or ongoing impacts to the environment?	<input type="checkbox"/>	<input type="checkbox"/>	<input type="checkbox"/>	<input type="checkbox"/>	<input checked="" type="checkbox"/>
d) Expose people or structure to significant risks including downslope or downstream flooding or landslides, as a result of runoff, post-fire slope instability, or drainage changes?	<input type="checkbox"/>	<input type="checkbox"/>	<input type="checkbox"/>	<input type="checkbox"/>	<input checked="" type="checkbox"/>

The City and County of San Francisco does not contain any state responsibility areas for fire prevention or lands classified as very high fire hazard severity zones.<sup>208</sup> There are no landslide-prone areas in the immediate vicinity of the site.<sup>209</sup> Therefore, topics E.22(a), E.22(b), E.22(c) and E.22(d) are not applicable.

Topics	Potentially Significant Impact	Less than Significant with Mitigation Incorporated	Less than Significant Impact	No Impact	Not Applicable
<b>23. MANDATORY FINDINGS OF SIGNIFICANCE.</b>					
<b>Does the project:</b>					
a) Have the potential to substantially degrade the quality of the environment, substantially reduce the habitat of a fish or wildlife species, cause a fish or wildlife population to drop below self-sustaining levels, threaten to eliminate a plant or animal community, substantially reduce the number or restrict the range of a rare or endangered plant or animal, or eliminate important examples of the major periods of California history or prehistory?	<input type="checkbox"/>	<input checked="" type="checkbox"/>	<input type="checkbox"/>	<input type="checkbox"/>	<input type="checkbox"/>
b) Have impacts that are individually limited, but cumulatively considerable? ("Cumulatively considerable" means that the incremental effects of a project are considerable when viewed in connection with the effects of past projects, the effects of other current projects, and the effects of probable future projects.)	<input type="checkbox"/>	<input type="checkbox"/>	<input checked="" type="checkbox"/>	<input type="checkbox"/>	<input type="checkbox"/>
c) Have environmental effects which will cause substantial adverse effects on human beings, either directly or indirectly?	<input type="checkbox"/>	<input checked="" type="checkbox"/>	<input type="checkbox"/>	<input type="checkbox"/>	<input type="checkbox"/>

The proposed project would not substantially reduce the habitat of a fish or wildlife species, cause a fish or wildlife population to drop below self-sustaining levels, threaten to eliminate a plant or animal community, or reduce the number or restrict the range of a rare or endangered plant or animal.

<sup>208</sup> California Department of Forestry and Fire Protection (CAL FIRE), *San Francisco County Fire Hazard Severity Zone (FHSZ) Map, 2019*, <https://legis.fire.ca.gov/FHSZ/>, accessed July, 8, 2019.

<sup>209</sup> City and County of San Francisco, *San Francisco General Plan, Community Safety*, an Element of the General Plan of the City and County of San Francisco, October 2012.

As described in Section E.4, Cultural Resources and Section E.5, Tribal Cultural Resources, construction activities associated with the proposed project could result in potential impacts on unknown archeological resources, human remains, and tribal cultural resources. These impacts would be less than significant with implementation of Mitigation Measures M-CR-2, Archeological Testing and Archeological Monitoring, and M-TC-1, Tribal Cultural Resources Interpretive Program. As described in Section E.15, Biological Resources, removal of the street trees during the nesting season could result in potential impacts to nesting birds. This impact would be less than significant with implementation of Mitigation Measure M-BI-2, Preconstruction Nesting Bird Surveys and Buffer Areas. As described in Section E.16, Geology and Soils, construction activities associated with the proposed project could result in potential impacts on paleontological resources. These impacts would be less than significant with implementation of Mitigation Measures M-GE-4a through M-GE-4d. Therefore, the proposed project would not result in a significant impact through the elimination of important examples of major periods of California history or prehistory.

Section E of the initial study has addressed cumulative impacts under each environmental topic and determined that the proposed project, in combination with reasonably foreseeable projects, would not result in significant cumulative impacts.

As described in Section E.7, Noise, the proposed project would result in substantial temporary noise level increases in excess of established standards and groundborne vibration impacts on sensitive receptors at the 301 Mission Street. These impacts would be less than significant with implementation of Mitigation Measures M-NO-1a, General Construction Noise Control Measures, M-NO-1b, Noise Reduction Techniques for Equipment Used in Nighttime Delivery Activity, and M-NO-2, Limited Use of Vibratory Rollers. As described in Section E.8, Air Quality, the proposed project would result in potentially significant impacts related to criteria air pollutants and health risk. These impacts would be less than significant with implementation of Mitigation Measures M-AQ-1, Construction Air Quality. Therefore, the proposed project would not cause substantial adverse effects on human beings, either directly or indirectly, with the implementation of the mitigation measures.

---

## F. MITIGATION MEASURES AND IMPROVEMENT MEASURES

The following mitigation measures have been identified in this initial study to reduce potentially significant impacts resulting from the proposed project to less-than-significant levels. An improvement measure recommended to reduce a less than significant impact is also identified below. The project sponsor has agreed to implement all mitigation measures and the improvement measure identified in the initial study.

### F.1 Mitigation Measures

**Mitigation Measure M-CR-2: Archeological Testing and Monitoring.** Based on a reasonable presumption that archeological resources may be present within the project site, the following measures shall be undertaken to avoid any potentially significant adverse effect from the proposed project on buried or submerged historical resources. The project sponsor shall retain the services of an archeological consultant from the rotational Department Qualified Archeological Consultants List (QACL) maintained by the Planning Department archeologist. The project sponsor shall contact the Department archeologist to obtain the names and contact information for the next three

archeological consultants on the QACL, with specialized expertise in geoarcheology and historical archeology. The archeological consultant shall undertake an archeological testing and monitoring program as specified herein. In addition, the consultant shall be available to conduct a data recovery program if required pursuant to this measure. The archeological consultant's work shall be conducted in accordance with this measure at the direction of the Environmental Review Officer (ERO). All plans and reports prepared by the consultant as specified herein shall be submitted first and directly to the ERO for review and comment, and shall be considered draft reports subject to revision until final approval by the ERO. Archeological data recovery programs required by this measure could suspend construction of the project for up to a maximum of four weeks. At the direction of the ERO, the suspension of construction can be extended beyond four weeks only if such a suspension is the only feasible means to reduce to a less-than-significant level potential effects on a significant archeological resource as defined in CEQA Guidelines section 15064.5(a) and (c).

*Consultation with Descendant Communities.* On discovery of an archeological site associated with descendant Native Americans, the Overseas Chinese, or other potentially interested descendant group, an appropriate representative of the descendant group and the ERO shall be contacted. The representative of the descendant group shall be given the opportunity to monitor archeological field investigations of the site and to offer recommendations to the ERO regarding appropriate archeological treatment of the site, of recovered data from the site, and, if applicable, any interpretative treatment of the associated archeological site. A copy of the Final Archeological Resources Report shall be provided to the representative of the descendant group.

*Archeological Testing and Monitoring Program.* The archeological consultant shall prepare and submit to the ERO for review and approval an archeological testing plan and archeological monitoring plan (ATP/AMP). The ATP/AMP shall identify the property types of the expected archeological resource(s) that potentially could be adversely affected by the proposed project, the testing method to be used, and the locations recommended for testing and monitoring. The purpose of the archeological testing and monitoring program will be to determine to the extent possible the presence or absence of archeological resources or strata with potential to include archeological resources and to identify and to evaluate whether any archeological resource encountered on the site constitutes an historical resource under CEQA.

The archeological testing and monitoring program shall be conducted in accordance with the approved ATP/AMP, as follows:

**Archeological testing** shall consist of geoarcheological coring prior to the beginning of project excavations and/or in concert with post-approval geotechnical testing, and shall, at minimum, include sampling of the uppermost 5 feet of the Young Bay Mud and the uppermost 5 feet of the Colma Sands Formation, or of the Old Bay Clay, where this stratum directly underlies the Young Bay Mud stratum. At the completion of the archeological testing program, the archeological consultant shall submit a written report of the findings to the ERO. If based on the archeological testing program the archeological consultant finds that significant archeological resources may be present, the ERO in consultation with the archeological consultant shall determine if additional measures are warranted. Additional measures that may be undertaken include additional archeological testing, modifications to the archeological monitoring program, and/or implementation of an archeological data recovery program, as detailed below. No archeological

data recovery shall be undertaken without the prior approval of the ERO or the Planning Department archeologist.

**Archeological monitoring** shall include at least intermittent monitoring of excavations within bay fill and the upper portion of the Young Bay Mud stratum, and selective monitoring of the installation of the 36-inch-diameter outer casings. The archeological consultant, project sponsor, and ERO shall meet and consult on any adjustments needed in the scope of archeological monitoring based on the results of geoarcheological testing and the judgment of the project archeologist, reasonably prior to the commencement of mass excavation and casing installations. Whether or not significant archeological resources are encountered, the archeological consultant shall submit a written report of the findings of the monitoring program to the ERO. If no potential archeological resources are identified, the final report shall consist of an Archaeological Testing Results Report/ Archaeological Monitoring Results Report (AMRR/ATRR). If significant resources are identified, the consultant shall prepare a Final Archaeological Resources Report (FARR), the contents of which are detailed below.

In addition:

- Prior to the beginning of construction soil disturbance, the archeological consultant shall advise all project contractors to be on the alert for evidence of the presence of the expected resource(s), of how to identify the evidence of the expected resource(s), and of the appropriate protocol in the event of apparent discovery of an archeological resource;
- The archeological monitor(s) shall be present on the project site according to a schedule agreed upon by the archeological consultant and the ERO until the ERO has, in consultation with the project archeological consultant, determined that project construction activities could have no effects on significant archeological deposits;
- The archeological monitor shall record and be authorized to collect soil samples and artifactual/ecofactual material as warranted for analysis;
- If an intact archeological deposit is encountered, all soils-disturbing activities in the vicinity of the deposit shall cease. The archeological monitor shall be empowered to temporarily redirect demolition/excavation/pile installation/construction activities and equipment until the deposit is evaluated. If in the case of pile installation or deep foundation activities (foundation, shoring, etc.), the archeological monitor has cause to believe that the pile installation or deep foundation activities may affect an archeological resource, the pile installation or deep foundation activities shall be terminated until an appropriate evaluation of the resource has been made in consultation with the ERO. The archeological consultant shall immediately notify the ERO of the encountered archeological deposit. The archeological consultant shall make a reasonable effort to assess the identity, integrity, and significance of the encountered archeological deposit, and present the findings of this assessment to the ERO.

*Archeological Data Recovery Program.* The archeological data recovery program, when required through the process set forth above, shall be conducted in accord with an archeological data recovery plan (ADRP). The archeological consultant, project sponsor, and ERO shall meet and consult on the scope of the ADRP prior to preparation of a draft ADRP. The archeological consultant shall submit a draft ADRP to the ERO. The ADRP shall identify how the proposed data recovery program will preserve the significant information the archeological resource is expected to contain. That is, the ADRP will identify what scientific/historical research questions are applicable to the expected resource, what data classes the resource is expected to possess, and how

the expected data classes would address the applicable research questions. Data recovery, in general, should be limited to the portions of the historical resource that could be adversely affected by the proposed project. Destructive data recovery methods shall not be applied to portions of the archeological resources if nondestructive methods are practical.

The scope of the ADRP shall include the following elements:

- Field Methods and Procedures – Descriptions of proposed field strategies, procedures, and operations
- Cataloguing and Laboratory Analysis – Description of selected cataloguing system and artifact analysis procedures
- Discard and Deaccession Policy – Description of and rationale for field and post-field discard and deaccession policies
- Interpretive Program – Consideration of an on-site/off-site public interpretive program based on the results of the archeological data recovery program
- Security Measures – Recommended security measures to protect the archeological resource from vandalism, looting, and non-intentionally damaging activities
- Final Report – Description of proposed report format and distribution of results
- Curation – Description of the procedures and recommendations for the curation of any recovered data having potential research value, identification of appropriate curation facilities, and a summary of the accession policies of the curation facilities

*Human Remains, Associated or Unassociated Funerary Objects.* The treatment of human remains and of associated or unassociated funerary objects discovered during any soils disturbing activity shall comply with applicable State and federal laws. This shall include immediate notification of the Medical Examiner of the City and County of San Francisco and, in the event of the Medical Examiner's determination that the human remains are Native American remains, notification of the California State Native American Heritage Commission, which will appoint a Most Likely Descendant (MLD). The MLD will complete his or her inspection of the remains and make recommendations or preferences for treatment within 48 hours of being granted access to the site (Public Resources Code section 5097.98). The ERO also shall be notified immediately upon the discovery of human remains.

The project sponsor and ERO shall make all reasonable efforts to develop a Burial Agreement ("Agreement") with the MLD, as expeditiously as possible, for the treatment and disposition, with appropriate dignity, of human remains and associated or unassociated funerary objects (as detailed in CEQA Guidelines section 15064.5(d)). The Agreement shall take into consideration the appropriate excavation, removal, recordation, scientific analysis, custodianship, curation, and final disposition of the human remains and associated or unassociated funerary objects. If the MLD agrees to scientific analyses of the remains and/or associated or unassociated funerary objects, the archeological consultant shall retain possession of the remains and associated or unassociated funerary objects until completion of any such analyses, after which the remains and associated or unassociated funerary objects shall be reinterred or curated as specified in the Agreement.

Nothing in existing State regulations or in this mitigation measure compels the project sponsor and the ERO to accept treatment recommendations of the MLD. However, if the ERO, project sponsor



and MLD are unable to reach an Agreement on scientific treatment of the remains and associated or unassociated funerary objects, the ERO, with cooperation of the project sponsor, shall ensure that the remains and/or mortuary materials are stored securely and respectfully until they can be reinterred on the property, with appropriate dignity, in a location not subject to further or future subsurface disturbance.

Treatment of historic-period human remains and of associated or unassociated funerary objects discovered during any soil-disturbing activity, additionally, shall follow protocols laid out in the project's archeological treatment documents, and in any related agreement established between the project sponsor, Medical Examiner and the ERO.

*Final Archeological Resources Report.* The archeological consultant shall submit a Draft Final Archeological Resources Report (FARR) to the ERO that evaluates the historical significance of any discovered archeological resource and describes the archeological and historical research methods employed in the archeological testing/monitoring/data recovery program(s) undertaken. The Draft FARR shall also include an Interpretation Plan for public interpretation of all significant archeological features.

Once approved by the ERO, copies of the FARR shall be distributed as follows: California Historical Resources Information Center Northwest Information Center (NWIC) shall receive one copy and the ERO shall receive a copy of the transmittal of the FARR to the NWIC. The Environmental Planning division of the Planning Department shall receive one bound, one unbound and one unlocked, searchable PDF copy on CD of the FARR along with copies of any formal site recordation forms (CA DPR 523 series) and/or documentation for nomination to the National Register of Historic Places/California Register of Historical Resources. In instances of high public interest in or the high interpretive value of the resource, the ERO may require a different final report content, format, and distribution than that presented above.

**Mitigation Measure M-TC-1: Tribal Cultural Resources Interpretive Program.** If the Environmental Review Officer (ERO) determines that a significant archeological resource is present, and if in consultation with the affiliated Native American tribal representatives, the ERO determines that the resource constitutes a tribal cultural resource and that the resource could be adversely affected by the proposed project, the proposed project shall be redesigned so as to avoid any adverse effect on the significant tribal cultural resource, if feasible.

If the ERO determines that preservation-in-place of the tribal cultural resource is both feasible and effective, then the archeological consultant shall prepare an archeological resource preservation plan (ARPP). Implementation of the approved ARPP by the project sponsor and the archeological consultant shall be required when feasible.

If the ERO, in consultation with the affiliated Native American tribal representatives and the project sponsor, determines that preservation-in-place of the tribal cultural resources is not a sufficient or feasible option, the project sponsor shall implement an interpretive program of the tribal cultural resource in consultation with affiliated tribal representatives. An interpretive plan produced in consultation with the ERO and affiliated tribal representatives, at a minimum, and approved by the ERO would be required to guide the interpretive program. The plan shall identify, as appropriate, proposed locations for installations or displays, the proposed content and materials

of those displays or installation, the producers or artists of the displays or installation, and a long-term maintenance program. The interpretive program may include artist installations, preferably by local Native American artists, oral histories with local Native Americans, artifacts displays and interpretation, and educational panels or other informational displays.

**Mitigation Measure M-NO-1a: General Construction Noise Control Measures.** To ensure that project noise from construction activities is minimized to the maximum extent feasible, the project sponsor shall undertake the following:

- The project sponsor shall require the general contractor to ensure that equipment and trucks used for project construction utilize the best available noise control techniques (e.g., improved mufflers, equipment redesign, use of intake silencers, ducts, engine enclosures and acoustically attenuating shields or shrouds, wherever feasible).
- The project sponsor shall require the general contractor to locate stationary noise sources (such as compressors) as far from adjacent or nearby sensitive receptors as possible, to muffle such noise sources, and to construct barriers around such sources and/or the construction site, which could reduce construction noise by as much as 5 dBA. To further reduce noise, the contractor shall locate stationary equipment in pit areas or excavated areas, if feasible.
- The project sponsor shall require the general contractor to use impact tools (e.g., jack hammers, pavement breakers, and rock drills) that are hydraulically or electrically powered wherever possible to avoid noise associated with compressed air exhaust from pneumatically powered tools. Where use of pneumatic tools is unavoidable, an exhaust muffler on the compressed air exhaust shall be used, along with external noise jackets on the tools, which could reduce noise levels by as much as 10 dBA.
- The project sponsor shall include noise control requirements in specifications provided to construction contractors. Such requirements could include, but not be limited to, performing all work in a manner that minimizes noise to the extent feasible; use of equipment with effective mufflers; undertaking the most noisy activities during times of least disturbance to surrounding residents and occupants, as feasible; and selecting haul routes that avoid residential buildings inasmuch as such routes are otherwise feasible.
- Prior to the issuance of the building permit, the project sponsor shall submit to the planning department and Department of Building Inspection (building department) a Construction Noise Management Plan identifying all measures to be implemented and identifying a contact person and phone number to respond to and track complaints pertaining to construction noise. These measures shall include (1) a procedure and phone numbers for notifying the building department, the Department of Public Health (health department), and the Police Department (during regular construction hours and off-hours); (2) a sign posted on site describing noise complaint procedures and a complaint hotline number that shall be answered at all times during construction; (3) designation of an on-site construction complaint and enforcement manager for the project; and (4) notification of neighboring residents and non-residential building managers within 300 feet of the project construction area at least 30 days in advance of commencement of construction activities.
- The general contractor or other designated person(s) shall prepare a weekly noise monitoring log report that shall be made available to the planning department upon request. The log shall include any noise complaints received, whether in connection with an exceedance or not, as

well as any noise complaints received through calls to 311 or the building department if the contractor is made aware of them (for example, via a building department notice, inspection, or investigation). Any weekly report that includes an exceedance or for a period during which a complaint is received shall be submitted to the planning department within three business days following the week in which the exceedance or complaint occurred. A report shall be submitted to the planning department at the completion of construction. The report shall document noise levels, exceedances of standards, if reported, and corrective action(s) taken.

**Mitigation Measure M-NO-1b: Noise Reduction Techniques for Equipment Used in Nighttime Delivery Activity.** The project sponsor shall notify the Planning Department Development Performance Coordinator of any night noise permit application filed with the Department of Building Inspection on the day of filing and any emergency/unanticipated activity with the potential to exceed standard as soon as possible. The project sponsor shall implement all of the following noise reduction techniques to reduce nighttime construction delivery noise during Stages 3 and 4:

- The crane used for nighttime deliveries shall be directionally positioned such that the exhaust faces away from the building at 301 Mission Street. This measure would be expected to reduce noise levels by 2 to 3 dBA.
- Provide acoustically rated shielding around crane engine. This measure would be expected to reduce noise levels by 5 to 12 dBA depending on the proximity of shielding to the crane engine.
- The crane shall be operated in ECO silent mode<sup>210</sup> during nighttime hours. This measure would be expected to reduce noise levels by 3 to 5 dBA.
- Forklifts shall employ self-adjusting directional backup alarms. Such alarms constantly measure the background noise and can reduce their sound level by 20 dBA or more.

**Mitigation Measure M-NO-2: Limited Use of Vibratory Rollers.** The project sponsor shall require that the contractors use non-vibratory excavator mounted compaction wheels and small, smooth drum rollers for final compaction of any asphalt base and asphalt concrete. If needed to meet compaction requirements, smaller vibratory rollers shall be used to minimize vibration levels during repaving activities where needed to meet vibration standards.

**Mitigation Measure M-AQ-1: Construction Air Quality.** The project sponsor or contractor shall provide the Planning Department with a certification statement that the sponsor or contractor agrees to fully comply with the following requirements which shall be included in contract specifications:

- All construction equipment shall be maintained and properly tuned in accordance with the manufacturer's specifications. All equipment shall be checked by a certified mechanic and determined to be running in proper condition prior to operation.

<sup>210</sup> The proposed crane can operate in an "ECO silent" mode that regulates the engine speed such that it can be restricted to a predefined level, thus lowering noise emissions.

- Idling times shall be minimized either by shutting equipment off when not in use or reducing the maximum idling time to two minutes.
- The project construction contractor shall not use diesel generators for construction purposes where feasible alternative sources of power are available.
- All construction equipment, diesel trucks, and generators shall be equipped with Best Available Control Technology for emission reductions of NOx and Particulate Matter, including Tier 4 Interim or Final or alternative fuel engines where such equipment is available and feasible for use:
  - The following equipment shall have Tier 4 final engines: air compressors, bore/drill rigs, compactor, concrete pump, crawler tractors, excavator, generator sets/power pack, pavers, rollers, rough terrain forklifts, rubber tired loaders, skid steer loaders, and track drill.
  - The following equipment shall have Tier 4 interim or final engines: backhoes.
  - The following equipment shall have Tier 1 or newer engines: truck mount drills.
- Should any deviations in the construction equipment list or tier levels be required, the project sponsor shall present documentation to the satisfaction of the ERO that any such deviation would not result in an exceedance of the average daily NOx significance threshold or any health risk threshold.

**Mitigation Measure M-BI-2: Preconstruction Nesting Bird Surveys and Buffer Areas.** Nesting birds and their nests shall be protected during construction by implementation of the following measures for each construction phase:

- a. To the extent feasible, conduct initial activities including but not limited to vegetation removal, tree trimming or removal, ground disturbance, building demolition, site grading, and other construction activities which may compromise breeding birds or the success of their nests outside of the nesting season (January 15 through August 15).
- b. If construction during the bird nesting season cannot be fully avoided, a qualified wildlife biologist\* shall conduct pre-construction nesting surveys within 14 days prior to the start of construction or demolition at areas that have not been previously disturbed by project activities or after any construction breaks of 14 days or more. Surveys shall be performed for suitable habitat within 250 feet of the project site in order to locate any active nests of common bird species and within 500 feet of the project site to locate any active raptor (birds of prey) nests.
- c. If active nests are located during the preconstruction nesting bird surveys, a qualified biologist shall evaluate if the schedule of construction activities could affect the active nests and if so, the following measures would apply:
  - i. If construction is not likely to affect the active nest, construction may proceed without restriction; however, a qualified biologist shall regularly monitor the nest at a frequency determined appropriate for the surrounding construction activity to confirm there is no adverse effect. Spot-check monitoring frequency would be determined on a nest-by-nest basis considering the particular construction activity, duration, proximity to the nest, and physical barriers which may screen activity from the nest. The qualified biologist may revise his/her determination at any time during the nesting season in coordination with the Planning Department.

- ii. If it is determined that construction may affect the active nest, the qualified biologist shall establish a no-disturbance buffer around the nest(s) and all project work shall halt within the buffer until a qualified biologist determines the nest is no longer in use. Typically, these buffer distances are 250 feet for passerines and 500 feet for raptors; however, the buffers may be adjusted if an obstruction, such as a building, is within line-of-sight between the nest and construction.
  - iii. Modifying nest buffer distances, allowing certain construction activities within the buffer, and/or modifying construction methods in proximity to active nests shall be done at the discretion of the qualified biologist and in coordination with the Planning Department, who would notify CDFW. Necessary actions to remove or relocate an active nest(s) shall be coordinated with the Planning Department and approved by CDFW.
  - iv. Any work that must occur within established no-disturbance buffers around active nests shall be monitored by a qualified biologist. If adverse effects in response to project work within the buffer are observed and could compromise the nest, work within the no disturbance buffer(s) shall halt until the nest occupants have fledged.
  - v. Any birds that begin nesting within the project area and survey buffers amid construction activities are assumed to be habituated to construction-related or similar noise and disturbance levels, so exclusion zones around nests may be reduced or eliminated in these cases as determined by the qualified biologist in coordination with the Planning Department, who would notify CDFW. Work may proceed around these active nests as long as the nests and their occupants are not directly impacted.
- d. In the event inactive nests are observed within or adjacent to the project site at any time throughout the year, any removal or relocation of the inactive nests shall be at the discretion of the qualified biologist in coordination with the Planning Department, who would notify and seek approval from the CDFW, as appropriate. Work may proceed around these inactive nests.
- \* Typical experience requirements for a "qualified biologist" include a minimum of four years of academic training and professional experience in biological sciences and related resource management activities, and a minimum of two years of experience conducting surveys for each species that may be present within the project area.

---

**Mitigation Measure M-GE-4a: Project Paleontologist.** The project sponsor or its contractor shall retain a qualified professional paleontologist (qualified paleontologist) prior to the approval of demolition or grading permits. The qualified paleontologist shall attend the project kick-off meeting and project progress meetings on an as-needed basis, shall report to the project site for drilling activities associated with installation of the outer casings for the perimeter piles that are anticipated to return Colma Sands or Old Bay Clay materials, and shall implement the duties outlined in Mitigation Measures M-GE-4b through M-GE-4d.

---

**Mitigation Measure M-GE-4b: Worker Training.** Prior to the start of ground-disturbing activity related to the installation of the outer casings for the perimeter piles, which is anticipated to return Colma Sands or Old Bay Clay materials, the qualified paleontologist shall prepare paleontological resources sensitivity training materials for use during Project-wide Worker Environmental Awareness Training (or equivalent). The paleontological resources sensitivity training shall be conducted by a qualified environmental trainer working under the supervision of the qualified

paleontologist. In the event construction crews are phased, additional trainings shall be conducted for new construction personnel. The training session shall focus on the recognition of the types of paleontological resources that could be encountered within the project site and the procedures to be followed if they are found, as outlined in the approved Paleontological Resources Monitoring and Mitigation Plan in Mitigation Measure M-GE-4c. The project sponsor and/or its contractor shall retain documentation demonstrating that all construction personnel attended the training prior to the start of work on the site, and shall provide the documentation to the Planning Department Project Manager upon request.

**Mitigation Measure M-GE-4c: Paleontological Monitoring.** The qualified paleontologist shall prepare, and the project sponsor and/or its contractors shall implement, a Paleontological Resources Monitoring and Mitigation Plan (PRMMP). The project sponsor shall submit the plan to the planning department for review and approval at least 30 days prior to the start of construction. This plan shall address specifics of monitoring and mitigation and comply with the City requirements, as follows:

- The qualified paleontologist shall identify, and the project sponsor or its contractor(s) shall retain, qualified paleontological resource monitors (qualified monitors).
- The qualified paleontologist and/or the qualified monitors under the direction of the qualified paleontologist shall conduct full-time paleontological resources monitoring of the installation of the 36-inch-diameter outer casings for all ground-disturbing activities anticipated to return Colma Sands or Old Bay Clay materials.
- Monitors shall have the authority to temporarily halt or divert work away from exposed fossils in order to evaluate and recover the fossil specimens.
- If construction or other project personnel discover any potential fossils during construction, regardless of the depth of work or location and regardless of whether the site is being monitored, work at the discovery location shall cease until the qualified paleontologist, project sponsor, and ERO shall meet and consult on the appropriate course of action at the 36-inch-diameter outer casing locations, based on the nature of the recovered paleontological resource and the judgment of the qualified paleontologist, reasonably provided prior to continuing with the installation of outer casings. The qualified paleontologist shall determine the significance of any paleontological resources discovered, and shall determine the appropriate treatment for significant paleontological resources in accordance with City standards. Whether or not a significant paleontological resource has been encountered, the qualified paleontologist shall assess the discovery, make recommendations as to the appropriate treatment, and submit a written report of the findings of the monitoring program to the ERO. Mitigation Measure M-GE-4d regarding significant fossil treatment is described further below.
- Monitors shall prepare daily logs detailing the types of activities and soils observed, and any discoveries. The qualified paleontologist shall prepare a final monitoring and mitigation report to document the results of the monitoring effort and any curation of fossils. The project sponsor shall provide the daily logs to the City Planning Department upon request, and shall provide the final report to the City Planning Department upon completion.

**Mitigation Measure M-GE-4d: Significant Fossil Treatment.** If any find is deemed significant following the process outlined in Mitigation Measure M-GE-4c, the qualified paleontologist shall salvage and prepare the fossil for permanent curation with a certified repository with retrievable storage.

## F.2 Improvement Measure

**Improvement Measure I-GE-1: Sponsor Reimbursement for Engineering Design Review Team Review of Construction and Post-Construction Monitoring Data.** The project sponsor should cooperate with the Department of Building Inspection (building department) in its engagement of the Engineering Design Review Team (peer review team) convened during review and evaluation of the monitoring data collected for the project during and post construction. The project sponsor should reimburse the building department for the costs of the monitoring data review and evaluation by the peer review team.

## G1. PUBLIC NOTICE AND COMMENT

A "Notification of Project Receiving Environmental Review" was mailed on June 14, 2019 to owners and occupants of the affected property and within 300 feet of the project site, neighborhood groups for the project vicinity, and public agencies. In addition, this notice was sent to people who requested to receive notice regarding this project. Seven comment letters were received in response to the notification. The following concerns were expressed by members of the public:

- Construction noise impacts;
- Air quality impacts to residents at the project site during construction; and
- Impacts to Golden Gate Transit bus stops.

These concerns were incorporated into the environmental review of the proposed project and addressed in Section A, Project Description, Section E.6, Transportation and Circulation, Section E.7, Noise, and Section E.8, Air Quality. Other comments related to the notification and distribution process for environmental documents related to the proposed project will be accommodated.

## G2. NOTIFICATION OF INTENT TO ADOPT A MITIGATED NEGATIVE DECLARATION

On November 20, 2019, the planning department circulated a Notice of Availability of and Intent to Adopt a Preliminary Mitigated Negative Declaration and Initial Study. The notice was circulated to state and local agencies, interested organizations and individuals, and property owners and residents within 300 feet of the project site as well as residents of the Tower building at 301 Mission Street. Notices were also posted at multiple locations around the project site.

The planning department received a comment expressing concerns about noise resulting from nighttime truck deliveries of construction materials that are proposed to occur approximately five nights per week during Stages 3 and 4 (i.e., approximately between mid 2020 and mid 2021) of the project construction. The comment requests that these deliveries be restricted to specific hours, such as 8 p.m. to 10 p.m. and 6 a.m. to 7 a.m. The comment also requests information about whether any concrete pours would take place at night.

As discussed in Section E.7, Noise, on p. 101 of the FMND, section 2908 of the noise ordinance prohibits any person or entity from erecting, constructing, demolishing, excavating, altering, or repairing any building or structure between 8 p.m. of any given day up to 7 a.m. of the following day, if the noise level created is in excess of the ambient noise level by 5 dBA at the nearest property line, unless a special permit from a city agency such as public works has been applied for and granted. The project sponsor anticipates that nighttime deliveries would occur during Stages 3 and 4 of the project construction. The noise analysis prepared for the project assumes that no concrete pours would occur at night. Because the construction noise analysis concluded that the nighttime deliveries, proposed to occur within the public right-of-way during Stages 3 and 4 of the project construction, would result in noise levels exceeding the ambient noise levels by 5 dBA, the project sponsor would likely need to obtain a special permit before the commencement of project construction from public works in order to conduct the proposed nighttime deliveries. In reviewing the requested special permit, public works would consider the need for nighttime truck deliveries and whether to restrict the hours of nighttime deliveries.

The comment suggests that the construction noise analysis should assume that noise sensitive receptors at 181 Fremont Street residential development are facing north toward the project site. The comment also inquires about whether noise monitoring would be conducted during project construction. As discussed in the FMND (and as explained below), the sponsor would be required to monitor noise levels during project construction. As explained in note b for Table 19, Nighttime Noise Levels from Stages 3 and 4 Overnight Deliveries, on p. 101 of the FMND, the construction noise analysis assumes that the residential noise sensitive receptors are located at the north property line of 181 Fremont Street residential development so as to yield conservative (i.e., worst case) results. As discussed in Section E.7 on pp. 101-102 of the FMND, Mitigation Measure M-NO-1a: General Construction Noise Control Measures requires that the project sponsor submit to the planning department and building department a Construction Noise Management Plan identifying all the measures that are required to be implemented. Mitigation Measure M-NO-1a also requires that the project sponsor prepare a weekly noise monitoring log report and submit any weekly report that includes a noise standard exceedance to the planning department within three business days following the week in which the noise exceedance or complaint occurred.

In addition, Mitigation Measure M-NO-1b: Noise Reduction Techniques for Equipment Used in Nighttime Delivery Activity requires that the project sponsor implement several noise reduction techniques to reduce nighttime construction delivery noise during Stages 3 and 4 of the project construction, as discussed on pp. 102-103 of the FMND.



## G. DETERMINATION

On the basis of this Initial Study:

- I find that the proposed project COULD NOT have a significant effect on the environment, and a NEGATIVE DECLARATION will be prepared.
- I find that although the proposed project could have a significant effect on the environment, there will not be a significant effect in this case because revisions in the project have been made by or agreed to by the project proponent. A MITIGATED NEGATIVE DECLARATION will be prepared.
- I find that the proposed project MAY have a significant effect on the environment, and an environmental impact report is required.
- I find that the proposed project MAY have a "potentially significant impact" or "potentially significant unless mitigated" impact on the environment, but at least one effect 1) has been adequately analyzed in an earlier document pursuant to applicable legal standards, and 2) has been addressed by mitigation measures based on the earlier analysis as described on attached sheets. An ENVIRONMENTAL IMPACT REPORT is required, but it must analyze only the effects that remain to be addressed.
- I find that although the proposed project could have a significant effect on the environment, because all potentially significant effects (a) have been analyzed adequately in an earlier EIR or NEGATIVE DECLARATION pursuant to applicable standards, and (b) have been avoided or mitigated pursuant to that earlier EIR or NEGATIVE DECLARATION, including revisions or mitigation measures that are imposed upon the proposed project, no further environmental documentation is required.

DATE: 12-27-2019

  
for Lisa Gibson  
Environmental Review Officer  
for  
John Rahaim  
Director of Planning

## H. INITIAL STUDY PREPARERS

### H.1 San Francisco Planning Department

Planning Department, City and County of San Francisco  
Environmental Planning Division  
1650 Mission Street, Suite 400  
San Francisco, CA 94103

- Environmental Review Officer: Lisa Gibson
- Principal Environmental Planner: Debra Dwyer
- Senior Environmental Planner: Kei Zushi
- Environmental Planner: Jennifer McKellar
- Transportation Supervisor: Wade Wietgreffe
- Senior Transportation Planner: Jenny Delumo
- Archeologist: Sally Morgan
- Principal Noise Planner: Chelsea Fordham
- Senior Noise Planner: Alesia Hsiao
- Principal Air Quality Planner: Jessica Range

### H.2 Department of Building Inspection

Department of Building Inspection, City and County of San Francisco  
1660 Mission Street  
San Francisco, CA 94103

- Acting Deputy Director for Plan Review/Manager of Plan Review: Gary Ho
- Southeast Plan Review Supervisor: Richard Tam

### H.3 Office of the City Attorney

Office of the City Attorney, City and County of San Francisco  
City Hall, Room 234  
1 Dr. Carlton B. Goodlett Place  
San Francisco, CA 94102

- City Attorney: John Malamut

### H.4 Environmental Consultants

Environmental Science Associates  
550 Kearny Street, Suite 800  
San Francisco, CA 94108

- Project Manager: Susan Yogi
- Project Director: Hillary Gitelman
- Deputy Project Manager: Paul Stephenson
- Air Quality and Health Risk Assessment: Brian Schuster
- Air Quality and Health Risk Assessment: Sarah Patterson
- Noise: Chris Sanchez

- Environmental Planner: Elliott Schwimmer
- Historic Resources: Johanna Kahn
- Archeological Resources: Matt Russell
- Archeological Resources: Paul Zimmer
- Archeological Resources: Heidi Koenig
- Transportation and Circulation: Shadde Rosenblum
- Geology and Soils, Hazards and Hazardous Materials: Michael Burns
- Word Processing: Joel Miller
- Graphics: Ron Teitel, James Songco
- Document Production: Logan Sakai

#### **CHS Consulting Group**

220 Montgomery Street, Suite 346  
San Francisco, CA 94104

- Project Manager: Migi Lee
- Project Principal: Chi-Hsin Shao

### **H.5. Project Sponsor**

#### **Millennium Tower Homeowner's Association**

301 Mission Street, Level B-1  
San Francisco, CA 94103

- Howard Dickstein

#### **J. Abrams Law, P.C.**

One Maritime Plaza, Suite 1900  
San Francisco, CA 94111

- Jim Abrams
- Nick Roosevelt

#### **Simpson Gumpertz & Heger**

100 Pine Street, Suite 1600  
San Francisco, CA 94111

- Ronald Hamburger, PE, SE
- Stephen Harris, SE

#### **Slate Geotechnical Consultants**

490 43rd Street  
Oakland, CA 94609

- Debra Murphy

#### **John Egan, PE, GE**

766 Brookside Drive  
Danville, CA 94526

#### **CBG**

2633 Camino Ramón #350  
San Ramon, CA 94583

- Angelo Obertello

#### **AllWest Environmental**

2141 Mission Street, Suite 100  
San Francisco, CA 94110

- Marc Cunningham
- Leonard Niles, PG, CHG

#### **Shimmick Construction Company, Inc.**

8201 Edgewater Drive, Suite 202  
Oakland, CA 94621

- Drew Weichert
- Aron Oshio
- Anthony Lucido
- Rusty Lucido

#### **Mission Street Development LLC**

735 Market St #6  
San Francisco, CA 94103

- Steven Hood

Appendix A  
**Construction Transportation  
Management Plan**



# 301 Mission Street Perimeter Pile Upgrade Project Transportation Management Plan

Final – October, 2019

Prepared For: City and County of San Francisco Planning Department  
Case No.2018-016691ENV

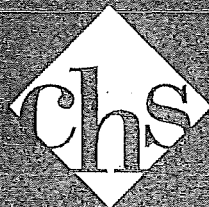

Consulting Group

220 Montgomery Street, Suite 346 San Francisco, CA 94104

## TABLE OF CONTENTS

<b>1.0 INTRODUCTION .....</b>	<b>1</b>
1.1 PROJECT SITE.....	1
1.2 PROJECT DESCRIPTION .....	2
<i>Affected Public Rights-of-Way</i> .....	3
<i>Construction Access Routes</i> .....	7
<b>2.0 TRANSPORTATION MANAGEMENT PLAN.....</b>	<b>9</b>
2.1 PUBLIC TRANSIT.....	10
2.2 MOTORIZED VEHICLES .....	11
2.3 WALKING/ACCESSIBILITY.....	13
2.4 BICYCLING.....	14
2.5 PASSENGER AND COMMERCIAL LOADING .....	14
2.6 EMERGENCY ACCESS.....	15
2.7 CONCURRENT CONSTRUCTION PROJECTS .....	16
2.8 TMP IMPLEMENTATION AND MONITORING .....	17
2.9 CONTINGENCY PLAN .....	17
2.10 OPERATIONAL PLAN .....	18
<b>3.0 SUMMARY.....</b>	<b>19</b>

### LIST OF FIGURES

Figure 1 – Construction Boundary during Stages 1 through 5.....	5
Figure 2 – Construction Boundary during Stage 6.....	6
Figure 3 – Construction Truck Access Routes .....	8
Figure 4 –TMP Strategies .....	23

### LIST OF TABLES

Table 1 – Construction Schedule and Travel Demand .....	2
Table 2 – Summary of Transportation Management Strategies .....	19

### APPENDICES

Appendix A	Baseline Roadway Geometry
Appendix B	Existing and Baseline Volumes Summary Memorandum
Appendix C	Project Volumes Summary

# 1.0 INTRODUCTION

---

The purpose of this Transportation Management Plan (TMP) is to provide a comprehensive set of approaches and strategies that would minimize potential transportation impacts related to the construction of the proposed Perimeter Pile Upgrade Project at 301 Mission Street (herein referred to as the “proposed project” or “project construction”). The objectives are to maintain a safe and efficient movement of motorized vehicles, pedestrians, transit passengers, bicycle traffic and commercial traffic through and around the construction zone and to provide public awareness of potential impacts on Fremont, Mission, and Beale streets. The TMP was prepared in collaboration with the Millennium Tower Homeowners’ Association (MTHA), Shimmick Construction (Contractor), San Francisco Municipal Transportation Agency (SFMTA), and San Francisco Planning Department (SF Planning Department). Regional public transit agencies were also consulted during the preparation of this TMP.

## 1.1 Project Site

The project site is in the public right-of-way on Mission and Fremont streets adjacent to the parcel at 301 Mission Street which is occupied by two buildings: a 645-foot-tall Millennium Tower (301 Mission Street) on the western portion of the site and a 125-foot-tall structure and atrium (collectively called the Podium building) on the eastern portion. The Tower and Podium buildings include 551,000 square feet of residential space (419 dwelling units), 9,400 square feet of ground level retail/commercial space (bank and restaurant), and 24,365 square feet of open space. There are 339 parking spaces contained within four basement levels under the Podium building. Three off-street loading docks are located at the southeast corner of the parcel: two are equipped with loading dock equipped to level to the height of the truck being loaded/unloaded, and reserved in 4-hour increments on weekdays only; and the third is for shorter-duration drop-off activities such as food delivery, mail, and package delivery seven days a week.

There is a two-way driveway on the south side of the two buildings, connecting Fremont Street to Beale Street. This driveway provides vehicular ingress/egress to the parking garage and loading facilities. The driveways are 30 feet wide and 27 feet wide on Fremont and Beale streets, respectively. Additionally, a porte cochere off the driveway accommodates passenger loading for residents. Pedestrian access to the ground-floor bank in the Tower building is from Mission Street near the Fremont Street intersection. Pedestrian access to the Tower and Podium residences are available from the porte cochere and Mission and Beale streets. Pedestrian access to the restaurant is provided along Mission and Beale Streets. An approximately 100-foot-long on-street passenger loading/unloading zone and a 20-foot-long on-street commercial loading/unloading zone are located adjacent to the Podium building frontage on Mission Street. There are no vehicle curb cuts along the Mission Street frontage. There is no curbside on-street parking permitted along the Mission, Fremont, and Beale Street frontages. There are no existing bicycle facilities on Fremont, Mission, or Beale streets.



The MTHA has provided data showing that the Tower has experienced differential settlement due to consolidation and compression of the soil layer beneath the Colma Sand, which is known as Old Bay Clay. The MTHA has provided monitoring data indicating that the greatest amount of settlement at 17.3 inches has occurred at the northwest corner of the Tower near the corner of Fremont and Mission streets.

## 1.2 Project Description

The proposed project consists of a structural upgrade related to the Tower foundation that includes installation of an extension of the existing mat foundation at the northwest corner of the Tower, supported by 52 new piles extending to bedrock. The proposed project would be constructed in six stages, spanning over approximately 22 months (640 days), and it is anticipated to begin in early 2020. It is assumed that construction would continue to occur during the holiday moratorium period.<sup>1</sup> Construction activities would occur Monday through Friday from 7 a.m. to 8 p.m. for the entire duration of project construction (Stages 1 through 6). It is noted that during Stages 3 and 4, there would be a second shift on weekdays from 8 p.m. to 7 a.m. to receive overnight deliveries for approximately two to three nights per week. These deliveries would involve the use of a crane and fork lift. Construction may occur on Saturdays and Sundays when needed during any stage.<sup>2</sup> Table 1 shows the estimated number of construction workers and truck demand generated for each construction stage. The estimated maximum number of daily workers on site during any stage would be 22; the estimated number of daily trucks would range from 10 to 25, generating up to 50 daily truck trips assuming one inbound trip and one outbound trip for each truck.

**Table 1 – Construction Schedule and Travel Demand**

Construction Stage and Activity	Expected Duration (days) <sup>1</sup>	Number of Daily Workers		Number of Truck Loads <sup>2</sup>					
		Shift 1	Shift 2	Material Deliveries <sup>3</sup>			Export/Import		
				Total	Daily	Peak Hour	Total	Daily	Peak Hour
1. Site Preparation, Mobilization, and Test Pile	90	11	-	107	10	3	0	0	0
2. Demolition and Shoring	60	11	-	74	10	3	34	10	3
3. Installation of Outer Casings and Piles	160	11	10	107	10	3	75	10	5
4. Piling and Mat Slab Extension	110	22	10	115	10	3	250	10	5
5. Mat Slab Extension	90	11	-	82	10	3	150	10	5
6. Jacking, Vault	130	15	-	74	10	3	106	15	5

<sup>1</sup> MTHA would apply for a holiday construction moratorium waiver and continue with construction activities between the day after Thanksgiving and January 1.

<sup>2</sup> Since the project site includes public right-of-ways in the *Area of Important Streets* per the Blue Book, all construction activities and hours for the proposed project need to be approved by the SFMTA.

Construction, Backfill, and Site Restoration								
<b>Total Construction</b>	<b>640</b>			<b>559</b>			<b>615</b>	

Source: Millennium Tower Homeowners Association, 2019.

Notes:

1. Represents the overall duration from start to end dates of each stage. The actual number of work days during each stage would be shorter than the overall duration due to weekends and holidays.
2. Each truck load is assumed to carry 10 cubic yards of import/export materials. Each truck load would generate two trips including one inbound trip and one outbound trip per truck load.
3. Include deliveries of ready mix concrete, drill casing, drilled shaft rebar, equipment, and supplier deliveries.

Affected Public Rights-of-Way

Before construction activities begin, the Contractor would install both concrete barriers (e.g., k-rail) and fences along the outer side of the closed lanes on Fremont and Mission streets, and fences along the outer edge of the sidewalk on Beale Street. All construction activities would be contained inside the concrete barriers and fences. The Contractor would then install protected pedestrian walkways and prepare the construction site to allow for staging, truck and equipment access, and protection or relocation of utilities. The project construction would affect the following public rights-of-way:

- Fremont Street – Fremont Street would have one left-turn lane, one through lane, and one through and right-turn shared lane in the northbound direction. The Contractor would install concrete barriers and fences approximately 12 feet west of the Fremont Street east sidewalk between the northern edge of the driveway and Mission Street. This change would require a temporary closure of four elements within the public right-of-way for the entire duration of project construction from Stages 1 through 6. Those four elements would be: 1) the northbound exclusive right-turn lane approaching Mission Street, 2) the Fremont Street east sidewalk along the Tower frontage, 3) the nearside Golden Gate Transit bus stop near the southeast corner of the Fremont Street/Mission Street intersection, and 4) south and east crosswalks at the Fremont Street/Mission Street intersection. Muni guy poles currently installed in the sidewalk (and associated overhead electric trolley wires) would be relocated approximately 10 feet westward.<sup>3</sup>
- Mission Street – Mission Street would have two eastbound lanes and one westbound lane. The Contractor would install concrete barriers and fences approximately 11.6 feet north of the Mission Street existing south sidewalk between Fremont and Beale streets. This change would require a temporary closure of two elements within the public right-of-way for the entire duration of project construction from Stages 1 through 6. Those two elements would be: 1) the eastbound bus-only lane and 2) the western half of the Mission Street south sidewalk. The ground floor bank would remain closed during construction. An approximately four-foot-wide pedestrian walkway with overhead and side protection would be constructed along the Mission Street frontage between Beale Street and the Tower and Podium building entrance to provide

<sup>3</sup> Muni guy poles provide support to the Overhead Contact System (OCS) for Muni electric trolley buses. Per SFMTA requirements, these poles must be placed no further than 100 feet apart.

access to the residences and the ground floor restaurant. As a result, pedestrian right-of-way along the eastern half of the Mission Street south sidewalk would be reduced from 15 feet to approximately four feet in width. Muni guy poles currently installed in the sidewalk (and associated overhead electric trolley wires and the switch that allows trolley buses to make the right turn from eastbound Mission Street onto southbound Beale Street) would be relocated approximately 15 feet northward.

- Beale Street – The Contractor would install fences along the outer edge of the Beale Street west sidewalk between the northern edge of the driveway and Mission Street. An approximately four-foot-wide pedestrian walkway with overhead and side protection would be constructed along the Beale Street frontage. As a result, pedestrian right-of-way along the Beale Street west sidewalk would be reduced from 23 feet to approximately four feet in width during Stages 1 through 5. During Stage 6, the sidewalk along Beale Street frontage would be restored to full width for pedestrians. There would be no closure of existing travel lanes.

There would be breaks in the concrete barriers and fences to allow construction vehicle access as well as San Francisco Fire Department access to fire department connections. The driveway between Fremont and Beale streets would be kept open at all times, except for approximately 40 to 50 days in Stage 3. During that period, vehicular access to and from the existing development site would be maintained at Beale Street only, with vehicular turn around allowed within the driveway. **Figure 1** presents the construction boundary for Stages 1 through 5 and description of the proposed changes compared to the Baseline condition.<sup>4</sup> **Appendix A** includes a figure depicting the Baseline Condition for reference. **Figure 2** presents the construction boundary for Stage 6 and description of the proposed changes compared to Stage 5.

---

<sup>4</sup> Baseline Condition assumes the Transbay Transit Center is reopened and there would be changes to transit routes operating along Mission, Fremont, and Beale streets.

1796

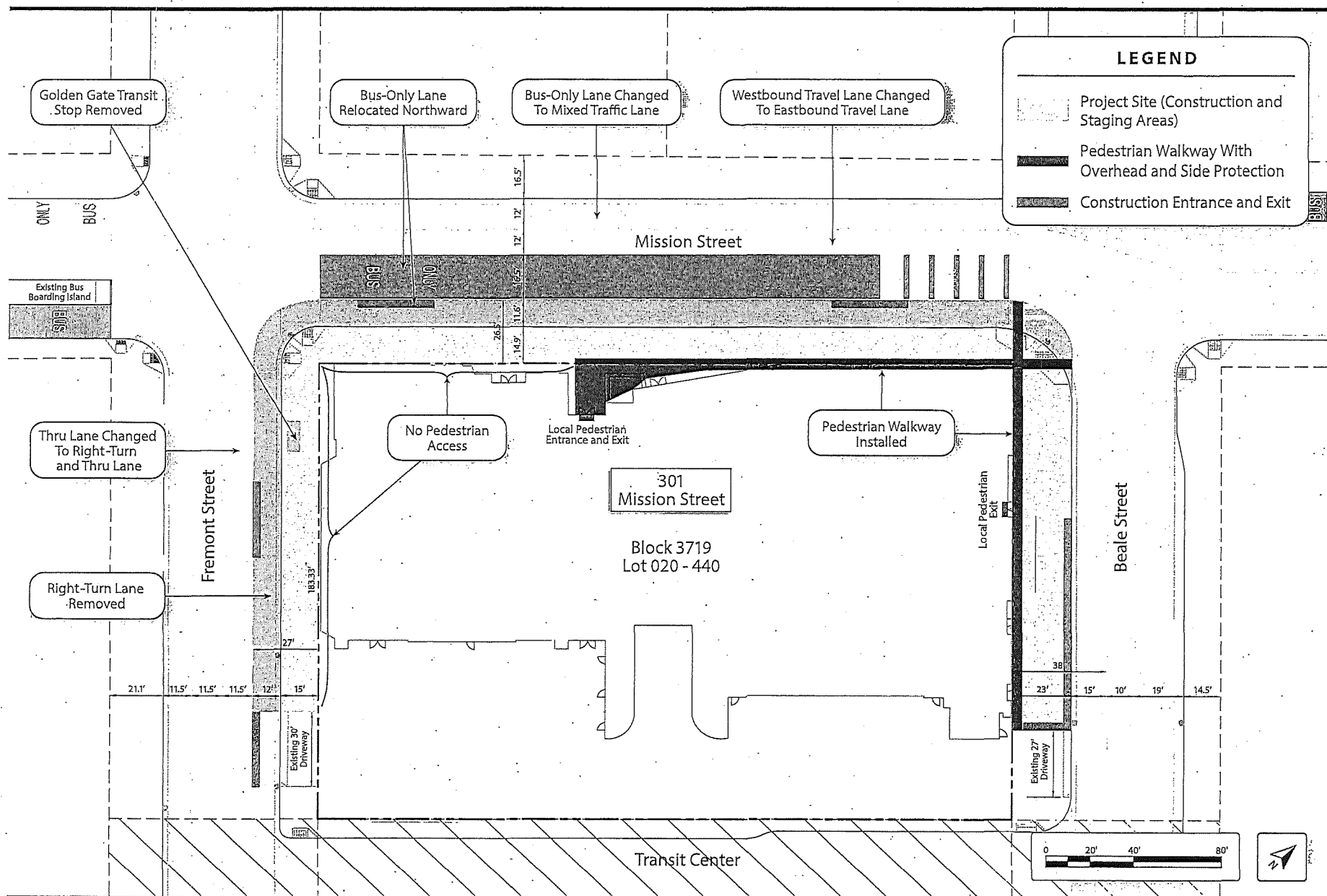

301 Mission Street Seismic Upgrade Project Transportation Management Plan - Final



Figure 1 Construction Boundary During Stages 1 Through 5 and Changes From Baseline Condition

1797

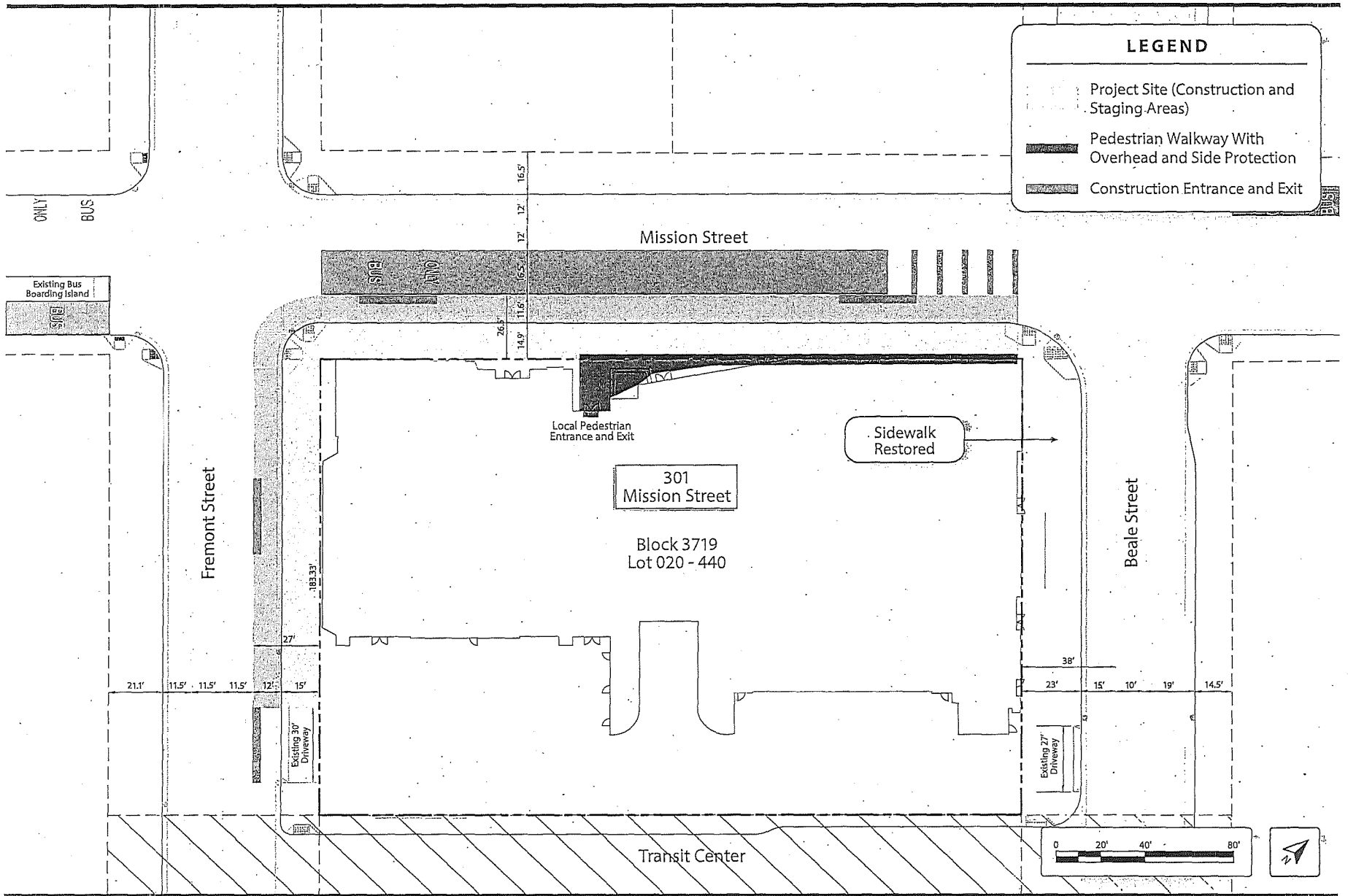

301 Mission Street Seismic Upgrade Project Transportation Management Plan - Final

### Construction Access Routes

The majority of construction trucks are expected to approach the project site from northbound Fremont Street, and enter the construction staging area through the gates/breaks provided along the construction site perimeter on Fremont Street, Mission Street, or Beale Street. When trucks enter the staging area from Beale Street, they would back into the staging area from southbound Beale Street. Approximately 50 total truck loads would be needed to haul the demolition debris to appropriate sites for disposal or recycling. Exact locations of potential disposal sites are unknown at this time, but it is anticipated that they would be in the East Bay. **Figure 3** presents anticipated construction truck routes to and from the project site.

The Contractor would provide off-site staging areas for materials and supplies that cannot be located on site due to space constraints. The exact locations of staging areas are undetermined at this time, but it is anticipated that they would be within five miles of the project site. The Contractor would not provide any worker parking spaces either on-site or at off-site staging areas, but workers would be paid for off-site parking or public transportation costs to the site.

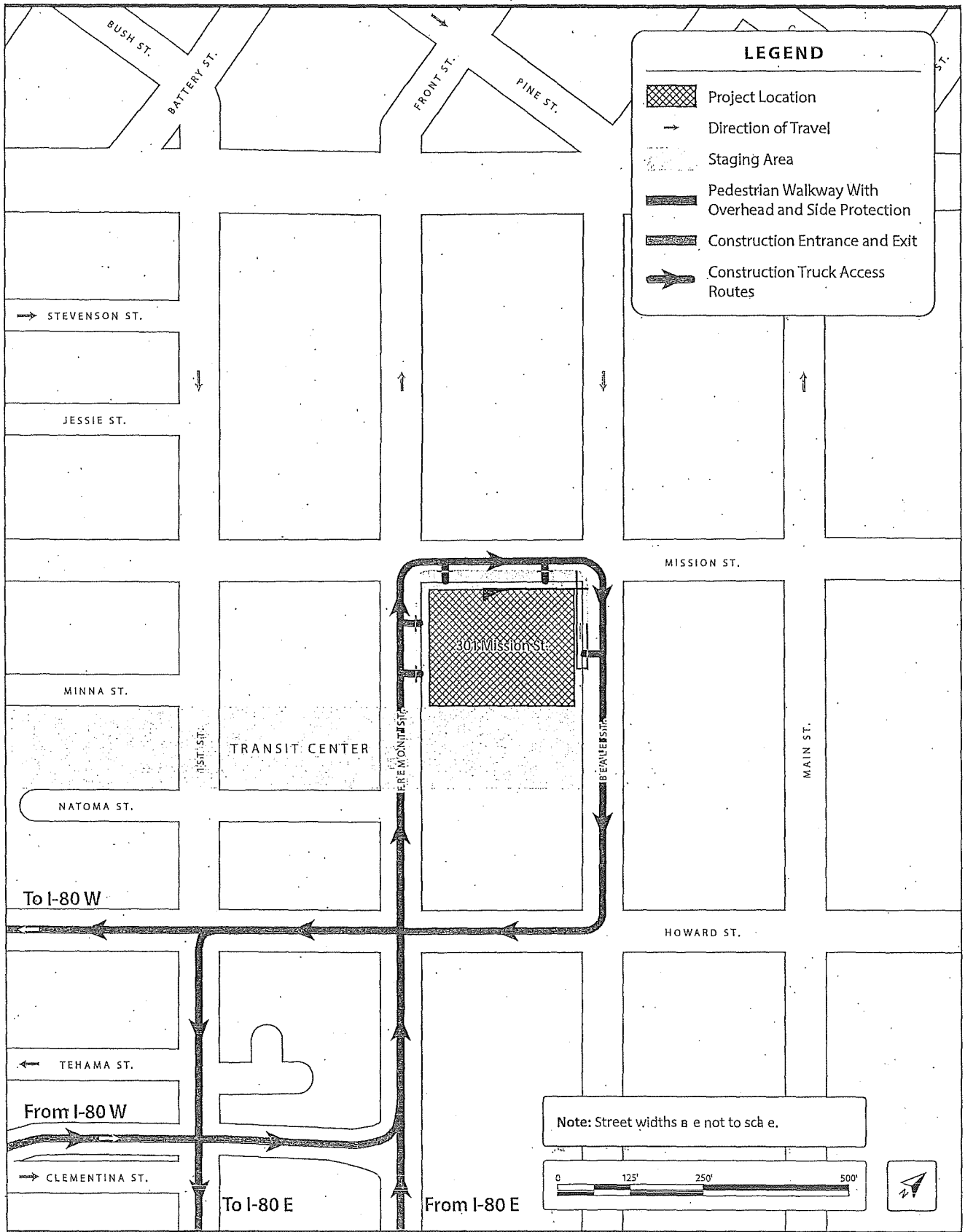

301 Mission Street Seismic Upgrade Project Transportation Management Plan - Final

## 2.0 TRANSPORTATION MANAGEMENT PLAN

---

The Contractor will be required to follow the City of San Francisco's *Regulations for Working in San Francisco Streets (the "Blue Book")* published by the SFMTA and San Francisco Public Works' regulations during the construction period. The *Blue Book* establishes rules and guidance so that work can be done safely and with the least possible interference with pedestrians, bicycle, transit and vehicular traffic. It also describes permits contractors must obtain from SFMTA. All traffic control, warning and guidance devices must conform to the California Manual on Uniform Traffic Control Devices (MUTCD). It is the policy of SFPW that a safe and accessible path of travel be provided for all pedestrians, including those with disabilities, around and/or through construction sites.<sup>5</sup> In addition, per the State of California Division of Occupational Safety and Health (CAL OSHA) regulations, any boom type equipment that moves vertically must maintain a ten-foot radial clearance and any other equipment must maintain a six-foot clearance from Muni overhead wires.

TMP lays out a set of strategies designed to manage construction impacts of the proposed project based on the understanding of transportation conditions prior to the start of construction, but some of the TMP strategies may be adjusted based on conditions at the time of construction commencement. Therefore, the proposed strategies are grouped into the following three categories to help understand the likelihood of implementing different strategies:

- Strategies that shall be implemented with certainty – Many of these strategies are required as part of the Blue Book, and SFPW and CAL OSHA regulations.
- Strategies that could be implemented based on conditions at the time of construction commencement – Adjustments or additional coordination may be needed by responsible parties depending on transportation conditions at the time of construction commencement.
- Strategies that could be explored for the purpose of the TMP, but may not be feasible to implement – They are recommended to improve transportation conditions but are not required.

The following sections present TMP strategies for each mode of travel (transit, motorized vehicles, pedestrian, bicycling, loading, and emergency access), TMP implementation and monitoring plans, and contingency and operational plans. **Appendix B**, the Existing and Baseline Volumes Summary Memorandum, includes transit, traffic, pedestrian, bicycle, and loading volumes under the Existing and Baseline Conditions. **Appendix C**, Project Volumes Summary, includes the transit, traffic, pedestrian bicycle, and loading volumes affected during the project construction.

---

<sup>5</sup> San Francisco Public Works. 2008. *Guidelines for the Placement of Barricades at Construction Sites* (Order No. 167,840). Online at [http://sfpublicworks.org/sites/default/files/Guidelines for Placement of Barricades 0.pdf](http://sfpublicworks.org/sites/default/files/Guidelines%20for%20Placement%20of%20Barricades%200.pdf). Accessed May 23, 2019.



## 2.1 Public Transit

The proposed project would relocate Muni guy poles and associated overhead electric trolley wires along Mission and Fremont Streets. In addition, Muni Routes 5, 5R, 7, 38, and 38R, which run eastbound on Mission Street and make a right-turn on southbound Beale Street to Transbay Transit Center, would be temporarily rerouted to run eastbound on Market Street and make a right-turn on southbound Beale Street.<sup>6</sup> These routes would temporarily use the existing midblock Muni stop on the west side of Beale Street between Market and Mission streets. The existing Muni Route 14 stop on north side of Mission Street west of Beale Street would be temporarily closed.

The existing Golden Gate Transit stop on Fremont Street adjacent to the Tower serving Routes 2, 4, and 27 would be removed and relocated to another Golden Gate Transit stop located on the east side of Fremont Street north of Mission Street. That stop is currently used by Golden Gate Transit's part-time Routes 38, 44, and 58. Since Route 27 operates full-time between 4:30 a.m. and 7:40 p.m. and Routes 2 and 4 operate part-time, Golden Gate Transit would consider moving one or all three part-time routes (38, 44, and 58) to another Golden Gate Transit stop further north on Fremont Street to accommodate these routes.

Golden Gate Transit Routes 30, 70, 101, 101X and SamTrans Routes 292 and 398 travelling eastbound on Mission Street currently use the curbside stop on Mission Street by Salesforce Tower to drop off passengers. Due to the closure of the eastbound bus-only lane on Mission Street, these routes would be required to maneuver from the curb lane west of Fremont Street to the restriped bus-only lane located east of Fremont Street, and make a right-turn onto southbound Beale Street around the proposed construction staging area.

The contractor would use the following strategies to maintain reliable access to public transit and reduce potentially hazardous conditions related to transit operations during project construction:

### Strategies that shall be implemented

- The existing "Bus Only" signs mounted on the north sidewalk of Mission Street shall be removed or covered during the project construction.
- Concrete barriers and fences including signs bordering the project site shall not encroach onto the adjacent bus-only lane on eastbound Mission Street, and eleven-foot-width shall be maintained for the eastbound bus-only lane on Mission Street between Fremont and Beale streets.
- At least one sign shall be provided and continuously maintained at bus stops (for Routes 5, 5R, 7, 14, 38, and 38R) that SFMTA has authorized to be closed or relocated, and at the new bus stop

<sup>6</sup> The Transbay Transit Center is considered a near-term baseline because it was temporarily closed due to structural repair at the commencement of this Initial Study. However, the repair has been completed and the transit center is fully operational as of Monday, August 12, 2019.

location. The sign(s) shall indicate the routes affected, new stop location, and the start and end dates.

- The MTHA shall work with Golden Gate Transit and the affected property owner(s) to establish extended or temporary stops for Routes 2, 4, and 27 whose stop on the southeast corner of Fremont/Mission intersection is proposed for removal during the project construction.
- Golden Gate Transit service changes to Routes 2, 4, and 27 shall be posted at the temporary stop location currently proposed at Fremont Street north of Mission Street.
- Trolley buses operating along Fremont Street (Routes 5 and 5R) and Mission Street (Route 14) shall reach the overhead trolley wires when going around the work area.

Strategies that could be implemented based on conditions at the time of construction commencement

- The closest lane to the construction staging area on eastbound Mission Street could be marked "Bus and Taxi Only" or painted in red.
- The repurposed westbound travel lane on Mission Street could have the existing red paint removed to indicate that mixed-flow traffic is allowed.
- Golden Gate Transit could consider relocating stop for Routes 2, 4, and 27 to the east side of Fremont Street north of Mission Street.
- Golden Gate Transit and SamTrans buses could continue to use the existing eastbound Mission Street bus lane west of Fremont Street and continue to the restriped bus lane east of Fremont. Alternatively, Golden Gate Transit and SamTrans could work with SFMTA to use the existing Muni boarding island on eastbound Mission Street west of Fremont Street.

Strategies that could be explored for the purpose of TMP, but may not be feasible to implement

- The existing westbound traffic signal at the Mission Street/Beale Street intersection could be modified to include a "Queue Jump Signal", which would allow westbound transit buses to have a priority movement before general traffic. Alternately, during the first week of project construction, SFMTA could dispatch Parking Control Officers (PCOs) to manually manage traffic at Beale Street/Mission Street intersection during the AM (7 a.m. to 9 a.m.) and PM (4 p.m. to 6 p.m.) peak periods.

## 2.2 Motorized Vehicles

During the project construction, Mission Street would have two eastbound lanes and one westbound lane between Fremont and Beale streets. The number one westbound lane would be converted to eastbound, and the existing number two eastbound bus-only lane would be relocated to the number one eastbound travel lane. Muni buses in the westbound direction would share the travel lane with general traffic in the same direction. The existing right-turn pocket on northbound Fremont Street turning onto eastbound Mission Street would be removed, and the number three lane would be converted to a through-movement and right-turn shared lane. There would be no change in travel lanes on Beale Street. **Figures 1 and 2** above present the lane striping changes during the project construction.

The contractor would use the following strategies to manage traffic:

### Strategies that shall be implemented

- The existing number three lane on Fremont Street shall include a shared through and right-turn arrow pavement marking to allow northbound movement to share the lane with right-turning vehicles.
- No project construction truck traffic shall be allowed on eastbound Mission Street during the AM (7 a.m. to 9 a.m.) and PM (4 p.m. to 6 p.m.) peak periods.
- No project construction truck traffic shall be allowed on northbound Fremont Street during the AM (7 a.m. to 9 a.m.) peak period.
- An Extralegal Truck Permit shall be applied for a vehicle travelling on local streets for any distance within the City of San Francisco if the overall dimensions and/or weight exceed 8.5 feet in width, 65 feet in length, 14 feet in height, and over 34,000 pounds weight on any one axle.
- When trucks make egress movements at the construction entrance/exit on Fremont, Mission, or Beale Street, flaggers, a temporary stop sign, or a combination of these methods shall be used to slow approaching traffic.
- Fences shall be installed at least one foot clear from the edge of the adjacent travel lane (i.e., to prevent side mirrors hitting the fence).
- “Road Work Ahead” signs, “Right Lane Closed Ahead” signs, and illuminated Arrow Board Displays shall be posted on the south side of Mission Street west of Fremont Street, and on Fremont Street south of Howard Street for advanced notice.
- Advance warning signs (e.g., reverse curve sign) shall be installed on Mission Street west of Fremont Street and east of Beale Street to give road users advance notice of travel lane shifts and to minimize associated hazards.
- Construction Worker Trip Reduction (CWTR) program shall be implemented to encourage workers to carpool, use transit, walk, or bike to the project site. CTMR program measures may include, but are not limited to, providing the City’s Commuter Benefits Program, subsidizing public transit fares, providing a sufficient number of bicycle parking spaces on site, charging construction workers for parking at off-site staging areas, and implementing parking cash out program in place of providing free parking. Commuter Benefits Program, subsidizing public transit fares, and implementing parking cash out program in place of providing free parking.

### Strategies that could be implemented based on conditions at the time of construction commencement

- The existing westbound bus lane striping between Fremont and Beale streets could be removed to indicate general traffic is allowed.
- The existing number two eastbound bus lane on Mission Street between Fremont and Beale streets could be painted in the relocated bus lane.

### Strategies that could be explored for the purpose of TMP, but may not be feasible to implement

- The existing westbound traffic signal at the Mission Street/Beale Street intersection could be modified to include a “Queue Jump Signal” to allow westbound transit buses to have a priority movement before general traffic.

## 2.3 Walking/Accessibility

Pedestrian crossings at the Mission Street/Fremont Street intersection would be directed to use the north and west crosswalks only, and pedestrians walking along the east side of Fremont Street south of the project site would be directed to use the west sidewalk at both Howard and Natoma streets. Pedestrian signage would be provided at the southwest corner of Mission Street/Beale Street intersection to indicate the Mission Street walkway is for access to the 301 Mission Street building only, and the Beale Street walkway is narrowed to approximately four feet wide.

The contractor would employ the following strategies to manage pedestrian access and reduce potentially hazardous conditions for pedestrians during project construction:

### Strategies that shall be implemented

- “Sidewalk Closed Ahead/Local Access Only/Cross Here” signs shall be posted on the south side of Mission Street east of Beale Street to divert pedestrians towards alternative crosswalks prior to reaching the Mission Street/Beale Street intersection except for the tenants and visitors to 301 Mission Street.
- “Sidewalk Closed /Use Other Side/Cross Here” signs shall be posted to divert pedestrians towards alternative crosswalks prior to reaching the Mission Street/Fremont Street intersection at the following locations: on the south side of Mission Street west of Fremont Street; along the east side of Fremont Street north of Mission Street, and south of Natoma Street.
- Signs shall be posted on the Minna Street sidewalks east of Fremont Street to inform pedestrians that Fremont Street sidewalk to the north is closed and to divert them towards Howard Street.
- Signs shall be placed on the Beale Street west sidewalk north of Mission Street and south of the project site, to inform pedestrians of the narrowed pedestrian right-of-way, of approximately four feet in width, between Mission Street and the driveway, and to suggest using alternate intersections, if possible.
- Pedestrian barricades shall be installed at the north end of the east crosswalk and the west end of the south crosswalk at the Mission Street/Fremont Street intersection.
- Flaggers shall be required where workers or equipment temporarily block a pedestrian walkway for access into and out of a construction area (e.g., near Mission Street/Beale Street intersection).
- Pedestrian walkways shall maintain a minimum four-foot width and smooth surface for wheelchair access. It shall include ADA compliant wheelchair ramps for connection to the west and the south crosswalks at the Mission Street/Beale Street intersection.

- Pedestrian walkways shall be designed to provide a clear view of the oncoming eastbound traffic on Mission Street and southbound traffic on Beale Street for pedestrians waiting to cross the west and south crosswalks; respectively, at the Mission Street/Beale Street intersection.
- Pedestrian walkways shall include lighting for pedestrians at all times.
- Pedestrian walkways shall be regularly maintained and kept clear of potential construction hazards, such as holes, cracks, debris, dust, and mud.
- Pedestrian facilities including sidewalks and street trees shall be restored to their original condition.

Strategies that could be implemented based on conditions at the time of construction commencement

- All or a portion of the southwest corner of Mission Street/Beale Street intersection could be restored to existing condition during Stage 6, to provide a wider pedestrian right-of-way along Beale Street (i.e., wider than four feet) for those crossing from the northwest corner of the intersection.

## 2.4 Bicycling

Bicycle travel patterns would not change, as there are no existing bicycle facilities (e.g., class 2 bicycle lanes) along the Fremont, Mission, and Beale Street project frontages. While the elimination of one travel lane along Mission and Fremont streets would increase vehicular traffic volume in the remaining travel lanes, it would have minimum impacts on bicycle traffic.

The contractor would employ the following strategies to manage bicycle access and reduce potentially hazardous conditions for bicyclists during project construction:

Strategies that shall be implemented

- “Bicycle Crossing/ Share the Road” signs and sharrow pavement markings shall be placed along the south side of Mission Street west of Fremont Street for eastbound bicyclists, on the north side of Mission Street east of Beale Street for westbound bicyclists, and on Fremont Street north of Howard Street for northbound bicyclists along the construction frontage.
- “Trucks Crossing” signs, a temporary stop sign, flaggers or a combination of these methods shall be used to alert bicyclists of construction trucks making wide turns in and out of the access points of the construction zone on Fremont, Mission, or Beale Street.

## 2.5 Passenger and Commercial Loading

As part of the proposed project, the existing 100-foot-long white passenger loading zone and 20-foot-long yellow commercial loading zone located adjacent to the Podium building frontage on Mission Street would be removed. There would be no change to loading facilities along Fremont and Beale Streets as these two sections have no existing passenger or commercial loading zones. The nearest on-street loading zones include a 65-foot-long white passenger loading zone on the west side of Beale Street

north of Mission Street (approximately 340 feet from the project site) and a 90-foot-long yellow zone on the east side of Fremont Street north of Mission Street (approximately 300 feet from the project site).

The contractor would use the following strategies manage access related to passenger and commercial loading operations during project construction:

Strategies that shall be implemented

- “No Stopping and Tow-Away” signs shall be posted on the construction fences along Fremont, Mission, and Beale Street frontages to prohibit any on-street loading occurrences.
- Residents of the Tower and Podium buildings shall be notified to use the porte cochere off the two-way driveway for all passenger and commercial loading occurrences.
- The restaurant tenant shall notify patrons of changes in site access on their website and encourage patrons to use other nearby passenger loading zones.
- Transportation Network Companies (TNC) shall be notified to implement geofencing around the project frontages to prohibit loading activities.
- The MTHA shall provide required residential loading spaces (approximately six spaces) in the porte cochere.

Strategies that could be implemented based on conditions at the time of construction commencement

- Illegal loading occurrences along the project site frontages could be enforced by PCOs during the AM (7 a.m. to 9 a.m.) and PM (4 p.m. to 7 p.m.) peak periods or using cameras installed on Muni vehicles.

Strategies that could be explored for the purpose of TMP, but may not be feasible to implement

- The project sponsor could work with SFMTA to temporarily convert convenient on-street parking locations to loading, such as some of the motorcycle parking on the south side of Mission Street east of Beale Street to passenger loading to replace the passenger loading space on Mission Street between Beale and Fremont Streets that would be removed during project construction.

## 2.6 Emergency Access

The nearest San Francisco Fire Department (SFFD) fire stations and San Francisco Police Department (SFPD) stations include:

- Fire Station No. 35 at 399 The Embarcadero (about 0.4 miles west of the project site)
- Fire Station No. 1 at 935 Folsom Street (about one mile southwest of the project site)
- Fire Station No. 13 at 530 Sansome Street (about 0.5 miles northwest of the project site)
- SF Police Southern Station at 1251 3rd Street (about 1.3 miles southeast of the project site)

The following strategies are proposed to accommodate emergency services access during project construction:

Strategies that shall be implemented

- Contractors shall coordinate with administrators of the nearest emergency service providers and provide advance notification of the timing, location, and duration of construction activities, including lane closures and suggested alternative routes.
- Breaks in the barriers shall be provided along the construction site perimeter to allow construction traffic, and allow SFFD access to fire department connections at all times.<sup>7</sup>

## 2.7 Concurrent Construction Projects

The following two projects may potentially overlap with the timeline of the project construction and its geographic boundary<sup>8</sup>:

- Transbay Block 4/ 200 Folsom Street/ 200-272 Main Street (Planning Department Case No. 2018-015785ENV) – The project would construct a 47-story, 501-foot-tall building containing a total of approximately 683 dwelling units, ground-floor-retail, and an underground garage with 327 parking spaces. The construction schedule is unknown at this time.
- Active Beale Street – On Beale Street SFMTA would implement 1) a transit-only lane on westside Beale Street from Market Street to Natoma Street; 2) a protected, two-way cycle track on eastside Beale Street from Market Street to Folsom Street; 3) an extension of the existing bus zone on westside Beale Street between Market and Mission Streets; 4) wider sidewalks near Market Street and between Howard and Folsom streets; 5) protected bicycle turn boxes at the Beale Street/Howard Street intersection; 6) a loading zone on westside Beale Street between Howard and Folsom streets; and 7) restoring a casual carpool pick-up zone on westside Beale Street between Howard and Folsom streets. The construction may begin as early as winter 2020.

Increases in construction traffic and roadway constraints on Beale Street may be expected if the proposed project construction overlaps with one or more of the above-listed projects. The Contractor shall be required to work with the City Transportation Advisory Staff Committee (TASC) and the concurrent construction project sponsors to minimize any potential overlapping construction transportation impacts. The Contractor, in conjunction with the concurrent construction project sponsors, shall propose a construction traffic management plan that includes measures to reduce

<sup>7</sup> There are three existing fire department connections mounted on each side of the building on Fremont, Mission, and Beale Street frontages. These fire department connections would be modified and extended from the building face to the edge of the construction zone, to allow the fire department to maintain access.

<sup>8</sup> For the purpose of TMP, the geographic boundary for concurrent construction projects is Market Street to the north, Folsom Street to the south, First Street to the west, and Main Street to the east.

potential construction traffic conflicts, such as staggering start and end times or adjusting the overall construction schedule.

## 2.8 TMP Implementation and Monitoring

The Contractor would be required to coordinate with various City departments such as SFMTA, SFPUC and SFPW through the TASC to develop coordinated plans that would address construction-related vehicle routing and transit, bicycle and pedestrian movements near the project site for the entire duration of project construction (Stages 1 through 6). The MTHA shall for the duration of project construction carry out public outreach to communicate with residents, business owners, and civic stakeholders, by providing all information pertinent to construction activity, sequence, and possible impacts for the proposed project.

The MTHA shall implement the agreed-upon TMP measures, comply with agency policies, and monitor and report to SFMTA whether the impacts meet the desired level of safety and mobility performance. The MTHA shall keep records of project events and incidents (e.g., queue spillovers, crashes, and complaints) based on field observations, crash data, operational information, and construction and safety inspections. Performance aspects to monitor/measure include safety, recurring congestion, incident-related delay, and community and environmental impacts. In the case of excessive delays resulting in extended queues onto a downstream intersection, the Contractor shall work with SFMTA to adjust work plans, working hours, traffic control plans, and TMP strategies to mitigate these issues.

## 2.9 Contingency Plan

A contingency plan should be prepared to minimize effects on traffic and circulation during project construction when congestion or safety concerns exceed the original TMP estimates. This situation may result from unforeseen events, such as work zone incidents (e.g. work zone crashes, a sewer collapse, essential service interruption or a water main break, unavoidable lane closures beyond the TMP specifications), or higher-than-predicted traffic demand. The following actions shall be incorporated into the contingency plan and provided prior to the start of construction for approval by SFMTA:

- The Contractor shall provide appropriate personnel to monitor activities and make decisions regarding activation of contingency plans. Clearly defined trigger points shall be identified with each critical path activity to establish when the contingency plan is activated.
- The contingency plan shall list and describe all standby equipment and secondary material suppliers that can be made available to complete the operations in the event of equipment failure, or unexpected loss of material.
- The contingency plan shall include a decision tree with clearly defined lines of communication and authority. The names and telephone numbers of the Contractor's Project Manager, San Francisco Police Department, and other applicable City officials shall be provided.
- Traffic handling strategies in the contingency plan shall include notification to transit agencies (Muni, Golden Gate Transit, and SamTrans) and to the media of traffic changes, and activation of alternative routes/detours in the case of work zone incidents resulting in additional lane closures.



## 2.10 Operational Plan

After construction is completed, there would be no operational changes to the project components (i.e., structural upgrade made to the Tower foundation within the public rights-of-way) or the Tower and Podium building operations. Pedestrian access, transit circulation, and vehicular access would be restored to existing conditions. Therefore, no additional TMP strategies would be required for operation.

Routine inspections would not be required, but inspections would be performed following a major earthquake. The inspection would require two individuals to remove the vault manhole cover, access the vaults, and visually observe the condition of the jacks, jacking beams, and rods. The Contractor would apply for a non-exclusive easement<sup>9</sup> and other related construction permits to build manholes in sidewalk areas of Fremont and Mission streets to access vaults.

---

<sup>9</sup> A non-exclusive easement will give the MTHA the right to install and maintain the perimeter pile and mat extension system in a public right-of-way, but will not have the right to exclude others from also using the easement area so long as those other users do not conflict with the proposed project.

### 3.0 Summary

Table 2 provides a summary of proposed transportation management strategies by mode and type. Figure 4 provides a visual presentation of physical strategies proposed in the TMP.

**Table 2 – Summary of Transportation Management Strategies**

Mode of Travel	Type <sup>1</sup>	Strategies
Public Transit	Shall Implement	<ul style="list-style-type: none"> <li>• The existing “Bus Only” signs mounted on the Mission Street north sidewalk shall be removed or covered.</li> <li>• Concrete barriers and fences including signs bordering the project site shall not encroach onto the adjacent bus-only lane on eastbound Mission Street, and the eastbound bus-only lane on Mission Street between Fremont and Beale streets shall be at least twelve feet wide during construction.</li> <li>• At least one sign shall be provided and continuously maintained at bus stops (for Routes 5, 5R, 7, 14, 38, and 38R) that SFMTA has authorized to be closed or relocated, and at the new bus stop location. The sign(s) shall indicate the routes affected, new stop location, and the start and end dates.</li> <li>• The MTHA shall work with Golden Gate Transit and the affected property owner(s) to establish extended or temporary stops for Routes 2, 4, and 27 whose stop on the southeast corner of Fremont/Mission intersection is proposed for relocation during the project construction.</li> <li>• Golden Gate Transit service changes to Routes 2, 4, and 27 shall be posted at the temporary stop location currently proposed at Fremont Street north of Mission Street.</li> <li>• Trolley buses operating along Fremont Street (Routes 5 and 5R) and Mission Street (Route 14) shall reach the overhead trolley wires when going around the work area.</li> </ul>
	Could Implement	<ul style="list-style-type: none"> <li>• The closest lane to the construction staging area on eastbound Mission Street could be marked “Bus and Taxi Only” or painted in red.</li> <li>• The repurposed westbound travel lane on Mission Street could have the existing red paint removed.</li> <li>• Golden Gate Transit could consider relocating stop for Routes 2, 4, and 27 to the following locations: the east side of Fremont Street north of Mission Street, the east side of Fremont street south of Howard Street, and the west side of Beale Street north of Mission Street.</li> <li>• Golden Gate Transit and SamTrans buses could continue to use the existing eastbound Mission Street bus lane west of Fremont Street and continue to the restriped bus lane east of Fremont. Alternatively, Golden Gate Transit and SamTrans could work with SFMTA to use the existing Muni boarding island on eastbound Mission Street west of Fremont Street.</li> </ul>
	Could Explore	<ul style="list-style-type: none"> <li>• The existing westbound traffic signal at the Mission Street/Beale Street intersection could be modified to include a “Queue Jump” Signal. Alternately, SFMTA could dispatch parking control officers (PCOs) to manually manage traffic at Beale Street/Mission Street intersection during the AM (7 a.m. to 9 a.m.) and PM (4 p.m. to 6 p.m.) peak periods.</li> </ul>

Motorized Vehicles	Shall Implement	<ul style="list-style-type: none"> <li>• The third travel lane from the west curb/sidewalk on Fremont Street (south of Mission Street) shall include a shared through and right-turn arrow pavement marking.</li> <li>• No project construction truck traffic shall be allowed on eastbound Mission Street during the AM (7 a.m. to 9 a.m.) and PM (4 p.m. to 6 p.m.) peak periods.</li> <li>• No project construction truck traffic shall be allowed on northbound Fremont Street during the AM (7 a.m. to 9 a.m.) peak period.</li> <li>• An Extralegal Truck Permit shall be applied for a vehicle travelling on local streets for any distance within the City of San Francisco if the overall dimensions and/or weight exceed 8.5 feet in width, 65 feet in length, 14 feet in height, and over 34,000 pounds weight on any one axle.</li> <li>• When trucks make egress movements at the construction entrance/exit on Fremont, Mission, or Beale Street, flaggers, a temporary stop sign, or a combination of these methods shall be used to slow approaching traffic.</li> <li>• Fences shall be installed at least one foot clear from the edge of the adjacent travel lane.</li> <li>• "Road Work Ahead" signs, "Right Lane Closed Ahead" signs, and illuminated Arrow Board Displays shall be posted on the south side of Mission Street west of Fremont Street, and on Fremont Street south of Howard Street.</li> <li>• Advance warning signs (e.g., reverse curve sign) shall be installed on Mission Street west of Fremont Street and east of Beale Street.</li> <li>• Construction Worker Trip Reduction (CWTR) program shall be implemented. CWTR program measures may include, but not limited to, providing City's Commuter Benefits Program, subsidizing public transit fares, and implementing parking cash out program in place of providing free parking.</li> </ul>
	Could Implement	<ul style="list-style-type: none"> <li>• The existing westbound bus lane striping between Fremont and Beale streets could be removed.</li> <li>• The existing number two eastbound bus lane on Mission Street between Fremont and Beale streets could be painted in the relocated bus lane.</li> </ul>
	Could Explore	<ul style="list-style-type: none"> <li>• The existing westbound traffic signal at the Mission Street/Beale Street intersection could be modified to include a "Queue Jump Signal".</li> </ul>
Walking/Accessibility	Shall Implement	<ul style="list-style-type: none"> <li>• "Sidewalk Closed Ahead/Local Access Only/Cross Here" signs shall be posted on the south side of Mission Street east of Beale Street.</li> <li>• "Sidewalk Closed /Use Other Side/Cross Here" signs shall be posted at the following locations: on the south side of Mission Street west of Fremont Street; along the east side of Fremont Street north of Mission Street, and south of Natoma Street.</li> <li>• Signs shall be posted on the Minna Street sidewalks east of Fremont Street.</li> <li>• Signs shall be placed on the Beale Street west sidewalk north of Mission Street and south of the project site.</li> <li>• Pedestrian barricades shall be installed at the north end of the east crosswalk and the west end of the south crosswalk at the Mission Street/Fremont Street intersection.</li> <li>• Flaggers shall be required where workers or equipment temporarily block a pedestrian walkway for access into and out of a construction area (e.g., near the intersection of Mission and Beale streets).</li> </ul>

		<ul style="list-style-type: none"> <li>• Pedestrian walkways shall maintain a minimum four-foot width and smooth surface for wheelchair access. It shall include ADA compliant wheelchair ramps for connection to the west and the south crosswalks at the Mission Street/Beale Street intersection.</li> <li>• Pedestrian walkways shall be designed to provide a clear view of the oncoming eastbound traffic on Mission Street and southbound traffic on Beale Street for pedestrians waiting to cross the west and south crosswalks, respectively, at the Mission Street/Beale Street intersection.</li> <li>• Pedestrian walkways shall include lighting for pedestrians at all times.</li> <li>• Pedestrian walkways shall be regularly maintained and kept clear of potential construction hazards, such as holes, cracks, debris, dust, and mud.</li> <li>• Pedestrian facilities including the sidewalks and street trees shall be restored to their original condition.</li> <li>• The southwest corner of Mission Street/Beale Street intersection shall be restored to existing condition during Stage 6, to provide a wider pedestrian right-of-way along Beale Street (i.e., wider than 4 feet) for those crossing from the northwest corner of the intersection.</li> </ul>
Bicycling	Shall Implement	<ul style="list-style-type: none"> <li>• “Bicycle Crossing/ Share the Road” signs and sharrow pavement markings shall be placed along the south side of Mission Street west of Fremont Street for eastbound bicyclists, on the north side of Mission Street east of Beale Street for westbound bicyclists, and on Fremont Street north of Howard Street for northbound bicyclists along the construction frontage.</li> <li>• “Trucks Crossing” signs, a temporary stop sign, flaggers or a combination of these methods shall be used to alert bicyclists when construction trucks are making wide turns to access in and out of the construction zone on Fremont, Mission, or Beale Street.</li> </ul>
Passenger and Commercial Loading	Shall Implement	<ul style="list-style-type: none"> <li>• “No Stopping and Tow-Away” signs shall be posted on the construction fences along Fremont, Mission, and Beale Street frontages.</li> <li>• Residents of the Tower and Podium buildings shall be notified to use the porte cochere off the two-way driveway for all passenger and commercial loading occurrences.</li> <li>• The restaurant tenant shall post on their website instructions for patron access to the site and encourage patrons to use other nearby passenger loading zone.</li> <li>• Transportation Network Companies (TNC) shall be notified to implement geofencing along the project frontages to prohibit loading activities.</li> <li>• MTHA shall provide required residential loading spaces (approximately six spaces) in the porte cochere.</li> </ul>
	Could Implement	<ul style="list-style-type: none"> <li>• Illegal loading occurrences along the project site frontages could be enforced by PCOs during the AM (7 a.m. to 9 a.m.) and PM (4 p.m. to 6 p.m.) peak periods or using cameras installed on Muni vehicles.</li> </ul>
	Could Explore	<ul style="list-style-type: none"> <li>• The project sponsor could work with SFMTA to temporarily convert convenient on-street parking locations to passenger loading spaces to replace the passenger loading space on Mission Street between Beale and Fremont Streets that would be removed during project construction.</li> </ul>
Emergency Access	Shall Implement	<ul style="list-style-type: none"> <li>• Contractors shall coordinate with administrators of the nearest emergency service providers such as police and fire stations, and notify these services in</li> </ul>

		<p>advance of the timing, location, duration of construction activities, as well as the lane closures and suggested alternative routes.</p> <ul style="list-style-type: none"> <li>• Breaks in the barriers shall be provided along the construction site perimeter to allow construction traffic access as well as San Francisco Fire Department access to fire department connections at all times.</li> </ul>
--	--	--

Source: CHS Consulting Group, 2019.

Notes:

1. Shall Implement include strategies that shall be implemented; Could Implement include strategies that could be implemented based on conditions at the time of construction commencement; Could Explore include strategies that could be explored for the purpose of TMP.

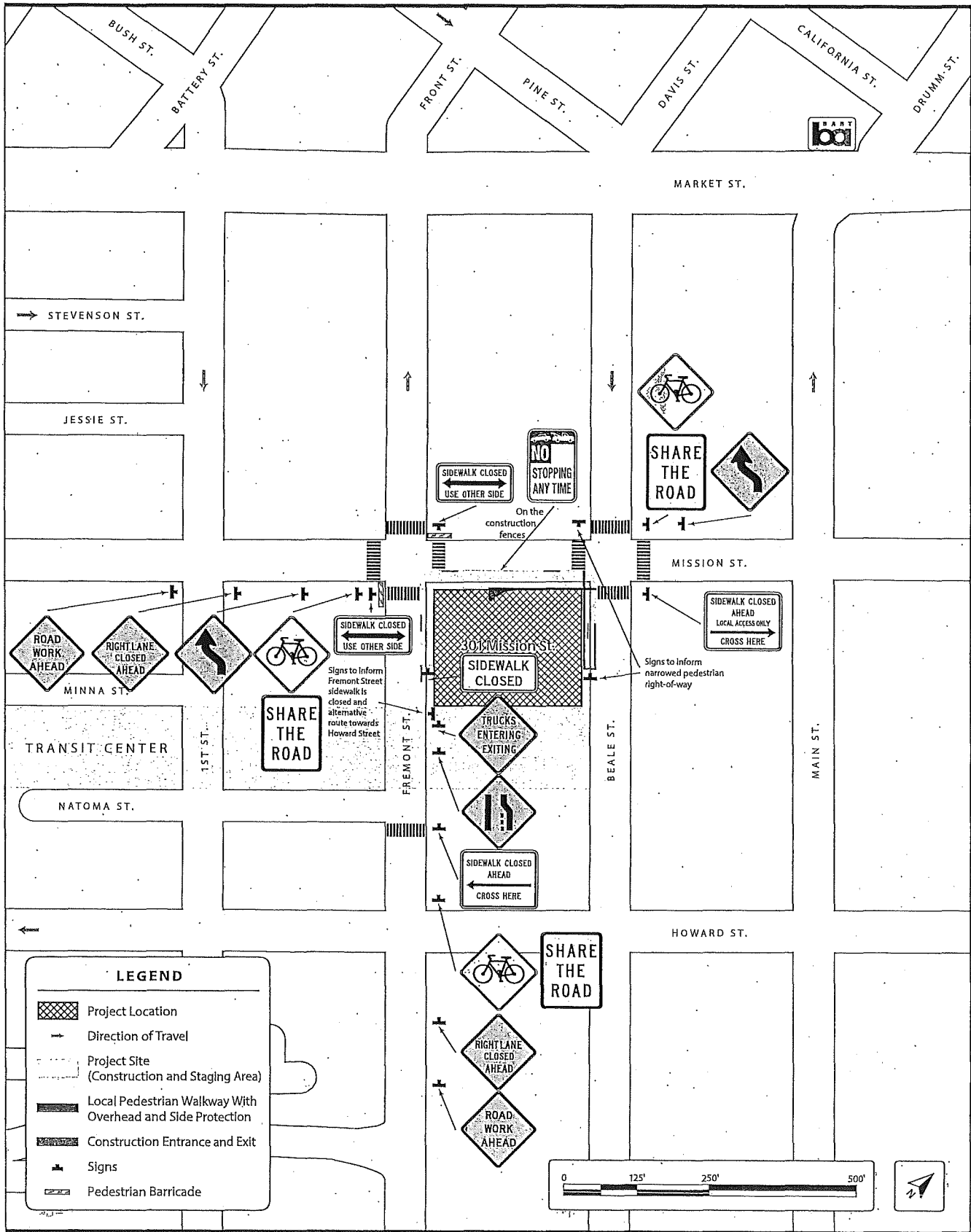

301 Mission Street Seismic Upgrade Project Transportation Management Plan - Final



Figure 4  
TMP Strategies

Note: TMP strategies are subject to change, and not all strategies are shown. Please refer to TMP for full texts.

The following appendices to this Transportation Management Plan have been left out because they are included as part of Appendix B Technical Transportation Appendices

- Appendix A      Baseline Roadway Geometry (*see Appendix B, Attachment B.1*)
- Appendix B      Existing and Baseline Volumes Summary Memorandum (*See Appendix B, Attachment B.3*)
- Appendix C      Project Volumes Summary (*See Appendix B, Attachment B.4*)

Appendix B  
**Transportation Technical  
Appendix**





**Attachment B.1**  
**Existing and Baseline Roadway**  
**Geometry**



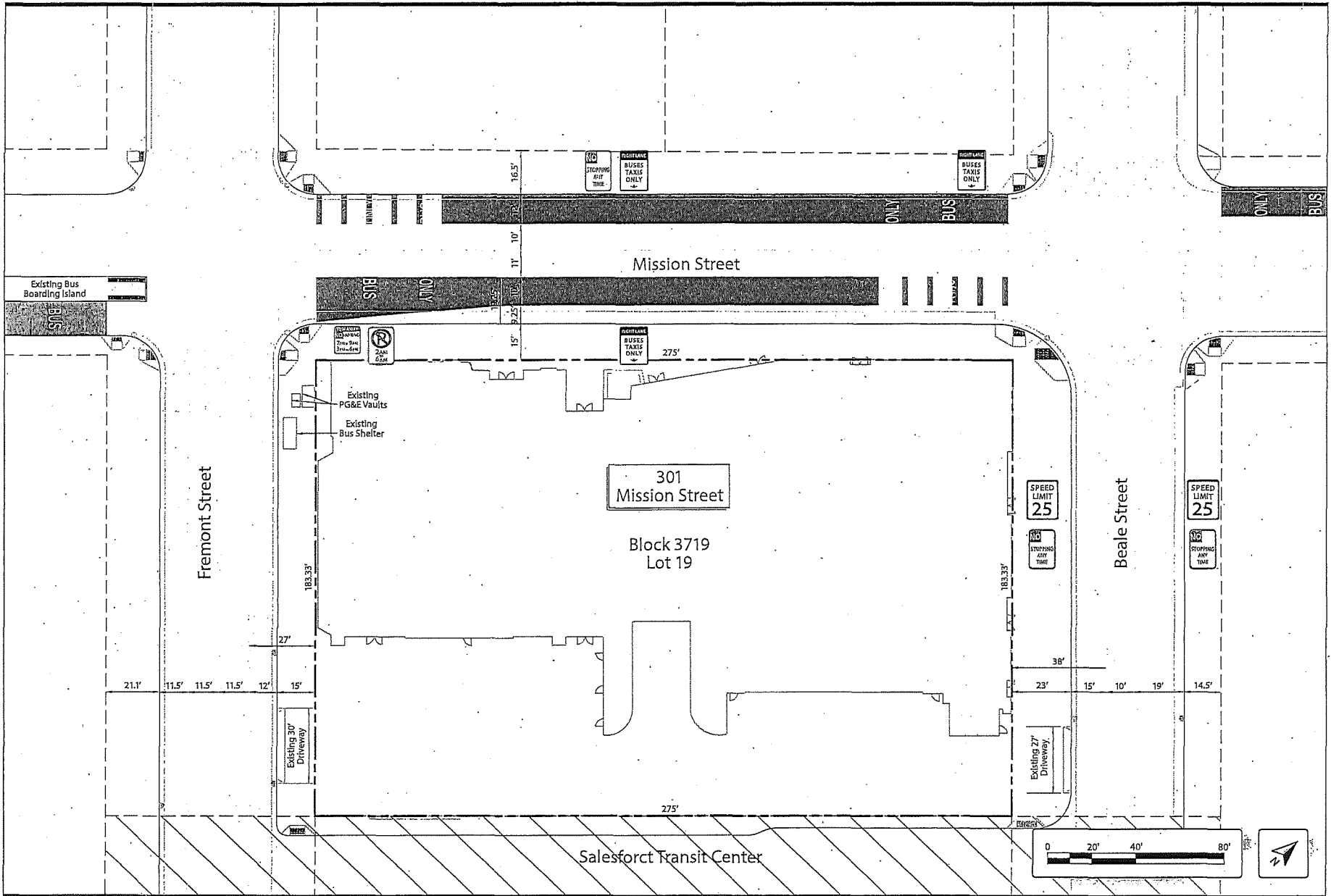

301 Mission Street Seismic Upgrade Transportation Impact Study



Attachment B.2  
**Vehicle Turning Movement,  
Pedestrian, and Loading Counts**



Fremont St  
Mission St



Date: 04-09-2019

Count Period: 7:00 AM to 9:00 AM

Peak Hour: 8:00 AM to 9:00 AM

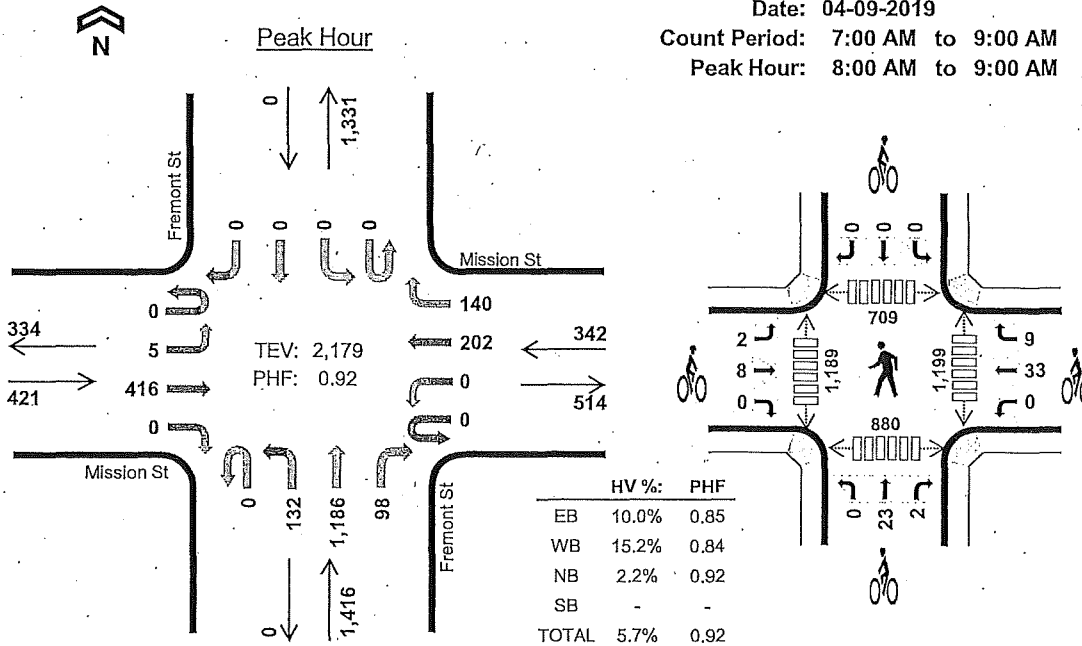

Two-Hour Count Summaries

Interval Start	Mission St Eastbound				Mission St Westbound				Fremont St Northbound				Fremont St Southbound				15-min Total	Rolling One Hour	
	UT	LT	TH	RT	UT	LT	TH	RT	UT	LT	TH	RT	UT	LT	TH	RT			
7:00 AM	0	1	74	0	0	0	38	24	0	27	234	15	0	0	0	0	413	0	
7:15 AM	0	0	57	0	0	0	32	28	0	31	296	20	0	0	0	0	464	0	
7:30 AM	0	1	78	0	0	0	32	30	0	31	298	12	0	0	0	0	482	0	
7:45 AM	0	1	79	0	0	0	32	36	0	33	284	17	0	0	0	0	482	1,841	
8:00 AM	0	2	82	0	0	0	48	23	0	35	266	21	0	0	0	0	477	1,905	
8:15 AM	0	1	104	0	0	0	47	38	0	31	295	22	0	0	0	0	538	1,979	
8:30 AM	0	1	107	0	0	0	45	39	0	36	314	33	0	0	0	0	575	2,072	
8:45 AM	0	1	123	0	0	0	62	40	0	30	311	22	0	0	0	0	589	2,179	
Count Total	0	8	704	0	0	0	336	258	0	254	2,298	162	0	0	0	0	4,020	0	
Peak Hour	All	0	5	416	0	0	0	202	140	0	132	1,186	98	0	0	0	0	2,179	0
	HV	0	0	42	0	0	0	25	27	0	4	22	5	0	0	0	0	125	0
	HV%	-	0%	10%	-	-	-	12%	19%	-	3%	2%	5%	-	-	-	-	6%	0

Note: Two-hour count summary volumes include heavy vehicles but exclude bicycles in overall count.

Interval Start	Heavy Vehicle Totals					Bicycles					Pedestrians (Crossing Leg)				
	EB	WB	NB	SB	Total	EB	WB	NB	SB	Total	East	West	North	South	Total
7:00 AM	16	19	7	0	42	2	4	1	0	7	104	135	71	90	400
7:15 AM	9	17	11	0	37	0	2	1	0	3	146	128	93	130	497
7:30 AM	13	13	13	0	39	4	6	3	0	13	165	208	117	148	638
7:45 AM	10	14	13	0	37	2	4	4	0	10	227	249	123	169	768
8:00 AM	9	16	9	0	34	2	7	6	0	15	220	239	132	212	803
8:15 AM	7	11	8	0	26	5	15	6	0	26	295	304	172	232	1,003
8:30 AM	15	12	6	0	33	3	6	6	0	15	316	344	165	188	1,013
8:45 AM	11	13	8	0	32	0	14	7	0	21	368	302	240	248	1,158
Count Total	90	115	75	0	280	18	58	34	0	110	1,841	1,909	1,113	1,417	6,280
Peak Hour	42	52	31	0	125	10	42	25	0	77	1,199	1,189	709	880	3,977



Two-Hour Count Summaries - Heavy Vehicles																		
Interval Start	Mission St				Mission St				Fremont St				Fremont St				15-min Total	Rolling One Hour
	Eastbound				Westbound				Northbound				Southbound					
	UT	LT	TH	RT	UT	LT	TH	RT	UT	LT	TH	RT	UT	LT	TH	RT		
7:00 AM	0	0	16	0	0	0	9	10	0	2	5	0	0	0	0	0	42	0
7:15 AM	0	0	9	0	0	0	9	8	0	1	9	1	0	0	0	0	37	0
7:30 AM	0	0	13	0	0	0	8	5	0	3	8	2	0	0	0	0	39	0
7:45 AM	0	0	10	0	0	0	8	6	0	2	8	3	0	0	0	0	37	155
8:00 AM	0	0	9	0	0	0	8	8	0	1	7	1	0	0	0	0	34	147
8:15 AM	0	0	7	0	0	0	5	6	0	1	4	3	0	0	0	0	26	136
8:30 AM	0	0	15	0	0	0	5	7	0	2	3	1	0	0	0	0	33	130
8:45 AM	0	0	11	0	0	0	7	6	0	0	8	0	0	0	0	0	32	125
Count Total	0	0	90	0	0	0	59	56	0	12	52	11	0	0	0	0	280	0
Peak Hour	0	0	42	0	0	0	25	27	0	4	22	5	0	0	0	0	125	0

Two-Hour Count Summaries - Bikes																		
Interval Start	Mission St				Mission St				Fremont St				Fremont St				15-min Total	Rolling One Hour
	Eastbound				Westbound				Northbound				Southbound					
	LT	TH	RT		LT	TH	RT		LT	TH	RT		LT	TH	RT			
7:00 AM	0	2	0	0	0	4	0	0	0	1	0	0	0	0	0	0	7	0
7:15 AM	0	0	0	0	0	1	1	0	0	1	0	0	0	0	0	0	3	0
7:30 AM	1	3	0	0	0	4	2	0	0	3	0	0	0	0	0	0	13	0
7:45 AM	0	2	0	0	0	2	2	0	0	4	0	0	0	0	0	0	10	33
8:00 AM	0	2	0	0	0	6	1	0	0	6	0	0	0	0	0	0	15	41
8:15 AM	2	3	0	0	0	11	4	0	0	5	1	0	0	0	0	0	26	64
8:30 AM	0	3	0	0	0	5	1	0	0	6	0	0	0	0	0	0	15	66
8:45 AM	0	0	0	0	0	11	3	0	0	6	1	0	0	0	0	0	21	77
Count Total	3	15	0	0	0	44	14	0	0	32	2	0	0	0	0	0	110	0
Peak Hour	2	8	0	0	0	33	9	0	0	23	2	0	0	0	0	0	77	0

Note: U-Turn volumes for bikes are included in Left-Turn, if any.

### Fremont St Mission St



Date: 04-09-2019  
 Count Period: 4:00 PM to 6:00 PM  
 Peak Hour: 5:00 PM to 6:00 PM

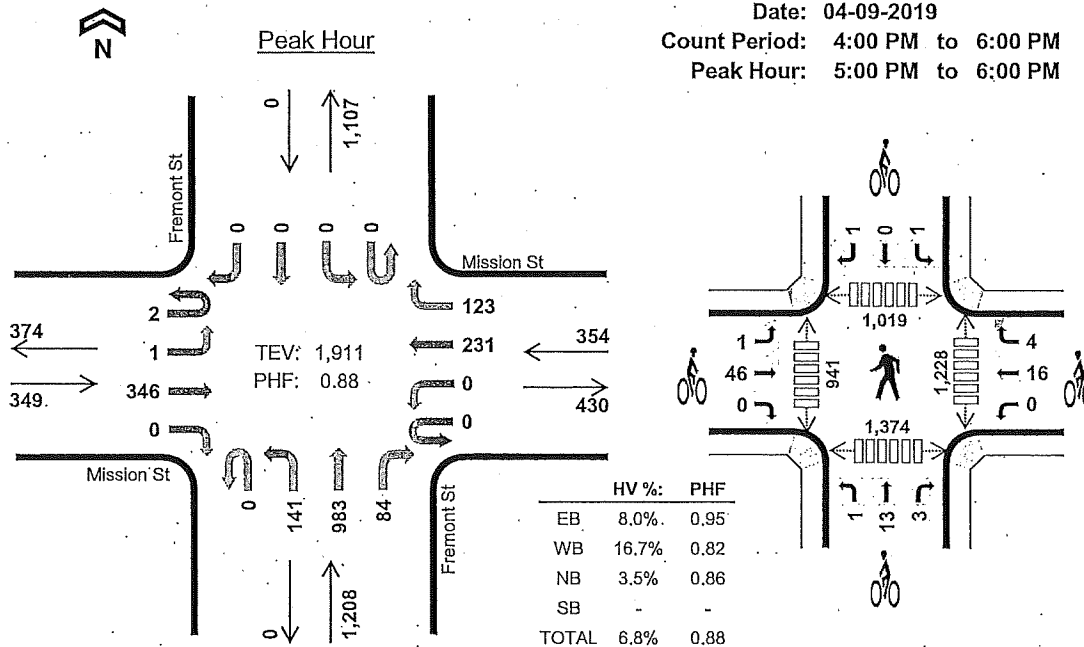

#### Two-Hour Count Summaries

Interval Start	Mission St Eastbound				Mission St Westbound				Fremont St Northbound				Fremont St Southbound				15-min Total	Rolling One Hour
	UT	LT	TH	RT	UT	LT	TH	RT	UT	LT	TH	RT	UT	LT	TH	RT		
4:00 PM	0	2	78	0	0	0	49	23	0	31	216	24	0	0	0	0	423	0
4:15 PM	0	3	88	0	0	0	41	18	0	26	227	12	0	0	0	0	415	0
4:30 PM	0	1	68	0	0	0	52	31	0	30	234	21	0	0	0	0	437	0
4:45 PM	0	1	86	0	0	0	61	26	0	23	255	15	0	0	0	0	467	1,742
5:00 PM	2	1	84	0	0	0	57	25	0	32	245	26	0	0	0	0	472	1,791
5:15 PM	0	0	92	0	0	0	56	29	0	33	222	16	0	0	0	0	448	1,824
5:30 PM	0	0	88	0	0	0	44	35	0	33	234	17	0	0	0	0	451	1,838
5:45 PM	0	0	82	0	0	0	74	34	0	43	282	25	0	0	0	0	540	1,911
Count Total	2	8	666	0	0	0	434	221	0	251	1,915	156	0	0	0	0	3,653	0
Peak Hour	All	2	1	346	0	0	231	123	0	141	983	84	0	0	0	0	1,911	0
	HV	0	0	28	0	0	31	28	0	0	41	1	0	0	0	0	129	0
	HV%	0%	0%	8%	-	-	-	13%	23%	-	0%	4%	1%	-	-	-	7%	0

Note: Two-hour count summary volumes include heavy vehicles but exclude bicycles in overall count.

Interval Start	Heavy Vehicle Totals					Bicycles					Pedestrians (Crossing Leg)				
	EB	WB	NB	SB	Total	EB	WB	NB	SB	Total	East	West	North	South	Total
4:00 PM	5	18	13	0	36	6	3	5	0	14	221	165	145	258	789
4:15 PM	6	13	5	0	24	7	8	3	1	19	193	164	163	264	784
4:30 PM	7	15	15	0	37	5	2	2	0	9	218	196	155	275	844
4:45 PM	8	16	10	0	34	16	3	6	0	25	243	233	154	251	881
5:00 PM	6	17	18	0	41	5	8	2	1	16	318	273	291	422	1,304
5:15 PM	7	19	5	0	31	12	8	5	0	25	330	269	266	351	1,216
5:30 PM	6	11	14	0	31	16	3	1	1	21	287	204	235	336	1,062
5:45 PM	9	12	5	0	26	14	1	9	0	24	293	195	227	265	980
Count Total	54	121	85	0	260	81	36	33	3	153	2,103	1,699	1,636	2,422	7,860
Peak Hour	28	59	42	0	129	47	20	17	2	86	1,228	941	1,019	1,374	4,562

Two-Hour Count Summaries - Heavy Vehicles																		
Interval Start	Mission St				Mission St				Fremont St				Fremont St				15-min Total	Rolling One Hour
	Eastbound				Westbound				Northbound				Southbound					
	UT	LT	TH	RT	UT	LT	TH	RT	UT	LT	TH	RT	UT	LT	TH	RT		
4:00 PM	0	0	5	0	0	0	10	8	0	1	12	0	0	0	0	0	36	0
4:15 PM	0	0	6	0	0	0	7	6	0	0	5	0	0	0	0	0	24	0
4:30 PM	0	0	7	0	0	0	7	8	0	1	14	0	0	0	0	0	37	0
4:45 PM	0	0	8	0	0	0	9	7	0	0	8	2	0	0	0	0	34	131
5:00 PM	0	0	6	0	0	0	8	9	0	0	17	1	0	0	0	0	41	136
5:15 PM	0	0	7	0	0	0	11	8	0	0	5	0	0	0	0	0	31	143
5:30 PM	0	0	6	0	0	0	5	6	0	0	14	0	0	0	0	0	31	137
5:45 PM	0	0	9	0	0	0	7	5	0	0	5	0	0	0	0	0	26	129
Count Total	0	0	54	0	0	0	64	57	0	2	80	3	0	0	0	0	260	0
Peak Hour	0	0	28	0	0	0	31	28	0	0	41	1	0	0	0	0	129	0
Two-Hour Count Summaries - Bikes																		
Interval Start	Mission St			Mission St			Fremont St			Fremont St			15-min Total	Rolling One Hour				
	Eastbound			Westbound			Northbound			Southbound								
	LT	TH	RT	LT	TH	RT	LT	TH	RT	LT	TH	RT						
4:00 PM	1	5	0	0	3	0	0	4	1	0	0	0	14	0				
4:15 PM	0	7	0	0	6	2	0	3	0	0	0	1	19	0				
4:30 PM	0	5	0	0	2	0	0	2	0	0	0	0	9	0				
4:45 PM	0	16	0	0	3	0	1	5	0	0	0	0	25	67				
5:00 PM	0	5	0	0	7	1	0	1	1	0	0	1	16	69				
5:15 PM	0	12	0	0	8	0	0	4	1	0	0	0	25	75				
5:30 PM	0	16	0	0	1	2	0	1	0	1	0	0	21	87				
5:45 PM	1	13	0	0	0	1	1	7	1	0	0	0	24	86				
Count Total	2	79	0	0	30	6	2	27	4	1	0	2	153	0				
Peak Hour	1	46	0	0	16	4	1	13	3	1	0	1	86	0				
Note: U-Turn volumes for bikes are included in Left-Turn, if any.																		

### Beale St Mission St



Date: 04-09-2019

Count Period: 7:00 AM to 9:00 AM

Peak Hour: 8:00 AM to 9:00 AM

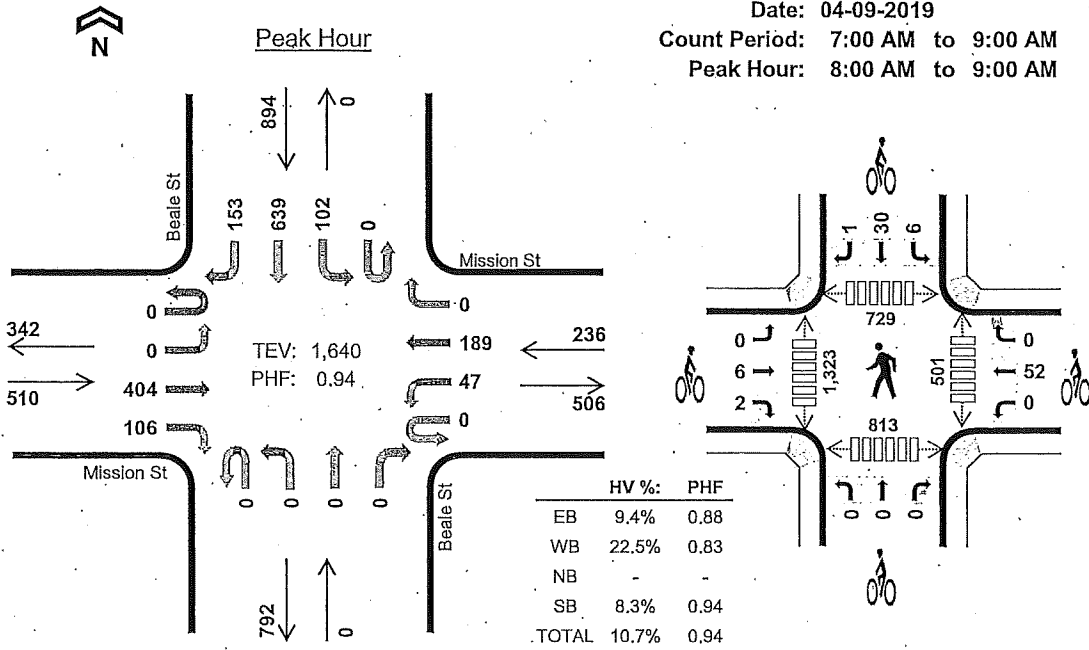

#### Two-Hour Count Summaries

Interval Start	Mission St Eastbound				Mission St Westbound				Beale St Northbound				Beale St Southbound				15-min Total	Rolling One Hour	
	UT	LT	TH	RT	UT	LT	TH	RT	UT	LT	TH	RT	UT	LT	TH	RT			
7:00 AM	0	0	69	19	0	9	39	0	0	0	0	0	0	18	77	24	255	0	
7:15 AM	0	0	61	17	0	4	35	0	0	0	0	0	0	26	102	22	267	0	
7:30 AM	0	0	62	26	0	7	33	0	0	0	0	0	0	25	112	29	294	0	
7:45 AM	0	0	67	26	0	10	37	0	0	0	0	0	0	30	120	33	323	1,139	
8:00 AM	0	0	80	24	0	6	40	0	0	0	0	0	0	28	146	29	353	1,237	
8:15 AM	0	0	104	19	0	12	43	0	0	0	0	0	0	20	180	38	416	1,386	
8:30 AM	0	0	108	30	0	15	49	0	0	0	0	0	0	28	158	46	434	1,526	
8:45 AM	0	0	112	33	0	14	57	0	0	0	0	0	0	26	155	40	437	1,640	
Count Total	0	0	663	194	0	77	333	0	0	0	0	0	0	201	1,050	261	2,779	0	
Peak Hour	All	0	0	404	106	0	47	189	0	0	0	0	0	0	102	639	153	1,640	0
	HV	0	0	32	16	0	3	50	0	0	0	0	0	0	3	68	3	175	0
	HV%	-	-	8%	15%	-	6%	26%	-	-	-	-	-	-	3%	11%	2%	11%	0

Note: Two-hour count summary volumes include heavy vehicles but exclude bicycles in overall count.

Interval Start	Heavy Vehicle Totals					Bicycles					Pedestrians (Crossing Leg)				
	EB	WB	NB	SB	Total	EB	WB	NB	SB	Total	East	West	North	South	Total
7:00 AM	20	17	0	20	57	2	3	0	4	9	30	112	58	86	286
7:15 AM	10	15	0	19	44	0	4	0	6	10	46	127	86	86	345
7:30 AM	14	13	0	21	48	2	10	0	2	14	49	222	121	111	503
7:45 AM	13	14	0	17	44	2	5	0	4	11	85	230	95	93	503
8:00 AM	11	16	0	17	44	0	8	0	7	15	113	270	143	152	678
8:15 AM	10	10	0	20	40	3	14	0	9	26	136	344	195	215	890
8:30 AM	15	14	0	17	46	3	11	0	7	21	113	308	175	207	803
8:45 AM	12	13	0	20	45	2	19	0	14	35	139	401	216	239	995
Count Total	105	112	0	151	368	14	74	0	53	141	711	2,014	1,089	1,189	5,003
Peak Hour	48	53	0	74	175	8	52	0	37	97	501	1,323	729	813	3,366

Two-Hour Count Summaries - Heavy Vehicles																		
Interval Start	Mission St				Mission St				Beale St				Beale St				15-min Total	Rolling One Hour
	Eastbound				Westbound				Northbound				Southbound					
	UT	LT	TH	RT	UT	LT	TH	RT	UT	LT	TH	RT	UT	LT	TH	RT		
7:00 AM	0	0	13	7	0	0	17	0	0	0	0	0	2	16	2	57	0	
7:15 AM	0	0	10	0	0	0	15	0	0	0	0	0	1	16	2	44	0	
7:30 AM	0	0	11	3	0	0	13	0	0	0	0	0	1	20	0	48	0	
7:45 AM	0	0	8	5	0	0	14	0	0	0	0	0	0	17	0	44	193	
8:00 AM	0	0	6	5	0	1	15	0	0	0	0	0	0	16	1	44	180	
8:15 AM	0	0	7	3	0	0	10	0	0	0	0	0	0	19	1	40	176	
8:30 AM	0	0	11	4	0	2	12	0	0	0	0	0	0	16	1	46	174	
8:45 AM	0	0	8	4	0	0	13	0	0	0	0	0	3	17	0	45	175	
Count Total	0	0	74	31	0	3	109	0	0	0	0	0	7	137	7	368	0	
Peak Hour	0	0	32	16	0	3	50	0	0	0	0	0	3	68	3	175	0	

Two-Hour Count Summaries - Bikes																		
Interval Start	Mission St			Mission St			Beale St			Beale St			15-min Total	Rolling One Hour				
	Eastbound			Westbound			Northbound			Southbound								
	LT	TH	RT	LT	TH	RT	LT	TH	RT	LT	TH	RT						
7:00 AM	0	2	0	0	3	0	0	0	0	0	3	1	9	0				
7:15 AM	0	0	0	0	4	0	0	0	0	2	4	0	10	0				
7:30 AM	0	2	0	1	9	0	0	0	0	0	2	0	14	0				
7:45 AM	0	2	0	0	5	0	0	0	0	2	2	0	11	44				
8:00 AM	0	0	0	0	8	0	0	0	0	2	5	0	15	50				
8:15 AM	0	3	0	0	14	0	0	0	0	1	7	1	26	66				
8:30 AM	0	2	1	0	11	0	0	0	0	1	6	0	21	73				
8:45 AM	0	1	1	0	19	0	0	0	0	2	12	0	35	97				
Count Total	0	12	2	1	73	0	0	0	0	10	41	2	141	0				
Peak Hour	0	6	2	0	52	0	0	0	0	6	30	1	97	0				

Note: U-Turn volumes for bikes are included in Left-Turn, if any.

### Beale St Mission St



Date: 04-09-2019

Count Period: 4:00 PM to 6:00 PM

Peak Hour: 5:00 PM to 6:00 PM

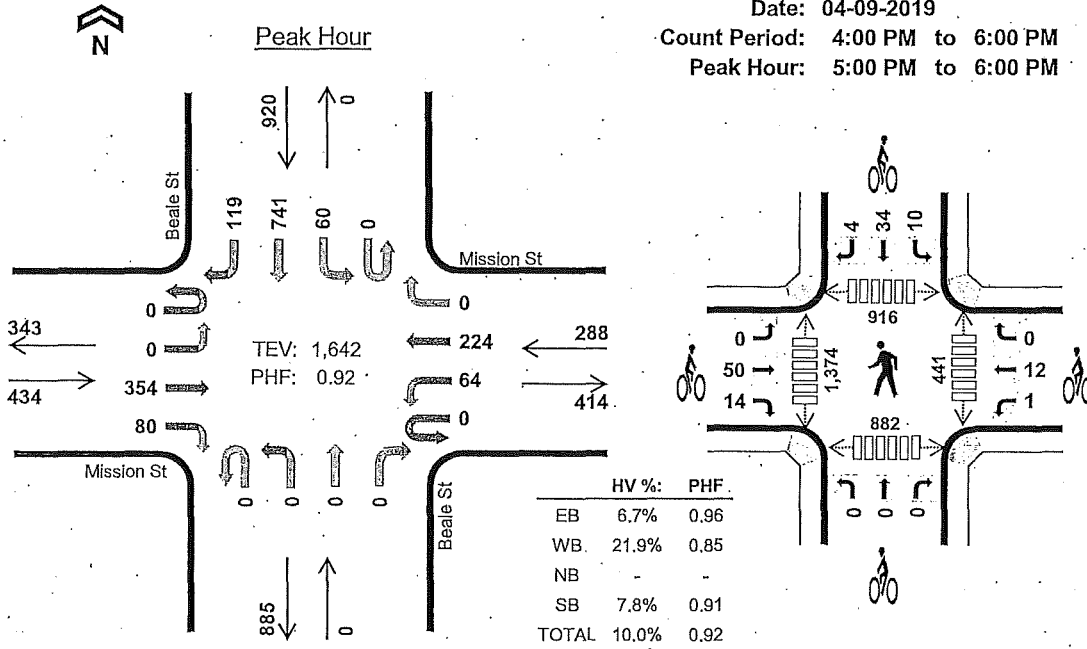

#### Two-Hour Count Summaries

Interval Start	Mission St Eastbound				Mission St Westbound				Beale St Northbound				Beale St Southbound				15-min Total	Rolling One Hour	
	UT	LT	TH	RT	UT	LT	TH	RT	UT	LT	TH	RT	UT	LT	TH	RT			
4:00 PM	0	0	69	33	0	14	41	0	0	0	0	0	0	17	187	24	385	0	
4:15 PM	0	0	71	30	0	8	47	0	0	0	0	0	0	14	166	21	357	0	
4:30 PM	0	0	75	17	0	22	56	0	0	0	0	0	0	12	154	20	356	0	
4:45 PM	0	0	80	22	0	13	62	0	0	0	0	0	0	8	190	27	402	1,500	
5:00 PM	0	0	86	27	0	16	51	0	0	0	0	0	0	15	175	31	401	1,516	
5:15 PM	0	0	93	17	0	21	64	0	0	0	0	0	0	14	215	23	447	1,606	
5:30 PM	0	0	86	20	0	12	45	0	0	0	0	0	0	17	177	29	386	1,636	
5:45 PM	0	0	89	16	0	15	64	0	0	0	0	0	0	14	174	36	408	1,642	
Count Total	0	0	649	182	0	121	430	0	0	0	0	0	0	111	1,438	211	3,142	0	
Peak Hour	All	0	0	354	80	0	64	224	0	0	0	0	0	0	60	741	119	1,642	0
	HV	0	0	21	8	0	7	56	0	0	0	0	0	0	6	61	5	164	0
	HV%	-	-	6%	10%	-	11%	25%	-	-	-	-	-	-	10%	8%	4%	10%	0

Note: Two-hour count summary volumes include heavy vehicles but exclude bicycles in overall count.

Interval Start	Heavy Vehicle Totals					Bicycles					Pedestrians (Crossing Leg)				
	EB	WB	NB	SB	Total	EB	WB	NB	SB	Total	East	West	North	South	Total
4:00 PM	6	15	0	19	40	9	4	0	10	23	75	237	185	183	680
4:15 PM	6	15	0	20	41	9	2	0	7	18	87	275	178	202	742
4:30 PM	7	13	0	14	34	4	6	0	5	15	76	298	151	179	704
4:45 PM	10	17	0	20	47	16	2	0	6	24	88	270	154	166	678
5:00 PM	7	18	0	17	42	7	4	0	11	22	122	379	252	274	1,027
5:15 PM	7	18	0	17	42	18	5	0	18	41	129	389	248	224	990
5:30 PM	6	13	0	18	37	23	3	0	11	37	102	318	218	201	839
5:45 PM	9	14	0	20	43	16	1	0	8	25	88	288	198	183	757
Count Total	58	123	0	145	326	102	27	0	76	205	767	2,454	1,584	1,612	6,417
Peak Hour	29	63	0	72	164	64	13	0	48	125	441	1,374	916	882	3,613

Two-Hour Count Summaries - Heavy Vehicles																		
Interval Start	Mission St				Mission St				Beale St				Beale St				15-min Total	Rolling One Hour
	Eastbound				Westbound				Northbound				Southbound					
	UT	LT	TH	RT	UT	LT	TH	RT	UT	LT	TH	RT	UT	LT	TH	RT		
4:00 PM	0	0	4	2	0	1	14	0	0	0	0	0	0	0	18	1	40	0
4:15 PM	0	0	4	2	0	0	15	0	0	0	0	0	0	1	17	2	41	0
4:30 PM	0	0	6	1	0	0	13	0	0	0	0	0	0	0	14	0	34	0
4:45 PM	0	0	6	4	0	3	14	0	0	0	0	0	0	0	19	1	47	162
5:00 PM	0	0	6	1	0	1	17	0	0	0	0	0	0	2	14	1	42	164
5:15 PM	0	0	4	3	0	2	16	0	0	0	0	0	0	1	13	3	42	165
5:30 PM	0	0	4	2	0	2	11	0	0	0	0	0	0	2	15	1	37	168
5:45 PM	0	0	7	2	0	2	12	0	0	0	0	0	0	1	19	0	43	164
Count Total	0	0	41	17	0	11	112	0	0	0	0	0	0	7	129	9	326	0
Peak Hour	0	0	21	8	0	7	56	0	0	0	0	0	0	6	61	5	164	0

Two-Hour Count Summaries - Bikes																		
Interval Start	Mission St				Mission St				Beale St				Beale St				15-min Total	Rolling One Hour
	Eastbound				Westbound				Northbound				Southbound					
	LT	TH	RT	LT	TH	RT	LT	TH	RT	LT	TH	RT	LT	TH	RT			
4:00 PM	0	9	0	0	4	0	0	0	0	0	10	0	23	0				
4:15 PM	0	8	1	0	2	0	0	0	0	2	3	2	18	0				
4:30 PM	0	4	0	1	5	0	0	0	0	1	4	0	15	0				
4:45 PM	0	12	4	0	2	0	0	0	0	2	4	0	24	80				
5:00 PM	0	7	0	0	4	0	0	0	0	2	8	1	22	79				
5:15 PM	0	11	7	0	5	0	0	0	0	6	11	1	41	102				
5:30 PM	0	17	6	1	2	0	0	0	0	2	7	2	37	124				
5:45 PM	0	15	1	0	1	0	0	0	0	0	8	0	25	125				
Count Total	0	83	19	2	25	0	0	0	0	15	55	6	205	0				
Peak Hour	0	50	14	1	12	0	0	0	0	10	34	4	125	0				

Note: U-Turn volumes for bikes are included in Left-Turn, if any.

Fremont St  
Howard St



Date: 04-09-2019

Count Period: 7:00 AM to 9:00 AM

Peak Hour: 8:00 AM to 9:00 AM

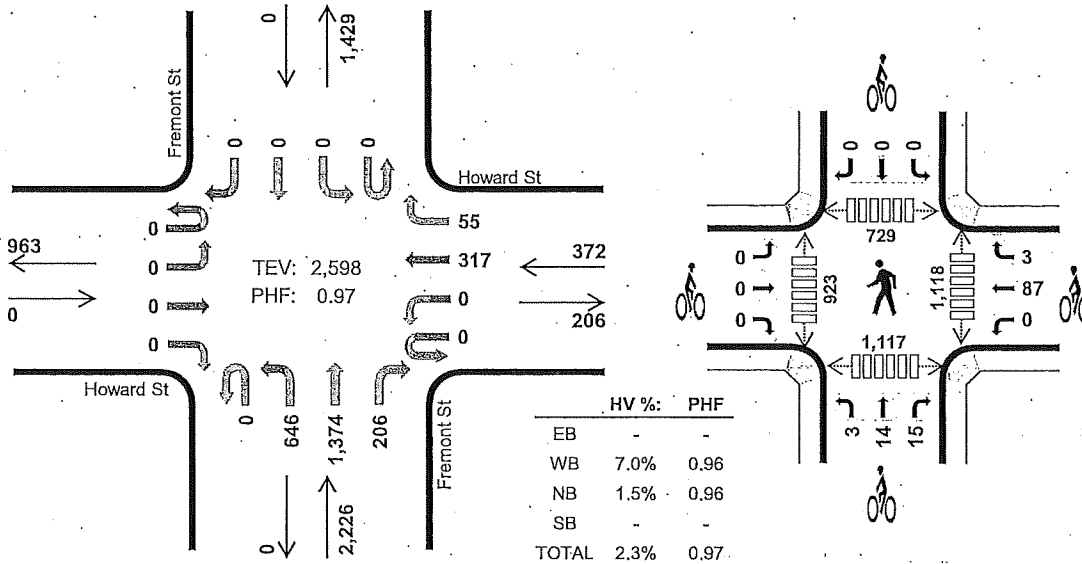

Two-Hour Count Summaries

Interval Start	Howard St Eastbound				Howard St Westbound				Fremont St Northbound				Fremont St Southbound				15-min Total	Rolling One Hour	
	UT	LT	TH	RT	UT	LT	TH	RT	UT	LT	TH	RT	UT	LT	TH	RT			
7:00 AM	0	0	0	0	0	0	48	8	0	148	282	67	0	0	0	0	553	0	
7:15 AM	0	0	0	0	0	0	73	12	0	169	343	53	0	0	0	0	650	0	
7:30 AM	0	0	0	0	0	0	65	9	0	163	321	64	0	0	0	0	622	0	
7:45 AM	0	0	0	0	0	0	60	10	0	170	332	62	0	0	0	0	634	2,459	
8:00 AM	0	0	0	0	0	0	82	12	0	168	310	41	0	0	0	0	613	2,519	
8:15 AM	0	0	0	0	0	0	76	13	0	165	351	54	0	0	0	0	659	2,528	
8:30 AM	0	0	0	0	0	0	78	14	0	156	363	59	0	0	0	0	670	2,576	
8:45 AM	0	0	0	0	0	0	81	16	0	157	350	52	0	0	0	0	656	2,598	
Count Total	0	0	0	0	0	0	563	94	0	1,296	2,652	452	0	0	0	0	5,057	0	
Peak Hour	All	0	0	0	0	0	0	317	55	0	646	1,374	206	0	0	0	0	2,598	0
	HV	0	0	0	0	0	0	19	7	0	4	23	7	0	0	0	0	60	0
	HV%	-	-	-	-	-	-	6%	13%	-	1%	2%	3%	-	-	-	-	2%	0

Note: Two-hour count summary volumes include heavy vehicles but exclude bicycles in overall count.

Interval Start	Heavy Vehicle Totals					Bicycles					Pedestrians (Crossing Leg)				
	EB	WB	NB	SB	Total	EB	WB	NB	SB	Total	East	West	North	South	Total
7:00 AM	0	3	14	0	17	0	3	0	0	3	93	86	77	93	349
7:15 AM	0	4	17	0	21	0	6	1	0	7	110	103	80	118	411
7:30 AM	0	7	14	0	21	0	12	3	0	15	124	165	99	161	549
7:45 AM	0	6	18	0	24	0	15	3	0	18	227	151	134	192	704
8:00 AM	0	9	11	0	20	0	19	9	0	28	248	185	168	262	863
8:15 AM	0	5	7	0	12	0	22	6	0	28	237	250	177	243	907
8:30 AM	0	8	5	0	13	0	22	5	0	27	277	234	186	300	997
8:45 AM	0	4	11	0	15	0	27	12	0	39	356	254	198	312	1,120
Count Total	0	46	97	0	143	0	126	39	0	165	1,672	1,428	1,119	1,681	5,900
Peak Hour	0	26	34	0	60	0	90	32	0	122	1,118	923	729	1,117	3,887



Two-Hour Count Summaries - Heavy Vehicles																		
Interval Start	Howard St				Howard St				Fremont St				Fremont St				15-min Total	Rolling One Hour
	Eastbound				Westbound				Northbound				Southbound					
	UT	LT	TH	RT	UT	LT	TH	RT	UT	LT	TH	RT	UT	LT	TH	RT		
7:00 AM	0	0	0	0	0	0	3	0	0	4	6	4	0	0	0	0	17	0
7:15 AM	0	0	0	0	0	0	4	0	0	1	13	3	0	0	0	0	21	0
7:30 AM	0	0	0	0	0	0	5	2	0	2	10	2	0	0	0	0	21	0
7:45 AM	0	0	0	0	0	0	5	1	0	0	12	6	0	0	0	0	24	83
8:00 AM	0	0	0	0	0	0	6	3	0	2	7	2	0	0	0	0	20	86
8:15 AM	0	0	0	0	0	0	4	1	0	0	5	2	0	0	0	0	12	77
8:30 AM	0	0	0	0	0	0	7	1	0	0	4	1	0	0	0	0	13	69
8:45 AM	0	0	0	0	0	0	2	2	0	2	7	2	0	0	0	0	15	60
Count Total	0	0	0	0	0	0	36	10	0	11	64	22	0	0	0	0	143	0
Peak Hour	0	0	0	0	0	0	19	7	0	4	23	7	0	0	0	0	60	0

Two-Hour Count Summaries - Bikes																		
Interval Start	Howard St			Howard St			Fremont St			Fremont St			15-min Total	Rolling One Hour				
	Eastbound			Westbound			Northbound			Southbound								
	LT	TH	RT	LT	TH	RT	LT	TH	RT	LT	TH	RT						
7:00 AM	0	0	0	0	3	0	0	0	0	0	0	0	0	0	3	0		
7:15 AM	0	0	0	0	5	1	0	0	1	0	0	0	0	0	7	0		
7:30 AM	0	0	0	0	12	0	0	3	0	0	0	0	0	0	15	0		
7:45 AM	0	0	0	0	13	2	0	2	1	0	0	0	0	0	18	43		
8:00 AM	0	0	0	0	18	1	1	3	5	0	0	0	0	0	28	68		
8:15 AM	0	0	0	0	22	0	0	4	2	0	0	0	0	0	28	89		
8:30 AM	0	0	0	0	21	1	2	0	3	0	0	0	0	0	27	101		
8:45 AM	0	0	0	0	26	1	0	7	5	0	0	0	0	0	39	122		
Count Total	0	0	0	0	120	6	3	19	17	0	0	0	0	0	165	0		
Peak Hour	0	0	0	0	87	3	3	14	15	0	0	0	0	0	122	0		

Note: U-Turn volumes for bikes are included in Left-Turn, if any.

**Fremont St  
Howard St**

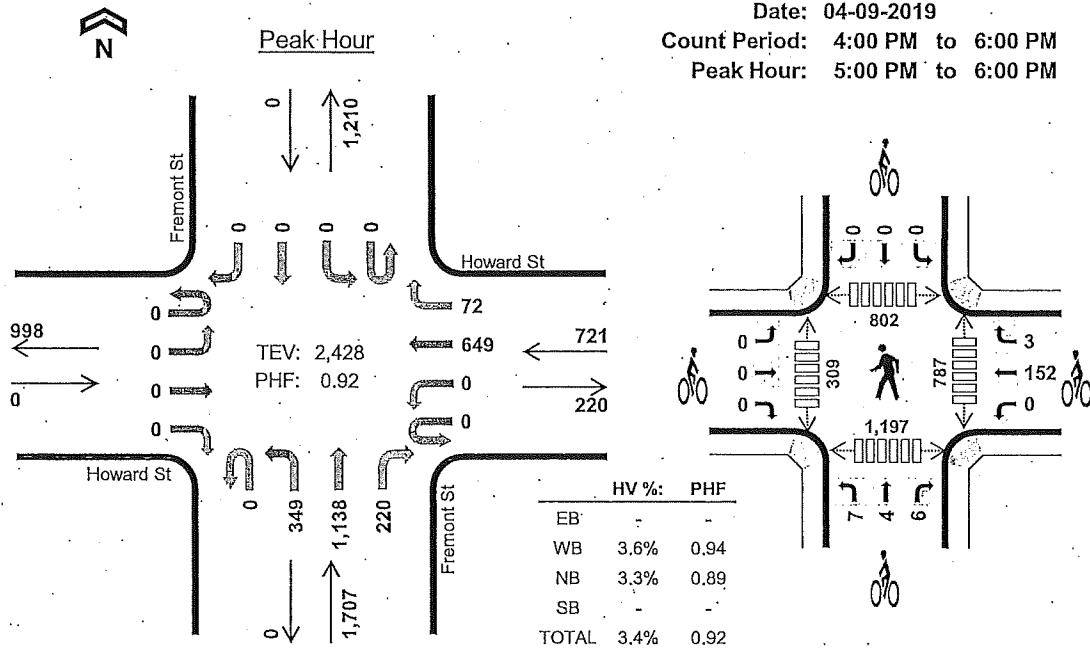

**Two-Hour Count Summaries**

Interval Start	Howard St Eastbound				Howard St Westbound				Fremont St Northbound				Fremont St Southbound				15-min Total	Rolling One Hour	
	UT	LT	TH	RT	UT	LT	TH	RT	UT	LT	TH	RT	UT	LT	TH	RT			
4:00 PM	0	0	0	0	0	0	145	24	0	64	254	47	0	0	0	0	534	0	
4:15 PM	0	0	0	0	0	0	145	8	0	75	260	44	0	0	0	0	532	0	
4:30 PM	0	0	0	0	0	0	148	15	0	101	257	55	0	0	0	0	576	0	
4:45 PM	0	0	0	0	0	0	149	16	0	74	282	50	0	0	0	0	571	2,213	
5:00 PM	0	0	0	0	0	0	151	11	0	76	280	49	0	0	0	0	567	2,246	
5:15 PM	0	0	0	0	0	0	172	19	0	89	253	57	0	0	0	0	590	2,304	
5:30 PM	0	0	0	0	0	0	168	17	0	100	270	53	0	0	0	0	608	2,336	
5:45 PM	0	0	0	0	0	0	158	25	0	84	335	61	0	0	0	0	663	2,428	
Count Total	0	0	0	0	0	0	1,236	135	0	663	2,191	416	0	0	0	0	4,641	0	
Peak Hour	All	0	0	0	0	0	0	649	72	0	349	1,138	220	0	0	0	0	2,428	0
	HV	0	0	0	0	0	0	25	1	0	4	39	14	0	0	0	0	83	0
	HV%	-	-	-	-	-	-	4%	1%	-	1%	3%	6%	-	-	-	-	3%	0

Note: Two-hour count summary volumes include heavy vehicles but exclude bicycles in overall count.

Interval Start	Heavy Vehicle Totals					Bicycles					Pedestrians (Crossing Leg)				
	EB	WB	NB	SB	Total	EB	WB	NB	SB	Total	East	West	North	South	Total
4:00 PM	0	3	18	0	21	1	13	2	0	16	137	47	106	194	484
4:15 PM	0	3	7	0	10	0	9	4	0	13	116	36	98	191	441
4:30 PM	0	6	21	0	27	0	17	1	0	18	136	53	133	195	517
4:45 PM	0	4	12	0	16	0	31	4	0	35	143	76	135	239	593
5:00 PM	0	7	21	0	28	0	28	3	0	31	216	82	219	317	834
5:15 PM	0	7	9	0	16	0	49	3	0	52	209	85	184	321	799
5:30 PM	0	5	17	0	22	0	36	5	0	41	202	75	203	272	752
5:45 PM	0	7	10	0	17	0	42	6	0	48	160	67	196	287	710
Count Total	0	42	115	0	157	1	225	28	0	254	1,319	521	1,274	2,016	5,130
Peak Hour	0	26	57	0	83	0	155	17	0	172	787	309	802	1,197	3,095

Two-Hour Count Summaries - Heavy Vehicles																		
Interval Start	Howard St				Howard St				Fremont St				Fremont St				15-min Total	Rolling One Hour
	Eastbound				Westbound				Northbound				Southbound					
	UT	LT	TH	RT	UT	LT	TH	RT	UT	LT	TH	RT	UT	LT	TH	RT		
4:00 PM	0	0	0	0	0	0	3	0	0	3	13	2	0	0	0	0	21	0
4:15 PM	0	0	0	0	0	0	2	1	0	2	3	2	0	0	0	0	10	0
4:30 PM	0	0	0	0	0	0	6	0	0	2	16	3	0	0	0	0	27	0
4:45 PM	0	0	0	0	0	0	2	2	0	0	10	2	0	0	0	0	16	74
5:00 PM	0	0	0	0	0	0	6	1	0	1	16	4	0	0	0	0	28	81
5:15 PM	0	0	0	0	0	0	7	0	0	0	7	2	0	0	0	0	16	87
5:30 PM	0	0	0	0	0	0	5	0	0	3	11	3	0	0	0	0	22	82
5:45 PM	0	0	0	0	0	0	7	0	0	0	5	5	0	0	0	0	17	83
Count Total	0	0	0	0	0	0	38	4	0	11	81	23	0	0	0	0	157	0
Peak Hour	0	0	0	0	0	0	25	1	0	4	39	14	0	0	0	0	83	0

Two-Hour Count Summaries - Bikes																	
Interval Start	Howard St			Howard St			Fremont St			Fremont St			15-min Total	Rolling One Hour			
	Eastbound			Westbound			Northbound			Southbound							
	LT	TH	RT	LT	TH	RT	LT	TH	RT	LT	TH	RT					
4:00 PM	0	1	0	0	13	0	0	2	0	0	0	0	16	0			
4:15 PM	0	0	0	1	8	0	1	1	2	0	0	0	13	0			
4:30 PM	0	0	0	0	16	1	0	0	1	0	0	0	18	0			
4:45 PM	0	0	0	0	28	3	0	2	2	0	0	0	35	82			
5:00 PM	0	0	0	0	28	0	1	0	2	0	0	0	31	97			
5:15 PM	0	0	0	0	47	2	0	1	2	0	0	0	52	136			
5:30 PM	0	0	0	0	36	0	3	1	1	0	0	0	41	159			
5:45 PM	0	0	0	0	41	1	3	2	1	0	0	0	48	172			
Count Total	0	1	0	1	217	7	8	9	11	0	0	0	254	0			
Peak Hour	0	0	0	0	152	3	7	4	6	0	0	0	172	0			

Note: U-Turn volumes for bikes are included in Left-Turn, if any.

### Fremont St Market St



Date: 04-09-2019

Count Period: 7:00 AM to 9:00 AM

Peak Hour: 8:00 AM to 9:00 AM

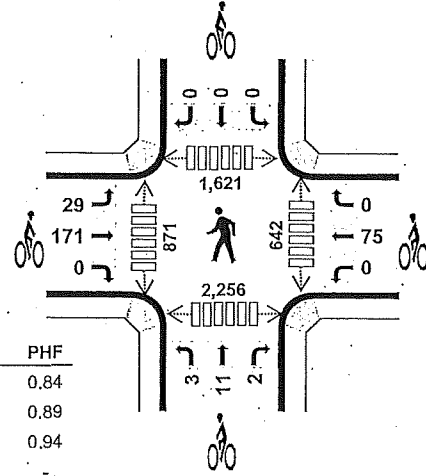
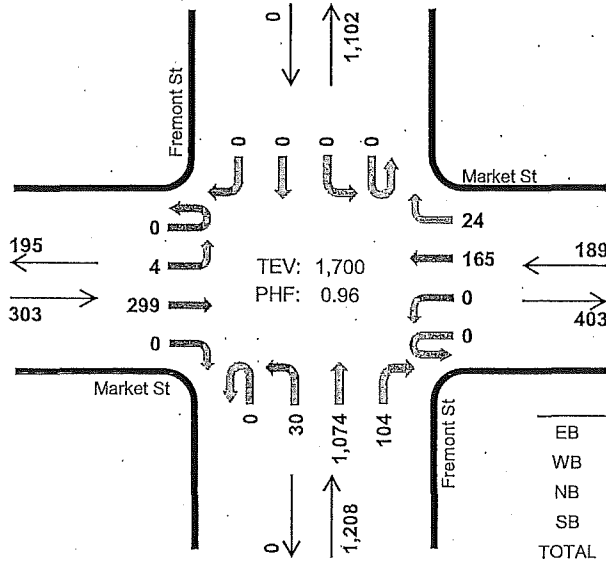

	HV %:	PHF
EB	34.7%	0.84
WB	40.7%	0.89
NB	4.1%	0.94
SB	-	-
TOTAL	13.6%	0.96

#### Two-Hour Count Summaries

Interval Start	Market St Eastbound				Market St Westbound				Fremont St Northbound				Fremont St Southbound				15-min Total	Rolling One Hour	
	UT	LT	TH	RT	UT	LT	TH	RT	UT	LT	TH	RT	UT	LT	TH	RT			
7:00 AM	0	2	47	0	0	0	25	4	0	9	227	12	0	0	0	0	326	0	
7:15 AM	0	2	65	0	0	0	35	1	0	6	275	17	0	0	0	0	401	0	
7:30 AM	0	0	56	0	0	0	27	2	0	12	261	36	0	0	0	0	394	0	
7:45 AM	0	1	62	0	0	0	34	5	0	7	267	31	0	0	0	0	407	1,528	
8:00 AM	0	3	87	0	0	0	40	3	0	7	248	17	0	0	0	0	405	1,607	
8:15 AM	0	1	84	0	0	0	44	5	0	9	273	21	0	0	0	0	437	1,643	
8:30 AM	0	0	67	0	0	0	43	10	0	6	285	30	0	0	0	0	441	1,690	
8:45 AM	0	0	61	0	0	0	38	6	0	8	268	36	0	0	0	0	417	1,700	
Count Total	0	9	529	0	0	0	286	36	0	64	2,104	200	0	0	0	0	3,228	0	
Peak Hour	All	0	4	299	0	0	0	165	24	0	30	1,074	104	0	0	0	0	1,700	0
	HV	0	0	105	0	0	0	77	0	0	26	16	7	0	0	0	0	231	0
	HV%	-	0%	35%	-	-	-	47%	0%	-	87%	1%	7%	-	-	-	-	14%	0

Note: Two-hour count summary volumes include heavy vehicles but exclude bicycles in overall count.

Interval Start	Heavy Vehicle Totals					Bicycles					Pedestrians (Crossing Leg)				
	EB	WB	NB	SB	Total	EB	WB	NB	SB	Total	East	West	North	South	Total
7:00 AM	24	13	12	0	49	16	5	0	0	21	70	75	227	203	575
7:15 AM	25	15	17	0	57	19	5	1	0	25	66	124	238	261	689
7:30 AM	20	15	18	0	53	30	9	5	0	44	121	139	348	356	964
7:45 AM	25	16	15	0	56	29	3	5	0	37	115	191	302	356	964
8:00 AM	21	22	16	0	59	32	14	3	0	49	120	183	400	468	1,171
8:15 AM	33	16	10	0	59	50	19	3	0	72	169	210	406	538	1,323
8:30 AM	29	20	8	0	57	57	24	5	0	86	161	233	403	580	1,377
8:45 AM	22	19	15	0	56	61	18	5	0	84	192	245	412	670	1,519
Count Total	199	136	111	0	446	294	97	27	0	418	1,014	1,400	2,736	3,432	8,582
Peak Hour	105	77	49	0	231	200	75	16	0	291	642	871	1,621	2,256	5,390

Two-Hour Count Summaries - Heavy Vehicles																		
Interval Start	Market St				Market St				Fremont St				Fremont St				15-min Total	Rolling One Hour
	Eastbound				Westbound				Northbound				Southbound					
	UT	LT	TH	RT	UT	LT	TH	RT	UT	LT	TH	RT	UT	LT	TH	RT		
7:00 AM	0	0	24	0	0	0	13	0	0	6	6	0	0	0	0	0	49	0
7:15 AM	0	1	24	0	0	0	15	0	0	5	11	1	0	0	0	0	57	0
7:30 AM	0	0	20	0	0	0	15	0	0	8	6	4	0	0	0	0	53	0
7:45 AM	0	0	25	0	0	0	16	0	0	5	8	2	0	0	0	0	56	215
8:00 AM	0	0	21	0	0	0	22	0	0	7	5	4	0	0	0	0	59	225
8:15 AM	0	0	33	0	0	0	16	0	0	7	3	0	0	0	0	0	59	227
8:30 AM	0	0	29	0	0	0	20	0	0	5	2	1	0	0	0	0	57	231
8:45 AM	0	0	22	0	0	0	19	0	0	7	6	2	0	0	0	0	56	231
Count Total	0	1	198	0	0	0	136	0	0	50	47	14	0	0	0	0	446	0
Peak Hour	0	0	105	0	0	0	77	0	0	26	16	7	0	0	0	0	231	0
Two-Hour Count Summaries - Bikes																		
Interval Start	Market St			Market St			Fremont St			Fremont St			15-min Total	Rolling One Hour				
	Eastbound			Westbound			Northbound			Southbound								
	LT	TH	RT	LT	TH	RT	LT	TH	RT	LT	TH	RT						
7:00 AM	3	13	0	0	5	0	0	0	0	0	0	0	0	0	21	0		
7:15 AM	1	18	0	0	5	0	0	1	0	0	0	0	0	0	25	0		
7:30 AM	1	29	0	0	9	0	0	5	0	0	0	0	0	0	44	0		
7:45 AM	4	25	0	0	3	0	0	4	1	0	0	0	0	0	37	127		
8:00 AM	5	27	0	0	14	0	1	2	0	0	0	0	0	0	49	155		
8:15 AM	5	45	0	0	19	0	1	2	0	0	0	0	0	0	72	202		
8:30 AM	11	46	0	0	24	0	1	4	0	0	0	0	0	0	86	244		
8:45 AM	8	53	0	0	18	0	0	3	2	0	0	0	0	0	84	291		
Count Total	38	256	0	0	97	0	3	21	3	0	0	0	0	0	418	0		
Peak Hour	29	171	0	0	75	0	3	11	2	0	0	0	0	0	291	0		
Note: U-Turn volumes for bikes are included in Left-Turn, if any.																		

**Fremont St  
Market St**



Date: 04-09-2019  
Count Period: 4:00 PM to 6:00 PM  
Peak Hour: 5:00 PM to 6:00 PM

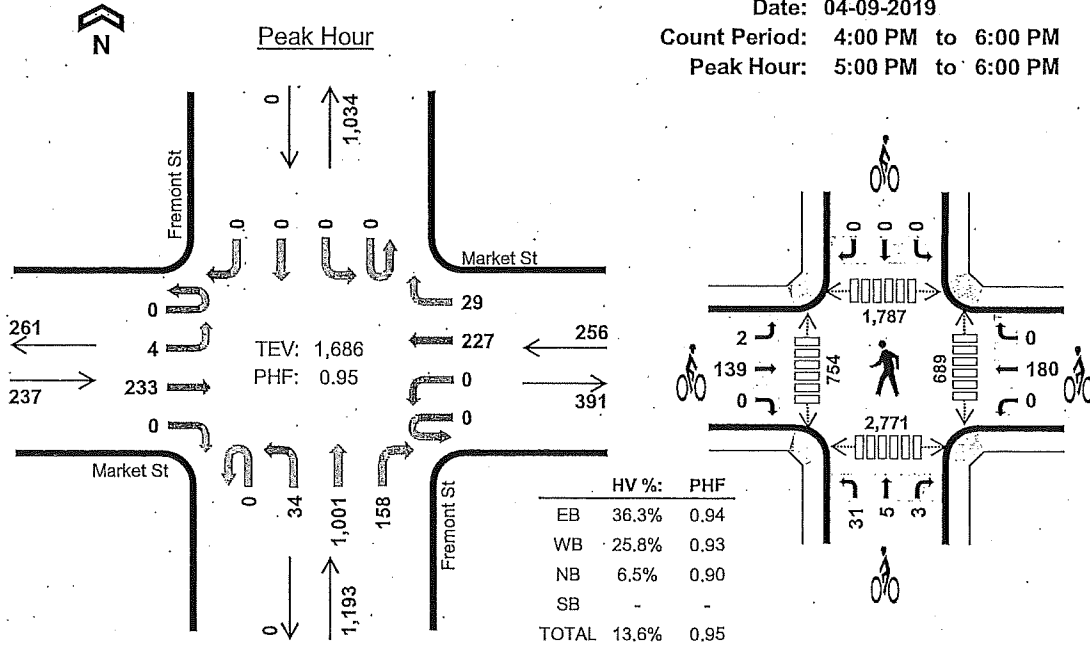

**Two-Hour Count Summaries**

Interval Start	Market St Eastbound				Market St Westbound				Fremont St Northbound				Fremont St Southbound				15-min Total	Rolling One Hour	
	UT	LT	TH	RT	UT	LT	TH	RT	UT	LT	TH	RT	UT	LT	TH	RT			
4:00 PM	0	0	48	0	0	0	46	4	0	10	227	26	0	0	0	0	361	0	
4:15 PM	0	0	58	0	0	0	52	6	0	5	229	31	0	0	0	0	381	0	
4:30 PM	0	2	64	0	0	0	41	6	0	7	238	35	0	0	0	0	393	0	
4:45 PM	0	0	50	0	0	0	53	5	0	7	239	44	0	0	0	0	398	1,533	
5:00 PM	0	2	61	0	0	0	56	8	0	9	230	43	0	0	0	0	409	1,581	
5:15 PM	0	2	60	0	0	0	59	10	0	8	247	40	0	0	0	0	426	1,626	
5:30 PM	0	0	62	0	0	0	57	5	0	10	246	29	0	0	0	0	409	1,642	
5:45 PM	0	0	50	0	0	0	55	6	0	7	278	46	0	0	0	0	442	1,686	
Count Total	0	6	453	0	0	0	419	50	0	63	1,934	294	0	0	0	0	3,219	0	
Peak Hour	All	0	4	233	0	0	0	227	29	0	34	1,001	158	0	0	0	0	1,686	0
	HV	0	0	86	0	0	0	66	0	0	26	44	8	0	0	0	0	230	0
	HV%	-	0%	37%	-	-	-	29%	0%	-	76%	4%	5%	-	-	-	-	14%	0

Note: Two-hour count summary volumes include heavy vehicles but exclude bicycles in overall count.

Interval Start	Heavy Vehicle Totals					Bicycles					Pedestrians (Crossing Leg)				
	EB	WB	NB	SB	Total	EB	WB	NB	SB	Total	East	West	North	South	Total
4:00 PM	19	15	19	0	53	20	20	6	0	46	143	113	162	426	844
4:15 PM	29	21	12	0	62	24	12	14	0	50	102	143	180	437	862
4:30 PM	24	13	24	0	61	11	20	6	0	37	143	152	246	492	1,033
4:45 PM	19	18	12	0	49	18	25	8	0	51	139	157	233	456	985
5:00 PM	23	20	29	0	72	41	46	11	0	98	189	220	458	790	1,657
5:15 PM	18	15	17	0	50	43	48	7	0	98	185	195	363	726	1,469
5:30 PM	24	17	20	0	61	32	37	11	0	80	164	182	459	627	1,432
5:45 PM	21	14	12	0	47	25	49	10	0	84	151	157	507	628	1,443
Count Total	177	133	145	0	455	214	257	73	0	544	1,216	1,319	2,608	4,582	9,725
Peak Hour	86	66	78	0	230	141	180	39	0	360	689	754	1,787	2,771	6,001

Two-Hour Count Summaries - Heavy Vehicles																		
Interval Start	Market St				Market St				Fremont St				Fremont St				15-min Total	Rolling One Hour
	Eastbound				Westbound				Northbound				Southbound					
	UT	LT	TH	RT	UT	LT	TH	RT	UT	LT	TH	RT	UT	LT	TH	RT		
4:00 PM	0	0	19	0	0	0	15	0	0	8	11	0	0	0	0	0	53	0
4:15 PM	0	0	29	0	0	0	21	0	0	5	6	1	0	0	0	0	62	0
4:30 PM	0	0	24	0	0	0	13	0	0	7	15	2	0	0	0	0	61	0
4:45 PM	0	0	19	0	0	0	18	0	0	5	5	2	0	0	0	0	49	225
5:00 PM	0	0	23	0	0	0	20	0	0	8	18	3	0	0	0	0	72	244
5:15 PM	0	0	18	0	0	0	15	0	0	8	8	1	0	0	0	0	50	232
5:30 PM	0	0	24	0	0	0	17	0	0	5	13	2	0	0	0	0	61	232
5:45 PM	0	0	21	0	0	0	14	0	0	5	5	2	0	0	0	0	47	230
Count Total	0	0	177	0	0	0	133	0	0	51	81	13	0	0	0	0	455	0
Peak Hour	0	0	86	0	0	0	66	0	0	26	44	8	0	0	0	0	230	0
Two-Hour Count Summaries - Bikes																		
Interval Start	Market St			Market St			Fremont St			Fremont St			15-min Total	Rolling One Hour				
	Eastbound			Westbound			Northbound			Southbound								
	LT	TH	RT	LT	TH	RT	LT	TH	RT	LT	TH	RT						
4:00 PM	0	20	0	0	20	0	2	4	0	0	0	0	46	0				
4:15 PM	1	23	0	0	12	0	5	3	6	0	0	0	50	0				
4:30 PM	0	11	0	0	20	0	5	0	1	0	0	0	37	0				
4:45 PM	3	15	0	0	25	0	7	0	1	0	0	0	51	184				
5:00 PM	0	41	0	0	46	0	8	2	1	0	0	0	98	236				
5:15 PM	0	43	0	0	48	0	6	1	0	0	0	0	98	284				
5:30 PM	2	30	0	0	37	0	11	0	0	0	0	0	80	327				
5:45 PM	0	25	0	0	49	0	6	2	2	0	0	0	84	360				
Count Total	6	208	0	0	257	0	50	12	11	0	0	0	544	0				
Peak Hour	2	139	0	0	180	0	31	5	3	0	0	0	360	0				
Note: U-Turn volumes for bikes are included in Left-Turn, if any.																		



Date: 04-09-2019  
 Count Period: 7:00 AM to 9:00 AM  
 Peak Hour: 8:00 AM to 9:00 AM

1840

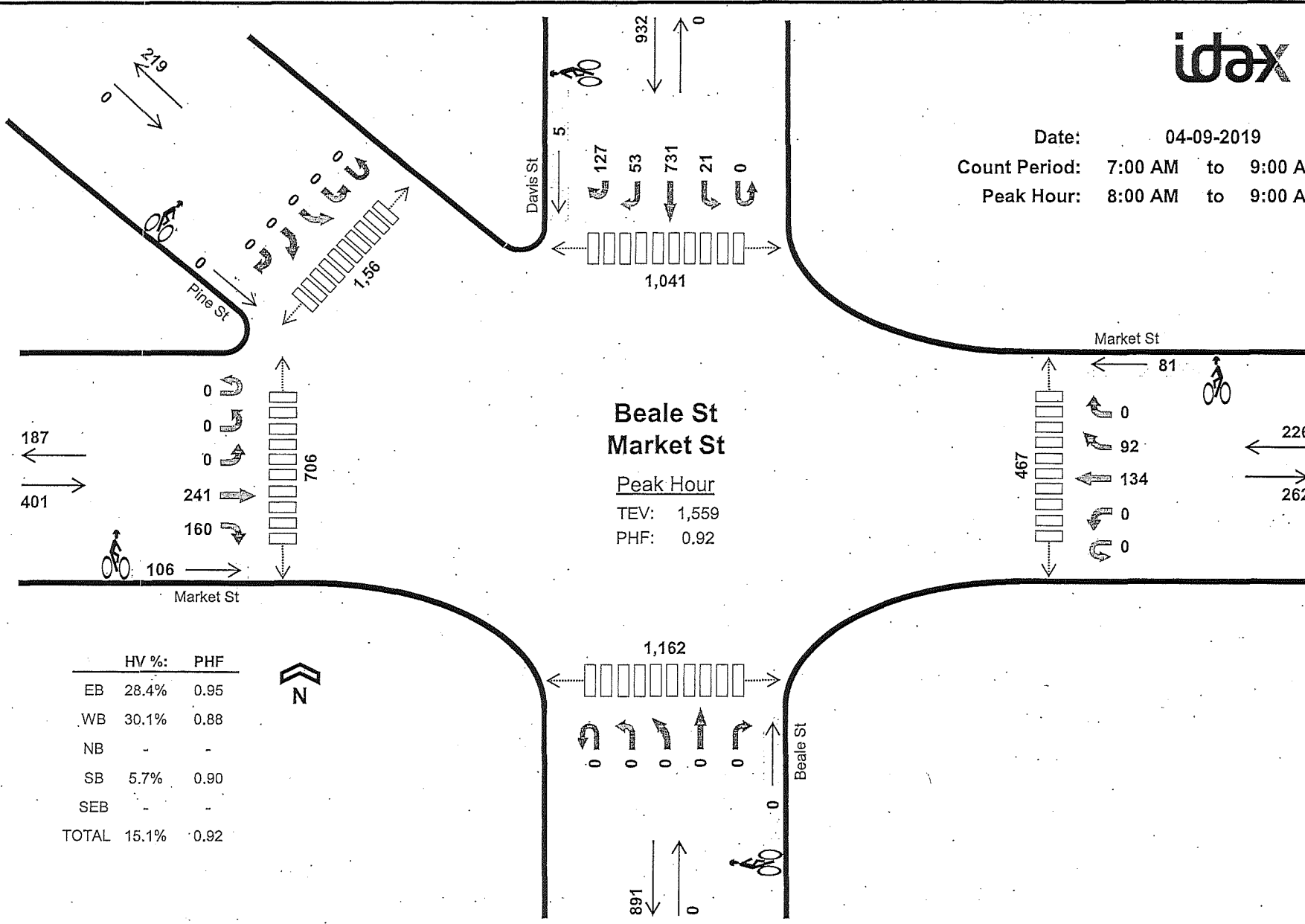

	HV %:	PHF
EB	28.4%	0.95
WB	30.1%	0.88
NB	-	-
SB	5.7%	0.90
SEB	-	-
TOTAL	15.1%	0.92





Two-Hour Count Summaries

Interval Start	Market St Eastbound					Market St Westbound					Beale St Northbound					Davis St Southbound					Pine St Southeastbound					15-min Total	Rolling One Hour
	UT	HL	LT	TH	RT	UT	LT	TH	BR	RT	UT	LT	BL	TH	RT	UT	LT	TH	RT	HR	UT	HL	BL	BR	HR		
7:00 AM	0	0	0	34	30	0	0	20	23	0	0	0	0	0	0	0	3	86	9	29	0	0	0	0	0	234	0
7:15 AM	0	0	0	41	38	0	0	27	12	0	0	0	0	0	0	0	5	116	8	35	0	0	0	0	0	282	0
7:30 AM	0	0	0	54	38	0	0	23	22	0	0	0	0	0	0	0	5	124	5	36	0	0	0	0	0	307	0
7:45 AM	0	0	0	50	41	0	0	29	24	0	0	0	0	0	0	0	4	142	8	32	0	0	0	0	0	330	1,153
8:00 AM	0	0	0	58	44	0	0	31	16	0	0	0	0	0	0	0	5	148	13	32	0	0	0	0	0	347	1,266
8:15 AM	0	0	0	63	43	0	0	32	26	0	0	0	0	0	0	0	6	203	17	34	0	0	0	0	0	424	1,408
8:30 AM	0	0	0	69	34	0	0	40	24	0	0	0	0	0	0	0	2	196	11	33	0	0	0	0	0	409	1,510
8:45 AM	0	0	0	51	39	0	0	31	26	0	0	0	0	0	0	0	8	184	12	28	0	0	0	0	0	379	1,559
Count Total	0	0	0	420	307	0	0	233	173	0	0	0	0	0	0	0	38	1,199	83	259	0	0	0	0	0	2,712	0
Peak Hour	All	0	0	241	160	0	0	134	92	0	0	0	0	0	0	0	21	731	53	127	0	0	0	0	0	1,559	0
	HV	0	0	56	58	0	0	64	4	0	0	0	0	0	0	0	1	19	13	20	0	0	0	0	0	235	0
	HV%	-	-	23%	36%	-	-	48%	4%	-	-	-	-	-	-	-	5%	3%	25%	16%	-	-	-	-	-	15%	0

Note: Two-hour count summary volumes include heavy vehicles but exclude bicycles in overall count.

Interval Start	Heavy Vehicle Totals						Bicycles					Pedestrians (Crossing Leg)						
	EB	WB	NB	SB	SEB	Total	EB	WB	NB	SB	SEB	Total	East	West	North	South	Northwest	Total
7:00 AM	24	14	0	13	0	51	12	6	0	3	0	21	37	56	140	147	204	584
7:15 AM	25	11	0	17	0	53	16	5	0	1	0	22	63	89	162	192	228	734
7:30 AM	27	12	0	17	0	56	24	16	0	0	0	40	83	103	256	268	259	969
7:45 AM	25	13	0	14	0	52	24	10	0	0	0	34	89	109	183	250	275	906
8:00 AM	27	18	0	13	0	58	18	12	0	2	0	32	90	147	237	224	311	1,009
8:15 AM	31	16	0	12	0	59	24	26	0	2	0	52	126	185	272	280	417	1,280
8:30 AM	32	18	0	10	0	60	34	26	0	0	0	60	133	168	262	299	352	1,214
8:45 AM	24	16	0	18	0	58	30	17	0	1	0	48	118	206	270	359	485	1,438
Count Total	215	118	0	114	0	447	182	118	0	9	0	309	739	1,063	1,782	2,019	2,531	8,734
Peak Hr	114	68	0	53	0	235	106	81	0	5	0	192	467	706	1,041	1,162	1,565	4,941

841

Two-Hour Count Summaries - Heavy Vehicles

Interval Start	Market St Eastbound					Market St Westbound					Beale St Northbound					Davis St Southbound					n/a Southeastbound					15-min Total	Rolling One Hour
	UT	HL	LT	TH	RT	UT	LT	TH	BR	RT	UT	LT	BL	TH	RT	UT	LT	TH	RT	HR	UT	HL	BL	BR	HR		
7:00 AM	0	0	0	12	12	0	0	13	1	0	0	0	0	0	0	0	1	6	0	6	0	0	0	0	0	51	0
7:15 AM	0	0	0	11	14	0	0	11	0	0	0	0	0	0	0	0	1	5	3	8	0	0	0	0	0	53	0
7:30 AM	0	0	0	13	14	0	0	12	0	0	0	0	0	0	0	0	0	8	2	7	0	0	0	0	0	56	0
7:45 AM	0	0	0	15	10	0	0	13	0	0	0	0	0	0	0	0	0	7	3	4	0	0	0	0	0	52	212
8:00 AM	0	0	0	13	14	0	0	16	2	0	0	0	0	0	0	0	0	2	6	5	0	0	0	0	0	58	219
8:15 AM	0	0	0	16	15	0	0	14	2	0	0	0	0	0	0	0	0	6	2	4	0	0	0	0	0	59	225
8:30 AM	0	0	0	17	15	0	0	18	0	0	0	0	0	0	0	0	0	4	2	4	0	0	0	0	0	60	229
8:45 AM	0	0	0	10	14	0	0	16	0	0	0	0	0	0	0	0	1	7	3	7	0	0	0	0	0	58	235
Count Total	0	0	0	107	108	0	0	113	5	0	0	0	0	0	0	0	3	45	21	45	0	0	0	0	0	447	0
Peak-Hour	0	0	0	56	58	0	0	64	4	0	0	0	0	0	0	0	1	19	13	20	0	0	0	0	0	235	0

Two-Hour Count Summaries - Bikes

Interval Start	Market St Eastbound					Market St Westbound					Beale St Northbound					Davis St Southbound					n/a Southeastbound					15-min Total	Rolling One Hour
	UT	HL	LT	TH	RT	UT	LT	TH	BR	RT	UT	LT	BL	TH	RT	UT	LT	TH	RT	HR	UT	HL	BL	BR	HR		
7:00 AM	0	0	0	11	1	0	0	5	1	0	0	0	0	0	0	0	0	0	1	2	0	0	0	0	0	21	0
7:15 AM	0	0	0	15	1	0	0	4	1	0	0	0	0	0	0	0	0	0	0	1	0	0	0	0	0	22	0
7:30 AM	0	0	0	23	1	0	0	12	4	0	0	0	0	0	0	0	0	0	0	0	0	0	0	0	0	40	0
7:45 AM	0	0	0	24	0	0	0	6	4	0	0	0	0	0	0	0	0	0	0	0	0	0	0	0	0	34	117
8:00 AM	0	0	0	18	0	0	0	9	3	0	0	0	0	0	0	0	0	0	2	0	0	0	0	0	0	32	128
8:15 AM	0	0	0	24	0	0	1	21	4	0	0	0	0	0	0	0	0	0	2	0	0	0	0	0	0	52	158
8:30 AM	0	0	0	34	0	0	0	24	2	0	0	0	0	0	0	0	0	0	0	0	0	0	0	0	0	60	178
8:45 AM	0	0	0	26	4	0	0	13	4	0	0	0	0	0	0	0	0	1	0	0	0	0	0	0	0	48	192
Count Total	0	0	0	175	7	0	1	94	23	0	0	0	0	0	0	0	0	1	3	5	0	0	0	0	0	309	0
Peak-Hour	0	0	0	102	4	0	1	67	13	0	0	0	0	0	0	0	0	1	2	2	0	0	0	0	0	192	0

1842



Date: 04-09-2019  
 Count Period: 4:00 PM to 6:00 PM  
 Peak Hour: 4:45 PM to 5:45 PM

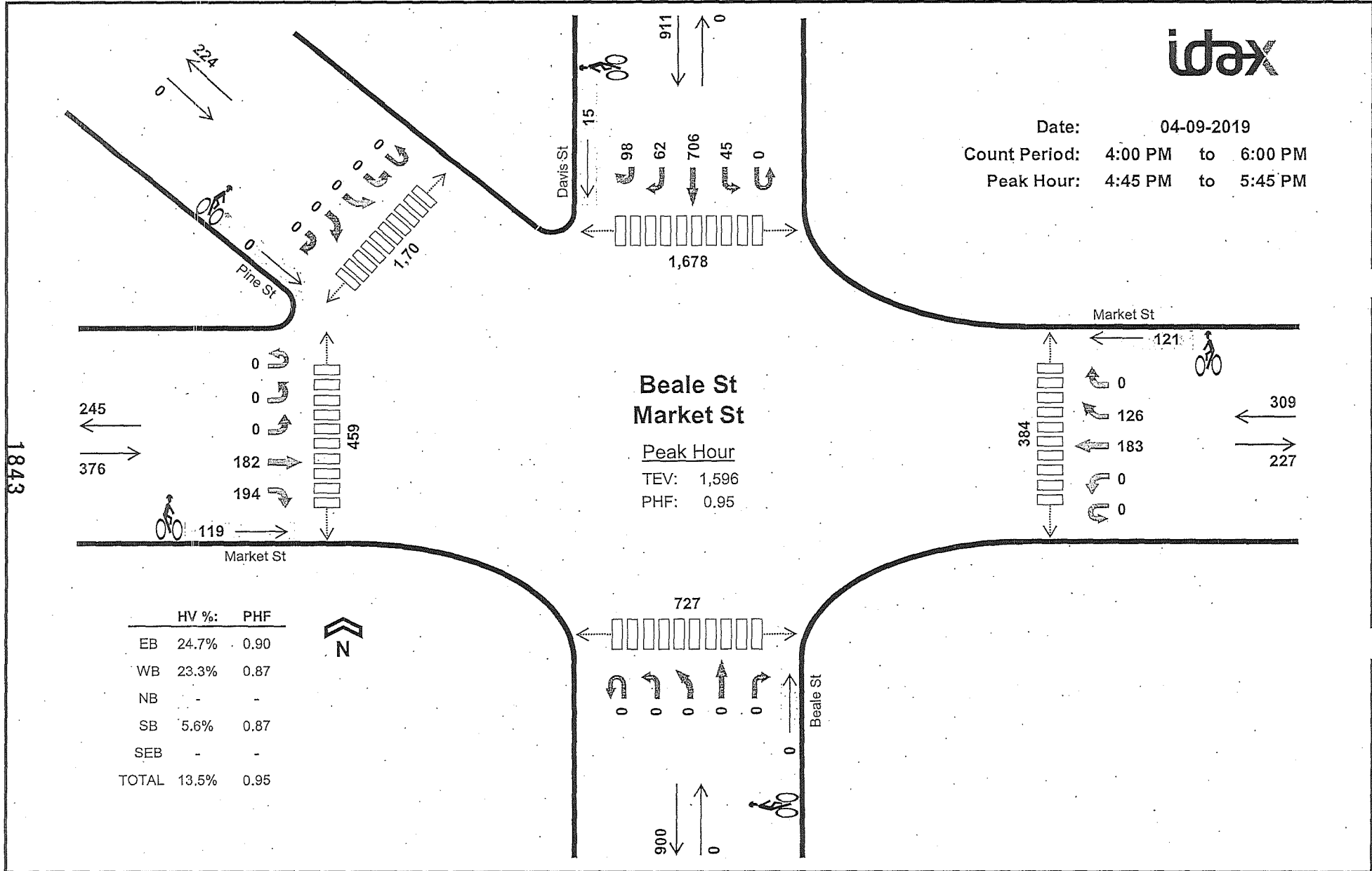

Two-Hour Count Summaries

Interval Start	Market St Eastbound					Market St Westbound					Beale St Northbound					Davis St Southbound					Pine St Southeastbound					15-min Total	Rolling One Hour
	UT	HL	LT	TH	RT	UT	LT	TH	BR	RT	UT	LT	BL	TH	RT	UT	LT	TH	RT	HR	UT	HL	BL	BR	HR		
4:00 PM	0	0	0	38	39	0	0	38	18	0	0	0	0	0	0	0	12	180	12	30	0	0	0	0	0	367	0
4:15 PM	0	0	0	45	42	0	0	39	35	0	0	0	0	0	0	0	10	149	14	19	0	0	0	0	0	353	0
4:30 PM	0	0	0	55	34	0	0	37	33	0	0	0	0	0	0	0	9	150	13	26	0	0	0	0	0	357	0
4:45 PM	0	0	0	42	54	0	0	41	31	0	0	0	0	0	0	0	7	171	14	20	0	0	0	0	0	380	1,457
5:00 PM	0	0	0	53	51	0	0	52	37	0	0	0	0	0	0	0	12	161	15	22	0	0	0	0	0	403	1,493
5:15 PM	0	0	0	39	45	0	0	48	26	0	0	0	0	0	0	0	15	200	19	27	0	0	0	0	0	419	1,559
5:30 PM	0	0	0	48	44	0	0	42	32	0	0	0	0	0	0	0	11	174	14	29	0	0	0	0	0	394	1,596
5:45 PM	0	0	0	49	41	0	0	41	27	0	0	0	0	0	0	0	5	176	19	22	0	0	0	0	0	380	1,596
Count Total	0	0	0	369	350	0	0	338	239	0	0	0	0	0	0	0	81	1,361	120	195	0	0	0	0	0	3,053	0
Peak Hour	All	0	0	0	182	194	0	0	183	126	0	0	0	0	0	0	45	706	62	98	0	0	0	0	0	1,596	0
	HV	0	0	0	43	50	0	0	65	7	0	0	0	0	0	0	3	22	1	25	0	0	0	0	0	216	0
	HV%	-	-	-	24%	26%	-	-	36%	6%	-	-	-	-	-	-	-	7%	3%	2%	26%	-	-	-	-	-	14%

Note: Two-hour count summary volumes include heavy vehicles but exclude bicycles in overall count.

Interval Start	Heavy Vehicle Totals						Bicycles					Pedestrians (Crossing Leg)						
	EB	WB	NB	SB	SEB	Total	EB	WB	NB	SB	SEB	Total	East	West	North	South	Northwest	Total
4:00 PM	22	17	0	10	0	49	19	19	0	6	1	45	72	99	311	203	403	1,088
4:15 PM	27	21	0	14	0	62	19	13	0	3	0	35	73	111	258	190	329	961
4:30 PM	27	20	0	8	0	55	13	15	0	2	0	30	71	117	285	202	373	1,048
4:45 PM	22	18	0	12	0	52	13	16	0	2	0	31	83	118	329	159	380	1,069
5:00 PM	26	17	0	13	0	56	37	37	0	6	0	80	108	121	498	167	412	1,306
5:15 PM	19	19	0	16	0	54	35	40	0	3	0	78	94	96	443	193	469	1,295
5:30 PM	26	18	0	10	0	54	34	28	0	4	0	66	99	124	408	208	440	1,279
5:45 PM	21	16	0	15	0	52	21	31	0	4	0	56	90	140	393	245	417	1,285
Count Total	190	146	0	98	0	434	191	199	0	30	1	421	690	926	2,925	1,567	3,223	9,331
Peak-Hr	93	72	0	51	0	216	119	121	0	15	0	255	384	459	1,678	727	1,701	4,949

1844

Two-Hour Count Summaries - Heavy Vehicles

Interval Start	Market St Eastbound					Market St Westbound					Beale St Northbound					Davis St Southbound					n/a Southeastbound					15-min Total	Rolling One Hour
	UT	HL	LT	TH	RT	UT	LT	TH	BR	RT	UT	LT	BL	TH	RT	UT	LT	TH	RT	HR	UT	HL	BL	BR	HR		
4:00 PM	0	0	0	9	13	0	0	15	2	0	0	0	0	0	0	0	0	4	1	5	0	0	0	0	0	49	0
4:15 PM	0	0	0	14	13	0	0	19	2	0	0	0	0	0	0	0	2	7	0	5	0	0	0	0	0	62	0
4:30 PM	0	0	0	15	12	0	0	17	3	0	0	0	0	0	0	0	1	4	0	3	0	0	0	0	0	55	0
4:45 PM	0	0	0	9	13	0	0	17	1	0	0	0	0	0	0	0	0	7	0	5	0	0	0	0	0	52	218
5:00 PM	0	0	0	13	13	0	0	16	1	0	0	0	0	0	0	0	2	4	1	6	0	0	0	0	0	56	225
5:15 PM	0	0	0	9	10	0	0	16	3	0	0	0	0	0	0	0	1	7	0	8	0	0	0	0	0	54	217
5:30 PM	0	0	0	12	14	0	0	16	2	0	0	0	0	0	0	0	0	4	0	6	0	0	0	0	0	54	216
5:45 PM	0	0	0	9	12	0	0	15	1	0	0	0	0	0	0	0	0	7	0	8	0	0	0	0	0	52	216
Count Total	0	0	0	90	100	0	0	131	15	0	0	0	0	0	0	0	6	44	2	46	0	0	0	0	0	434	0
Peak Hour	0	0	0	43	50	0	0	65	7	0	0	0	0	0	0	0	3	22	1	25	0	0	0	0	0	216	0

Two-Hour Count Summaries - Bikes

Interval Start	Market St Eastbound					Market St Westbound					Beale St Northbound					Davis St Southbound					n/a Southeastbound					15-min Total	Rolling One Hour
	UT	HL	LT	TH	RT	UT	LT	TH	BR	RT	UT	LT	BL	TH	RT	UT	LT	TH	RT	HR	UT	HL	BL	BR	HR		
4:00 PM	0	0	0	18	1	0	0	17	2	0	0	0	0	0	0	0	0	5	1	0	0	0	0	1	0	45	0
4:15 PM	0	0	0	18	1	0	0	13	0	0	0	0	0	0	0	0	0	2	1	0	0	0	0	0	0	35	0
4:30 PM	0	0	0	13	0	0	0	15	0	0	0	0	0	0	0	0	0	0	1	1	0	0	0	0	0	30	0
4:45 PM	0	0	0	13	0	0	0	15	1	0	0	0	0	0	0	0	0	0	1	1	0	0	0	0	0	31	141
5:00 PM	0	0	0	36	1	0	0	33	4	0	0	0	0	0	0	0	1	2	3	0	0	0	0	0	0	80	176
5:15 PM	0	0	0	35	0	0	0	39	1	0	0	0	0	0	0	0	0	1	2	0	0	0	0	0	0	78	219
5:30 PM	0	0	0	34	0	0	0	28	0	0	0	0	0	0	0	0	0	2	2	0	0	0	0	0	0	66	255
5:45 PM	0	0	0	20	1	0	0	30	1	0	0	0	0	0	0	0	0	1	3	0	0	0	0	0	0	56	280
Count Total	0	0	0	187	4	0	0	190	9	0	0	0	0	0	0	0	1	13	14	2	0	0	0	1	0	421	0
Peak Hour	0	0	0	118	1	0	0	115	6	0	0	0	0	0	0	0	1	5	8	1	0	0	0	0	0	255	0

1845



City: San Francisco  
 Location: Location 1 - North Entrance (Howard St)  
 Date: 4/9/2019  
 Count Type: Pedestrian Count

	Entering			TOTAL PEDS
	EB Right Peds	SB Thru Peds	WB Left Peds	
7:00	5	1	4	10
7:15	6	0	3	9
7:30	6	1	4	11
7:45	3	2	0	5
8:00	12	1	6	19
8:15	15	2	2	19
8:30	7	0	2	9
8:45	3	0	0	3
<b>TOTAL</b>	<b>57</b>	<b>7</b>	<b>21</b>	<b>85</b>

	Entering			TOTAL PEDS
	EB Right Peds	SB Thru Peds	WB Left Peds	
16:00	94	1	15	110
16:15	86	2	31	119
16:30	116	0	35	151
16:45	112	11	36	159
17:00	181	7	63	251
17:15	167	8	46	221
17:30	185	10	49	244
17:45	137	2	47	186
<b>TOTAL</b>	<b>1078</b>	<b>41</b>	<b>322</b>	<b>1441</b>

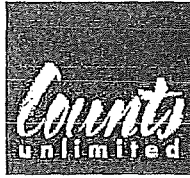

City: San Francisco  
 Location: Location 2 - Main E. Entrance (Main St)  
 Date: 4/9/2019  
 Count Type: Pedestrian Count

	Entering			TOTAL PEDS
	SB Right Peds	WB Thru Peds	NB Left Peds	
7:00	0	0	3	3
7:15	2	0	3	5
7:30	2	0	4	6
7:45	2	0	1	3
8:00	4	0	3	7
8:15	2	0	2	4
8:30	1	0	2	3
8:45	6	0	2	8
<b>TOTAL</b>	<b>19</b>	<b>0</b>	<b>20</b>	<b>39</b>

	Entering			TOTAL PEDS
	SB Right Peds	WB Thru Peds	NB Left Peds	
16:00	55	13	20	88
16:15	44	12	11	67
16:30	59	7	24	90
16:45	98	19	18	135
17:00	96	12	30	138
17:15	86	13	28	127
17:30	115	8	21	144
17:45	84	17	17	118
<b>TOTAL</b>	<b>637</b>	<b>101</b>	<b>169</b>	<b>907</b>

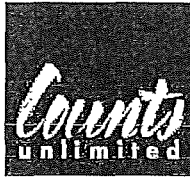

City: San Francisco  
 Location: Location 3 - Secondary E. Entrance (Main St)  
 Date: 4/9/2019  
 Count Type: Pedestrian Count

	Entering		TOTAL PEDS
	SB Right Peds	NB Left Peds	
7:00	0	0	0
7:15	0	2	2
7:30	0	0	0
7:45	0	1	1
8:00	1	1	2
8:15	0	0	0
8:30	0	1	1
8:45	0	0	0
<b>TOTAL</b>	<b>1</b>	<b>5</b>	<b>6</b>

	Entering		TOTAL PEDS
	SB Right Peds	NB Left Peds	
16:00	8	31	39
16:15	18	27	45
16:30	36	22	58
16:45	28	31	59
17:00	62	37	99
17:15	58	33	91
17:30	19	42	61
17:45	45	35	80
<b>TOTAL</b>	<b>274</b>	<b>258</b>	<b>532</b>





City: San Francisco  
 Location: Location 4 - Outbound Bus Dwy  
 Date: 4/9/2019  
 Count Type: Pedestrian Count

	Entering			TOTAL PEDS
	EB Left Peds	NB Thru Peds	WB Right Peds	
7:00	0	1	0	1
7:15	0	1	0	1
7:30	2	0	0	2
7:45	0	0	0	0
8:00	0	1	0	1
8:15	0	0	0	0
8:30	0	0	0	0
8:45	0	0	0	0
<b>TOTAL</b>	<b>2</b>	<b>3</b>	<b>0</b>	<b>5</b>

	Entering			TOTAL PEDS
	EB Left Peds	NB Thru Peds	WB Right Peds	
16:00	1	2	0	3
16:15	0	2	2	4
16:30	0	1	0	1
16:45	0	0	0	0
17:00	0	0	0	0
17:15	0	1	0	1
17:30	0	0	0	0
17:45	0	0	0	0
<b>TOTAL</b>	<b>1</b>	<b>6</b>	<b>2</b>	<b>9</b>



City: San Francisco  
 Location: Location 5a - southern Greyhound Entrance  
 Date: 4/9/2019  
 Count Type: Pedestrian Count

	Entering			TOTAL PEDS
	EB Left Peds	WB Right Peds	Vehicle Drop-Off	
7:00	3	1	2	6
7:15	2	1	3	6
7:30	2	0	0	2
7:45	0	0	0	0
8:00	0	6	1	7
8:15	1	1	0	2
8:30	6	0	0	6
8:45	1	0	2	3
<b>TOTAL</b>	<b>15</b>	<b>9</b>	<b>8</b>	<b>32</b>

	Entering			TOTAL PEDS
	EB Left Peds	WB Right Peds	Vehicle Drop-Off	
16:00	5	10	4	19
16:15	5	7	2	14
16:30	4	4	1	9
16:45	0	2	3	5
17:00	1	1	1	3
17:15	2	5	2	9
17:30	0	2	1	3
17:45	2	3	1	6
<b>TOTAL</b>	<b>19</b>	<b>34</b>	<b>15</b>	<b>68</b>



City: San Francisco  
 Location: Location 5b - west Greyhound Driveway  
 Date: 4/9/2019  
 Count Type: Pedestrian Count

	Entering		TOTAL PEDS
	NB Right Peds	SB Left Peds	
7:00	2	1	3
7:15	0	2	2
7:30	0	4	4
7:45	0	1	1
8:00	0	1	1
8:15	1	1	2
8:30	0	0	0
8:45	0	0	0
<b>TOTAL</b>	<b>3</b>	<b>10</b>	<b>13</b>

	Entering		TOTAL PEDS
	NB Right Peds	SB Left Peds	
16:00	1	14	15
16:15	0	11	11
16:30	1	2	3
16:45	0	2	2
17:00	1	1	2
17:15	2	7	9
17:30	1	2	3
17:45	1	1	2
<b>TOTAL</b>	<b>7</b>	<b>40</b>	<b>47</b>



City: San Francisco  
Location: Location 6 - Secondary western Entrance (Beale St  
Date: 4/9/2019  
Count Type: Pedestrian Count

	Entering		TOTAL PEDS
	NB Right Peds	SB Left Peds	
7:00	0	0	0
7:15	1	0	1
7:30	1	0	1
7:45	1	0	1
8:00	0	0	0
8:15	2	0	2
8:30	1	0	1
8:45	0	0	0
<b>TOTAL</b>	<b>6</b>	<b>0</b>	<b>6</b>

	Entering		TOTAL PEDS
	NB Right Peds	SB Left Peds	
16:00	3	1	4
16:15	6	0	6
16:30	3	0	3
16:45	4	1	5
17:00	3	0	3
17:15	8	1	9
17:30	0	2	2
17:45	2	0	2
<b>TOTAL</b>	<b>29</b>	<b>5</b>	<b>34</b>



City: San Francisco  
Location: Location 7 - Main western Entrance (Beale St)  
Date: 4/9/2019  
Count Type: Pedestrian Count

	Entering		TOTAL PEDS
	NB Right Peds	SB Left Peds	
7:00	3	5	8
7:15	9	3	12
7:30	44	7	51
7:45	48	12	60
8:00	31	9	40
8:15	40	2	42
8:30	9	10	19
8:45	24	14	38
<b>TOTAL</b>	<b>208</b>	<b>62</b>	<b>270</b>

	Entering		TOTAL PEDS
	NB Right Peds	SB Left Peds	
16:00	27	78	105
16:15	84	120	204
16:30	52	130	182
16:45	66	168	234
17:00	67	212	279
17:15	133	198	331
17:30	79	217	296
17:45	74	172	246
<b>TOTAL</b>	<b>582</b>	<b>1295</b>	<b>1877</b>



City: San Francisco  
Location: TOTAL OF ALL SITES ENTERING/EXITING  
Date: 4/9/2019  
Count Type: Pedestrian Count

	ENTERING TOTAL	EXITING TOTAL	TOTAL
7:00	31	235	266
7:15	38	316	354
7:30	77	472	549
7:45	71	564	635
8:00	77	785	862
8:15	71	496	567
8:30	39	663	702
8:45	52	769	821
<b>TOTAL</b>	<b>456</b>	<b>4300</b>	<b>4756</b> 47%

	TOTAL PEDS	TOTAL PEDS	TOTAL
16:00	383	42	425
16:15	470	34	504
16:30	497	35	532
16:45	599	52	651
17:00	775	69	844
17:15	798	45	843
17:30	753	43	796
17:45	640	37	677
<b>TOTAL</b>	<b>4915</b>	<b>357</b>	<b>5272</b>

AM PEAK HOUR 7:15A - 8:15A	
Inbound	Outbound
263	2137

2400

263	2137
263	2137
100%	100%

LOC #2	Inbound	Outbound
From/To N	10	264
From/To S	11	45

LOC #3	Inbound	Outbound
From/To N	1	130
From/To S	4	34

From/To N	630	15
From/To S	269	22

LOC #6	Inbound	Outbound
From/To N	1	0
From/To S	16	0

LOC #5B	Inbound	Outbound
From/To N	16	12
From/To S	2	4

PM PEAK HOUR 4:15A - 5:15P	
Inbound	Outbound
2341	

check sum	2341
check sum	2341
100%	100%

Outbound	LOC #4	Inbound	Outbound
13	From/To W	4	3
5	From/To E	0	1

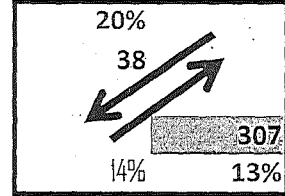
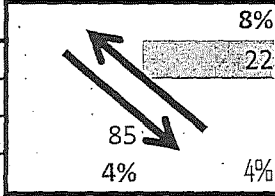

LOC #5A	Inbound	Outbound	LOC #4
From/To W	17	11	From/To
From/To E	14	7	From/To

1955

# AC Transit Transbay Ridership vs. Transbay Terminal Pedestrian Entry/Exit Counts

Route	Peak Frequency	Off Peak Frequency	Average Daily Ridership	Average Daily Ridership					
				to/from SF Only [1]	Peak Ridership [2]	AM (6-10AM) [3]	PM (4-8PM) [3]	AM (7-9AM) [4]	PM (4-6PM) [4]
C	20-70	-	400	400	400	190	210	142	158
CB	20-40	-	247	247	247	117	130	88	97
E	30-60	-	379	379	379	180	199	135	149
F	30	30	1,833	1,466	733	348	385	261	289
FS	20-55	-	503	503	503	239	264	179	198
G	30-60	-	452	452	452	214	238	161	178
H	20-35	-	592	592	592	281	311	211	233
J	20-60	-	836	836	836	396	440	297	330
L	15-50	-	668	668	668	317	351	238	263
LA	15-30	-	457	457	457	217	240	163	180
LC	-	3 trips	56	56	0	-	-	-	-
M	35-40	-	224	179	179	85	94	64	71
NL	15	20-30	3,022	2,418	1,209	573	635	430	477
NX	8-20	-	312	312	312	148	164	111	123
NX1	15-20	-	200	200	200	95	105	71	79
NX2	10-25	-	265	265	265	126	139	94	104
NX3	15-30	-	332	332	332	157	175	118	131
NX4	15-35	-	368	368	368	175	193	131	145
NXC	-	2 trips	33	33	0	-	-	-	-
O	10-30	60	1,822	1,458	729	346	383	259	287
OX	10-30	-	625	625	625	296	329	222	246
P	8-30	-	926	926	926	439	487	329	365
S	15-60	-	225	225	225	107	118	80	89
SB	10-30	-	403	403	403	191	212	143	159
U	30-60	-	375	300	300	142	158	107	118
V	10-30	-	765	765	765	363	402	272	302
W	15-40	-	563	563	563	267	296	200	222
Z	2 trips each way	-	52	52	52	25	27	18	21
<b>Total</b>			<b>16,935</b>	<b>12,720</b>	<b>6,033</b>	<b>6,687</b>	<b>4,525</b>	<b>5,015</b>	

Source: AC Transit 2018 Annual Ridership and Route Performance Report, October 24, 2018.

Notes:

- [1] Routes F, M, NL, O, and U include local passenger trips in the East Bay. Assumes 80% of total passengers on these routes travel to/from SF.
- [2] Routes F, NL, and O run throughout the day. Assumes 50% of daily ridership occur during the AM and PM peak periods on these routes.
- [3] Peak period ridership is split AM 47% and PM 53% based on pedestrian counts collected during AM vs. PM peak periods on 4/10/2019.
- [4] Assumes 75% of 4-hour peak period ridership occurs during the peak 2-hour period.

### Validation

	2018 AC Transit Ridership	2019 CHS Entry/Exit Counts	Difference [1]	
AM (7-9AM)	4,525	4,756	231	5%
PM (4-6PM)	5,015	5,272	257	5%

[1] The difference could be attributed to ridership on Lynx, AmTrak, or Greyhound buses, which also stop in the Temporary Transbay Terminal.



### Pedestrian Trip Distribution

INBOUND			
Direction		AM	PM
A	Northwest	70	1162
B	Northeast	24	656
C	Southwest	147	307
D	Southeast	22	216

20% of A	14	232
100% of B	24	656
Total	38	888
Check Sum =	38	888

OUTBOUND			
Direction		AM	PM
A	Northwest	1221	43
B	Northeast	571	45
C	Southwest	260	38
D	Southeast	85	64

20% of A	244	9
100% of B	571	45
Total	815	54
Check Sum =	815	54

TOTAL		
	AM	PM
20% of A	1,291	1,205
100% of B	595	701

AM						
		6		6		3
		50%		14		
		6	12	6		6
Mission	6	6		20		3
38		32		14		20%
		12		50%		6
		Fremont		Beale		3

AM						
		143		143		71
		50%		244		
		143	286	143		143
Mission	143	143		387		71
815		672		244		20%
		286		50%		143
		Fremont		Beale		71

PM						
		164		164		82
		50%		232		
		164	328	164		164
Mission	164	164		396		82
888		724		232		20%
		328		50%		164
		Fremont		Beale		82

PM						
		11		11		6
		50%		9		
		11	23	11		11
Mission	11	11		20		6
54		42		9		20%
		23		50%		11
		Fremont		Beale		6

### Pedestrian Crossing Volumes

Crosswalk	AM			PM		
	Existing	Added	Baseline	Existing	Added	Baseline
Mission St/ Fremont St						
North	709	149	858	1,019	175	1,194
South	880	704	1,584	1,374	767	2,141
East	1,199	149	1,348	1,228	175	1,403
West	1,189	149	1,338	941	175	1,116
Total	3,977	1,151	5,128	4,562	1,293	5,855
Mission St/ Beale St						
North	729	149	878	916	175	1,091
South	813	149	962	882	175	1,057
East	501	74	575	441	88	529
West	1,323	407	1,730	1,374	416	1,790
Total	3,366	779	4,145	3,613	854	4,467

1857

19162 - SoMa - Loading Zone Duration  
 9-Apr  
 Loading Zone/Passenger Survey  
 IDAX Data Solutions

**Location: Mission St, North Blockface**

Instance	ading Activ	Arrival Time	Leaving Time	Duration	Legal Loading	Comments
1	Passenger	8:06:13	8:06:33	0:00:20	N	Drop
2	Passenger	8:13:17	8:13:22	0:00:05	N	Drop
3	Passenger	8:14:17	8:14:31	0:00:14	N	Drop
4	Passenger	8:18:43	8:18:54	0:00:11	N	Drop
5	Passenger	8:19:42	8:19:51	0:00:09	N	Drop
6	Passenger	8:21:09	8:21:29	0:00:20	N	Drop
7	Passenger	8:24:06	8:24:14	0:00:08	N	Drop
8	Passenger	8:25:43	8:25:50	0:00:07	N	Drop
9	Passenger	8:27:14	8:27:21	0:00:07	N	Drop
10	Passenger	8:30:17	8:30:27	0:00:10	N	No Activity
11	Passenger	8:34:47	8:35:03	0:00:16	N	Drop
12	Passenger	8:38:58	8:39:07	0:00:09	N	Drop
13	Passenger	8:39:18	8:39:34	0:00:16	N	Drop
14	Passenger	8:40:43	8:40:54	0:00:11	N	Drop
15	Commercia	8:42:53	8:45:39	0:02:46	N	Loading
16	Passenger	8:50:01	8:50:06	0:00:05	N	Drop
17	Passenger	8:54:17	8:54:31	0:00:14	N	Drop
18	Passenger	9:02:10	9:02:35	0:00:25	N	Drop
19	Passenger	9:05:29	9:07:16	0:01:47	N	Pick Up
20	Passenger	9:07:58	9:08:05	0:00:07	N	Drop
21	Passenger	9:10:40	9:10:47	0:00:07	N	Drop
22	Passenger	9:12:04	9:12:15	0:00:11	N	Drop
23	Passenger	9:12:27	9:12:48	0:00:21	N	Drop
24	Passenger	9:13:53	9:14:05	0:00:12	N	Drop
25	Passenger	9:24:33	9:24:42	0:00:09	N	Pick Up
26	Passenger	9:25:51	9:25:58	0:00:07	N	Drop
27	Passenger	9:28:50	9:30:02	0:01:12	N	Pick Up
28	Passenger	9:36:08	9:36:25	0:00:17	N	Pick Up
29	Passenger	9:36:30	9:37:41	0:01:11	N	Pick Up
30	Passenger	9:44:47	9:45:23	0:00:36	N	Drop
31	Passenger	9:49:29	9:49:39	0:00:10	N	Drop
32	Passenger	9:58:22	9:58:31	0:00:09	N	Drop
33	Passenger	10:09:02	10:09:10	0:00:08	N	Drop
34	Passenger	10:10:27	10:10:32	0:00:05	N	Drop
35	Passenger	10:17:30	10:17:44	0:00:14	N	Pick Up
36	Passenger	10:23:04	10:23:14	0:00:10	N	Drop
37	Commercia	10:29:22	10:47:27	0:18:05	N	Working
38	Commercia	10:32:56	10:47:25	0:14:29	N	Working
39	Passenger	10:47:56	10:48:44	0:00:48	N	Drop
40	Commercia	10:48:51	11:10:35	0:21:44	N	Working

41	Passenger	10:56:27	10:56:46	0:00:19	N	Pick Up
42	Passenger	10:58:52	10:59:15	0:00:23	N	Drop
43	Passenger	11:12:48	11:12:57	0:00:09	N	Drop
44	Passenger	11:14:47	11:15:36	0:00:49	N	Pick Up
45	Passenger	11:37:49	11:38:11	0:00:22	N	Drop
46	Passenger	11:45:20	11:45:44	0:00:24	N	Drop
47	Passenger	11:49:53	11:50:00	0:00:07	N	Drop
48	Passenger	11:51:55	11:52:39	0:00:44	N	Pick Up
49	Passenger	11:55:45	11:56:49	0:01:04	N	Drop
50	Passenger	12:05:19	12:05:39	0:00:20	N	Drop
51	Passenger	12:15:10	12:15:25	0:00:15	N	Drop
52	Passenger	12:19:50	12:20:17	0:00:27	N	Drop
53	Passenger	12:27:31	12:27:48	0:00:17	N	Drop
54	Commercia	12:31:46	12:32:16	0:00:30	N	Loading
55	Passenger	12:52:33	12:52:43	0:00:10	N	No Activity
56	Passenger	12:53:34	12:54:27	0:00:53	N	No Activity
57	Passenger	12:58:44	12:59:13	0:00:29	N	Pick Up
58	Passenger	13:07:01	13:07:07	0:00:06	N	Pick Up
59	Passenger	13:24:11	13:24:54	0:00:43	N	Pick Up
60	Passenger	13:38:00	13:38:07	0:00:07	N	Pick Up
61	Passenger	13:57:26	13:58:19	0:00:53	N	Drop & Pick Up
62	Passenger	14:04:21	14:05:15	0:00:54	N	Drop
63	Passenger	14:04:44	14:05:03	0:00:19	N	No Activity
64	Passenger	14:22:01	14:22:09	0:00:08	N	Pick Up
65	Passenger	14:22:27	14:23:42	0:01:15	N	No Activity
66	Passenger	14:23:58	14:24:04	0:00:06	N	Drop
67	Passenger	14:42:59	14:43:04	0:00:05	N	Pick Up
68	Passenger	14:51:52	14:52:15	0:00:23	N	Drop
69	Passenger	15:11:16	15:11:33	0:00:17	N	Pick Up
70	Passenger	15:19:37	15:20:17	0:00:40	N	No Activity
71	Passenger	15:43:42	15:44:31	0:00:49	N	Pick Up
72	Passenger	15:55:26	15:55:45	0:00:19	N	Pick Up
73	Passenger	16:40:23	16:40:47	0:00:24	N	Pick Up
74	Passenger	16:43:07	16:43:19	0:00:12	N	No Activity
75	Passenger	16:43:15	16:43:52	0:00:37	N	Pick Up
76	Passenger	17:08:29	17:08:38	0:00:09	N	Pick Up
77	Passenger	17:25:43	17:26:25	0:00:42	N	Pick Up
78	Passenger	17:36:04	17:36:14	0:00:10	N	Drop
79	Passenger	17:36:46	17:36:54	0:00:08	N	Pick Up
80	Passenger	17:37:27	17:38:23	0:00:56	N	Pick Up
81	Passenger	17:48:18	17:48:59	0:00:41	N	Pick Up

Center Of The Road

1	Passenger	8:16:53	8:17:03	0:00:10	N	Drop
2	Passenger	8:28:47	8:28:59	0:00:12	N	Pick Up
3	Passenger	8:31:46	8:32:02	0:00:16	N	Drop

4	Passenger	8:46:54	8:47:05	0:00:11	N	Drop
5	Passenger	9:11:11	9:11:17	0:00:06	N	Drop
6	Passenger	9:22:43	9:22:53	0:00:10	N	Drop
7	Passenger	9:43:30	9:44:02	0:00:32	N	Drop
8	Passenger	9:46:29	9:46:52	0:00:23	N	Drop
9	Passenger	9:52:52	9:53:01	0:00:09	N	Drop
10	Passenger	10:13:55	10:14:06	0:00:11	N	Drop
11	Passenger	11:00:05	11:00:45	0:00:40	N	Drop
12	Passenger	11:31:20	11:32:09	0:00:49	N	Drop
13	Passenger	11:53:45	11:54:47	0:01:02	N	Drop
14	Passenger	12:23:44	12:24:38	0:00:54	N	Drop
15	Passenger	12:40:48	12:41:17	0:00:29	N	Drop
16	Passenger	13:10:33	13:10:53	0:00:20	N	Drop
17	Passenger	16:29:32	16:29:40	0:00:08	N	Pick Up
18	Passenger	17:58:34	17:59:28	0:00:54	N	Pick Up

**Bus**

1	Commercial	8:02:09	8:02:39	N	Pick Up & Drop
2	Commercial	8:07:49	8:08:10	N	Pick Up & Drop
3	Commercial	8:10:59	8:11:13	N	Pick Up & Drop
4	Commercial	8:13:49	8:14:04	N	Pick Up & Drop
5	Commercial	8:27:22	8:27:42	N	Pick Up & Drop
6	Commercial	8:30:18	8:30:45	N	Pick Up & Drop
7	Commercial	8:33:24	8:33:47	N	Pick Up & Drop
8	Commercial	8:36:19	8:36:33	N	Pick Up & Drop
9	Commercial	8:39:22	8:39:34	N	Pick Up & Drop
10	Commercial	8:40:53	8:41:12	N	Pick Up & Drop
11	Commercial	8:42:22	8:42:36	N	Pick Up & Drop
12	Commercial	8:48:23	8:48:34	N	Pick Up & Drop
13	Commercial	8:56:05	8:56:23	N	Pick Up & Drop
14	Commercial	8:58:48	8:59:03	N	Pick Up & Drop
15	Commercial	9:07:48	9:08:02	N	Pick Up & Drop
16	Commercial	9:08:16	9:08:29	N	Pick Up & Drop
17	Commercial	9:15:22	9:15:36	N	Pick Up & Drop
18	Commercial	9:24:28	9:24:52	N	Pick Up & Drop
19	Commercial	9:28:47	9:29:01	N	Pick Up & Drop
20	Commercial	9:31:58	9:32:05	N	Pick Up & Drop
21	Commercial	9:33:19	9:33:28	N	Pick Up & Drop
22	Commercial	9:51:22	9:51:40	N	Pick Up & Drop
23	Commercial	9:53:12	9:53:21	N	Pick Up & Drop
24	Commercial	10:07:04	10:07:23	N	Pick Up & Drop
25	Commercial	10:13:10	10:13:22	N	Pick Up & Drop
26	Commercial	10:24:12	10:24:37	N	Pick Up & Drop
27	Commercial	10:34:16	10:34:29	N	Pick Up & Drop
28	Commercial	10:36:40	10:37:17	N	Pick Up & Drop
29	Commercial	10:43:15	10:44:30	N	Pick Up & Drop

30	Commercia	11:10:34	11:11:20	N	Pick Up & Drop
31	Commercia	11:14:10	11:14:24	N	Pick Up & Drop
32	Commercia	11:17:53	11:18:01	N	Pick Up & Drop
33	Commercia	11:18:18	11:18:32	N	Pick Up & Drop
34	Commercia	11:28:04	11:28:36	N	Pick Up & Drop
35	Commercia	11:37:03	11:37:19	N	Pick Up & Drop
36	Commercia	11:40:26	11:41:05	N	Pick Up & Drop
37	Commercia	11:52:56	11:53:08	N	Pick Up & Drop
38	Commercia	11:55:24	11:55:35	N	Pick Up & Drop
39	Commercia	12:02:03	12:02:18	N	Pick Up & Drop
40	Commercia	12:04:21	12:04:38	N	Pick Up & Drop
41	Commercia	12:11:41	12:11:59	N	Pick Up & Drop
42	Commercia	12:11:54	12:12:08	N	Pick Up & Drop
43	Commercia	12:16:54	12:17:06	N	Pick Up & Drop
44	Commercia	12:19:13	12:19:30	N	Pick Up & Drop
45	Commercia	12:28:04	12:28:16	N	Pick Up & Drop
46	Commercia	12:40:25	12:40:43	N	Pick Up & Drop
47	Commercia	12:42:03	12:42:19	N	Pick Up & Drop
48	Commercia	12:50:30	12:50:48	N	Pick Up & Drop
49	Commercia	12:50:35	12:50:50	N	Pick Up & Drop
50	Commercia	12:55:21	12:55:34	N	Pick Up & Drop
51	Commercia	12:57:29	12:58:26	N	Pick Up & Drop
52	Commercia	12:58:01	12:58:17	N	Pick Up & Drop
53	Commercia	13:06:41	13:06:57	N	Pick Up & Drop
54	Commercia	13:12:57	13:13:04	N	Pick Up & Drop
55	Commercia	13:19:14	13:19:30	N	Pick Up & Drop
56	Commercia	13:21:57	13:22:10	N	Pick Up & Drop
57	Commercia	13:30:25	13:30:39	N	Pick Up & Drop
58	Commercia	13:39:16	13:39:29	N	Pick Up & Drop
59	Commercia	13:40:31	13:40:42	N	Pick Up & Drop
60	Commercia	13:44:11	13:44:23	N	Pick Up & Drop
61	Commercia	13:47:06	13:47:30	N	Pick Up & Drop
62	Commercia	13:51:45	13:51:58	N	Pick Up & Drop
63	Commercia	13:56:54	13:57:10	N	Pick Up & Drop
64	Commercia	14:02:54	14:03:07	N	Pick Up & Drop
65	Commercia	14:07:56	14:08:09	N	Pick Up & Drop
66	Commercia	14:09:15	14:09:31	N	Pick Up & Drop
67	Commercia	14:18:08	14:18:23	N	Pick Up & Drop
68	Commercia	14:19:10	14:19:25	N	Pick Up & Drop
69	Commercia	14:21:48	14:22:18	N	Pick Up & Drop
70	Commercia	14:35:29	14:35:53	N	Pick Up & Drop
71	Commercia	14:38:13	14:38:30	N	Pick Up & Drop
72	Commercia	14:43:00	14:43:15	N	Pick Up & Drop
73	Commercia	14:47:59	14:48:11	N	Pick Up & Drop
74	Commercia	14:50:34	14:50:54	N	Pick Up & Drop
75	Commercia	14:54:22	14:54:41	N	Pick Up & Drop
76	Commercia	15:01:12	15:01:26	N	Pick Up & Drop

77	Commercia	15:02:28	15:02:40	N	Pick Up & Drop
78	Commercia	15:08:46	15:09:01	N	Pick Up & Drop
79	Commercia	15:11:42	15:12:00	N	Pick Up & Drop
80	Commercia	15:12:03	15:23:43	N	Pick Up & Drop
81	Commercia	15:13:17	15:13:30	N	Pick Up & Drop
82	Commercia	15:18:08	15:18:33	N	Pick Up & Drop
83	Commercia	15:21:03	15:21:17	N	Pick Up & Drop
84	Commercia	15:24:50	15:27:57	N	Pick Up & Drop
85	Commercia	15:25:16	15:25:32	N	Pick Up & Drop
86	Commercia	15:25:49	15:26:05	N	Pick Up & Drop
87	Commercia	15:30:01	15:30:17	N	Pick Up & Drop
88	Commercia	15:31:17	15:31:35	N	Pick Up & Drop
89	Commercia	15:33:13	15:33:27	N	Pick Up & Drop
90	Commercia	15:38:46	15:39:02	N	Pick Up & Drop
91	Commercia	15:39:29	15:39:59	N	Pick Up & Drop
92	Commercia	15:41:48	15:42:08	N	Pick Up & Drop
93	Commercia	15:45:18	15:45:52	N	Pick Up & Drop
94	Commercia	15:48:10	15:48:28	N	Pick Up & Drop
95	Commercia	15:49:16	15:49:28	N	Pick Up & Drop
96	Commercia	15:49:40	15:50:00	N	Pick Up & Drop
97	Commercia	15:49:45	15:50:04	N	Pick Up & Drop
98	Commercia	15:56:47	15:57:08	N	Pick Up & Drop
99	Commercia	15:56:52	15:57:17	N	Pick Up & Drop
100	Commercia	15:58:17	15:59:00	N	Pick Up & Drop
101	Commercia	16:01:20	16:02:33	N	Pick Up & Drop
102	Commercia	16:03:01	16:03:16	N	Pick Up & Drop
103	Commercia	16:10:18	16:10:40	N	Pick Up & Drop
104	Commercia	16:10:29	16:10:52	N	Pick Up & Drop
105	Commercia	16:11:47	16:12:00	N	Pick Up & Drop
106	Commercia	16:16:24	16:16:38	N	Pick Up & Drop
107	Commercia	16:18:16	16:18:29	N	Pick Up & Drop
108	Commercia	16:25:17	16:25:32	N	Pick Up & Drop
109	Commercia	16:26:53	16:27:05	N	Pick Up & Drop
110	Commercia	16:33:11	16:33:29	N	Pick Up & Drop
111	Commercia	16:34:14	16:34:29	N	Pick Up & Drop
112	Commercia	16:35:52	16:36:06	N	Pick Up & Drop
113	Commercia	16:36:00	16:36:12	N	Pick Up & Drop
114	Commercia	16:40:18	16:40:37	N	Pick Up & Drop
115	Commercia	16:45:03	16:45:27	N	Pick Up & Drop
116	Commercia	16:46:16	16:46:28	N	Pick Up & Drop
117	Commercia	16:47:49	16:48:02	N	Pick Up & Drop
118	Commercia	16:52:19	16:52:52	N	Pick Up & Drop
119	Commercia	16:54:10	16:54:26	N	Pick Up & Drop
120	Commercia	16:58:24	16:58:53	N	Pick Up & Drop
121	Commercia	17:03:04	17:03:26	N	Pick Up & Drop
122	Commercia	17:05:59	17:06:15	N	Pick Up & Drop
123	Commercia	17:10:17	17:10:28	N	Pick Up & Drop

124	Commercia	17:10:23	17:10:43	N	Pick Up & Drop
125	Commercia	17:13:21	17:13:37	N	Pick Up & Drop
126	Commercia	17:14:52	17:15:02	N	Pick Up & Drop
127	Commercia	17:14:54	17:15:19	N	Pick Up & Drop
128	Commercia	17:18:13	17:18:27	N	Pick Up & Drop
129	Commercia	17:19:27	17:19:50	N	Pick Up & Drop
130	Commercia	17:20:59	17:21:07	N	Pick Up & Drop
131	Commercia	17:22:33	17:22:49	N	Pick Up & Drop
132	Commercia	17:25:27	17:25:45	N	Pick Up & Drop
133	Commercia	17:27:11	17:27:58	N	Pick Up & Drop
134	Commercia	17:28:29	17:28:47	N	Pick Up & Drop
135	Commercia	17:32:45	17:33:23	N	Pick Up & Drop
136	Commercia	17:34:48	17:35:00	N	Pick Up & Drop
137	Commercia	17:35:44	17:35:58	N	Pick Up & Drop
138	Commercia	17:37:14	17:37:30	N	Pick Up & Drop
139	Commercia	17:46:18	17:46:47	N	Pick Up & Drop
140	Commercia	17:48:18	17:48:28	N	Pick Up & Drop
141	Commercia	17:51:01	17:51:08	N	Pick Up & Drop
142	Commercia	17:51:18	17:51:54	N	Pick Up & Drop
143	Commercia	17:54:03	17:54:16	N	Pick Up & Drop
144	Commercia	17:56:51	17:57:07	N	Pick Up & Drop

**KEY**

Loading Activity

Commercial     *unloading cargo out of trucks*

Passenger     *People getting out of cars*

Arrival Time

Time vehicle stopped along curb

Leaving Time

Time vehicle left curb

Legal Loading

Y     Loaded/unloaded on existing loading zones

N     Loaded/unloaded in red zone



## 19162 - SoMa - Loading Zone Duration

9-Apr

Loading Zone/Passenger Survey

IDAX Data Solutions

**Location: Mission St, South Blockface**

Instance	ading Activ	Arrival Time	Leaving Time	Duration	Legal Loading	Comments
1	Passenger	8:00:41	8:00:56	0:00:15	Y	Drop
2	Passenger	8:05:24	8:05:36	0:00:12	Y	Drop
3	Passenger	8:09:32	8:10:27	0:00:55	Y	Pick Up
4	Passenger	8:11:29	8:11:31	0:00:02	Y	Drop
5	Passenger	8:12:28	8:12:36	0:00:08	Y	Drop
6	Passenger	8:18:48	8:19:02	0:00:14	Y	Pick Up
7	Passenger	8:23:32	8:23:40	0:00:08	Y	Drop
8	Passenger	8:23:35	8:23:40	0:00:05	N	Drop
9	Passenger	8:28:10	8:28:24	0:00:14	Y	Drop
10	Passenger	8:31:10	8:31:22	0:00:12	Y	Drop
11	Passenger	8:36:18	8:36:34	0:00:16	Y	Drop
12	Passenger	8:38:31	8:39:12	0:00:41	Y	Drop
13	Passenger	8:40:17	8:40:25	0:00:08	Y	Drop
14	Passenger	8:40:44	8:41:04	0:00:20	Y	Drop
15	Passenger	8:40:48	8:41:19	0:00:31	Y	Drop
16	Passenger	8:44:44	8:45:08	0:00:24	Y	Drop
17	Passenger	8:47:47	8:47:55	0:00:08	Y	Drop
18	Passenger	8:49:01	8:49:15	0:00:14	Y	Drop
19	Passenger	8:56:00	11:09:35	2:13:35	Y	Parking
20	Passenger	8:59:32	8:59:49	0:00:17	N	Drop
21	Passenger	9:03:27	9:04:13	0:00:46	Y	Drop
22	Passenger	9:03:45	9:04:14	0:00:29	Y	Drop
23	Passenger	9:04:51	9:05:10	0:00:19	Y	Drop
24	Passenger	9:09:21	9:10:42	0:01:21	Y	Drop
25	Passenger	9:14:31	9:16:01	0:01:30	Y	No Activity
26	Passenger	9:15:56	9:19:00	0:03:04	N	Drop
27	Passenger	9:16:14	9:17:28	0:01:14	Y	Drop
28	Passenger	9:18:29	9:18:57	0:00:28	N	Drop
29	Passenger	9:22:05	9:22:31	0:00:26	Y	Drop
30	Passenger	9:27:52	9:28:23	0:00:31	Y	Drop
31	Commercia	9:28:02	10:28:44	1:00:42	N	Working
32	Passenger	9:28:55	9:29:48	0:00:53	N	Drop
33	Passenger	9:30:23	9:30:32	0:00:09	Y	Pick Up
34	Commercia	9:33:36	10:28:36	0:55:00	N	Working
35	Passenger	9:42:56	9:44:11	0:01:15	Y	Pick Up
36	Passenger	9:45:34	9:45:51	0:00:17	Y	Pick Up
37	Passenger	9:48:34	9:49:07	0:00:33	Y	Drop
38	Passenger	9:49:46	9:52:22	0:02:36	Y	Pick Up
39	Passenger	9:50:18	9:53:32	0:03:14	Y	Pick Up
40	Passenger	9:56:27	9:57:22	0:00:55	Y	No Activity

41	Passenger	9:59:32	9:59:43	0:00:11	Y	Drop
42	Passenger	10:02:41	10:02:58	0:00:17	Y	Drop
43	Passenger	10:08:07	10:08:39	0:00:32	Y	Drop
44	Passenger	10:08:17	10:08:29	0:00:12	Y	Drop
45	Passenger	10:13:59	10:14:11	0:00:12	Y	Pick Up
46	Passenger	10:21:11	10:21:29	0:00:18	Y	Pick Up
47	Passenger	10:26:43	10:26:53	0:00:10	Y	Drop
48	Commercia	10:29:06	10:30:26	0:01:20	Y	No Activity
49	Passenger	10:31:01	10:32:21	0:01:20	N	Drop
50	Passenger	10:32:40	10:32:52	0:00:12	N	Drop
51	Passenger	10:32:48	10:37:35	0:04:47	Y	Pick Up
52	Passenger	10:35:54	10:36:47	0:00:53	Y	Drop
53	Passenger	10:40:48	10:41:01	0:00:13	Y	Drop
54	Passenger	10:55:17	10:56:10	0:00:53	N	Drop
55	Passenger	11:11:08	11:11:18	0:00:10	Y	Drop
56	Passenger	11:22:08	11:23:06	0:00:58	Y	Drop
57	Passenger	11:23:30	11:23:55	0:00:25	Y	Pick Up
58	Passenger	11:23:40	11:24:22	0:00:42	Y	Pick Up
59	Passenger	11:25:02	11:25:21	0:00:19	Y	Drop
60	Passenger	11:27:00	11:27:49	0:00:49	Y	Pick Up
61	Passenger	11:27:32	11:27:42	0:00:10	Y	Drop
62	Passenger	11:28:53	11:29:04	0:00:11	Y	Drop
63	Passenger	11:31:16	11:36:22	0:05:06	Y	Parking
64	Passenger	11:33:08	12:04:07	0:30:59	Y	Parking
65	Passenger	11:36:36	11:42:25	0:05:49	Y	Parking
66	Passenger	11:37:17	11:37:28	0:00:11	N	Drop
67	Passenger	11:42:36	11:45:36	0:03:00	Y	Parking
68	Passenger	11:45:02	11:45:27	0:00:25	Y	No Activity
69	Passenger	11:57:31	12:01:44	0:04:13	Y	Pick Up
70	Passenger	12:03:14	12:03:26	0:00:12	Y	Pick Up
71	Commercia	12:03:44	12:03:59	0:00:15	Y	No Activity
72	Passenger	12:03:51	12:04:39	0:00:48	N	Drop
73	Passenger	12:08:28	12:11:40	0:03:12	Y	Parking
74	Passenger	12:10:19	12:29:41	0:19:22	Y	Parking
75	Passenger	12:15:34	12:15:37	0:00:03	Y	Drop
76	Passenger	12:18:53	12:21:00	0:02:07	N	Parking
77	Passenger	12:19:52	12:20:33	0:00:41	Y	Drop
78	Passenger	12:20:34	12:20:42	0:00:08	N	Drop
79	Passenger	12:22:02	12:22:55	0:00:53	Y	No Activity
80	Passenger	12:22:20	12:22:59	0:00:39	Y	No Activity
81	Passenger	12:25:58	12:27:15	0:01:17	Y	Drop
82	Passenger	12:36:49	12:36:55	0:00:06	Y	Pick Up
83	Passenger	12:38:25	12:38:58	0:00:33	Y	Pick Up
84	Passenger	12:40:26	12:43:33	0:03:07	Y	Pick Up
85	Passenger	12:40:35	12:41:16	0:00:41	Y	Drop
86	Passenger	12:43:10	12:43:28	0:00:18	Y	Drop
87	Passenger	12:44:37	12:44:53	0:00:16	Y	Drop

88	Passenger	12:49:57	12:50:13	0:00:16	Y	Drop
89	Passenger	13:00:58	13:02:01	0:01:03	Y	Drop
90	Commercia	13:01:43	13:04:02	0:02:19	Y	No Activity
91	Passenger	13:07:05	13:15:11	0:08:06	Y	Pick Up
92	Passenger	13:10:09	13:10:31	0:00:22	Y	Drop
93	Passenger	13:11:18	13:12:52	0:01:34	Y	No Activity
94	Passenger	13:19:12	13:19:30	0:00:18	Y	Drop
95	Passenger	13:20:09	13:20:23	0:00:14	Y	Drop
96	Passenger	13:21:26	13:21:44	0:00:18	Y	Pick Up
97	Passenger	13:34:48	13:35:10	0:00:22	Y	Drop
98	Passenger	13:36:58	13:40:10	0:03:12	Y	Pick Up
99	Passenger	13:37:22	13:38:41	0:01:19	N	Pick Up
100	Passenger	13:40:58	13:41:09	0:00:11	Y	Pick Up
101	Passenger	13:42:16	13:42:38	0:00:22	Y	Pick Up
102	Passenger	13:50:48	13:51:08	0:00:20	Y	Drop
103	Passenger	13:51:12	13:51:15	0:00:03	N	Pick Up
104	Passenger	13:56:24	13:56:47	0:00:23	Y	Drop
105	Passenger	13:57:16	13:57:26	0:00:10	Y	Pick Up
106	Passenger	13:59:36	14:00:18	0:00:42	Y	Pick Up
107	Passenger	14:00:52	14:01:25	0:00:33	Y	Drop
108	Passenger	14:01:49	14:01:57	0:00:08	Y	Pick Up
109	Passenger	14:02:25	14:02:41	0:00:16	Y	Drop
110	Passenger	14:06:52	14:07:04	0:00:12	Y	Drop
111	Passenger	14:09:59	14:10:29	0:00:30	Y	Drop
112	Passenger	14:16:00	14:16:12	0:00:12	Y	Drop
113	Passenger	14:19:01	14:19:57	0:00:56	Y	Pick Up
114	Passenger	14:21:05	14:21:17	0:00:12	Y	Pick Up
115	Passenger	14:32:52	14:33:02	0:00:10	Y	Drop
116	Passenger	14:36:16	14:36:27	0:00:11	Y	Drop
117	Passenger	14:36:57	14:37:10	0:00:13	Y	Drop
118	Passenger	14:38:16	14:38:39	0:00:23	Y	Pick Up
119	Passenger	14:40:46	14:41:06	0:00:20	Y	No Activity
120	Passenger	14:44:50	14:45:11	0:00:21	Y	No Activity
121	Passenger	14:53:08	14:53:12	0:00:04	Y	Drop
122	Passenger	15:00:27	15:00:42	0:00:15	Y	Drop
123	Passenger	15:01:44	15:05:05	0:03:21	Y	Pick Up
124	Passenger	15:04:27	15:05:47	0:01:20	Y	Pick Up & Drop
125	Passenger	15:19:11	15:21:48	0:02:37	Y	Drop
126	Passenger	15:21:00	15:21:23	0:00:23	Y	Pick Up
127	Passenger	15:21:42	15:23:01	0:01:19	Y	No Activity
128	Passenger	15:27:22	15:27:31	0:00:09	Y	Drop
129	Passenger	15:28:11	15:28:34	0:00:23	Y	Pick Up
130	Passenger	15:31:12	15:32:29	0:01:17	Y	Pick Up
131	Passenger	15:38:24	15:40:07	0:01:43	Y	No Activity
132	Passenger	15:38:38	15:39:09	0:00:31	Y	Pick Up
133	Passenger	15:39:05	15:40:54	0:01:49	Y	Pick Up & Drop
134	Passenger	15:40:07	15:40:55	0:00:48	N	No Activity

135	Passenger	15:41:20	15:41:54	0:00:34	Y	No Activity
136	Passenger	15:44:06	15:44:46	0:00:40	Y	Drop
137	Passenger	15:44:32	15:44:42	0:00:10	N	Pick Up
138	Passenger	15:44:48	15:45:56	0:01:08	Y	Drop
139	Passenger	15:45:31	15:45:40	0:00:09	N	Pick Up
140	Passenger	15:47:39	15:47:48	0:00:09	Y	Pick Up
141	Passenger	15:50:50	15:51:02	0:00:12	Y	No Activity
142	Passenger	15:51:37	15:51:57	0:00:20	Y	Pick Up
143	Passenger	15:55:38	15:55:54	0:00:16	Y	Pick Up
144	Passenger	15:55:52	15:56:38	0:00:46	Y	Pick Up
145	Passenger	16:02:03	16:02:25	0:00:22	Y	Pick Up
146	Passenger	16:02:44	16:06:50	0:04:06	Y	Pick Up & Drop
147	Passenger	16:09:34	16:09:56	0:00:22	Y	Pick Up
148	Passenger	16:10:17	16:12:28	0:02:11	Y	No Activity
149	Passenger	16:14:56	16:16:47	0:01:51	Y	Pick Up & Drop
150	Passenger	16:21:27	16:22:42	0:01:15	Y	Drop
151	Passenger	16:22:17	16:22:45	0:00:28	Y	No Activity
152	Passenger	16:26:55	16:31:45	0:04:50	Y	No Activity
153	Passenger	16:28:33	16:29:07	0:00:34	Y	Drop
154	Passenger	16:30:05	16:30:18	0:00:13	Y	Drop
155	Passenger	16:30:44	16:30:50	0:00:06	Y	Drop
156	Passenger	16:35:52	16:36:04	0:00:12	Y	Drop
157	Passenger	16:38:57	16:40:08	0:01:11	Y	No Activity
158	Passenger	16:39:56	16:42:02	0:02:06	Y	Pick Up
159	Passenger	16:42:35	16:42:51	0:00:16	N	No Activity
160	Passenger	16:43:41	16:43:58	0:00:17	N	Pick Up
161	Passenger	16:47:39	16:47:59	0:00:20	Y	Drop
162	Passenger	16:53:43	16:57:38	0:03:55	Y	Pick Up
163	Passenger	16:56:58	16:59:12	0:02:14	Y	No Activity
164	Passenger	16:58:17	17:00:39	0:02:22	Y	Pick Up
165	Passenger	16:59:21	17:00:15	0:00:54	Y	Pick Up
166	Passenger	17:00:38	17:00:46	0:00:08	Y	Pick Up
167	Passenger	17:01:04	17:03:14	0:02:10	Y	Pick Up
168	Passenger	17:02:42	17:03:15	0:00:33	Y	No Activity
169	Passenger	17:02:47	17:03:21	0:00:34	N	No Activity
170	Passenger	17:05:41	17:09:56	0:04:15	Y	Pick Up
171	Passenger	17:11:41	17:14:55	0:03:14	Y	Pick Up
172	Passenger	17:20:52	17:21:06	0:00:14	Y	Drop
173	Passenger	17:32:22	17:32:53	0:00:31	Y	Drop
174	Passenger	17:32:57	17:33:43	0:00:46	Y	No Activity
175	Passenger	17:35:42	17:35:51	0:00:09	Y	Drop
176	Passenger	17:46:12	17:47:27	0:01:15	Y	Pick Up & Drop
177	Passenger	17:46:30	17:47:27	0:00:57	Y	Pick Up & Drop
178	Passenger	17:48:30	17:48:40	0:00:10	N	Drop
179	Passenger	17:50:50	17:52:25	0:01:35	Y	No Activity
180	Passenger	17:50:57	17:51:07	0:00:10	Y	Drop
181	Passenger	17:54:43	17:56:42	0:01:59	Y	No Activity

182	Passenger	17:54:55	17:55:33	0:00:38	Y	Pick Up
183	Passenger	17:55:33	18:00:00	0:04:27	N	End of survey time
184	Passenger	17:56:28	17:57:27	0:00:59	Y	Pick Up
185	Commercial	17:56:37	17:57:35	0:00:58	Y	No Activity
186	Passenger	17:58:19	17:58:27	0:00:08	N	Drop

**KEY**

Loading Activity

Commercial     *unloading cargo out of trucks*

Passenger     *People getting out of cars*

Arrival Time

Time vehicle stopped along curb

Leaving Time

Time vehicle left curb

Legal Loading

Y                Loaded/unloaded on existing loading zones

N                Loaded/unloaded in red zone

19162 - SoMa - Loading Zone Duration

9-Apr

Loading Zone/Passenger Survey

IDAX Data Solutions

**Location: Beale St, West Blockface (up to driveway)**

Instance	ading Activ	Arrival Time	Leaving Time	Duration	Legal Loading	Comments
1	Commercia	8:35:19	8:50:21	0:15:02	N	Delivery
2	Passenger	8:41:15	9:42:11	1:00:56	N	Drop
3	Commercia	8:42:36	9:10:29	0:27:53	N	Parking
4	Passenger	9:03:58	9:04:08	0:00:10	N	Drop
5	Passenger	9:13:07	9:13:17	0:00:10	N	Drop
6	Passenger	9:43:50	9:44:14	0:00:24	N	Drop
7	Passenger	9:53:31	9:54:44	0:01:13	N	Drop
8	Passenger	11:34:39	11:37:34	0:02:55	N	No Activity
9	Passenger	11:40:35	11:40:45	0:00:10	N	Pick Up
10	Passenger	11:42:32	11:42:42	0:00:10	N	Pick Up
11	Passenger	12:18:11	12:19:01	0:00:50	N	Waiting
12	Passenger	12:37:22	12:49:10	0:11:48	N	No Activity
13	Passenger	12:39:39	12:39:52	0:00:13	N	Pick Up
14	Passenger	12:59:22	12:59:55	0:00:33	N	Pick Up
15	Passenger	13:02:13	13:02:38	0:00:25	N	Pick Up
16	Passenger	14:41:33	14:41:43	0:00:10	N	Pick Up
17	Passenger	14:45:01	14:45:08	0:00:07	N	Pick Up
18	Passenger	15:08:14	15:08:22	0:00:08	N	Pick Up
19	Passenger	15:36:00	15:36:08	0:00:08	N	Drop
20	Passenger	15:46:29	15:46:39	0:00:10	N	Pick Up
21	Passenger	15:52:36	15:52:52	0:00:16	N	Drop
22	Passenger	16:07:39	16:07:46	0:00:07	N	Drop
23	Passenger	16:11:38	16:11:59	0:00:21	N	Drop
24	Passenger	16:18:10	16:18:39	0:00:29	N	Drop
25	Passenger	16:35:33	16:35:47	0:00:14	N	Drop
26	Passenger	17:00:00	17:00:12	0:00:12	N	Drop
27	Passenger	17:25:56	17:26:35	0:00:39	N	Pick Up
28	Passenger	17:37:28	17:37:38	0:00:10	N	Drop

**KEY**

Loading Activity

Commercial      *unloading cargo out of trucks*

Passenger      *People getting out of cars*

Arrival Time

Time vehicle stopped along curb

Leaving Time

Time vehicle left curb

Legal Loading

Y                  Loaded/unloaded on existing loading zones

N                  Loaded/unloaded in red zone



19162 - SoMa - Loading Zone Duration

9-Apr

Loading Zone/Passenger Survey

IDAX Data Solutions

**Location: Fremont St, East Blockface (up to driveway)**

Instance	ading Activ	Arrival Time	Leaving Time	Duration	Legal Loading	Comments
1	Passenger	8:13:25	8:13:33	0:00:08	N	Pick Up
2	Passenger	8:30:04	8:30:12	0:00:08	N	Pick Up
3	Commercia	9:04:54	9:05:03	0:00:09	N	Drop
4	Passenger	9:16:24	9:16:47	0:00:23	N	Pick Up
5	Passenger	9:55:29	9:55:39	0:00:10	N	Drop
6	Passenger	10:21:21	10:21:30	0:00:09	N	Drop
7	Passenger	10:36:09	10:36:23	0:00:14	N	Pick Up
8	Passenger	10:57:23	10:57:35	0:00:12	N	Drop
9	Passenger	11:28:19	11:28:34	0:00:15	N	Drop
10	Passenger	11:37:58	11:38:12	0:00:14	N	Drop
11	Passenger	11:38:02	11:38:52	0:00:50	N	Drop
12	Passenger	12:04:43	12:04:53	0:00:10	N	Pick Up
13	Passenger	12:21:35	12:22:25	0:00:50	N	Drop
14	Passenger	12:23:50	12:24:23	0:00:33	N	Drop
15	Passenger	12:48:28	12:48:39	0:00:11	N	Pick Up
16	Passenger	13:16:41	13:17:43	0:01:02	N	Pick Up
17	Passenger	13:25:31	13:27:21	0:01:50	N	Pick Up
18	Passenger	14:04:20	14:04:41	0:00:21	N	Pick Up
19	Passenger	14:52:34	14:52:42	0:00:08	N	Drop
20	Passenger	14:54:21	14:54:35	0:00:14	N	Pick Up
21	Passenger	15:11:07	15:11:17	0:00:10	N	Pick Up
22	Passenger	15:36:47	15:36:59	0:00:12	N	Pick Up
23	Passenger	15:38:15	15:38:22	0:00:07	N	Drop
24	Passenger	16:45:23	16:45:34	0:00:11	N	Drop
25	Passenger	16:55:13	16:55:22	0:00:09	N	Pick Up
26	Passenger	16:57:28	16:57:44	0:00:16	N	Pick Up
27	Passenger	17:03:50	17:05:17	0:01:27	N	Pick Up & Drop
28	Passenger	17:07:50	17:09:46	0:01:56	N	Pick Up & Drop
29	Passenger	17:18:14	17:19:47	0:01:33	N	Pick Up & Drop
30	Passenger	17:33:14	17:33:25	0:00:11	N	Pick Up
31	Passenger	17:42:51	17:43:10	0:00:19	N	Drop

**KEY**

Loading Activity

Commercial            *unloading cargo out of trucks*

Passenger            *People getting out of cars*

Arrival Time

Time vehicle stopped along curb

Leaving Time

Time vehicle left curb

Legal Loading

Y                        Loaded/unloaded on existing loading zones

N                        Loaded/unloaded in red zone

Time	Beale Driveway														Fremont Driveway													
	Private Autos		Commercial Trucks		Delivery/Sprinter Vans		Pickup Trucks		Limousines		Buses		Passenger Vans/Mini-Shuttles		Private Autos		Commercial Trucks		Delivery/Sprinter Vans		Pickup Trucks		Limousines		Buses		Passenger Vans/Mini-Shuttles	
	Ins	Outs	Ins	Outs	Ins	Outs	Ins	Outs	Ins	Outs	Ins	Outs	Ins	Outs	Ins	Outs	Ins	Outs	Ins	Outs	Ins	Outs	Ins	Outs	Ins	Outs	Ins	Outs
8:00	2	3	1	1	0	0	1	0	0	0	0	0	0	0	0	5	0	0	0	0	0	0	0	0	0	0	0	0
8:15	1	5	0	0	1	0	0	0	0	0	0	0	0	0	2	4	0	1	0	0	0	0	0	0	0	0	0	0
8:30	6	5	0	0	0	0	0	1	0	0	0	0	0	0	0	3	0	0	0	1	0	0	0	0	0	0	0	0
8:45	3	3	0	0	0	0	0	0	0	0	0	0	0	0	1	3	0	0	1	1	0	0	0	0	0	0	0	0
9:00	2	5	0	0	1	1	0	0	0	0	0	0	0	0	4	5	0	0	0	0	0	0	0	0	0	0	0	0
9:15	4	2	0	0	0	0	0	0	0	0	0	0	0	0	4	5	0	0	0	0	0	1	0	0	0	0	0	0
9:30	2	2	0	0	0	0	0	0	0	0	0	0	0	1	0	0	0	0	0	0	0	0	0	0	0	0	0	0
9:45	2	0	1	0	0	0	1	0	0	0	0	0	0	0	1	0	0	0	0	0	0	0	0	0	0	0	0	0
10:00	1	3	0	0	1	0	0	0	1	0	0	0	0	0	4	2	0	0	0	0	0	0	0	0	0	0	0	0
10:15	4	1	0	1	0	0	0	0	0	0	0	0	0	0	2	0	0	0	0	0	0	0	0	0	0	0	0	0
10:30	7	4	0	0	0	0	0	0	0	0	0	0	0	1	4	0	0	0	0	0	0	0	0	0	0	0	0	0
10:45	5	4	1	0	2	3	0	0	0	0	0	0	0	1	5	0	0	0	0	0	0	0	0	0	0	0	0	0
11:00	2	3	0	0	0	1	0	0	0	0	0	0	0	0	3	0	0	0	0	0	0	0	0	0	0	0	0	0
11:15	3	1	0	0	1	0	0	0	0	0	0	0	0	1	6	0	0	0	0	0	0	0	0	0	0	0	0	0
11:30	1	2	0	1	0	1	0	0	0	0	0	0	0	2	0	0	0	0	0	0	0	0	0	0	0	0	0	0
11:45	1	1	0	0	1	0	0	0	0	0	0	0	0	5	0	0	0	0	1	0	0	0	0	0	0	0	0	0
12:00	4	2	0	0	0	0	0	0	0	0	0	0	0	0	0	0	0	0	0	0	0	0	0	0	0	0	0	0
12:15	3	5	1	0	0	0	0	0	0	0	0	0	0	1	0	0	0	0	0	0	0	0	0	0	0	0	0	0
12:30	4	2	0	0	1	0	0	0	0	0	0	0	0	1	1	0	0	0	0	0	0	0	0	0	0	0	0	0
12:45	4	5	0	1	0	1	0	0	0	0	0	0	0	2	5	0	0	0	0	0	0	0	0	0	0	0	0	0
13:00	4	1	0	0	1	0	0	0	0	0	0	0	0	0	3	0	0	0	0	0	0	0	0	0	0	0	0	0
13:15	5	8	0	0	1	1	1	0	0	0	0	0	0	3	2	0	0	0	0	0	0	0	0	0	0	0	0	0
13:30	5	7	0	0	1	0	0	0	0	0	0	0	0	3	2	0	0	1	0	1	0	0	0	0	0	0	0	0
13:45	3	3	0	0	0	0	0	0	0	0	0	0	0	3	2	0	0	0	0	0	0	0	0	0	0	0	0	0
14:00	3	1	0	0	1	0	0	0	0	0	0	0	0	1	2	0	0	0	0	0	0	0	0	0	0	0	0	0
14:15	3	2	1	0	0	1	0	0	0	0	0	0	0	4	2	0	0	0	0	0	0	0	0	0	0	0	0	0
14:30	3	1	0	1	0	1	0	0	0	0	0	0	0	1	4	0	0	0	0	0	0	0	0	0	0	0	0	0
14:45	1	2	0	0	1	1	0	0	0	0	0	0	0	7	2	0	0	0	0	0	0	0	0	0	0	0	0	0
15:00	3	4	1	0	0	0	0	0	0	0	0	0	0	1	3	0	0	0	0	0	0	0	0	0	0	0	0	0
15:15	4	1	0	1	0	0	0	0	0	0	0	0	0	3	3	0	0	0	0	0	0	0	0	0	0	0	0	0
15:30	8	3	0	0	0	0	0	0	0	0	0	0	0	1	7	0	0	0	0	0	0	0	0	0	0	0	0	0
15:45	2	1	0	0	0	0	1	0	0	0	0	0	0	2	4	0	0	0	0	0	0	0	0	0	0	0	0	0
16:00	2	0	0	0	1	0	0	1	0	0	0	0	0	1	4	0	0	0	0	0	0	0	0	0	0	0	0	0
16:15	2	2	0	0	0	0	0	0	0	0	0	0	0	8	0	0	0	0	0	0	0	0	0	0	0	0	0	0
16:30	4	1	0	0	0	1	0	0	0	0	0	0	0	0	5	0	0	0	0	0	0	0	0	0	0	0	0	0
16:45	7	1	0	0	0	0	0	0	0	0	0	0	0	0	2	0	0	0	0	0	0	0	0	0	0	0	0	0
17:00	6	0	0	0	0	0	0	0	0	0	0	0	0	1	2	0	0	0	0	0	0	0	0	0	0	0	0	0
17:15	3	2	0	0	0	0	0	0	0	0	0	0	0	4	5	0	0	0	0	0	0	0	0	0	0	0	0	0
17:30	6	1	0	0	0	0	0	0	0	0	0	0	0	2	0	0	0	0	0	0	0	0	0	0	0	0	0	0
17:45	5	2	0	0	0	2	1	0	0	0	0	0	0	2	4	0	0	0	0	0	0	0	0	0	0	0	0	0
Total:	140	101	6	6	16	14	4	2	0	0	0	0	0	77	112	0	1	1	4	0	2	0	0	0	0	0	0	0

1875

**Attachment B.3**  
**Existing and Baseline Volumes**  
**Summary**





220 Montgomery Street  
Suite 346  
San Francisco, CA 94104  
(415) 392-9688 P  
(415) 392-9788 F  
www.chsconsulting.net

## Memorandum

Date: May 8, 2019

To: Jenny Delumo and Wade Wietgreffe, San Francisco Planning Department

From: Migi Lee and Chi-Hsin Shao, CHS Consulting Group

Re: 301 Mission Street Perimeter Pile Upgrade Project – Volume Estimation for Baseline Condition

---

This memo presents a summary of the existing traffic, bicycle, and pedestrian volumes, and loading data, collected in the vicinity of the 301 Mission Street project site, and describes the assumptions used to estimate the traffic, transit, bicycle, and pedestrian volumes for the Baseline Condition which assumes the Salesforce Transit Center is reopened. **Appendix A** includes the existing counts data.

### Traffic Volumes

Existing traffic volumes were collected at the following five intersections on Tuesday, April 9, 2019 during the AM (7 a.m. to 9 a.m.) and PM (4 p.m. to 6 p.m.) peak periods:

- Market Street/Fremont Street
- Market Street/Beale Street
- Mission Street/Fremont Street
- Mission Street/Beale Street
- Howard Street/Fremont Street

**Figure 1** presents the existing turning movement volumes at the above five intersections. Traffic volumes for the Baseline Condition were estimated by adjusting the transit vehicle volumes along Market, Mission, Fremont, Beale, and Howard streets based on changes to transit routes when the Salesforce Transit Center reopens. Affected transit routes and adjusted volumes are presented under *Transit Volumes* below. It is assumed that non-transit vehicle volumes along these streets would not substantially change when the Transit Center reopens because there would be no change in street lane geometry. **Figure 2** presents the adjusted turning movement volumes at the above five intersections under the Baseline Condition. **Table 1** provides a comparison of traffic volumes along the project frontages (Mission, Fremont, and Beale streets) under the Existing and Baseline Conditions.

The existing traffic volumes on Mission Street are approximately 30 percent higher in the eastbound direction than the westbound direction. Under the Baseline Condition, the eastbound traffic volumes on Mission Street would increase by approximately 10 percent during the AM and PM peak hours, while the westbound traffic volumes would decrease by 10 percent. Traffic volumes on Fremont Street would increase by approximately four percent during the AM and PM peak hours. Traffic volumes on Beale Street south of Mission Street would not substantially



change because the transit vehicles currently traveling in the southbound through movement would shift to eastbound Mission Street and make a right-turn movement on Beale Street instead.

**Table 1 – Traffic Volumes under Existing and Baseline Conditions**

Street	Segment	AM Peak Hour			PM Peak Hour		
		Existing	Baseline	Change	Existing	Baseline	Change
Mission Street	EB (Fremont St. – Beale St.)	510	566	+56	434	478	+44
	WB (Beale St. – Fremont St.)	342	306	-36	354	323	-31
Fremont Street	NB (Howard St. – Mission St.)	1,416	1,470	+54	1,208	1,254	+46
Beale Street	SB (Mission St. – Howard St.)	792	792	0	885	885	0

Source: CHS Consulting Group, 2019.

Notes: EB=Eastbound; WB=Westbound; NB=Northbound; SB=Southbound

**Transit Volumes**

Existing transit routes that currently travel along Mission, Fremont, and Beale streets in the project vicinity are<sup>1</sup>:

- Muni Routes 2, 5, 5R, 7, 9, 9R, 14, 14R, 14X, 30X, 38, 38R, 41, 81X, and 82X
- Golden Gate Transit Routes 2, 4, 8, 18, 24, 27, 30, 38, 44, 54, 56, 58, 70, 72, 74, 76, 101, and 101X
- SamTrans Routes 292

Existing transit vehicle volumes for the above routes were compiled using Muni, Golden Gate Transit, and SamTrans’ current transit schedules and route maps published on their websites. **Figure 3** presents the existing transit vehicle turning movement volumes at the above five intersections. Transit vehicle volumes for the Baseline Condition were estimated based on the changes to transit routes that would go into effect when the Salesforce Transit Center reopens, as provided or published by San Francisco Municipal Transportation Agency (SFMTA), Golden Gate Transit, and SamTrans. The following changes would occur when the Salesforce Transit Center reopens:

- Muni Routes 5 and 5R which currently travel along southbound Beale Street (from eastbound Market Street), eastbound Howard Street (stopping by the Temporary Transbay Terminal on Howard Street) and northbound Main Street would be rerouted to travel along southbound First Street, eastbound Mission Street, southbound Beale Street (stopping in the Salesforce Transit Center), and northbound Fremont Street. As a result, vehicle trips on the eastbound Mission Street and northbound Fremont Street would increase by 19 trips during the AM peak hour and 15 trips during the PM peak hour.
- Muni Routes 7, 38 and 38R which currently travel along southbound Beale Street (from eastbound Market Street), eastbound Folsom Street, northbound Main Street (stopping by the Temporary Transbay Terminal on Main Street), westbound Mission Street, and northbound Fremont Street would be rerouted to travel along southbound First Street, eastbound Mission Street, southbound Beale Street (stopping in the Salesforce Transit Center), and northbound Fremont Street. As a result, vehicle trips on the eastbound

<sup>1</sup> AC Transit, Greyhound and Amtrak buses currently operate in and out of the Temporary Transbay Terminal and would move to the upper deck of the Salesforce Transit Center once it reopens. They would not travel along the project frontages.

Mission Street and northbound Fremont Street would increase by 29 trips during the AM peak hour and 25 trips during the PM peak hour. Likewise, vehicle trips on the westbound Mission Street would decrease by 29 trips during the AM peak hour and 25 trips during the PM peak hour.

- Muni Route 2 which currently travels along southbound Spear Street (from eastbound Market Street), eastbound Mission Street and northbound Stueart Street would be rerouted to travel along southbound First Street, eastbound Mission Street and northbound Stueart Street. As a result, vehicle trips on the eastbound Mission Street would increase by eight trips during the AM peak hour and four trips during the PM peak hour.
- Golden Gate Transit Routes 30, 70, 101, 101X which currently travel along southbound Beale Street (from eastbound Mission Street), eastbound Folsom Street, northbound Main Street (stopping by the Temporary Transbay Terminal on Main Street) and westbound Mission Street would be rerouted to travel along southbound Beale Street (stopping in the Salesforce Transit Center), and northbound Fremont Street.<sup>2</sup> As a result, vehicle trips on northbound Fremont Street would increase by four trips during the AM and PM peak hours. Likewise, vehicle trips on westbound Mission Street would decrease by four trips during the AM and PM peak hours.
- SamTrans Route 292 which currently travels along southbound Beale Street (from eastbound Market Street), eastbound Folsom Street, northbound Main Street (stopping by the Temporary Transbay Terminal on Main Street), and westbound Mission Street would be rerouted to travel along southbound Beale Street, westbound Howard Street, and northbound Fremont Street with a stop on westbound Mission Street west of Fremont Street. As a result, vehicle trips on northbound Fremont Street would increase by two trips during the AM and PM peak hours. Likewise, vehicle trips on westbound Mission Street would decrease by two trips during the AM and PM peak hours.<sup>3</sup>

Figure 4 shows the transit vehicle turning movements at the above five intersections under the Baseline Condition. Table 2 compares transit vehicle volumes along the project frontages under the Existing and Baseline Conditions. Appendix B includes transit maps and detailed transit vehicle turning-movement volumes for each route. Transit vehicle trips would increase along eastbound Mission and Fremont streets by 56 trips during the AM peak hour and 44 trips during the PM peak hour due to changes to Muni routes 5, 5R, 7, 38, and 38R, which currently travel southbound on Beale Street to the Temporary Transbay Terminal being rerouted to travel eastbound on Mission Street and make a right-turn onto southbound Beale Street before entering the Transit Center and travelling northbound on Fremont Street. Transit vehicle trips on westbound Mission Street would be reduced by approximately 36 trips during the AM peak hour and 31 trips during the PM peak hour because Muni routes 7, 38, and 38R, and Golden Gate Transit (Routes 30, 70, 101, 101X) and SamTrans (Route 292) routes which currently travel northbound on Main Street by the Temporary Transbay Terminal and westbound on Mission Street would be rerouted to southbound Beale Street and into the Transit Center or westbound Howard Street. Transit vehicle volumes on Beale Street south of Mission Street would not substantially change because the transit vehicles

<sup>2</sup> Muni Order Bulletin 2018-1147, received from Brian Dusseault, SFMTA on March 28, 2019.

<sup>3</sup> It is assumed that after dropping off the last passengers at the farside bus stop on the eastbound Mission Street at First Street, SamTrans buses would travel southbound on Beale Street, westbound on Howard Street, and northbound on Fremont Street to pick up passengers at the nearside bus stop on the westbound Mission Street at First Street.



currently traveling in the southbound through movement would shift to the eastbound Mission Street and make a right-turn movement on Beale Street instead.

**Table 2 – Transit Vehicle Volumes under Existing and Baseline Conditions**

Street	Segment	Existing (April 2019)				Baseline			
		Muni	GGT	ST	Total	Muni	GGT	ST	Total
<b>AM Peak Hour</b>									
Mission Street	EB (Fremont Street – Beale Street)	24	5	2	31	80	5	2	87
	WB (Beale Street – Fremont Street)	45	4	2	52	16	0	0	16
Fremont Street	NB (Howard Street – Mission Street)	0	2	0	2	48	6	2	56
Beale Street	SB (Mission Street – Howard Street)	73	5	2	80	73	5	2	80
<b>PM Peak Hour</b>									
Mission Street	EB (Fremont Street – Beale Street)	15	3	2	20	59	3	2	64
	WB (Beale Street – Fremont Street)	47	4	2	53	22	0	0	22
Fremont Street	NB (Howard Street – Mission Street)	0	34	0	34	40	38	2	80
Beale Street	SB (Mission Street – Howard Street)	52	3	2	57	52	3	2	57

Source: CHS Consulting Group, 2019; San Francisco Municipal Transportation Agency, 2019; Golden Gate Transit, 2019; SamTrans, 2019.

Notes: EB=Eastbound; WB=Westbound; NB=Northbound; SB=Southbound; GGT=Golden Gate Transit; ST=SamTrans

### Bicycle Volumes

Existing bicycle volumes were collected at the above five intersections on Tuesday, April 9, 2019 during the AM and PM peak periods. Figure 5 presents the existing bicycle volumes at the above five intersections. It is assumed that bicycle volumes along Mission, Fremont, and Beale streets in the project vicinity would not substantially change after the Transit Center reopens because bicycle volumes along these streets are generally low and there would be no change in street lane geometry. In short, bicycle volumes under both the Existing and Baseline Conditions are considered to be the same. Table 3 summarizes the bicycle volumes along the project frontages.

**Table 3 – Bicycle Volumes under Existing and Baseline Conditions**

Street	Segment	Existing and Baseline Conditions	
		AM Peak Hour	PM Peak Hour
Mission Street	Eastbound (Fremont Street – Beale Street)	10	50
	Westbound (Beale Street – Fremont Street)	42	20
Fremont Street	Northbound (Howard Street – Mission Street)	25	17
Beale Street	Southbound (Mission Street – Howard Street)	32	49

Source: CHS Consulting Group, 2019.

### Pedestrian Volumes

Existing pedestrian volumes were collected at the above five study intersections on Tuesday, April 9, 2019 during the AM and PM peak periods. In addition, the existing pedestrian volumes were collected at pedestrian entry and exit locations surrounding the Temporary Transbay Terminal on Wednesday, April 10, 2019 during the AM and PM

peak periods, in order to understand trip distribution patterns for the Transbay Terminal passengers who would eventually shift to the Salesforce Transit Center once it reopens. **Appendix C** includes the pedestrian survey data.

A total of 2,400 pedestrians (263 inbound and 2,137 outbound) travelled to and from the Temporary Transbay Terminal during the AM peak hour.<sup>4</sup> Approximately 54 percent, 25 percent, 17 percent, and four percent of these pedestrians accessed the terminal through the northwest, northeast, and southwest and southeast corners of the terminal, respectively. During the PM peak hour, a total of 2,531 pedestrians travelled to and from the Temporary Transbay Terminal. Approximately 48 percent, 28 percent, 14 percent, and 11 percent of these pedestrians accessed the terminal through the northwest, northeast, and southwest and southeast corners of the terminal respectively.

Because the primary access point for the Salesforce Transit Center is located one block northwest of the Temporary Transbay Terminal, a portion of the existing passengers using Beale Street or other streets located east of Beale Street to access the temporary terminal would potentially shift to Fremont or Beale Street and increase pedestrian volumes at the Mission Street/Fremont Street intersection when the Salesforce Transit Center reopens. These pedestrian volumes were estimated and added onto the Mission Street/Fremont Street and Mission Street/Beale Street intersections using the following assumptions:

- Approximately 20 percent of the passengers using the northwest corner of the Temporary Transbay Terminal are assumed to be added to the Mission Street/Fremont Street intersection, including approximately 258 passengers during the AM peak hour and 241 passengers during the PM peak hour.<sup>5</sup>
- All passengers using the northeast corner of the Temporary Transbay Terminal are assumed to be added to the Mission Street/Fremont Street and Mission Street/Beale Street intersection, including approximately 595 passengers during the AM peak hour and 701 passengers during the PM peak hour.<sup>6</sup>

**Table 4** shows a comparison of pedestrian crossing volumes at the Mission Street/Fremont Street and Mission Street/Beale Street intersections under the Existing and Baseline Conditions. Under the Baseline Condition, the

---

<sup>4</sup> The Transbay Terminal/Caltrain Downtown Extension/Redevelopment Project EIR assumed that the 2020 projection of the average weekday ridership on AC Transit Transbay routes would not be substantially different from the 2001 weekday Transbay ridership of 15,205 passengers. The passenger counts collected at the Temporary Transbay Terminal on April 10, 2019 were validated against the 2018 average weekday ridership on AC Transit's Transbay routes (16,935 passengers), which is higher than the 2020 projection assumed in the EIR.

<sup>5</sup> It is assumed that the majority of pedestrians currently using the northwest corner of the Temporary Transbay Terminal come from north of Market Street between 2<sup>nd</sup> and Beale streets, and that these pedestrians are spread amongst 2<sup>nd</sup> Street (20 percent), 1<sup>st</sup> Street (40 percent), Fremont Street (20 percent), and Beale Street (20 percent) based on approximate spacing of these streets. Pedestrians currently walking down on Beale Street to travel to the Temporary Transbay Terminal (20 percent of the total pedestrians using the northwest corner of the Temporary Transbay Terminal) are anticipated to walk further to Fremont Street when the Salesforce Transit Center reopens.

<sup>6</sup> While some of the pedestrians currently using the northeast corner of the Temporary Transbay Terminal may only cross the Mission Street/Beale Street intersection, all pedestrians are assumed to use the main entrance/exit of the Salesforce Transit Center and cross the Mission Street/Fremont Street intersection as well for the purpose of conservative analysis. All passengers are generally encouraged to use the main entrance/exit instead of a side entrance/exit from Beale Street.



total pedestrian crossing volumes would increase by approximately 30 percent during the AM and PM peak hours.<sup>7</sup> Appendix C includes pedestrian volume estimation spreadsheet

Table 4 – Pedestrian Volumes under Existing and Baseline Conditions

Intersection	Crosswalk	AM Peak Hour			PM Peak Hour		
		Existing	Baseline	Change	Existing	Baseline	Change
Mission Street/ Fremont Street	North	709	858	+149	1,019	1,194	+175
	South	880	1,584	+704	1,374	2,141	+767
	East	1,199	1,348	+149	1,228	1,403	+175
	West	1,189	1,338	+149	941	1,116	+175
	<b>Total</b>	<b>3,977</b>	<b>5,128</b>	<b>+1,151</b>	<b>4,562</b>	<b>5,855</b>	<b>1,293</b>
Mission Street/ Beale Street	North	729	878	+149	916	1,091	+175
	South	8113	962	+149	882	1,057	+175
	East	501	575	+74	441	5529	+88
	West	1,323	1,730	+407	1,374	1,790	+416
	<b>Total</b>	<b>3,366</b>	<b>4,145</b>	<b>+779</b>	<b>3,613</b>	<b>4,467</b>	<b>+854</b>

Source: CHS Consulting Group, 2019.

### Loading Demand

An existing passenger and commercial loading survey was conducted at the following locations on Tuesday, April 9, 2019 from 8 a.m. to 6 p.m.:

- North side of Mission Street between Fremont and Beale streets
- South side of Mission Street between Fremont and Beale streets
- East side of Fremont Street between Mission Street and project site driveway
- West side of Beale Street between Mission Street and project site driveway
- Project site driveways on Fremont and Beale streets

Table 5 summarizes the existing passenger and commercial loading demand along the project frontages and the project site driveway. Appendix D includes loading survey data. A total of 366 loading activities occurred between 8 a.m. and 6 p.m., and approximately half of the loading activities occurred illegally along red curbs or No-Stopping Tow Away zones.<sup>8</sup> It is anticipated that loading demand in the project vicinity would not substantially change after the Salesforce Transit Center reopens.

<sup>7</sup> Added pedestrian trips are double counted if they require crossing more than one leg of the intersection.

<sup>8</sup> The only legally allowed loading areas are the white passenger loading zone and the yellow commercial loading zone located on the south side of Mission Street in front of the project site. Commercial vehicles cannot legally double park on the south side of Mission Street due to the presence of a bus-only lane in the adjacent lane. The rest of loading survey area is red curbed or No-Stopping Tow-Away zone.

**Table 5 – Existing Passenger and Commercial Loading Demand**

Survey Location	Legal Zone <sup>1</sup>	Daily Loading Counts 8AM-6PM			Average Duration (m:s)		Max Queue <sup>2</sup>
		Passenger	Commercial	Total	Passenger	Commercial	
North Side of Mission Street	No	94	5	99	00:24	10:46	1
South Side of Mission Street	No	22	2	24	00:49	57:51	3
	Yes	157	4	161	02:09	01:13	6
East Side of Fremont Street	No	30	1	31	00:28	00:09	2
West Side of Beale Street	No	26	2	28	00:53 <sup>3</sup>	21:28	1
<b><i>On-Street Total</i></b>		<b><i>329</i></b>	<b><i>14</i></b>	<b><i>343</i></b>			
Project Site Driveways <sup>4</sup>	Yes	N/A	23	N/A	N/A	N/A	N/A
<b><i>Grand Total</i></b>		<b><i>329</i></b>	<b><i>37</i></b>	<b><i>366</i></b>			

Source: CHS Consulting Group, 2019.

Notes:

1. Legal zones represent where loading activities are legally allowed such as yellow freight loading zone or white passenger loading zone. Areas that are not designated for loading include red curbed areas or No Stopping/Tow-Away zones.
2. Represents the maximum number of vehicles engaged in loading activities at any given time during the survey period.
3. Excludes a single instance of a passenger vehicle parked for more than one hour.
4. Passenger loading data are not available because it is not feasible to differentiate vehicles engaged in passenger loading activities vs. parking among regular passenger vehicles entering and exiting the driveway. Commercial loading activities represent counts of delivery vehicles entering or exiting either Fremont or Beale Street driveway. Each count of commercial loading activity represents one vehicle activity (one inbound trip and one outbound trip).

The following appendices to this Existing and Baseline Volumes Summary Memo have been left out because they are included as part of Appendix B Technical Transportation Appendices:

Appendix A      Vehicle Turning Movement Counts (*see Appendix B, Attachment B.2*)

Appendix D      Loading Survey Data (*See Appendix B, Attachment B.2*)

# Appendix B

---

Transit Maps

Transit Turning Movement Volumes

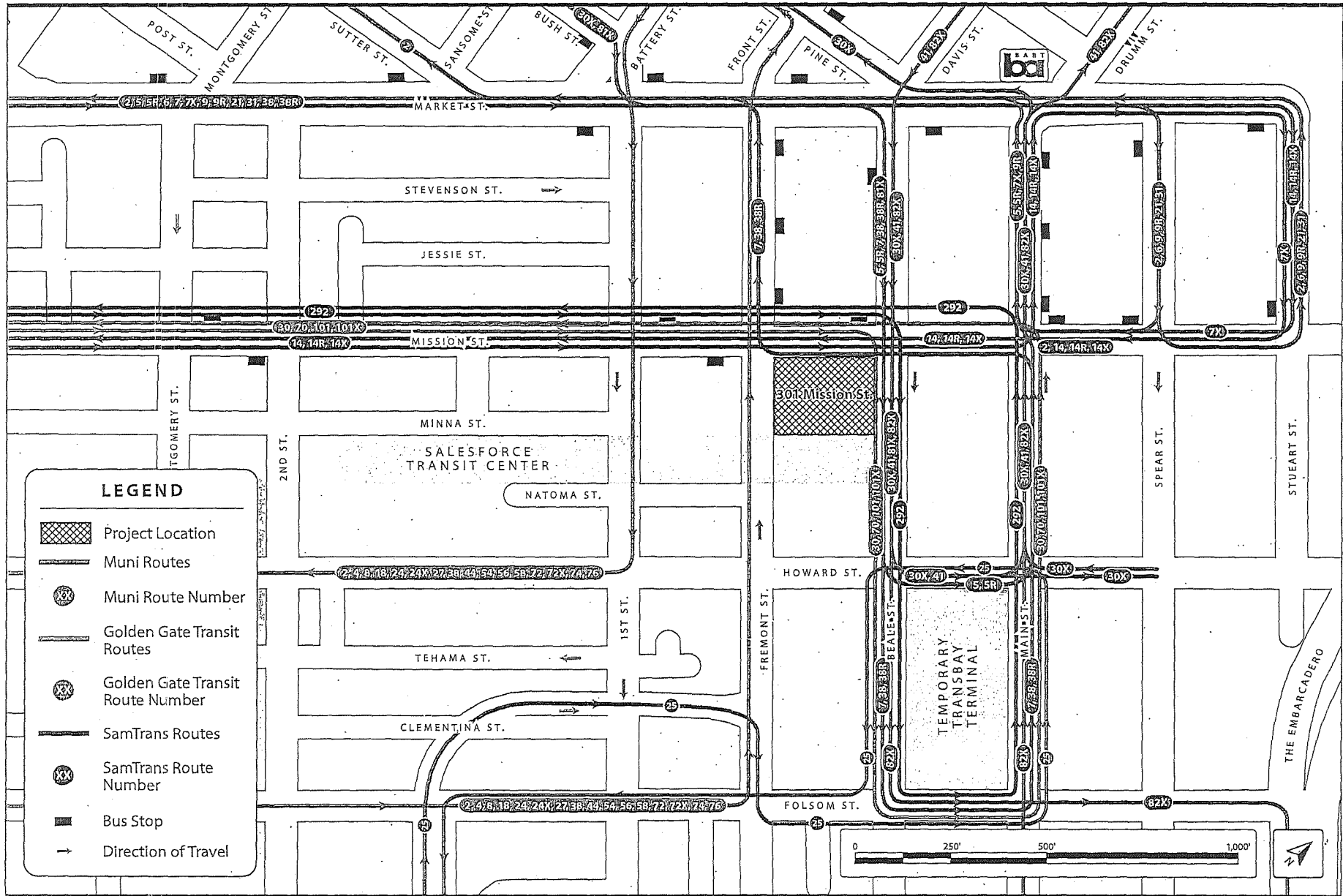

301 Mission Street Seismic Upgrade Transportation Impact Study



Transit Network Under Existing Condition

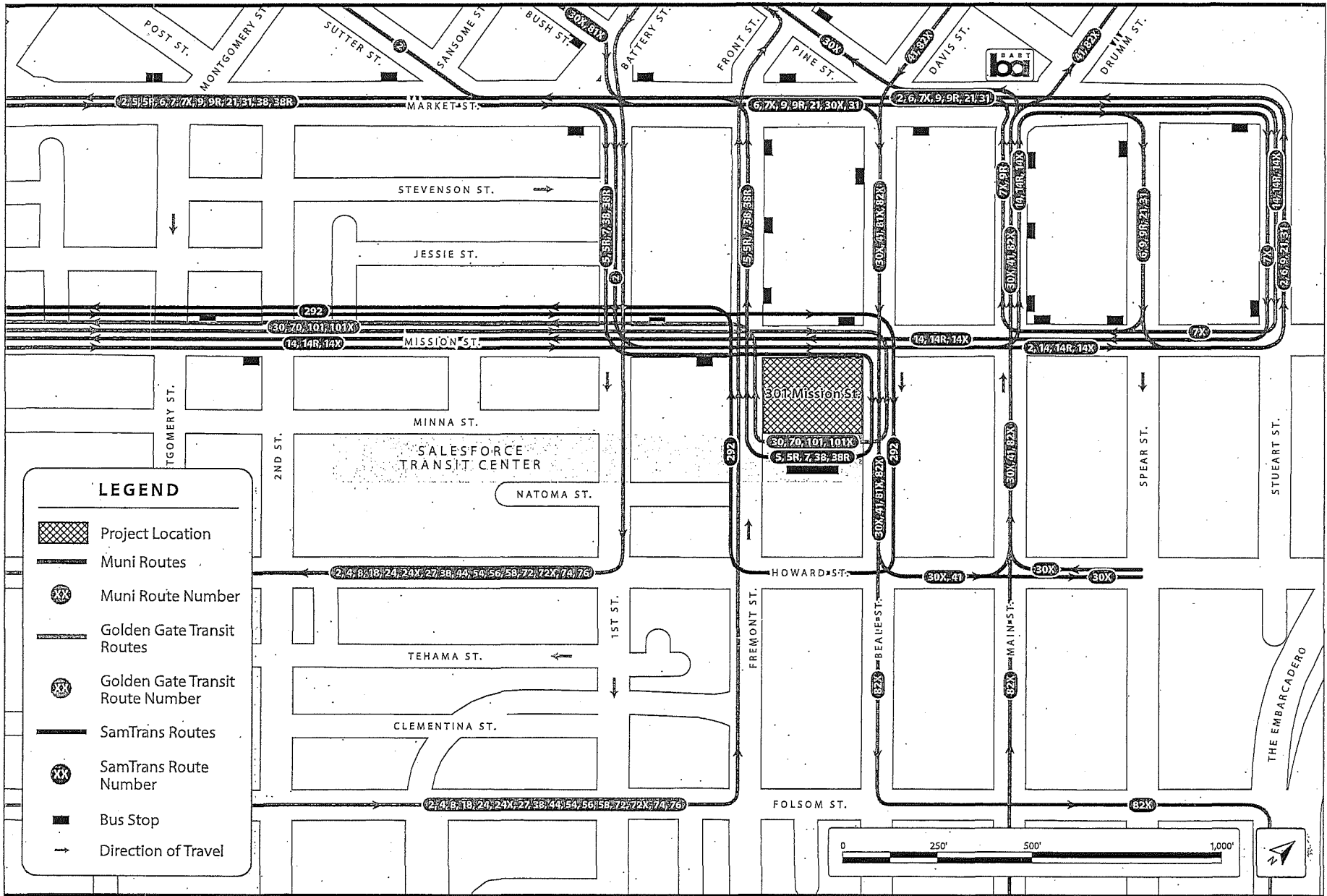

301 Mission Street Seismic Upgrade Transportation Impact Study



TABLE 1 - EXISTING MUNI SERVICE

Route	Category <sup>1</sup>	Direction	Hours of Operation	Weekday Headways <sup>2</sup> (minutes)		Nearest Stop (Distance) <sup>3</sup>
				a.m.	p.m.	
2	Grid	Inbound	6:20 a.m. - 7:55 p.m.	8	14	Mission / Fremont (260 ft)
		Outbound	6:24 a.m. - 8:00 p.m.	8	14	Mission / Main (800 ft)
5	Grid	Inbound	24 hours	9	10	Beale / Mission (800 ft)
		Outbound	24 hours	9	10	Market / Front (850 ft)
5R	Rapid Bus	Inbound	7:08 a.m. - 7:37 p.m.	5	7	Beale / Mission (800 ft)
		Outbound	7:04 a.m. - 7:06 p.m.	5	7	Market / Front (850 ft)
6	Grid	Inbound	6:14 a.m. - 1:04 a.m.	10	11	Market / Beale (1,350 ft)
		Outbound	6:16 a.m. - 1:08 a.m.	10	11	Market / Battery (1,200 ft)
7	Frequent	Inbound	6:27 a.m. - 1:10 a.m.	10	11	Beale / Mission (800 ft)
		Outbound	6:15 a.m. - 12:10 a.m.	10	11	Mission / Beale (380 ft)
7X	Specialized	Inbound	7:08 a.m. - 9:27 a.m.	8	-	Market / Beale (1,350 ft)
		Outbound	3:50 p.m. - 6:20 p.m.	-	10	Market / Front (850 ft)
9	Frequent	Inbound	5:30 a.m. - 12:10 a.m.	9	9	Beale / Mission (800 ft)
		Outbound	5:30 a.m. - 12:10 a.m.	9	9	Market / Front (850 ft)
9R	Rapid Bus	Inbound	6:20 a.m. - 7:00 p.m.	9	9	Beale / Mission (800 ft)
		Outbound	6:20 a.m. - 7:00 p.m.	9	9	Market / Front (850 ft)
14	Frequent	Inbound	24 hours	8	9	Mission / Fremont (260 ft)
		Outbound	24 hours	8	9	Mission / 1st (500 ft)
14R	Rapid Bus	Inbound	6:47 a.m. - 6:59 p.m.	8	8	Mission / Fremont (260 ft)
		Outbound	6:50 a.m. - 7:00 p.m.	8	8	Mission / 1st (500 ft)
14X	Specialized	Inbound	7:04 a.m. - 10:56 a.m.	8	-	Mission / Fremont (260 ft)
		Outbound	3:00 p.m. - 6:40 p.m.	-	9	Mission / 1st (500 ft)
30X	Specialized	Inbound	6:30 a.m. - 10:30 a.m.	6	-	Beale / Mission (800 ft)
		Outbound	3:40 p.m. - 7:00 p.m.	-	10	Main / Market (1,100 ft)
31	Grid	Inbound	5:22 a.m. - 12:43 a.m.	12	14	Market / 1st (900 ft)
		Outbound	5:30 a.m. - 12:51 a.m.	12	14	Market / Front (850 ft)
38	Frequent	Inbound	24 hours	8	8	Beale / Mission (800 ft)
		Outbound	24 hours	8	8	Mission / Beale (380 ft)
38R	Rapid Bus	Inbound	6:36 a.m. - 8:48 p.m.	4	5	Beale / Howard (1,000 ft)
		Outbound	6:44 a.m. - 8:54 p.m.	4	5	Main / Howard (1,000 ft)
41	Specialized	Inbound	5:22 a.m. - 7:07 p.m.	5	8	Beale / Mission (800 ft)
		Outbound	5:30 a.m. - 7:25 p.m.	5	8	Main / Market (1,100 ft)

81X	Specialized	Inbound	7:04 a.m. - 9:30 a.m.	20	-	Beale / Mission (800 ft)
82X	Specialized	Inbound	6:06 a.m. - 9:13 a.m.	20	-	Main / Market (1,100 ft)
		Outbound	3:44 p.m. - 6:07 p.m.	-	15	Beale / Mission (800 ft)

NOTE:

1. Rapid Bus include some of the busiest routes in the Muni network with wider stop spacing, frequent vehicle arrivals and transit priority enhancements along the routes; Frequent routes combined with Rapid Bus create the Transit Priority Network; Grid routes combine with Transit Priority Network to form an expansive core grid that lets customers get to their destinations with no more than a short walk, or a seamless transfer; Specialized routes augment existing service during specific times of day to serve a specific need, or serve travel demand related to special events.
2. The scheduled time duration between public transit vehicles on the same route.
3. Distances are approximate and are measured from the center of the project site along local streets to reach the nearest stop. Distances are not measured in a straight line between two points or places.

SOURCE: San Francisco Municipal Transportation Agency, 2019; Prepared by CHS Consulting Group, 2019.

TABLE 2 - EXISTING GOLDEN GATE TRANSIT SERVICE

Route	Direction	Hours of Operation	Weekday Headways (minutes) <sup>1</sup>		Nearest Stop (Distance) <sup>2</sup>
			a.m.	p.m.	
4	Inbound	5 a.m.-7 p.m.	5 - 10	N/A	1st / Stevenson (850 ft)
	Outbound	6:30 a.m.-8 p.m.	60	8 - 15	Fremont / Mission (350 ft)
27	Inbound	4:30 a.m.- 6:40 p.m.	15 - 30	60	1st / Stevenson (850 ft)
	Outbound	6:40 a.m.- 7:40 p.m.	N/A	30	Fremont / Mission (350 ft)
30	Inbound	5:50 a.m.- 12 a.m.	75	60	Mission / Fremont (260 ft)
	Outbound	5 a.m.-2 a.m.	60	60	Mission / Fremont (260 ft)
38	Inbound	6 a.m.- 9 a.m.	25 - 35	N/A	1st / Stevenson (850 ft)
	Outbound	4 p.m. - 7 p.m.	N/A	30	Fremont / Mission (350 ft)
44	Inbound	6:45 a.m.- 9:15 a.m.	60	N/A	1st / Stevenson (850 ft)
	Outbound	4 p.m. - 6:40 p.m.	N/A	60	Fremont / Mission (350 ft)
54	Inbound	4:40 a.m.- 9:50 a.m.	20 - 30	N/A	1st / Stevenson (850 ft)
	Outbound	2:30 p.m. - 8:30 p.m.	N/A	20 - 30	Fremont / Mission (350 ft)
56	Inbound	5:40 a.m.- 9 a.m.	30 - 35	N/A	1st / Stevenson (850 ft)
	Outbound	3:30 p.m. - 7:30 p.m.	N/A	25 - 35	Fremont / Mission (350 ft)
58	Inbound	6 a.m.- 9 a.m.	30	N/A	1st / Stevenson (850 ft)
	Outbound	4:30 p.m. - 7 p.m.	N/A	30	Fremont / Mission (350 ft)
70	Inbound	5 a.m.- 12:30 a.m.	60	60	Mission / Fremont (260 ft)
	Outbound	5 a.m.- 1:20 a.m.	60	60	Mission / Fremont (260 ft)
72	Inbound	7 a.m.- 9:30 a.m.	N/A	N/A	1st / Stevenson (850 ft)
	Outbound	6 p.m. - 8:30 p.m.	N/A	N/A	Fremont / Mission (350 ft)
72X	Inbound	4 a.m.- 9 a.m.	20 - 25	N/A	1st / Stevenson (850 ft)
	Outbound	2p.m. - 7:30 p.m.	N/A	20 - 30	Fremont / Mission (350 ft)

74	Inbound	4:30 a.m.- 9 a.m.	30	N/A	1st / Stevenson (850 ft)
	Outbound	3 p.m. - 7:30 p.m.	N/A	30	Fremont / Mission (350 ft)
76	Inbound	5 a.m.- 8:40 a.m.	30	N/A	1st / Stevenson (850 ft)
	Outbound	3 p.m. - 7:20 p.m.	N/A	30	Fremont / Mission (350 ft)
101	Inbound	4 a.m.- 12 p.m.	30	60	Mission / Fremont (260 ft)
	Outbound	5:20 a.m.- 2:30 a.m.	30	60	Mission / Fremont (260 ft)
101X	Inbound	6 a.m.- 9:40 a.m.	90	-	Mission / Fremont (260 ft)

NOTE:

1. N/A indicates that routes run on specific time points with irregular intervals.
2. Distances are approximate and are measured from the center of the project site along local streets to reach the nearest stop. Distances are not measured in a straight line between two points or places.

SOURCE: Golden Gate Bridge, Highway, and Transportation District, 2019; Prepared by CHS Consulting Group, 2019.

TABLE 3 - EXISTING SAMTRANS SERVICE

Route	Direction	Hours of Operation	Weekday Headways (minutes)		Nearest Stop (Distance) <sup>1</sup>
			a.m.	p.m.	
292	Inbound	5:22 a.m. - 2:30 a.m.	30	30	Mission / 1st (500 ft)
	Outbound	4:30 a.m. - 12:00 a.m.	30	30	Mission / 1st (500 ft)
398	Inbound	5:09 a.m. - 11:19 p.m.	60	60	Mission / 1st (500 ft)
	Outbound	5:07 a.m. - 12:09 a.m.	60	60	Mission / 1st (500 ft)

NOTE:

1. Distances are approximate and are measured from the center of the project site along local streets to reach the nearest stop. Distances are not measured in a straight line between two points or places.

SOURCE: SamTrans, 2019; Prepared by CHS Consulting Group, 2019.







# Appendix C

---

Pedestrian Count Survey Data



City: San Francisco  
 Location: Location 1 - North Entrance (Howard St)  
 Date: 4/9/2019  
 Count Type: Pedestrian Count

	Entering			TOTAL PEDS
	EB Right Peds	SB Thru Peds	WB Left Peds	
7:00	5	1	4	10
7:15	6	0	3	9
7:30	6	1	4	11
7:45	3	2	0	5
8:00	12	1	6	19
8:15	15	2	2	19
8:30	7	0	2	9
8:45	3	0	0	3
<b>TOTAL</b>	<b>57</b>	<b>7</b>	<b>21</b>	<b>85</b>

	Entering			TOTAL PEDS
	EB Right Peds	SB Thru Peds	WB Left Peds	
16:00	94	1	15	110
16:15	86	2	31	119
16:30	116	0	35	151
16:45	112	11	36	159
17:00	181	7	63	251
17:15	167	8	46	221
17:30	185	10	49	244
17:45	137	2	47	186
<b>TOTAL</b>	<b>1078</b>	<b>41</b>	<b>322</b>	<b>1441</b>



BOARD of SUPERVISORS



City Hall  
1 Dr. Carlton B. Goodlett Place, Room 244  
San Francisco 94102-4689  
Tel. No. 554-5184  
Fax No. 554-5163  
TDD/TTY No. 554-5227

## NOTICE OF PUBLIC HEARING

### BOARD OF SUPERVISORS OF THE CITY AND COUNTY OF SAN FRANCISCO

NOTICE IS HEREBY GIVEN THAT the Board of Supervisors of the City and County of San Francisco will hold a public hearing to consider the following proposal and said public hearing will be held as follows, at which time all interested parties may attend and be heard:

**Date:** Tuesday, March 3, 2020

**Time:** 3:00 p.m.

**Location:** Legislative Chamber, Room 250, located at City Hall  
1 Dr. Carlton B. Goodlett Place, San Francisco, CA

**Subjects:** **File No. 191253.** Ordinance ordering the vacation of the sidewalk portion of streets on the south side of Mission Street at the intersection of Mission and Fremont Streets and on the east side of Fremont Street at the same intersection to allow a structural upgrade of the 301 Mission Street high-rise building known as Millennium Tower, subject to certain conditions; rededicating the area subject to the street vacation to public use for street and right-of-way purposes after the City's issuance of an easement for the abovementioned structural upgrade; adopting environmental findings under the California Environmental Quality Act; adopting findings that the vacation and rededication of the street area are consistent with the General Plan, and the eight priority policies of Planning Code, Section 101.1; and authorizing actions in furtherance of this Ordinance.

In accordance with Administrative Code, Section 67.7-1, persons who are unable to attend the hearing on this matter may submit written comments to the City prior to the time the hearing begins. These comments will be made part of the official public record in this matter, and shall be brought to the attention of the Board of Supervisors. Written comments should be addressed to Angela Calvillo, Clerk of the Board, City Hall, 1 Dr. Carlton B. Goodlett Place, Room 244, San Francisco, CA, 94102. Information relating to this matter can be found in the Legislative Research Center at [sfgov.legistar.com/legislation](http://sfgov.legistar.com/legislation). Meeting agenda information relating to this matter will be available for public review on Friday, February 28, 2020.

A handwritten signature in blue ink that reads "Angela Calvillo".

Angela Calvillo, Clerk of the Board

DATED/POSTED: February 14, 2020  
PUBLISHED: February 16 and 23, 2020



## PROOF OF POSTING

Legislative File No. 191253 - Street Vacation - Millennium Tower 301 Mission Perimeter Pile Upgrade Project

Description of Items:

**Ordinance ordering the vacation of the sidewalk portion of streets on the south side of Mission Street at the intersection of Mission and Fremont Streets and on the east side of Fremont Street at the same intersection to allow a structural upgrade of the 301 Mission Street high-rise building known as Millennium Tower, subject to certain conditions; rededicating the area subject to the street vacation to public use for street and right-of-way purposes after the City's issuance of an easement for the abovementioned structural upgrade; adopting environmental findings under the California Environmental Quality Act; adopting findings that the vacation and rededication of the street area are consistent with the General Plan, and the eight priority policies of Planning Code, Section 101.1; and authorizing actions in furtherance of this Ordinance.**

I, Dragomir Rajic, an employee of the City and County of San Francisco, posted the above described document(s) in at least three (3) public places along the street(s) to be affected at least ten (10) days in advance of the hearing (pursuant to CA Streets and Highways Code, Section 970.5):

Date: 02-13-2020

Time: 01 PM - 03 PM

Location: 301 Mission Street & Fremont Street

Signature: *Dragomir Rajic*

Instructions: Upon completion, original must be filed in the above referenced file.



APPROVED: \_\_\_\_\_  
 BRUCE R. STORRS  
 CITY & COUNTY SURVEYOR

DATE \_\_\_\_\_

**CITY AND COUNTY OF SAN FRANCISCO PUBLIC WORKS**  
 SUBDIVISION AND MAPPING

MAP TITLE  
 STREET VACATION OF A PORTION OF MISSION STREET AND FREMONT STREET

FILE: SUR 2019- \_\_\_\_\_

SHEET 1 OF 1

SCALE: 1"=30'

REVISION \_\_\_\_\_

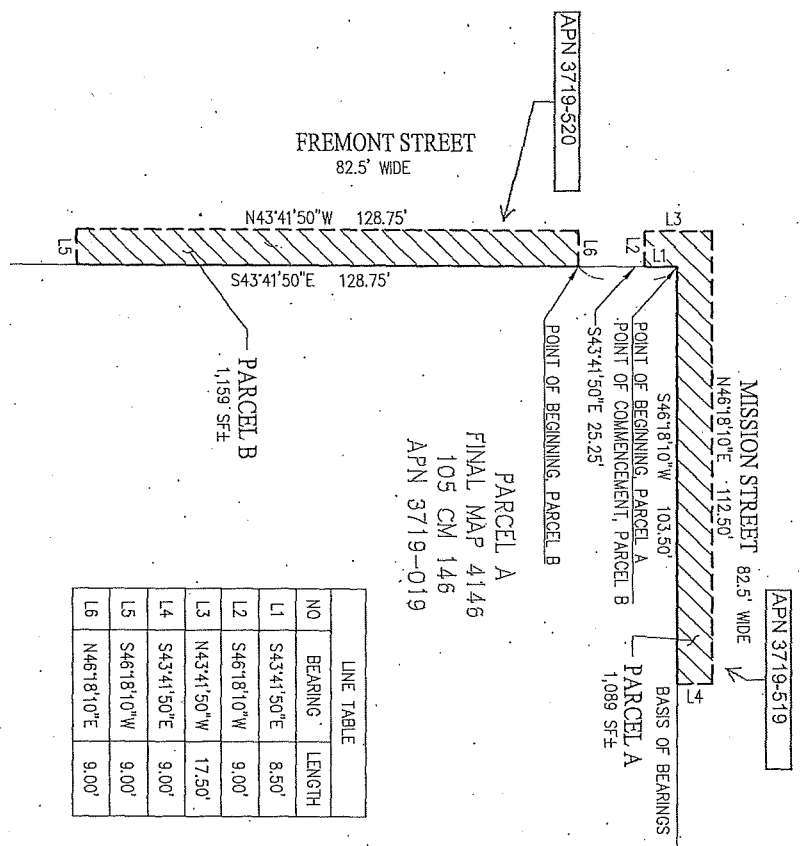
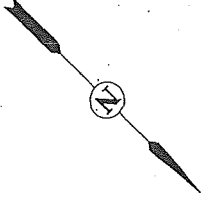
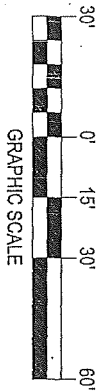

NO	BEARING	LENGTH
L1	S43°41'50"E	8.50'
L2	S46°18'10"W	9.00'
L3	N43°41'50"W	17.50'
L4	S43°41'50"E	9.00'
L5	S46°18'10"W	9.00'
L6	N46°18'10"E	9.00'

- LEGEND:**
- VACATION BOUNDARY
  - PROPERTY LINE
  - ////// AREA TO BE VACATED

- NOTES:**
1. PARCELS A AND B LIE BETWEEN ELEVATIONS OF STREET LEVEL AND -295.60 FEET.
  2. REFERENCE BENCHMARK: BM 10110, ELEV: 12.139 FEET (SF-VD13 DATUM)
  3. THE BASIS OF BEARINGS FOR THIS DRAWING IS THE SOUTH LINE OF MISSION STREET BEING N46°18'10"E PER RECORD OF SURVEY 6428 (EE SM 19).
  4. ALL DISTANCES SHOWN HEREON ARE IN FEET AND DECIMALS THEREOF.

**REFERENCES:**

RECORD OF SURVEY 6428 (EE SURVEY MAPS 19),  
 FINAL MAP 4146 (105 CM 146)

OFFICE OF THE MAYOR  
SAN FRANCISCO



LONDON N. BREED  
RECEIVED MAYOR  
BOARD OF SUPERVISORS  
SAN FRANCISCO

2019 DEC 10 PM 4:57

BY Sle B

TO: Angela Calvillo, Clerk of the Board of Supervisors  
FROM: Sophia Kittler

RE: [Street Vacation - Millennium Tower 301 Mission Perimeter Pile Upgrade Project]

DATE: Tuesday, December 10, 2019

---

**Ordinance ordering the vacation of the sidewalk portion of streets on the south side of Mission Street at the intersection of Mission and Fremont Streets and on the east side of Fremont Street at the same intersection to allow a structural upgrade of the 301 Mission Street high-rise building known as Millennium Tower, subject to certain conditions; rededicating the area subject to the street vacation to public use for street and right-of-way purposes after the City's issuance of an easement for the abovementioned structural upgrade; adopting environmental findings under the California Environmental Quality Act; adopting findings that the vacation and rededication of the street area are consistent with the City's General Plan and the eight priority policies of Planning Code, Section 101.1; and authorizing actions in furtherance of this ordinance.**

Should you have any questions, please contact Sophia Kittler at 415-554-6153.