

File No. 180731

Committee Item No. _____

Board Item No. 36

COMMITTEE/BOARD OF SUPERVISORS

AGENDA PACKET CONTENTS LIST

Committee: _____
Board of Supervisors Meeting

Date: _____
Date: July 17, 2018

Cmte Board

- Motion
- Resolution
- Ordinance
- Legislative Digest
- Budget and Legislative Analyst Report
- Youth Commission Report
- Introduction Form
- Department/Agency Cover Letter and/or Report
- MOU
- Grant Information Form
- Grant Budget
- Subcontract Budget
- Contract/Agreement
- Form 126 – Ethics Commission
- Award Letter
- Application
- Public Correspondence

OTHER

- Public Works Order No. 187835 - June 6, 2018
- Planning Department Map Decision - April 13, 2017
- Planning Department Memo - May 7, 2015
- Planning Commission Motion No. 18853 - April 18, 2013
- Tax Certificates - June 12, 2018
- Final Maps
- _____
- _____
- _____

Prepared by: Jocelyn Wong
Prepared by: _____

Date: July 12, 2018
Date: _____

1 [Final Map 9294 - 369-18th Avenue]

2

3 **Motion approving Final Map No. 9294, being a four lot vertical subdivision, 43**
4 **residential unit, five commercial unit, and 43 parking space condominium mixed-use**
5 **project, located at 369-18th Avenue, being a subdivision of Assessor’s Parcel Block**
6 **No. 1450, Lot No. 008; and adopting findings pursuant to the General Plan, and the**
7 **priority policies of Planning Code, Section 101.1.**

8

9 MOVED, That the certain map entitled “FINAL MAP 9294”, a four lot vertical
10 subdivision, 43 residential unit, five commercial unit, and 43 parking space condominium
11 mixed use project, located at 369 18th Avenue, being a subdivision of Assessor’s Parcel
12 Block No. 1450, Lot No. 008, comprising eight sheets, approved June 6, 2018, by Department
13 of Public Works Order No. 187835 is hereby approved and said map is adopted as an Official
14 Final Map Number 9294; and, be it

15 FURTHER MOVED, That the San Francisco Board of Supervisors adopts as its own
16 and incorporates by reference herein as though fully set forth the findings made by the
17 Planning Department; by its letter dated April 13, 2017, that the proposed subdivision is
18 consistent with the objectives and policies of the General Plan, and the priority policies of
19 Planning Code, Section 101.1; and, be it

20 FURTHER MOVED, That the San Francisco Board of Supervisors hereby authorizes
21 the Director of the Department of Public Works to enter all necessary recording information on
22 the Final Map and authorizes the Clerk of the Board of Supervisors to execute the Clerk’s
23 Statement as set forth herein; and, be it

24

25

1
2
3
4
5
6
7
8
9
10
11
12
13
14
15
16
17
18
19
20
21
22
23
24
25

FURTHER MOVED, That approval of this map is also conditioned upon compliance by the subdivider with all applicable provisions of the San Francisco Subdivision Code and amendments thereto.

DESCRIPTION APPROVED:



Bruce R. Storrs, PLS
City and County Surveyor

RECOMMENDED:

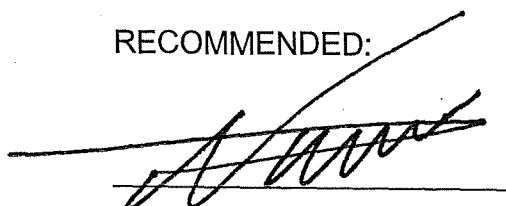

Mohammed Nuru
Director of Public Works



BOARD OF SUPERVISORS
SAN FRANCISCO

2018 JUL -5 PM 3:17

BY AK

Office of the City and County Surveyor
1155 Market Street, 3rd Floor
San Francisco, Ca 94103

(415) 554-5827 * www.SFPublicWorks.org



Mark Farrell, Mayor
Mohammed Nuru, Director

Bruce R. Storrs, City and County Surveyor

Public Works Order No: 187835

**CITY AND COUNTY OF SAN FRANCISCO
SAN FRANCISCO PUBLIC WORKS**

APPROVING FINAL MAP 9294, 369 18TH AVENUE, A 91 UNIT MIXED-USE CONDOMINIUM PROJECT,
BEING A SUBDIVISION OF ASSESSORS PARCEL NUMBER 1450-008

A 91 UNIT MIXED-USE CONDOMINIUM PROJECT

The City Planning Department in its letter dated April, 13, 2017 stated that the subdivision is consistent with the General Plan and the Priority Policies of City Planning Code Section 101.1.

The Director of Public Works, the Advisory Agency, acting in concurrence with other City agencies, has determined that said Final Map complies with all subdivision requirements related thereto. Pursuant to the California Subdivision Map Act and the San Francisco Subdivision Code, the Director recommends that the Board of Supervisors approve the aforementioned Final Map.

Transmitted herewith are the following:

1. One (1) paper copy of the Motion approving said map – one (1) copy in electronic format.
2. One (1) mylar signature sheet and one (1) paper set of the "Final Map 9294", comprising 8 sheets.
3. One (1) copy of the Tax Certificate from the Office of the Treasurer and Tax Collector certifying that there are no liens against the property for taxes or special assessments collected as taxes.
4. One (1) copy of the letter dated April, 13, 2017, from the City Planning Department stating the subdivision is consistent with the General Plan and the Priority Policies set forth in City Planning Code Section 101.1.

It is recommended that the Board of Supervisors adopt this legislation.

RECOMMENDED:

APPROVED:



X Bruce Storrs

Storrs, Bruce
City and County Surveyor
Signed by: Storrs, Bruce

X Mohammed Nuru

Nuru, Mohammed
Director, DPW
Signed by: Nuru, Mohammed





City and County of San Francisco
 San Francisco Public Works · Bureau of Street-Use and Mapping
 1155 Market Street, 3rd Floor · San Francisco, CA 94103
 sfpublicworks.org · tel 415-554-5810 · fax 415-554-6161



TENTATIVE MAP DECISION

Date: March 10, 2017

Department of City Planning
 1650 Mission Street, Suite 400
 San Francisco, CA 94103

Attention: Mr. Scott F. Sanchez

Project ID: 9294			
Project Type: 4 Lot Vertical Subdivision, 43 Residential Unit, 5 Commercial Unit and 43 Parking Space Mixed-Use Condominium Project			
Address#	StreetName	Block	Lot
5400	GEARY BLVD	1450	008
Tentative Map Referral			

Please review and respond to this referral within 30 days in accordance with the Subdivision Map Act.

Sincerely,

James Ryan
 2017.03.09 16:10:55 -08'00'

for, Bruce R. Storrs, P.L.S.
 City and County Surveyor

The subject Tentative Map has been reviewed by the Planning Department and does comply with applicable provisions of the Planning Code. On balance, the Tentative Map is consistent with the General Plan and the Priority Policies of Planning Code Section 101.1 based on the attached findings. The subject referral is exempt from California Environmental Quality Act (CEQA) environmental review as categorically exempt Class _____, CEQA Determination Date _____, based on the attached checklist.

The subject Tentative Map has been reviewed by the Planning Department and does comply with applicable provisions of the Planning Code subject to the attached conditions.

Planning Commission Motion 18853

The subject Tentative Map has been reviewed by the Planning Department and does not comply with applicable provisions of the Planning Code due to the following reason(s):

PLANNING DEPARTMENT

Signed Laura Ajello

Digitally signed by Laura Ajello
 DN: dc=ogp, dc=sfgov, dc=cityplanning, ou=CityPlanning,
 ou=Current Planning, cn=Laura Ajello,
 email=Laura.Ajello@sfgov.org
 Date: 2017.04.13 12:07:25 -07'00'

Date April 13, 2017

Planner's Name Laura Ajello
 for, Scott F. Sanchez, Zoning Administrator



SAN FRANCISCO PLANNING DEPARTMENT

MEMO

PROJECT UPDATE MEMO (NOT FOR HEARING)

1650 Mission St.
Suite 400
San Francisco,
CA 94103-2479

Reception:
415.558.6378

Fax:
415.558.6409

Planning
Information:
415.558.6377

DATE: May 7, 2015
TO: Planning Commissioners
FROM: Mary Woods
Staff Planner - 558.6315 or mary.woods@sfgov.org
RE: 5400 Geary Boulevard, the Alexandria Theatre Site
Planning Commission Motion No. 18853 for
Conditional Use Authorization under Case No. 2004.0482CEK!

On April 25, 2013, the Planning Commission approved a Conditional Use Authorization for the renovation of the existing Alexandria Theatre building, and the construction of a new mixed-use building with underground parking on the adjacent surface parking lot. The new four-story mixed-use development would consist of two levels of underground parking with 122 spaces, approximately 4,800 square feet of retail spaces on the ground floor, and 37 dwelling units on the upper floors, including 13 one-bedroom units, 18 two-bedroom units, and 6 three-bedroom units.

In August, 2014, Department staff sent to the Commission a Project Update Memo describing a proposed modification to the approved four-story mixed-use building containing retail on the ground floor and dwelling units on all four floor levels. That modification would increase the original dwelling unit count from 37 to 41, and the below market-rate unit count from 4 to 5.

In the current proposal, the project sponsor is proposing to increase the dwelling unit count from 41 to 43 in the four-story mixed-use building. The number of below market-rate units provided on-site would remain at five.

Department staff has reviewed the proposed revisions and found them to be in conformance with the original approval.

cc: Supervisor Eric Mar

Attachments:
Planning Commission Motion No. 18853
Parcel/Zoning Map, Sanborn Map
August 7, 2014 Project Update Memo
Proposed Plans for the Mixed-Use Building

Memo



SAN FRANCISCO PLANNING DEPARTMENT

Subject to: (Select only if applicable)

- Inclusionary Housing (Sec. 415)
- Jobs Housing Linkage Program (Sec. 313)
- Downtown Park Fee (Sec. 139)
- Better Streets Plan (Sec. 138.1)
- First Source Hiring (Admin. Code Chapter 83)
- Transit Impact Development Fee (Sec. 411)

1650 Mission St.
Suite 400
San Francisco,
CA 94103-2479

Reception:
415.558.6378

Fax:
415.558.6409

Planning
Information:
415.558.6377

Planning Commission Motion No. 18853

HEARING DATE: APRIL 25, 2013

Date: April 18, 2013
Case No.: 2004.0482CE!
Project Address: 5400 GEARY BOULEVARD
Zoning: NC-3 (Moderate-Scale Neighborhood Commercial) District
 40-X Height and Bulk District
Block/Lot: 1450/008
Project Sponsor: Alexandria Enterprises, LLC
 c/o Ronald Yu
 5418A Geary Boulevard
 San Francisco, CA 94132.
Staff Contact: Mary Woods – (415) 558-6315
mary.woods@sfgov.org

ADOPTING FINDINGS RELATING TO THE APPROVAL OF A CONDITIONAL USE AUTHORIZATION PURSUANT TO SECTIONS 121.1, 121.2, 303(C), 712.11 AND 712.21 OF THE PLANNING CODE TO ALLOW A DEVELOPMENT LOT SIZE EXCEEDING 9,999 SQUARE FEET AND A NON-RESIDENTIAL USE SIZE EXCEEDING 5,999 SQUARE FEET, IN AN NC-3 (MODERATE-SCALE NEIGHBORHOOD COMMERCIAL) DISTRICT AND 40-X HEIGHT AND BULK DISTRICT.

PREAMBLE

On June 1, 2004, Alexandria Enterprises, LLC (hereinafter "Project Sponsor") filed an application with the Planning Department (hereinafter "Department") for Conditional Use authorization under Planning Code Sections 121.1, 121.2, 303(c), 712.11 and 712.21 to allow a development lot size exceeding 9,999 square feet and a non-residential use size exceeding 5,999 square feet, in an NC-3 (Moderate-Scale Neighborhood Commercial) District, and 40-X Height and Bulk District.

On April 25, 2013, the San Francisco Planning Commission (hereinafter "Commission") conducted a duly noticed public hearing at a regularly scheduled meeting on Conditional Use Application No. 2004.0482CE!.

On November 24, 2010, the Preliminary Mitigated Negative Declaration (PMND) for the Project was prepared and published for public review; and,

The PMND was available for public comment until January 24, 2011. No appeal of the PMND was filed with the Department; and

On May 26, 2011, the Department adopted the Final Mitigated Negative Declaration (FMND) and found that the contents of said report and the procedures through which the FMND was prepared, publicized, and reviewed complied with the California Environmental Quality Act (California Public Resources Code Sections 21000 et seq.) (CEQA), Title 14 California Code of Regulations Sections 15000 et seq. (the "CEQA Guidelines") and Chapter 31 of the San Francisco Administrative Code ("Chapter 31"); and

The Department found the FMND was adequate, accurate and objective, reflected the independent analysis and judgment of the Planning Department, and approved the FMND for the Project in compliance with CEQA, the CEQA Guidelines and Chapter 31.

Department staff prepared a Mitigation Monitoring and Reporting Program (MMRP), setting forth measures to reduce potential environmental effects. These mitigation measures reduce all potential significant impacts to less than significant levels and are set forth in entirety in the MMRP, attached to the Draft Motion as EXHIBIT C.

These materials were made available to the public and this Commission for this Commission's review, consideration and action.

The Department is the custodian of records, located in the File for Case No. 2004.0482E, at 1650 Mission Street, Fourth Floor, San Francisco, California.

The Commission has heard and considered the testimony presented to it at the public hearing and has further considered written materials and oral testimony presented on behalf of the Project Sponsor, Department staff, and other interested parties.

MOVED, that the Commission hereby authorizes the Conditional Use requested in Application No. 2004.0482CE!, subject to the conditions contained in "EXHIBIT A" of this motion, based on the following findings:

FINDINGS

Having reviewed the materials identified in the preamble above, and having heard all testimony and arguments, this Commission finds, concludes, and determines as follows:

1. The above recitals are accurate and constitute findings of this Commission.
2. **Site Description and Present Use.** The Project is located at the northwest corner of Geary Boulevard and 18th Avenue, in Assessor's Block 1450, Lot 008. The property is located within an NC-3 (Moderate-Scale Neighborhood Commercial) District and 40-X Height and Bulk District.

Existing uses on the Project Site include the closed 3-screen Alexandria Theatre, a 53-foot tall, two-story building containing approximately 17,000 square feet, including three small retail establishments fronting on Geary Boulevard, and a 57-space surface parking lot fronting on 18th Avenue. The three existing retail businesses include a gift store, an appliance store and an engineering office. The Alexandria Theatre closed in February, 2004. The parking lot is currently operated by an attendant for fee-based public parking.

3. **Surrounding Properties and Neighborhood.** The Project Site is situated towards the western end of the NC-3 District along the three-mile Geary Boulevard commercial corridor that stretches from the Western Addition to the Outer Richmond, through four neighborhoods. This corridor is bounded by Divisadero Street to the east and 28th Avenue in the west. The MUNI line "38-Geary" runs in front of the Project Site linking the Richmond area to Downtown and the Financial District. Other transit lines are also nearby and are within walking distance of the Site. Except for the commercial uses located on Geary Boulevard, the Project Site is surrounded by predominantly residential dwellings and residentially zoned districts to the west, north and east of the site. To the east of the site on 18th Avenue, existing uses also include a YMCA, a community center, and a church. Buildings on the subject block and facing block on Geary Boulevard range from one to two stories tall with primarily commercial uses on the ground floor and a few residential units on the upper floor. Commercial uses on the subject and facing blocks on Geary Boulevard include a gift store, an appliance store, a comic store, postal supplies store, a dry cleaner, shoe repair, restaurants, banks, grocery stores, a paint store, a medical supply store, and other professional offices. The Clement Street commercial corridor is one block north of the Project Site.
4. **Project Description.** The proposed Project consists of two components: (1) the renovation of the existing Alexandria Theatre building, and (2) the construction of a new mixed-use building with underground parking on the adjacent surface parking lot. Renovations to the Alexandria Theatre building include the conversion from a three-screen theatre to a 221-seat single-screen theatre, the creation of new retail spaces (6,300 square feet) on the ground floor, and a restaurant space (7,000 square feet) on the second floor. The surface parking lot will be removed and replaced with a new four-story mixed-use development with two levels of underground parking (122 spaces). The new building will contain retail spaces (4,800 square feet) on the ground floor, and 37 dwelling units on the upper floors, including 13 one-bedroom units, 18 two-bedroom units, and 6 three-bedroom units. The development would total approximately 109,000 square feet.

Section 312 -neighborhood notification was conducted in conjunction with the Conditional Use authorization process.

5. **Public Comment.** To date, the Department has received one e-mail in opposition to the Project expressing concerns related to building security, construction noise and pollution. Staff has met with one neighbor who expressed concerns about the massing of the new mixed-use building, structural integrity/building safety of adjacent buildings during construction, soil stability, and traffic problems along 18th Avenue. Staff has also received general inquiries about the scope of work related to the proposed Project. Staff has not received any correspondence in support of the

proposed project. The Project Sponsor and its representatives held several community outreach meetings beginning in 2010. Issues discussed ranged from the reuse of the existing theatre building, design of the new mixed-use building with retail/commercial uses on the ground floor and dwelling units above, affordability and type of units proposed, feasibility of retail uses in the theatre building, parking and traffic, and street trees.

6. **First Source Hiring Program.** The Project is subject to the requirements of the First Source Hiring Program (Chapter 83 of the Administrative Code) for projects creating ten (10) or more new residential units. The Project Sponsor will comply with the requirements of this Program. Prior to the issuance of any Building Permit or a First Addendum to a Site Permit, the Project Sponsor will have an approved and signed First Source Hiring Memorandum of Understanding (MOU) from the First Source Hiring Administrator, which will be evidenced in writing. This MOU will include Exhibit A, Construction First Source Hiring Agreement, and Exhibit B, End-Use First Source Hiring Agreement. Before the Commission can act on the Project, the Project Sponsor must complete the "Affidavit for First Source Hiring Program".

The Project Sponsor has submitted a complete Affidavit for First Source Hiring Program, a copy of which is attached to the Draft Motion

7. **Planning Code Compliance:** The Commission finds that the Project is consistent with the relevant provisions of the Planning Code in the following manner:
 - A. **Large Lot Development.** Sections 121.1 and 712.11 state that a Conditional Use authorization is required for development of large lot size exceeding 9,999 square feet in Neighborhood Commercial Districts.

The existing lot is irregular-shaped with an area of approximately 37,000 square feet.

- B. **Non-Residential Use Size.** Sections 121.2 and 712.21 state that a Conditional Use authorization is required for development of large lot size exceeding 5,999 square feet in Neighborhood Commercial Districts.

The existing theatre building contains approximately 17,000 square feet of non-residential uses. The Project proposes to add an additional 69,000 square feet of non-residential uses, including new retail spaces, a restaurant, and two levels of underground parking for 122 spaces.

- C. **Basic Floor Area Ratio.** Section 124 limits the building square footage to 3.6 square feet of building area for every 1 square feet of lot area, or approximately 134,000 square feet of building area for the subject site. However, in NC Districts, the FAR limits do not apply to dwellings or to other residential uses per Section 124(b).

The entire Project would total approximately 109,000 square feet, of which, approximately 40,000 square feet is related to residential uses.

- D. **Front Setback.** Section 132 is not applicable. There is no front setback requirement for buildings in NC-3 Districts.
- E. **Rear Yard.** Section 134(a)(1) requires that a rear yard equal to 25% of the lot depth be provided opposite the site's frontage. Further, Section 134(a)(1)(C) requires that in NC-3 Districts, rear yards must be provided at the lowest story containing a dwelling unit, and at each succeeding story of the building.

The new mixed-use building has a 30-foot rear yard setback (25% of the 120-foot lot depth) at all the residential levels. The Project provides a single rear yard totaling approximately 6,000 square feet.

- F. **Useable Open Space.** Section 135 typically requires 80 square feet of usable open space be provided for every dwelling unit, when provided as private open space, in NC-3 Districts. The open space requirement must be multiplied by 1.33 when provided as common open space.

For the proposed 37-unit Project, approximately 4,000 square feet of common useable open space would be required. For 30 of the units, the Project will provide common useable open space at the rear yard totaling approximately 4,300 square feet (3,200 square feet required). Additional common useable open space is also provided on the second floor interior courtyard, totaling approximately 1,800 square feet. The remaining seven units contain private useable open space in the form of private decks and yards, totaling approximately 1,300 (560 square feet required). All private open spaces meet the minimum area requirements of the Code.

- G. **Better Streets Plan.** Section 138.1 establishes requirements for the improvement of the public right-of-way associated with development projects, such that the public right-of-way may be safe, accessible, convenient and attractive to pedestrian use and travel by all modes of transportation.

The Project's streetscape and pedestrian improvements include a mid-block bulb-out on 18th Avenue, a small mid-block public plaza on 18th Avenue at the junction of the existing theatre building and the new mixed-use building, new street trees on both Geary Boulevard and 18th Avenue, permeable paving, benches and moveable seating, motorcycle and bike parking, lighting fixtures, and various hedges and plantings along 18th Avenue.

- H. **Dwelling Unit Exposure.** Section 140 requires that all dwelling units face a public street or side yard at least 25 feet in width, a required rear yard, or an open area of 25 feet in width.

All of the units in the proposed Project meet this requirement.

- I. **Street Frontage in Neighborhood Commercial Districts.** Section 145.1 requires in NC Districts containing specific uses, including retail stores, that building lobbies do not exceed 40 feet of building frontage, that parking entrances are no more than 20 feet wide, that ground floors have a minimum 10-foot ceiling height, and that the ground floor street

frontage be at least 60% transparent in order to allow visibility to the inside of the building. The use of dark or mirrored glass shall not count towards the required transparent area. Any decorative railings or decorated grille work, other than wire mesh, which is placed in front or behind ground floor windows, shall be at least 75 percent open to perpendicular view.

The proposed Project is consistent with the relevant provisions under Section 145.1. The proposed two lobbies totals 20 feet in width. The parking entrance is 15 wide. The ground floor ceiling height is 11 feet. Along 18th Avenue, new transparency/glazing will be added to the existing theatre building totaling 62%, while the new mixed-use building will have 70% transparency at the street frontage.

- J. **Parking.** Section 151 requires one off-street parking space for each dwelling unit; one off-street parking space for each 200 square feet of occupied floor area where the occupied floor area exceeds 5,000 square feet for restaurants; one off-street parking space for each 500 square feet of occupied floor area up to 20,000 where the occupied floor area exceeds 5,000 square feet for retail stores, and one off-street parking space for each 8 seats over 50 seats for movie theatres. Section 152 requires one off-street freight loading space for retail stores where the gross floor area of structure or use is over 10,000 square feet but less than 60,000 square feet in newly constructed structures. Section 155(i) requires one handicapped parking space for each 25 off-street parking spaces provided. Sections 155(j), 155.2(c) and 155.4(e) require 1 bicycle space for every 20 automobile spaces for garages containing between 120 and 500 automobile spaces, where the most restrictive provisions prevail. Section 155.4(f) requires that new and existing commercial buildings must provide adequate signs or notices to advertise the availability of bicycle parking. Section 166 requires one car sharing space for the first 50 spaces plus one for every additional 50 spaces.

The proposed Project meets the provisions of the parking requirements as follows: 37 spaces for the dwelling units, 25 spaces for the retail stores, 32 spaces for the restaurant, 28 spaces for the movie theatre, for a total of 122 spaces for the Project. The Project will also provide two car share spaces and six handicapped spaces at the site.

The Project would not be required to have off-street freight loading spaces because the Project proposes approximately 5,000 square feet of retail uses in a new four-story building. The existing theatre building at approximately 19,000 square feet contains no off-street freight loading space.

The Project would be required to provide 6 bicycle parking spaces. The existing site contains no bicycle parking spaces. The Project proposes to add 20 "Class 1" bicycle parking spaces at the new mixed-use building, as well as additional on-street bicycle and motorcycle parking. Adequate signs or notices of the availability of bicycle parking will be provided at the Project Site.

- K. **Residential Density.** Sections 207.4 and 712.91, which set forth density restrictions for dwelling units in NC Districts, state that one dwelling unit is allowed for each 600 square feet of lot area.

Based on a lot area of approximately 37,000 square feet, 62 dwelling units are permitted. The Project proposes to develop 37 dwelling units, four of which (12%) will be inclusionary affordable units.

- L. **Change in Use/Demolition of a Movie Theatre.** Section 303(k) states that a change in use or demolition of a movie theatre use must meet the additional criteria set forth under this Section in addition to Section 303(c).

This Code Section does not apply to the proposed Project since the Project's environmental evaluation application was filed on May 19, 2004, prior to the effective date of July 27, 2004. However, renovations to the existing theatre building include the conversion from a three-screen theatre to a 221-seat single-screen theatre on the second floor.

- M. **Transit Impact Development Fee.** Sections 411 through 411.8 authorizes the imposition of certain development impact fees on new non-residential development projects or conversion of non-residential space of at least 800 gross square feet to offset impacts on the transit system. Land use categories for all impact fees are defined in Section 401.

The Project Sponsor will comply with the requirements of this section prior to the issuance of a Site Permit.

- N. **Inclusionary Affordable Housing Program.** Section 415 (formerly Section 315) sets forth the requirements and procedures for the Inclusionary Affordable Housing Program. Under Planning Code Section 415.3, these requirements apply to projects that consist of ten or more units, where the first application (EE or BPA) was applied for before July 18, 2006. Pursuant to Planning Code Section 415.5 and 415.6, the Project is meeting the Inclusionary Affordable Housing Program requirement through the On-site Affordable Housing Alternative by providing 12% of the proposed dwelling units as affordable.

The Project Sponsor has demonstrated that it is eligible for the On-Site Affordable Housing Alternative under Planning Code Section 415.5 and 415.6, and has submitted an 'Affidavit of Compliance with the Inclusionary Affordable Housing Program: Planning Code Section 415,' to satisfy the requirements of the Inclusionary Affordable Housing Program by providing the affordable housing on-site instead of through payment of the Affordable Housing Fee. In order for the Project Sponsor to be eligible for the On-Site Affordable Housing Alternative, the Project Sponsor must submit an 'Affidavit of Compliance with the Inclusionary Affordable Housing Program: Planning Code Section 415,' to the Planning Department stating that any affordable units designated as on-site units shall be sold as ownership units and will remain as ownership units for the life of the project. The Project Sponsor submitted such Affidavit on April 16, 2013. The EE application was submitted on May 19, 2004. Four units (1 one-bedroom, 2 two-bedroom, and 1 three-bedroom) of the 37 units provided will be affordable units. If the Project becomes ineligible to meet its Inclusionary Affordable Housing Program obligation through the On-site Affordable Housing Alternative, it must pay the Affordable Housing Fee with interest, if applicable.

- O. Signage. Any proposed signage will be subject to the review and approval of the Planning Department and must comply with Article 6 of the Planning Code.
8. Planning Code Section 303(c) establishes criteria for the Planning Commission to consider when reviewing applications for Conditional Use approval. On balance, the Project does comply with said criteria in that:
- A. The proposed uses and building, at the size and intensity contemplated and at the proposed location, will provide a development that is necessary or desirable, and compatible with, the neighborhood or the community.

The Geary Boulevard corridor is one of the longest continuous neighborhood commercial districts in the City stretching from Divisadero Street to the east to 28th Avenue in the west. The existing Alexandria Theatre building was built in 1923. It was a neighborhood movie theatre until closing in 2004. The theatre building has been vacant since then; however, the three small retail storefronts and engineering office along Geary Boulevard remain in operation. The proposed Project consists of two components: (1) the renovation of the existing Alexandria Theatre building, and (2) the construction of a new mixed-use building with underground parking on the adjacent surface parking lot. Renovations to the Alexandria Theatre building include the conversion from a three-screen theatre to a 221-seat single-screen theatre, the creation of new retail spaces (6,300 square feet) on the ground floor, and a restaurant space (7,000 square feet) on the second floor. The surface parking lot will be removed and replaced with a new four-story mixed-use development with two levels of underground parking for 122 spaces. The new building will contain retail spaces (4,800 square feet) on the ground floor, and 37 dwelling units on the upper floors. The development would total approximately 109,000 square feet.

The Project is necessary and desirable because the adaptive re-use of the existing theatre building will remove a blighted site and bring activity to this portion of the commercial corridor. The new mixed-use development will add 37 dwelling units to the City's housing stock, 12% of which will be inclusionary affordable units. New retail storefronts will be provided at the existing and new buildings along 18th Avenue. This will add new pedestrian interest and vitality along 18th Avenue.

The proposed Project will be built to today's Green Building and sustainability requirements under both "Build It Green's" Green Point Rating System and the U.S. Green Building Council's LEED program. In addition, the local codes also have requirements to develop and implement pollution prevention and site run-off controls as required by the City's Public Utilities Commission. The Project proposes to meet or exceed these requirements, according to the Project architect.

- (1) In Neighborhood Commercial Districts, if the proposed development lot exceeds the limitation (9,999 square feet) found in Planning Code Section 121.1, the following shall be considered:
- (i) The mass and façade of the proposed structure are compatible with the existing scale of the district; and

The proposed Project is compatible with the existing scale of the district in that it is typified by ground floor commercial uses with housing on the upper floors. Prominent buildings in mass and scale occupy corner lots, such as the existing Alexandria Theatre building. The new four-story building is typical of the surrounding three to four-story residential buildings in the district.

- (ii) The façade of the proposed structure is compatible with design features of adjacent facades that contribute to the positive visual quality of the district.

The addition of storefront entrances along the east side of the existing theatre building along 18th Avenue will relieve an existing blank wall and create a street façade compatible with those along Geary Boulevard. The design of the residential portions of the new mixed-use building takes into account neighboring residential developments by using scale, materials, and architectural elements, such as bays and cornices to relate to the older residential streetscape to the north along 18th Avenue. The overall character of the new mixed-use building is Spanish/Mediterranean of a type that was popular in the 1920s when both the Alexandria Theatre and much of the housing in the surrounding Richmond neighborhood was built. The visual mass of the asymmetrical silhouette is broken down with square and semi-octagonal bay windows, an arcaded ground floor level, variations in surface color to differentiating the bays and inset balconies at the top floor.

- (2) In Neighborhood Commercial Districts, if the proposed use is to be located at a location in which the square footage exceeds the limitation (5,999 square feet) found in Planning Code Section 121.2(a), the following shall be considered:

- i. The intensity of activity in the district is not such that allowing the larger use will be likely to foreclose the location of other needed neighborhood-serving uses in the area; and

The Project area consists of a wide variety of neighborhood-serving uses. No uses would be foreclosed by the Project. The existing retail stores on the ground floor of the theatre building will not be foreclosed. Any potential tenants in the new retail spaces will need to seek permit approvals and meet the requirements of the NC-3 zoning provisions.

- ii. The proposed use will serve the neighborhood, in whole or in significant part, and the nature of the use requires a larger size in order to function; and

The renovated theatre building will house a variety of uses that are permitted within the zoning district. Although the Project has a total of approximately 12,000 square feet of retail/commercial spaces in the overall project, they are not contiguous; rather, they are broken down into three different components: existing storefronts along Geary Boulevard, new retail spaces inside the existing theatre building, and ground floor storefronts in the

new mixed-use building. The commercial spaces in the existing and new mixed-use buildings may be further reduced in size to suit the needs of potential tenants.

- iii. The building in which the use is to be located is designed in discrete elements which respect the scale of development in the district; and

The Project consists of two discrete buildings. The theatre building has existed at the site since 1923. The building was much larger than its immediate neighboring context, featuring blade signs that towered over the retail strip below, like a church spire. The signs are visible from a distance of many blocks away. In addition, the theatre building is situated on a corner lot, so that its larger form is an anchor as a destination place.

The new mixed-use building, with its varied materials, bay windows and balconies, is broken down to minimize the mass of the building, and provide interest at the pedestrian level.

- B. The proposed project will not be detrimental to the health, safety, convenience or general welfare of persons residing or working in the vicinity. There are no features of the project that could be detrimental to the health, safety or convenience of those residing or working the area, in that:

- i. Nature of proposed site, including its size and shape, and the proposed size, shape and arrangement of structures;

The height and bulk of the existing theatre building will remain the same. The Project proposes to renovate the inside of the theatre building by adding a new restaurant, a 221-seat theatre, and retail stores. The existing surface parking lot will be replaced with a four-story mixed-use building with two levels of underground parking. The Project Site is a corner lot with two street frontages, Geary Boulevard and 18th Avenue. The design of the new building has been created to be compatible with the scale and context of the surrounding neighborhood.

- ii. The accessibility and traffic patterns for persons and vehicles, the type and volume of such traffic, and the adequacy of proposed off-street parking and loading;

The Project Site is well-served by public transit. Several MUNI transit lines run directly in front of or near the Site. The Project proposes a two-level underground parking for 122 cars, including 2 car share spaces, 20 bicycle spaces, as well as on-street bicycle and motorcycle parking.

- iii. The safeguards afforded to prevent noxious or offensive emissions such as noise, glare, dust and odor;

No noxious or offensive emissions will be associated with the Project.

- iv. Treatment given, as appropriate, to such aspects as landscaping, screening, open spaces, parking and loading areas, service areas, lighting and signs;

The Project provides both private and common useable open space at the ground floor rear yard and at the upper floor interior courtyard. The Project's streetscape and pedestrian improvements include a mid-block bulb-out on 18th Avenue, a small mid-block public plaza on 18th Avenue at the junction of the existing theatre building and the new mixed-use building, new street trees on both Geary Boulevard and 18th Avenue, permeable paving, benches and moveable seating, motorcycle and bike parking, lighting fixtures, and various hedges and plantings along 18th Avenue.

- C. That the use as proposed will comply with the applicable provisions of the Planning Code and will not adversely affect the General Plan.

The Project complies with relevant requirements and standards of the Planning Code, and is consistent with objectives and policies of the General Plan as detailed below.

- D. That the use as proposed would provide development that is in conformity with the purpose of the applicable Neighborhood Commercial District.

The proposed Project is consistent with the stated purpose of the NC-3 (Moderate-Scale Neighborhood Commercial) District in that the intended use is to renovate an existing theatre building and replace an underutilized parking lot with a mixed use development. The larger lot size and use size are required due to the irregularly-shaped lot.

- 9. **General Plan Compliance.** The Project is, on balance, consistent with the following Objectives and Policies of the General Plan:

HOUSING ELEMENT

Objectives and Policies

OBJECTIVE 1:

IDENTIFY AND MAKE AVAILABLE FOR DEVELOPEMNT ADEQUATE SITES TO MEET THE CITY'S HOUSING NEEDS, ESPECIALLY PERMANENTLY AFFORDABLE HOUSING.

Policy 1.1:

Plan for the full range of housing needs in the City and County of San Francisco, especially affordable housing.

Policy 1.8:

Promote mixed-use development, and include housing, particularly permanently affordable housing, in new commercial, institutional or other single use development projects.

Policy 1.10

Support new housing projects, especially affordable housing, where households can easily rely on public transportation, walking and bicycling for the majority of daily trips.

The new mixed-use building will contain retail spaces (approximately 4,800 square feet) on the ground floor, and 37 dwelling units on the upper floors, including 13 one-bedroom units, 18 two-bedroom units, and 6 three-bedroom units. The Project will provide four on-site inclusionary affordable housing units.

OBJECTIVE 11:

SUPPORT AND RESPECT THE DIVERSE AND DISTINCT CHARACTER OF SAN FRANCISCO'S NEIGHBORHOODS.

Policy 11.1:

Promote the construction and rehabilitation of well-designed housing that emphasizes beauty, flexibility, and innovative design, and respects existing neighborhood character.

Policy 11.6

Foster a sense of community through architectural design, using features that promote community interaction

The Project will provide streetscape and pedestrian improvements that include a mid-block bulb-out, a small public plaza with seating and open space, allowing people to meet and interact informally and foster the neighborhood's social experiences and offerings.

COMMERCE AND INDUSTRY ELEMENT

Objectives and Policies

OBJECTIVE 6:

MAINTAIN AND STRENGTHEN VIABLE NEIGHBORHOOD COMMERCIAL AREAS EASILY ACCESSIBLE TO CITY RESIDENTS.

Policy 6.1:

Ensure and encourage the retention and provision of neighborhood-serving goods and services in the city's neighborhood commercial districts, while recognizing and encouraging diversity among the districts.

Policy 6.3

Preserve and promote the mixed commercial-residential character in neighborhood commercial districts. Strike a balance between the preservation of existing affordable housing and needed expansion of commercial activity.

Policy 6.9

Regulate uses so that traffic impacts and parking problems are minimized

No commercial tenant would be displaced. The Project would not prevent the district from achieving optimal diversity in the types of goods and services available in the neighborhood. The Project will provide desirable goods and services to the neighborhood and will provide resident employment opportunities to those in the community. Further, the Project Site is located within a Neighborhood Commercial District and is thus consistent with activities in the commercial land use plan. The Project will also provide adequate on-site parking to meet the needs of the commercial and residential uses so that the Project will not significantly increase traffic congestion or parking problems in the neighborhood.

URBAN DESIGN ELEMENT

Objectives and Policies

OBJECTIVE 1:

EMPHASIS OF THE CHARACTERISTIC PATTERN WHICH GIVES TO THE CITY AND ITS NEIGHBORHOODS AN IMAGE, A SENSE OF PURPOSE, AND A MEANS OF ORIENTATION.

Policy 1.3:

Recognize that buildings, when seen together, produce a total effect that characterizes the city and its districts.

Policy 1.10:

Indicate the purposes of streets by adopting and implementing the Better Streets Plan, which identifies a hierarchy of street types and appropriate streetscape elements for each street type.

The Project's streetscape and pedestrian improvements include a mid-block bulb-out on 18th Avenue, a small mid-block public plaza on 18th Avenue at the junction of the existing theatre building and the new mixed-use building, new street trees on both Geary Boulevard and 18th Avenue, permeable paving, benches and moveable seating, motorcycle and bike parking, lighting fixtures, and various hedges and plantings along 18th Avenue.

OBJECTIVE 2:

CONSERVATION OF RESOURCES WHICH PROVIDE A SENSE OF NATURE, CONTINUITY WITH THE PAST, AND FREEDOM FROM OVERCROWDING.

Policy 2.5:

Use care in remodeling of older buildings, in order to enhance rather than weaken the original character of such buildings.

Policy 2.6:

Respect the character of older development nearby in the design of new buildings.

The Project consists of two components: (1) the renovation of the existing Alexandria Theatre building, built circa 1923, and (2) the construction of a new four-story mixed-use building on the adjacent surface parking lot. Renovations to the Alexandria Theatre building, while retaining all of its unique historic

character defining features, will include new commercial, restaurant and theatre uses. The surface parking lot will be removed and replaced with a new four-story mixed-use development with two levels of underground parking for 122 spaces.

10. Planning Code Section 101.1(b) establishes eight priority-planning policies and requires review of permits for consistency with said policies. On balance, the project does comply with said policies in that:

- A. That existing neighborhood-serving retail uses be preserved and enhanced and future opportunities for resident employment in and ownership of such businesses be enhanced.

The proposed Project will preserve a neighborhood theatre while adding new retail spaces and a restaurant to the existing theatre building. The Project will also replace an underutilized parking lot with a new four-story mixed-use development with retail storefronts on the ground floor and 37 dwelling units in the upper floors. The Project's new retail spaces will offer new employment opportunities and business ownerships.

- B. That existing housing and neighborhood character be conserved and protected in order to preserve the cultural and economic diversity of our neighborhoods.

With the adaptive reuse of the theatre building, the existing neighborhood character will be preserved and enhanced. The design of the new mixed-use building will be compatible with the scale and design of the existing neighborhood.

- C. That the City's supply of affordable housing be preserved and enhanced,

The Project will add four inclusionary affordable housing units to the City's housing stock.

- D. That commuter traffic not impede MUNI transit service or overburden our streets or neighborhood parking.

The Project Site is well-served by public transit. Several MUNI transit lines run directly in front of or near the Site. The Project proposes a two-level underground parking for 122 cars, including 2 car share spaces, 20 bicycle spaces, as well as on-street bicycle and motorcycle parking.

- E. That a diverse economic base be maintained by protecting our industrial and service sectors from displacement due to commercial office development, and that future opportunities for resident employment and ownership in these sectors be enhanced.

The Project will not displace any service or industry establishment. The Project will not affect industrial or service sector uses or related employment opportunities. Ownership of industrial or service sector businesses will not be affected by this Project.

- F. That the City achieves the greatest possible preparedness to protect against injury and loss of life in an earthquake.

The Project will comply with all current earthquake safety requirements of the City's Building Code for the new building as well as the existing theatre building.

- G. That landmarks and historic buildings be preserved.

While the existing 1923 theatre building is not a landmark, it is considered a historic resource under CEQA. It will not be significantly altered as part of the Project.

- H. That our parks and open space and their access to sunlight and vistas be protected from development.

The Project will maintain the existing theatre building's envelope and height, while the new building will not exceed the 40-foot height limit; therefore, the Project will not affect existing parks and open spaces.

11. The Project is consistent with and would promote the general and specific purposes of the Code provided under Section 101.1(b) in that, as designed, the Project would contribute to the character and stability of the neighborhood and would constitute a beneficial development.
12. The Commission hereby finds that approval of the Conditional Use authorization would promote the health, safety and welfare of the City.

DECISION

That based upon the Record, the submissions by the Project Sponsor, the staff of the Department and other interested parties, the oral testimony presented to this Commission at the public hearings, and all other written materials submitted by all parties, the Commission hereby APPROVES Conditional Use Application No. 2004.0482CEI subject to the following conditions attached hereto as "EXHIBIT A" in general conformance with plans filed with the Application, dated April 5, 2013 and labeled "EXHIBIT B", which is incorporated herein by reference as though fully set forth.

The Commission has reviewed and considered the Final Mitigated Negative Declaration (FMND) and the Mitigation Monitoring and Reporting Program (MMRP), and the record as a whole and finds that there is no substantial evidence that the project will have a significant effect on the environment with the adoption of the mitigation measures contained in the MMRP to avoid potential significant environmental effects associated with the Project.

The Commission hereby adopts the FMND and MMRP attached hereto as EXHIBIT C and incorporated herein as part of this Motion by this reference thereto. All required mitigation measures identified in the FMND and contained in the MMRP are included as conditions of approval.

The Commission further finds that since the FMND was finalized, there have been no substantial project changes and no substantial changes in project circumstances that would require major revisions to the FMND due to the involvement of new significant environmental effects or an increase in the severity of previously identified significant impacts, and there is no new information of substantial importance that would change the conclusions set forth in the FMND.

APPEAL AND EFFECTIVE DATE OF MOTION: Any aggrieved person may appeal this Conditional Use Authorization to the Board of Supervisors within thirty (30) days after the date of this Motion No. 18853. The effective date of this Motion shall be the date of this Motion if not appealed (After the 30-day period has expired) OR the date of the decision of the Board of Supervisors if appealed to the Board of Supervisors. For further information, please contact the Board of Supervisors at (415) 554-5184, City Hall, Room 244, 1 Dr. Carlton B. Goodlett Place, San Francisco, CA 94102.

I hereby certify that the Planning Commission ADOPTED the foregoing Motion on April 25, 2013.

Jonas P. Ionin
Acting Commission Secretary

AYES: Commissioners Antonini, Fong, Hillis, Moore and Wu

NAYS: None

ABSENT: Commissioners Borden and Sugaya

ADOPTED: April 25, 2013

EXHIBIT A

Conditions of Approval

AUTHORIZATION

This authorization is for a Conditional Use Authorization to allow a development lot size exceeding 9,999 square feet and a non-residential use size exceeding 5,999 square feet, pursuant to Planning Code Sections 121.1, 121.2, 303(c), 712.11 and 712.21, in an NC-3 (Moderate-Scale Neighborhood Commercial) District, and 40-X Height and Bulk District; in general conformance with plans dated April 5, 2013 and labeled "EXHIBIT B" included in the docket for Case No. 2004.0482CE! and subject to conditions of approval reviewed and approved by the Commission on April 25, 2013 under Motion No. 18853. This authorization and the conditions contained herein run with the property and not with a particular Project Sponsor, business, or operator.

RECORDATION OF CONDITIONS OF APPROVAL

Prior to the issuance of the Building Permit Application or commencement of use for the project, the Zoning Administrator shall approve and order the recordation of a Notice in the Official Records of the Recorder of the City and County of San Francisco for the subject property. This Notice shall state that the Project is subject to the conditions of approval contained herein and reviewed and approved by the Planning Commission on April 25, 2013 under Motion No. 18853.

PRINTING OF CONDITIONS OF APPROVAL ON PLANS

The conditions of approval under the "EXHIBIT A" of this Planning Commission Motion No. 18853 shall be reproduced on the Index Sheet of construction plans submitted with the Site or Building Permit Application for the Project. The Index Sheet of the construction plans shall reference to the Conditional Use authorization and any subsequent amendments or modifications.

SEVERABILITY

The Project shall comply with all applicable City codes and requirements. If any clause, sentence, section, or any part of these conditions of approval is for any reason held to be invalid, such invalidity shall not affect or impair other remaining clauses, sentences, or sections of these conditions. This decision conveys no right to construct, or to receive a Building Permit. The Project Sponsor shall include any subsequent responsible party.

CHANGES AND MODIFICATIONS

Changes to the approved plans may be approved administratively by the Zoning Administrator. Significant changes and modifications of conditions shall require Planning Commission approval of a new Conditional Use authorization.

Conditions of Approval, Compliance, Monitoring, and Reporting

PERFORMANCE

1. **Validity and Expiration.** The authorization and right vested by virtue of this action is valid for three (3) years from the effective date of the Motion. A Building Permit Application from the Department of Building Inspection to construct the project and/or commence the approved use must be issued as this Conditional Use authorization is only an approval of the proposed Project and conveys no independent right to construct the project or to commence the approved use. The Planning Commission may, in a public hearing, consider the revocation of the approvals granted if a Site or Building Permit has not been obtained within three (3) years of the date of the Motion approving the Project. Once a Site or Building Permit has been issued, construction must commence within the timeframe required by the Department of Building Inspection and be continued diligently to completion. The Commission may also consider revoking the approvals if a permit for the Project has been issued but is allowed to expire and more than three (3) years have passed since the Motion was approved.

For information about compliance, contact Code Enforcement, Planning Department at 415-575-6863, www.sf-planning.org.

2. **Extension.** This authorization may be extended at the discretion of the Zoning Administrator only where failure to issue a permit by the Department of Building Inspection to perform said tenant improvements is caused by a delay by a local, State or Federal agency or by any appeal of the issuance of such permit(s).

For information about compliance, contact Code Enforcement, Planning Department at 415-575-6863, www.sf-planning.org.

3. **Mitigation Measures.** Mitigation measures described in the MMRP for the FMND (Case No. 2004.0482E) attached as EXHIBIT C are necessary to avoid potential significant effects of the proposed Project, and have been agreed to by the Project Sponsor. Their implementation is a condition of Project approval.

For information about compliance, contact Code Enforcement, Planning Department at 415-575-6863, www.sf-planning.org.

DESIGN – COMPLIANCE AT PLAN STAGE

4. **Final Materials.** The Project Sponsor shall continue to work with Planning Department on the building design. Final materials, glazing, color, texture, landscaping, and detailing shall be subject to Planning Department staff review and approval. The Building/Site Permit Application and/or the Architectural Addenda shall be reviewed and approved by the Planning Department prior to issuance.

For information about compliance, contact the Case Planner, Planning Department at 415-558-6378, www.sf-planning.org.

5. **Garbage, Composting and Recycling Storage Placement.** Space for the collection and storage of garbage, composting, and recycling shall be provided within enclosed areas on the property and

clearly labeled and illustrated on the Building Permit plans. Space for the collection and storage of recyclable and compostable materials that meets the size, location, accessibility and other standards specified by the San Francisco Recycling Program shall be provided at the ground level of the buildings.

For information about compliance, contact the Case Planner, Planning Department at 415-558-6378, www.sf-planning.org

6. **Lighting Plan.** The Project Sponsor shall submit an exterior lighting plan to the Planning Department prior to Planning Department's approval of the Building/Site Permit Application.
For information about compliance, contact the Case Planner, Planning Department at 415-558-6378, www.sf-planning.org.
7. **Noise.** Plans submitted with the building permit application for the approved project shall incorporate acoustical insulation and other sound proofing measures to control noise.
For information about compliance, contact the Case Planner, Planning Department at 415-558-6378, www.sf-planning.org
8. **Odor Control Unit.** In order to ensure any significant noxious or offensive odors are prevented from escaping the premises once the Project is operational, the Building/Site Permit application to implement the Project shall include air cleaning or odor control equipment details and manufacturer specifications on the plans. Odor control ducting shall not be applied to the primary façade of the building
For information about compliance, contact the Case Planner, Planning Department at 415-558-6378, www.sf-planning.org
9. **Rooftop Mechanical Equipment.** Pursuant to Planning Code 141, the Project Sponsor shall submit a roof plan to the Planning Department prior to Planning approval of the Building Permit application. Rooftop mechanical equipment, if any is proposed as part of the Project, is required to be screened so as not to be visible from any point at or below the roof level of the subject building.
For information about compliance, contact the Case Planner, Planning Department at 415-558-6378, www.sf-planning.org.
10. **Signage Program.** Any proposed signage shall be subject to the review and approval of the Planning Department and must comply with Article 6 of the Planning Code.
For information about compliance, contact the Case Planner, Planning Department at 415-558-6378, www.sf-planning.org.
11. **Street Trees/Streetscape Plan.** Pursuant to Planning Code Section 138.1, the Project Sponsor shall submit a streetscape plan to the Department prior to Department's approval of the Building/Site Permit Application indicating that seventeen (17) street trees shall be provided, including 13 evergreen trees, two palm trees, and two accent trees. Other streetscape and pedestrian improvements shall include a mid-block bulb-out on 18th Avenue, a mid-block public

plaza on 18th Avenue, permeable paving, benches and moveable seating, lighting fixtures, and various hedges and plantings along 18th Avenue.

For information about compliance, contact the Case Planner, Planning Department at 415-558-6378, www.sf-planning.org.

12. **Transformer Vault.** The location of individual project PG&E Transformer Vault installations has significant effects to San Francisco streetscapes when improperly located. However, they may not have any impact if they are installed in preferred locations. Therefore, the Department recommends the following preference schedule in locating new transformer vaults, in order of most to least desirable:
- (a) On-site, in a basement area accessed via a garage or other access point without use of separate doors on a ground floor façade facing a public right-of-way;
 - (b) On-site, in a driveway, underground;
 - (c) On-site, above ground, screened from view, other than a ground floor façade facing a public right-of-way;
 - (d) Public right-of-way, underground, under sidewalks with a minimum width of 12 feet, avoiding effects on streetscape elements, such as street trees; and based on Better Streets Plan guidelines;
 - (e) Public right-of-way, underground; and based on Better Streets Plan guidelines;
 - (f) Public right-of-way, above ground, screened from view; and based on Better Streets Plan guidelines;
 - (g) On-site, in a ground floor façade (the least desirable location).

Unless otherwise specified by the Department, Department of Public Work's Bureau of Street Use and Mapping (DPW BSM) should use this preference schedule for all new transformer vault installation requests.

For information about compliance, contact the Bureau of Street use and Mapping, Department of Public Works at 415-554-5810, <http://sfdpw.org>.

PARKING AND TRAFFIC

13. **Automobile Parking.** The Project Sponsor shall provide 122 spaces for the Project, including two (2) car share spaces and six (6) handicapped spaces.
For information about compliance, contact Code Enforcement, Planning Department at 415-575-6863, www.sf-planning.org.
14. **Bicycle Parking.** The Project Sponsor shall provide twenty (20) on-site "Class 1" bicycle parking spaces. Adequate signs or notices of the availability of bicycle parking shall also be provided at the Project Site.
For information about compliance, contact Code Enforcement, Planning Department at 415-575-6863, www.sf-planning.org.
15. **Managing Traffic During Construction.** The Project Sponsor and construction contractor(s) shall coordinate with the Traffic Engineering and Transit Divisions of the San Francisco Municipal Transportation Agency (SFMTA), the Police Department, the Fire Department, the

Planning Department, and other construction contractor(s) for any concurrent nearby Projects to manage traffic congestion and pedestrian circulation impacts during construction of the Project.
For information about compliance, contact Code Enforcement, Planning Department at 415-575-6863, www.sf-planning.org.

16. **Parking for Affordable Units.** All off-street parking spaces shall be made available to Project residents only as a separate "add-on" option for purchase or rent and shall not be bundled with any Project dwelling unit for the life of the dwelling units. The required parking spaces may be made available to residents within a quarter mile of the Project. All affordable dwelling units pursuant to Planning Code Section 415 shall have equal access to use of the parking as the market rate units, with parking spaces priced commensurate with the affordability of the dwelling unit. Each unit within the Project shall have the first right of refusal to rent or purchase a parking space until the number of residential parking spaces are no longer available. No conditions may be placed on the purchase or rental of dwelling units, nor may homeowner's rules be established, which prevent or preclude the separation of parking spaces from dwelling units.
For information about compliance, contact Code Enforcement, Planning Department at 415-575-6863, www.sf-planning.org.

PROVISIONS

17. **First Source Hiring.** The Project shall adhere to the requirements of the First Source Hiring Construction and End-Use Employment Program approved by the First Source Hiring Administrator, pursuant to Section 83.4(m) of the Administrative Code. The Project Sponsor shall comply with the requirements of this Program regarding construction work and on-going employment required for the Project.
For information about compliance, contact the First Source Hiring Manager at 415-581-2335, www.business.services@sfgov.org
18. **Inclusionary Affordable Housing.** The Project Sponsor shall comply with the requirements of the Planning Code Section 415 (formerly Section 315) for the Project as follows:
1. **Number of Required Units.** Pursuant to Planning Code Section 415.6, the Project is required to provide 12% of the proposed dwelling units as affordable to qualifying households. The Project contains 37 units; therefore, four (4) affordable units are required. The Project Sponsor will fulfill this requirement by providing the 4 affordable units on-site. If the number of market-rate units change, the number of required affordable units shall be modified accordingly with written approval from Planning Department staff in consultation with the Mayor's Office of Housing ("MOH").
For information about compliance, contact the Case Planner, Planning Department at 415-558-6378, www.sf-planning.org or the Mayor's Office of Housing at 415-701-5500, www.sf-moh.org.
 2. **Unit Mix.** The Project contains 13 one-bedroom, 18 two-bedroom, and 6 three-bedroom units; therefore, the required affordable unit mix is 1 one-bedroom, 2 two-bedroom, and 1 three-

bedroom units. If the market-rate unit mix changes, the affordable unit mix will be modified accordingly with written approval from Planning Department staff in consultation with MOH.

For information about compliance, contact the Case Planner, Planning Department at 415-558-6378, www.sf-planning.org or the Mayor's Office of Housing at 415-701-5500, www.sf-moh.org.

3. **Unit Location.** The affordable units shall be designated on a reduced set of plans recorded as a Notice of Special Restrictions on the property prior to the issuance of the first construction permit.

For information about compliance, contact the Case Planner, Planning Department at 415-558-6378, www.sf-planning.org or the Mayor's Office of Housing at 415-701-5500, www.sf-moh.org.

4. **Phasing.** If any building permit is issued for partial phasing of the Project, the Project Sponsor shall have designated not less than twelve percent (12%) of the each phase's total number of dwelling units as on-site affordable units

For information about compliance, contact the Case Planner, Planning Department at 415-558-6378, www.sf-planning.org or the Mayor's Office of Housing at 415-701-5500, www.sf-moh.org.

5. **Duration.** Under Planning Code Section 415.8, all units constructed pursuant to Section 415.6, must remain affordable to qualifying households for the life of the Project.

For information about compliance, contact the Case Planner, Planning Department at 415-558-6378, www.sf-planning.org or the Mayor's Office of Housing at 415-701-5500, www.sf-moh.org.

6. **Other Conditions.** The Project is subject to the requirements of the Inclusionary Affordable Housing Program under Section 415 et seq. of the Planning Code and City and County of San Francisco Inclusionary Affordable Housing Program Monitoring and Procedures Manual ("Procedures Manual"). The Procedures Manual, as amended from time to time, is incorporated herein by reference, as published and adopted by the Planning Commission, and as required by Planning Code Section 415. Terms used in these conditions of approval and not otherwise defined shall have the meanings set forth in the Procedures Manual. A copy of the Procedures Manual can be obtained at the MOH at 1 South Van Ness Avenue or on the Planning Department or Mayor's Office of Housing's websites, including on the internet at:

<http://sf-planning.org/Modules/ShowDocument.aspx?documentid=4451>.

As provided in the Inclusionary Affordable Housing Program, the applicable Procedures Manual is the manual in effect at the time the subject units are made available for sale.

For information about compliance, contact the Case Planner, Planning Department at 415-558-6378, www.sf-planning.org or the Mayor's Office of Housing at 415-701-5500, www.sf-moh.org.

- a. The affordable unit(s) shall be designated on the building plans prior to the issuance of the first construction permit by the Department of Building Inspection ("DBI"). The affordable unit(s) shall (1) reflect the unit size mix in number of bedrooms of the market rate units, (2) be constructed, completed, ready for occupancy and marketed no later than the market rate units, and (3) be evenly distributed throughout the building; and (4) be of comparable overall quality, construction and exterior appearance as the market rate units in the principal project. The interior features in affordable units should be the same as those of the market units in the

principal project, but need not be the same make, model or type of such item as long they are of good and new quality and are consistent with then-current standards for new housing. Other specific standards for on-site units are outlined in the Procedures Manual.

- b. If the units in the building are offered for sale, the affordable unit(s) shall be sold to first time home buyer households, as defined in the Procedures Manual, whose gross annual income adjusted for household size does not exceed an average of ninety (90) percent of Area Median Income under the income table called "Maximum Income by Household Size" derived from the Unadjusted Area Median Income for HUD Metro Fair Market Rent Area that contains San Francisco. The initial sales price of such units shall be calculated according to the Procedures Manual. Limitations on (i) reselling; (ii) renting; (iii) recouping capital improvements; (iv) refinancing; and (v) procedures for inheritance apply and are set forth in the Inclusionary Affordable Housing Program and the Procedures Manual.
- c. The Project Sponsor is responsible for following the marketing, reporting, and monitoring requirements and procedures as set forth in the Procedures Manual. MOH shall be responsible for overseeing and monitoring the marketing of affordable units. The Project Sponsor must contact MOH at least six months prior to the beginning of marketing for any unit in the building.
- d. Required parking spaces shall be made available to initial buyers or renters of affordable units according to the Procedures Manual.
- e. Prior to the issuance of the first construction permit by DBI for the Project, the Project Sponsor shall record a Notice of Special Restriction on the property that contains these conditions of approval and a reduced set of plans that identify the affordable units satisfying the requirements of this approval. The Project Sponsor shall promptly provide a copy of the recorded Notice of Special Restriction to the Department and to the MOH or its successor.
- f. The Project Sponsor has demonstrated that it is eligible for the On-site Affordable Housing Alternative under Planning Code Section 415.6 instead of payment of the Affordable Housing Fee, and has submitted the *Affidavit of Compliance with the Inclusionary Affordable Housing Program: Planning Code Section 415*, to the Planning Department stating that any affordable units designated as on-site units shall be sold as ownership units and will remain as ownership units for the life of the Project.
- g. If the Project Sponsor fails to comply with the Inclusionary Affordable Housing Program requirement, the Director of DBI shall deny any and all site or building permits or certificates of occupancy for the development project until the Planning Department notifies the Director of compliance. A Project Sponsor's failure to comply with the requirements of Planning Code Section 415 et seq. shall constitute cause for the City to record a lien against the development project and pursue any and all available remedies at law.
- h. If the Project becomes ineligible at any time for the On-site Affordable Housing Alternative, the Project Sponsor or its successor shall pay the Affordable Housing Fee prior to issuance of

the first construction permit or may seek a fee deferral as permitted under Ordinances 0107-10 and 0108-10. If the Project becomes ineligible after issuance of its first construction permit, the Project Sponsor shall notify the Department and MOH and pay interest on the Affordable Housing Fee at a rate equal to the Development Fee Deferral Surcharge Rate in Section 107A.13.3.2 of the San Francisco Building Code and penalties if applicable.

19. **Transit Impact Development Fee.** Pursuant to Planning Code Section 411 (formerly Chapter 38 of the Administrative Code), the Project Sponsor shall pay the Transit Impact Development Fee (TIDF) as required by and based on drawings submitted with the Building Permit Application. Prior to the issuance of a temporary certificate of occupancy, the Project Sponsor shall provide the Planning Director with certification that the fee has been paid.

For information about compliance, contact the Case Planner, Planning department at 415-558-6378, www.sfplanning.org

MONITORING - AFTER ENTITLEMENT

20. **Enforcement.** Violation of any of the Planning Department conditions of approval contained in this Motion or of any other provisions of Planning Code applicable to this Project shall be subject to the enforcement procedures and administrative penalties set forth under Planning Code Section 176 or Section 176.1. The Planning Department may also refer the violation complaints to other city departments and agencies for appropriate enforcement action under their jurisdiction.

For information about compliance, contact Code Enforcement, Planning Department at 415-575-6863, www.sf-planning.org

21. **Revocation due to Violation of Conditions.** Should implementation of this Project result in complaints from interested property owners, residents, or commercial lessees which are not resolved by the Project Sponsor and found to be in violation of the Planning Code and/or the specific conditions of approval for the Project as set forth in Exhibit A of this Motion, the Zoning Administrator shall refer such complaints to the Commission, after which it may hold a public hearing on the matter to consider revocation of this authorization.

For information about compliance, contact Code Enforcement, Planning Department at 415-575-6863, www.sf-planning.org.

22. **Changes to Building Design and/or Materials.** A new Conditional Use authorization shall be required if the project design and/or materials, such as windows, storefront, door surround, roof tiles, and canopy elements, to the Alexandria Theatre building and/or the new mixed-use building are modified in the future.

For information about compliance, contact Code Enforcement, Planning Department at 415-575-6863, www.sf-planning.org.

OPERATION

23. **Security, Supervision, Maintenance and General Upkeep of the Alexandria Theatre Building and the Adjoining Parking Lot Site.** The Project Sponsor shall provide strict security and regular maintenance of the parking lot site and the theatre building to prevent any vandalism of

the theatre interior, and to protect its resources (i.e., architectural features and details) until such time the Project is completed as designed.

For information about compliance, contact Code Enforcement, Planning Department at 415-575-6863, www.sf-planning.org.

24. **Community Liaison.** Prior to issuance of a Building Permit to construct the Project and implement the approved use, the Project Sponsor shall appoint a community liaison officer to deal with the issues of concern to owners and occupants of nearby properties. The Project Sponsor shall provide the Zoning Administrator with written notice of the name, business address, and telephone number of the community liaison. Should the contact information change, the Zoning Administrator shall be made aware of such change. The community liaison shall report to the Zoning Administrator what issues, if any, are of concern to the community and what issues have not been resolved by the Project Sponsor.

For information about compliance, contact Code Enforcement, Planning Department at 415-575-6863, www.sf-planning.org.

25. **Garbage, Recycling, and Composting Receptacles.** Garbage, recycling, and compost containers shall be kept within trash enclosures on the premises and hidden from public view, and placed outside only when being serviced by the disposal company. Trash shall be contained and disposed of pursuant to garbage and recycling receptacles guidelines set forth by the Department of Public Works.

For information about compliance, contact Bureau of Street Use and Mapping, Department of Public Works at 415-554-5810, <http://sfdpw.org/>.

26. **Noise Control.** The premises shall be adequately soundproofed or insulated for noise and operated so that incidental noise shall not be audible beyond the premises or in other sections of the building and fixed-source equipment noise shall not exceed the decibel levels specified in the San Francisco Noise Control Ordinance.

For information about compliance with the fixed mechanical objects such as rooftop air conditioning, restaurant ventilation systems, and motors and compressors with acceptable noise levels, contact the Environmental Health Section, Department of Public Health at (415) 252-3800, www.sfdph.org.

For information about compliance with the construction noise, contact the Department of Building Inspection, 415-558-6570, www.sfdbi.org.

For information about compliance with the amplified sound including music and television contact the Police Department at 415-553-1012 or 415-5530123, www.sf-police.org

27. **Odor Control.** While it is inevitable that some low level of odor may be detectable to nearby residents and passersby, appropriate odor control equipment shall be installed and maintained to prevent any significant noxious or offensive odors from escaping the premises. The Building Permit Application to implement the Project shall include air cleaning or odor control equipment details and manufacturer specifications on the plans.

For information about compliance with odor or other chemical air pollutants emission standards and air quality regulations contact the Bay Area Air Quality Management District (BAAQMD), 1-800-334-

ODOR (6367), www.baaqmd.gov and Code Enforcement, Planning Department at 415-575-6863, www.sf-planning.org.

28. **Sidewalk Maintenance.** The Project Sponsor shall maintain the main entrance to the building and all sidewalks abutting the subject property in a clean and sanitary condition in compliance with the Department of Public Works' Streets and Sidewalk Maintenance Standards.
For information about compliance, contact Bureau of Street Use and Mapping, Department of Public Works, 415-695-2017, <http://sfdpw.org/>



CERTIFICATE SHOWING TAXES A LIEN, BUT NOT YET DUE

I, David Augustine, Tax Collector of the City and County San Francisco, State of California, do hereby certify, pursuant to the provisions of California Government Code Section 66492 et. seq., that the subdivision designated on the map entitled is subject to the following City & County property taxes and Special Assessments which are a lien on the property but which taxes are not yet due:

Block No. 1450 Lot No. 008

Address: 5400 Geary Blvd

Estimated probable assessed value of property within the proposed Subdivision/Parcel

Map: \$26,111,572

Established or estimated tax rate: 1.2000%

Estimated taxes liened but not yet due: \$313,339.00

Amount of Assessments not yet due: \$392.00

These estimated taxes and special assessments have been paid.

David Augustine, Tax Collector

Dated this 12th day of June. This certificate is valid for the earlier of 60 days from this date or December 31, 2018. If this certificate is no longer valid please contact the Office of Treasurer and Tax Collector to obtain another certificate.

Office of the Treasurer & Tax Collector
City and County of San Francisco

Property Tax Section



José Cisneros, Treasurer

**CERTIFICATE OF REDEMPTIONS OFFICER
SHOWING TAXES AND ASSESSMENTS PAID.**

I, David Augustine, Tax Collector of the City and County San Francisco, State of California, do hereby certify, pursuant to the provisions of California Government Code Section 66492 et. seq., that according to the records of my office, there are no liens against the subdivision designated on the map entitled:

Block No. 1450 Lot No. 008

Address: 5400 Geary Blvd

for unpaid City & County property taxes or special assessments collected as taxes, except taxes or assessments not yet payable.

David Augustine, Tax Collector

The above certificate pertains to taxes and special assessments collected as taxes for the period prior to this current tax year.

Dated this 12th day of June. This certificate is valid for the earlier of 60 days from this date or December 31, 2018. If this certificate is no longer valid please contact the Office of Treasurer and Tax Collector to obtain another certificate.

OWNER'S STATEMENT:

"WE HEREBY STATE THAT WE ARE ALL THE OWNERS OF AND HOLDERS OF SECURITY INTEREST OR HAVE SOME RIGHT, TITLE, OR INTEREST IN AND TO THE REAL PROPERTY INCLUDED WITHIN THE SUBDIVISION SHOWN UPON THIS MAP; THAT WE ARE THE ONLY PERSONS WHOSE CONSENT IS NECESSARY TO PASS A CLEAR TITLE TO SAID REAL PROPERTY; THAT WE HEREBY CONSENT TO MAKING AND RECORDING OF SAID MAP AS SHOWN WITHIN THE DISTINCTIVE BORDERLINE THAT SAID MAP CONSTITUTES AND CONSISTS OF A SURVEY MAP SHOWING MONUMENTATION ON THE GROUND WITHIN THE MEANING OF PARAGRAPHS 4120 AND 4285 OF THE CIVIL CODE OF THE STATE OF CALIFORNIA; AND THAT WE HEREBY CONSENT TO THE MAKING AND RECORDING OF SAID MAP PURSUANT TO DIVISION 4, PART 5, CHAPTER 3, ARTICLE 4 OF THE CIVIL CODE OF THE STATE OF CALIFORNIA."

IN WITNESS WHEREOF, WE, THE UNDERSIGNED, HAVE CAUSED THIS STATEMENT TO BE EXECUTED.

OWNERS:

TIMESPACE SAN FRANCISCO LLC, A CALIFORNIA LIMITED LIABILITY COMPANY

[Signature]
YIHUA LI, MANAGING MEMBER

BENEFICIARY:

FIRST COMMERCIAL BANK USA

BY: [Signature] FVP
TITLE:

Michael Wang
PRINT NAME:

OWNER'S ACKNOWLEDGMENT:

A NOTARY PUBLIC OR OTHER OFFICER COMPLETING THIS CERTIFICATE VERIFIES ONLY THE IDENTITY OF THE INDIVIDUAL WHO SIGNED THE DOCUMENT TO WHICH THIS CERTIFICATE IS ATTACHED, AND NOT THE TRUTHFULNESS, ACCURACY, OR VALIDITY OF THAT DOCUMENT.

STATE OF CALIFORNIA
COUNTY OF Santa Clara
ON 04/11/2018 BEFORE ME, Linda Pao, NOTARY PUBLIC
(INSERT NAME)

PERSONALLY APPEARED: *Yihua Li*
WHO PROVED TO ME ON THE BASIS OF SATISFACTORY EVIDENCE TO BE THE PERSON(S) WHOSE NAME(S) WAS SUBSCRIBED TO THE WITHIN INSTRUMENT AND ACKNOWLEDGED TO ME THAT ~~(S)~~ HE(S) THEY EXECUTED THE SAME IN ~~(S)~~ HER/THEIR AUTHORIZED CAPACITY(IES), AND THAT BY ~~(S)~~ HE(S) HE(S) HER/HIS SIGNATURE(S) ON THE INSTRUMENT THE PERSON(S) OR THE ENTITY UPON BEHALF OF WHICH THE PERSON(S) ACTED, EXECUTED THE INSTRUMENT.

I CERTIFY UNDER PENALTY OF PERJURY UNDER THE LAWS OF THE STATE OF CALIFORNIA THAT THE FOREGOING PARAGRAPH IS TRUE AND CORRECT.

WITNESS MY HAND AND OFFICIAL SEAL.

Linda Pao Linda Pao
SIGNATURE: PRINTED NAME:

02/01/2020 2139202
COMMISSION EXPIRES: COMMISSION # OF NOTARY:

Santa Clara
PRINCIPAL COUNTY OF BUSINESS:

RECORDER'S STATEMENT:

FILED THIS _____ DAY OF _____, 20____, AT _____, CA.
IN BOOK _____ OF CONDOMINIUM MAPS, AT PAGE(S) _____, AT THE REQUEST OF
FREDERICK T. SEHER.

SIGNED _____
COUNTY RECORDER

SURVEYOR'S STATEMENT:

THIS MAP WAS PREPARED BY ME OR UNDER MY DIRECTION AND IS BASED UPON A FIELD SURVEY IN CONFORMANCE WITH THE REQUIREMENTS OF THE SUBDIVISION MAP ACT AND LOCAL ORDINANCE AT THE REQUEST OF YORKE LEE ON FEBRUARY 08, 2017. I HEREBY STATE THAT ALL THE MONUMENTS ARE OF THE CHARACTER AND OCCUPY THE POSITIONS INDICATED AND THAT THE MONUMENTS ARE SUFFICIENT TO ENABLE THE SURVEY TO BE RETRACED, AND THAT THIS FINAL MAP SUBSTANTIALLY CONFORMS TO THE CONDITIONALLY APPROVED TENTATIVE MAP.



[Signature]
FREDERICK T. SEHER, PLS
LICENSE NO. 6216

DATE: 05-24-18

CITY AND COUNTY SURVEYOR'S STATEMENT:

I HEREBY STATE THAT I HAVE EXAMINED THIS MAP; THAT THE SUBDIVISION AS SHOWN IS SUBSTANTIALLY THE SAME AS IT APPEARED ON THE TENTATIVE MAP, AND ANY APPROVED ALTERATIONS THEREOF; THAT ALL PROVISIONS OF THE CALIFORNIA SUBDIVISION MAP ACT AND ANY LOCAL ORDINANCES APPLICABLE AT THE TIME OF THE APPROVAL OF THE TENTATIVE MAP HAVE BEEN COMPLIED WITH; AND THAT I AM SATISFIED THIS MAP IS TECHNICALLY CORRECT.

BRUCE R. STORRS, CITY AND COUNTY SURVEYOR
CITY AND COUNTY OF SAN FRANCISCO

BY: [Signature]
BRUCE R. STORRS L.S. 6914

DATE: JUNE 8 2018



3703

BENEFICIARY ACKNOWLEDGMENT:

A NOTARY PUBLIC OR OTHER OFFICER COMPLETING THIS CERTIFICATE VERIFIES ONLY THE IDENTITY OF THE INDIVIDUAL WHO SIGNED THE DOCUMENT TO WHICH THIS CERTIFICATE IS ATTACHED, AND NOT THE TRUTHFULNESS, ACCURACY, OR VALIDITY OF THAT DOCUMENT.

STATE OF CALIFORNIA
COUNTY OF Santa Clara
ON 04/12/2018 BEFORE ME, Linda Pao, NOTARY PUBLIC
(INSERT NAME)

PERSONALLY APPEARED: *Michael Wang*
WHO PROVED TO ME ON THE BASIS OF SATISFACTORY EVIDENCE TO BE THE PERSON(S) WHOSE NAME(S) WAS SUBSCRIBED TO THE WITHIN INSTRUMENT AND ACKNOWLEDGED TO ME THAT ~~(S)~~ HE(S) THEY EXECUTED THE SAME IN ~~(S)~~ HER/THEIR AUTHORIZED CAPACITY(IES), AND THAT BY ~~(S)~~ HE(S) HE(S) HER/HIS SIGNATURE(S) ON THE INSTRUMENT THE PERSON(S) OR THE ENTITY UPON BEHALF OF WHICH THE PERSON(S) ACTED, EXECUTED THE INSTRUMENT.

I CERTIFY UNDER PENALTY OF PERJURY UNDER THE LAWS OF THE STATE OF CALIFORNIA THAT THE FOREGOING PARAGRAPH IS TRUE AND CORRECT.

WITNESS MY HAND AND OFFICIAL SEAL.

Linda Pao Linda Pao
SIGNATURE: PRINTED NAME:

02/01/2020 2139202
COMMISSION EXPIRES: COMMISSION # OF NOTARY:

Santa Clara
PRINCIPAL COUNTY OF BUSINESS:

FINAL MAP NO. 9294
BEING A 4 LOT VERTICAL SUBDIVISION,
43 RESIDENTIAL UNIT, 5 COMMERCIAL UNIT,
AND 43 PARKING SPACE CONDOMINIUM
MIXED USE PROJECT

BEING A MERGER AND SUBDIVISION OF THAT CERTAIN REAL PROPERTY AS DESCRIBED IN THAT CERTAIN GRANT DEED RECORDED ON JUNE 16, 2015, DOCUMENT NUMBER 2015-K076322-00 OF OFFICIAL RECORDS, ON FILE IN THE OFFICE OF THE RECORDER OF THE CITY AND COUNTY OF SAN FRANCISCO, CALIFORNIA.

ALSO BEING A PART OF OUTSIDE LAND BLOCK NO. 199

CITY AND COUNTY OF SAN FRANCISCO

CALIFORNIA
APRIL, 2018



Frederick T. Seher & Associates, Inc.
PROFESSIONAL LAND SURVEYORS
841 LOMBARDO STREET, SAN FRANCISCO, CA 94133
PHONE (415) 921-7690 FAX (415) 921-7655

SHEET ONE OF EIGHT SHEETS

3704

TAX STATEMENT:

I, ANGELA CALVILLO, CLERK OF THE BOARD OF SUPERVISORS OF THE CITY AND COUNTY OF SAN FRANCISCO, STATE OF CALIFORNIA, DO HEREBY STATE THAT THE SUBDIVIDER HAS FILED A STATEMENT FROM THE TREASURER AND TAX COLLECTOR OF THE CITY AND COUNTY OF SAN FRANCISCO, SHOWING THAT ACCORDING TO THE RECORDS OF HIS OR HER OFFICE THERE ARE NO LIENS AGAINST THIS SUBDIVISION OR ANY PART THEREOF FOR UNPAID STATE, COUNTY, MUNICIPAL OR LOCAL TAXES, OR SPECIAL ASSESSMENTS COLLECTED AS TAXES.

DATED DAY OF, 20.....

CLERK OF THE BOARD OF SUPERVISORS
CITY AND COUNTY OF SAN FRANCISCO
STATE OF CALIFORNIA

CLERK'S STATEMENT:

I, ANGELA CALVILLO, CLERK OF THE BOARD OF SUPERVISORS OF THE CITY AND COUNTY OF SAN FRANCISCO, STATE OF CALIFORNIA, HEREBY STATE THAT SAID BOARD OF SUPERVISORS BY

ITS MOTION NO. ADOPTED, 20....., APPROVED THIS MAP ENTITLED, "FINAL MAP NO. 9294".

IN TESTIMONY WHEREOF, I HAVE HEREUNTO SUBSCRIBED MY HAND AND CAUSED THE SEAL OF THE OFFICE TO BE AFFIXED.

BY: DATE:
CLERK OF THE BOARD OF SUPERVISORS
CITY AND COUNTY OF SAN FRANCISCO
STATE OF CALIFORNIA

APPROVALS:

THIS MAP IS APPROVED THIS 6TH DAY OF June, 2018

BY ORDER NO. 187835

BY: DATE:

MOHAMMED NURU
DIRECTOR OF PUBLIC WORKS AND ADVISORY AGENCY
CITY AND COUNTY OF SAN FRANCISCO
STATE OF CALIFORNIA

APPROVED AS TO FORM:

DENNIS J. HERRERA, CITY ATTORNEY

BY:

DEPUTY CITY ATTORNEY
CITY AND COUNTY OF SAN FRANCISCO

BOARD OF SUPERVISORS' APPROVAL:

ON, 20....., THE BOARD OF SUPERVISORS OF THE CITY AND COUNTY OF SAN FRANCISCO, STATE OF CALIFORNIA APPROVED AND PASSED MOTION NO.

....., A COPY OF WHICH IS ON FILE IN THE OFFICE OF THE BOARD

OF SUPERVISORS IN FILE NO.

GENERAL NOTES:

A) THIS MAP IS THE SURVEY MAP PORTION OF A CONDOMINIUM PLAN AS DESCRIBED IN CALIFORNIA CIVIL CODE SECTIONS 4120 AND 4285. THIS CONDOMINIUM PROJECT IS LIMITED TO A MAXIMUM NUMBER OF FORTY-THREE (43) DWELLING UNITS AND FORTY-EIGHT (48) COMMERCIAL UNITS.

B) ALL INGRESS(ES), EGRESS(ES), PATH(S) OF TRAVEL, FIRE/EMERGENCY EXIT(S) AND EXITING COMPONENTS, EXIT PATHWAY(S) AND PASSAGEWAY(S), STAIRWAY(S), CORRIDOR(S), ELEVATOR(S), AND COMMON USE ACCESSIBLE FEATURE(S) AND FACILITIES SUCH AS RESTROOMS THAT THE BUILDING CODE REQUIRES FOR COMMON USE SHALL BE HELD IN COMMON UNDIVIDED INTEREST.

C) UNLESS SPECIFIED OTHERWISE IN THE GOVERNING DOCUMENTS OF A CONDOMINIUM HOMEOWNERS' ASSOCIATION, INCLUDING ITS CONDITIONS, COVENANTS, AND RESTRICTIONS, THE HOMEOWNERS' ASSOCIATION SHALL BE RESPONSIBLE, IN PERPETUITY, FOR THE MAINTENANCE, REPAIR, AND REPLACEMENT OF:

(i) ALL GENERAL USE COMMON AREA IMPROVEMENTS; AND
(ii) ALL FRONTING SIDEWALKS, ALL PERMITTED OR UNPERMITTED PRIVATE ENCROACHMENTS AND PRIVATELY MAINTAINED STREET TREES FRONTING THE PROPERTY, AND ANY OTHER OBLIGATION IMPOSED ON PROPERTY OWNERS FRONTING A PUBLIC RIGHT-OF-WAY PURSUANT TO THE PUBLIC WORKS CODE OR OTHER APPLICABLE MUNICIPAL CODES.

D) IN THE EVENT THE AREAS IDENTIFIED IN (C)(i) ARE NOT PROPERLY MAINTAINED, REPAIRED, AND REPLACED ACCORDING TO THE CITY REQUIREMENTS, EACH HOMEOWNER SHALL BE RESPONSIBLE TO THE EXTENT OF HIS/HER PROPORTIONATE OBLIGATION TO THE HOMEOWNERS' ASSOCIATION FOR THE MAINTENANCE, REPAIR, AND REPLACEMENT OF THOSE AREAS. FAILURE TO UNDERTAKE SUCH MAINTENANCE, REPAIR, AND REPLACEMENT MAY RESULT IN CITY ENFORCEMENT AND ABATEMENT ACTIONS AGAINST THE HOMEOWNERS' ASSOCIATION AND/OR THE INDIVIDUAL HOMEOWNERS, WHICH MAY INCLUDE, BUT NOT BE LIMITED TO IMPOSITION OF A LIEN AGAINST THE HOMEOWNER'S PROPERTY.

E) APPROVAL OF THIS MAP SHALL NOT BE DEEMED APPROVAL OF THE DESIGN, LOCATION, SIZE, DENSITY OR USE OF ANY STRUCTURE(S) OR ANCILLARY AREAS OF THE PROPERTY ASSOCIATED WITH STRUCTURES, NEW OR EXISTING, WHICH HAVE NOT BEEN REVIEWED OR APPROVED BY APPROPRIATE CITY AGENCIES NOR SHALL SUCH APPROVAL CONSTITUTE A WAIVER OF THE SUBDIVIDER'S OBLIGATION TO ABATE ANY OUTSTANDING MUNICIPAL CODE VIOLATIONS. ANY STRUCTURES CONSTRUCTED SUBSEQUENT TO APPROVAL OF THIS FINAL MAP SHALL COMPLY WITH ALL RELEVANT MUNICIPAL CODES, INCLUDING BUT NOT LIMITED TO THE PLANNING, HOUSING AND BUILDING CODES, IN EFFECT AT THE TIME OF ANY APPLICATION FOR REQUIRED PERMITS.

F) BAY WINDOWS, FIRE ESCAPES AND OTHER ENCROACHMENTS (IF ANY SHOWN HEREON, THAT EXIST, OR THAT MAY BE CONSTRUCTED) ONTO OR OVER GEARY BOULEVARD AND 18TH AVENUE ARE PERMITTED THROUGH AND ARE SUBJECT TO THE RESTRICTIONS SET FORTH IN THE BUILDING CODE AND PLANNING CODE OF THE CITY AND COUNTY OF SAN FRANCISCO. THIS MAP DOES NOT CONVEY ANY OWNERSHIP INTEREST IN SUCH ENCROACHMENT AREAS TO THE CONDOMINIUM UNIT OWNER(S).

G) SIGNIFICANT ENCROACHMENTS, TO THE EXTENT THEY WERE VISIBLE AND OBSERVED, ARE NOTED HEREON. HOWEVER, IT IS ACKNOWLEDGED THAT OTHER ENCROACHMENTS FROM ONTO ADJOINING PROPERTIES MAY EXIST OR BE CONSTRUCTED. IT SHALL BE THE RESPONSIBILITY SOLELY OF THE PROPERTY OWNERS INVOLVED TO RESOLVE ANY ISSUES THAT MAY ARISE FROM ANY ENCROACHMENTS WHETHER DEPICTED HEREON OR NOT. THIS MAP DOES NOT PURPORT TO CONVEY ANY OWNERSHIP INTEREST IN AN ENCROACHMENT AREA TO ANY PROPERTY OWNER.

NOTES:

THE PROPERTY SHOWN HEREIN IS SUBJECT TO THE TERMS AND PROVISIONS AS DESCRIBED IN THE FOLLOWING RECORDED DOCUMENTS:

"HAZARDOUS SUBSTANCES CERTIFICATE AND INDEMNITY AGREEMENT"
RECORDED MAY 03, 2016
DOC. NO. 2016-K238835-00

"NOTICE OF SPECIAL RESTRICTIONS UNDER THE CITY PLANNING CODE"
RECORDED ON OCTOBER 08, 2015
DOC. NO. 2015-J769109-00

FINAL MAP NO. 9294
BEING A 4 LOT VERTICAL SUBDIVISION,
43 RESIDENTIAL UNIT, 5 COMMERCIAL UNIT,
AND 43 PARKING SPACE CONDOMINIUM
MIXED USE PROJECT

BEING A MERGER AND SUBDIVISION OF THAT CERTAIN REAL PROPERTY AS DESCRIBED IN THAT CERTAIN GRANT DEED RECORDED ON JUNE 16, 2015, DOCUMENT NUMBER 2015-K076322-00 OF OFFICIAL RECORDS, ON FILE IN THE OFFICE OF THE RECORDER OF THE CITY AND COUNTY OF SAN FRANCISCO, CALIFORNIA.

ALSO BEING A PART OF OUTSIDE LAND BLOCK NO. 199

CITY AND COUNTY OF SAN FRANCISCO

CALIFORNIA
APRIL, 2018



Frederick T. Seher & Associates, Inc.
PROFESSIONAL LAND SURVEYORS
941 LOMBARD STREET, SAN FRANCISCO, CA 94133
PHONE (415) 921-7990 FAX (415) 921-7955

SHEET TWO OF EIGHT SHEETS

3705

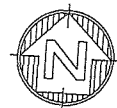
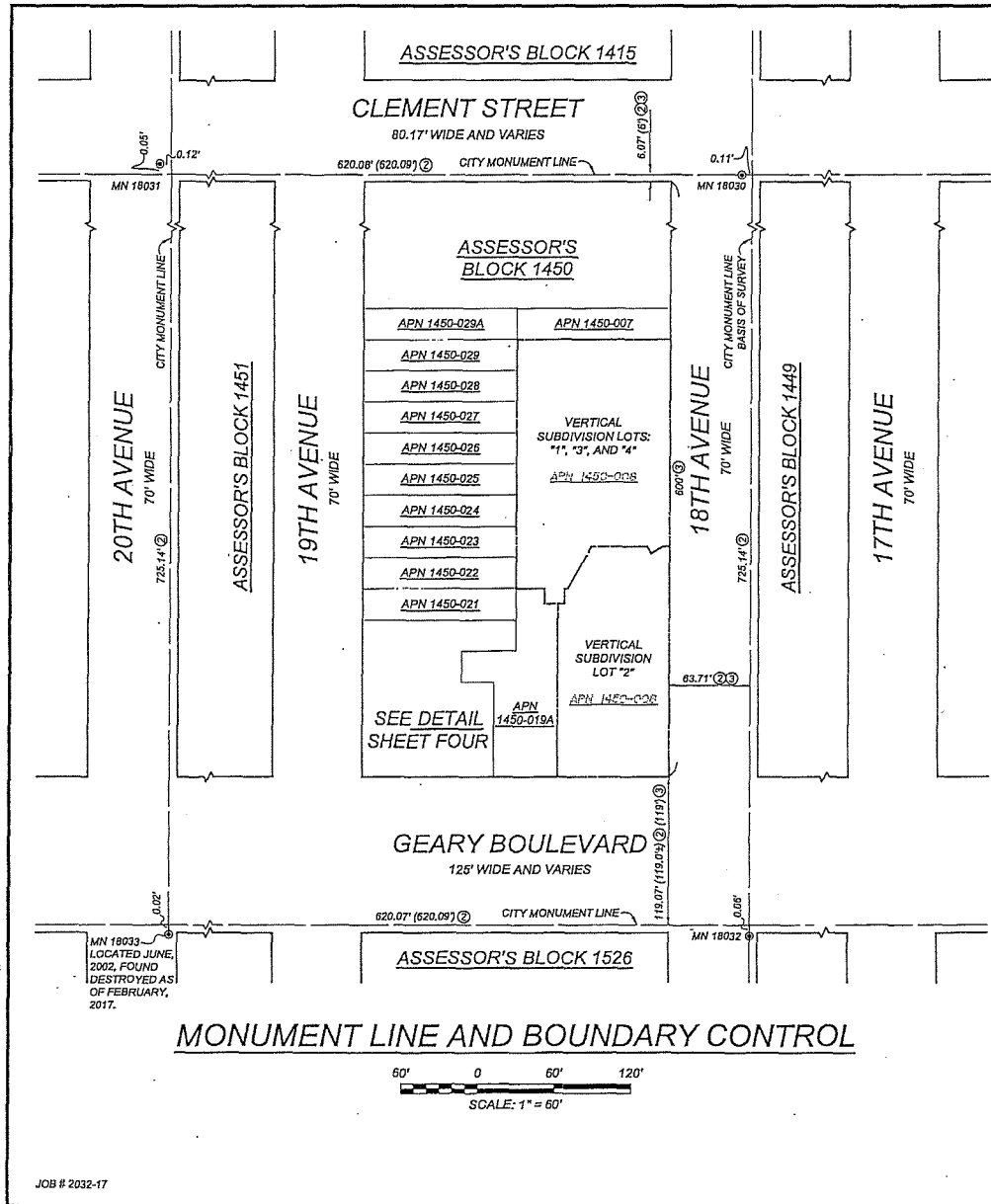

LINETYPES:
 ————— PROPERTY LINE
 - - - - - CHANGE IN LOWER ELEVATION (L.E.)
 - - - - - CHANGE IN UPPER ELEVATION (U.E.)

LEGEND:

- SET BRASS NAIL & TAG (3/4") L.S. 6216 IN CURB
- FOUND NAIL & TAG PER REFERENCE (OR AS NOTED)
- () INDICATES RECORD DATA IN DISCREPANCY WITH MEASURED, PER REFERENCE
- ⊙ INDICATES FOUND CITY MONUMENT, STONE OR CONCRETE MONUMENT WITH LEAD PLUG AND BRASS PIN IN HAND HOLE WELL (OR AS NOTED).
- L "L" CUT, ORIGIN AS NOTED (OR UNKNOWN)
- T "T" CUT, ORIGIN AS NOTED (OR UNKNOWN)
- N/F NOW OR FORMERLY
- CLR CLEAR OF PROPERTY LINE
- MN ##### MONUMENT IDENTIFICATION PER CITY AND COUNTY OF SAN FRANCISCO DATABASE
- OVR OVER PROPERTY LINE

MAP AND DEED REFERENCES:

- ① GRANT DEED RECORDED JUNE 16, 2015, DOCUMENT NUMBER 2015-K076322-00, ON FILE IN THE OFFICE OF THE RECORDER OF THE CITY AND COUNTY OF SAN FRANCISCO.
- ② MONUMENT MAP NO. 083, ON FILE IN THE OFFICE OF THE CITY AND COUNTY SURVEYOR.
- ③ BLOCK DIAGRAM OF RICHMOND BLOCK NO. 199, ON FILE IN THE OFFICE OF THE CITY AND COUNTY SURVEYOR.

PROJECT BENCHMARK - DESCRIPTION:
 ELEVATIONS HEREON WERE OBTAINED FROM A GROUP OF CITY BENCHMARKS, LOCATED AT THE INTERSECTION OF GEARY BOULEVARD AND 20TH AVENUE. ELEVATIONS ARE BASED ON CITY AND COUNTY OF SAN FRANCISCO "OLD CITY" DATUM*, C.C. 33"W, + CUT CONC CURB AT ISLAND. ELEVATION = 135.425.

ASSESSOR'S PARCEL NUMBER (APN) NOTE:
 THE PROPOSED ASSESSOR PARCEL NUMBERS SHOWN HEREON ARE FOR INFORMATIONAL USE ONLY AND SHOULD NOT BE RELIED UPON FOR ANY OTHER PURPOSE.

SUBDIVISION OF APN 1450-008

LOT	PROPOSED APN
LOT 1*	1450-047
LOT 2*	1450-048
LOT 3*	1450-049
LOT 4*	1450-050

FURTHER SUBDIVISION OF LOT 1* (APN 1450-047)

UNIT NUMBER	PROPOSED APN
COMM. UNIT	1450-051
101-110	1450-056 THRU 065
201-212	1450-068 THRU 077
301-311	1450-078 THRU 088
401-410	1450-089 THRU 098

FURTHER SUBDIVISION OF LOT 2* (APN 1450-048)

UNIT NUMBER	PROPOSED APN
UNIT 1	1450-052
UNIT 2	1450-053
UNIT 3	1450-054
UNIT 4	1450-055

FURTHER SUBDIVISION OF LOT 4* (APN 1450-050)

PARKING SPACE #	PROPOSED APN
P-01 THRU P-10	1450-099 THRU 108
P-11 THRU P-20	1450-109 THRU 118
P-21 THRU P-30	1450-119 THRU 128
P-31 THRU P-40	1450-129 THRU 138
P-41 THRU P-43	1450-139 THRU 141

BOUNDARY NOTES:

1. ALL ANGLES ARE 90° UNLESS OTHERWISE NOTED; MONUMENT LINES ARE AS SHOWN.
2. ALL DISTANCES SHOWN HEREON ARE MEASURED UNLESS SHOWN OTHERWISE.
3. ALL DISTANCES ARE MEASURED IN FEET AND DECIMALS THEREOF.
4. DETAILS NEAR FOUND "L" CUTS AND PROPERTY LINE ARE NOT TO SCALE AND ARE EXAGGERATED FOR CLARITY.

BASIS OF SURVEY:
 BLOCK LINES OF BLOCK 1450 WERE ESTABLISHED PARALLEL AND PERPENDICULAR TO THE CITY MONUMENT LINE IDENTIFIED AS BASIS OF SURVEY LINE. OTHER STREET LINES SHOWN HEREON WERE NOT ESTABLISHED. THEY ARE SHOWN TO FACILITATE THE RECOVERY OF MONUMENT LINE REFERENCE POINTS.

FINAL MAP NO. 9294
 BEING A 4 LOT VERTICAL SUBDIVISION,
 43 RESIDENTIAL UNIT, 5 COMMERCIAL UNIT,
 AND 43 PARKING SPACE CONDOMINIUM
 MIXED USE PROJECT

BEING A MERGER AND SUBDIVISION OF THAT CERTAIN REAL PROPERTY AS DESCRIBED IN THAT CERTAIN GRANT DEED RECORDED ON JUNE 16, 2015, DOCUMENT NUMBER 2015-K076322-00 OF OFFICIAL RECORDS, ON FILE IN THE OFFICE OF THE RECORDER OF THE CITY AND COUNTY OF SAN FRANCISCO, CALIFORNIA.

ALSO BEING A PART OF OUTSIDE LAND BLOCK NO. 189

CITY AND COUNTY OF SAN FRANCISCO
 SCALE AS NOTED

CALIFORNIA
 APRIL, 2018



Frederick T. Seher & Associates, Inc.
 PROFESSIONAL LAND SURVEYORS
 841 LOMBARD STREET, SAN FRANCISCO, CA 94133
 PHONE (415) 921-7890 FAX (415) 921-7855

SHEET THREE OF EIGHT SHEETS

APN: 1450-008 369 18TH AVENUE

MONUMENT LINE AND BOUNDARY CONTROL

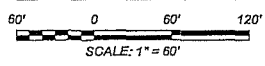

3706

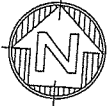
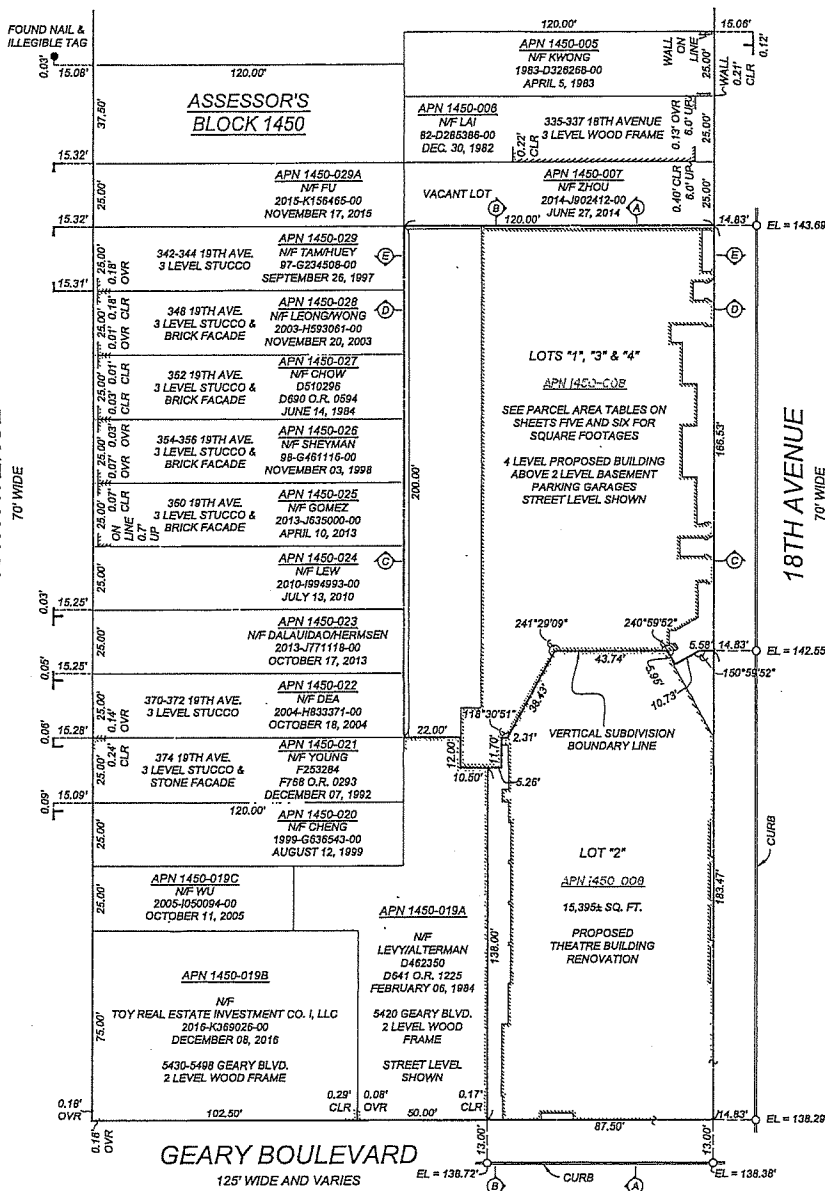

LINETYPES:

— PROPERTY LINE
 - - - CHANGE IN LOWER ELEVATION (L.E.)
 - - - CHANGE IN UPPER ELEVATION (U.E.)

LEGEND:

○ SET BRASS NAIL & TAG (3/4" L.S. 6216 IN CURB (OR AS NOTED)

● FOUND NAIL & TAG PER REFERENCE (OR AS NOTED)

() INDICATES RECORD DATA IN DISCREPANCY WITH MEASURED, PER REFERENCE

⊙ INDICATES FOUND CITY MONUMENT, STONE OR CONCRETE MONUMENT WITH LEAD PLUG AND BRASS PIN IN HAND HOLE WELL (OR AS NOTED).

L "L" CUT, ORIGIN AS NOTED (OR UNKNOWN)

T "T" CUT, ORIGIN AS NOTED (OR UNKNOWN)

EL ELEVATION

NF NOW OR FORMERLY

CLR CLEAR OF PROPERTY LINE

MN ##### MONUMENT IDENTIFICATION PER CITY AND COUNTY OF SAN FRANCISCO DATABASE

O.R. OFFICIAL RECORDS

OVR OVER PROPERTY LINE

NOTES:

DISTANCES FROM BUILDING CORNERS TO PROPERTY LINE WERE MEASURED 6.0" UP FROM GROUND (OR AS NOTED). BUILDING TRIMS ARE EXCLUDED FROM THESE DISTANCES.

PROJECT SHEET NOTES:

SEE SHEET 6 FOR VERTICAL SECTION A-A

SEE SHEET 7 FOR VERTICAL SECTIONS B-B THROUGH E-E

SEE SHEET 8 FOR 3-DIMENSIONAL ISOMETRIC VIEWS

PROJECT BENCHMARK - DESCRIPTION:

ELEVATIONS HEREON WERE OBTAINED FROM A GROUP OF CITY BENCHMARKS, LOCATED AT THE INTERSECTION OF GEARY BOULEVARD AND 20TH AVENUE. ELEVATIONS ARE BASED ON CITY AND COUNTY OF SAN FRANCISCO "OLD CITY DATUM", C.C. 33' W. + CUT CONC CURB AT ISLAND. ELEVATION = 135.425'.

BOUNDARY NOTES:

- ALL ANGLES ARE 90° UNLESS OTHERWISE NOTED; MONUMENT LINES ARE AS SHOWN.
- ALL DISTANCES SHOWN HEREON ARE MEASURED UNLESS SHOWN OTHERWISE.
- ALL DISTANCES ARE MEASURED IN FEET AND DECIMALS THEREOF.
- DETAILS NEAR FOUND "L" CUTS AND PROPERTY LINE ARE NOT TO SCALE AND ARE EXAGGERATED FOR CLARITY.

FINAL MAP NO. 9294
 BEING A 4 LOT VERTICAL SUBDIVISION,
 43 RESIDENTIAL UNIT, 5 COMMERCIAL UNIT,
 AND 43 PARKING SPACE CONDOMINIUM
 MIXED USE PROJECT

BEING A MERGER AND SUBDIVISION OF THAT CERTAIN REAL PROPERTY AS DESCRIBED IN THAT CERTAIN GRANT DEED RECORDED ON JUNE 16, 2015, DOCUMENT NUMBER 2015-K076322-00 OF OFFICIAL RECORDS, ON FILE IN THE OFFICE OF THE RECORDER OF THE CITY AND COUNTY OF SAN FRANCISCO, CALIFORNIA.

ALSO BEING A PART OF OUTSIDE LAND BLOCK NO. 199
 CITY AND COUNTY OF SAN FRANCISCO CALIFORNIA
 SCALE AS NOTED APRIL, 2018

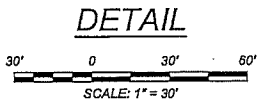

Frederick T. Seher & Associates, Inc.
 PROFESSIONAL LAND SURVEYORS
 841 LOMBARD STREET, SAN FRANCISCO, CA 94133
 PHONE (415) 921-7600 FAX (415) 921-7655

SHEET FOUR OF EIGHT SHEETS

3707

EASEMENT NOTE:

EASEMENTS #1 THRU #7, FOR INGRESS/EGRESS, VEHICULAR INGRESS/EGRESS, ELEVATORS, UTILITIES, AND BICYCLE PARKING, AS DELINEATED AND SHOWN HEREON, SHALL BE CREATED IN "DECLARATION ESTABLISHING RECIPROCAL EASEMENTS, COVENANTS AND RESTRICTIONS RUNNING WITH THE LAND AND PROVIDING FOR JOINT MAINTENANCE OF 389 18TH AVENUE/400 GEARY BOULEVARD", TO BE RECORDED BY SEPARATE INSTRUMENT.

PARCEL AREAS OF BASEMENT LEVEL 1		
LOT	PROPOSED APN	SQ. FT.
LOT "1"	1450-051, 056 THRU 098	576
LOT "2"	1450-082 THRU 055	15,395
LOT "3"	1450-048	21,280
TOTAL		37,251

LINETYPES:

- PROPERTY LINE
- CHANGE IN LOWER ELEVATION (L.E.)
- CHANGE IN UPPER ELEVATION (U.E.)
- EASEMENT

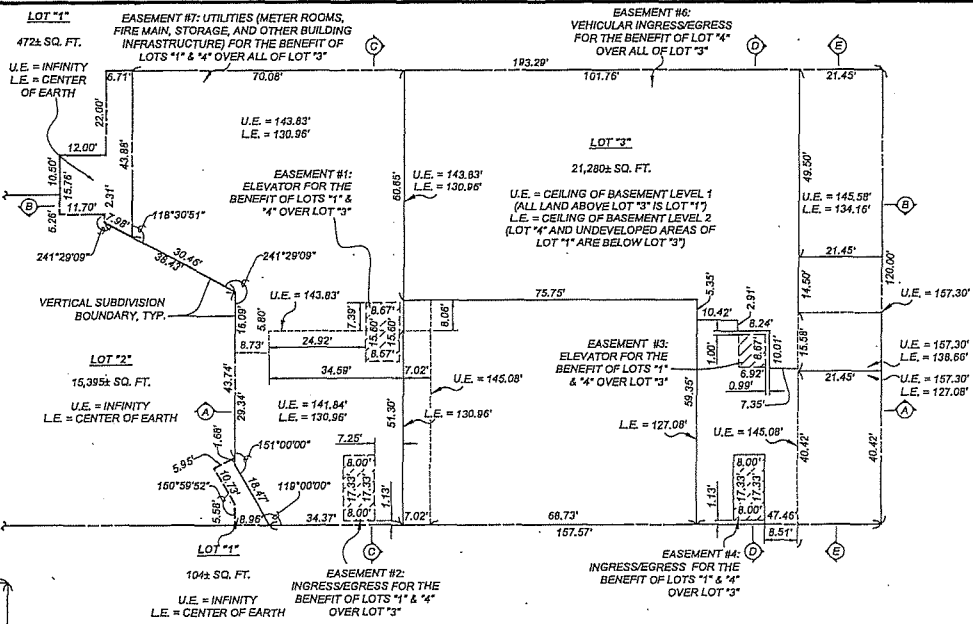

BASEMENT LEVEL 1

SCALE: 1" = 20'

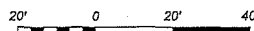

FINAL MAP NO. 9294

BEING A 4 LOT VERTICAL SUBDIVISION,
43 RESIDENTIAL UNIT, 5 COMMERCIAL UNIT,
AND 43 PARKING SPACE CONDOMINIUM
MIXED USE PROJECT

PARCEL AREAS OF BASEMENT LEVEL 2		
LOT	PROPOSED APN	SQ. FT.
LOT "1"	1450-051, 056 THRU 098	1,945
LOT "2"	1450-082 THRU 055	15,395
LOT "4"	1450-059 THRU 141	19,911
TOTAL		37,251

BEING A MERGER AND SUBDIVISION OF THAT CERTAIN REAL PROPERTY AS DESCRIBED IN THAT CERTAIN GRANT DEED RECORDED ON JUNE 16, 2015, DOCUMENT NUMBER 2015-K076322-00 OF OFFICIAL RECORDS, ON FILE IN THE OFFICE OF THE RECORDER OF THE CITY AND COUNTY OF SAN FRANCISCO, CALIFORNIA.

ALSO BEING A PART OF OUTSIDE LAND BLOCK NO. 199

CITY AND COUNTY OF SAN FRANCISCO
SCALE AS NOTED

CALIFORNIA
APRIL, 2018

PROJECT BENCHMARK - DESCRIPTION:

ELEVATIONS HEREON WERE OBTAINED FROM A GROUP OF CITY BENCHMARKS LOCATED AT THE INTERSECTION OF GEARY BOULEVARD AND 20TH AVENUE. ELEVATIONS ARE BASED ON CITY AND COUNTY OF SAN FRANCISCO "OLD CITY DATUM": C.C. 33' W, + CUT CONC CURB AT ISLAND. ELEVATION = 135.425'



Frederick T. Seher & Associates, Inc.
PROFESSIONAL LAND SURVEYORS
841 LOMBARO STREET, SAN FRANCISCO, CA 94133
PHONE (415) 921-7690 FAX (415) 921-7655

SHEET FIVE OF EIGHT SHEETS

BASEMENT LEVEL 2

SCALE: 1" = 20'



SCALE: 1" = 20'

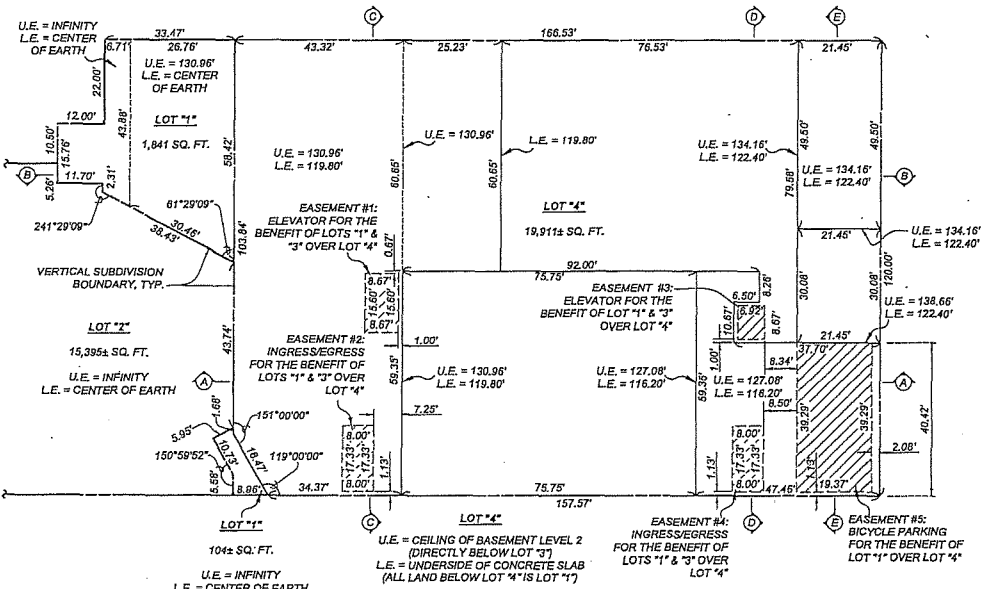

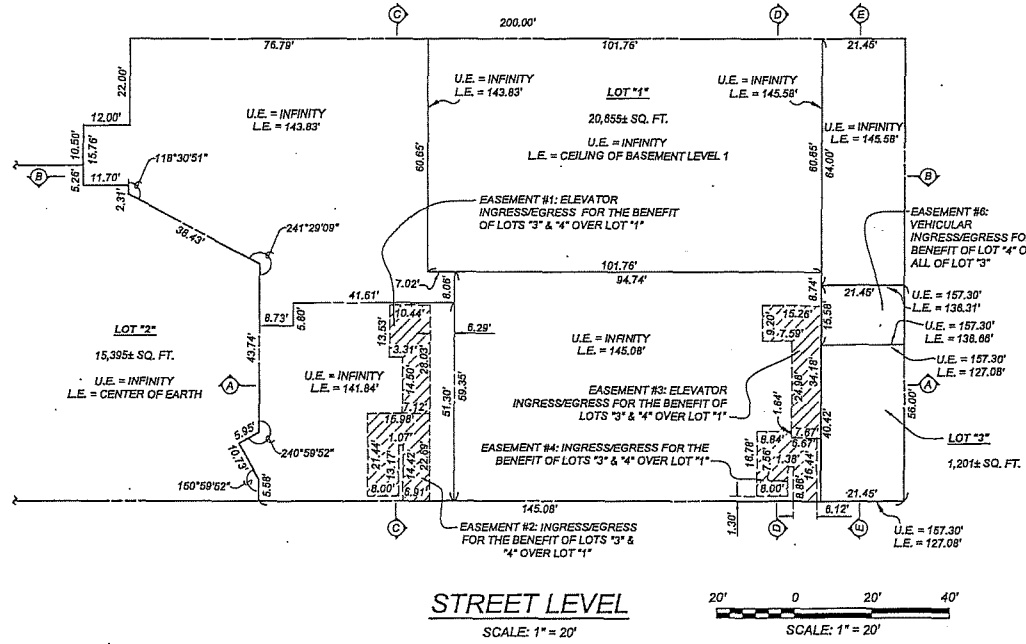

PARCEL AREAS OF STREET LEVEL		
LOT	PROPOSED APN:	SQ. FT.
LOT 1*	1450-051; 055 THRU 098	20,655
LOT 2*	1450-052 THRU 055	15,395
LOT 3*	1450-049	1,201
TOTAL		37,251

EASEMENT NOTE:
EASEMENTS #1 THRU #7, FOR INGRESS/EGRESS, VEHICULAR INGRESS/EGRESS, ELEVATORS, UTILITIES, AND BICYCLE PARKING, AS DELINEATED AND SHOWN HEREON, SHALL BE CREATED IN DECLARATION ESTABLISHING RECIPROCAL EASEMENTS, COVENANTS AND RESTRICTIONS RUNNING WITH THE LAND AND PROVIDING FOR JOINT MAINTENANCE OF 369 16TH AVENUE/5400 GEARY BOULEVARD, TO BE RECORDED BY SEPARATE INSTRUMENT.

LINETYPES:
 - - - - - PROPERTY LINE
 - - - - - CHANGE IN LOWER ELEVATION (L.E.)
 - - - - - CHANGE IN UPPER ELEVATION (U.E.)
 // // // // EASEMENT

PROJECT BENCHMARK - DESCRIPTION:
ELEVATIONS HEREON WERE OBTAINED FROM A GROUP OF CITY BENCHMARKS, LOCATED AT THE INTERSECTION OF GEARY BOULEVARD AND 20TH AVENUE. ELEVATIONS ARE BASED ON CITY AND COUNTY OF SAN FRANCISCO "OLD CITY DATUM", C.C. 33" W, + CUT CONC CURB AT ISLAND. ELEVATION = 135.425'

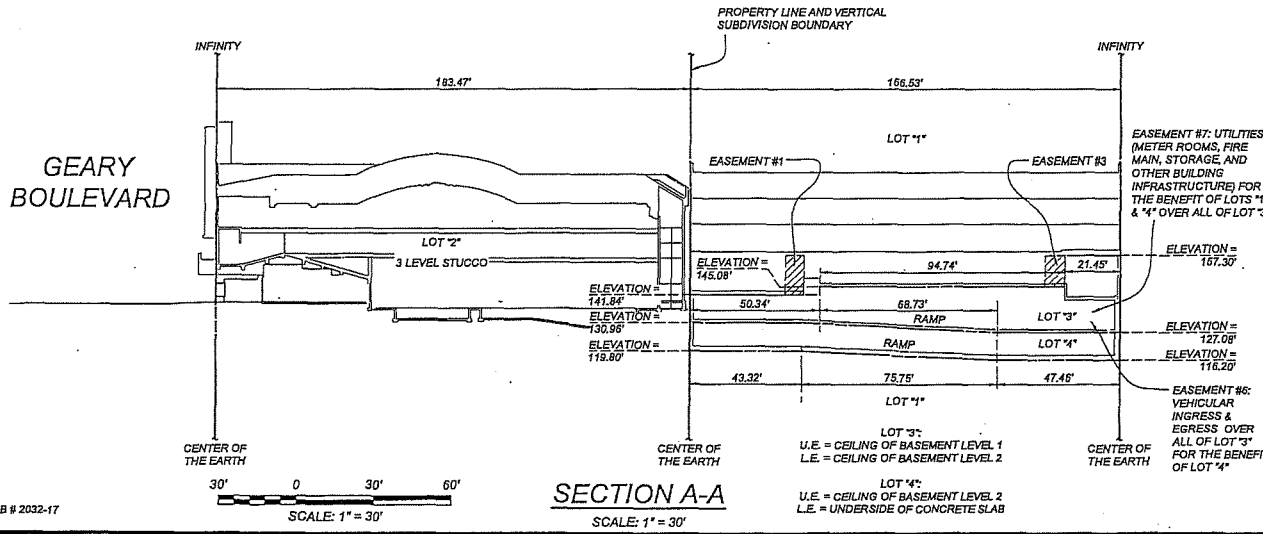
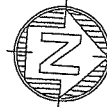

FINAL MAP NO. 9294
 BEING A 4 LOT VERTICAL SUBDIVISION,
 43 RESIDENTIAL UNIT, 5 COMMERCIAL UNIT,
 AND 43 PARKING SPACE CONDOMINIUM
 MIXED USE PROJECT

BEING A MERGER AND SUBDIVISION OF THAT CERTAIN REAL PROPERTY AS DESCRIBED IN THAT CERTAIN GRANT DEED RECORDED ON JUNE 16, 2015, DOCUMENT NUMBER 2015-K076322-00 OF OFFICIAL RECORDS, ON FILE IN THE OFFICE OF THE RECORDER OF THE CITY AND COUNTY OF SAN FRANCISCO, CALIFORNIA.

ALSO BEING A PART OF OUTSIDE LAND BLOCK NO. 199

CITY AND COUNTY OF SAN FRANCISCO
SCALE AS NOTED

CALIFORNIA
APRIL, 2018



Frederick T. Seher & Associates, Inc.
 PROFESSIONAL LAND SURVEYORS
 841 LOMBARD STREET, SAN FRANCISCO, CA 94133
 PHONE (415) 921-7690 FAX (415) 921-7655

3709

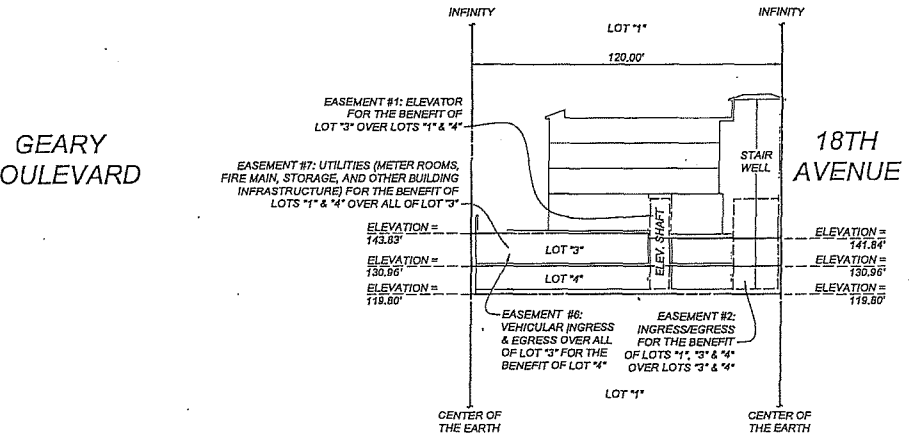
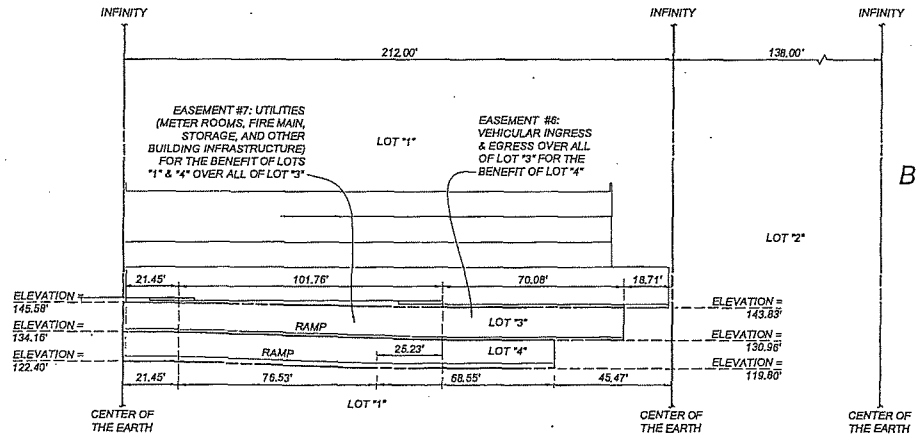

LINETYPES:

———— PROPERTY LINE
- - - - - CHANGE IN LOWER ELEVATION (L.E.)
- - - - - CHANGE IN UPPER ELEVATION (U.E.)
////// EASEMENT

LOT "3*"
U.E. = CEILING OF BASEMENT LEVEL 1
L.E. = CEILING OF BASEMENT LEVEL 2

LOT "4*"
U.E. = CEILING OF BASEMENT LEVEL 2
L.E. = UNDERSIDE OF CONCRETE SLAB

PROJECT BENCHMARK - DESCRIPTION:

ELEVATIONS HEREON WERE OBTAINED FROM A GROUP OF CITY BENCHMARKS, LOCATED AT THE INTERSECTION OF GEARY BOULEVARD AND 20TH AVENUE. ELEVATIONS ARE BASED ON CITY AND COUNTY OF SAN FRANCISCO "OLD CITY DATUM", C.C. 33' W, + CUT CONC CURB AT ISLAND. ELEVATION = 135.425'

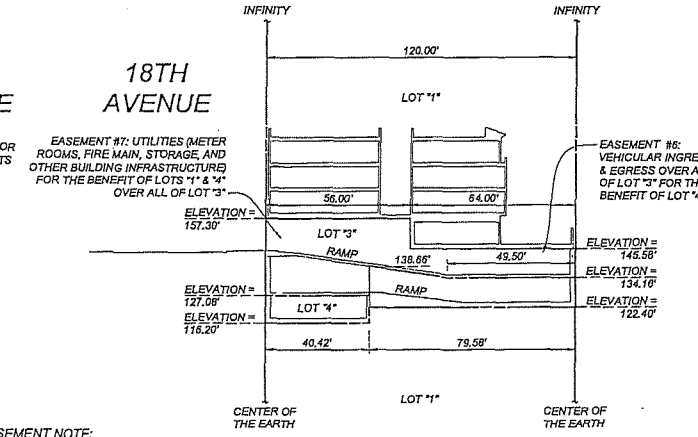
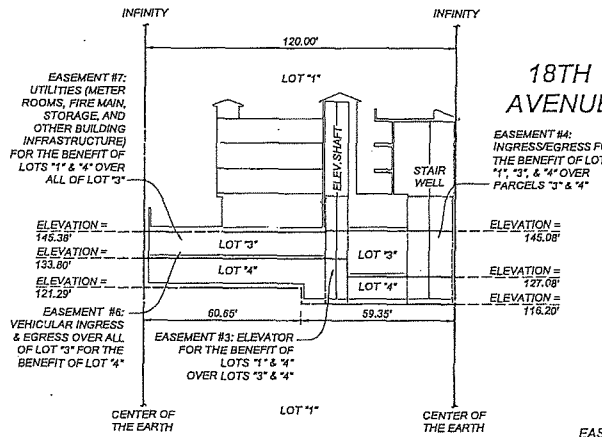

EASEMENT NOTE:

EASEMENTS #1 THRU #7, FOR INGRESS/EGRESS, VEHICULAR INGRESS/EGRESS, ELEVATORS, UTILITIES, AND BICYCLE PARKING, AS DELINEATED AND SHOWN HEREON, SHALL BE CREATED IN DECLARATION ESTABLISHING RECIPROCAL EASEMENTS, COVENANTS AND RESTRICTIONS RUNNING WITH THE LAND AND PROVIDING FOR JOINT MAINTENANCE OF 369 18TH AVENUE/5400 GEARY BOULEVARD TO BE RECORDED BY SEPARATE INSTRUMENT.

FINAL MAP NO. 9294
BEING A 4 LOT VERTICAL SUBDIVISION,
43 RESIDENTIAL UNIT, 5 COMMERCIAL UNIT,
AND 43 PARKING SPACE CONDOMINIUM
MIXED USE PROJECT

BEING A MERGER AND SUBDIVISION OF THAT CERTAIN REAL PROPERTY AS DESCRIBED IN THAT CERTAIN GRANT DEED RECORDED ON JUNE 16, 2015, DOCUMENT NUMBER 2015-K078322-00 OF OFFICIAL RECORDS, ON FILE IN THE OFFICE OF THE RECORDER OF THE CITY AND COUNTY OF SAN FRANCISCO, CALIFORNIA.

ALSO BEING A PART OF OUTSIDE LAND BLOCK NO. 199
CITY AND COUNTY OF SAN FRANCISCO
SCALE AS NOTED
CALIFORNIA
APRIL, 2018



Frederick T. Seher & Associates, Inc.
PROFESSIONAL LAND SURVEYORS
841 LOMBARD STREET, SAN FRANCISCO, CA 94133
PHONE (415) 921-7690 FAX (415) 921-7655

SHEET SEVEN OF EIGHT SHEETS

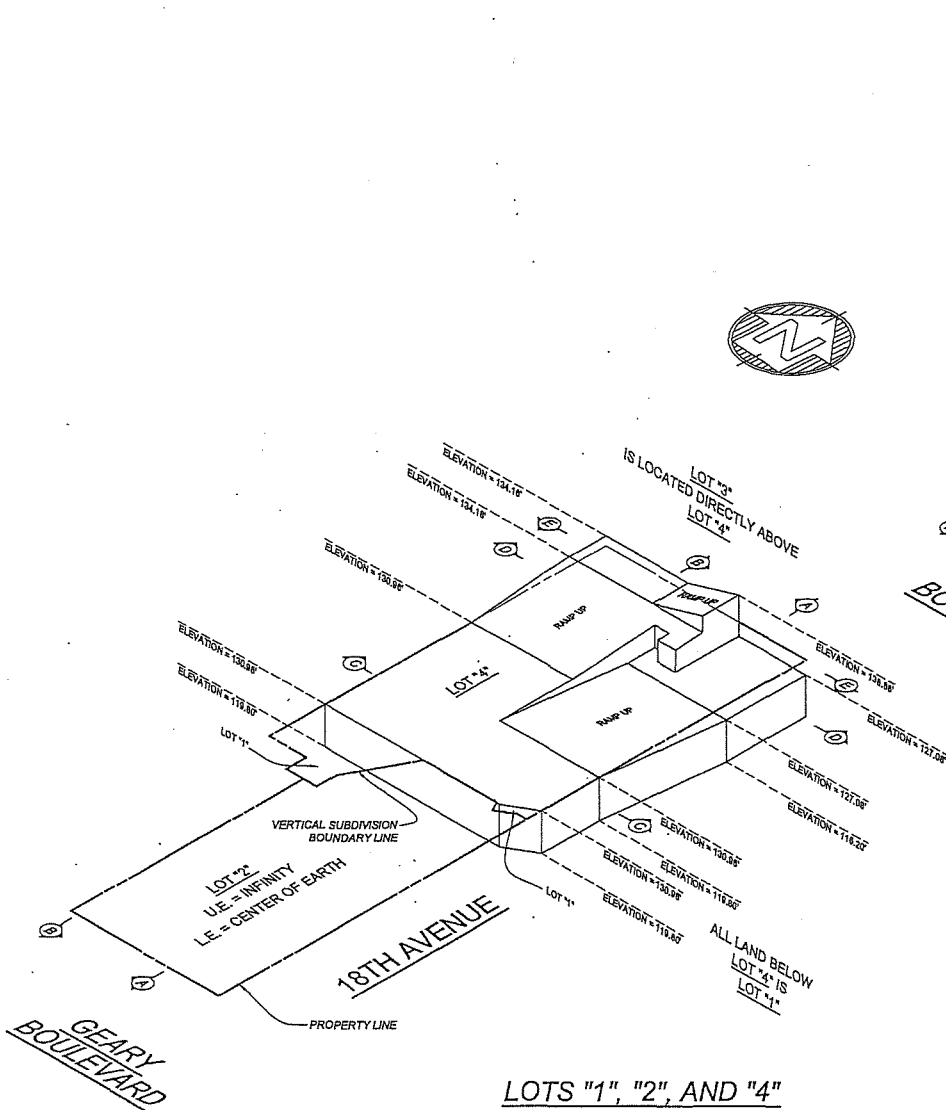

LOTS "1", "2", AND "4"
ISOMETRIC VIEW

HORIZONTAL SCALE: 1" = 40'
VERTICAL SCALE: 1" = 80'

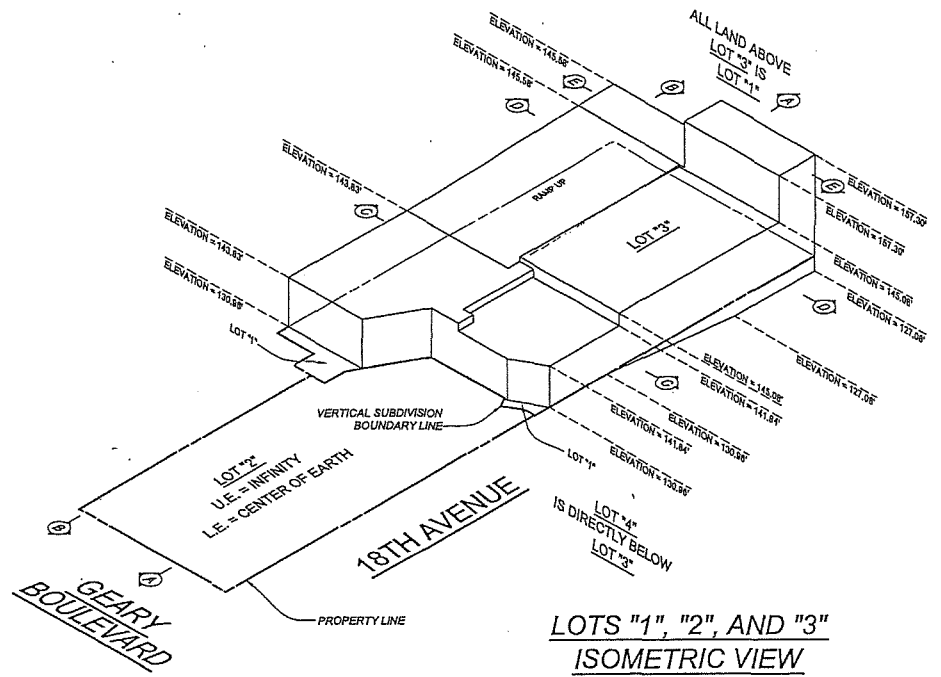

LOTS "1", "2", AND "3"
ISOMETRIC VIEW

HORIZONTAL SCALE: 1" = 40'
VERTICAL SCALE: 1" = 80'

LOT "1":
U.E. = CEILING OF BASEMENT LEVEL 1
L.E. = CEILING OF BASEMENT LEVEL 2

LOT "4":
U.E. = CEILING OF BASEMENT LEVEL 2
L.E. = UNDERSIDE OF CONCRETE SLAB

PROJECT BENCHMARK - DESCRIPTION:

ELEVATIONS HEREON WERE OBTAINED FROM A GROUP OF CITY BENCHMARKS, LOCATED AT THE INTERSECTION OF GEARY BOULEVARD AND 20TH AVENUE. ELEVATIONS ARE BASED ON CITY AND COUNTY OF SAN FRANCISCO "OLD CITY DATUM", C.C. 33' W, + CUT CONC CURB AT ISLAND. ELEVATION = 135.425'

FINAL MAP NO. 9294
BEING A 4 LOT VERTICAL SUBDIVISION,
43 RESIDENTIAL UNIT, 5 COMMERCIAL UNIT,
AND 43 PARKING SPACE CONDOMINIUM
MIXED USE PROJECT

BEING A MERGER AND SUBDIVISION OF THAT CERTAIN REAL PROPERTY AS DESCRIBED IN THAT CERTAIN GRANT DEED RECORDED ON JUNE 16, 2015, DOCUMENT NUMBER 2015-K076322-00 OF OFFICIAL RECORDS, ON FILE IN THE OFFICE OF THE RECORDER OF THE CITY AND COUNTY OF SAN FRANCISCO, CALIFORNIA.

ALSO BEING A PART OF OUTSIDE LAND BLOCK NO. 199

CITY AND COUNTY OF SAN FRANCISCO
SCALE AS NOTED

CALIFORNIA
APRIL, 2018



Frederick T. Seher & Associates, Inc.
PROFESSIONAL LAND SURVEYORS
841 LOMBARD STREET, SAN FRANCISCO, CA 94133
PHONE (415) 921-7890 FAX (415) 921-7855

SHEET EIGHT OF EIGHT SHEETS

APN: 1450-008 369 18TH AVENUE