

File No. 191066

Committee Item No. 4

Board Item No. 18

COMMITTEE/BOARD OF SUPERVISORS

AGENDA PACKET CONTENTS LIST

Committee: Government Audit and Oversight

Date: Nov. 21, 2019

Board of Supervisors Meeting:

Date: Dec. 10, 2019

Cmte Board

- | | | |
|-------------------------------------|-------------------------------------|--|
| <input type="checkbox"/> | <input type="checkbox"/> | Motion |
| <input checked="" type="checkbox"/> | <input checked="" type="checkbox"/> | Resolution |
| <input type="checkbox"/> | <input type="checkbox"/> | Ordinance |
| <input type="checkbox"/> | <input type="checkbox"/> | Legislative Digest |
| <input type="checkbox"/> | <input type="checkbox"/> | Budget and Legislative Analyst Report |
| <input type="checkbox"/> | <input type="checkbox"/> | Youth Commission Report |
| <input type="checkbox"/> | <input type="checkbox"/> | Introduction Form |
| <input type="checkbox"/> | <input type="checkbox"/> | Department/Agency Cover Letter and/or Report |
| <input type="checkbox"/> | <input type="checkbox"/> | MOU |
| <input type="checkbox"/> | <input type="checkbox"/> | Grant Information Form |
| <input type="checkbox"/> | <input type="checkbox"/> | Grant Budget |
| <input type="checkbox"/> | <input type="checkbox"/> | Subcontract Budget |
| <input checked="" type="checkbox"/> | <input checked="" type="checkbox"/> | DRAFT Mills Act Agreement |
| <input type="checkbox"/> | <input type="checkbox"/> | Form 126 – Ethics Commission |
| <input type="checkbox"/> | <input type="checkbox"/> | Award Letter |
| <input checked="" type="checkbox"/> | <input checked="" type="checkbox"/> | Mills Act Application Docs |
| <input type="checkbox"/> | <input type="checkbox"/> | Public Correspondence |

OTHER

- | | | |
|-------------------------------------|-------------------------------------|---|
| <input type="checkbox"/> | <input checked="" type="checkbox"/> | <u>Planning Presentation – November 21, 2019</u> |
| <input checked="" type="checkbox"/> | <input checked="" type="checkbox"/> | <u>Planning Case Report – October 2, 2019</u> |
| <input checked="" type="checkbox"/> | <input checked="" type="checkbox"/> | <u>HPC Reso No. 1092 – October 2, 2019</u> |
| <input checked="" type="checkbox"/> | <input checked="" type="checkbox"/> | <u>Assessor's Mills Act Valuation</u> |
| <input checked="" type="checkbox"/> | <input checked="" type="checkbox"/> | <u>Assessor's Updated Estimated Tax Savings Chart</u> |
| <input checked="" type="checkbox"/> | <input checked="" type="checkbox"/> | <u>Transmittal Letter – October 15, 2019</u> |

Prepared by: John Carroll

Date: Nov. 15, 2019

Prepared by: John Carroll

Date: Nov. 21, 2019

1 [Mills Act Historical Property Contract - 64 Potomac Street]
2

3 **Resolution approving an historical property contract between Gustav Lindqvist &**
4 **Caroline Ingeborn, the owners of 64 Potomac Street, and the City and County of San**
5 **Francisco, under Administrative Code, Chapter 71; and authorizing the Planning**
6 **Director and the Assessor-Recorder to execute and record the historical property**
7 **contract.**
8

9 WHEREAS, The California Mills Act (Government Code, Sections 50280 et seq.)
10 authorizes local governments to enter into a contract with the owners of a qualified historical
11 property who agree to rehabilitate, restore, preserve, and maintain the property in return for
12 property tax reductions under the California Revenue and Taxation Code; and

13 WHEREAS, The Planning Department has determined that the actions contemplated in
14 this Resolution comply with the California Environmental Quality Act (California Public
15 Resources Code, Sections 21000 et seq.); and

16 WHEREAS, Said determination is on file with the Clerk of the Board of Supervisors in
17 File No. 191066, is incorporated herein by reference, and the Board herein affirms it; and

18 WHEREAS, San Francisco contains many historic buildings that add to its character
19 and international reputation and that have not been adequately maintained, may be
20 structurally deficient, or may need rehabilitation, and the costs of properly rehabilitating,
21 restoring; and preserving these historic buildings may be prohibitive for property owners; and

22 WHEREAS, Administrative Code, Chapter 71 was adopted to implement the provisions
23 of the Mills Act and to preserve these historic buildings; and
24
25

1 WHEREAS, 64 Potomac Street is designated as a Contributor to the Duboce Park
2 Historic District and thus qualifies as an historical property as defined in Administrative Code,
3 Section 71.2; and

4 WHEREAS, A Mills Act application for an historical property contract has been
5 submitted by Gustav Lindqvist & Caroline Ingeborn, the owners of 64 Potomac Street,
6 detailing rehabilitation work and proposing a maintenance plan for the property; and

7 WHEREAS, As required by Administrative Code, Section 71.4(a), the application for
8 the historical property contract for 64 Potomac Street was reviewed by the Assessor's Office
9 and the Historic Preservation Commission; and

10 WHEREAS, The Assessor-Recorder has reviewed the historical property contract and
11 has provided the Board of Supervisors with an estimate of the property tax calculations and
12 the difference in property tax assessments under the different valuation methods permitted by
13 the Mills Act in its report transmitted to the Board of Supervisors on October 15, 2019, which
14 report is on file with the Clerk of the Board of Supervisors in File No. 191066 and is hereby
15 declared to be a part of this Resolution as if set forth fully herein; and

16 WHEREAS, The Historic Preservation Commission recommended approval of the
17 historical property contract in its Resolution No. 1092, including approval of the Rehabilitation
18 Program and Maintenance Plan, attached to said Resolution, which is on file with the Clerk of
19 the Board of Supervisors in File No. 191066 and is hereby declared to be a part of this
20 Resolution as if set forth fully herein; and

21 WHEREAS, The draft historical property contract between Gustav Lindqvist & Caroline
22 Ingeborn, the owners of 64 Potomac Street, and the City and County of San Francisco is on
23 file with the Clerk of the Board of Supervisors in File No. 191066 and is hereby declared to be
24 a part of this Resolution as if set forth fully herein; and

1 WHEREAS, The Board of Supervisors has conducted a public hearing pursuant to
2 Administrative Code, Section 71.4(d) to review the Historic Preservation Commission's
3 recommendation and the information provided by the Assessor's Office in order to determine
4 whether the City should execute the historical property contract for 64 Potomac Street; and

5 WHEREAS, The Board of Supervisors has balanced the benefits of the Mills Act to the
6 owner of 64 Potomac Street with the cost to the City of providing the property tax reductions
7 authorized by the Mills Act, as well as the historical value of 64 Potomac Street and the
8 resultant property tax reductions, and has determined that it is in the public interest to enter
9 into a historical property contract with the applicants; now, therefore, be it

10 RESOLVED, That the Board of Supervisors hereby approves the historical property
11 contract between Gustav Lindqvist & Caroline Ingeborn, the owners of 64 Potomac Street,
12 and the City and County of San Francisco; and, be it

13 FURTHER RESOLVED, That the Board of Supervisors hereby authorizes the Planning
14 Director and the Assessor-Recorder to execute the historical property contract and record the
15 historical property contract.

2019 Mills Act Contracts

Government Audit and Oversight Committee Review

November 21, 2019



**SAN FRANCISCO
PLANNING DEPARTMENT**

What is the Mills Act?

- California's leading financial incentive program for historic preservation since 1972.
- Contract between the City and property owner that allows for a potential reduction in property taxes.
- Tax savings will be used to offset cost of rehabilitation, restoration, and maintenance work in conformance with the Secretary's Standards.
- Only local financial incentive program for restoring, rehabilitating, and maintaining eligible properties to promote appreciation of the City's architecture, history, and culture.



Active Mills Act Contracts

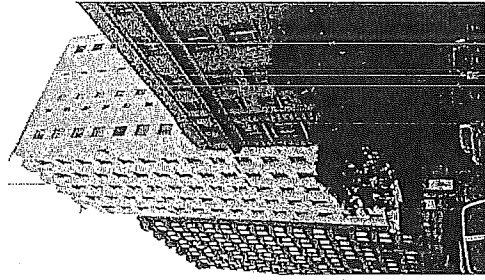
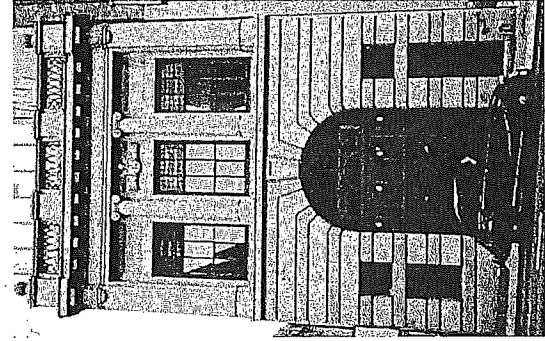
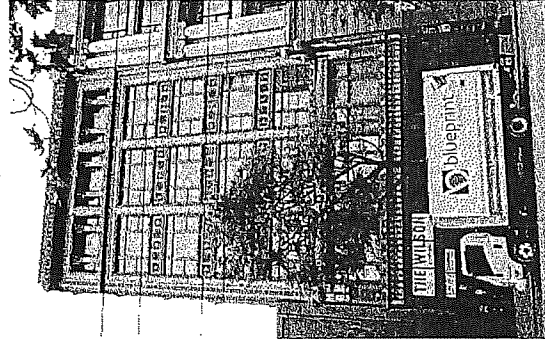
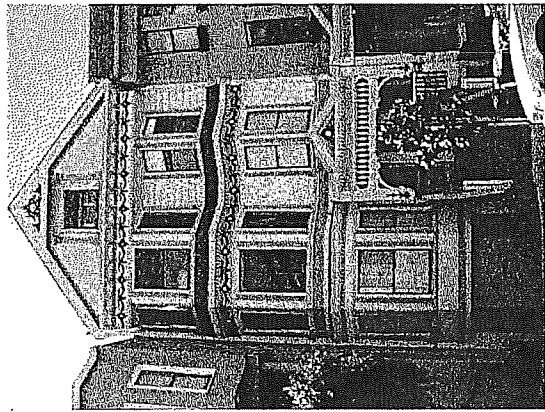
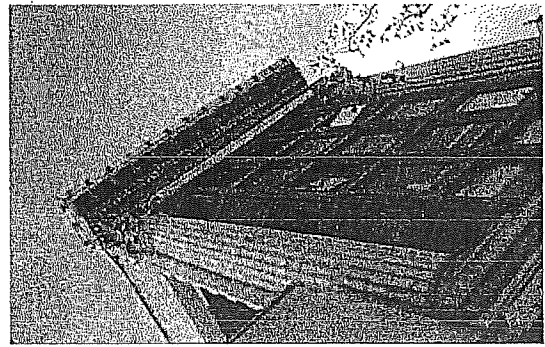
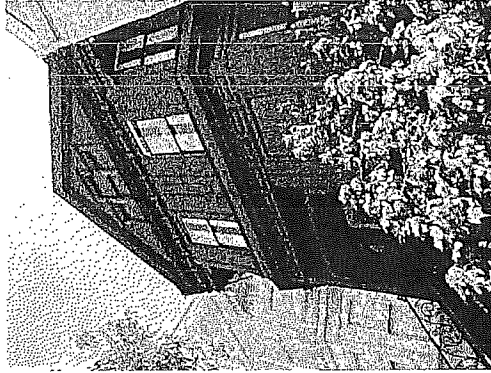
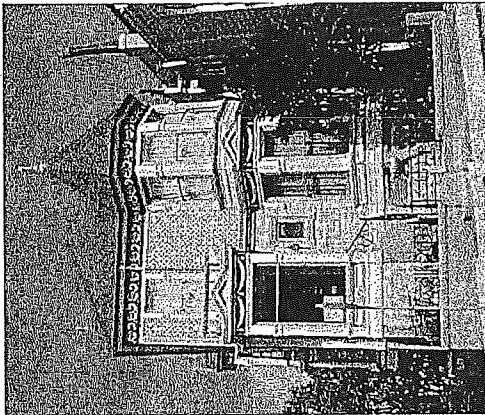
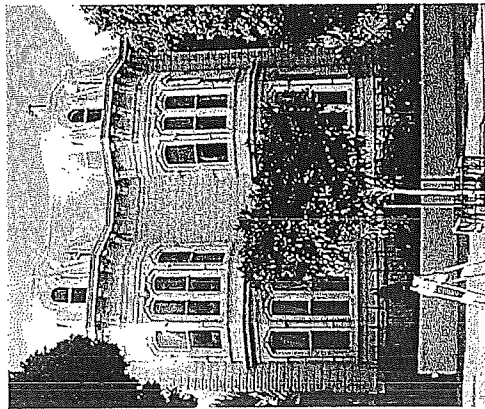

2251 Webster Street (built c. 1900)
Contributor to Webster Street Historic District
District 2

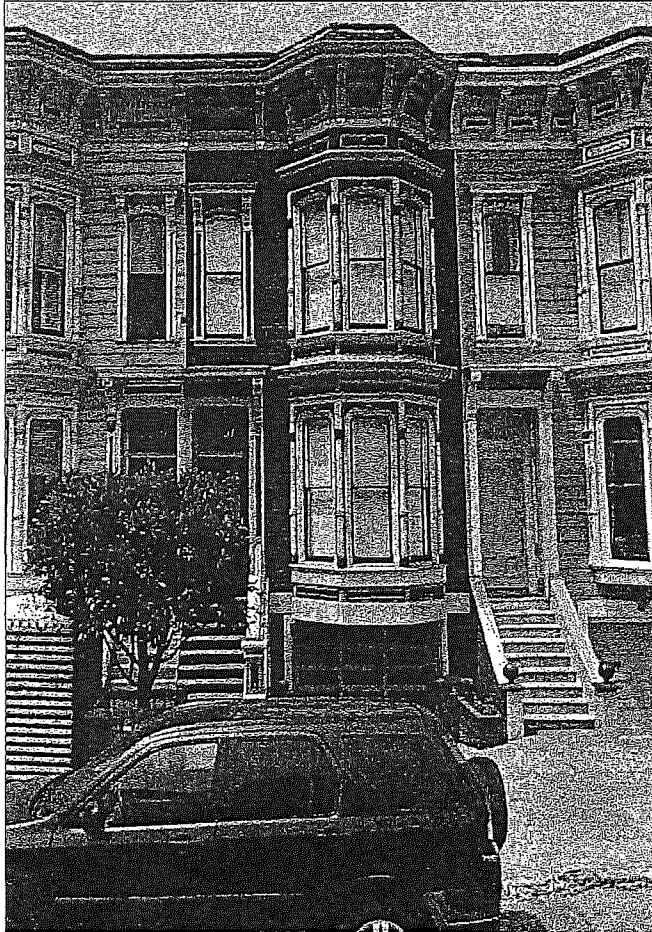

- Estimated Property Tax Savings of \$14,184 (a 66.37%% reduction from factored base year value)
- Rehabilitation work is estimated to cost \$113,610 over ten years
- Maintenance work is estimated to cost \$2,880 annually



1401 Howard Street (built 1913)
Landmark No. 120, Saint Joseph's Church
District 6



- Estimated Property Tax Savings of \$66,974 (a 31.20% reduction from factored base year value)
- Rehabilitation work is estimated to cost \$291,065 over ten years
- Maintenance work is estimated to cost \$31,040 annually



64 Potomac Street (built 1899)
Duboce Park Historic District
District 8



- Estimated Property Tax Savings of \$22,679 (a 76.47% reduction from factored base year value)
- Rehabilitation work is estimated to cost \$126,035 over ten years
- Maintenance work is estimated to cost \$4,000 annually



2168 Market Street (built 1907)
Landmark No. 267, Swedish American Hall Building
District 8

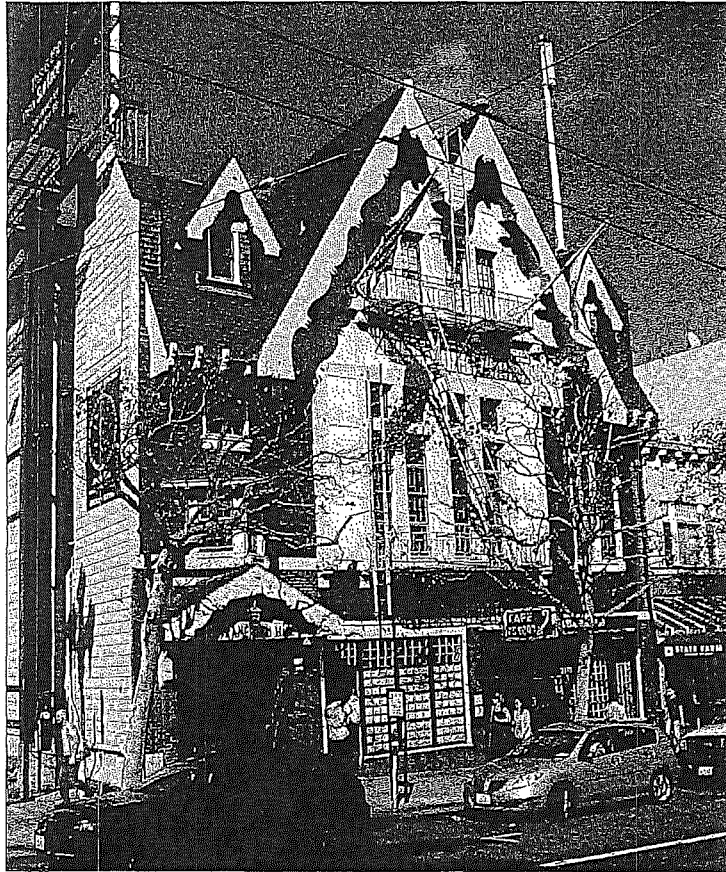

- Estimated Property Tax Savings of \$0 (a 0.00% reduction from factored base year value)
- Rehabilitation work is estimated to cost \$95,160 over ten years
- Maintenance work is estimated to cost \$7,500 annually

1413



2731-2735 Folsom Street (built 1900)
Landmark No. 276, Gaughran House



- Estimated Property Tax Savings of \$35,495 (a 49.46% reduction from factored base year value)
- Rehabilitation work is estimated to cost \$305,573 over ten years
- Maintenance work is estimated to cost \$5,148 annually



Recording Requested by, and
when recorded, send notice to:
Shannon Ferguson
1650 Mission Street, Suite 400
San Francisco, CA 94103-2414

CALIFORNIA MILLS ACT HISTORIC PROPERTY AGREEMENT

THIS AGREEMENT is entered into by and between the City and County of San Francisco, a California municipal corporation ("City") and Gustav Lindqvist & Caroline Ingeborn ("Owners").

RECITALS

Owners are the owners of the property located at 64 Potomac Street, in San Francisco, California (Block 0866, Lot 014). The building located at 64 Potomac Street is designated as a contributor to the Duboce Park Historic District pursuant to Article 10 of the Planning Code, and is also known as the "Historic Property". The Historic Property is a Qualified Historic Property, as defined under California Government Code Section 50280.1.

Owners desire to execute a rehabilitation and ongoing maintenance project for the Historic Property. Owners' application calls for the rehabilitation and restoration of the Historic Property according to established preservation standards, which it estimates will cost one hundred thirty four thousand and forty six dollars (\$134,046.00). (See Rehabilitation Plan, Exhibit A.) Owners' application calls for the maintenance of the Historic Property according to established preservation standards, which is estimated will cost approximately four thousand dollars (\$4,000.00) annually (See Maintenance Plan, Exhibit B).

The State of California has adopted the "Mills Act" (California Government Code Sections 50280-50290, and California Revenue & Taxation Code, Article 1.9 [Section 439 et seq.]) authorizing local governments to enter into agreements with property Owners to reduce their property taxes, or to prevent increases in their property taxes, in return for improvement to and maintenance of historic properties. The City has adopted enabling legislation, San Francisco Administrative Code Chapter 71, authorizing it to participate in the Mills Act program.

Owners desire to enter into a Mills Act Agreement (also referred to as a "Historic Property Agreement") with the City to help mitigate anticipated expenditures to restore and maintain the Historic Property. The City is willing to enter into such Agreement to mitigate these expenditures and to induce Owners to restore and maintain the Historic Property in excellent condition in the future.

NOW, THEREFORE, in consideration of the mutual obligations, covenants, and conditions contained herein, the parties hereto do agree as follows:

1. Application of Mills Act. The benefits, privileges, restrictions and obligations provided for in the Mills Act shall be applied to the Historic Property during the time that this Agreement is in effect commencing from the date of recordation of this Agreement.

2. Rehabilitation of the Historic Property. Owners shall undertake and complete the work set forth in Exhibit A ("Rehabilitation Plan") attached hereto according to certain standards and requirements. Such standards and requirements shall include, but not be limited to: the Secretary of the Interior's Standards for the Treatment of Historic Properties ("Secretary's Standards"); the rules and regulations of the Office of Historic Preservation of the California Department of Parks and Recreation ("OHP Rules and Regulations"); the State Historical Building Code as determined applicable by the City; all applicable building safety standards; and the requirements of the Historic Preservation Commission, the Planning Commission, and the Board of Supervisors, including but not limited to any Certificates of Appropriateness approved under Planning Code Article 10. The Owners shall proceed diligently in applying for any necessary permits for the work and shall apply for such permits within no more than six (6) months after recordation of this Agreement, shall commence the work within six (6) months of receipt of necessary permits, and shall complete the work within three (3) years from the date of receipt of permits. Upon written request by the Owners, the Zoning Administrator, at his or her discretion, may grant an extension of the time periods set forth in this paragraph. Owners may apply for an extension by a letter to the Zoning Administrator, and the Zoning Administrator may grant the extension by letter without a hearing. Work shall be deemed complete when the Director of Planning determines that the Historic Property has been rehabilitated in accordance with the standards set forth in this Paragraph. Failure to timely complete the work shall result in cancellation of this Agreement as set forth in Paragraphs 12 and 13 herein.

3. Maintenance. Owners shall maintain the Historic Property during the time this Agreement is in effect in accordance with the standards for maintenance set forth in Exhibit B ("Maintenance Plan"), the Secretary's Standards; the OHP Rules and Regulations; the State Historical Building Code as determined applicable by the City; all applicable building safety standards; and the requirements of the Historic Preservation Commission, the Planning Commission, and the Board of Supervisors, including but not limited to any Certificates of Appropriateness approved under Planning Code Article 10.

4. Damage. Should the Historic Property incur damage from any cause whatsoever, which damages fifty percent (50%) or less of the Historic Property, Owners shall replace and repair the damaged area(s) of the Historic Property. For repairs that do not require a permit, Owners shall commence the repair work within thirty (30) days of incurring the damage and shall diligently prosecute the repair to completion within a reasonable period of time, as determined by the City. Where specialized services are required due to the nature of the work and the historic character of the features damaged, "commence the repair work" within the meaning of this paragraph may include contracting for repair services. For repairs that require a permit(s), Owners shall proceed diligently in applying for any necessary permits for the work and shall apply for such permits within no more than sixty (60) days after the damage has been incurred, commence the repair work within one hundred twenty (120) days of receipt of the required permit(s), and shall diligently prosecute the repair to completion within a reasonable period of time, as determined by the City. Upon written request by the Owners, the Zoning Administrator, at his or her discretion, may grant an extension of the time periods set forth in this paragraph. Owners may apply for an extension by a letter to the Zoning Administrator, and the Zoning Administrator may grant the extension by letter without a hearing. All repair work shall comply with the design and standards established for the Historic Property in Exhibits A and B attached hereto and Paragraph 3 herein. In the case of damage to twenty percent (20%) or more of the Historic Property due to a catastrophic event, such as an earthquake, or in the case of damage from any cause whatsoever that destroys more than fifty percent (50%) of the Historic Property, the City and Owners may mutually agree to terminate this Agreement. Upon such termination, Owners shall not be obligated to pay the cancellation fee set forth in Paragraph 13 of this Agreement. Upon such termination, the City shall assess the full value of the Historic Property without regard to any restriction imposed upon the Historic Property by this Agreement and Owners shall

pay property taxes to the City based upon the valuation of the Historic Property as of the date of termination.

5. Insurance. Owners shall secure adequate property insurance to meet Owners' repair and replacement obligations under this Agreement and shall submit evidence of such insurance to the City upon request.

6. Inspections and Compliance Monitoring. Prior to entering into this Agreement and every five years thereafter, and upon seventy-two (72) hours advance notice, Owners shall permit any representative of the City, the Office of Historic Preservation of the California Department of Parks and Recreation, or the State Board of Equalization, to inspect of the interior and exterior of the Historic Property, to determine Owners' compliance with this Agreement. Throughout the duration of this Agreement, Owners shall provide all reasonable information and documentation about the Historic Property demonstrating compliance with this Agreement, as requested by any of the above-referenced representatives.

7. Term. This Agreement shall be effective upon the date of its recordation and shall be in effect for a term of ten years from such date ("Term"). As provided in Government Code section 50282, one year shall be added automatically to the Term, on each anniversary date of this Agreement, unless notice of nonrenewal is given as set forth in Paragraph 9 herein.

8. Valuation. Pursuant to Section 439.4 of the California Revenue and Taxation Code, as amended from time to time, this Agreement must have been signed, accepted and recorded on or before the lien date (January 1) for a fiscal year (the following July 1-June 30) for the Historic Property to be valued under the taxation provisions of the Mills Act for that fiscal year.

9. Notice of Nonrenewal. If in any year of this Agreement either the Owners or the City desire not to renew this Agreement, that party shall serve written notice on the other party in advance of the annual renewal date. Unless the Owners serves written notice to the City at least ninety (90) days prior to the date of renewal or the City serves written notice to the Owners sixty (60) days prior to the date of renewal, one year shall be automatically added to the Term of the Agreement. The Board of Supervisors shall make the City's determination that this Agreement shall not be renewed and shall send a notice of nonrenewal to the Owners. Upon receipt by the Owners of a notice of nonrenewal from the City, Owners may make a written protest. At any time prior to the renewal date, City may withdraw its notice of nonrenewal. If either party serves notice of nonrenewal of this Agreement, this Agreement shall remain in effect for the balance of the period remaining since the original execution or the last renewal of the Agreement, as the case may be. Thereafter, the Owners shall pay property taxes to the City without regard to any restriction imposed on the Historic Property by this Agreement, and based upon the Assessor's determination of the fair market value of the Historic Property as of expiration of this Agreement.

10. Payment of Fees. As provided for in Government Code Section 50281.1 and San Francisco Administrative Code Section 71.6, upon filing an application to enter into a Mills Act Agreement with the City, Owners shall pay the City the reasonable costs related to the preparation and approval of the Agreement. In addition, Owners shall pay the City for the actual costs of inspecting the Historic Property, as set forth in Paragraph 6 herein.

11. Default. An event of default under this Agreement may be any one of the following:

(a) Owners' failure to timely complete the rehabilitation work set forth in Exhibit A, in accordance with the standards set forth in Paragraph 2 herein;

(b) Owners' failure to maintain the Historic Property as set forth in Exhibit B, in accordance with the requirements of Paragraph 3 herein;

- (c) Owners' failure to repair any damage to the Historic Property in a timely manner, as provided in Paragraph 4 herein;
- (d) Owners' failure to allow any inspections or requests for information, as provided in Paragraph 6 herein;
- (e) Owners' failure to pay any fees requested by the City as provided in Paragraph 10 herein;
- (f) Owners' failure to maintain adequate insurance for the replacement cost of the Historic Property, as required by Paragraph 5 herein; or
- (g) Owners' failure to comply with any other provision of this Agreement.

An event of default shall result in Cancellation of this Agreement as set forth in Paragraphs 12 and 13 herein, and payment of the Cancellation Fee and all property taxes due upon the Assessor's determination of the full value of the Historic Property as set forth in Paragraph 13 herein. In order to determine whether an event of default has occurred, the Board of Supervisors shall conduct a public hearing as set forth in Paragraph 12 herein prior to cancellation of this Agreement.

12. Cancellation. As provided for in Government Code Section 50284, City may initiate proceedings to cancel this Agreement if it makes a reasonable determination that Owners have breached any condition or covenant contained in this Agreement, has defaulted as provided in Paragraph 11 herein, or has allowed the Historic Property to deteriorate such that the safety and integrity of the Historic Property is threatened or it would no longer meet the standards for a Qualified Historic Property. In order to cancel this Agreement, City shall provide notice to the Owners and to the public and conduct a public hearing before the Board of Supervisors as provided for in Government Code Section 50285. The Board of Supervisors shall determine whether this Agreement should be cancelled.

13. Cancellation Fee. If the City cancels this Agreement as set forth in Paragraph 12 above, and as required by Government Code Section 50286, Owners shall pay a Cancellation Fee of twelve and one-half percent (12.5%) of the fair market value of the Historic Property at the time of cancellation. The City Assessor shall determine fair market value of the Historic Property without regard to any restriction imposed on the Historic Property by this Agreement. The Cancellation Fee shall be paid to the City Tax Collector at such time and in such manner as the City shall prescribe. As of the date of cancellation, the Owners shall pay property taxes to the City without regard to any restriction imposed on the Historic Property by this Agreement and based upon the Assessor's determination of the fair market value of the Historic Property as of the date of cancellation.

14. Enforcement of Agreement. In lieu of the above provision to cancel the Agreement, the City may bring an action to specifically enforce or to enjoin any breach of any condition or covenant of this Agreement. Should the City determine that the Owners has breached this Agreement, the City shall give the Owners written notice by registered or certified mail setting forth the grounds for the breach. If the Owners do not correct the breach, or do not undertake and diligently pursue corrective action to the reasonable satisfaction of the City within thirty (30) days from the date of receipt of the notice, then the City may, without further notice, initiate default procedures under this Agreement as set forth in Paragraph 12 and bring any action necessary to enforce the obligations of the Owners set forth in this Agreement. The City does not waive any claim of default by the Owners if it does not enforce or cancel this Agreement.

15. Indemnification. The Owners shall indemnify, defend, and hold harmless the City and all of its boards, commissions, departments, agencies, agents and employees (individually and collectively, the "City") from and against any and all liabilities, losses, costs, claims, judgments, settlements, damages, liens, fines, penalties and expenses incurred in connection with or arising in whole or in part from: (a) any accident, injury to or death of a person, loss of or damage to

property occurring in or about the Historic Property; (b) the use or occupancy of the Historic Property by the Owners, their Agents or Invitees; (c) the condition of the Historic Property; (d) any construction or other work undertaken by Owners on the Historic Property; or (e) any claims by unit or interval Owners for property tax reductions in excess those provided for under this Agreement. This indemnification shall include, without limitation, reasonable fees for attorneys, consultants, and experts and related costs that may be incurred by the City and all indemnified parties specified in this Paragraph and the City's cost of investigating any claim. In addition to Owners' obligation to indemnify City, Owners specifically acknowledge and agree that they have an immediate and independent obligation to defend City from any claim that actually or potentially falls within this indemnification provision, even if the allegations are or may be groundless, false, or fraudulent, which obligation arises at the time such claim is tendered to Owners by City, and continues at all times thereafter. The Owners' obligations under this Paragraph shall survive termination of this Agreement.

16. Eminent Domain. In the event that a public agency acquires the Historic Property in whole or part by eminent domain or other similar action, this Agreement shall be cancelled and no cancellation fee imposed as provided by Government Code Section 50288.

17. Binding on Successors and Assigns. The covenants, benefits, restrictions, and obligations contained in this Agreement shall run with the land and shall be binding upon and inure to the benefit of all successors in interest and assigns of the Owners. Successors in interest and assigns shall have the same rights and obligations under this Agreement as the original Owners who entered into the Agreement.

18. Legal Fees. In the event that either the City or the Owners fail to perform any of their obligations under this Agreement or in the event a dispute arises concerning the meaning or interpretation of any provision of this Agreement, the prevailing party may recover all costs and expenses incurred in enforcing or establishing its rights hereunder, including reasonable attorneys' fees, in addition to court costs and any other relief ordered by a court of competent jurisdiction. Reasonable attorneys' fees of the City's Office of the City Attorney shall be based on the fees regularly charged by private attorneys with the equivalent number of years of experience who practice in the City of San Francisco in law firms with approximately the same number of attorneys as employed by the Office of the City Attorney.

19. Governing Law. This Agreement shall be construed and enforced in accordance with the laws of the State of California.

20. Recordation. Within 20 days from the date of execution of this Agreement, the parties shall cause this Agreement to be recorded with the Office of the Recorder of the City and County of San Francisco. From and after the time of the recordation, this recorded Agreement shall impart notice to all persons of the parties' rights and obligations under the Agreement, as is afforded by the recording laws of this state.

21. Amendments. This Agreement may be amended in whole or in part only by a written recorded instrument executed by the parties hereto in the same manner as this Agreement.

22. No Implied Waiver. No failure by the City to insist on the strict performance of any obligation of the Owners under this Agreement or to exercise any right, power, or remedy arising out of a breach hereof shall constitute a waiver of such breach or of the City's right to demand strict compliance with any terms of this Agreement.

23. Authority. If the Owners sign as a corporation or a partnership, each of the persons executing this Agreement on behalf of the Owners does hereby covenant and warrant that such entity is a duly authorized and existing entity, that such entity has and is qualified to do business

in California, that the Owners have full right and authority to enter into this Agreement, and that each and all of the persons signing on behalf of the Owners are authorized to do so.

24. Severability. If any provision of this Agreement is determined to be invalid or unenforceable, the remainder of this Agreement shall not be affected thereby, and each other provision of this Agreement shall be valid and enforceable to the fullest extent permitted by law.

25. Tropical Hardwood Ban. The City urges companies not to import, purchase, obtain or use for any purpose, any tropical hardwood or tropical hardwood product.

26. Charter Provisions. This Agreement is governed by and subject to the provisions of the Charter of the City.

27. Signatures. This Agreement may be signed and dated in parts

IN WITNESS WHEREOF, the parties hereto have executed this Agreement as follows:

CITY AND COUNTY OF SAN FRANCISCO:

By: _____ DATE: _____
Carmen Chu, Assessor-Recorder

By: _____ DATE: _____
John Rahaim, Director of Planning

APPROVED AS TO FORM:
DENNIS J. HERRERA
CITY ATTORNEY

By: _____ DATE: _____
Andrea Ruiz-Esquide, Deputy City Attorney

OWNERS

By: _____ DATE: _____
Gustav Lindqvist, Owner

By: _____ DATE: _____
Caroline Ingeborn, Owner

OWNER(S) SIGNATURE(S) MUST BE NOTARIZED.
ATTACH PUBLIC NOTARY FORMS HERE.

Exhibit A: Rehabilitation/Restoration Plan for 64 Potomac Street

Scope: #1		Building Feature: Roofs	
Rehab/Restoration X	Maintenance	Completed	Proposed X
Contract year work completion: 2020			
Total Cost: \$15,500 (see line item 07.300 in Contractor's bid)			
<p>Description of work: The current roof is of medium status. We will engage a licensed roofing contractor to replace the current roof with new shingles. Installation of the new roof will avoid changing the roof configuration, or altering, removing or obscuring character-defining features of the building, including decorative elements in the gable ends, as well as eave trim and moldings. New gutters and down sprouts will be installed to be able to direct water away from the building.</p>			

Scope: #2		Building Feature: Exterior Walls	
Rehab/Restoration X	Maintenance	Completed	Proposed X
Contract year work completion: 2020			
Total Cost: \$33,000. (see line items 09.900 and items under section 07 with the exception of 07.300)			
<p>Description of work: We will repair wood siding at all elevations of the house as necessary and thereafter repaint the house in its entirety. Any repairs or replacements will avoid altering, removing or obscuring character-defining features of the building and all materials that are used will be made in kind e.g. wood for wood.</p>			

Scope: #3		Building Feature: Windows and doors	
Rehab/Restoration X	Maintenance	Completed	Proposed X
Contract year work completion: 2020			
Total Cost: \$7235			
<p>Description of work: All three of the exterior doors at the front of the house, including the garage door, need to be replaced. The design of the new doors will be replaced to match the historic character of the house.</p> <p>All of the windows facing the street in the house will be repaired and thus match with the historically appropriate character and function.</p> <p>\$3,385 for repairing windows. \$3,850 for new door. These estimates are based off of www.homeadvisor.com</p>			

Scope: #4		Building Feature: Front Stairs	
Rehab/Restoration X	Maintenance	Completed	Proposed X
Contract year work completion: 2020			
Total Cost: \$22,300. (see line item 06.300 in Contractor's bid)			
Description of work: Remove existing terrazzo finish at the exterior front stairs and restore stairs and handrails to original design and materials (wood) based on historic documents and neighboring houses.			

Scope: #5		Building Feature: Seismic Strengthening of Foundation	
Rehab/Restoration X	Maintenance	Completed	Proposed X
Contract year work completion: 2020			
Total Cost: \$48,000. (see line items 03.100 and 06.100 in Contractor's bid) + \$39,500 (see line items 2-5 under Additional Costs in Contractor extra costs)			
Description of work: Seismic strengthening of house foundation. The drain will be moved from inside the garage to a trench drain by the garage door in order prevent water from flowing into the garage and creating damage to the foundation over time.			

Exhibit B: Maintenance Plan for 64 Potomac Street

Scope: #1		Building Feature: Roof	
Rehab/Restoration	Maintenance <input checked="" type="checkbox"/>	Completed	Proposed <input checked="" type="checkbox"/>
Contract year work completion: Annually			
Total Cost: Average annual cost of \$500			
<p>Description of work: When the roof has been replaced we will perform our own inspections annually. We will ensure to keep gutters and downspouts clear from debris as well as remove any overhanging branches. We will broom sweep branch or leaf debris.</p> <p>In addition, we will have a licensed roofing contractor conduct periodic inspections approximately every 5 years to ensure that it remains in good condition. Any repairs or replacements needed as a consequence of these inspections will be performed.</p> <p>Both these routines, will be informed by the guidance outlined in the National Park Service's Preservation Brief 47: Maintaining the Exterior of Small and Medium Size Historic Buildings.</p>			

Scope: #2		Building Feature: Exterior Walls	
Rehab/Restoration	Maintenance <input checked="" type="checkbox"/>	Completed	Proposed <input checked="" type="checkbox"/>
Contract year work completion: Annually			
Total Cost: \$1,000 annually			
<p>Description of work: When the house has been repainted we will inspect the wooden elements of the exterior of the house annually and repaint as necessary. If any damage or deterioration is found, the extent and the nature of the damage will be assessed and addressed. Any repairs or replacements will avoid altering, removing or obscuring character-defining features of the building and all materials that are used will be made in kind e.g. wood for wood. This maintenance routine will be informed by the guidance outlined in the National Park Service's Preservation Brief 47: Maintaining the Exterior of Small and Medium Size Historic Buildings.</p>			

Scope: #3		Building Feature: Openings	
Rehab/Restoration	Maintenance <input checked="" type="checkbox"/>	Completed	Proposed <input checked="" type="checkbox"/>
Contract year work completion: Annually			
Total Cost: \$1,000 annually			
Description of work: We will inspect the exterior doors and windows annually. We will look for signs of moist and dry rot and confirm functionality. If any repair or replacement is found necessary this will be done in line with the house historic character and any materials used will be in kind. This maintenance routine will be informed by the guidance outlined in the National Park Service's Preservation Brief 47: Maintaining the Exterior of Small and Medium Size Historic Buildings.			

Scope: #4		Building Feature: Front stairs	
Rehab/Restoration	Maintenance <input checked="" type="checkbox"/>	Completed	Proposed <input checked="" type="checkbox"/>
Contract year work completion: Annually			
Total Cost: \$500 annually			
Description of work: We will maintain the front stairs on an ongoing basis keeping it free from dust, dirt and debris. We will perform our own annual inspections of the stairs and if needed make any repairs or replacements deemed necessary. Any repairs or replacements will avoid altering, removing or obscuring character-defining features of the building and all materials that are used will be made in kind. This maintenance routine will be informed by the guidance outlined in the National Park Service's Preservation Brief 47: Maintaining the Exterior of Small and Medium Size Historic Buildings.			

Scope: #5		Building Feature: Foundation and Perimeter Grades	
Rehab/Restoration	Maintenance <input checked="" type="checkbox"/>	Completed	Proposed <input checked="" type="checkbox"/>
Contract year work completion: Annually			
Total Cost: \$1,000 annually			
Description of work: The foundation will be inspected annually to check for signs of water or other damages. If any damages are identified these will be remediated immediately. All maintenance work will be informed by the guidance outlined in the National Park Service's Preservation Brief 47: Maintaining the Exterior of Small and Medium Size Historic Buildings.			



SAN FRANCISCO PLANNING DEPARTMENT

Mills Act Historical Property Contracts Case Report

1650 Mission St.
Suite 400
San Francisco,
CA 94103-2479

Reception:
415.558.6378

Fax:
415.558.6409

Planning
Information:
415.558.6377

Hearing Date: October 2, 2019
Staff Contact: Michelle Taylor – (415) 575-9197
Michelle Taylor@sfgov.org
Reviewed By: Elizabeth Gordon-Jonckheer – (415) 575-8728.
Elizabeth Gordon-Jonckheer @sfgov.org

a. *Filing Date:* May 1, 2019
Case No.: 2019-006323MLS
Project Address: 2251 Webster Street (District 2)
Landmark District: Contributor to the Webster Street Historic District
Zoning: RH-2 (Residential-House, Two-Family District)
Height & Bulk: 40-X
Block/Lot: 0612/001A
Applicant: Sally A. Sadosky Revocable Trust
2251 Webster Street
San Francisco, CA 94115

b. *Filing Date:* May 1, 2019
Case No.: 2019-006384MLS
Project Address: 1401 Howard Street (District 6)
Landmark No.: 120
Zoning: RCD – Regional Commercial District
Height and Bulk: 55/65-X
Block/Lot: 3517/035
Applicant: 1401 Howard LLC
1401 Howard Street
San Francisco, CA 94103

c. *Filing Date:* May 1, 2019
Case No.: 2019-006322MLS
Project Address: 64 Potomac Street (District 8)
Landmark District: Contributor to the Duboce Park Historic District
Zoning: RH-2 (Residential-House, Two-Family District)
Height and Bulk: 40-X
Block/Lot: 0866/014
Applicant: Gustav Lindquist & Caroline Ingeborn
64 Potomac Street
San Francisco, CA 94117

- d. *Filing Date:* May 1, 2019
Case No.: 2019-005831MLS
Project Address: 2168 Market Street (District 8)
Landmark No.: 267
Zoning: NCT – Upper Market Neighborhood Commercial Transit
Height and Bulk: 40/50-X
Block/Lot: 3542/062
Applicant: Swedish Society of San Francisco
2168 Market Street
San Francisco, CA 94114
- e. *Filing Date:* May 1, 2019
Case No.: 2019-006455MLS
Project Address: 2731-2735 Folsom Street (District 9)
Landmark No.: 276
Zoning: RH-2 – Residential-House, Two-Family
Height and Bulk: 40-X
Block/Lot: 3640/031
Applicant: Adele Feng
2733 Folsom Street
San Francisco, CA 94110

PROPERTY DESCRIPTIONS

- a. **2251 Webster Street:** The subject property is located on the west side of Webster Street between Washington and Clay streets, Assessor's Block 0612, Lot 001A. The subject property is located within a RH-2 (Residential-House, Two-Family District) zoning district and a 40-X Height and Bulk district. The subject property is a contributing building to the Webster Street Historic District. It is a two-story, plus basement, wood-frame, single-family dwelling designed in the Italianate style and built in circa 1900.
- b. **1401 Howard Street:** The subject property is located on the south corner of Howard and 10th Streets, Assessor's Block 3517, Lot 035. The subject property is located within an RCD (Regional Commercial District) zoning district and a 55/65-X Height and Bulk district. The subject property, historically known as St. Joseph's Church, is an Article 10 individual landmark (No. 120), located in the California Register Western SOMA Light Industrial and Residential Historic District, and added to the National Register of Historic Places in 1982. The subject property is a former Catholic church constructed in 1913 and designed in the Romanesque Revival style by architect John J. Foley.
- c. **64 Potomac Street:** The subject property is located on the east side of Potomac Street between Waller Street and Duboce Park, Assessor's Block 0866 Lot 014. The subject property is located within a RH-2 (Residential-House, Two-Family District) zoning district and a 40-X Height and

Bulk district. The subject property is a contributing building to the Article 10 Duboce Park Historic District. It is a two story over garage, wood-frame, single-family dwelling built in 1899 and features a gable roof and bay window.

- d. 2168 Market Street: The subject property is located on the north side of Market Street between Sanchez and Church streets, Assessor's Block 3542 Lot 062. The subject property is located within an NCT (Upper Market Neighborhood Commercial Transit) zoning district and a 40/50-X Height and Bulk district. The subject property is an Article 10 individual landmark (No. 267). It is a three-story wood-frame commercial building constructed in 1907 and designed by master architect August Noridn.
- e. 2731-2735 Folsom Street: The subject property is located on the west side of Folsom Street between 23rd and 24th streets, Assessor's Block 3640, Lot 031. The subject property is located within the RH-2 (Residential House, Two Family) zoning district and 40-X Height and Bulk district. The subject property is a three-story, wood frame, three-unit residential building with a rectangular plan. The subject property is an Article 10 individual landmark building (No. 276). The subject property was designed in the Beaux-Arts style by architect James Francis Dunn (1874-1921) and constructed in 1900 for James Gaughran.

PROJECT DESCRIPTION

This project is a Mills Act Historical Property Contract application.

MILLS ACT REVIEW PROCESS

Once a Mills Act application is received, the matter is referred to the Historic Preservation Commission (HPC) for review. The HPC shall conduct a public hearing on the Mills Act application, historical property contract, and proposed rehabilitation and maintenance plan, and make a recommendation for approval or disapproval to the Board of Supervisors.

The Board of Supervisors will hold a public hearing to review and approve or disapprove the Mills Act application and contract. The Board of Supervisors shall conduct a public hearing to review the Historic Preservation Commission recommendation, information provided by the Assessor's Office, and any other information the Board requires in order to determine whether the City should execute a historical property contract for the subject property.

The Board of Supervisors shall have full discretion to determine whether it is in the public interest to enter into a Mills Act contract and may approve, disapprove, or modify and approve the terms of the contract. Upon approval, the Board of Supervisors shall authorize the Director of Planning and the Assessor-Recorder's Office to execute the historical property contract.

MILLS ACT REVIEW PROCEDURES

The Historic Preservation Commission is requested to review and make recommendations on the following:

- The draft Mills Act Historical Property Contract between the property owner and the City and County of San Francisco.
- The proposed rehabilitation and maintenance plan.

The Historic Preservation Commission may also comment in making a determination as to whether the public benefit gained through restoration, continued maintenance and preservation of the property is sufficient to outweigh the subsequent loss of property taxes to the City.

APPLICABLE PRESERVATION STANDARDS

Ordinance No. 191-96 amended the San Francisco Administrative Code by adding Chapter 71 to implement the California Mills Act, California Government Code Sections 50280 *et seq.* The Mills Act authorizes local governments to enter into contracts with private property owners who will rehabilitate, restore, preserve, and maintain a “qualified historical property.” In return, the property owner enjoys a reduction in property taxes for a given period. The property tax reductions must be made in accordance with Article 1.9 (commencing with Section 439) of Chapter 3 of Part 2 of Division 1 of the California Revenue and Taxation Code.

TERM

Mills Act contracts must be made for a minimum term of ten years. The ten-year period is automatically renewed by one year annually to create a rolling ten-year term. One year is added automatically to the initial term of the contract on the anniversary date of the contract, unless notice of nonrenewal is given or the contract is terminated. If the City issues a notice of nonrenewal, then one year will no longer be added to the term of the contract on its anniversary date and the contract will only remain in effect for the remainder of its term. The City must monitor the provisions of the contract until its expiration and may terminate the Mills Act contract at any time if it determines that the owner is not complying with the terms of the contract or the legislation. Termination due to default immediately ends the contract term. Mills Act contracts remain in force when a property is sold.

ELIGIBILITY

San Francisco Administrative Code Chapter 71, Section 71.2, defines a “qualified historic property” as one that is not exempt from property taxation and that is one of the following:

- (a) Individually listed in the National Register of Historic Places;
- (b) Listed as a contributor to an historic district included on the National Register of Historic Places;
- (c) Designated as a City landmark pursuant to San Francisco Planning Code Article 10;
- (d) Designated as contributory to a landmark district designated pursuant to San Francisco Planning Code Article 10; or
- (e) Designated as significant (Categories I or II) or contributory (Categories III or IV) to a conservation district designated pursuant to San Francisco Planning Code Article 11.

Mill Act Applications
October 2, 2019

2019-006323MLS (2251 Webster Street); 2019-006384MLS (1401 Howard Street); 2019-
006323MLS (64 Potomac Street); 2019-005831MLS (2168 Market Street);
2019-006455MLS (2731-2735 Folsom Street);

All properties that are eligible under the criteria listed above must also meet a tax assessment value to be eligible for a Mills Act Contract. The tax assessment limits are listed below:

Residential Buildings

Eligibility is limited to a property tax assessment value of not more than \$3,000,000.

Commercial, Industrial or Mixed-Use Buildings

Eligibility is limited to a property tax assessment value of not more than \$5,000,000.

Properties may be exempt from the tax assessment values if it meets any one of the following criteria:

- The qualified historic property is an exceptional example of architectural style or represents a work of a master architect or is associated with the lives of persons important to local or national history; or
- Granting the exemption will assist in the preservation and rehabilitation of a historic structure (including unusual and/or excessive maintenance requirements) that would otherwise be in danger of demolition, deterioration, or abandonment;

Properties applying for a valuation exemption must provide evidence that it meets the exemption criteria, including a historic structure report to substantiate the exceptional circumstances for granting the exemption. The Historic Preservation Commission shall make specific findings in determining whether to recommend to the Board of Supervisors that the valuation exemption should be approved. Final approval of this exemption is under the purview of the Board of Supervisors.

PRIORITY CRITERIA CONSIDERATIONS

Staff reviewed all applications on the merits of five Priority Consideration. The five priority considerations are:

Necessity: The project will require a financial incentive to help ensure the preservation of the property. This criterion will establish that the property is in danger of deterioration and in need of substantial rehabilitation and restoration that has significant associated costs. Properties with open complaints, enforcement cases or violations will not meet this criterion.

Investment: The project will result in additional private investment in the property other than for routine maintenance. This may include seismic retrofitting and substantial rehabilitation and restoration work. This criterion will establish that the owner is committed to investing in the restoration, rehabilitation and maintenance the property.

Distinctiveness: The project preserves a distinctive example of a property that is especially deserving of a contract due to its exceptional nature.

Recently Designated City Landmarks: properties that have been recently designated landmarks will be given priority consideration.

Legacy Business: The project will preserve a property at which a business included in the Legacy Business Registry is located. This criterion will establish that the owner is committed to preserving the property, including physical features that define the existing Legacy Business.

PUBLIC/NEIGHBORHOOD INPUT

The Department has not received any public comment regarding the Mills Act Historical Property Contract.

STAFF ANALYSIS

The Department received five Mills Act applications by the May 1, 2019 filing date. The Project Sponsors, Planning Department Staff, and the Office of the City Attorney have negotiated the five attached draft historical property contracts, which include a draft rehabilitation and maintenance plan for the historic building. Department Staff believes the draft historical property contracts and plans are adequate. Please see below for complete analysis.

- a. 2251 Webster Street: As detailed in the Mills Act application, the applicant proposes to rehabilitate and maintain the historic property. Staff determined that the proposed work, detailed in the attachments, is consistent with the Secretary of Interior's Standards for Rehabilitation.

The subject property is currently valued by the Assessor's Office as under \$3,000,000 (see attached Market Analysis and Income Approach reports) and did not require a Historic Structure Report.

The applicant completed some rehabilitation of the building in 2019, including dry rot repair and painting with an estimated cost of \$12,650. The proposed Rehabilitation Plan includes in kind window replacement, interior plaster and lathe repair from and exterior leak, in-kind replacement of the front and rear doors, roof repair and replacement, painting. Rehabilitation work is estimated to cost \$113,610 over ten years.

The proposed Maintenance Plan includes annual inspection of the wood siding, windows, and roof. Maintenance work is estimated to cost \$2,880 annually. Any needed repairs will be made in kind and will avoid altering, removing or obscuring character-defining features of the building.

No changes to the use of the property are proposed. Please refer to the attached Rehabilitation and Maintenance Plan for a full description of the proposed work. The attached draft historical property contract will help the applicant mitigate these expenditures and will induce the applicant to maintain the property in excellent condition in the future.

The subject property meets three of the five Priority Considerations: Necessity, Investment and Distinctiveness. The proposed rehabilitation will require significant associated costs to ensure the preservation of the subject property. The property owner will invest additional money towards

the rehabilitation other than for routine maintenance. Finally, the proposed rehabilitation project will preserve a distinctive example of a grouping of Italianate homes constructed circa 1900. The subject property does not meet the Recently Designated City Landmarks or the Legacy Business criteria. The building was designated an Article 10 landmark district in 1991 and therefore is not a recent landmark. A Legacy Business is not located at the subject property.

- b. 1401 Howard Street: As detailed in the Mills Act application, the applicant proposes to rehabilitate and maintain the historic property. Staff determined that the proposed work, detailed in the attachments, is consistent with the Secretary of Interior's Standards for Rehabilitation.

The subject property is currently valued by the Assessor's Office at over \$5,000,000 (see attached Market Analysis and Income Approach reports); therefore, an exemption from the tax assessment value is required. The subject property qualifies for an exemption as it is designated an individual landmark under Article 10 of the Planning Code. A Historic Structure Report was required in order to demonstrate that granting the exemption would assist in the preservation of a property that might otherwise be in danger of demolition, deterioration or abandonment.

In 2018, the applicant completed a full rehabilitation and restoration of the building and received final approval for the Federal Historic Preservation Tax Incentive in September 2018. Work included the restoration of exterior and interior finishes, seismic strengthening, repair of the slate roof, and restoration of the sheet metal domes. The cost of the completed work was approximately \$3,962,310.00.

Future rehabilitation and restoration scope items include full repainting of the interior and exterior. The estimated cost of the proposed rehabilitation work is \$291,065.00 over ten years.

The proposed Maintenance Plan includes annual inspection of exterior stucco, metal roof elements, windows, doors, and roof on a regular basis. The applicant will be maintaining interior character defining features identified in the National Register nomination, such as the entry lobby floors, plaster detailing, and woodwork. Maintenance work is estimated to cost \$31,040 annually. Any needed repairs will be made in kind and will avoid altering, removing or obscuring character-defining features of the building.

No changes to the use of the property are proposed. Please refer to the attached Rehabilitation and Maintenance Plan for a full description of the proposed work. The attached draft historical property contract will help the applicant mitigate these expenditures and will induce the applicant to maintain the property in excellent condition in the future.

The subject property meets two of the five Priority Considerations: Distinctiveness and Investment. The building represents a distinctive example of the Romanesque Revival architectural style. Completed in 2018, the applicant has invested in a full building restoration and rehabilitation scope, including seismic strengthening. The subject application does not meet the Necessity, Recently Designated Landmark, and Legacy Business criteria. The applicant completed a full building rehabilitation and restoration scope in 2018 and the building is in excellent condition; therefore, the application does not meet the Necessity criteria. The building

was designated an Article 10 landmark in 1980 and therefore is not a recent landmark. A Legacy Business is not located at the subject property.

- c. 64 Potomac Street: As detailed in the Mills Act application, the applicant proposes to rehabilitate and maintain the historic property. Staff determined that the proposed work, detailed in the attachments, is consistent with the Secretary of Interior's Standards for Rehabilitation.

The subject property is currently valued by the Assessor's Office as under \$3,000,000 (see attached Market Analysis and Income Approach reports) and did not require a Historic Structure Report.

The proposed Rehabilitation Plan includes seismic strengthening, roof replacement, wood siding repair and painting, front façade window repair, restoration of front stairs, front door and garage door replacement. Rehabilitation work is estimated to cost \$126,035 over ten years.

The proposed Maintenance Plan includes annual inspection of roof, gutters and downspouts, windows, doors, foundation, and wood siding and trim. Any needed repairs will be made in kind and will avoid altering, removing or obscuring character-defining features of the building. Maintenance work is estimated to cost approximately \$4,000 annually.

No changes to the use of the property are proposed. Please refer to the attached Rehabilitation and Maintenance Plan for a full description of the proposed work. The attached draft historical property contract will help the applicant mitigate these expenditures and will induce the applicant to maintain the property in excellent condition in the future.

The subject property meets three of the five Priority Considerations: Necessity, Investment and Distinctiveness. The proposed rehabilitation will require significant associated costs to ensure the preservation of the subject property. The property owner will invest additional money towards the rehabilitation other than for routine maintenance. Finally, the proposed rehabilitation project will preserve a distinctive example of Victorian style home. The subject property does not meet the Recently Designated City Landmarks or the Legacy Business criteria. The building was designated an Article 10 landmark district in 2013 and therefore is not a recent landmark. A Legacy Business is not located at the subject property.

- d. 2168 Market Street: As detailed in the Mills Act application, the applicant proposes to rehabilitate and maintain the historic property. Staff determined that the proposed work, detailed in the attachments, is consistent with the Secretary of Interior's Standards for Rehabilitation.

The subject property is currently valued by the Assessor's Office as under \$5,000,000 (see attached Market Analysis and Income Approach reports) and did not require a Historic Structure Report.

The proposed Rehabilitation Plan includes repair and restoration of the exterior front entry features such as terrazzo, doors, windows, and brick. Rehabilitation work is estimated to cost \$95,160 over ten years.

The proposed Maintenance Plan includes annual inspection of front façade, windows, interior wood elements, and roof. Any needed repairs resulting from inspection will be made in kind and will avoid altering, removing or obscuring character-defining features of the building. Maintenance work is estimated to cost approximately \$7,500 annually.

No changes to the use of the property are proposed. Please refer to the attached Rehabilitation and Maintenance Plan for a full description of the proposed work. The attached draft historical property contract will help the applicant mitigate these expenditures and will induce the applicant to maintain the property in excellent condition in the future. A Certificate of Appropriateness has been submitted for the following scopes to be completed in the next two to three years: replace existing non historic main doors and supporting framework; replace non-historic glass window facing market street with leaded glass window to match the historic nature of the façade.

The subject property meets three of the five Priority Considerations. It represents an exceptional example of the Arts & Crafts architectural style and therefore meets the Distinctiveness priority consideration. The building was designated an Article 10 landmark in 2015 and was designated on the National Register of Historic Places in 2019 and therefore is a recent landmark. In 2015 the applicant performed a full building rehabilitation, including seismic strengthening and elevator upgrades, at the subject property; therefore, the subject property not meet the Necessity or Investment criteria. Café du Nord, a registered Legacy Business ca. 2016, is located at the subject property and will continue to operate as such.

- e. 2731-2735 Folsom Street: As detailed in the Mills Act application, the applicant proposes to rehabilitate and maintain the historic property. Staff determined that the proposed work, detailed in the attachments, is consistent with the Secretary of Interior's Standards for Rehabilitation.

The subject property is currently valued by the Assessor's Office at over \$3,000,000 (see attached Market Analysis and Income Approach reports); therefore, an exemption from the tax assessment value is required. The subject property qualifies for an exemption as it is designated an individual landmark under Article 10 of the Planning Code. A Historic Structure Report was required in order to demonstrate that granting the exemption would assist in the preservation of a property that might otherwise be in danger of demolition, deterioration or abandonment.

The building underwent a full rehabilitation c.2014 which included full re-painting of all elevations, façade restoration, structural strengthening, and re-roofing. The proposed Rehabilitation Plan includes dry rot repair of wood elements at the base of the building, repair and restoration of windows, improve site drainage against foundation of building, repaint exterior, replace roof flashing, and fully re-roof the building. Rehabilitation work is estimated to cost \$305,573 over ten years.

The proposed Maintenance Plan includes annual inspection of gutters and downspouts, windows, front facade, and roof. Any needed repairs resulting from inspection will be made in

kind and will avoid altering, removing or obscuring character-defining features of the building. Maintenance work is estimated to cost approximately \$5,148 annually.

No changes to the use of the property are proposed. Please refer to the attached Rehabilitation and Maintenance Plan for a full description of the proposed work. The attached draft historical property contract will help the applicant mitigate these expenditures and will induce the applicant to maintain the property in excellent condition in the future.

The subject property meets three of the five Priority Considerations: Distinctiveness, Investment and Recently Designated City Landmark. The subject property represents a distinctive and well-preserved example of the Beaux-Arts style architecture. The property owner will be investing additional money towards the rehabilitation other than for routine maintenance. Additionally, in 2017 the City of San Francisco designated the subject building as an individual landmark under Article 10. The subject property does not meet the Necessity and Legacy Business criteria. In 2014, a full building rehabilitation, including seismic strengthening, was performed therefore the building is in good condition. Furthermore, the building is fully occupied and is not in danger of deterioration or abandonment. A Legacy Business is not located at the subject property.

ASSESSOR-RECORDER INFORMATION

Based on information received from the Assessor-Recorder, the following properties will receive an estimated first year reduction as a result of the Mills Act Contract. Please refer to the attached Preliminary Valuation spreadsheet prepared by the Assessor for detailed information about each property.

- a) 2251 Webster Street: Estimated Property Tax Savings of \$14,184 (a 66.37% reduction from factored base year value).
- b) 1401 Howard Street: Estimated Property Tax Savings of \$66,974 (a 31.20% reduction from factored base year value)
- c) 64 Potomac Street: Estimated Property Tax Savings of \$22,679 (a 76.47% reduction from factored base year value)
- d) 2168 Market Street: Estimated Property Tax Savings of \$0 (a 0.00% reduction from factored base year value). The property owner is aware that they will not receive a tax savings but would like to move forward with the Mills Act knowing that the property will be re-evaluated in the future.
- e) 2731-2735 Folsom Street: Estimated Property Tax Savings of \$35,495 (a 49.46% reduction from factored base year value)

PLANNING DEPARTMENT RECOMMENDATION

- The Planning Department recommends that the Historic Preservation Commission adopt a resolution recommending approval of the Mills Act Historical Property Contracts and Rehabilitation and Maintenance Plans to the Board of Supervisors for the following properties:
 - a. 2251 Webster Street
 - b. 1401 Howard Street
 - c. 64 Potomac Street
 - d. 2168 Market Street
 - e. 2731-2735 Folsom Street

ISSUES AND OTHER CONSIDERATIONS

Mills Act Contract property owners are required to submit an annual affidavit demonstrating compliance with Rehabilitation and Maintenance Plans.

HISTORIC PRESERVATION COMMISSION ACTIONS

Review and adopt a resolution for each property:

1. Recommending to the Board of Supervisors approval of the proposed Mills Act Historical Property Contract between the property owner(s) and the City and County of San Francisco;
2. Approving the proposed Mills Act Rehabilitation and Maintenance Plan for each property.

Attachments:

- a. 2251 Webster Street:
 - Site & Aerial Photos
 - Draft Resolution
 - Draft Mills Act Historical Property Contract
 - Draft Rehabilitation Program & Maintenance Plan
 - Draft Mills Act Valuation provided by the Assessor-Recorder's Office
 - Pre-Approval Inspection Report
 - Mills Act Application
- b. 1401 Howard Street:
 - Site & Aerial Photos
 - Draft Resolution
 - Draft Mills Act Historical Property Contract
 - Draft Rehabilitation Program & Maintenance Plan
 - Draft Mills Act Valuation provided by the Assessor-Recorder's Office
 - Pre-Approval Inspection Report
 - Mills Act Application

Mill Act Applications
October 2, 2019

2019-006323MLS (2251 Webster Street); 2019-006384MLS (1401 Howard Street); 2019-006323MLS (64 Potomac Street); 2019-005831MLS (2168 Market Street); 2019-006455MLS (2731-2735 Folsom Street);

Historic Structure Report

c. 64 Potomac Street:

Site & Aerial Photos
Draft Resolution
Draft Mills Act Historical Property Contract
Draft Rehabilitation Program & Maintenance Plan
Draft Mills Act Valuation provided by the Assessor-Recorder's Office
Pre-Approval Inspection Report
Mills Act Application

d. 2168 Market Street:

Site & Aerial Photos
Draft Resolution
Draft Mills Act Historical Property Contract
Draft Rehabilitation Program & Maintenance Plan
Draft Mills Act Valuation provided by the Assessor-Recorder's Office
Pre-Approval Inspection Report
Mills Act Application

e. 2731-2735 Folsom Street:

Site & Aerial Photos
Draft Resolution
Draft Mills Act Historical Property Contract
Draft Rehabilitation Program & Maintenance Plan
Draft Mills Act Valuation provided by the Assessor-Recorder's Office
Pre-Approval Inspection Report
Mills Act Application
Historic Structure Report

Case No.: 2019-006322MLS
Project Address: 64 Potomac Street (District 8)
Landmark District: Contributor to the Duboce Park Historic District
Zoning: RH-2 (Residential – House, Two Family)
Height and Bulk: 40-X
Block/Lot: 0866/014
Applicant: Gustav Lindqvist & Caroline Ingeborn
64 Potomac Street
San Francisco, CA 94117

SITE PHOTO



AERIAL PHOTO



SUBJECT PROPERTY



SAN FRANCISCO PLANNING DEPARTMENT

Historic Preservation Commission Resolution No. 1092

HEARING DATE: OCTOBER 2, 2019

Case No.: 2019-006322MLS
Project Address: 64 Potomac Street (District 8)
Landmark District: Contributor to the Duboce Park Historic District
Zoning: RH-2 – Residential-House, Two Family
Height and Bulk: 40-X
Staff Contact: Shannon Ferguson – (415) 575-9074
shannon.ferguson@sfgov.org
Reviewed By: Elizabeth Gordon-Jonckheer – (415) 575-8728
Elizabeth Gordon-Jonckheer @sfgov.org

1650 Mission St.
Suite 400
San Francisco,
CA 94103-2479

Reception:
415.558.6378

Fax:
415.558.6409

Planning
Information:
415.558.6377

ADOPTING FINDINGS RECOMMENDING TO THE BOARD OF SUPERVISORS APPROVAL OF THE DRAFT MILLS ACT HISTORICAL PROPERTY CONTRACT, REHABILITATION PROGRAM, AND MAINTENANCE PLAN FOR 64 POTOMAC STREET.

WHEREAS, The Mills Act, California Government Code Sections 50280 et seq. (“the Mills Act”) authorizes local governments to enter into contracts with owners of private historical property who assure the rehabilitation, restoration, preservation and maintenance of a qualified historical property; and

WHEREAS, in accordance with Article 1.9 (commencing with Section 439) of Chapter 3 of Part 2 of Division 1 of the California Revenue and Taxation Code, the City and County of San Francisco may provide certain property tax reductions, such as those provided for in the Mills Act; and

WHEREAS, Ordinance No. 191-96 amended the San Francisco Administrative Code by adding Chapter 71, to implement Mills Act locally; and

WHEREAS, The Planning Department has determined that the actions contemplated in this Resolution are categorically exempt from with the California Environmental Quality Act (California Public Resources Code Sections 21000 et seq.) under section 15331; and

WHEREAS, the existing building located at 64 Potomac Street is a contributor to the Duboce Park Historic District and thus qualifies as a historical property for purposes of the Mills Act; and

WHEREAS, The Planning Department has reviewed the Mills Act Application, draft Historical Property Contract, Rehabilitation Program, and Maintenance Plan for 64 Potomac Street, which are located in Case Docket No. 2019-006322MLS. The Planning Department recommends approval of the draft Mills Act historical property contract, rehabilitation program, and maintenance plan; and

WHEREAS, The Historic Preservation Commission (HPC) recognizes the historic building at 64 Potomac Street as an historical resource and believes the Rehabilitation Program and Maintenance Plan are appropriate for the property; and

WHEREAS, at a duly noticed public hearing held on October 2, 2019, the HPC reviewed documents, correspondence and heard oral testimony on the Mills Act Application, Draft Historical Property Contract, Rehabilitation Program, and Maintenance Plan for 64 Potomac Street, which are located in Case Docket No. 2019-006322MLS.

THEREFORE, BE IT RESOLVED That the HPC hereby recommends that the Board of Supervisors approve the Draft Mills Act Historical Property Contract, including the Rehabilitation Program, and Maintenance Plan for the historic building located at 64 Potomac Street, attached herein as Exhibits A and B, and fully incorporated by this reference.

BE IT FURTHER RESOLVED That the HPC hereby directs its Commission Secretary to transmit this Resolution, the Draft Mills Act Historical Property Contract, including the Rehabilitation Program, and Maintenance Plan for 64 Potomac Street, and other pertinent materials in the case file 2019-006322MLS to the Board of Supervisors.

I hereby certify that the foregoing Resolution was ADOPTED by the Historic Preservation Commission on October 2, 2019.



Jonas P. Ionin
Commissions Secretary

- AYES: Johns, Pearlman, So, Hyland, Matsuda, Black
- NOES: None
- ABSENT: None
- RECUSED: Foley
- ADOPTED: October 2, 2019

Exhibit A: Rehabilitation/Restoration Plan for 64 Potomac Street

Scope: #1		Building Feature: Roofs	
Rehab/Restoration X	Maintenance	Completed	Proposed X
Contract year work completion: 2020			
Total Cost: \$15,500 (see line item 07.300 in Contractor's bid)			
<p>Description of work: The current roof is of medium status. We will engage a licensed roofing contractor to replace the current roof with new shingles. Installation of the new roof will avoid changing the roof configuration, or altering, removing or obscuring character-defining features of the building, including decorative elements in the gable ends, as well as eave trim and moldings. New gutters and down sprouts will be installed to be able to direct water away from the building.</p>			

Scope: #2		Building Feature: Exterior Walls	
Rehab/Restoration X	Maintenance	Completed	Proposed X
Contract year work completion: 2020			
Total Cost: \$33,000. (see line items 09.900 and items under section 07 with the exception of 07.300)			
<p>Description of work: We will repair wood siding at all elevations of the house as necessary and thereafter repaint the house in its entirety. Any repairs or replacements will avoid altering, removing or obscuring character-defining features of the building and all materials that are used will be made in kind e.g. wood for wood.</p>			

Scope: #3		Building Feature: Windows and doors	
Rehab/Restoration <input checked="" type="checkbox"/>	Maintenance	Completed	Proposed <input checked="" type="checkbox"/>
Contract year work completion: 2020			
Total Cost: \$7235			
<p>Description of work: All three of the exterior doors at the front of the house, including the garage door, need to be replaced. The design of the new doors will be replaced to match the historic character of the house.</p> <p>All of the windows facing the street in the house will be repaired and thus match with the historically appropriate character and function.</p> <p>\$3,385 for repairing windows. \$3,850 for new door. These estimates are based off of www.homeadvisor.com</p>			

Scope: #4		Building Feature: Front Stairs	
Rehab/Restoration <input checked="" type="checkbox"/>	Maintenance	Completed	Proposed <input checked="" type="checkbox"/>
Contract year work completion: 2020			
Total Cost: \$22,300. (see line item 06.300 in Contractor's bid)			
<p>Description of work: Remove existing terrazzo finish at the exterior front stairs and restore stairs and handrails to original design and materials (wood) based on historic documents and neighboring houses.</p>			

Scope: #5		Building Feature: Seismic Strengthening of Foundation	
Rehab/Restoration <input checked="" type="checkbox"/>	Maintenance	Completed	Proposed <input checked="" type="checkbox"/>
Contract year work completion: 2020			
Total Cost: \$48,000. (see line items 03.100 and 06.100 in Contractor's bid) + \$39,500 (see line items 2-5 under Additional Costs in Contractor extra costs)			
<p>Description of work: Seismic strengthening of house foundation. The drain will be moved from inside the garage to a trench drain by the garage door in order prevent water from flowing into the garage and creating damage to the foundation over time.</p>			

Exhibit B: Maintenance Plan for 64 Potomac Street

Scope: #1		Building Feature: Roof	
Rehab/Restoration	Maintenance <input checked="" type="checkbox"/>	Completed	Proposed <input checked="" type="checkbox"/>
Contract year work completion: Annually			
Total Cost: Average annual cost of \$500			
<p>Description of work: When the roof has been replaced we will perform our own inspections annually. We will ensure to keep gutters and downspouts clear from debris as well as remove any overhanging branches. We will broom sweep branch or leaf debris.</p> <p>In addition, we will have a licensed roofing contractor conduct periodic inspections approximately every 5 years to ensure that it remains in good condition. Any repairs or replacements needed as a consequence of these inspections will be performed.</p> <p>Both these routines, will be informed by the guidance outlined in the National Park Service's Preservation Brief 47: Maintaining the Exterior of Small and Medium Size Historic Buildings.</p>			

Scope: #2		Building Feature: Exterior Walls	
Rehab/Restoration	Maintenance <input checked="" type="checkbox"/>	Completed	Proposed <input checked="" type="checkbox"/>
Contract year work completion: Annually			
Total Cost: \$1,000 annually			
<p>Description of work: When the house has been repainted we will inspect the wooden elements of the exterior of the house annually and repaint as necessary. If any damage or deterioration is found, the extent and the nature of the damage will be assessed and addressed. Any repairs or replacements will avoid altering, removing or obscuring character-defining features of the building and all materials that are used will be made in kind e.g. wood for wood. This maintenance routine will be informed by the guidance outlined in the National Park Service's Preservation Brief 47: Maintaining the Exterior of Small and Medium Size Historic Buildings.</p>			

Scope: #3		Building Feature: Openings	
Rehab/Restoration	Maintenance <input checked="" type="checkbox"/>	Completed	Proposed <input checked="" type="checkbox"/>
Contract year work completion: Annually			
Total Cost: \$1,000 annually			
Description of work: We will inspect the exterior doors and windows annually. We will look for signs of moist and dry rot and confirm functionality. If any repair or replacement is found necessary this will be done in line with the house historic character and any materials used will be in kind. This maintenance routine will be informed by the guidance outlined in the National Park Service's Preservation Brief 47: Maintaining the Exterior of Small and Medium Size Historic Buildings.			

Scope: #4		Building Feature: Front stairs	
Rehab/Restoration	Maintenance <input checked="" type="checkbox"/>	Completed	Proposed <input checked="" type="checkbox"/>
Contract year work completion: Annually			
Total Cost: \$500 annually			
Description of work: We will maintain the front stairs on an ongoing basis keeping it free from dust, dirt and debris. We will perform our own annual inspections of the stairs and if needed make any repairs or replacements deemed necessary. Any repairs or replacements will avoid altering, removing or obscuring character-defining features of the building and all materials that are used will be made in kind. This maintenance routine will be informed by the guidance outlined in the National Park Service's Preservation Brief 47: Maintaining the Exterior of Small and Medium Size Historic Buildings.			

Scope: #5		Building Feature: Foundation and Perimeter Grades	
Rehab/Restoration	Maintenance <input checked="" type="checkbox"/>	Completed	Proposed <input checked="" type="checkbox"/>
Contract year work completion: Annually			
Total Cost: \$1,000 annually			
Description of work: The foundation will be inspected annually to check for signs of water or other damages. If any damages are identified these will be remediated immediately. All maintenance work will be informed by the guidance outlined in the National Park Service's Preservation Brief 47: Maintaining the Exterior of Small and Medium Size Historic Buildings.			



Office of the Assessor / Recorder - City and County of San Francisco
2019 Mills Act Valuation

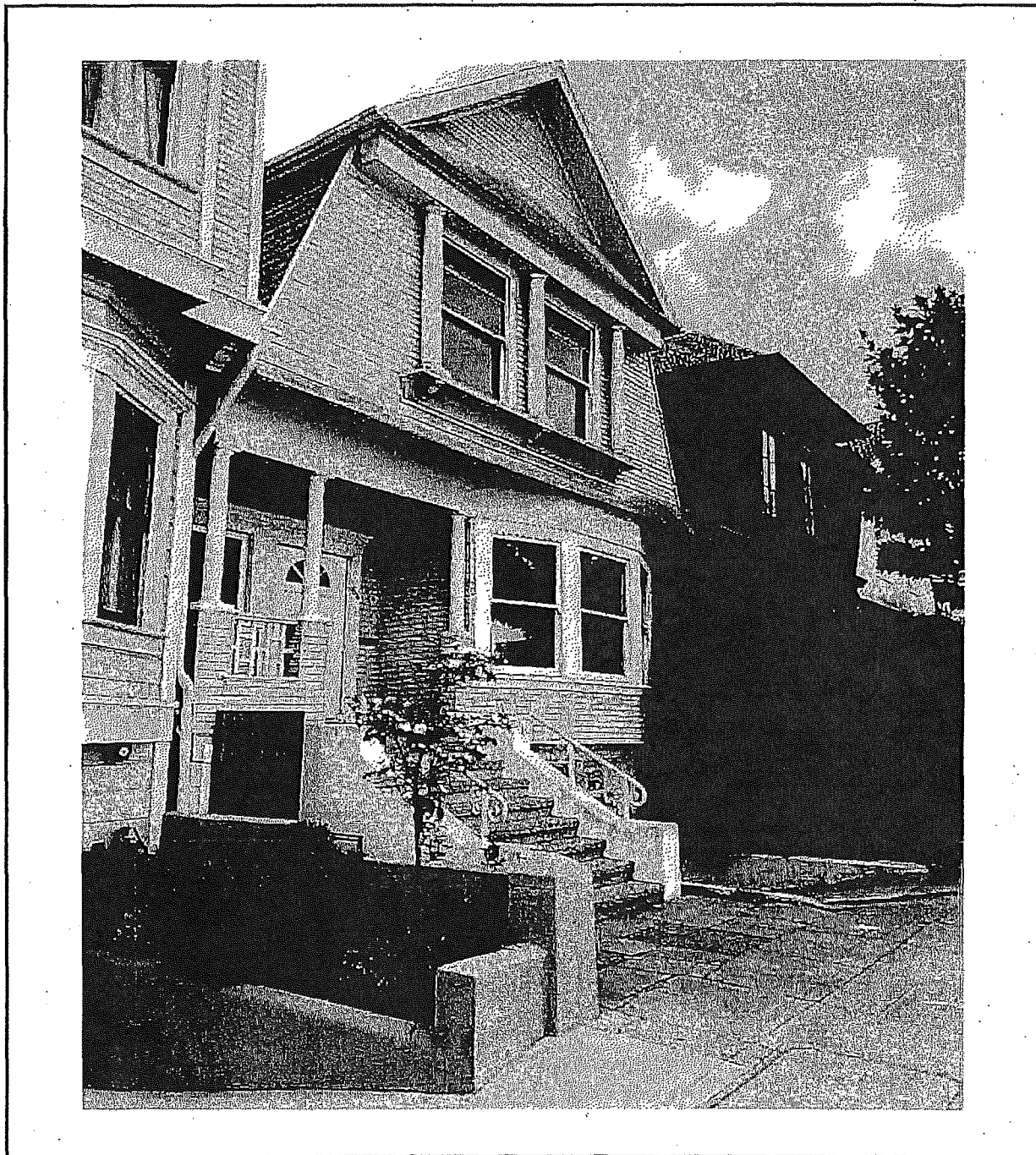

64 Potomac St

**OFFICE OF THE ASSESSOR-RECORDER - CITY & COUNTY OF SAN FRANCISCO
MILLS ACT VALUATION**

APN:	0866 014	Lien Date:	7/1/2019
Address:	64 Potomac St	Application Date:	4/28/2019
SF Landmark No.:	N/A	Valuation Date:	7/1/2019
Applicant's Name:	Gustav Lindqvist	Valuation Term:	12 Months
Agt./Tax Rep./Atty:	0.00	Last Sale Date:	5/7/2018
Fee Appraisal Provided:	N/A	Last Sale Price:	\$2,500,000

FACTORED BASE YEAR (Roll) VALUE		INCOME CAPITALIZATION APPROACH		SALES COMPARISON APPROACH	
Land	\$1,785,000	Land	\$360,000	Land	\$ 1,500,000
Imps.	\$765,000	Imps.	\$240,000	Imps.	\$1,000,000
Personal Prop	\$0	Personal Prop	\$0	Personal Prop	\$0
Total	\$2,550,000	Total	\$600,000	Total	\$ 2,500,000

Property Description

Property Type:	SFR	Year Built:	1900	Neighborhood:	Hayes Valley
Type of Use:	SFR	(Total) Rentable Area:	1750	Land Area:	2,247
Owner-Occupied:	Yes	Stories:	2	Zoning:	RH-2
Unit Type:	Residential	Parking Spaces:	1		

Total No. of Units: 1

Special Conditions (Where Applicable)

Note, subject property currently has permit #201812219020 filed for: "Interior renovation of kitchen and e [sic] bath 2nd fl. add new bath at 2nd fl. New structural posts and beams [sic] to accomodate partition changes. Remove e [sic] chimney, install 4 new windows rear. Replace 8 windows in kind". Work was started on 2/20/2019 but suspended on 7/8/2019.

Conclusions and Recommendations

	Per Unit	Per SF	Total
Factored Base Year Roll	\$2,550,000	\$1,457	\$ 2,550,000
Income Approach - Direct Capitalization	\$600,000	\$343	\$ 600,000
Sales Comparison Approach	\$2,500,000	\$1,429	\$ 2,500,000
Recommended Value Estimate	\$ 600,000	\$ 343	\$ 600,000

Appraiser:	Irving Pham	Principal Appraiser:	Orla Fahy	Date of Report:	7/1/2019
-------------------	-------------	-----------------------------	-----------	------------------------	----------

SUBJECT PHOTOGRAPHS AND LOCATOR MAP

Address: 64 Potomac St

APN: 0866 014

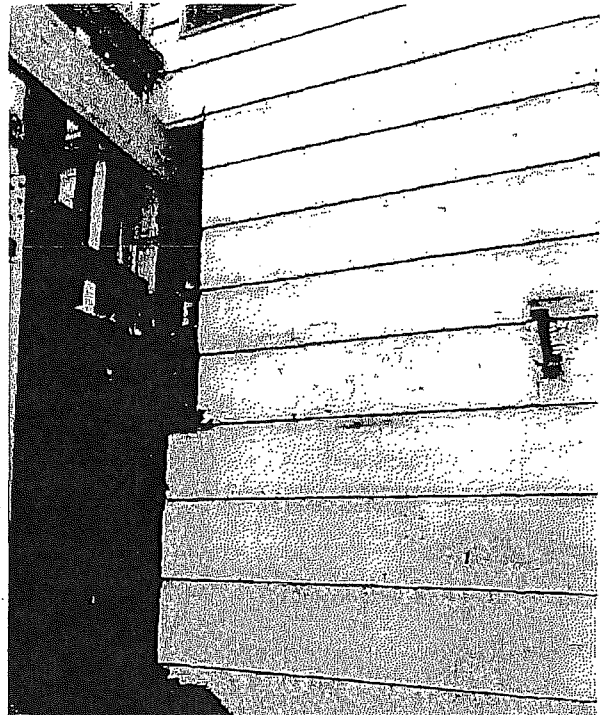
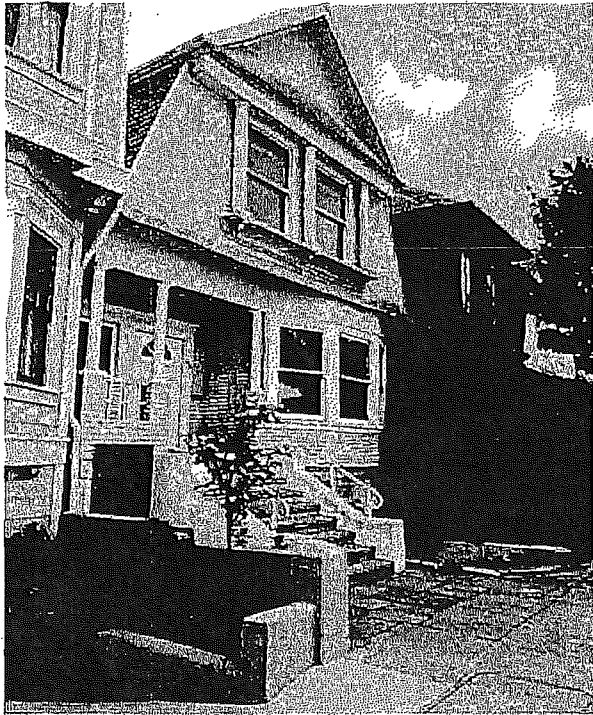

1449

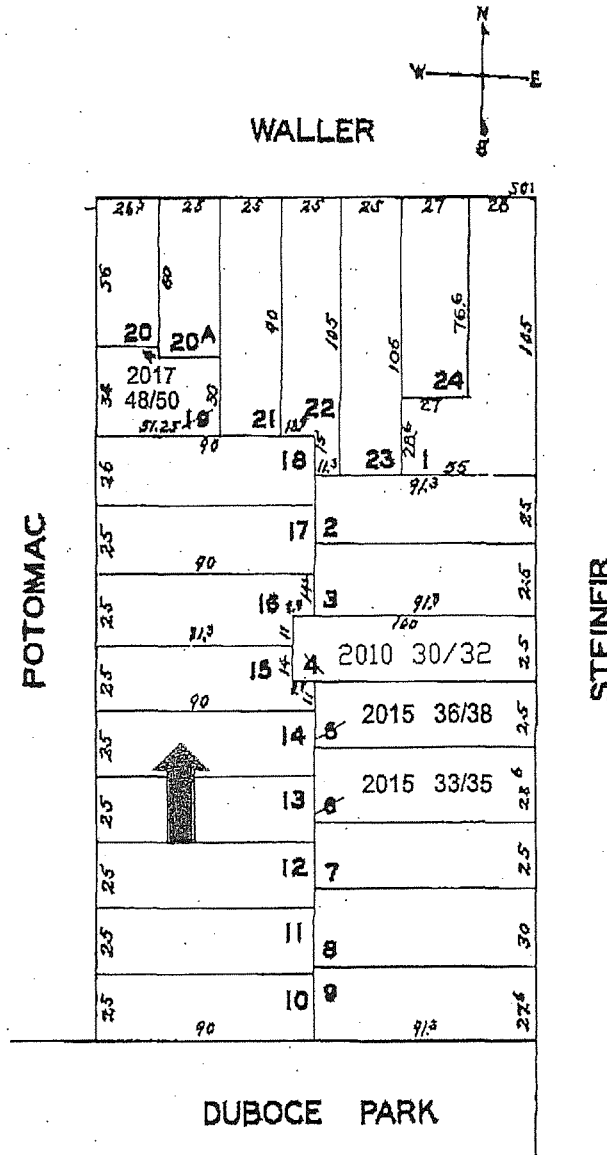
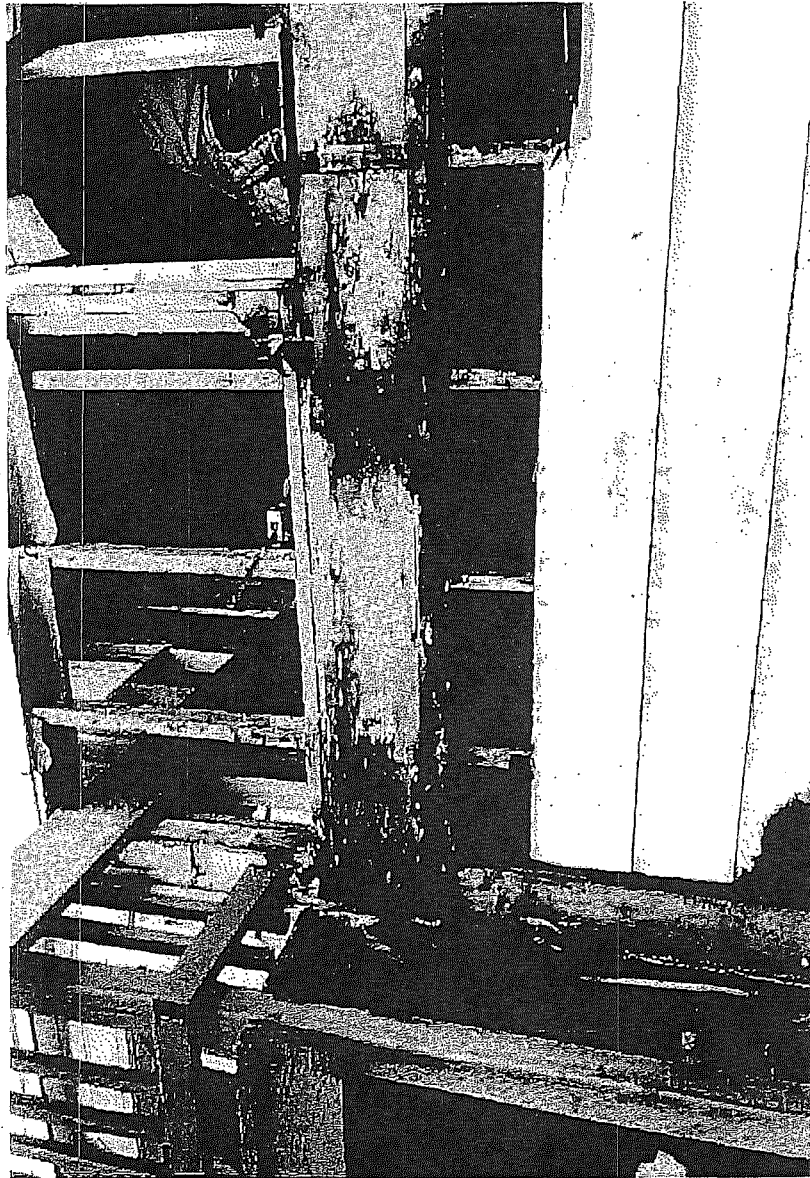

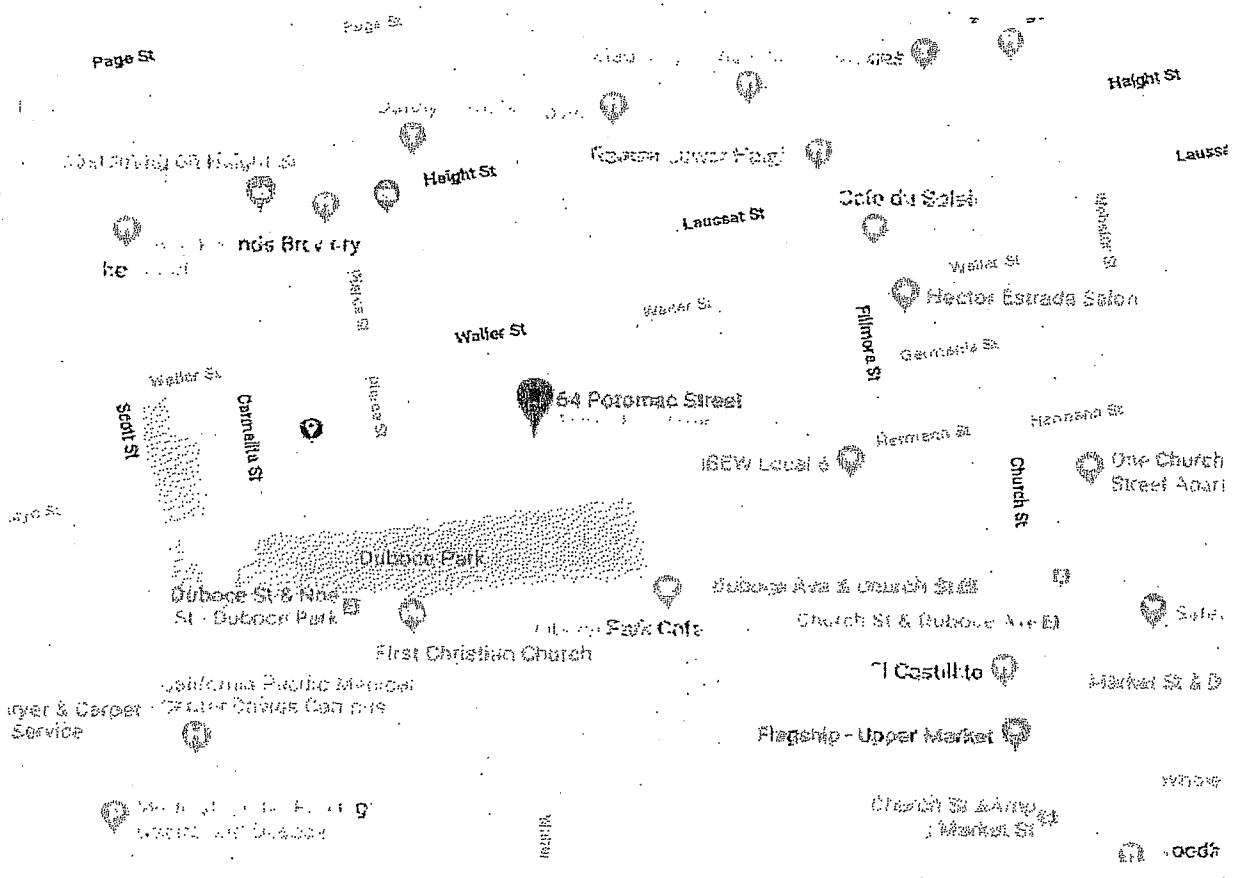

INCOME APPROACH

Address: 64 Potomac St

Lien Date: 7/1/2019

	<u>Monthly Rent</u>		<u>Annualized</u>	
Potential Gross Income*	\$6,500	x	12	\$78,000
Less: Vacancy & Collection Loss			3%	<u>(\$2,340)</u>
Effective Gross Income				\$75,660
Less: Anticipated Operating Expenses (Pre-Property Tax)**			15%	<u>(\$11,349)</u>
Net Operating Income (Pre-Property Tax)				\$64,311

Restricted Capitalization Rate

2019 interest rate per State Board of Equalization			4.7500%	
Risk rate (4% owner occupied / 2% all other property types)			4.0000%	
2018 property tax rate ***			1.1630%	
Amortization rate for improvements only				
Remaining economic life (Years)	40	0.0250	<u>0.7500%</u>	
Improvements constitute % of total property value	30%			10.6630%

RESTRICTED VALUE ESTIMATE **\$603,123**

Rounded to the nearest \$10,000 **\$600,000**

Notes:

- * Potential Gross Income was based on rental comps selected on next page. The projected rent was weighted more for Comps #2 & 5 due to their similar living area range to the subject's GLA.
- ** Annual operating expenses include water service, refuse collection, insurance, and regular maintenance items. Assumes payment of PG&E by lessee.
- *** The 2019 property tax rate will be determined in September, 2019.

Rent Comparables

Address: 64 Potomac St
Lien Date: 7/1/2019

Rental Comp #1



Rental Source: MLS
Address: 4087 17th St
Cross Streets: Diamond St
SF: 1,945
Layout: SFR: 3br/2ba, 1 car parking
Monthly Rent: \$8,500
Rent/Foot/Mo: \$4.37
Annual Rent/Foot: \$52.44

Rental Comp #2

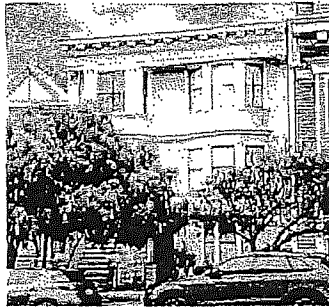

Holpads
Address: 112 Divisadero St
Cross Streets: Duboce St
SF: 1,500
Layout: SFR: 3br/2ba, No parking
Monthly Rent: \$6,600
Rent/Foot/Mo: \$4.40
Annual Rent/Foot: \$52.80

Rental Comp #3

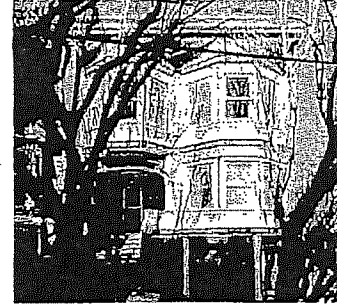

Holpads
Address: 152 Henry Street
Cross Streets: Castro St
SF: 2,000
Layout: Duplex: 3br/2ba, 1 car parking
Monthly Rent: \$8,000
Rent/Foot/Mo: \$4.00
Annual Rent/Foot: \$48.00

Rental Comp #4

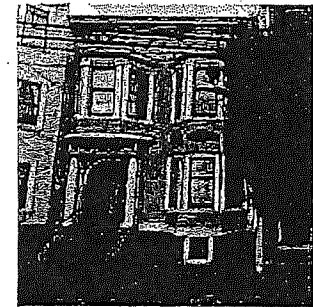

Holpads
Address: 81 Waller St
Cross Streets: 14th St
SF: 1,935
Layout: SFR: 2br/1.5ba, No parking
Monthly Rent: \$6,114
Rent/Foot/Mo: \$3.16
Annual Rent/Foot: \$37.92

Rental Comp #5



Rental Source: Craigslist
Address: 1412 Golden Gate
Cross Streets: Steiner St
SF: 1,700
Layout: SFH: 3br/2.5ba, No car parking.
Monthly Rent: \$6,976

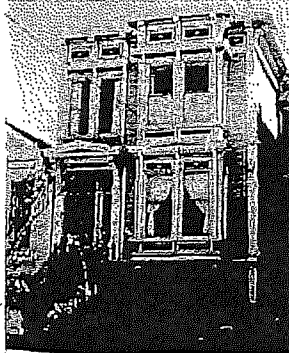

Rental Comp #6



Zillow/Craigslist
Address: 70-72 Webster St
Cross Streets: Germana St
SF: 1,800
Layout: Duplex: 3br/2ba, 2 car parking
Monthly Rent: \$7,650

1452

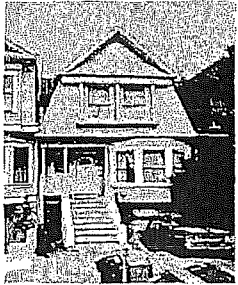
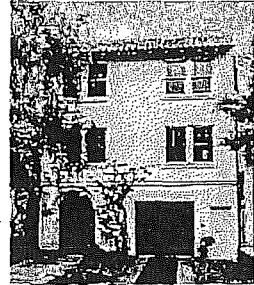
SINGLE FAMILY MARKET ANALYSIS

APN	Subject-A 0866 014	Sale 1-B 2608-048	Sale 2-C 0874 011	Sale 3-D 3561 042			
							
Address	64 Potomac St	15 Park Hill Ave	32 Church St	69 Beaver St			
Sales Price		\$2,620,000	\$2,810,000	\$2,617,000			
Sale Price / Square Foot		\$1,310	\$1,198	\$1,506			
	Description	Description	Adjust	Description	Adjust	Description	Adjust
Date of Valuation/Sale	07/01/19	10/09/18		06/25/18		03/19/18	
Neighborhood	Hayes Valley	5 - Buena Vista/Ashbury	\$131,000	5 - Duboce Triangle	\$84,000	5 - Duboce Triangle	\$79,000
Proximity to Subject	--						
Land Area	2,247	2,874	(31,000)	1,995	13,000	2,875	(31,000)
View Type	Neighborhood	City Lights, Hills				al Garden/Greenbelt	
Year Built	1900	1921		1924		1892	
Condition Type	Average	Average		Good	(\$84,000)	Above Average	(\$52,000)
Traffic	Quiet/Residential	Similar		Busy	\$141,000	Similar	
Building Area	1,750	2,000	(150,000)	2,345	(357,000)	1,738	
Total Number of Rooms	6						
Bedroom Count	2	3		3		3	
Bath Count	1.0	1.5	(\$25,000)	2.5	(\$75,000)	2	(\$50,000)
Number of Stories							
Parking Type/Count	1	1	\$0	2	(\$50,000)	2	(\$50,000)
Bonus Living Area	None						
Net Adjustments			(\$75,000)		(\$328,000)		(\$104,000)
Indicated Value	\$2,500,000		\$2,545,000		\$2,482,000		\$2,513,000
Adjust: \$ Per Sq. Ft.	\$1,429		\$1,454		\$1,418		\$1,436

Value Range:	Low	High	VALUE CONCLUSION:	\$2,500,000	\$1,429
Adjust. \$ Per Sq. Ft.	\$2,482,000	\$2,545,000		\$2,500,000	\$1,429
	\$1,418	\$1,454			

REMARKS: The subject's property features were based on archive data from the Assessor's records.

Adjustments are made to the comparables. (Rounded to the nearest \$1,000.)

*Lot Area adj. based on per square foot of \$ 50 over a % variance o 5%

*GLA adjustment based on per square foot of \$ 600 over a % variance o 5%



SAN FRANCISCO PLANNING DEPARTMENT

PRE-APPROVAL INSPECTION REPORT

Report Date: May 23, 2019
Inspection Date: May 24, 2019; 9:00am
Filing Date: May 1, 2019
Case No.: 2019-006322MLS
Project Address: 64 Potomac
Block/Lot: 0866/014
Eligibility: Contributor to the Duboce Park Historic District
Zoning: RH-2 – Residential-House, Two-Family
Height & Bulk: 40-X
Supervisor District: District 8 (Rafael Mandelman)
Project Sponsor: Gustav Lindqvist
Address: 64 Potomac
San Francisco, CA 94117
415-470-1096
gustav.lindqvist@me.com
Staff Contact: Michelle Taylor – (415) 575-9197
michelle.taylor@sfgov.org
Reviewed By: Tim Frye – (415) 575-6822
tim.frye@sfgov.org

1650 Mission St.
Suite 400
San Francisco,
CA 94103-2479

Reception:
415.558.6378

Fax:
415.558.6409

Planning
Information:
415.558.6377

PRE-INSPECTION

Application fee paid

Record of calls or e-mails to applicant to schedule pre-contract inspection

5/13/19: Email applicant to schedule site visit.

5/22/19: Confirm site visit for 5/23/19 at 9:00am.

INSPECTION OVERVIEW

Date and time of inspection: Thursday, May 23, 2019, 9:00am

Parties present: Michelle Taylor, Gustav Lindqvist, and Sean O'Neill of Seapoint Construction

- Provide applicant with business cards
- Inform applicant of contract cancellation policy
- Inform applicant of monitoring process

Inspect property. If multi-family or commercial building, inspection included a:

- Thorough sample of units/spaces
- Representative
- Limited
- Review any recently completed and in progress work to confirm compliance with Contract.
- Review areas of proposed work to ensure compliance with Contract.
- Review proposed maintenance work to ensure compliance with Contract.
- Identify and photograph any existing, non-compliant features to be returned to original condition during contract period. Applicant has removed approximately 50% of exterior rear siding without a permit. Applicant explained that the rear siding exhibited extensive dry rot and needed to be replaced. I advised applicant to apply for a building permit and Administrative Certificate of Appropriateness (ACOA) to remove and replace the siding in kind. (See photos below)

Yes No Does the application and documentation accurately reflect the property's existing condition? If no, items/issues noted:
No. The property is currently undergoing interior and partial exterior rehabilitation work (Building Permit No. 201812219020). Photos provided in application show the property prior to the current work. Photos below show current condition at site visit.
Additionally, Applicant has removed approximately 50% of exterior rear siding without a permit. Applicant explained that the rear siding exhibited extensive dry rot and needed to be replaced. I advised applicant to apply for a building permit and Administrative Certificate of Appropriateness (ACOA).

Yes No Does the proposed scope of work appear to meet the Secretary of the Interior's Standards? If no, items/issues noted:

Yes No Does the property meet the exemption criteria, including architectural style, work of a master architect, important persons or danger of deterioration or demolition without rehabilitation? If no, items/issues noted: N/A

Yes No Conditions for approval? If yes, see below.

NOTES

64 Potomac Street (District 8) 64 Potomac Street is located on the east side of Potomac Street between Waller Street and Duboce Avenue, Assessor's Block 0866 Lot 014. The subject property is located within a RH-2 (Residential-House, Two-Family District) zoning district and a 40-X Height and Bulk district. The subject property is a contributing building to the Article 10 Duboce Park Historic District. It is a two story over garage, wood-frame, single-family dwelling built in 1899 and features a gable roof and bay window.

The subject property is currently valued by the Assessor's Office at under \$3,000,000. Therefore, an exemption from the tax assessment value is not required.

The applicant is currently rehabilitating the property under Building Permit Number 201812219020. The permitted scope of work includes seismic strengthening, chimney removal, full window replacement at all elevations, garage door replacement, enlargement of openings at the rear elevation (not visible from the street), and interior improvements. Additionally, the applicant's rehabilitation plan proposes siding repairs, re-roofing, front door replacement, restoration of the front steps, and full repainting. The estimated cost of the proposed rehabilitation work is \$126,035.

At the site visit, applicant was advised on a number of clarifications and modifications to the proposed rehabilitation plan. These included:

- A site visit concluded that rear siding removal occurred without a building permit and without an entitlement (Administrative Certificate of Appropriateness) as required for the Duboce Park Historic District. The applicant was advised to submit an Admin COA and building permit.
- The applicant was advised to submit an Admin COA for the proposed replacement of the existing front door with a historically compatible design.
- Applicant originally proposed replacing the original wood-frame hung windows with Marvin Wood Ultimate with Ogee lug inserts at the front façade; however, these windows are not a true replacement in kind. The applicant has opted instead to repair the windows in conformance with the Secretary of the Interior's Standards. Applicant updated the Rehabilitation Plan to reflect this change.
- The applicant was advised that the repair of the rear deck is not a qualifying scope of work and cannot be included in a Rehabilitation Plan.
- Applicant will be providing drawings and/or product information for the proposed garage door for the Mills Act application to ensure that new door is compatible with neighborhood.
- Applicant was advised that re-roofing requires a building permit but does not require an Admin COA.
- Applicant was advised that restoration of the front stairs and/or railings to their historic look and materials will require a building permit and Admin COA.

The maintenance plan proposes to inspect and make any necessary repairs to the siding, windows, front porch, and roof on an annual basis. The estimated cost of maintenance work is \$4,000 annually.

PHOTOGRAPHS

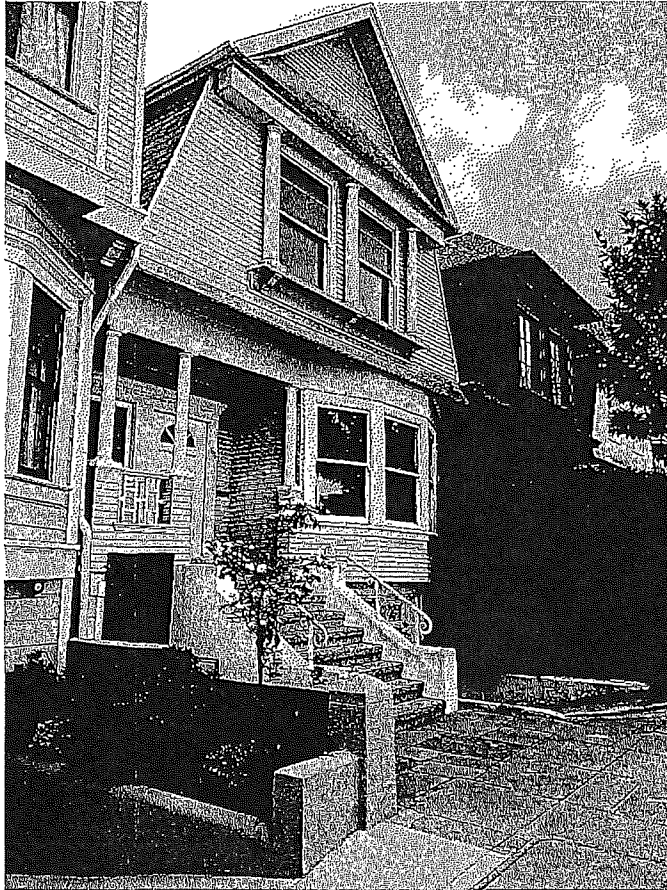

Front façade prior to current work (above) and rear façade including removal of rear siding (below)

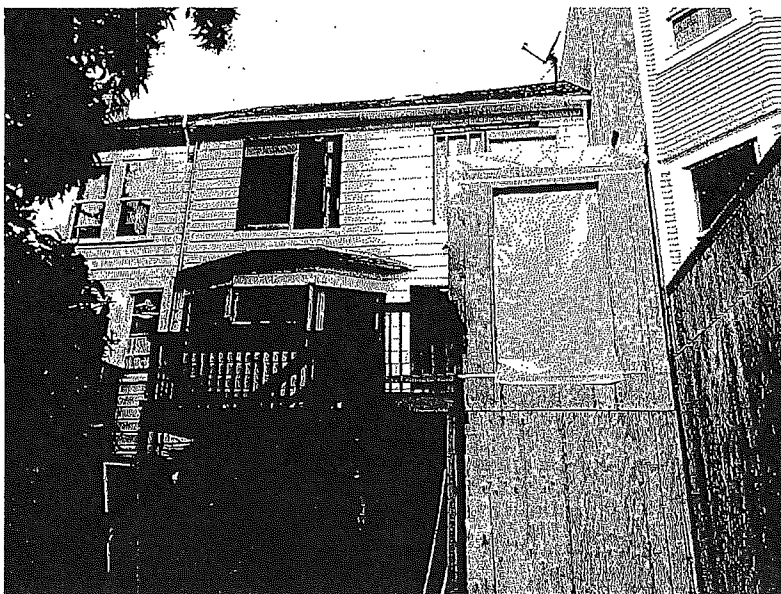

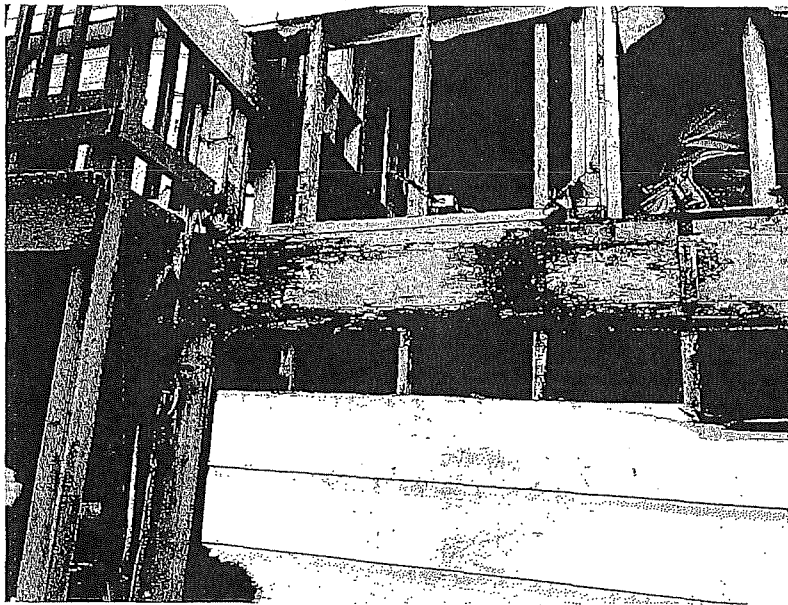
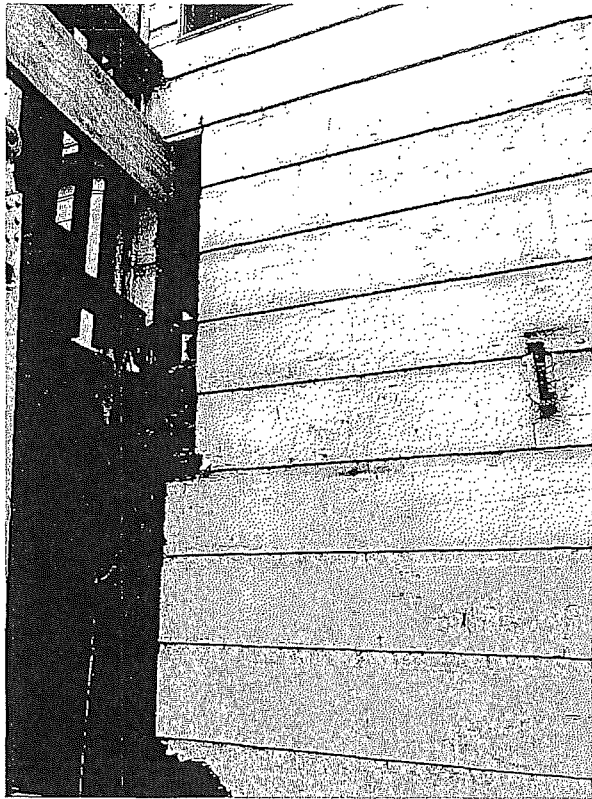

Detail photos of dry rot located at rear of building

MILLS ACT HISTORICAL PROPERTY CONTRACT

Application Checklist:

Applicant should complete this checklist and submit along with the application to ensure that all necessary materials have been provided. Saying "No" to any of the following questions may nullify the timelines established in this application.

1 Mills Act Application	YES <input checked="" type="checkbox"/> NO <input type="checkbox"/>
Has each property owner signed? Has each signature been notarized?	
2 High Property Value Exemption Form & Historic Structure Report	YES <input type="checkbox"/> NO <input type="checkbox"/> N/A <input checked="" type="checkbox"/>
Required for Residential properties with an assessed value over \$3,000,000 and Commercial/Industrial properties with an assessed value over \$5,000,000. Have you included a copy of the Historic Structures Report completed by a qualified consultant?	
3 Draft Mills Act Historical Property Contract	YES <input checked="" type="checkbox"/> NO <input type="checkbox"/>
Are you using the Planning Department's standard "Historical Property Contract?" Have all owners signed and dated the contract? Have all signatures been notarized?	
4 Notary Acknowledgement Form	YES <input type="checkbox"/> NO <input type="checkbox"/>
Is the Acknowledgement Form complete? Do the signatures match the names and capacities of signers?	
5 Draft Rehabilitation/Restoration/Maintenance Plan	YES <input checked="" type="checkbox"/> NO <input type="checkbox"/>
Have you identified and completed the Rehabilitation, Restoration, and Maintenance Plan organized by contract year, including all supporting documentation related to the scopes of work?	
6 Photographic Documentation	YES <input checked="" type="checkbox"/> NO <input type="checkbox"/>
Have you provided both interior and exterior images (either digital, printed, or on a CD)? Are the images properly labeled?	
7 Site Plan	YES <input checked="" type="checkbox"/> NO <input type="checkbox"/>
Does your site plan show all buildings on the property including lot boundary lines, street name(s), north arrow and dimensions?	
8 Tax Bill	YES <input checked="" type="checkbox"/> NO <input type="checkbox"/>
Did you include a copy of your most recent tax bill?	
9 Rental Income Information	YES <input type="checkbox"/> NO <input checked="" type="checkbox"/>
Did you include information regarding any rental income on the property, including anticipated annual expenses, such as utilities, garage, insurance, building maintenance, etc.?	
10 Payment	YES <input type="checkbox"/> NO <input type="checkbox"/>
Did you include a check payable to the San Francisco Planning Department? Current application fees can be found on the Planning Department Fee Schedule under Preservation Applications.	
11 Recordation Requirements	YES <input type="checkbox"/> NO <input type="checkbox"/>
A Board of Supervisors approved and fully executed Mills Act Historical Property contract must be recorded with the Assessor-Recorder. The contract must be <u>accompanied</u> by the following in order to meet recording requirements:	
<ul style="list-style-type: none"> - All approvals, signatures, recordation attachments - Fee: Check payable to the Office of the Assessor-Recorder" in the appropriate recording fee amount. Please visit www.sfassessor.org for an up-to-date fee schedule for property contracts. - Preliminary Change of Ownership Report (PCOR). Please visit www.sfassessor.org for an up-to-date PCOR (see example on page 20). 	

APPLICATION FOR Mills Act Historical Property Contract

Applications must be submitted in both hard copy and digital copy form to the Planning Department at 1650 Mission St., Suite 400 by May 1st in order to comply with the timelines established in the Application Guide. Please submit only the Application and required documents.

1. Owner/Applicant Information (If more than three owners, attach additional sheets as necessary.)

PROPERTY OWNER 1 NAME: Gustav Lindqvist	TELEPHONE: (415) 470 1096
PROPERTY OWNER 1 ADDRESS: 64 Potomac Street, San Francisco, CA 94117	EMAIL: gustav.lindqvist@me.com
PROPERTY OWNER 2 NAME: Caroline Ingebom	TELEPHONE: (415) 691 0694
PROPERTY OWNER 2 ADDRESS: 64 Potomac Street, San Francisco, CA 94117	EMAIL: caro.ingebom@gmail.com
PROPERTY OWNER 3 NAME:	TELEPHONE:
PROPERTY OWNER 3 ADDRESS:	EMAIL:

2. Subject Property Information

PROPERTY ADDRESS: 64 Potomac Street	ZIP CODE: 94117
PROPERTY PURCHASE DATE: May 17, 2018	ASSESSOR BLOCK/LOT(S): 0866/014
MOST RECENT ASSESSED VALUE: \$2,493,000	ZONING DISTRICT: -RH-2

Are taxes on all property owned within the City and County of San Francisco paid to date? YES NO

Is the entire property owner-occupied? YES NO
If No, please provide an approximate square footage for owner-occupied areas vs. rental income (non-owner-occupied areas) on a separate sheet of paper.

Do you own other property in the City and County of San Francisco? YES NO
If Yes, please list the addresses for all other property owned within the City of San Francisco on a separate sheet of paper.

Are there any outstanding enforcement cases on the property from the San Francisco Planning Department or the Department of Building Inspection? YES NO
If Yes, all outstanding enforcement cases must be abated and closed for eligibility for the Mills Act.

I/we am/are the present owner(s) of the property described above and hereby apply for an historical property contract. By signing below, I affirm that all information provided in this application is true and correct. I further swear and affirm that false information will be subject to penalty and revocation of the Mills Act Contract.

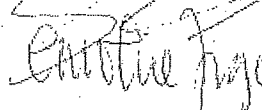
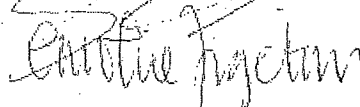
Owner Signature: 	Date: 4/28/19
Owner Signature: 	Date: 4/28/19
Owner Signature:	Date:

3. Property Value Eligibility:

Choose one of the following options:

The property is a Residential Building valued at less than \$3,000,000.

YES NO

The property is a Commercial/Industrial Building valued at less than \$5,000,000.

YES NO

*If the property value exceeds these options, please complete the following: Application of Exemption.

Application for Exemption from Property Tax Valuation

If answered "no" to either question above please explain on a separate sheet of paper, how the property meets the following two criteria and why it should be exempt from the property tax valuations.

1. The site, building, or object, or structure is a particularly significant resource and represents an exceptional example of an architectural style, the work of a master, or is associated with the lives of significant persons or events important to local or natural history; or
2. Granting the exemption will assist in the preservation of a site, building, or object, or structure that would otherwise be in danger of demolition, substantial alteration, or disrepair. (A Historic Structures Report, completed by a qualified historic preservation consultant, must be submitted in order to meet this requirement.)

4. Property Tax Bill

All property owners are required to attach a copy of their recent property tax bill.

PROPERTY OWNER NAMES:

Gustav Lindqvist

Caroline Ingeborn

MOST RECENT ASSESSED PROPERTY VALUE:

\$2,493,000

PROPERTY ADDRESS:

64 Potomac Street, San Francisco, CA 94117

5. Other Information

All property owners are required to attach a copy of all other information as outlined in the checklist on page 7 of this application.

By signing below, I/we acknowledge that I/we am/are the owner(s) of the structure referenced above and by applying for exemption from the limitations herein, under the penalty of perjury, that the information attached and provided is accurate.

Owner Signature:

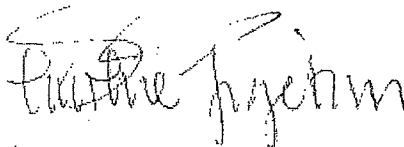

Date: 4/28/19

Owner Signature:

Date:

Owner Signature:

Date:

5. Rehabilitation/Restoration & Maintenance Plan

A 10 Year Rehabilitation/Restoration Plan has been submitted detailing work to be performed on the subject property	YES <input checked="" type="checkbox"/> NO <input type="checkbox"/>
A 10 Year Maintenance Plan has been submitted detailing work to be performed on the subject property	YES <input checked="" type="checkbox"/> NO <input type="checkbox"/>
Proposed work will meet the <i>Secretary of the Interior's Standards for the Treatment of Historic Properties</i> and/or the California Historic Building Code.	YES <input checked="" type="checkbox"/> NO <input type="checkbox"/>
Property owner will ensure that a portion of the Mills Act tax savings will be used to finance the preservation, rehabilitation, and maintenance of the property	YES <input checked="" type="checkbox"/> NO <input type="checkbox"/>

Use this form to outline your rehabilitation/restoration plan. Copy this page as necessary to include all items that apply to your property. Begin by listing recently completed rehabilitation work (if applicable) and continue with work you propose to complete within the next ten years, followed by your proposed maintenance work. Arranging all scopes of work in order of priority.

Please note that *all applicable Codes and Guidelines apply to all work*, including the Planning Code and Building Code. If components of the proposed Plan require approvals by the Historic Preservation Commission, Planning Commission, Zoning Administrator, or any other government body, these approvals must be secured prior to applying for a Mills Act Historical Property Contract. This plan will be included along with any other supporting documents as part of the Mills Act Historical Property contract.

# 1 (Provide a scope number)	BUILDING FEATURE
Rehab/Restoration <input type="checkbox"/>	Maintenance <input type="checkbox"/>
Completed <input type="checkbox"/>	Proposed <input type="checkbox"/>
CONTRACT YEAR FOR WORK COMPLETION:	
TOTAL COST (rounded to nearest dollar):	
DESCRIPTION OF WORK	
X	

6. Draft Mills Act Historical Property Agreement

Please complete the following Draft Mills Act Historical Property Agreement and submit with your application. A final Mills Act Historical Property Agreement will be issued by the City Attorney once the Board of Supervisors approves the contract. The contract is not in effect until it is fully executed and recorded with the Office of the Assessor-Recorder.

Any modifications made to this standard City contract by the applicant or if an independently-prepared contract is used, it shall be subject to approval by the City Attorney prior to consideration by the Historic Preservation Commission and the Board of Supervisors. This will result in additional application processing time and the timeline provided in the application will be nullified.

Recording Requested by,
and when recorded, send notice to:
Director of Planning
950 Mission Street
San Francisco, California 94103-2414

California Mills Act Historical Property Agreement

PROPERTY NAME (IF ANY)

64 Potomac Street

PROPERTY ADDRESS

San Francisco, California

THIS AGREEMENT is entered into by and between the City and County of San Francisco, a California municipal corporation ("City") and Caroline Ingeborn and Gustav Lindqvist ("Owner/s").

RECITALS

Owners are the owners of the property located at 64 Potomac Street, in San Francisco, California

PROPERTY ADDRESS

0866

014

The building located at

64 Potomac Street

BLOCK NUMBER

LOT NUMBER

PROPERTY ADDRESS

is designated as part of Landmark District: Duboce Park pursuant to Article 10 of the planning code (e.g. "a City Landmark pursuant to Article 10 of the Planning Code") and is also known as the N/A

HISTORIC NAME OF PROPERTY (IF ANY)

Owners desire to execute a rehabilitation and ongoing maintenance project for the Historic Property. Owners' application calls for the rehabilitation and restoration of the Historic Property according to established preservation standards, which it estimates will cost approximately One hundred ninety three thousand (\$ \$193,000). See Rehabilitation Plan, Exhibit A.

AMOUNT IN WORD FORMAT

AMOUNT IN NUMERICAL FORMAT

Owners' application calls for the maintenance of the Historic Property according to established preservation standards, which is estimated will cost approximately Eighty thousand (\$ \$80,000) annually. See Maintenance Plan, Exhibit B.

AMOUNT IN WORD FORMAT

AMOUNT IN NUMERICAL FORMAT

The State of California has adopted the "Mills Act" (California Government Code Sections 50280-50290, and California Revenue & Taxation Code, Article 1.9 [Section 439 et seq.] authorizing local governments to enter into agreements with property owners to potentially reduce their property taxes in return for improvement to and maintenance of historic properties. The City has adopted enabling legislation, San Francisco Administrative Code Chapter 71, authorizing it to participate in the Mills Act program.

Owners desire to enter into a Mills Act Agreement (also referred to as a "Historic Property Agreement") with the City to help mitigate its anticipated expenditures to restore and maintain the Historic Property. The City is willing to enter into such Agreement to mitigate these expenditures and to induce Owners to restore and maintain the Historic Property in excellent condition in the future.

NOW, THEREFORE, in consideration of the mutual obligations, covenants, and conditions contained herein, the parties hereto do agree as follows:

Mills Act Application

1. Application of Mills Act.

The benefits, privileges, restrictions and obligations provided for in the Mills Act shall be applied to the Historic Property during the time that this Agreement is in effect commencing from the date of recordation of this Agreement.

2. Rehabilitation of the Historic Property.

Owners shall undertake and complete the work set forth in Exhibit A ("Rehabilitation Plan") attached hereto according to certain standards and requirements. Such standards and requirements shall include, but not be limited to: the Secretary of the Interior's Standards for the Treatment of Historic Properties ("Secretary's Standards"); the rules and regulations of the Office of Historic Preservation of the California Department of Parks and Recreation ("OHP Rules and Regulations"); the State Historical Building Code as determined applicable by the City; all applicable building safety standards; and the requirements of the Historic Preservation Commission, the Planning Commission, and the Board of Supervisors, including but not limited to any Certificates of Appropriateness approved under Planning Code Article 10. The Owners shall proceed diligently in applying for any necessary permits for the work and shall apply for such permits not less than six (6) months after recordation of this Agreement, shall commence the work within six (6) months of receipt of necessary permits, and shall complete the work within three (3) years from the date of receipt of permits. Upon written request by the Owners, the Zoning Administrator, at his or her discretion, may grant an extension of the time periods set forth in this paragraph. Owners may apply for an extension by a letter to the Zoning Administrator, and the Zoning Administrator may grant the extension by letter without a hearing. Work shall be deemed complete when the Director of Planning determines that the Historic Property has been rehabilitated in accordance with the standards set forth in this Paragraph. Failure to timely complete the work shall result in cancellation of this Agreement as set forth in Paragraphs 13 and 14 herein.

3. Maintenance.

Owners shall maintain the Historic Property during the time this Agreement is in effect in accordance with the standards for maintenance set forth in Exhibit B ("Maintenance Plan"), the Secretary's Standards; the OHP Rules and Regulations; the State Historical Building Code as determined applicable by the City; all applicable building safety standards; and the requirements of the Historic Preservation Commission, the Planning Commission, and the Board of Supervisors, including but not limited to any Certificates of Appropriateness approved under Planning Code Article 10.

4. Damage.

Should the Historic Property incur damage from any cause whatsoever, which damages fifty percent (50%) or less of the Historic Property, Owners shall replace and repair the damaged area(s) of the Historic Property. For repairs that do not require a permit, Owners shall commence the repair work within thirty (30) days of incurring the damage and shall diligently prosecute the repair to completion within a reasonable period of time, as determined by the City. Where specialized services are required due to the nature of the work and the historic character of the features damaged, "commence the repair work" within the meaning of this paragraph may include contracting for repair services. For repairs that require a permit(s), Owners shall proceed diligently in applying for any necessary permits for the work and shall apply for such permits not less than sixty (60) days after the damage has been incurred, commence the repair work within one hundred twenty (120) days of receipt of the required permit(s), and shall diligently prosecute the repair to completion within a reasonable period of time, as determined by the City. Upon written request by the Owners, the Zoning Administrator, at his or her discretion, may grant an extension of the time periods set forth in this paragraph. Owners may apply for an extension by a letter to the Zoning Administrator, and the Zoning Administrator may grant the extension by letter without a hearing. All repair work shall comply with the design and standards established for the Historic Property in Exhibits A and B attached hereto and Paragraph 3 herein. In the case of damage to twenty percent (20%) or more of the Historic Property due to a catastrophic event, such as an earthquake, or in the case of damage from any cause whatsoever that destroys more than fifty percent (50%) of the Historic Property, the City and Owners may mutually agree to terminate this Agreement. Upon such termination, Owners shall not be obligated to pay the cancellation fee set forth in Paragraph 14 of this Agreement. Upon such termination, the City shall assess the full value of the Historic Property without regard to any restriction imposed upon the Historic Property by this Agreement and Owners shall pay property taxes to the City based upon the valuation of the Historic Property as of the date of termination.

5. Insurance.

Owners shall secure adequate property insurance to meet Owners' repair and replacement obligations under this Agreement and shall submit evidence of such insurance to the City upon request.

6. Inspections.

Owners shall permit periodic examination of the exterior and interior of the Historic Property by representatives of the Historic Preservation Commission, the City's Assessor, the Department of Building Inspection, the Planning Department, the Office of Historic Preservation of the California Department of Parks and Recreation, and the State Board of Equalization, upon seventy-two (72) hours advance notice, to monitor Owners' compliance with the terms of this Agreement. Owners shall provide all reasonable information and documentation about the Historic Property demonstrating compliance with this Agreement as requested by any of the above-referenced representatives.

7. Term.

This Agreement shall be effective upon the date of its recordation and shall be in effect for a term of ten years from such date ("Initial Term"). As provided in Government Code section 50282, one year shall be added automatically to the Initial Term, on each anniversary date of this Agreement, unless notice of nonrenewal is given as set forth in Paragraph 10 herein.

8. Valuation.

Pursuant to Section 439.4 of the California Revenue and Taxation Code, as amended from time to time, this Agreement must have been signed, accepted and recorded on or before the lien date (January 1) for a fiscal year (the following July 1-June 30) for the Historic Property to be valued under the taxation provisions of the Mills Act for that fiscal year.

9. Termination.

In the event Owners terminates this Agreement during the Initial Term, Owners shall pay the Cancellation Fee as set forth in Paragraph 15 herein. In addition, the City Assessor-Recorder shall determine the fair market value of the Historic Property without regard to any restriction imposed on the Historic Property by this Agreement and shall reassess the property taxes payable for the fair market value of the Historic Property as of the date of Termination without regard to any restrictions imposed on the Historic Property by this Agreement. Such reassessment of the property taxes for the Historic Property shall be effective and payable six (6) months from the date of Termination.

10. Notice of Nonrenewal.

If in any year after the Initial Term of this Agreement has expired either the Owners or the City desires not to renew this Agreement that party shall serve written notice on the other party in advance of the annual renewal date. Unless the Owners serves written notice to the City at least ninety (90) days prior to the date of renewal or the City serves written notice to the Owners sixty (60) days prior to the date of renewal, one year shall be automatically added to the term of the Agreement. The Board of Supervisors shall make the City's determination that this Agreement shall not be renewed and shall send a notice of nonrenewal to the Owners. Upon receipt by the Owners of a notice of nonrenewal from the City, Owners may make a written protest. At any time prior to the renewal date, City may withdraw its notice of nonrenewal. If in any year after the expiration of the Initial Term of the Agreement, either party serves notice of nonrenewal of this Agreement, this Agreement shall remain in effect for the balance of the period remaining since the execution of the last renewal of the Agreement.

11. Payment of Fees.

Within one month of the execution of this Agreement, City shall tender to Owners a written accounting of its reasonable costs related to the preparation and approval of the Agreement as provided for in Government Code Section 50281.1 and San Francisco Administrative Code Section 71.6. Owners shall promptly pay the requested amount within forty-five (45) days of receipt.

12. Default.

An event of default under this Agreement may be any one of the following:

- (a) Owners' failure to timely complete the rehabilitation work set forth in Exhibit A in accordance with the standards set forth in Paragraph 2 herein;
- (b) Owners' failure to maintain the Historic Property in accordance with the requirements of Paragraph 3 herein;
- (c) Owners' failure to repair any damage to the Historic Property in a timely manner as provided in Paragraph 4 herein;
- (d) Owners' failure to allow any inspections as provided in Paragraph 6 herein;
- (e) Owners' termination of this Agreement during the Initial Term;
- (f) Owners' failure to pay any fees requested by the City as provided in Paragraph 11 herein;
- (g) Owners' failure to maintain adequate insurance for the replacement cost of the Historic Property; or
- (h) Owners' failure to comply with any other provision of this Agreement.

An event of default shall result in cancellation of this Agreement as set forth in Paragraphs 13 and 14 herein and payment of the cancellation fee and all property taxes due upon the Assessor's determination of the full value of the Historic Property as set forth in Paragraph 14 herein. In order to determine whether an event of default has occurred, the Board of Supervisors shall conduct a public hearing as set forth in Paragraph 13 herein prior to cancellation of this Agreement.

13. Cancellation.

As provided for in Government Code Section 50284, City may initiate proceedings to cancel this Agreement if it makes a reasonable determination that Owners have breached any condition or covenant contained in this Agreement, has defaulted as provided in Paragraph 12 herein, or has allowed the Historic Property to deteriorate such that the safety and integrity of the Historic Property is threatened or it would no longer meet the standards for a Qualified Historic Property. In order to cancel this Agreement, City shall provide notice to the Owners and to the public and conduct a public hearing before the Board of Supervisors as provided for in Government Code Section 50285. The Board of Supervisors shall determine whether this Agreement should be cancelled. The cancellation must be provided to the Office of the Assessor-Recorder for recordation.

14. Cancellation Fee.

If the City cancels this Agreement as set forth in Paragraph 13 above, Owners shall pay a cancellation fee of twelve and one-half percent (12.5%) of the fair market value of the Historic Property at the time of cancellation. The City Assessor shall determine fair market value of the Historic Property without regard to any restriction imposed on the Historic Property by this Agreement. The cancellation fee shall be paid to the City Tax Collector at such time and in such manner as the City shall prescribe. As of the date of cancellation, the Owners shall pay property taxes to the City without regard to any restriction imposed on the Historic Property by this Agreement and based upon the Assessor's determination of the fair market value of the Historic Property as of the date of cancellation.

15. Enforcement of Agreement.

In lieu of the above provision to cancel the Agreement, the City may bring an action to specifically enforce or to enjoin any breach of any condition or covenant of this Agreement. Should the City determine that the Owners has breached this Agreement, the City shall give the Owners written notice by registered or certified mail setting forth the grounds for the breach. If the Owners do not correct the breach, or if it does not undertake and diligently pursue corrective action, to the reasonable satisfaction of the City within thirty (30) days from the date of receipt of the notice, then the City may, without further notice, initiate default procedures under this Agreement as set forth in Paragraph 13 and bring any action necessary to enforce the obligations of the Owners set forth in this Agreement. The City does not waive any claim of default by the Owners if it does not enforce or cancel this Agreement.

16. Indemnification.

The Owners shall indemnify, defend, and hold harmless the City and all of its boards, commissions, departments, agencies, agents and employees (individually and collectively, the "City") from and against any and all liabilities, losses, costs, claims, judgments, settlements, damages, liens, fines, penalties and expenses incurred in connection with or arising in whole or in part from: (a) any accident, injury to or death of a person, loss of or damage to property occurring in or about the Historic Property; (b) the use or occupancy of the Historic Property by the Owners, their Agents or Invitees; (c) the condition of the Historic Property; (d) any construction or other work undertaken by Owners on the Historic Property; or (e) any claims by unit or interval Owners for property tax reductions in excess those provided for under this Agreement. This indemnification shall include, without limitation, reasonable fees for attorneys, consultants, and experts and related costs that may be incurred by the City and all indemnified parties specified in this Paragraph and the City's cost of investigating any claim. In addition to Owners' obligation to indemnify City, Owners specifically acknowledge and agree that they have an immediate and independent obligation to defend City from any claim that actually or potentially falls within this indemnification provision, even if the allegations are or may be groundless, false, or fraudulent, which obligation arises at the time such claim is tendered to Owners by City, and continues at all times thereafter. The Owners' obligations under this Paragraph shall survive termination of this Agreement.

17. Eminent Domain.

In the event that a public agency acquires the Historic Property in whole or part by eminent domain or other similar action, this Agreement shall be cancelled and no cancellation fee imposed as provided by Government Code Section 50288.

18. Binding on Successors and Assigns.

The covenants, benefits, restrictions, and obligations contained in this Agreement shall be deemed to run with the land and shall be binding upon and inure to the benefit of all successors and assigns in interest of the Owners.

19. Legal Fees.

In the event that either the City or the Owners fail to perform any of their obligations under this Agreement or in the event a dispute arises concerning the meaning or interpretation of any provision of this Agreement, the prevailing party may recover all costs and expenses incurred in enforcing or establishing its rights hereunder, including reasonable attorneys' fees, in addition to court costs and any other relief ordered by a court of competent jurisdiction. Reasonable attorneys fees of the City's Office of the City Attorney shall be based on the fees regularly charged by private attorneys with the equivalent number of years of experience who practice in the City of San Francisco in law firms with approximately the same number of attorneys as employed by the Office of the City Attorney.

20. Governing Law.

This Agreement shall be construed and enforced in accordance with the laws of the State of California.

21. Recordation.

The contract will not be considered final until this agreement has been recorded with the Office of the Assessor-Recorder of the City and County of San Francisco.

22. Amendments.

This Agreement may be amended in whole or in part only by a written recorded instrument executed by the parties hereto in the same manner as this Agreement.

23. No Implied Waiver.

No failure by the City to insist on the strict performance of any obligation of the Owners under this Agreement or to exercise any right, power, or remedy arising out of a breach hereof shall constitute a waiver of such breach or of the City's right to demand strict compliance with any terms of this Agreement.

24. Authority.

If the Owners sign as a corporation or a partnership, each of the persons executing this Agreement on behalf of the Owners does hereby covenant and warrant that such entity is a duly authorized and existing entity, that such entity has and is qualified to do business in California, that the Owner has full right and authority to enter into this Agreement, and that each and all of the persons signing on behalf of the Owners are authorized to do so.

25. Severability.

If any provision of this Agreement is determined to be invalid or unenforceable, the remainder of this Agreement shall not be affected thereby, and each other provision of this Agreement shall be valid and enforceable to the fullest extent permitted by law.

26. Tropical Hardwood Ban.

The City urges companies not to import, purchase, obtain or use for any purpose, any tropical hardwood or tropical hardwood product.

27. Charter Provisions.

This Agreement is governed by and subject to the provisions of the Charter of the City.

28. Signatures.

This Agreement may be signed and dated in parts

IN WITNESS WHEREOF, the parties hereto have executed this Agreement as follows.

CARMEN CHU
ASSESSOR-RECORDER
CITY & COUNTY OF SAN FRANCISCO

Date

JOHN RAHAIM
DIRECTOR OF PLANNING
CITY & COUNTY OF SAN FRANCISCO

Date

APPROVED AS PER FORM:
DENNIS HERRERA
CITY ATTORNEY
CITY & COUNTY OF SAN FRANCISCO

Signature

Date

Print name
DEPUTY CITY ATTORNEY

Signature

4/28/19
Date

Signature

4/28/19
Date

GUSTAV LINDQVIST
Print name
OWNER

CAROLINE INGEBØEN
Print name
OWNER

Owner/s' signatures must be notarized. Attach notary forms to the end of this agreement.
(If more than one owner, add additional signature lines. All owners must sign this agreement.)

ACKNOWLEDGMENT

A notary public or other officer completing this certificate verifies only the identity of the individual who signed the document to which this certificate is attached, and not the truthfulness, accuracy, or validity of that document.

State of California
County of SAN FRANCISCO)

On 4/28/19 before me, J. MINJIRAS, Notary Public
(insert name and title of the officer)

personally appeared GUSTAV LINDQVIST, CAROLINE INGEBORN
who proved to me on the basis of satisfactory evidence to be the person(s) whose name(s) is/are subscribed to the within instrument and acknowledged to me that he/she/they executed the same in his/her/their authorized capacity(ies), and that by his/her/their signature(s) on the instrument the person(s), or the entity upon behalf of which the person(s) acted, executed the instrument.

I certify under PENALTY OF PERJURY under the laws of the State of California that the foregoing paragraph is true and correct.

WITNESS my hand and official seal.

Signature J. Minjiras (Seal)

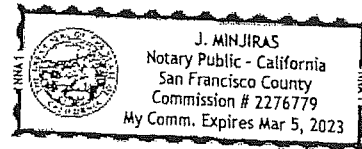

We believe that our property on 64 Potomac Street meets the priority consideration criteria for the Mills Act program according to the following:

Necessity - In its current state the property is uninhabitable. There is no functioning bathroom or kitchen, severe dry rot, bad smell due to animals being kept inside by previous owner. Furthermore the facade is in a really bad shape with dry rot in several places and most of the 6 windows facing the front are broken and/or has damaged framing. Please see the attached photos. The significant leakage and poor condition of the property puts the house in danger of further deterioration. The costs associated with stemming this are substantial. Attached is a bid from the contractor Seapoint Construction giving us a minimum cost of \$627,000, including structural work (see below), in order to rehabilitate and restore the house

Investment - We will be investing significant amounts to do a seismic retrofitting of the house. In addition to that we are investing in a new roof. More detail can be found in the attached permit set, which has been approved. This shows our commitment to the restoration and rehabilitation and maintenance of the property.

Distinctiveness - The property is located in the Duboce Park Landmark District, which supports the exceptional nature of the property.

Gustav Lindqvist - Owner

Caroline Ingeborn - Owner



City & County of San Francisco
 José Cisneros, Treasurer
 David Augustine, Tax Collector
 Supplemental Property Tax Bill (Secured)
 FOR FISCAL YEAR JULY 1, 2018 THROUGH JUNE 30, 2019

1 Dr. Carlton B. Goodlett Place
 City Hall, Room 140
 San Francisco, CA 94102
 www.sftreasurer.org

Vol 06	Block 0866	Lot 014	Tax Bill No 805712	Mail Date 02/25/2019	Property Location 64 POTOMAC ST
-----------	---------------	------------	-----------------------	-------------------------	------------------------------------

Assessee: NAME PRIVATE PER CA AB 2238

**ADDRESS INFORMATION
 NOT AVAILABLE ONLINE**

TOTAL TAX DUE		\$28,749.74
First Installment	Second Installment	
\$14,374.87	\$14,374.87	
DUE	DUE	
04/01/2019	07/31/2019	

Assessed Value			
Description	New Base Year Value	Current Roll	Supplemental Assessment
Land	1,750,000	18,250	1,731,750
Improvement, Structure	750,000	9,716	740,284
Less HO Exemption	7,000	7,000	
Less Other Exemption			
Assessed Value Total	2,493,000	20,966	2,472,034

Supplemental assessment - see back for details

For The Period 07/01/2018 THROUGH 06/30/2019		
Tax Rate 1.1630%	Rate Factor 100%	Event Date 05/17/2018

Keep this portion for your records. See back of bill for payment options and additional information.



City & County of San Francisco
 Supplemental Property Tax Bill (Secured)
 FOR THE PERIOD 07/01/2018 THROUGH 06/30/2019

Pay online at SFTREASURER.ORG

Vol 06	Block 0866	Lot 014	Tax Bill No 805712	Mail Date 02/25/2019	Property Location 64 POTOMAC ST
-----------	---------------	------------	-----------------------	-------------------------	------------------------------------

Detach stub and return with payment.
 Write your block and lot on your check.
 2nd installment cannot be accepted unless 1st is paid.

2nd Installment Due
\$14,374.87

2

San Francisco Tax Collector
 Secured Supplemental Property Tax
 P.O. Box 7426
 San Francisco, CA 94120-7426

If paid or postmarked after **JULY 31, 2019**
 the amount due (includes delinquent penalty of 10% and
 other applicable fees) is:

\$15,857.35

0608660001400 805712 001437487 000143748 071918 2503



City & County of San Francisco
 Supplemental Property Tax Bill (Secured)
 FOR THE PERIOD 07/01/2018 THROUGH 06/30/2019

Pay online at SFTREASURER.ORG

Vol 06	Block 0866	Lot 014	Tax Bill No 805712	Mail Date 02/25/2019	Property Location 64 POTOMAC ST
-----------	---------------	------------	-----------------------	-------------------------	------------------------------------

Detach stub and return with payment.
 Write your block and lot on your check.

1st Installment Due
\$14,374.87

1

San Francisco Tax Collector
 Secured Supplemental Property Tax
 P.O. Box 7426
 San Francisco, CA 94120-7426

If paid or postmarked after **APRIL 1, 2019**
 the amount due (includes delinquent penalty
 of 10%) is:

\$15,812.35

0608660001400 805712 001437487 000143748 041918 1503

Pay Now	Contact Us
<p>Online: www.sftreasurer.org</p> <p>Mail a check payable to "SF Tax Collector" with the bottom portion of bill in the enclosed envelope</p> <p>In person at City Hall, Room 140 8 am - 5 PM, Monday - Friday, excluding holidays. Expect longer than normal wait times around delinquency dates.</p>	<p>Free language assistance Call: 3-1-1 415-701-2311 from outside of San Francisco</p> <p>Submit question online: www.sftreasurer.org/contact-us</p>

Supplemental tax bills are issued in addition to the annual tax bill, generally due to a change in ownership or new construction in accordance with Article XIII A of the California Constitution.

If you disagree with the assessed value as shown on your tax bill, you have the right to an informal assessment review by the Assessor-Recorder's Office. Visit www.sfassessor.org for more information. You also have the right to file an application for reduction in assessment for the following year by filing a written application with the Assessment Appeals Board, City Hall, 1 Dr. Carlton B. Goodlett Place, Room 405, San Francisco, CA 94102. The filing period is July 2 to September 15. Visit www.sfgov.org/aab or call 415-554-6778 for more information. If an informal or formal assessment review is requested, relief from penalties shall apply only to the difference between the Assessor-Recorder's final determination of value and the value on the assessment roll for the fiscal year covered.

Property Tax Postponement for Senior Citizens, Blind, or Disabled Persons

The State Controller's Office (SCO) administers the Property Tax Postponement (PTP) program, which allows eligible homeowners to postpone payment of current year property taxes on their primary residence. PTP applications are accepted from October 1 to February 10 each year. Go to the SCO website at www.sco.ca.gov/ardtax_prop_tax_postponement.html for more information. If you have any questions or to request an application, call 1-800-952-5661 or email postponement@sco.ca.gov

Did you...

Submit payment for the exact amount?

Confirm that you have sufficient funds in your account? If your payment is not honored by the bank, the payment is null and void and a \$50.00 "Payment Failure Fee" will be charged in addition to any late payment penalties.

If the delinquent date falls on a Saturday, Sunday or legal holiday, no penalty is charged if payment is made by 5 PM on the next business day.

If any portion of the total amount due is unpaid after 5 PM on June 30, 2019, it will be necessary to pay (a) delinquent penalties, (b) costs, (c) redemption penalties, and (d) a redemption fee. After 5 years of tax delinquency, the Tax Collector has the power to sell tax-defaulted property that is not redeemed.

Did you...

Submit payment for the exact amount?

Confirm that you have sufficient funds in your account? If your payment is not honored by the bank, the payment is null and void and a \$50.00 "Payment Failure Fee" will be charged in addition to any late payment penalties.

If the delinquent date falls on a Saturday, Sunday or legal holiday, no penalty is charged if payment is made by 5 PM on the next business day.

If any portion of the total amount due is unpaid after 5 PM on June 30, 2019, it will be necessary to pay (a) delinquent penalties, (b) costs, (c) redemption penalties, and (d) a redemption fee. After 5 years of tax delinquency, the Tax Collector has the power to sell tax-defaulted property that is not redeemed.

Exhibit A: Rehabilitation/Restoration Plan for 64 Potomac Street

Scope: #1		Building Feature: Roofs	
Rehab/Restoration <input checked="" type="checkbox"/>	Maintenance	Completed	Proposed <input checked="" type="checkbox"/>
Contract year work completion: 2020			
Total Cost: \$15,500 (see line item 07.300 in Contractor's bid)			
<p>Description of work: The current roof is of medium status. We will engage a licensed roofing contractor to replace the current roof with new shingles. Installation of the new roof will avoid changing the roof configuration, or altering, removing or obscuring character-defining features of the building, including decorative elements in the gable ends, as well as eave trim and moldings. New gutters and down sprouts will be installed to be able to direct water away from the building.</p>			

Scope: #2		Building Feature: Exterior Walls	
Rehab/Restoration <input checked="" type="checkbox"/>	Maintenance	Completed	Proposed <input checked="" type="checkbox"/>
Contract year work completion: 2020			
Total Cost: \$33,000. (see line items 09.900 and items under section 07 with the exception of 07.300)			
<p>Description of work: We will repair wood siding at all elevations of the house as necessary and thereafter repaint the house in its entirety. Any repairs or replacements will avoid altering, removing or obscuring character-defining features of the building and all materials that are used will be made in kind e.g. wood for wood.</p>			

Scope: #3		Building Feature: Windows and doors	
Rehab/Restoration X	Maintenance	Completed	Proposed X
Contract year work completion: 2020			
Total Cost: \$7235			
<p>Description of work: All three of the exterior doors at the front of the house, including the garage door, need to be replaced. The design of the new doors will be replaced to match the historic character of the house.</p> <p>All of the windows facing the street in the house will be repaired and thus match with the historically appropriate character and function.</p> <p>\$3,385 for repairing windows. \$3,850 for new door. These estimates are based off of www.homeadvisor.com</p>			

Scope: #4		Building Feature: Front Stairs	
Rehab/Restoration X	Maintenance	Completed	Proposed X
Contract year work completion: 2020			
Total Cost: \$22,300. (see line item 06.300 in Contractor's bid)			
Description of work: Remove existing terrazzo finish at the exterior front stairs and restore stairs and handrails to original design and materials (wood) based on historic documents and neighboring houses.			

Scope: #5		Building Feature: Seismic Strengthening of Foundation	
Rehab/Restoration X	Maintenance	Completed	Proposed X
Contract year work completion: 2020			
Total Cost: \$48,000. (see line items 03.100 and 06.100 in Contractor's bid) + \$39,500 (see line items 2-5 under Additional Costs in Contractor extra costs)			
Description of work: Seismic strengthening of house foundation. The drain will be moved from inside the garage to a trench drain by the garage door in order prevent water from flowing into the garage and creating damage to the foundation over time.			

Exhibit B: Maintenance Plan for 64 Potomac Street

Scope: #1		Building Feature: Roof	
Rehab/Restoration	Maintenance <input checked="" type="checkbox"/>	Completed	Proposed <input checked="" type="checkbox"/>
Contract year work completion: Annually			
Total Cost: Average annual cost of \$500			
<p>Description of work: When the roof has been replaced we will perform our own inspections annually. We will ensure to keep gutters and downspouts clear from debris as well as remove any overhanging branches. We will broom sweep branch or leaf debris.</p> <p>In addition, we will have a licensed roofing contractor conduct periodic inspections approximately every 5 years to ensure that it remains in good condition. Any repairs or replacements needed as a consequence of these inspections will be performed.</p> <p>Both these routines, will be informed by the guidance outlined in the National Park Service's Preservation Brief 47: Maintaining the Exterior of Small and Medium Size Historic Buildings.</p>			

Scope: #2		Building Feature: Exterior Walls	
Rehab/Restoration	Maintenance <input checked="" type="checkbox"/>	Completed	Proposed <input checked="" type="checkbox"/>
Contract year work completion: Annually			
Total Cost: \$1,000 annually			
<p>Description of work: When the house has been repainted we will inspect the wooden elements of the exterior of the house annually and repaint as necessary. If any damage or deterioration is found, the extent and the nature of the damage will be assessed and addressed. Any repairs or replacements will avoid altering, removing or obscuring character-defining features of the building and all materials that are used will be made in kind e.g. wood for wood. This maintenance routine will be informed by the guidance outlined in the National Park Service's Preservation Brief 47: Maintaining the Exterior of Small and Medium Size Historic Buildings.</p>			

Scope: #3		Building Feature: Openings	
Rehab/Restoration	Maintenance <input checked="" type="checkbox"/>	Completed	Proposed <input checked="" type="checkbox"/>
Contract year work completion: Annually			
Total Cost: \$1,000 annually			
Description of work: We will inspect the exterior doors and windows annually. We will look for signs of moist and dry rot and confirm functionality. If any repair or replacement is found necessary this will be done in line with the house historic character and any materials used will be in kind. This maintenance routine will be informed by the guidance outlined in the National Park Service's Preservation Brief 47: Maintaining the Exterior of Small and Medium Size Historic Buildings.			

Scope: #4		Building Feature: Front stairs	
Rehab/Restoration	Maintenance <input checked="" type="checkbox"/>	Completed	Proposed <input checked="" type="checkbox"/>
Contract year work completion: Annually			
Total Cost: \$500 annually			
Description of work: We will maintain the front stairs on an ongoing basis keeping it free from dust, dirt and debris. We will perform our own annual inspections of the stairs and if needed make any repairs or replacements deemed necessary. Any repairs or replacements will avoid altering, removing, or obscuring character-defining features of the building and all materials that are used will be made in kind. This maintenance routine will be informed by the guidance outlined in the National Park Service's Preservation Brief 47: Maintaining the Exterior of Small and Medium Size Historic Buildings.			

Scope: #5		Building Feature: Foundation and Perimeter Grades	
Rehab/Restoration	Maintenance <input checked="" type="checkbox"/>	Completed	Proposed <input checked="" type="checkbox"/>
Contract year work completion: Annually			
Total Cost: \$1,000 annually			
Description of work: The foundation will be inspected annually to check for signs of water or other damages. If any damages are identified these will be remediated immediately. All maintenance work will be informed by the guidance outlined in the National Park Service's Preservation Brief 47: Maintaining the Exterior of Small and Medium Size Historic Buildings.			

SEAPOINT 64 POTOMAC

Quote #: 7LJ5EX

A Proposal for Window and Door Products prepared for:
Job Site:
94124

Shipping Address:
GOLDEN STATE WINDOW & DOOR DESIGN
1085 ESSEX AVENUE
RICHMOND, CA 94801

ROMAN SANCHEZ
GOLDEN STATE WINDOW & DOOR
DESIGN
625 POTRERO AVENUE
SAN FRANCISCO, CA 94110-2116
Phone: (415) 462-0020

Email: rsanchez@goldenstatewdd.com

This report was generated on 5/6/2019 12:00:23 PM using the Marvin Order Management System, version 0002.26.00 (Current). Price in USD. Unit availability and price are subject to change. Dealer terms and conditions may apply.

Featuring products from:



- MATTE BLACK HARDWARE NOT AVAILABLE
ON MARVIN WOOD ULTIMATE DOUBLE HUNG'S.
I SUBBED OIL-RUBBED BRONZE (CLOSEST IN APPEARANCE)

- UNITS

UNIT SUMMARY

The following is a schedule of the windows and doors for this project. For additional unit details, please see Line Item Quotes.

Additional charges, tax or Terms and Conditions may apply. Detail pricing is per unit.

NUMBER OF LINES: 14	TOTAL UNIT QTY: 23	EXT NET PRICE: USD 21,590.09
---------------------	--------------------	------------------------------

LINE	MARK UNIT	BRAND	ITEM	NET PRICE	QTY	EXTENDED NET PRICE
1	LIVING RM	Marvin	Wood Ultimate Insert Double Hung IO 39" X 68 1/2" Entered as Inside Opening 39" X 68 1/2"	1,112.76	2	2,225.52
2	LIVING RM	Marvin	Wood Ultimate Insert Double Hung IO 47" X 68 1/2" Entered as Inside Opening 47" X 68 1/2"	1,257.28	1	1,257.28
3	UPPER BED	Marvin	Wood Ultimate Insert Double Hung IO 48" X 68 1/2" Entered as Inside Opening 48" X 68 1/2"	1,257.28	2	2,514.56
4	UPPER BED WOC	Marvin	Parts: 11850640 KIT, WINDOW OPENING CONTROL DEVICE, WHITE	26.60	2	53.20
5	LUG KITS FOR WOOD DH	Marvin	Parts: 11894145 OGEE LUG KIT - WUDH- WINDH	23.05	5	115.25
6	B214. MST BED	Marvin	Wood Ultimate Outswing French Door CN 4070 RO 49 5/8" X 86 1/2" Entered as CN 4070	4,018.36	1	4,018.36
7	W3 MST BED	Marvin	Wood Ultimate Double Hung CN 3224 RO 38 3/8" X 57 1/2" Entered as CN 3224	853.85	1	853.85
8	W4 MASTER BATH	Marvin	Wood Ultimate Double Hung CN 4024 RO 46 3/8" X 57 1/2" Entered as CN 4024	1,220.93	1	1,220.93
9	W4 OPENING CONTROL DEV.	Marvin	Parts: 11850640 KIT, WINDOW OPENING CONTROL DEVICE, WHITE	26.60	1	26.60
10	HALL BATH	Integrity	All Ultrex Awning RO 19 1/4" X 35 1/2" Entered as FS 18 3/4" X 35"	573.73	1	573.73
11	STAIR	Non- Marvin	Materials WOOD REPLACEMENT SASH, 20" X 36" 1-1/2" LOW E IG 2" TOP AND SIDES, 3-1/4" BOTTOM	426.00	1	426.00
12	ENTRY	Non-	Materials	629.00	1	629.00

		Marvin	WOOD REPLACEMENT SASH, 36" X 40" 1-1/2" LOW E IG TEMPERED, 2" TOP AND SIDES, 3- 1/4" BOTTOM			
13	1ST FLR REAR KITCHEN	Marvin	Wood Ultimate Outswing French Door CN 4070 RO 49 5/8" X 86 1/2" Entered as CN 4070	4,018.36	1	4,018.36
14	1ST FLR REAR DINING	Marvin	Wood Ultimate Double Hung CN 2632 RO 32 3/8" X 73 1/2" Entered as CN 2632	1,219.15	3	3,657.45

LINE ITEM QUOTES

The following is a schedule of the windows and doors for this project. For additional unit details, please see Line Item Quotes. Additional charges, tax or Terms and Conditions may apply. Detail pricing is per unit.

Line #1	Mark Unit: LIVING RM	Net Price:		1,112.76
Qty: 2		Ext. Net Price:	USD	2,225.52

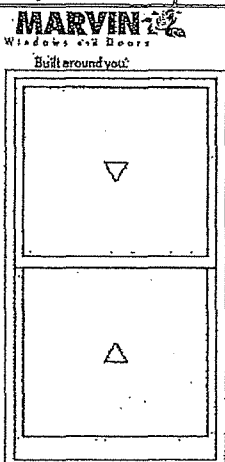

As Viewed From The Exterior

Entered As: IO
 FS 38 5/8" X 68 11/16"
 IO 39" X 68 1/2"
Egress Information
 Width: 35 1/16" Height: 28 41/64"
 Net Clear Opening: 6.97 SqFt
Performance Information
 U-Factor: 0.29
 Solar Heat Gain Coefficient: 0.3
 Visible Light Transmittance: 0.52
 Condensation Resistance: 57
 CPD Number: MAR-N-364-02152-00001
 ENERGY STAR: NC
Performance Grade
 Licensee #739
 AAMA/WDMA/CSA/101/LS.2/A440-08
 LC-PG30 1143X1981 mm (45X78 in)
 LC-PG30 DP ±30/-30
 FL1516Z

Primed Pine Exterior.....	33.69
Primed Pine Interior.....	33.69
Wood Ultimate Insert Double Hung.....	968.24
Inside Opening 39" X 68 1/2"	
8 Degree-Frame Bevel	
Top Sash	
Primed Pine Sash Exterior	
Primed Pine Sash Interior	
IG -1 Lite	
Low E2 w/Argon	
Stainless Perimeter Bar	
Ovolo Exterior Glazing Profile	
Ovolo Interior Glazing Profile	
Bottom Sash	
Primed Pine Sash Exterior	
Primed Pine Sash Interior	
IG -1 Lite	
Low E2 w/Argon	
Stainless Perimeter Bar	
Ovolo Exterior Glazing Profile	
Ovolo Interior Glazing Profile	
Oil Rubbed Bronze Sash Lock.....	61.18
1 Per Unit Oil Rubbed Bronze Sash Lift.....	31.03
White Jamb Hardware.....	13.30
No Screen.....	-28.37
4 9/16" Jamb	

***Note: Unit Availability and Price is Subject to Change

Initials required

Seller: _____

Buyer: _____

*FIELD APPLIED OGEE LUGS
 KEYS QUOTED ON LINE #5*

*OPTION PRICE FOR INTEGRAL WOOD
 OGEE LUGS IS 630.00 PER WINDOW*

Line #2	Mark Unit: LIVING RM	Net Price:		1,257.28
Qty: 1		Ext. Net Price:	USD	1,257.28

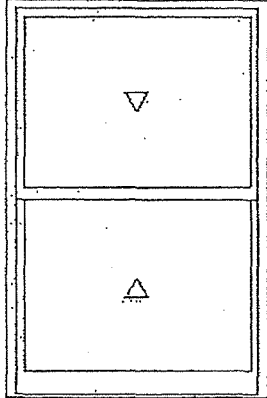

As Viewed From The Exterior

Entered As: IO
 FS 46 5/8" X 68 11/16"
 IO 47" X 68 1/2"
 Egress Information
 Width: 43 1/16" Height: 28 41/64"
 Net Clear Opening: 8.56-SqFt
 Performance Information
 U-Factor: 0.29
 Solar Heat Gain Coefficient: 0.3
 Visible Light Transmittance: 0.52
 Condensation Resistance: 57
 CPD Number: MAR-N-364-02152-00001
 ENERGY STAR: NC
 Performance Grade
 No Performance Grade Information available.

Primed Pine Exterior.....	33.69
Primed Pine Interior.....	33.69
Wood Ultimate Insert Double Hung.....	1,114.54
Inside Opening: 47" X 68 1/2"	
8 Degree Frame Bevel	
Top Sash	
Primed Pine Sash Exterior	
Primed Pine Sash Interior	
IG - 1 Lite	
Low E2 w/Argon	
Stainless Perimeter Bar	
Ovolo Exterior Glazing Profile	
Ovolo Interior Glazing Profile	
Bottom Sash	
Primed Pine Sash Exterior	
Primed Pine Sash Interior	
IG - 1 Lite	
Low E2 w/Argon	
Stainless Perimeter Bar	
Ovolo Exterior Glazing Profile	
Ovolo Interior Glazing Profile	
Oil Rubbed Bronze Sash Lock.....	61.18
1 Per Unit: Oil Rubbed Bronze Sash Lift.....	31.03
White Jamb Hardware.....	13.30
No Screen.....	30.15
4 9/16" Jamb	

***Note: Unit Availability and Price is Subject to Change

Initials required

Seller: _____

Buyer: _____

ADDER FOR INTEGRAL WOOD
 OVEC LWS = 630.00 plus tax

Line #3	Mark Unit: UPPER BED	Net Price:		1,257.28
Qty: 2		Ext. Net Price:	USD	2,514.56

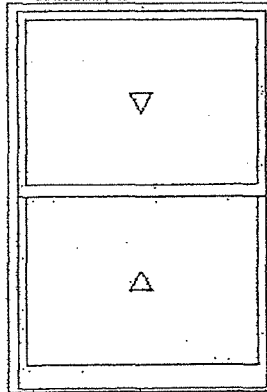

As Viewed From The Exterior

Entered As: IO
 FS 47 5/8" X 68 11/16"
 IO 48" X 68 1/2"
 Egress Information
 Width: 44 1/16" Height: 28 41/64"
 Net Clear Opening: 8.76-SqFt

Primed Pine Exterior.....	33.69
Primed Pine Interior.....	33.69
Wood Ultimate Insert Double Hung.....	1,114.54
Inside Opening: 48" X 68 1/2"	
8 Degree Frame Bevel	
Top Sash	
Primed Pine Sash Exterior	
Primed Pine Sash Interior	
IG - 1 Lite	
Low E2 w/Argon	
Stainless Perimeter Bar	
Ovolo Exterior Glazing Profile	
Ovolo Interior Glazing Profile	
Bottom Sash	
Primed Pine Sash Exterior	
Primed Pine Sash Interior	
IG - 1 Lite	
Low E2 w/Argon	
Stainless Perimeter Bar	
Ovolo Exterior Glazing Profile	
Ovolo Interior Glazing Profile	
Oil Rubbed Bronze Sash Lock.....	61.18
1 Per Unit: Oil Rubbed Bronze Sash Lift.....	31.03
White Jamb Hardware.....	13.30
No Screen.....	30.15
4 9/16" Jamb	

ADDER FOR INTEGRAL
 WOOD OVEC LWS = 630 plus tax

Performance Information
 U-Factor: 0.29
 Solar Heat Gain Coefficient: 0.3
 Visible Light Transmittance: 0.52
 Condensation Resistance: 57
 CPD Number: MAR-N-364-02152-00001
 ENERGY STAR: NC
 Performance Grade
 No Performance Grade Information available.

***Note: Unit Availability and Price is Subject to Change

Initials required

Seller: _____

Buyer: _____

Line #4	Mark Unit: UPPER BED WOC	Net Price:	26.60
Qty: 2		Ext. Net Price:	53.20
		USD	

No Image Available

Marvin Parts

11850640 KIT, WINDOW OPENING CONTROL DEVICE, WHITE.....26.60

Initials required

Seller: _____

Buyer: _____

Line #5	Mark Unit: LUG KITS FOR WOOD DH	Net Price:	23.05
Qty: 5	LIVING RM, LIVING RM, UPPER BED	Ext. Net Price:	115.25
		USD	

No Image Available

Marvin Parts

11894145 OGEE LUG KIT - WUDH-WINDH.....23.05

OGEE LUG KITS - FIELD APPLIED

Initials required

Seller: _____

Buyer: _____

Line #6	Mark Unit: B214 MST BED	Net Price:	4,018.36
Qty: 1		Ext. Net Price:	4,018.36
		USD	

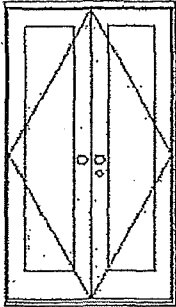

Inactive Active

As Viewed From The Exterior

Entered As: CN
 CN 4070
 FS 48 5/8" X 86"
 RO 49.5/8" X 86 1/2"

Primed Pine Exterior.....92.21
 Primed Pine Interior.....92.21
 Wood Ultimate Outswing/French Door - XX Left Hand.....3,610.51
 CN 4070
 Rough Opening 49 5/8" X 86 1/2"
 Traditional Panels
 Left Panel
 Primed Pine Sash Exterior
 Primed Pine Sash Interior
 IG - 1 Lite
 Tempered Low E2 w/Argon
 Stainless Perimeter Bar
 Ogee Interior Glazing Profile
 Right Panel
 Primed Pine Sash Exterior
 Primed Pine Sash Interior
 IG - 1 Lite
 Tempered Low E2 w/Argon
 Stainless Perimeter Bar
 Ogee Interior Glazing Profile
 Multi-Point Lock on Active Panel
 No Handle Set on Active Panel
 Multi-Point Lock on Inactive Panel.....92.21
 No Handle Set on Inactive Panel

Egress Information
 Width: 39 47/64" Height: 82 1/4"
 Net Clear Opening: 22.70 SqFt
Performance Information
 U-Factor: 0.29
 Solar Heat Gain Coefficient: 0.22
 Visible Light Transmittance: 0.39
 Condensation Resistance: 62
 CPD Number: MAR-N-414-14544-00001
 ENERGY STAR: N, NC, SC, S
 Performance Grade
 No Performance Grade Information available.

Matte Black Adjustable Hinges 3 Per Panel.....	58.52
Brönze Ultrex Sill.....	
Beige Weather Strip.....	41.67
Bare Oak Sill Liner.....	26.60
4 9/16" Jambs.....	
Primed Pine BMC - Top.....	15.96
Installed Installation Brackets.....	20.39
***Note: Unit Availability and Price is Subject to Change	
Initials required	
Seller: _____	
Buyer: _____	

Line #7	Mark Unit: W3 MST BED	Net Price:	853.85
Qty: 1		Ext. Net Price:	853.85
		USD	



Built around you.

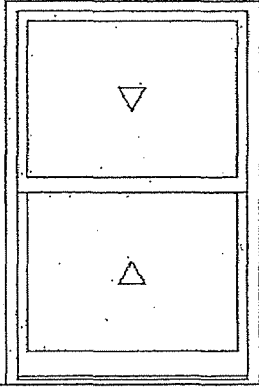

As Viewed From The Exterior

Entered As: CN
 CN 3224
 ES 37 3/8" X 57"
 RO 38 3/8" X 57 1/2"
Egress Information
 Width: 33 13/16" Height: 22 1/4"
 Net Clear Opening: 5.22 SqFt
Performance Information
 U-Factor: 0.29
 Solar Heat Gain Coefficient: 0.29
 Visible Light Transmittance: 0.51
 Condensation Resistance: 57
 CPD Number: MAR-N-68-05547-00001
 ENERGY STAR: NC
 Performance Grade
 License: #1109
 AAMA/WDMA/CSA/101/1.S.2/A440-08
 LC-PG40 1051X2464 mm (41.4X97 in)
 LC-PG40 DP +40/-40
 PL15162

Primed Pine Exterior.....	33.69
Primed Pine Interior.....	33.69
Wood Ultimate Double Hung.....	668.55
-CN 3224	
Rough Opening w/ Subsill	
38 3/8" X 57 1/2"	
Top Sash	
Primed Pine Sash Exterior	
Primed Pine Sash Interior	
IG - 1 Lite	
Low E2 w/Argon	
Stainless Perimeter Bar	
Ovolo Exterior Glazing Profile	
Ovolo Interior Glazing Profile	
Bottom Sash	
Primed Pine Sash Exterior	
Primed Pine Sash Interior	
IG - 1 Lite	
Low E2 w/Argon	
Stainless Perimeter Bar	
Ovolo Exterior Glazing Profile	
Ovolo Interior Glazing Profile	
Oil Rubbed Bronze Sash Lock.....	61.18
1 Per Unit Oil Rubbed Bronze Sash Lift.....	31.03
White Jamb Hardware.....	13.30
No Screen.....	23.94
4 9/16" Jambs.....	
Exterior Casing - None.....	14.19
Primed Pine Standard Subsill.....	
6" Long Sill Horns.....	30.15
Installed Installation Brackets.....	20.39
***Note: Unit Availability and Price is Subject to Change	
Initials required	
Seller: _____	
Buyer: _____	

Line #8	Mark Unit: W4 MASTER BATH	Net Price:	USD	1,220.93
Qty: 1		Ext. Net Price:		1,220.93

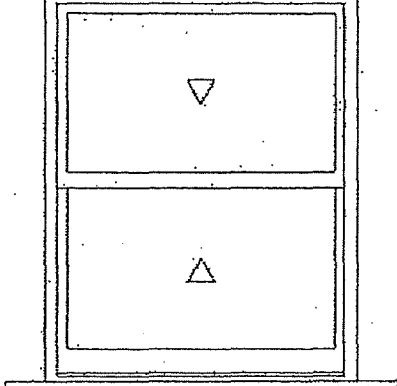

As Viewed From The Exterior

Entered As: CN
 CN 4024
 FS 45 3/8" X 57"
 RO 46 3/8" X 57 1/2"
 Egress Information
 Wjth: 41 13/16" Height: 22 1/4"
 Net Clear Opening: 6.46 SqFt
 Performance Information
 U-Factor: 0.29
 Solar Heat Gain Coefficient: 0.29
 Visible Light Transmittance: 0.51
 Condensation Resistance: 57
 CPD Number: MAR-N-68-05547-00001
 ENERGY STAR: NC
 Performance Grade
 Licensee #739
 AAMA/WDMA/CSA/101/1S.2/A440-08
 LC-PG40 1153X1551 mm (45.4X61.1 in)
 LC-PG40 DP #40/-40
 FL3516Z

Primed Pine Exterior.....	33.69
Primed Pine Interior.....	33.69
Wood Ultimate Double Hung.....	728.84
CN 4024	
Rough Opening, w/ Subsill	
46 3/8" X 57 1/2"	
Glass Add For All Sash/Panels.....	310.33
Top Sash:	
Primed Pine Sash Exterior	
Primed Pine Sash Interior	
IG - 1 Lite	
Tempered Low E2 w/Argon	
Stainless Perimeter Bar	
Ovolo Exterior Glazing Profile	
Ovolo Interior Glazing Profile	
Bottom Sash:	
Primed Pine Sash Exterior	
Primed Pine Sash Interior	
IG - 1 Lite	
Tempered Low E2 w/Argon	
Stainless Perimeter Bar	
Ovolo Exterior Glazing Profile	
Ovolo Interior Glazing Profile	
Oil Rubbed Bronze Sash Lock.....	61.18
1 Per Unit Oil Rubbed Bronze Sash Lift.....	31.03
White Jamb Hardware.....	13.30
No Screen.....	-26.60
4 9/16" Jamb	
Exterior Casing - None.....	-15.07
Primed Pine Standard Subsill	
6" Long Sill Horns.....	30.15
Installed Installation Brackets.....	20.39

***Note: Unit Availability and Price is Subject to Change

Initials required

Seller: _____

Buyer: _____

Line #9	Mark Unit: W4 OPENING CONTROL DEV.	Net Price:	USD	26.60
Qty: 1		Ext. Net Price:		26.60

No Image Available

Marvin Parts	
11850640 KIT, WINDOW OPENING CONTROL DEVICE, WHITE.....	26.60

Initials required

Seller: _____

Buyer: _____

Line #10	Mark Unit: HALL BATH	Net Price:	573.73
Qty: 1		Ext. Net Price:	573.73
		USD	

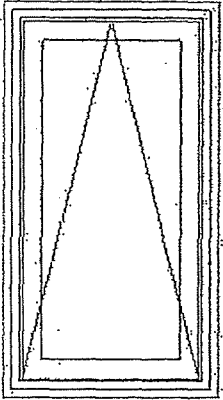

As Viewed From The Exterior

Entered As: ES
 FS 18 3/4" X 35"
 RO.19 1/4" X 35 1/2"
 Egress Information
 No Egress Information available.
 Performance Information
 U-Factor: 0.29
 Solar Heat Gain Coefficient: 0.29
 Visible Light Transmittance: 0.49
 Condensation Resistance: 57
 CPD Number: MAR-N-377-00206-00001
 ENERGY STAR: NC
 Performance Grade
 Licensee #1038
 AAMA/WDMA/CSA/101/1S.2/A440-11
 LC-PG40 1207X902 mm (47.5X35.5 in)
 LC-PG40 DP +40/-40
 FL13630

Stone White Exterior
 Stone White Interior
 Integrity Awning - Roto Operating.....424.67
 All Ultrex
 Frame Size: 18 3/4" X 35"
 Rough Opening 19 1/4" X 35 1/2"
 0 Degree Frame Bevel
 IG-1 Lite.....56.33
 Tempered-Low E2 w/Argon
 Stainless Perimeter Bar
 White Folding Handle
 Interior Aluminum Screen.....25.13
 Charcoal Fiberglass Mesh
 Stone White Surround
 2 1/4" Jamb's
 Thru Jamb Installation
 Frame Filler.....22.53
 1" Frame Expander.....45.07
 ***Frame Expander Ship Loose
 ***Note: integrity All Ultrex rough openings are 1/2" greater than overall
 frame size width and 1/2" greater than frame size height. Please take note of
 this when ordering All Ultrex custom sized units.
 ***Note: Unit Availability and Price is Subject to Change

Initials required

Seller: _____

Buyer: _____

Line #11	Mark Unit: STAIR	Net Price:	426.00
Qty: 1		Ext. Net Price:	426.00
		USD	

Materials WOOD REPLACEMENT SASH, 20" X 36" 1-1/2" LOW E IG 2" TOP AND SIDES, 3-1/4" BOTTOM

Initials required

Seller: _____

Buyer: _____

Line #12	Mark Unit: ENTRY	Net Price:	629.00
Qty: 1		Ext. Net Price:	629.00
		USD	

Materials WOOD REPLACEMENT SASH, 36" X 40" 1-1/2" LOW E IG TEMPERED, 2" TOP AND SIDES, 3-1/4"
 BOTTOM 629.00

Initials required

Seller: _____

Buyer: _____

Line #13	Mark Unit: 1ST FLR REAR KITCHEN	Net Price:	4,018.36
Qty: 1		Ext. Net Price:	4,018.36
		USD	

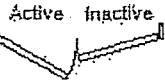
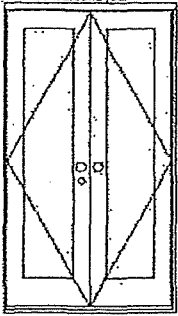

As Viewed From The Exterior

Entered As: CN
 CN 4070
 FS 48 5/8" X 86"
 RO-49 5/8" X 86 1/2"
Egress Information
 Width: 39.47/64" Height: 82.1/4"
 Net Clear Opening: 22.70 SqFt
Performance Information
 U-Factor: 0.29
 Solar Heat Gain Coefficient: 0.22
 Visible Light Transmittance: 0.39
 Condensation Resistance: 62
 CPD Number: MAR-N-414-14544-00001
 ENERGY STAR: N, NC, SC, S
 Performance Grade
 No Performance Grade Information available.

Primed Pine Exterior.....	92.21
Primed Pine Interior.....	92.21
Wood Ultimate Outswing French Door - XX Right Hand.....	3,610.51
CN 4070	
Rough Opening 49 5/8" X 86 1/2"	
Traditional Panels	
Left Panel	
Primed Pine Sash Exterior	
Primed Pine Sash Interior	
IG - 1 Lite	
Tempered Low E2 w/Argon	
Stainless Perimeter Bar	
Ogee Interior Glazing Profile	
Right Panel	
Primed Pine Sash Exterior	
Primed Pine Sash Interior	
IG - 1 Lite	
Tempered Low E2 w/Argon	
Stainless Perimeter Bar	
Ogee Interior Glazing Profile	
Multi-Point Lock on Active Panel	
No Handle Set on Active Panel	
Multi-Point Lock on Inactive Panel.....	92.21
No Handle Set on Inactive Panel	
Matte Black Adjustable Hinges 3 Per Panel.....	58.52
Bronze Ultrex Sill	
Beige Weather Strip.....	41.67
Bare Oak Sill Liner.....	26.60
4 9/16" Jambs	
Primed Pine BMC - Top.....	15.96
Installed Installation Brackets.....	20.39

***Note: Unit Availability and Price is Subject to Change

Initials required

Seller: _____

Buyer: _____

Line #14	Mark Unit: 1ST FLR REAR DINING	Net Price:		1,219.15
Qty: 3		Ext. Net Price:	USD	3,657.45

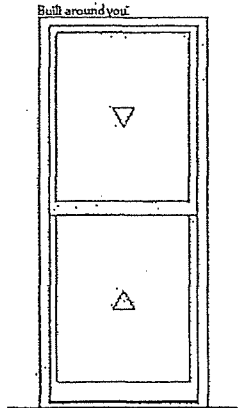

As Viewed From The Exterior

Entered As: CN
 CN 2632
 FS 31 3/8" X 73"
 RO 32 3/8" X 73 1/2"
 Egress Information
 Width: 27 13/16" Height: 30 1/4"
 Net Clear Opening: 5.84 SqFt
 Performance Information
 U-Factor: 0.29
 Solar Heat Gain Coefficient: 0.29
 Visible Light Transmittance: 0.51
 Condensation Resistance: 57
 CPD Number: MAR-N-68-05547-00001
 ENERGY STAR: NC
 Performance Grade
 Licensee #739
 AAMA/WDMA/CSA/1017.1.S.2/A440-08
 LC-PG40 899X2059 mm (35.4X81.1 in)
 LC-PG40 DP +40/-40
 FL15162

Primed Pine Exterior.....	33.69
Primed Pine Interior.....	33.69
Wood Ultimate Double Hung.....	728.84
CN 2632	
Rough Opening w/Subsill	
32 3/8" X 73 1/2"	
Glass Add For All Sash/Panels.....	310.33
Top Sash	
Primed Pine Sash Exterior	
Primed Pine Sash Interior	
IG - 1 Lite	
Tempered Low E2 w/Argon	
Stainless Perimeter Bar	
Ovolo Exterior Glazing Profile	
Ovolo Interior Glazing Profile	
Bottom Sash	
Primed Pine Sash Exterior	
Primed Pine Sash Interior	
IG - 1 Lite	
Tempered Low E2 w/Argon	
Stainless Perimeter Bar	
Ovolo Exterior Glazing Profile	
Ovolo Interior Glazing Profile	
Oil Rubbed Bronze Sash Lock.....	61.18
1 Per Unit Oil Rubbed Bronze Sash Lift.....	31.03
White Jamb Hardware.....	13.30
No Screen.....	26.60
4 9/16" Jamb	
Exterior Casing - None.....	16.85
Primed Pine Standard Subsill	
6" Long Sill Horns.....	30.15
Installed Installation Brackets.....	20.39

***Note: Unit Availability and Price is Subject to Change

Initials Required

Seller: _____

Buyer: _____

Project Subtotal Net Price: USD	20,535.09
Taxable Materials: USD	1,055.00
8.500% Sales Tax: USD	1,835.16
Project Total Net Price: USD	23,425.25

Product and Performance Information

NFRC energy ratings and values may vary depending on the exact configuration of glass thickness used on the unit. This data may change over time due to ongoing product changes or updated test results or requirements.

The National Fenestration Rating Council (NFRC) has developed and operates a uniform national rating system for the energy performance of fenestration products, including windows and doors. For additional information regarding this rating system, see www.nfrc.org.

NFRC energy values and ratings may change over time due to ongoing product changes, updated test results or requirements.

Review the map below to determine if your units meet ENERGY STAR for your location.

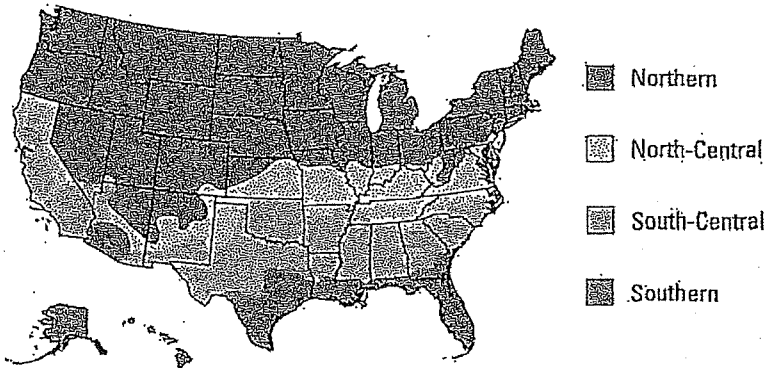
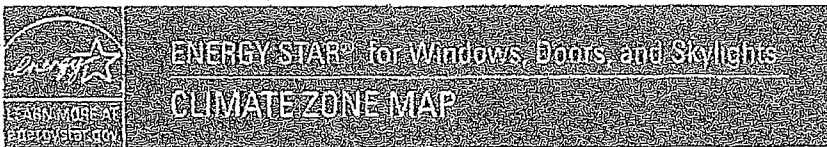

International Energy Conservation Code (IECC) Climate Regions

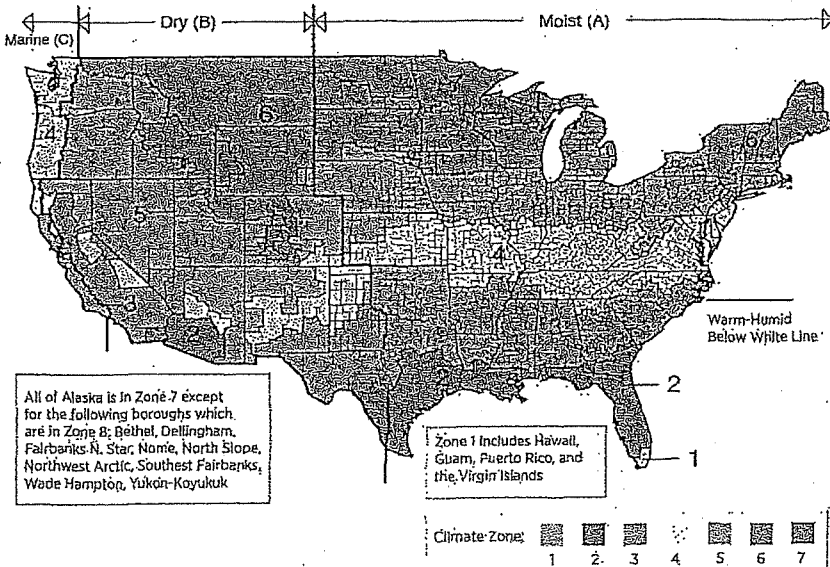

PURCHASE APPROVAL/SIGN OFF

Project Subtotal Net Price: USD	20,535.09
Taxable Materials: USD	1,055.00
8.500% Sales Tax: USD	1,835.16
Project Total Net Price: USD	23,425.25

I have reviewed all line item quotes in detail and agree that the product specifications and pricing are accurate, and I approve the project for order. I acknowledge that additional charges, tax or Terms and Conditions may apply.

Seller: _____



Buyer: _____

CALIFORNIA USERS

About California Proposition 65

California's Proposition 65 entitles California consumers to special warnings for products that contain chemicals known to the state of California to cause cancer and birth defects or other reproductive harm.

We are providing the following warnings in connection with this quote:

-  **WARNING:** This product can expose you to chemicals including titanium dioxide, which is known to the State of California to cause cancer. For more information, go to www.P65Warnings.ca.gov.
-  **WARNING:** This product can expose you to chemicals including methanol, which is known to the State of California to cause birth defects or other reproductive harm. For more information, go to www.P65Warnings.ca.gov.
-  **WARNING:** Drilling, sawing, sanding or machining wood products can expose you to wood dust, a substance known to the State of California to cause cancer. Avoid inhaling wood dust or use a dust mask or other safeguards for personal protection. For more information go to www.P65Warnings.ca.gov/wood.

FLEETWOOD CERTIFIED PROPOSAL

GOLDEN STATE WIN & DOOR - SF

Phone: 415-462-0020

PROPOSAL #32, DETAIL REPORT version 1

WWW.GOLDENSTATELUMBER.COM

(Prices honored if order confirmed by 10/3/2019)

ver: 1

Quote# 32

32

Customer: SEAPOINT

#

Est. Lead Time: 7-9 Weeks

Office Address:

Shipping Address:

PO:

Contact:

Job Name: 64 POTOMAC

Phone:

SF

Quoted By: user

Quote Date: 5/6/2019

Call time: _____ contact:

Net Frame Dimension in inches: (width x height)
Unless otherwise noted, all frames are viewed from exterior!

Comments:

Job Specific Series Defaults

(Unless otherwise specified per item)

Review Product options carefully

<u>Series 250-T</u>	
Finish:	CLASS I, Dk. BRONZE ANODIZED
Hardware:	BLACK
Glass:	1" Clear Cardinal 272 5mm- R,0.625argon,Clear 5mm-R (Glazed) CLR5AE5G
Spacer:	Black Endure (Bent Corners)
Frame type:	Nail-On (Assembled)
Boxing:	Cardboard
Awng-Handle	Cam (4-Bar)
Awng-Hinge_type	4-Bar
Awng-Limit_Device	No
Awng-Screens	None
Awng-Swing	Outside
Geometry	Std-4 Sides
Security_Locks	No
Sill	See Frame Type
SillPan	Yes
Structural_Rating	To meet a minimum 105 MPH(Vult) wind speed
Thermal_Frame	Yes
Water_Rating	Performance varies init.

FLEETWOOD CERTIFIED PROPOSAL

GOLDEN STATE WIN & DOOR - SF

Phone: 415-462-0020

PROPOSAL #32, DETAIL REPORT version 1

WWW.GOLDENSTATELUMBER.COM

(Prices honored if order confirmed by 10/3/2019)

ver: 1

Quote# 32.

32

Notes:

ITEM: 1-0 SERIES 250-T A/O.

QTY	Each	Resale Price
1	\$2,915.72	\$2,915.72

Viewed from Exterior
NFW=48.5 x NFH= 94:25

_____ Init.

Room Ref: 1ST FLR REAR OFFICE

Weight/lb: 247.52 Cube/ft: 13.37

NFRC: FLE-M-92-00339-00001



*operable Awning
over Fixed window*

Structural Options:
(Sill-Tdt-cl)_47.125-HEIGHT

Option Name	Option
Customer	Internal SDLs may rattle
Customer	Preserve glass film on 1 and 4 surfaces
Customer	SDLs equally divided in glass (not daylight)
Caution:	2 Cam Handles(pnl>40in)
Boxing	Cardboard
SDL	Ext/Int. 3/4in. Flat (SL-1C)
SDL_Division	Default (Equally Divided)
SDL_Pattern	3W4H
Energy_NFRC	U-Value:0.48_SHGC:0.28
Energy_Simulated	U-Value:0.38_SHGC:0.34

Based on your geographical area, additional Shipping charges may apply.

Orders are subject to standard terms & conditions.

*SPECIAL notes are subject to factory review.

Review Online Documents Before Final Product Selections

Homeowners

- Care & Maintenance
- The Right Choices
- Your Order

Professionals/Energy Compliance

- True Energy Efficiency (video)
- Energy Compliance vs. TRUE Efficiency

Professionals/Extreme Conditions

- Smart Building Practices

Item Sub-Total:	\$2,915.72
Factory Misc. Charges:	\$0.00
Factory Shipping & Handling:	\$0.00
<hr/>	
Installation Labor:	Not Included
Drawings/Engineering:	Not Included
Freight/Delivery:	Not Included
Other Products Provided:	Not Included
Other Labor Provided:	Not Included
Sales Tax (8.5%):	\$247.84
<hr/>	
Resale Grand Total	\$3,163.56

*(may not include S&H or Tax)

Total Weight/lb:	247.52
Total Cube/ft:	13.37

Price valid for 90 days from quote date. Orders may be delayed if credit terms are not established for this order before the final confirmation is signed.

Please Sign and return on acceptance: _____ date: ___/___/___

FLEETWOOD CERTIFIED PROPOSAL

GOLDEN STATE WIN & DOOR - SF

Phone: 415-462-0020

PROPOSAL #32, DETAIL REPORT version 1

WWW.GOLDENSTATELUMBER.COM

(Prices honored if order confirmed by 10/3/2019)

ver:1

Quote# 32

32



5/6/2019

Job Name: 64 POTOMAC

Customer: SEAPOINT

Quote: #32

MANUFACTURER

ENERGY REPORT

Job Specific Summary

The U-Factor and SHGC values provided in this report comply with NFRC 100 and NFRC 200. A summary of these values has been presented as a Weighted Average to assist dealers in assessing the general impact if changes are made to the Window or Door order, e.g. glass type change.

Additionally, Fleetwood has provided a column of Simulated Performance Alternative energy values that may be a useful tool in illustrating how the size of a Door or Window will impact the true living conditions inside the home. By request, Fleetwood will provide Manufacturer Labels for such values. For more information about Simulated Performance Alternative, visit Fleetwood's website; under the Professionals menu, select Energy Compliance, then Energy Code Compliance.

Product Type / Category Information:

(Metric/SI version available upon request.)

Category:	Series:	Item:	Glazing*:	VT:	NFRC:	Simulated Performance Alternative	Glazing Area
					U-Factor / SHGC	U-Factor / SHGC	(ft2)*Qty:
WINDOW	Series 250-T	1-0	A	0.45	0.48 0.28	0.38 0.34	31.74 [48.5x94.25]*1

WINDOW Weighted Average:				(ft2): 31.74
NFRC:	U-Factor:	0.48	SHGC:	0.28
Simulated Performance Alternative		0.38		0.34

The "Performance method" for certification is recommended; wherein envelope components can be "traded off" to allow the desired windows and doors. (See Energy Code Compliance for a list of common trade-offs.)

The overall product U-Factor combines the center-of-glass, product frame and edge-of-glass U-Factors in a frame model. Note: All U-factors and SHGC values are shown with non-tinted glass. Tint on glass will further reduce the SHGC values.

*Glazing Type:	Description:		
A CLR5AE5G	1" Clear Cardinal 272.5mm-R 0.625argon Clear 5mm-R	0.25	0.41

NFRC Prescriptive Sizes:		
Series	Configuration	Width x Height (in)
Series 250-T	Awning	59" x 23

References:

- U-Factor: The rated Winter U-Factor of the fenestration product, in Btu/hr-ft2-°F.
- SHGC: Solar Heat Gain Coefficient.
- VT: Visible Transmittance.
- Area (ft2): The area of the surface in square feet.
- NFRC: National Fenestration Rating Council.
- IECC: International Energy Conservation Code.

Seapoint Construction, Inc.

3145 Geary Boulevard, #312
San Francisco, CA 94118 US
(415) 596-3168
sean@seapointconstruction.com



Invoice

BILL TO
Caroline Ingeborn & Gustav Lindqvist
64 Potomac Street
San Francisco, CA

INVOICE 64-2
DATE 04/25/2019
TERMS Due on receipt
DUE DATE 04/25/2019

DATE	ACTIVITY	QTY	RATE	AMOUNT
04/25/2019	General Requirements 1.000 General Requirements	0.1299024	102,323.00	13,292.00
04/25/2019	Site Set up & Maint. 2.100 Site Set up/Maint.	0.125	16,458.00	2,057.25
04/25/2019	Demolition 2.200 Demo & Concrete Cutting	0.3732218	25,588.00	9,550.00
04/25/2019	Earthwork 2.300 Earthwork/Grading	1	6,000.00	6,000.00
04/25/2019	Shoring 2.400 Shoring & Underpinning	0	3,200.00	0.00
04/25/2019	Drainage 2.600 Drainage/Site Utilities	0	5,270.00	0.00
04/25/2019	Landscape 2.900 Landscape	0	4,800.00	0.00
04/25/2019	Concrete 3.100 Poured in Place Concrete	1	10,575.00	10,575.00
04/25/2019	Carpentry 6.100 Rough Carpentry	0.50	37,650.00	18,825.00
04/25/2019	Carpentry 6.200 Ext Finish Carpentry	0	5,923.00	0.00
04/25/2019	Carpentry 6.250 Int Finish Carpentry	0	32,004.00	0.00
04/25/2019	Carpentry 6.300 Architectural Woodwork	0	22,284.00	0.00
04/25/2019	Water Proofing 7.130 Waterproofing	0	3,415.00	0.00
04/25/2019	Insulation 7.200 Insulation	0	7,063.00	0.00
04/25/2019	Roofing 7.300 Roofing & Membrane	0	15,500.00	0.00
04/25/2019	Siding 7.400 Cladding & Siding	0	4,600.00	0.00
04/25/2019	Sheetmetal 7.600 Sheetmetal Fabrication	0	3,720.00	0.00
04/25/2019	Caulking 7.800 Caulking & Sealants	0	750.00	0.00
04/25/2019	Doors 8.100 Interior & Exterior Doors	0	17,250.00	0.00

04/25/2019	Doors 8.110 Specialty Doors - Garage	0	4,000.00	0.00
04/25/2019	Windows 8.500 Windows	0	22,750.00	0.00
04/25/2019	Hardware 8.700 Finish Hardware	0	9,700.00	0.00
04/25/2019	Windows 8.800 Glazing	0	4,000.00	0.00
04/25/2019	Finishes 9.100 Stucco & Plaster	0	4,000.00	0.00
04/25/2019	Finishes 9.250 Gypsum Board	0	22,228.00	0.00
04/25/2019	Finishes 9.300 Tile	0	12,640.00	0.00
04/25/2019	Finishes 9.600 Wood Flooring	0	26,250.00	0.00
04/25/2019	Finishes 9.800 Carpets/Resilient Flooring	0	2,880.00	0.00
04/25/2019	Finishes 9.900 Painting & Wall Coverings	0	39,005.00	0.00
04/25/2019	Specialties 10.800 Bath Accessories	0	420.00	0.00
04/25/2019	Appliances 11.400 Appliances	0	1,520.00	0.00
04/25/2019	Plumbing 15.100 Plumbing	0	36,110.00	0.00
04/25/2019	HVAC 15.500 HVAC	0	11,700.00	0.00
04/25/2019	Electrical 16.100 Electrical	0	38,580.00	0.00
				Subtotal: 60,299.25
04/25/2019	Overheads 10%	0	560,156.00	0.00
04/25/2019	Profit 2%	0	560,156.00	0.00
04/25/2019	ADDITIONAL COSTS	0		0.00
04/25/2019	Services 1. Add Powder Room	0	6,900.00	0.00
04/25/2019	Services 2. Add Concrete Beam in Garage	1	6,750.00	6,750.00
04/25/2019	Services 3. Additional Excavation	1	4,320.00	4,320.00
04/25/2019	Services 4. Additional structural Framing	0.5000431	11,592.00	5,796.50
04/25/2019	Services 5. Dry Rot Replacement Work	1	16,840.00	16,840.00

BALANCE DUE

\$94,005.75



Lic #896999

PRELIMINARY Cost Estimate - 64 Potomac

Architectural plans by , dated

Structural Plans by , dated

Feb 27, 2019

Item CSI	Item Description	TOTAL	Notes
1.000	General Requirements	102,323	Based on 6 month duration, project management, supervision, special procedures, temporary utilities, site equipment and material, layout, clean up, general labor, tools, workplaces, safety and contract/project close out
01.200	Project Coordination	-	Included
01.300	Permits/Fees/Inspections	-	By Owner
01.350	Project Manager	-	Included
01.370	On-Site Supervision	-	Included
01.500	Site Protect. & Temp Facil.	-	Included
01.595	Punchlist Items	-	Included
01.600	Tools, Equip, Mat. Handling	-	Included
01.700	Clean Up	-	Daily Clean Up during Project
01.800	Special Inspections	-	By Owner
		-	
2.000	Sitework	-	
02.100	Site Set up/Maintenance	16,458	Tool & equipment rental, finish protection, final clean
02.200	Demolition & Concrete Cutting	25,588	Basement/First/Second level demo
02.300	Earthwork/Grading	6,000	Hand-dig at new footing
02.400	Shoring and Underpinning	3,200	Shoring @ stairs
02.500	Underground Piped Utilities	-	NA
02.510	Asphalt Paving	-	NA
02.600	Drainage/Site Utilities	5,270	Exterior & Interior Drains
02.900	Landscape (Hardscape)	4,800	Driveway new/Sidewalk patch-in
3.000	Concrete		
03.100	Poured In Place Concrete	10,575	New footing & concrete patching @ new drain tie-ins
03.300	Concrete Specialties	-	NA
03.370	Concrete Slabs	-	NA
4.000	Masonry	-	NA
04.200	CMU and Brick	-	
04.300	Glass Block	-	
04.400	Slab Stone/Countertops	-	
04.420	Exterior Stone Cladding	-	
04.600	Cast Stone	-	
5.000	Metals	-	NA
05.100	Structural Steel	-	
05.750	Metal Fabrication	-	
6.000	Wood & Plastic	-	

06.100	Rough Carpentry	37,650	New structural Framing
9	Exterior Finish Carpentry	5,923	Exterior door and window casing/parapet trim
06.250	Interior Finish Carpentry	32,004	Interior door and window casings/baseboard/crown/paneling/wainscoating
06.270	Interior Stairs and Railings	-	NA
06.300	Architectural Woodwork	22,284	Stair railing treatments
06.400	Casework	-	NA
06.700	Plastics	-	NA
		-	
7	Thermal and moisture protection	-	
07.130	Waterproofing	3,415	Door & window waterproof wraps/parapet waterproofing
07.160	Cementitious Waterproofing	-	NA
07.200	Insulation	7,063	Wall/Ceiling/Floor Insulation
07.300	Roofing and Membranes	15,500	New roof through out
07.400	Cladding & Siding	4,600	Rear elevation patch-ins/front elevation patch-ins
07.600	Sheetmetal Fabrication	3,720	New door & window heads/parapet flashings
07.700	Gutters and Downspouts	-	NA
07.800	Caulking and sealants	750	Supplemental caulking and sealants
8	Doors & Windows	-	
08.100	Interior & Exterior Doors	17,250	Allowance pending homeowners final decision.
08.110	Speciality Doors - Garage	4,000	Sectional garage door
08.300	Overhead Doors	-	NA
08.500	Windows	22,750	Allowance replacements & custom wood - need window schedule
08.600	Skylights	-	NA
08.700	Finish Hardware	9,700	Hardware Labor/Designer providing materials
08.800	Glazing	4,000	Master bath enclosure/kid's bath glass panel
	Finishes	-	
09.100	Stucco and Plaster	4,000	Ceiling medallions
09.200	Drywall	-	NA
09.250	Gypsum Board	22,228	
09.300	Tile	12,640	Tile labor only - materials by designer
09.400	Terrazo	-	NA
09.600	Wood Flooring	26,250	New chevron hardwood first & second levels/stair cladding
09.800	Carpets/Resilient Flooring	2,880	Vinyl flooring @ basement foyer and laundry area
09.900	Painting and Wall Coverings	39,005	New interior/Exterior complete
10	Specialties	-	
10.300	Fireplaces	-	NA
10.800	Bath Accessories	420	Labor, Designer/homeowner providing materials
		-	
11	Equipment	-	
11.010	Vacuum System	-	
11.400	Appliances	1,520	to save fees assume owner vendor furnishes/installs, Seapoint coordinates
		-	
12	Furnishing	-	NA

		-	
13	Special Construction	-	NA
		-	
14	Conveying Systems	-	NA
14.100	Dumbwaiter	-	
14.200	Elevators	-	
		-	
15	Mechanical	-	
15.100	Plumbing	36,110	Rough and Trim. Fixtures by Designer
15.300	Fire Protection	-	NA
15.400	Plumbing Fixtures	-	NA
15.500	HVAC	11,700	New HVAC, New Vent. @ baths, laundry, kitchen. Superintendent coordination
15.700	Hydronic Heating		
		-	
16	Electrical	-	
16.100	Electrical	38,580	Rough and Trim, recessed and florescent lights. Fixture Allowance \$2550 pending. Decorative & surface mounted Fixtures by Owner
16.500	Electrical Fixtures	-	
16.700	Communications	-	
16.800	Sound and Video	-	
	Misc. Materials	-	
SUBTOTAL		560,156.00	
OH @ 10%		56,015.60	
Profit 2%		11,203.12	
TOTAL		627,374.72	

64 POTOMAC STREET SAN FRANCISCO, CA 94117

OWNER

Caroline Ingeborn
Gustav Lindqvist
64 Potomac Street
San Francisco, CA 94117

CONSULTANTS

INTERIOR DESIGN
HOMEWORK
1627 McAllister Street
San Francisco, CA 94115

STRUCTURAL ENGINEERING
FTF ENGINEERING, INC
1916 McAllister Street
San Francisco, CA 94115

PROJECT DATA

BLOCK & LOT: 0866/014
LOT SIZE: 25' x 90' = 2,250 SF
ZONING: RH-2
REAR YARD: AVERAGE OF ADJACENT BLDG
CONSTRUCTION TYPE: V-B NON-SPRINKLERED
EXISTING OCCUPANCY: SINGLE FAMILY
PROPOSED OCCUPANCY: SINGLE FAMILY
APPLICABLE CODES: 2018 CALIFORNIA CODES W/ SAN FRANCISCO AMENDMENTS

SCOPE OF WORK

1. Interior renovation of Kitchen and Dining Room.
2. Addition of new Bathroom at 2nd Floor.
3. Interior renovation of existing 2nd Floor Bathroom with new fixtures, finishes and fittings.
4. New structural posts and beams to accommodate interior partition changes.
5. Provide new electrical, plumbing and mechanical within areas of work.
6. Remove brick chimney. Provide new roof at chimney.
7. Provide 4 new windows at rear of 1st, 2nd Floor.
8. Provide 8 new wood windows to replace & match existing wood windows at front of 1st, 2nd Floor.

VICINITY MAP

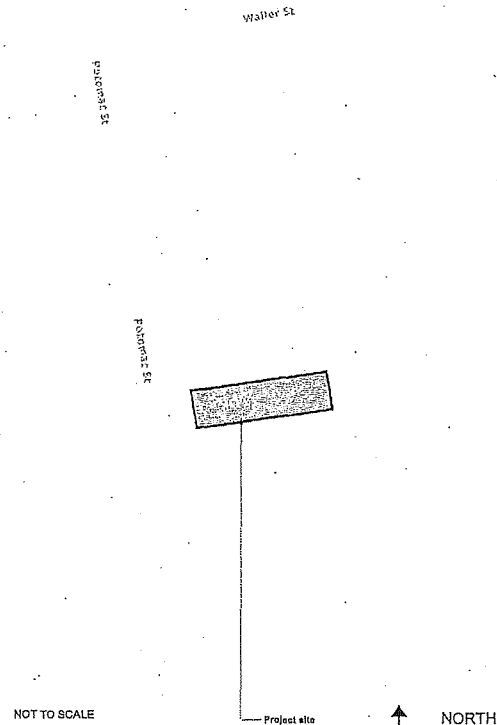

GENERAL NOTES

1. All work shall be performed in complete compliance with all applicable codes laws ordinances and regulations of all authorities having jurisdiction over the work. All Contractors shall hold harmless the Architect/Engineer and the Owner from all damages and/or penalty arising out of violation thereof.
2. All attachments connections or fastening of any nature are to be properly and permanently secured in conformance with the best practice of the building industry. Drawing show only special requirements to assist the contractor and do not illustrate every detail.
3. The Contractor shall be responsible for verifying all conditions dimensions and measurements in the field before beginning work. Any and all discrepancies, unusual circumstances, errors omissions and/or conflicts shall be reported to the Architect/Engineer's and the Owners attention immediately before proceeding with the work.
4. The Contractor shall be responsible for coordination between Architectural, Structural, Fire Protection, Mechanical, Plumbing, and Electrical. This includes reviewing the requirements of individual systems before ordering and installation of any work, verify all architectural details and all finish conditions (whether depicted in drawings or not) with the same disciplines.
5. Unless otherwise noted, all angles shall be right angles, all lines which appear parallel shall be parallel, and all items which appear centered shall be centered. The Contractor shall be responsible for maintaining all lines to level, plumb and square.
6. The Contractor shall be responsible for all shoring and protection during construction. All existing improvements to remain shall be protected. All materials delivered to the site shall be properly stored and protected until installation. All lumber shall be protected from moisture and stored above ground.
7. Detailed and/or larger scale drawings shall take precedence over general and smaller scale drawings. Figure dimensions shall take precedence over scale dimensions. All scale dimensions shall be verified.
8. All work shall be done under permit. Plans and calculations if required shall be submitted to and approved by the building department. Contractor shall be responsible for obtaining all required permits.
9. Note that Mechanical, Electrical, Fire Protection, Plumbing and Communications are design build items. Architectural drawings shall show design intent contractor to confirm all system requirements with building owner and Architect prior to installation. Contractor/subcontractor shall submit plans for their respective work to the building department as required for plan check and permit issuance, including paying for all plan check and permit fees.
10. The Contractor shall be responsible for applying in obtaining all required per inspections to confirm with local building and fire codes.
11. Do not scale drawings. Written dimensions govern.
12. Details shown our typical, similar detail apply in similar conditions.
13. Verify clearances for vents, chases, soffits, fixtures before any construction, ordering of or installation of any item of work.
14. Unless otherwise noted the contractor shall provide solid blocking and backing as required for all nailing of interior trim and finishes, and shall coordinate and provide all framing, backing and bracing as necessary for installation of equipment indicated on the drawings, provide backing plates and all bath accessories, handrails, cabinets, towel bars, wall-mounted fixtures and any other items attached to wall.
15. Install all fixtures, equipment, and materials per manufacturers recommendations and code requirements. All appliances, fixtures, and equipment associated with Plumbing, Electrical, Mechanical systems shall be listed by nationally recognized an approved agency.
16. Thermal and sound insulating shall comply with C.B.C. sec. 719.
17. All wall and ceiling finishes shop comply with C.B.C. chapter 8.
18. All new smoke detectors to be hard wired.

DRAWING INDEX

- A0 Cover Sheet
- A1 Site Plan
- A2 Basement Plans
- A3 1st Floor Plans
- A4 2nd Floor Plans
- A5 Exterior Elevations

- S1
- S2
- S3
- S4

HOMEWORK
1627 McALLISTER STREET
SAN FRANCISCO CA 94115
415.057.5912

PERMIT SET
NOT FOR CONSTRUCTION

64 POTOMAC ST

REVISION	DATE
Permit Set	12.12.18

COVER SHEET

SCALE: N.T.S.

SHEET

A0

ELECTRICAL NOTES:

Electrical subpanel(s) on floor plans. Panels shall not be located in the vicinity of easily ignitable material(s) such as clothing closets. Panels in firewall shall be reallocated or properly protected to maintain firewall separation.

GFCI protected outlets at the following locations:

- (A) Garage
- (B) Unfinished basement, crawl and storage spaces
- (C) Within 6' of sink or basin
- (D) Exterior (waterproof)

Receptacle outlets at the following locations:

- (A) 12' O.C. max and within 6' of the end of walls
- (B) Any wall space 2' or more wide
- (C) At each kitchen and dining area counter space wider than 12' so that no point in any hallway 10' or more in length.

Light fixture in tub or shower enclosures and exterior light fixtures shall be labeled suitable for damp locations.

Appliances fastened in place, such as dishwashers, garbage disposals, trash compactor's, microwave ovens, etc. shall be supplied by separate branch circuit rated for the appliance or load served.

Receptacles for fixed appliances shall be accessible, not behind appliance.

A circuit suitable for the load with minimum of 30 amp years is required for an electrical clothes dryer.

ENERGY NOTES:

Permanently installed luminaires in kitchen shall be high efficacy luminaires. Up to 50% of wattage, as determined in section 130(C), of permanently installed luminaires in kitchen may be in luminaires that are not high efficacy luminaires, provided that these luminaires are controlled by switch is separate from those controlling the high efficacy luminaires.

Each room containing a water closet shall have at least one luminaire with lamps and efficacy of not less than 40 lumens per watt for 15 watt or smaller, 50 lumens per watt for 16watt - 40watt and 60 lumens per watt for 40 watt or higher. If there is more than one luminaire in the room, the high efficacy luminaire shall be switched at an entrance to the room.

Light fixtures recessed into insulated ceilings must be approved for a zero clearance insulation cover my underwriters laboratories or other approved laboratories. Fireplaces, decorative gas appliances and gas logs installation of factory built and masonry fireplace shall include:

- (A) Closeable metal or glass doors
- (B) Combustion air intake (5 in. sq. minimum) to draw air from outside of the building directly into light-filling or combustion air control device. Exception: an outside combustion air intake is not required if the fireplace is installed over concrete slab flooring and the fireplace is not located on an exterior wall.
- (C) A flue damper with a readily accessible control. Exception: When a gas log, log lighter, or decorative gas appliance is installed in a fireplace, the flue damper shall be blocked open if required by the manufacturer's installation or the state Mechanical Code.

PLUMBING AND MECHANICAL NOTES:

Air ducts shall be No.26 GA galvanized steel metal or a fire damper provided when the ducts penetrate the occupancy separation between the garage and the house.

Smooth metal duct for dryer exhaust extending to outside.

Non-removable backflow prevention devices on all exterior hose bibs.

Size of water closet to be maximum allowable 1.6 gallons per flush.

Shower and tub shower shall be provided with pressure balance or thermostatic mixing valve controls. Handle positions stops shall be provided on such valves and shall be adjusted per manufacturers instructions to deliver a maximum mixed water setting of 120°F. The water heater thermostat shall not be considered a suitable control for meeting this provision, UPC 4107.

Doors and panels a shower and bathtub enclosure and adjacent wall openings within 60 inches above a standing surface and drain inlet shall be fully tempered. Laminated asp safety glasses or approved plastic.

Tempered glass shall be a fixed with a permanent label.

SANITATION NOTES:

Shower stall finish shall be ceramic tile extending 70 inches above the drain inlet.

Moisture resistant underlayment(e.g. water resistant gypsum board) to a height of 70 inches above the drain inlet UBC 8067.1.3.

BATHROOM NOTES:

Exhaust fans are capable of providing five air changes per hour.

Exhaust fans with Backdraft damper shall terminate minimum 3 feet from any property line and building opening.

Branch circuits a 20A circuit is required to serve the required bathroom outlets. This circuit cannot supply any other receptacle lights and (ans) etc.

NOTES:

A smoke detector shall be in all bedrooms in and area is leading to them.

Environmental air duct exhaust with Backdraft damper shall terminate 3 feet minimum from property line and building opening.

Venting systems shall terminate not less than 4 feet below or 4 feet horizontally from, and not less than 1 foot above a door, and open a window or a gravity and air inlet into a building. Venting system shall terminate at least 3 feet above an outside or make up air inlet located within 10 feet at least 4 feet from the property line except a public way.

Potomac Street

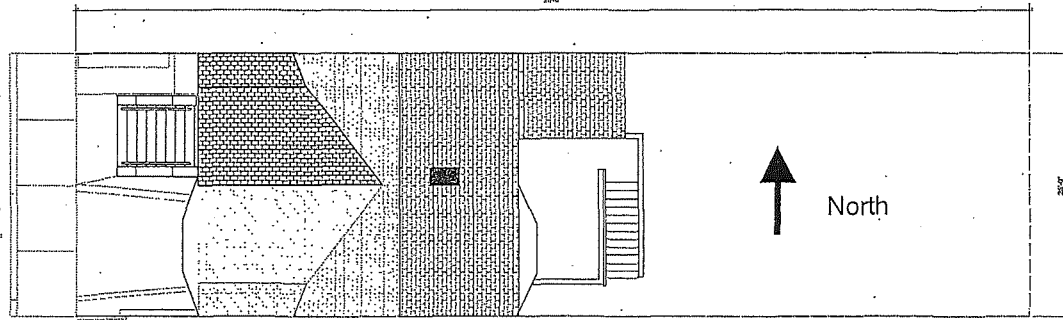

1 EXISTING SITE PLAN
SCALE: 3/16"= 1'-0"

Potomac Street

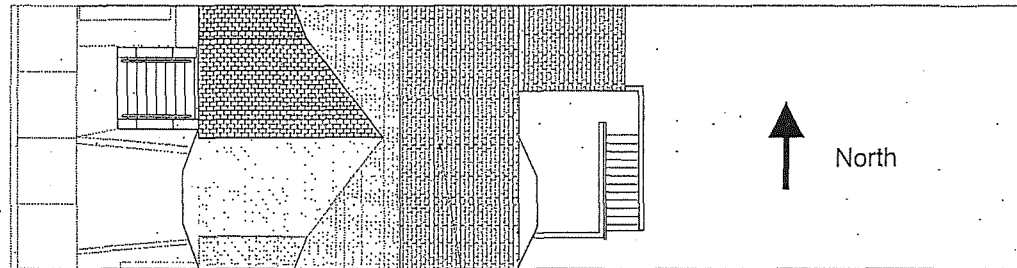

2 PROPOSED SITE PLAN
SCALE: 3/16"= 1'-0"

1504

HOMEWORK
1927 MCALLISTER STREET
SAN FRANCISCO CA 94115
415.857.6912

PERMIT SET
NOT FOR CONSTRUCTION

64 POTOMAC ST

REVISION	DATE
Permit Set	12.12.18

SITE PLAN

SCALE: 3/16"=1'-0"

SHEET
A1

1505

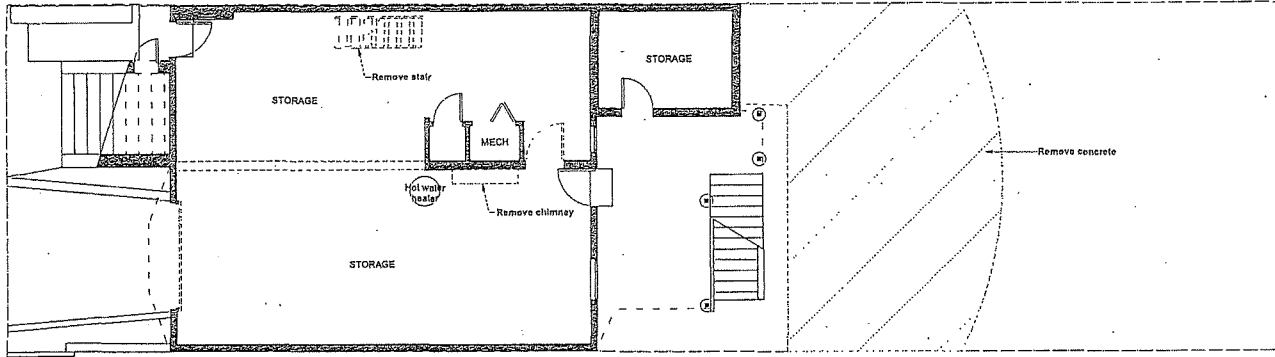

2 EXISTING/DEMO BASEMENT FLOOR PLAN
SCALE: 1/4"= 1'-0"

LEGEND
--- Demo Wall

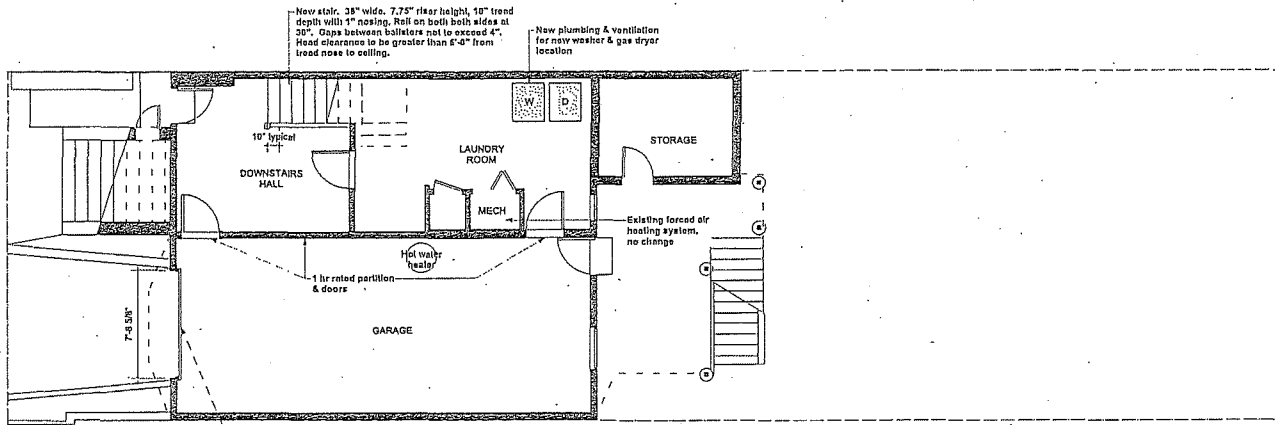

1 PROPOSED BASEMENT FLOOR PLAN
SCALE: 1/4"= 1'-0"

HOMEWORX
1627 MCALLISTER STREET
SAN FRANCISCO CA 94115
415.867.5912

PERMIT SET
NOT FOR CONSTRUCTION

64 POTOMAC ST

REVISION DATE
Permit Set 12.12.18

BASEMENT FLOOR PLANS
SCALE: 1/4"=1'-0"

SHEET
A2

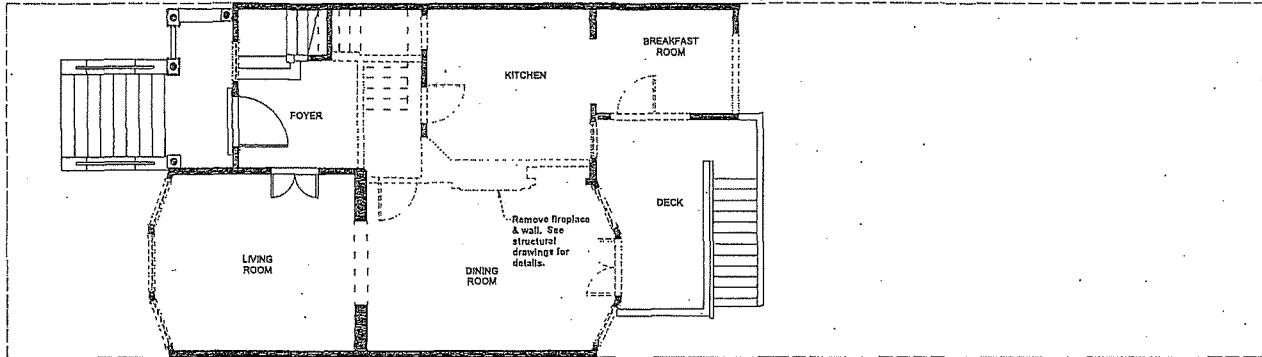

2 EXISTING/DEMO 1ST FLOOR PLAN
SCALE: 1/4" = 1'-0"

Legend
--- Demo Wall

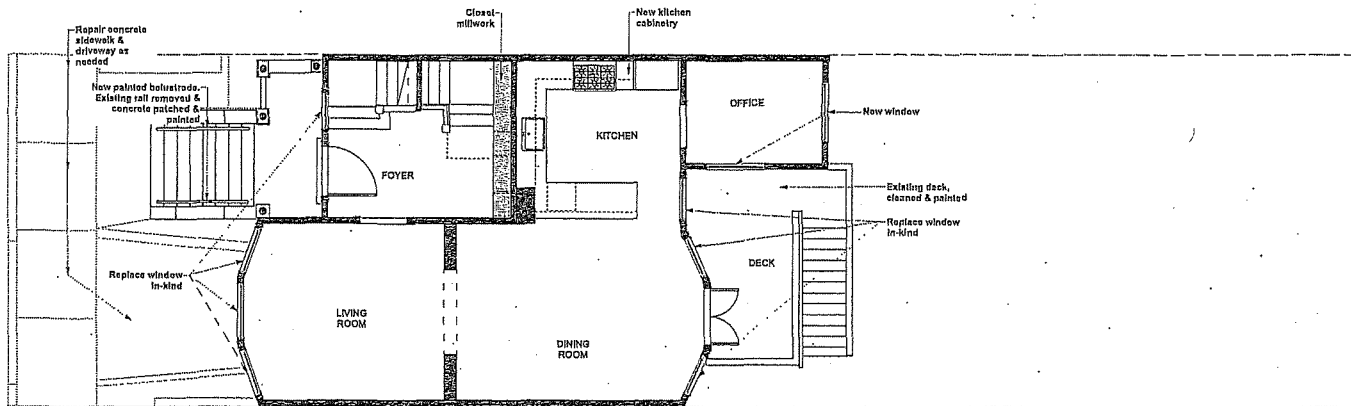

1 PROPOSED 1ST FLOOR PLAN
SCALE: 1/4" = 1'-0"

1506

HOMework
1627 MCALLISTER STREET
SAN FRANCISCO CA 94115
415.087.5912

PERMIT SET
NOT FOR CONSTRUCTION

64 POTOMAC ST

REVISION	DATE
Permit Set	12.12.18

1ST FLOOR PLANS

SCALE: 1/4" = 1'-0"
SHEET

A3

1507

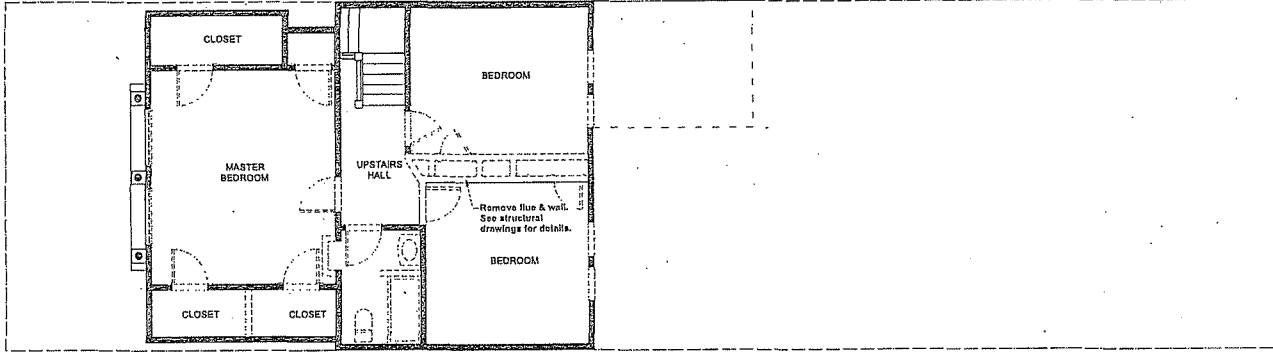

2 EXISTING/DEMO 2ND FLOOR PLAN
SCALE: 1/4" = 1'-0"

LEGEND
--- Demo Wall

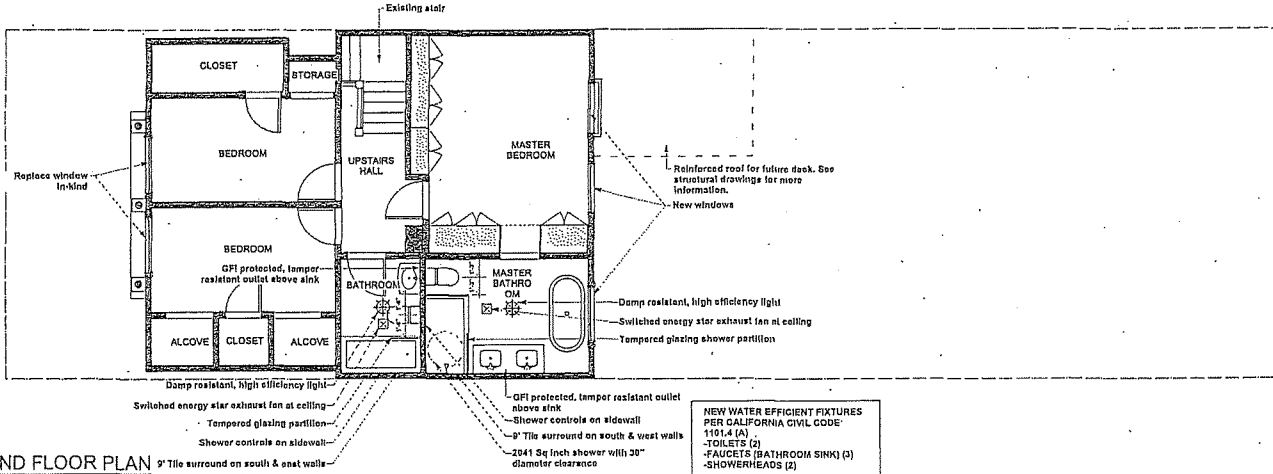

1 PROPOSED 2ND FLOOR PLAN
SCALE: 1/4" = 1'-0"

NEW WATER EFFICIENT FIXTURES
PER CALIFORNIA CIVIL CODE
1101.4 (A)
-TOILETS (2)
-FAUCETS (BATHROOM SINK) (3)
-SHOWERHEADS (2)

HOMework
1627 MCALLISTER STREET
SAN FRANCISCO CA 94115
415.857.5912

PERMIT SET
NOT FOR CONSTRUCTION

64 POTOMAC ST

REVISION DATE
Permit Set 12.12.18

2ND FLOOR
PLANS

SCALE: 1/4" = 1'-0"

SHEET
A4

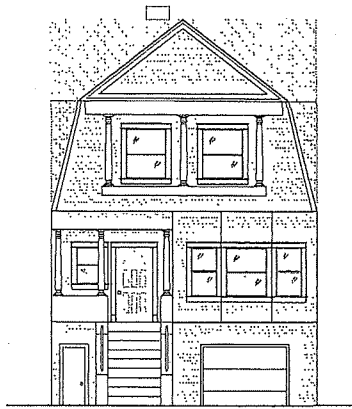

1 EXISTING FRONT ELEVATION
SCALE: 3/16"= 1'-0"

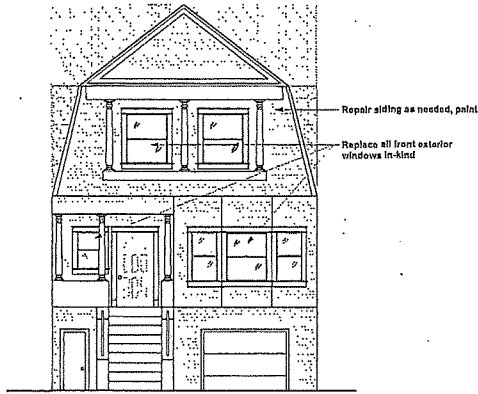

2 PROPOSED FRONT ELEVATION
SCALE: 3/16"= 1'-0"

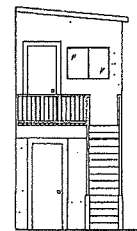

5 EXISTING (REAR) PARTIAL NORTH ELEVATION
SCALE: 3/16"= 1'-0"

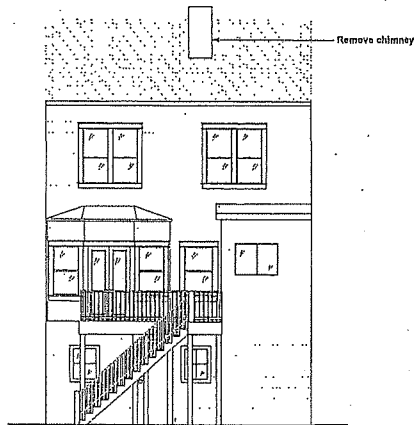

3 EXISTING REAR ELEVATION
SCALE: 3/16"= 1'-0"

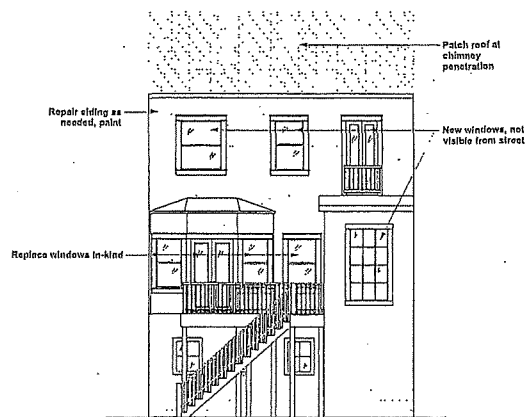

4 PROPOSED REAR ELEVATION
SCALE: 3/16"= 1'-0"

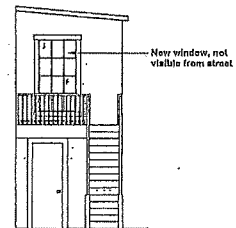

6 PROPOSED (REAR) PARTIAL NORTH ELEVATION
SCALE: 3/16"= 1'-0"

HOMework
1627 MCALLISTER STREET
SAN FRANCISCO CA 94115
415.057.5912

PERMIT SET
NOT FOR CONSTRUCTION

64 POTOMAC ST

REVISION DATE
Permit Set 12.12.18

EXTERIOR
ELEVATIONS

SCALE: 3/16"=1'-0"
SHEET

A5

VIII. ROUGH CARPENTRY:

1. PROVIDE SAHM LUMBER IN CONFORMANCE WITH THE GRADING RULES OF THE WEST COAST LUMBER INSPECTION BUREAU (WCLIB) FOR THE SPECIES AND GRADE DESIGNATED. MOISTURE CONTENT SHALL NOT EXCEED 18%.
2. PROVIDE DOUGLAS FIR-LARCH SAHM LUMBER UNLESS NOTED OTHERWISE. AS A MINIMUM, PROVIDE THE FOLLOWING GRADES:
JOISTS..... NO. 2
BEAMS AND HEADERS..... NO. 1
WALL STUDS..... NO. 1 & BETTER
POSTS..... NO. 1 & BETTER
SILLS, PLATES, AND BLOCKING..... NO. 2
3. PROVIDE ENGINEERED LUMBER IN CONFORMANCE WITH THE FOLLOWING SPECIFICATIONS:

ITEM	Fb (PSI)	Fv (PSI)	E (PSI)
PSL	2,900	290	2.0x10 ⁶
LVL	2,600	285	1.90x10 ⁶
LSL	2,325	310	1.55x10 ⁶

4. PROVIDE PRESSURE-TREATED WOOD FOR ALL EXPOSED MEMBERS AND ALL MEMBERS IN CONTACT WITH CONCRETE, MASONRY, OR SOIL. ALL NAILS IN CONTACT WITH PRESSURE-TREATED LUMBER SHALL BE EITHER HOT-DIPPED GALVANIZED (MEETING ASTM A153 CLASS D) OR STAINLESS STEEL. ALL HARDWARE IN CONTACT WITH PRESSURE-TREATED LUMBER SHALL BE EITHER HOT-DIPPED GALVANIZED (MEETING ASTM A653 CLASS G185), OR STAINLESS STEEL.
5. AS A MINIMUM, ATTACH AND INTERCONNECT ALL FRAMING MEMBERS IN ACCORDANCE WITH THE NAILING SCHEDULE CONTAINED IN TABLE 2304.8.1 IN THE CALIFORNIA BUILDING CODE. NAILS MAY BE BOX OR COMMON WIRE, AS ALLOWED IN FOOTNOTES OF TABLE. NAILS CALLED FOR ON PLANS AND DETAILS SHALL BE COMMON WIRE. HOT-DIPPED GALVANIZED NAILS SHALL BE USED WHERE EXPOSED TO WEATHER OR IN CONTACT WITH PRESSURE-TREATED LUMBER.
6. PROVIDE FULL-DEPTH SOLID BLOCKING OR OTHER MEANS OF LATERAL SUPPORT AT ENDS AND BEARING POINTS OF ALL JOISTS, RAFTERS, BEAMS, AND HEADERS, AND AT INTERMEDIATE INTERVALS NOT TO EXCEED 8'-0".
7. DESIGNATIONS FOR HARDWARE ARE BASED ON SIMPSON STRONG-TIE CO., INC. SUBSTITUTION OF NON-SIMPSON HARDWARE IS NOT ACCEPTABLE.
8. INSTALL HARDWARE IN STRICT ACCORDANCE WITH THE MANUFACTURER'S RECOMMENDATIONS. USE ALL SPECIFIED FASTENERS.
9. ALL NAILS SHALL BE COMMON WIRE NAILS. "SHORT" NAILS SUPPLIED BY SIMPSON STRONG-TIE SHALL ONLY BE USED IN ACCORDANCE WITH THE MANUFACTURER'S INSTRUCTIONS, AND SHALL NOT BE USED WHEN ATTACHING THROUGH PLYWOOD TO FRAMING MEMBERS BEHIND.
10. PLYWOOD SUBFLOORING SHALL BE 3/4" APA RATED STUR-D-FLOOR SHEATHING (48/24), GROUP 1 EXPOSURE 1, UNLESS NOTED OTHERWISE. PANEL EDGES SHALL BE TONGUE AND GROOVED. LAY PANELS WITH FACE GRAIN ACROSS SUPPORT. STAGGER JOINTS. NAIL ALL SUPPORTED EDGES WITH 10d NAILS @ 6" O.C. AND AT ALL INTERIOR BEARINGS WITH 10d NAILS @ 12" O.C., UNLESS OTHERWISE NOTED. NAILS SHALL BE RINGSHANK OR SCREW NAILS DRIVEN FLUSH. GLUE PLYWOOD TO ALL SUPPORTS AND AT TONGUE AND GROOVE JOINTS IN ACCORDANCE WITH APA GLUED FLOOR SYSTEM.
11. PLYWOOD WALL SHEATHING SHALL BE 1/2" APA RATED SHEATHING, UNLESS NOTED OTHERWISE. ALL UNSUPPORTED EDGES SHALL BE BLOCKED. NAIL ALL PLYWOOD EDGES WITH 10d NAILS @ 6" AND INTERIOR BEARINGS WITH 10d NAILS @ 12" O.C., UNLESS OTHERWISE NOTED. NAILS SHALL BE DRIVEN FLUSH BUT SHALL NOT FRACTURE THE SURFACE OF THE PLYWOOD. MINIMUM SHEET WIDTH FOR PLYWOOD ON SHEAR WALLS SHALL BE 24".
12. PLYWOOD ROOF SHEATHING SHALL BE 5/8" APA RATED SHEATHING. ALL ROOF SHEATHING SHALL BE LAID WITH FACE GRAIN PERPENDICULAR TO THE JOISTS. STAGGER JOINTS. NAIL ALL PLYWOOD EDGES WITH 10d NAILS @ 6" O.C. AND INTERIOR BEARINGS WITH 10d NAILS @ 12" O.C., UNLESS OTHERWISE NOTED. NAILS SHALL BE DRIVEN FLUSH, BUT SHALL NOT FRACTURE THE SURFACE OF PLYWOOD.

IX. EPOXY GROUTING:

1. WHERE EPOXY IN CONCRETE IS INDICATED ON PLANS OR DETAILS, USE HILTI HIT-RE 500 V3 (ICC ESR-3814), HILTI HIT-HY 200 (ICC ESR-3187), SIMPSON SET-XR ADHESIVE (ICC ESR-2508), OR DEWALT PURE 110+ ADHESIVE (ICC ESR-3298) FOR USE IN CONCRETE. (CONTRACTOR MAY SUBMIT OTHER EPOXY SYSTEMS FOR APPROVAL ALONG WITH AN ICC-ES OR IAP/IO UES REPORT DEMONSTRATING COMPLIANCE WITH THE 2015 IBC FOR THE SPECIFIC PRODUCT.)
2. WHERE EPOXY IN URM IS INDICATED ON PLANS OR DETAILS, USE HILTI HIT-HY 70 ADHESIVE ANCHOR SYSTEM (ICC ESR-3342), SIMPSON SET ADHESIVE (ICC ESR-1772) OR DEWALT AC100+ GOLD (ICC ESR-4105) FOR USE IN UNREINFORCED MASONRY. PLASTIC MESH SCREEN TUBES PER ICC ESR-3342, ICC ESR-1772 OR STEEL MESH SCREEN TUBES PER ICC ESR-4105 SHALL BE USED AT ALL ANCHOR LOCATIONS (CONTRACTOR MAY SUBMIT OTHER EPOXY SYSTEMS FOR APPROVAL ALONG WITH ICC-ES OR IAP/IO UES REPORT DEMONSTRATING COMPLIANCE WITH THE 2015 IBC FOR THE SPECIFIC PRODUCT.)
3. DRILL HOLES TO EPOXY MANUFACTURER'S RECOMMENDED SIZE. CLEAN HOLES WITH A CIRCULAR WIRE OR NYLON BRUSH AND BLOW OUT WITH COMPRESSED AIR.
4. SLOWLY INSERT ROD OR BAR WHILE TURNING ONE FULL ROTATION. DO NOT DISTURB DOWEL UNTIL EPOXY HAS SET.
5. INSTALL ADHESIVE ANCHORS THAT ARE TO BE UNDER SUSTAINED TENSION LOADING IN HORIZONTAL TO VERTICAL OVERHEAD ORIENTATION SHALL BE DONE BY A CERTIFIED ADHESIVE ANCHOR INSTALLER (AAI) AS CERTIFIED THROUGH ACI AND IN ACCORDANCE WITH ACI 318-2014 (SECTION 17.8.2.2). PROOF OF CURRENT CERTIFICATION SHALL BE SUBMITTED TO THE ENGINEER FOR APPROVAL PRIOR TO COMMENCEMENT OF INSTALLATION.
6. PER ACI 318-2014 (SECTION 17.1.2) ADHESIVE ANCHORS SHALL BE INSTALLED IN CONCRETE HAVING A MINIMUM AGE OF 21 DAYS AT THE TIME OF ANCHOR INSTALLATION. FOR INSTALLATIONS SOONER THAN 21 DAYS CONSULT ADHESIVE MANUFACTURER.

X. TESTING AND INSPECTION:

1. SPECIAL INSPECTIONS SHALL BE PERFORMED BY AN APPROVED INDEPENDENT TESTING AND INSPECTION AGENCY OR AS INDICATED BELOW.
2. THE INSPECTION AGENCY SHALL BE RETAINED BY AND PAID FOR BY THE OWNER.
3. THE CONTRACTOR SHALL SUBMIT TO THE ENGINEER, PRIOR TO BEGINNING CONSTRUCTION, A DETAILED LIST OF "SPECIAL INSPECTION" ITEMS INDICATING THE SCOPE OF TESTING AND INSPECTION AND THE AGENCY OR ENGINEER PERFORMING THE WORK.
4. THE INSPECTION AGENCY SHALL PROVIDE INSPECTION REPORTS TO THE ARCHITECT & STRUCTURAL ENGINEER. THE REPORTS SHALL INCLUDE ANY ITEMS WHICH ARE IN NON-COMPLIANCE WITH THE DESIGN DOCUMENTS.
5. THE STRUCTURAL ENGINEER WILL REQUIRE A FINAL REPORT FROM THE INSPECTION AGENCY. THE REPORT NEEDS TO SHOW THAT ALL DEFICIENCIES MENTIONED IN EARLIER REPORTS HAVE BEEN CORRECTED. COPIES OF THE TESTING AND INSPECTION REPORT SHALL BE SENT TO THE BUILDING DEPARTMENT, ARCHITECT, STRUCTURAL ENGINEER AND OWNER.
6. PROVIDE "SPECIAL INSPECTIONS" FOR ALL ITEMS AS REQUIRED BY THE CALIFORNIA BUILDING CODE, 2016 EDITION, SEE SHEET S-1.0 UNDER "SPECIAL INSPECTION AND STRUCTURAL OBSERVATION."

INSPECTIONS BY INDEPENDENT AGENCY:

- A. CONCRETE PLACEMENT: DURING THE TAKING OF TEST SPECIMENS AND PLACING OF REINFORCED CONCRETE, EXCEPT CONCRETE WHERE THE SPECIFIED STRENGTH IS 2,500 PSI OR LESS, FOUR TEST CYLINDERS FROM EACH 150 CUBIC YARDS OR FRACTION THEREOF POURED IN ANY ONE DAY SHALL BE SECURED AND REPORTED BY AN INDEPENDENT TESTING AGENCY; ONE TO BE TESTED AT 7 DAYS, TWO AT 28 DAYS, AND THE FOURTH HELD IN RESERVE.
- B. BOLTS DRILLED AND EPOXIED INTO EXISTING CONCRETE.
- C. PULL/TORQUE TESTS PER SFB3 SEC. 1607C & 11615C.

INSPECTIONS BY ENGINEER OF RECORD:

- D. BOLTS CAST IN CONCRETE: PRIOR TO AND DURING THE PLACEMENT OF CONCRETE AROUND BOLTS.
- E. CONCRETE REINFORCING STEEL: DURING PLACING OF REINFORCING STEEL. EXCEPTION: THE SPECIAL INSPECTOR NEED NOT BE PRESENT DURING ENTIRE REINFORCING STEEL-PLACING OPERATIONS, PROVIDED HE/SHE HAS INSPECTED FOR CONFORMANCE WITH THE APPROVED PLANS PRIOR TO THE CLOSURE OF FORMS OR THE DELIVERY OF CONCRETE TO THE JOBSITE.
- F. PLYWOOD SHEAR WALLS-NAILING, CLIPS, STRAPS, HOLDDOWNS.

XI. STRUCTURAL OBSERVATIONS:

1. THE STRUCTURAL ENGINEER WILL REPORT ANY OBSERVED DEFICIENCIES TO THE OWNER, CONTRACTOR OR BUILDING OFFICIAL FOLLOWING SITE VISITS. THE STRUCTURAL ENGINEER WILL PROVIDE A WRITTEN REPORT TO THE ARCHITECT AFTER EACH SITE VISIT. HOWEVER, THE STRUCTURAL ENGINEER'S SITE VISITS ARE NOT CONSIDERED AS INSPECTION VISITS. THE INSPECTION AGENCY RETAINED AND PAID FOR BY THE OWNER SHALL PROVIDE INSPECTION REPORTS TO THE ARCHITECT/STRUCTURAL ENGINEER. THE REPORTS SHALL INCLUDE ANY ITEMS WHICH ARE IN NON-COMPLIANCE WITH THE DESIGN DOCUMENTS.
2. AFTER THE STRUCTURAL ENGINEER RECEIVES THE FINAL REPORT, FROM THE SPECIAL INSPECTION AGENCY, THE STRUCTURAL ENGINEER WILL SUBMIT A FINAL SUMMARY REPORT DOCUMENTING SITE VISITS AND OBSERVATIONS, NOTING ANY DEFICIENCIES THAT CORRECTIVE WORK HAS BEEN COMPLETED, AND THAT CONSTRUCTION PROCEEDED IN ACCORDANCE WITH THE APPROVED PLANS, SPECIFICATIONS AND APPLICABLE CODES AND REGULATIONS PER SECTION 1704 OF THE CALIFORNIA BUILDING CODE.
3. STRUCTURAL OBSERVATION BY THE DESIGN ENGINEER IS REQUIRED AT THE FOLLOWING PHASES, AND PRIOR TO COVERING WITH OTHER WORK:
 - A. BEFORE CLOSING OF FORMS - FOUNDATION REINFORCING AND BOLTS INSTALLED IN CONCRETE.
 - B. PLYWOOD DIAPHRAGM NAILING - PRIOR TO COVERING WITH WALL FRAMING OR OTHER WORK.
 - C. PLYWOOD SHEAR WALL NAILING AND ALL RELATED-HOLD DOWNS, STRAPS, CLIPS, ETC.
4. FOR A COMPLETE LIST OF REQUIRED "STRUCTURAL OBSERVATION" SEE SHEET S-000 UNDER "SPECIAL INSPECTION AND STRUCTURAL OBSERVATION."



FTF ENGINEERING, INC.
1916 McAllister Street
San Francisco, CA 94115
tel - 415-931-8460
fax - 415-931-8461
www.ftfengineering.com

**INGEBORN-GUSTAV
RESIDENCE**
 64 Potomac Street
 San Francisco, CA 94117



Issue:	Date:
Building Permit:	12.18.2018

Scale: AS NOTED
Job No. 18-114

General Notes II

S-001

1511

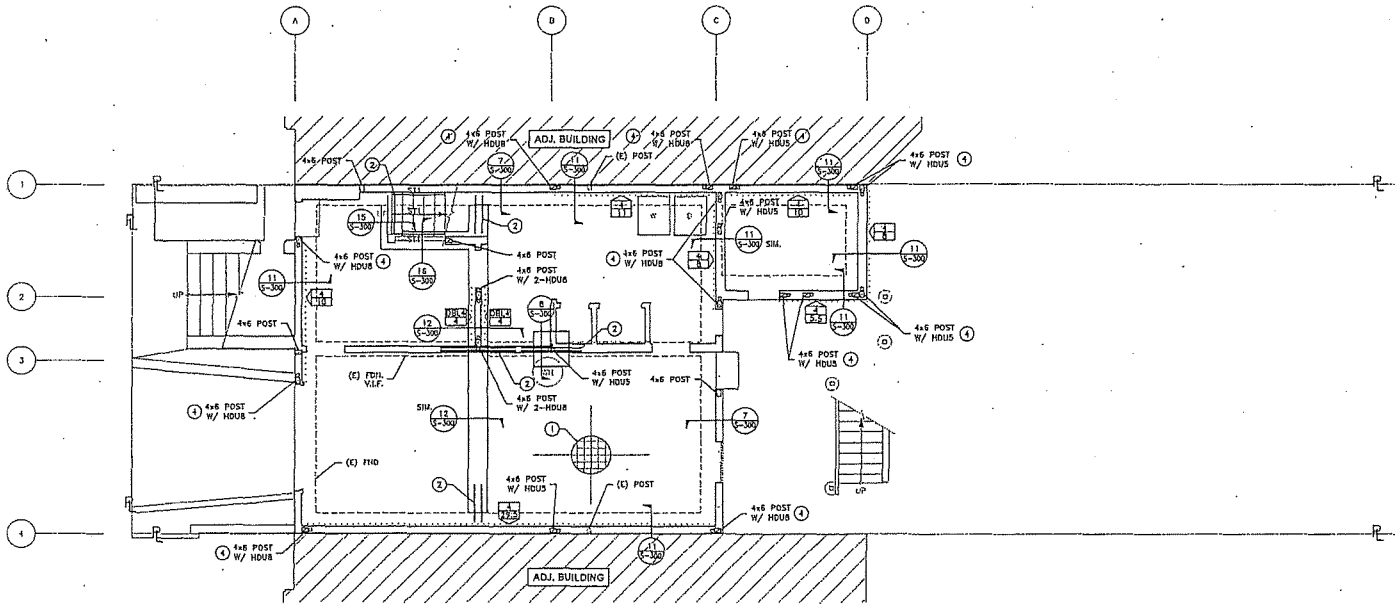

1 BASEMENT FOUNDATION PLAN

SCALE: 1/4" = 1'-0"



LEGEND

- ===== WALLS
- ====-(U) FOUNDATION
- ====-(E) FOUNDATION BELOW
- ====-(O) FOUNDATION BELOW
- HOLDDOWN
- ⊕ X = DENOTES S.W. EDGE JAILING
- ⊕ Y = DENOTES S.W. LENGTH IN FEET
- REF. S-510 FOR FHD S.W. DETAILS
- ⊕ (U) POST ABOVE
- ⊕ (E) POST ABOVE
- ⊕ REFERS TO NOTE #

BEAM SCHEDULE

MARK	SIZE	MATERIAL	NOTES
S11	19"x14"	LVL	SIRHIGER CUT TO SIZE

SHEET NOTES:

- ① (E) CONCRETE SLAB ON GRADE AT GARAGE
- ② 2"x4" DOWELS DRILL 6" DEEP & EPOXY TO (E) CONCRETE
- ③ NOT USED
- ④ DRILL & EPOXY ANCHOR ROD FOR HOLD DOWN PER DETAIL 9/3-810. PULL TEST 20% OF EACH DIAMETER ROD PER SCHEDULE. IF FAILURES OCCUR NOTIFY E.O.R. AND TEST ALL ANCHORS.

GENERAL NOTES:

1. FOR TYPICAL CONCRETE DETAILS SEE SHEET S-200.
2. FOR TYPICAL WOOD FRAMING DETAILS SEE S-600.
3. FOR TYPICAL SHEAR WALL DETAILS SEE S-610.
4. POST FOR HOLDDOWN MAY CONSIST OF MULTIPLE PILES OF 2x STUDS TO ACHIEVE NOMINAL POST SIZE. STITCH PILES WITH S.J.L. PER S.W. SCHEDULE.



HTF ENGINEERING, INC
 1916 McAllister Street
 San Francisco, CA 94116
 tel - 415-931-8460
 fax - 415-931-8461
 www.htfengineering.com

**INGEBORN-GUSTAV
 RESIDENCE**
 64 Potomac Street
 San Francisco, CA 94117



Issuer	Date
Building Permit	12.18.2018

Scale: AS NOTED
 Job No. 18-114

Basement
 Foundation Plan

S-200

1512

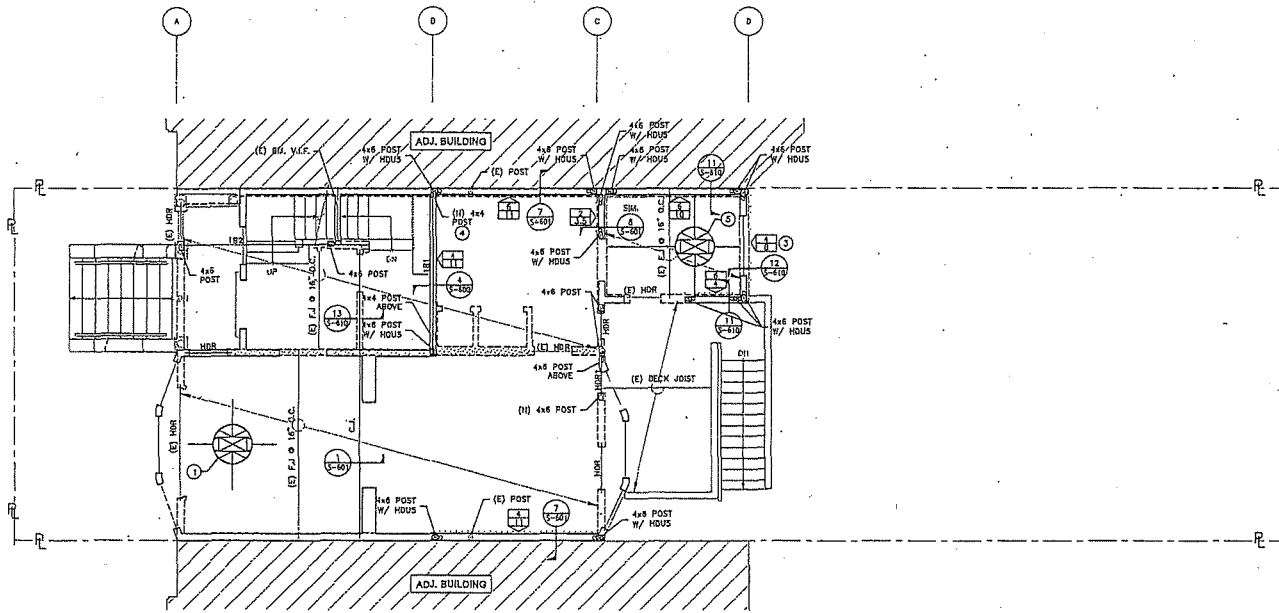

1 FIRST FLOOR FRAMING PLAN

SCALE: 1/4" = 1'-0"



LEGEND

- ===== WALLS
- WALLS BELOW
- HOLDINGS
- ⊕ X = DENOTES S.W. EDGE NAILING
- ⊕ Y = DENOTES S.W. LENGTH IN FEET
- REF. S-616 FOR FPOD S.W. DETAILS
- (U) POST ABOVE & BELOW
- (U) POST ABOVE
- (U) POST BELOW
- (E) POST ABOVE
- (E) POST BELOW
- C.J. COLLECTOR JOIST
- (C) 2x JOIST
- (U) WOOD BEAM
- (C) WOOD BEAM
- ===== SIMPSON STRONG WALL
- INTERIOR BEARING WALL BELOW
- ① REFERS TO NOTE 1

BEAM SCHEDULE		
MARK	SIZE	MATERIAL NOTES
1B1	2x8-85"	PSL
1B2	3x8-88"	PSL
HDR1	4x10	D.F.#1 SEE DET. 7/S-800
HDR		SEE SCHED. D.F.#1 SEE DET. 7/S-800

SHEET NOTES:

- ① (U) 3/4" PLYWOOD OVERLAY ON (E) SHEATHING WITH 104 @ 6" O.C. PER DETAIL 1/S-800
- ② SEE DETAIL 5/S-500 FOR WOOD POST AT STEEL BEAM
- ③ STRAP AROUND OPENING IN SHEAR WALL PER DETAIL 1/S-810
- ④ SISTER 4x4 POST TO 4x6 WITH SDS PER SHEAR WALL SCHEDULE
- ⑤ (U) FLOOR PLYWOOD DIAPHRAGM PER DETAIL 2x3/S-600

GENERAL NOTES:

1. FOR TYPICAL STEEL DETAILS SEE S-500.
2. FOR TYPICAL WOOD FRAMING DETAILS SEE S-600.
3. FOR TYPICAL SHEAR WALL DETAILS SEE S-610.



FTF ENGINEERING, INC.
 3216 McAllister Street
 San Francisco, CA 94116
 Tel - 415-831-8400
 Fax - 415-831-8461
 www.ftfengineering.com

**INGEBORN-GUSTAV
 RESIDENCE**
 64 Potomac Street
 San Francisco, CA 94117



Issue: _____ Date: _____
 Building Permit: 12.18.2018

Scale: AS NOTED
 Job No. 18-114

First Floor Framing Plan

S-201

1513

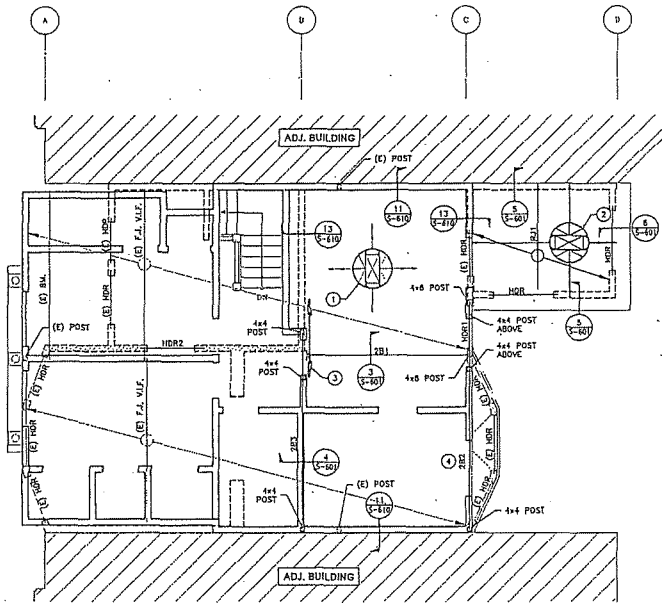

1 SECOND FLOOR FRAMING PLAN

SCALE: 1/4" = 1'-0"



JOIST SCHEDULE			
MARK	SPACING	JOIST	MATERIAL NOTES
RJ1	16" O.C.	1 1/2"x8"	LVL U210

BEAM SCHEDULE			
MARK	SIZE	MATERIAL	NOTES
ZB1	5 1/2"x8"	PSL	
ZB2	3 1/2"x8"	PSL	
ZB3	2 1/2"x8"	PSL	
HDR1	4x10	D.F.#1	SEE DET. 7/5-600
HDR2	4x10	D.F.#1	SEE DET. 7/5-600
HDR	SEE SCHED.	D.F.#1	SEE DET. 7/5-600

SHEET NOTES:

- (E) 1x STRAIGHT SHEATHED DIAPHRAGM WITH HARDWOOD FLOOR OVERLAY
- (H) ROOF PLYWOOD DIAPHRAGM PER DETAIL 1/2/5-600
- HORIZONTAL NODUS FROM JOIST TO BEAM
- VERIFY IN FIELD THE EXISTING FRAMING OF THE ROOF OF THE BAY WINDOW BEFORE INSTALLING ZB2. NOTIFY ENGINEER OF RECORD.

GENERAL NOTES:

- FOR TYPICAL WOOD FRAMING DETAILS SEE S-600.
- FOR TYPICAL SHEAR WALL DETAILS SEE S-610.

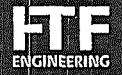

FTF ENGINEERING, INC
 1916 McAllister Street
 San Francisco, CA 94115
 Tel - 415-331-8400
 Fax - 415-331-8401
 www.ftfengineering.com

INGEBORN-GUSTAV
 RESIDENCE
 64 Potomac Street
 San Francisco, CA 94117



Issue: _____ Date: _____
 Building Permit 12.18.2018

Scale: AS NOTED
 Job No. 18-114

Second Floor
 Framing Plan

S-202



Project:	Building Permit: 12122018
Date:	12.12.2018
Scale:	AS NOTED
Job No.:	18-114
Roof Framing Plan	
S-203	

LEGEND	WALLS	WALLS BELOW	WALLS	INDEX
---	(D) POST BELOW	(D) POST BELOW	5" x 8"	PSL
---	(E) POST BELOW	(E) POST BELOW	3" x 8"	PSL
---	(G) 2" JOIST	(G) 2" JOIST	4" x 10	D.F.J.
---	(H) WOOD BEAM	(H) WOOD BEAM		SEE SCHED. D.F.J.
---	(I) WOOD BEAM	(I) WOOD BEAM		SEE SCHED. D.F.J.
Ⓢ	REFERS TO NOTE #			

BEAM SCHEDULE	INDEX
H81	5" x 8" PSL
H82	3" x 8" PSL
H83	4" x 10 D.F.J.
H84	4" x 10 D.F.J.

SHEET NOTES:
Ⓢ (E) PLYWOOD ROOF SHEATHING

GENERAL NOTES:
1. FOR TYPICAL WOOD FRAMING DETAILS SEE S-100.

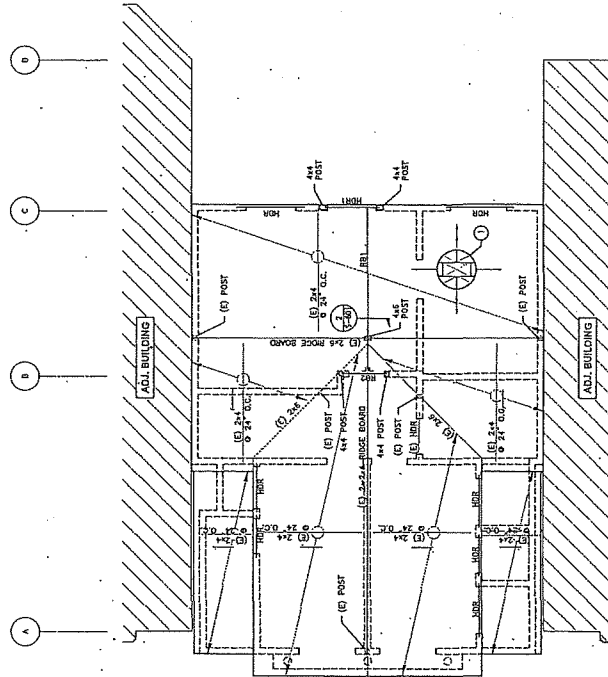

1 ROOF FRAMING PLAN
SCALE: 1/4" = 1'-0"

1515

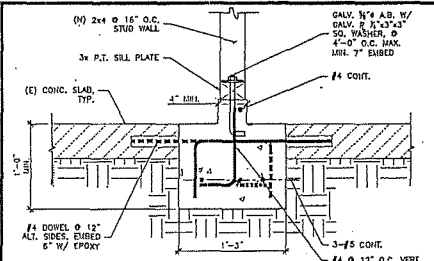

16 (N) FOUNDATION AT (N) WALL
SCALE: 1-1/2" = 1'-0"

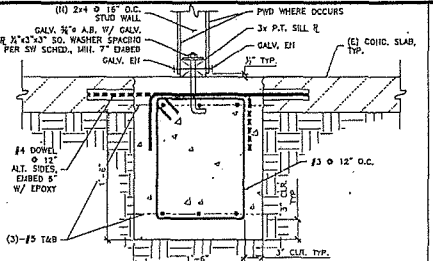

12 INTERIOR GRADE BEAM AT (E) SLAB
SCALE: 1-1/2" = 1'-0"

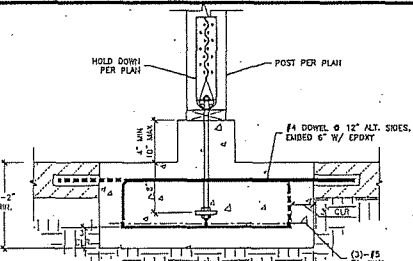

8 SPREAD FOOTING
SCALE: 1-1/2" = 1'-0"

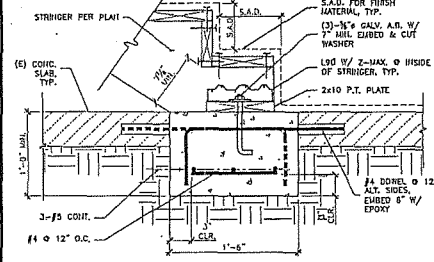

15 STAIR STRINGER AT FOOTING
SCALE: 1-1/2" = 1'-0"

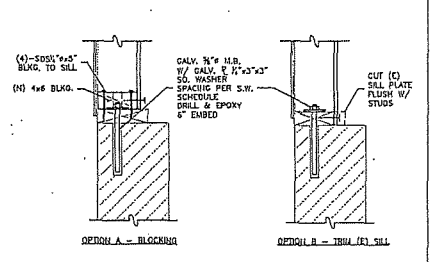

11 (N) SHEAR WALL AT (E) FOUNDATION
SCALE: 1-1/2" = 1'-0"

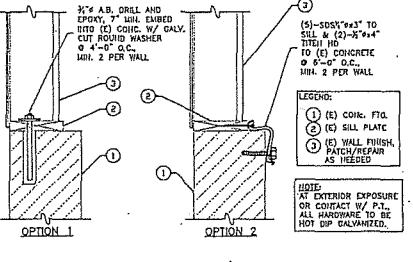

7 BOLTING OF (E) WALLS TO (E) FOUNDATION
SCALE: 1-1/2" = 1'-0"

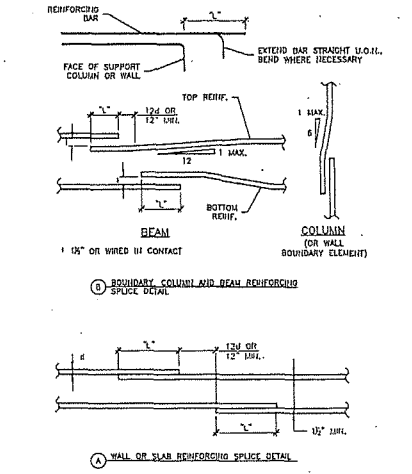

13 NOT USED
SCALE: N.T.S.

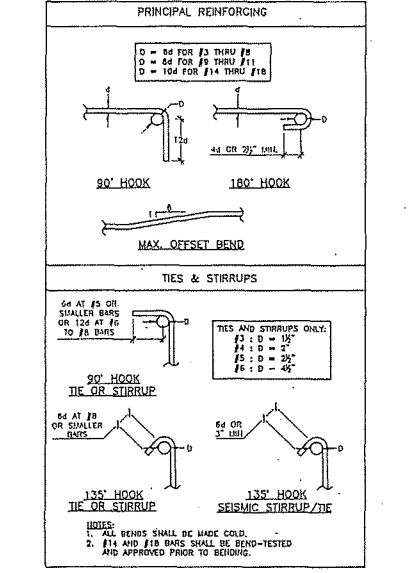

5 STANDARD HOOK & TIE DETAILS
SCALE: 1" = 1'-0"

REINFORCING BAR SPLICE AND STRAIGHT DEVELOPMENT LENGTHS SCHEDULE

NORMAL WEIGHT CONCRETE REF: ACI318-11

TENSION SPLICE	BAR SIZE (OR. 60)	#3	#4	#5	#6	#7	#8	#9	#10	#11
CLASS A & B DEVELOPMENT LENGTHS (d)	2,500	TOP 23"	31"	39"	47"	66"	78"	80"	99"	110"
	OTHER	18"	24"	30"	36"	53"	60"	68"	76"	85"
	3,000	TOP 21"	28"	36"	43"	62"	71"	80"	90"	100"
	OTHER	16"	22"	27"	33"	48"	55"	62"	70"	77"
CLASS B - L (h)	4,000	TOP 16"	23"	31"	37"	54"	62"	70"	78"	87"
	OTHER	14"	19"	24"	28"	42"	47"	54"	60"	67"
	2,500	TOP 30"	41"	51"	61"	89"	101"	114"	129"	143"
	OTHER	23"	31"	39"	47"	68"	78"	88"	98"	110"
CLASS B - L (h)	3,000	TOP 28"	37"	46"	56"	81"	93"	104"	118"	131"
	4,000	TOP 21"	28"	36"	43"	62"	71"	80"	90"	100"
OTHER	TOP 24"	32"	40"	48"	70"	80"	90"	102"	113"	
	OTHER	18"	25"	31"	37"	54"	62"	70"	78"	87"

NOTE: PROVIDE 30% LONGER LAP LENGTH FOR LIGHTWEIGHT CONCRETE.

1. CLASS "A" SPLICES SHALL BE USED WHEN ONE-HALF OR LESS OF THE TOTAL REINFORCEMENT IS SPLICED WITHIN THE REQUIRED LAP LENGTH.

2. CLASS "B" SPLICES SHALL BE USED WHEN MORE THAN ONE-HALF OF THE TOTAL REINFORCEMENT IS SPLICED WITHIN THE REQUIRED LAP LENGTH.

3. #6 = NOMINAL DIAMETER OF A BAR.

4. TOP BARS ARE HORIZONTAL REINFORCING WITH MORE THAN 12" OF CONCRETE BELOW THE BAR.

5. OTHER BARS ARE ALL VERTICAL, ALL HORIZONTAL WALL REINFORCING, AND HORIZONTAL REINFORCING WITH LESS THAN 12" OF CONCRETE BELOW BAR.

6. SMALLER BAR LAP LENGTH MAY BE USED WHEN SPLICING DIFFERENT SIZE BARS.

7. LAP SPLICES ARE NOT PERMITTED IF MECHANICAL SPLICES ARE SHOWN.

8. NON-CONTACT LAP SPLICED BARS SHALL NOT BE SPACED TRANSVERSELY FURTHER APART THAN 20% OF THE REQUIRED LAP LENGTH OR 8 INCHES.

9. LAP TOP BARS AT MIDSPAN AND BOTTOM BARS AT SUPPORTS UNLESS OTHERWISE SHOWN.

10. DOWNED BAR SPLICES:
 A. INDIVIDUAL BAR SPLICES WITHIN THE GUILDE SHALL NOT OVERLAP EACH OTHER.
 B. INCREASE LAP LENGTH 50% AT THREE BARS.
 C. INCREASE LAP LENGTH 50% AT FOUR BARS.

1 REINFORCING BAR SPLICE SCHEDULE & NOTES
SCALE: N.T.S.



FTF ENGINEERING, INC
 1018 McAllister Street
 San Francisco, CA 94115
 tel - 415-931-8460
 fax - 415-931-8461
 www.ftfengineering.com

INGEBORN-GUSTAV
 RESIDENCE
 64 Potomac Street
 San Francisco, CA 94117



Issue: _____ Date: _____
 Building Permit: _____
 Scale: AS NOTED
 Job No. 18-114

Concrete Details

S-300

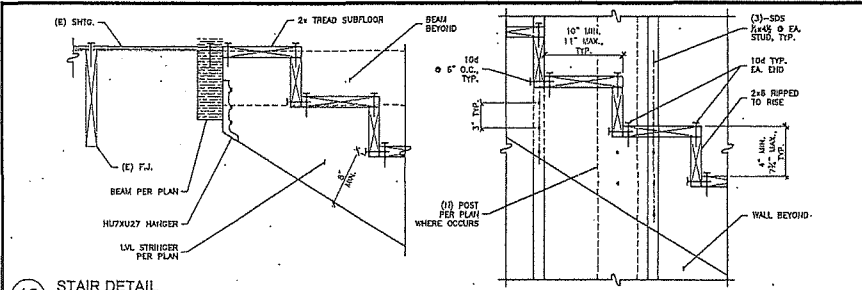

16 STAIR DETAIL

SCALE: 1-1/2\"/>

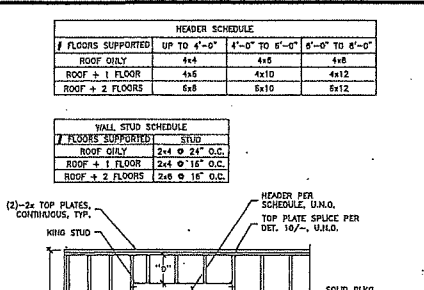

7 TYPICAL STUD WALL FRAMING ELEVATION

SCALE: 3/8\"/>

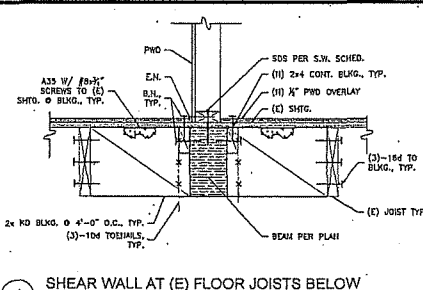

4 SHEAR WALL AT (E) FLOOR JOISTS BELOW

SCALE: 1-1/2\"/>

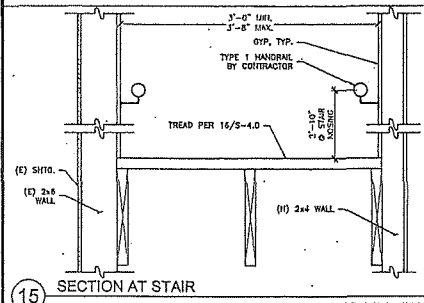

15 SECTION AT STAIR

SCALE: 1-1/2\"/>

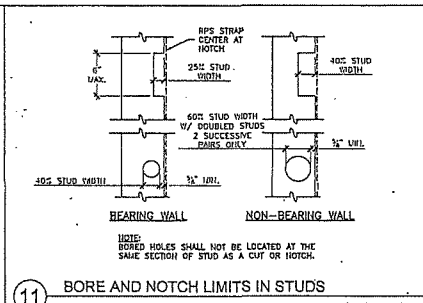

11 BORE AND NOTCH LIMITS IN STUDS

SCALE: 1-1/2\"/>

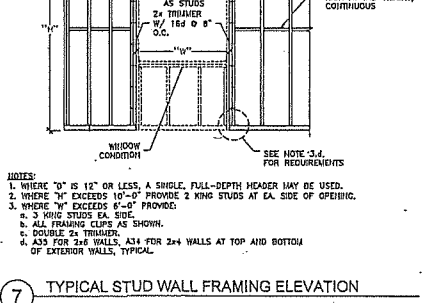

3 DIAPHRAGM SCHEDULE

SCALE: N. T. S.

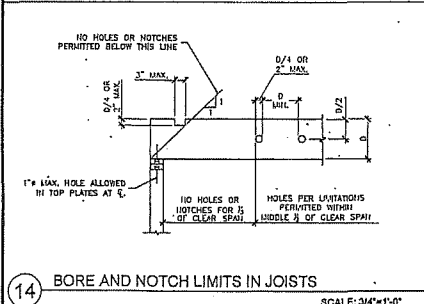

14 BORE AND NOTCH LIMITS IN JOISTS

SCALE: 3/4\"/>

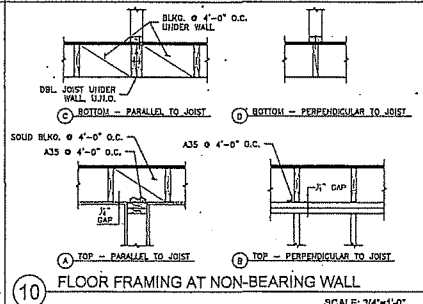

10 FLOOR FRAMING AT NON-BEARING WALL

SCALE: 3/4\"/>

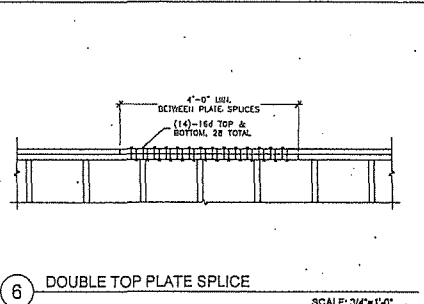

6 DOUBLE TOP PLATE SPLICE

SCALE: 3/4\"/>

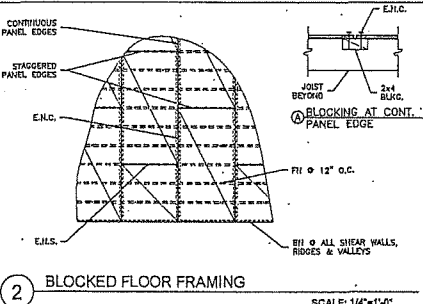

2 BLOCKED FLOOR FRAMING

SCALE: 1/4\"/>

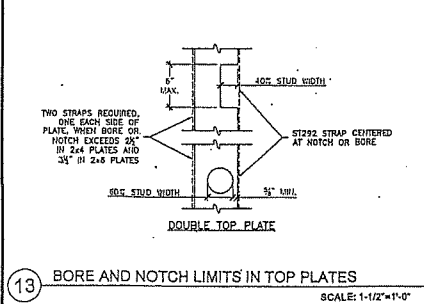

13 BORE AND NOTCH LIMITS IN TOP PLATES

SCALE: 1-1/2\"/>

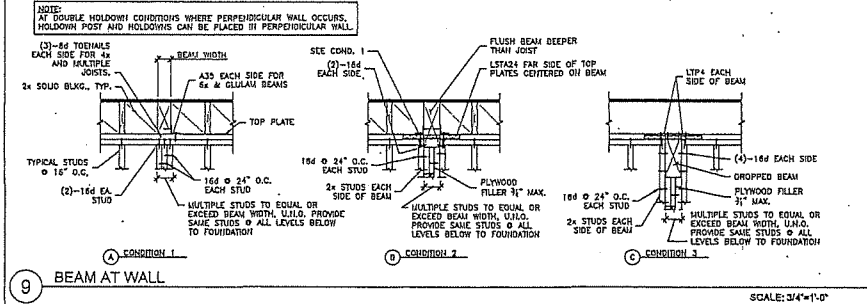

9 BEAM AT WALL

SCALE: 3/4\"/>

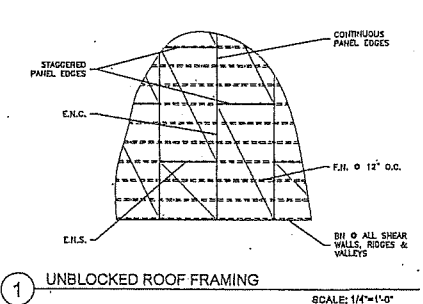

1 UNBLOCKED ROOF FRAMING

SCALE: 1/4\"/>

HTF
ENGINEERING

HTF ENGINEERING, INC
1318 McAllister Street
San Francisco, CA 94115
Tel - 415-931-8480
fax - 415-931-8461
www.htfengineering.com

INGEBORN-GUSTAV
RESIDENCE

64 Potomac Street
San Francisco, CA 94117



Issue:	Date:
Building Permit:	12.18.2015
Scale:	AS-NOTED
Job No.:	18-114

Wood Framing Details I

S-600

1517

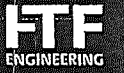
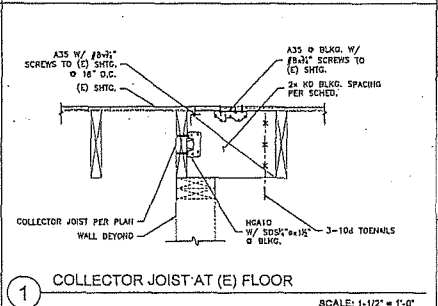
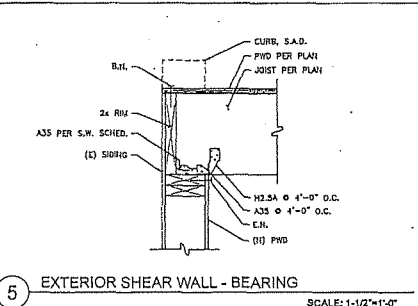
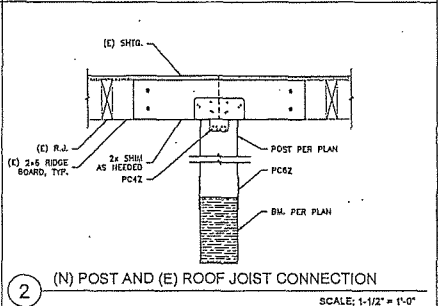
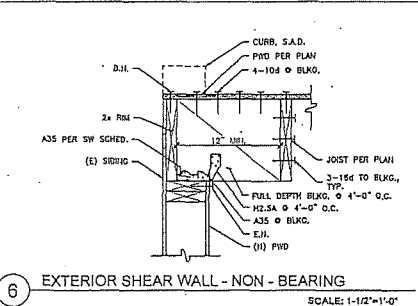
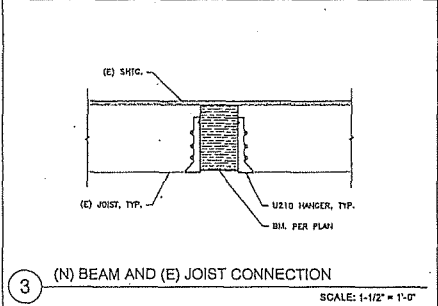
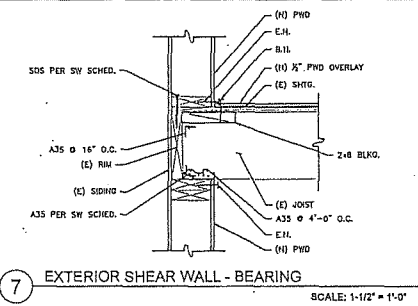
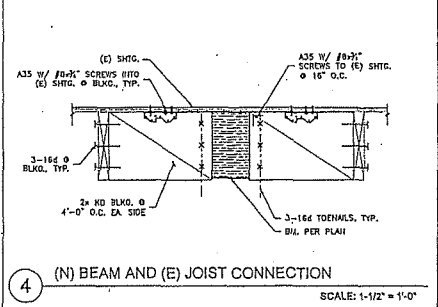
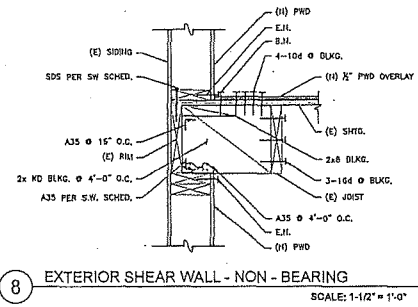

FTF ENGINEERING, INC
1818 McAllister Street
San Francisco, CA 94115
Tel - 415-931-8460
Fax - 415-933-8461
www.ftfengineering.com

INGEBORN-GUSTAV RESIDENCE

64 Potomac Street
San Francisco, CA 94117



Issue:	Date:
Building Permit	12.18.2018
Scale:	AS-NOTED
Job No.	18-114

Wood Framing Details II

S-601

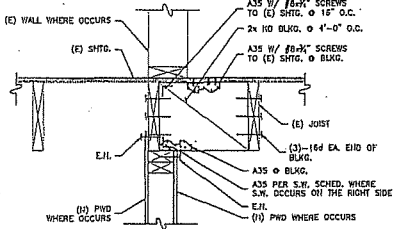

12 EXTERIOR SHEAR WALL - NON-BEARING SCALE: 1-1/2" = 1'-0"

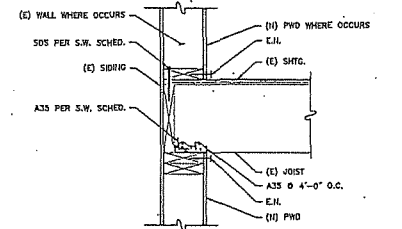

11 EXTERIOR SHEAR WALL - BEARING SCALE: 1-1/2" = 1'-0"

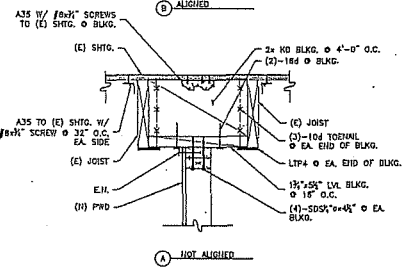

13 INTERIOR SHEAR WALL SCALE: 1-1/2" = 1'-0"

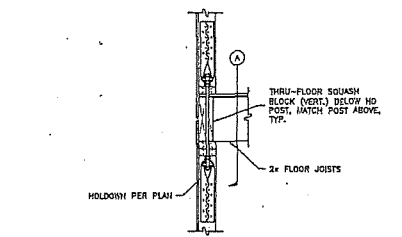
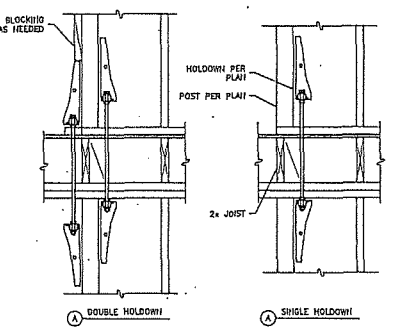

7 TYPICAL HOLDOWN BETWEEN FLOORS SCALE: 1" = 1'-0"

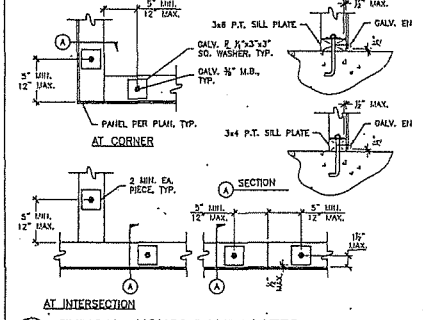

3 TYPICAL ANCHOR BOLT PLATES SCALE: 1" = 1'-0"

HOLDOWN SCHEDULE					
SIMPSON MODEL No.	ANCHOR BOLT DIA.	ANCHOR EMBED.	DRILL & EPOXY EMBED.	POST MIN.	PAB
HDU2	3/4"	8"	10"	4x4	5
HDU4.5	3/4"	8"	10"	4x4	5
HDUB	3/4"	12"	13"	4x4	7
HDGB	1/2"	12"	13"	4x4	7
HDV11	1"	14"	15"	6x6	8

NOTES:
 1. ANCHOR BOLT MATERIAL SHALL BE ASTM A36 THREADED ROD OR ASTM A307 OR BETTER BOLTS, U.N.C.
 2. CONCRETE ANCHOR EMBEDMENT IS INTO CONCRETE FOOTING, WALL OR SLAB (NOT INCLUDING CURB HEIGHT) U.N.C.
 3. PROVIDE ALL REQUIRED FASTENERS TO POST OR STUDS PER SIMPSON CATALOG AND EC-ESP-2336 REPORT.

2 HOLDOWN SCHEDULE SCALE: N.T.S.

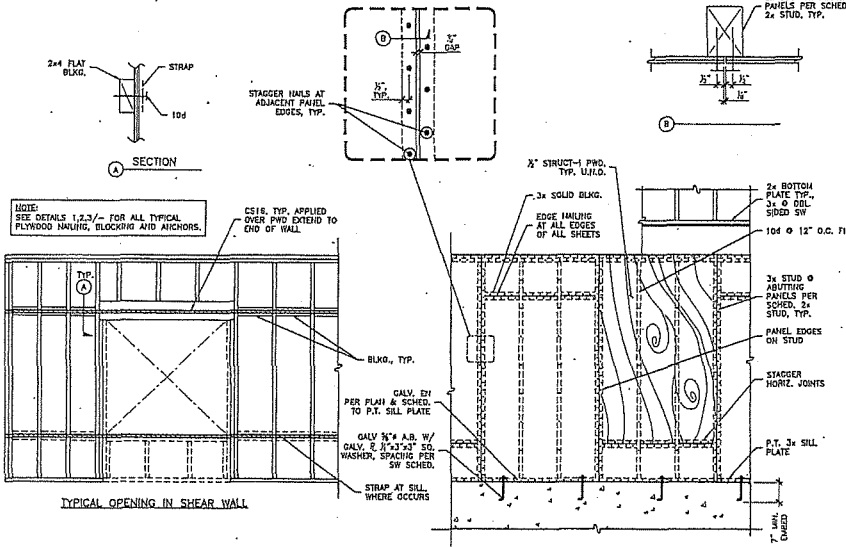

13 TYPICAL OPENING IN SHEAR WALL SCALE: 1/2" = 1'-0"

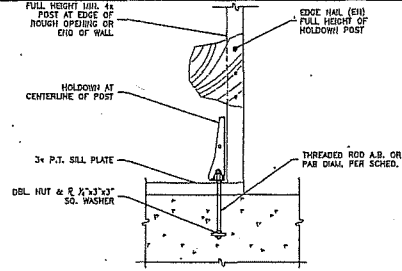

6 TYPICAL HOLDOWN AT (N) CONCRETE SCALE: 1" = 1'-0"

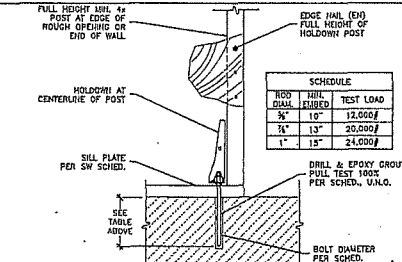

5 TYPICAL HOLDOWN AT (E) CONCRETE SCALE: 1" = 1'-0"

SHEAR WALL SCHEDULE					
TYPE	E.I.H.	A35 CUR	SDS 1/2\"/>		
1	2' 0\"/>				
2	3' 0\"/>				
3	4' 0\"/>				
4	6' 0\"/>				
5	2' 0\"/>				
6	3' 0\"/>				

NOTES:
 1. ALL PANELS SHALL BE 1/2\"/>

1 SHEAR WALL SCHEDULE SCALE: N.T.S.



FTF ENGINEERING, INC
 1518 McAllister Street
 San Francisco, CA 94115
 tel - 415-931-8480
 fax - 415-931-8481
 www.ftfengineering.com

INGEBORN-GUSTAV
 RESIDENCE
 64 Potomac Street
 San Francisco, CA 94117



Issue: Building Permit
 Date: 12.18.2018

Scale: AS NOTED
 Job No. 18-114

Wood Shear Wall
 Details

S-610

Three Way Value Comparison:

Lesser of the 3 Comparisons

APN	Address	Property Type	Owner Occupied	Year Built	Square Feet	2019 Factored Base Year Value	Restricted Value by Income	Market Value	Taxable Mills Act Value	Reduction In Assessed Value	Percentage % Reduction From FBV	2018 Property Tax Rate	Estimated Property Tax Savings
05-0612-001A	2251 Webster	Single Family	Yes	1900	1,586	\$ 1,837,603	\$ 618,000	\$ 1,840,000	\$ 618,000	\$ (1,219,603)	-66.37%	1.1630%	(\$14,184)
06-0866-014	64 Potomac	Single Family	Yes	1900	1,750	\$ 2,550,000	\$ 600,000	\$ 2,500,000	\$ 600,000	\$ (1,950,000)	-76.47%	1.1630%	(\$22,679)
23-3517-035	1401 Howard	Office	No	1913	21,943	\$ 18,458,740	\$12,700,000	\$13,700,000	\$ 12,700,000	\$ (5,758,740)	-31.20%	1.1630%	(\$66,974)
23-3542-062	2168-2174 Market	Retail	No	1907	17,132	\$ 684,218	\$ 4,030,000	\$ 6,850,000	\$ 684,218	\$ -	0.00%	1.1630%	\$0
24-3640-031	2731-2735 Folsom	3-units	Yes / No	1900	5,200	\$ 6,170,997	\$ 3,119,000	\$ 6,500,000	\$ 3,119,000	\$ (3,051,997)	-49.46%	1.1630%	(\$35,495)



**SAN FRANCISCO
PLANNING DEPARTMENT**

RECEIVED
BOARD OF SUPERVISORS
SAN FRANCISCO

2019 OCT 15 PM 2:25

BY AK

October 15, 2018

Ms. Angela Calvillo, Clerk
Board of Supervisors
City and County of San Francisco
City Hall, Room 244
1 Dr. Carlton B. Goodlett Place
San Francisco, CA 94102

1650 Mission St.
Suite 400
San Francisco,
CA 94103-2479

Reception:
415.558.6378

Fax:
415.558.6409

Planning
Information:
415.558.6377

Re: Transmittal of Planning Department Case Numbers: 2019-006323MLS;
2019-006384MLS; 2019-006322MLS; 2019-005831MLS; 2019-006455MLS

Six Individual Mills Act Historical Property Contract Applications for the
following addresses: 2251 Webster Street; 1401 Howard Street; 64 Potomac
Street; 2168 Market Street; 2731-2735 Folsom Street

BOS File Nos: _____ (pending)

Historic Preservation Commission Recommendation: Approval

Dear Ms. Calvillo,

On October 2, 2019 the San Francisco Historic Preservation Commission (hereinafter
"Commission") conducted a duly noticed public hearing at a regularly scheduled meeting to
consider the proposed Mills Act Historical Property Contract Applications. At the October 2,
2018 hearing, the Commission voted to approve the proposed Resolutions.

The Resolutions recommend the Board of Supervisors approve the Mills Act Historical Property
Contracts as each property is a historical resource and the proposed Rehabilitation and
Maintenance plans are appropriate and conform to the *Secretary of the Interior's Standard for the
Treatment of Historic Properties*. Please refer to the attached exhibits for specific work to be
completed for each property.

The Project Sponsors submitted the Mills Act applications on May 1, 2019. As detailed in the
Mills Act application, the Project Sponsors have committed to Rehabilitation and Maintenance
plans that will include both annual and cyclical scopes of work. The Mills Act Historical
Property Contract will help the Project Sponsors mitigate expenditures and enable the Project
Sponsors to maintain their historic properties in excellent condition in the future.

The Planning Department will administer an inspection program to monitor the provisions of
the contract. This program will involve a yearly affidavit issued by the property owner verifying
compliance with the approved Maintenance and Rehabilitation plans as well as a cyclical 5-year
site inspection.

Transmittal Materials
Mills Act Historical Property Contracts

The Mills Act Historical Property Contracts are time sensitive. Contracts must be recorded with the Assessor-Recorder by December 30, 2019 to become effective in 2020. We respectfully request these items be introduced at the next available hearing date. Your prompt attention to this matter is appreciated.

If you have any questions or require further information, please do not hesitate to contact me.

Sincerely,



Aaron D. Starr
Manager of Legislative Affairs

cc: John Carroll, Office of the Clerk of the Board
Andrea Ruiz-Esquide, City Attorney's Office

Attachments:

Mills Act Contract Case Report, dated October 2, 2019
Assessor Valuation Table

2251 Webster Street

Historic Preservation Commission Resolution
Draft Mills Act Historical Property Contract
Draft Rehabilitation & Maintenance Plans
Draft Mills Act Valuation provided by the Assessor-Recorder's Office
Mills Act Application

1401 Howard Street

Historic Preservation Commission Resolution
Draft Mills Act Historical Property Contract
Draft Rehabilitation & Maintenance Plans
Draft Mills Act Valuation provided by the Assessor-Recorder's Office
Mills Act Application
Historic Structure Report

64 Potomac Street

Historic Preservation Commission Resolution
Draft Mills Act Historical Property Contract
Draft Rehabilitation & Maintenance Plans
Draft Mills Act Valuation provided by the Assessor-Recorder's Office
Mills Act Application

2168 Market Street

Historic Preservation Commission Resolution

**Transmittal Materials
Mills Act Historical Property Contracts**

Draft Mills Act Historical Property Contract
Draft Rehabilitation & Maintenance Plans
Draft Mills Act Valuation provided by the Assessor-Recorder's Office
Mills Act Application
Historic Structure Report

2731-2735 Folsom Street

Historic Preservation Commission Resolution
Draft Mills Act Historical Property Contract
Draft Rehabilitation & Maintenance Plans
Draft Mills Act Valuation provided by the Assessor-Recorder's Office
Mills Act Application