

File No. 100047

Committee Item No. 1

Board Item No. _____

COMMITTEE/BOARD OF SUPERVISORS

AGENDA PACKET CONTENTS LIST

Committee: Land Use and Economic Development Date February 1, 2010

Board of Supervisors Meeting Date _____

Cmte Board

- | | | |
|-------------------------------------|--------------------------|--|
| <input type="checkbox"/> | <input type="checkbox"/> | Motion |
| <input checked="" type="checkbox"/> | <input type="checkbox"/> | Resolution |
| <input type="checkbox"/> | <input type="checkbox"/> | Ordinance |
| <input type="checkbox"/> | <input type="checkbox"/> | Legislative Digest |
| <input type="checkbox"/> | <input type="checkbox"/> | Budget Analyst Report |
| <input type="checkbox"/> | <input type="checkbox"/> | Legislative Analyst Report |
| <input type="checkbox"/> | <input type="checkbox"/> | Youth Commission Report |
| <input type="checkbox"/> | <input type="checkbox"/> | Introduction Form (for hearings) |
| <input checked="" type="checkbox"/> | <input type="checkbox"/> | Department/Agency Cover Letter and/or Report |
| <input type="checkbox"/> | <input type="checkbox"/> | MOU |
| <input type="checkbox"/> | <input type="checkbox"/> | Grant Information Form |
| <input type="checkbox"/> | <input type="checkbox"/> | Grant Budget |
| <input type="checkbox"/> | <input type="checkbox"/> | Subcontract Budget |
| <input type="checkbox"/> | <input type="checkbox"/> | Contract/Agreement |
| <input type="checkbox"/> | <input type="checkbox"/> | Form 126 – Ethics Commission |
| <input type="checkbox"/> | <input type="checkbox"/> | Award Letter |
| <input type="checkbox"/> | <input type="checkbox"/> | Application |
| <input type="checkbox"/> | <input type="checkbox"/> | Public Correspondence |

OTHER

(Use back side if additional space is needed)

- | | | | |
|---|-------------------------------------|--------------------------|-----------------------------------|
| * | <input checked="" type="checkbox"/> | <input type="checkbox"/> | Draft Ordinance - File No. 100046 |
| | <input type="checkbox"/> | <input type="checkbox"/> | _____ |
| | <input type="checkbox"/> | <input type="checkbox"/> | _____ |
| | <input type="checkbox"/> | <input type="checkbox"/> | _____ |
| | <input type="checkbox"/> | <input type="checkbox"/> | _____ |

Completed by: Alisa Somera Date January 28, 2010

Completed by: _____ Date _____

An asterisked item represents the cover sheet to a document that exceeds 25 pages.
The complete document can be found in the file and the online version.

1 [Planning Code - Interim Controls Related To Affordable Housing Requirements]

2

3 **Resolution approving interim controls providing that the alternatives provided to**

4 **project applicants of residential development under Planning Code Section 315 et seq.**

5 **shall, except for certain eligible projects, be suspended and replaced by an interim**

6 **affordable housing fee that is equivalent to the current in lieu fee and amending the**

7 **housing requirements for residential projects in the Rincon Hill Area Plan for 18**

8 **months or until a permanent ordinance amending Planning Code Section 315 et seq. is**

9 **adopted; and making findings of consistency with the priority policies of Planning**

10 **Code Section 101.1 and environmental findings.**

11

12 WHEREAS, The Board of Supervisors makes the following findings related to

13 imposition of interim zoning controls:

14 (1) Planning Code Section 306.7 provides for the imposition of interim zoning controls

15 to accomplish objectives related to the public interest. The provision and generation of

16 affordable housing is a recognized public purpose and is within the public interest of the City

17 and County of San Francisco.

18 (2) Pursuant to this resolution, the Board of Supervisors proposes interim controls for

19 residential housing projects that are set forth in a draft ordinance amending Planning Code

20 Section 315 et seq. being introduced at the Board of Supervisors simultaneously and on file

21 with the Clerk of the Board in File No. 100046 ("Draft Ordinance"). If adopted, the interim

22 controls will insure that the applications currently being processed by the City will not be in

23 conflict with the current proposed amendments to Planning Code Section 315 et seq in the

24 Draft Ordinance. The interim controls affect projects that are currently subject to the

25 provisions of Planning Code Section 315 et seq. currently known as the Residential

1 Inclusionary Affordable Housing Program ("Program"). The interim controls do not increase
2 the requirements of the Program; rather the interim controls require the payment of an
3 affordable housing fee in most circumstances. The Affordable Housing fee is the same as the
4 current "in lieu" fee.

5 (3) The interim controls will also modify the housing requirements of the Rincon Hill
6 Area Plan by deleting the requirement that 50 percent of all on- or off-site units must be
7 provided as rental units.

8 (4) The affordable housing fee, which is equivalent to the current in lieu fee and the
9 other alternatives for a project applicant, if eligible, to build on- or off-site affordable housing
10 are supported by the findings set out in the Draft Ordinance, including the study undertaken
11 by Keyser Marston Associates entitled "Nexus analysis in support of the Inclusionary Housing
12 Program, or an analysis of the impact of development of market rate housing on affordable
13 housing supply and demand." The study is on file with the Clerk of the Board of Supervisors
14 in File No. 061529. Specifically, the Board finds that this study and the findings in the Draft
15 Ordinance support the affordable housing fee proposed in these interim controls because it:
16 identifies the purpose of the fee to mitigate impacts on the demand for affordable housing in
17 the City; identifies the use to which the fee is to be put as being to increase the City's
18 affordable housing supply; and establishes a reasonable relationship between the use of the
19 fee for affordable housing and the need for affordable housing and the construction of new
20 market rate housing. Moreover, the Board finds that the current requirements proposed in
21 these interim controls are less than the cost of mitigation and do not include the costs of
22 remedying any existing deficiencies. The Board also finds that the study establishes that the
23 current Program requirements and the requirements being proposed in these interim controls
24 do not duplicate other city requirements or fees.

1 (5) This Board has considered the impact on the public health, safety, peace, and
2 general welfare if the interim controls proposed herein were not imposed.

3 (6) This Board has determined that the public interest will be best served by imposition
4 of these interim controls at this time in order to ensure that the legislative scheme that may be
5 ultimately adopted is not undermined during the planning and legislative process for
6 permanent controls, which process shall be conducted within a reasonable time.

7 WHEREAS, The Board of Supervisors makes the following findings of consistency with
8 the Priority Policies set forth in Planning Code Section 101.1. These interim controls advance
9 Priority Policy 3 that the City's supply of affordable housing be preserved and enhanced.
10 These interim controls do not conflict with other priority policies and are, on balance,
11 consistent with the Priority Policies.

12 WHEREAS, The Planning Department has determined that the actions contemplated in
13 this Resolution are in compliance with the California Environmental Quality Act (California
14 Public Resources Code §§ 21000 et seq.). Said determination is on file with the Clerk of the
15 Board of Supervisors in File No. 100047 and is incorporated herein by reference. Now,
16 therefore, be it

17 RESOLVED That the provisions of the Draft Ordinance entitled "Amending Inclusionary
18 Housing Ordinance " on file with the Clerk of the Board of Supervisors in File No. 100046 ,
19 which is hereby declared to be a part of this motion as if set forth fully herein, shall be adopted
20 as interim zoning controls; and therefore be it,

21 FURTHER RESOLVED That, upon imposition of these interim controls, the Planning
22 Department shall conduct a study of the contemplated zoning proposal and shall propose
23 permanent legislation or recommend adoption, modification, or disapproval of the Draft
24 Ordinance proposed by the Board of Supervisors; and therefore be it,

1 FURTHER RESOLVED That, notwithstanding Planning Code Section 315.3(b), the
2 requirements of these Interim Controls shall take effect immediately upon adoption and apply
3 to all projects regardless of application date; and therefore be it,

4 FURTHER RESOLVED That these interim zoning controls shall remain in effect for 18
5 months unless extended in accordance with Planning Code Section 306.7(h) or until
6 permanent controls are adopted to address the issues posed by the impact of new market-
7 rate residential development on the need for affordable housing.

BOARD of SUPERVISORS



City Hall
Dr. Carlton B. Goodlett Place, Room 244
San Francisco 94102-4689
Tel. No. 554-5184
Fax No. 554-5163
TDD/TTY No. 554-5227

January 14, 2010

File No. 100047

Bill Wycko
Environmental Review Officer
Planning Department
1650 Mission Street, 4th Floor
San Francisco, CA 94103

Dear Mr. Wycko:

On January 12, 2010, Mayor Newsom introduced the following proposed legislation:

File: 100047

Resolution approving interim controls providing that the alternatives provided to project applicants of residential development under Planning Code Section 315 et seq. shall, except for certain eligible projects, be suspended and replaced by an interim affordable housing fee that is equivalent to the current in lieu fee and amending the housing requirements for residential projects in the Rincon Hill Area Plan for 18 months or until a permanent ordinance amending Planning Code Section 315 et seq. is adopted; and making findings of consistency with the priority policies of Planning Code Section 101.1 and environmental findings.

The legislation is being transmitted to you for environmental review, pursuant to Planning Code Section 306.7(c).

Angela Calvillo, Clerk of the Board

Handwritten signature of Alisa Somera in cursive.

By: Alisa Somera, Committee Clerk
Land Use & Economic Development Committee

Attachment

cc: Nannie Turrell, Major Environmental Analysis
Brett Bollinger, Major Environmental Analysis

*No 4 a project per CEQA
Guide lines Section 15378(b)(4)
Nannie R. Turrell
January 14, 2010*

Environmental Review Referral

7/23/09

1 [Planning Code, Administrative Code – Amending Inclusionary Housing Ordinance]

2
3 **Ordinance amending the Planning Code and Administrative Code by amending the**
4 **Residential Inclusionary Affordable Housing Program, Planning Code Section 315 et**
5 **seq. (the "Program") to change the name of the Program to the Affordable Housing**
6 **Program and to require all project applicants to pay the Affordable Housing fee unless**
7 **they are eligible for an alternative; making other amendments to the Program including**
8 **expanding the uses of the Citywide Affordable Housing Fund, deleting provisions**
9 **relating to certain requirements for off-site units, and deleting provisions requiring a**
10 **refund of fees after issuance of certificate of occupancy; amending Section 827 to**
11 **delete the requirement that 50% of on- or off-site affordable housing units provided**
12 **under Section 315 et seq. in the Rincon Hill Area Plan be provided as rental; amending**
13 **the Administrative Code by amending Chapter 56 related to Development Agreements**
14 **to create certain exceptions from its requirements for rental housing developments**
15 **with on-site inclusionary units; and making findings including findings under the**
16 **California Environmental Quality Act.**

17 NOTE: Additions are single-underline italics Times New Roman;
18 deletions are ~~strike-through italics Times New Roman~~.
19 Board amendment additions are double-underlined;
20 Board amendment deletions are ~~strike-through normal~~.

21 Be it ordained by the People of the City and County of San Francisco:

22 Section 1. Findings. The Board of Supervisors finds and declares as follows:

23 (a) The Planning Department has determined that the actions contemplated in this
24 Ordinance are in compliance with the California Environmental Quality Act (California Public
25 Resources Code sections 21000 et seq.). Said determination is on file with the Clerk of the

1 Board of Supervisors in File No. _____ and is incorporated herein by
2 reference.

3 (b) On _____, 2009, the Planning Commission, in Resolution
4 No. _____ approved and recommended for adoption by the Board this legislation
5 and adopted findings that it is consistent, on balance, with the City's General Plan and eight
6 priority policies of Planning Code Section 101.1. The Board adopts these findings as its own.
7 A copy of said Resolution is on file with the Clerk of the Board of Supervisors in File No.
8 _____, and is incorporated by reference herein.

9 (c) Pursuant to Planning Code Section 302, this Board of Supervisors finds that this
10 legislation will serve the public necessity, convenience, and welfare for the reasons set forth in
11 Planning Commission Resolution No. _____, and incorporates such reasons by
12 reference herein.

13 Section 2. The San Francisco Planning Code is hereby amended by amending
14 Sections 315, 315.1, 315.2, 315.3, 315.4, 315.5, 315.6 and adding Section 315.10, to read as
15 follows:

16 **SEC. 315. - HOUSING REQUIREMENTS FOR RESIDENTIAL AND LIVE/WORK**
17 **DEVELOPMENT PROJECTS.**

18 Sections 315.1—315.9 set forth the requirements and procedures for the Residential
19 *Inclusionary* Affordable Housing Program ("Program"). The *Department of City* Planning
20 *Department* and the Mayor's Office of Housing shall periodically publish a Procedures Manual
21 containing procedures for monitoring and enforcement of the policies and procedures for
22 implementation of this Program. The Procedures Manual must be made available at the
23 Zoning Counter of the Planning Department and on the Planning Department's web site. The
24 Procedures Manual shall not be amended, except for an annual update of the affordability
25

Mayor Newsom, Supervisor Chiu

1 housing guidelines, which reflect updated income limits, prices, and rents, without approval of
2 the Planning Commission or as otherwise specified herein.

3 The Procedures Manual in effect at the time of initial purchase or initial rental of a unit
4 shall govern the regulation of that unit until it is sold or re-rented unless an owner or current
5 tenant chooses to be governed by all of the more up-to-date provisions of the then-current
6 Procedures Manual. In that case, the owner or tenant must agree to be governed by the
7 totality of the new regulations — an owner or tenant may not pick some provisions from the
8 Procedures Manual in effect at the time of initial purchase or initial rental and some in effect in
9 the then-current Procedures Manual. If the owner or tenant chooses to be governed by the
10 then-current Procedures Manual he or she shall sign an agreement with the City to that effect,
11 and the Planning Department and Mayor's Office of Housing shall apply all of the rules and
12 regulations in the then-current Procedures Manual to the unit.

13 **SEC. 315.1. - DEFINITIONS.**

14 The following definitions shall govern interpretation of this ordinance:

15 (1) "Affordable housing project" shall mean a housing project containing units
16 constructed to satisfy the requirements of Sections 315.4 or 315.5.

17 (2) "Affordable to a household" shall mean a purchase price that a household can
18 afford to pay based on an annual payment for all housing costs, as defined in California Code
19 of Regulations ("CCR") Title 25, Section 6920, as amended from time to time, of 33 percent of
20 the combined household annual gross income, assuming a down payment recommended by
21 the Mayor's Office of Housing in the Procedures Manual, and available financing, or a rent
22 that does not exceed 30 percent of a household's combined annual gross income. Where
23 applicable, the purchase price or rent may be adjusted to reflect the absence or existence of a
24 parking space(s), subject to the Department's policy on unbundled parking for affordable
25 housing units as specified in the Procedures Manual and amended from time to time.

Mayor Newsom, Supervisor Chiu

1 (3) "Affordable to qualifying households" shall mean:

2 (A) With respect to owned units, the average purchase price on the initial sale of all
3 affordable owned units in an affordable housing project shall not exceed the allowable
4 average purchase price and all units must be sold only to households with annual gross
5 incomes up to and including 120 percent of median income for the City and County of San
6 Francisco. In addition, each unit shall be sold:

7 (i) Only to households with an annual gross income equal to or less than the
8 qualifying limits for a household of moderate income, adjusted for household size;

9 (ii) On the initial sale, at or below the maximum purchase price; and

10 (iii) On subsequent sales at or below the prices to be determined by the Director
11 Mayor's Office of Housing in the Conditions of Approval or Notice of Special Restrictions
12 according to the formula specified in the Procedures Manual, as amended from time to time,
13 such that the units remain affordable to qualifying households. The formula in the Procedures
14 Manual may permit the seller to include certain allowable capital improvements in the sales
15 price.

16 (B) With respect to rental units in an affordable housing project, the average annual
17 rent, including the cost utilities paid by the tenant according to HUD utility allowance
18 established by the San Francisco Housing Authority, shall not exceed the allowable average
19 annual rent. Each unit shall be rented:

20 (i) Only to households with an annual gross income equal to or less than the
21 qualifying limits for a household of low income as defined in this Section;

22 (ii) At or less than the maximum annual rent.

23 (4) "Allowable average purchase price" shall mean a price for all affordable owned
24 units of the size indicated below that are affordable to a household of median income as
25 defined in this Section, adjusted for the household size indicated below as of the date of the

Mayor Newsom, Supervisor Chiu

close of escrow, and, where applicable, adjusted to reflect the Department's policy on unbundled parking for affordable housing units as specified in the Procedures Manual and amended from time to time:

Number of Bedrooms (or, for live/work units square foot equivalency)	Number of Persons in Household
0 (Less than 600 square feet)	1
1 (601 to 850 square feet)	2
2 (851 to 1,100 square feet)	3
3 (1,101 to 1,300 square feet)	4
4 (More than 1,300 square feet)	5

(5) "Allowable average annual rent" shall mean annual rent for an affordable rental unit of the size indicated below that is 30 percent of the annual gross income of a household of *median low* income as defined in this Section, adjusted for the household size indicated below, and, where applicable, adjusted to reflect the Department's policy on unbundled parking for affordable housing units as specified in the Procedures Manual and amended from time to time:

Number of Bedrooms (or, for live/work units square foot equivalency)	Number of Persons in Household
0 (Less than 600 square feet)	1

1	1 (601 to 850 square feet)	2
2	2 (851 to 1,100 square feet)	3
3	3 (1,101 to 1,300 square feet)	4
4	4 (More than 1,300 square feet)	5

6 (6) "Annual gross income" shall mean gross income as defined in CCR Title 25,
7 Section 6914, as amended from time to time, except that the Mayor's Office of Housing may,
8 in order to promote consistency with the procedures of the San Francisco Redevelopment
9 Agency, develop an asset test that differs from the State definition if it publishes that test in
10 the Procedures Manual.

11 (7) "Average annual rent" shall mean the total annual rent for the calendar year
12 charged by a housing project for all affordable rental units in the project of an equal number of
13 bedrooms divided by the total number of affordable units in the project with that number of
14 bedrooms.

15 (8) "Average purchase price" shall mean the purchase price for all affordable owned
16 units in an affordable housing project of an equal number of bedrooms divided by the total
17 number of affordable units in the project with that number of bedrooms.

18 (9) "Community apartment" shall be as defined in San Francisco Subdivision Code
19 Section 1308(b).

20 (9a) "Conditional use" for purposes of this Ordinance means a conditional use
21 authorization which, pursuant to the Planning Code, is required for the residential component
22 of a project.

23 (10) "Conditions of approval" shall be a set of written conditions imposed by the
24 Planning Commission or another permit-issuing City agency or appellate body to which a
25 project applicant agrees to adhere and fulfill when it receives a conditional use or planned unit

1 development permit for the construction of a principal project or other housing project subject
2 to this Program.

3 (11) "Condominium" shall be as defined in California Civil Code Section 783.

4 (12) "Director" shall mean the Director of City Planning or his or her designee,
5 including other City agencies or departments.

6 (13) "First certificate of occupancy" shall mean either a temporary certificate of
7 occupancy or a Certificate of Final Completion and Occupancy as defined in San Francisco
8 Building Code Section 109, whichever is issued first.

9 (14) Intentionally Left Blank.

10 (15) "Household" shall mean any person or persons who reside or intend to reside in
11 the same housing unit.

12 (16) "Household of low income" shall mean a household whose combined annual
13 gross income for all members does not exceed 60 percent of median income for the City and
14 County of San Francisco, as calculated by the Mayor's Office of Housing using data from the
15 United States Department of Housing and Urban Development (HUD) and adjusted for
16 household size or, if data from HUD is unavailable, calculated by the Mayor's Office of
17 Housing using other publicly available and credible data and adjusted for household size.

18 (17) "Household of median income" shall mean a household whose combined annual
19 gross income for all members does not exceed 100 percent of the median income for the City
20 and County of San Francisco, as calculated by the Mayor's Office of Housing using data from
21 the United States Department of Housing and Urban Development (HUD) and adjusted for
22 household size or, if data from HUD is unavailable, calculated by the Mayor's Office of
23 Housing using other publicly available and credible data and adjusted for household size.

24 (17A) "Household of moderate income" shall mean a household whose combined
25 annual gross income for all members does not exceed 120 percent of the median income for

1 the City and County of San Francisco, as calculated by the Mayor's Office of Housing using
2 data from the United States Department of Housing and Urban Development (HUD) and
3 adjusted for household size or, if data from HUD is unavailable, calculated by the Mayor's
4 Office of Housing using other publicly available and credible data and adjusted for household
5 size.

6 (18) "Housing project" shall mean any development which has residential units as
7 defined in the Planning Code, including but not limited to dwellings, group housing,
8 independent living units, and other forms of development which are intended to provide long-
9 term housing to individuals and households. "Housing project" shall not include that portion of
10 a development that qualifies as an Institutional Use under the Planning Code. "Housing
11 project" for purposes of this Program shall also include the development of live/work units as
12 defined by Planning Code Section 102.13. Housing project for purposes of this Program shall
13 mean all phases or elements of a multi-phase or multiple lot residential development.

14 (19) "Housing unit" or "unit" shall mean a dwelling unit as defined in San Francisco
15 Housing Code Section 401.

16 (20) "Live/work unit" shall be as defined in San Francisco Planning Code Section
17 102.13.

18 (21) "Live/work project" shall mean a housing project containing more than one
19 live/work unit.

20 (22) "Long term housing" shall mean housing intended for occupancy by a person or
21 persons for 32 consecutive days or longer.

22 (23) "Market rate housing" shall mean housing constructed in the principal project
23 that is not subject to sales or rental restrictions.

24 (24) "Maximum annual rent" shall mean the maximum rent that a housing developer
25 may charge any tenant occupying an affordable unit for the calendar year. The maximum

1 annual rent for an affordable housing unit of the size indicated below shall be no more than 30
 2 percent of the annual gross income for a household of low income as defined in this Section,
 3 as adjusted for the household size indicated below as of the first date of the tenancy:

Number of Bedrooms (or, for live/work units square foot equivalency)	Number of Persons in Household
0 (Less than 600 square feet)	1
1 (601 to 850 square feet)	2
2 (851 to 1100 square feet)	3
3 (1101 to 1300 square feet)	4
4 (More than 1300 square feet)	5

13 (25) "Maximum purchase price" shall mean the maximum purchase price for an
 14 affordable owned unit of the size indicated below that is affordable to a household of
 15 moderate income, adjusted for the household size indicated below, assuming an annual
 16 payment for all housing costs of 33 percent of the combined household annual gross income,
 17 a down payment recommended by MOH and set forth in the Procedures Manual, and
 18 available financing:

Number of Bedrooms (or, for live/work units square foot equivalency)	Number of Persons in Household
0 (Less than 600 square feet)	1

1	1 (601 to 850 square feet)	2
2	2 (851 to 1100 square feet)	3
3	3 (1101 to 1300 square feet)	4
4	4 (More than 1300 square feet)	5

6 (25A) "Mayor's Office of Housing" *or* "MOH" shall mean the Mayor's Office of Housing
7 or its successor.

8 (26) "Notice of Special Restrictions" shall mean a document recorded with the San
9 Francisco Recorder's Office for any unit subject to this Program detailing the sale and resale
10 or rental restrictions and any restrictions on purchaser or tenant income levels included as a
11 Condition of Approval of the principal project relating to the unit.

12 (27) "Off-site unit" shall mean a unit affordable to qualifying households constructed
13 pursuant to this Ordinance on a site other than the site of the principal project.

14 (28) "On-site unit" shall mean a unit affordable to qualifying households constructed
15 pursuant to this Ordinance on the site of the principal project.

16 (29) "Ordinance" shall mean Planning Code Sections 315.1 through 315.9.

17 (30) "Owned unit" shall mean a unit affordable to qualifying households which is a
18 condominium, stock cooperative, community apartment, or detached single-family home. The
19 owner or owners of an owned unit must occupy the unit as their primary residence.

20 (31) "Owner" shall mean the record owner of the fee or a vendee in possession.

21 (32) "Principal project" shall mean a housing development on which a requirement to
22 provide affordable housing units is imposed.

23 (33) "Procedures Manual" shall mean the City and County of San Francisco
24 Affordable Housing Monitoring Procedures Manual issued by the San Francisco Department
25 of City Planning, as amended.

Mayor Newsom, Supervisor Chiu

1 (34) "Program" shall mean the Residential *Inclusionary* Affordable Housing Program.

2 (35) "Project applicant" shall mean an applicant for a building permit or a site permit
3 or an applicant for a conditional use permit or planned unit development permit, seeking
4 approval from the Planning Commission or Planning Department for construction of a housing
5 project subject to this Section, such applicant's successors and assigns.

6 (36) "Rent" or "rental" shall mean the total charges for rent, utilities, and related
7 housing services to each household occupying an affordable unit.

8 (37) "Rental unit" shall mean a unit affordable to qualifying households which is not a
9 condominium, stock cooperative, or community apartment.

10 (38) "Student housing" shall mean a building where 100 percent of the residential
11 uses are affiliated with and operated by an accredited post-secondary educational institution.
12 Typically, student housing is for rent, not for sale. This housing shall provide lodging or both
13 meals and lodging, by prearrangement for one week or more at a time. This definition only
14 applies in the Eastern Neighborhoods Mixed Use Districts.

15 **SEC. 315.2. - FINDINGS.**

16 The Board of Supervisors hereby finds and declares as follows:

17 **Affordable Housing:** The findings in Planning Code Section 315.2 of the Inclusionary
18 Affordable Housing Ordinance are hereby readopted and updated as follows:

19 1. Affordable housing is a paramount statewide concern. In 1980, the Legislature
20 declared in Government Code Section 65580:

21 (a) The availability of housing is of vital statewide importance, and the early
22 attainment of decent housing and a suitable living environment for every California family is a
23 priority of the highest order.
24
25

Mayor Newsom, Supervisor Chiu

1 (b) The early attainment of this goal requires the cooperative participation of
2 government and the private sector in an effort to expand housing opportunities and
3 accommodate the housing needs of Californians of all economic levels.

4 (c) The provision of housing affordable to low-and moderate-income households
5 requires the cooperation of all levels of government.

6 (d) Local and state governments have a responsibility to use the powers vested in
7 them to facilitate the improvement and development of housing to make adequate provision
8 for the housing needs of all economic segments of the community.

9 The Legislature further stated in Government Code Section 65581 that:

10 It is the intent of the Legislature in enacting this article:

11 (a) To assure that counties and cities recognize their responsibilities in contributing
12 to the attainment of the state housing goal.

13 (b) To assure that counties and cities will prepare and implement housing elements
14 which will move toward attainment of the state housing goal.

15 (c) To recognize that each locality is best capable of determining what efforts are
16 required by it to contribute to the attainment of the state housing goal.

17 The California Legislature requires each local government agency to develop a
18 comprehensive long-term general plan establishing policies for future development. As
19 specified in the Government Code (at Sections 65300, 65302(c), and 65583(c)), the plan must
20 (1) "encourage the development of a variety of types of housing for all income levels,
21 including multifamily rental housing"; (2) "[a]ssist in the development of adequate housing to
22 meet the needs of low- and moderate-income households"; and (3) "conserve and improve
23 the condition of the existing affordable housing stock, which may include addressing ways to
24 mitigate the loss of dwelling units demolished by public or private action."
25

1 2. San Francisco faces a continuing shortage of affordable housing for very low
2 and low-income residents. The San Francisco Planning Department reported that for the four-
3 year period between 2000 and 2004, 8,389 total new housing units were built in San
4 Francisco. This number includes 1,933 units for low and very low-income households out of a
5 total need of 3,930 low and very low-income housing units for the same period. According to
6 the state Department of Housing and Community Development, there will be a regional need
7 for 230,743 new housing units in the nine Bay Area counties from 1999—2006. Of that
8 amount, at least 58 percent, or 133, 164 units, are needed for moderate, low and very low-
9 income households. The Association of Bay Area Governments (ABAG) is responsible for
10 dividing the total regional need numbers among its member governments which includes both
11 counties and cities. ABAG estimates that San Francisco's low and very low-income housing
12 production need from 1999 through 2006 is 7,370 units out of a total new housing need of
13 20,372 units, or 36 percent of all units built. Within the past four years, only 23 percent of all
14 housing built, or 49 percent of the previously projected housing need for low and very low-
15 income housing for the same period, was produced in San Francisco. The production of
16 moderate income rental units also fell short of the ABAG goal. Only 351 moderate income
17 units were produced over the previous four years, or four percent of all units built, compared
18 to ABAG's call for 28 percent of all units to be affordable to households of moderate income.
19 Given the need for 3,007 moderate income units over the four-year period, only 12 percent of
20 the projected need for moderate income units was built.

21 3. In response to the above mandate from the California Legislature and the
22 projections of housing needs for San Francisco, San Francisco has instituted several
23 strategies for producing new affordable housing units. The 2004 Housing Element of the
24 General Plan recognizes the need to support affordable housing production by increasing site
25 availability and capacity for permanently affordable housing through the inclusion of affordable

Mayor Newsom, Supervisor Chiu

1 units in larger housing projects. Further, the City, as established in the General Plan, seeks to
2 encourage the distribution of affordable housing throughout all neighborhoods and, thereby,
3 offer diverse housing choices and promote economic and social integration. The 2004
4 Housing Element calls for an increase in the production of new affordable housing and for the
5 development of mixed income housing to achieve social and cultural diversity. This legislation
6 furthers the goals of the State Legislature and the General Plan.

7 4. The 2005 Consolidated Plan for July 1, 2000—June 30, 2005, issued by the
8 Mayor's Office of Community Development and the Mayor's Office of Housing, establishes
9 that extreme housing pressures face San Francisco, particularly in regard to low- and
10 moderate-income residents. Many elements constrain housing production in the City. This is
11 especially true of affordable housing. As discussed in the 2004 Housing Element published by
12 the City Planning Department. San Francisco is largely built out, with very few large open
13 tracts of land to develop. As noted in the 2000 Consolidated Plan, its geographical location at
14 the northern end of a peninsula inherently prevents substantial new development. There is no
15 available adjacent land to be annexed, as the cities located on San Francisco's southern
16 border are also dense urban areas. Thus new construction of housing is limited to areas of the
17 City not previously designated as residential areas, infill sites, or to areas with increased
18 density. New market-rate housing absorbs a significant amount of the remaining supply of
19 land and other resources available for development and thus limits the supply of affordable
20 housing.

21 There is a great need for affordable rental and owner-occupied housing in the City.
22 Housing cost burden is one of the major standards for determining whether a locality is
23 experiencing inadequate housing conditions, defined as households that expend 30 percent
24 or more of gross income for rent or 35 percent or more of household income for owner costs.
25 The 2000 Census indicates that 64,400 renter households earning up to 80 percent of the

Mayor Newsom, Supervisor Chiu

1 area median income are cost burdened. Of these, about 25,000 households earn less than 50
2 percent AMI and pay more than 50 percent of their income to rent. According to more recent
3 data from the American Housing Survey, 80,662 total renter households, or 41 percent, are
4 cost burdened in 2003. A significant number of owners are also cost burdened. According to
5 2000 Census data, 18,237 of owners are cost-burdened, or 23 percent of all owner
6 households. The 2003 American Housing Survey indicates that this level has risen to 29
7 percent.

8 The San Francisco residential real estate market is one of the most expensive in the
9 United States. In May 2005, the California Association of Realtors reported that the median
10 priced home in San Francisco was \$755,000.00. This is 18 percent higher than the median
11 priced home one year earlier, 44 percent higher than the State of California median, and 365
12 percent higher than the nation average. While the national homeownership rate is
13 approximately 69 percent, only approximately 35 percent of San Franciscans own their own
14 home. The majority of market-rate homes for sale in San Francisco are priced out of the reach
15 of low and moderate income households. In May 2005, the average rent for a two-bedroom
16 apartment was \$1,821.00, which is affordable to households earning over \$74,000.00.

17 These factors contribute to a heavy demand for affordable housing in the City that the
18 private market cannot meet. Each year the number of market rate units that are affordable to
19 low income households is reduced by rising market rate rents and sales prices. The number
20 of households benefiting from rental assistance programs is far below the need established by
21 the 2000 Census. Because the shortage of affordable housing in the City can be expected to
22 continue for many years, it is necessary to maintain the affordability of the housing units
23 constructed by housing developers under this Program. The 2004 Housing Element of the
24 General Plan recognizes this need. Objective 1 of the Housing Element is to provide new
25 housing, especially permanently affordable housing, in appropriate locations which meets

Mayor Newsom, Supervisor Chiu

1 identified housing needs and takes into account the demand for affordable housing created by
2 employment demand. Objective 6 is to protect the affordability of existing housing, and to
3 ensure that housing developed to be affordable be kept affordable for 50—75 year terms, or
4 even longer if possible.

5 In 2004 the National Housing Conference issued a survey entitled "Inclusionary
6 Zoning: The California Experience." The survey found that as of March 2003, there were 107
7 cities and counties using inclusionary housing in California, one-fifth of all localities in the
8 state. Overall, the inclusionary requirements were generating large numbers of affordable
9 units. Only six percent of jurisdictions reported voluntary programs, and the voluntary nature
10 appears to compromise the local ability to guarantee affordable housing production. While
11 there was a wide range in the affordability percentage-requirements for inclusionary housing,
12 the average requirement for affordability in rental developments is 13 percent. Approximately
13 half of all jurisdictions require at least 15 percent to be affordable, and one-quarter require 20
14 percent or more to be affordable.

15 5. Development of new market-rate housing makes it possible for new residents to
16 move to the City. These new residents place demands on services provided by both public
17 and private sectors. Some of the public and private sector employees needed to meet the
18 needs of the new residents earn incomes only adequate to pay for affordable housing.
19 Because affordable housing is in short supply within the City, such employees may be forced
20 to live in less than adequate housing within the City, pay a disproportionate share of their
21 incomes to live in adequate housing within the City, or commute ever-increasing distances to
22 their jobs from housing located outside the City. These circumstances harm the City's ability
23 to attain goals articulated in the City's General Plan and place strains on the City's ability to
24 accept and service new market-rate housing development.

25
Mayor Newsom, Supervisor Chiu

1 6. The payment of an Affordable Housing Fee by developers of market rate
2 housing is justified for the reasons stated herein and has identifiable benefits to the City.
3 Because it is not financially feasible in most circumstances to develop new housing affordable to very-
4 low, low, and moderate-income households, the City and County provide direct housing investments to
5 developers to enable the creation of affordable housing. The affordable housing fee will be used to
6 help subsidize these development costs and provide administrative support for these programs and
7 other affordable housing development activities administered by the City and County. Without these
8 funds, the City and County would be less able to meet its affordable housing needs and the Regional
9 Housing Needs goals established by ABAG and the State of California for the City and County for
10 2006-2013.

11 The affordable housing fee also enables affordable housing developments to leverage outside
12 development funding from the private sector, and the State and Federal Government. This development
13 work also creates economic activity, particularly construction work, which provides high-paying jobs
14 to residents and workers in the City and County.

15 In addition, it is not financially feasible for the typical moderate income household to purchase
16 a home in San Francisco. For these reasons, the Affordable Housing Fee may also be used to provide
17 downpayment assistance to low and moderate income homebuyers and provide administrative support
18 for these programs and other first-time homebuyer assistance administered by the City and County.

19 However, The development of affordable housing on the same site as market-rate
20 housing also increases social and economic integration vis-a-vis housing in the City and has
21 corresponding social and economic benefits to the City. Inclusionary housing provides a
22 healthy job and housing balance. Inclusionary housing provides more affordable housing
23 close to employment centers which in turn may have a positive economic impact by reducing
24 such costs as commuting and labor costs. However, there may also be trade-offs where
25 constructing affordable units at a different site than the site of the principle project may

Mayor Newsom, Supervisor Chiu

1 produce a greater number of affordable units without additional costs to the project applicant.

2 If a project applicant may produce a significantly greater number of affordable units off-site
3 then it is in the best interest of the City to permit the development of affordable units at a
4 different location than that of the principal project.

5 7. Provided project applicants can take these requirements into consideration
6 when negotiating to purchase land for a housing project, the requirements of this Section are
7 generally financially feasible for project applicants to meet, particularly because of the benefits
8 being conferred by the City to housing projects under this ordinance. This Ordinance provides
9 a means by which a project applicant may seek a reduction or waiver of *the Affordable Housing*
10 *Fee or a reduction or waiver of the alternative the requirements of this Program of this mitigation*
11 *fees* if the project applicant can show that imposition of these requirements would create an
12 unlawful financial burden.

13 8. Conditional Use and Planned Unit Development Permits permit the development
14 of certain uses not permitted as of right in specific districts or greater density of permitted
15 residential uses. As the General Plan recognizes, through the conditional use and planned
16 unit development process, applicants for housing projects generally receive material
17 economic benefits. Such applicants are generally permitted to build in excess of the generally
18 applicable black letter requirements of the Planning Code for housing projects resulting in
19 increased density, bulk, or lot coverage or a reduction in parking or other requirements or an
20 approval of a more intensive use over that permitted without the conditional use permit or
21 planned unit development permit. Through the conditional use and planned unit development
22 process, building standards can be relaxed in order to promote lower cost home construction.
23 An additional portion of San Francisco's affordable housing needs can be supplied (with no
24 public subsidies or financing) by private sector housing developers developing *inclusionary*
25 affordable units in their large market-rate projects in exchange for the density and other

Mayor Newsom, Supervisor Chiu

1 bonuses conferred by conditional use or planned unit development approvals, provided it is
2 financially attractive for private sector housing developers to seek such conditional use and/or
3 planned unit development approvals.

4 9. Live/work as defined in the Planning Code recognizes that "residential living
5 space" is an integral part of a live/work unit. A substantial portion of new housing development
6 in San Francisco has been live/work units in Mixed Use Districts South of Market and in
7 industrially zoned areas of San Francisco where residential development has not traditionally
8 been permitted as of right. Live/work development projects are subject to less stringent
9 development standards than other types of housing projects in certain Mixed Use Districts and
10 industrially zoned areas. Live/work developments are conferred an equivalent benefit as
11 projects going through the conditional use or planned unit development permit process by
12 virtue of the fact that (1) live/work developments are not required to get a conditional use
13 permit for housing development in some Mixed Use Districts and in all industrially zoned
14 districts where other residential uses are required to get a conditional use permit; (2) live/work
15 developments receive a five-foot height bonus above prevailing height limits for specific
16 neighborhoods; (3) live/work units are permitted to cover 100 percent of a lot rather than the
17 stricter lot coverage requirements that apply to other residential development, typically
18 requiring rear yards equal to 15 feet in length or 25 percent of the lot, whichever is greater.
19 Given these benefits conferred by statute which allow live/work developments to exceed the
20 limitations on other housing development in the City, the Board of Supervisors finds that, for
21 purposes of this Program, live/work developments are conferred a private benefit equal to or
22 in excess of housing projects which require a conditional use or planned unit development
23 permit. The relaxed building standards applied to live/work projects promote the ability to
24 include lower cost home production in live/work projects. A unit meets the definition of
25 California Civil Code Section 1940(c) as a "dwelling unit" because it "is used as a home,

Mayor Newsom, Supervisor Chiu

1 residence or sleeping place by one person who maintains a household or by two or more
2 persons who maintain a common household." Live/work units shall not be considered
3 "commercial real property" for purposes of Civil Code Section 1954.25 et seq.

4 10. The City wants to balance the burden on private property owners with the
5 demonstrated need for affordable housing in the City. ~~For the reasons stated above, the Board of~~
6 ~~Supervisors thus intends to increase the inclusionary housing requirements for all residential projects.~~
7 ~~In order to balance the burden on property owners, the Board intends to limit the application of an~~
8 ~~inclusionary housing requirement to 15 percent for housing projects that do not receive any of the~~
9 ~~benefits described above through the conditional use or planned unit development process, or in~~
10 ~~live/work projects. A slightly higher percentage will be applied to projects which generally receive~~
11 ~~benefits through the conditional use or planned unit development process, or in live/work projects.~~ The
12 Housing Element (Policy 4.2) states: Include affordable units in larger housing developments.
13 It also calls for the City to review its inclusionary housing program regularly to ensure fair
14 burden and not constrain new housing production. The Board of Supervisors has reviewed the
15 ~~inclusionary~~ affordable housing program and finds that, for purposes of the Housing Element
16 of the General Plan, ~~increasing the inclusionary housing requirements~~ the current Affordable
17 Housing Fee – set at the equivalent to providing 20% of the total number of units as affordable units
18 (or less for projects approved under prior requirements)-- ensures more fair burden on all housing
19 development and will not constrain new housing production. The Board of Supervisors has
20 reviewed the ~~inclusionary~~ affordable housing program and finds that, for purposes of the
21 Housing Element of the General Plan, a housing project of five units or more is a larger
22 housing project. ~~Expanding the inclusionary housing~~ Applying the Affordable Housing Program
23 requirements to buildings of five units or more ensures more fair burden on all housing
24 development and will not constrain new housing production.
25

Mayor Newsom, Supervisor Chiu

1 11. The findings of Planning Code Section 313.2 for the Jobs-Housing Linkage
2 Program, Planning Code Sections 313 et seq., relating to the shortage of affordable housing,
3 the low vacancy rate of housing affordable to persons of lower and moderate income, and the
4 decrease in construction of affordable housing in the City are hereby readopted.

5 12. The Land Use and Economic Development Committee of the Board of
6 Supervisors held hearings on this legislation on July 12 and 19, 2006. At those hearings, the
7 Committee heard testimony from Planning Department staff and consultant Kate Funk of
8 Keyser Marston and Associates regarding a study undertaken at the direction of the Planning
9 Department by the consultant Keyser Marston Associates. The study was entitled Inclusionary
10 Housing Program Sensitivity Analysis, dated July 7, 2006, and was undertaken to examine
11 the economic impacts of adjusted inclusionary requirements on market-rate housing projects
12 ("Sensitivity Analysis"). The study can be found in Board File No. 051685 and is incorporated
13 herein by reference. The study was guided by the Planning Department and Mayor's Office of
14 Housing and informed by a Technical Advisory Committee comprised of a variety of experts
15 from the San Francisco Housing Development and Affordable Housing Advocacy
16 Communities. Planning Department staff presented a report summarizing the findings of the
17 Sensitivity Analysis and the recommendations of the Technical Advisory Committee. That
18 report, dated July 10, 2006, is found in Board File No. 051685 and is incorporated herein by
19 reference. After considering the Sensitivity Analysis and staff report and hearing the
20 recommendations and testimony of the Planning Department, Mayor's Office of Housing,
21 members of the Technical Advisory Committee, and members of the public including
22 representatives of housing developers, community members, and affordable housing
23 advocates, the Land Use and Economic Development Committee considered various
24 amendments to the legislation. The Committee found, among other things, that it was in the
25 public interest to increase the percentage requirements of the ordinance, but not by as much

Mayor Newsom, Supervisor Chiu

1 as originally proposed; to modify the application dates of the ordinance to grandfather more
2 existing projects from the increased percentage requirements, but to make most projects
3 subject to the other requirements of the ordinance; and to require further study on some
4 issues by the Planning Department and Mayor's Office of Housing.

5 13. The City of San Francisco, under the direction of the Office of the Controller, is
6 undertaking a comprehensive program of analyses to update its programs and supporting
7 documentation for many types of fees, including updating nexus analyses in support of
8 development impact fees. At the direction of the Board of Supervisors and as part of this
9 larger analysis, the City contracted with Keyser Marston Associates to prepare a nexus
10 analysis in support of the Inclusionary Housing Program, or an analysis of the impact of
11 development of market rate housing on affordable housing supply and demand. The Planning
12 Department and Mayor's Office of Housing worked closely with the consultant and also
13 consulted with the Technical Advisory Committee, noted above, comprised of a variety of
14 experts from the San Francisco housing development and affordable housing advocacy
15 communities.

16 The City's current position is that the City's *Inclusionary Affordable* Housing Program
17 ~~including the in lieu fee provision which is offered as an alternative to building units within market rate~~
18 ~~projects,~~ is not subject to the requirements of the Mitigation Fee Act, Government Code
19 Sections 66000 et seq. While the City does not expect to alter its position on this matter, due
20 to past legislative actions supporting such a study, the Citywide study being undertaken to
21 conduct nexus studies in other areas, and a general interest in determining whether the
22 *Inclusionary* Program can be supported by a nexus type analysis as an additional support
23 measure, the City contracted to undertake the preparation of a nexus analysis at this time.

24 The final study can be found in Board of Supervisors File No. _____
25 and is incorporated by reference herein. The Board of Supervisors has reviewed the study

Mayor Newsom, Supervisor Chiu

1 and staff analysis and report of the study and, on that basis finds that the study supports the
2 current *inclusionary housing* requirements of the Affordable Housing Program including, but not
3 limited to, the primary requirement that project applicants pay the Affordable Housing Fee.

4 Specifically, the Board finds that this study: identifies the purpose of the fee to mitigate
5 impacts on the demand for affordable housing in the City; identifies the use to which the fee is
6 to be put as being to increase the City's affordable housing supply; and establishes a
7 reasonable relationship between the use of the fee for affordable housing and the need for
8 affordable housing and the construction of new market rate housing. Moreover, the Board
9 finds that the current *inclusionary* requirements are less than the cost of mitigation and do not
10 include the costs of remedying any existing deficiencies. The Board also finds that the study
11 establishes that the current *inclusionary* requirements do not duplicate other city requirements
12 or fees.

13 14. The Board of Supervisors recognizes that this *Inclusionary Affordable* Housing
14 Program is only one part of the City's overall strategy for providing affordable housing. The
15 City will spend over \$154 million in capital funds on affordable housing in 2006-07 of
16 combined expenditures by the Mayor's Office of Housing and San Francisco Redevelopment
17 Agency, but not including expenditures by the Department of Public Health or the Human
18 Services Agency. At the very most, only \$22 million of those monies will come from
19 contributions from private developers through this Inclusionary Program or other similar
20 programs. The City expects to spend over \$78 million on affordable housing in 2007-08 and,
21 the current expectation is that only \$2.5 million of those monies will come from contributions
22 from private developers through this *Inclusionary* Program or other similar programs.

23 **SEC. 315.3. - APPLICATION.**

24 (a) This Ordinance shall apply to any housing project that consists of five or more
25 units where an individual project or a phased project is to be undertaken and where the total

1 undertaking comprises a project with five or more units, even if the development is on
2 separate but adjacent lots; and

3 (1) Does not require Planning Commission approval as a conditional use or planned
4 unit development;

5 (2) Requires Planning Commission approval as a conditional use or planned unit
6 development;

7 (3) Consists of live/work units as defined by Planning Code Section 102.13; or

8 (4) Requires Planning Commission approval of replacement housing destroyed by
9 earthquake, fire or natural disaster only where the destroyed housing included units restricted
10 under the Residential Inclusionary Housing Program or the City's predecessor inclusionary
11 housing policy, condominium conversion requirements, or other affordable housing program.

12 (b) ~~This~~ The provisions of Ordinance No. _____ shall apply to all housing projects
13 that have not received a first site or building permit on or before the effective date of ~~this~~
14 ~~Ordinance No. _____~~ with the following exceptions. Until these application dates take effect
15 as described below, the provisions of the ~~Ordinance Program~~ as it exists on July 18, 2006 shall
16 govern. The provisions of Ordinance No. _____, including the provisions relating to the
17 Affordable Housing Fee and the alternatives to the payment of the fee, shall become effectively
18 immediately upon adoption and shall apply to all projects regardless of application date.

19 (1) The amendments to the off-site requirements in Section 315.5(c) and (d) relating
20 to location and type of off-site housing, and Section 315.4(e) relating to when a developer
21 shall declare whether it will choose an alternative to the on-site requirement shall apply only to
22 projects that receive their Planning Commission or Department approval on or after the
23 effective date of Ordinance No. _____ ~~this legislation~~.

24 (2) The amendments to the percentage-requirements of this Ordinance No.
25 _____ that govern the number of affordable units a housing project is required to provide in

Mayor Newsom, Supervisor Chiu

1 Section 315.4(a) and 315.5(a) apply only to housing projects that submit their first application,
2 including an environmental evaluation application or any other Planning Department or
3 Building Department application, on or after July 18, 2006. Notwithstanding the foregoing, the
4 amendments to the percentage-requirements of this Ordinance No. _____ also apply to any
5 project that has not received its final Planning Commission or Department approvals before
6 July 18, 2006 for housing projects that receive a Zoning Map amendment or Planning Code
7 text amendment related to their project approvals that (A) results in a net increase in the
8 number of permissible residential units, or (B) results in a material increase in the net
9 permissible residential square footage. For purposes of subsection B above a material
10 increase shall mean an increase of 5 percent or more, or an increase in 10,000 square feet or
11 more, whichever is less.

12 (3) The amendments in Section 315.1 to the way median income is calculated apply
13 to any housing project that has not received a first site or building permit by the effective date
14 of ~~this~~ Ordinance No. _____.

15 (4) This Ordinance No. _____ shall apply to all housing projects of 5 to 9 units that
16 filed their first application, including an environmental evaluation application or any other
17 Planning Department application on or after July 18, 2006.

18 (c) ~~This Ordinance~~ The requirements of this Program shall not apply to:

19 (1) That portion of a housing project located on property owned by the United
20 States or any of its agencies or leased by the United States or any of its agencies for a period
21 in excess of 50 years, with the exception of such property not used exclusively for a
22 governmental purpose;

23 (2) That portion of a housing project located on property owned by the State of
24 California or any of its agencies, with the exception of such property not used exclusively for a
25 governmental or educational purpose; or

Mayor Newsom, Supervisor Chiu

1 (3) That portion of a housing project located on property under the jurisdiction of the
2 San Francisco Redevelopment Agency or the Port of San Francisco where the application of
3 this Ordinance is prohibited by California or local law;

4 (4) A project using California Debt Limit Allocation Committee (CDLAC) tax-exempt bonds
5 as long as the project provides 20 percent of the units as affordable at 50 percent of area median income
6 for on-site housing or 25 percent of the units as affordable at 50 percent of area median income for off-
7 site housing.

8 (d) Waiver or Reduction:

9 (1) A project applicant of any project subject to the requirements in this Program
10 may appeal to the Board of Supervisors for a reduction, adjustment, or waiver of the
11 requirements based upon the absence of any reasonable relationship or nexus between the
12 impact of development and either the amount of the fee charged or the *inclusionary program*
13 requirement.

14 (2) A project applicant subject to the requirements of this Program who has
15 received an approved building permit, conditional use permit or similar discretionary approval
16 and who submits a new or revised building permit, conditional use permit or similar
17 discretionary approval for the same property may appeal for a reduction, adjustment or waiver
18 of the requirements with respect to the number of lots or square footage of construction
19 previously approved.

20 (3) Any such appeal shall be made in writing and filed with the Clerk of the Board no
21 later than 15 days after the date the Planning Department sends notice to the project
22 applicant of the number of affordable units required as provided in Section 315.4(a) and
23 315.5(a). The appeal shall set forth in detail the factual and legal basis for the claim of waiver,
24 reduction, or adjustment. The Board of Supervisors shall consider the appeal at the hearing
25 within 60 days after the filing of the appeal. The appellant shall bear the burden of presenting

Mayor Newsom, Supervisor Chiu

1 substantial evidence to support the appeal, including comparable technical information to
2 support appellant's position. The decision of the Board shall be by a simple majority vote and
3 shall be final. If a reduction, adjustment, or waiver is granted, any change in use within the
4 project shall invalidate the waiver, adjustment, or reduction of the fee or *inclusionary program*
5 requirement. If the Board grants a reduction, adjustment or waiver, the Clerk of the Board
6 shall promptly transmit the nature and extent of the reduction, adjustment or waiver to the
7 Treasurer.

8 (e) For projects that have received a first site or building permit prior to the effective
9 date of this legislation, the requirements in effect prior to the effective date of this Ordinance
10 *No. _____* shall apply.

11 **SEC. 315.4. - ~~ON-SITE HOUSING REQUIREMENT AND BENEFITS~~ AFFORDABLE**
12 **HOUSING FEE.**

13 Except as provided in Section 315.4(e), all housing projects subject to this Program
14 through the application of Section 315.3 shall be required to ~~construct on-site units~~ *pay an*
15 *affordable housing fee* subject to the following requirements:

16 (a) By paying ~~an in-lieu~~ *a* fee to the Treasurer for use by the Mayor's Office of
17 Housing for the purpose of constructing at an alternate site the type of housing required by
18 Section 315.5 within the City and County of San Francisco.

19 (b) The amount of the fee which may be paid by the project applicant subject to this
20 ~~Program Ordinance in lieu of developing and providing housing required by Section 315.4~~ shall be
21 determined by Mayor's Office of Housing ("MOH") utilizing the following factors:

22 (1) The number of units *equivalent to the applicable percentage of the number of units in*
23 *the principle project. The applicable percentage shall be 20% or the percentage that applied to the*
24 *project if the project is subject to the requirements of an earlier version of this Program due to the date*
25 *it submitted its application required by Section 315.5 if the project applicant were to elect to meet the*

Mayor Newsom, Supervisor Chiu

1 ~~requirements of this section by off site housing development.~~ For the purposes of this section, the
2 City shall calculate the fee using the direct fractional result of the total number of units
3 multiplied by the applicable percentage of off site housing required, rather than rounding up the
4 resulting figure as required by Section 315.5(a).

5 (2) The affordability gap using data on the cost of construction of residential housing
6 from the "San Francisco Sensitivity Analysis Summary Report: Inclusionary Housing Program"
7 prepared by Keyser Marston Associates, Inc. in August 2006 for the Maximum Annual Rent or
8 Maximum Purchase Price for the equivalent unit sizes. The Planning Department and MOH
9 shall update the technical report from time to time as they deem appropriate in order to ensure
10 that the affordability gap remains current.

11 (3) No later than July 1 of each year, the Mayor's Office of Housing shall adjust the
12 ~~in-lieu fee payment option~~ and provide a report on its adjustment to the Board of Supervisors.
13 MOH shall provide notice of any fee adjustment on its website at least 30 days prior to the
14 adjustment taking effect. The Mayor's Office of Housing is authorized to develop an
15 appropriate methodology for indexing the fee, based on adjustments in the costs of
16 constructing housing and in the price of housing in San Francisco. The method of indexing
17 shall be published in the Procedures Manual.

18 (c) Within 30 days of determining the amount of the fee to be paid by the applicant,
19 MOH shall transmit the amount of the fee to the Treasurer. Prior to the issuance by DBI of the
20 first site or building permit for the project applicant, the project applicant must notify the
21 Planning Department and MOH in writing that it has paid in full the sum required to the
22 Treasurer. If the project applicant fails by the applicable date to demonstrate to the Planning
23 Department that the project applicant has paid the applicable sum in full to the Treasurer, DBI
24 shall deny any and all site or building permits or certificates of occupancy for the development
25

1 project until the Planning Department notifies DBI and MOH that such payment has been
2 made.

3 (d) Upon payment of the fee in full to the Treasurer and upon request of the project
4 applicant, the Treasurer shall issue a certification that the fee has been paid. The project
5 applicant shall present such certification to the Planning Department, DBI and MOH prior to
6 the issuance by DBI of the first site or building permit or certificate of occupancy for any
7 development subject to this Section. Any failure of the Treasurer, DBI, or Planning
8 Department to give any notice under this Section shall not relieve a project applicant from
9 compliance with this Section. Where DBI inadvertently issues a site or building permit without
10 payment of the fee, DBI shall not issue any certificate of occupancy for the project without
11 notification from the Treasurer that the fee required by this Section has been paid. The
12 procedure set forth in this subsection is not intended to preclude enforcement of the
13 provisions of this section pursuant to any other section of this Code, or other authority under
14 the laws of the State of California.

15 (e) All monies contributed pursuant to this section shall be deposited in the special
16 fund maintained by the Controller called the Citywide Affordable Housing Fund.

17 (1) Except as provided in subsection (2) below, the receipts in the Fund are hereby
18 appropriated in accordance with law to be used to (1) increase the supply of housing
19 affordable to qualifying households subject to the conditions of this Section, (2) provide
20 downpayment assistance to low and moderate income homebuyers; and (23) pay the expenses of
21 MOH in connection with monitoring and administering compliance with the requirements of the
22 Program. MOH is authorized to use funds in an amount not to exceed \$200,000 every 5 years
23 to conduct follow-up studies under Section 315.8(e) and to update the ~~in-lieu~~ affordable housing
24 fee amounts as described above in Section 315.64(b). All other monitoring and administrative
25 expenses shall be appropriated through the annual budget process or supplemental

Mayor Newsom, Supervisor Chiu

1 appropriation for MOH. The fund shall be administered and expended by MOH, which shall
2 have the authority to prescribe rules and regulations governing the Fund which are consistent
3 with this Section.

4 (2) **"Small Sites Funds":**

5 (A) **Designation of funds:** MOH shall designate and separately account for 10% of
6 all *in-lieu* fees that it receives under Section 315 et seq., excluding *in-lieu* fees that are
7 geographically targeted such as those in Sections 315.4(a)(1) and 827(b)(5)(C), to support
8 acquisition and rehabilitation of Small Sites ("Small Sites Funds"). MOH shall continue to
9 divert 10% of all *in-lieu* fees for this purpose until the Small Sites Funds reach a total of \$15
10 million at which point, MOH will stop designating funds for this purpose. At such time as
11 designated Small Sites Funds are expended and dip below \$15 million, MOH shall start
12 designating funds again for this purpose, such that at no time the Small Sites Funds shall
13 exceed \$15 million. When the total amount of *in-lieu* fees paid to the City under Section 315 et
14 seq. totals less than \$10 million over the preceding 12 month period, the Mayor's Office of
15 Housing is authorized to temporarily divert funds from the Small Sites Fund for other
16 purposes. The Mayor's Office of Housing must keep track of the diverted funds, however,
17 such that when the amount of *in-lieu* fees paid to the City under Section 315 et seq. meets or
18 exceeds \$10 million over the preceding 12 month period, the Mayor's Office of Housing shall
19 commit all of the previously diverted funds and 10% any new funds, subject to the cap above,
20 to the Small Sites Fund.

21 (B) **Use of Small Sites Funds.** The funds shall be used exclusively to acquire or
22 rehabilitate "Small Sites" defined as properties consisting of less than 25 units. Units
23 supported by monies from the fund shall be designated as housing affordable to qualifying
24 households as defined in Section 315.1 for no less than 55 years. Properties supported by the
25 Small Sites Funds must be either (i) rental properties that will be maintained as rental

1 properties; (ii) vacant properties that were formerly rental properties as long as those
2 properties have been vacant for a minimum of two years prior to the effective date of this
3 legislation, (iii) properties that have been the subject of foreclosure or (iv) a Limited Equity
4 Housing Cooperative as defined in Subdivision Code Sections 1399.1 et seq. or a property
5 owned or leased by a non-profit entity modeled as a Community Land Trust.

6 (C) **Initial Funds:** If, within 18 months from the date of adoption of this ordinance,
7 the Mayor's Office of Housing dedicates an initial one-time contribution of other eligible funds
8 to be used initially as Small Sites Funds, the Mayor's Office of Housing may use the
9 equivalent amount of Small Sites Funds received from *in-lieu* fees for other purposes
10 permitted by the Citywide Affordable Housing Fund until the amount of the initial one-time
11 contribution is reached.

12 (D) **Annual Report:** At the end of each fiscal year, the Mayor's Office of Housing
13 shall issue a report to the Board of Supervisors regarding the amount of Small Sites Funds
14 received from *in-lieu* fees under this legislation, and a report of how those funds were used.

15 (E) **Intent:** In adopting this ordinance regarding Small Sites Funds, the Board of
16 Supervisors does not intend to preclude the Mayor's Office of Housing from expending other
17 eligible sources of funding on Small Sites as described in this Section, or from allocating or
18 expending more than \$15 million of other eligible funds on Small Sites.

19 (f) Lien Proceedings.

20 (1) A project applicant's failure to comply with the requirements of this *Section*
21 *Program* shall constitute cause for the City to record a lien against the development project in
22 the sum of the *in-lieu* fee required under this Ordinance, as adjusted under this Section.

23 (2) If, for any reason, the fee imposed pursuant to this Ordinance remains unpaid
24 following issuance of the permit, the Treasurer shall initiate proceedings to impose the lien in
25 accordance with the procedures set forth in Chapter 10, Article XX of the San Francisco

Mayor Newsom, Supervisor Chiu

1 Administrative Code to make the entire unpaid balance of the fee, including interest, a lien
2 against all parcels used for the development project. The Treasurer shall send all notices
3 required by that Article to the owner of the property as well as the sponsor. The Treasurer
4 shall also prepare a preliminary report notifying the sponsor of a hearing to confirm such
5 report by the Board of Supervisors at least 10 days before the date of the hearing. The report
6 to the sponsor shall contain the sponsor's name, a description of the sponsor's development
7 project, a description of the parcels of real property to be encumbered as set forth in the
8 Assessor's Map Books for the current year, a description of the alleged violation of this
9 Ordinance, and shall fix a time date and place for hearing. The Treasurer shall cause this
10 report to be mailed to the sponsor and each owner of record of the parcels of real property
11 subject to lien. Except for the release of lien recording fee authorized by Administrative Code
12 Section 10.237, all sums collected by the Tax Collector pursuant to this Ordinance shall be
13 held in trust by the Treasurer and deposited in the Citywide Affordable Housing Fund
14 established in Section 313.12.

15 (3) Any notice required to be given to a sponsor or owner shall be sufficiently given
16 or served upon the sponsor or owner or all purposes hereunder if personally served upon the
17 sponsor or owner or if deposited, postage prepaid, in a post office letterbox addressed in the
18 name of the sponsor or owner at the official address of the sponsor or owner maintained by
19 the Tax Collector for the mailing of tax bills or, if no such address is available, to the sponsor
20 at the address of the development project, and to the applicant for the site or building permit
21 at the address on the permit application.

22 (g) In the event a building permit expires prior to completion of the work on and
23 commencement of occupancy of a housing project so that it will be necessary to obtain a new
24 permit to carry out any development, the obligation to comply with this Program shall be
25 cancelled, and any in-lieu fee previously paid to the Treasurer shall be refunded. If and when

Mayor Newsom, Supervisor Chiu

1 the sponsor applies for a new permit, the procedures set forth in this Ordinance regarding
2 construction of housing or payment of the in-lieu fee shall be followed.

3 (h) ~~In the event that a development project for which an in-lieu fee imposed under this
4 Section has been fully paid is demolished or converted to a use or uses not subject to this ordinance
5 prior to the expiration of its estimated useful life, the City shall refund to the sponsor a portion of the
6 amount of an in-lieu fee paid. The portion of the fee refunded shall be determined on a pro-rata basis
7 according to the ratio of the remaining useful life of the project at the time of demolition or conversion
8 in relation to its total useful life. For purposes of this Ordinance, the useful life of a development
9 project shall be 50 years.~~

10 If a housing project is located in an Area Plan with additional or specific affordable housing
11 requirements such as those set forth in Section 315.10 or elsewhere in this Code, the more specific
12 provisions shall apply in lieu of or in addition to those provided in this Program, as applicable.

13 (a) ~~Number of Units:~~

14 (1)

15 (A) ~~For any housing development of any height that is located in an area with a specific~~
16 ~~inclusionary housing requirement, the more specific inclusionary housing requirement shall apply. In~~
17 ~~addition, the following provisions shall apply only to the following Area Plans as provided below:~~

18 (i) ~~Market and Octavia Area Plan: The requirements of Sections 315 through 315.9 shall~~
19 ~~apply in the Plan Area subject to the following:~~

20 ~~An additional affordable housing requirement shall apply in the Market and Octavia Plan Area~~
21 ~~as follows:~~

22 ~~Definitions. The definitions in Section 326.2 and 318.2 shall apply.~~

23 ~~Amount of fee: All projects that have not received Planning Department or Commission~~
24 ~~approval as of the effective date of this legislation and that are subject to the Residential Inclusionary~~
25 ~~Affordable Housing Program shall pay an additional affordable housing fee per square foot of~~

Mayor Newsom, Supervisor Chiu

1 ~~Residential Space Subject to the Community Improvements Impact Fee as follows; \$8.00 in the Van~~
2 ~~Ness Market Special Use District; \$4.00 in the NCT District; and \$0.00 in the RTO District. A project~~
3 ~~applicant shall not pay a fee for any square foot of space designated as a below market rate unit under~~
4 ~~this inclusionary affordable housing program or any other unit that is designated as an affordable~~
5 ~~housing unit under a Federal, State, or local restriction in a manner that maintains affordability for a~~
6 ~~term no less than 50 years.~~

7 ~~Timing of payment: The fee shall be paid before the City issues a first certificate of occupancy~~
8 ~~for the project.~~

9 ~~Use of Fee: The additional affordable housing requirement specified in this Section for the~~
10 ~~Market and Octavia Plan Area shall be paid into the Citywide Affordable Housing Fund, but the funds~~
11 ~~shall be separately accounted for. MOH shall expend the funds according to the following priorities:~~
12 ~~First, to increase the supply of housing affordable to qualifying households in the Market and Octavia~~
13 ~~Plan Area; second, to increase the supply of housing affordable to qualifying households within 1 mile~~
14 ~~of the boundaries of the Plan Area; third, to increase the supply of housing affordable to qualifying~~
15 ~~households in the City and County of San Francisco. The funds may also be used for monitoring and~~
16 ~~administrative expenses subject to the process described in Section 315.6(e).~~

17 ~~Other fee provisions: This additional affordable housing fee shall be subject to the following~~
18 ~~provisions of Sections 326 et seq.; the inflation adjustment provisions of Section 326.3(d); the waiver~~
19 ~~and reduction provisions of Section 326.3(h); the lien proceedings in Section 326.4; and the refund~~
20 ~~provisions of Section 326.5. This additional affordable housing fee may not be met through the in-kind~~
21 ~~provision of community improvements or Community Facilities (Mello-Roos) financing options of~~
22 ~~Sections 326.3(e) and (f).~~

23 ~~Findings: The Board of Supervisors hereby finds that the additional affordable housing~~
24 ~~requirements of this Section are supported by the Nexus Study performed by Keyser Marston and~~
25 ~~Associates referenced in Section 315.2(12) and found in Board File No. 081152. The Board of~~

Mayor Newsom, Supervisor Chiu

1 ~~Supervisors has reviewed the study and staff analysis and report of the study and, on that basis finds~~
2 ~~that the study supports the current inclusionary housing requirements combined with the additional~~
3 ~~affordable housing fee. Specifically, the Board finds that the study: identifies the purpose of the~~
4 ~~additional fee to mitigate impacts on the demand for affordable housing in the City; identifies the use to~~
5 ~~which the additional fee is to be put as being to increase the City's affordable housing supply; and~~
6 ~~establishes a reasonable relationship between the use of the additional fee for affordable housing and~~
7 ~~the need for affordable housing and the construction of new market rate housing. Moreover, the Board~~
8 ~~finds that the current inclusionary requirements combined with the additional fee are less than the cost~~
9 ~~of mitigation and do not include the costs of remedying any existing deficiencies. The Board also finds~~
10 ~~that the study establishes that the current inclusionary requirements and additional fee do not duplicate~~
11 ~~other City requirements or fees.~~

12 ~~Furthermore, the Board finds that generally an account has been established, funds~~
13 ~~appropriated, and a construction schedule adopted for affordable housing projects funded through the~~
14 ~~Inclusionary Housing program and the additional fee or that the in lieu fees and the additional fee will~~
15 ~~reimburse the City for expenditures on affordable housing that have already been made.~~

16 ~~Furthermore, the Board finds that a major Market and Octavia Area Plan objective is to direct~~
17 ~~new market rate housing development to the area. That new market rate development will greatly out~~
18 ~~number both the number of units and potential new sites within the plan area for permanently~~
19 ~~affordable housing opportunities. The City and County of San Francisco has adopted a policy in its~~
20 ~~General Plan to meet the affordable housing needs of its general population and to require new~~
21 ~~housing development to produce sufficient affordable housing opportunities for all income groups, both~~
22 ~~of which will not be met by the projected housing development in the plan area. In addition, the "Draft~~
23 ~~Residential Nexus Analysis City and County of San Francisco" of December 2006 indicates that market~~
24 ~~rate housing itself generates additional lower income affordable housing needs for the workforce~~
25 ~~needed to serve the residents of the new market rate housing proposed for the plan area. In order to~~

Mayor Newsom, Supervisor Chiu

1 ~~meet the demand created for affordable housing by the specific policies of the Plan and to be consistent~~
2 ~~with the policy of the City and County of San Francisco it is found that an additional affordable~~
3 ~~housing fee need be included on all market rate housing development in the Plan Area with priority for~~
4 ~~its use being given to the Plan area.~~

5 (ii)

6 ~~Eastern Neighborhoods Project Area: The requirements of Sections 315 through 315.9 and 319~~
7 ~~shall apply in the Eastern Neighborhoods Plan Area subject to the following and subject to any stated~~
8 ~~exceptions elsewhere in this Code, including the specific provisions in Section 319:~~

9 ~~Definitions:~~

10 ~~"Gross square footage" shall have the meaning set forth in Section 102.9.~~

11 ~~"Development Application" shall have the meaning set forth in Section 175.6.~~

12 ~~"Eastern Neighborhood Controls" shall have the meaning set forth in Section 175.6.~~

13 ~~Application. The option described in this subsection (ii) shall only be provided to development projects~~
14 ~~that are subject to the Eastern Neighborhood Controls as defined in Section 175.6 (e), and consist of 20~~
15 ~~units or less or less than 25,000 gross square feet. Amount of Fee. All projects subject to this subsection~~
16 ~~may choose to pay a square foot in lieu fee instead of the in lieu fee provided for in Section 315.6 as~~
17 ~~follows. If this option is selected, the project applicant shall pay \$40.00 per gross square foot of net~~
18 ~~new residential development. The calculation of gross square feet shall not include nonresidential uses,~~
19 ~~including any retail, commercial, or PDR uses, and all other space used only for storage and services~~
20 ~~necessary to the operation or maintenance of the building itself.~~

21 ~~Timing of Payment. The project applicant shall pay the fee prior to issuance by DBI of the first~~
22 ~~site or building permit for the project. At the project applicant's option, it may choose to pay only 50%~~
23 ~~of the fee prior to issuance by DBI of the first site or building permit and, prior to issuance of the first~~
24 ~~site or building permit, the City shall impose a lien on the property for the remaining 50% of the fee~~
25 ~~through the procedures set forth in Section 315.6(f) except that no interest will accrue for the first~~

Mayor Newsom, Supervisor Chiu

1 ~~twelve months from the issuance of the first site or building permit for the project. The project~~
2 ~~applicant shall pay the remaining 50% of the fee prior to issuance by DBI of a first certificate of~~
3 ~~occupancy. When 100% of the fee is paid, including interest if applicable, the City shall remove the~~
4 ~~lien.~~

5 ~~Use of Fee. The fee shall be paid into the Citywide Affordable Housing Fund, but the funds shall~~
6 ~~be separately accounted for. MOH shall expend the funds according to the following priorities: First,~~
7 ~~to increase the supply of housing affordable to qualifying households in the Eastern Neighborhoods~~
8 ~~Project Areas; second, to increase the supply of housing affordable to qualifying households within 1~~
9 ~~mile of the boundaries of the Eastern Neighborhoods Project Areas; third, to increase the supply of~~
10 ~~housing affordable to qualifying households in the City and County of San Francisco. The funds may~~
11 ~~also be used for monitoring and administrative expenses subject to the process described in Section~~
12 ~~315.6(e).~~

13 ~~Findings. The Board of Supervisors hereby finds that the fee provisions of this Section are~~
14 ~~equivalent to or less than the fees for developments of over 20 units previously adopted by the Board in~~
15 ~~Ordinance No. 051685 and 060529 and are also supported by the Nexus Study performed by Keyser~~
16 ~~Marston and Associates referenced in Section 315.2(12) and found in Board File No. 081152. The~~
17 ~~Board of Supervisors has reviewed the study and staff analysis prepared by the Mayor's Office of~~
18 ~~Housing dated July 24, 2008 in Board File No. 081152 and on that basis finds that the study supports~~
19 ~~the current proposed changes to the inclusionary housing requirements for projects of 20 units or less~~
20 ~~in the Eastern Neighborhood Area Plan. Specifically, the Board finds that the study and staff memo:~~
21 ~~identifies the purpose of the additional fee to mitigate impacts on the demand for affordable housing in~~
22 ~~the City; identifies the use to which the additional fee is to be put as being to increase the City's~~
23 ~~affordable housing supply; and establishes a reasonable relationship between the use of the additional~~
24 ~~fee for affordable housing and the need for affordable housing and the construction of new market rate~~
25 ~~housing. Moreover, the Board finds that the new inclusionary requirements are less than the cost of~~

Mayor Newsom, Supervisor Chiu

1 ~~mitigation and do not include the costs of remedying any existing deficiencies. The Board also finds~~
2 ~~that the study establishes that the inclusionary requirements do not duplicate other City requirements~~
3 ~~or fees.~~

4 ~~Furthermore, the Board finds that generally an account has been established, funds~~
5 ~~appropriated, and a construction schedule adopted for affordable housing projects funded through the~~
6 ~~Inclusionary Housing program and the in lieu fees will reimburse the City for expenditures on~~
7 ~~affordable housing that have already been made.~~

8 ~~Furthermore, the Board finds that small scale development faces a number of challenges in the~~
9 ~~current development climate, including limited access to credit and often, a higher land cost per unit~~
10 ~~for the small sites on which they develop. Because of these and other variations from larger scale~~
11 ~~development, they operate under a somewhat unique development model which cannot be fully~~
12 ~~encapsulated within the constraints of the Eastern Neighborhoods Financial Analysis, prepared to~~
13 ~~assess the financial feasibility of increasing housing requirements and impact fees in the Plan Areas.~~
14 ~~To address these challenges, the Board finds that a number of slight modifications to the affordable~~
15 ~~housing requirements of the Eastern Neighborhoods, to apply to small projects (defined as 20 units or~~
16 ~~fewer, or less than 25,000 gross square feet) are appropriate.~~

17 ~~(B) — Buildings 120 feet in height and under or buildings of over 120 feet in height that do not~~
18 ~~meet the criteria in subsection (C) below: Except as provided in Subsection (C) below, the Planning~~
19 ~~Department shall require for housing projects covered by Section 315.3(a)(1), as a condition of~~
20 ~~Planning Department approval of a project's building permit, and by Section 315.3(a)(2), (3) and (4),~~
21 ~~as a Condition of Approval of a conditional use or planned unit development permit or as a condition~~
22 ~~of Planning Department approval of a live/work project, that 15 percent of all units constructed on the~~
23 ~~project site shall be affordable to qualifying households so that a project applicant must construct 15~~
24 ~~times the total number of units produced in the principal project beginning with the construction of the~~
25

Mayor Newsom, Supervisor Chiu

1 ~~fifth unit. If the total number of units is not a whole number, the project applicant shall round up to the~~
2 ~~nearest whole number for any portion of .5 or above.~~

3 ~~The Planning Department shall provide written notice by mail to the project applicant of the~~
4 ~~number of affordable units which shall be required within 30 days of approval by the Planning~~
5 ~~Department or Planning Commission.~~

6 ~~(C) Buildings of over 120 feet in height. Except as provided in subsection (A) above, the~~
7 ~~requirements of this Subsection shall apply to any project that is over 120 feet in height and does not~~
8 ~~require a Zoning Map amendment or Planning Code text amendment related to its project approvals~~
9 ~~which (i) results in a net increase in the number of permissible residential units, or (ii) results in a~~
10 ~~material increase in the net permissible residential square footage as defined in Section 315.3(b)(2) or~~
11 ~~has not received or will not receive a zoning map amendment or Planning Code text amendment as part~~
12 ~~of an Area Plan adopted after January 1, 2006 which (i) results in a net increase in the number of~~
13 ~~permissible residential units, or (ii) results in a material increase in the net permissible residential~~
14 ~~square footage as defined in Section 315.3(b)(2). The Planning Department shall require for housing~~
15 ~~projects covered by this Subsection and Section 315.3(a)(1), as a condition of Planning Department~~
16 ~~approval of a project's building permit, or by this Subsection and by Section 315.3(a)(2), (3) and (4), as~~
17 ~~a Condition of Approval of a conditional use or planned unit development permit or as a condition of~~
18 ~~Planning Department approval of a live/work project, that 12 percent of all units constructed on the~~
19 ~~project site shall be affordable to qualifying households so that a project applicant must construct 12~~
20 ~~times the total number of units produced in the principal project beginning with the construction of the~~
21 ~~fifth unit. If the total number of units is not a whole number, the project applicant shall round up to the~~
22 ~~nearest whole number for any portion of .5 or above. Consistent with the conclusions of the Mayor's~~
23 ~~Office of Housing study authorized in Section 315.8(e), the Mayor's Office of Housing shall recommend~~
24 ~~and the Board of Supervisors shall consider whether the requirements of this Subsection for buildings~~
25 ~~of over 120 feet in height shall continue or expire after approximately five years.~~

Mayor Newsom, Supervisor Chiu

1 ~~The Planning Department shall provide written notice by mail to the project applicant of the~~
2 ~~number of affordable units which shall be required within 30 days of approval by the Planning~~
3 ~~Department or Planning Commission. This notice shall also be sent to project applicants who elect to~~
4 ~~pay an in lieu fee.~~

5 ~~(2) If the principal project has resulted in demolition, conversion, or removal of affordable~~
6 ~~housing units renting or selling to households at income levels and/or for a rental rate or sales price~~
7 ~~below corresponding income thresholds for units affordable to qualifying households, the Planning~~
8 ~~Commission shall require that the project applicant replace the number of affordable units removed~~
9 ~~with units of a comparable number of bedrooms or provide that 15 percent of all units constructed as~~
10 ~~part of the new project shall be affordable to qualifying households, whichever is greater.~~

11 ~~(b)~~

12 ~~Timing of Construction: On site inclusionary housing required by this Section 315.4 must be~~
13 ~~constructed, completed, and ready for occupancy no later than the market rate units in the principal~~
14 ~~project.~~

15 ~~(c) Type of Housing: The type of affordable housing needed in San Francisco is documented~~
16 ~~in the City's Consolidated Plan and the Residence Element of the General Plan. In general, affordable~~
17 ~~units constructed under this Section 315.4 shall be comparable in number of bedrooms, exterior~~
18 ~~appearance and overall quality of construction to market rate units in the principal project. The Notice~~
19 ~~of Special Restrictions or Conditions of Approval shall include a specific number of units at specified~~
20 ~~unit sizes for affordable units. The square footage of affordable units and interior features in affordable~~
21 ~~units do not need to be same as or equivalent to those in market rate units in the principal project, so~~
22 ~~long as they are of good quality and are consistent with then current standards for new housing. Where~~
23 ~~applicable, parking shall be offered to the affordable units subject to the terms and conditions of the~~
24 ~~Department's policy on unbundled parking for affordable housing units as specified in the Procedures~~
25 ~~Manual and amended from time to time. Unless provided otherwise by the Mayor's Office of Housing in~~

Mayor Newsom, Supervisor Chiu

1 ~~writing, if the units in the market rate portion of the development are ownership units, then the~~
2 ~~affordable units shall be ownership units and if the market rate units are rental units, then the~~
3 ~~affordable units shall be rental units.~~

4 ~~(d) Marketing the Units: The Mayor's Office of Housing shall be responsible for overseeing~~
5 ~~and monitoring the marketing of affordable units under this Section. In general, the marketing~~
6 ~~requirements and procedures shall be contained in the Procedures Manual as amended from time to~~
7 ~~time and shall apply to the affordable units in the project. The Mayor's Office of Housing may develop~~
8 ~~occupancy standards for units of different bedroom sizes in the Procedures Manual in order to promote~~
9 ~~an efficient allocation of affordable units. The Mayor's Office of Housing may require in the~~
10 ~~Procedures Manual that prospective purchasers complete homebuyer education training or fulfill other~~
11 ~~requirements. The Mayor's Office of Housing shall develop a list of minimum qualifications for~~
12 ~~marketing firms that market affordable units under this ordinance, referred to the Procedures Manual~~
13 ~~as Below Market Rate (BMR units). Within 3 months from the effective date of this legislation, the~~
14 ~~Mayor's Office of Housing shall recommend to the Planning Commission that these minimum~~
15 ~~qualifications be published in the Procedures Manual such that, upon approval of the qualifications by~~
16 ~~the Planning Commission, no developer marketing units under the Inclusionary Housing Program shall~~
17 ~~be able to market BMR units except through a firm meeting all of the minimum qualifications. For~~
18 ~~purposes of this ordinance, any developer that has not yet submitted a marketing plan to the Mayor's~~
19 ~~Office of Housing by the date of Planning Commission approval of the qualifications shall be required~~
20 ~~to comply with this section. The Notice of Special Restrictions or Conditions of Approval shall specify~~
21 ~~that the marketing requirements and procedures contained in the Procedures Manual as amended from~~
22 ~~time to time, shall apply to the affordable units in the project.~~

23 ~~(H)~~

24 ~~Lottery: At the initial offering of affordable units in a housing project, the Mayor's Office of~~
25 ~~Housing must require the use of a public lottery approved by the Mayor's Office of Housing to select~~

Mayor Newsom, Supervisor Chiu

1 ~~purchasers or tenants. The Mayor's Office of Housing shall also hold a general public lottery and~~
2 ~~maintain and utilize a list generated from this lottery or utilize a list generated from a recent lottery at~~
3 ~~another similar housing project to fill spaces in units that become available for re-sale or occupancy in~~
4 ~~any housing project subject to this ordinance after the initial offering. The list shall be updated from~~
5 ~~time to time but in no event less than annually to ensure that it remains current.~~

6 ~~(2) Preferences: The Mayor's Office of Housing shall create a lottery system that gives~~
7 ~~preference to people who live or work in San Francisco. MOH shall propose policies and procedures~~
8 ~~for implementing this preference to the Planning Commission for inclusion in the Procedures Manual.~~
9 ~~Otherwise, it is the policy of the Board of Supervisors to treat all households equally in allocating~~
10 ~~affordable units under this Program.~~

11 ~~(ei) **Alternatives To Payment Of Affordable Housing Fee:**~~

12 ~~(1) Eligibility: A project sponsor is only eligible to meet the requirements of this Program~~
13 ~~through one of the alternatives provided in this Subsection if the project sponsor either:~~

14 ~~(A) Submits an affidavit to the Planning Department prior to project approval by the~~
15 ~~Department or the Commission, as applicable, that any affordable units provided under this Program~~
16 ~~shall be sold as ownership units and will remain as ownership units for the life of the project; or~~

17 ~~(B) Submits to the Department a contract demonstrating that the project's on- or off-site~~
18 ~~units are not subject to the Costa Hawkins Rental Housing Act, California Civil Code Section 1954.50~~
19 ~~because, under Section 1954.52(b), it has entered into an agreement with a public entity in~~
20 ~~consideration for a direct financial contribution or any other forms of assistance specified in California~~
21 ~~Government Code Sections 65915 et seq. and it submits an Acknowledgement of such to the Department.~~

22 ~~(C) Enters into a Development Agreement with the City and County of San Francisco under~~
23 ~~California Government Code Section 65864 et seq. and Chapter 56 of the San Francisco~~
24 ~~Administrative Code, permitting the project to be eligible for on- site units as an alternative to payment~~
25

1 of the Affordable Housing Fee to satisfy the requirements of the Program and obligating the project
2 sponsor to provide the affordable units on-site.

3 (2) If the project sponsor is eligible under Subsection (1) above, ~~t~~The project sponsor
4 may elect to satisfy the requirements of Section 315.4 by one of the alternatives specified in
5 this Section. If a project sponsor is eligible, ~~t~~The project sponsor has the choice between the
6 alternatives and the Planning Commission may not require a specific alternative. The project
7 sponsor must elect an alternative before it receives project approvals from the Planning
8 Commission or Planning Department and that alternative will be a condition of project
9 approval. Notwithstanding the foregoing, if a project sponsor elects an alternative *other than*
10 *the on-site alternative*, the project sponsor still has the option to ~~choose the on-site alternative~~ pay
11 the fee up to the issuance of the first site or building permit. If a project sponsor fails to elect an
12 alternative before project approval by the Planning Commission or Planning Department or if a
13 project becomes ineligible for an alternative, the provisions of Section 315.4 shall apply. The
14 alternatives are as follows:

15 (1A) Constructing units affordable to qualifying households at an alternative site
16 within the City and County of San Francisco pursuant to the requirements of Section 315.5.

17 (2B) Constructing units affordable to qualifying households on-site of the principle project
18 ~~Paying an in-lieu fee to the Mayor's Office of Housing~~ pursuant to the requirements of Section
19 315.6.

20 (3C) Any combination of ~~construction of on-site units~~ payment of the affordable housing fee
21 as provided in Section 315.4, construction of off-site units as provided in Section 315.5, or
22 ~~payment of an in-lieu fee~~ construction of on-site units as provided in Section 315.6, provided that
23 the project applicant constructs or pays the fee at the appropriate percentage or fee level
24 required for that option.

25 (4)

Mayor Newsom, Supervisor Chiu

1 ~~Using California Debt Limit Allocation Committee (CDLAC) tax exempt bonds under the~~
2 ~~requirements of Section 315.5(g).~~

3 (f) **Benefits:** If the project applicant is eligible for and elects to satisfy the
4 inclusionary housing requirements through the production of on-site inclusionary housing in
5 this Section 315.4, the project applicant who filed an application on or after June 18, 2001
6 shall at his or her option, be eligible to receive a refund for only that portion of the housing
7 project which is affordable for the following fees: a conditional use or other fee required by
8 Planning Code Section 352, if applicable; an environmental review fee required by
9 Administrative Code Section 31.46B, if applicable; a building permit fee required by the
10 Building Code and by Planning Code Section 355 for the portion of the housing project that is
11 affordable. The project applicant shall pay the building fee for the portion of the project that is
12 market-rate.

13 The Controller shall refund fees from any appropriated funds to the project applicant on
14 application by the project applicant. The application must include a copy of the certificate of
15 occupancy for all units affordable to a qualifying household required by the Inclusionary
16 Affordable Housing Program. It is the policy of the Board of Supervisors to appropriate money
17 for this purpose from the General Fund.

18 **SEC. 315.5. - COMPLIANCE THROUGH OFF-SITE HOUSING DEVELOPMENT**

19 **ALTERNATIVE.**

20 If the project applicant elects and the project applicant is eligible, pursuant to Section
21 315.4(e), that the project applicant will build off-site units to satisfy the requirements of this
22 Program, the project applicant shall meet the following requirements:

23 (a) **Number of Units:** The number of units constructed off-site shall be as follows:

24 (1)

25

1 (A) For any housing development of any height that is located in an area with a
2 specific inclusionary housing requirement set forth in Section 315.10 or elsewhere in this Code, the
3 more specific off-site inclusionary housing requirement shall apply.

4 (B) Buildings of 120 feet and under in height or buildings of over 120 feet in height
5 that do not meet the criteria in subsection (C) below: Except as provided in Subsection (A),
6 the for projects described in Section 315.3(a)(1), (2), (3), and (4) 20 percent so that a project
7 applicant must construct .20 times the total number of units produced in the principal project
8 beginning with the construction of the fifth unit. If the total number of units is not a whole
9 number, the project applicant shall round up to the nearest whole number for any portion of .5
10 or above. The Planning Department shall provide written notice by mail to the project
11 applicant of the number of affordable units which shall be required within 30 days of approval
12 by the Planning Department or Planning Commission. This notice shall also be sent to project
13 applicants who elect to pay an in-lieu fee.

14 (C) Buildings of over 120 feet in height. Except as provided in subsection (A) above,
15 the requirements of this Subsection shall apply to any project that is over 120 feet in height
16 and does not require a Zoning Map amendment or Planning Code text amendment related to
17 its project approvals which (i) results in a net increase in the number of permissible residential
18 units, or (ii) results in a material increase in the net permissible residential square footage as
19 defined in Section 315.3(b)(2); or has not received or will not receive a zoning map
20 amendment or Planning Code text amendment as part of an Area Plan adopted after January
21 1, 2006 which (i) results in a net increase in the number of permissible residential units, or (ii)
22 results in a material increase in the net permissible residential square footage as defined in
23 Section 315.3(b)(2). The Planning Department shall require for housing projects covered by
24 this Subsection and Section 315.3(a)(1), as a condition of Planning Department approval of a
25 project's building permit, or by this Subsection and by Section 315.3(a)(2), (3) and (4), as a

Mayor Newsom, Supervisor Chiu

1 Condition of Approval of a conditional use or planned unit development permit or as a
2 condition of Planning Department approval of a live/work project, that 17 percent of all units
3 constructed on the project site shall be affordable to qualifying households so that a project
4 applicant must construct .17 times the total number of units produced in the principal project
5 beginning with the construction of the fifth unit. If the total number of units is not a whole
6 number, the project applicant shall round up to the nearest whole number for any portion of .5
7 or above. Consistent with the conclusions of the Mayor's Office of Housing study authorized in
8 Section 315.8(e), the Mayor's Office of Housing shall recommend and the Board of
9 Supervisors shall consider whether the requirements of this Subsection for buildings of over
10 120 feet in height shall continue or expire after approximately five years. The Planning
11 Department shall provide written notice by mail to the project applicant of the number of
12 affordable units which shall be required within 30 days of approval by the Planning
13 Department or Planning Commission. This notice shall also be sent to project applicants who
14 elect to pay an in-lieu fee.

15 (b) **Timing of Construction:** The project applicant shall insure that the off-site units
16 are constructed, completed, and ready for occupancy no later than the market rate units in the
17 principal project.

18 (c) **Location of off-site housing:** The project applicant must insure that off-site
19 units are located within one mile of the principal project (the "one-mile radius"). ~~Notwithstanding~~
20 ~~the foregoing, each year 25% of off-site units may be constructed outside of the one-mile radius. These~~
21 ~~units shall be called "citywide off-site units" and may be constructed anywhere in the City, subject to~~
22 ~~the limitations below. In determining the allowable number of citywide off-site units, each fiscal year~~
23 ~~MOH shall take the average number of off-site units receiving a first certificate of occupancy over the~~
24 ~~past five years. In determining the average, MOH shall not include any year where no off-site units~~
25 ~~received a first certificate of occupancy. MOH shall publish the allowable number of citywide off-site~~

Mayor Newsom, Supervisor Chiu

1 ~~units for a given year on July 1 of each year. The Planning Department, in consultation with MOH,~~
2 ~~shall then grant permission to a project applicant to use citywide off-site units on a first-come, first-~~
3 ~~serve basis until the maximum allowable number of citywide off-site units is reached. If the maximum~~
4 ~~number of allowable citywide off-site units is not used in a given year, the citywide off-site units shall~~
5 ~~be carried over to the next fiscal year. If a project applicant does not receive a first certificate of~~
6 ~~occupancy for a citywide off-site unit within 2 years of the date the Planning Department grants~~
7 ~~permission for the citywide off-site unit, then the Zoning Administrator shall have the authority to~~
8 ~~revoke the permission to use the citywide off-site unit and to grant those units to another project~~
9 ~~applicant. Citywide off-site units shall not be built in districts zoned M-1 or M-2, or within a quarter~~
10 ~~mile of a high concentration of public housing units. A high concentration of public housing units shall~~
11 ~~mean a development or developments that consist of 200 or more publicly owned and operated~~
12 ~~affordable housing units.~~

13 (d) **Type of Housing:** The type of affordable housing needed in San Francisco is
14 documented in the City's Consolidated Plan and the Residence Element of the General Plan.
15 New affordable rental housing and ownership housing affordable to households earning less
16 than the median income is greatly needed in San Francisco. The Planning Department shall
17 develop Quality Standards for Off-Site Affordable Housing Units and recommend such
18 standards to the Planning Commission for adoption as part of the Procedures Manual. All off-
19 site units constructed under this Section must be provided *as rental housing for the life of the*
20 *project or, if they are ownership units as ownership housing unless the project applicant meets the*
21 *eligibility requirement of Section 315.4(j)(1)(B) and* must be affordable to households earning no
22 more than 80 percent of the median income for the City and County of San Francisco. Nothing
23 in this section shall limit a developer from meeting the requirements of this Section through
24 the construction of units in a limited equity or land trust form of ownership if such units
25 otherwise meet all of the requirements for off-site housing. In general, affordable units

1 constructed under this Section 315.5 shall be comparable in number of bedrooms, exterior
 2 appearance and overall quality of construction to market rate units in the principal project. The
 3 total square footage of the off-site affordable units constructed under this Section 315.5 shall
 4 be no less than the calculation of the total square footage of the on-site market-rate units in
 5 the principal project multiplied by the relevant on-site percentage requirement for the project
 6 specified in Section 315.4. The Notice of Special Restrictions or Conditions of Approval shall
 7 include a specific number of units at specified unit sizes - including number of bedrooms and
 8 minimum square footage - for affordable units. The interior features in affordable units need
 9 not be the same as or equivalent to those in market rate units in the principal project, so long
 10 as they are consistent with the Planning Department's Quality Standards for Off-Site
 11 Affordable Housing Units found in the Procedures Manual. Where applicable, parking shall be
 12 offered to the affordable units subject to the terms and conditions of the Department's policy
 13 on unbundled parking for affordable housing units as specified in the Procedures Manual and
 14 amended from time to time. If the residential units in the principal project are live/work units
 15 which do not contain bedrooms or are other types of units which do not contain bedrooms
 16 separated from the living space, the off-site units shall be comparable in size according to the
 17 following equivalency calculation between live/work and units with bedrooms:

Number of Bedrooms (or, for live/work units square foot equivalency)	Num ber of Persons in Household
0 (Less than 600 square feet)	1

1	1 (601 to 850 square feet)	2
2	2 (851 to 1,100 square feet)	3
3	3 (1,101 to 1,300 square feet)	4
4	4 (More than 1,300 square feet)	5

6 (e) **Marketing the Units:** They Mayor's Office of Housing shall be responsible for
7 overseeing and monitoring the marketing of affordable units under this Section. In general, the
8 marketing requirements and procedures shall be contained in the Procedures Manual as
9 amended from time to time and shall apply to the affordable units in the project. The Mayor's
10 Office of Housing may develop occupancy standards for units of different bedroom sizes in
11 the Procedures Manual in order to promote an efficient allocation of affordable units. The
12 Mayor's Office of Housing may require in the Procedures Manual that prospective purchasers
13 complete homebuyer education training or fulfill other requirements. The Mayor's Office of
14 Housing shall develop a list of minimum qualifications for marketing firms that market
15 affordable units under this ordinance, referred to the Procedures Manual as Below Market
16 Rate (BMR units). Within three months from the effective date of this legislation, the Mayor's
17 Office of Housing shall recommend to the Planning Commission that these minimum
18 qualifications be published in the Procedures Manual such that, upon approval of the
19 qualifications by the Planning Commission, no developer marketing units under the
20 Inclusionary Housing Program shall be able to market BMR units except through a firm
21 meeting all of the minimum qualifications. For purposes of this ordinance, any developer that
22 has not yet submitted a marketing plan to the Mayor's Office of Housing by the date of
23 Planning Commission approval of the qualifications shall be required to comply with this
24 section. The Notice of Special Restrictions or Conditions of Approval shall specify that the
25

1 marketing requirements and procedures contained in the Procedures Manual as amended
2 from time to time, shall apply to the affordable units in the project.

3 (1) **Lottery:** At the initial offering of affordable units in a housing project, the
4 Mayor's Office of Housing must require the use of a public lottery approved by MOH to select
5 purchasers or tenants. The Mayor's Office of Housing shall also hold a general public lottery
6 and maintain and utilize a list generated from this lottery or utilize a list generated from a
7 recent lottery at another similar housing project to fill spaces in units that become available for
8 re-sale or occupancy in any housing project subject to this Ordinance after the initial offering.
9 The list shall be updated from time to time but in no event less than annually to insure that it
10 remains current.

11 (2) **Preferences:** The Mayor's Office of Housing shall create a lottery system that
12 gives preference to people who live or work in San Francisco. MOH shall propose policies and
13 procedures for implementing this preference to the Planning Commission for inclusion in the
14 Procedures Manual. Otherwise, it is the policy of the Board of Supervisors to treat all
15 households equally in allocating affordable units under this Program.

16 (f) Affordable units constructed under Section 315.5 shall not have received
17 development subsidies from any Federal, State or local program established for the purpose
18 of providing affordable housing, and shall not be counted to satisfy any affordable housing
19 requirement for the off-site development.

20 ~~(g) Notwithstanding the provisions of Section 315.5(f) above, a developer may use~~
21 ~~California Debt Limit Allocation Committee (CDLAC) tax exempt bonds to help fund its obligations~~
22 ~~under this ordinance as long as it provides 20 percent of the units as affordable at 50 percent of area~~
23 ~~median income for on-site housing or 25 percent of the units as affordable at 50 percent of area median~~
24 ~~income for off-site housing. Except as provided in this subsection, all units provided under this Section~~
25

Mayor Newsom, Supervisor Chiu

1 ~~must meet all of the requirements of this ordinance and the Procedures Manual for either on- or off-site~~
2 ~~housing.~~

3 SEC. 315.6. - ~~COMPLIANCE THROUGH IN LIEU FEE, ON-SITE ALTERNATIVE~~

4 (a) Number of Units. The number of units constructed off-site shall be as follows:

5 (1)

6 (A) For any housing development of any height that is located in an area with a specific
7 inclusionary housing requirement set forth in Section 315.10 or elsewhere in this Code, the more
8 specific on-site inclusionary housing requirement shall apply; or

9 (B) Buildings 120 feet in height and under or buildings of over 120 feet in height that do not
10 meet the criteria in subsection (C) below: Except as provided in Subsection (C) below, the Planning
11 Department shall require for housing projects covered by Section 315.3(a)(1), as a condition of
12 Planning Department approval of a project's building permit, and by Section 315.3(a)(2), (3) and (4),
13 as a Condition of Approval of a conditional use or planned unit development permit or as a condition
14 of Planning Department approval of a live/work project, that 15 percent of all units constructed on the
15 project site shall be affordable to qualifying households so that a project applicant must construct .15
16 times the total number of units produced in the principal project beginning with the construction of the
17 fifth unit. If the total number of units is not a whole number, the project applicant shall round up to the
18 nearest whole number for any portion of .5 or above.

19 The Planning Department shall provide written notice by mail to the project applicant of the
20 number of affordable units which shall be required within 30 days of approval by the Planning
21 Department or Planning Commission.

22 (C) Buildings of over 120 feet in height. Except as provided in subsection (A) above, the
23 requirements of this Subsection shall apply to any project that is over 120 feet in height and does not
24 require a Zoning Map amendment or Planning Code text amendment related to its project approvals
25 which (i) results in a net increase in the number of permissible residential units, or (ii) results in a

Mayor Newsom, Supervisor Chiu

1 material increase in the net permissible residential square footage as defined in Section 315.3(b)(2) or
2 has not received or will not receive a zoning map amendment or Planning Code text amendment as part
3 of an Area Plan adopted after January 1, 2006 which (i) results in a net increase in the number of
4 permissible residential units, or (ii) results in a material increase in the net permissible residential
5 square footage as defined in Section 315.3(b)(2). The Planning Department shall require for housing
6 projects covered by this Subsection and Section 315.3(a)(1), as a condition of Planning Department
7 approval of a project's building permit, or by this Subsection and by Section 315.3(a)(2), (3) and (4), as
8 a Condition of Approval of a conditional use or planned unit development permit or as a condition of
9 Planning Department approval of a live/work project, that 12 percent of all units constructed on the
10 project site shall be affordable to qualifying households so that a project applicant must construct .12
11 times the total number of units produced in the principal project beginning with the construction of the
12 fifth unit. If the total number of units is not a whole number, the project applicant shall round up to the
13 nearest whole number for any portion of .5 or above. Consistent with the conclusions of the Mayor's
14 Office of Housing study authorized in Section 315.8(e), the Mayor's Office of Housing shall recommend
15 and the Board of Supervisors shall consider whether the requirements of this Subsection for buildings
16 of over 120 feet in height shall continue or expire after approximately five years.

17 The Planning Department shall provide written notice by mail to the project applicant of the
18 number of affordable units which shall be required within 30 days of approval by the Planning
19 Department or Planning Commission. This notice shall also be sent to project applicants who elect to
20 pay an in-lieu fee.

21 (2) If the principal project has resulted in demolition, conversion, or removal of affordable
22 housing units renting or selling to households at income levels and/or for a rental rate or sales price
23 below corresponding income thresholds for units affordable to qualifying households, the Planning
24 Commission shall require that the project applicant replace the number of affordable units removed
25

Mayor Newsom, Supervisor Chiu

1 with units of a comparable number of bedrooms or provide that 15 percent of all units constructed as
2 part of the new project shall be affordable to qualifying households, whichever is greater.

3 (b) **Timing of Construction:** On-site affordable housing required by this Section 315.6 must
4 be constructed, completed, and ready for occupancy no later than the market rate units in the principal
5 project.

6 (c) **Type of Housing:** The type of affordable housing needed in San Francisco is
7 documented in the City's Consolidated Plan and the Residence Element of the General Plan. In
8 general, affordable units constructed under this Section 315.6 shall be comparable in number of
9 bedrooms, exterior appearance and overall quality of construction to market rate units in the principal
10 project. The Notice of Special Restrictions or Conditions of Approval shall include a specific number of
11 units at specified unit sizes for affordable units. The square footage of affordable units and interior
12 features in affordable units do not need to be same as or equivalent to those in market rate units in the
13 principal project, so long as they are of good quality and are consistent with then-current standards for
14 new housing. Where applicable, parking shall be offered to the affordable units subject to the terms and
15 conditions of the Department's policy on unbundled parking for affordable housing units as specified in
16 the Procedures Manual and amended from time to time. On-site affordable units shall be ownership
17 units unless the project applicant meets the eligibility requirement of Section 315.4(j)(1)(B).

18 (d) **Marketing the Units:** The Mayor's Office of Housing shall be responsible for overseeing
19 and monitoring the marketing of affordable units under this Section. In general, the marketing
20 requirements and procedures shall be contained in the Procedures Manual as amended from time to
21 time and shall apply to the affordable units in the project. The Mayor's Office of Housing may develop
22 occupancy standards for units of different bedroom sizes in the Procedures Manual in order to promote
23 an efficient allocation of affordable units. The Mayor's Office of Housing may require in the
24 Procedures Manual that prospective purchasers complete homebuyer education training or fulfill other
25 requirements. The Mayor's Office of Housing shall develop a list of minimum qualifications for

Mayor Newsom, Supervisor Chiu

1 marketing firms that market affordable units under this ordinance, referred to the Procedures Manual
2 as Below Market Rate (BMR units). Within 3 months from the effective date of this legislation
3 (Ordinance No. _____), the Mayor's Office of Housing shall recommend to the Planning
4 Commission that these minimum qualifications be published in the Procedures Manual such that, upon
5 approval of the qualifications by the Planning Commission, no developer marketing units under the
6 Inclusionary Housing Program shall be able to market BMR units except through a firm meeting all of
7 the minimum qualifications. For purposes of Ordinance No. _____, any developer that has not yet
8 submitted a marketing plan to the Mayor's Office of Housing by the date of Planning Commission
9 approval of the qualifications shall be required to comply with this section. The Notice of Special
10 Restrictions or Conditions of Approval shall specify that the marketing requirements and procedures
11 contained in the Procedures Manual as amended from time to time, shall apply to the affordable units
12 in the project.

13 (1) Lottery: At the initial offering of affordable units in a housing project, the Mayor's
14 Office of Housing must require the use of a public lottery approved by the Mayor's Office of Housing to
15 select purchasers or tenants. The Mayor's Office of Housing shall also hold a general public lottery
16 and maintain and utilize a list generated from this lottery or utilize a list generated from a recent
17 lottery at another similar housing project to fill spaces in units that become available for re-sale or
18 occupancy in any housing project subject to this ordinance after the initial offering. The list shall be
19 updated from time to time but in no event less than annually to ensure that it remains current.

20 (2) Preferences: The Mayor's Office of Housing shall create a lottery system that gives
21 preference to people who live or work in San Francisco. MOH shall propose policies and procedures
22 for implementing this preference to the Planning Commission for inclusion in the Procedures Manual.
23 Otherwise, it is the policy of the Board of Supervisors to treat all households equally in allocating
24 affordable units under this Program.

25
Mayor Newsom, Supervisor Chiu

1 ~~If the project applicant elects, pursuant to Section 315.4(e)(2) that the project applicant will pay~~
2 ~~an in lieu fee to satisfy the requirements of this Program, the project applicant shall meet the following~~
3 ~~requirements:~~

4 ~~(a) — By paying an in lieu fee to the Treasurer for use by the Mayor's Office of Housing for~~
5 ~~the purpose of constructing at an alternate site the type of housing required by Section 315.5 within the~~
6 ~~City and County of San Francisco.~~

7 ~~(b) — The amount of the fee which may be paid by the project applicant subject to this~~
8 ~~Ordinance in lieu of developing and providing housing required by Section 315.4 shall be determined~~
9 ~~by Mayor's Office of Housing ("MOH") utilizing the following factors:~~

10 ~~(1) — The number of units required by Section 315.5 if the project applicant were to elect to~~
11 ~~meet the requirements of this section by off site housing development. For the purposes of this section,~~
12 ~~the City shall calculate the fee using the direct fractional result of the total number of units multiplied~~
13 ~~by the percentage of off site housing required, rather than rounding up the resulting figure as required~~
14 ~~by Section 315.5(a).~~

15 ~~(2) — The affordability gap using data on the cost of construction of residential housing from~~
16 ~~the "San Francisco Sensitivity Analysis Summary Report: Inclusionary Housing Program" prepared by~~
17 ~~Keyser Marston Associates, Inc. in August 2006 for the Maximum Annual Rent or Maximum Purchase~~
18 ~~Price for the equivalent unit sizes. The Planning Department and MOH shall update the technical~~
19 ~~report from time to time as they deem appropriate in order to ensure that the affordability gap remains~~
20 ~~current.~~

21 ~~(3) — No later than July 1 of each year, the Mayor's Office of Housing shall adjust the in lieu~~
22 ~~fee payment option and provide a report on its adjustment to the Board of Supervisors. MOH shall~~
23 ~~provide notice of any fee adjustment on its website at least 30 days prior to the adjustment taking effect.~~
24 ~~The Mayor's Office of Housing is authorized to develop an appropriate methodology for indexing the~~
25

Mayor Newsom, Supervisor Chiu

1 ~~fee, based on adjustments in the costs of constructing housing and in the price of housing in San~~
2 ~~Francisco. The method of indexing shall be published in the Procedures Manual.~~

3 ~~(c) Within 30 days of determining the amount of the fee to be paid by the applicant, MOH~~
4 ~~shall transmit the amount of the fee to the Treasurer. Prior to the issuance by DBI of the first site or~~
5 ~~building permit for the project applicant, the project applicant must notify the Planning Department~~
6 ~~and MOH in writing that it has paid in full the sum required to the Treasurer. If the project applicant~~
7 ~~fails by the applicable date to demonstrate to the Planning Department that the project applicant has~~
8 ~~paid the applicable sum in full to the Treasurer, DBI shall deny any and all site or building permits or~~
9 ~~certificates of occupancy for the development project until the Planning Department notifies DBI and~~
10 ~~MOH that such payment has been made.~~

11 ~~(d) Upon payment of the fee in full to the Treasurer and upon request of the project~~
12 ~~applicant, the Treasurer shall issue a certification that the fee has been paid. The project applicant~~
13 ~~shall present such certification to the Planning Department, DBI and MOH prior to the issuance by~~
14 ~~DBI of the first site or building permit or certificate of occupancy for any development subject to this~~
15 ~~Section. Any failure of the Treasurer, DBI, or Planning Department to give any notice under this~~
16 ~~Section shall not relieve a project applicant from compliance with this Section. Where DBI~~
17 ~~inadvertently issues a site or building permit without payment of the fee, DBI shall not issue any~~
18 ~~certificate of occupancy for the project without notification from the Treasurer that the fee required by~~
19 ~~this Section has been paid. The procedure set forth in this subsection is not intended to preclude~~
20 ~~enforcement of the provisions of this section pursuant to any other section of this Code, or other~~
21 ~~authority under the laws of the State of California.~~

22 ~~(e) All monies contributed pursuant to this section shall be deposited in the special fund~~
23 ~~maintained by the Controller called the Citywide Affordable Housing Fund.~~

24 ~~(1) Except as provided in subsection (2) below, the receipts in the Fund are hereby~~
25 ~~appropriated in accordance with law to be used to (1) increase the supply of housing affordable to~~

Mayor Newsom, Supervisor Chiu

1 ~~qualifying households subject to the conditions of this Section, and (2) pay the expenses of MOH in~~
2 ~~connection with monitoring and administering compliance with the requirements of the Program. MOH~~
3 ~~is authorized to use funds in an amount not to exceed \$200,000 every 5 years to conduct follow-up~~
4 ~~studies under Section 315.8(e) and to update the in-lieu fee amounts as described above in Section~~
5 ~~315.6(b). All other monitoring and administrative expenses shall be appropriated through the annual~~
6 ~~budget process or supplemental appropriation for MOH. The fund shall be administered and expended~~
7 ~~by MOH, which shall have the authority to prescribe rules and regulations governing the Fund which~~
8 ~~are consistent with this Section.~~

9 ~~(2) "Small Sites Funds":~~

10 ~~(A) Designation of funds: MOH shall designate and separately account for 10% of all in~~
11 ~~lieu fees that it receives under Section 315 et seq., excluding in lieu fees that are geographically~~
12 ~~targeted such as those in Sections 315.4(a)(1) and 827(b)(5)(C), to support acquisition and~~
13 ~~rehabilitation of Small Sites ("Small Sites Funds"). MOH shall continue to divert 10% of all in lieu fees~~
14 ~~for this purpose until the Small Sites Funds reach a total of \$15 million at which point, MOH will stop~~
15 ~~designating funds for this purpose. At such time as designated Small Sites Funds are expended and dip~~
16 ~~below \$15 million, MOH shall start designating funds again for this purpose, such that at no time the~~
17 ~~Small Sites Funds shall exceed \$15 million. When the total amount of in lieu fees paid to the City under~~
18 ~~Section 315 et seq. totals less than \$10 million over the preceding 12-month period, the Mayor's Office~~
19 ~~of Housing is authorized to temporarily divert funds from the Small Sites Fund for other purposes. The~~
20 ~~Mayor's Office of Housing must keep track of the diverted funds, however, such that when the amount~~
21 ~~of in lieu fees paid to the City under Section 315 et seq. meets or exceeds \$10 million over the~~
22 ~~preceding 12-month period, the Mayor's Office of Housing shall commit all of the previously diverted~~
23 ~~funds and 10% any new funds, subject to the cap above, to the Small Sites Fund.~~

24 ~~(B) Use of Small Sites Funds. The funds shall be used exclusively to acquire or rehabilitate~~
25 ~~"Small Sites" defined as properties consisting of less than 25 units. Units supported by monies from the~~

Mayor Newsom, Supervisor Chiu

1 ~~fund shall be designated as housing affordable to qualifying households as defined in Section 315.1 for~~
2 ~~no less than 55 years. Properties supported by the Small Sites Funds must be either (i) rental properties~~
3 ~~that will be maintained as rental properties; (ii) vacant properties that were formerly rental properties~~
4 ~~as long as those properties have been vacant for a minimum of two years prior to the effective date of~~
5 ~~this legislation, (iii) properties that have been the subject of foreclosure or (iv) a Limited Equity~~
6 ~~Housing Cooperative as defined in Subdivision Code Sections 1399.1 et seq. or a property owned or~~
7 ~~leased by a non-profit entity modeled as a Community Land Trust.~~

8 ~~(C) — Initial Funds: If, within 18 months from the date of adoption of this ordinance, the~~
9 ~~Mayor's Office of Housing dedicates an initial one-time contribution of other eligible funds to be used~~
10 ~~initially as Small Sites Funds, the Mayor's Office of Housing may use the equivalent amount of Small~~
11 ~~Sites Funds received from in-lieu fees for other purposes permitted by the Citywide Affordable Housing~~
12 ~~Fund until the amount of the initial one-time contribution is reached.~~

13 ~~(D) — Annual Report: At the end of each fiscal year, the Mayor's Office of Housing shall issue~~
14 ~~a report to the Board of Supervisors regarding the amount of Small Sites Funds received from in-lieu~~
15 ~~fees under this legislation, and a report of how those funds were used.~~

16 ~~(E) — Intent: In adopting this ordinance regarding Small Sites Funds, the Board of~~
17 ~~Supervisors does not intend to preclude the Mayor's Office of Housing from expending other eligible~~
18 ~~sources of funding on Small Sites as described in this Section, or from allocating or expending more~~
19 ~~than \$15 million of other eligible funds on Small Sites.~~

20 ~~(f) — Lien Proceedings:~~

21 ~~(1) — A project applicant's failure to comply with the requirements of this Section shall~~
22 ~~constitute cause for the City to record a lien against the development project in the sum of the in-lieu~~
23 ~~fee required under this Ordinance, as adjusted under this Section.~~

24 ~~(2) — If, for any reason, the fee imposed pursuant to this Ordinance remains unpaid following~~
25 ~~issuance of the permit, the Treasurer shall initiate proceedings to impose the lien in accordance with~~

Mayor Newsom, Supervisor Chiu

1 ~~the procedures set forth in Chapter 10, Article XX of the San Francisco Administrative Code to make~~
2 ~~the entire unpaid balance of the fee, including interest, a lien against all parcels used for the~~
3 ~~development project. The Treasurer shall send all notices required by that Article to the owner of the~~
4 ~~property as well as the sponsor. The Treasurer shall also prepare a preliminary report notifying the~~
5 ~~sponsor of a hearing to confirm such report by the Board of Supervisors at least 10 days before the~~
6 ~~date of the hearing. The report to the sponsor shall contain the sponsor's name, a description of the~~
7 ~~sponsor's development project, a description of the parcels of real property to be encumbered as set~~
8 ~~forth in the Assessor's Map Books for the current year, a description of the alleged violation of this~~
9 ~~Ordinance, and shall fix a time date and place for hearing. The Treasurer shall cause this report to be~~
10 ~~mailed to the sponsor and each owner of record of the parcels of real property subject to lien. Except~~
11 ~~for the release of lien recording fee authorized by Administrative Code Section 10.237, all sums~~
12 ~~collected by the Tax Collector pursuant to this Ordinance shall be held in trust by the Treasurer and~~
13 ~~deposited in the Citywide Affordable Housing Fund established in Section 313.12.~~

14 (3) ~~Any notice required to be given to a sponsor or owner shall be sufficiently given or~~
15 ~~served upon the sponsor or owner or all purposes hereunder if personally served upon the sponsor or~~
16 ~~owner or if deposited, postage prepaid, in a post office letterbox addressed in the name of the sponsor~~
17 ~~or owner at the official address of the sponsor or owner maintained by the Tax Collector for the~~
18 ~~mailing of tax bills or, if no such address is available, to the sponsor at the address of the development~~
19 ~~project, and to the applicant for the site or building permit at the address on the permit application.~~

20 (g) ~~In the event a building permit expires prior to completion of the work on and~~
21 ~~commencement of occupancy of a housing project so that it will be necessary to obtain a new permit to~~
22 ~~carry out any development, the obligation to comply with this Program shall be cancelled, and any in-~~
23 ~~lieu fee previously paid to the Treasurer shall be refunded. If and when the sponsor applies for a new~~
24 ~~permit, the procedures set forth in this Ordinance regarding construction of housing or payment of the~~
25 ~~in lieu fee shall be followed.~~

Mayor Newsom, Supervisor Chiu

1 ~~(h) In the event that a development project for which an in lieu fee imposed under this~~
2 ~~Section has been fully paid is demolished or converted to a use or uses not subject to this ordinance~~
3 ~~prior to the expiration of its estimated useful life, the City shall refund to the sponsor a portion of the~~
4 ~~amount of an in lieu fee paid. The portion of the fee refunded shall be determined on a pro-rata basis~~
5 ~~according to the ratio of the remaining useful life of the project at the time of demolition or conversion~~
6 ~~in relation to its total useful life. For purposes of this Ordinance, the useful life of a development~~
7 ~~project shall be 50 years.~~

8 SEC 315.10: AFFORDABLE HOUSING REQUIREMENTS SPECIFIC TO AREA PLANS

9 This Section applies specific housing requirements to certain Area Plans. For any housing
10 development of any height that is located in an area with a specific affordable housing requirement, the
11 more specific affordable housing requirement shall apply. The following provisions shall apply only to
12 the following Area Plans as provided below:

13 (a) Market and Octavia Area Plan: The requirements of Sections 315 through 315.9 shall
14 apply in the Plan Area subject to the following except that an additional affordable housing
15 requirement shall apply in the Market and Octavia Plan Area as follows:

16 (1) Definitions. The definitions in Section 326.2 and 318.2 shall apply.

17 (2) Amount of fee: All projects that have not received Planning Department or Commission
18 approval as of the effective date of this legislation and that are subject to the Affordable Housing
19 Program shall pay an additional affordable housing fee per square foot of Residential Space Subject to
20 the Community Improvements Impact Fee as follows; \$8.00 in the Van Ness Market Special Use
21 District; \$4.00 in the NCT District; and \$0.00 in the RTO District. A project applicant shall not pay a
22 fee for any square foot of space designated as a below market rate unit under this affordable housing
23 program or any other unit that is designated as an affordable housing unit under a Federal, State, or
24 local restriction in a manner that maintains affordability for a term no less than 50 years.

1 (3) Timing of payment: The fee shall be paid before the City issues a first certificate of
2 occupancy for the project.

3 (4) Use of Fee: The additional affordable housing requirement specified in this Section for
4 the Market and Octavia Plan Area shall be paid into the Citywide Affordable Housing Fund, but the
5 funds shall be separately accounted for. MOH shall expend the funds according to the following
6 priorities: First, to increase the supply of housing affordable to qualifying households in the Market
7 and Octavia Plan Area; second, to increase the supply of housing affordable to qualifying households
8 within 1 mile of the boundaries of the Plan Area; third, to increase the supply of housing affordable to
9 qualifying households in the City and County of San Francisco. The funds may also be used for
10 monitoring and administrative expenses subject to the process described in Section 315.6(e).

11 (5) Other fee provisions: This additional affordable housing fee shall be subject to the
12 following provisions of Sections 326 et seq.; the inflation adjustment provisions of Section 326.3(d); the
13 waiver and reduction provisions of Section 326.3(h); the lien proceedings in Section 326.4; and the
14 refund provisions of Section 326.5. This additional affordable housing fee may not be met through the
15 in-kind provision of community improvements or Community Facilities (Mello Roos) financing options
16 of Sections 326.3(e) and (f).

17 (6) Findings: The Board of Supervisors hereby finds that the additional affordable housing
18 requirements of this Section are supported by the Nexus Study performed by Keyser Marston and
19 Associates referenced in Section 315.2(12) and found in Board File No. 081152. The Board of
20 Supervisors has reviewed the study and staff analysis and report of the study and, on that basis finds
21 that the study supports the current inclusionary housing requirements combined with the additional
22 affordable housing fee. Specifically, the Board finds that the study: identifies the purpose of the
23 additional fee to mitigate impacts on the demand for affordable housing in the City; identifies the use to
24 which the additional fee is to be put as being to increase the City's affordable housing supply; and
25 establishes a reasonable relationship between the use of the additional fee for affordable housing and

Mayor Newsom, Supervisor Chiu

1 the need for affordable housing and the construction of new market rate housing. Moreover, the Board
2 finds that the current inclusionary requirements combined with the additional fee are less than the cost
3 of mitigation and do not include the costs of remedying any existing deficiencies. The Board also finds
4 that the study establishes that the current inclusionary requirements and additional fee do not duplicate
5 other City requirements or fees.

6 Furthermore, the Board finds that generally an account has been established, funds
7 appropriated, and a construction schedule adopted for affordable housing projects funded through the
8 Inclusionary Housing program and the additional fee or that the in lieu fees and the additional fee will
9 reimburse the City for expenditures on affordable housing that have already been made.

10 Furthermore, the Board finds that a major Market and Octavia Area Plan objective is to direct
11 new market rate housing development to the area. That new market rate development will greatly out
12 number both the number of units and potential new sites within the plan area for permanently
13 affordable housing opportunities. The City and County of San Francisco has adopted a policy in its
14 General Plan to meet the affordable housing needs of its general population and to require new
15 housing development to produce sufficient affordable housing opportunities for all income groups, both
16 of which will not be met by the projected housing development in the plan area. In addition, the "Draft
17 Residential Nexus Analysis City and County of San Francisco" of December 2006 indicates that market
18 rate housing itself generates additional lower income affordable housing needs for the workforce
19 needed to serve the residents of the new market rate housing proposed for the plan area. In order to
20 meet the demand created for affordable housing by the specific policies of the Plan and to be consistent
21 with the policy of the City and County of San Francisco it is found that an additional affordable
22 housing fee need be included on all market rate housing development in the Plan Area with priority for
23 its use being given to the Plan area.

24
25
Mayor Newsom, Supervisor Chiu

1 (b) Eastern Neighborhoods Project Area: The requirements of Sections 315 through 315.9
2 and 319 shall apply in the Eastern Neighborhoods Plan Area subject to the following and subject to
3 any stated exceptions elsewhere in this Code, including the specific provisions in Section 319:

4 (1) Definitions:

5 "Gross square footage" shall have the meaning set forth in Section 102.9.

6 "Development Application" shall have the meaning set forth in Section 175.6.

7 "Eastern Neighborhood Controls" shall have the meaning set forth in Section 175.6.

8 Application. The option described in this subsection (ii) shall only be provided to development projects
9 that are subject to the Eastern Neighborhood Controls as defined in Section 175.6 (e), and consist of 20
10 units or less or less than 25,000 gross square feet. Amount of Fee. All projects subject to this subsection
11 may choose to pay a square foot in lieu fee instead of the in lieu fee provided for in Section 315.6 as
12 follows. If this option is selected, the project applicant shall pay \$40.00 per gross square foot of net
13 new residential development. The calculation of gross square feet shall not include nonresidential uses,
14 including any retail, commercial, or PDR uses, and all other space used only for storage and services
15 necessary to the operation or maintenance of the building itself.

16 (2) Timing of Payment. The project applicant shall pay the fee prior to issuance by DBI of
17 the first site or building permit for the project. At the project applicant's option, it may choose to pay
18 only 50% of the fee prior to issuance by DBI of the first site or building permit and, prior to issuance of
19 the first site or building permit, the City shall impose a lien on the property for the remaining 50% of
20 the fee through the procedures set forth in Section 315.6(f) except that no interest will accrue for the
21 first twelve months from the issuance of the first site or building permit for the project. The project
22 applicant shall pay the remaining 50% of the fee prior to issuance by DBI of a first certificate of
23 occupancy. When 100% of the fee is paid, including interest if applicable, the City shall remove the
24 lien.

1 (3) Use of Fee. The fee shall be paid into the Citywide Affordable Housing Fund, but the
2 funds shall be separately accounted for. MOH shall expend the funds according to the following
3 priorities: First, to increase the supply of housing affordable to qualifying households in the Eastern
4 Neighborhoods Project Areas; second, to increase the supply of housing affordable to qualifying
5 households within 1 mile of the boundaries of the Eastern Neighborhoods Project Areas; third, to
6 increase the supply of housing affordable to qualifying households in the City and County of San
7 Francisco. The funds may also be used for monitoring and administrative expenses subject to the
8 process described in Section 315.6(e).

9 (4) Findings. The Board of Supervisors hereby finds that the fee provisions of this Section
10 are equivalent to or less than the fees for developments of over 20 units previously adopted by the
11 Board in Ordinance No. 051685 and 060529 and are also supported by the Nexus Study performed by
12 Keyser Marston and Associates referenced in Section 315.2(12) and found in Board File No. 081152.
13 The Board of Supervisors has reviewed the study and staff analysis prepared by the Mayor's Office of
14 Housing dated July 24, 2008 in Board File No. 081152 and on that basis finds that the study supports
15 the current proposed changes to the inclusionary housing requirements for projects of 20 units or less
16 in the Eastern Neighborhood Area Plan. Specifically, the Board finds that the study and staff memo:
17 identifies the purpose of the additional fee to mitigate impacts on the demand for affordable housing in
18 the City; identifies the use to which the additional fee is to be put as being to increase the City's
19 affordable housing supply; and establishes a reasonable relationship between the use of the additional
20 fee for affordable housing and the need for affordable housing and the construction of new market rate
21 housing. Moreover, the Board finds that the new inclusionary requirements are less than the cost of
22 mitigation and do not include the costs of remedying any existing deficiencies. The Board also finds
23 that the study establishes that the inclusionary requirements do not duplicate other City requirements
24 or fees.

25
Mayor Newsom, Supervisor Chiu

1 Furthermore, the Board finds that generally an account has been established, funds
2 appropriated, and a construction schedule adopted for affordable housing projects funded through the
3 Inclusionary Housing program and the in lieu fees will reimburse the City for expenditures on
4 affordable housing that have already been made.

5 Furthermore, the Board finds that small scale development faces a number of challenges in the
6 current development climate, including limited access to credit and often, a higher land cost per unit
7 for the small sites on which they develop. Because of these and other variations from larger-scale
8 development, they operate under a somewhat unique development model which cannot be fully
9 encapsulated within the constraints of the Eastern Neighborhoods Financial Analysis, prepared to
10 assess the financial feasibility of increasing housing requirements and impact fees in the Plan Areas.
11 To address these challenges, the Board finds that a number of slight modifications to the affordable
12 housing requirements of the Eastern Neighborhoods, to apply to small projects (defined as 20 units or
13 fewer, or less than 25,000 gross square feet) are appropriate.

14 Section 2. The San Francisco Planning Code is hereby amended by amending Section
15 827, to read as follows:

16 **SEC. 827. - RINCON HILL DOWNTOWN RESIDENTIAL MIXED USE DISTRICT (RH-**
17 **DTR).**

18 The Rincon Hill Downtown Residential Mixed Use District (RH-DTR), the boundaries of
19 which are shown in Section Map No. 1 of the Zoning Map, is established for the purposes set
20 forth below.

21 The RH-DTR District is adjacent to the southern edge of the downtown, generally
22 bounded by Folsom Street, the Bay Bridge, the Embarcadero, and Essex Street. High-density
23 residential uses and supporting commercial and institutional uses are allowed and
24 encouraged within the limits set by height, bulk, and tower spacing controls. Folsom Street is
25 intended to develop as the neighborhood commercial heart of the Rincon Hill and Transbay

Mayor Newsom, Supervisor Chiu

1 neighborhoods, and pedestrian-oriented uses are required on the ground floor. Individual
2 townhouse dwelling units with ground floor entries directly to the street are required on streets
3 that will become primarily residential, including First, Fremont, Beale, Main, and Spear
4 Streets.

5 While lot coverage is limited for all levels with residential uses that do not face onto
6 streets or alleys, traditional rear yard open spaces are not required except in the limited
7 instances where there is an existing pattern of them, such as smaller lots on the Guy Place
8 block. Specific height, bulk, and setback controls establish appropriate heights for both towers
9 and mid-rise podium development and ensure adequate spacing between towers in order to
10 establish a neighborhood scale and ensure light and air to streets and open spaces. Setbacks
11 are required where necessary to provide transition space for ground floor residential uses and
12 to ensure sunlight access to streets and open spaces. Off-street parking must be located
13 below grade.

14 Given the need for services and open space resulting from new development, projects
15 will provide or contribute funding for the creation of public open space and community facilities
16 as described in the Rincon Hill Area Plan of the General Plan. The Rincon Hill Streetscape
17 Plan, part of the Area Plan, proposes to enhance and redesign most streets in the district to
18 create substantial new open space amenities, improve pedestrian conditions, and improve the
19 flow of local traffic and transit. Detailed standards for the provision of open spaces, mid-block
20 pathways, and residential entries are provided to ensure that new buildings contribute to
21 creating a public realm of the highest quality in Rincon Hill.

22 **Table 827**

23 RINCON HILL DOWNTOWN RESIDENTIAL MIXED USE
24 DISTRICT ZONING CONTROL TABLE

	Rincon Hill Downtown Residential
--	---

			Mixed Use District Zoning
	Zoning	§	Controls
o.	Category	References	
	;vk;Building and Siting Standards		
10	Height and Bulk	§§ 102.12, 105, 106, 250—252, 260, 270	Varies 45—550 feet. For height limits, see Zoning Map 1H and § 263.19; for bulk controls, see § 270(e).;vk;
11	Lot Size <i>[Per Development]</i>	§§ 890.56, 121	No limit
12	Rear Yard/Site Coverage	§ 136	100 percent lot coverage permitted; up to 80 percent for parcels that front the north side of Guy Place and for all parcels at residential levels where not all units face onto streets or alleys. § 825(b)(1) and 827(a)(4).
13	Setbacks	Ground Floor Residential Design Guidelines	Building setback of 3 to 10 ft. for all buildings except towers on Spear, Main, Beale, Fremont, and First Streets. § 827(a)(2) and (6). Upper-story setback of 10 ft. required above a height of 65 feet on both sides of Spear, Main, Beale, Fremont, and First Streets. § 827(a)(5).

1
2
3
4
5
6
7
8
9
10
11
12
13
14
15
16
17
18
19
20
21
22
23
24
25

			Sun access plane setback of 50 degrees for all buildings 85' and lower on the south side of east-west mid-block pathways. § 827(a)(5).
14	Street-Facing Uses	§§ 145.1, 145.4, Ground Floor Residential Design Guidelines	Active uses required on all street frontages. See §§ 145.1, 825(b). Ground-level residential or commercial requirements based on location. See §§ 145.4 and 827(a)(2).
15	Parking and Loading Access: Prohibition	§ 155(r)	Prohibited on Folsom Street from Essex Street to The Embarcadero. § 827(a)(8) and 155(r)
16	Parking and Loading Access: Siting and Dimensions	§§ 145.14, 151.1, 155(r)	No parking permitted aboveground, except on sloping sites. Parking access limited to two openings, max. 11' wide each, loading access limited to one 15' opening. § 825(b)(7) and 827(a)(8).
17	Awning	§ 890.21	P, § 136.2(a)
18	Canopy	§ 890.24	P, § 136.2(b)
	Marquee	§ 890.58	P, § 136.2(c)

1	19			
2	Non-Residential Standards and Uses			
3	20	Required Residential to Non-Residential Use Ratio	§ 102.10	Non-residential uses limited to occupiable sf per 6 occupiable sf devoted to residential uses. § 825(c)(2).
4				
5				
6				
7				
8	21	Use Size [Non-Residential]	§§ 890.130, 145.14	P for non-residential uses up to 25,000 sq. ft., C above. No individual ground floor tenant may occupy more than 75' of frontage for a depth of 25' from Folsom Street. §§ 145.14.
9				
10				
11				
12				
13	22	Open Space	§§ 135, 135.3	1 sq. ft. of publicly-accessible open space for every 50 sq. ft. of non-residential use over 10,000 sq. ft. § 135.3
14				
15				
16				
17	23	Off-Street Parking [Office uses]	§§ 150, 151, 151.1, 153—157, 204.5	None Required. Parking that is accessory to office space limited to 7% of GFA.
18				
19				
20	24	Off-Street Parking [Non-Residential, other than office uses]	§§ 150, 151, 151.1, 153—157, 204.5	None Required. Parking limited as described in Section 151.1.
21				
22				
23				
24	25	Off-Street Freight Loading	§§ 150, 152.2, 153—155,	None Required. Loading maximums described in Section 152.2.
25				

1
2
3
4
5
6
7
8
9
10
11
12
13
14
15
16
17
18
19
20
21
22
23
24
25

		204.5	
	All Non-Residential Uses Permitted, except as described below.		
26	§825(c)(1)(A)		
27	Drive-Up Facility	§ 890.30	NP
28	Walk-Up Facility	§ 890.140	P if recessed 3 ft. C otherwise.
29	Hospital or Medical Center	§ 124.1, 890.44	C
30	Other Institutions	§ 890.50	C
31	Public Use	§ 890.80	C
32	Movie Theater	§ 890.64	C
33	Nighttime Entertainment	§§ 102.17, 803.5(g)	C
34	Adult Entertainment	§ 890.36	NP
35	Massage Establishment	§ 890.60 Article 29 Health Code	C

1
2
3
4
5
6
7
8
9
10
11
12
13
14
15
16
17
18
19
20
21
22
23
24
25

36	Automobile Parking Lot, Community Commercial	§§ 890.9, 156, 160	NP
37	Automobile Parking Garage, Community Commercial	§ 890.10, 160	C, per the criteria of Section 157.1
38	Automotive Gas Station	§ 890.14	NP
39	Automotive Service Station	§ 890.18, 890.19	NP
40	Automotive Repair	§ 890.15	NP
41	Automotive Wash	§ 890.20	NP
42	Automotive Sale or Rental	§ 890.13	C
43	Mortuary	§ 890.62	C
44	Hours of Operation	§ 890.48	C. 2 a.m.—6 a.m.

1		Business Sign	§§ 602—	P. § 607.2(f)
2	45		604, 608.1, 608.2	
3		Tobacco	§ 890.123	C
4	45a	Paraphernalia		
5		Establishments		
6	;vk;Residential Standards and Uses			
7		Residential	§ 890.88	P;vk;
8	46	Use		
9		Residential	§ 890.88(a)	No Limit. § 207.5(d)
10	47	Density,		Unit Mix Required § 207.6
11		Dwelling Units		
12		Residential	§ 890.88(b)	No Limit. §§ 207.5 (d)
13	48	Density,		
14		Group Housing		
15		Usable Open	§ 135, 136	75 sq. ft. per unit; up to 50% may
16	49	Space [Per		be provided off-site if publicly
17		Residential Unit]		accessible. § 135 and 827(a)(9).
18		Accessory Off-	§§ 151.1,	None Required. Up to one car per
19	50	Street	153—157, 159—	2 dwelling units permitted; up to one car
20		Parking, Residential	160, 204.5	per dwelling unit per procedures and
21				criteria of Sections 151.1 825(b)(7) and
22				827 (a)(8).
23		Residential	§ 790.84,	C
24				
25				

1	51	Conversions	Ch. 41	
2			Admin. Code	
3		Residential		C
4	52	Demolition		
5		Fringe	§§ 249.35,	P subject to the restrictions set
6	53	Financial Service	890.113	forth in Section 249.35, including, but
7				not limited to, the proximity restrictions
8				set forth in Subsection 249.35(c)(3).
9				

10

11 (a) **Building Standards.**

12 (1) **Development Concept.** The development concept is for podium development
 13 up to 85 feet in height, with slender residential towers spaced to provide ample light and air to
 14 the district. New development will contribute to the creation of a substantial amount of public
 15 open space, as well as provide private common areas, courtyards, and balconies. Streets will
 16 be improved to provide widened sidewalks with substantial public open space. Ground floor
 17 uses will be pedestrian-oriented in character, consisting primarily of retail on Folsom Street,
 18 and individual townhouse-style residential units on First, Fremont, Beale, Main, and Spear
 19 Streets, as well as on alleys and mid-block pathways. Parking will be located below grade,
 20 and building utilities (loading bays, service doors, garage doors) will be located in sidewalk
 21 vaults or on secondary frontages.

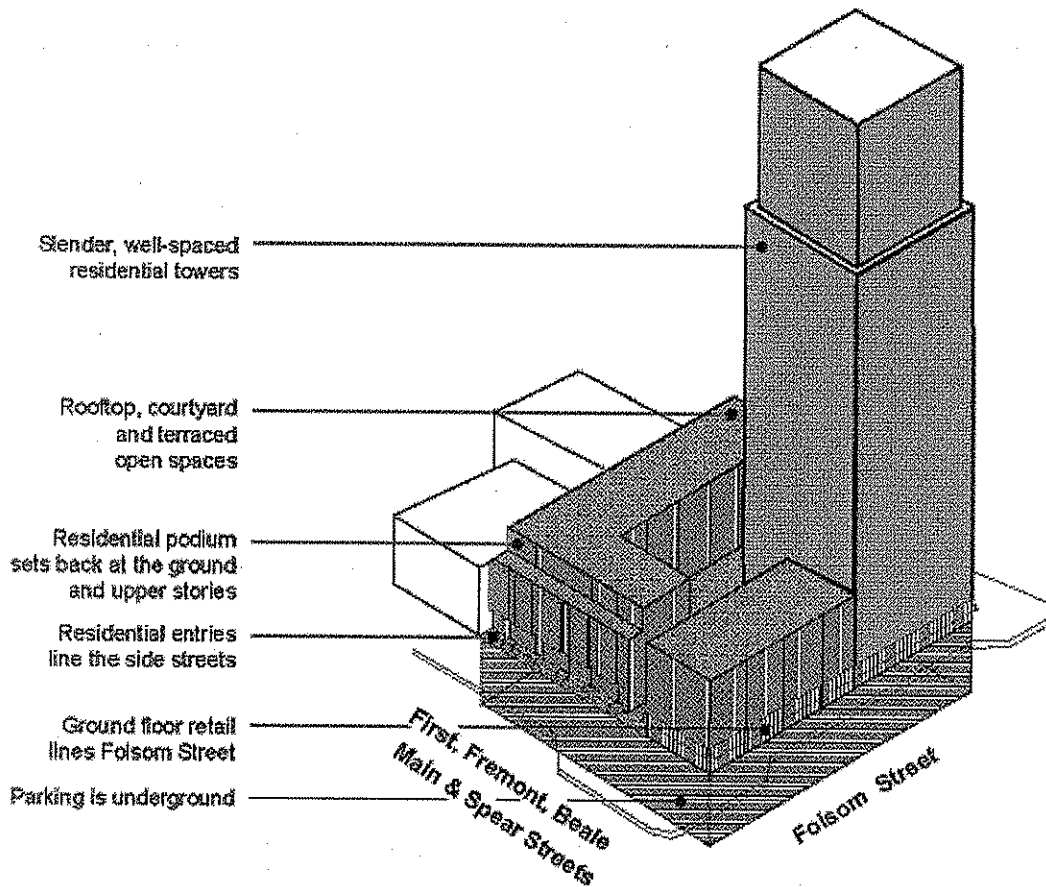

(2) **Street-Facing Use Requirements.** Pedestrian-oriented retail, residential, institutional uses, and community services are required ground floor uses on all street facing frontages, except for the minimum frontage required for fire doors, parking and loading access, and other utilities.

(A) **Required Ground Floor Retail Spaces.** For frontages facing Folsom Street, ground floor space suitable for retail use is required for no less than 75 percent of all frontages, as specified in Section 145.4.

(B) **Required Individual Ground Floor Residential Units.** For building frontages facing Fremont, First, Main, Beale and Spear Streets more than 60 feet from an intersection with Folsom, Harrison, or Bryant Streets, and for building frontages facing Guy Place and

1 Lansing Street, individual ground floor residential units with direct pedestrian access to the
2 sidewalk are required at intervals of no greater than 25 feet, except where residential lobbies,
3 parking and loading access, utilities, and open space are necessary and provided pursuant to
4 the allowances of Section 827 and other sections of this Code. Individual ground floor
5 residential units are also encouraged along Harrison Street, Bryant Street, and alleys and
6 mid-block pedestrian paths where appropriate.

7 Figure 827(B): Frontages Where Ground Floor Retail Uses Are Required.

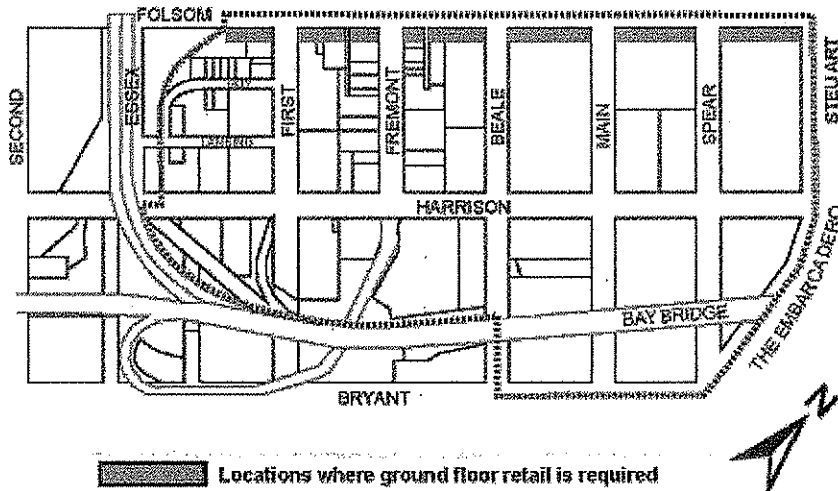
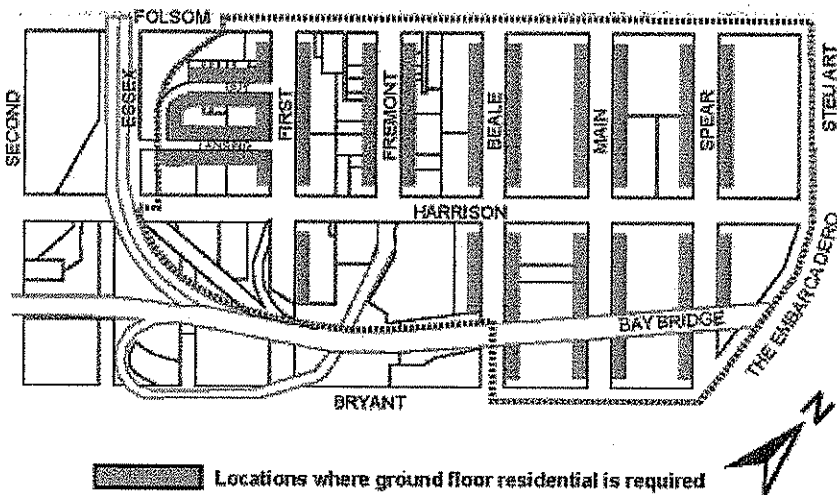

Figure 827: Frontages Where Ground Floor Residential Users/Entries Are Required.



(3) **Required Streetwall.** Building area below 85 feet in height is required to be built to 100 percent of all property lines facing public rights-of-way, except where setbacks are required by this Section and except where publicly accessible open space is provided according to the provisions of this Section. Recesses, insets and breaks between buildings are permitted to provide vertical articulation to the facade, provided the overall integrity of the streetwall is maintained.

(4) **Lot Coverage.** Lots fronting only on the north side of Guy Place are permitted up to 80 percent lot coverage.

(5) **Upper Story Setback.** To ensure adequate sunlight to streets, alleys, and pedestrian pathways, upper story setbacks are required as follows:

(A) All buildings are required to set back at least 10 feet above a height of 65 feet along Spear, Main, Beale, Fremont and First Streets. This requirement shall not apply to street frontage occupied by a building taller than 85 feet. This upper story setback requirement shall also not apply to the first 60 linear feet of frontage from corners at Folsom, Harrison, and Bryant Streets.

1 (B) Buildings greater than 60 linear feet from a major street along Guy Place,
2 Lansing Street, and any proposed or existing private or public mid-block pedestrian pathways,
3 are required to be set back at least 10 feet above 45 feet in height from said right-of-way.

4 (C) In order to increase sun access to mid-block pathways and uses along such
5 pathways, all building frontage on the southeast side of mid-block pathways not occupied by a
6 building taller than 85 feet must set back upper stories by 10 feet above a building height of
7 45 feet. For projects on the south side of a mid-block pedestrian pathway taller than 65 feet,
8 an additional upper story setback of 10 feet is required above a building height of 65 feet.

9 (i) **Modifications.** For any lot on the north side of a required mid-block pedestrian
10 pathway, a modification from the required upper story setback of 10 feet above a height of 45
11 feet may be granted according to the provisions of Section 309.1, provided that, in total, the
12 building is set back by a volume equal to what would be required by meeting the standard in
13 (C) above, and the modification would substantially improve the accessibility, design and
14 character of the mid-block pedestrian pathway.

15 **Figure 827(D): Required Upper Story Stepbacks**

16
17
18
19
20
21
22
23
24
25

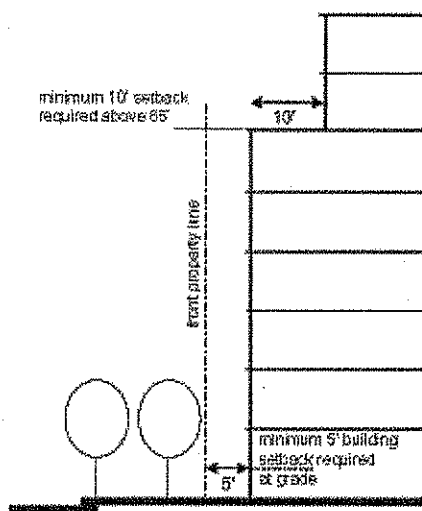

First, Fremont, Main, Beale, and Spear Streets

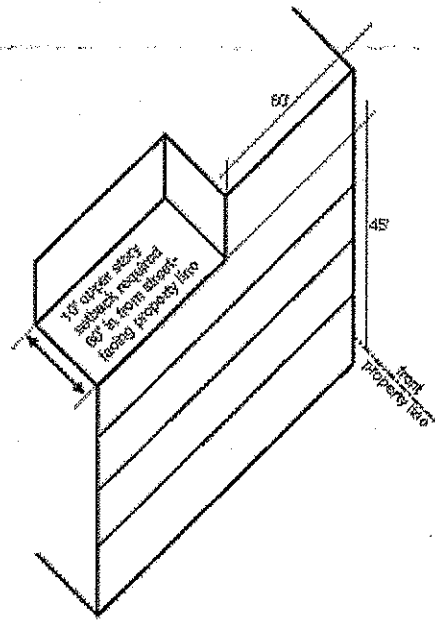

Guy Place, Lansing Street, or mid-block pedestrian pathway

(6) **Ground Floor Residential Units.** Where ground floor residential units are required along Spear, Main, Beale, Fremont, and First Streets, the design standards of the Ground Floor Residential Design Guidelines apply. Ground floor residential units along Guy Place and Lansing Street, within the footprint of towers taller than 105 feet, and those that are proposed in locations where they are not required, are encouraged to meet the standards in this subsection to the greatest degree possible.

(7) **Ground Floor Commercial Design.** Ground floor commercial spaces must meet the standards set in Section 145.1 and 145.4.

1 **Figure 827(E): Ground Floor Commercial Frontages**

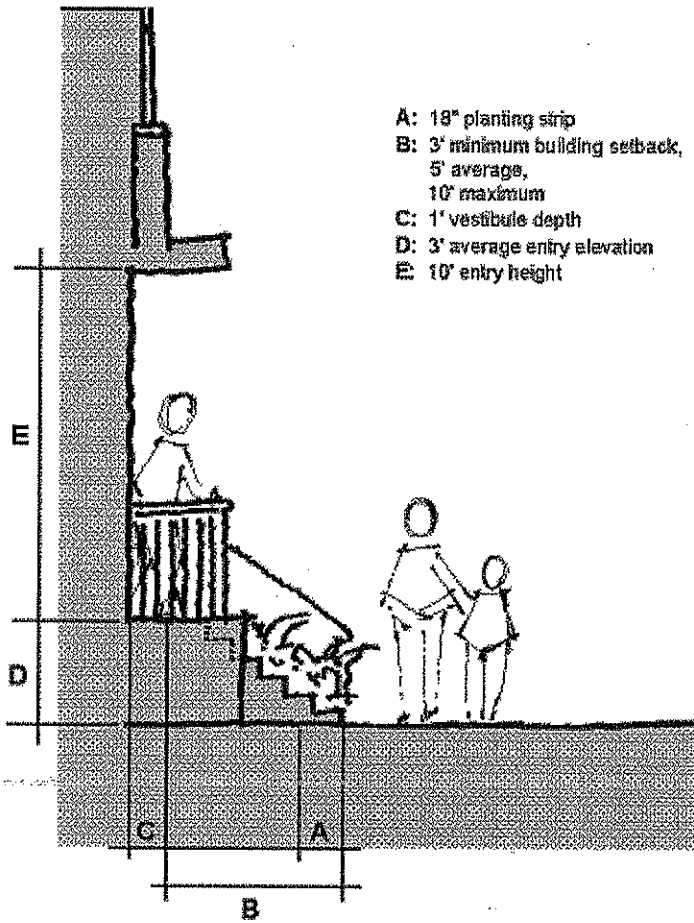

17 **(8) Off- Street Parking and Loading.**

18 **(A) Parking and Loading Access.**

19 (i) **Width of openings.** The maximum permitted width of all combined parking and
20 loading openings on Guy Place and Lansing Street for any single project is 20 feet.

21 (ii) **Folsom Street.** Access to off-street parking is not permitted on Folsom Street
22 for lots with frontage on another street. For lots fronting solely on Folsom Street, access to
23 parking on a Folsom Street frontage is permitted only through the processes established by
24

25 Mayor Newsom, Supervisor Chiu

1 Section 309.1 by demonstrating that every effort has been made to minimize negative impact
2 on the pedestrian quality of the street. Loading may not be accessed from Folsom Street.

3 (9) **Open Space.**

4 (1) In addition to the standards of Section 135, open space intended to fulfill the
5 requirements of off-site or publicly-accessible open space may include streetscape
6 improvements with landscaping and pedestrian amenities on Guy Place and Lansing Street,
7 beyond basic street tree planting or street lighting as otherwise required by this Code, in
8 accordance with the Streetscape Plan of the Rincon Hill Area Plan.

9 (10) **Streetscape Standards.**

10 (A) **Sidewalk Treatments.**

11 (i) For all frontages abutting a public sidewalk, the project sponsor is required to
12 install sidewalk widening, street trees, lighting, decorative paving, seating and landscaping in
13 accordance with the Streetscape Plan of the Rincon Hill Area Plan, developed by the Planning
14 Department and approved by the Board of Supervisors.

15 (ii) Prior to approval by the Board of Supervisors of a Streetscape Plan for Rincon
16 Hill, the Planning Commission, through the procedures of Section 309.1, shall require an
17 applicant to install sidewalk widening, street trees, lighting, decorative paving, seating, and
18 landscaping in keeping with the intent of the Rincon Hill Area Plan of the General Plan and in
19 accordance with subsections (iii)—(vi) below.

20 (iii) Sidewalk treatments shall comply with any applicable ordinances and with any
21 applicable regulation of the Art Commission, the Department of Public Works and the Bureau
22 of Light, Heat and Power of the Public Utility Commission regarding street lighting, sidewalk
23 paving, and sidewalk landscaping.

24 (iv) The Streetscape Plan and any Commission requirement pursuant to subsection
25 (ii) shall require the abutting property owner or owners to hold harmless the City and County

Mayor Newsom, Supervisor Chiu

1 of San Francisco, its officers, agents, and employees, from any damage or injury caused by
2 reason of the design, construction or maintenance of the improvements, and shall require the
3 owner or owners or subsequent owner or owners of the respective property to be solely liable
4 for any damage or loss occasioned by any act.

5 (v) Notwithstanding the provisions of this Section, an applicant shall apply for all
6 required permits for changes to the legislated sidewalk widths and street improvements and
7 pay all required fees.

8 (vi) The owner of the property is required to maintain all those improvements other
9 than lighting.

10 (B) **Mid-Block Pedestrian Pathways.** For developments on Assessor's Blocks
11 3744—3748, the Commission may require, pursuant to Section 309.1, the applicant to provide
12 a mid-block pedestrian pathway for the entire depth of their property where called for by the
13 Rincon Hill Area Plan of the General Plan. This pathway shall be designed in accordance with
14 the standards of this Section.

15 (i) **Design.** The design of the pathway shall meet the following minimum
16 requirements:

17 (AA) Have a minimum width of 20 feet from building face to building face;

18 (BB) Have a minimum clear walking width of 10 feet free of any obstructions.

19 (CC) Be open to the sky and free from all encroachments for that entire width, except
20 for those permitted in front setbacks by Section 136 of this Code;

21 (DD) Provide such ingress and egress as will make the area easily accessible to the
22 general public;

23 (EE) Be protected from uncomfortable wind, as called for elsewhere in this Code;

24 (FF) Be publicly accessible, as defined elsewhere in this Section;

25

1 (GG) Be provided with special paving, furniture, landscaping, and other amenities that
2 facilitate pedestrian use;

3 (HH) Be provided with ample pedestrian lighting to ensure pedestrian comfort and
4 safety;

5 (II) Be free of any changes in grade or steps not required by the natural topography
6 of the underlying hill; and

7 (JJ) Be fronted by active ground floor uses, such as individual townhouse residential
8 units, to the greatest extent possible.

9 (ii) Prior to issuance of a permit of occupancy, informational signage directing the
10 general public to the pathway shall be placed in a publicly conspicuous outdoor location at
11 street level stating its location, the right of the public to use the space and the hours of use,
12 and the name and address of the owner or owner's agent responsible for maintenance.

13 (iii) The owner of the property on which the pathway is located shall maintain it by
14 keeping the area clean and free of litter and keeping in a functional and healthy state any
15 street furniture, lighting and/or plant material that is provided.

16 (iv) Notwithstanding the provisions of this subsection, an applicant shall obtain all
17 required permits for changes to the legislated sidewalk and street improvements and pay all
18 required fees.

19 (v) The property owner or owners must hold harmless the City and County of San
20 Francisco, its officers, agents, and employees, from any damage or injury caused by reason
21 of the design, construction or maintenance of the improvements, and shall require the owner
22 or owners or subsequent owner or owners of the respective property to be solely liable for any
23 damage or loss occasioned by any act.

24 (b) **Uses.**

25
Mayor Newsom, Supervisor Chiu

1 (1) **Housing Requirement for Residential Developments.** The requirements of

2 Sections 315 through 315.9 shall apply in the RH-DTR subject to the following exceptions:

3 (A) If constructed on-site, a minimum of 12 percent of the total units constructed,
4 and if constructed off-site, a minimum of 17 percent of the total units constructed, shall be
5 affordable to and occupied by qualifying persons and families as defined elsewhere in this
6 Code.

7 (B) Below-market-rate units as required by Sections 315 through 315.9 that are built
8 off-site must be built within the area bounded by Market Street, the Embarcadero, King Street,
9 Division Street, and South Van Ness Avenue.

10 (C) No less than fifty percent (50%) of the fees that are paid due to development in
11 the Rincon Hill Area Plan under Section 315.4(e)(2) and 315.6 shall be paid into the Citywide
12 Affordable Housing Fund, but the funds shall be separately accounted for and designated
13 exclusively to increase the supply of affordable housing in the SOMA area.

14 (D) ~~Fifty percent (50%) of the below market rate units as required by Section 315 through~~
15 ~~315.9 that are built on- or off site must be provided as rental units for the life of the project, as defined~~
16 ~~in Planning Code Section 315.7(a).~~

17 (E) —The Mayor's Office of Housing must submit a resolution to the Board of
18 Supervisors with a plan for the use of all *in-lieu affordable housing* fee payments generated
19 from the Rincon Hill Plan prior to any expenditure of the Funds.

20 Section 3: The San Francisco Administrative Code is hereby amended by amending
21 Sections 56.2, 56.3, and 56.20 to read as follows:

22 SEC. 56.2. - PURPOSE AND APPLICABILITY.

23 (a) The purpose of this Chapter is to strengthen the public planning process by
24 encouraging private participation in the achievement of comprehensive planning goals and
25 reducing the economic costs of development. A development agreement reduces the risks

Mayor Newsom, Supervisor Chiu

1 associated with development, thereby enhancing the City's ability to obtain public benefits
2 beyond those achievable through existing ordinances and regulations. To accomplish this
3 purpose the procedures, requirements and other provisions of this Chapter are necessary to
4 promote orderly growth and development (such as, where applicable and appropriate,
5 provision of housing, employment and small business opportunities to all segments of the
6 community including low income persons, minorities and women), to ensure provision for
7 adequate public services and facilities at the least economic cost to the public, and to ensure
8 community participation in determining an equitable distribution of the benefits and costs
9 associated with development.

10 (b) Such agreements shall only be used for (1) affordable housing developments or
11 (2) large multi-phase and/or mixed-use developments involving public improvements,
12 services, or facilities installations, requiring several years to complete, as defined below in
13 Section 56.3, or a housing development with a minimum of 1,000 units, as defined below in
14 Section 56.3; or (3) rental housing developments with on-site inclusionary units, as defined below in
15 Section 56.3.

16 **SEC. 56.3. - DEFINITIONS.**

17 The following definitions shall apply for purposes of this Chapter:

18 (a) "Affordable housing development" shall mean for purposes of Section
19 56.2(b)(1), any housing development which has a minimum of 30 percent of its units
20 affordable to low income households, and a total of 60 percent of its units affordable to
21 households, as defined by the U.S. Census, whose immediate household income does not
22 exceed 120 percent of the median household income for the San Francisco Primary
23 Metropolitan Statistical Area, with the remaining 40 percent of its units unrestricted as to
24 affordability. For purposes of this definition of "affordable housing development," "low income"
25 shall mean the income of households, as defined by the U.S. Census whose immediate

1 household income does not exceed 80 percent of the median household income for the San
2 Francisco Primary Metropolitan Statistical Area. "Median household income" for the San
3 Francisco Primary Metropolitan Statistical Area shall be as determined by the U.S.
4 Department of Housing and Urban Development and adjusted according to the determination
5 of that Department and published from time to time. In the event that such income
6 determinations are no longer published by the Department of Housing and Urban
7 Development, median household income shall mean the median gross yearly income of a
8 household in the City and County of San Francisco, adjusted for household size, as published
9 periodically by the California Department of Housing and Community Development. Such
10 affordable housing development may include neighborhood commercial facilities which are
11 physically and financially an integral part of the affordable housing project and which will
12 provide services to local residents.

13 (b) "Applicant/Developer" shall mean a person or entity who has legal or equitable
14 interest in the real property which is the subject of the proposed or executed development
15 agreement for an "affordable housing development" or a "large multi-phase and/or mixed-use
16 development," as those terms are defined herein, or such person's or entity's authorized
17 agent or successor in interest; provided, however, that an entity which is subject to the
18 requirements of City Planning Code Section 304.5 relating to institutional master plans does
19 not qualify as an applicant for a development agreement.

20 (c) "Collateral agreement" shall mean a written contract entered into by the
21 applicant/developer and/or governmental agencies with other entities (including, but not
22 limited to, community coalitions) for the purpose of having said entities provide for and
23 implement social, economic, or environmental benefits or programs; provided, however, that
24 such term does not include agreements between the applicant/developer or governmental
25 agencies and (1) construction contractors and subcontractors, (2) construction managers, (3)

1 material suppliers, and (4) architects, engineers, and lawyers for customary architectural,
2 engineering or legal services.

3 (d) "Commission" shall mean the City Planning Commission.

4 (e) "Director" shall mean the Director of Planning.

5 (f) "Housing development with a minimum of 1,000 units" shall mean a proposed
6 residential development project which: (1) is on a site which exceeds two and one-half acres
7 in area, (2) includes two or more buildings to be constructed on the site, and (3) includes a
8 proposal for constructing or participating in providing, either off-site or on-site, public
9 improvements, facilities, or services beyond those achievable through existing ordinances and
10 regulations.

11 (g) "Large multi-phase and/or mixed-use development" shall mean a proposed
12 development project which: (1) is on a site which exceeds five acres in area, (2) includes two
13 or more buildings to be constructed sequentially on the site, and (3) includes a proposal for
14 constructing or participating in providing, either off-site or on-site, public improvements,
15 facilities, or services beyond those achievable through existing ordinances and regulations.

16 (h) "Material modification" shall mean any proposed amendment or modification to
17 either a proposed development agreement approved by the Commission, or a previously
18 executed development agreement, which amendment or modification is otherwise required by
19 the terms of the development agreement, which changes any provision thereof regarding the
20 following: (1) duration of the agreement; (2) permitted uses of the subject property; (3) density
21 or intensity of the permitted uses; (4) location, height or size of any structures, buildings, or
22 major features; (5) reservation or dedication of land; (6) any conditions, terms, restrictions and
23 requirements relating to subsequent discretionary actions as to design, improvements,
24 construction standards and specifications; (7) any other condition or covenant relating to the
25 financing or phasing of the development which substantially modifies the use of the property,

Mayor Newsom, Supervisor Chiu

1 the phasing of the development, or the consideration exchanged between the parties as
2 recited in the proposed development agreement; (8) the type, number, affordability level,
3 and/or tenure of any proposed affordable housing as well as any change as to performance of
4 such public benefits, including but not limited to timing, phasing, method of performance or
5 parties involved; or (9) any other terms or conditions of the development agreement if the
6 development agreement provides that amendment of said specified term or condition would
7 be a material modification.

8 (i) "Minor modification" shall mean any amendment or modification to the
9 development agreement which relates to any provision not deemed to be a "material
10 modification."

11 (j) "Rental housing developments with on-site inclusionary units" shall mean a proposed
12 residential development project the project sponsor of which covenants to provide on-site units to
13 satisfy the Affordable Housing Program, as set forth in Planning Code Sections 315-315.10, as an
14 alternative to payment of the Affordable Housing Fee.

15 SEC. 56.20. - FEE.

16 In order to defray the cost to the City and County of San Francisco of preparing,
17 adopting, and amending a development agreement, a fee shall be charged and collected in
18 accord with the procedures described below:
19

20 (a) Cost Estimate and Application Report. The reasonable costs to the various
21 departments of the City and County of San Francisco including, but not limited to, the
22 Department of City Planning, the Department of Public Works, the Mayor's Office of Housing
23 and Economic Development, the Real Estate Department and the City Attorney's Office for
24 staff time, necessary consultant services and associated costs of materials and administration
25

Mayor Newsom, Supervisor Chiu

1 will vary according to the size and complexity of the project. Accordingly, upon receipt of an
2 application for a development agreement, the Department of City Planning, after consultation
3 with the applicant/developer, any other parties identified in the application as parties to the
4 proposed development agreement, and the affected City and County departments, shall
5 prepare an estimated budget of the reasonable costs to be incurred by the City and County
6 (1) in the preparation and adoption of the proposed development agreement, and (2) in the
7 preparation of related documents where the costs incurred are not fully funded through other
8 City fees or funds; provided, however, that if the projected time schedule exceeds one year,
9 then the estimated budget shall be prepared for the initial 12-month period only, and the
10 estimated budgets for any subsequent 12-month time periods shall be prepared prior to the
11 end of the prior 12-month period.
12

13 The Director shall also prepare a report for the Commission and Board describing the
14 application, the anticipated public benefits listed in the application pursuant to Section 56.4(b),
15 and the projected time schedule for development agreement negotiations.
16

17 (b) Commission and Board of Supervisors Consideration. The Commission shall
18 recommend to the Board of Supervisors that a fee be imposed of a specified amount after
19 reviewing the cost estimate prepared by the Director and conducting a public hearing
20 pursuant to Section 56.4(c). If the Board of Supervisors approves the fee amount by
21 resolution, the fee shall be paid within 30 days after the effective date of the resolution. The
22 fee shall be paid in a single installment or, at the discretion of the Director, in four equal
23 installments, payable periodically over the estimated time frame for which the estimated
24
25

Mayor Newsom, Supervisor Chiu

1 budget has been prepared, with the first installment due within 30 days after the effective date
2 of the fee resolution.

3 (c) Deposit. The applicant/developer may prepay up to 50 percent of the amount of
4 the fee (as calculated in the Director's estimated budget) into a Development Agreement Fund
5 established for that purpose to enable the affected City Departments and agencies to begin
6 work on the application. Such funds shall be deemed appropriated for the purposes identified
7 in the cost estimate, and shall be credited against the final fee amount specified in the fee
8 resolution if such resolution is ultimately adopted by the Board of Supervisors. If the Board
9 fails to adopt such fee resolution, then the Controller shall return any prepaid funds remaining
10 unexpended or unobligated to the applicant/developer. If the Board approves a fee amount
11 which is less than the amount which the applicant/developer prepaid, then the Controller shall
12 return that portion of the difference between the fee amount and the prepaid funds which
13 remains unexpended or unobligated to the applicant/developer.
14

15 (d) Development Agreement Fund. There is hereby created a Development
16 Agreement Fund wherein all funds received under the provisions of this section shall be
17 deposited. All expenditures from the Fund shall be for purposes of reviewing the application
18 for, or proposed material modification to, a development agreement and preparing the
19 documents necessary to the approval of the development agreement, or a material
20 modification thereto. Up to 50 percent of the annual cost estimate is hereby deemed
21 appropriated for such purposes if the applicant/developer chooses to prepay such amount
22 pursuant to Subsection (c) above. All other funds are subject to the budget and fiscal powers
23 of the Board of Supervisors. Interest earned on such amounts deposited in said Fund shall
24
25

Mayor Newsom, Supervisor Chiu

1 accrue to the Fund for the purposes set forth herein. Upon the execution of a development
2 agreement, or withdrawal by an applicant/developer of its application, any unexpended or
3 unobligated portion of the fee paid by the applicant/developer shall be returned to the
4 applicant/developer.

5 (e) Waiver for Affordable Housing. The Board of Supervisors may, by resolution,
6 waive all or a portion of the fee required pursuant to this section for affordable housing
7 developments, as that term is defined in Section 56.3, only if it finds that such waiver is
8 necessary to achieve such affordable housing development.

10 (f) Other Fees. Payment of fees charged under this section does not waive the fee
11 requirements of other ordinances. The fee provisions set forth herein are not intended to
12 address fees or funding for parties to collateral agreements.

13 (g) Not Applicable to Rental Housing With On-Site Inclusionary Units. The hearings and fee
14 required pursuant to this section shall not apply to development agreements entered into with project
15 sponsors of rental housing developments with on-site inclusionary units as that term is defined in
16 Section 56.3(j) if the provision of on-site inclusionary units is the primary purpose of the Development
17 Agreement.

21 APPROVED AS TO FORM:
22 DENNIS J. HERRERA, City Attorney

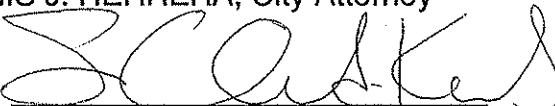
23 By: 
24 Susan Cleveland-Knowles
25 Deputy City Attorney

Mayor Newsom, Supervisor Chiu