

**STATE OF CALIFORNIA DEPARTMENT OF TRANSPORTATION
AIRSPACE LEASE
MARLER - JOHNSON PARK AGREEMENT
04-SF-101-25**

SUMMARY OF LEASE PROVISIONS

LESSOR: CALIFORNIA DEPARTMENT OF TRANSPORTATION

LESSEE (local agency): CITY AND COUNTY OF SAN FRANCISCO

PREMISES: Lease Area No.SF-101-25, as shown on Exhibit A, located under SF-101 between Valencia and Stevenson Streets, in the City of San Francisco, County of San Francisco, State of California (Article 1).

LEASE TERM: 20 years plus one 10-year extension option (Article 2)

INITIAL TERM LEASE AMOUNT: \$2,335,343.00 (Article 3)

SECURITY DEPOSIT: \$0.00 (Article 14)

PUBLIC USE: City of San Francisco Maintained Public Dog Park and Parking Area

LIABILITY INSURANCE: \$25,000,000 - Self Insured (Article 8)

ADDRESS FOR NOTICES:

To LESSOR:

Via US Mail:

Department of Transportation
Right of Way Airspace MS 11
P.O. Box 23440
Oakland, CA 94623-0440

In Person:

Department of Transportation
Right of Way Airspace MS 11
111 Grand Avenue
Oakland, CA 94612-3771

To LESSEE: Director of Property
City & County of San Francisco
25 Van Ness, Suite 400
San Francisco, CA 94102

LESSEE Contact: John Updike Office ph. (415) 554-9850

ARTICLE 1	LEASE; PREMISES
ARTICLE 2	TERM
ARTICLE 3	LEASE RATE
	3.1 Minimum Rent for Initial Term
	3.2 Intentionally deleted
ARTICLE 4	USE
	4.1 Specified Use
	4.2 Condition of Premises
	4.3 Prohibited Uses
	4.4 LESSOR'S Rules and Regulations
	4.5 Water Pollution Control
ARTICLE 5	IMPROVEMENTS
	5.1 Authorized Improvements
	5.2 Required Sign
	5.3 Removal of Improvements
ARTICLE 6	REMOVAL OF PERSONAL PROPERTY
ARTICLE 7	MAINTENANCE AND REPAIRS
	7.1 LESSEE'S Obligations
	7.2 LESSOR'S Rights
ARTICLE 8	INSURANCE
	8.1 Exemption of LESSOR from Liability
	8.2 Liability Insurance
	8.3 Failure to Procure and Maintain Insurance
ARTICLE 9	PAYMENT OF TAXES
ARTICLE 10	RIGHT OF ENTRY
	10.1 Inspection, Maintenance, Construction, and Operation of Freeway Structures
	10.2 Future Transportation Project
	10.3 Retrofitting of Freeway Structures
ARTICLE 11	DEFAULT
	11.1 Default
	11.2 LESSOR'S Remedies
ARTICLE 12	ASSIGNMENTS, SUBLEASES AND ENCUMBRANCES
ARTICLE 13	NONDISCRIMINATION
ARTICLE 14	SECURITY DEPOSIT
ARTICLE 15	ADDITIONAL PROVISIONS
	15.1 Quiet Enjoyment
	15.2 Captions, Attachments, Defined Terms
	15.3 Entire Agreement
	15.4 Severability
	15.5 Time is of the Essence
	15.6 Binding Effect; Choice of Law
	15.7 Waiver
	15.8 Notices
	15.9 No Reservation
	15.10 Force Majeure
	15.11 Termination of Lease
ADDENDUM TO LEASE – CITY OF SAN FRANCISCO ADDITIONAL CLAUSES	
EXHIBIT A – Premises	
EXHIBIT B – Initial Improvements	
EXHIBIT C – 2010 Caltrans Standard Plans – Drain Inlets	

STATE OF CALIFORNIA DEPARTMENT OF TRANSPORTATION
AIRSPACE LEASE – MARLER-JOHNSON PARK AGREEMENT

THIS LEASE (the "Lease"), dated April 22, 2013, is by and between the STATE OF CALIFORNIA, acting by and through its Department of Transportation, hereinafter called "LESSOR," and the CITY AND COUNTY OF SAN FRANCISCO, a municipal corporation, a bonafide public agency, hereinafter called "LESSEE."

WITNESSETH

It has been determined that the intended and described purpose of this leasehold is a proper use by a bonafide public agency pursuant to Section 14013 of the Government Code of the State of California; and

For and in consideration of the rental and the covenants, conditions, agreements, and stipulations set forth herein, LESSOR and LESSEE agree as follows:

ARTICLE 1. LEASE; PREMISES

Subject to the provisions of this Lease, LESSOR leases to LESSEE and LESSEE leases from LESSOR those certain Premises situated in the City of San Francisco, County of San Francisco, State of California, sometimes designated as lease area number SF-101-25, said demised area shown on the map marked Exhibit A.

EXCEPTING THEREFROM all those portions of the above-described Premises occupied by the supports and foundations of the existing structure.

ALSO EXCEPTING THEREFROM all that portion of said Premises above a horizontal plane 10 feet below the underside of the superstructure of the existing structure, which plane extends to a line 15 feet, measured horizontally, beyond the outermost protrusion of the superstructure of said existing structure.

This Lease is subject to the following (collectively, the "Existing Encumbrances"): (1) all easements, covenants, conditions, restrictions, reservations, rights of way, liens, encumbrances and other matters of record, (2) all matters discoverable by physical inspection of the Premises or that would be discovered by an accurate survey of the Premises and (3) all matters known to LESSEE or of which LESSEE has notice, constructive or otherwise including, without limitations, those shown on attached Exhibit A. LESSOR hereby represents that, except for this Lease, it has not issued any leases, permits, easements or any other agreements that provide any third party with the right to use or occupy any portion of the Premises during the term of this Lease. If LESSEE discovers any Existing Encumbrance that materially prevents LESSEE from using the Premises for the uses permitted under Section 4.1 of this Lease, LESSEE shall have the right to terminate this Lease by delivering written notice of such termination to LESSOR.

ARTICLE 2. TERM

The term of this Lease shall be for twenty years commencing on the later date (“Commencement Date”) to occur of (i) the Construction Date (defined as follows) and (ii) the date this Lease has been fully executed and delivered and LESSOR has issued an encroachment permit (the “Encroachment Permit”) to LESSEE for the installation of the improvements described in the attached “Exhibit B” (the “Initial Improvements”). The Construction Date shall be the earlier to occur of (a) OCTOBER 1, 2013, and (b) the ninetieth (90th) day immediately following LESSEE’s award of a contract for the construction of the Initial Improvements.

The term of this Lease shall expire on the twentieth (20th) anniversary of the Commencement Date (“Expiration Date”), unless earlier terminated by LESSEE or by LESSOR pursuant to the terms of this Lease. At LESSEE’S option, and with LESSOR’S concurrence, this Lease may be renewed for one additional ten-year option by LESSEE delivering written notice of its exercise of such option no less than 180 days prior to the date such option term is to commence. LESSEE shall have the right to terminate its exercise of its option to extend the term of this Lease if it does not agree to the new rent for such extended term determined pursuant to the terms and conditions in Section 3.4.

ARTICLE 3. LEASE RATE

3.1 Minimum Rent for Initial Term

LESSEE shall pay to LESSOR as minimum rent for the period commencing on the Commencement Date and terminating on the Expiration Date (the “Initial Term”), without deduction, setoff, prior notice, or demand, the sum of \$2,335,343.00 (the “Prepayment Amount”), which shall be amortized in equal amounts over the Initial Term. Within ___ days following the Commencement Date, LESSEE shall deliver the Prepayment Amount for LESSEE’s advance payment of such rent for Initial Term. If this Lease is terminated prior to the Expiration Date for any reason, within ___ days of such early termination, LESSOR shall return to LESSEE the unamortized portion of the Prepayment Amount, calculated by dividing the Prepayment Amount by the number of months in the Initial Term, and multiplying such resulting amount by the number of months between such early termination date and the Expiration Date. If there are any partial months between the early termination date and the Expiration Date, the unamortized portion of the Prepayment Amount for such month shall be prorated at the rate of 1/30th of the Prepayment Amount applicable to such month.

All rent checks shall have printed on their face the following tenancy reference number 04-SF-101-26-25 and shall be paid to LESSOR at the following address:

Via Mail:

Department of Transportation
Attn: Cashier
P.O. Box 168019
Sacramento, CA 95816

Via Hand Delivery:

Department of Transportation OR Department of Transportation

Attn: Cashier
1820 Alhambra Blvd., 2nd Floor
Sacramento, CA 95816

Right of Way Airspace Development
111 Grand Avenue, MS 11
Oakland, CA 95612

3.2 [Intentionally deleted]

3.3 LESSOR's Compensation upon Assignment, Transfer or Sublease of LESSEE's Leasehold

(a) In the event that LESSOR permits LESSEE to voluntarily assign, transfer or sublease any of LESSEE's rights in the Premises, after recovering its costs incurred in connection with such assignment, transfer or sublease, LESSEE shall pay to LESSOR compensation in connection with the transaction in an amount equal to fifty percent (50%) of any and all consideration, whether in present payments or in future payments, which LESSEE receives from an assignee, transferee or sublessee in excess of the amortized Prepayment Amount applicable to the months between the effective date of such assignment, transfer or sublease and the Expiration Date; provided, however, that LESSEE shall have the right from time to time, upon notice to but without the consent of LESSOR, to transfer this Lease or use and occupancy of all or any of the Premises to any department, commission or agency of LESSEE for any or all of the uses permitted under this Lease without payment of any such compensation and without obtaining LESSOR's consent. Neither LESSEE's use of a third party parking operator to operate the parking area portion of the Premises, nor any public parking at such parking area, shall be deemed to be an assignment, transfer or sublease of LESSEE's rights in the Premises.

(b) Payment by LESSEE of the amount of compensation required under this Section 3.3 is a condition to LESSOR's giving its consent to any assignment, transfer or sublease under Article 16, and LESSOR may withhold its consent to any such assignment, transfer or sublease until this compensation has been paid. In addition, before LESSOR gives its consent to any such transaction, LESSEE shall deliver to the assignee, transferee or sublessee a written summary of all sums due and owing to LESSOR under this section and shall deliver to LESSOR a written acknowledgement by the assignee, transferee or sublessee that said person affirms that the sums are due and owing to LESSOR and that said person accepts responsibility for ensuring that such sums are paid directly to LESSOR.

3.4 Reevaluation of Minimum Monthly Rent For Extended Term

It is the intent of LESSOR and LESSEE to maintain a fair market lease rate during any extended term of this Lease. If LESSEE exercises its option to extend the term of this Lease pursuant to Article 2, at the sole election of LESSOR prior to the commencement of such extended term, a fair market lease rate for the first year of such extended term may be determined in the manner set forth below and shall be established as the minimum monthly rent commencing immediately following such determination as provided for below. The minimum monthly rent established for the first year of an extended term by this section shall be subject to a 2% annual adjustment on each anniversary of the commencement of such extended term.

The term "fair market lease rate" means the most probable rental price a ten (10) year lease for the Premises, excluding the Initial Improvements and any other improvements constructed by LESSEE thereon pursuant to this Lease, should bring in a competitive and open market under all conditions requisite to a fair transaction, with each party acting prudently and knowledgeably, and assuming the price is not affected by undue stimulus, and leasing with full knowledge of the purpose

and uses to which the Premises is being put and the restrictions on use contained in this Lease.

The parties intend to establish the fair market lease rate through negotiation. In an effort to encourage productive negotiations, within 30 days after LESSEE notifies LESSOR that it wishes to exercise its right to extend the term of this Lease pursuant to Article 2, LESSOR shall have the right to notify LESSEE of its intent to reevaluate the property and provides LESSEE with its proposed new rate for the extended term. If LESSOR and LESSEE have not mutually agreed upon the fair market lease rate for the Premises for the first year of an extended term at least 30 days immediately prior to the commencement of such extended term, then LESSOR shall unilaterally set the fair market lease rate based on data collected from a rent survey of reasonably comparable Caltrans and non-Caltrans owned properties and shall use the highest per square foot rate paid by a LESSEE for a comparable property with a comparable use and for a period equal to the applicable term within approximately a two mile radius of the subject Premises.

If LESSOR and LESSEE have not mutually agreed upon the fair market lease rate for the Premises for an upcoming extended term at least 30 days immediately prior to the commencement of such extended term, and LESSOR thereafter unilaterally sets the fair market lease rate, LESSEE shall have the option to accept the new lease rate or within 30 days of being notified in writing of the new lease rate, LESSEE may object to the new lease rate and elect to terminate its exercise of its option to extend to term of the Lease with no penalty. Such termination notice must be provided by LESSEE to LESSOR in writing. LESSEE's election to terminate its exercise of its option to extend to term of the Lease shall place the LESSEE in the same theoretical position as if the entire maximum initial term of this Lease had run its course and expired. LESSEE shall have no further rights other than those expressed within this Lease relevant to termination. In the case that LESSEE does not provide notice of intent to terminate, the new fair market lease rate established by LESSOR shall become effective on the first day of the extended term, and if LESSEE fails to pay the new fair market lease rate, LESSOR shall treat LESSEE's failure to pay the new lease rate during the extended term as a material breach.

3.5 Reevaluation on Change in Use

LESSOR expressly reserves the right to establish a new minimum monthly rent as a condition to LESSOR's approval of any use of the Premises not specifically permitted by Section 4.1 and as a condition to any amendment to or changes in the uses permitted by that section. If a new minimum monthly rent is set pursuant to this section during the Initial Term, the difference between any such new minimum monthly rent and the amortized Prepayment Amount applicable to the months between the date such new minimum monthly rent is established and the Expiration Date shall be paid in advance on or before the first day of each month following the establishment of such new minimum monthly rent. If a new minimum monthly rent is set pursuant to this section during any extended term, the difference between any such new minimum monthly rent and the initial minimum monthly rent for such extended term shall be paid in advance on or before the first day of each month following the establishment of such new minimum monthly rent.

3.6 Reevaluation on Transfer

Although Article 16 generally prohibits any assignments, transfers, subleases, and encumbrances, LESSOR expressly reserves the right to establish a new minimum monthly rent as a condition to LESSOR's specific approval of any transfer, or assignment of this Lease or any

subletting of all or any portion of the Premises; provided, however, that LESSEE shall have the right from time to time, upon notice to but without the consent of LESSOR, to transfer this Lease or use and occupancy of all or any of the Premises to any department, commission or agency of LESSEE for any or all of the uses permitted under this Lease without any such new minimum monthly rent and without obtaining LESSOR's consent.

ARTICLE 4. USE

4.1 Specified Use

The Premises shall be used and occupied by LESSEE only and exclusively for the purpose of a public park, recreational area, and/or parking. Unless LESSOR exercises its rights under Article 10 in a manner that makes the remaining LESSEE improvements on the Premises inappropriate for a dog park, parking shall only be on the Premises as designated on the approved development plans attached hereto as Exhibit B further depict the proposed use of the Premises as the dog park portion of the SoMa West Skatepark and Dog Park and as a parking area. The Premises shall be maintained at the sole cost and expense of LESSEE in an orderly, clean, safe and sanitary condition. LESSOR will terminate this Lease immediately if LESSEE uses the Premises for any purpose other than parking or non-revenue generating park or recreational uses (provided that LESSEE shall have the right to sell beverages and food to users of the Premises and to charge a fee to use the Premises if the revenues from such activities are used only to fund LESSEE's payment of rent pursuant to this Lease or pursuant to Airspace Lease (04-SF-101-26) between LESSOR and LESSEE (the "Skatepark Lease") or LESSEE's costs in performing its obligations under this Lease or the Skatepark Lease or making approved improvements to the Premises or the premises described in the Skatepark Lease).

The Premises shall at all times be subject to all uses by the LESSOR as may be deemed necessary by LESSOR for highway facilities without interference by LESSEE, as provided for within Article 10.

4.2 Condition of Premises

LESSEE hereby accepts the Premises "AS-IS." LESSOR makes no representation or warranty with respect to the condition of the Premises or the suitability thereof for the conduct of LESSEE's business, nor has LESSOR agreed to undertake any modification, alteration or improvement to the Premises.

4.3 Prohibited Uses

LESSEE is to use the Premises for a public park and recreational and parking purposes only. The following are specifically prohibited:

- (a) Using the Premises in violation of any law, statute, zoning restriction, ordinance or governmental rule or regulation or requirements.
- (b) Operating or installing a gasoline or petroleum supply station, transporting or storing gasoline or petroleum products under the structures, except those products stored within an operable vehicle for exclusive use by that vehicle.

- (c) Manufacturing or storage or use of flammable materials, explosives or other materials, deemed by LESSOR to be a potential fire or other hazard to the transportation facility located above the Premises.
- (d) Using, creating, storing or allowing any hazardous materials on the Premises, except as otherwise expressly permitted in this Lease; provided that LESSEE may use such materials in such limited amounts as are customarily used for cleaning or maintaining improvements similar to the Initial Improvements or any other LESSEE improvements at the Premises so long as such use is in compliance with all applicable environmental laws. Fuel stored in a motor vehicle for the exclusive use in such vehicle is excepted.
- (e) Depositing or disposing of any hazardous materials on the Premises. LESSOR, or its agents or contractors, shall at all times have the right to go upon and inspect the Premises and the operations thereon to assure compliance with the requirements herein stated. Inspection may include taking samples of substances and materials present for testing, and/or the testing of soils or underground tanks on the Premises; provided that LESSOR shall provide LESSEE with 10 days' prior written notice of any such sampling or testing.

Hazardous materials are those substances listed or described for toxicity, reactivity, corrosivity or flammability criteria in Division 4.5, Chapter 11, Articles 1 through 5 of Title 22 of the California Code of Regulations, as well as any other substance which poses a hazard to health or environment.

- (f) Constructing, erecting, maintaining or permitting any sign, banner or flag upon the Premises, except as provided for in Section 5.3 or permitted under the Encroachment Permit, without the prior written approval of LESSOR, which shall not be unreasonably withheld, conditioned or delayed; provided, however, that LESSEE shall not need LESSOR's prior written approval to install temporary signs, banners or flags to promote activities at the Premises ("Temporary Signs") as long as the installed Temporary Signs are not attached to any portion of the overhead freeway structure and its support columns. LESSOR's shall make all reasonable efforts to notify LESSEE in writing of LESSOR's approval or disapproval of a proposed sign, banner, or flag on or before the thirtieth (30th) day immediately following LESSEE's delivery of written request for LESSOR's approval. LESSEE shall not place, construct or maintain upon the Premises any advertising media that include moving or rotating parts, searchlights, flashing lights, loudspeakers, phonographs or other similar visual or audio media.
- (g) Parking or storing wrecked or inoperable vehicles of any kind on the Premises. All parked or stored vehicles must be capable of being started and driven off the Premises. Vehicles will not be permitted to remain overnight on the Premises.
- (h) Conducting or permitting the vending or sale of any goods or services upon the Premises except as specifically permitted under Section 4.1.
- (i) Any activity that damages or endangers any highway structure on the Premises, including its supports and foundations, or interferes with the operation of such

structure.

- (j) Dumping or disposing of refuse or other unsightly materials on, in, under or about the Premises.
- (k) Conducting any activities on or about the Premises that constitute waste, nuisance or unreasonable annoyance (including, without limitation, emission of objectionable odors, noises or lights) to the public; provided, however, that LESSOR agrees that the operation of a dog park and a parking area on the Premises (assuming the public users of the Premises are not in violation of this list of prohibitions) will not constitute waste, nuisance or unreasonable annoyance.

LESSEE shall take all commercially practicable measures to ensure that its users at the Premises not conduct any activities prohibited under this Section. Repeated uncured incidents of the LESSEE's invitees at the Premises violating this Section shall constitute "nuisance" or an "unreasonable annoyance" per Section 4.3(k) and shall further constitute a material breach and default by LESSEE per Section 11.1(c) regardless whether the prohibited activities were conducted by third party users, as LESSEE's intended use of the Premises is to invite the public to use the Premises in compliance with the rules and regulations established by LESSEE and LESSOR.

4.4 LESSOR'S Rules and Regulations

LESSEE shall faithfully observe and comply with the rules and regulations that LESSOR shall from time to time promulgate for the protection of the transportation facility and the safety of the traveling public and which are required of all LESSOR tenants. LESSOR does not currently have rules and regulations for the Premises and LESSOR reserves the right from time to time to promulgate reasonable rules and regulations for the protection of the transportation facility and the safety of the traveling public and to make reasonable modifications to said rules and regulations, each of which shall be binding upon LESSEE upon delivery of a copy of them to LESSEE. If such new rules and regulations materially impact LESSEE's use of the Premises, LESSEE shall have the right to terminate this Lease by delivering written notice of such termination to LESSOR within the 90-day period immediately following LESSEE's receipt of such new rules and regulations.

4.5 Water Pollution Control

LESSEE operates a combined sanitary and stormwater sewer system at the Premises and the surrounding areas under its own separate NPDES permit. Best Management Practices (BMPs) are further required per San Francisco Municipal Code.

LESSEE shall comply with all applicable State and Federal water pollution control requirements regarding storm water and non-storm water discharges from the LESSEE's leasehold area and will be responsible for all permits applicable to the Premises, including if applicable to the Premises, but not limited to, the National Pollutant Discharge Elimination System (NPDES) General Permit and Waste Discharge Requirements for Discharges of Stormwater Associated with Industrial Activities (Excluding Construction), the NPDES General Permit for Stormwater Discharges Associated with Construction and Land Disturbance Activities, and the Caltrans Municipal Separate Storm Sewer System NPDES Permit, and permits and ordinances issued to and promulgated by municipalities, counties, drainage districts, and other local agencies regarding

discharges of storm water and non-storm water to sewer systems, storm drain systems, or any watercourses under the jurisdiction of the above agencies. Copies of the current storm water related NPDES permits are available on the State Water Resources Control Board's website at http://www.swrcb.ca.gov/water_issues/programs/stormwater/.

LESSEE understands the discharge of non-storm water into the storm sewer system at the Premises may be prohibited under the ordinances listed above. In order to prevent the discharge of pollutants to storm water resulting from contact with hazardous material, the storage or stockpile of hazardous material on Premises is strictly prohibited.

LESSEE shall implement and maintain the BMPs required by permits, ordinance, and regulations applicable to the Premises, including those specified in Articles 4.1 and 4.2 of the San Francisco Public Works Code, and, to the extent applicable to LESSEE's use of the Premises, the BMPs set forth in the following manuals:

(1) Right of Way Property Management and Airspace Storm Water Guidance Manual available for review online at: www.dot.ca.gov/hq/row/rwstormwater, and

(2) Construction Site Best Management Practices Manual, available for review online at: www.dot.ca.gov/hq/construc/stormwater/manuals.htm.

In the event of conflict between the above-referenced manuals and this Lease, this Lease shall control.

LESSEE shall provide LESSOR with any Standard Industrial Classification (SIC) code applicable to LESSEE'S facilities and activities on the Premises. A list of SIC codes regulated under the General Industrial Permit may be found at the State Water Resources Control Board website: http://www.waterboards.ca.gov/water_issues/programs/stormwater/gen_indus.shtml. Other SIC codes may be found at www.osha.gov/pls/imis/sicsearch.html.

LESSOR, or its agents or contractors, shall at all times have the right to enter and inspect the Premises and the operations thereon to assure compliance with all stormwater permits, ordinances, and regulations applicable to the Premises. Inspection may include taking samples of substances and materials present for testing, and/or the testing of storm sewer systems or watercourses on the Premises; provided that LESSOR shall provide LESSEE with 10 days' prior written notice of any such sampling or testing.

Notwithstanding anything to the contrary in this Section, LESSEE shall have the right to perform any maintenance, including regular washing, reasonably necessary to keep the improvements constructed on the Premises by LESSEE in a good and clean operating condition.

4.6 Legal Status of the Dog Park.

LESSOR has not received any notice that the Premises is a significant park or recreation area pursuant to the provisions of 23 U.S.C. section 138 and 49 U.S.C. section 303 (collectively, "Section 4(f)"). It is hereby understood and agreed by LESSOR and LESSEE that the dog park is not intended to convert the Premises into a significant park or recreation area pursuant to the provisions of Section 4(f), and LESSEE shall not knowingly install, nor permit any of its sublessees to install, any improvements at the Premises that would cause the Premises to be a significant park

or recreation area under Section 4(f). In the event that the Premises is declared a significant park or recreation area under Section 4(f) due to the dog park or any improvements installed at the Premises by LESSEE or its sublessee(s), LESSEE shall assume all burden, monetary or otherwise, in securing any Section 4(f) remedy required to minimize any harm that any of LESSOR's proposed projects would otherwise cause to the dog park or any such improvements; provided, however, that if any Section 4(f) remedy is so required, LESSEE shall have the right to terminate this Lease to relieve LESSOR of the obligation to perform, and for LESSEE to assume the burden for, such Section 4(f) remedy. LESSEE shall deliver written notice of any such termination of this Lease pursuant to the foregoing sentence to LESSOR on or before the thirtieth (30th) day that a determination is made to require LESSOR to perform a Section 4(f) remedy to minimize any harm to the Premises.

ARTICLE 5. COMMENCEMENT AND COMPLETION OF INITIAL CONSTRUCTION

5.1 Commencement of Construction

No improvements of any kind shall be placed in, on, or, upon the Premises, and no alterations shall be made in, on, or, upon the Premises other than the Initial Improvements. LESSEE shall commence construction of the Initial Improvements within 365 calendar days of the Commencement Date. For the purposes of this Article, construction shall be deemed to have commenced upon the issuance by LESSOR of an Encroachment Permit. In the event construction is not commenced within the time set forth herein, this Lease may be terminated by LESSOR and thereafter be of no further force and effect.

LESSEE shall be solely responsible for maintaining all improvements constructed by LESSEE on the Premises in a good and clean condition as specified in Article 7 below.

LESSEE shall be liable for any and all construction activities, permitted or not, that may occur on the Premises and its improvements during the term of this Lease, and shall indemnify and hold LESSOR harmless from any claims of liability arising solely from LESSOR's ownership of the Premises during the term of this Lease. LESSEE's obligations pursuant to the foregoing sentence shall not apply to any claims of liability arising from any acts at the Premises by LESSOR or its officers, employees, or agents, from any gross negligence or willful misconduct by LESSOR or its officers, employees, or agents, from any liability arising from the operation of any highway structure on the Premises, or arising during any period during which LESSOR has possession of the Premises.

5.2 Subsequent Improvements

If LESSEE desires any additional improvements in, on, or upon the Premises, or any alterations to said Premises, including landscaping, LESSEE shall prepare development plans describing the proposed additional improvements or alterations, and shall submit such development plans to LESSOR, for review by LESSOR and Federal Highway Administration ("FHWA"). LESSEE shall not make any additional improvements or alterations, including landscaping, without the review and approval of the LESSOR and FHWA documented by the issuance of a Caltrans Encroachment Permit.

LESSEE shall begin the construction of any additional improvements on the Premises

within 90 days after obtaining an appropriate encroachment permit to construct such additional improvements from the LESSOR. All work shall be completed according to the development plan within 360 days of the issuance of such encroachment permit.

5.3 Required Sign

LESSEE shall post the Premises, at LESSEE's cost, with a 12"x12" sign (or any larger size reasonably acceptable to LESSOR) giving the following notice:

“This park has been developed for your convenience by (name of Lessee) under a lease with the California Department of Transportation. The lease is subject to termination if the property is needed for State highway purposes.”

5.4 Removal of Improvements

(a) Removal Upon Termination of Lease; Early Termination to Fund Removal

Upon termination of this Lease for any reason whatsoever, LESSEE agrees to remove the Initial Improvements and all other improvements at the Premises made by LESSEE or on behalf of LESSEE (collectively, the “Lessee Improvements”), at LESSEE’S sole expense, within 90 days of termination, unless LESSOR subsequently agrees in writing that LESSEE may leave such Lessee Improvements at the Premises at the end of the term of this Lease. If LESSEE fails to remove all Lessee Improvements which LESSEE is required to remove, LESSOR may remove such Lessee Improvements at the expense of LESSEE after first providing no less than 30 days prior written notice to LESSEE of the date on which it intends to perform such removal work. If LESSOR performs such removal work after providing such notice, at LESSOR’s option, (1) may demand and collect its costs and expenses as additional rent through this Lease, or (2) may bring an action for recovery of such costs, together with all expenses and attorneys’ fees incurred by reason of said action. LESSEE shall tender possession of the Premises to LESSOR in a good paved condition, fully fenced, and suitable for immediate use as a public parking lot; however, LESSEE shall not be obligated to stripe the Premises in anticipation of a future parking use. LESSEE shall have the right to terminate this Lease prior to the Expiration Date if LESSEE elects to use the funds it would have used to pay rent between such early termination date and the Expiration Date to pay for the costs of removing the Lessee Improvements pursuant to this Section.

(b) Removal Upon LESSOR’s Temporary Entry

If LESSOR requires temporary possession of a portion of the Premises or the entire Premises to perform any activities pursuant to Article 10 of this Lease, LESSEE acknowledges that the performance of such activities may cause damage to, or require removal of (at LESSEE’s sole cost), the Lessee Improvements. LESSOR shall use commercially reasonable efforts to conduct the activities specified in Article 10 in a manner that reasonably minimizes any such damage or removal to the Lessee Improvements so long as those efforts do not increase the cost of performing the required activities. If LESSEE fails to remove all noticed conflicting Lessee Improvements, LESSOR may remove such improvements, and, at LESSOR’s option, (1) may demand and collect its costs and expenses as additional rent through this Lease, or (2) may bring an action for recovery of such costs.

(c) Restoration of Improvements

At the conclusion of LESSOR's temporary entry onto and possession of the Premises to perform any of the activities specified in Article 10 of this Lease, LESSOR shall NOT be responsible for restoring any Lessee Improvements damaged or removed by LESSOR in performing such activities. If LESSEE desires to restore such damaged or removed Lessee Improvements it may do so at its expense. If LESSEE elects not to make such restoration, LESSEE shall have the right not to do so and to terminate this Lease by delivering written notice of such termination within ninety (90) days of the date that LESSOR returns possession of the entire Premises to LESSEE, and LESSEE shall remove any remaining Lessee Improvements and restore the Premises pursuant to the provisions of subsection (a) hereinabove.

(d) Drainage Improvements

LESSEE proposes to improve the drainage of the Premises by the installation of additional drainage inlets that will connect to the LESSEE owned stormwater system. At the termination of the Lease for any reason, in addition to removing the Lessee Improvements, as a part of the Premises restoration, LESSEE, at its sole cost, shall ensure the drain inlet fixtures conform to the Caltrans Standard Plans current at the time of the lease termination. The relevant 2010 Caltrans Standard Plans for drainage inlets is attached for reference as Exhibit C.

ARTICLE 6. REMOVAL OF PERSONAL PROPERTY

LESSEE may remove any personal property from time to time within 45 days of the expiration of the term. LESSEE shall repair all damage (structural or otherwise) caused to the Premises or any improvements thereon by any such removal.

Any personal property not removed by LESSEE within 45 days following expiration of the term shall be deemed to be abandoned by LESSEE and shall, without compensation to LESSEE, become the LESSOR'S property, free and clear of all claims to or against them by LESSEE or any other person.

ARTICLE 7. MAINTENANCE AND REPAIRS

7.1 LESSEE'S Obligations

LESSEE, at its own cost and expense, shall maintain the Premises, the improvements and landscaping thereon including the Premises drainage facilities; and including fences heretofore (as may be modified under the Encroachment Permit) or hereafter erected by LESSEE or LESSOR in compliance with this Lease, in good and clean order, repair and condition and in compliance with all requirements of law, subject to ordinary wear and tear that does not reduce the attractiveness and utility of the Premises; provided, however, that LESSEE's obligations under this Section shall not apply to any freeway structure on the Premises other than as expressly set forth below as to LESSOR's structural columns within the Premises. LESSEE shall also, at its own cost and expense, maintain the lighting on the Premises in first class order, repair and condition.

LESSOR and LESSEE recognize that because of the length of the term of this Lease it may be necessary for LESSEE to perform certain substantial maintenance, repair, rehabilitation or

reconstruction (hereinafter collectively referred to as "repair" or "repairs") of the improvements in order to ensure that the Premises are kept in first-class order, repair and condition.

LESSEE hereby expressly waives the right to make repairs at the expense of LESSOR and the benefit of the provisions of Sections 1941 and 1942 of the California Civil Code or any successor amendments thereto.

LESSEE shall take all steps necessary to effectively protect the existing columns of the structure on the Premises and any future structure appurtenances installed on the Premises by LESSOR, from damage incident to LESSEE'S use of said Premises and improvements, all without expense to LESSOR. LESSEE shall, at its own cost and expense, repair in accordance with LESSOR'S standards any damage to any property owned by LESSOR, including, but not limited to, the existing columns of the structure on the Premises and any future structure appurtenances on the Premises installed by LESSOR, caused by LESSEE or its invitees incurred as a result of operation of a dog park at the Premises, but excluding any damage caused by the acts of LESSOR or its agents, contractors, representatives or invitees or occurring during any period that LESSOR has possession of the portion of the Premises where such damage occurred.

LESSEE shall designate in writing to LESSOR a representative who shall be responsible for the day-to-day operation and level of maintenance, cleanliness and general order of the Premises.

7.2 LESSOR'S Rights

In the event LESSEE fails to perform LESSEE'S obligations under this Article, LESSOR shall give LESSEE notice to do such acts as are reasonably required to so maintain the Premises. If within thirty (30) days after LESSOR sends written notice to repair or quit, LESSEE fails to do the work and fails to proceed in good faith to prosecute it to completion, said deficiency shall be deemed a material breach.

ARTICLE 8. INSURANCE

8.1 Indemnification

Neither LESSOR nor any its officers or employees is responsible for any injury, damage, or liability occurring by reason of anything done or omitted to be done by LESSEE pursuant to this Lease, including any work performed by LESSEE at the Premises.

It is understood and agreed LESSEE will fully defend, indemnify, and save harmless LESSOR and all of its officers and employees from all claims, suits, or actions of every kind brought forth under any theory of liability occurring by reason of anything done or omitted to be done by LESSEE under this Lease. LESSEE's obligations to defend, indemnify, and save harmless LESSOR extends to any and all claims, suits, or actions of every kind brought forth under any theory of liability occurring due to the use of the Premises during LESSEE's possession of the Premises as a public park or recreation area, including those arising from the operation of a skate park, the operations of any skate park vendor, the use of the skate park, or the design, construction, and maintenance of a public park, recreation area, or skate park.

LESSEE shall include in any contract it enters with any contractor who designs, constructs,

maintains, or operates the skate park a requirement that such contractor will fully defend, indemnify and save harmless LESSOR and its officers and employees from any and all claims, suits or actions of every kind brought forth under any theory of liability occurring due to such contractor's performance of its obligations or rights under such contract. If LESSEE has any additional insured endorsements executed naming LESSOR to comply with this provision, LESSEE shall provide copies of the additional insured endorsements and a Certificate of Insurance to LESSOR.

Furthermore, LESSEE agrees it controls the Premises during LESSEE's possession of the Premises, except to the extent that LESSOR uses the Premises pursuant to its reserved rights under this Lease. As such, LESSEE agrees to defend, indemnify and hold harmless LESSOR, its officers and employees for any and all claims arising out of the allegedly dangerous condition of public property based upon the condition of the Premises during LESSEE's possession of the Premises, except to the extent such claims arise from the freeway structure located above the Premises or LESSOR's activities on or use of the Premises.

LESSOR agrees to defend, indemnify and save harmless LESSEE, its officers, employees, and agents from any and all claims, suits or actions of every kind brought forth under any theory of liability with respect to the freeway structure located above the Premises or the activities of LESSOR or its officers, employees, and agents at the Premises, except to the extent such claims, suits or actions arise by reason of the sole or active negligence of LESSEE, its officers, employees, and agents.

8.2 Self-Insurance

LESSOR acknowledges LESSEE maintains a self-insurance program agrees that LESSEE shall not be required to carry any third party insurance with respect to this Lease at any time that LESSEE maintains such self-insurance. LESSOR agrees LESSEE's self-insurance is sufficient to meet LESSEE'S insurance obligations under this Lease if the self-insurance provides coverage as broad as a Commercial General Liability insurance policy, as provided on ISO Form CG 0001 or equivalent, for the Premises.

LESSEE's self-insurance shall provide per occurrence and aggregate limits of liability of not less than Twenty-Five Million Dollars (\$25,000,000).

LESSEE is also required to notify LESSOR in writing not less than thirty (30) days prior to the effective date of the termination of its self-insurance coverage. If such notice is given, LESSEE is required to obtain a Commercial General Liability policy providing the coverage required by this Article and an effective date the same as the termination date of the self-insurance to avoid any disruption in coverage. If LESSEE purchases a Commercial General Liability policy to meet the requirements of this Article, LESSEE shall have LESSOR named as an additional insured under the policy and provide a copy of the complete policy to LESSOR.

By executing this Lease, LESSEE expressly acknowledges LESSEE's self-insurance program meets the requirements of this provision. This provision does not apply if LESSEE acquires private insurance in place of self-insurance.

8.3 Completed Operations Coverage

To cover all liability related to any defective design or construction of Lessee Improvements (including the design or construction of a public park as specifically identified within Article 4), LESSEE shall require all third party design professionals or contractors used by City to design or construct the Lessee Improvements to carry, during such design or construction period, professional liability coverage insuring against negligent acts, errors or omissions in connection with such contractor's design or construction work. LESSEE shall also require any third party contractor for the construction of the Lessee Improvements to provide commercial completed operations insurance coverage for such construction for the period required under applicable law.

8.4 Failure to Procure and Maintain Insurance

If LESSEE fails to procure or maintain LESSEE's self-insurance described in Section 8.2 above, or private insurance in place of LESSEE's self insurance, LESSEE shall cease and desist from using the Premises and any improvements to the Premises. LESSEE shall also prevent members of the public from gaining access to the Premises during any period in which such insurance coverage is not in full force and effect.

ARTICLE 9. PAYMENT OF TAXES

LESSEE agrees to pay all taxes and assessments that may be legally assessed on LESSEE'S possessory interest under this Lease or income generated at the Premises by LESSEE or its sublessee(s).

ARTICLE 10. RIGHT OF ENTRY

10.1 Inspection, Maintenance, Construction and Operation of Freeway Structures

LESSOR, through its agents or representatives, and other city, county, state and federal agencies, through their agents or representatives, shall have full right and authority to enter in and upon the Premises and any building or improvements situated thereon at any and all reasonable times during the term of this Lease for the purpose of inspecting the same without interference or hindrance by LESSEE, its agents or representatives.

LESSOR further reserves the right of entry for the purpose of inspecting the Premises, or the doing of any and all acts necessary or proper on said Premises in connection with the protection, maintenance, reconstruction, and operation of the freeway structures and its appurtenances; provided, further, that LESSOR reserves the further right, at its discretion, to immediate possession of the same in case of any national or other emergency, or for the purpose of preventing sabotage, and for the protection of said freeway structures, in which event the term of this Lease shall be extended for a period equal to the emergency occupancy by LESSOR, and during said period LESSEE shall be relieved, to the degree of interference, from the performance of conditions or covenants specified herein. LESSOR further reserves the right of entry by any authorized officer, engineer, employee, contractor or agent of the LESSOR for the purpose of performing any maintenance activities upon the property which LESSEE has failed to perform after the expiration of the applicable cure period specified in Section 11.1.

10.2 Future Transportation Projects

At any time following the fifth (5th) anniversary of the Commencement Date, LESSOR may cancel this Lease upon 90 days notice for any future transportation project that requires LESSOR's possession of the Premises if such project would continue through the then remaining term of this Lease. In that event, LESSEE will have no claim upon LESSOR and waives any and all claims for compensation, damages or relocation assistance. If LESSOR's Division of Right of Way Office of Airspace Development ("RW Airspace") learns of a potential future transportation project at the Premises, RW Airspace agrees to notify LESSEE, and to meet and confer with LESSEE, as early as is reasonably feasible during the concept and schematic design phases for such project. If such project may temporarily or permanently affect the use of the Premises by LESSEE, LESSOR agrees to confer with LESSEE and consider in good faith any reasonable modifications to such project or alternative proposals proposed by LESSEE that would avoid or mitigate such impact on the Premises or LESSEE's use of the Premises while still consistent with LESSOR's overall transportation project objectives. If LESSOR believes that employing a modification or alternative proposed by LESSEE will result in additional cost or expense to LESSOR's project, LESSOR shall notify LESSEE of the anticipated cost in writing. If, after receiving such estimate, LESSEE requests in writing that LESSOR proceed with such modification or alternative requested by LESSEE, LESSEE agrees to reimburse LESSOR for its actual incurred additional cost or expense resulting from making such requested modification or alternative. If LESSEE's improvements conflict with LESSOR's project, the conflicting improvements shall be removed by LESSEE, at its sole cost, pursuant to Section 5.4.

In the event LESSOR determines that it needs to obtain possession of all or a portion of the Premises for any future transportation project, but such project will be completed prior to the expiration of the then remaining term of this Lease, LESSOR shall, at least ninety (90) days prior to the effective date of the commencement of such possession, notify LESSEE in writing describing the extent of the possession and the effective date of the commencement of such possession. Upon the effective date of said notice, LESSEE shall peaceably surrender possession of all or any specified portion of the Premises. The rent stated in Section 3.1 shall be equitably reduced by the same percentage as the portion of the Premises which was surrendered; provided, however, that if LESSEE's is unable to use the remaining portion of the Premises for any of the Permitted Uses without such surrendered portion, the rent stated in Section 3.1 shall be fully abated until the entire Premises is returned to LESSEE. If LESSOR takes possession of a portion of the Premises for any future transportation project that will continue for more than twenty-four (24) months, and the portion of the Premises remaining in possession of LESSEE is rendered unusable due to such project, LESSEE shall have the right to terminate this Lease by delivering no less than thirty (30) days' prior written notice of such termination to LESSOR. This reduction in rent and termination right shall be LESSEE'S sole remedies against LESSOR for LESSEE'S inability to possess or use the entire area of the Premises on account of LESSOR'S exercise of its rights under this Section, and LESSEE expressly waives any right it may have to recover compensation, damages or relocation assistance from LESSOR on account thereof.

LESSOR shall use commercially reasonable efforts to conduct future transportation project work in a manner that reasonably minimizes any such damage or removal to the Lessee Improvements. LESSEE acknowledges that the performance of the future transportation project work may cause damage to the Lessee Improvements. LESSEE expressly agrees to release any claims that it may have against LESSOR for such damage.

10.3 Retrofitting of Freeway Structures

LESSEE acknowledges LESSOR may be required to perform retrofit work on all or a part of the freeway structures that are situated on and above the Premises. LESSOR shall have the right to impose such restrictions on LESSEE'S right to enter, occupy, and use the Premises and to construct improvements thereon as LESSOR deems are necessary to enable it to complete construction of all freeway structural retrofit work without interference from LESSEE.

In the event LESSOR determines that it needs to obtain possession of all or a portion of the Premises, or needs to place restrictions on LESSEE'S use of the Premises, to accommodate such retrofit work, LESSOR shall, at least ninety (90) days prior to the effective date of the commencement of such possession or restrictions notify LESSEE in writing describing the extent of the possession or restrictions and the effective date of their commencement. If such notice is for any possession by Landlord, it shall further describe any other Landlord property in the general vicinity available for lease by Tenant pursuant to the terms and conditions of this Lease. Landlord shall use commercially reasonable efforts to identify such alternative Landlord property. Although Landlord shall identify any available Landlord property within the vicinity of the Premises, Landlord shall not be obligated to provide Tenant with a replacement property in the event all or a portion of the Premises is repossessed by Landlord. Upon the effective date of said notice, LESSEE shall peaceably surrender possession all or any specified portion of the Premises or comply with the restrictions as stated therein, as applicable. The rent stated in Section 3.1 shall be equitably reduced to reflect the portion of the Premises surrendered and the portion of the Lease term for which the Premises was surrendered; provided, however, if the portion of Premises to be surrendered by LESSEE will render the remaining portion of the Premises unusable for the Permitted Uses, LESSEE shall have the right to terminate this Lease by delivering no less than thirty (30) days' prior written notice of such termination to LESSOR. This reduction in rent and right of early termination shall be LESSEE'S sole remedy against LESSOR for LESSEE'S inability to possess or use the entire area of the Premises on account of LESSOR'S exercise of its rights under this Section, and LESSEE expressly waives any right it may have to recover compensation, damages or relocation assistance from LESSOR on account thereof.

LESSEE shall conduct its operations on the Premises in such a manner so as not to interfere with LESSOR'S or its contractor's performance of any structural retrofit work done on or above the Premises. LESSOR shall use commercially reasonable efforts to conduct such structural retrofit work in a manner that reasonably minimizes any such damage or removal to the Lessee Improvements. LESSEE acknowledges that the performance of the structural retrofit work may cause damage to the Lessee Improvements. LESSEE expressly agrees to release any claims it may have against LESSOR from all such damage to the improvements.

ARTICLE 11. DEFAULT

11.1 Default

The occurrence of any of the following shall constitute a material breach and default of this Lease by LESSEE:

- (a) Any failure by LESSEE to pay lease payment or any other monetary sums required to be paid hereunder, where such failure continues for ten (10) business days after written notice thereof has been given by LESSOR to LESSEE.

- (b) The abandonment or vacation of the Premises by LESSEE. Failure to occupy and operate the Premises for sixty (60) consecutive days following the mailing of written notice from LESSOR to LESSEE calling attention to the abandonment shall be deemed an abandonment or vacation.
- (c) A failure by LESSEE to observe and perform any other provision of this Lease to be observed or performed by LESSEE, where such failure continues for thirty (30) days after written notice thereof by LESSOR to LESSEE; provided, however, that if the nature of such default is such that it cannot be reasonably cured within such thirty (30) day period, LESSEE shall not be deemed to be in default if LESSEE shall within such period commence such cure and thereafter diligently prosecute the same to completion.

11.2 LESSOR'S Remedies

In the event of any material default or breach by LESSEE, LESSOR may at any time after expiration of the applicable notice and cure period, without limiting LESSOR in the exercise of any right of remedy at law or in equity that LESSOR may have by reason of such default or breach

- (a) Terminate LESSEE'S right to possession by any lawful means, in which case this Lease shall immediately terminate and LESSEE shall immediately surrender possession of the Premises to LESSOR. In such event LESSOR shall be entitled to recover from LESSEE all damages incurred by LESSOR by reason of LESSEE'S default including, but not limited to, the following:
 - (i) any amount necessary to compensate LESSOR for all the detriment proximately caused by LESSEE'S failure to perform its obligations under this Lease or which in the ordinary course of events would be likely to result therefrom; plus
 - (ii) at LESSOR'S election, such other amounts in addition to or in lieu of the foregoing as may be permitted from time to time by applicable State law. Upon any such re-entry LESSOR shall have the right to make any reasonable repairs, alterations or modifications to the Premises, which LESSOR in its sole discretion deems reasonable and necessary.

ARTICLE 12. ASSIGNMENTS, SUBLEASES AND ENCUMBRANCES

The LESSEE shall not assign, sublease, or encumber the Premises in any matter whatsoever, nor shall this Lease be recorded.

ARTICLE 13. NONDISCRIMINATION

LESSEE, for itself, its agents, contractors, employees, officers, and personal representatives, successors in interest, and assigns, as a part of the consideration hereof, does hereby covenant and agree as a covenant running with the land that:

- (a) No person, on the ground of race, color, or national origin shall be excluded from participation in, be denied the benefits of, or otherwise subjected to discrimination in the use of said facilities,
- (b) In connection with the construction of any improvements on said land and the furnishing of services thereon, no discrimination shall be practiced in the selection of employees and contractors, by contractors in the selection and retention of first tier subcontractors, and by first tier subcontractors in the selection and retention of second tier subcontractors,
- (c) Such discrimination shall not be practiced against the public in its access to and use of the facilities and services provided for public accommodations (such as eating, sleeping, rest, recreation, and vehicle servicing) constructed or operated on, over, or under the Premises,
- (d) LESSEE shall use the Premises in compliance with all other requirements imposed pursuant to Title 49, Code of Federal Regulations, Part 21 and as said regulations may be amended. In the event of breach of any of the above nondiscrimination covenants, the LESSOR shall have the right to terminate this Lease, and to re-enter and repossess said land and the facilities thereon, and hold the same as if said Lease had never been made or issued.

ARTICLE 14. SECURITY DEPOSIT

LESSEE shall maintain on deposit with LESSOR the sum of \$ 0.00 to guarantee the faithful performance of the conditions of this agreement. LESSOR shall not be required to keep this Security Deposit separate from its general funds, and LESSEE shall not be entitled to interest on such deposit. If LESSEE shall fully and faithfully perform every provision of this Lease to be performed by it, the Security Deposit or any balance thereof shall be returned to LESSEE at the expiration of the lease term and after LESSEE has properly vacated the Premises.

ARTICLE 15 ADDITIONAL PROVISIONS

15.1 Quiet Enjoyment

LESSOR covenants and agrees with LESSEE that upon LESSEE paying lease payment and other monetary sums due under the Lease and performing its covenants and conditions, LESSEE shall and may peaceably and quietly have, hold and enjoy the Premises for the term, subject however, to the terms of the Lease.

15.2 Captions, Attachments, Defined Terms

The captions of the Articles of this Lease are for convenience only and shall not be deemed to be relevant in resolving any question of interpretation or construction of any section of this Lease.

Any marginal or clause headings on this lease are not a part of this and shall have no effect upon the construction or interpretation of any part hereof.

15.3 Entire Agreement

This instrument along with any addenda, exhibits and attachments hereto constitutes the entire agreement between LESSOR and LESSEE relative to the Premises and this agreement and the exhibits and attachments may be altered, amended or revoked only by an instrument in writing signed by both LESSOR and LESSEE. LESSOR and LESSEE agree hereby that all prior or contemporaneous oral agreements between and among themselves and their agents and representatives relative to the leasing of the Premises are merged in or revoked by this agreement.

15.4 Severability

If any terms or provision of this Lease shall, to any extent, be determined by a court of competent jurisdiction to be invalid or unenforceable, the remainder of this Lease shall not be affected thereby, and each term and provision of this Lease shall be valid and be enforceable to the fullest extent permitted by law.

15.5 Time is of the Essence

Time is of the essence of each and all of the terms and provisions of this Lease.

15.6 Binding Effect; Choice of Law

The terms and conditions of this lease shall extend and be binding upon and inure to the benefits of the heirs, executors, administrators or to any approved successor of the LESSEE. The terms and conditions of this Lease shall be governed by the laws of the State of California, if any legal action is initiated, the venue shall be in the appropriate court of the State of California in the county in which the Premises are located

15.7 Waiver

No covenant, term or condition or the breach thereof shall be deemed waived, except by written consent of the party against whom the waiver is claimed and any waiver or the breach of any covenant, term or condition shall not be deemed to be a waiver of any preceding or succeeding breach of the same or any other covenant, term or condition. Acceptance by LESSOR of any performance by LESSEE after the time the same shall have become due shall not constitute a waiver by LESSOR of the breach or default of any covenant, term or condition. Acceptance by LESSOR of any performance by LESSEE after the time the same shall have become due shall not constitute a waiver by LESSOR of the breach or default of any covenant, term or condition unless otherwise expressly agreed to by LESSOR in writing.

15.8 Notices

All notices or demands of any kind required or desired to be given by LESSOR or LESSEE hereunder shall be in writing and shall be deemed delivered forty-eight (48) hours after depositing the notice or demand in the United States mail, certified or registered, postage prepaid, addressed to the LESSOR or LESSEE respectively at the addresses set forth in the Summary of Lease Provisions on the first page of this Lease.

15.9 No Reservation

Submission of this instrument for examination or signature by LESSEE does not constitute a reservation of or option for lease; it is not effective as a lease or otherwise until execution and delivery by both LESSOR and LESSEE.

15.10 Force Majeure

If either LESSOR or LESSEE shall be delayed or prevented from the performance of any act required hereunder by reason of acts of nature, governmental restrictions, regulations or controls (except those reasonably foreseeable in connection with the uses contemplated by this Lease) or other cause without fault and beyond the control of the party obligated (except financial inability), performance of such act shall be excused for the period of the delay and the period for the performance of any such act shall be extended for a period equivalent to the period of such delay. Nothing in this clause shall excuse LESSEE from prompt payment of any rent, taxes, insurance or any other charge required of LESSEE, except as may be expressly provided in this Lease.

15.11 Addendum

The Addendum to Lease attached hereto is made a part hereof for all purposes.

[REMAINDER OF PAGE INTENTIONALLY BLANK]

In Witness Whereof, LESSOR and LESSEE have executed this Lease as of the date first written above.

LESSOR
STATE OF CALIFORNIA
DEPARTMENT OF TRANSPORTATION

Dated: _____

By: _____
LINDA EMADZADEH, Chief
R/W Airspace, LPA, and Excess Lands

LESSEE
CITY AND COUNTY OF SAN FRANCISCO,
A MUNICIPAL CORPORATION

Dated: _____

By: _____
JOHN UPDIKE
Director of Property

APPROVED AS TO FORM:
DENNIS J. HERRERA,
City Attorney

By: _____
Carol Wong, Deputy City Attorney

ADDENDUM TO AIRSPACE LEASE AGREEMENT

This Addendum to Airspace Lease Agreement (this "Addendum") is a part of and modifies that certain Airspace Lease Agreement (the "Base Lease") for Lease Area No.SF-101-26 between the State of California, acting by and through its Department of Transportation ("LESSOR"), and the City and County of San Francisco, a municipal corporation ("LESSEE"), dated as of _____.

All undefined, capitalized terms used in this Addendum shall have the meanings given to them in the Base Lease. All references in the Base Lease and in this Addendum to "the Lease" or "this Lease" shall mean the Base Lease, as modified by this Addendum.

1. Non-Liability of LESSEE Officials, Employees and Agents. Notwithstanding anything to the contrary in this Lease, no elective or appointive board, commission, member, officer, employee or agent of LESSEE shall be personally liable to LESSOR, its successors and assigns, in the event of any default or breach by LESSEE or for any amount which may become due to LESSOR, its successors and assigns, or for any obligation of LESSEE under this Lease.
2. Controller's Certification of Funds. The terms of this Lease shall be governed by and subject to the budgetary and fiscal provisions of the LESSEE's Charter. Notwithstanding anything to the contrary contained in this Lease, there shall be no obligation for the payment or expenditure of money by LESSEE under this Lease unless the LESSEE's Controller first certifies, pursuant to Section 3.105 of the LESSEE's Charter, that there is a valid appropriation from which the expenditure may be made and that unencumbered funds are available from the appropriation to pay the expenditure. Without limiting the foregoing, if in any fiscal year of LESSEE after the fiscal year in which the term of this Lease commences, sufficient funds for the payment of Rent and any other payments required under this Lease are not appropriated, then LESSEE may terminate this Lease, without penalty, liability or expense of any kind to LESSEE, except for LESSEE's obligation to remove the constructed improvements and restore the Premises to the prior condition per Articles 5 and 6, as of the last date on which sufficient funds are appropriated. LESSEE shall use its reasonable efforts to give LESSOR reasonable advance notice of such termination
3. Non Discrimination in LESSEE Contracts and Benefits Ordinance. To the extent LESSOR is subject to San Francisco Administrative Code Section 12B, in the performance of this Lease, LESSOR covenants and agrees not to discriminate on the basis of the fact or perception of a person's race, color, creed, religion, national origin, ancestry, age, sex, sexual orientation, gender identity, domestic partner status, marital status, disability, weight, height, or Acquired Immune Deficiency Syndrome or HIV status (AIDS/HIV status) against any employee or, any LESSEE employee working with, or applicant for employment with, LESSOR in any of LESSOR's operations within the United States, or against any person seeking accommodations, advantages, facilities, privileges, services, or membership in all business, social, or other establishments or organizations operated by LESSOR.
4. MacBride Principles - Northern Ireland. LESSEE urges companies doing business in Northern Ireland to move toward resolving employment inequities and encourages them to abide by the MacBride Principles as expressed in San Francisco Administrative Code Section 12F.1 et seq. LESSEE also urges San Francisco companies to do business with corporations that abide by the MacBride Principles. LESSOR acknowledges that it has read and understands the above statement

of LESSEE concerning doing business in Northern Ireland.

5. Tropical Hardwood and Virgin Redwood Ban. LESSEE urges companies not to import, purchase, obtain or use for any purpose, any tropical hardwood, tropical hardwood wood product, virgin redwood, or virgin redwood wood products.

6. Bicycle Storage Facilities. Article 1.5, Section 155.1, of the San Francisco Planning Code (the "Planning Code") requires the provision of bicycle storage at City-leased buildings at no cost to LESSOR and if funds are available. In the event public and/or private donations, grants or other funds become available, at any time during the term of this Lease including any extension thereof, LESSEE may apply for a Caltrans Encroachment Permit proposing to install compliant bicycle storage at the Premises per Section 5.2 hereinabove.

EXHIBIT A

Premises

[see attached]

EXHIBIT B

Initial Improvements

[see attached]

NO.	DATE	DESCRIPTION	BY

REFERENCE INFORMATION
 SHEET NO. OF SHEETS



INFRASTRUCTURE DIVISION
 DEPARTMENT OF PUBLIC WORKS
 CITY AND COUNTY OF SAN FRANCISCO



DESIGNED	DATE	APPROVED	DATE
DRAWN	DATE	SECTION MANAGER	DATE
CHECKED	DATE	DEPUTY SECTION MANAGER	DATE

SCALE
 1" = 16'-0"
 SHEET OF SHEETS
 1 of 1

SOUTH OF MARKET WEST IMPROVEMENTS
SOMA WEST DOG PARK
DETAIL REFERENCE PLAN

CONTRACT NO.	14521
DRAWING NO.	DDP-4.1
SHEET NO.	

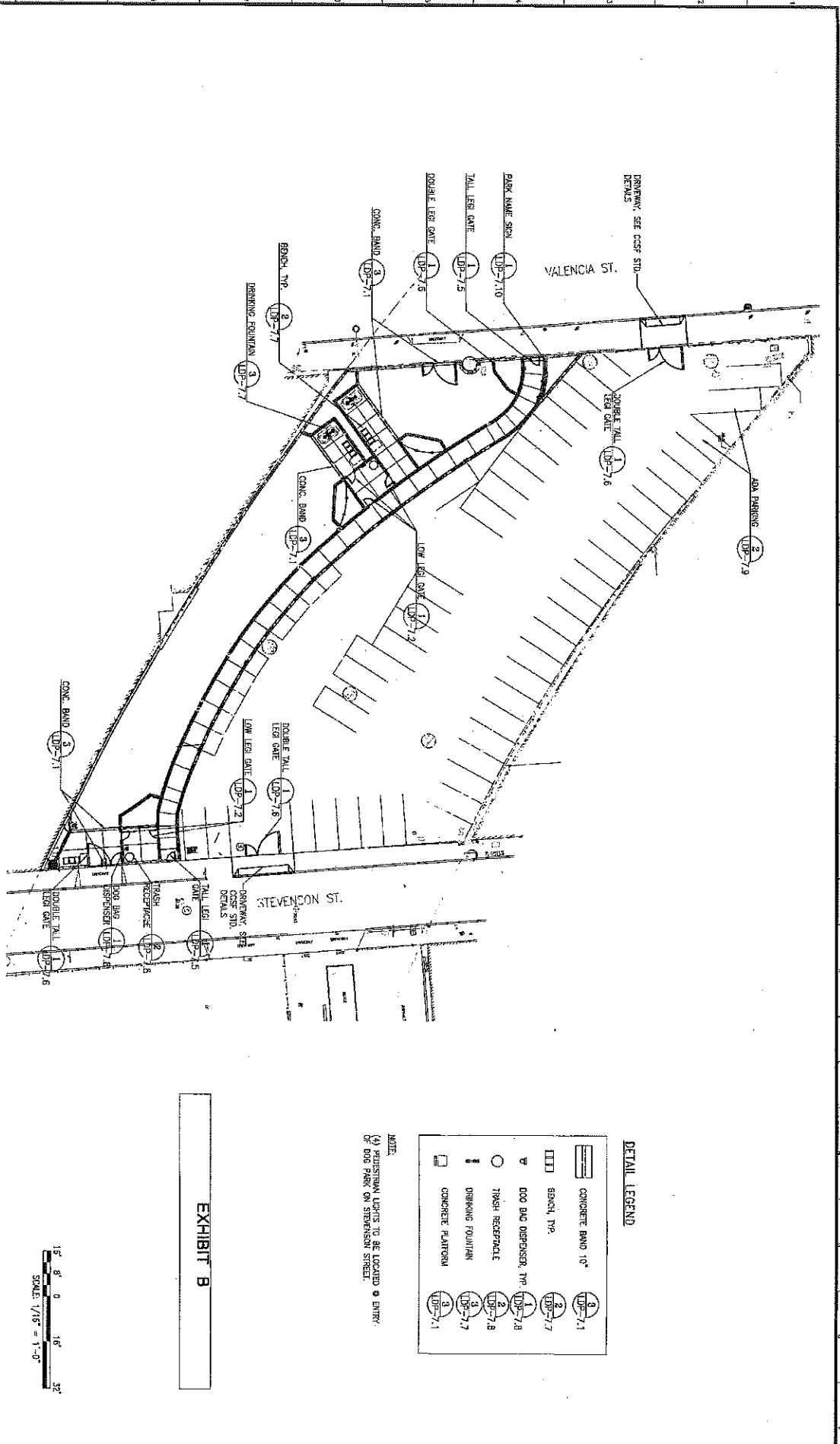

EXHIBIT C

2010 Caltrans Standard Plans – Drain Inlets

[see attached]

TO ACCOMPANY PLANS DATED _____

DIST: COUNTY ROUTE TOTAL PROJECT SHEET NO. SHEETS

REGISTERED CIVIL ENGINEER
 October 19, 2012
 PLANS APPROVAL DATE
 THE STATE OF CALIFORNIA ON 15 OCTOBER 2012
 IN WASHINGTON, DISTRICT OF COLUMBIA
 CIVIL ENGINEER

NOTES:

- "h" is the difference in elevation between the outlet pipe flow line and the normal gutter grade line un depressed.
- For "h" wall thickness, see Table A below.
- Wall reinforcing not required when "h" is 8'-0" or less and the unsupported width or length is 7'-0" or less. Walls exceeding these limits shall be reinforced with #4 bars @ 1'-6" ± centers.
- Inlet bottom reinforcing not required. See Standard Plan D74C for alternative reinforced bottom and alternative half round bottom.
- Steps-Name required where "h" is less than 2'-6". Where "h" is 2'-6" or more, install steps with lowest rung 1'-0" above the floor and highest rung not more than 6" below top of inlet. The distance between steps shall not exceed 1'-0" and shall be uniform throughout the length of the wall. Place steps in the wall without an opening. Steps inserts may be substituted for the bar steps. Step inserts shall comply with State Industrial Safety requirements. See Standard Plan D74C for step details.
- Details shown apply to both metal and concrete pipes.
- Pipes(s) can be placed in any wall.
- Curb section shall match adjacent curb.
- Basin floors shall have wood trowel finish and a minimum slope of 1:25 from all directions toward inlet pipe.
- Set Inlet so that grate bars are parallel to direction of principal surface flow.
- See Revised Standard Plans D77A and D77B for grate and frame details and weights of miscellaneous iron and steel.
- See Standard Plan D78A for gutter depression details.
- This dimension will vary with different grates, curbs, types, box width and wall thickness.
- Bar may be rotated as necessary to clear opening, there "L" is 6" or less, bar may be omitted.
- Where "L" is 6" or less, wall thickness shall be as shown in table A.
- Cast-in-place inlets to be formed around all pipes/stubs intersecting the inlet, and concrete poured in one continuous operation. Precast inlets shall have reinforced connections conforming to details for Type GCP Inlet shown on Standard Plan D756. See Standard Specifications for mortar composition.

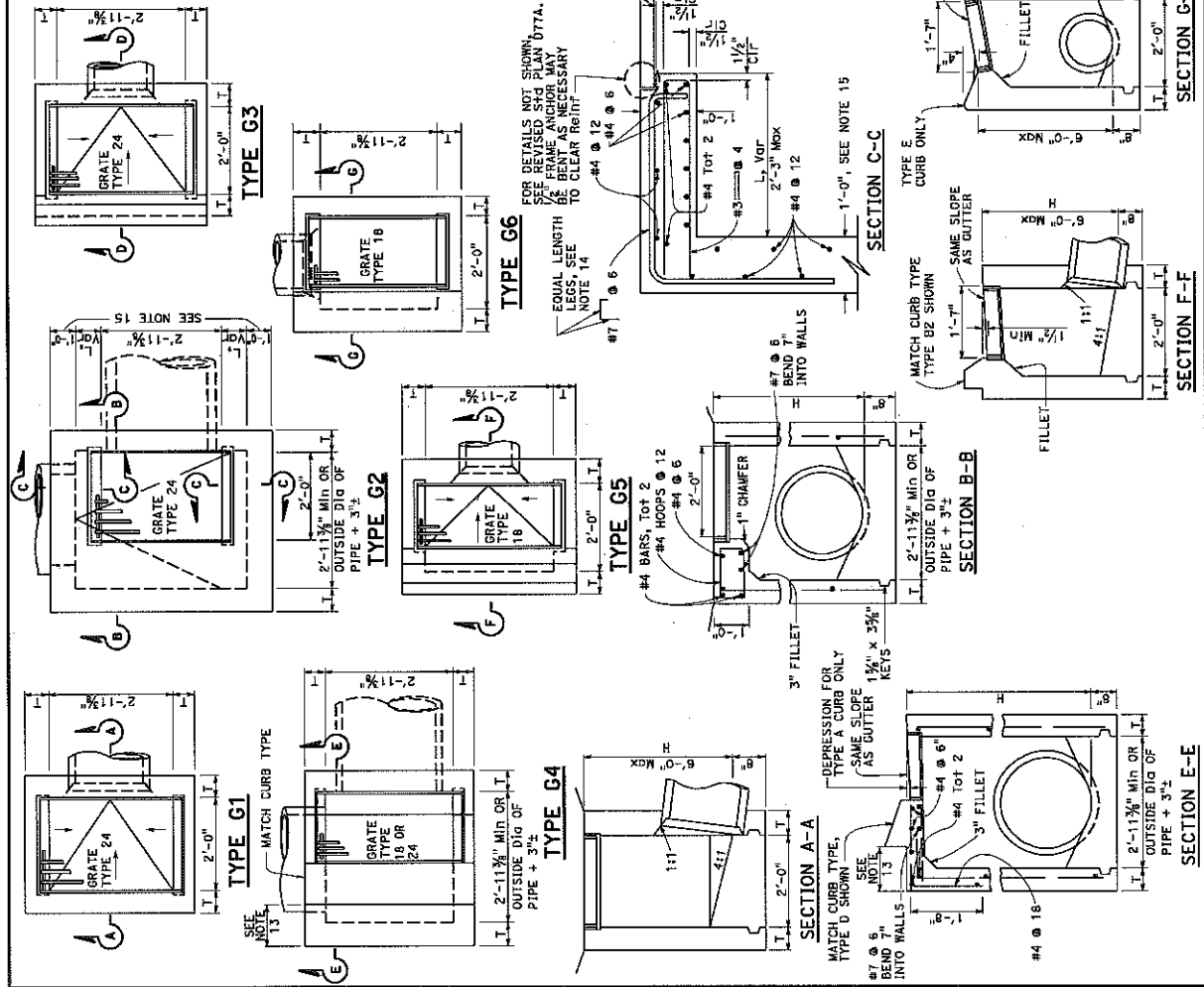

TABLE A

TYPE	CONCRETE QUANTITIES		ADDITIONAL PCC PER FOOT (CY)	SEE NOTE A	SEE NOTE A	SEE NOTE A
	H=3'-0" TO 8'-0" (T=6")	H=8'-1" TO 20'-0" (T=8")				
G-1	0.95	0.220	3.50	SEE NOTE A	SEE NOTE A	0.357
G-2 ^{1/2}	1.31	0.255	3.50	SEE NOTE A	SEE NOTE A	0.357
G-3	1.03	0.220	3.48	SEE NOTE A	SEE NOTE A	0.357
G-4 ^{1/2} (TYPE 24)	1.27	0.255	3.50	SEE NOTE A	SEE NOTE A	0.357
G-4 ^{1/2} (TYPE 18)	1.30	0.255	3.50	SEE NOTE A	SEE NOTE A	0.357
G-5	1.02	0.220	3.50	SEE NOTE A	SEE NOTE A	0.357
G-6	1.04	0.220	3.50	SEE NOTE A	SEE NOTE A	0.357

NOTE A-1
 Maximum allowable height 6'-0".

STATE OF CALIFORNIA
 DEPARTMENT OF TRANSPORTATION
DRAINAGE INLETS
 NO SCALE

REVISED STANDARD PLAN RSP D73
 RSP D73 DATED OCTOBER 19, 2012 SUPERSEDES STANDARD PLAN D73
 DATED MAY 20, 2011 - PAGE 156 OF THE STANDARD PLANS BOOK DATED 2010.

REGISTERED CIVIL ENGINEER
 JULY 20, 2012
 LICENSE APPROVAL DATE
 REGISTERED PROFESSIONAL ENGINEER
 STATE OF CALIFORNIA
 NO. 42302-14
 EXPIRES 7/20/17

TO ACCOMPANY PLANS DATED _____

NOTES:

1. Grate type numbers refer to approximate clear spacing, in inches and number of bars, respectively.
2. Contractor has the option of using cast ductile iron, cast carbon steel, welded, bolted, or cast and block grate.
3. Rounded top of bars optional on all grates.
4. Pipe inlets with a grate shall be placed so that bars parallel direction of principle surface flow.
5. Complete joint penetration butt welds may be substituted for the fillet welds on all anchors.
6. Standard square, hexagon, round or equivalent headed anchors may be substituted for the right angle hooks on the anchors shown on this plan.
7. Grate and frame weights are based on welded grates (weights of face angles, steps, protection bars, etc. are not included).
8. Connect chain to grate and frame only at locations shown on the plans. When chain is required, do not use cast ductile iron grates.

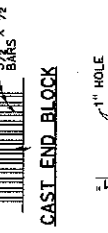
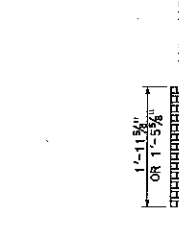

SPACING SAME AS FOR WELDED OR BOLTED GRATE.



BOTH ENDS HELD TOGETHER BY SOLID CASTING



HELD 2'-0" OF 3/4" HEAT-TREATED CHAIN TO FRAME AND GRATE. SEE NOTE 8 > 1/4" x 1/2"

6" Max BEARING BAR

W = 1/8" OR 2"

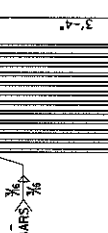
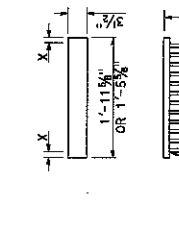

SECTION B-B

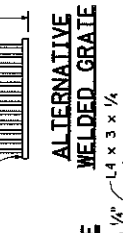

SECTION C-C

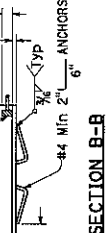

1/2" x 1/2" BOLTS FOR 5/8" HOLES OR 3/4" x 1/2" BOLTS FOR 3/4" HOLES

CUT WASHERS SPACER SPOT WELD OR PEEN

SEE TABLE

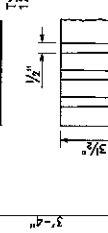
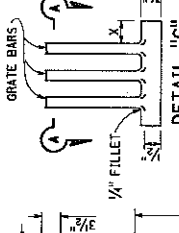

SECTION B-B

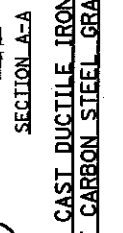

SECTION C-C

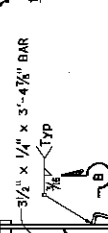

1/2" x 1/2" BOLTS FOR 5/8" HOLES OR 3/4" x 1/2" BOLTS FOR 3/4" HOLES

CUT WASHERS SPACER SPOT WELD OR PEEN

SEE TABLE

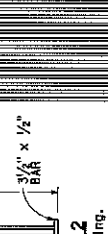
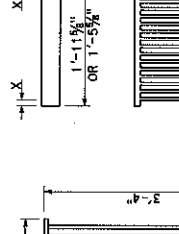

TYPE 24-9

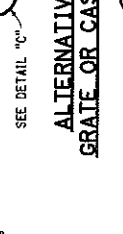

TYPE 24-12

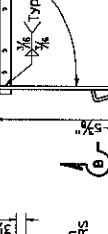

1 3/8" Clear spacing. Use in locations off roadbed on highways where bicycles and pedestrians are excluded.

1 1/2" Clear spacing. Use in locations off roadbed on highways where bicycles and pedestrians are excluded.

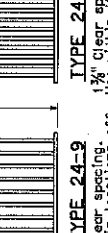
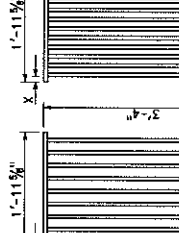

TYPE 24-9

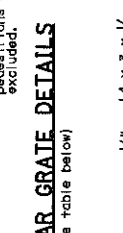

TYPE 24-12

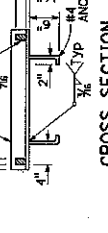

1 3/8" Clear spacing. Use in locations off roadbed on highways where bicycles and pedestrians are excluded.

1 1/2" Clear spacing. Use in locations off roadbed on highways where bicycles and pedestrians are excluded.

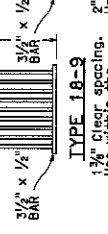
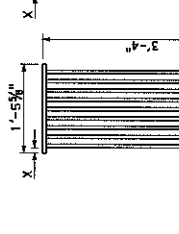

TYPE 24-9

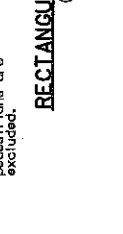

TYPE 24-12

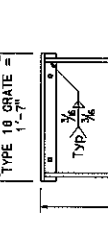

1 3/8" Clear spacing. Use in locations off roadbed on highways where bicycles and pedestrians are excluded.

1 1/2" Clear spacing. Use in locations off roadbed on highways where bicycles and pedestrians are excluded.

SEE DETAIL "C"

SEE DETAIL "C"

SEE DETAIL "C"

SEE DETAIL "C"

SEE DETAIL "C"

SEE DETAIL "C"

SEE DETAIL "C"

SEE DETAIL "C"

SEE DETAIL "C"

SEE DETAIL "C"

SEE DETAIL "C"

SEE DETAIL "C"

SEE DETAIL "C"

SEE DETAIL "C"

SEE DETAIL "C"

SEE DETAIL "C"

SEE DETAIL "C"

SEE DETAIL "C"

SEE DETAIL "C"

SEE DETAIL "C"

SEE DETAIL "C"

SEE DETAIL "C"

SEE DETAIL "C"

SEE DETAIL "C"

SEE DETAIL "C"

SEE DETAIL "C"

SEE DETAIL "C"

SEE DETAIL "C"

SEE DETAIL "C"

SEE DETAIL "C"

SEE DETAIL "C"

SEE DETAIL "C"

SEE DETAIL "C"

SEE DETAIL "C"

SEE DETAIL "C"

SEE DETAIL "C"

SEE DETAIL "C"

SEE DETAIL "C"

SEE DETAIL "C"

SEE DETAIL "C"

SEE DETAIL "C"

SEE DETAIL "C"

SEE DETAIL "C"

SEE DETAIL "C"

SEE DETAIL "C"

SEE DETAIL "C"

SEE DETAIL "C"

SEE DETAIL "C"

SEE DETAIL "C"

SEE DETAIL "C"

SEE DETAIL "C"

SEE DETAIL "C"

SEE DETAIL "C"

SEE DETAIL "C"

SEE DETAIL "C"

SEE DETAIL "C"

SEE DETAIL "C"

SEE DETAIL "C"

SEE DETAIL "C"

SEE DETAIL "C"

SEE DETAIL "C"

SEE DETAIL "C"

SEE DETAIL "C"

SEE DETAIL "C"

SEE DETAIL "C"

SEE DETAIL "C"

SEE DETAIL "C"

SEE DETAIL "C"

SEE DETAIL "C"

SEE DETAIL "C"

SEE DETAIL "C"

SEE DETAIL "C"

SEE DETAIL "C"

SEE DETAIL "C"

SEE DETAIL "C"

SEE DETAIL "C"

SEE DETAIL "C"

SEE DETAIL "C"

SEE DETAIL "C"

SEE DETAIL "C"

SEE DETAIL "C"

SEE DETAIL "C"

SEE DETAIL "C"

SEE DETAIL "C"

SEE DETAIL "C"

SEE DETAIL "C"

SEE DETAIL "C"

SEE DETAIL "C"

SEE DETAIL "C"

SEE DETAIL "C"

SEE DETAIL "C"

SEE DETAIL "C"

SEE DETAIL "C"

SEE DETAIL "C"

SEE DETAIL "C"

SEE DETAIL "C"

SEE DETAIL "C"

SEE DETAIL "C"

SEE DETAIL "C"

SEE DETAIL "C"

SEE DETAIL "C"

SEE DETAIL "C"

SEE DETAIL "C"

SEE DETAIL "C"

SEE DETAIL "C"

SEE DETAIL "C"

SEE DETAIL "C"

SEE DETAIL "C"

SEE DETAIL "C"

SEE DETAIL "C"

SEE DETAIL "C"

SEE DETAIL "C"

SEE DETAIL "C"

SEE DETAIL "C"

SEE DETAIL "C"

SEE DETAIL "C"

SEE DETAIL "C"

SEE DETAIL "C"

SEE DETAIL "C"

SEE DETAIL "C"

SEE DETAIL "C"

SEE DETAIL "C"

SEE DETAIL "C"

SEE DETAIL "C"

SEE DETAIL "C"

SEE DETAIL "C"

SEE DETAIL "C"

SEE DETAIL "C"

SEE DETAIL "C"

SEE DETAIL "C"

SEE DETAIL "C"

SEE DETAIL "C"

SEE DETAIL "C"

SEE DETAIL "C"

SEE DETAIL "C"

SEE DETAIL "C"

SEE DETAIL "C"

SEE DETAIL "C"

SEE DETAIL "C"

SEE DETAIL "C"

SEE DETAIL "C"

SEE DETAIL "C"

SEE DETAIL "C"

SEE DETAIL "C"

SEE DETAIL "C"

SEE DETAIL "C"

SEE DETAIL "C"

SEE DETAIL "C"

SEE DETAIL "C"

SEE DETAIL "C"

SEE DETAIL "C"

SEE DETAIL "C"

SEE DETAIL "C"

SEE DETAIL "C"

SEE DETAIL "C"

SEE DETAIL "C"

SEE DETAIL "C"

SEE DETAIL "C"

SEE DETAIL "C"

SEE DETAIL "C"

SEE DETAIL "C"

SEE DETAIL "C"

SEE DETAIL "C"

SEE DETAIL "C"

SEE DETAIL "C"

SEE DETAIL "C"

SEE DETAIL "C"

SEE DETAIL "C"

SEE DETAIL "C"

SEE DETAIL "C"

SEE DETAIL "C"

SEE DETAIL "C"

SEE DETAIL "C"

SEE DETAIL "C"

SEE DETAIL "C"

SEE DETAIL "C"

SEE DETAIL "C"

SEE DETAIL "C"

SEE DETAIL "C"

SEE DETAIL "C"

SEE DETAIL "C"

SEE DETAIL "C"

SEE DETAIL "C"

SEE DETAIL "C"

SEE DETAIL "C"

SEE DETAIL "C"

SEE DETAIL "C"

SEE DETAIL "C"

SEE DETAIL "C"

SEE DETAIL "C"

SEE DETAIL "C"

SEE DETAIL "C"

SEE DETAIL "C"

SEE DETAIL "C"

SEE DETAIL "C"

SEE DETAIL "C"

PROJECT NO. 001-1232
 COUNTY ROUTE TOTAL SHEETS SHEET NO. 11
 REGISTERED CIVIL ENGINEER
 JULY 20, 2012
 APPROVAL DATE
 THIS APPROVAL DATE IS VALID FOR THE PROJECT ONLY. THE ENGINEER SHALL BE RESPONSIBLE FOR THE DESIGN AND CONSTRUCTION OF THIS WORK. THE STATE OF CALIFORNIA SHALL NOT BE RESPONSIBLE FOR THE DESIGN AND CONSTRUCTION OF THIS WORK.

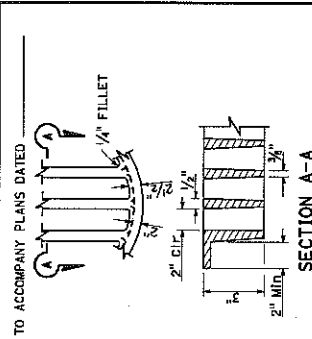

ALTERNATIVE CAST DUCTILE IRON GRATE OR CAST CARBON STEEL GRATE TYPE 36R AND 36RX

BASIS FOR MISC IRON AND STEEL FINALS PAY WEIGHTS FOR DRAINAGE INLETS

INLET TYPE	GRATE TYPE	NO. OF GRATES	WEIGHT LBS
24-10C	2	391	
24-10S	2	456	
24-12X	2	473	
24-13	2	374	
24-10C	1	202	
00, 00L, 01, 02, 03, 04 (TYPE 24)	1	239	
24-13	1	188	
18-8S	1	187	
18-9X	1	148	
18-10	1	148	
18-8S	2	374	
18-9X	2	374	
18-10	2	298	
24-10C	2	404	
24-10S	2	458	
24-12X	2	478	
24-13	2	376	
36RX (Mod)	1	196	
36RX	1	215	
36R (Mod)	1	220	
36R	1	236	
TRASH RACK			2
GRATE CHAIN			3

BICYCLE TRAVERSABLE GRATE DETAILS
 NO SCALE
 STATE OF CALIFORNIA
 DEPARTMENT OF TRANSPORTATION
 RSP D77B DATED JULY 20, 2012. SUPERSEDES STANDARD PLAN RSP D77B DATED MAY 20, 2011 - PAGE 155 OF THE STANDARD PLANS BOOK DATED 2010.

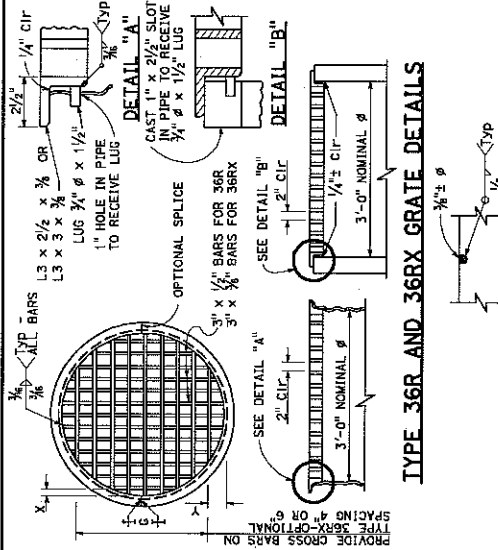

TYPE 36R AND 36RX GRATE DETAILS

3/8" ϕ Cross bars may be fillet welded, resistance welded or electroforged to 36RX GRATE (WELDED STEEL)

GRATE BAR SPACING TABLE

TYPE	NO. OF BARS	CLEAR BAR SPACING	X SPACING	Y SPACING	Z
36R	13	2 1/2"	2 1/2"	6"	-
36RX (STEEL)	15	2 1/4"	2 1/4"	5 1/4"	-
36RX (CAST)	13	2 1/4"	2 1/4"	5 1/4"	5"
36RX MOD (STEEL)	13	2 1/4"	2 1/4"	5 1/4"	5 1/4"
36RX MOD (CAST)	12	2 1/4"	2 1/4"	5 1/4"	5 1/4"

NOTES:
 1. With alternative grates are allowed - Final pay based on alternative with the lesser weight.
 2. Use frame shown on Standard Plan D74A, D74B or RSP D77A as appropriate.
 3. When Type 24-10S, 24-12X or 24-13 grates are used with 600 Inlets, a 1/2" x 3/4" steel bar shall be welded across the center of inlet frame to separate the individual grates.
 4. See Revised Standard Plan RSP D77A for connecting chain to welded grate and frame. When chain is required, do not use cast ductile iron grate.

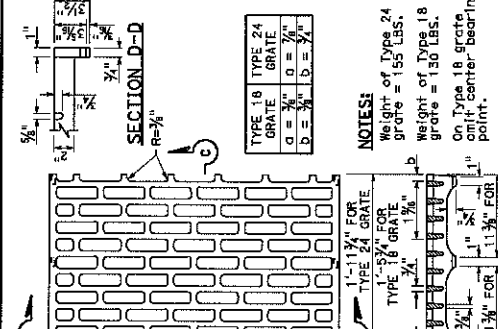

TYPE 18-8C AND 24-10C GRATE
 (Cast ductile iron)

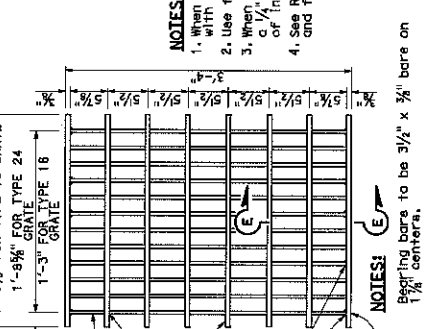

NOTES:
 1. Bearing bars to be 3/2" x 3/4" bars on 1 1/2" centers.
 2. 12 Bars for Type 24 grate - 9 bars for Type 18 grates. (Type 24 grate shown).
 Weight of Type 24 grate = 192 LBS.
 Weight of Type 18 grate = 145 LBS.
 3/4" ϕ Cross bars may be fillet welded, resistance welded or electroforged to bearing bars.

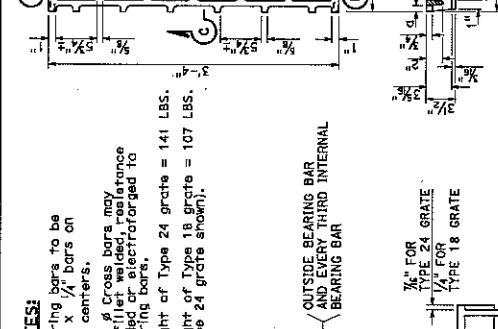

TYPE 18-10 AND 24-13 GRATE
 (Welded Steel)

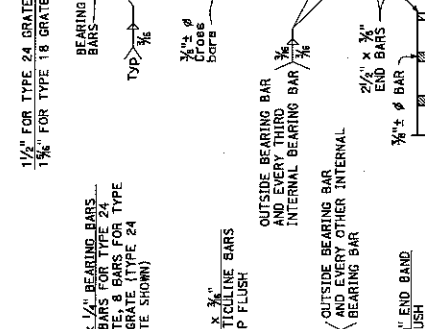

NOTES:
 1. Bearing bars to be 3/2" x 3/4" bars on 1 1/2" centers.
 2. 12 Bars for Type 24 grate - 9 bars for Type 18 grates. (Type 24 grate shown).
 Weight of Type 24 grate = 192 LBS.
 Weight of Type 18 grate = 145 LBS.
 3/4" ϕ Cross bars may be fillet welded, resistance welded or electroforged to bearing bars.

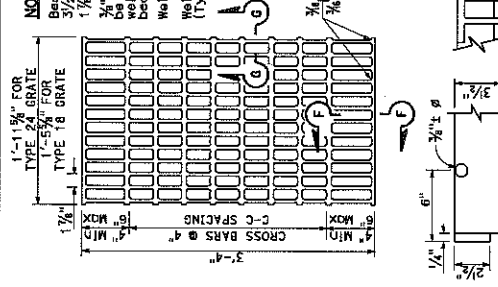

TYPE 18-8S AND 24-10S GRATE
 (Welded Steel) Reticuline type

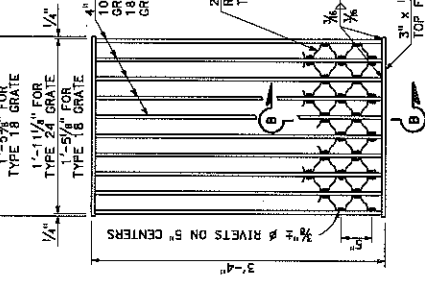

NOTES:
 1. Bearing bars to be 3/2" x 3/4" bars on 1 1/2" centers.
 2. 12 Bars for Type 24 grate - 9 bars for Type 18 grates. (Type 24 grate shown).
 Weight of Type 24 grate = 192 LBS.
 Weight of Type 18 grate = 145 LBS.
 3/4" ϕ Cross bars may be fillet welded, resistance welded or electroforged to bearing bars.