

File No. 171078

Committee Item No. 7  
Board Item No. 15

### COMMITTEE/BOARD OF SUPERVISORS

#### AGENDA PACKET CONTENTS LIST

Committee: Budget & Finance Committee

Date November 2, 2017

Board of Supervisors Meeting

Date November 14, 2017

#### Cmte Board

- |                                     |                                     |  |
|-------------------------------------|-------------------------------------|--|
| <input type="checkbox"/>            | <input type="checkbox"/>            | Motion                                       |
| <input checked="" type="checkbox"/> | <input checked="" type="checkbox"/> | Resolution                                   |
| <input type="checkbox"/>            | <input type="checkbox"/>            | Ordinance                                    |
| <input type="checkbox"/>            | <input type="checkbox"/>            | Legislative Digest                           |
| <input checked="" type="checkbox"/> | <input checked="" type="checkbox"/> | Budget and Legislative Analyst Report        |
| <input type="checkbox"/>            | <input type="checkbox"/>            | Youth Commission Report                      |
| <input type="checkbox"/>            | <input type="checkbox"/>            | Introduction Form                            |
| <input checked="" type="checkbox"/> | <input checked="" type="checkbox"/> | Department/Agency Cover Letter and/or Report |
| <input type="checkbox"/>            | <input type="checkbox"/>            | MOU  |
| <input type="checkbox"/>            | <input type="checkbox"/>            | Grant Information Form                       |
| <input type="checkbox"/>            | <input type="checkbox"/>            | Grant Budget                                 |
| <input type="checkbox"/>            | <input type="checkbox"/>            | Subcontract Budget                           |
| <input checked="" type="checkbox"/> | <input checked="" type="checkbox"/> | Contract/Agreement                           |
| <input checked="" type="checkbox"/> | <input checked="" type="checkbox"/> | Form 126 – Ethics Commission                 |
| <input type="checkbox"/>            | <input type="checkbox"/>            | Award Letter                                 |
| <input type="checkbox"/>            | <input type="checkbox"/>            | Application                                  |
| <input type="checkbox"/>            | <input type="checkbox"/>            | Public Correspondence                        |

#### OTHER

(Use back side if additional space is needed)

- |                                     |                                     |                                       |
|-------------------------------------|-------------------------------------|---------------------------------------|
| <input checked="" type="checkbox"/> | <input checked="" type="checkbox"/> | <u>Airport Commission Resolutions</u> |
| <input type="checkbox"/>            | <input type="checkbox"/>            | _____                                 |
| <input type="checkbox"/>            | <input type="checkbox"/>            | _____                                 |
| <input type="checkbox"/>            | <input type="checkbox"/>            | _____                                 |
| <input type="checkbox"/>            | <input type="checkbox"/>            | _____                                 |
| <input type="checkbox"/>            | <input type="checkbox"/>            | _____                                 |
| <input type="checkbox"/>            | <input type="checkbox"/>            | _____                                 |
| <input type="checkbox"/>            | <input type="checkbox"/>            | _____                                 |
| <input type="checkbox"/>            | <input type="checkbox"/>            | _____                                 |
| <input type="checkbox"/>            | <input type="checkbox"/>            | _____                                 |
| <input type="checkbox"/>            | <input type="checkbox"/>            | _____                                 |

Completed by: Linda Wong

Date October 27, 2017

Completed by: Linda Wong

Date November 6, 2017

1 [Airport Professional Services Agreement Modification No. 10 - CAGE Professional Services,  
2 Inc. dba CAGE, Inc. - International Terminal Checked Baggage Handling Projects - Not to  
3 Exceed \$10,695,000, and Further Modifications Not to Exceed \$14,500,000]

4 **Resolution retroactively approving Modification No. 10 to Airport Contract No. 9024.9,**  
5 **Construction Management Services for the International Terminal Checked Baggage**  
6 **Inspection System Modernization Program and Baggage Handling System**  
7 **Improvements Project, with CAGE Professional Services, Inc. dba CAGE, Inc., for a**  
8 **total amount not to exceed \$10,695,000 for services from September 30, 2017, through**  
9 **September 30, 2018, pursuant to Charter, Section 9.118(b); and approving an amount**  
10 **for further modifications to increase the total amount not to exceed \$14,500,000 for**  
11 **services through December 31, 2020.**

12  
13 WHEREAS, The International Terminal Checked Baggage Inspection System ("CBIS")  
14 Modernization Program ("Modernization Program") is a \$134,000,000 project to upgrade and  
15 replace the CBIS and Checked Baggage Resolution Area ("CBRA") for the Airport's  
16 International Terminal Building ("ITB"); the Baggage Handling System ("BHS") Improvements  
17 Project is a \$43,000,000 project to provide BHS control upgrades and improvements to the  
18 ITB BHS; and

19 WHEREAS, The Modernization Program is reimbursable under the Transportation  
20 Security Agency's ("TSA's") Recapitalization Program; the original Other Transaction  
21 Agreement with the TSA for reimbursement through the Recapitalization Program included  
22 construction management services; and

23 WHEREAS, On June 30, 2011, by Resolution No. 11-0146, the Commission awarded  
24 Contract No. 9024.9, Construction Management Services for the International Terminal and  
25

1 Terminal 3, Boarding Area F Checked Baggage Inspection Systems Modernization Program  
2 and Internal Terminal Baggage Handling System Improvements Project ("Contract") to CAGE  
3 Professional Services, Inc. dba CAGE, Inc. ("CAGE"), in the not to exceed amount of  
4 \$585,805 and a term of six months for initial services; and

5 WHEREAS, In January 2012, the Commission awarded a design-build agreement to  
6 VanDerLande Industries, Inc. in an amount not to exceed \$64,344,000 for the Modernization  
7 Program, the ITB BHS Project, Boarding Area F BHS improvements, and a BHS transfer line  
8 connecting Boarding Areas E and F; and

9 WHEREAS, By various resolutions, the Commission authorized Modification Nos. 1  
10 through 3 to the Contract with CAGE, increasing the not to exceed amount to \$7,000,000 and  
11 extending the term through June 30, 2014, for management of the design-build agreement;  
12 and

13 WHEREAS, Due to ongoing issues with the operational performance of the TSA-  
14 furnished screening equipment and its effect on Airport and airline operational capacity, in  
15 June 2014, the Airport and the TSA agreed to put the Modernization Program on hold; for this  
16 reason, the Airport determined to close out the design-build agreement with VanDerLande  
17 Industries, Inc. effective March 31, 2015, and re-scope the agreement's components; and

18 WHEREAS, The original Other Transaction Agreement ("OTA") with the TSA was  
19 successfully closed out on September 26, 2016; the TSA and the Airport agreed to include the  
20 Modernization Program in another OTA for Terminal 1 BHS work; the new OTA does not  
21 contain enough funds for reimbursement of the remainder of this Contract, so it will be funded  
22 by the Airport; and

23 WHEREAS, The Airport ultimately determined to solicit a new design-build agreement  
24 for the Modernization Program and ITB BHS upgrades, and separately solicit the Boarding  
25

1 Area F BHS work as part of the Airport's Terminal 3 West Improvements Project; the other  
2 components were completed under the VanDerLande agreement; and

3 WHEREAS, By various resolutions, the Commission authorized Modification Nos. 4, 5,  
4 6, and 8 to the Contract with CAGE, increasing the not to exceed amount to \$9,945,000 and  
5 extending the term through September 30, 2017; these modifications included support of the  
6 re-scoping of the BHS projects and the solicitation of a new design-builder for the ITB work;  
7 and

8 WHEREAS, On May 2, 2017, the Commission awarded a design-build agreement for  
9 the ITB BHS work to Skanska USA Building, Inc.; because construction management services  
10 for the Terminal 3 BHS work is no longer provided under the Contract with CAGE, the  
11 Contract title was amended through Modification No. 8 to "International Terminal Checked  
12 Baggage Inspection System Modernization Program and Baggage Handling System  
13 Improvements Project"; and

14 WHEREAS, The Airport Director executed Modifications No. 7 and 9 to the Contract  
15 with CAGE to add sub-consultants and update labor rates with no changes to the Contract  
16 amount or term; and

17 WHEREAS, By Resolution No. 17-0155 dated June 20, 2017, the Commission  
18 approved Modification No. 10 to the Contract with CAGE, increasing the not to exceed  
19 amount to \$10,695,000 and extending the term through September 30, 2018; and

20 WHEREAS, The Airport Staff estimates the total amount of construction management  
21 services required under the Contract with CAGE to support the delivery of the design-build  
22 project will not exceed \$14,500,000 for a term through December 31, 2020; and

23 WHEREAS, San Francisco Charter Section 9.118(b) provides that the agreements  
24 entered into by a department, board, or commission requiring anticipated expenditures by the  
25

1 City and County of ten million dollars or more, shall be subject to approval by the Board of  
2 Supervisors by resolution; now, therefore, be it

3 RESOLVED, That the Board of Supervisors hereby retroactively approves Modification  
4 No. 10 to Airport Contract No. 9024.9, Construction Management Services for the  
5 International Terminal Checked Baggage Inspection System Modernization Program and  
6 Baggage Handling System Improvements Project, with CAGE Professional Services, Inc. dba  
7 CAGE, Inc. for a total amount not to exceed \$10,695,000 for services from September 30,  
8 2017, through September 30, 2018, a copy of which is contained in Board of Supervisors' File  
9 No. 171078 along with the Contract and all previously executed modifications; and, be it

10 FURTHER RESOLVED, That the Board of Supervisors hereby authorizes further  
11 modifications to the Contract, upon Airport Commission approval, up to a not-to-exceed  
12 amount of \$14,500,000 for services through December 31, 2020, provided any future  
13 modification does not change other material terms of the Contract; and, be it

14 FURTHER RESOLVED, That within thirty (30) days of Modification No. 10 being fully  
15 executed by all parties, the Commission shall provide the a copy to the Clerk of the Board for  
16 inclusion in the official file.

<p><b>Item 7</b> <b>File 17-1078</b></p>	<p><b>Department:</b> San Francisco International Airport (Airport)</p>
--	---

**EXECUTIVE SUMMARY**

**Legislative Objectives**

- The proposed resolution would approve Modification #10 to the contract between the Airport and CAGE, Inc. (CAGE) for construction management services to the International Terminal Checked Baggage Inspection System and Baggage Handling System modernization projects.

**Key Points**

- The Airport entered into a construction management services contract with CAGE in 2011. The Airport has modified the contract nine times, extending the term through September 2017 and increasing the contract amount to \$9,945,000. Modification #10 extends the contract end date by one year from September 30, 2017 to September 30, 2018 and increases the contract amount by \$750,000 from \$9,945,000 to \$10,695,000.
- The proposed resolution would also authorize the Airport to enter into future contract modifications with CAGE without Board of Supervisors approval to increase the contract amount from \$10,695,000 to \$14,500,000 and extend the contract term through December 31, 2020. According to the Airport, the current Airport Commission’s policy is to renew construction management services agreements on an annual basis; the Airport is requesting to increase the contract amount and extend the contract term in the future without Board of Supervisors approval because the Airport anticipates further annual modifications for CAGE to complete construction management work at the International Terminal.
- The Budget and Analyst recommends approval of Modification #10. Because approval of future modifications without further Board of Supervisors approval does not conform to Charter Section 9.118(b), approval of future contract modifications is a policy matter for the Board of Supervisors.

**Fiscal Impact**

- The budget for the Checked Baggage Inspection System and Baggage Handling System modernization projects is \$177,000,000, of which \$100,574,183 is reimbursed by TSA, resulting in net costs to the Airport of \$76,425,817.

**Recommendations**

- Amend the proposed resolution to provide for retroactive approval to September 30, 2017.
- Approve the proposed Modification #10.
- Approval of future contract modifications without further Board of Supervisors approval is a policy matter for the Board.

**MANDATE STATEMENT**

City Charter Section 9.118(b) states that any contract (with the exception of construction contracts) entered into by a department, board or commission that (1) has a term of more than ten years, (2) requires expenditures of \$10 million or more, or (3) requires a modification of more than \$500,000 is subject to Board of Supervisors approval.

**BACKGROUND**

The San Francisco International Airport (Airport) five-year Capital Improvement Program includes upgrade and replacement of the International Terminal Checked Baggage Inspection System and Checked Baggage Handling System, and control upgrades and improvements to the Baggage Handling System. The Airport entered into an agreement with the Transportation Security Administration (TSA) to reimburse the Airport for part of the Airport's costs to modernize the Checked Baggage Inspection System and the Baggage Handling System.

In June 2011, the Airport entered into a construction management services contract with CAGE, Inc. (CAGE), following a competitive Request for Proposals (RFP), for modernization of the Checked Baggage Inspection System and the Baggage Handling System at the International Terminal and Terminal 3 Boarding Area F. The initial contract between the Airport and CAGE was for the not to exceed amount of \$585,805 and an initial term of six months through December 2011 in order for CAGE to provide technical design review for the project. The Airport has modified the contract nine times, extending the term through September 2017 and increasing the contract amount by \$9,359,495, from \$585,505 to \$9,945,000, as shown in Table 1 below.

**Table 1: Original Contract and Modifications**

<b>Contract and Modification</b>	<b>Begin Date</b>	<b>End Date</b>	<b>Amount</b>	<b>Increase</b>
Original Agreement	June 2011	Dec 2011	\$585,505	
Mod. #1	Dec 2011	Dec 2013	\$5,408,614	\$4,823,109
Mod. #2	July 2012	Dec 2013	\$6,189,414	780,800
Mod. #3	Dec 2013	June 2014	\$7,000,000	810,586
Mod. #4	June 2014	Dec 2014	\$7,800,000	800,000
Mod. #5	Dec 2014	Sep 2015	\$8,595,000	795,000
Mod. #6	Sep 2015	Sep 2016	\$9,945,000	1,350,000
Mod. #7	Sep 2015	Sep 2016	\$9,945,000	0
Mod. #8	Sep 2016	Sep 2017	\$9,945,000	0
Mod. #9	Sep 2016	Sep 2017	\$9,945,000	0
<b>Total</b>				<b>\$9,359,495</b>

According to Ms. Geri Rayca, Airport Contract Management Unit Manager, the Airport has entered into nine contract modifications for a contract total of \$9,945,000, which is \$55,000 less than the threshold amount of \$10,000,000 that requires Board of Supervisors approval under Charter Section 9.118(b), because the Airport typically awards professional service contracts for construction-related services on a one-year term with annual contract renewals.

According to Ms. Rayca, the nine contract modifications were both due to annual contract renewals and due to ongoing issues with the performance of TSA-furnished screening equipment that affected airline operational capacity. The Airport entered into a design-build contract for modernization of the Checked Baggage Inspection System and Baggage Handling System with VanDerLande Industries, Inc. in January 2012, but the Airport and TSA decided to put the project on hold and closed out the contract with VanDerLande in March 2015, after completion of the project at Terminal 3, but prior to completion of the project at the International Terminal. Close out of the VanDerLande contract required additional work for CAGE, including auditing and review of costs.

After agreeing with the TSA to resume the project, the Airport entered into a design-build contract with Skanska USA Building Inc. (Skanska) in May 2017 for the remaining Checked Baggage Inspection System and Baggage Handling System modernization projects at the International Terminal. The original agreement between the Airport and TSA to reimburse the Airport for the Checked Baggage Inspection System, and the Baggage Handling System modernization expired on September 26, 2016, but TSA allowed the Airport to include the International Terminal Checked Baggage Inspection System and Baggage Handling System modernization projects into another agreement, which had been designated for Terminal 1 work.

#### **DETAILS OF PROPOSED LEGISLATION**

The proposed resolution would approve Modification #10 to the contract between the Airport and CAGE for construction management services to the International Terminal Checked Baggage Inspection System and Baggage Handling System modernization projects. Modification #10 extends the contract end date by one year from September 30, 2017 to September 30, 2018, and increases the contract amount by \$750,000 from \$9,945,000 to \$10,695,000.

The proposed resolution would also authorize the Airport to enter into future contract modifications with CAGE without Board of Supervisors approval to increase the contract amount from \$10,695,000 to \$14,500,000 and extend the contract term through December 31, 2020. According to Ms. Rayca, the Airport is requesting to increase the contract amount and extend the contract term without Board of Supervisors approval because the Airport anticipates further annual modifications for CAGE to complete construction management work at the International Terminal.

The current contract between the Airport and CAGE expired on September 30, 2017. Therefore, the proposed resolution should be amended to provide for retroactive approval.

#### **FISCAL IMPACT**

The budget for the Checked Baggage Inspection System and Baggage Handling System modernization projects in the International Terminal and Terminal 3 Boarding Area F<sup>1</sup> is

<sup>1</sup> As noted above, the Terminal 3 project was completed in March 2015.



\$177,000,000, of which \$100,574,183 is reimbursed by TSA, resulting in net costs to the Airport of \$76,425,817, as shown in Table 2 below.

**Table 2: Project Budget and Reimbursements**

<b>Contractor</b>	<b>Budget</b>
VanDerLande	\$83,000,000
Skanska	77,500,000
CAGE	14,500,000
Internal Costs	2,000,000
<i>Total Costs</i>	<i>\$177,000,000</i>
TSA Reimbursements Received	41,144,777
TSA Reimbursements Expected	59,429,406
<i>Total TSA Reimbursements</i>	<i>\$100,574,183</i>
<b>Net Cost to Airport</b>	<b>\$76,425,817</b>

The total contract not to exceed amount authorized by the proposed resolution is \$14,500,000, of which \$2,308,256 is reimbursed by TSA, for net costs to the Airport of \$12,191,744, as shown in Table 3 below.

**Table 3: Summary of Estimated Payments to CAGE**

<b>Contract Modification</b>	<b>Authorized Amount</b>	<b>Paid to CAGE</b>	<b>Reimbursed by TSA</b>	<b>Net Cost to Airport</b>
Initial Contract and Modifications 1-9	\$9,945,000	\$8,962,145	\$2,308,256	\$6,653,889
Modification 10 (Expected)	<u>750,000</u>	<u>1,732,855</u>	<u>0</u>	<u>1,732,855</u>
Subtotal	\$10,695,000	\$10,695,000	\$2,308,256	\$8,386,744
Future Modifications (Expected)	<u>3,805,000</u>	<u>3,805,000</u>	<u>0</u>	<u>3,805,000</u>
Total	\$14,500,000	\$14,500,000	\$2,308,256	\$12,191,744

The Budget and Analyst recommends approval of Modification #10 to increase the contract amount by \$750,000, from \$9,945,000 to \$10,695,000 and extend the contract end date by one year from September 30, 2017 to September 30, 2018. Because approval of future modifications without further Board of Supervisors approval does not conform to Charter Section 9.118(b), approval of future contract modifications to increase the contract amount by \$3,805,000, from \$10,695,000 to \$14,500,000, and extend the term to December 31, 2020 is a policy matter for the Board of Supervisors.

**RECOMMENDATIONS**

1. Amend the proposed resolution to provide for retroactive approval to September 30, 2017.
2. Approve the proposed Modification #10.
3. Approval of future contract modifications without further Board of Supervisors approval is a policy matter for the Board.

**City and County of San Francisco  
Airport Commission  
P.O. Box 8097  
San Francisco, California 94128**

**Modification No. 10**

**Contract No. 9024.9**

**Construction Management Services for the International Terminal Checked Baggage Inspection System Modernization and Baggage Handling System Improvements Project**

THIS MODIFICATION (this "Modification") is made as of **June 20, 2017**, in San Francisco, California, by and between **CAGE Professional Services, Inc.** ("Contractor"), and the City and County of San Francisco, a municipal corporation ("City"), acting by and through its Airport Commission or the Commission's designated agent, hereinafter referred to as "**Commission.**"

**RECITALS**

WHEREAS, City and Contractor have entered into the Agreement (as defined below); and

WHEREAS, on June 30, 2011, by Resolution No. 11-0146, the Commission awarded this Agreement to the Contractor; and

WHEREAS, on October 4, 2011, by Resolution Number 11-0221 the Commission approved Modification No. 1 for a new term ending on December 31, 2013; and

WHEREAS, on July 17, 2012, by Resolution Number 12-0158, the Commission approved Modification No. 2 to increase the contract amount and modify the consultants' overhead rates; and

WHEREAS, on December 3, 2013, by Resolution Number 13-0248, the Commission approved Modification No. 3 for a new term ending June 30, 2014; and

WHEREAS, on June 17, 2014, by Resolution Number 14-0124, the Commission approved Modification No. 4 for a new term ending December 31, 2014; and

WHEREAS, on December 2, 2014, by Resolution Number 14-0249, the Commission approved Modification No. 5 for a new term ending September 30, 2015; and

WHEREAS, on September 1, 2015, by Resolution Number 15-0171, the Commission approved Modification No. 6 for a new term ending September 30, 2016; and

WHEREAS, on November 1, 2015, City and Contractor through Modification No. 7 administratively modified the Agreement to include new subconsultants and services; and

WHEREAS, on August 9, 2016, by Resolution Number 16-0221, the Commission approved Modification No. 8 for a new term ending September 30, 2017, approved revising the Agreement title to "Construction Management Services for the International Terminal Checked Baggage Inspection System Modernization Program and Baggage Handling System Improvements" to reflect the new direction for implementation of the projects, and updated labor and overhead rates; and

WHEREAS, on October 1, 2016, City and Contractor through Modification No. 9 administratively modified the Agreement to update a subconsultant's overhead rate; and

WHEREAS, City and Contractor desire to modify the Agreement on the terms and conditions set forth herein to extend the contract duration for a new ending date of September 30, 2018, to increase the contract amount, and to make other administrative changes; and

WHEREAS, on June 20, 2017, by Resolution No. 17-0155, the Commission approved this Modification to the Agreement to increase the contract amount by \$750,000, for a not-to-exceed total contract amount of \$10,695,000, and extend the term of the contract through September 30, 2018; and

WHEREAS, on \_\_\_\_\_ by Resolution No. \_\_\_\_\_, the Board of Supervisors approved the Agreement under San Francisco Charter Section 9.118; and

WHEREAS, approval for this Agreement was obtained when the Civil Service Commission approved PSC No. 4099-09/10 on September 19, 2016; and

NOW, THEREFORE, Contractor and the City agree as follows:

**1. Definitions.** The following definitions shall apply to this Modification:

**a. Agreement.** The term "Agreement" shall mean the Agreement dated June 30, 2011 between Contractor and City, as amended by the:

First Amendment,	dated October 4, 2011; and
Second Amendment,	dated July 17, 2012; and
Third Amendment,	dated December 3, 2013; and
Fourth Modification,	dated June 17, 2014; and
Fifth Modification,	dated December 2, 2014; and
Sixth Modification,	dated September 1, 2015; and
Seventh Modification,	dated November 1, 2015; and
Eighth Modification,	dated August 9, 2016; and
Ninth Modification,	dated October 1, 2016.

**b. Other Terms.** Terms used and not defined in this Modification shall have the meanings assigned to such terms in the Agreement.

**2. Section 2. Term of the Agreement** is hereby amended to extend the term of the contract through September 30, 2018.

**3. Section 5. Compensation** is hereby amended as follows:

Paragraph A of Section 5, Compensation, is deleted in its entirety and replaced with the following language:

A. Compensation shall be made in monthly payments on or before the 30th day of each month for work, as set forth in Section 4 of this Agreement, that the Airport Director or designee, in his or her sole discretion, concludes has been performed as of the last day of the immediately preceding month. In no event shall the amount of this Agreement exceed **Ten Million Six Hundred Ninety Five Thousand Dollars (\$10,695,000)**. The breakdown of costs associated with this Agreement appears in Appendix B.4,

"Calculation of Charges," attached hereto and incorporated by reference as though fully set forth herein. No charges shall be incurred under this Agreement nor shall any payments become due to Contractor until reports, services, or both, required under this Agreement are received from Contractor and approved by the Airport as being in accordance with this Agreement. City may withhold payment to Contractor in any instance in which Contractor has failed or refused to satisfy any material obligation provided for under this Agreement.

**4. Section 65 Federal Contract Provisions is amended as follows:**

Section 65.B, CIVIL RIGHTS ACT OF 1964, TITLE VI – CONTRACTOR CONTRACTUAL REQUIREMENTS is deleted in its entirety and replaces with the following:

**B. Federal Nondiscrimination Requirements.** During the performance of this Agreement, Contractor, for itself, its assignees, and successors in interest (hereinafter referred to as "Contractor") agrees as follows:

1. **Compliance with Regulations:** Contractor (hereinafter includes consultants) will comply with the Title VI List of Pertinent Nondiscrimination Acts And Authorities, as they may be amended from time to time, which are herein incorporated by reference and made a part of this Agreement.

2. **Non-Discrimination:** Contractor, with regard to the work performed by it during the Agreement, will not discriminate on the grounds of race, color, or national origin in the selection and retention of subcontractors, including procurements of materials and leases of equipment. Contractor will not participate directly or indirectly in the discrimination prohibited by the Nondiscrimination Acts and Authorities, including employment practices when the Agreement covers any activity, project, or program set forth in Appendix B of 49 CFR part 21.

3. **Solicitations for Subcontracts: Including Procurements of Materials and Equipment:** In all solicitations, either by competitive bidding, or negotiation made by Contractor for work to be performed under a subcontract, including procurements of materials, or leases of equipment, each potential subcontractor or supplier will be notified by Contractor of Contractor's obligations under this Agreement and the Nondiscrimination Acts And Authorities on the grounds of race, color, or national origin.

4. **Information and Reports:** Contractor will provide all information and reports required by the Acts, the Regulations, and directives issued pursuant thereto and will permit access to its books, records, accounts, other sources of information, and its facilities as may be determined by the Airport or the Federal Aviation Administration to be pertinent to ascertain compliance with such Nondiscrimination Acts And Authorities and instructions. Where any information required of a contractor is in the exclusive possession of another who fails or refuses to furnish the information, the contractor will so certify to the Airport or the Federal Aviation Administration, as appropriate, and will set forth what efforts it has made to obtain the information.

5. **Sanctions for Noncompliance:** In the event of a contractor's noncompliance with the Non-discrimination provisions of this Agreement, the Airport will impose such contract sanctions as it or the Federal Aviation Administration may determine to be appropriate, including, but not limited to:

(a) Withholding payments to the contractor under the contract until the contractor complies; and/or

(b) Cancelling, terminating, or suspending a contract, in whole or in part.

6. **Incorporation of Provisions:** Contractor will include the provisions of paragraphs B.1 through B.6 in every subcontract, including procurements of materials and leases of equipment, unless exempt by the Acts, the Regulations and directives issued pursuant thereto. Contractor will take action with

respect to any subcontract or procurement as the Airport or the Federal Aviation Administration may direct as a means of enforcing such provisions including sanctions for noncompliance. Provided, that if Contractor becomes involved in, or is threatened with litigation by a subcontractor, or supplier because of such direction, Contractor may request the Airport to enter into any litigation to protect the interests of the Airport. In addition, Contractor may request the United States to enter into the litigation to protect the interests of the United States.

7. **Title VI List of Pertinent Nondiscrimination Acts and Authorities.** During the performance of this Agreement, Contractor, for itself, its assignees, and successors in interest (hereinafter referred to as the "Contractor") agrees to comply with the following non-discrimination statutes and authorities; including but not limited to:

- Title VI of the Civil Rights Act of 1964 (42 U.S.C. § 2000d *et seq.*, 78 stat. 252), (prohibits discrimination on the basis of race, color, national origin);
- 49 CFR part 21 (Non-discrimination In Federally-Assisted Programs of The Department of Transportation—Effectuation of Title VI of The Civil Rights Act of 1964);
- The Uniform Relocation Assistance and Real Property Acquisition Policies Act of 1970, (42 U.S.C. § 4601), (prohibits unfair treatment of persons displaced or whose property has been acquired because of Federal or Federal-aid programs and projects);
- Section 504 of the Rehabilitation Act of 1973, (29 U.S.C. § 794 *et seq.*), as amended, (prohibits discrimination on the basis of disability); and 49 CFR part 27;
- The Age Discrimination Act of 1975, as amended, (42 U.S.C. § 6101 *et seq.*), (prohibits discrimination on the basis of age);
- Airport and Airway Improvement Act of 1982, (49 USC § 471, Section 47123), as amended, (prohibits discrimination based on race, creed, color, national origin, or sex);
- The Civil Rights Restoration Act of 1987, (PL 100-209), (Broadened the scope, coverage and applicability of Title VI of the Civil Rights Act of 1964, The Age Discrimination Act of 1975 and Section 504 of the Rehabilitation Act of 1973, by expanding the definition of the terms "programs or activities" to include all of the programs or activities of the Federal-aid recipients, sub-recipients and contractors, whether such programs or activities are Federally funded or not);
- Titles II and III of the Americans with Disabilities Act of 1990, which prohibit discrimination on the basis of disability in the operation of public entities, public and private transportation systems, places of public accommodation, and certain testing entities (42 U.S.C. §§ 12131 – 12189) as implemented by Department of Transportation regulations at 49 CFR parts 37 and 38;
- The Federal Aviation Administration's Non-discrimination statute (49 U.S.C. § 47123) (prohibits discrimination on the basis of race, color, national origin, and sex);
- Executive Order 12898, Federal Actions to Address Environmental Justice in Minority Populations and Low-Income Populations, which ensures non-discrimination against minority populations by discouraging programs, policies, and activities with disproportionately high and adverse human health or environmental effects on minority and low-income populations;
- Executive Order 13166, Improving Access to Services for Persons with Limited English Proficiency, and resulting agency guidance, national origin discrimination includes discrimination because of limited English proficiency (LEP). To ensure compliance with Title VI, you must take reasonable steps to ensure that LEP persons have meaningful access to your programs (70 Fed. Reg. at 74087 to 74100);
- Title IX of the Education Amendments of 1972, as amended, which prohibits you from discriminating because of sex in education programs or activities (20 U.S.C. 1681 *et seq.*).

6. **New Section 66. Airport Commission Rules and Regulations** is hereby added to read as follows:

**66. Airport Commission Rules and Regulations.** Contractor agrees to comply with the Airport Commission's Rules and Regulations for the San Francisco International Airport as amended from time to time. A copy of the current Rules and Regulations can be found at: <http://www.flysfo.com/about-sfo/the-organization/rules-and-regulations>.

7. **New Section 67. Federal Fair Labor Standard Act** is hereby added to read as follows:

**67. Federal Fair Labor Standards Act.** This Agreement incorporates by reference the provisions of 29 CFR part 201, the Federal Fair Labor Standards Act (FLSA), with the same force and effect as if given in full text. The FLSA sets minimum wage, overtime pay, recordkeeping, and child labor standards for full and part time workers. Contractor has full responsibility to monitor compliance to the referenced statute or regulation. Contractor must address any claims or disputes that arise from this requirement directly with the U.S. Department of Labor – Wage and Hour Division.

8. **New Section 68. Occupational Safety and Health Act of 1970** is hereby added to read as follows:

**68. Occupational Safety and Health Act of 1970.** This Agreement incorporates by reference the requirements of 29 CFR Part 1910 with the same force and effect as if given in full text. Contractor must provide a work environment that is free from recognized hazards that may cause death or serious physical harm to the employee. Contractor retains full responsibility to monitor its compliance and their subcontractor's compliance with the applicable requirements of the Occupational Safety and Health Act of 1970 (20 CFR Part 1910). Contractor must address any claims or disputes that pertain to a referenced requirement directly with the U.S. Department of Labor – Occupational Safety and Health Administration.

9. **Appendices Deleted.** All Appendices incorporated in this Agreement prior to the date of this Modification are deleted in their entirety. The following Appendices are incorporated through this Modification:

Appendix A.3 – Services to be Provided by Contractor



Appendix B.4 – Calculation of Charges

Appendix C.4 – Other Transaction Agreement No. HSTS04-13-H-CT1140

10. **Effective Date.** Each of the changes set forth in this Modification shall be effective on and after the date of this Modification.

11. **Legal Effect.** Except as expressly changed by this Modification, all of the terms and conditions of the Agreement shall remain unchanged and in full force and effect.

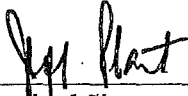
IN WITNESS WHEREOF, Contractor and City have executed this Modification as of the date first referenced above.

CITY	CONTRACTOR
AIRPORT COMMISSION CITY AND COUNTY OF SAN FRANCISCO	
By: _____ Ivar C. Satero, Airport Director	 _____ Authorized Signature
Attest:	Jeff Plant President CAGE Professional Services, Inc. 6303 Commerce Drive, Suite 150 Irving, Texas 75063 972-550-1001
By _____ Jean Caramatti, Secretary Airport Commission	81238 City Vendor Number
Resolution No: 17-0155	75-2722503 Federal Employer ID Number
Adopted on: June 20, 2017	
Approved as to Form:	
Dennis J. Herrera City Attorney	
By  Heather Wolnick Deputy City Attorney	

- Appendix A.3 – Services to be Provided by Contractor
- Appendix B.4 – Calculation of Charges
- Appendix C.4 – Other Transaction Agreement No. HSTS04-13-H-CT1140

**Appendix A.3**  
**Services to be provided by Contractor**

This Appendix A.3, Scope of Services, incorporated through Modification No. 10 replaces Appendix A, "Services to be provided by Contractor" dated June 30, 2011, Appendix A.1 incorporated into the Agreement through the First Amendment, Supplemental Appendix A.2 incorporated into the Agreement through Modification No. 6 and revisions to Appendix A.2 incorporated through Modification No. 7.

**1. INTRODUCTION**

**PROJECT DESCRIPTION:**

The following is a general project description for the International Terminal Checked Baggage Inspection System Modernization and International Terminal Baggage Handling System Improvements Project (Project). The Airport reserves the right to amend this description.

- A. **International Terminal Checked Baggage Inspection System (CBIS) Modernization.** The International Terminal common use terminal systems are shared by various airlines and operated and maintained by an airline consortium contractor (SFOTEC), including the Baggage Handling System (BHS). Two existing checked baggage inspection system (CBIS) areas are not in compliance with the Transportation Security Administration's (TSA) current Planning Design Guidelines (PGDS v5.0), and the TSA screening equipment is at the end of its useful life. The CBIS improvements will include: new TSA screening equipment with higher throughput; new servers, new network; new network and programmable logic controls (PLC); new distributed input/output (I/O) controls; new Human Machine Interface (HMI); new and reconfigured baggage conveyor equipment; and new and relocated Checked Bag Reconciliation Areas (CBRA's). The two CBRA's will be on the ground floor and will be enclosed in new air conditioned rooms.
- B. **Terminal 3 Boarding Area F CBIS Modernization.** Deleted.
- C. **International Terminal BHS Improvements.** The common use International Terminal BHS includes twelve ticket islands, twenty four outbound makeup devices, and oversize and transfer bag systems. The common use inbound BHS includes twelve drop off and claim carousels. The common use terminal management system, baggage sortation system and airline tag readers were recently replaced. The Airport will consider adding improved tracking technology. Other portions of the BHS are obsolete and at the end of its useful life. The International Terminal BHS improvements will include: new servers, new network and PLC; new HMI; new I/O controls; new high speed/capacity diverters to replace pushers; variable frequency drives and other energy-saving equipment.
- D. **Other Transaction Agreement.** The Airport and the TSA have entered into an Other Transaction Agreement No. HSTS04-13-H-CT1140 (OTA), executed on September 26, 2013, for 100% reimbursement of design and construction costs for the Modernization Program under the TSA's Recapitalization Program. The executed OTA will become part of the Contractor's agreement (Appendix C.4) and the Contractor will be responsible for the management, reporting, implementation, and ensuring Airport compliance with the terms and conditions of the OTA.

**2. GENERAL CONSTRUCTION MANAGEMENT SCOPE DESCRIPTION:**



The Contractor will provide the following services:

- A. Provide design submittal technical reviews for constructability, functionality, value engineering, building code and PGDS compliance for the International Terminal and Terminal 3, Boarding Area F CBIS Modernization, including baggage handling systems, architectural, structural, vertical transportation, mechanical, electrical, fire protection and special systems.
- B. Provide design submittal technical reviews for constructability, functionality, value engineering and building code compliance for the International Terminal BHS Improvements, including baggage handling systems, structural, mechanical, electrical, fire protection and special systems.
- C. Track and document all design review comments by the TSA, Airport, airlines and other stakeholders.
- D. Review and validate the Airport design consultant's cost estimates with current industry pricing.
- E. Provide scheduling analysis for the design, design-build contractor selection, and procurement, installation and certification process. Scheduling analysis will emphasize construction phasing in an operational environment.
- F. Provide monthly status, cost and schedule reports in accordance with TSA and Airport guidelines.
- G. Prepare invoice summaries, with a separate accounting system for all costs that are eligible for reimbursement by the TSA under the OTA. Assist the Airport in preparing invoices to the TSA.
- H. Provide technical assistance to the Airport in the preparation of a Request for Proposal (RFP) for the design-build contractor.
- I. Initiate meetings and communication with all stakeholders to achieve a collaborative process.
- J. Provide timely meeting reports and an issues/action log, with responsible party and due dates.
- K. Provide administrative support to the Airport Project Manager (PM). Initiate communication with the PM first as a pre-requisite to discussions with other Airport, airline and TSA management.
- L. Provide administrative and technical support to the Airport to close out the completed design-build contract and submit timely reimbursement requests to the TSA.
- M. Provide support services for design coordination and cost estimating for a future design-build RFQ/RFP.
- N. Provide general contract administration and project management support services in support of all construction activities.

### 3. CONSTRUCTION MANAGEMENT SCOPE DESCRIPTION

The Contractor shall provide all labor, materials, equipment and services to provide the following construction management services:

**A. Project Controls and Reporting.**

1. The Contractor shall provide a comprehensive project control system that has been successfully deployed and approved by the Commission. The project controls and reporting system shall be capable of complying with the reporting requirements mandated for federally funded projects. The Contractor shall recommend a format to use for deliverables and shall adjust the format to meet the requirements of the Airport.
2. The Contractors deliverables and reports shall be in electronic format compatible with the Airport's current software applications and must be accompanied by multiple hard copy color duplicates, unless alternatives are proposed and accepted for use by the Airport.
3. The following Project deliverables shall be provided by the Contractor during all tasks and phases of the Project:

a. Monthly Cost Reports:

- (i) Prepare and submit monthly cost and budget reports;
- (ii) Monitor actual Project costs, including costs and payments to Contractors and Contractors;
- (iii) Monitor expenditures incurred by Airport staff and all Project participants;
- (iv) Prepare monthly cash flow and trend reports and additional reports as may be requested by the Airport; and
- (v) Anticipate and report all potential Project issues. Provide cost recovery recommendations on a monthly basis.

b. Monthly Schedule Reports

Updated Schedule: Monitor progress in relationship to the existing baseline schedules. Prepare detailed monthly schedule reports and schedule trend reports. Provide schedule recovery recommendations on a monthly basis.

c. Monthly Progress Reports

Provide a monthly report including a concise executive summary and a comprehensive matrix of significant project achievements, risks and problems, responsible parties, and anticipated resolution date. The Contractor will provide a critique of the work product of the designer and the design-build Contractor. Report information will not carry over from month to month.

- (i) Prepare Project progress reports: Reports shall be developed to the appropriate level suitable for distribution to different management levels within the Airport organization

as well as the TSA and airlines. Provide reports monthly, quarterly, annually, or at frequencies specified by the Airport.

- (ii) Collect scope, schedule and budget data from information provided by Airport staff, other Contractors and Contractors, and outside agencies. Compile and present the information in a comprehensive format.
  - (iii) Provide a monthly status, cost and schedule reports in accordance with TSA and Airport guidelines. Include an executive summary; listing of significant issues, responsible parties and anticipated resolution dates; reports on payments, cash flow, and cost trends; and a detailed progress schedule, tracked against the original baseline schedule.
- d. Construction Manager's Monthly Report.

The Contractor will submit a written monthly report to the Airport detailing services provided to the Airport under this Agreement. The Contractor will report on its progress and document any problems known by the Contractor in performing the work.

- e. The Project will be managed by the Contractor to comply with the terms of the OTA and maintain reimbursement eligibility. The Contractor will be responsible for the management, reporting, implementation, and compliance with the terms and conditions of the OTA which is Appendix D of this agreement.

## **B. Project Scheduling Services**

- 1. The Contractor shall:
  - a. Compile and validate Project schedules from all Airport designers, Contractors, and/or design-builders, as well as external agencies.
  - b. Generate Project schedules, including all design phase schedules.
  - c. Develop, review, and monitor Project schedules at various levels appropriate to the required management level during all Project phases.
  - d. Identify and analyze dependencies, controls, and interfaces between the Project, with other airport operational activities, and/or with external projects. Perform Project analysis sequences to optimize project implementation.
  - e. Review and monitor construction schedules and coordinate schedules with other Airport projects.
  - f. Provide schedule reporting and analysis services at the appropriate management level.
  - g. Review and verify written daily, weekly and monthly phasing, installation, cutover and contingency plans with the design-build Contractor and lead coordination meetings with Airport, TSA and airline stakeholders as necessary. Written reports shall be timely and with sufficient notice before work commences.

### **C. Project Budget Services**

1. The Contractor shall support the Airport's financial analyses by:
  - a. Preparing and reviewing Project hard and soft cost budget estimates resulting in the establishment of a Project budget.
  - b. Review actual costs reports, invoices, and supporting documentation against the Project budget. Verify the accuracy of segregated TSA reimbursable costs and Airport costs and summarize actual costs for each funding source.
  - c. Provide Project level cost and trend management services for design, Contractor and design-build costs, segregated by TSA and Airport funding sources.
  - d. Provide a wide range of cost estimates, including pre-construction, concept, budgetary, design, construction, and engineer's estimates.
  - e. Establish a cost management system in alignment with, and supportive of, the Airport's budgeting and accounting requirements and systems.
  - f. Establish, review, and support management of appropriate budgetary contingencies and reviewing Project risks.
  - g. Provide budget and funding report services, documenting sources of funds, and provide cash flow projections for the Project.
  - h. Develop and maintain procedures to forecast Project costs and advise the Airport on corrective actions if budget forecasts are to be exceeded.
  - i. Prepare reports and maintain compliance with all OTA and federal regulations; including invoice preparation and tracking.

### **D. Document Control Services**

1. The Contractor shall:
  - a. Maintain files of all Project documentation in an integrated, accessible electronic format with a hard copy stored in a retrievable system.
  - b. Maintain status logs of Project documents such as: design activities and status reports, requests for information, submittals, substitution requests, etc.
  - c. Assess current computerized document control/reporting systems and recommend upgrades or replacements to support the Project and all associated projects.
  - d. Develop and maintain systems for the efficient distribution of Project documents to Contractors, agencies; City departments, and other stakeholders as directed.

### **E. Project Coordination**

1. The Contractor shall:

- a. Assist Airport staff with Project coordination and development efforts with Airport operations, airlines, TSA and other stakeholders.
- b. Assist with the establishment, implementation, and modification of Project administrative procedures, including contract preparation.
- c. Implement and support a timely Action Item system to track key Project activities, naming the person responsible for each action item and due date.
- d. Coordinate and document stakeholder programming and design review input.
- e. Assist Airport staff with identifying and coordinating Airport and tenant utilities and existing conditions infrastructure documentation.
- f. Assist Airport staff with TSA security systems and equipment coordination.
- g. Assist Airport staff with maintaining active terminal operations, phasing, protection, environmental issues, off-hours work, utility cutovers and associated activities.
- h. Document all meetings for the duration of the Project. Meeting reports will be written only by qualified Contractor staff experienced in the subject matter. In order to enhance productivity, the Contractor will provide a concise meeting format including brief description, the individual responsible, and due date. The Contractor will limit meeting discussions and adjust participation, as much as possible, to those individuals directly responsible for the subject matter. The Contractor will distribute weekly meeting look ahead schedules, including limited invitation lists.
- i. Initiate communication first with the Airport Project Manager on Project related issues as a pre-requisite to discussions with other Airport, airline and TSA management and staff. The Contractor shall report all discussions initiated by other Airport, airline and TSA management and staff to the Airport Project Manager. The Contractor shall only accept direction from the Airport Project Manager.
- j. Establish email communication standards. These communication standards, to be implemented by the Airport Project Manager, designer, and Contractor, shall be structured to limit communication to factual discussion and is addressed only to those individuals directly involved unless directed otherwise by the Airport Project Manager. The standards shall specify that individual responses to email received will not be transmitted "reply to all" unless justified. Emails will not be copied or forwarded to supervisors without prior agreement. Extended discussions will be by telephone, with the result documented by email.

**F. Project Planning**

1. The Contractor shall:

- a. a. Assist with planning and programming studies, which may include special engineering studies and reports such as seismic analysis, facility condition assessments, geotechnical/hazmat investigations, etc.
- b. Assist with pre-design and/or pre-construction activities.

#### **G. Design Management Services**

1. The Contractor shall:

- a. Provide third party, peer, and quality assurance reviews of design deliverables and construction documents.
- b. Provide management and administration of professional services and/or construction contracts (including any design-build contracts).
- c. Provide design oversight, monitor design progress and deliverables and recommend corrective action when required.
- d. Assist in the development of Project design standards.
- e. Support the Airport's Public Information and Community Outreach program with suitable documentation in a variety of media.
- f. Provide 100% design submittal reviews for constructability, functionality, building code and PGDS compliance for the baggage handling systems, architectural, structural, vertical transportation, mechanical, electrical, fire protection and special systems.
- g. Track and participate in the design build Contractor's BIM modeling and design coordination process.
- h. Track the design build Contractor's permitting process with the Airport Building Inspection and Code Authority (BICE).
- i. Track and document all design review comments by the TSA, Airport, airlines and other stakeholders.
- j. Provide requested conceptual or schematic design review services in support of the Project as directed by the Airport.

#### **H. Construction Administration Services**

1. The Contractor shall:

- a. Review all design/builder drawings/specifications, shop drawings, submittals, and any other design documents and provide review comments to the Airport.

- b. Develop a punch list at design/build substantial completion.
- c. Provide any necessary support for design management services.
- d. Ensure the efficient, timely and synchronous scheduling and coordination of all design and construction aspects of the Project.

#### **I. Construction Management Services**

- 1. The Contractor shall:
  - a. Review construction documents for constructability, impact to Airport operations, and consistency with the Project schedule and provide review comments to the Airport.
  - b. Review construction work plans and provide review comments to the Airport.
  - c. Report on and participate in the construction trade subcontract procurement process for design-build work.
  - d. Review and/or prepare construction quality assurance/quality control plans and provide review comments to the Airport.
  - e. Provide technical, full-time, on-site observation and inspection of the progress and quality of the construction work.
  - f. Monitor environmental inspection for Contractor's compliance with environmental regulations.
  - g. Examine materials and equipment being incorporated into the work to verify that they are handled, stored, and installed properly.
  - h. Coordinate or procure the services of testing laboratories to assure that the proper number and type of tests are being performed in a timely manner.
  - i. Provide special inspections and materials testing as required.
  - j. Prepare inspection and engineer's reports for submission to the Airport.
  - k. Manage the submission of samples, shop drawings, Operation & Maintenance (O&M) manuals, and other submittals between Contractors and the Airport. The Contractor shall maintain a log of all submittals. Review as-built documentation, maintenance manuals and training requirements. Coordinate training with maintainers.
  - l. Identify problems encountered in accomplishing the work and recommend appropriate action to the Airport in order to resolve problems with a minimum effect on the timely completion of the Project.
  - m. Maintain a log of any requests for information and prepare the Airport's non-technical responses.

- n. Review and recommend progress pay requests and provide review comments to the Airport.
- o. Review Contractor reports, as-built drawings, and other construction documentation and ensure information is captured in the Airport's record keeping system.
- p. Attend job site meetings and prepare meeting minutes. The Contractor shall review and communicate information presented.
- q. Monitor compliance by all Airport Contractors on the Project with all contract terms and conditions including, but not limited to, federal requirements, certified payroll, labor standards, drug policy, security requirements, site cleanliness, and safety.
- r. Administer the evaluation and negotiation of change orders and prepare and process change orders and contract modifications.
- s. Manage activation activities and prepare written status reports.
- t. Conduct final inspections prior to Project acceptance, notify the Airport in a timely manner of the results of the inspections, and administer acceptance procedures and tests for each phase of the Project.
- u. Perform project closeout activities.
- v. Support dispute and/or claim resolution analysis and reconciliation efforts.
- w. Review and validate the design build Contractors Task Order cost estimates for both hard and soft costs. Track overall budgeting against the TSA OTA estimate. Track the design build Contractor's monthly invoice cost breakdown against the Task Order line item budgets, and identify cost trends to determine monthly budget forecasts.
- x. Track the design build Contractor's daily, weekly and monthly schedules. Scheduling analysis will emphasize phasing and cutovers in an operational environment.
- y. Review the design build Contractor's monthly invoices; including design build Contractor's documentation of actual costs; as required under the Federal Actual Cost plus Fixed Fee contract. Actual cost documentation, including electronic certified payrolls (labor time cards) and material and equipment receipts must be referenced to each Task Order budget line item.
- z. Prepare invoice summaries for all Airport, Airport design Contractors, Contractor and design build costs that are eligible for reimbursement by the TSA under the OTA. Assist the Airport in preparing invoices to the TSA.
- aa. Attend and review simulations and Factory Acceptance Testing.



- bb. Initiate meetings and communication with all stakeholders to achieve a collaborative process. Meetings will be written by qualified Contractor staff, using a concise spreadsheet format, with parties responsible and due dates listed.
- cc. Lead daily construction and operations interface meetings with Airport, TSA and airline operations and maintenance managers.
- dd. Coordinate construction phasing, cutover and contingency planning with design build Contractor and all Airport, TSA and airline stakeholders. Planning for uninterrupted operations will override all other considerations. All work activities will have a detailed written plan and a contingency plan, approved by the Airport, TSA and airline operations and maintenance managers prior to the work proceeding.
- ee. Establish construction quality standards with Airport approval, based on documented mockups with digital photos.
- ff. Coordinate construction and conduct necessary quality control measures of architectural, structural, vertical transportation, mechanical, electrical, fire protection and special systems.
- gg. Provide a record of daily installation progress and quality control inspections with digital photos.
- hh. Review the design build Contractor's safety plan documentation, education and enforcement.
- ii. Attend BICE inspections.
- jj. Coordinate TSA progress inspections, screening equipment deliveries and installation.
- kk. Coordinate TSA Integrated Site Acceptance Test (ISAT) certification processes. Multiple ISAT certifications will be necessary due to construction phasing.
- ll. Coordinate Airport's BHS site acceptance tests, and stress test demonstrations.
- mm. Provide for Special Inspections by a California licensed testing and inspection agency for concrete, structural steel and attachments.
- nn. Provide timely meeting reports and an issues/action logs, with responsible party and due dates.
- oo. Coordinate requests for information (RFI) by the design build Contractor, and obtain responses from the designer, Airport or airline stakeholders. Provide an RFI log and a track and identify late responses.
- pp. Review requests for scope changes and provide recommendations to the Airport for approval. Review Task Order budgets submitted by the design build Contractor for scope changes and provide independent estimates for Airport approval. Track pending and approved scope changes and identify late responses.

- qq. Provide a coordinated punch list for completed construction, including the lists from Contractor inspections, Airport's designer, and BICE, TSA, Airport and airline stakeholders.
- rr. Provide administrative support to the Airport Project Manager.
- ss. Provide documentation and participate in the coordination of Federal audits.

### **3. REPORTS**

Contractor shall submit written reports as requested by the Airport. Format for the content of such reports shall be determined by the Airport. The timely submission of all reports is a necessary and material term and condition of this Agreement. The reports, including any copies, shall be submitted on recycled paper and printed on double-sided pages to the maximum extent possible.

### **4. DEPARTMENT LIAISON**

In performing the services provided for in this Agreement, Contractor's liaison with the Airport will be the individual listed in the Section 25, Notices to Parties, of the Agreement.

**APPENDIX B.4  
CALCULATION OF CHARGES**

**1. GENERAL**

- 1.1 As set forth in Section 5.A "Compensation" of the Agreement, Compensation for work performed under this Agreement will be on a time and materials basis unless otherwise pre-approved by the Airport.
- 1.2 No charges shall be incurred under this Agreement nor shall any payments become due to Contractor until reports, services, or both required under this Agreement are received from Contractor and approved by the Airport as being in accordance with this Agreement. In no event shall the Airport be liable for interest or late charges for any late payments.

**2. METHOD OF PAYMENT**

- 2.1 Unless approved otherwise by the Airport, Contractor's services shall be invoiced on a monthly basis and payment will be made within thirty (30) days of receipt of an acceptable invoice with satisfactory backup documentation, approved by the Airport Project Manager. The term "invoice" shall include Contractor's bill or other written request for payment under this Agreement for services performed. All invoices shall be made in writing.
- 2.2 Contractor shall invoice for the Work performed in conformance with procedures approved by the Airport.
- 2.2.1 Such invoices shall segregate current costs from previously invoiced costs.
- 2.2.2 Costs for individual labor shall be segregated by task and subtasks, if any.
- 2.2.3 In no case shall Contractor invoice include costs which the Airport has disallowed or otherwise indicated that it will not recognize. Costs shall be invoiced by Contractor's accounting categories and shall be subject to the audit provisions of this Agreement.
- 2.2.4 Each invoice shall clearly distinguish Contractor's personnel that is invoiced at the home office overhead rate versus the field office overhead rate. See Article 3 below for rate definitions.
- 2.2.5 Such invoices shall be as a minimum, (i) mechanically accurate, (ii) substantially evidenced and properly supported and (iii) in compliance with generally accepted accounting principles.
- 2.3 Contractor shall also certify, for each invoice, that (i) the hourly rates for direct labor, whether for Contractor or its subcontractor(s), to be reimbursed under this Agreement are not in excess of the actual hourly rates in effect for Contractor or subcontractor employees engaged in the performance of services under this Agreement at that time, and (ii) that such hourly rates are in conformance with the Agreement.
- 2.4 The Airport reserves the right to withhold payment(s) otherwise due Contractor in the event of Contractor's material non-compliance with any of the provisions of this Agreement, including, but not limited to, the requirements imposed upon Contractor in Section 15, Insurance and Section 16,

Indemnification. The Airport shall provide notice of withholding, and may continue the withholding until Contractor has provided evidence of compliance which is acceptable to the Airport.

2.5 All invoices shall be made in writing and delivered or mailed to the Airport at the mailing address listed in Section 25, Notice to Parties, of the Agreement.

**3. LABOR RATES AND FEES**

**3.1 Direct Labor Rate and Direct Labor Rate Adjustment**

- 3.1.1 The direct labor rate shall not exceed Ninety-eight Dollars (\$98) per hour. Any rate in excess of this cap will require prior written approval from the Airport's Project Manager.
- 3.1.2 Salaried personnel shall be paid on a maximum of 40 hours per week, with no overtime. Salaried personnel assigned to multiple Projects shall be paid on a pro-rata share of a 40-hour week. Contractor shall maintain signed time cards or other verifiable time records showing all assigned Projects and the shared calculation.
- 3.1.3 The approved direct labor rates stated in this Appendix B.3 shall remain in effect for one year from the date of Modification No. 10. If the Agreement is extended, the Airport may approve an annual adjustment to the direct hourly labor rates on the anniversary of the Effective Date of Modification No. 10, based on an increase in the Consumer Price Index for the preceding twelve (12) months for the San Francisco Bay Area as published by the U.S. Department of Labor, Bureau of Labor Statistics, under the title of: "Services Less Rent of Shelter – All Urban Consumers – San Francisco/Oakland/San Jose, California" or on an increase in the wages of comparable classifications as reflected in the collective bargaining agreements between the City and County of San Francisco and the labor organization representing those classifications, whichever is lower. Such adjustment is subject to prior written approval by the Airport and must be included in a written modification to the Agreement before any increase labor rate is incurred, unless the adjustment is made to meet the requirements of prevailing or minimum wage legislative mandates. In no event will the adjustment exceed the lower of the above specified indices unless the proposed adjustment is made pursuant to other specific terms of this Agreement or is necessary to meet the requirements of prevailing or minimum wage legislative mandates.

**3.2 Overhead Rates**

3.2.1 The Airport shall pay the lesser of a firm's current audited overhead rates, or the maximum approved overhead rates as follows:

<b>FIRM NAME</b>	<b>OVERHEAD RATE</b>
CAGE Professional Services, Inc.	141.59%
KPA Group	179.01%
Chaves & Assoc.	134.94%
EPC Consultants	Field = 106.90% and Home Office = 110.24%
M Lee Corp	131.96%
Apex Testing	76.44%
Grindstone Group, LLC	75.52%

Cooper Pugeda Management, Inc.	105.21%
Faith Group, LLC	129.8%

3.2.2 Contractor shall submit to the Airport current certified reviewed financial audit report(s) of overhead cost rates for home and/or field office rates upon request for a change or addition to the maximum approved overhead rates stated in this Paragraph 3.2.

3.2.3 The home office overhead cost rate shall be used when staff works in an office provided by the Contractor. The field office overhead cost rate shall be used when staff is assigned full time to an office provided by the Airport. To qualify for the field office overhead cost rate the Airport shall provide office spaces, utilities, telephone service, internet access, and computers.

### 3.3 Fee

The maximum Fee of **ten percent (10%)** shall be applied to the sum of direct labor and overhead only, whether Contractor or subcontractors of any tier. The Fee shall not be applied to Other Direct Costs.

### 3.4 Approved Mark-Up on First-Tier Subcontractors

Contractor is permitted a **two percent (2%)** mark-up on first tier subcontractor invoices.

### 3.5 Direct Labor Rates

The approved base direct labor rates are as follows:

CLASSIFICATION	RANGE OF RATES
Admin Support	\$22.50 - \$37.50
Analyst	\$25 - \$40
CAD Designer	\$25 - \$40
Commissioning Manager	\$35 - \$65
Construction Manager	\$45 - \$85
Design Manager	\$35 - \$65
Document Control	\$38 - \$45
Estimator	\$45 - \$75
Field Engineer	\$30 - \$70
Office Engineer	\$30 - \$70
Project Controls Manager	\$60 - \$85
Project Manager	\$55 - \$98
Resident Engineer I	\$35 - \$55
Resident Engineer II	\$50 - \$70
Resident Engineer III	\$60 - \$75
Scheduler	\$60 - \$80
Senior Cost Controls Manager	\$55 - \$75
Senior Network Designer	\$50 - \$65
Senior Systems Designer	\$55 - \$70
Site Manager/Commissioning Specialist	\$30 - \$60

#### 4. OTHER DIRECT COSTS (ODC)

- 4.1 Only actual costs incurred by Contractor shall be allowed and invoiced as ODCs. Contractor shall not submit any cost in excess of \$500 without prior written authorization from Airport. There shall be no mark-ups of any kind allowed on costs reimbursed under this Paragraph 4. Costs shall be allowable only to the extent that costs incurred, or otherwise established prices, are consistent with the Federal Cost Principles (Title 48, Code of Federal Regulations, Part 31).
- 4.2 The following items are considered normal Agreement costs, a part of the Approved Overhead Rates, and are not considered ODCs: (a) phone calls, faxes, mail, express mail, courier delivery or overnight delivery service charges, or other communications charges between members of Contractor's team, regardless of location; regional phone calls and faxes for all area codes having any geographical land area within 100 miles of San Francisco even though its outlying boundary exceeds the 100 mile limitation; (b) Internet gateways, electronic mail service or other technology-based communication service, FTP sites, or data file transfer or research services; (c) travel by Contractor or its subcontractors between its home office and the San Francisco Bay Area; (d) travel within 100 mile radius of San Francisco; travel outside 100 mile radius of San Francisco unless approved in writing in advance by the Airport; (e) in-house coordination materials among Contractor's team and subcontractors, including photocopy and drawing materials, messenger services; and (f) food and beverage and/or entertainment charges of any kind unless approved in writing in advance by the Chief Development Officer of Planning, Design & Construction.
- 4.4 Unless authorized by the Chief Development Officer of Planning, Design & Construction, the Airport will not reimburse Contractor for the costs of business travel, contractor meals, and accommodations, this includes specialists that are based out of town and not assigned to the jobsite office. Travel and *per diem* expenses for the project team's management, jobsite personnel, or staff that commute to or from other offices or residences are not allowed. When authorized, travel expenses shall be in accordance with the City & County of San Francisco Travel Guidelines can be found at the following link:  
[https://www.google.com/url?q=http://sfcontroller.org/Modules/ShowDocument.aspx%3Fdocumentid%3D2174&sa=U&ved=0CAUQFjAAahUKEwjU0\\_TaqLjHAhUImogKHT3iCMw&client=internal-uds-cse&usg=AFQjCNHkyPKe3iRnxQ0y7-OQ2M7NqoiPbA](https://www.google.com/url?q=http://sfcontroller.org/Modules/ShowDocument.aspx%3Fdocumentid%3D2174&sa=U&ved=0CAUQFjAAahUKEwjU0_TaqLjHAhUImogKHT3iCMw&client=internal-uds-cse&usg=AFQjCNHkyPKe3iRnxQ0y7-OQ2M7NqoiPbA)

**END OF APPENDIX B.4**



APPENDIX C.4  
**OTHER TRANSACTION AGREEMENT**  
**HSTS04-13-H-CT1140**

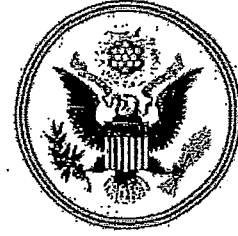
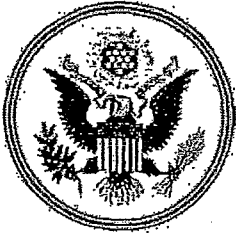

**OTHER TRANSACTION AGREEMENT**

**BETWEEN**

**DEPARTMENT OF HOMELAND SECURITY  
TRANSPORTATION SECURITY ADMINISTRATION**

**AND**

**THE CITY AND COUNTY OF SAN FRANCISCO  
Operating through its Airport Commission ("Commission")**

**RELATING TO**

**SAN FRANCISCO INTERNATIONAL AIRPORT (SFO)  
Checked Baggage Recapitalization & Optimization Screening Construction Services  
Project.**

---

Negotiated by the TSA pursuant to  
Aviation and Transportation Security Act, Pub. L. 107-71, 115 Stat. 597  
49 U.S.C. §114(m)(1) and 106(l)(6).

---

**HSTS04-13-H-CT1140**



## ARTICLE I - PARTIES

The parties to this Other Transaction Agreement (OTA) are the U.S. Department of Homeland Security, Transportation Security Administration (TSA) and the City and County of San Francisco, operating through its Airport Commission ("Commission"), as owner and operator of the San Francisco International Airport (SFO or Airport). The TSA and the Commission agree to cooperate in good faith and to perform their respective obligations in executing the purpose of this OTA.

## ARTICLE II - LEGAL AUTHORITY

This OTA is entered into under the Commission of the Aviation and Transportation Security Act, Pub. L. 107-71, 115 Stat. 597, specifically 49 U.S.C. § 114(m)(1) and 106(l)(6), which authorizes other transaction agreements.

## ARTICLE III - SCOPE

The purpose of this OTA is to set forth the terms and conditions, as well as establish the respective cost-sharing obligations of the TSA and the Commission with respect to the design, engineering and construction-related services necessary to implement the construction of the TSA recapitalization and optimization project design submitted by the Commission and reviewed by TSA pursuant to the TSA Planning Guidelines and Design Standards (PGDS) Version 4.1 found at:

<http://www.tsa.gov/research-center/airport-checked-baggage-guidance-materials>

This Project undertaken by the Commission involves the modification to or construction of the Airport terminal building infrastructure to recapitalize and optimize the TSA EDS systems located within the Checked Baggage Inspection System (CBIS). Terminal modifications include required changes to baggage conveyor components, mechanical, plumbing, electrical, structural, and telecommunications infrastructure to provide for the installation of Explosive Detection Equipment (EDS) within the baggage screening area, Explosive Trace Detection (ETD) equipment in the Checked Baggage Resolution areas, and the installation of applicable CBIS hardware and software for use with a checked baggage in-line baggage screening system. The objective of the Project is to enhance Airport security and baggage screening capabilities and throughput.

This OTA also includes design services for 70% and 100% drawings and specifications that will be submitted to TSA for review in accordance with the published TSA PGDS Version 4.1. This OTA does not include design services for the 30% design deliverable. The Commission will be responsible for developing various cost-effective solutions to replace fifteen (15) Explosive Detection System (EDS) machines currently located in Terminal 1 of the Airport, while minimizing the impact to operations and reducing the number of EDS by using higher throughput technology units (as appropriate). The solutions that the Commission proposes should be based upon a baggage screening rate derived from the current baggage screening rate and a projected, future screening rate. Solutions based upon such a combined current and future rate will allow the TSA to consider all cost factors available when making its decision of the optimal solution.

## ARTICLE IV – COST SHARING AND OTHER RESPONSIBILITIES

1. **Capital Costs:** The estimated cost of the Project (Total Project Cost) relates to the activities to modify the airport terminal building infrastructure and the baggage handling system (BHS) to support the installation and operation of the EDS and ETD equipment. It does not include the costs of acquisition, delivery or installation of the EDS and ETD equipment itself. TSA will be solely responsible for the acquisition, delivery, installation, and testing of the EDS and ETD equipment at the designated Project location(s). The Total Project Cost includes the cost for the construction effort and the design effort for 70% and 100% design deliverables, but does not include the cost for the 30% design deliverable. All work performed by the Commission pursuant to this OTA shall be accomplished in accordance with the TSA PGDS v. 4.1.

2. The cost of the security-related portion of the Project has been determined to be \$59,429,406.00 (CBIS Project Costs).

A. **Recapitalization and Optimization:** TSA agrees to reimburse the Commission for 100% of the allowable, allocable, and reasonable CBIS Project Costs specifically related to the **Recapitalization and Optimization** scope of effort that is estimated at \$59,429,406.

B. **Total:** The CBIS Project Cost for Recapitalization and Optimization includes design and construction management in addition to construction costs. This OTA is not to exceed a total reimbursement of \$59,429,406.00 (TSA Reimbursement Limit).

3. TSA will determine allowable and allocable costs in accordance with the OMB Circular A-87 "Cost Principles for State, Local and Indian Tribal Governments" codified at 2 C.F.R. Part 225 (together with Appendices A – D) and Appendix F of the TSA PGDS. TSA will reimburse the Commission on an actual expense basis supported by one or more invoices submitted by the Commission in accordance with Article X "Payment." The parties understand and agree that all Project costs in excess of the TSA Reimbursement Limit of \$59,429,406, as well as any costs that are inconsistent with OMB A-87 and the guidance set forth in the TSA PGDS, shall be borne solely by the Commission unless otherwise agreed by the TSA in a written modification in accordance with this Article IV and Article XIII "Changes and/or Modifications." Should the TSA reimbursements of \$59,429,406, as adjusted pursuant to Article XIII, represent more than 100% percent of the final allowable and allocable, and reasonable CBIS Project Costs for the **Recapitalization and Optimization** scope of effort, the Commission will refund TSA sufficient funds such that TSA's total reimbursement will equal no more than 100% of the final allowable, allocable and reasonable CBIS Project Costs for the **Recapitalization and Optimization** scope of effort.

4. All costs requested for reimbursement must satisfy the requirements of both TSA's PDGS v. 4.1 and OMB Circular A-87. In general, the costs for which TSA will provide reimbursement under this OTA are limited to those costs associated with the CBIS area, the Checked Baggage Resolution Area (CBRA), and EDS network equipment room (if applicable to the CBIS Project) as defined in TSA's PDGS. Appendix F of the TSA's PDGS provides guidance regarding the reimbursable costs for TSA CBIS Projects.

A. Examples of costs commonly considered reimbursable under this OTA include:

- Soft cost allowances consisting of Design Fees, Project Management, Construction Management, Escalation, Design Contingency and Construction Contingency
- Construction Costs:
  - Demolition (airport building or BHS components related to the CBIS area.)
  - BHS infrastructure upgrades, platforms, catwalks located within the CBIS screening area.
  - BHS: The BHS portion located within the CBIS screening area, including redesign and upgrading of conveyors to support the integration of the EDS screening system.
  - Conveyor redesign and upgrade within the CBIS screening area.
  - Build out of the EDS network equipment room
  - Acoustical treatment in the CBRA area.
  - Heating, Ventilation, Air Conditioning (HVAC) to maintain equipment and employee environmental requirements for CBIS, CBRA and EDS network equipment room.
  - Electrical and communications infrastructure (cabling, control panels) and basic lighting fixtures for the CBIS and CBRA.
  - Telephone systems/pager systems for TSA CBIS screening area.
  - Basic architectural finishes.

Identification of cost classifications herein does not create any obligation on TSA's part beyond the requirements found in OMB Circular A-87 and TSA's PDGS v. 4.1.

B. Examples of costs not considered reimbursable include, but are not limited to:

- Exterior Building Shell.
- Baggage make-up carrousel or outbound sortation systems.
- Maintenance, repair parts or spare parts (other than spare parts which are initially provided by the Original Equipment Manufacturer during the installation of new equipment) for airport terminal improvements including the baggage handling conveyor components installed under this Project.
- Manual encoding consoles or stations.
- Employee break rooms, administrative office space and restrooms not intended for the sole use of TSA staff.
- Architecturally pleasing enhancements.
- Extended warranties beyond one (1) year.

5. TSA will review the Commission's requests for changes or associated costs beyond the scope of the Project. Requests from the Commission for modifications or revisions must be submitted in the form of a change order request. Change Orders shall not be considered authorization to exceed the TSA Reimbursement Limit unless the Commission submits to the TSA Contracting Officer and Contracting Officer's Representative (COR) prior written notification of the expected impact to the CBIS Project Cost and the corresponding impact to the TSA Reimbursement Limit, and the TSA Contracting Officer agrees in writing to the proposed Change Order, including the proposed increase to the CBIS Project Cost and the TSA Reimbursement Limit. The Commission may not use the TSA contingency funds provided for the Project, as identified by TSA as part of this OTA, without prior written approval from the TSA Contracting Officer. The Commission will not be reimbursed for any work performed

under a change order unless approved in writing by the TSA Contracting Officer in accordance with Article XIII of the OTA.

## **ARTICLE V: PROJECT RESPONSIBILITIES**

The primary Project responsibilities of the TSA and the Commission are outlined below. In addition to primary Project Responsibilities, specific technical responsibilities for the two parties are contained in Appendix B, "Project and Acceptance Testing Requirements", attached hereto and incorporated by reference into this OTA. The Project will be overseen by the Commission, except for those portions of the Project that are TSA's sole responsibility as set forth in this OTA.

### **A. TSA Responsibilities**

1. Provide the TSA's PGDS, as well as the EDS equipment specification upon request from the Airport.
2. Advise as to the type of EDS equipment to be provided at each Project design phase submission.
3. Furnish, deliver, install and test the EDS and ETD equipment.
4. Provide EDS Original Equipment Manufacturer Technical Support Advisory Services to the Airport regarding installation, integration and networking of the EDS units into the BHS.
5. Provide the CBIS System Specific Test Plan (SSTP) to the Airport for the commissioning, coordination and testing of the CBIS. See PGDS Appendix D for testing details. See Appendix B for further specifics relating to the TSA testing portion of the Project.
6. Establish and conduct the Integrated Site Acceptance Testing (ISAT) for the in-line CBIS performance capabilities with joint support from the Airport.
7. Review and approve ISAT results before the in-line CBIS is certified as ready for operational use.
8. Provide training for Transportation Security Officer personnel on the EDS equipment.
9. Evaluate the in-line CBIS in operation for 30 days after substantial use begins.
10. Review and consider requested changes submitted by the Airport to the CBIS design. Any changes in scope or associated costs must be approved in accordance with Article XIII "Changes and/or Modifications".
11. Provide maintenance, repair, and refurbishment to all TSA EDS and ETD equipment throughout its life cycle at no cost to the Commission.
12. Review and concur with the Recapitalization Project design, plans, and specifications for 70% and 100% design packages for the installation of the replacement EDS units in the CBIS based upon the recommendations and guidelines in the TSA PGDS in effect at the time of execution of this OTA.

### **B. Commission/Airport Responsibilities**

1. Except for the responsibilities of the TSA, as outlined above, the CBIS Project will be managed and overseen by the Commission. The Commission, acting through such contractors as it may engage, will provide the engineering and design services, as well

as the associated construction and baggage handling system contractors, necessary for successful completion of the Project. The Commission will provide oversight of such contractor(s) to ensure the Project conforms to the TSA endorsed design, PGDS criteria and is completed within the prescribed costs and schedule identified and incorporated herein as Appendix C.

2. CBIS designs should be OSHA compliant; adhere to the applicable EDS and ETD installation and integration guide specifications; and should comply with all applicable Federal, State, and local building regulations. Provisions will be made in the CBIS design that will allow TSA and its contractor's full ingress to and egress from the CBIS area for the installation, operation, testing, maintenance, and repair of the EDS and ETD equipment.
3. Obtain all necessary construction licenses, insurance permits and approvals.
4. The Commission shall deliver a firm EDS delivery schedule requirement date to TSA no later than 60 days after construction contract award. This schedule will be reviewed and approved by TSA based on OEM EDS delivery schedules. If project cannot meet the acceptance date, the Commission will be responsible for the safekeeping of the EDS in a secure and climate controlled environment until such time the system(s) can be installed at the agreed upon site. The Commission will be solely responsible for any damages and or extra startup costs associated with or that occur during this delay.
5. Ensure the Project site will be ready to accommodate the installation of the EDS units when delivered. Project site preparation includes, but is not limited to, BHS modifications, mechanical, heating, electrical site preparation, including infrastructure to protect electrical or fiber optic cables, environmental controls, and any other airport terminal infrastructure work required to support the operational environment of the EDS and ETD units.
6. Facilitate the installation of the EDS units by providing a clear path during rigging and EDS installation, and provide sufficient space to allow for initial deployment activities (such as uncrating the device).
7. Provide three (3) feet of maintenance access space around the equipment so that spare parts may be removed and replaced.
8. Once installed, provide reasonable measures to protect the EDS and ETD equipment from harm, theft, and water intrusion in the screening area.
9. Prior to TSA ISAT Testing, it shall be the Commission /Airport's responsibility to exercise due diligence to protect and insure the EDS equipment from damage due to ongoing construction or weather.
10. The Airport shall provide for personnel, assistance, equipment and support services to jointly execute the Test Readiness Review (TRR) and ISAT leading to the commissioning and acceptance of the CBIS. Support will include but not be limited to:
  - a. Test bag laydown and storage areas secure and protected from the elements.
  - b. Baggage handlers for test bag staging, induction and retrieval during testing and commissioning including personnel and equipment necessary to move test bags between staging and ISAT areas.
  - c. Ensure representatives of the Baggage Handling System Contractor (BHSC), and System Programmer(s) are on site to run the CBIS during ISAT and resolve deficiencies found during testing.

- d. Airport badging required for TSA contractor ISAT team members shall be executed in a timely manner such that no greater than two (2) trips to the airport are necessary to complete all badging requirements to be issued and receive an airport badge. Should this requirement not be met, the Airport/ILDT shall provide all escorts necessary to allow the TSA ISAT Team to conduct the ISAT and follow-on live operations run-in observation.
  - e. Provide TSA and their Contractors full and complete most recent documentation of the project to include "approved for Construction" sets of the mechanical, electrical and controls drawings and control descriptions, see Appendix B for details.
11. Perform and bear all cost of the operation, maintenance and repairs for the airport terminal installed property such as the baggage handling conveyor system, including the conveyors in the baggage screening matrix, heating, air conditioning, electrical and mechanical infrastructure in support of this Project.
  12. Submit monthly milestone and project progress status reports by the 10<sup>th</sup> of each month to the TSA Contracting Officer's Representative (COR)/Regional Deployment Coordinator (RDC), TSA Site Lead Contractor and TSA Contracting Officer. Specific requirements for the content of the monthly project status report are identified in Appendix D.
  13. CBIS designs and construction shall meet all requirements of the TSA Security Technology Integrated Program (STIP) Data Requirements for Checked Baggage Systems as shown in Appendix E. The Airport shall provide all deliverables required in the STIP Data Requirements to the TSA COR/RDC.
  14. Receive concurrence from TSA at each stage of the design review in order to proceed to the next design review stage.
  15. Provide a budgetary construction cost estimate with the 70% and 100% design reviews for the Project.
  16. Ensure the EDS OEM site planning, installation, integration and networking guidelines are incorporated into the design to ensure operational, maintenance and environmental specifications are met.
  17. As part of the design, provide reasonable measures to protect the EDS and ETD equipment from harm, theft, and water intrusion in the screening area.
  18. Incorporate heating, ventilation, air conditioning into the design as well as OSHA requirements for those spaces occupied by TSA personnel.

For additional clarification regarding roles and responsibilities see Appendix B.

### **C. Operation and Maintenance Costs**

It is understood and agreed that the EDS and ETD security screening equipment are and will at all times remain the property of the TSA. TSA will maintain, repair, and refurbish the EDS and ETD units at no cost to the Commission.

Except for the EDS and ETD security screening equipment owned by the TSA and separately provided for use at the Airport, the Commission shall own and have title to all airport terminal building improvements made in accordance with this OTA such as heating, ventilation, air conditioning, electrical and mechanical infrastructure, baggage handling conveyor systems and controls, or other assets which are acquired and installed under this OTA in support of this

Project. It will remain the responsibility of the Commission, its contractors or lessees acting through such agents as it may use, to maintain, repair and or replace such airport property to sustain the operational environment of the EDS and ETD security screening equipment. Title to all airport terminal building improvements that were purchased or reimbursed using Federal funds for this Project, shall become the property of the Commission, whether purchased with TSA or the Commission's funds.

#### **D. Deliverables**

Appendix D identifies other required deliverables to be submitted by the Commission and/or Airport.

#### **ARTICLE VI - EFFECTIVE DATE AND TERM**

The term of this OTA shall be from the date of execution of the OTA until five years from the date of execution, unless earlier terminated by the parties pursuant to Article XV "Termination" as provided herein or extended by mutual agreement pursuant to Article XIII "Changes and/or Modifications", in order to allow the Commission time to submit a final invoice, close out the Project, and address any other issues. The Commission agrees to work with TSA to close this OTA within six (6) months of completion of the Project including successful ISAT acceptance testing and operational run-in of the in-line CBIS.

The Commission will establish and provide to the TSA Regional Deployment Coordinator (RDC) and TSA CO, within 30 days of execution of this OTA, Project Milestones that allow objective measurement of progress toward completion. TSA maintains the right to identify any additional Project Milestones to be tracked by the Commission.

#### **ARTICLE VII - ACCEPTANCE AND TESTING**

TSA will deem the Design Project complete upon review and concurrency of the 100% design submittal package for the Commission. The 100% design submittal package must conform to the TSA PGDS Version 4.1, where feasible.

TSA will deem the CBIS-related portion of the Project complete upon successful results of the TSA ISAT (Integrated Site Acceptance Test) as conducted by the TSA independent Acceptance Test Contractor and successful completion of the 30-day Operational Run-In period. TSA ISAT will evaluate the CBIS against the TSA PGDS version stated in this OTA as well as assess and comment on functional and performance differences to the most current version of the PGDS version published at the time of ISAT.

Successful completion of Project requires the correction of CBIS deficiencies identified during the TSA ISAT as documented in the Quick Look Report (QLR) and as followed up at the end of the Operational Run-In period in the Test Summary Report (TSR). TSA will release the funds retained pursuant to Article X only after the CBIS has passed the ISAT test and Operational Run-In period and the deficiencies have been corrected. Additional details are contained in Appendix C, "Project and Acceptance Testing Requirements"

#### **ARTICLE VIII - AUTHORIZED REPRESENTATIVES**

The authorized representative for each party shall act on behalf of that party for all matters related to this OTA. Each party's authorized representative may appoint one or more personnel to act as an authorized representative for any administrative purpose related to this OTA, provided written notice of such appointment is made to the other party to this OTA. The authorized representatives for the parties are as follows:

A. TSA Points of Contact:

Contracting Officer's Representative/Regional Deployment Coordinator:

Shahzan Akber

Mail Stop TSIF #32

Transportation Security Administration

1 Post Office Road

Washington, DC 20528-6032

Phone: 571-227-5645

E-Mail: Shahzan.Akber@tsa.dhs.gov

Contracting Officer:

Kerry Toscano

701 South 12<sup>th</sup> Street

Arlington, VA 20598-6025

Phone: 571-227-4932

E-Mail: Kerry.Toscano@dhs.gov

Only the TSA Contracting Officer (CO) shall have the authority to bind the Federal government with respect to scope of work, funding and liability. The TSA Regional Deployment Coordinator (RDC) is also the TSA Contracting Officer Representative (COR) and is responsible for the technical administration of this OTA and technical liaison with the Commission. The TSA COR is not authorized to change the scope of work, to make any commitment or otherwise obligate the TSA, or authorize any changes which affect the liability of the TSA such as amount or level of funding.

The Commission must notify the TSA CO and COR in the event that any TSA employee or TSA contracted agent takes any action that may be interpreted by the Commission as direction which could increase the Project costs and could cause the Commission to seek reimbursement from TSA in excess of the TSA's total reimbursement liability as defined in Articles IV and IX of this OTA.

B. Commission/Airport Points of Contact:

The Commission/Airport Point of Contact for all correspondence is:

Greg McCarthy

Project Manager

San Francisco International Airport

Design, Construction, & Technology

Phone: 650-821-5204

E-Mail: Greg.McCarthy@flysfo.com



**ARTICLE IX - FUNDING AND LIMITATIONS**

TSA will provide funding to the Commission in an amount not to exceed \$59,429,406.00 (TSA Reimbursement Limit). Funds in the amount of \$59,429,406.00 are hereby obligated and made available for payment for performance of this OTA. Expenses incurred in executing the work identified herein are chargeable to:

Procurement Request (PR)	Accounting Code	Funding Amount
2113203CT1140	5CF05XB010D2013SWE044GE013723006200622CTO/59030 01518010000/251B/TSA DIRECT/DEF. TASK	\$6,000,246
	5CF12XB010D2013SWE044GE013723006200622CTO/59030 01518010000/251B/TSA DIRECT/DEF. TASK	\$53,429,160
<b>TOTAL FUNDING AMOUNT</b>		<b>\$59,429,406</b>

In the event of termination or expiration of this OTA, any TSA funds that have not been spent or incurred for allowable expenses prior to the date of termination and are not reasonably necessary to cover allowable and allocable costs as of the date of termination will be returned and/or de-obligated from this OTA. TSA's liability to make payments to the Commission is limited to the funds obligated and available for payment hereunder, including written modifications to this OTA.

Under no circumstances will TSA be responsible to reimburse the Commission/Airport for profit or the general costs of government. The Commission may recover the allowable direct costs of the Commission personnel performing work necessary under this OTA, as well as the allowable and allocable costs of the contractors hired by the Commission to perform the necessary work under this OTA. Profit and overhead costs for the Commission contractors performing work on the Project are allowable costs. Submission of a cost allocation plan is required to address any indirect costs, to include the Commission/Airport employees, who work on multiple activities that will result in a request for reimbursement under this OTA. TSA will not be responsible for costs incurred by the Commission/Airport, its contractors or agents to perform work not in compliance with the TSA requirements in this OTA. The TSA CO has the right to recoup any payments made to the Commission/Airport if the TSA CO determines that the invoices exceed the actual costs incurred, or if the work substantially deviates from the TSA approved CBIS design requirements for the Project pursuant to this OTA.

TSA will reimburse only for allowable, allocable and reasonable costs in accordance with the OMB Circular No. A-87 in effect on the Effective Date of the OTA (codified at 2 C.F.R. Part 225) and the allowable/not-allowable costs identified in Appendix F of TSA's PGDS v 4.1.

**ARTICLE X - PAYMENT**

The United States Coast Guard Finance Center performs the payment function on behalf of the TSA. For purposes of submission to the Coast Guard Finance Center, the Commission must submit a completed Summary Invoice. Registration in the System for Award Management (SAM) is mandatory for invoice payment. To obtain information regarding SAM, please refer to <https://www.sam.gov/portal/public/SAM/>.

Invoices for reimbursable expenses will be submitted every sixty (60) days, as expenses are incurred, and must be prepared properly in accordance with the terms of this Agreement. For periods in which the Commission has not incurred a reimbursable expense, an invoice is not required. Expenses are considered to accrue on the date that the Commission is invoiced from a contractor, sub-contractor, supplier, or provider of services. Reimbursement by TSA is conditioned upon submission to TSA of an invoice identifying the Project costs that have been incurred and paid. The TSA will make its best effort to make payment to the Commission within 90 days from receipt of each properly prepared invoice for reimbursement of incurred Project costs.

Ten percent (10%) of all submitted costs identified by TSA as allowable, allocable and reasonable shall be retained by TSA until completion of the Project, and shall only be reimbursed to the Commission upon successful completion of all of its obligations under this OTA, including, completed system documentation submitted to TSA and successful completion of all testing as required in Article VII of this OTA.

In the event that an invoice for reimbursable expenses is not received by the TSA within a twelve (12) month period, the TSA reserves the right to terminate the OTA per Article XV "Termination."

The TSA reimbursement process consists of two steps.

Step I – Summary Invoice Submittal to the U.S. Coast Guard Finance Center for Payment, and at a minimum should contain the following information:

- (1) Other Transaction Agreement Number
- (2) Invoice Number and Invoice Date
- (3) Complete Business Name and Remittance Address
- (4) Point of Contact with address, telephone, fax and e-mail address
- (5) Tax Identification Number and DUN's Number
- (6) Dollar Amount of Reimbursement requested
- (7) Signature of the Commission's authorized representative and the following certification language: *"This is to certify that the services set forth herein were performed during the period stated and that the incurred costs billed were actually expended for the Project."*

The Summary Invoice may be submitted by standard mail or by electronic transmission to the following address(s):

Mailing Address: TSA Commercial Invoices  
 USCG Finance Center  
 P.O. Box 4111  
 Chesapeake, VA 23327

Email: FIN-SMB-TSAINVOICES@uscg.mil

Step 2 – Submission of Summary Invoice and Supporting Documentation

### Submittal to TSA for Approval of Payment:

The TSA CO and the COR are required to review and the TSA CO will approve all invoices prior to payment. To aid in this review, the Commission shall provide a copy of the Summary Invoice along with all receipts, contractor pay requests and other supporting information which specify the vendor, services provided, and products delivered as well as the appropriate documentation that the Commission has paid these obligations. The Commission should provide this supporting information simultaneously with Step 1 to expedite the payment process.

The Support Documentation should contain the following items:

- Summary Invoice from Step 1
- An executive summary project overview with the first invoice
- A summary spreadsheet providing a categorized breakdown of the amount invoiced
- Signed, approved and legible copies of each individual contractor's invoice to include schedules of values scope of work
  - Copies of contracts and change orders that provide support for the actual work being invoiced
  - Vendor and subcontractor invoices with specific details about services provided
  - Rationale for all allocations or unusual calculations or assumptions
  - Copies of subcontractor's invoices if listed on a prime contractor's invoice as a single amount (copies of timesheets and detailed backup not required if descriptions are clear and specific)
- Proof of payment by the Commission for each invoice in the form of copies of check/warrants, bank wire transfers, or accounting systems transactions

The Summary Invoice and supporting documentation may be submitted by email or mail via CD or paper documents to the below addresses. The final closeout invoice should include proof that all required deliverables have been provided.

TSA Contracting Officer's Representative  
 Shahzan Akber  
 Transportation Security Administration  
 TSA Systems Integration Facility  
 1 Post Office Way  
 Washington, D.C. 20528-6032  
 Mail Stop TSA TSIF - #32  
 Email: OSTCBD@tsa.dhs.gov

TSA Contracting Officer  
 C/O Mr. Henry Edquist  
 Faithful & Gould  
 1725 Duke Street, Suite #200  
 Alexandria, VA 22314  
 Phone: 571-403-8777  
 Email: Henry.Edquist@fgould.com

Upon completion of the review of the supporting documentation for the Summary Invoice, the TSA CO and the TSA RDC/COR will advise the Coast Guard Finance Center regarding payment of the Summary Invoice.

TSA may pay any charges due under this OTA by electronic funds transfer, check, or other means.

**ARTICLE XI - AUDITS**

The Federal Government, including the Comptroller General of the United States, has the right to examine or audit relevant financial records for a period not to exceed three (3) years after expiration of the terms of this OTA. The Commission and its contractors must maintain an established accounting system that complies with generally accepted accounting principles. Records related to disputes arising out of this OTA shall be maintained and made available until such disputes have been resolved. As used in this paragraph, "records" includes books, documents, accounting procedures and practices, and other data, regardless of type and regardless of whether such items are in written form, in the form of computer data, or in any other form related to this OTA.

The Commission shall maintain all records and other evidence sufficient to reflect costs claimed to have been incurred or anticipated to be incurred directly or indirectly in performance of this OTA. The TSA CO or the authorized representative of the TSA CO shall have the right to examine and audit those records at any time, or from time to time. The right of examination shall include inspection at all reasonable times at the offices of the Commission or at the offices of the Commission's contractor(s) responsible for the Construction Project. The Commission will be required to submit cost or pricing data and supporting information in connection with any invoice relating to this OTA if requested by the TSA CO.

This Article XI shall not be construed to require the Commission or its contractors or subcontractors to create or maintain any record that they do not maintain in the ordinary course of business pursuant to a provision of law, provided that those entities maintain records which conform to generally accepted accounting practices.

The Commission shall insert a clause containing the terms of Article XI – Audits in all of its contracts and subcontracts under this OTA that exceed \$100,000.00 (One Hundred Thousand Dollars).

**ARTICLE XII – REQUIRED FEDERAL PROCUREMENT PROVISIONS**

Competition in the award of contracts or procurements resulting from this Project is strongly encouraged and the Commission should promote competition to the maximum extent practicable. The Commission may follow its local procurement requirements for this OTA. The Commission agrees to include in its contract(s) a provision that the Commission's designs and work for this Construction Project are required to comply with the TSA's PGDS Version 4.1, where feasible.

**ARTICLE XIII – CHANGES AND/OR MODIFICATIONS**

Changes and modifications to this OTA shall be in writing and signed by the TSA CO and duly executed by the authorized representative of Commission. Any modification shall cite to this OTA and shall state the exact nature of the change and/or modification. No oral statement by any person shall be interpreted as modifying or otherwise affecting the terms of this OTA. The properly signed written modification shall be attached to this OTA and thereby becomes a part of this OTA.

**ARTICLE XIV – DISPUTES**

When possible, disputes will be resolved by informal discussion between the parties. All disputes arising under or related to this OTA shall be resolved under this Article. Disputes, as used in this OTA, mean a written demand or written assertion by one of the parties seeking, as a matter of right, the adjustment or interpretation of OTA terms, or other relief arising under this OTA. The dispute shall be made in writing and signed by a duly authorized representative of the Commission or the TSA. At a minimum, a dispute under this OTA shall include a statement of facts, adequate supporting data and a request for relief. In the event that the parties are unable to resolve any disagreement through good faith negotiations, the dispute will be reviewed and adjudicated by the TSA Assistant Secretary or his or her designee. If a party disagrees with the decision of the TSA Assistant Secretary or his or her designee, they may pursue other available legal remedies.

**ARTICLE XV – TERMINATION**

In addition to any other termination rights provided by this OTA, either party may terminate this OTA at any time prior to its expiration date, with or without cause, and without incurring any liability or obligation to the terminated party (other than payment of amounts due and performance of obligations accrued, in each case on or prior to the termination date) by giving the other party at least thirty (30) days prior written notice of termination. Upon receipt of a notice of termination, the receiving party shall take immediate steps to stop the accrual of any additional obligations that might require payment.

In the event of termination or expiration of this OTA, any TSA funds that have not been spent or incurred for allowable expenses prior to the date of termination and are not reasonably necessary to cover termination expenses will be returned and/or de-obligated from this OTA.

**ARTICLE XVI – CONSTRUCTION OF THE AGREEMENT**

This OTA is an "other transaction" issued under 49 U.S.C. § 106(l) and 114(m)(1) and is not a procurement contract, grant or cooperative agreement. Nothing in this OTA shall be construed as incorporating by reference or implication any provision of Federal acquisition law or regulation. It is not intended to be, nor shall it be construed as creation of a partnership, corporation, or other business entity between the parties.

Each party acknowledges that all parties hereto participated equally in the negotiation and drafting of this OTA and any amendments thereto, and that, accordingly, this OTA shall not be construed more stringently against one party than against the other.

This OTA constitutes the entire agreement between the parties with respect to the subject matter hereof and supersedes all prior agreements, understandings, negotiations and discussions, whether oral or written, of the parties.

In the event that any Article and/or parts of this OTA are determined to be void or otherwise invalid or unenforceable, such Article or portions thereof shall lapse. No such lapse will affect the rights, responsibilities, and obligations of the parties under this OTA, except as provided therein. If either party determines that such lapse has or may have a material effect on the

performance of the OTA, such party shall promptly notify the other party, and shall negotiate in good faith a mutually acceptable amendment to the OTA if appropriate to address the effect of the lapse.

#### **ARTICLE XVII - PROTECTION OF INFORMATION**

The parties agree that they shall take appropriate measures to protect all proprietary, privileged, confidential, or otherwise Sensitive Security Information (SSI) that may come into their possession as a result of this OTA.

##### **A. RELEASE OF TECHNICAL DATA**

No Sensitive Security Information (SSI), as defined in 49 CFR Parts 15 and 1520, concerning the scope of this OTA, shall be published or released to the public without prior written approval of the TSA Assistant Secretary or his or her designee. Guidance regarding SSI may be found in Appendix G, "Checked Baggage Screening Equipment Sensitive Security Information Identification Guide", of the TSA PGDS.

##### **B. RECORDS AND RELEASE OF INFORMATION**

All Sensitive Security Information (SSI), as defined in 49 CFR Part 1520, shall be handled in accordance with TSA policies and regulations. All employees, contractors, and subcontractors assigned to work under this OTA are subject to the provisions of 49 CFR Part 1520, Protection of Sensitive Security Information, because they act for, or carry out duties for, or on behalf of the TSA. SSI may not be disclosed except in accordance with the provisions of that rule or where TSA otherwise approves.

##### **C. MEDIA**

Neither the Commission, nor its contractors shall include in its publicity or public affairs activities related to the subject matter of this OTA any SSI unless written approval has been received from the TSA Office of Security Capabilities or the TSA Office of Strategic Communication and Public Affairs. The purpose of this provision is to preclude the inadvertent release of SSI to the general public.

#### **ARTICLE XVIII - SURVIVAL OF PROVISIONS**

The following provision of this OTA shall survive the termination of this OTA: Article IV – Cost Sharing and Other Responsibilities; Article IX – Funding and Limitations; Article XI – Audits; Article XII – Required Federal Procurement Provisions; Article XIV – Disputes, Article XVII – Protection of Information and Article XVIII – Survival of Provisions.

IN WITNESS WHEREOF, the Parties have entered into this Agreement by their duly authorized officers this 26<sup>th</sup> day of September, 2013.

U. S. Department of Homeland Security  
Transportation Security Administration

The City and County of San Francisco  
(Acting through its Airport Commission  
as owner and operator of the San Francisco  
International Airport)

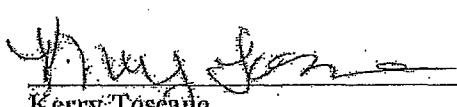
  
\_\_\_\_\_  
Kerry Toscano  
TSA Contracting Officer

  
\_\_\_\_\_  
John L. Martin  
Airport Director

9/26/2013  
\_\_\_\_\_  
Date

9/20/13  
\_\_\_\_\_  
Date

Authorized by Airport Commission

Resolution No. 13-0180

Adopted: Aug. 12, 2013

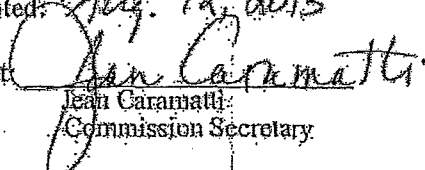
Attest:   
\_\_\_\_\_  
Jean Caramatti  
Commission Secretary

Approved as to Form

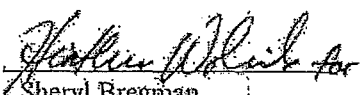
By:   
\_\_\_\_\_  
Sheryl Bregman  
City Attorney

**Appendix A**  
**TSA Planning Guidelines and Design Standards**  
**Deliverables Checklist**

Figure 2-4  
**DELIVERABLES CHECKLIST**

PROJECT PHASE DELIVERABLES	SECTION	COMPLETION	PROJECT PHASE DELIVERABLES	SECTION	COMPLETION
<b>Pre-Design Phase</b>	<b>2.2.1</b>		<b>Detailed Design Phase (continued)</b>		
Preliminary Alternatives Analysis Report			<b>70% Design Submittals (continued)</b>		
Preferred Alternatives Analysis Report			Description of Operations		
<b>Schematic Design Phase</b>			Preliminary Contingency Plan		
Basis of Design Report	<b>2.2.2</b>		70% Specifications		
Detailed Program Requirements			Draft Site Specific Configuration Management Plan		
High-Level Flow-Based Modeling Assumptions and Results			Stakeholder Review and Approval Documentation		
Preliminary Concept Plans			70% Estimate of Probable Construction and O&M Costs		
Phasing and Constructability Technical Memoranda			Phasing Schedule		
ROM Estimate of Probable Construction and O&M Costs			Conveyor Manifest		
Stakeholder Review and Approval Documentation			Updated EDS Equipment List		
Preliminary Project Schedule			<b>100% Design Submittals</b>	<b>2.2.3</b>	
<b>Detailed Design Phase</b>	<b>2.2.2</b>		Bid Documents		
<b>30% Design Submittals</b>	<b>2.2.3.1</b>		Final Description of Operations		
Updated Basis of Design Report			Contingency Plans		
Operational Standards Assessment			Project Specifications		
Preliminary Plans			Draft Site Specific Configuration Management Plan		
Cross Sections			Stakeholder Review and Approval Documentation		
Description of Operations			Final Estimate of Probable Construction and O&M Costs		
Baggage and Data Flow Charts			Final Phasing Schedule		
Table of Contents for CBIS			Updated EDS Equipment List		
Screening Equipment Installation Guidelines			Operational Training Materials and Documentation		
Outline of Reporting Capabilities			<b>Construction Phase</b>	<b>2.2.4</b>	
Stakeholder Review and Approval Documentation			Changes to Approved 100% Design Submittals		
30% Estimate of Probable Construction and O&M Costs			Construction Schedule		
Preliminary Phasing Schedule			Courtesy Copies of Shop and Installation Drawings		
Conveyor Manifest			<b>Testing and Commissioning Phase</b>	<b>2.2.5</b>	
EDS Equipment List			Pre-ISAT Documentation		
<b>70% Design Submittals</b>	<b>2.2.3.2</b>		ISAT Documentation		
Updated Basis of Design Report			<b>Project Closeout Phase</b>	<b>2.2.6</b>	
Updated Operational Standards Assessment			As-built CBIS Documentation Submittal		
70% Design Drawings			Final Copy of the PLC Program with Drawings		
Cross Sections			Final Copy of Disaster Recovery Procedures		



## Appendix B Project and Acceptance Testing Requirements

**Scope:** TSA support for the in-line Checked Baggage Inspection System (CBIS) solution will encompass design, construction and commissioning to support the in-line CBIS.

**A. TSA responsibilities with regard to the Project are listed below in sections 1.1 to 1.7. Many responsibilities are delegated to TSA contractors such as the EDS Original Equipment (OEM) Manufacturer, TSA Site Lead Contractor, and TSA Acceptance Test Contractor but ultimate responsibility resides with TSA.**

### 1.1 EDS PLACEMENT

If applicable, TSA will ship, rig and install EDS machines and associated EDS screening equipment, to include any necessary ETD screening equipment, in their respective operational locations within the CBIS Project location. TSA, through the EDS OEM or other TSA contractors, shall be responsible for coordinating and integrating activities regarding placement of EDS equipment with the local TSA Point of Contact and Airport Point of Contact.

### 1.2 INSTALLATION SUPPORT

#### 1.2.1 Project Management

As applicable, the TSA Site Lead Contractor and the EDS OEM shall be responsible for providing technical support throughout the entire period of performance during the installation Project. The OEM shall be responsible for all labor, materials, equipment, and support services required for planning, managing, and supervising all items related to the installation of the EDS units and associated ancillary equipment.

#### 1.2.2 Technical Support

TSA will provide technical support to the Project through existing TSA contracts with the EDS OEM, TSA Site Lead Contractor, and TSA Acceptance Testing Contractor.

- The identified TSA Site Lead Contractor should be included in all relevant CBIS planning/project meetings relevant to TSA contributions to the Project. Project schedules and updates should be provided to the TSA Site Lead Contractor to ensure TSA has timely and sufficient notice of deliverable dates. The TSA Site Lead Contractor will assess the project progress against the project schedule and approved design to advise TSA of issues related to cost, schedule and/or performance impacts to the in-line project.
- The EDS OEM shall provide technical consultations to the TSA Regional Deployment Coordinator (RDC), TSA Site Lead Contractor, TSA Acceptance Test Lead, TSA Acceptance Testing Contractor and Airport regarding Project efforts that may include, but are not limited to: teleconferences; reviews of drawings and specifications; and exchanges of technical documentation such as specifications, manuals, and guides.
- TSA Acceptance Testing Contractor shall support ISAT of the CBIS (the EDS units, BHS and the integration between them) and will develop relevant CBIS test plans and reports that will be shared with the Airport.

- Support for the development and execution of the TSA Other Transaction Agreement in place between TSA and the Commission will be provided by TSA Office of Acquisition.
- Oversight and coordination of technical aspects of the Project will be provided by the TSA Regional Deployment Coordinator.
- Local TSA personnel shall support coordination of issues between TSA Regional Deployment Coordinator (RDC) and the Airport as directed by the Federal Security Director (FSD).

### **1.2.3 Commissioning Services**

TSA, through the EDS OEM and its other TSA contractors, shall be responsible for all labor, materials, equipment, and support services needed to assemble, power up, configure, and install the EDS machines into the required operational condition. The EDS OEM shall provide technical support, documentation, and installation of the EDS units and the associated local Baggage Viewing Stations (BVS) after confirmation that all pre-installation requirements have been met. The EDS OEM shall coordinate with the TSA RDC, TSA Site Lead Contractor, TSA Acceptance Test Lead, and the Airport to perform system testing.

### **1.3 Acceptance Testing**

Mandatory testing for this system includes Site Acceptance Testing (SAT) for the EDS units following installation; pre-Integrated Site Acceptance Testing following the integration of the EDS units with the BHS is affirmed through a Test Readiness Review (TRR) and Test Readiness Notice (TRN); and Integrated Site Acceptance Testing (ISAT) is conducted prior to TSA acceptance of the CBIS system for operational use. TSA may elect to oversee BHS pre-ISAT conduct to confirm readiness of the system and conduct the TRR within the timeline of the ISAT to reduce the overall testing timeline. See the following table for minimum lead time requirements for testing activities.

Table 1. ISAT Timeline

Lead Times for ISAT (Days Prior to projected test date)	Activity	Responsible Parties
Site Initiation or $\geq 180$ days from ISAT	Site Survey Data Collection Checklist provided to the ILDT to complete to support the ISAT Site Specific Test Plan (SSTP) development.	TSA RDC, TSA Site Lead Contractor
$\geq 120$ days	<p>Completed Site Survey Data Collection Checklist and supporting site documentation received by TSA Acceptance Test Contractor from TSA Site Lead Contractor, to include:</p> <ul style="list-style-type: none"> <li>• Any and All Approved Request for Variance (RFV)</li> <li>• Basis of Design Report</li> <li>• Sample BHS &amp; CBIS Reports for all PGDS required Reports</li> <li>• BHS &amp; EDS Network Diagrams and Server Architecture</li> <li>• Local Procedures for Fail-Safe, E-Stop, Jam Clearing and IQ Test Conduct</li> <li>• Airport/Airline Bag Induction/Hygiene Procedures</li> <li>• BHS Specifications</li> <li>• Controls Description and/or Description of Operation (if both exist then provide both)</li> <li>• Fail-safe and/or E-Stop Zone Drawings</li> <li>• BHS Mechanical Plan and Elevation Drawings from Natural Induction Locations to &amp; through the CBIS, CBRA and Make-up Locations with Conveyors labeled, Plan View Drawings and Electrical Drawings of the BHS/CBIS with Control Station &amp; Photoeye Locations and labeling. All drawings will be "Approved for Construction" by the Airport and not Pre-Bid or Bid Use Only versions.</li> <li>• At least 1 Plan/OverView Drawing that shows the entire CBIS in a single view</li> <li>• Conveyor Motor Manifest to include not less than (Conveyor Name, Phase, Conveyor Type, Degree of Turn, Degree</li> </ul>	ILDT, TSA Site Lead Contractor

	<p>of Incline/Decline, Length, Speed in FPM, Motor HP, Control Type (VFD yes/no), Brake Type, Motor Type, drive Type, FLA Rating).</p> <ul style="list-style-type: none"> <li>• Installation &amp; Commissioning Phasing Plan Narrative and Phasing Plan Drawings</li> <li>• Construction and Testing Schedule(s)</li> </ul>	
≥90 days	<p>On-site Site Survey Meeting held, to conduct initial test coordination and review the draft SSTP. This visit will allow the TSA Acceptance Test Contractor to tour the site, review the draft SSTP with the ILDT, coordinate logistics and manpower and initiate the SIDA badge application process, if required. TSA Site Lead Contractor coordinates schedule with the ILDT and TSA's Acceptance Test Contractor.</p>	<p>ILDT, TSA RDC, TSA Site Lead Contractor, TSA Acceptance Test Contractor</p>
≥45 days	<p>Final SSTP Review Meeting between the TSA Acceptance Test Contractor and the ILDT to review the final SSTP, include any other approved RFV, verify logistics &amp; manpower, and review specific tests to be performed. <u>Any requests for variance from the SSTP testing requirements must be delivered in writing to the TSA RDC prior to this meeting for review and response.</u> This is the last chance for the ILDT to disclose any test standards that cannot be met in writing and formally justify exemption from test criteria. Any final revisions to the SSTP will be made and distributed to the ILDT and RDC prior to test execution.</p>	<p>ILDT, TSA Site Lead Contractor, TSA Acceptance Test Contractor, TSA RDC</p>
Typically 14 days to 1 day	<p>TSA Acceptance Test Contractor will ship test articles to the ILDT. The ILDT receives the test articles and stores in a secure and weather protected laydown area as agreed to by the ILDT and TSA Acceptance Testing Contractor in the Final SSTP Review Meeting.</p>	<p>ILDT, TSA Acceptance Test Contractor</p>
≥11 business days	<p>CBIS pre-testing - The ILDT conducts pre-testing. The TSA Site Lead contractor will provide oversight of CBIS pre-testing to validate the Test Readiness Notification (TRN) to the TSA RDC and Acceptance Test</p>	<p>ILDT, TSA Site Lead Contractor</p>

	<p>Team. The ILDT delivers internal pre-ISAT test results to the TSA Site Lead Contractor and the Site and TRR readiness confirmation letter to the TSA RDC and Acceptance Test Team. Upon successful review, the TSA Site Lead Contractor is deployed to the site within 7 days.</p> <p>Note: TSA may combine TRN with CBIS pre-testing and/or conduct TRR as a subset of ISAT</p>	
≥7 business days	<p>TSA Acceptance Testing Contractor or Site Lead Contractor initiates &amp; performs the TRR.</p> <p>Note: TRR Performance by Acceptance Testing Contractor will be a subset of overall ISAT duration and permit passed tests to be credited toward ISAT completion. TRR failure will result in 2 week moratorium.</p>	ILDT, TSA Site Lead Contractor
≥3 business days	<p>When notice of successful TRR is completed and delivered to the TSA Acceptance Testing Contractor via a TRN no later than COB Wednesday (5:00 p.m. EST), ISAT deployment will occur the following Monday. If delivered any time Thursday through Sunday, the TSA Test Team deployment will occur on the second Monday.</p>	TSA Site Lead Contractor, TSA Acceptance Test Contractor
1 business days	<p>TSA Acceptance Test Contractor travel day (normally Monday)</p>	TSA Acceptance Test Contractor
Test start	<p>TSA Acceptance Test Contractor travel day (normally Monday) with mobilization activities and an in-brief meeting with ILDT on the next business day. Prior to start of testing, TSA Acceptance Test Contractor will accept PLC code from TSA Site Lead Contractor or ILDT prior to the start of testing. TSA Acceptance Test Contractor and ILDT will work together to perform ISAT and collect BHS and EDS performance documentation. Prior to departing the site, an Out-brief meeting will be held for all site stakeholders.</p>	ILDT, TSA Acceptance Test Contractor, TSA Site Lead Contractor
≤2 business days after ISAT complete	<p>QLR is submitted by the TSA Test Acceptance Contractor to the TSA Acceptance Test Lead and RDC for review</p>	TSA Acceptance Test Contractor, TSA Acceptance

	and approval	Test Lead, TSA RDC
X business days after QLR receipt	TSA conducts ISAT review board based on QLR results to determine readiness of CBIS to enter Live Operations and Bag Screening or whether to return CBIS to ILDT for correction of deficiencies prior to Live Operations	TSA RDC, TSA Acceptance Test Lead,
5 business days after ISAT review board decision	QLR is distributed by the TSA Deployment RDC	TSA RDC
For 30+ days from start of substantial use	The TSA Acceptance Test Contractor remotely monitors system performance during live operations run-in period and observes system on-site for 3+ days	ILDT, TSA Acceptance Test Contractor, TSA Test Lead
5 business days following completion of data collection and onsite observation for run-in	The TSA Acceptance Test Contractor provides a Test Summary Report (TSR) to the TSA Acceptance Test Lead and RDC for review and approval.	TSA Acceptance Test Contractor, TSA RDC, TSA Acceptance Test Lead
5 business days	RDC distributes TSA approved TSR to ILDT	ILDT, TSA RDC

**1.3.1. Site Acceptance Testing (SAT)**

The EDS OEM shall coordinate and conduct SAT testing on the EDS machines in the presence of a TSA designated government witness. The EDS OEM shall implement and coordinate testing by issuing a Test Readiness Notification (TRN) at least 7 days prior to the scheduled Acceptance testing. Passing SAT results are required prior to final integration of EDS to the BHS and to certify equipment readiness for operational use in screening baggage. In the event that the TSA supplied EDS units cannot meet SAT test requirements, TSA will ensure that any EDS machine defects are corrected or that the EDS unit is replaced.

**1.3.2. Site Specific Test Plan Development (SSTP)**

TSA has arranged for its Acceptance Test Contractor to develop a SSTP based on testing criteria outlined in the TSA PGDS Appendix D. The Draft SSTP will be based on the Airport's responses to a Site Planning Checklist to be completed  $\geq 120$  days in advance of ISAT. The Final SSTP shall be delivered to the Airport between 60 and 30 days in advance of projected ISAT start-up. The ILDT and TSA Acceptance Testing Contractor will conduct review meetings of the Draft SSTP and Final SSTP per schedule in Table 1, Section 1.3 of this OTA prior to ISAT. Any requests for deviation from the SSTP testing requirements must be delivered in writing through a RFV to the TSA RDC and Acceptance Test Lead prior to this Final SSTP meeting for review and response.

The TSA RDC and TSA Acceptance Test Lead will review/evaluate any requests for phased testing (e.g. non-consecutive testing activities requiring multiple TSA Test Team trips). Such

requests must be supported by compelling justification and submitted in writing through a RFV to the TSA RDC and TSA Acceptance Test Lead during the design process and well in advance of SSTP development. Programming or mechanical changes made before ISAT (typically during Contractor pre-testing) must be documented and provided to the TSA RDC and TSA Acceptance Testing Contractor. Once a system enters TRR, no variances will be permitted to the testing criteria.

### 1.3.3. Integrated Site Acceptance Testing (ISAT)

**Scheduling and Coordination:** Construction schedule including the ISAT start date(s) and duration(s) shall be shared with the TSA Site Lead Contractor, TSA RDC, TSA Acceptance Test Lead and TSA Acceptance Test Contractor through weekly and monthly meetings and reports upon submission of the SSTP checklist to ensure all stakeholders maintain schedule awareness. This schedule shall be distributed each time changes are made to the ISAT start date and/or duration. Changes made to the schedule within two weeks of the planned ISAT start date may relieve the TSA of the obligation to begin testing within three business days of the TRR. In this situation, the ISAT start date could depend on TSA's testing workload and resource allocation.

#### Test Results and Reports:

Testing results will be shared in hard copy format with the Airport from the RDC through the local TSA Point of Contact. Test results will identify security, efficiency and safety concerns.

There are four (4) possible test outcomes:

- **Meets PGDS Criteria** – The system under test meets CBIS design and PGDS criteria.
- **Minor Defects Found** – The system under test had no security failures and performance deficiencies would not impede system performance and staffing levels.
- **Major Defects Found** – The system under test had no security failures but performance deficiencies would be detrimental to system performance and/or staffing levels.
- **Fail** – The system under test produced security failures and/or deficiencies that would be excessively detrimental to system performance and staffing levels.

In the event of a failed ISAT result, TSA reserves the right to defer any subsequent re-tests for a period of at least 30 days.

## 1.4 INTEGRATION SERVICES

### 1.4.1. BHS Support

The EDS OEM shall assist the Commission's contractor to establish digital and serial communication for the EDS units. Once communication between devices has been established, the EDS OEM shall provide the following support and integration services.

- Assist the BHS contractor to obtain efficient EDS operation.
- Provide on-site Integration Engineer Support Services to facilitate the entire integration effort with the BHS.
- Be available to support system testing and validation conducted by internal or external organizations including the Integrated Site Acceptance Test (ISAT) and pre-ISAT Project testing and throughout the planning phases including the issuance of the ISAT TRN and TRR.

- During initial Live Operations Run-In , provide system performance documentation and technical assistance as requested by TSA, TSA Acceptance Testing Contractor and/or the ILDT.

#### **1.4.2. Software and Hardware**

Following SAT and throughout the integration effort, the EDS OEM shall install and test the required software and hardware to allow for digital and serial communication between the EDS and the BHS PLC if required. Functionality of the EDS BHS interface hardware and software shall be verified by the EDS OEM at the interface box prior to working with the Airport BHS contractor to ensure a proper operating PLC interface and to avoid delays.

### **1.5 SYSTEM NETWORKING**

#### **1.5.1 Network Infrastructure**

The EDS OEM shall provide required patch cables and miscellaneous hardware to interface between network patch panel and EDS OEM supplied networking components.

#### **1.5.2 Network Services**

The EDS OEM shall provide: training for TSA staff; coordination and support for TSA and testing certification; and resources to conduct installation, testing, and initial operational support for networking. No other network may interface with the networked airport screening solution. The implemented assigned network for operation shall be an isolated, stand-alone network.

### **1.6. TRAINING**

TSA will provide training for TSA screening staff on the operation of the EDS and ETD equipment.

### **1.7. MAINTENANCE**

Upon successful completion of SAT testing for each unit, TSA will maintain and repair the EDS and ETD units throughout their lifecycles.

**B. COMMISSION'S RESPONSIBILITIES** with regard to the Project are listed below in sections 2.1 to 2.5 listed below.

### **2.0 DESIGN**

The Commission will undertake design of a baggage screening system in accordance with the TSA PGDS to meet the needs of the Airport and TSA FSD. The Commission shall submit all applicable design requirements to the TSA RDC for review and as further defined in Chapter 2 of PGDS Version 4.1. The Commission shall respond to TSA design review comments promptly and in writing prior to the start of the next design phase for the CBIS Project.

#### **2.1 EDS PLACEMENT**

If applicable, the Commission shall ensure that the Project site will be ready to accommodate the installation of the EDS and associated equipment. The Commission shall provide adequate protection to the EDS machines and to the airport infrastructure during any and all EDS



movements. The Commission shall coordinate with the EM to integrate all activities regarding placement of EDS equipment. The Commission shall provide reasonable measures to protect the EDS and ETD equipment from damage in the screening area.

#### **2.1.1 Site Readiness and Storage**

The Commission shall confirm site readiness to receive EDS units to the TSA Site Lead Contractor no later than 10 business days prior to requested delivery date. Site readiness shall address availability of temporary or permanent power; removal of obstacles to the rigging path; and adequacy of physical environmental conditions within the delivery area that meet EDS OEM standards for protecting the EDS units. The Commission shall provide secure storage for the EDS units and any ancillary screening equipment if site conditions at the time of delivery do not provide adequate protection. The Commission shall provide secure storage space for hardware associated with EDS integration and multiplexing until it can be installed by EDS OEM Integration Support Staff. Failure to meet these minimum requirements may result in reallocation of equipment to other sites, thus affecting the airport's overall project schedule.

#### **2.1.2 Rigging Services**

The Commission will be responsible for providing rigging path verification, ingress path, and/or structural analysis. If required, the Airport will remove and replace any walls, windows, glass, doors, or other physical barriers in support of rigging activities.

### **2.2 INSTALLATION SUPPORT**

#### **2.2.1 Power Requirements**

The Commission will provide terminations to the EDS for electrical power. The Commission will be responsible for providing all infrastructure power requirements including separate metering. If applicable, the Commission will design and install all power requirements to terminal locations within the Checked Baggage Resolution Areas and at EDS locations. The Commission will provide cabling from terminations to EDS equipment. The Commission shall attest to the availability of power supply to adequately support the EDS and associated equipment in accordance with OEM specifications and be liable for damage to this equipment resulting from intentional deviations to accepted power supply conditions.

#### **2.2.2 Commissioning Services**

The Commission will be responsible for obtaining all other infrastructures not mentioned in Section 2.2.1 to support EDS operations and maintenance.

### **2.3 INTEGRATION SERVICES**

The Commission shall ensure that the BHS Contractor coordinates with EDS OEM in support of integration activities (e.g. installation and testing the required software and hardware to allow for digital and serial communication between the EDS and the BHS PLC) as needed. Terminations to the EDS for BHS PLC communication shall be performed by the Commission.

### **2.4 NETWORKING**

#### **2.4.1 Network Infrastructure**

The Commission will design and install all communication conduit, fiber, etc. as required by the EDS OEM's design criteria for the EDS and EDS networking system, including but not limited

to connectivity of Checked Baggage Resolution Areas, TSA network control room, and BHS Control Room as required. Exact parameters will be reviewed at Project start-up by TSA.

The Commission will provide cabling and network patch panels in TSA control rooms, ETD search areas, and the TSA network room as determined by the network design conducted in conjunction with the Commission. The EDS OEM shall provide required patch cables and miscellaneous hardware to interface between network patch panel and EDS OEM-supplied networking components. The Commission will provide all electrical outlets to support installation and operation of a fully multiplexed explosive detection system.

#### **2.4.2. Network Services**

No other network may interface with the networked airport screening solution. The implemented assigned network for operation shall be an isolated, stand-alone network.

### **2.5. ACCEPTANCE - TESTING SUPPORT**

The Project schedule shall allow for sufficient time to conduct mandatory testing of the EDS units after installation and integration. The Project schedule shall also factor in minimum lead times for notification of readiness for testing (7 days for SAT; 3 days for TRR; and at least 3 business days for ISAT). The Commission shall identify operational windows in time in which testing activities can be accomplished. Testing activities will be scheduled for normal 8-hour business days (Monday-Friday) and should not include holidays.

Testing activities shall also be scheduled such that test articles shall not be comingled either physically with Live Passenger Bags on existing or new screening systems or their electronic screening images shall not appear on consoles being used for Live Passenger Bag screening. Use of temporary networks or phased testing to accommodate the separation of Live Bags and Test Articles must be approved in writing through a RFV in advance of TRR/ISAT by the TSA RDC and TSA Acceptance Test Lead.

Requests for overtime or multiple shifts are discouraged and will only be considered based on compelling justification. The TSA RDC and TSA Acceptance Test Lead will review/evaluate any requests for phased testing (e.g. non-consecutive testing activities requiring multiple test team trips). Such requests must be in writing supported by compelling justification and submitted to the TSA RDC well in advance of SSTP development. Programming or mechanical changes made before ISAT (typically during Contractor pre-testing or TRR) must be documented and provided to the TSA RDC and Acceptance Test Contractor.

#### **2.5.1 Site Specific Test Plan (SSTP)**

The Commission shall ensure that information needed to develop an accurate SSTP is provided to TSA Test Acceptance Lead at the earliest opportunity, but no later than 120 days prior to the requested testing date. Required documentation includes:

- Completed Site Survey Data Collection Checklist
- Any and All Approved Request for Variance (RFV)
- Basis of Design Report
- Sample BHS & CBIS Reports for all PGDS required Reports
- BHS & EDS Network Diagrams and Server Architecture
- Local Procedures for Fail-Safe, E-Stop, Jam Clearing and IQ Test Conduct
- Airport/Airline Bag Induction/Hygiene Procedures
- BHS Specifications
- Controls Description and/or Description of Operation (if both exist then provide both)
- Fail-safe and/or E-Stop Zone Drawings
- BHS Mechanical Plan and Elevation Drawings from Natural Induction Locations to & through the CBIS, CBRA and Make-up Locations with Conveyors labeled Plan View Drawings and Electrical Drawings of the BHS/CBIS with Control Station & Photoeye Locations and labeling. All drawings will be "Approved for Construction" by the Airport and not Pre-Bid or Bid Use Only versions.
- At least 1 Plan/Overview Drawing that shows the entire CBIS in a single view
  - Conveyor Motor Manifest to include not less than (Conveyor Name, Phase, Conveyor Type, Degree of Turn, Degree of Incline/Decline, Length, Speed in FPM, Motor HP, Control Type (VFD yes/no), Brake Type, Motor Type, drive Type, FLA Rating).
  - Installation & Commissioning Phasing Plan Narrative and Phasing Plan Drawings
- Construction and Testing Schedules provided through weekly and monthly meetings and reports prior to ISAT.

All drawings shall be clearly visible and readable when plotted on Arch D Size Stock. All documents shall be submitted electronically (e.g. text documents in MS Word or PDF and drawings in AutoCAD [.dwg] or PDF.)

Any system constraints that will prevent compliance with TSA testing and performance criteria must be disclosed in writing to TSA as far in advance as possible to allow for evaluation of applicable waivers. Any restrictions on system availability and accessibility for testing shall be disclosed. Cutover plans including any phasing plans that will affect the TSA Acceptance Test Contractor's ability to test the full system from ticket counters and curbside inductions (if applicable) through the outbound/sortation system shall also be disclosed to allow for the development of an accurate SSTP. Cutover plans that will result in multiple testing phases shall also be presented to the TSA RDC in writing for review and approval prior to the Test Coordination Meeting and no later than 30 days prior to ISAT.

The Commission will have the opportunity to review and comment on SSTP in advance of testing. Comments and/or questions should be directed to the TSA RDC and the TSA Site Lead Contractor.

#### **2.5.2. Test Readiness Report (TRR)**

This pre-ISAT activity is conducted by TSA Site Lead Contractor in coordination with the Commission (typically the BHS Contractor.) The purpose of this testing activity is to assure TSA of site readiness for ISAT and is a precursor for TSA authorization for TSA Acceptance

Test Contractor to deploy. The Commission will be provided TRR data sheets by the TSA Site Lead Contractor. BHS/CBIS configuration and operation shall be in final form intended for bag screening operations. Unless mutually agreed to, changes/improvements to BHS/CBIS between TRR and ISAT are not authorized. The Commission must address security and efficiency defects found during TRR and be prepared to implement mutually agreed upon corrective actions prior to ISAT.

Required input from the Project Team will include:

**Functional Testing Documentation:** Testing authentication must be clearly reported and show every test with bag ID and declared status on printed EDS FDRS (Field Data Reports) and on the printed Critical Tracking PEC Report (as required in PGDS Section 7.2.14) resulting bag destination. Ledger forms should show test date, type of test, identification of bag destination location, and ID number of the bags arriving at that location. These reports should be organized and indexed in an electronic media/file or loose-leaf binder(s)

- Each test shall conclude with an indication of successfully passing the required criteria of BHS specification and testing criteria and if conflict or failure exists, then so indicate with an explanation.
- Presentation of completed testing and TRR required documentation to TSA Site Lead not less than 7 business days prior to anticipated Pre-ISAT date is required.

**System Mixed Bag Test and System Throughput Test Observation:** Sufficient numbers of test bags (no less than 100 test bags per EDS) will be utilized to "stress" the BHS/CBIS as would occur during peak operating times. Test bag set profile should be similar to the TSA Acceptance Test Contractor's test bag profile.

- A real-time observation by TSA Site Lead Contractor of a global BHS/CBIS System Mixed Bag Test and System Throughput Test using clear and suspect bags is required.
- All EDS equipment must be operational.
- All baggage entry points must be utilized.

The TSA Site Lead Contractor or Acceptance Testing Contractor performs the TRR. If successful, a Test Readiness Notice is issued to the TSA RDC and the TSA Acceptance Test Contractor for ISAT deployment. If delivered by COB Monday through Wednesday (5:00 p.m. EST), ISAT deployment will occur the following Monday. If delivered any time Thursday through Sunday, ISAT deployment will occur on the second Monday. If changes are made to the system following TRR without prior coordination with TSA, ISAT testing shall be postponed pending submission of documentation for review and evaluation by TSA and its Acceptance Test Contractor (see paragraph 2.5.7)

**2.5.3. Logistical Support Needs:** The Commission shall identify and provide any logistical or support needs that will impact TRR and ISAT testing, to include:

- any process needed to obtain sufficient baggage tags should the system use IATA baggage tracking mechanisms, pier tags should the system use pier tags, or blank bag tags if the system does not use IATA baggage tracking mechanisms; Quantities of tags needed will be coordinated during the Site Survey Meeting and the SSTP review Meetings

- any process needed to obtain sufficient baggage tubs/totes (typically 20 per installed EDS)
- any process needed to obtain sufficient bag transportation devices (tugs, totes, carts, etc.) needed to move test articles in and around the CBIS, CBRA, laydown area and sort/claim devices
- any process needed to obtain safety training and/or General Contractor access for TSA Acceptance Test Contractor, as required"
- any process needed to obtain airport badges/access for TSA Acceptance Test Contractor personnel; and/or personnel escorts. Airport SIDA Badging Process shall not require more than 2 trips of test team personnel to the site, 1 work week maximum duration each, to obtain SIDA badges including fingerprinting, SIDA Training, testing, issuing and pickup.
- availability of BHSC and BHS Programmer to operate BHS during ISAT and provide support for ISAT Testing and diagnostic activities (BHS reports, investigations, and explanations to questions from the TSA Acceptance Test Contractor)
- provide baggage handling support for testing activities including bag loading, unloading, transport, fault recovery, during ISAT and TRR including movement between test and laydown/storage areas; and
- availability of support for delivery and secure and weather protected storage of TSA Acceptance Contractor test bags for ISAT (100 bags per EDS contained in 2 LD3s per 100 bags.)

**2.5.4. ISAT Testing:** The TSA Acceptance Test Contractor will meet with the Commission between 30 and 45 days prior to testing to coordinate the conduct of ISAT testing. The TSA Acceptance Test Lead and the Commission will finalize details relating to the scheduling and duration of the testing. (Generally allow one day of travel for ISAT Testing Team in and out; one day for Site Mobilization; one day per EDS Spur Line; one day per System Level Test (Dieback, Mixed Bag Sortation and Throughput; one day for demobilization and cleanup). It is recommended to schedule one to two additional days for unforeseen testing delays or contingences.

#### **2.5.5. Test Results and Reports**

The Airport shall report corrective actions to be applied and the timeline associated with deficiency corrections. Corrective actions shall address all defects identified in the TRR/TRN (pre-ISAT) or QLR (ISAT). TSA is not obligated to accept or operate a baggage screening system that does not meet the minimum test standards.

#### **2.5.6. Operational Run-In**

The Run-In period will extend for a minimum of 30 days from the start of substantial operations with cutover of substantial input and output lines. This period of time shall be discussed and agreed to by all parties during the SSTP development process, and reconfirmed at the completion of the ISAT. Substantial Operations shall normally be defined as when the CBIS is processing 85% or greater of its normal (not peak) operational daily load of "checked bags or luggage" for the time period at hand (i.e. not based on future dates of operation). This period shall also be dependent on resolution of deficiencies found during testing and Run-In. Once a week during the Run-In period, the Airport or their authorized representatives shall forward electronic

versions of all CBIS Reports required by PGDS Chapter 7, Section 7.2.14. to the TSA Acceptance Testing Contractor. After receipt, review and analysis of at least 21 days of performance data, TSA and their Acceptance Test Contractor will deploy to the site in either the 4<sup>th</sup> or 5<sup>th</sup> week of Substantial Live Operations to physically verify closure of open deficiencies, and assess observe system operation against the data reported. The ILDT or their Contractors will also pull and provide the PLC Code for the same PLCs as provided at ISAT start. Based on the data analysis and physical observations, a recommendation will be made to TSA via a Test Summary Report (TSR) to end the Run-In period, extend the Run-In period, and/or change the operational status of the CBIS.

#### **2.5.7. Post Commissioning Activities:**

The TSA Site Lead Contractor will conduct 30-day operational run-in observations of the system following successful ISAT testing.

The Airport shall provide the TSA RDC a written response outlining corrective actions that will be taken due to outstanding deficiencies, issues, and action items identified in the Quick Look Report (QLR) and Test Summary Report within two (2 weeks of receipt of the QLR or TSR.

For the continued and secure operation of the CBIS, all changes to the BHS system that impact the CBIS operation during and after its initial commissioning must be reviewed, evaluated, and endorsed by TSA before they are implemented by the Airport. The Post-ISAT changes procedure must be provided in accordance with PGDS Appendix D. The procedure is to be followed for all changes to CBIS systems other than those required for normal routine and periodic maintenance/repairs to the BHS system. The Airport responsible for the BHS system shall assemble an information package for submittal to TSA RDC which includes the following minimum information.

- Written description of all proposed physical and programming changes to the BHS and CBIS system(s)
- Reason for proposed change(s)
- Anticipated impact to system operation (e.g. increased throughput, lowered tracking losses, elimination of bag jams)
- Drawings showing affected areas
- Any potential security, tracking or efficiency impacts, including impacts on TSA manpower or operations
- Testing procedures
- Proposed date of changes

A CBIS Configuration Change Request Form will be provided by TSA. This package shall be delivered to the local TSA FSD who shall review the package. The local TSA FSD shall add any comments he/she may have and forward the form to the following email address: OSTCBD@dhs.gov.

The TSA will review and analyze the efficacy and impact of these changes to determine if it may be necessary for TSA to re-certify the CBIS system(s). Once the review has been completed, TSA shall notify the local TSA FSD and the Airport with the TSA recommendation and testing requirements for the system changes,

**APPENDIX C**  
**Milestone Schedule**

Design & Construction Services Milestones	[Dates to be included]
Project Validated / Notice to Proceed (NTP)	
Design OTA Awarded	
Facility Modification OTA Awarded	
Pre-Design Deliverables Submitted	
Pre-Design Deliverables Approved	
Schematic Design Deliverables Submitted	
Schematic Design Deliverables Approved	
30% TSA Design Deliverables Submitted	
30% TSA Design Deliverables Approved	
70% TSA Design Deliverables Submitted	
70% TSA Design Deliverables Approved	
100% TSA Design Deliverables Submitted	
Final Construction Drawings Approved	
Facility Modification NTP (if applicable)	
Facility Modification Progress Meetings (reoccurring)	
Facility Modification Substantially Complete (if applicable)	
Site Assessment and Survey Report Submitted	
Site Installation Plan (SIP) Submitted	
SIP Approved	
EDS Delivered and Placed	
Site Acceptance Test (SAT) Passed	
Integrated Site Acceptance Test (iSAT) Test Readiness Review Complete (if applicable)	
iSAT Passed (if applicable)	
EDS Installation/Networking Start	
EDS Installation/Networking Finish	
EDS Decommissioned (if applicable)	
EDS Removal Start (if applicable)	
EDS Removal Finish (if applicable)	
Live Bag Screening (LBS) Start	
Record Dwgs / CAD As-Built Submitted	
TSA Final Sign-off of Project	
Final Invoice Submitted	
Project Completion Notification Submitted	
Project Finish / Contract Closeout	

### APPENDIX D, SCHEDULE OF DELIVERABLES

The following deliverables are required to be submitted by the Commission:

Item	Submitted To:	Frequency or Due Date
Design: 70% and 100% to include detailed construction cost estimate	TSA Regional Deployment Coordinator	In accordance with the TSA PGDS, version 4.1
EDS Delivery Schedule	TSA Regional Deployment Coordinator	NLT 30 Days after Construction Contract Award
Schedule of Values (Design, Construction, Baggage Handling Contracts)	TSA Regional Deployment Coordinator TSA Contracting Officer	Within 30 days after execution of the TSA Agreement or upon issuing Notice to Proceed to Contractor. To be updated on a monthly basis and submitted with the monthly report.
Copies of the Design and related Construction Contracts and Change Orders	TSA Regional Deployment Coordinator TSA Contracting Officer	Upon contract award. Change Orders affecting the CBIS Project require advance TSA approval.
Monthly Milestone and Project Status Report	TSA Regional Deployment Coordinator TSA Contracting Officer TSA Site Lead Contractor	By the 10 <sup>th</sup> of each month. Electronic submission is requested if feasible.
Quarterly Project Financial Statement	TSA Regional Deployment Coordinator TSA Contracting Officer FinanceConfirm@tsa.dhs.gov	Quarterly upon execution of the OTA.
Summary report of Small Business/Disadvantage Business Enterprises utilization Report	TSA Contracting Officer	By September 30 <sup>th</sup> each year and upon completion of the Project via email
<b>CONSTRUCTION PHASE</b>		
Mechanical and Electrical Shop Drawings	TSA Regional Deployment Coordinator TSA Site Lead Contractor	Upon completion by the Commission
Close Out Process		
Close Out Process – Correction of testing deficiencies	Close Out Report submitted to TSA Regional Deployment Coordinator and TSA Site Lead Contractor	Airport responses within (2) weeks of receipt of QLR and TSR to address noted CBIS
Final Copy of PLC program and software disaster recovery	TSA Regional Deployment Coordinator	No later than 30 days after commissioning of system(s)



procedure in electronic format.		
As Built Drawings in electronic format, .dwg (AutoCAD) or comparable format to include final description of operations; mechanical layouts, including belt speeds in CAD and PDF file format.	TSA Regional Deployment Coordinator	No later than 30 days after 30-day operational run-in period
Overview of drawings of the Matrix/Node, Resolution Room, OSR Room as applicable. dwg (AutoCAD) or comparable format	TSA Regional Deployment Coordinator	30 days after 30-day operational run-in period
Final Invoice	TSA Regional Deployment Coordinator TSA CO	No later than 90 days after final sign-off of system by TSA Deployment Manager, following successful operational run-in period and start of live bag screening
<b>POST COMMISSIONING CHANGES</b>		
CBIS Changes after Commissioning.	OSTCBD@dhs.gov	See Post Commissioning Requirements, Appendix B, paragraph 2.5.7

The Monthly Milestone and Project Report are to be submitted by the 10<sup>th</sup> of each month. A draft Monthly report template will be submitted via separate correspondence. The Monthly Milestone and Project Report shall address the following:

- a. Actual start and/or finish dates for updated/completed activities.
- b. Remaining duration, required to complete each activity started, or scheduled to start, but not completed
- c. The Project's progress to include Project Percent Completion; cost incurred and invoiced to date; a forecast the Project completion date and final costs; as well as monthly schedule and budget variances throughout the Project.
- d. Percentage for completed and partially completed activities.
- e. Any CO approved changes including, but not limited to new activities, deleted activities, activity duration changes, and change in logic relationships between activities.
- f. Status date for the schedule update.
- g. A statement that identifies and describes any current or anticipated delays that includes the following information: identification of the delayed activity by description and activity code; type of delay; cause of the delay; effect of the delay on other activities, milestones, and completion dates; identification of actions needed to avoid or mitigate the delay.
- h. Summary of cost incurred and invoiced to date.

- i. Description of lessons learned
- j. Construction Schedule in both PDF and "live"/usable format to depict the critical path, baseline and actual date information; predecessors/successors and shall be broken down to a minimum of three (3) WBS levels where applicable.

The construction schedule will be used for all planned TSA activities (delivery of equipment, scheduling of testing, etc).

## APPENDIX E STIP DATA REQUIREMENTS FOR CHECKED BAGGAGE SYSTEMS

The TSA HQ Office of Information Technology (OIT) and Security Technology Integrated Program (STIP) require STIP-enabled transportation security equipment (TSE) to have specific connections to securely and reliably network the equipment. Multiple parties play a role in this portion of Checked Baggage Inspection System (CBIS) specification and execution.

### **Roles and Responsibilities for Implementing STIP**

As CBISs are recapitalized or optimized, the project owner's contractor will provide new telecommunications outlets and cables as needed to support new technology. If a CBIS reconfiguration is initiated as part of a recapitalization/optimization, safety effort, new technology deployment or any other CBIS redesign initiative, the CBIS contractor will be responsible for restoring the previous state of connectivity ("make whole"), including development of the scope of work (SOW). Implementation in the field will occur via the CBIS contractor. A working group, or Integrated Local Design Team (ILDIT) must be formed consisting of representatives from the Airport Authority, FSD staff, OSC, OIT and STIP. The group should meet immediately via conference call once it has been determined that a CBIS is going to be recapitalized or optimized. This action will ensure that ALL aspects of the CBIS redesign have been identified and assigned to a specific group for action and funding. The ILDIT will organize the working group members, develop, review and approve the SOW. The OIT Field Regional Manager (FRM) shall always be consulted when a CBIS redesign is initiated and will provide the necessary routing information to ensure the checked baggage systems are appropriately cabled to a networked TSA IT cabinet.

### **The IMAC Process**

The IMAC Process is the mechanism by which TSA OIT will procure and install IT hardware (e.g. network switch) following the IT infrastructure build-out of a CBIS contractor. The OSC Regional Deployment Manager (RDM) shall be responsible for engaging OIT at project initiation and including the respective regional Field Relations Manager (FRM) throughout the construction process.

The IMAC process takes between 30 and 45 days and needs to be initiated to complete the following tasks:

- Procurement, configuration and shipment of IT hardware.
- Installation of IT hardware
- Patch cabling of checked baggage equipment
- Validation of network connectivity for checked baggage equipment
- Validations of STIP EM sever registration for checked baggage equipment.

It is imperative to engage each team member as early as possible in order to avoid any gaps in IT services.

### Specific Design Standards and Requirements

Two modular jacks consisting of a flush-mounted telecommunications outlet box plus/minus 10 feet from the equipment are required. Even though one is redundant, both terminations should be connected using Cat5e or Cat6 4-pair 100 ohm unshielded twisted pair (UTP) or screened twisted pair (ScTP) cable and terminated on the patch panel in the closest TSA IT cabinet. The data cable type should be based on the existing conditions at the Checked Baggage Inspection System (CBIS). The purpose of this connectivity is so that TSA HQ can review statistical data over the network from screening equipment for a particular airport and time period without having to go to the site.

Installation and/or relocation of Cat5e/Cat6 data cabling will meet or exceed the specifications listed in the TSA Structured Cabling System Guidelines dated July 2012 [Attached]. This document will be provided by the TSA to the ILDT.

In addition, the following requirements should be met:

- All ETDs and stand-alone EDSs will have 1 “dual telecommunications outlet”.
- It is assumed that when a multiplex server is present, connectivity to TSANet will terminate at the multiplex server cabinet, therefore connectivity to TSANet for each EDS is not required.
- All core drilling will support a minimum of 4 “modular jacks”.
- All new fiber installations will be multimode fibers, either multimode fiber, either 50/125 or 62.5/125 micron fibers or 50/125 or 62.5/125 micron fibers, six-strand bundles enclosed in inner duct.
- All cabinet installations require 2 110v 20A service.
- All cabinet installations will meet the local seismic rating requirements and can be floor/bracket mounted.
- All cabling outside of TSA controlled space must be in Rigid Metal Tubing (RMT) conduit. Any deviance will must be approved through existing RFV procedures.
- All newly installed and existing data jacks and associated patch panels must comply with TSA’s approved scheme [see provided TSA Structured Cabling System Guidelines dated July 2012].
- Provide TSA completed Data Capture Sheet [Attached] and cable certification paperwork prior to established I-Sat date.

Figure 1 illustrates all of the equipment that must be connected to the Main Distribution Frame (MDF)/Intermediate Distribution Frame (IDF) IT cabinet for a stand-alone CBIS configuration. When the EDS are in a stand-alone configuration, each EDS must be connected to the patch panel.

Figure 1  
STAND-ALONE CBIS CONFIGURATION

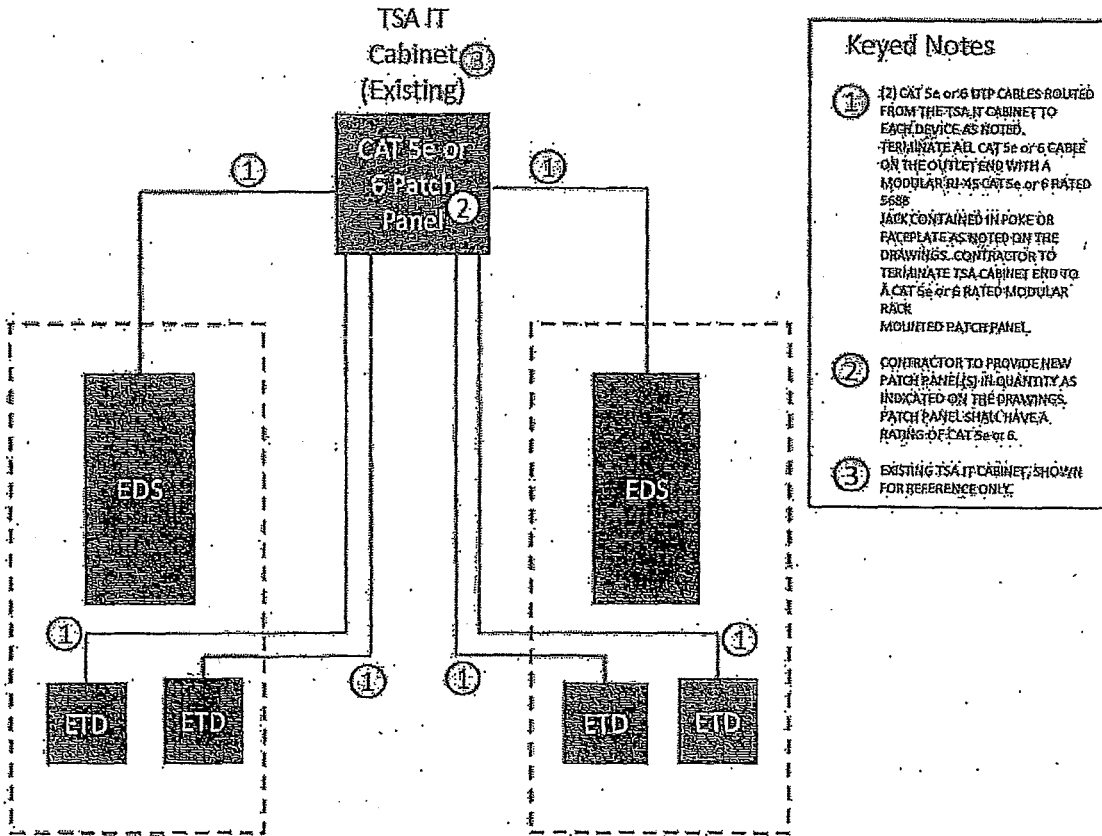
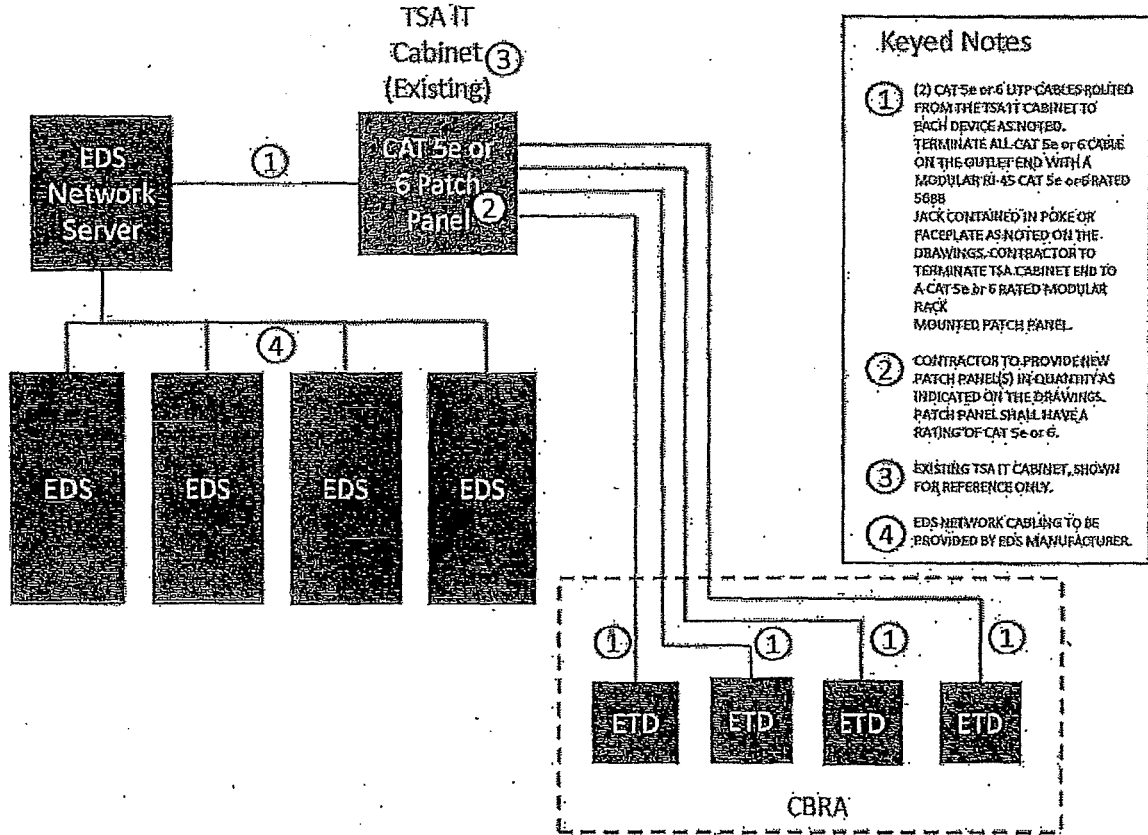

Figure 2 illustrates all of the equipment that must be connected to the IDF IT cabinet for a CBIS where the EDS machines are already networked together. When the EDS machines are networked together (i.e., MUX, NEDS, etc.), the connection only needs to be made to the EDS Network Server(s).

Figure 2:  
NETWORKED CBIS CONFIGURATION



At a minimum, the following guidelines should be considered when designing a new CBIS or reconfiguring an existing CBIS.

- If an existing TSA IT cabinet is within 295 feet of the CBIS:
  - Verify that the existing switches have sufficient open ports to accommodate the required number of drops
  - Notify TSA OIT FRM if the existing switch capacity will not accommodate the required number of drops so that additional equipment can be procured;
  - Punch down cabling from the individual CBIS devices in the patch panel of the IT cabinet

- If there is no IT cabinet within 295 feet of the CBIS:
  - Install an appropriate IT cabinet. Refer to Figure 3 for the IT cabinet specifications
  - Run fiber optic cable from the IT cabinet to an existing TSA IT cabinet
  - Notify TSA OIT FRM so that additional equipment can be procured.
  - Punch down cabling from the individual CBIS devices in the patch panel of the IT cabinet
  - Initiate IMAC group to install jumper cables from the patch panel to the switch and activate port

Figure 3  
IT CABINET

IT Cabinet	Size	1 or more per checkpoint depending on size	For 24H, 36H and 48H:	For 60H and 72H:	Size patch panels to accommodate all TSA data outlets at the check point plus 100% spare, minimum.	30" front end rear access is required.
	Size 24H 24.0" H x 27.3" W x 30.0" D Weight: 97 lbs		<ul style="list-style-type: none"> <li>• Dedicated</li> <li>• 30A, 125V, 3KVA/Cabinet</li> <li>• 2 Pole, 3Ww Grounding</li> <li>• NEMA 1E-30R Receptacle</li> <li>• 3KVA UPS</li> <li>• 6" power cord from the IT cabinet to the receptacle</li> </ul>		<ul style="list-style-type: none"> <li>• Size patch panels to accommodate all TSA data outlets at the check point plus 100% spare, minimum.</li> <li>• Size giga bit network switch to accommodate all data outlets in checkpoint plus 100%.</li> <li>• Provide a minimum of four pair single mode fiber optic cable from IT cabinet to the TSA mesh distribution frame.</li> </ul>	<ul style="list-style-type: none"> <li>• These cabinets will receive all data communication lines from the SSCP so the cabinet should be located as close to the SSCP as possible, but in a secure location. Careful consideration needs to be given to the IT cabinet location because the exhaust fan for cooling can be loud when located in a confined space with TSA or airport personnel.</li> <li>• Equipment racks can be loaded into the cabinet from the front or the back at the location where the cabinet is installed. Although not required, side access would improve rack accessibility and TSA personnel mobility around the cabinet.</li> <li>• Refer to Program of Requirements dated July 2005, Section 14-D for labeling, cable management and administration of IT cabinet.</li> <li>• Refer to Program of Requirements dated July 2005, Section 15-D for acceptance testing of IT circuits.</li> <li>• Watercooled cabinets are an option in some instances, but must adhere to all applicable local codes and standards. Recommend consultation with the Field Regional Manager (FRM) when considering a watercooled alternative.</li> </ul>
	Size 36H 35.0" H x 27.3" W x 30.0" D Weight: 124 lbs					
	Size 48H 48.0" H x 27.3" W x 30.0" D Weight: 151 lbs					
	Size 60H 60.0" H x 27.3" W x 30.0" D Weight: 246 lbs		<ul style="list-style-type: none"> <li>• Dedicated</li> <li>• 30A, 208V, 6KVA/Cabinet</li> <li>• 2 Pole, 3Ww Grounding</li> <li>• NEMA 1E-30R Receptacle</li> <li>• 6KVA UPS</li> <li>• 8" power cord from the IT cabinet to the receptacle</li> </ul>			
	Size 72H 72.0" H x 27.3" W x 30.0" D Weight: 274 lbs					

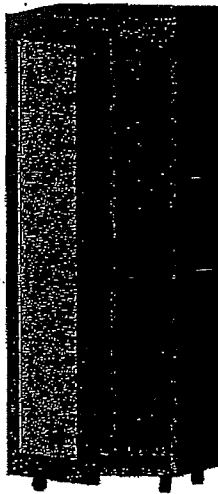

Isometric View

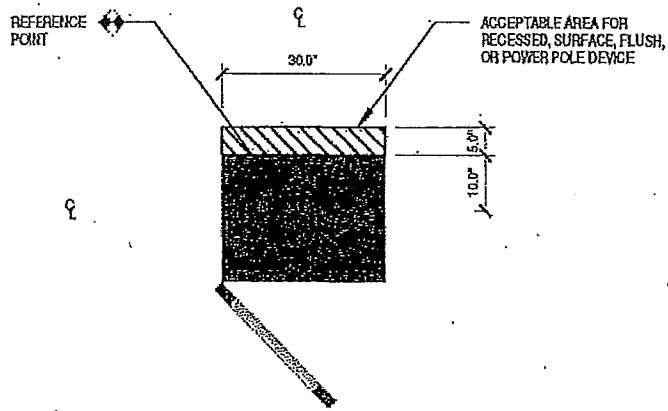



PLAN VIEW

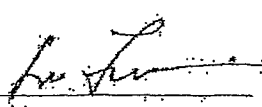

Transportation  
Security  
Administration

**OTHER TRANSACTION AGREEMENT**

<b>OTA NUMBER</b>		<b>REQUISITION NUMBER</b>	
HSTS04-13-H-CT1140 Modification Number: P00001		2116206CT1208	
<b>ISSUED TO</b>		<b>ISSUED BY</b>	
City and County of San Francisco San Francisco International Airport (SFO) PO Box 3097 San Francisco, CA 94128 DUNS: 046004081		Bonnie Evangelista, Contracting Officer Transportation Security Administration 701 S. 12 <sup>th</sup> St Arlington, VA 20598-6025 Bonnie.evangelista@tsa.dhs.gov	
<b>PROGRAM TITLE</b>			
Program Office: Office of Security Capabilities Program: Electronic Baggage Screening Program Period of Performance: 9/26/2013-9/26/2018			
<b>FISCAL DATA</b>			
PR Number: 2116206CT1208 Accounting Line: n/a Obligated Amount: \$0			
<b>PURPOSE</b>			
In accordance with Article XIII <i>Changes and/or Modifications</i> the purpose of this modification is to revise Article III <i>Scope</i> and update Article VIII <i>Authorized Representatives</i> . See additional pages for further details.			
<b>AUTHORIZED SIGNATURES</b>			
IN WITNESS WHEREOF, the Parties have entered into this Agreement by their duly authorized officers.			
 Signature _____ Date July 8, 2016 _____ John L. Martin, Airport Director PRINTED NAME AND TITLE		 <small>Digitally signed by BONNIE EVANGELISTA DN: cn=BONNIE EVANGELISTA, ou=Transportation Security Administration, o=Department of Homeland Security, c=US, email=BONNIE.EVANGELISTA@tsa.dhs.gov</small> Contracting Officer's Signature _____ Date 7/13/2016 _____ Bonnie Evangelista, TSA Contracting Officer PRINTED NAME AND TITLE	

Approved as to form:  
**DENNIS J. HERRERA**  
City Attorney

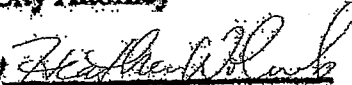
By   
**Deputy City Attorney**



I This modification changes Article III as follows.

**MODIFY FROM:**

**ARTICLE III – SCOPE**

The purpose of this OTA is to set forth the terms and conditions, as well as establish the respective cost-sharing obligations and responsibilities of the TSA and the Commission with respect to the design, engineering and construction-related services necessary to implement the construction of the TSA recapitalization and optimization project design submitted by the Commission and reviewed by TSA pursuant to the TSA Planning Design Guidelines and Design Standards (PGDS) Version 4.1 found at [http://www.tsa.gov/research/checked\\_baggage\\_material.shim](http://www.tsa.gov/research/checked_baggage_material.shim).

This Project undertaken by the Commission involves the modification to or construction of the Airport terminal building infrastructure to recapitalize and optimize the TSA EDS systems located within the Checked Baggage Inspection System (CBIS). Terminal modifications include required changes to baggage conveyor components, mechanical, plumbing, electrical, structural, and telecommunications infrastructure to provide for the installation of Explosive Detection Equipment (EDS) within the baggage screening area, Explosive Trace Detection (ETD) equipment in the Checked Baggage Resolution areas, and the installation of applicable CBIS hardware and software for use with a checked baggage in-line baggage screening system. The objective of the Project is to enhance Airport security and baggage screening capabilities and throughput.

This OTA also includes design services for 70% and 100% drawings and specifications that will be submitted to TSA for review in accordance with the published TSA PGDS Version 4.1; this OTA does not include design services for the 30% design deliverable. The Commission will be responsible for developing various cost-effective solutions to replace fifteen (15) Explosive Detection System (EDS) machines currently located in Terminal 1 of the Airport, while minimizing the impact to operations and reducing the number of EDS by using higher throughput technology units (as appropriate). The solutions that the Commission proposes should be based upon a baggage screening rate derived from the current baggage screening rate and a projected future screening rate. Solutions based upon such a combined current and future rate will allow the TSA to consider all cost factors available when making its decision of the optimal solution.

**MODIFY TO:**

**ARTICLE III – SCOPE**

The purpose of this Agreement is to set forth the terms and conditions, as well as establish the respective cost-sharing obligations and responsibilities of the TSA and the CITY with respect to the design and construction-related services necessary to implement the optimization of in-line systems at Terminal 1, International Terminal A (BAA) and International Terminal G (BAG) (hereinafter "Project") submitted by the CITY and approved by TSA pursuant to the TSA Planning Guidelines and Design Standards (PGDS) Version 5.0 dated July 16, 2015, which can be found at:

<https://www.fbo.gov/index?s=opportunity&mode=form&id=2cd2d67c3aea24381c955dd52e07d142&tab=core&cvview=1>.

This OTA also includes design services for 70% and 100% drawings and specifications for the Terminal 1 project as well as 100% drawings and specifications for the BAA and BAG projects. This Project undertaken by the CITY involves the modification or construction of the Airport terminal building infrastructure to optimize and install the TSA Explosives Detection Systems (EDS) equipment located within the Checked Baggage Inspection System (CBIS). Terminal modifications include required changes to baggage conveyor components, mechanical, plumbing, electrical, structural, and telecommunications infrastructure to provide for the installation of EDS within the baggage screening area, Explosive Trace Detection (ETD) systems in the Checked Baggage Resolution Areas (CBRA), CBIS hardware and software for use with a checked baggage in-line baggage screening system. The objective of the Project is to enhance Airport security and baggage screening capabilities.

II. This modification revises the TSA Points of Contact in Paragraph A of Article VIII *Authorized Representatives* as follows.

Regional Deployment Coordinator/Contracting Officer Representative  
Gregory Cypher  
Transportation Security Administration  
Office of Security Capabilities, TSA-16  
TSIF Building  
1 West Post Office Road  
Washington, DC 20528-6932  
Phone: 571-227-2320  
E-Mail: [gregory.cypher@tsa.dhs.gov](mailto:gregory.cypher@tsa.dhs.gov)

Contracting Officer:  
Bonnie Evangelista  
Transportation Security Administration  
Office of Acquisition, TSA-25  
701 S. 12<sup>th</sup> Street  
Arlington, VA 22202  
Phone: 571-227-1655  
E-Mail: [bonnie.evangelista@tsa.dhs.gov](mailto:bonnie.evangelista@tsa.dhs.gov)

III. This administrative modification is being executed at no additional cost to the Government. The TSA Reimbursement Limit of \$59,429,406 as detailed in Article IV *Cost Sharing and Other Responsibilities* and all other terms and conditions remain unchanged and in full force and effect.

--End of Modification--

AIRPORT COMMISSION

CITY AND COUNTY OF SAN FRANCISCO

RESOLUTION NO. 17-0155

**APPROVAL OF MODIFICATION NO. 10 (ANNUAL RENEWAL) TO PROFESSIONAL SERVICES CONTRACT NO. 9024.9, CONSTRUCTION MANAGEMENT SERVICES FOR THE INTERNATIONAL TERMINAL CHECKED BAGGAGE INSPECTION SYSTEM MODERNIZATION PROGRAM AND BAGGAGE HANDLING SYSTEM IMPROVEMENTS PROJECT, WITH CAGE PROFESSIONAL SERVICES, INC. DBA CAGE, INC., IN AN AMOUNT NOT TO EXCEED \$750,000 FOR A NEW CONTRACT AMOUNT OF \$10,695,000 AND FOR AN ADDITIONAL YEAR OF SERVICES THROUGH SEPTEMBER 30, 2018**

WHEREAS, the International Terminal Building (ITB) Checked Baggage Inspection System (CBIS) Modernization Program and Baggage Handling System Improvements Project (Project) provides for the upgrade and replacement of the CBIS and Checked Baggage Resolution Area (CBRA) for the ITB under the TSA's Recapitalization Program. In addition, the Project provides for BHS control upgrades and improvements to the ITB baggage handling system; and

WHEREAS, on March 1, 2011, by Resolution No. 11-0045, the Commission authorized the Director to execute an Other Transaction Agreement (OTA) with the TSA for 90% reimbursement of design costs, including construction management services during construction, for the ITB and Boarding Area F (BAF) CBIS Modernization Program; and

WHEREAS, on June 30, 2011, by Resolution No. 11-0146, the Commission awarded this Contract 9024.9 to CAGE Professional Services, Inc. dba CAGE, Inc. for Construction Management (CM) Services for Project; and

WHEREAS, by various resolutions, the Commission has approved Modification Nos. 1 through 8 to provide for contract renewals tied to the schedule of the design-build contracts, for services through September 30, 2017, and for a not to exceed contract amount of \$9,945,000. Administrative Modification No. 9 was issued with no change to the contract amount or duration; and

WHEREAS, Staff and CAGE Inc., have reached agreement on scope, staffing and fee for an additional year of services; and

WHEREAS, the total budget for this Contract will be \$14,221,000 for services through September 30, 2020 to provide general contract administration and construction management support services for the full duration of the new design-build contract; and

AIRPORT COMMISSION  
CITY AND COUNTY OF SAN FRANCISCO  
RESOLUTION NO. 17-0155

WHEREAS, this Modification No. 10 to Contract No. 9024.9 with CAGE, Inc. increases the contract by \$750,000 for a new contract not to exceed amount of \$10,695,000 for another year of services through September 30, 2018; and

WHEREAS, due to the federal funding component for these services, the Airport encouraged proposers to utilize "best efforts" to subcontract at least 10% of the work to certified Federal Small Business Enterprises (SBE). Due to the specialized nature of the services, CAGE, Inc. has so far achieved a 7.0% SBE sub-consultant participation; now, therefore, be it

RESOLVED, that the Commission hereby approves Modification No. 10 to Professional Services Contract No. 9024.9, Construction Management Services for the International Terminal Checked Baggage Inspection System Modernization Program and Baggage Handling System Improvements Project, with CAGE Professional Services, Inc. dba CAGE, Inc. in an amount of \$750,000 for a new contract amount not to exceed \$10,695,000 for an additional year of services through September 30, 2018; and, therefore, be further

RESOLVED, that this Commission directs the Commission Secretary to seek Board of Supervisors approval for Airport Contract No. 9024.9, Construction Management Services for the International Terminal Checked Baggage Inspection System Modernization Program and Baggage Handling System Improvements Project, with CAGE Professional Services, Inc. dba CAGE, Inc. in conformance with San Francisco Charter Section 9.118(b).

Page 2 of 2

*I hereby certify that the foregoing resolution was adopted by the Airport Commission  
at its meeting of*

~~==~~ JUN 20 2017

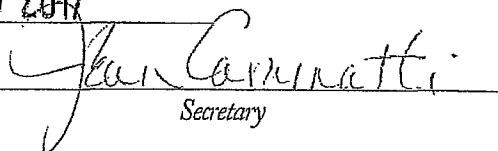
  
Secretary



San Francisco International Airport

**MEMORANDUM**

June 20, 2017

TO: AIRPORT COMMISSION  
Hon. Larry Mazzola, President  
Hon. Linda S. Crayton, Vice President  
Hon. Eleanor Johns  
Hon. Richard J. Guggenlime  
Hon. Peter A. Stern

FROM: Airport Director

SUBJECT: Approval of Modification No. 10 (Annual Renewal) to Professional Services Contract No. 9024.9, Construction Management Services for the International Terminal Checked Baggage Inspection System Modernization Program and Baggage Handling System Improvements Project

DIRECTOR'S RECOMMENDATION: APPROVE MODIFICATION NO. 10 TO PROFESSIONAL SERVICES CONTRACT NO. 9024.9, CONSTRUCTION MANAGEMENT SERVICES FOR THE INTERNATIONAL TERMINAL CHECKED BAGGAGE INSPECTION SYSTEM MODERNIZATION PROGRAM AND BAGGAGE HANDLING SYSTEM IMPROVEMENTS PROJECT, WITH CAGE PROFESSIONAL SERVICES, INC. DBA CAGE, INC., IN AN AMOUNT OF \$750,000 FOR A NEW CONTRACT AMOUNT NOT TO EXCEED \$10,695,000, AND FOR AN ADDITIONAL YEAR OF SERVICES THROUGH SEPTEMBER 30, 2018.

**Executive Summary**

Transmitted herewith for your approval is a proposed Resolution approving Modification No. 10 to Professional Services Contract No. 9024.9, Construction Management (CM) Services for the International Terminal Checked Baggage Inspection System (CBIS) Modernization Program and Baggage Handling System (BHS) Improvements Project (Project), with CAGE Professional Services, Inc. dba CAGE, Inc., in a new Contract amount not to exceed \$10,695,000 for an additional year of services through September 30, 2018.

As part of the Airport's 5-year Capital Improvement Program, the CBIS Modernization Program provides for the upgrade and replacement of the CBIS and Checked Baggage Resolution Area (CBRA) for the International Terminal Building (ITB) under the TSA's Recapitalization Program. In addition, the Project provides for BHS control upgrades and improvements to the ITB baggage handling system.

This Contract provides CM support services for the Project. This Modification will provide for the programming and design phases, along with early construction services, for the new Contract No. 11002.66 Design-Build Services for completion of the Project.

This Modification provides for the yearly renewal of CM support services.

AIRPORT COMMISSION CITY AND COUNTY OF SAN FRANCISCO

THIS PRINT COVERS CALENDAR ITEM NO. 5

EDWIN M. LEE  
MAYOR

LARRY MAZZOLA  
PRESIDENT

LINDA S. CRAYTON  
VICE PRESIDENT

ELEANOR JOHNS

RICHARD J. GUGGENHIME

PETER A. STERN

IVAR C. SATERO  
AIRPORT DIRECTOR

### Background

On March 1, 2011, by Resolution No. 11-0045, the Commission authorized the Director to execute an Other Transaction Agreement (OTA) with the TSA for 90% reimbursement of design costs, including CM services, for the ITB and Boarding Area F (BAF) CBIS Modernization Program under the TSA's Recapitalization Program, which funds the modernization of the TSA's Explosive Detection Systems equipment within the CBIS and CBRAs.

On June 30, 2011, by Resolution No. 11-0146, the Commission awarded this Contract No. 9024.9, CM Services for the ITB and BAF CBIS Modernization Program and Baggage Handling System Improvements Project, to CAGE, Inc.

By various resolutions, the Commission has approved Modification Nos. 1 through 8 for this Contract to provide for contract renewals tied to the design and construction schedule of the Project. The current contract is \$9,945,000 for services through September 30, 2017. Please refer to Attachment A for a Summary of Commission Actions to date for this Contract.

Administrative Modification No. 9 was executed on January 20, 2017 to update sub-consultants labor calculations and made no changes to the Contract amount or duration.

The Commission originally awarded a design-build contract for this Project on January 17, 2012, by Resolution No. 12-0002. However, the Airport put this Project on hold due to ongoing issues with the TSA-furnished screening equipment and its effect on Airport and airline operational capacity. The original design-build contract was closed out effective March 31, 2015.

After successful discussions with the TSA, this Project resumed. On May 2, 2017, by Resolution No. 17-0094, the Commission awarded Contract No. 11002.66 to Skanska Building USA Inc. for Design-Build Services for the completion of the Project.

This Modification No. 10 extends the CM contract duration for another year of services and proposes to increase the not-to-exceed contract amount by \$750,000, for a new contract amount of at \$10,695,000 for services through September 30, 2018. In the next year, CAGE, Inc. will provide services to support the programming and design phases as well as construction management services to support early construction activities. The total budget for this contract is \$14,221,000, with an estimated duration through September 30, 2020. Staff will return to the Commission to request approval for the remaining years of services needed to complete the Project. This Project is funded from the Airport's 5-year Capital Improvement Program. Staff continues to work with the TSA to determine the portion of the Project costs that may be reimbursed by the TSA.

Since this contract will exceed \$10 million, pending Commission authorization, the Airport will seek Board of Supervisor's approval as required by the San Francisco Charter Section 9.118(b) for the full estimated costs of the contract and duration.

Due to the federal funding component for these services, there are no Local Business Enterprise sub-consultant participation goals for the Contract. Staff encouraged proposers to utilize "best efforts" to subcontract at least 10% of the work to certified federal Small Business Enterprise

(SBE). Due to the specialized nature of the services, CAGE, Inc. has so far achieved a 7.0% SBE sub-consultant participation.

**Recommendation**

Based on the above, I recommend the Commission approve Modification No. 10 to Contract No. 9024.9, Construction Management Services for the International Terminal Building Check Baggage Inspection System Modernization Program and Baggage Handling System Improvements Project, with CAGE Professional Services, Inc. dba CAGE, Inc. in an amount of \$750,000, for a new Contract amount not to exceed \$10,695,000, for services through September 30, 2018.



Alvar C. Satero  
Airport Director

Prepared by: Geoffrey W. Neumayr  
Chief Development Officer  
Planning, Design & Construction

Attachments

City and County of San Francisco  
Airport Commission  
P.O. Box 8097  
San Francisco, California 94128

Ninth Modification

Contract No. 9024.9

Construction Management Services for the International Terminal Checked Baggage Inspection  
System Modernization and Baggage Handling System Improvements Project

THIS MODIFICATION (this "Modification") is made as of October 1, 2016, in San Francisco, California, by and between CAGE Professional Services, Inc. ("Contractor"), and the City and County of San Francisco, a municipal corporation ("City"), acting by and through its Airport Commission or the Commission's designated agent, hereinafter referred to as "Commission."

RECITALS

WHEREAS, City and Contractor have entered into the Agreement (as defined below); and

WHEREAS, on June 30, 2011, by Resolution No. 11-0146, the Commission awarded this Agreement to the Contractor; and

WHEREAS, on October 4, 2011, by Resolution Number 11-0221 the Commission approved Modification No. 1 for a new term ending on December 31, 2013; and

WHEREAS, on July 17, 2012, by Resolution Number 12-0158, the Commission approved Modification No. 2 to increase the contract amount and modify the consultants' overhead rates; and

WHEREAS, on December 3, 2013, by Resolution Number 13-0248, the Commission approved Modification No. 3 for a new term ending June 30, 2014; and

WHEREAS, on June 17, 2014, by Resolution Number 14-0124, the Commission approved Modification No. 4 for a new term ending December 31, 2014; and

WHEREAS, on December 2, 2014, by Resolution Number 14-0249, the Commission approved Modification No. 5 for a new term ending September 30, 2015; and

WHEREAS, on September 1, 2015, by Resolution Number 15-0171, the Commission approved Modification No. 6 for a new term ending September 30, 2016; and

WHEREAS, on November 1, 2015, City and Contractor administratively modified the Agreement to include new subconsultants and services through Modification No. 7; and

WHEREAS, on August 9, 2016, by Resolution Number 16-0221, the Commission approved Modification No. 8 for a new term ending September 30, 2017, approved revising the Agreement title to "Construction Management Services for the International Terminal Checked Baggage Inspection System Modernization Program and Baggage Handling System Improvements," and updated labor and overhead rates; and



WHEREAS, City and Contractor desire to administratively modify the Agreement to update a subcontractor's overhead rate; and

WHEREAS, approval for this Agreement was obtained when the Civil Service Commission approved PSC No. 4099-09/10 on September 19, 2016; and

NOW, THEREFORE, Contractor and the City agree as follows:

1. **Definitions.** The following definitions shall apply to this Modification:

a. **Agreement.** The term "Agreement" shall mean the Agreement dated June 30, 2011 between Contractor and City, as amended by the:

First Amendment,	dated October 4, 2011; and
Second Amendment,	dated July 17, 2012; and
Third Amendment,	dated December 3, 2013; and
Fourth Modification,	dated June 17, 2014; and
Fifth Modification,	dated December 2, 2014; and
Sixth Modification,	dated September 1, 2015; and
Seventh Modification,	dated November 1, 2015; and
Eighth Modification,	dated August 9, 2016.

b. ~~Other Terms.~~ Terms used and not defined in this Modification shall have the meanings assigned to such terms in the Agreement.



2. **Appendix B.3, Calculation of Charges** is hereby amended to replace Chaves & Associates' overhead rate with the following rate:

Firm Name	Overhead Rate
Chaves & Assoc.	134.94%

3. **Effective Date.** Each of the modifications set forth herein shall be effective on and after the date of this Modification.

4. **Legal Effect.** Except as expressly changed by this Modification, all of the terms and conditions of the Agreement shall remain unchanged and in full force and effect.

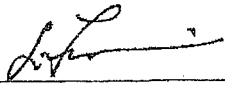
IN WITNESS WHEREOF, Contractor and City have executed this Modification as of the date first referenced above.

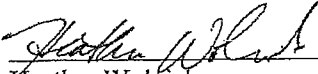
<p><b>CITY</b> AIRPORT COMMISSION CITY AND COUNTY OF SAN FRANCISCO</p> <p>By:  Ivar C. Satero, Airport Director</p> <p>Approved as to Form: Dennis J. Herrera City Attorney</p>	<p><b>CONTRACTOR</b></p> <p> Authorized Signature</p> <p>Jeff Plant President CAGE Professional Services, Inc. 6303 Commerce Drive, Suite 150 Irving, Texas 75063 972-550-1001</p> <p>81238 City Vendor Number</p>
<p>By:  Heather Wolnick Deputy City Attorney</p>	<p>75-2722503 Federal Employer ID Number</p>

City and County of San Francisco  
Airport Commission  
P.O. Box 8097  
San Francisco, California 94128

**Eighth Modification**

**Contract No. 9024.9**

**Construction Management Services for the International Terminal Checked Baggage Inspection System Modernization and Baggage Handling System Improvements Project**

THIS MODIFICATION (this "Modification") is made as of August 9, 2016, in San Francisco, California, by and between CAGE Professional Services, Inc. ("Contractor"), and the City and County of San Francisco, a municipal corporation ("City"), acting by and through its Airport Commission or the Commission's designated agent, hereinafter referred to as "Commission."

RECITALS

WHEREAS, City and Contractor have entered into the Agreement (as defined below); and

WHEREAS, on June 30, 2011, by Resolution No. 11-0146, the Commission awarded this Agreement to the Contractor; and

WHEREAS, on October 4, 2011, by Resolution Number 11-0221 the Commission approved Modification No. 1 for a new term ending on December 31, 2013; and

WHEREAS, on July 17, 2012, by Resolution Number 12-0158, the Commission approved Modification No. 2 to increase the contract amount and modify the consultants' overhead rates; and

WHEREAS, on December 3, 2013, by Resolution Number 13-0248, the Commission approved Modification No. 3 for a new term ending June 30, 2014; and

WHEREAS, on June 17, 2014, by Resolution Number 14-0124, the Commission approved Modification No. 4 for a new term ending December 31, 2014; and

WHEREAS, on December 2, 2014, by Resolution Number 14-0249, the Commission approved Modification No. 5 for a new term ending September 30, 2015; and

WHEREAS, on September 1, 2015, by Resolution Number 15-0171, the Commission approved Modification No. 6 for a new term ending September 30, 2016; and

WHEREAS, on November 1, 2015, City and Contractor through the Seventh Modification administratively modify the Agreement to include new subconsultants and services; and

WHEREAS, City and Contractor desire to modify the Agreement on the terms and conditions set forth herein to extend the contract duration by twelve (12) months for a new ending date of September 30, 2017; and

WHEREAS, Commission approved this Modification pursuant to Resolution Number 16-0221 on August 9, 2016 and approved revising the Agreement title to "Construction Management Services for the

International Terminal Checked Baggage Inspection System Modernization Program and Baggage Handling System Improvements;" and

WHEREAS, approval for this Agreement was obtained when the Civil Service Commission approved PSC No. 4099-09/10 on June 2, 2014; and

NOW, THEREFORE, Contractor and the City agree as follows:

1. **Definitions.** The following definitions shall apply to this Modification:

a. **Agreement.** The term "Agreement" shall mean the Agreement dated June 30, 2011 between Contractor and City, as amended by the:

First Amendment,	dated October 4, 2011; and
Second Amendment,	dated July 17, 2012; and
Third Amendment,	dated December 3, 2013; and
Fourth Modification,	dated June 17, 2014; and
Fifth Modification,	dated December 2, 2014; and
Sixth Modification,	dated September 1, 2015; and
Seventh Modification,	dated November 1, 2015

b. **Other Terms.** Terms used and not defined in this Modification shall have the meanings assigned to such terms in the Agreement

2. **Section 2. Terms of the Agreement** is hereby amended to extend the term of the contract for twelve (12) months for a new ending date of September 30, 2017.

3. **Section 5. Compensation** is hereby amended as follows:

A. Compensation shall be made in monthly payments on or before the 30th day of each month for work, as set forth in Section 4 of this Agreement, that the Airport Director or designee, in his or her sole discretion, concludes has been performed as of the last day of the immediately preceding month. In no event shall the amount of this Agreement exceed **Nine Million Nine Hundred Forty-five Thousand Dollars (\$9,945,000)**. The breakdown of costs associated with this Modification No. 8 appears in Appendix B.3, "Supplement to Calculation of Charges," attached hereto and incorporated by reference as though fully set forth herein. No charges shall be incurred under this Agreement nor shall any payments become due to Contractor until reports, services, or both, required under this Agreement are received from Contractor and approved by Design & Construction as being in accordance with this Agreement. City may withhold payment to Contractor in any instance in which Contractor has failed or refused to satisfy any material obligation provided for under this Agreement.

4. **Appendix B, Calculation of Charges, B.1, Supplemental Supplement to Calculation of Charges, and B.2 Supplemental Supplement to Calculation of Charges** are hereby deleted in their entirety and replaced with Appendix B.3, Calculation of Charges.

5. **Effective Date.** Each of the modifications set forth herein shall be effective on and after the date of this Modification.

6. **Legal Effect.** Except as expressly changed by this Modification, all of the terms and conditions of the Agreement shall remain unchanged and in full force and effect.

IN WITNESS WHEREOF, Contractor and City have executed this Modification as of the date first referenced above.

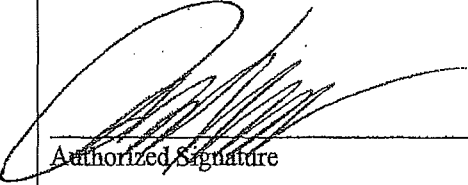
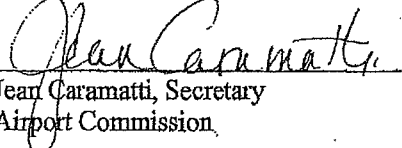
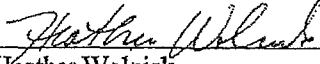
CITY	CONTRACTOR
AIRPORT COMMISSION CITY AND COUNTY OF SAN FRANCISCO	
By:  Ivar C. Satero, Airport Director	 Authorized Signature
Attest:	John Boodee President CAGE Professional Services, Inc. 6303 Commerce Drive, Suite 150 Irving, Texas 75063 972-550-1001
By:  Jean Caramatti, Secretary Airport Commission	81238 City Vendor Number  75-272503 Federal Employer ID Number
Resolution No: 16-0221	
Adopted on: August 09, 2016	
Approved as to Form:	
Dennis J. Herrera City Attorney	
By:  Heather Wolnick Deputy City Attorney	

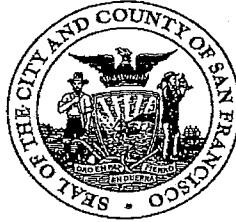

### Appendix B.3 Calculation of Charges

This is Appendix B.3 attached to, and incorporated by reference in the Agreement made on **June 30, 2011** between the City and County of San Francisco, acting by and through its Airport Commission (Commission), and **CAGE Professional Services Inc.** (Contractor) providing for construction management services for the International Terminal Checked Baggage Inspection System Modernization and Baggage Handling System Improvements Project

#### A. General

1. For the compensation for complete and satisfactory performance of services detailed in Appendix A.2 of the Agreement are set forth in paragraph 5.A. "Compensation" of the Agreement and all Agreement modifications.
2. No charges shall be incurred under this Agreement nor shall any payments become due to the Contractor until reports, services, or both required under this Agreement are received from the Contractor and approved by the Commission as being in accordance with this Agreement. In no event shall the Commission be liable for interest or late charges for any late payments.
3. Compensation for work performed under this Agreement will be on a time and material payment basis, except when lump sum is pre-approved by the Commission's Project Manager. Such compensation shall be allowable only to the extent that costs incurred, or otherwise established prices, are consistent with the Federal Cost Principles (Title 48, Code of Federal Regulations, Part 31).

#### B. Method of Payment

1. Unless approved otherwise by the Commission, the Contractor's services shall be invoiced on a monthly basis and payment will be made within thirty (30) days of receipt of an acceptable invoice with satisfactory backup documentation, approved by the Commission's Project Manager. As used herein, the term "invoice" shall include the Contractor's bill or written request for payment under this Agreement for services performed. All invoices shall be made in writing.
2. Unless approved otherwise by the Commission's Project Manager, the Contractor shall, within three (3) days after receipt of payment by the Airport specified in this Agreement pay to all of its immediate subcontractors (or their respective assignees) the amounts to which they are entitled,

after deducting any prior payments and any amounts due and payable to the Contractor by those subcontractors.

3. Contractor shall invoice for the Work performed in conformance with procedures approved by the Commission.
  - a. Such invoices shall segregate current costs from previously invoiced costs.
  - b. Costs for individual labor shall be segregated by task and subtasks, if any.
  - c. Notwithstanding the above, in no case shall the Contractor invoice include costs which Airport has disallowed or otherwise indicated that it will not recognize.
  - d. Each invoice shall clearly distinguish Contractor's personnel that is invoiced at the home office rate versus the field office rate. See paragraph F below for rate definitions.
4. Such invoices shall be as a minimum, (i) mechanically accurate, (ii) substantially vouchered and properly supported and (iii) in compliance with generally accepted accounting principles
5. Contractor shall also certify, for each invoice, that (i) the hourly rates for direct labor, whether for Contractor or its subcontractor(s), to be reimbursed under this Agreement are not in excess of the actual hourly rates in effect for Contractor or subcontractor employees engaged in the performance of services under this Agreement at that time, and (ii) that such hourly rates are in conformance with the Agreement.
6. The fee for Contractor or any of its subcontractors shall be billed monthly on all direct labor for services provided in the current invoice at the percentage described in paragraph E below.
7. The Commission's Project Manager reserves the right to withhold payment(s) otherwise due the Contractor in the event of Contractor's material non-compliance with any of the provisions of this Agreement, including, but not limited to, the requirements imposed upon the Contractor in Article 15, Insurance, and Article 16, Indemnification. The Airport shall provide notice of withholding, and may continue the withholding until Contractor has provided evidence of compliance which is acceptable to the Airport.
8. All invoices shall be made in writing and delivered or mailed to the Airport's mailing address listed in Section 25, Notice to Parties, of the Agreement:

#### C. Direct Salary Rate and Direct Salary Rate Adjustment

1. The direct labor rate shall not exceed **Ninety-eight Dollars (\$98)** per hour. Any rate in excess of this cap will require prior written approval from the Commission's Project Manager.
2. Salaried personnel shall be paid on a maximum of 40 hours per week, with no overtime. Salaried personnel assigned to multiple projects shall be paid on a pro-rata share of a 40-hour week. Signed time cards shall be provided showing all assigned projects and the shared calculation.

3. The approved billing rates stated in this Modification No. 8 shall remain in effect for one year on the first calendar day following the certified date of this Modification No. 8. At the option of the Commission, this is a multi-year contract, the Commission may approve an annual adjustment to the direct hourly labor rates, based on an increase in the Consumer Price Index for the preceding twelve (12) months for the San Francisco Bay Area as published by the U.S. Department of Labor, Bureau of Labor Statistics, under the title of: "Services Less Rent or Shelter – All Urban Consumers – San Francisco/Oakland/San Jose, California" or on an increase in the wages of comparable classifications as reflected in the collective bargaining agreements between the City and County of San Francisco and the labor organization representing those classifications, whichever is lower. Such adjustment is subject to prior written approval by the Commission and must be included in a written modification to the Agreement before any increase labor rate is incurred, unless the adjustment is made to meet the requirements of prevailing or minimum wage legislative mandates. In no event will the adjustment exceed the lower of the above specified indices unless the proposed adjustment is made pursuant to other specific terms of this Agreement or is necessary to meet the requirements of prevailing or minimum wage legislative mandates.

**D. Billing Rates**

1. Billing rates and overhead rates shall be used for reimbursement of the cost portion of this Agreement. Billing rates shall be the sum of approved hourly direct base labor rates as set forth in paragraph G below plus indirect cost. Indirect cost rates are as follows:

<b>Firm Name</b>	<b>Overhead Rate</b>
CAGE Professional Services, Inc.	141.59%
KPA Group	179.01%
Chaves & Assoc.	112.20%
EPC Consultants	Field = 106.90% and Home Office = 110.24%
M Lee Corp	131.96%
Apex Testing	76.44%
Grindstone Group, LLC	75.52%
Cooper Pugeda Management, Inc.	105.21%
Brock Solutions	N/A
Innovation Technology Partners, Inc.	N/A
Faith Group, LLC	129.8%

2. Contractor shall submit to the Commission current certified reviewed financial audit report(s) of overhead cost rates for home and/or field office rates upon request for a change or addition to the approved overhead rates stated in this Paragraph.
3. Whenever possible, overhead rates shall be established for home office and field office work. The home office rate shall be used when staff works in an office provided by Contractor. The field office rate shall be used when staff is assigned full time to an office provided by the Commission. To qualify for the field office rate, the Commission shall also provide normal office equipment and materials for field office staff such as computers, printers, internet access, phone service, fax, copier, and other office materials such as paper, clips, pens, and pencils.



**E. Fee**

The Fee for Contractor's work effort, including any subcontractor work at any tier, shall be ten percent (10%) of estimated direct labor of the Contractor and any subcontractors at any tier. There shall be no additional fixed fee markup on the work of first and lower tier subcontractors.

The Airport will allow Prime Contractor or Joint Venture a **two percent (2%)** mark-up on first tier subcontractor invoices only.

**F. Other Direct Cost (ODC)**

1. The following items are considered normal Agreement costs, a part of the Approved Overhead Rates, and are not considered ODCs: (a) phone calls, faxes, mail, express mail, courier delivery or overnight delivery service charges, or other communications charges between members of the Contractor's team, regardless of location; regional phone calls and faxes for all area codes having any geographical land area within 100 miles of San Francisco even though its outlying boundary exceeds the 100 mile limitation; (b) Internet gateways, electronic mail service or other technology-based communication service, FTP sites, or data file transfer or research services; (c) travel by the Contractor or its subcontractors between its home office and the San Francisco Bay Area; (d) travel within 100 mile radius of San Francisco; travel outside 100 mile radius of San Francisco unless approved in writing in advance by the Commission; (e) in-house coordination materials among the Contractor's team and subcontractors, including photocopy and drawing materials, messenger services; (f) presentation materials; and (g) food and beverage and/or entertainment charges of any kind unless approved in writing in advance by the Chief Development Officer.

2. Unless authorized by the Chief Development Officer, the Commission will not reimburse the Contractor for the costs of business travel, contractor meals, and accommodations, this includes specialists that are based out of town and not assigned to the jobsite office. Travel and *per diem* expenses for the project team's management, jobsite personnel, or staff that commute to or from other offices or residences are not allowed. When authorized, travel expenses shall be in accordance with the City & County of San Francisco Travel Guidelines can be found at the following link:

[https://www.google.com/url?q=http://sfcontroller.org/Modules/ShowDocument.aspx%3Fdocumentid%3D2174&sa=U&ved=0CAUQFjAAahUKBwjU0\\_TaqLjHAhUImogKHT3iCMw&client=internal-uds-cse&usg=AFQjCNHkyPKe3iRnxQ0y7-0Q2M7NqoiPbA](https://www.google.com/url?q=http://sfcontroller.org/Modules/ShowDocument.aspx%3Fdocumentid%3D2174&sa=U&ved=0CAUQFjAAahUKBwjU0_TaqLjHAhUImogKHT3iCMw&client=internal-uds-cse&usg=AFQjCNHkyPKe3iRnxQ0y7-0Q2M7NqoiPbA)

3. Any ODC expenses in excess of \$500 shall be pre-approved by the Project Manager.

**F. Direct Labor Rates**

The approved base hourly rates are as follows:

<u>CLASSIFICATION</u>	<u>RANGE OF RATES</u>
Admin Support.	\$22.50 - \$37.50
Analyst	\$25 - \$40
CAD Designer	\$25 - \$40
Commissioning Manager	\$35 - \$65
Construction Manager	\$45 - \$85
Design Manager	\$35 - \$65
Document Control	\$38 - \$45
Estimator	\$45 - \$75
Field Engineer	\$30 - \$70
Office Engineer	\$30 - \$70
Project Controls Manager	\$60 - \$85
Project Manager	\$55 - \$98
Resident Engineer I	\$35 - \$55
Resident Engineer II	\$50 - \$70
Resident Engineer III	\$60 - \$75
Scheduler	\$60 - \$80
Senior Cost Controls Manager	\$55 - \$75
Senior Network Designer	\$50 - \$65
Senior Systems Designer	\$55 - \$70
Site Manager/Commissioning Specialist	\$30 - \$60
Special Inspector	\$35 - \$60

#### **H. Lump Sum Payments**

The approved lump sum payments are as follows:

Brock Solutions: \$72,375

Innovation Technology Partners, Inc.: \$190,882

END OF APPENDIX B. 3

AIRPORT COMMISSION

CITY AND COUNTY OF SAN FRANCISCO

RESOLUTION NO. 16-0221

**MODIFICATION NO. 8 TO CONTRACT NO. 9024.9, CONSTRUCTION MANAGEMENT SERVICES FOR THE INTERNATIONAL TERMINAL CHECKED BAGGAGE INSPECTION SYSTEM MODERNIZATION PROGRAM AND BAGGAGE HANDLING SYSTEM IMPROVEMENTS PROJECT, WITH CAGE PROFESSIONAL SERVICES, INC. DBA CAGE, INC., TO EXTEND THE CONTRACT DURATION BY 12 MONTHS FOR SERVICES THROUGH SEPTEMBER 30, 2017**

- WHEREAS, the International Terminal Building (ITB) Checked Baggage Inspection System (CBIS) Modernization Program and Baggage Handling System Improvements Project (Project) provides for the upgrade and replacement of the CBIS and Checked Baggage Resolution Area (CBRA) for the ITB under the TSA's Recapitalization Program. In addition, the Project provides for BHS control upgrades and improvements to the ITB baggage handling system; and
- WHEREAS, on March 1, 2011, by Resolution No. 11-0045, the Commission authorized the Director to execute an Other Transaction Agreement (OTA) with the TSA for 90% reimbursement of design costs, including construction management services during design, for the ITB and Boarding Area F (BAF) CBIS Modernization Program; and
- WHEREAS, on June 30, 2011, by Resolution No. 11-0146, the Commission awarded this Contract 9024.9 to CAGE Professional Services, Inc. dba CAGE, Inc. for Construction Management (CM) Services for Project; and
- WHEREAS, by various resolutions, the Commission has approved Modification Nos. 1 through 7 to provide for contract renewals tied to the schedule of the design-build contract, for a current contract amount not to exceed \$9,945,000, with a duration of 63 months through September 30, 2016; and
- WHEREAS, this Modification No. 8 to Contract No. 9024.9 with CAGE, Inc. extends the contract for another year of services through September 30, 2017 with no increase to the contract amount, to allow for support services for design coordination and cost estimating for a future design-build Request for Qualifications/Proposals. Once the new design-build contract has been awarded, Staff may recommend continuing this contract to provide general contract administration and project management support services for the full duration of the new design-build contract; and
- WHEREAS, this Project will now only include the work within the International Terminal, not BAF. It is anticipated that the BAF scope will be performed under a future, separate Airport contract. Reference to BAF in the Project's title has been removed to reflect this revised scope; and

AIRPORT COMMISSION

CITY AND COUNTY OF SAN FRANCISCO

RESOLUTION NO. 16-0221

WHEREAS, due to the federal funding component for these services, the Airport encouraged proposers to utilize "best efforts" to subcontract at least 10% of the work to certified Federal Small Business Enterprises (SBE). Due to the specialized nature of the services, CAGE, Inc. is committed to achieving a 7.5% SBE sub-consultant participation; now, therefore be it

RESOLVED, that the Commission hereby approves Modification No. 8 to Contract No. 9024.9, Construction Management Services for the International Terminal Checked Baggage Inspection System Modernization Program and Baggage Handling System Improvements Project, with CAGE Professional Services, Inc. dba CAGE, Inc. to extend the contract duration by 12 months for services through September 30, 2017, and with no increase in the contract amount.

Page 2 of 2

I hereby certify that the foregoing resolution was adopted by the Airport Commission

at its meeting of \_\_\_\_\_

AUG 09 2016

1644

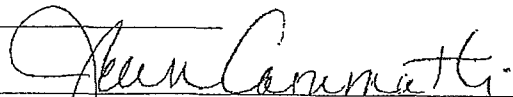
  
Secretary



San Francisco International Airport

MEMORANDUM

August 9, 2016

TO: AIRPORT COMMISSION  
Hon. Larry Mazzola, President  
Hon. Linda S. Crayton, Vice President  
Hon. Eleanor Johns  
Hon. Richard J. Guggenlime  
Hon. Peter A. Stern

FROM: Airport Director

SUBJECT: Modification No. 8 to Professional Services Contract No. 9024.9, Construction Management Services for the International Terminal Checked Baggage Inspection System Modernization Program and Baggage Handling System Improvements

DIRECTOR'S RECOMMENDATION: APPROVE MODIFICATION NO. 8 TO PROFESSIONAL SERVICES CONTRACT NO. 9024.9, CONSTRUCTION MANAGEMENT SERVICES FOR THE INTERNATIONAL TERMINAL CHECKED BAGGAGE INSPECTION SYSTEM MODERNIZATION PROGRAM AND BAGGAGE HANDLING SYSTEM IMPROVEMENTS PROJECT, WITH CAGE PROFESSIONAL SERVICES, INC. DBA CAGE, INC., TO EXTEND THE CONTRACT DURATION BY 12 MONTHS FOR SERVICES THROUGH SEPTEMBER 30, 2017

Executive Summary

Transmitted herewith for your approval is a proposed Resolution approving Modification No. 8 to Professional Services Contract No. 9024.9, Construction Management Services for the International Terminal Checked Baggage Inspection System (CBIS) Modernization Program and Baggage Handling System (BHS) Improvements Project, with CAGE Professional Services, Inc. dba CAGE, Inc., to extend the contract duration through September 30, 2017.

The CBIS Modernization Program provides for the upgrade and replacement of the CBIS and Checked Baggage Resolution Area (CBRA) for the International Terminal Building (ITB) under the TSA's Recapitalization Program. In addition, the Project provides for BHS control upgrades and improvements to the ITB baggage handling system.

This Contract provides construction management support (CM) services for the Project. This Modification will provide time for design analysis and detailing of scope so that a new design-build contract can be procured for completion of the Project. This time extension will also allow for project management services for the early design phases of the new design-build contract.

Background

On March 1, 2011, by Resolution No. 11-0045, the Commission authorized the Director to execute an Other Transaction Agreement (OTA) with the TSA for 90% reimbursement of design costs, including construction management services, for the ITB and Boarding Area F (BAF) CBIS Modernization Program under the TSA's Recapitalization Program, which funds the modernization of the TSA's Explosive Detection Systems equipment within the CBIS and CBRAs.

THIS PRINT COVERS CALENDAR ITEM NO. 6

AIRPORT COMMISSION CITY AND COUNTY OF SAN FRANCISCO

EDWIN M. LEE      LARRY MAZZOLA      LINDA S. CRAYTON      ELEANOR JOHNS      RICHARD J. GUGGENHIME      PETER A. STERN      IVAR C. SATERO  
MAYOR      PRESIDENT      VICE PRESIDENT      AIRPORT DIRECTOR

On June 30, 2011, by Resolution No. 11-0146, the Commission awarded this Contract No. 9024.9, CM Services for the ITB and BAF CBIS Modernization Program and Baggage Handling System Improvements Project, to CAGE, Inc. By various resolutions, the Commission has approved Modification Nos. 1 through 6 for this Contract to provide for contract renewals tied to the design and construction schedule of the Project. The current contract not-to-exceed amount is \$9,945,000 with a duration of 63 months for services through September 30, 2016.

Previous design-build services for this Project were provided by Vanderlande Industries (VI). The Airport put this Project on hold due to ongoing issues with the TSA-furnished screening equipment and its effect on Airport and airline operational capacity. Staff determined it was in the best interest of the Airport to close out the design-build contract with VI effective March 31, 2015.

After successful discussions with the TSA, this Project is ready to resume. This Project will now only include the work within the International Terminal, not BAF. It is anticipated that the BAF scope will be performed under a future, separate Airport contract. Reference to BAF in the Project's title has been removed to reflect this revised scope.

This Modification No. 8 extends the CM contract duration for another year of services with no increase to the contract value. In the next year, CAGE, Inc. will provide support services for design coordination and cost estimating for a future design-build Request for Qualifications/Proposals. Once the new design-build contract has been awarded, Staff may recommend continuing this CM contract to provide general contract administration and project management services for the full duration of the new design-build contract.

Modification No. 8 proposes that the not-to-exceed contract amount remains at \$9,945,000 with a new total contract duration of 75 months through September 30, 2017. This Project is funded from the Airport's 5-year Capital Improvement Plan. Staff continues to work with the TSA to determine the portion of the Project costs that may be reimbursed by the TSA.

Due to the federal funding component for these services, there are no Local Business Enterprise sub-consultant participation goals for the Contract. Staff encouraged proposers to utilize "best efforts" to subcontract at least 10% of the work to certified federal Small Business Enterprise (SBE). Due to the specialized nature of the services, CAGE, Inc. has achieved a 7.5% SBE sub-consultant participation.

### Recommendation

Based on the above, I recommend the Commission approve Modification No. 8 to Contract No. 9024.9, Construction Management Services for the International Terminal Building Check Baggage Inspection System Modernization Program and Baggage Handling System Improvements Project, with CAGE Professional Services, Inc. dba CAGE, Inc. to extend the contract duration by 12 months for services through September 30, 2017.

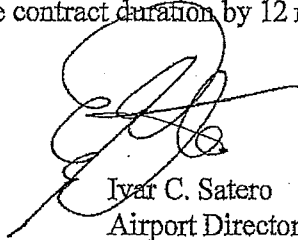

Iyar C. Satero  
Airport Director

Prepared by: Geoffrey W. Neumayr  
Chief Development Officer  
Design & Construction

Attachment

**City and County of San Francisco  
Airport Commission  
P.O. Box 8097  
San Francisco, California 94128**

**Seventh Modification  
Contract 9024.9**

THIS MODIFICATION (this "Modification") is made as of November 1, 2015, in San Francisco, California, by and between CAGE Professional Services, Inc. ("Contractor"), and the City and County of San Francisco, a municipal corporation ("City"), acting by and through its Airport Commission or the Commission's designated agent, hereinafter referred to as "Commission."

RECITALS

WHEREAS, City and Contractor have entered into the Agreement (as defined below); and

WHEREAS, on June 30, 2011, by Resolution No. 11-0146, the Commission awarded this Agreement to the Contractor; and

WHEREAS, on October 4, 2011, by Resolution Number 11-0221 the Commission approved Modification No. 1 for a new term ending on December 31, 2013; and

WHEREAS, on July 17, 2012, by Resolution Number 12-0158, the Commission approved Modification No. 2; and

WHEREAS, on December 3, 2013, by Resolution Number 13-0248, the Commission approved Modification No. 3 for a new term ending June 30, 2014; and

WHEREAS, on June 17, 2014, by Resolution Number 14-0124, the Commission approved Modification No. 4 for a new term ending December 31, 2014; and

WHEREAS, on December 2, 2014, by Resolution Number 14-0249, the Commission approved Modification No. 5 for a new term ending September 30, 2015; and

WHEREAS, on September 1, 2015, by Resolution Number 15-0171, the Commission approved Modification No. 6 for a new term ending September 30, 2016; and

WHEREAS, City and Contractor desire to administratively modify the Agreement to include new subconsultants and services; and

WHEREAS, approval for this Agreement was obtained when the Civil Service Commission approved PSC No. 4099-09/10 on June 2, 2014; and

NOW, THEREFORE, Contractor and the City agree as follows:

1. **Definitions.** The following definitions shall apply to this Modification:

a. **Agreement.** The term "Agreement" shall mean the Agreement dated June 30, 2011 between Contractor and City, as amended by the:

First Amendment,	dated October 4, 2011; and
Second Amendment,	dated July 17, 2012; and
Third Amendment,	dated December 3, 2013; and
Fourth Modification,	dated June 17, 2014; and
Fifth Modification,	dated December 2, 2014; and
Sixth Modification,	dated September 1, 2015

b. **Other Terms.** Terms used and not defined in this Modification shall have the meanings assigned to such terms in the Agreement

2. **Supplemental Appendix A.2 Services to be provided by Contractor** is hereby amended to include the following:

O. Provide simulation modeling for the entire International Terminal Building (ITB) Baggage Handling System (BHS). The deliverables to be submitted by the contractor include the following:

- a) Functional Specification
- b) Model Development
- c) Verification and validation meeting
- d) Analysis of contingency mode functionality and TS staffing levels
- e) Final Presentation
- f) 3 runtime Automod licenses

P. Perform 3D laser scanning and documentation within the existing baggage handling system area within Boarding Area A and G. The deliverables to be submitted by the contractor include the following:

- a) Scan and Register all targets
- b) Delivery of Point Clouds
- c) Publish TruViews
- d) Delivery of Revit models for scan

3. **Appendix B.1.2 Supplemental Supplement to Compensation and Payment** is hereby amended as follows:

II. PROVISIONAL INDIRECT COST RATES

B. The provisional indirect cost rate to be applied to Contractor's and subcontractor's direct labor as set forth in Contractor's and subcontractors' submissions shall be:

<b>TABLE 1</b>	
FIRM	PROVISIONAL OVERHEAD RATE
CAGE Professional Services, Inc.	141.59%
KPA Group	179.01%
Chaves & Assoc.	112.20%
EPC Consultants	Field = 106.90% and Home Office = 110.24%
M Lee Corp	131.96%
Apex Testing	76.44%



Grindstone Group, LLC	75.52%
Cooper Pugaeda Management, Inc.	105.21%
Brock Solutions*	N/A
Innovation Technology* Partners, Inc.	N/A

\* The method of payment for Brock Solutions and Innovation Technology Partners, Inc., will be based on lump sum. The total lump sum price paid to subcontractor will include compensation for all work and deliverables. No additional compensation will be paid to subcontractor, unless there is a change in the scope of the work. In the instance of a change in the scope of work, adjustment to the total lump sum compensation will be negotiated between subcontractor and SFO. Adjustment in the total lump sum compensation will not be effective until authorized by contract modification and approved by SFO.

4. **Effective Date.** Each of the modifications set forth herein shall be effective on and after the date of this Modification.

5. **Legal Effect.** Except as expressly changed by this Modification, all of the terms and conditions of the Agreement shall remain unchanged and in full force and effect.

IN WITNESS WHEREOF, Contractor and City have executed this Modification as of the date first referenced above.

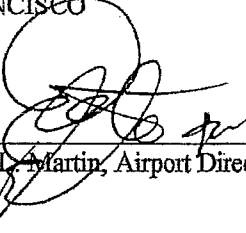
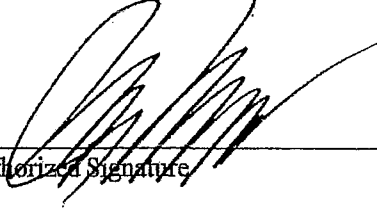
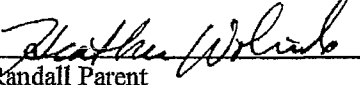
CITY	CONTRACTOR
AIRPORT COMMISSION CITY AND COUNTY OF SAN FRANCISCO	
By:  John L. Martin, Airport Director	Authorized Signature 
Approved as to Form: Dennis J. Herrera City Attorney	John Boodee President CAGE Professional Services, Inc. 6303 Commerce Drive, Suite 150 Irving, Texas 75063 972-550-1001
By:  Randall Parent Deputy City Attorney	81238 City Vendor Number  75-2722503 Federal Employer ID Number

City and County of San Francisco  
Airport Commission  
P.O. Box 8097  
San Francisco, California 94128

Sixth Modification  
Contract 9024.9

THIS MODIFICATION (this "Modification") is made as of September 1, 2015, in San Francisco, California, by and between CAGE Professional Services, Inc. ("Contractor"), and the City and County of San Francisco, a municipal corporation ("City"), acting by and through its Airport Commission or the Commission's designated agent, hereinafter referred to as "Commission."

RECITALS

WHEREAS, City and Contractor have entered into the Agreement (as defined below); and

WHEREAS, on June 30, 2011, by Resolution No. 11-0146, the Commission awarded this Agreement to the Contractor; and

WHEREAS, on October 4, 2011, by Resolution Number 11-0221 the Commission approved Modification No. 1 for a new term ending on December 31, 2013; and

WHEREAS, on July 17, 2012, by Resolution Number 12-0158, the Commission approved Modification No. 2; and

WHEREAS, on December 3, 2013, by Resolution Number 13-0248, the Commission approved Modification No. 3 for a new term ending June 30, 2014; and

WHEREAS, on June 17, 2014, by Resolution Number 14-0124, the Commission approved Modification No. 4 for a new term ending December 31, 2014; and

WHEREAS, on December 2, 2014, by Resolution Number 14-0249, the Commission approved Modification No. 5 for a new term ending September 30, 2015; and

WHEREAS, City and Contractor desire to modify the Agreement on the terms and conditions set forth herein to increase contract amount by One Million Three Hundred Fifty Thousand Dollars (\$1,350,000) for a new total not to exceed amount of Nine Million Nine Hundred Forty-five Thousand Dollars (\$9,945,000) and extend the term through September 30, 2016; and

WHEREAS, Commission approved this Modification No. 6 pursuant to Resolution Number 15-0171 on September 1, 2015; and

WHEREAS, approval for this Agreement was obtained when the Civil Service Commission approved PSC No. 4099-09/10 on June 2, 2014; and

NOW, THEREFORE, Contractor and the City agree as follows:

1. **Definitions.** The following definitions shall apply to this Modification:

a. **Agreement.** The term "Agreement" shall mean the Agreement dated June 30, 2011 between Contractor and City, as amended by the:

First Amendment,	dated October 4, 2011, and
Second Amendment,	dated July 17, 2012, and
Third Amendment,	dated December 3, 2013, and
Fourth Modification,	dated June 17, 2014
Fifth Modification,	dated December 2, 2014

b. **Contract Monitoring Division.** Effective July 28, 2012, with the exception of Sections 14B.9(D) and 14B.17(F), all of the duties and functions of the Human Rights Commission under Chapter 14B of the Administrative Code (LBE Ordinance) were transferred to the City Administrator, Contract Monitoring Division ("CMD"). Wherever "Human Rights Commission" or "HRC" appears in the Agreement in reference to Chapter 14B of the Administrative Code or its implementing Rules and Regulations, it shall be construed to mean "Contract Monitoring Division" or "CMD" respectively.

c. **Other Terms.** Terms used and not defined in this Modification shall have the meanings assigned to such terms in the Agreement.

2. **Section 2. Term of the Agreement** is hereby amended to extend the term of the contract for twelve (12) months for a new ending date of September 30, 2016.

3. **Section 5. Compensation** is hereby amended to increase the total compensation payable by an amount not to exceed **One Million Three Hundred Fifty Thousand Dollars (\$1,350,000)** for a new total not to exceed amount of **Nine Million Nine Hundred Forty-five Thousand Dollars (\$9,945,000)**.

4. **Appendix A, Services to be provided by Contractor** is hereby amended to include **Supplemental Appendix A.2, Services to be provided by Contractor.**

5. **Appendix C.2, Approved Staffing Plan** is hereby amended to include **Supplemental Appendix C.2.2, Approved Staffing Plan.**

6. **Effective Date.** Each of the modifications set forth herein shall be effective on and after the date of this Modification.

7. **Legal Effect.** Except as expressly changed by this Modification, all of the terms and conditions of the Agreement shall remain unchanged and in full force and effect.

IN WITNESS WHEREOF, Contractor and City have executed this Modification as of the date first referenced above.

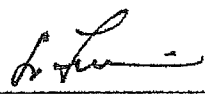
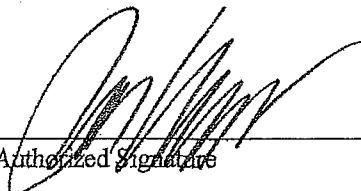
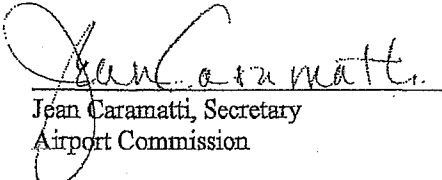
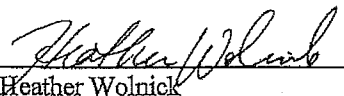
CITY	CONTRACTOR
AIRPORT COMMISSION CITY AND COUNTY OF SAN FRANCISCO	
By:  John L. Martin, Airport Director	 Authorized Signature
Attest:  By:  Jean Caramatti, Secretary Airport Commission	John Boodee President CAGE Professional Services, Inc. 6303 Commerce Drive, Suite 150 Irving, Texas 75063 972-550-1001
Resolution No: 15-0171	81238 City Vendor Number
Adopted on: September 1, 2015	75-2722503 Federal Employer ID Number
Approved as to Form:  Dennis J. Herrera City Attorney	
By:  Heather Wolnick Deputy City Attorney	

Appendices:

Supplemental A.2: Services to be provided by Contractor  
Supplemental C.2.2: Approved Staffing Plan



**Supplemental Appendix A.2  
Services to be provided by Contractor**

This Supplemental Appendix A.2 attached to, and incorporated by reference in the Agreement made on June 30, 2011 between the City and County of San Francisco, acting by and through its Airport Commission (Commission), and CAGE Professional Services, Inc. (Contractor) providing for construction management services for the International Terminal and Boarding Area F Checked Baggage Inspection System Modernization Program, and the International Terminal Baggage Handling System Improvements Project.

**1. INTRODUCTION**

The following changes are made to Appendix A:

**PROJECT DESCRIPTION:**

The following is a general project description for the International Terminal and Terminal 3, Boarding Area F Checked Baggage Inspection System Modernization and International Terminal Baggage Handling System Improvements Project (Project). The Airport reserves the right to amend this description.

**A. International Terminal Checked Baggage Inspection System (CBIS) Modernization. NO CHANGE**

**B. International Terminal BHS Improvements. NO CHANGE**

**C. General**

- 1) The Airport and the TSA have entered into an Other Transaction Agreement No. HSTS04-11-H-CT1149 (OTA), executed on March 23, 2011, to define roles and responsibilities and develop a budget and funding plan for the development of CBIS design documents and construction management design support services. Thereafter, these design documents will serve as bridging documents for the design-build portion of the International Terminal and Terminal 3, Boarding Area F CBIS modernization work. The executed OTA will become part of the Contractor's agreement (Appendix D) and the Contractor will be responsible for the management, reporting, implementation, and ensuring Airport compliance with the terms and conditions of the OTA. The TSA is committed to funding 90% of the costs for the International Terminal CBIS modernization design bridging documents.

2) NO CHANGE

**2. CONSTRUCTION MANAGEMENT SCOPE DESCRIPTION**

**Contractor Services for International Terminal and Terminal 3, Boarding Area F CBIS Modernization and International Terminal BHS Improvements Design.**

The Contractor will provide the following services:

- A. Provide design submittal technical reviews for constructability, functionality, value engineering, building code and PGDS compliance for the International Terminal and Terminal 3, Boarding Area F CBIS Modernization, including baggage handling systems, architectural, structural, vertical transportation, mechanical, electrical, fire protection and special systems.
- B. Provide design submittal technical reviews for constructability, functionality, value engineering and building code compliance for the International Terminal BHS Improvements, including baggage handling systems, structural, mechanical, electrical, fire protection and special systems.
- C. NO CHANGE
- D. NO CHANGE
- E. NO CHANGE
- F. NO CHANGE
- G. NO CHANGE
- H. NO CHANGE
- I. NO CHANGE
- J. NO CHANGE
- K. NO CHANGE
- L. Provide administrative and technical support to the Airport to close out the completed design-build contract and submit timely reimbursement requests to the TSA.
- M. Provide support services for design coordination and cost estimating for a future design-build RFQ/RFP.
- N. Provide general contract administration and project management support services in support of all construction activities.

The following changes are made to Appendix A.1:

**3. CONSTRUCTION MANAGEMENT SCOPE DESCRIPTION**

A. NO CHANGE

B. NO CHANGE

C. NO CHANGE

D. NO CHANGE

E. NO CHANGE

F. Project Planning

1. No Change

a. No Change

b. No Change

c. Provide support services for design coordination and cost estimating for a future design-build RFP.

G. NO CHANGE

H. NO CHANGE

I. NO CHANGE

**4. REPORTS**

NO CHANGE

**5. DEPARTMENT LIAISON**

NO CHANGE



CAGE - Construction Management / Activation BHS System  
Project Trend 8/10/16

Workhours per Month	2015								2016								Base Rate	OH	Total Hourly Rate	Travel	
	Jun	Jul	Aug	Sep	Oct	Nov	Dec	Jan	Feb	Mar	Apr	May	Jun	Jul	Aug	Sep					
Construction Manager (Wiseley)	176	184	168	176	176	168	184	182	160	184	168	168	176				\$ 80.10	1,2788	\$ 150.65	\$ 268,602	\$ 21,000
Desktop Manager (Seldinger)				168	176	176	168	184	182	160	184	168	168	176			\$ 44.76	1,2788	\$ 112.20	\$ 162,813	\$ 35,000
Field Tech/Inspector (Daffron)				168	176	176	168	184	182	160	184	168	168	176			\$ 37.59	1,2788	\$ 94.23	\$ 177,145	\$ 35,000
Chavez & Assoc (Doo Control)	176	82	128	176	176	168	184	182	160	184	168	168	88	80	82	84	\$ 39.50	1,5728	\$ 108.98	\$ 247,771	
Office Engineer				176	176	168	184	182	160	184	168	168	176	160	184	168	\$ 25.00	1,0521	\$ 124.15	\$ 276,114	
Inspector							184	182	160	184	168	168	176				\$ 55.00	1,0521	\$ 124.15	\$ 147,689	
Cost Controls	176	128	116	128	128	116	120	108	122	128	116	116	122	112	128	116	\$ 70.95	1,0521	\$ 158.83	\$ 314,300	
Project Coordinator	70	70	70	70	70	70	70	70	70	70	70	70	70	70	70	70	\$ 70.00	1,0521	\$ 158.01	\$ 178,973	

Subtotal	\$ 4,714,707
Office Exp.	\$ 21,000
Travel	\$ 91,000
Seating	\$ 250,000
System Emulation	\$ 100,000
Chavez OH Adj.	\$ 75,000
Prev. thru May-16	\$ 7,693,875
<b>TOTAL</b>	<b>\$ 8,942,582</b>

Current Contract Value \$ 8,695,000  
Mod #6 Adtl Value \$ 1,347,582

AIRPORT COMMISSION

CITY AND COUNTY OF SAN FRANCISCO

RESOLUTION NO. **15 - 0171 -**

**MODIFICATION NO. 6 TO CONTRACT NO. 9024.9, CONSTRUCTION MANAGEMENT SERVICES FOR THE INTERNATIONAL TERMINAL AND TERMINAL 3 BOARDING AREA F CHECKED BAGGAGE INSPECTION SYSTEM MODERNIZATION PROGRAM AND THE INTERNATIONAL TERMINAL BAGGAGE HANDLING SYSTEM IMPROVEMENTS PROJECT, IN AN AMOUNT OF \$1,350,000 FOR A TOTAL CONTRACT AMOUNT NOT TO EXCEED \$9,945,000 AND TO INCREASE THE CONTRACT DURATION THROUGH SEPTEMBER 30, 2016**

WHEREAS, the Checked Baggage Inspection System (CBIS) Modernization Program provides for the upgrade and replacement of the CBIS and Checked Baggage Resolution Area (CBRA) for the International Terminal (ITB) and for Boarding Area F (BAF), under the TSA's Recapitalization Program. In addition, the Project provides for baggage handling system (BHS) control upgrades and improvements to the ITB BHS as well as Boarding Area E (BAE) to BAF BHS Transfer Line; and

WHEREAS, on March 1, 2011, by Resolution No. 11-0045, the Commission authorized the Director to execute an Other Transaction Agreement (OTA) with the TSA for 90% reimbursement of design costs, including construction management services during design, for the ITB and BAF CBIS Modernization Program; and

WHEREAS, on June 30, 2011, by Resolution No. 11-0146, the Commission awarded this Contract 9024.9 to CAGE Professional Services, Inc. dba CAGE, Inc. for Construction Management (CM) Services for Project; and

WHEREAS, by various resolutions, the Commission has approved Modification Nos. 1 through 5 to provide for contract renewals tied to the schedule of the design-build contract, for a current contract amount not to exceed \$8,595,000, with a duration of 51 months; and

WHEREAS, this Modification No. 6 to Contract No. 9024.9 with CAGE, Inc. extends the contract for another year of services through September 30, 2016 and increases the contract amount by \$1,350,000 to allow for close out of the completed design-build baggage handling contract, reimbursement requests to the TSA, and support services for design coordination and cost estimating for a future design-build Request for Qualifications/Proposals. Once the new design-build contract has been awarded, this contract will provide for general contract administration and project management support services to support construction activities. Staff may recommend continuing this contract to provide these services for the full duration of the new design-build contract; and

AIRPORT COMMISSION  
CITY AND COUNTY OF SAN FRANCISCO  
RESOLUTION NO. 15-0171

WHEREAS, due to the federal funding component for these services, the Airport encouraged proposers to utilize "best efforts" to subcontract at least 10% of the work to certified Federal Small Business Enterprises (SBE). Due to the specialized nature of the services, CAGE, Inc. is committed to achieving a 7.5% SBE sub-consultant participation; now, therefore be it

RESOLVED, that the Commission hereby approves Modification No. 6 to Contract No. 9024.9, Construction Management Services for the International Terminal and Boarding Area F Checked Baggage Inspection System Modernization Program, Boarding Area E Checked Baggage Inspection System Activation and the International Terminal Baggage Handling System Improvements Project, with CAGE Professional Services, Inc. dba CAGE, Inc. in an amount of \$1,350,000 for a new total contract amount not to exceed \$9,945,000 for services through September 30, 2016.

Page 2 of 2

*I hereby certify that the foregoing resolution was adopted by the Airport Commission*

*at its meeting of*

SEP 01 2015

1659

*[Signature]*  
Secretary



San Francisco International Airport

MEMORANDUM  
September 1, 2015

TO: AIRPORT COMMISSION  
Hon. Larry Mazzola, President  
Hon. Linda S. Crayton, Vice President  
Hon. Eleanor Johns  
Hon. Richard J. Guggenlime  
Hon. Peter A. Stern

FROM: Airport Director

SUBJECT: Modification No. 6 to Professional Services Contract No. 9024.9, Construction Management Services for the International Terminal and Terminal 3 Boarding Area F Checked Baggage Inspection System Modernization Program and the International Terminal Baggage Handling System Improvements

DIRECTOR'S RECOMMENDATION: APPROVE MODIFICATION NO. 6 TO PROFESSIONAL SERVICES CONTRACT NO. 9024.9, CONSTRUCTION MANAGEMENT SERVICES FOR THE INTERNATIONAL TERMINAL AND TERMINAL 3 BOARDING AREA F CHECKED BAGGAGE INSPECTION SYSTEM MODERNIZATION PROGRAM AND THE INTERNATIONAL TERMINAL BAGGAGE HANDLING SYSTEM IMPROVEMENTS PROJECT, IN AN AMOUNT OF \$1,350,000 FOR A NEW TOTAL CONTRACT AMOUNT NOT TO EXCEED \$9,945,000 AND EXTENDING THE CONTRACT DURATION THROUGH SEPTEMBER 30, 2016

Executive Summary

Transmitted herewith for your approval is a proposed Resolution approving Modification No. 6 to Professional Services Contract No. 9024.9, Construction Management (CM) Services for the International Terminal and Terminal 3 Boarding Area F (BAF) Checked Baggage Inspection System (CBIS) Modernization Program, Boarding Area E (BAE) CBIS Activation and the International Terminal (ITB) Baggage Handling System Improvements Project, with CAGE Professional Services, Inc. dba CAGE, Inc., in an amount of \$1,350,000 for a total contract amount not to exceed \$9,945,000 and extending the contract duration through September 30, 2016.

The CBIS Modernization Program provides for the upgrade and replacement of the CBIS and Checked Baggage Resolution Area (CBRA) for the ITB and for BAF, under the TSA's Recapitalization Program. In addition, the Project provides for BHS control upgrades and improvements to the ITB baggage handling system as well as BAE to BAF Baggage Handling System Transfer Line.

AIRPORT COMMISSION CITY AND COUNTY OF SAN FRANCISCO THIS PRINT COVERS CALENDAR ITEM NO. 4  
EDWIN M. LEE MAYOR LARRY MAZZOLA PRESIDENT LINDA S. CRAYTON VICE PRESIDENT ELEANOR JOHNS RICHARD J. GUGGENHIME PETER A. STERN JOHN L. MARTIN AIRPORT DIRECTOR

This contract provides construction management support services for the Project. This modification will provide the required construction management services to close out the current design-build contract and design analysis and detailing of scope so that a design-build contract can be procured for completion of the Project.

### Background

On March 1, 2011, by Resolution No. 11-0045, the Commission authorized the Director to execute an Other Transaction Agreement (OTA) with the TSA for 90% reimbursement of design costs, including construction management services, for the ITB and BAF CBIS Modernization Program under the TSA's Recapitalization Program, which funds modernization of the TSA's Explosive Detection Systems equipment within the CBIS and CBRAs.

On June 30, 2011, by Resolution No. 11-0146, the Commission awarded this Contract No. 9024.9 to CAGE, Inc. for CM Services. The past design-build services for this Project were provided by VanDerLande Industries (VI) with a contract amount of \$83,868,927 and a contract expiration date of March 31, 2015. By various resolutions, the Commission has approved Modification Nos. 1 through 5 for this CM contract to provide for contract renewals tied to the schedule of the design-build contract, for a current contract amount not to exceed \$8,595,000, with a duration of 51 months.

Due to ongoing issues with the operational performance of the TSA-furnished screening equipment and its effect on Airport and airline operational capacity, the Modernization Project under the TSA's Recapitalization Program was put on hold and the Airport determined to close out the design-build contract with VI. The Project is ready to resume after successful discussions with the TSA. Additional design analysis is needed to determine the scope, budget and schedule required to complete the Project. Once the scope, budget, and schedule for completion of the Project are determined and agreed to with the TSA, the Airport intends to issue a new Request for Qualifications/Proposals (RFQ/RFP) for design-build services to complete the Project.

This Modification No. 6 extends the contract duration by 12 months for another year of services through September 30, 2016 and increases the contract amount by \$1,350,000. In the next year, CAGE, Inc. will be supporting Airport Staff's efforts to close out of the completed design-build contract and submit reimbursement requests to the TSA. CAGE, Inc. will also provide support services for design coordination and cost estimating for a future design-build RFQ/RFP. Once the new design-build contract has been awarded, CAGE, Inc. will provide general contract administration and project management support services in support of construction activities. Staff may recommend continuing this contract to provide these services for the full duration of the new design-build contract.

Staff and Consultant have reached agreement on scope, staffing and fee for the next year of services. The modified not-to-exceed amount is \$9,945,000 with a contract duration of 63 months through September 30, 2016. This Modification will be funded from the Airport's 5-year Capital Improvement Plan. Staff is still working with the TSA to determine what portion of the future work may be reimbursed by the TSA.

Due to the federal funding component for these services, there are no Local Business Enterprise sub-consultant participation goals for the contract. Staff encouraged proposers to utilize "best efforts" to subcontract at least 10% of the work to certified federal Small Business Enterprise (SBE). Due to the specialized nature of the services, CAGE, Inc. has achieved a 7.5% SBE sub-consultant participation.

**Recommendation**

Based on the above, I recommend the Commission approve Modification No. 6 to Contract No. 9024.9, Construction Management Services for the ITB and BAF CBIS Modernization Program, BAE CBIS Activation and the ITB Terminal BHS Improvements Project, with CAGE Professional Services, Inc. (dba CAGE, Inc.) in an amount of \$1,350,000 for a total contract amount not to exceed \$9,945,000 and to extend the contract duration through September 30, 2016.

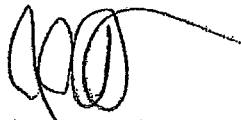

John L. Martin  
Airport Director

Prepared by: -Geoffrey W. Neumayr  
Deputy Airport Director  
Design & Construction

Attachment

**City and County of San Francisco  
Airport Commission  
P.O. Box 8097  
San Francisco, California 94128**

**Fifth Modification  
Contract No. 9024.9**

**Construction Management Services for the International Terminal and  
Terminal 3 Boarding Area F Checked Baggage Inspection System Modernization Program  
and the International Terminal Baggage Handling System Improvements Project**

THIS MODIFICATION (this "Modification") is made as of December 2, 2014, in San Francisco, California, by and between CAGE Professional Services, Inc. ("Contractor"), and the City and County of San Francisco, a municipal corporation ("City"), acting by and through its Airport Commission or the Commission's designated agent, hereinafter referred to as "Commission."

RECITALS

WHEREAS, City and Contractor have entered into the Agreement (as defined below); and

WHEREAS, the Commission adopted Resolution Number 11-0146 on June 30, 2011 which awarded said Agreement for the period of June 30, 2011 through December 31, 2011; and

WHEREAS, the Commission adopted Resolution Number 11-0221 on October 4, 2011 which awarded Modification number 1 for a new term ending on December 31, 2013; and

WHEREAS, the Commission adopted Resolution Number 12-0158 on July 17, 2012 which awarded Modification number 2; and

WHEREAS, the Commission adopted Resolution Number 13-0248 on December 3, 2013 which awarded Modification number 3; and

WHEREAS, the Commission adopted Resolution Number 14-0124 on June 17, 2014 which awarded Modification number 4; and

WHEREAS, City and Contractor desire to modify the Agreement on the terms and conditions set forth herein to incorporate a new subcontractor, extend the performance period, and increase the contract amount; and

WHEREAS, Commission approved this Modification 5 pursuant to Resolution Number 14-0249 on December 2, 2014; and

WHEREAS, approval for this Modification was obtained when the Civil Service Commission approved Contract number PSC #4099-09/10 on June 2, 2014; and

WHEREAS, the Commission desires to modify the Agreement for administrative changes required by recently enacted San Francisco contracting ordinances; and

NOW, THEREFORE, Contractor and the City agree as follows:

1. **Definitions.** The following definitions shall apply to this Modification:

a. **Agreement.** The term "Agreement" shall mean the Agreement dated June 30, 2011 between Contractor and City, as amended by the:

First Amendment,	dated October 4, 2011, and
Second Amendment,	dated July 17, 2012, and
Third Amendment,	dated December 3, 2013, and
Fourth Modification,	dated June 17, 2014

b. **Other Terms.** Terms used and not defined in this Modification shall have the meanings assigned to such terms in the Agreement.

2. **Section 2. Term of the Agreement** is hereby amended to extend the term of the contract for nine (9) months for a new ending date of September 30, 2015.

3. **Section 5. Compensation** is hereby amended to increase the total compensation payable by an amount not to exceed Seven Hundred Ninety-Five Thousand Dollars (\$795,000) for a new total not to exceed amount of Eight Million, Five Hundred Ninety-Five Thousand Dollars (\$8,595,000) and to incorporate the following revised appendices: Appendix B.1.2: Supplement to Provisional Indirect Cost Rate Agreement; Appendix B.2: Supplement to Calculation of Charges; and Appendix C.1.2: Supplement to Cost Proposal and Rates.

4. **New Section 32. Earned Income Credit (EIC) Forms** is hereby replaced in its entirety with a **New Section 32. Consideration of Criminal History in Hiring and Employment Decisions** to read as follows:

**32. Consideration of Criminal History in Hiring and Employment Decisions.**

a. Contractor agrees to comply fully with and be bound by all of the provisions of Chapter 12T "City Contractor/Subcontractor Consideration of Criminal History in Hiring and Employment Decisions," of the San Francisco Administrative Code (Chapter 12T), including the remedies provided, and implementing regulations, as may be amended from time to time. The provisions of Chapter 12T are incorporated by reference and made a part of this Agreement as though fully set forth herein. The text of the Chapter 12T is available on the web at [www.sfgov.org/olse/fco](http://www.sfgov.org/olse/fco). A partial listing of some of Contractor's obligations under Chapter 12T is set forth in this Section. Contractor is required to comply with all of the applicable provisions of 12T, irrespective of the listing of obligations in this Section. Capitalized terms used in this Section and not defined in this Agreement shall have the meanings assigned to such terms in Chapter 12T.

b. The requirements of Chapter 12T shall only apply to the Contractor's or Subcontractor's operations to the extent those operations are in furtherance of the performance of this Agreement, and shall apply only to applicants and employees who would be or are performing work in furtherance of this Agreement, whose employment is or would be in whole or in substantial part physically located in the City and County of San Francisco, which excludes Airport property.

1) Applicants or employees who would be or are performing work in furtherance of this Agreement may be required to be screened by the U.S. Department of Homeland Security for security badging. A rejection by the U.S. Department of Homeland Security of an applicant's or employee's security badging application, and the resulting inability of the Contractor to hire the



applicant or assign the employee to perform services under this Agreement, shall not be considered an Adverse Action under Chapter 12T.

c. Contractor shall incorporate by reference in all subcontracts the provisions of Chapter 12T, and shall require all subcontractors to comply with such provisions. Contractor's failure to comply with the obligations in this subsection shall constitute a material breach of this Agreement.

d. Contractor or Subcontractor shall not inquire about, require disclosure of, or if such information is received, base an Adverse Action on an applicant's or potential applicant for employment or employee's: (1) Arrest not leading to a Conviction, unless the Arrest is undergoing an active pending criminal investigation or trial that has not yet been resolved; (2) participation in or completion of a diversion or a deferral of judgment program; (3) a Conviction that has been judicially dismissed, expunged, voided, invalidated, or otherwise rendered inoperative; (4) a Conviction or any other adjudication in the juvenile justice system; (5) a Conviction that is more than seven years old, from the date of sentencing; or (6) information pertaining to an offense other than a felony or misdemeanor, such as an infraction.

e. Contractor or Subcontractor shall not inquire about or require applicants, potential applicants for employment, or employees to disclose on any employment application the facts or details of any conviction history, unresolved arrest, or any matter identified in subsection 32.4, above. Contractor or Subcontractor shall not require such disclosure or make such inquiry until either after the first live interview with the person, or after a conditional offer of employment.

f. Contractor or Subcontractor shall state in all solicitations or advertisements for employees that are reasonably likely to reach persons who are reasonably likely to seek employment to be performed under this Agreement, that the Contractor or Subcontractor will consider for employment qualified applicants with criminal histories in a manner consistent with the requirements of Chapter 12T.

g. Contractor and Subcontractors shall post the notice prepared by the Office of Labor Standards Enforcement (OLSE), available on OLSE's website, in a conspicuous place at every workplace, job site, or other location under the Contractor or Subcontractor's control at which work is being done or will be done in furtherance of the performance of this Agreement. The notice shall be posted in English, Spanish, Chinese, and any language spoken by at least 5% of the employees at the workplace, job site, or other location at which it is posted.

h. Contractor understands and agrees that if it fails to comply with the requirements of Chapter 12T, the City shall have the right to pursue any rights or remedies available under Chapter 12T, including but not limited to, a penalty of \$50 for a second violation and \$100 for a subsequent violation for each employee, applicant or other person as to whom a violation occurred or continued, termination or suspension in whole or in part of this Agreement.

**5. Effective Date.** Each of the modifications set forth in Section 2 shall be effective on and after the date of this Modification.

**6. Legal Effect.** Except as expressly changed by this Modification, all of the terms and conditions of the Agreement shall remain unchanged and in full force and effect.

IN WITNESS WHEREOF, Contractor and City have executed this Modification as of the date first referenced above.

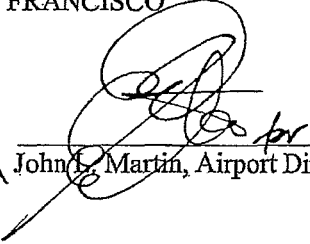
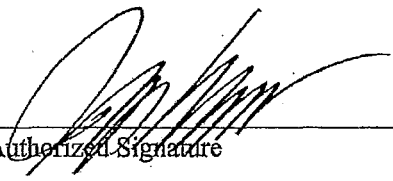
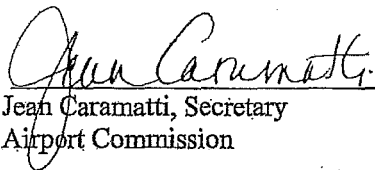
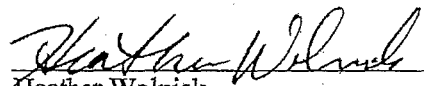
CITY	CONTRACTOR
AIRPORT COMMISSION CITY AND COUNTY OF SAN FRANCISCO	
By:  John L. Martin, Airport Director	 Authorized Signature
Attest:	John Boodee President CAGE Professional Services, Inc. 6303 Commerce Drive, Suite 150 Irving, Texas 75063 972-550-1001
By:  Jean Caramatti, Secretary Airport Commission	81238 City Vendor Number
Resolution No: 14-0249	75-2722503 Federal Employer ID Number
Adopted on: December 2, 2014	
Approved as to Form:	
Dennis J. Herrera City Attorney	
By:  Heather Wolnick Deputy City Attorney	

**Appendices**

- B.2 Supplement to Calculation of Charges
- B.1.2 Supplement to Compensation and Payment
- C.1.2 Supplement to Cost Proposal and Rates

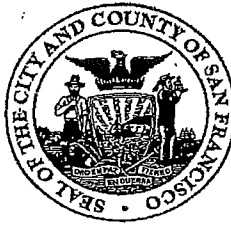

**APPENDIX B.2 SUPPLEMENTAL  
SUPPLEMENT TO CALCULATION OF CHARGES**

This is Appendix B.2 attached to, and incorporated by reference in the Agreement made on **June 30, 2011** between the City and County of San Francisco, acting by and through its Airport Commission ("Commission" or "Airport"), and **CAGE Professional Services Inc.** ("Contractor") providing for construction management services for the International Terminal and Terminal 3, Boarding Area F Checked Baggage Inspection System Modernization and International Terminal Baggage Handling System Improvements Project, Task One

**A. General – No Change**

**B. Method of Payment – Section B.8 is modified as follows:**

8. All invoices shall be made in writing and delivered or mailed to the Airport as follows:

By US mail:                   **Greg McCarthy, Project Manager**  
San Francisco International Airport  
Design and Construction (Contract 9024.9)  
P.O. Box 8097  
San Francisco, CA 94128

By Personal Delivery  
or Express Mail:           **Greg McCarthy, Project Manager**  
San Francisco International Airport  
Delta/Singapore Building  
Design and Construction (Contract 9024.9)  
710 N. McDonnell Road, 2<sup>nd</sup> Floor  
San Francisco, CA 94128

**C. Direct Salary Rate and Direct Salary Rate Adjustment – No Change**

**D. Billing Rates**

1. Subject to Appendix B.1.2 Supplemental, Supplement to Compensation and Payment, Provisional Indirect Cost Rate Agreement of this Agreement, billing rates and overhead rates shall be used for reimbursement of the cost portion of this cost plus fee Agreement as stipulated in Appendix C.3.1 and Appendix C.3.2 Supplemental, SFO 9024.9 FAR Rates of this Agreement. Billing rates shall be the sum of direct salary rates plus indirect cost as stipulated in Appendix B.1.2. Billing rates may be adjusted on July 1<sup>st</sup> of each year when the direct labor rates are adjusted as stated in Appendix B, Section C.3.2.

- 
2. Whenever possible, billing rates shall be established for home office work using a home office indirect cost rate and field office work using a field office indirect cost rate. The home office indirect cost rate shall be used when staff works in an office provided by the Contractor. The field office indirect cost rate shall be used when staff is assigned full time to an office provided by the Commission. To qualify for the field office indirect cost rate the Commission shall also provide normal office equipment and materials for field office staff such as computers, printers, internet access, phone service, fax, copier, and other office materials such as paper, clips, pens, and pencils.

**E. Fee -- No Change**

**F. Other Direct Cost -- No Change**

**G. The approved staffing plan and hourly rate schedule are detailed in Appendix C.1, C.1.2, C.2 and C.3 of this agreement.**

**APPENDIX B.1.2 SUPPLEMENTAL  
SUPPLEMENT TO COMPENSATION AND PAYMENT**

**FORM OF  
PROVISIONAL INDIRECT COST RATE AGREEMENT**

This is an Appendix B.1.2 attached to, and incorporated by reference in the Agreement made on **June 30, 2011** between the City and County of San Francisco ("City"), acting by and through its Airport Commission ("Commission" or "Airport"), and **CAGE Professional Services Inc.** ("Contractor") providing for construction management services for the International Terminal and Terminal 3, Boarding Area F Checked Baggage Inspection System Modernization and International Terminal Baggage Handling System Improvements Project. Pursuant to Agreement No. 9024.9 between the parties, the Cost Principles contained in FAR, and practices required by the applicable Cost Accounting Standards in FAR, Contractor and City agree as follows:

I. DEFINITIONS – NO CHANGE

II. PROVISIONAL INDIRECT COST RATES

This Agreement will employ a temporary provisional indirect cost rate which has been established for award of the Agreement and reimbursement of indirect cost pending the establishment of a final indirect cost rate for the period of time when the services were performed. The provisional indirect cost rates set forth in this Agreement are applicable to all services in the Services to be provided by Contractor identified in Appendix A or in Modifications issued by the City, pending the determination of the final indirect cost rates for Contractor or certain subcontractors.

- A. Subcontractors at any tier with estimated total billings exceeding \$100,000 shall enter into a provisional indirect cost rate agreement with the Contractor. The provisional indirect cost rates for subcontractor indirect costs shall be as set forth below for the Services to be provided by Contractor or in any Change Order.
- B. The provisional indirect cost rate to be applied to Contractor's and subcontractor's direct labor as set forth in Contractor's and subcontractors' submissions shall be:

<b>TABLE 1</b>	
FIRM	PROVISIONAL OVERHEAD RATE
CAGE Professional Services, Inc.	141.59%
KPA Group	179.01%
Chaves & Assoc	112.20%
EPC Consultants	Field = 106.90% and Home Office = 110.24%
M Lee Corp	131.96%
Apex Testing	76.44%
Grindstone Group, LLC	75.52%
Cooper Pugada Management, Inc.	105.21%

- C. The provisional indirect cost rate shall be applicable until the final indirect cost rate for the audited period is established. If negotiations are not conducted for the second or subsequent twelve (12) month periods within ninety (90) days after completion of the previous period, the

---

provisional indirect cost shall be utilized for the subsequent period(s) until an actual indirect cost rate is mutually agreed upon between the Contractor and the City.

D. The provisional indirect cost rates set forth in Table 1 shall be used for all new work performed under the Agreement or Modifications until such time that the final indirect cost rate for that new work is established.

E. There shall be no indirect cost rate or general administrative expense (G&A) mark-up applied to materials, other direct costs (ODC's), nor for Facilities Capital Cost of Money for either the Contractor or any of its subcontractors at any tier.

III. AUDITED INDIRECT COST RATE – NO CHANGE

III. FINAL INDIRECT COST RATE – NO CHANGE

IV. OTHER – NO CHANGE

**CT9024.9: CAGE, Inc. - CM Services for CBIS Modernization Project**

	Max Base Rate	2015								
		Jan	Feb	Mar	Apr	May	Jun	Jul	Aug	Sep
<i>Workhours per Month:</i>		176	160	176	176	168	176	184	168	176
<b>CAGE Inc.</b>										
Site & Commissioning Specialist	\$ 40.00	176	80							
<b>Chaves &amp; Assoc</b>										
Document Control	\$ 42.00	176	160	176	176	168	176	184	168	88
<b>CPM</b>										
Construction Manager	\$ 75.00	35	32	35	35	34	35	37		
Office Engineer/Inspector	\$ 60.00	176	120	88						
Project Controls	\$ 75.00	176	160	176	176	126	132	138	84	88

OVERHEAD RATES		
	2013 Actual	2014 Provisional
CAGE, Inc.	127.88%	127.88%
CPM Services, Inc.	105.21%	105.21%
Chaves & Assoc	TBD	TBD

AIRPORT COMMISSION

CITY AND COUNTY OF SAN FRANCISCO

RESOLUTION NO. 14-0249

**MODIFICATION NO. 5 TO CONTRACT NO. 9024.9, CONSTRUCTION MANAGEMENT SERVICES FOR THE INTERNATIONAL TERMINAL AND TERMINAL 3 BOARDING AREA F CHECKED BAGGAGE INSPECTION SYSTEM MODERNIZATION PROGRAM AND THE INTERNATIONAL TERMINAL BAGGAGE HANDLING SYSTEM IMPROVEMENTS PROJECT, WITH CAGE PROFESSIONAL SERVICES, INC. (DBA CAGE, INC.) TO INCREASE THE NOT-TO-EXCEED AMOUNT BY \$795,000 FOR A FINAL TOTAL CONTRACT AMOUNT NOT TO EXCEED \$8,595,000 AND TO INCREASE THE CONTRACT DURATION BY NINE MONTHS FOR A TOTAL CONTRACT DURATION OF 51 MONTHS**

WHEREAS, in 2011, the Transportation Security Administration (TSA) initiated a Recapitalization Program for the purpose of funding the modernization of the TSA's Explosive Detection Systems equipment within Airport bag room Checked Baggage Inspection Systems (CBIS); and

WHEREAS, on March 1, 2011, by Resolution No. 11-0045, the Commission authorized the Director to execute an Other Transaction Agreement (OTA) with the TSA for 90% reimbursement of design costs, including construction management services during design, for the International Terminal (IT) and Boarding Area F (BAF) Checked Baggage Inspection System (CBIS) Modernization Program under the TSA's Recapitalization Program; and

WHEREAS, on June 30, 2011, by Resolution No. 11-0146, the Commission awarded this Contract 9024.9 to CAGE, Inc. (dba CAGE Professional Services, Inc.) for Construction Management (CM) Services for the IT and BAF CBIS Modernization Program and the IT Baggage Handling System (BHS) Improvements Project. The original Contract Amount was a not-to-exceed amount of \$585,805, with an initial contract duration of six months for CM support services for the design phase ending on December 29, 2011; and

WHEREAS, by various resolutions, the Commission has approved Modification Nos. 1 through 4 to provide for contract renewals tied to the schedule of the 9024.A contract, for a correct contract amount not to exceed \$7,800,000, with a duration of 42 months; and

WHEREAS, this Modification No. 5 to Contract No. 9024.9 with CAGE, Inc. extends the contract duration by nine months for a final completion date of September 30, 2015 and increases the contract amount by \$795,000 to allow for closeout of the project, completion of reimbursement requests to the TSA, and the possible design coordination for a future bid package. The final not-to-exceed amount is \$8,595,000 with a total contract duration is 51 months. This Modification will be funded from the Airport's 5-year Capital Improvement Plan; and



AIRPORT COMMISSION

CITY AND COUNTY OF SAN FRANCISCO

RESOLUTION NO. 14-0249

WHEREAS, due to the federal funding component for these services, there are no Local Business Enterprise (LBE) sub-consultant participation goals for the contract. The Airport encouraged proposers to utilize "best efforts" to subcontract at least 10% of the work to certified small and disadvantaged businesses (SDB). Due to the specialized nature of the services, CAGE, Inc. is committed to achieving a 5.8% SDB sub-consultant participation; now, therefore be it

RESOLVED, that the Commission hereby approves Modification No. 5 to Contract No. 9024.9, Construction Management Services for the International Terminal and Boarding Area F Checked Baggage Inspection System Modernization Program, Boarding Area E Checked Baggage Inspection System Activation and the International Terminal Baggage Handling System Improvements Project with CAGE Professional Services, Inc. (dba CAGE, Inc.) to increase the not-to-exceed amount by \$795,000 for a final total contract amount not to exceed \$8,595,000 and to extend the contract duration by nine months for a total contract duration of 51 months and a new completion date of September 30, 2015.

Page 2 of 2

*I hereby certify that the foregoing resolution was adopted by the Airport Commission*

*at its meeting of* \_\_\_\_\_

**DEC 02 2014**

1673

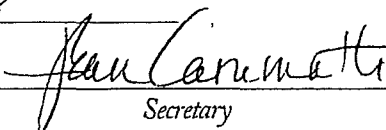
  
Secretary



San Francisco International Airport

MEMORANDUM

December 2, 2014

TO: AIRPORT COMMISSION  
Hon. Larry Mazzola, President  
Hon. Linda S. Crayton, Vice President  
Hon. Eleanor Johns  
Hon. Richard J. Guggenlime  
Hon. Peter A. Stern

FROM: Airport Director

SUBJECT: Modification No. 5 to Contract No. 9024.9, Construction Management Services for the International Terminal and Terminal 3 Boarding Area F Checked Baggage Inspection System Modernization Program and the International Terminal Baggage Handling System Improvements

DIRECTOR'S RECOMMENDATION: APPROVE MODIFICATION NO. 5 TO CONTRACT NO. 9024.9, CONSTRUCTION MANAGEMENT SERVICES FOR THE INTERNATIONAL TERMINAL AND TERMINAL 3 BOARDING AREA F CHECKED BAGGAGE INSPECTION SYSTEM MODERNIZATION PROGRAM AND THE INTERNATIONAL TERMINAL BAGGAGE HANDLING SYSTEM IMPROVEMENTS PROJECT, WITH CAGE PROFESSIONAL SERVICES, INC. (DBA CAGE, INC.) TO INCREASE THE NOT-TO-EXCEED AMOUNT BY \$795,000 FOR A FINAL TOTAL CONTRACT AMOUNT NOT TO EXCEED \$8,595,000 AND INCREASE THE CONTRACT DURATION BY NINE MONTHS FOR A TOTAL CONTRACT DURATION OF 51 MONTHS

Executive Summary

Transmitted herewith for your approval is a proposed Resolution approving Modification No. 5 to Contract No. 9024.9, Construction Management (CM) Services for the International Terminal and Terminal 3 Boarding Area F (BAF) Checked Baggage Inspection System (CBIS) Modernization Program, Boarding Area E (BAE) CBIS Activation and the International Terminal (IT) Baggage Handling System Improvements Project with CAGE Professional Services, Inc. (dba CAGE, Inc.), to increase the not-to-exceed amount by \$795,000 for a final total contract amount not to exceed \$8,595,000 and increase the contract duration by nine months for a total contract duration of 51 months.

Background

In 2011, the Transportation Security Administration (TSA) initiated a Recapitalization Program for the purpose of funding the modernization of the TSA's Explosive Detection Systems equipment within Airport bag room CBIS.

On March 1, 2011, by Resolution No. 11-0045, the Commission authorized the Director to execute an Other Transaction Agreement (OTA) with the TSA for 90% reimbursement of design costs, including construction management services, for the IT and BAF CBIS Modernization Program under the TSA's Recapitalization Program.

AIRPORT COMMISSION CITY AND COUNTY OF SAN FRANCISCO

THIS PRINT COVERS CALENDAR ITEM NO. 8

EDWIN M. LEE      LARRY MAZZOLA      LINDA S. CRAYTON      ELEANOR JOHNS      RICHARD J. GUGGENHIME      PETER A. STERN      JOHN L. MARTIN  
MAYOR      PRESIDENT      VICE PRESIDENT      AIRPORT DIRECTOR

On June 30, 2011, by Resolution No. 11-0146, the Commission awarded Contract No. 9024.9 to CAGE, Inc. for Construction Management (CM) Services. CAGE, Inc. provides CM services for Contract No. 9024.A Design-Build Services for this Project with VanDerLande Industries (VI) with a contract amount of \$83,868,927 and a contract expiration date of March 31, 2015. The construction project includes:

- IT and Terminal 3 BAF CBIS Modernization Program ("Modernization Program");
- BAE CBIS Activation;
- IT Baggage Handling System (BHS) Improvements Project

The original not-to-exceed contract amount was \$585,805, with an initial contract duration of six months for CM services for the design phase only.

By various resolutions, the Commission has approved Modification Nos. 1 through 4 to provide for contract renewals tied to the schedule of the 9024.A contract, for a correct contract amount not to exceed \$7,800,000, with a duration of 42 months.

This Modification No. 5 to Contract No. 9024.9 with CAGE, Inc. extends the contract duration by nine months for a final completion date of September 30, 2015 and increases the contract amount by \$795,000 to allow for closeout of the project, completion of reimbursement requests to the TSA, and the possible design coordination for a future bid package. The final modified not-to-exceed amount is \$8,595,000 with a total contract duration of 51 months. This Modification will be funded from the Airport's 5-year Capital Improvement Plan.

Due to ongoing issues with the operational performance of the TSA furnished screening equipment and its effect on Airport and airline operational capacity, the Modernization Project under the TSA's Recapitalization Program is on hold. Once a mutual resolution between the TSA and Airport is reached, the Airport will reevaluate the program and develop a revised project delivery strategy to complete the program.

Due to the federal funding component for these services, there are no Local Business Enterprise (LBE) sub-consultant participation goals for the contract. Staff encouraged proposers to utilize "best efforts" to subcontract at least 10% of the work to certified small disadvantaged businesses (SDB). Due to the specialized nature of the services, CAGE, Inc. is committed to achieving a 5.8% SDB sub-consultant participation.

### Recommendation

Based on the above, I recommend the Commission approve Modification No. 5 to Contract No. 9024.9, CM Services for the IT and BAF CBIS Modernization Program, BAE CBIS Activation and the IT Terminal BHS Improvements Project with CAGE Professional Services, Inc. (dba CAGE, Inc.) to increase the not-to-exceed amount by \$795,000 for a final total contract amount not to exceed \$8,595,000 and to extend the contract duration by nine months for a total contract duration of 51 months and a new completion date of September 30, 2015.



John L. Martin  
Airport Director

Prepared by: Geoffrey W. Neumayr  
Deputy Airport Director  
Design & Construction

**City and County of San Francisco  
Airport Commission  
P.O. Box 8097  
San Francisco, California 94128**

**Fourth Modification**

THIS MODIFICATION (this "Modification") is made as of **June 17, 2014**, in San Francisco, California, by and between **CAGE Professional Services, Inc.** ("Contractor"), and the City and County of San Francisco, a municipal corporation ("City"), acting by and through its Airport Commission or the Commission's designated agent, hereinafter referred to as "**Commission.**"

RECITALS

WHEREAS, City and Contractor have entered into the Agreement (as defined below); and

WHEREAS, the Commission adopted Resolution Number 11-0146 on June 30, 2011 which awarded said Agreement for the period of June 30, 2011 through December 31, 2011; and

WHEREAS, the Commission adopted Resolution Number 11-0221 on October 4, 2011 which awarded Modification number 1 for a new term ending on December 31, 2013; and

WHEREAS, the Commission adopted Resolution Number 12-0158 on July 17, 2012 which awarded Modification number 2; and

WHEREAS, the Commission adopted Resolution Number 13-0248 on December 3, 2013 which awarded Modification number 3; and

WHEREAS, City and Contractor desire to modify the Agreement on the terms and conditions set forth herein to extend professional services for a six (6) month period for a new end date of December 31, 2014 and increase compensation payable in the not-to-exceed amount of Eight Hundred Thousand Dollars (\$800,000) for a not-to-exceed contract amount of Seven Million Eight Hundred Thousand Dollars (\$7,800,000); and

WHEREAS, Commission approved this Modification 4 pursuant to Resolution Number **14-0124** on **June 17, 2014**; and

WHEREAS, approval for this Modification was obtained when the Civil Service Commission approved Contract number PSC #4099-09/10 on June 2, 2014; and

WHEREAS, prior modifications were identified as "Amendments", this and further modifications are, and will be, identified as "Modifications"; and

NOW, THEREFORE, Contractor and the City agree as follows:

**1. Definitions.** The following definitions shall apply to this Modification:

**a. Agreement.** The term "Agreement" shall mean the Agreement dated June 30, 2011 between Contractor and City, as amended by the:

**First Amendment, dated October 4, 2011, and**

**Second Amendment, dated July 17, 2012, and  
Third Amendment, dated December 3, 2013**

b. **Other Terms.** Terms used and not defined in this Modification shall have the meanings assigned to such terms in the Agreement.

2. **Section 2. Term of the Agreement** is hereby amended to extend the term of the contract for six (6) months for a new ending date of December 31, 2014.

3. **Section 5. Compensation** is hereby amended to increase the total compensation payable by an amount not to exceed Eight Hundred Thousand Dollars (\$800,000) for a new total not to exceed amount of Seven Million, Eight Hundred Thousand Dollars (\$7,800,000).

4. **Section 25, Notices to the Parties** is deleted in its entirety and replaced with the following:

25. **Notices to the Parties.** Unless otherwise indicated elsewhere in this Agreement, all written communications sent by the parties may be by U.S. mail, or by e-mail, and shall be addressed as follows:

To City: Greg McCarthy  
Project Manager  
San Francisco International Airport  
Design and Construction  
P.O. Box 8097  
San Francisco, California 94128  
Email: [greg.mccarthy@flysf0.com](mailto:greg.mccarthy@flysf0.com)  
Fax: (650) 821-7779

To Contractor: Peter Bjostad  
Vice President  
Cage, Inc.  
6440 N. Beltline Road, Suite 125  
Irving, Texas 75063  
Email: [pjostad@cage-inc.com](mailto:pjostad@cage-inc.com)  
Fax: (972) 550-9221

5. **Effective Date.** Each of the modifications set forth in Section 2 shall be effective on and after June 17, 2014.

6. **Legal Effect.** Except as expressly modified by this Modification, all of the terms and conditions of the Agreement shall remain unchanged and in full force and effect.

IN WITNESS WHEREOF, Contractor and City have executed this Modification as of the date first referenced above.

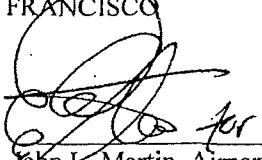
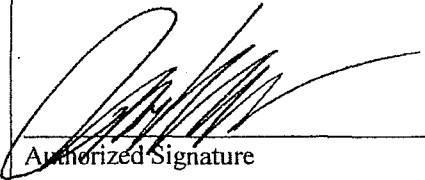
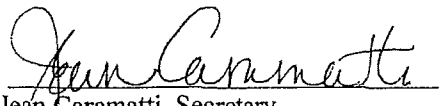
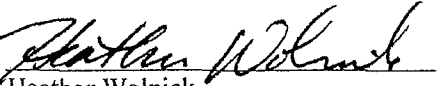
CITY	CONTRACTOR
AIRPORT COMMISSION CITY AND COUNTY OF SAN FRANCISCO	
By:  John L. Martin, Airport Director	 Authorized Signature
Attest:	John Boodee President
By:  Jean Caramatti, Secretary Airport Commission	CAGE Professional Services, Inc. 6303 Commerce Drive, Suite 150 Irving, Texas 75063 972-550-1001
Resolution No: 14-0124	81238 City Vendor Number
Adopted on: June 17, 2014	75-2722503 Federal Employer ID Number
Approved as to Form:	
Dennis J. Herrera City Attorney	
By:  Heather Wolnick Deputy City Attorney	

AIRPORT COMMISSION

CITY AND COUNTY OF SAN FRANCISCO

RESOLUTION NO. 14-0124

**MODIFICATION NO. 4 TO CONTRACT NO. 9024.9, CONSTRUCTION MANAGEMENT (CM) SERVICES FOR THE INTERNATIONAL TERMINAL (IT) AND TERMINAL 3 (T3) BOARDING AREA F (BAF) CHECKED BAGGAGE INSPECTION SYSTEM (CBIS) MODERNIZATION PROGRAM AND THE IT BAGGAGE HANDLING SYSTEM (BHS) IMPROVEMENTS PROJECT, WITH CAGE, INC. TO INCREASE THE NOT-TO-EXCEED AMOUNT BY \$800,000 AND INCREASE THE CONTRACT COMPLETION DATE SIX MONTHS FOR A NEW TOTAL CONTRACT AMOUNT NOT TO EXCEED \$7,800,000 AND ESTABLISH A NEW CONTRACT DURATION ENDING DECEMBER 31, 2014**

WHEREAS, on March 1, 2011, by Resolution No. 11-0045, the Commission authorized the Director to execute an Other Transaction Agreement (OTA) with the Transportation Security Administration (TSA) for 90% reimbursement of design costs, including construction management services during design, for the IT and BAF CBIS Modernization Program under the TSA's Recapitalization Program; and

WHEREAS, on June 30, 2011, by Resolution No. 11-0146, the Commission awarded the Contract to CAGE, Inc. for CM Services for the IT and T3, BAF CBIS Modernization Program and the IT BHS Improvements Project. In a not to exceed amount of \$585,805, with a contract duration of six months for CM support services for the design-phase ending on December 29, 2011; and

WHEREAS, on October 4, 2011, by Resolution No. 11-0221, the Commission authorized Modification No. 1 to this Contract in an amount not to exceed \$4,823,109, for CM services during the construction phase through December 29, 2013 for a total Contract Amount not to exceed \$5,408,914; and

WHEREAS, on July 17, 2012, by Resolution No. 12-0158, the Commission authorized Modification No. 2 to this Contract in an amount not to exceed \$780,800 for a total contract amount not to exceed \$6,189,714, and with no change to the contract duration; and

WHEREAS, on December 03, 2013, by Resolution No. 13-0248, the Commission authorized Modification No. 3 to this Contract in an amount not to exceed \$810,286 for a total contract amount not to exceed \$7,000,000, and a new contract duration of 36 months, ending June 30, 2014; and

WHEREAS, per the OTA, the project team has designed, installed and placed into operation four Explosive Detection System (EDS) Screening Machines. The original TSA approved design cannot accommodate the increased screening requirement requiring a final joint solution between the Airport, TSA and other stakeholders is not expected to be reached until October 2014; and

WHEREAS, CM Services by CAGE Inc. are required for ongoing construction during the time required to develop a final joint solution with the TSA; and now, therefore be it

RESOLVED, that the Commission hereby approves Modification No. 4 to Contract No. 9024.9, CM Services for the IT and BAF CBIS Modernization Program, BAA CBIS Activation and the IT BHS Improvements Project to increase the not to exceed amount by \$800,000 and a time extension of six-months for a new total contract amount not to exceed \$7,800,000 with a new contract duration of 42 months, ending December 31, 2014.

I hereby certify that the foregoing resolution was adopted by the Airport Commission  
at its meeting of \_\_\_\_\_

JUN 17 2014

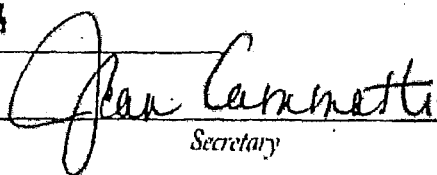
  
Secretary



San Francisco International Airport

**MEMORANDUM**

June 17, 2014

**TO:** AIRPORT COMMISSION  
 Hon. Larry Mazzola, President  
 Hon. Linda S. Crayton, Vice President  
 Hon. Eleanor Johns  
 Hon. Richard J. Guggenlime  
 Hon. Peter A. Stern

**FROM:** Airport Director

**SUBJECT:** Modification No. 4 to Contract No. 9024.9, Construction Management (CM) Services for the International Terminal (IT) and Terminal 3 (T3) Boarding Area F (BAF) Checked Baggage Inspection System (CBIS) Modernization Program and the IT Baggage Handling System (BHS) Improvements Project

**DIRECTOR'S RECOMMENDATION:** APPROVE MODIFICATION NO. 4 TO CONTRACT NO. 9024.9, CM SERVICES FOR THE IT & T3, BAF CBIS MODERNIZATION PROGRAM AND THE IT BHS IMPROVEMENTS PROJECT, WITH CAGE, INC. FOR AN INTERIM PERIOD OF SIX MONTHS (THROUGH DECEMBER 31, 2014) IN THE AMOUNT OF \$800,000, FOR A NEW TOTAL CONTRACT AMOUNT NOT TO EXCEED \$7,800,000

Executive Summary

Transmitted herewith for your approval is a proposed resolution approving Modification No. 4 to Contract No. 9024.9, CM Services for the IT and BAF CBIS Modernization Program, BAA CBIS Activation and the IT Baggage Handling System Improvements Project in the amount of \$800,000. This amendment establishes a new not-to-exceed amount of \$7,800,000 and extends the contract duration by six months for a new contract termination date of December 31, 2014.

Background

The Commission awarded Contract No. 9024.9 on June 30, 2011, by Resolution No. 11-0146. The Commission awarded the Contract to CAGE, Inc. for CM Services for the IT and T3, BAF CBIS Modernization Program, BAA CBIS Activation and the IT Baggage Handling System Improvements Project. The original not-to-exceed amount was \$585,805, with a contract duration of six months for CM support services for the design phase ending on December 29, 2011.

On October 4, 2011, by Resolution No. 11-0221, the Commission authorized Modification No. 1 to this Contract in an amount not to exceed \$4,823,109, for CM services during the construction phase through December 29, 2013, for a total Contract Amount not to exceed \$5,408,914.

On July 17, 2012, by Resolution No. 12-0158, the Commission authorized the Modification No. 2 to this Contract in an amount no to exceed \$780,800 for a total contract amount not to exceed \$6,189,714, and with no change to the contract duration.

AIRPORT COMMISSION CITY AND COUNTY OF SAN FRANCISCO

THIS PRINT COVERS CALENDAR ITEM NO. 7

EDWIN M. LEE  
MAYOR

LARRY MAZZOLA  
PRESIDENT

LINDA S. CRAYTON  
VICE PRESIDENT

ELEANOR JOHNS

RICHARD J. GUGGENHIME

PETER A. STERN

JOHN L. MARTIN  
AIRPORT DIRECTOR



On December 3, 2013, by Resolution 13-0248, the Commission authorized the Modification No. 3 to this Contract in an amount not to exceed \$810,286 for a total contract amount not to exceed \$7,000,000, and with a contract duration ending June 30, 2014.

CAGE, Inc. provides CM services for the construction Contract No. 9024.A with VanDerLande Industries (VI) with a contract amount of \$83,138,927. The contract is primarily a cost-plus-fee agreement with material bid items. The VI Contract is divided into 4 tasks: Task 1 and Task 2 contain work covered under a reimbursable Other Transaction Agreement (OTA) with the Transportation Security Administration (TSA). Task 3 and Task 4 are associated with non-OTA reimbursable work outside the CBIS/Checked Baggage Resolution Area (CBRA) areas (e.g. BAE improvements, transfer line, etc.).

For Tasks 1 and 2 (under the OTA) the CBIS Project provides for the design and construction services for the recapitalization of the TSA Explosive Detection System (EDS) equipment within the CBIS at the IT Terminal A and G and T3, BAF.

Per the OTA, the design and construction of the project has followed the TSA prepared Planning Guidelines and Design Standards (PGDS). To date, the project team has installed and placed into operation four TSA furnished CTX 9800 Screening Machines, which are producing significantly higher alarm rates than what was forecasted in the TSA PGDS. The higher alarm rates force an increased amount of bags to be sent to the TSA CBRA areas (where bags are searched manually). The original design of the project cannot accommodate these higher alarm rates. Additional CTX machines, recirculation and temporary conveyors were required to be installed as a temporary measure to maintain Airport operations. All of these items were not included in the original OTA Scope of Work but are necessary to install the systems and maintain Airport operations. The Airport is discussing options with the TSA and other stakeholders to reach a final joint solution, but a solution is not expected to be reached until October 2014.

To the extent that the project team cannot reasonably determine how this joint solution will affect the overall program scope and budget, this amendment requests a six-month time extension for CM services with CAGE, Inc. while the joint solution is being developed. The CM services are required for ongoing construction during the interim, as follows:

- 1) to facilitate a joint solution with a possible redesign of the CBRA areas;
- 2) to provide CM Services for the BHS re-control work underway on Task 3;
- 3) to provide CM Services for remaining safety updates on Task 4; and
- 4) to continue the necessary support documentation to seek reimbursement from the TSA under the current OTA agreement, including the possible development of a new or amended OTA for any agreed-upon redesign of the CBRA areas.

This Modification No. 4 to Contract No. 9024.9 with CAGE, Inc. increases the contract time of services by six months, and the contract amount by \$800,000 to allow for reassessment of the program, through to December 31, 2014. This modification will be funded from the Airport's 5-year Capital Improvement Plan, recently approved by the Commission on February 18, 2014.

Depending on the outcome of the joint solution with TSA, Staff will assess the overall program changes needed by November 2014, to complete the intended OTA Scope and return to the Commission to request approval for any changes required to implement this joint solution.

Due to the federal funding component for these services, there are no Local Business Enterprise (LBE) subconsultant participation goals for the contract. The Airport encouraged proposers to utilize "best efforts" to subcontract at least 10% of the work to certified small and disadvantaged businesses (SDB). Due to the specialized nature of the services, CAGE Inc. is committed to achieving a 5.8% SDB subconsultant participation.

**Recommendation**

Based on the above, I recommend the Commission approve this Modification No. 4 to Contract No. 9024.9, CM Services for the IT and BAF CBIS Modernization Program, BAA CBIS Activation and the IT Terminal BHS Improvements Project with CAGE, In., to increase the not-to-exceed amount by \$800,000 and a time extension of six-months for a new total contract amount not to exceed \$7,800,000 with a new contract duration ending December 31, 2014.



John L. Martin  
Airport Director

Prepared by: Geoffrey W Neumayr  
Deputy Airport Director  
Design & Construction

Attachment

**City and County of San Francisco  
Airport Commission  
P.O. Box 8097  
San Francisco, California 94128**

**Third Amendment**

THIS AMENDMENT (this "Amendment") is made as of **December 3, 2013**, in San Francisco, California, by and between **CAGE Professional Services, Inc.** ("Contractor"), and the City and County of San Francisco, a municipal corporation ("City"), acting by and through its Airport Commission or the Commission's designated agent, hereinafter referred to as "Commission."

RECITALS

WHEREAS, City and Contractor have entered into the Agreement (as defined below); and

WHEREAS, the Commission adopted Resolution Number 11-0146 on June 30, 2011 which awarded said Agreement for the period of June 30, 2011 through December 31, 2011; and

WHEREAS, the Commission adopted Resolution Number 11-0221 on October 4, 2011 which awarded Modification number 1 for a new term ending on December 31, 2013; and

WHEREAS, the Commission adopted Resolution Number 12-0158 on July 17, 2012 which awarded Modification number 2; and

WHEREAS, City and Contractor desire to modify the Agreement on the terms and conditions set forth herein to extend professional services for a six (6) month period for a new end date of June 30, 2014 and increase compensation payable in the not-to-exceed amount of Eight Hundred Ten Thousand Two Hundred Eighty-six Dollars (\$810,286) in order to develop a joint solution between the Airport, the Transportation Security Administration (TSA) and other stakeholders regarding the increased screening requirements required by TSA; and

WHEREAS, Commission awarded this Modification 3 pursuant to Resolution Number **13-0248** on December 3, 2013; and

WHEREAS, administrative approval for this Amendment was obtained when the Department of Human Resources approved Contract number PSC #4099-09/10 on February 22, 2013; and

NOW, THEREFORE, Contractor and the City agree as follows:

**1. Definitions.** The following definitions shall apply to this Amendment:

**a. Agreement.** The term "Agreement" shall mean the Agreement dated June 30, 2011 between Contractor and City, as amended by the:

**First Amendment, dated October 4, 2011, and  
Second Amendment, dated July 17, 2012**

**b. Other Terms.** Terms used and not defined in this Amendment shall have the meanings assigned to such terms in the Agreement.

2. **Section 2. Term of the Agreement** is hereby amended to extend the term of the contract for six (6) months for a new ending date of June 30, 2014.

3. **Section 5. Compensation** is hereby amended to increase the total compensation payable by an amount not to exceed Eight Hundred Ten Thousand Two Hundred Eighty-six Dollars (\$810,286) for a new total not to exceed amount of Seven Million Dollars (\$7,000,000).

4. **Effective Date.** Each of the modifications set forth in Section 2 shall be effective on and after December 3, 2013.

5. **Legal Effect.** Except as expressly modified by this Amendment, all of the terms and conditions of the Agreement shall remain unchanged and in full force and effect.

IN WITNESS WHEREOF, Contractor and City have executed this Amendment as of the date first referenced above.

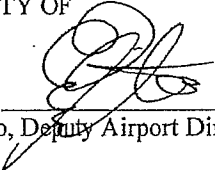
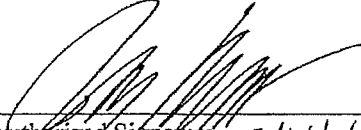
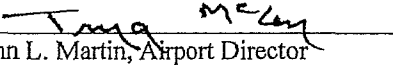
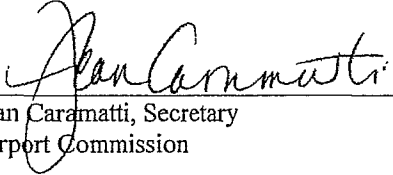
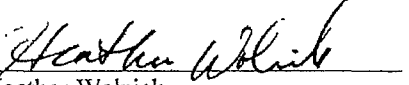
CITY	CONTRACTOR
AIRPORT COMMISSION CITY AND COUNTY OF SAN FRANCISCO	
Recommended By:  Ivar Satero, Deputy Airport Director	 Authorized Signature 2/14/14
By:  John L. Martin, Airport Director	John Boodee President CAGE Professional Services, Inc. 6303 Commerce Drive, Suite 150 Irving, Texas 75063 972-550-1001
Attest:	81238 City Vendor Number
By  Jean Caramatti, Secretary Airport Commission	75-2722503 Federal Employer ID Number
Resolution No: 13-0248	
Adopted on: December 3, 2013	
Approved as to Form:	
Dennis J. Herrera City Attorney	
By  Heather Wolnick Deputy City Attorney	

AIRPORT COMMISSION

CITY AND COUNTY OF SAN FRANCISCO

RESOLUTION NO. 14-0124

**MODIFICATION NO. 4 TO CONTRACT NO. 9024.9, CONSTRUCTION MANAGEMENT (CM) SERVICES FOR THE INTERNATIONAL TERMINAL (IT) AND TERMINAL 3 (T3) BOARDING AREA F (BAF) CHECKED BAGGAGE INSPECTION SYSTEM (CBIS) MODERNIZATION PROGRAM AND THE IT BAGGAGE HANDLING SYSTEM (BHS) IMPROVEMENTS PROJECT, WITH CAGE, INC. TO INCREASE THE NOT-TO-EXCEED AMOUNT BY \$800,000 AND INCREASE THE CONTRACT COMPLETION DATE SIX MONTHS FOR A NEW TOTAL CONTRACT AMOUNT NOT TO EXCEED \$7,800,000 AND ESTABLISH A NEW CONTRACT DURATION ENDING DECEMBER 31, 2014**

WHEREAS, on March 1, 2011, by Resolution No. 11-0045, the Commission authorized the Director to execute an Other Transaction Agreement (OTA) with the Transportation Security Administration (TSA) for 90% reimbursement of design costs, including construction management services during design, for the IT and BAF CBIS Modernization Program under the TSA's Recapitalization Program; and

WHEREAS, on June 30, 2011, by Resolution No. 11-0146, the Commission awarded the Contract to CAGE, Inc. for CM Services for the IT and T3, BAF CBIS Modernization Program and the IT BHS Improvements Project. In a not to exceed amount of \$585,805, with a contract duration of six months for CM support services for the design-phase ending on December 29, 2011; and

WHEREAS, on October 4, 2011, by Resolution No. 11-0221, the Commission authorized Modification No. 1 to this Contract in an amount not to exceed \$4,823,109, for CM services during the construction phase through December 29, 2013 for a total Contract Amount not to exceed \$5,408,914; and

WHEREAS, on July 17, 2012, by Resolution No. 12-0158, the Commission authorized Modification No. 2 to this Contract in an amount not to exceed \$780,800 for a total contract amount not to exceed \$6,189,714, and with no change to the contract duration; and

WHEREAS, on December 03, 2013, by Resolution No. 13-0248, the Commission authorized Modification No. 3 to this Contract in an amount not to exceed \$810,286 for a total contract amount not to exceed \$7,000,000, and a new contract duration of 36 months, ending June 30, 2014; and

WHEREAS, per the OTA, the project team has designed, installed and placed into operation four Explosive Detection System (EDS) Screening Machines. The original TSA approved design cannot accommodate the increased screening requirement requiring a final joint solution between the Airport, TSA and other stakeholders is not expected to be reached until October 2014; and

WHEREAS, CM Services by CAGE Inc. are required for ongoing construction during the time required to develop a final joint solution with the TSA; and now, therefore be it

RESOLVED, that the Commission hereby approves Modification No. 4 to Contract No. 9024.9, CM Services for the IT and BAF CBIS Modernization Program, BAA CBIS Activation and the IT BHS Improvements Project to increase the not to exceed amount by \$800,000 and a time extension of six-months for a new total contract amount not to exceed \$7,800,000 with a new contract duration of 42 months, ending December 31, 2014.

*I hereby certify that the foregoing resolution was adopted by the Airport Commission*

*at its meeting of* \_\_\_\_\_

JUN 17 2014

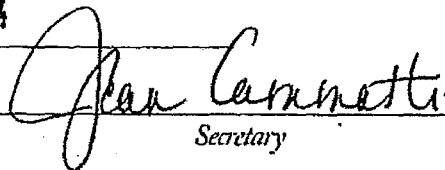
  
Secretary



San Francisco International Airport

**MEMORANDUM**

June 17, 2014

TO: AIRPORT COMMISSION  
 Hon. Larry Mazzola, President  
 Hon. Linda S. Crayton, Vice President  
 Hon. Eleanor Johns  
 Hon. Richard J. Guggenlime  
 Hon. Peter A. Stern

FROM: Airport Director

SUBJECT: Modification No. 4 to Contract No. 9024.9, Construction Management (CM) Services for the International Terminal (IT) and Terminal 3 (T3) Boarding Area F (BAF) Checked Baggage Inspection System (CBIS) Modernization Program and the IT Baggage Handling System (BHS) Improvements Project

DIRECTOR'S RECOMMENDATION: APPROVE MODIFICATION NO. 4 TO CONTRACT NO. 9024.9, CM SERVICES FOR THE IT & T3, BAF CBIS MODERNIZATION PROGRAM AND THE IT BHS IMPROVEMENTS PROJECT, WITH CAGE, INC. FOR AN INTERIM PERIOD OF SIX MONTHS (THROUGH DECEMBER 31, 2014) IN THE AMOUNT OF \$800,000, FOR A NEW TOTAL CONTRACT AMOUNT NOT TO EXCEED \$7,800,000

**Executive Summary**

Transmitted herewith for your approval is a proposed resolution approving Modification No. 4 to Contract No. 9024.9, CM Services for the IT and BAF CBIS Modernization Program, BAA CBIS Activation and the IT Baggage Handling System Improvements Project in the amount of \$800,000. This amendment establishes a new not-to-exceed amount of \$7,800,000 and extends the contract duration by six months for a new contract termination date of December 31, 2014.

**Background**

The Commission awarded Contract No. 9024.9 on June 30, 2011, by Resolution No. 11-0146. The Commission awarded the Contract to CAGE, Inc. for CM Services for the IT and T3, BAF CBIS Modernization Program, BAA CBIS Activation and the IT Baggage Handling System Improvements Project. The original not-to-exceed amount was \$585,805, with a contract duration of six months for CM support services for the design phase ending on December 29, 2011.

On October 4, 2011, by Resolution No. 11-0221, the Commission authorized Modification No. 1 to this Contract in an amount not to exceed \$4,823,109, for CM services during the construction phase through December 29, 2013, for a total Contract Amount not to exceed \$5,408,914.

On July 17, 2012, by Resolution No. 12-0158, the Commission authorized the Modification No. 2 to this Contract in an amount no to exceed \$780,800 for a total contract amount not to exceed \$6,189,714, and with no change to the contract duration.

AIRPORT COMMISSION CITY AND COUNTY OF SAN FRANCISCO

THIS PRINT COVERS CALENDAR ITEM NO. 7

EDWIN M. LEE  
MAYOR

LARRY MAZZOLA  
PRESIDENT

LINDA S. CRAYTON  
VICE PRESIDENT

ELEANOR JOHNS

RICHARD J. GUGGENHIME

PETER A. STERN

JOHN L. MARTIN  
AIRPORT DIRECTOR

On December 3, 2013, by Resolution 13-0248, the Commission authorized the Modification No. 3 to this Contract in an amount not to exceed \$810,286 for a total contract amount not to exceed \$7,000,000, and with a contract duration ending June 30, 2014.

CAGE, Inc. provides CM services for the construction Contract No. 9024.A with VanDerLande Industries (VI) with a contract amount of \$83,138,927. The contract is primarily a cost-plus-fee agreement with material bid items. The VI Contract is divided into 4 tasks: Task 1 and Task 2 contain work covered under a reimbursable Other Transaction Agreement (OTA) with the Transportation Security Administration (TSA). Task 3 and Task 4 are associated with non-OTA reimbursable work outside the CBIS/Checked Baggage Resolution Area (CBRA) areas (e.g. BAE improvements, transfer line, etc.).

For Tasks 1 and 2 (under the OTA) the CBIS Project provides for the design and construction services for the recapitalization of the TSA Explosive Detection System (EDS) equipment within the CBIS at the IT Terminal A and G and T3, BAF.

Per the OTA, the design and construction of the project has followed the TSA prepared Planning Guidelines and Design Standards (PGDS). To date, the project team has installed and placed into operation four TSA furnished CTX 9800 Screening Machines, which are producing significantly higher alarm rates than what was forecasted in the TSA PGDS. The higher alarm rates force an increased amount of bags to be sent to the TSA CBRA areas (where bags are searched manually). The original design of the project cannot accommodate these higher alarm rates. Additional CTX machines, recirculation and temporary conveyors were required to be installed as a temporary measure to maintain Airport operations. All of these items were not included in the original OTA Scope of Work but are necessary to install the systems and maintain Airport operations. The Airport is discussing options with the TSA and other stakeholders to reach a final joint solution, but a solution is not expected to be reached until October 2014.

To the extent that the project team cannot reasonably determine how this joint solution will affect the overall program scope and budget, this amendment requests a six-month time extension for CM services with CAGE, Inc. while the joint solution is being developed. The CM services are required for ongoing construction during the interim, as follows:

- 1) to facilitate a joint solution with a possible redesign of the CBRA areas;
- 2) to provide CM Services for the BHS re-control work underway on Task 3;
- 3) to provide CM Services for remaining safety updates on Task 4; and
- 4) to continue the necessary support documentation to seek reimbursement from the TSA under the current OTA agreement, including the possible development of a new or amended OTA for any agreed-upon redesign of the CBRA areas.

This Modification No. 4 to Contract No. 9024.9 with CAGE, Inc. increases the contract time of services by six months, and the contract amount by \$800,000 to allow for reassessment of the program, through to December 31, 2014. This modification will be funded from the Airport's 5-year Capital Improvement Plan, recently approved by the Commission on February 18, 2014.

Depending on the outcome of the joint solution with TSA, Staff will assess the overall program changes needed by November 2014, to complete the intended OTA Scope and return to the Commission to request approval for any changes required to implement this joint solution.



Due to the federal funding component for these services, there are no Local Business Enterprise (LBE) subconsultant participation goals for the contract. The Airport encouraged proposers to utilize "best efforts" to subcontract at least 10% of the work to certified small and disadvantaged businesses (SDB). Due to the specialized nature of the services, CAGE Inc. is committed to achieving a 5.8% SDB subconsultant participation.

**Recommendation**

Based on the above, I recommend the Commission approve this Modification No. 4 to Contract No. 9024.9, CM Services for the IT and BAF CBIS Modernization Program, BAA CBIS Activation and the IT Terminal BHS Improvements Project with CAGE, In., to increase the not-to-exceed amount by \$800,000 and a time extension of six-months for a new total contract amount not to exceed \$7,800,000 with a new contract duration ending December 31, 2014.

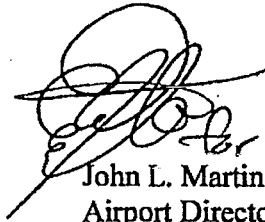

John L. Martin  
Airport Director

Prepared by: Geoffrey W Neumayr  
Deputy Airport Director  
Design & Construction

Attachment

**City and County of San Francisco  
Airport Commission  
P.O. Box 8097  
San Francisco, California 94128**

**Fourth Modification**

THIS MODIFICATION (this "Modification") is made as of **June 17, 2014**, in San Francisco, California, by and between **CAGE Professional Services, Inc.** ("Contractor"), and the City and County of San Francisco, a municipal corporation ("City"), acting by and through its Airport Commission or the Commission's designated agent, hereinafter referred to as "**Commission.**"

RECITALS

WHEREAS, City and Contractor have entered into the Agreement (as defined below); and

WHEREAS, the Commission adopted Resolution Number 11-0146 on June 30, 2011 which awarded said Agreement for the period of June 30, 2011 through December 31, 2011; and

WHEREAS, the Commission adopted Resolution Number 11-0221 on October 4, 2011 which awarded Modification number 1 for a new term ending on December 31, 2013; and

WHEREAS, the Commission adopted Resolution Number 12-0158 on July 17, 2012 which awarded Modification number 2; and

WHEREAS, the Commission adopted Resolution Number 13-0248 on December 3, 2013 which awarded Modification number 3; and

WHEREAS, City and Contractor desire to modify the Agreement on the terms and conditions set forth herein to extend professional services for a six (6) month period for a new end date of December 31, 2014 and increase compensation payable in the not-to-exceed amount of Eight Hundred Thousand Dollars (\$800,000) for a not-to-exceed contract amount of Seven Million Eight Hundred Thousand Dollars (\$7,800,000); and

WHEREAS, Commission approved this Modification 4 pursuant to Resolution Number **14-0124** on **June 17, 2014**; and

WHEREAS, approval for this Modification was obtained when the Civil Service Commission approved Contract number PSC #4099-09/10 on June 2, 2014; and

WHEREAS, prior modifications were identified as "Amendments", this and further modifications are, and will be, identified as "Modifications"; and

NOW, THEREFORE, Contractor and the City agree as follows:

**1. Definitions.** The following definitions shall apply to this Modification:

**a. Agreement.** The term "Agreement" shall mean the Agreement dated June 30, 2011 between Contractor and City, as amended by the:

**First Amendment, dated October 4, 2011, and**

**Second Amendment, dated July 17, 2012, and  
Third Amendment, dated December 3, 2013**

**b. Other Terms.** Terms used and not defined in this Modification shall have the meanings assigned to such terms in the Agreement.

2. **Section 2. Term of the Agreement** is hereby amended to extend the term of the contract for six (6) months for a new ending date of December 31, 2014.

3. **Section 5. Compensation** is hereby amended to increase the total compensation payable by an amount not to exceed Eight Hundred Thousand Dollars (\$800,000) for a new total not to exceed amount of Seven Million, Eight Hundred Thousand Dollars (\$7,800,000).

4. **Section 25, Notices to the Parties** is deleted in its entirety and replaced with the following:

**25. Notices to the Parties.** Unless otherwise indicated elsewhere in this Agreement, all written communications sent by the parties may be by U.S. mail, or by e-mail, and shall be addressed as follows:





To City: Greg McCarthy  
Project Manager  
San Francisco International Airport  
Design and Construction  
P.O. Box 8097  
San Francisco, California 94128  
Email: [greg.mccarthy@flysfo.com](mailto:greg.mccarthy@flysfo.com)  
Fax: (650) 821-7779

To Contractor: Peter Bjostad  
Vice President  
Cage, Inc.  
6440 N. Beltline Road, Suite 125  
Irving, Texas 75063  
Email: [pbjostad@cage-inc.com](mailto:pbjostad@cage-inc.com)  
Fax: (972) 550-9221

5. **Effective Date.** Each of the modifications set forth in Section 2 shall be effective on and after June 17, 2014.

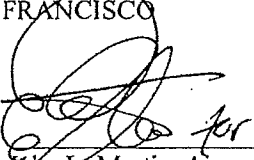
6. **Legal Effect.** Except as expressly modified by this Modification, all of the terms and conditions of the Agreement shall remain unchanged and in full force and effect.

IN WITNESS WHEREOF, Contractor and City have executed this Modification as of the date first referenced above.

CITY	CONTRACTOR
AIRPORT COMMISSION CITY AND COUNTY OF SAN FRANCISCO	
By:  John L. Martin, Airport Director	 Authorized Signature
Attest:	John Boodee President CAGE Professional Services, Inc. 6303 Commerce Drive, Suite 150 Irving, Texas 75063 972-550-1001
By:  Jean Caramatti, Secretary Airport Commission	81238 City Vendor Number
Resolution No: 14-0124	
Adopted on: June 17, 2014	75-2722503 Federal Employer ID Number
Approved as to Form:	
Dennis J. Herrera City Attorney	
By:  Heather Wolnick Deputy City Attorney	

AIRPORT COMMISSION  
CITY AND COUNTY OF SAN FRANCISCO  
RESOLUTION NO. 13 0248

**MODIFICATION NO. 3 TO CONTRACT NO. 9024.9, CONSTRUCTION MANAGEMENT SERVICES FOR THE INTERNATIONAL TERMINAL AND BOARDING AREA F CHECKED BAGGAGE INSPECTION SYSTEM MODERNIZATION PROGRAM, BOARDING AREA A CBIS ACTIVATION AND THE INTERNATIONAL TERMINAL BAGGAGE HANDLING SYSTEM IMPROVEMENTS PROJECT TO INCREASE THE NOT TO EXCEED AMOUNT BY \$810,286 AND INCREASE THE CONTRACT COMPLETION DATE SIX MONTHS FOR A NEW TOTAL CONTRACT AMOUNT NOT TO EXCEED \$7,000,000 AND ESTABLISH A NEW CONTRACT DURATION OF 33 MONTHS, ENDING SEPTEMBER 30, 2014, WITH CAGE, INC.**

- WHEREAS, on March 1, 2011, by Resolution No. 11-0045, the Commission authorized the Director to execute an OTA with the TSA for 90% reimbursement of design costs, including construction management services during design, for the IT and BAF CBIS Modernization Program under the TSA's Recapitalization Program; and
- WHEREAS, on June 30, 2011, by Resolution No. 11-0146, the Commission awarded the Contract to CAGE Inc. for CM Services for the IT and T3, BAF CBIS Modernization Program, BAA CBIS Activation and the IT BHS Improvements Project. The original not to exceed amount was \$585,805, with a contract duration of six months for CM support services for the design-phase ending on December 29, 2011; and
- WHEREAS, on October 4, 2011, by Resolution No. 11-0221, the Commission authorized the First Amendment to this Contract in an amount not to exceed \$4,823,109, for CM services during the construction phase through December 29, 2013 for a total Contract Amount not to exceed \$5,408,914; and
- WHEREAS, on July 17, 2012, by Resolution No. 12-0158, the Commission authorized the Second Amendment to this Contract in an amount not to exceed \$780,800 for a total contract amount not to exceed \$6,189,714, and with no change to the contract duration; and
- WHEREAS, per the OTA, the project team has designed, installed and placed into operation four (4) EDS Screening Machines per the TSA Planning Guidelines and Design Standards which are producing significantly higher alarm rates and has forced an increased amount of bags being sent to the CBRA areas than what was forecasted in the TSA PGDS. The original TSA approved design cannot accommodate the increased screening requirement requiring a final joint solution between the Airport, TSA and other stakeholders is not expected to be reached until March 2014; and
- WHEREAS, the extent of CM Services and remaining OTA Construction Work is not reasonably known without a final joint solution to the EDS Machines higher alarm rates but will be known in approximately 4 months and where CM Services by CAGE Inc. are required for ongoing construction and during the interim for the following reasons: 1) to facilitate a joint solution by where a new SEIO CTX Machine in International Terminal G will be installed and tested with a TSA provided software patch in February 2014; and 2) to expand the temporary CBRA area in BAF to address the BHS demands in the short term; and 3) to provide Construction Management Services for work not affected by this issue (primarily on Tasks 3 and 4) and work that is underway where stopping those activities would compromise the integrity of the BHS system; and 5) to continue the necessary support documentation to seek reimbursement

AIRPORT COMMISSION  
CITY AND COUNTY OF SAN FRANCISCO  
RESOLUTION NO. 13\_0248

from the TSA under the OTA agreement, including the development of the Request for Variance documentation; and now, therefore be it

RESOLVED, that the Commission hereby approves Modification No. 3 to Contract No. 9024.9, CM Services for the IT and BAF CBIS Modernization Program, BAA CBIS Activation and the IT BHS Improvements Project to increase the not to exceed amount by \$810,286 and increase the contract completion date six months for a new total contract amount not to exceed \$7,000,000 and establish a new contract duration of 33 months, ending June 30, 2014, with CAGE, Inc. and with a separate commission package to be submitted in May, 2014 describing the joint solution and overall impact on the program.

*I hereby certify that the foregoing resolution was adopted by the Airport Commission*

DEC 03 2013

at its meeting of \_\_\_\_\_

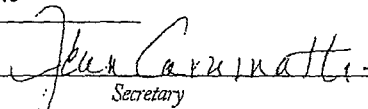
  
Secretary



San Francisco International Airport

**MEMORANDUM**

December 3, 2013

**TO:** AIRPORT COMMISSION  
 Hon. Larry Mazzola, President  
 Hon. Linda S. Crayton, Vice President  
 Hon. Eleanor Johns  
 Hon. Richard J. Guggenlime  
 Hon. Peter A. Stern

**FROM:** Airport Director

**SUBJECT:** Modification No. 3 to Contract No. 9024.9, Construction Management Services for the International Terminal (IT) and Terminal 3 (T3) Boarding Area F (BAF) Checked Baggage Inspection System (CBIS) Modernization Program, Boarding Area A (BAA) CBIS Activation and the IT Baggage Handling System (BHS) Improvements Project

**DIRECTOR'S RECOMMENDATION:** APPROVE MODIFICATION NO. 3 TO CONTRACT NO. 9024.9, CONSTRUCTION MANAGEMENT SERVICES FOR THE IT & T3, BAF CBIS MODERNIZATION PROGRAM AND THE IT BHS IMPROVEMENTS PROJECT FOR AN INTERIM PERIOD OF 6 MONTHS (THROUGH JUNE 30, 2014) IN THE AMOUNT OF \$810,286, FOR A NEW TOTAL CONTRACT AMOUNT NOT TO EXCEED \$7,000,000, WITH CAGE, INC.

Executive Summary

Transmitted herewith for your approval is a proposed resolution approving Modification No. 3 to Contract No. 9024.9, Construction Management (CM) Services for the IT and BAF CBIS Modernization Program, BAA CBIS Activation and the IT Baggage Handling System Improvements Project in the amount of \$810,286. This amendment establishes a new not to exceed amount of \$7,000,000 and extends the contract duration by six months for a new contract termination date of June 30, 2014.

Background

The Commission awarded this Contract No. 9024.9 on June 30, 2011, by Resolution No. 11-0146. The Commission awarded the Contract to CAGE Inc. for CM Services for the IT and T3, BAF CBIS Modernization Program, BAA CBIS Activation and the IT Baggage Handling System Improvements Project. The original not to exceed amount was \$585,805, with a contract duration of six months for CM support services for the design-phase ending on December 29, 2011.

On October 4, 2011, by Resolution No. 11-0221, the Commission authorized the First Amendment to this Contract in an amount not to exceed \$4,823,109, for CM services during the construction phase through December 29, 2013 for a total Contract Amount not to exceed \$5,408,914.

THIS PRINT COVERS CALENDAR ITEM NO. 5

AIRPORT COMMISSION CITY AND COUNTY OF SAN FRANCISCO

EDWIN M. LEE MAYOR	LARRY MAZZOLA PRESIDENT	LINDA S. CRAYTON VICE PRESIDENT	ELEANOR JOHNS	RICHARD J. GUGGENHIME	PETER A. STERN	JOHN L. MARTIN AIRPORT DIRECTOR
-----------------------	----------------------------	------------------------------------	---------------	-----------------------	----------------	------------------------------------

Post Office Box 8097 San Francisco, California 94128 Tel 650.821.5000 Fax 650.821.5005 www.flysfo.com

Due to the federal funding component for these services, there are no Local Business Enterprise (LBE) subconsultant participation goals for the contract. The Airport encouraged proposers to utilize "best efforts" to subcontract at least 10% of the work to certified small and disadvantaged businesses (SDB). Due to the specialized nature of the services, CAGE Inc. is committed to achieving a 5.8% SDB subconsultant participation.

**Recommendation**

Based on the above, I recommend the Commission approve this Modification No. 3 to Contract No. 9024.9, CM Services for the IT and BAF CBIS Modernization Program, BAA CBIS Activation and the IT Terminal BHS Improvements Project to increase the not to exceed amount by \$810,286 and increase the contract completion date six months for a new total contract amount not to exceed \$7,000,000 and establish a new contract duration of 33 months, ending June 30, 2014, with CAGE, Inc.



John L. Martin  
Airport Director

Prepared by: Ivar Satero  
Deputy Airport Director  
Design, Construction & Technology

Attachment



**City and County of San Francisco  
Airport Commission  
P.O. Box 8097  
San Francisco, California 94128**

**Second Amendment**

THIS AMENDMENT (this "Amendment") is made as of **July 17, 2012**, in San Francisco, California, by and between **CAGE Professional Services, Inc.** ("Contractor"), and the City and County of San Francisco, a municipal corporation ("City"), acting by and through its Airport Commission or the Commission's designated agent, hereinafter referred to as "**Commission.**"

**RECITALS**

WHEREAS, City and Contractor have entered into the Agreement (as defined below); and

WHEREAS, the Commission adopted Resolution Number **11-0146** on **June 30, 2011** which authorized the award of said Agreement for the period of **June 30, 2011 through December 31, 2011**; and

WHEREAS, City and Contractor desire to modify the Agreement on the terms and conditions set forth herein to increase the Agreement amount and to modify FAR compliant consultant overhead rates as approved by risk management; and

WHEREAS, Commission approved this Modification number 2 pursuant to Resolution Number **12-0158** on **July 17, 2012**; and

WHEREAS, approval for this Amendment was obtained when the Department of Human Resources approved Contract number PSC #4099-09/10 on February 22, 2013; and

WHEREAS, the Commission desires to modify the Agreement for administrative changes required by recently enacted San Francisco contracting ordinances; and

NOW, THEREFORE, Contractor and the City agree as follows:

**1. Definitions.** The following definitions shall apply to this Amendment:

**a. Agreement.** The term "Agreement" shall mean the Agreement dated June 30, 2011 between Contractor and City, as amended by the:

First Amendment, dated **October 4, 2011**

**b. Other Terms.** Terms used and not defined in this Amendment shall have the meanings assigned to such terms in the Agreement.

**2. Section 5. Compensation** is hereby amended to:

**a.** Increase the total compensation payable by an amount not to exceed Seven Hundred Eighty Thousand Eight Hundred Dollars (\$780,800) for a new total not to exceed amount of Six Million One Hundred Eighty-nine Thousand Seven Hundred Fourteen Dollars (\$6,189,714).

- b. Appendix B.1 is hereby modified to incorporate updated provisional overhead rates and is attached to this second amendment as Appendix B.1.1.
- c. Appendix C.1 is hereby deleted in its entirety and replaced with revised C.1.1 attached to this second amendment.
- d. Appendix C.2 is hereby deleted in its entirety and replaced with revised C.2.1 attached to this second amendment.
- e. Appendix C.3 is hereby deleted in its entirety and replaced with revised C.3.1 attached to this second amendment.

3. **Revised Section 8. Submitting False Claims; Monetary Penalties** is hereby replaced in its entirety to read as follows:

**8. Submitting False Claims; Monetary Penalties.**

Pursuant to San Francisco Administrative Code §21.35, any contractor, subcontractor or consultant who submits a false claim shall be liable to the City for the statutory penalties set forth in that section. The text of Section 21.35, along with the entire San Francisco Administrative Code is available on the web at:

<http://www.amlegal.com/nxt/gateway.dll?f=templates&fn=default.htm&vid=amlegal:sanfrancisco>

**ca** A contractor, subcontractor or consultant will be deemed to have submitted a false claim to the City if the contractor, subcontractor or consultant: (a) knowingly presents or causes to be presented to an officer or employee of the City a false claim or request for payment or approval; (b) knowingly makes, uses, or causes to be made or used a false record or statement to get a false claim paid or approved by the City; (c) conspires to defraud the City by getting a false claim allowed or paid by the City; (d) knowingly makes, uses, or causes to be made or used a false record or statement to conceal, avoid, or decrease an obligation to pay or transmit money or property to the City; or (e) is a beneficiary of an inadvertent submission of a false claim to the City, subsequently discovers the falsity of the claim, and fails to disclose the false claim to the City within a reasonable time after discovery of the false claim.

4. **Revised Section 33. Federal Non-Discrimination Provisions** is hereby replaced in its entirety to read as follows:

**33. Federal Non-Discrimination Provisions**

**49 CFR Part 21.** Contractor for itself, its personal representatives, successors in interest, and assigns, as part of the consideration hereof, does hereby covenant and agree that Contractor shall maintain and operate the Airport facilities and services in compliance with all requirements imposed pursuant to Title 49, Code of Federal Regulations, DOT, Subtitle A, Office of the Secretary, Part 21, Nondiscrimination in Federally-Assisted Programs of the Department of Transportation – Effectuation of Title VI of the Civil Rights Act of 1964, as said regulations may be amended. Contractor, for itself, its personal representatives, successors in interest, and assigns, agrees that Contractor in its operation at and use of San Francisco International Airport, covenants that (1) no person on the grounds of race, color, national origin or sex shall be excluded from participation in, denied the benefits of, or be otherwise subjected to discrimination in the use of said facilities; (2) that in the construction of any improvements on, over, or under the Airport and the furnishing of services thereon, no person on the grounds of race, color, national origin or sex shall be excluded from participation or denied the benefits of, or otherwise be subject to discrimination,

(3) that Contractor shall use all City premises in compliance with all other requirements imposed by or pursuant to Title 49, Code of Federal Regulations, DOT, Subtitle A – Office of the Secretary of Transportation, Part 21, Nondiscrimination in Federally-Assisted Programs of the Department of Transportation – Effectuation of Title VI of the Civil Rights Act of 1964, and as said Regulations may be amended. These Regulations are incorporated as though fully set forth herein. Contractor agrees to include the above statements in any subsequent contract that it enters into with subcontractors and cause those agreements to similarly include the statements, and cause those businesses to include the statements in further agreements.

**49 CFR Part 23.** This Agreement is subject to the requirements of the U.S. Department of Transportation's regulations, 49 Code of Federal Regulations, Part 23. Contractor agrees that it will not discriminate against any business owner because of the owner's race, color, national origin, or sex in connection with the award or performance of any concession agreement, management contract, or subcontract, purchase or lease agreement, or other agreement covered by 49 Code of Federal Regulations Part 23. Contractor agrees to include the above statements in any subsequent contract covered by 49 Code of Federal Regulations, Part 23, that it enters and cause those businesses to similarly include the statements in further agreements.

Failure by the contractor to comply with the requirements of this section is a material breach of this contract, which may result in the termination of this contract or such other remedy as the Airport deems appropriate.

5. **Revised Section 43. Requiring Minimum Compensation for Covered Employees** is hereby replaced in its entirety to read as follows:

**43. Requiring Minimum Compensation for Covered Employees**

a. Contractor agrees to comply fully with and be bound by all of the provisions of the Minimum Compensation Ordinance (MCO), as set forth in San Francisco Administrative Code Chapter 12P (Chapter 12P), including the remedies provided, and implementing guidelines and rules. The provisions of Sections 12P.5 and 12P.5.1 of Chapter 12P are incorporated herein by reference and made a part of this Agreement as though fully set forth. The text of the MCO is available on the web at [www.sfgov.org/olse/mco](http://www.sfgov.org/olse/mco). A partial listing of some of Contractor's obligations under the MCO is set forth in this Section. Contractor is required to comply with all the provisions of the MCO, irrespective of the listing of obligations in this Section.

b. The MCO requires Contractor to pay Contractor's employees a minimum hourly gross compensation wage rate and to provide minimum compensated and uncompensated time off. The minimum wage rate may change from year to year and Contractor is obligated to keep informed of the then-current requirements. Any subcontract entered into by Contractor shall require the subcontractor to comply with the requirements of the MCO and shall contain contractual obligations substantially the same as those set forth in this Section. It is Contractor's obligation to ensure that any subcontractors of any tier under this Agreement comply with the requirements of the MCO. If any subcontractor under this Agreement fails to comply, City may pursue any of the remedies set forth in this Section against Contractor.

c. Contractor shall not take adverse action or otherwise discriminate against an employee or other person for the exercise or attempted exercise of rights under the MCO. Such actions, if taken within 90 days of the exercise or attempted exercise of such rights, will be rebuttably presumed to be retaliation prohibited by the MCO.

d. Contractor shall maintain employee and payroll records as required by the MCO. If Contractor fails to do so, it shall be presumed that the Contractor paid no more than the minimum wage required under State law.

e. The City is authorized to inspect Contractor's job sites and conduct interviews with employees and conduct audits of Contractor.

f. Contractor's commitment to provide the Minimum Compensation is a material element of the City's consideration for this Agreement. The City in its sole discretion shall determine whether such a breach has occurred. The City and the public will suffer actual damage that will be impractical or extremely difficult to determine if the Contractor fails to comply with these requirements. Contractor agrees that the sums set forth in Section 12P.6.1 of the MCO as liquidated damages are not a penalty, but are reasonable estimates of the loss that the City and the public will incur for Contractor's noncompliance. The procedures governing the assessment of liquidated damages shall be those set forth in Section 12P.6.2 of Chapter 12P.

g. Contractor understands and agrees that if it fails to comply with the requirements of the MCO, the City shall have the right to pursue any rights or remedies available under Chapter 12P (including liquidated damages), under the terms of the contract, and under applicable law. If, within 30 days after receiving written notice of a breach of this Agreement for violating the MCO, Contractor fails to cure such breach or, if such breach cannot reasonably be cured within such period of 30 days, Contractor fails to commence efforts to cure within such period, or thereafter fails diligently to pursue such cure to completion, the City shall have the right to pursue any rights or remedies available under applicable law, including those set forth in Section 12P.6(c) of Chapter 12P. Each of these remedies shall be exercisable individually or in combination with any other rights or remedies available to the City.

h. Contractor represents and warrants that it is not an entity that was set up, or is being used, for the purpose of evading the intent of the MCO.

i. If Contractor is exempt from the MCO when this Agreement is executed because the cumulative amount of agreements with this department for the fiscal year is less than \$25,000, but Contractor later enters into an agreement or agreements that cause contractor to exceed that amount in a fiscal year, Contractor shall thereafter be required to comply with the MCO under this Agreement. This obligation arises on the effective date of the agreement that causes the cumulative amount of agreements between the Contractor and this department to exceed \$25,000 in the fiscal year.

**6. Revised Section 44. Requiring Health Benefits for Covered Employees** is hereby replaced in its entirety to read as follows:

**44. Requiring Health Benefits for Covered Employees.**

Contractor agrees to comply fully with and be bound by all of the provisions of the Health Care Accountability Ordinance (HCAO), as set forth in San Francisco Administrative Code Chapter 12Q, including the remedies provided, and implementing regulations, as the same may be amended from time to time. The provisions of section 12Q.5.1 of Chapter 12Q are incorporated by reference and made a part of this Agreement as though fully set forth herein. The text of the HCAO is available on the web at [www.sfgov.org/olse](http://www.sfgov.org/olse). Capitalized terms used in this Section and not defined in this Agreement shall have the meanings assigned to such terms in Chapter 12Q.

a. For each Covered Employee, Contractor shall provide the appropriate health benefit set forth in Section 12Q.3 of the HCAO. If Contractor chooses to offer the health plan option, such health plan shall meet the minimum standards set forth by the San Francisco Health Commission.

b. Notwithstanding the above, if the Contractor is a small business as defined in Section 12Q.3(e) of the HCAO, it shall have no obligation to comply with part (a) above.

c. Contractor's failure to comply with the HCAO shall constitute a material breach of this agreement. City shall notify Contractor if such a breach has occurred. If, within 30 days after receiving City's written notice of a breach of this Agreement for violating the HCAO, Contractor fails to cure such breach or, if such breach cannot reasonably be cured within such period of 30 days, Contractor fails to commence efforts to cure within such period, or thereafter fails diligently to pursue such cure to completion, City shall have the right to pursue the remedies set forth in 12Q.5.1 and 12Q.5(f)(1-6). Each of these remedies shall be exercisable individually or in combination with any other rights or remedies available to City.

d. Any Subcontract entered into by Contractor shall require the Subcontractor to comply with the requirements of the HCAO and shall contain contractual obligations substantially the same as those set forth in this Section. Contractor shall notify City's Office of Contract Administration when it enters into such a Subcontract and shall certify to the Office of Contract Administration that it has notified the Subcontractor of the obligations under the HCAO and has imposed the requirements of the HCAO on Subcontractor through the Subcontract. Each Contractor shall be responsible for its Subcontractors' compliance with this Chapter. If a Subcontractor fails to comply, the City may pursue the remedies set forth in this Section against Contractor based on the Subcontractor's failure to comply, provided that City has first provided Contractor with notice and an opportunity to obtain a cure of the violation.

e. Contractor shall not discharge, reduce in compensation, or otherwise discriminate against any employee for notifying City with regard to Contractor's noncompliance or anticipated noncompliance with the requirements of the HCAO, for opposing any practice proscribed by the HCAO, for participating in proceedings related to the HCAO, or for seeking to assert or enforce any rights under the HCAO by any lawful means.

f. Contractor represents and warrants that it is not an entity that was set up, or is being used, for the purpose of evading the intent of the HCAO.

g. Contractor shall maintain employee and payroll records in compliance with the California Labor Code and Industrial Welfare Commission orders, including the number of hours each employee has worked on the City Contract.

h. Contractor shall keep itself informed of the current requirements of the HCAO.

i. Contractor shall provide reports to the City in accordance with any reporting standards promulgated by the City under the HCAO, including reports on Subcontractors and Subtenants, as applicable.

j. Contractor shall provide City with access to records pertaining to compliance with HCAO after receiving a written request from City to do so and being provided at least ten business days to respond.

k. Contractor shall allow City to inspect Contractor's job sites and have access to Contractor's employees in order to monitor and determine compliance with HCAO. City may conduct random audits of Contractor to ascertain its compliance with HCAO. Contractor agrees to cooperate with City when it conducts such audits.

l. If Contractor is exempt from the HCAO when this Agreement is executed because its amount is less than \$25,000 (\$50,000 for nonprofits), but Contractor later enters into an agreement or agreements that cause Contractor's aggregate amount of all agreements with City to reach \$75,000, all the agreements shall be thereafter subject to the HCAO. This obligation arises on the effective date of the agreement that causes the cumulative amount of agreements between Contractor and the City to be equal to or greater than \$75,000 in the fiscal year.

**7. Section 64, Labor Peace / Card Check Rule is deleted in its entirety and replaced with the following:**

**64. Labor Peace / Card Check Rule.** Without limiting the generality of other provisions herein requiring Contractor to comply with all Airport Rules, Contractor shall comply with the Airport's Labor Peace / Card Check Rule, adopted on February 1, 2000, pursuant to Airport Commission Resolution No. 00-0049 (the "Labor Peace / Card Check Rule"). Capitalized terms not defined in this provision are defined in the Labor Peace/Card Check Rule. To comply with the Labor Peace/Card Check Rule, Contractor shall, among other actions: (a) Enter into a Labor Peace/Card Check Rule Agreement with any Labor Organization which requests such an agreement and which has registered with the Airport Director or his / her designee, within thirty (30) days after Labor Peace/Card Check Rule Agreement has been requested; (b) Not less than thirty (30) days prior to the modification of this Agreement, Contractor shall provide notice by mail to any Labor Organization or federation of labor organizations which have registered with the Airport Director or his / her designee (registered labor organization"), that Contractor is seeking to modify or extend this Agreement; (c) Upon issuing any request for proposals, invitations to bid, or similar notice, or in any event not less than thirty (30) days prior to entering into any Subcontract, Contractor shall provide notice to all registered Labor Organizations that Contractor is seeking to enter into such Subcontract; and (d) Contractor shall include in any subcontract with a Subcontractor performing services pursuant to any covered Contract, a provision requiring the Subcontractor performing services pursuant to any covered Contract, a provision requiring the Subcontractor to comply with the requirements of the Labor Peace/Card Check Rule. If Airport Director determines that Contractor violated the Labor Peace/Card Check Rule, Airport Director shall have the option to terminate this Agreement, in addition to exercising all other remedies available to him / her.

**8. Section 25, Notices to the Parties is deleted in its entirety and replaced with the following:**

**25. Notices to the Parties.** Unless otherwise indicated elsewhere in this Agreement, all written communications sent by the parties may be by U.S. mail, or by e-mail, and shall be addressed as follows:

To City: Greg McCarthy  
Project Manager  
San Francisco International Airport  
Airport Development & Technology Division  
P.O. Box 8097  
San Francisco, California 94128  
Email: [greg.mccarthy@flysf.com](mailto:greg.mccarthy@flysf.com)  
FAX: (650) 821-5304



To Contractor: Terry Brennan

Construction Manager  
CAGE Inc.  
6303 Commerce Drive, Suite 150  
Irving, Texas 75063  
Email: [tbrennan@cage-inc.com](mailto:tbrennan@cage-inc.com)  
FAX: (972) 550-9221

Any notice of default must be sent by registered mail.

9. **Effective Date.** Each of the modifications set forth in Section 2 shall be effective on and after July 17, 2012.
10. **Legal Effect.** Except as expressly modified by this Amendment, all of the terms and conditions of the Agreement shall remain unchanged and in full force and effect.

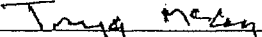
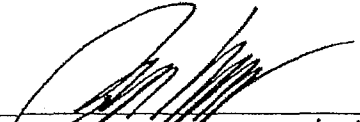
IN WITNESS WHEREOF, Contractor and City have executed this Amendment as of the date first referenced above.

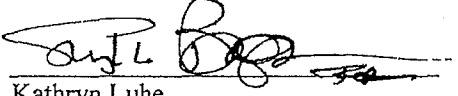
CITY	CONTRACTOR
AIRPORT COMMISSION CITY AND COUNTY OF SAN FRANCISCO	
By: <u></u> John L. Martin, Airport Director	<u></u> Authorized Signature <u>5/2/2013</u>
Attest:	John Boodee Printed Name
By: <u></u> Jean Caramatti, Secretary Airport Commission	President Title
Resolution No: 12-0158	<u>CAGE Professional Services, Inc.</u> Company Name
Adopted on: July 17, 2012	81238 City Vendor Number
Approved as to Form:	6303 Commerce Drive, Suite 150 Address
Dennis J. Herrera City Attorney	Irving, Texas 75063 City, State, ZIP
By: <u></u> Kathryn Luhe Deputy City Attorney	972-550-1001 Telephone Number
	75-2722503 Federal Employer ID Number



**Appendix B.1.1, Compensation and Payment**

**FORM OF  
PROVISIONAL INDIRECT COST RATE AGREEMENT**

This is revised Appendix B.1.1 attached to, and incorporated by reference in the Agreement made on **June 30, 2011** between the City and County of San Francisco, acting by and through its Airport Commission (Commission), and **CAGE Professional Services Inc.** (Contractor) providing for construction management services for the International Terminal and Terminal 3, Boarding Area F Checked Baggage Inspection System Modernization and International Terminal Baggage Handling System Improvements Project. Pursuant to Agreement No. 9024.9 between the parties, the Cost Principles contained in FAR, and practices required by the applicable Cost Accounting Standards in FAR, **CAGE Professional Services Inc.** (hereinafter referred to as "CONTRACTOR") and the CITY AND COUNTY OF SAN FRANCISCO, AIRPORT COMMISSION (hereinafter referred to as "City") agree as follows:

**II. PROVISIONAL INDIRECT COST RATES**

This Agreement will employ a temporary provisional indirect cost rate which has been established for award of the Agreement and reimbursement of indirect cost pending the establishment of a final indirect cost rate for the period of time when the services were performed. The provisional indirect cost rates set forth in this Agreement are applicable to all services in the Services to be provided by Contractor identified in Appendix A or in Modifications issued by the City, pending the determination of the final indirect cost rates for Contractor or certain subcontractors.

- B. The provisional indirect cost rate to be applied to Contractor's and subcontractor's direct labor as set forth in Contractor's and subcontractors' submissions shall be:

<b>TABLE 1</b>	
FIRM	PROVISIONAL OVERHEAD RATE
CAGE Professional Services, Inc.	141.59%
KPA Group	179.01%
Chaves & Assoc	112.20%
EPC Consultants	Field = 106.90% and Home Office = 110.24%
M Lee Corp	131.96%
Apex Testing	76.44%
Grindstone Group, LLC	75.52%

Except as expressly modified by this Second Amendment, all of the terms and conditions of the Agreement and appendices shall remain unchanged and in full force and effect.



**TASK-1 — Planning / Programming and Design**

Position	CAGE Inc			KPA Group + Subs			EPC Consultants			CHAYES & Assoc			M Lee Corporation			APEX Testing Labs			Grindstone Group		
	Hours	Rate	Extended Cost	Hours	Rate	Extended Cost	Hours	Rate	Extended Cost	Hours	Rate	Extended Cost	Hours	Rate	Extended Cost	Hours	Rate	Extended Cost	Hours	Rate	Extended Cost
Principal	0	\$ 225	\$ -	54	\$ 205	\$ 11,070															
Associate				124	\$ 173	\$ 21,452				120	\$ 181	\$ 21,720									
Construction Manager PH 1	805	\$ 138	\$ 111,093																		
Construction Manager PH 2	101	\$ 160	\$ 16,160																		
Cost Estimator													92	\$ 176	\$ 16,192						
Project Controls Manager																					
Senior Project Manager	100	\$ 128	\$ 12,800																		
Project Coordinator		\$ 140																			
Senior Software Specialist	190	\$ 138	\$ 26,220																		
Senior Controls Engineer	220	\$ 125	\$ 27,500																		
Senior Mechanical Engineer	190	\$ 123	\$ 23,370																		
Senior Engineer / Architect				54	\$ 165	\$ 8,910															
Engineer / Architect		\$ 105		80	\$ 195	\$ 15,600															
Document Controller				54	\$ 150	\$ 8,100															
Technical Writer	96	\$ 96	\$ 9,216							361	\$ 117	\$ 42,237									
PM Field Operations	192	\$ 132	\$ 25,344																		
Site Manager/Commissioning Specialist	384	\$ 102	\$ 39,168																		
Testing/Check-out Specialist		\$ 94																			
Project Analyst	40	\$ 81	\$ 3,240																		
QA/QC	80	\$ 76	\$ 6,080																		
First Source Hiring		\$ 25																			
Office Engineer										336	\$ 81	\$ 27,216									
CADD																					
<b>SUBTOTALS</b>	<b>2398</b>		<b>\$ 300,191</b>	<b>366</b>		<b>\$ 65,132</b>	<b>704</b>		<b>\$ 88,304</b>	<b>481</b>		<b>\$ 63,957</b>	<b>92</b>		<b>\$ 16,192</b>	<b>0</b>		<b>\$ -</b>	<b>160</b>		<b>\$ 13,366</b>
Reimbursable Expenses		\$ 19,331			\$ -			\$ -			\$ -			\$ -			\$ -				\$ -
<b>SUBTOTAL</b>		<b>\$ 319,522</b>			<b>\$ 65,132</b>			<b>\$ 88,304</b>			<b>\$ 63,957</b>			<b>\$ 16,192</b>			<b>\$ -</b>				<b>\$ 13,366</b>
<b>Grand Total Labor</b>		<b>\$ 566,474</b>																			
<b>Grand Total Expenses</b>		<b>\$ 19,331</b>																			
<b>PROJECT TOTAL TASK 1</b>		<b>\$ 585,805</b>																			
SFO First Source Hiring		\$ -																			
<b>GRAND TOTAL</b>		<b>\$ 585,805</b>																			

Rev 2 April 30, 2013

Construction Management Services For The International Terminal and Terminal 3 Boarding Area FCBIS  
 Modernization and International Terminal B15 Improvements  
 Project RFP No. 9024.9





HOURLY BILLING RATES							
	141.59%	179.01%	112.20%	106.90%	131.96%	76.44%	75.52%
Position	CAGE	KPA Group + Sub- Consultants	CHAVES & Assoc	EPC Consultants	ML Corp	APEX Testing	Grindstone Group
Principal	\$ 225	\$ 205				\$ 125	
Associate		\$ 173	\$ 181				
Construction Manager PH 1	\$ 138						
Construction Manager PH 2	\$ 160						
Cost Estimator					\$ 176		
Project Controls Manager				\$ 166			
Senior Project Manager	\$ 128						\$ 84
Project Coordinator	\$ 140						
Senior Software Specialist	\$ 138						
Senior Controls Engineer	\$ 125						
Senior Mechanical Engineer	\$ 123	\$ 165					
Senior Engineer / Architect		\$ 195					
Engineer / Architect / Designer	\$ 105	\$ 150				\$ 85	
Document Controller			\$ 117				
Technical Writer	\$ 96						
PM Field Operations	\$ 132						
Commissioning Manager	\$ 125						
Site Manager/ Commissioning Specialist	\$ 102						
Testing/Check-out Specialist	\$ 94						
Project Analyst	\$ 81						
QA/QC	\$ 76						
First Source Hiring	\$ 25						
Office Engineer				\$ 81			
CADD		\$60 - \$90					

Construction Management Services For The International Terminal and Terminal 3 Boarding Area F CBIS  
 Modernization and International Terminal BHS Improvements Project RFP No. 9024.9

**AIRPORT COMMISSION**

CITY AND COUNTY OF SAN FRANCISCO

RESOLUTION NO. 12 0158

**AUTHORIZE MODIFICATION NO. 2 TO CONTRACT NO. 9024.9, CONSTRUCTION MANAGEMENT SERVICES FOR THE INTERNATIONAL TERMINAL AND BOARDING AREA F CHECKED BAGGAGE INSPECTION SYSTEM MODERNIZATION PROGRAM, AND THE INTERNATIONAL TERMINAL BAGGAGE HANDLING SYSTEM IMPROVEMENTS PROJECT IN AN AMOUNT NOT TO EXCEED \$780,800.**

- WHEREAS, on March 1, 2011, by Resolution No. 11-0045, the Commission authorized the Director to execute an Other Transaction Agreement with the Transportation Security Administration (TSA) for 90% reimbursement of design costs, including construction management services during design, for the International Terminal and Boarding Area F Checked Baggage Inspection System Modernization Program under the TSA's Recapitalization Program, in an amount not to exceed \$3,279,870; and
- WHEREAS, on June 30, 2011, by Resolution No. 11-0146, the Commission authorized the initial award of Contract No. 9024.9, to CAGE Inc. for the Project in an amount not to exceed \$585,805, with a contract duration of six months, for the Task 1 CM support services during design only; and
- WHEREAS, on August 16, 2011, by Resolution No. 11-0177, the Commission authorized the Director to execute an OTA with the TSA for 90% reimbursement of construction costs, including Task 2 CM support services during construction, for the Program under the TSA's Recapitalization Program, in an amount not to exceed \$40,456,890; and
- WHEREAS, on October 4, 2011, by Resolution No. 11-0221, the Commission authorized Modification No. 1 to Contract No. 9024.9, to CAGE Inc., in an amount not to exceed \$4,823,109, for CM services for Tasks 2, 3 and 4, with a contract duration of 30 months, for a total contract amount not to exceed \$5,408,914; and
- WHEREAS, the Airport budgeted for Task 3 and 4 under the Airport's capital plan; and
- WHEREAS, the estimated construction cost of the Task 4 Boarding Area E to F BHS Transfer Line was in the amount of \$5,000,000, and the portion of Contract 9024.9 for CM services was not-to-exceed \$410,000; and
- WHEREAS, as a result of the much larger than anticipated expansion of UA into Boarding Area E, the Transfer Line size and complexity has increased to accommodate the larger bag volume; and
- WHEREAS, the increase to the construction estimate for the Boarding Area E to F BHS Transfer Line is \$9,294,927, for a total of \$14,294,927; and
- WHEREAS, the proposed increase to the not-to-exceed amount for Task 4 is \$780,800, which is budgeted under the Airport's capital plan, for a total proposed not-to-exceed amount for Contract 9024.9 of \$6,189,714; now, therefore be it
- RESOLVED, that the Commission hereby authorizes Modification No. 2 to professional services agreement, Contract No. 9024.9, Construction Management Services for the International Terminal and Boarding Area F Checked Baggage Inspection System Modernization Program, and the International Terminal Baggage Handling System Improvements Project, with CAGE Inc., for an amount not to exceed \$780,800, for a total contract amount not to exceed \$6,189,714, and with no change to the contract duration of thirty months.

*I hereby certify that the foregoing resolution was adopted by the Airport Commission*

at its meeting of JUL 17 2012

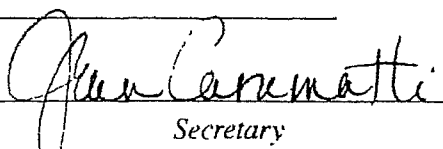
  
Secretary



San Francisco International Airport

**MEMORANDUM**

July 17, 2012

**TO:** AIRPORT COMMISSION  
Hon. Larry Mazzola, President  
Hon. Linda S. Crayton, Vice President  
Hon. Eleanor Johns  
Hon. Richard J. Guggenlime  
Hon. Peter A. Stern

**FROM:** Airport Director

**SUBJECT:** Modification No. 2 to Professional Services Agreement, Contract No. 9024.9, Construction Management Services for the International Terminal and Boarding Area F Checked Baggage Inspection System Modernization Program, and the International Terminal Baggage Handling System Improvement Project, with CAGE, Inc., in an amount not to exceed \$780,800.

**DIRECTOR'S RECOMMENDATION: AUTHORIZE MODIFICATION NO. 2 TO PROFESSIONAL SERVICES AGREEMENT, CONTRACT NO. 9024.9, CONSTRUCTION MANAGEMENT SERVICES FOR THE INTERNATIONAL TERMINAL AND BOARDING AREA F CHECKED BAGGAGE INSPECTION SYSTEM MODERNIZATION PROGRAM, AND THE INTERNATIONAL TERMINAL BAGGAGE HANDLING SYSTEM IMPROVEMENT PROJECT, WITH CAGE, INC., IN AN AMOUNT NOT TO EXCEED \$780,800.**

**Executive Summary**

Transmitted herewith for your approval is a proposed Resolution to authorize Modification No. 2 to Contract No. 9024.9, Construction Management Services for the International Terminal and Boarding Area F Checked Baggage Inspection System (CBIS) Modernization Program, and the International Terminal Baggage Handling System (BHS) Improvement Project, with Cage, Inc., in an amount not to exceed \$780,800, for a new total contract amount of \$6,189,714. Modification No. 2 provides for construction management services for the increased scope of the Boarding Area E to F BHS Transfer Line requirement, in order to accommodate the expanded operation of United Airlines in T3/Boarding Area E.

**Background**

On June 30, 2011, by Resolution No. 11-0146, the Commission authorized the initial award of Contract No. 9024.9, to CAGE Inc., in an amount not to exceed \$585,805, with a contract duration of six months, for the Task 1 CM support services during design only for the International Terminal and Boarding Area F CBIS Modernization Program under the TSA's Recapitalization Program.

On October 4, 2011, by Resolution No. 11-0221, the Commission authorized Modification No. 1 to this contract, in an amount not to exceed \$4,823,109 for CM services Tasks 2, 3 and 4, for a total contract amount not to exceed \$5,408,914, with a contract duration of 30 months.

THIS PRINT COVERS CALENDAR ITEM NO. 12

AIRPORT COMMISSION CITY AND COUNTY OF SAN FRANCISCO

EDWIN M. LEE MAYOR      LARRY MAZZOLA PRESIDENT      LINDA S. CRAYTON VICE PRESIDENT      ELEANOR JOHNS      RICHARD J. GUGGENHIME      PETER A. STERN      JOHN L. MARTIN AIRPORT DIRECTOR

The breakdown of tasks under Modification No. 1 is as follows:

1. Task 2 CBIS Modernization Construction	\$3,237,597
2. Task 3 International Terminal BHS Improvements	\$1,175,512
3. Task 4 Boarding Area E and F BHS Transfer Line	<u>\$ 410,000</u>
Total Not To Exceed Amount For Modification No. 1	\$4,823,109.

As per Modification No. 1, Task 4, CAGE, Inc., was to provide CM services for the Boarding Area E to F BHS Transfer Line, for the interconnection of the BAF and BAE BHS systems. The scope was based on the original airline gate plan in Boarding Area E, accommodating United Airlines (UA), Air Canada and USAir. At this time, the estimated construction cost of the Transfer Line scope was \$5,000,000, and the Task 4 cost for CM services was not to exceed \$410,000.

However, as a result of the much larger expansion of UA into Boarding Area E, the Transfer Line size and complexity has increased to accommodate the larger bag volume. Also, the construction of the Boarding Area E BHS improvements, previously provided for separately under Contract No. 8974.B, Terminal 3/Boarding Area E Improvements Project, and the Terminal 3/Boarding Area E ticket counter BHS improvements are now both proposed to be incorporated into the Boarding Area E to F BHS Transfer Line scope to ensure appropriate interface and coordination. The new estimate for the Transfer Line scope is \$14,294,927. Based on this, the proposed increase to the not-to-exceed amount for Task 4 is \$780,800, for a total of \$1,190,800. As a result, the proposed total not-to-exceed amount for Contract 9024.9 is \$6,189,714.

The estimated total value of the construction to be managed by the Consultant is \$64,344,000. The total authorized project budget for CM services, including materials testing and special inspection, is \$5,408,914. And, although the CM services budget for the Project is 8.4%, which is not within the Airport's overall goal of achieving 15% for project "soft cost" performance, Staff determined that the scope should include 24 hour CM oversight to ensure appropriate control during construction, due to the nature of the work, and the requirement that it occur at all hours to minimize disruption to the Airport's operation:

Due to the federal funding component for these services, there are no HRC LBE subconsultant participation goals for the contract. The Airport encouraged proposers to utilize "best efforts" to subcontract at least 10% of the work to certified small and disadvantaged businesses (SDB). There is no specific DBE subconsultant goal for this contract, but the Airport's overall 3-year DBE goal is 12%. Due to the specialized nature of the services, CAGE Inc. was able to achieve 5.8% SDB and DBE subconsultant participation.

**Recommendation**

Based upon the foregoing, I recommend your approval of Modification No. 2 to professional services agreement, Contract No. 9024.9, Construction Management Services for the International Terminal and Boarding Area F Checked Baggage Inspection System Modernization Program, and the International Terminal Baggage Handling System Improvement Project, to CAGE, Inc., in an amount not-to-exceed \$780,800, for a revised total not-to-exceed amount of \$6,189,714, and with no change to the contract duration of 30 months.

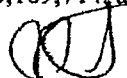
  
 John L. Martin  
 Airport Director

Prepared by: Ivar Satero  
 Deputy Airport Director  
 Design and Construction

**City and County of San Francisco  
Airport Commission  
P.O. Box 8097  
San Francisco, California 94128**

**First Amendment**

THIS AMENDMENT (this "Amendment") is made as of **October 4, 2011**, in San Francisco, California, by and between **CAGE Professional Services Inc.** ("Contractor"), and the City and County of San Francisco, a municipal corporation ("City"), acting by and through its Airport Commission or the Commission's designated agent, hereinafter referred to as "**Commission.**"

RECITALS

WHEREAS, City and Contractor have entered into the Agreement (as defined below); and

WHEREAS, the Commission adopted Resolution Number **11-0146** on **June 30, 2011** which authorized the award of said Agreement for the period of **June 30, 2011** through **December 31, 2011**; and

WHEREAS, City and Contractor desire to modify the Agreement on the terms and conditions set forth herein to incorporate construction management support services for Task 2, 3 and 4, increase the Agreement amount by \$4,823,109 and increase the Agreement duration for thirty months; and

WHEREAS, Commission approved this First Amendment pursuant to Resolution Number **11-0221** on **October 4, 2011**; and

WHEREAS, approval for this Agreement was obtained when the Civil Service Commission approved Contract number PSC #4099-09/10 on June 6, 2011; and

NOW, THEREFORE, Contractor and the City agree as follows:



1. **Definitions.** The following definitions shall apply to this Amendment:
  - a. **Agreement.** The term "Agreement" shall mean the Agreement dated **June 30, 2011** between Contractor and City.
  - b. **Other Terms.** Terms used and not defined in this Amendment shall have the meanings assigned to such terms in the Agreement.
2. **Section 2. Term of the Agreement** is hereby amended to extend the term of the contract for an **additional twenty-four months** for a new ending date of **December 31, 2013**.
3. **Section 4. Services Contractor agrees** to perform of the Agreement is amended to incorporate construction management services as detailed on Appendix A.1 attached hereto and incorporated by reference.
4. **Section 5. Compensation** is hereby amended to increase the total compensation payable by an amount not to exceed **\$4,823,109** for a new total not to exceed amount of **\$5,408,914**.



5. **Effective Date.** Each of the modifications set forth in Section 2 shall be effective on and after date of this First Amendment.

6. **Legal Effect.** Except as expressly modified by this Amendment, all of the terms and conditions of the Agreement shall remain unchanged and in full force and effect.

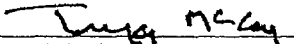
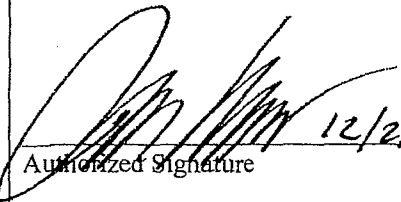
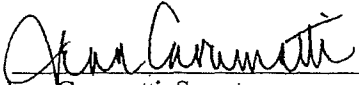
IN WITNESS WHEREOF, Contractor and City have executed this Amendment as of the date first referenced above.

CITY	CONTRACTOR
AIRPORT COMMISSION CITY AND COUNTY OF SAN FRANCISCO	
By:  John L. Martin, Airport Director	 12/21/2011 Authorized Signature
Attest:	John Boodée Printed Name
By:  Jean Caramatti, Secretary Airport Commission	President Title CAGE Professional Services, Inc. Company Name
Resolution No: 11-0221	81238 City Vendor Number
Adopted on: October 4, 2011	6440 N. Beltline Road, Suite 125 Address
Approved as to Form:  Dennis J. Herrera City Attorney	Irving, Texas 75063 City, State, ZIP  (972) 550-1001 Telephone Number
By:  Kathryn Luhe Deputy City Attorney	75-2722503 Federal Employer ID Number



**Appendix A.1**  
**Services to be provided by Contractor**

This Appendix A.1 attached to, and incorporated by reference in the Agreement made on June 30, 2011 between the City and County of San Francisco, acting by and through its Airport Commission (Commission), and CAGE Professional Services, Inc. (Contractor) providing for construction management services for the International Terminal and Boarding Area F Checked Baggage Inspection System Modernization Program, and the International Terminal Baggage Handling System Improvements Project.

The following construction management services are incorporated into the Agreement:

**CONSTRUCTION MANAGEMENT SCOPE DESCRIPTION (for Tasks 2, 3 and 4)**

The Contractor shall provide all labor, materials, equipment and services to provide the following construction management services:

**A. Project Controls and Reporting.**

1. The Contractor shall provide a comprehensive project control system that has been successfully deployed and approved by the Commission. The project controls and reporting system shall be capable of complying with the reporting requirements mandated for federally funded projects. The Contractor shall recommend a format to use for deliverables and shall adjust the format to meet the requirements of the Airport.
2. The Contractor's deliverables and reports shall be in electronic format compatible with the Airport's current software applications and must be accompanied by multiple hard copy color duplicates, unless alternatives are proposed and accepted for use by the Airport.
3. The following Project deliverables shall be provided by the Contractor during all tasks and phases of the Project:
  - a. Monthly Cost Reports:
    - (i) Prepare and submit monthly cost and budget reports;
    - (ii) Monitor actual Project costs, including costs and payments to Contractors and Contractors;

- (iii) Monitor expenditures incurred by Airport staff and all Project participants;
- (iv) Prepare monthly cash flow and trend reports and additional reports as may be requested by the Airport; and
- (v) Anticipate and report all potential Project issues. Provide cost recovery recommendations on a monthly basis.

b. Monthly Schedule Reports

Updated Schedule: Monitor progress in relationship to the existing baseline schedules. Prepare detailed monthly schedule reports and schedule trend reports. Provide schedule recovery recommendations on a monthly basis.

c. Monthly Progress Reports

Provide a monthly report including a concise executive summary and a comprehensive matrix of significant project achievements, risks and problems, responsible parties, and anticipated resolution date. The Contractor will provide a critique of the work product of the designer and the design-build Contractor. Report information will not carry over from month to month.

- (i) Prepare Project progress reports: Reports shall be developed to the appropriate level suitable for distribution to different management levels within the Airport organization as well as the TSA and airlines. Provide reports monthly, quarterly, annually, or at frequencies specified by the Airport.
- (ii) Collect scope, schedule and budget data from information provided by Airport staff, other Contractors and Contractors, and outside agencies. Compile and present the information in a comprehensive format.
- (iii) Provide a monthly status, cost and schedule reports in accordance with TSA and Airport guidelines. Include an executive summary; listing of significant issues, responsible parties and anticipated resolution dates; reports on payments, cash flow, and cost trends; and a detailed progress schedule, tracked against the original baseline schedule.

d. Construction Manager's Monthly Report.

The Contractor will submit a written monthly report to the Airport detailing services provided to the Airport under this Agreement. The Contractor will report on its progress and document any problems known by the Contractor in performing the work.

- e. The Project will be managed by the Contractor to comply with the terms of the OTA and maintain reimbursement eligibility. The Contractor will be responsible for the management, reporting, implementation, and compliance with the terms and conditions of the OTA which is Appendix D of this agreement.

## **B. Project Scheduling Services**

1. The Contractor shall:
  - a. Compile and validate Project schedules from all Airport designers, Contractors, and/or design-builders, as well as external agencies.
  - b. Generate Project schedules, including all design phase schedules.
  - c. Develop, review, and monitor Project schedules at various levels appropriate to the required management level during all Project phases.
  - d. Identify and analyze dependencies, controls, and interfaces between the Project, with other airport operational activities, and/or with external projects. Perform Project analysis sequences to optimize project implementation.
  - e. Review and monitor construction schedules and coordinate schedules with other Airport projects.
  - f. Provide schedule reporting and analysis services at the appropriate management level.
  - g. Review and verify written daily, weekly and monthly phasing, installation, cutover and contingency plans with the design-build Contractor and lead coordination meetings with Airport, TSA and airline stakeholders as necessary. Written reports shall be timely and with sufficient notice before work commences.

## **C. Project Budget Services**

1. The Contractor shall support the Airport's financial analyses by:
  - a. Preparing and reviewing Project hard and soft cost budget estimates resulting in the establishment of a Project budget.
  - b. Review actual costs reports, invoices, and supporting documentation against the Project budget. Verify the accuracy of segregated TSA reimbursable costs and Airport costs and summarize actual costs for each funding source.
  - c. Provide Project level cost and trend management services for design, Contractor and design-build costs, segregated by TSA and Airport funding sources.
  - d. Provide a wide range of cost estimates, including pre-construction, concept, budgetary, design, construction, and engineer's estimates.
  - e. Establish a cost management system in alignment with, and supportive of, the Airport's budgeting and accounting requirements and systems.
  - f. Establish, review, and support management of appropriate budgetary contingencies and reviewing Project risks.

- g. Provide budget and funding report services, documenting sources of funds, and provide cash flow projections for the Project.
- h. Develop and maintain procedures to forecast Project costs and advise the Airport on corrective actions if budget forecasts are to be exceeded.
- i. Prepare reports and maintain compliance with all OTA and federal regulations, including invoice preparation and tracking.

**D. Document Control Services**

- 1. The Contractor shall:
  - a. Maintain files of all Project documentation in an integrated, accessible electronic format with a hard copy stored in a retrievable system.
  - b. Maintain status logs of Project documents such as: design activities and status reports, requests for information, submittals, substitution requests, etc.
  - c. Assess current computerized document control/reporting systems and recommend upgrades or replacements to support the Project and all associated projects.
  - d. Develop and maintain systems for the efficient distribution of Project documents to Contractors, agencies, City departments, and other stakeholders as directed.

**E. Project Coordination**

- 1. The Contractor shall:
  - a. Assist Airport staff with Project coordination and development efforts with Airport operations, airlines, TSA and other stakeholders.
  - b. Assist with the establishment, implementation, and modification of Project administrative procedures, including contract preparation.
  - c. Implement and support a timely Action Item system to track key Project activities, naming the person responsible for each action item and due date.
  - d. Coordinate and document stakeholder programming and design review input.
  - e. Assist Airport staff with identifying and coordinating Airport and tenant utilities and existing conditions infrastructure documentation.
  - f. Assist Airport staff with TSA security systems and equipment coordination.
  - g. Assist Airport staff with maintaining active terminal operations, phasing, protection, environmental issues, off-hours work, utility cutovers and associated activities.

- h. Document all meetings for the duration of the Project. Meeting reports will be written only by qualified Contractor staff experienced in the subject matter. In order to enhance productivity, the Contractor will provide a concise meeting format including brief description, the individual responsible, and due date. The Contractor will limit meeting discussions and adjust participation, as much as possible, to those individuals directly responsible for the subject matter. The Contractor will distribute weekly meeting look ahead schedules, including limited invitation lists.
- i. Initiate communication first with the Airport Project Manager on Project related issues as a pre-requisite to discussions with other Airport, airline and TSA management and staff. The Contractor shall report all discussions initiated by other Airport, airline and TSA management and staff to the Airport Project Manager. The Contractor shall only accept direction from the Airport Project Manager.
- j. Establish email communication standards. These communication standards, to be implemented by the Airport Project Manager, designer, and Contractor, shall be structured to limit communication to factual discussion and is addressed only to those individuals directly involved unless directed otherwise by the Airport Project Manager. The standards shall specify that individual responses to email received will not be transmitted "reply to all" unless justified. Emails will not be copied or forwarded to supervisors without prior agreement. Extended discussions will be by telephone, with the result documented by email.

#### **F. Project Planning**

- 1. The Contractor shall:
  - a. Assist with planning and programming studies, which may include special engineering studies and reports such as seismic analysis, facility condition assessments, geotechnical/hazmat investigations, etc.
  - a. Assist with pre-design and/or pre-construction activities.

#### **G. Design Management Services**

- 1. The Contractor shall:
  - a. Provide third party, peer, and quality assurance reviews of design deliverables and construction documents.
  - b. Provide management and administration of professional services and/or construction contracts (including any design-build contracts).
  - c. Provide design oversight, monitor design progress and deliverables and recommend corrective action when required.

- d. Assist in the development of Project design standards.
- e. Support the Airport's Public Information and Community Outreach program with suitable documentation in a variety of media.
- f. Provide 100% design submittal reviews for constructability, functionality, building code and PGDS compliance for the baggage handling systems, architectural, structural, vertical transportation, mechanical, electrical, fire protection and special systems.
- g. Track and participate in the design build Contractor's BIM modeling and design coordination process.
- h. Track the design build Contractor's permitting process with the Airport Building Inspection and Code Authority (BICE).
- i. Track and document all design review comments by the TSA, Airport, airlines and other stakeholders.
- j. Provide requested conceptual or schematic design review services in support of the Project as directed by the Airport.

#### **H. Construction Administration Services**

- 1. The Contractor shall:
  - a. Review all design/builder drawings/specifications, shop drawings, submittals, and any other design documents and provide review comments to the Airport.
  - b. Develop a punch list at design/build substantial completion.
  - c. Provide any necessary support for design management services.
  - d. Ensure the efficient, timely and synchronous scheduling and coordination of all design and construction aspects of the Project.

#### **I. Construction Management Services**

- 1. The Contractor shall:
  - a. Review construction documents for constructability, impact to Airport operations, and consistency with the Project schedule and provide review comments to the Airport.
  - b. Review construction work plans and provide review comments to the Airport.
  - c. Report on and participate in the construction trade subcontract procurement process for design-build work.



- d. Review and/or prepare construction quality assurance/quality control plans and provide review comments to the Airport.
- e. Provide technical, full-time, on-site observation and inspection of the progress and quality of the construction work.
- f. Monitor environmental inspection for Contractor's compliance with environmental regulations.
- g. Examine materials and equipment being incorporated into the work to verify that they are handled, stored, and installed properly.
- h. Coordinate or procure the services of testing laboratories to assure that the proper number and type of tests are being performed in a timely manner.
- i. Provide special inspections and materials testing as required.
- j. Prepare inspection and engineer's reports for submission to the Airport.
- k. Manage the submission of samples, shop drawings, Operation & Maintenance (O&M) manuals, and other submittals between Contractors and the Airport. The Contractor shall maintain a log of all submittals. Review as-built documentation, maintenance manuals and training requirements. Coordinate training with maintainers.
- l. Identify problems encountered in accomplishing the work and recommend appropriate action to the Airport in order to resolve problems with a minimum effect on the timely completion of the Project.
- m. Maintain a log of any requests for information and prepare the Airport's non-technical responses.
- n. Review and recommend progress pay requests and provide review comments to the Airport.
- o. Review Contractor reports, as-built drawings, and other construction documentation and ensure information is captured in the Airport's record keeping system.
- p. Attend job site meetings and prepare meeting minutes. The Contractor shall review and communicate information presented.
- q. Monitor compliance by all Airport Contractors on the Project with all contract terms and conditions including, but not limited to, federal requirements, certified payroll, labor standards, drug policy, security requirements, site cleanliness, and safety.
- r. Administer the evaluation and negotiation of change orders and prepare and process change orders and contract modifications.
- s. Manage activation activities and prepare written status reports.

- t. Conduct final inspections prior to Project acceptance, notify the Airport in a timely manner of the results of the inspections, and administer acceptance procedures and tests for each phase of the Project.
- u. Perform project closeout activities.
- v. Support dispute and/or claim resolution analysis and reconciliation efforts.
- w. Review and validate the design build Contractors Task Order cost estimates for both hard and soft costs. Track overall budgeting against the TSA OTA estimate. Track the design build Contractor's monthly invoice cost breakdown against the Task Order line item budgets, and identify cost trends to determine monthly budget forecasts.
- x. Track the design build Contractor's daily, weekly and monthly schedules. Scheduling analysis will emphasize phasing and cutovers in an operational environment.
- y. Review the design build Contractor's monthly invoices; including design build Contractor's documentation of actual costs, as required under the Federal Actual Cost plus Fixed Fee contract. Actual cost documentation, including electronic certified payrolls (labor time cards) and material and equipment receipts must be referenced to each Task Order budget line item.
- z. Prepare invoice summaries for all Airport, Airport design Contractors, Contractor and design build costs that are eligible for reimbursement by the TSA under the OTA. Assist the Airport in preparing invoices to the TSA.
- aa. Attend and review simulations and Factory Acceptance Testing.
- bb. Initiate meetings and communication with all stakeholders to achieve a collaborative process. Meetings will be written by qualified Contractor staff, using a concise spreadsheet format, with parties responsible and due dates listed.
- cc. Lead daily construction and operations interface meetings with Airport, TSA and airline operations and maintenance managers.
- dd. Coordinate construction phasing, cutover and contingency planning with design build Contractor and all Airport, TSA and airline stakeholders. Planning for uninterrupted operations will override all other considerations. All work activities will have a detailed written plan and a contingency plan, approved by the Airport, TSA and airline operations and maintenance managers prior to the work proceeding.
- ee. Establish construction quality standards with Airport approval, based on documented mockups with digital photos.
- ff. Coordinate construction and conduct necessary quality control measures of architectural, structural, vertical transportation, mechanical, electrical, fire protection and special systems.

- gg. Provide a record of daily installation progress and quality control inspections with digital photos.
- hh. Review the design build Contractor's safety plan documentation, education and enforcement.
- ii. Attend BICE inspections.
- jj. Coordinate TSA progress inspections, screening equipment deliveries and installation.
- kk. Coordinate TSA Integrated Site Acceptance Test (ISAT) certification processes. Multiple ISAT certifications will be necessary due to construction phasing.
- ll. Coordinate Airport's BHS site acceptance tests, and stress test demonstrations.
- mm. Provide for Special Inspections by a California licensed testing and inspection agency for concrete, structural steel and attachments.
- nn. Provide timely meeting reports and an issues/action logs, with responsible party and due dates.
- oo. Coordinate requests for information (RFI) by the design build Contractor, and obtain responses from the designer, Airport or airline stakeholders. Provide an RFI log and a track and identify late responses.
- pp. Review requests for scope changes and provide recommendations to the Airport for approval. Review Task Order budgets submitted by the design build Contractor for scope changes and provide independent estimates for Airport approval. Track pending and approved scope changes and identify late responses.
- qq. Provide a coordinated punch list for completed construction, including the lists from Contractor inspections, Airport's designer, and BICE, TSA, Airport and airline stakeholders.
- rr. Provide administrative support to the Airport Project Manager.
- ss. Provide documentation and participate in the coordination of Federal audits.

### **3. REPORTS**

Contractor shall submit written reports as requested by the Design & Construction. Format for the content of such reports shall be determined by the Design & Construction. The timely submission of all reports is a necessary and material term and condition of this Agreement. The reports, including any copies, shall be submitted on recycled paper and printed on double-sided pages to the maximum extent possible.

### **4. DEPARTMENT LIAISON**

In performing the services provided for in this Agreement, Contractor's liaison with the Design & Construction will be Tom Rodrigues.

AIRPORT COMMISSION  
CITY AND COUNTY OF SAN FRANCISCO  
RESOLUTION NO. ~~11-0221~~

**AUTHORIZE MODIFICATION NO. 1 TO CONTRACT NO. 9024.9, CONSTRUCTION MANAGEMENT SERVICES FOR THE INTERNATIONAL TERMINAL AND BOARDING AREA F CHECKED BAGGAGE INSPECTION SYSTEM MODERNIZATION PROGRAM, AND THE INTERNATIONAL TERMINAL BAGGAGE HANDLING SYSTEM IMPROVEMENTS PROJECT IN AN AMOUNT NOT TO EXCEED \$4,823,109.**

- WHEREAS, on March 1, 2011, by Resolution No. 11-0045, the Commission authorized the Director to execute an Other Transaction Agreement with the Transportation Security Administration (TSA) for 90% reimbursement of design costs, including construction management services during design, for the International Terminal and Boarding Area F Checked Baggage Inspection System Modernization Program under the TSA's Recapitalization Program, in an amount not to exceed \$3,279,870; and
- WHEREAS, on June 30, 2011, by Resolution No. 11-0146, the Commission authorized the initial award of Contract No. 9024.9, to CAGE Inc. for the Project in an amount not to exceed \$585,805, with a contract duration of six months, for the Task 1 CM support services during design only; and
- WHEREAS, on August 16, 2011, by Resolution No. 11-0177, the Commission authorized the Director to execute an OTA with the TSA for 90% reimbursement of construction costs, including Task 2 CM support services during construction, for the Program under the TSA's Recapitalization Program, in an amount not to exceed \$40,456,890; and
- WHEREAS, the estimated cost for Task 2 CM support services is in an amount not to exceed \$3,237,597, for thirty months of services; and
- WHEREAS, the Airport has budgeted for the International Terminal Baggage Handling System (BHS) Improvements under the Airport's capital plan to replace equipment and systems that are beyond their useful life and impact the reliability of the BHS; and
- WHEREAS, the RFP for CM services included the Task 3 Airport's BHS Improvements, which Staff has negotiated with Cage for an amount not to exceed \$1,175,512, for thirty months of services, to be performed concurrently with Task 2; and
- WHEREAS, Staff has determined that BHS transfer line conveyors are required to allow for flexibility to direct bags from all Terminal 3 ticket counters to Boarding Areas E and F; and
- WHEREAS, these improvements are integrated with the Boarding Area F elements of the Modernization Program and should be installed concurrently, and by the same contractor to avoid issues with coordination, phasing and potential scope gaps; and
- WHEREAS, Staff recommends including CM support services for the BHS transfer line conveyors as Task 4 under this proposed Modification No. 1, in an amount not to exceed \$410,000, for thirty months of services, concurrently with Tasks 2 and 3; and
- WHEREAS, the total estimated cost for Tasks 2, 3 and 4 is in an amount not to exceed \$4,823,109; and

AIRPORT COMMISSION

CITY AND COUNTY OF SAN FRANCISCO

RESOLUTION NO. 11-0221

WHEREAS, due to the federal funding component for these services, there are no HRC LBE subconsultant participation goals for the contract; and

WHEREAS, there is no specific DBE subconsultant goal for this contract, but the Airport's overall 3-year DBE goal is 12%; and

WHEREAS, due to the specialized nature of the services, CAGE Inc. was able to achieve 5.8% SDB and DBE subconsultant participation; now, therefore be it

RESOLVED, that the Commission hereby authorizes Modification No. 1 to Professional Services Agreement, Contract No. 9024.9, Construction Management Services for the International Terminal and Boarding Area F Checked Baggage Inspection System Modernization Program, and the International Terminal Baggage Handling System Improvements Project, to CAGE Inc., for an amount not to exceed \$4,823,109, for a contract duration of thirty months, for the Task 2, 3 and 4 scope of services.

Page 2 of 2

*I hereby certify that the foregoing resolution was adopted by the Airport Commission*

*at its meeting of* OCT 04 2011

Jean Caramatti

Secretary



San Francisco International Airport

**MEMORANDUM**

October 4, 2011

TO: AIRPORT COMMISSION  
Hon. Larry Mazzola, President  
Hon. Linda S. Crayton, Vice President  
Hon. Eleanor Johns  
Hon. Richard J. Guggenhime  
Hon. Peter A. Stern

FROM: Airport Director

SUBJECT: Modification No. 1 to Professional Services Agreement, Contract No. 9024.9, Construction Management Services for the International Terminal and Boarding Area F Checked Baggage Inspection System Modernization Program, and the International Terminal Baggage Handling System Improvement Project, with CAGE, Inc., in an amount not to exceed \$4,823,109.

DIRECTOR'S RECOMMENDATION: AUTHORIZE MODIFICATION NO. 1 TO PROFESSIONAL SERVICES AGREEMENT, CONTRACT NO. 9024.9, CONSTRUCTION MANAGEMENT SERVICES FOR THE INTERNATIONAL TERMINAL AND BOARDING AREA F CHECKED BAGGAGE INSPECTION SYSTEM MODERNIZATION PROGRAM, AND THE INTERNATIONAL TERMINAL BAGGAGE HANDLING SYSTEM IMPROVEMENT PROJECT, WITH CAGE, INC., IN AN AMOUNT NOT TO EXCEED \$4,823,109.

**Executive Summary**

Transmitted herewith for your approval is a proposed Resolution to authorize Modification No. 1 to Contract No. 9024.9, with CAGE Inc. for Construction Management Services for the International Terminal and Boarding Area F Checked Baggage Inspection System Modernization Program, and the International Terminal Baggage Handling System Improvement Project. The proposed Modification No. 1 awards Tasks 2, 3 and 4 to Cage, in an amount not to exceed \$4,823,109, with a contract duration of thirty months.

**Background**

On March 1, 2011, by Resolution No. 11-0045, the Commission authorized the Director to execute an Other Transaction Agreement with the Transportation Security Administration (TSA) for 90% reimbursement of design costs, including construction management (CM) support services during design only, for the International Terminal and Boarding Area F Checked Baggage Inspection System Modernization Program under the TSA's Recapitalization Program, in an amount not to exceed \$3,279,870.

On March 1, 2011, by Resolution No. 11-0047, the Commission authorized Staff to issue a request for proposal (RFP) to provide CM support services for the International Terminal and Boarding Area F Checked Baggage Inspection System Modernization Program, and the

THIS PRINT COVERS CALENDAR ITEM NO. 4

AIRPORT COMMISSION CITY AND COUNTY OF SAN FRANCISCO

EDWIN M. LEE MAYOR LARRY MAZZOLA PRESIDENT LINDA S. CRAYTON VICE PRESIDENT ELEANOR JOHNS RICHARD J. GUGGENHIME PETER A. STERN JOHN L. MARTIN AIRPORT DIRECTOR

International Terminal Baggage Handling System Improvement project (Project). CAGE Inc. was determined to be the highest ranking respondent.

On June 7, 2011, by Resolution No. 11-0140, the Commission approved the selection of CAGE, Inc. as the highest ranked firm to provide CM support services for the Project, and authorized Staff to enter into negotiations and prepare a professional services contract for Commission consideration and award.

On June 30, 2011, by Resolution No. 11-0146, the Commission authorized the initial award of Contract No. 9024.9, to CAGE Inc. for the Project in an amount not to exceed \$585,805, with a contract duration of six months, for the Task 1 CM support services during design only.

This Modification No. 1 provides for the award of Tasks 2, 3 and 4 to Cage, in support of the Modernization Program and the Airport's BHS Improvements project.

#### Task 2

The TSA's intent was to issue a separate follow-on OTA for the construction phase of the Program. The 90% funding for the CM support services during the construction phase was to be included in the follow-on OTA. The RFP for CM services included the construction phase. The Resolution authorizing the initial award of Contract No. 9024.9 for Task 1 CM support services during design stated that Staff would return to the Commission to request authorization to award Tasks 2 and 3 to CAGE, Inc., following approval of the construction OTA for the Program.

On August 16, 2011, by Resolution No. 11-0177, the Commission authorized the Director to execute an OTA with the TSA for 90% reimbursement of construction costs, including Task 2 CM support services during construction, for the Program under the TSA's Recapitalization Program, in an amount not to exceed \$40,456,890.

Under Task 2, the CM will provide for a construction manager, resident engineers, project controls personnel, construction administration support, materials testing and special inspection and any other specialty construction management services required. The estimated cost for Task 2 is in an amount not to exceed \$3,237,597, for thirty months of services.

#### Task 3

The Airport has budgeted for the International Terminal Baggage Handling System (BHS) Improvements under the Airport's capital plan to replace equipment and systems that are beyond their useful life and impact the reliability of the BHS. The Airport's BHS Improvements are integrated with the TSA Program, and should be installed concurrently, and by the same contractor to avoid issues with coordination, phasing and potential scope gaps. The RFP for CM services included the Airport's BHS Improvements. The CM scope for Task 3 is similar to Tasks 1 and 2. The estimated cost is in an amount not to exceed \$1,175,512, for thirty months of services, concurrently with Task 2.



Task 4

Staff has determined that BHS transfer line conveyors are required to allow for flexibility to direct bags from all Terminal 3 ticket counters to Boarding Areas E and F. These improvements include mechanical equipment, computer equipment, and programming services, which are integrated with the Boarding Area F TSA Program and should be installed concurrently, and by the same contractor to avoid issues with coordination, phasing and potential scope gaps.

The Airport has budgeted for the BHS transfer conveyors under the Airport's capital plan. The estimated construction cost is in the amount of \$5,000,000. Staff recommends including Task 4 CM support services under this proposed Modification No. 1. The CM scope for Task 4 is similar to Tasks 1, 2 and 3. The estimated cost is in an amount not to exceed \$410,000, for thirty months of services, concurrently with Task 2 and 3.

The estimated total value of the construction to be managed by Airport staff and Consultant, including contingency, is \$64,344,000. The total project budget for construction management services, including materials testing and special inspection, is \$5,408,914. The construction management services budget for the Project is 8.4% which is not within the Airport's overall goal of achieving 15% for project "soft cost" performance (design, construction management, administrative, and materials testing/special inspection). However, Airport staff has determined that the scope of CM services for this Project should include 24 hour CM oversight to cover the various work areas, which will likely require double or triple shifting to minimize the impact on operations during construction.

Due to the federal funding component for these services, there are no HRC LBE subconsultant participation goals for the contract. The Airport encouraged proposers to utilize "best efforts" to subcontract at least 10% of the work to certified small and disadvantaged businesses (SDB). There is no specific DBE subconsultant goal for this contract, but the Airport's overall 3-year DBE goal is 12%. Due to the specialized nature of the services, CAGE Inc. was able to achieve 5.8% SDB and DBE subconsultant participation.

Recommendation

Based upon the foregoing, I recommend your approval of Modification No. 1 to Professional Services Agreement, Contract No. 9024.9, Construction Management Services for the International Terminal and Boarding Area F Checked Baggage Inspection System Modernization Program, and the International Terminal Baggage Handling System Improvement Project, to CAGE, Inc., for Tasks 2, 3 and 4, in an amount not to exceed \$4,823,109.



John L. Martin  
Airport Director

Prepared by: Ivar Satero  
Deputy Airport Director  
Design and Construction

Attachment

City and County of San Francisco  
Airport Commission  
P.O. Box 8097  
San Francisco, California 94128

Agreement between the City and County of San Francisco and  
CAGE Professional Services, Inc.

Contract No. 9024.9

This Agreement is made this 30th day of June, 2011, in the City and County of San Francisco, State of California, by and between: **CAGE Professional Services Inc., 6303 Commerce Drive, Suite 150, Irving, Texas 75063**, hereinafter referred to as "Contractor," and the City and County of San Francisco, a municipal corporation, hereinafter referred to as "City," acting by and through its Airport Commission or the Commission's designated agent, hereinafter referred to as "Commission."

**Recitals**

WHEREAS, Commission wishes to enter into a contract with the Contractor to provide construction management services for the International Terminal and Boarding Area F Checked Baggage Inspection System Modernization Program, and the International Terminal Baggage Handling System Improvements Project; and,

WHEREAS, Commission is authorized to enter into all contracts which relate to matters under its jurisdiction; and

WHEREAS, a Request for Proposal ("RFP") was issued on April 22, 2011, and City selected Contractor as the highest qualified scorer pursuant to the RFP; and

WHEREAS, Commission awarded this contract to Contractor on June 30, 2011, pursuant to Resolution No. 11-0146 in which it gave authorization and appropriated funds to proceed with Task One of the three contemplated tasks; and

WHEREAS, Contractor represents and warrants that it is qualified to perform the services required by City as set forth under this Contract; and,

WHEREAS, approval for this Agreement was obtained when the Civil Service Commission approved Contract number PSC #4099-09/10 on June 6, 2011;

Now, THEREFORE, the parties agree as follows:

**1. Certification of Funds; Budget and Fiscal Provisions; Termination in the Event of Non-Appropriation.** This Agreement is subject to the budget and fiscal provisions of the City's Charter. Charges will accrue only after prior written authorization certified by the Controller, and the amount of City's obligation hereunder shall not at any time exceed the amount certified for the purpose and period stated in such advance authorization. This Agreement will terminate without penalty, liability or expense of any kind to City at the end of any fiscal year if funds are not appropriated for the next succeeding fiscal year. If funds are appropriated for a portion of the fiscal year, this Agreement will terminate, without penalty, liability or expense of any kind at the end of the term for which funds are appropriated. City has no obligation to make appropriations for this Agreement in lieu of appropriations for new or other

agreements. City budget decisions are subject to the discretion of the Mayor and the Board of Supervisors. Contractor's assumption of risk of possible non-appropriation is part of the consideration for this Agreement.

THIS SECTION CONTROLS AGAINST ANY AND ALL OTHER PROVISIONS OF THIS AGREEMENT.

2. **Term of the Agreement.** Subject to Section 1, the term of this Agreement shall be from **June 30, 2011 to December 31, 2011.**

3. **Effective Date of Agreement.** This Agreement shall become effective when the Controller has certified to the availability of funds and Contractor has been notified in writing.

4. **Services Contractor Agrees to Perform.** The Contractor agrees to perform the services provided for in Appendix A, "Description of Services," attached hereto and incorporated by reference as though fully set forth herein. If Appendix A includes as-needed services, such services shall be requested by City through the issuance of a written task order signed by City and Contractor, which task order shall be made a part of and incorporated into the Agreement as though fully set forth herein without the need for a formal amendment to the Agreement. The task order shall include a description of the as-needed services; the deliverables, schedule for performance, cost, and method and timing of payment.

5. **Compensation.**

A. Compensation shall be made in monthly payments on or before the 30th day of each month for work, as set forth in Section 4 of this Agreement, that the Airport Director or designee, in his or her sole discretion, concludes has been performed as of the last day of the immediately preceding month. In no event shall the amount of this Agreement exceed **Five Hundred Eight-five Thousand Eight Hundred Five Dollars (\$585,805)**. The breakdown of costs associated with this Agreement appears in Appendix B, "Calculation of Charges," attached hereto and incorporated by reference as though fully set forth herein. All costs shall be subject to the provision in Appendix B.1, the Provisional Indirect Cost Rate Agreement. No charges shall be incurred under this Agreement nor shall any payments become due to Contractor until reports, services, or both, required under this Agreement are received from Contractor and approved by Design & Construction as being in accordance with this Agreement. City may withhold payment to Contractor in any instance in which Contractor has failed or refused to satisfy any material obligation provided for under this Agreement.

B. The Contractor agrees to pay each subcontractor under this Agreement for satisfactory performance of its contract no later than 30 days from the receipt of each payment the prime contractor receives from City. The Contractor agrees further to return retention payments to each subcontractor within 30 days after the subcontractor's work is satisfactorily completed. Any delay or postponement of payment from the above referenced time frame may occur only for good cause following written approval of the City. This clause applies to both DBE and non-DBE subcontractors.

C. The Airport Accounting is not authorized to pay monthly payment requests/invoices submitted by Contractor prior to Contractor's submission of Airport Federal Progress Payment Report – Federal Form 3 and Airport Federal Contract Exit Report and Affidavit – Federal Form 5 with the final payment request/invoice.

D. In no event shall City be liable for interest or late charges for any late payments.

E. The Contractor hereby states it is familiar with the provisions of Office of Management and Budget (OMB) Circular A-87, Cost Principles for State, Local and Indian Tribal Governments; that it understands the City does not intend to pay the Contractor for costs under this Agreement which are not reimbursable to City from its funding agencies in accordance with Circular A-87; and that all payments under this Agreement are subject to audit and adjustment.

**6. Guaranteed Maximum Costs.** The City's obligation hereunder shall not at any time exceed the amount certified by the Controller for the purpose and period stated in such certification. Except as may be provided by laws governing emergency procedures, officers and employees of the City are not authorized to request, and the City is not required to reimburse the Contractor for, Commodities or Services beyond the agreed upon contract scope unless the changed scope is authorized by amendment and approved as required by law. Officers and employees of the City are not authorized to offer or promise, nor is the City required to honor, any offered or promised additional funding in excess of the maximum amount of funding for which the contract is certified without certification of the additional amount by the Controller. The Controller is not authorized to make payments on any contract for which funds have not been certified as available in the budget or by supplemental appropriation.

**7. Payment; Invoice Format.** Invoices furnished by Contractor under this Agreement must be in a form acceptable to the Controller, and must include a unique invoice number. All amounts paid by City to Contractor shall be subject to audit by City. Payment shall be made by City to Contractor at the address specified in the section entitled "Notices to the Parties."

**8. Submitting False Claims; Monetary Penalties.** Pursuant to San Francisco Administrative Code §21.35, any contractor, subcontractor or consultant who submits a false claim shall be liable to the City for the statutory penalties set forth in that section. The text of Section 21.35, along with the entire San Francisco Administrative Code is available on the web at <http://www.municode.com/Library/clientCodePage.aspx?clientID=4201>. A contractor, subcontractor or consultant will be deemed to have submitted a false claim to the City if the contractor, subcontractor or consultant: (a) knowingly presents or causes to be presented to an officer or employee of the City a false claim or request for payment or approval; (b) knowingly makes, uses, or causes to be made or used a false record or statement to get a false claim paid or approved by the City; (c) conspires to defraud the City by getting a false claim allowed or paid by the City; (d) knowingly makes, uses, or causes to be made or used a false record or statement to conceal, avoid, or decrease an obligation to pay or transmit money or property to the City; or (e) is a beneficiary of an inadvertent submission of a false claim to the City, subsequently discovers the falsity of the claim, and fails to disclose the false claim to the City within a reasonable time after discovery of the false claim.

**9. Disallowance.** If Contractor claims or receives payment from City for a service, reimbursement for which is later disallowed by the State of California or United States Government, Contractor shall promptly refund the disallowed amount to City upon City's request. At its option, City may offset the amount disallowed from any payment due or to become due to Contractor under this Agreement or any other Agreement. By executing this Agreement, Contractor certifies that Contractor is not suspended, debarred or otherwise excluded from participation in federal assistance programs. Contractor acknowledges that this certification of eligibility to receive federal funds is a material terms of the Agreement.

**10. Taxes.** Payment of any taxes, including possessory interest taxes and California sales and use taxes, levied upon or as a result of this Agreement, or the services delivered pursuant hereto, shall be the obligation of Contractor. Contractor recognizes and understands that this Agreement may create a "possessory interest" for property tax purposes. Generally, such a possessory interest is not created unless

the Agreement entitles the Contractor to possession, occupancy, or use of City property for private gain. If such a possessory interest is created, then the following shall apply:

A. Contractor, on behalf of itself and any permitted successors and assigns, recognizes and understands that Contractor, and any permitted successors and assigns, may be subject to real property tax assessments on the possessory interest;

B. Contractor, on behalf of itself and any permitted successors and assigns, recognizes and understands that the creation, extension, renewal, or assignment of this Agreement may result in a "change in ownership" for purposes of real property taxes, and therefore may result in a revaluation of any possessory interest created by this Agreement. Contractor accordingly agrees on behalf of itself and its permitted successors and assigns to report on behalf of the City to the County Assessor the information required by Revenue and Taxation Code section 480.5, as amended from time to time, and any successor provision.

C. Contractor, on behalf of itself and any permitted successors and assigns, recognizes and understands that other events also may cause a change of ownership of the possessory interest and result in the revaluation of the possessory interest (see, e.g., Revenue & Tax Code section 64, as amended from time to time). Contractor accordingly agrees on behalf of itself and its permitted successors and assigns to report any change in ownership to the County Assessor, the State Board of Equalization or other public agency as required by law.

D. Contractor further agrees to provide such other information as may be requested by the City to enable the City to comply with any reporting requirements for possessory interests that are imposed by applicable law.

**11. Payment Does Not Imply Acceptance of Work.** The granting of any payment by City, or the receipt thereof by Contractor, shall in no way lessen the liability of Contractor to replace unsatisfactory work, equipment, or materials, although the unsatisfactory character of such work, equipment or materials may not have been apparent or detected at the time such payment was made. Materials, equipment, components, or workmanship that do not conform to the requirements of this Agreement may be rejected by City and in such case must be replaced by Contractor without delay.

**12. Qualified Personnel.** Work under this Agreement shall be performed only by competent personnel under the supervision of and in the employment of Contractor. Contractor will comply with City's reasonable requests regarding assignment of personnel, but all personnel, including those assigned at City's request, and must be supervised by Contractor. Contractor shall commit adequate resources to complete the project within the project schedule specified in this Agreement.

**13. Responsibility for Equipment.** City shall not be responsible for any damage to persons or property as a result of the use, misuse or failure of any equipment used by Contractor, or by any of its employees, even though such equipment be furnished, rented or loaned to Contractor by City.

**14. Independent Contractor; Payment of Taxes and Other Expenses.**

A. **Independent Contractor.** Contractor or any agent or employee of Contractor shall be deemed at all times to be an independent contractor and is wholly responsible for the manner in which it performs the services and work requested by City under this Agreement. Contractor or any agent or employee of Contractor shall not have employee status with City, nor be entitled to participate in any plans, arrangements, or distributions by City pertaining to or in connection with any retirement, health or other benefits that City may offer its employees. Contractor or any agent or employee of Contractor is

liable for the acts and omissions of itself, its employees and its agents. Contractor shall be responsible for all obligations and payments, whether imposed by federal, state or local law, including, but not limited to, FICA, income tax withholdings, unemployment compensation, insurance, and other similar responsibilities related to Contractor's performing services and work, or any agent or employee of Contractor providing same. Nothing in this Agreement shall be construed as creating an employment or agency relationship between City and Contractor or any agent or employee of Contractor. Any terms in this Agreement referring to direction from City shall be construed as providing for direction as to policy and the result of Contractor's work only, and not as to the means by which such a result is obtained. City does not retain the right to control the means or the method by which Contractor performs work under this Agreement.

**B. Payment of Taxes and Other Expenses.** Should City, in its discretion, or a relevant taxing authority such as the Internal Revenue Service or the State Employment Development Division, or both, determine that Contractor is an employee for purposes of collection of any employment taxes, the amounts payable under this Agreement shall be reduced by amounts equal to both the employee and employer portions of the tax due (and offsetting any credits for amounts already paid by Contractor which can be applied against this liability). City shall then forward those amounts to the relevant taxing authority. Should a relevant taxing authority determine a liability for past services performed by Contractor for City, upon notification of such fact by City, Contractor shall promptly remit such amount due or arrange with City to have the amount due withheld from future payments to Contractor under this Agreement (again, offsetting any amounts already paid by Contractor which can be applied as a credit against such liability). A determination of employment status pursuant to the preceding two paragraphs shall be solely for the purposes of the particular tax in question, and for all other purposes of this Agreement, Contractor shall not be considered an employee of City. Notwithstanding the foregoing, should any court, arbitrator, or administrative authority determine that Contractor is an employee for any other purpose, then Contractor agrees to a reduction in City's financial liability so that City's total expenses under this Agreement are not greater than they would have been had the court, arbitrator, or administrative authority determined that Contractor was not an employee.

## 15. Insurance.

A. Without in any way limiting Contractor's liability pursuant to the "Indemnification" section of this Agreement, Contractor must maintain in force, during the full term of the Agreement, insurance in the following amounts and coverage:

(1) Workers' Compensation, in statutory amounts, with Employers' Liability Limits not less than \$1,000,000 each accident, injury, or illness; and

(2) Commercial General Liability Insurance with limits not less than \$2,000,000 each occurrence Combined Single Limit for Bodily Injury and Property Damage, including Contractual Liability, Personal Injury, Products and Completed Operations; and

(3) Commercial Automobile Liability Insurance with limits not less than \$2,000,000 each occurrence Combined Single Limit for Bodily Injury and Property Damage, including Owned, Non-Owned and Hired auto coverage, as applicable.

(4) Professional liability insurance, applicable to Contractor's profession, with limits not less than \$2,000,000 per occurrence with respect to negligent acts, errors or omissions in connection with professional services to be provided under this Agreement.

B. Commercial General Liability and Commercial Automobile Liability Insurance policies must be endorsed to provide:

(1) Name as Additional Insured the City and County of San Francisco, its Officers, Agents, and Employees.

(2) That such policies are primary insurance to any other insurance available to the Additional Insured, with respect to any claims arising out of this Agreement, and that insurance applies separately to each insured against whom claim is made or suit is brought.

C. Regarding Workers' Compensation, Contractor hereby agrees to waive subrogation which any insurer of Contractor may acquire from Contractor by virtue of the payment of any loss. Contractor agrees to obtain any endorsement that may be necessary to effect this waiver of subrogation. The Workers' Compensation policy shall be endorsed with a waiver of subrogation in favor of the City for all work performed by the Contractor, its employees, agents and subcontractors.

D. All policies shall provide thirty days' advance written notice to the City of reduction or nonrenewal of coverage or cancellation of coverage for any reason. Notices shall be sent to the City address in the "Notices to the Parties" section.

E. Should any of the required insurance be provided under a claims-made form, Contractor shall maintain such coverage continuously throughout the term of this Agreement and, without lapse, for a period of three years beyond the expiration of this Agreement, to the effect that, should occurrences during the contract term give rise to claims made after expiration of the Agreement, such claims shall be covered by such claims-made policies.

F. Should any of the required insurance be provided under a form of coverage that includes a general annual aggregate limit or provides that claims investigation or legal defense costs be included in such general annual aggregate limit, such general annual aggregate limit shall be double the occurrence or claims limits specified above.

G. Should any required insurance lapse during the term of this Agreement, requests for payments originating after such lapse shall not be processed until the City receives satisfactory evidence of reinstated coverage as required by this Agreement, effective as of the lapse date. If insurance is not reinstated, the City may, at its sole option, terminate this Agreement effective on the date of such lapse of insurance.

H. Before commencing any operations under this Agreement, Contractor shall furnish to City certificates of insurance and additional insured policy endorsements with insurers with ratings comparable to A-, VIII or higher, that are authorized to do business in the State of California, and that are satisfactory to City, in form evidencing all coverage set forth above. Failure to maintain insurance shall constitute a material breach of this Agreement.

I. Approval of the insurance by City shall not relieve or decrease the liability of Contractor hereunder.

J. If a subcontractor will be used to complete any portion of this agreement, the Contractor shall ensure that the subcontractor shall provide all necessary insurance and shall name the City and County of San Francisco, its officers, agents and employees and the Contractor listed as additional insured.

**16. Indemnification.** Contractor shall indemnify and save harmless City and its officers, agents and employees from, and, if requested, shall defend them against any and all loss, cost, damage, injury, liability, and claims thereof for injury to or death of a person, including employees of Contractor or loss of or damage to property, arising directly or indirectly from Contractor's performance of this Agreement, including, but not limited to, Contractor's use of facilities or equipment provided by City or others, regardless of the negligence of, and regardless of whether liability without fault is imposed or sought to be imposed on City, except to the extent that such indemnity is void or otherwise unenforceable under applicable law in effect on or validly retroactive to the date of this Agreement, and except where such loss, damage, injury, liability or claim is the result of the active negligence or willful misconduct of City and is not contributed to by any act of, or by any omission to perform some duty imposed by law or agreement on Contractor, its subcontractors or either's agent or employee. The foregoing indemnity shall include, without limitation, reasonable fees of attorneys, consultants and experts and related costs and City's costs of investigating any claims against the City. In addition to Contractor's obligation to indemnify City, Contractor specifically acknowledges and agrees that it has an immediate and independent obligation to defend City from any claim which actually or potentially falls within this indemnification provision, even if the allegations are or may be groundless, false or fraudulent, which obligation arises at the time such claim is tendered to Contractor by City and continues at all times thereafter. Contractor shall indemnify and hold City harmless from all loss and liability, including attorneys' fees, court costs and all other litigation expenses for any infringement of the patent rights, copyright, trade secret or any other proprietary right or trademark, and all other intellectual property claims of any person or persons in consequence of the use by City, or any of its officers or agents, of articles or services to be supplied in the performance of this Agreement.

**17. Incidental and Consequential Damages.** The Contractor shall be responsible for its proportionate share of incidental and consequential damages resulting in whole or in part from the Contractor's acts or omissions. Nothing in this Agreement shall constitute a waiver or limitation of any rights that the City may have under applicable law except as otherwise expressly provided herein.

**18. Liability of City.** CITY'S PAYMENT OBLIGATIONS UNDER THIS AGREEMENT SHALL BE LIMITED TO THE PAYMENT OF THE COMPENSATION PROVIDED FOR IN SECTION 5 OF THIS AGREEMENT. NOTWITHSTANDING ANY OTHER PROVISION OF THIS AGREEMENT, IN NO EVENT SHALL CITY BE LIABLE, REGARDLESS OF WHETHER ANY CLAIM IS BASED ON CONTRACT OR TORT, FOR ANY SPECIAL, CONSEQUENTIAL, INDIRECT OR INCIDENTAL DAMAGES, INCLUDING, BUT NOT LIMITED TO, LOST PROFITS, ARISING OUT OF OR IN CONNECTION WITH THIS AGREEMENT OR THE SERVICES PERFORMED IN CONNECTION WITH THIS AGREEMENT.

**19. Liquidated Damages.** LEFT BLANK BY AGREEMENT OF THE PARTIES

**20. Default; Remedies.** Each of the following shall constitute an event of default ("Event of Default") under this Agreement:

A. Contractor fails or refuses to perform or observe any term, covenant or condition contained in any of the following Sections of this Agreement:

- |   |                                       |
|---|---------------------------------------|
| 8. Submitting False Claims                          | 30. Assignment                        |
| 10. Taxes   | 37. Drug-free Workplace Policy,       |
| 15. Insurance                                       | 53. Compliance with Laws              |
| 24. Proprietary or Confidential Information of City | 55. Supervision of Minors             |
|   | 57. Protection of Private Information |
|   | 58. Graffiti Removal                  |



B. Contractor fails or refuses to perform or observe any other term, covenant or condition contained in this Agreement, and such default continues for a period of ten days after written notice thereof from City to Contractor.

C. Contractor (a) is generally not paying its debts as they become due, (b) files, or consents by answer or otherwise to the filing against it of, a petition for relief or reorganization or arrangement or any other petition in bankruptcy or for liquidation or to take advantage of any bankruptcy, insolvency or other debtors' relief law of any jurisdiction, (c) makes an assignment for the benefit of its creditors, (d) consents to the appointment of a custodian, receiver, trustee or other officer with similar powers of Contractor or of any substantial part of Contractor's property or (e) takes action for the purpose of any of the foregoing.

D. A court or government authority enters an order (a) appointing a custodian, receiver, trustee or other officer with similar powers with respect to Contractor or with respect to any substantial part of Contractor's property, (b) constituting an order for relief or approving a petition for relief or reorganization or arrangement or any other petition in bankruptcy or for liquidation or to take advantage of any bankruptcy, insolvency or other debtors' relief law of any jurisdiction or (c) ordering the dissolution, winding-up or liquidation of Contractor.

E. On and after any Event of Default, City shall have the right to exercise its legal and equitable remedies, including, without limitation, the right to terminate this Agreement or to seek specific performance of all or any part of this Agreement. In addition, City shall have the right (but no obligation) to cure (or cause to be cured) on behalf of Contractor any Event of Default; Contractor shall pay to City on demand all costs and expenses incurred by City in effecting such cure, with interest thereon from the date of incurrence at the maximum rate then permitted by law. City shall have the right to offset from any amounts due to Contractor under this Agreement or any other agreement between City and Contractor all damages, losses, costs or expenses incurred by City as a result of such Event of Default and any liquidated damages due from Contractor pursuant to the terms of this Agreement or any other agreement. All remedies provided for in this Agreement may be exercised individually or in combination with any other remedy available hereunder or under applicable laws, rules and regulations. The exercise of any remedy shall not preclude or in any way be deemed to waive any other remedy.

## **21. Termination for Convenience**

A. City shall have the option, in its sole discretion, to terminate this Agreement, at any time during the term hereof, for convenience and without cause. City shall exercise this option by giving Contractor written notice of termination. The notice shall specify the date on which termination shall become effective.

B. Upon receipt of the notice, Contractor shall commence and perform, with diligence, all actions necessary on the part of Contractor to effect the termination of this Agreement on the date specified by City and to minimize the liability of Contractor and City to third parties as a result of termination. All such actions shall be subject to the prior approval of City. Such actions shall include, without limitation:

(1) Halting the performance of all services and other work under this Agreement on the date(s) and in the manner specified by City.

(2) Not placing any further orders or subcontracts for materials, services, equipment or other items.

(3) Terminating all existing orders and subcontracts.

(4) At City's direction, assigning to City any or all of Contractor's right, title, and interest under the orders and subcontracts terminated. Upon such assignment, City shall have the right, in its sole discretion, to settle or pay any or all claims arising out of the termination of such orders and subcontracts.

(5) Subject to City's approval, settling all outstanding liabilities and all claims arising out of the termination of orders and subcontracts.

(6) Completing performance of any services or work that City designates to be completed prior to the date of termination specified by City.

(7) Taking such action as may be necessary, or as the City may direct, for the protection and preservation of any property related to this Agreement which is in the possession of Contractor and in which City has or may acquire an interest.

C. Within 30 days after the specified termination date, Contractor shall submit to City an invoice, which shall set forth each of the following as a separate line item:

(1) The reasonable cost to Contractor, without profit, for all services and other work City directed Contractor to perform prior to the specified termination date, for which services or work City has not already tendered payment. Reasonable costs may include a reasonable allowance for actual overhead, not to exceed a total of 10% of Contractor's direct costs for services or other work. Any overhead allowance shall be separately itemized. Contractor may also recover the reasonable cost of preparing the invoice.

(2) A reasonable allowance for profit on the cost of the services and other work described in the immediately preceding subsection (1), provided that Contractor can establish, to the satisfaction of City, that Contractor would have made a profit had all services and other work under this Agreement been completed, and provided further, that the profit allowed shall in no event exceed 5% of such cost.

(3) The reasonable cost to Contractor of handling material or equipment returned to the vendor, delivered to the City or otherwise disposed of as directed by the City.

(4) A deduction for the cost of materials to be retained by Contractor, amounts realized from the sale of materials and not otherwise recovered by or credited to City, and any other appropriate credits to City against the cost of the services or other work.

D. In no event shall City be liable for costs incurred by Contractor or any of its subcontractors after the termination date specified by City, except for those costs specifically enumerated and described in the immediately preceding subsection (C). Such non-recoverable costs include, but are not limited to, anticipated profits on this Agreement, post-termination employee salaries, post-termination administrative expenses, post-termination overhead or unabsorbed overhead, attorneys' fees or other costs relating to the prosecution of a claim or lawsuit, prejudgment interest, or any other expense which is not reasonable or authorized under such subsection (C).

E. In arriving at the amount due to Contractor under this Section, City may deduct: (1) all payments previously made by City for work or other services covered by Contractor's final invoice; (2) any claim which City may have against Contractor in connection with this Agreement; (3) any invoiced costs or expenses excluded pursuant to the immediately preceding subsection (D); and (4) in instances in which, in the opinion of the City, the cost of any service or other work performed under this

Agreement is excessively high due to costs incurred to remedy or replace defective or rejected services or other work, the difference between the invoiced amount and City's estimate of the reasonable cost of performing the invoiced services or other work in compliance with the requirements of this Agreement.

F. City's payment obligation under this Section shall survive termination of this Agreement.

**22. Rights and Duties upon Termination or Expiration.** This Section and the following Sections of this Agreement shall survive termination or expiration of this Agreement:

8. Submitting False Claims
9. Disallowance
10. Taxes
11. Payment Does Not Imply Acceptance of Work
13. Responsibility for Equipment
14. Independent Contractor; Payment of Taxes and Other Expenses
15. Insurance
16. Indemnification
17. Incidental and Consequential Damages
18. Liability of City
24. Proprietary or Confidential Information of City
26. Ownership of Results
27. Works for Hire
28. Audit and Inspection of Records
48. Modification of Agreement.
49. Administrative Remedy for Agreement Interpretation.
50. Agreement Made in California; Venue
51. Construction
52. Entire Agreement
56. Severability
57. Protection of private information

Subject to the immediately preceding sentence, upon termination of this Agreement prior to expiration of the term specified in Section 2, this Agreement shall terminate and be of no further force or effect. Contractor shall transfer title to City, and deliver in the manner, at the times, and to the extent, if any, directed by City, any work in progress, completed work, supplies, equipment, and other materials produced as a part of, or acquired in connection with the performance of this Agreement, and any completed or partially completed work which, if this Agreement had been completed, would have been required to be furnished to City. This subsection shall survive termination of this Agreement.

**23. Conflict of Interest.** Through its execution of this Agreement, Contractor acknowledges that it is familiar with the provision of Section 15.103 of the City's Charter, Article III, Chapter 2 of City's Campaign and Governmental Conduct Code, and Section 87100 et seq. and Section 1090 et seq. of the Government Code of the State of California, and certifies that it does not know of any facts which constitutes a violation of said provisions and agrees that it will immediately notify the City if it becomes aware of any such fact during the term of this Agreement.

**24. Proprietary or Confidential Information of City.** Contractor understands and agrees that, in the performance of the work or services under this Agreement or in contemplation thereof, Contractor may have access to private or confidential information which may be owned or controlled by City and that such information may contain proprietary or confidential details, the disclosure of which to third parties may be damaging to City. Contractor agrees that all information disclosed by City to Contractor shall be

held in confidence and used only in performance of the Agreement. Contractor shall exercise the same standard of care to protect such information as a reasonably prudent contractor would use to protect its own proprietary data.

**25. Notices to the Parties.** Unless otherwise indicated elsewhere in this Agreement, all written communications sent by the parties may be by U.S. mail, or by e-mail, and shall be addressed as follows:

To City: Tom Rodrigues  
Project Manager  
San Francisco International Airport  
Design & Construction  
P.O. Box 8097  
San Francisco, California 94128  
Email: [tom.rodrigues@flysfo.com](mailto:tom.rodrigues@flysfo.com)  
FAX: (650) 821-7799

To Contractor: Terry Brennan  
Construction Manager  
CAGE Inc.  
6303 Commerce Drive, Suite 150  
Irving, Texas 75063  
Email: [tbrennan@cage-inc.com](mailto:tbrennan@cage-inc.com)  
FAX: (972) 550-9221

Any notice of default must be sent by registered mail.

**26. Ownership of Results.** Any interest of Contractor or its Subcontractors, in drawings, plans, specifications, blueprints, studies, reports, memoranda, computation sheets, computer files and media or other documents prepared by Contractor or its subcontractors in connection with services to be performed under this Agreement, shall become the property of and will be transmitted to City. However, Contractor may retain and use copies for reference and as documentation of its experience and capabilities.

**27. Works for Hire.** If, in connection with services performed under this Agreement, Contractor or its subcontractors create artwork, copy, posters, billboards, photographs, videotapes, audiotapes, systems designs, software, reports, diagrams, surveys, blueprints, source codes or any other original works of authorship, such works of authorship shall be works for hire as defined under Title 17 of the United States Code, and all copyrights in such works are the property of the City. If it is ever determined that any works created by Contractor or its subcontractors under this Agreement are not works for hire under U.S. law, Contractor hereby assigns all copyrights to such works to the City, and agrees to provide any material and execute any documents necessary to effectuate such assignment. With the approval of the City, Contractor may retain and use copies of such works for reference and as documentation of its experience and capabilities.

**28. Audit and Inspection of Records.** Contractor agrees to maintain and make available to the City, during regular business hours, accurate books and accounting records relating to its work under this Agreement. Contractor will permit City to audit, examine and make excerpts and transcripts from such books and records, and to make audits of all invoices, materials, payrolls, records or personnel and other data related to all other matters covered by this Agreement, whether funded in whole or in part under this Agreement. Contractor shall maintain such data and records in an accessible location and condition for a period of not less than five years after final payment under this Agreement or until after final audit has

been resolved, whichever is later. The State of California or any federal agency having an interest in the subject matter of this Agreement shall have the same rights conferred upon City by this Section.

**29. Subcontracting.** Contractor is prohibited from subcontracting this Agreement or any part of it unless such subcontracting is first approved by City in writing. Neither party shall, on the basis of this Agreement, contract on behalf of or in the name of the other party. An agreement made in violation of this provision shall confer no rights on any party and shall be null and void.

**30. Assignment.** The services to be performed by Contractor are personal in character and neither this Agreement nor any duties or obligations hereunder may be assigned or delegated by the Contractor unless first approved by City by written instrument executed and approved in the same manner as this Agreement.

**31. Non-Waiver of Rights.** The omission by either party at any time to enforce any default or right reserved to it, or to require performance of any of the terms, covenants, or provisions hereof by the other party at the time designated, shall not be a waiver of any such default or right to which the party is entitled, nor shall it in any way affect the right of the party to enforce such provisions thereafter.

**32. Earned Income Credit (EIC) Forms.** Administrative Code section 12O requires that employers provide their employees with IRS Form W-5 (The Earned Income Credit Advance Payment Certificate) and the IRS EIC Schedule, as set forth below. Employers can locate these forms at the IRS Office, on the Internet, or anywhere that Federal Tax Forms can be found. Contractor shall provide EIC Forms to each Eligible Employee at each of the following times: (i) within thirty days following the date on which this Agreement becomes effective (unless Contractor has already provided such EIC Forms at least once during the calendar year in which such effective date falls); (ii) promptly after any Eligible Employee is hired by Contractor; and (iii) annually between January 1 and January 31 of each calendar year during the term of this Agreement. Failure to comply with any requirement contained in subparagraph (a) of this Section shall constitute a material breach by Contractor of the terms of this Agreement. If, within thirty days after Contractor receives written notice of such a breach, Contractor fails to cure such breach or, if such breach cannot reasonably be cured within such period of thirty days, Contractor fails to commence efforts to cure within such period or thereafter fails to diligently pursue such cure to completion, the City may pursue any rights or remedies available under this Agreement or under applicable law. Any Subcontract entered into by Contractor shall require the subcontractor to comply, as to the subcontractor's Eligible Employees, with each of the terms of this section. Capitalized terms used in this Section and not defined in this Agreement shall have the meanings assigned to such terms in Section 12O of the San Francisco Administrative Code.

### **33. Federal Non-Discrimination Provisions**

**Contract Assurance:** The contractor or subcontractor shall not discriminate on the basis of race, color, national origin, or sex in the performance of this contract. The contractor shall carry out applicable requirements of 49 CFR Part 21 in the award and administration of federal assisted contracts. Failure by the contractor to carry out these requirements is a material breach of this contract, which may result in the termination of this contract or such other remedy, as the recipient deems appropriate. These regulations are incorporated as though fully set forth therein. The contractor agrees to include the above statement in any subsequent concession agreement or contract that it enters and cause those businesses to similarly include the statements in further agreements.

### **34. Nondiscrimination; Penalties**

A. **Contractor Shall Not Discriminate.** In the performance of this Agreement, Contractor agrees not to discriminate against any employee, City and County employee working with such contractor or subcontractor, applicant for employment with such contractor or subcontractor, or against any person seeking accommodations, advantages, facilities, privileges, services, or membership in all business, social, or other establishments or organizations, on the basis of the fact or perception of a person's race, color, creed, religion, national origin, ancestry, age, height, weight, sex, sexual orientation, gender identity, domestic partner status, marital status, disability or Acquired Immune Deficiency Syndrome or HIV status (AIDS/HIV status), or association with members of such protected classes, or in retaliation for opposition to discrimination against such classes.

B. **Subcontracts.** Contractor shall incorporate by reference in all subcontracts the provisions of §§12B.2 (a), 12B.2(c)-(k), and 12C.3 of the San Francisco Administrative Code (copies of which are available from Purchasing) and shall require all subcontractors to comply with such provisions. Contractor's failure to comply with the obligations in this subsection shall constitute a material breach of this Agreement.

C. **Nondiscrimination in Benefits.** Contractor does not as of the date of this Agreement and will not during the term of this Agreement, in any of its operations in San Francisco, on real property owned by San Francisco, or where work is being performed for the City elsewhere in the United States, discriminate in the provision of bereavement leave, family medical leave, health benefits, membership or membership discounts, moving expenses, pension and retirement benefits or travel benefits, as well as any benefits other than the benefits specified above, between employees with domestic partners and employees with spouses, and/or between the domestic partners and spouses of such employees, where the domestic partnership has been registered with a governmental entity pursuant to state or local law authorizing such registration, subject to the conditions set forth in §12B.2(b) of the San Francisco Administrative Code.

D. **Condition to Contract.** As a condition to this Agreement, Contractor shall execute the "Chapter 12B Declaration: Nondiscrimination in Contracts and Benefits" form (form HRC-12B-101) with supporting documentation and secure the approval of the form by the San Francisco Human Rights Commission.

E. **Incorporation of Administrative Code Provisions by Reference.** The provisions of Chapters 12B and 12C of the San Francisco Administrative Code are incorporated in this Section by reference and made a part of this Agreement as though fully set forth herein. Contractor shall comply fully with and be bound by all of the provisions that apply to this Agreement under such Chapters, including but not limited to the remedies provided in such Chapters. Without limiting the foregoing, Contractor understands that pursuant to §§12B.2(h) and 12C.3(g) of the San Francisco Administrative Code, a penalty of \$50 for each person for each calendar day during which such person was discriminated against in violation of the provisions of this Agreement may be assessed against Contractor and/or deducted from any payments due Contractor.

35. **MacBride Principles—Northern Ireland.** Pursuant to San Francisco Administrative Code §12F.5, the City and County of San Francisco urges companies doing business in Northern Ireland to move towards resolving employment inequities, and encourages such companies to abide by the MacBride Principles. The City and County of San Francisco urges San Francisco companies to do business with corporations that abide by the MacBride Principles. By signing below, the person executing this agreement on behalf of Contractor acknowledges and agrees that he or she has read and understood this section.

**36. Tropical Hardwood and Virgin Redwood Ban.** Pursuant to §804(b) of the San Francisco Environment Code, the City and County of San Francisco urges contractors not to import, purchase, obtain, or use for any purpose, any tropical hardwood, tropical hardwood wood product, virgin redwood or virgin redwood wood product.

**37. Drug-Free Workplace Policy.** Contractor acknowledges that pursuant to the Federal Drug-Free Workplace Act of 1989, the unlawful manufacture, distribution, dispensation, possession, or use of a controlled substance is prohibited on City premises. Contractor agrees that any violation of this prohibition by Contractor, its employees, agents or assigns will be deemed a material breach of this Agreement.

**38. Resource Conservation.** Chapter 5 of the San Francisco Environment Code ("Resource Conservation") is incorporated herein by reference. Failure by Contractor to comply with any of the applicable requirements of Chapter 5 will be deemed a material breach of contract.

**39. Compliance with Americans with Disabilities Act.** Contractor acknowledges that, pursuant to the Americans with Disabilities Act (ADA), programs, services and other activities provided by a public entity to the public, whether directly or through a contractor, must be accessible to the disabled public. Contractor shall provide the services specified in this Agreement in a manner that complies with the ADA and any and all other applicable federal, state and local disability rights legislation. Contractor agrees not to discriminate against disabled persons in the provision of services, benefits or activities provided under this Agreement and further agrees that any violation of this prohibition on the part of Contractor, its employees, agents or assigns will constitute a material breach of this Agreement.

**40. Sunshine Ordinance.** In accordance with San Francisco Administrative Code §67.24(e), contracts, contractors' bids, responses to solicitations and all other records of communications between City and persons or firms seeking contracts, shall be open to inspection immediately after a contract has been awarded. Nothing in this provision requires the disclosure of a private person or organization's net worth or other proprietary financial data submitted for qualification for a contract or other benefit until and unless that person or organization is awarded the contract or benefit. Information provided which is covered by this paragraph will be made available to the public upon request.

**41. Public Access to Meetings and Records.** If the Contractor receives a cumulative total per year of at least \$250,000 in City funds or City-administered funds and is a non-profit organization as defined in Chapter 12L of the San Francisco Administrative Code, Contractor shall comply with and be bound by all the applicable provisions of that Chapter. By executing this Agreement, the Contractor agrees to open its meetings and records to the public in the manner set forth in §§12L.4 and 12L.5 of the Administrative Code. Contractor further agrees to make-good faith efforts to promote community membership on its Board of Directors in the manner set forth in §12L.6 of the Administrative Code. The Contractor acknowledges that its material failure to comply with any of the provisions of this paragraph shall constitute a material breach of this Agreement. The Contractor further acknowledges that such material breach of the Agreement shall be grounds for the City to terminate and/or not renew the Agreement, partially or in its entirety.

**42. Limitations on Contributions.** Through execution of this Agreement, Contractor acknowledges that it is familiar with section 1.126 of the City's Campaign and Governmental Conduct Code, which prohibits any person who contracts with the City for the rendition of personal services, for the furnishing of any material, supplies or equipment, for the sale or lease of any land or building, or for a grant, loan or loan guarantee, from making any campaign contribution to (1) an individual holding a City elective office if the contract must be approved by the individual, a board on which that individual serves, or the board of a state agency on which an appointee of that individual serves, (2) a candidate for the office held by

such individual, or (3) a committee controlled by such individual, at any time from the commencement of negotiations for the contract until the later of either the termination of negotiations for such contract or six months after the date the contract is approved. Contractor acknowledges that the foregoing restriction applies only if the contract or a combination or series of contracts approved by the same individual or board in a fiscal year have a total anticipated or actual value of \$50,000 or more. Contractor further acknowledges that the prohibition on contributions applies to each prospective party to the contract; each member of Contractor's board of directors; Contractor's chairperson, chief executive officer, chief financial officer and chief operating officer; any person with an ownership interest of more than 20 percent in Contractor; any subcontractor listed in the bid or contract; and any committee that is sponsored or controlled by Contractor. Additionally, Contractor acknowledges that Contractor must inform each of the persons described in the preceding sentence of the prohibitions contained in Section 1.126. Contractor further agrees to provide to City the names of each person, entity or committee described above.

**43. Requiring Minimum Compensation for Covered Employees.**

A. Contractor agrees to comply fully with and be bound by all of the provisions of the Minimum Compensation Ordinance (MCO), as set forth in San Francisco Administrative Code Chapter 12P (Chapter 12P), including the remedies provided, and implementing guidelines and rules. The provisions of Chapter 12P are incorporated herein by reference and made a part of this Agreement as though fully set forth. The text of the MCO is available on the web at [www.sfgov.org/olse/mco](http://www.sfgov.org/olse/mco). A partial listing of some of Contractor's obligations under the MCO is set forth in this Section. Contractor is required to comply with all the provisions of the MCO, irrespective of the listing of obligations in this Section.

B. The MCO requires Contractor to pay Contractor's employees a minimum hourly gross compensation wage rate and to provide minimum compensated and uncompensated time off. The minimum wage rate may change from year to year and Contractor is obligated to keep informed of the then-current requirements. Any subcontract entered into by Contractor shall require the subcontractor to comply with the requirements of the MCO and shall contain contractual obligations substantially the same as those set forth in this Section. It is Contractor's obligation to ensure that any subcontractors of any tier under this Agreement comply with the requirements of the MCO. If any subcontractor under this Agreement fails to comply, City may pursue any of the remedies set forth in this Section against Contractor.

C. Contractor shall not take adverse action or otherwise discriminate against an employee or other person for the exercise or attempted exercise of rights under the MCO. Such actions, if taken within 90 days of the exercise or attempted exercise of such rights, will be rebuttably presumed to be retaliation prohibited by the MCO.

D. Contractor shall maintain employee and payroll records as required by the MCO. If Contractor fails to do so, it shall be presumed that the Contractor paid no more than the minimum wage required under State law.

E. The City is authorized to inspect Contractor's job sites and conduct interviews with employees and conduct audits of Contractor

F. Contractor's commitment to provide the Minimum Compensation is a material element of the City's consideration for this Agreement. The City in its sole discretion shall determine whether such a breach has occurred. The City and the public will suffer actual damage that will be impractical or extremely difficult to determine if the Contractor fails to comply with these requirements. Contractor agrees that the sums set forth in Section 12P.6.1 of the MCO as liquidated damages are not a penalty, but



are reasonable estimates of the loss that the City and the public will incur for Contractor's noncompliance. The procedures governing the assessment of liquidated damages shall be those set forth in Section 12P.6.2 of Chapter 12P.

G. Contractor understands and agrees that if it fails to comply with the requirements of the MCO, the City shall have the right to pursue any rights or remedies available under Chapter 12P (including liquidated damages), under the terms of the contract, and under applicable law. If, within 30 days after receiving written notice of a breach of this Agreement for violating the MCO, Contractor fails to cure such breach or, if such breach cannot reasonably be cured within such period of 30 days, Contractor fails to commence efforts to cure within such period, or thereafter fails diligently to pursue such cure to completion, the City shall have the right to pursue any rights or remedies available under applicable law, including those set forth in Section 12P.6(c) of Chapter 12P. Each of these remedies shall be exercisable individually or in combination with any other rights or remedies available to the City.

H. Contractor represents and warrants that it is not an entity that was set up, or is being used, for the purpose of evading the intent of the MCO.

I. If Contractor is exempt from the MCO when this Agreement is executed because the cumulative amount of agreements with this department for the fiscal year is less than \$25,000, but Contractor later enters into an agreement or agreements that cause contractor to exceed that amount in a fiscal year, Contractor shall thereafter be required to comply with the MCO under this Agreement. This obligation arises on the effective date of the agreement that causes the cumulative amount of agreements between the Contractor and this department to exceed \$25,000 in the fiscal year.

**44. Requiring Health Benefits for Covered Employees.** Contractor agrees to comply fully with and be bound by all of the provisions of the Health Care Accountability Ordinance (HCAO), as set forth in San Francisco Administrative Code Chapter 12Q, including the remedies provided, and implementing regulations, as the same may be amended from time to time. The provisions of Chapter 12Q are incorporated by reference and made a part of this Agreement as though fully set forth herein. The text of the HCAO is available on the web at [www.sfgov.org/olse](http://www.sfgov.org/olse). Capitalized terms used in this Section and not defined in this Agreement shall have the meanings assigned to such terms in Chapter 12Q.

A. For each Covered Employee, Contractor shall provide the appropriate health benefit set forth in Section 12Q.3 of the HCAO. If Contractor chooses to offer the health plan option, such health plan shall meet the minimum standards set forth by the San Francisco Health Commission.

B. Notwithstanding the above, if the Contractor is a small business as defined in Section 12Q.3 (e) of the HCAO, it shall have no obligation to comply with part (A) above.

C. Contractor's failure to comply with the HCAO shall constitute a material breach of this agreement. City shall notify Contractor if such a breach has occurred. If, within 30 days after receiving City's written notice of a breach of this Agreement for violating the HCAO, Contractor fails to cure such breach or, if such breach cannot reasonably be cured within such period of 30 days; Contractor fails to commence efforts to cure within such period, or thereafter fails diligently to pursue such cure to completion, City shall have the right to pursue the remedies set forth in 12Q.5.1 and 12Q.5 (f) (1-6). Each of these remedies shall be exercisable individually or in combination with any other rights or remedies available to City.

D. Any Subcontract entered into by Contractor shall require the Subcontractor to comply with the requirements of the HCAO and shall contain contractual obligations substantially the same as those set forth in this Section. Contractor shall notify City's Office of Contract Administration when it enters

into such a Subcontract and shall certify to the Office of Contract Administration that it has notified the Subcontractor of the obligations under the HCAO and has imposed the requirements of the HCAO on Subcontractor through the Subcontract. Each Contractor shall be responsible for its Subcontractors' compliance with this Chapter. If a Subcontractor fails to comply, the City may pursue the remedies set forth in this Section against Contractor based on the Subcontractor's failure to comply, provided that City has first provided Contractor with notice and an opportunity to obtain a cure of the violation.

E. Contractor shall not discharge, reduce in compensation, or otherwise discriminate against any employee for notifying City with regard to Contractor's noncompliance or anticipated noncompliance with the requirements of the HCAO, for opposing any practice proscribed by the HCAO, for participating in proceedings related to the HCAO, or for seeking to assert or enforce any rights under the HCAO by any lawful means.

F. Contractor represents and warrants that it is not an entity that was set up, or is being used, for the purpose of evading the intent of the HCAO.

G. Contractor shall maintain employee and payroll records in compliance with the California Labor Code and Industrial Welfare Commission orders, including the number of hours each employee has worked on the City Contract.

H. Contractor shall keep itself informed of the current requirements of the HCAO.

I. Contractor shall provide reports to the City in accordance with any reporting standards promulgated by the City under the HCAO, including reports on Subcontractors and Subtenants, as applicable.

J. Contractor shall provide City with access to records pertaining to compliance with HCAO after receiving a written request from City to do so and being provided at least ten business days to respond.

K. Contractor shall allow City to inspect Contractor's job sites and have access to Contractor's employees in order to monitor and determine compliance with HCAO.

L. City may conduct random audits of Contractor to ascertain its compliance with HCAO. Contractor agrees to cooperate with City when it conducts such audits.

M. If Contractor is exempt from the HCAO when this Agreement is executed because its amount is less than \$25,000 (\$50,000 for nonprofits), but Contractor later enters into an agreement or agreements that cause Contractor's aggregate amount of all agreements with City to reach \$75,000, all the agreements shall be thereafter subject to the HCAO. This obligation arises on the effective date of the agreement that causes the cumulative amount of agreements between Contractor and the City to be equal to or greater than \$75,000 in the fiscal year.

#### **45. First Source Hiring Program**

A. **Application of Administrative Code Provisions.** The provisions of Chapter 83 of the San Francisco Administrative Code apply to this Agreement. Contractor shall comply fully with, and be bound by, all of the provisions that apply to this Agreement under such Chapter, including but not limited to the remedies provided therein. Capitalized terms used in this Section and not defined in this Agreement shall have the meanings assigned to such terms in Chapter 83.

**B. First Source Hiring Agreement.** As an essential term of, and consideration for, any contract or property contract with the City, not exempted by the FSHA, the Contractor shall enter into a first source hiring agreement ("agreement") with the City, on or before the effective date of the contract or property contract. Contractors shall also enter into an agreement with the City for any other work that it performs in the City. Such agreement shall:

(1) Set appropriate hiring and retention goals for entry level positions. The employer shall agree to achieve these hiring and retention goals, or, if unable to achieve these goals, to establish good faith efforts as to its attempts to do so, as set forth in the agreement. The agreement shall take into consideration the employer's participation in existing job training, referral and/or brokerage programs. Within the discretion of the FSHA, subject to appropriate modifications, participation in such programs maybe certified as meeting the requirements of this Chapter. Failure either to achieve the specified goal or to establish good faith efforts will constitute noncompliance and will subject the employer to the provisions of Section 83.10 of this Chapter.

(2) Set first source interviewing, recruitment and hiring requirements, which will provide the San Francisco Workforce Development System with the first opportunity to provide qualified economically disadvantaged individuals for consideration for employment for entry level positions. Employers shall consider all applications of qualified economically disadvantaged individuals referred by the System for employment; provided however, if the employer utilizes nondiscriminatory screening criteria, the employer shall have the sole discretion to interview and/or hire individuals referred or certified by the San Francisco Workforce Development System as being qualified economically disadvantaged individuals. The duration of the first source interviewing requirement shall be determined by the FSHA and shall be set forth in each agreement, but shall not exceed 10 days. During that period, the employer may publicize the entry level positions in accordance with the agreement. A need for urgent or temporary hires must be evaluated, and appropriate provisions for such a situation must be made in the agreement.

(3) Set appropriate requirements for providing notification of available entry level positions to the San Francisco Workforce Development System so that the System may train and refer an adequate pool of qualified economically disadvantaged individuals to participating employers. Notification should include such information as employment needs by occupational title, skills, and/or experience required, the hours required, wage scale and duration of employment, identification of entry level and training positions, identification of English language proficiency requirements, or absence thereof, and the projected schedule and procedures for hiring for each occupation. Employers should provide both long-term job need projections and notice before initiating the interviewing and hiring process. These notification requirements will take into consideration any need to protect the employer's proprietary information.

(4) Set appropriate record keeping and monitoring requirements. The First Source Hiring Administration shall develop easy-to-use forms and record keeping requirements for documenting compliance with the agreement. To the greatest extent possible, these requirements shall utilize the employer's existing record keeping systems, be non-duplicative, and facilitate a coordinated flow of information and referrals.

(5) Establish guidelines for employer good faith efforts to comply with the first source hiring requirements of this Chapter. The FSHA will work with City departments to develop employer good faith effort requirements appropriate to the types of contracts and property contracts handled by each department. Employers shall appoint a liaison for dealing with the development and implementation of the employer's agreement. In the event that the FSHA finds that the employer under a City contract or

property contract has taken actions primarily for the purpose of circumventing the requirements of this Chapter, that employer shall be subject to the sanctions set forth in Section 83.10 of this Chapter.

- (6) Set the term of the requirements.
- (7) Set appropriate enforcement and sanctioning standards consistent with this Chapter.
- (8) Set forth the City's obligations to develop training programs, job applicant referrals, technical assistance, and information systems that assist the employer in complying with this Chapter.
- (9) Require the developer to include notice of the requirements of this Chapter in leases, subleases, and other occupancy contracts.

C. **Hiring Decisions.** Contractor shall make the final determination of whether an Economically Disadvantaged Individual referred by the System is "qualified" for the position.

D. **Exceptions.** Upon application by Employer, the First Source Hiring Administration may grant an exception to any or all of the requirements of Chapter 83 in any situation where it concludes that compliance with this Chapter would cause economic hardship.

E. **Liquidated Damages.** Contractor agrees:

- (1) To be liable to the City for liquidated damages as provided in this section;
- (2) To be subject to the procedures governing enforcement of breaches of contracts based on violations of contract provisions required by this Chapter as set forth in this section;
- (3) That the contractor's commitment to comply with this Chapter is a material element of the City's consideration for this contract; that the failure of the contractor to comply with the contract provisions required by this Chapter will cause harm to the City and the public which is significant and substantial but extremely difficult to quantify; that the harm to the City includes not only the financial cost of funding public assistance programs but also the insidious but impossible to quantify harm that this community and its families suffer as a result of unemployment; and that the assessment of liquidated damages of up to \$5,000 for every notice of a new hire for an entry level position improperly withheld by the contractor from the first source hiring process, as determined by the FSHA during its first investigation of a contractor, does not exceed a fair estimate of the financial and other damages that the City suffers as a result of the contractor's failure to comply with its first source referral contractual obligations.
- (4) That the continued failure by a contractor to comply with its first source referral contractual obligations will cause further significant and substantial harm to the City and the public, and that a second assessment of liquidated damages of up to \$10,000 for each entry level position improperly withheld from the FSHA, from the time of the conclusion of the first investigation forward, does not exceed the financial and other damages that the City suffers as a result of the contractor's continued failure to comply with its first source referral contractual obligations;
- (5) That in addition to the cost of investigating alleged violations under this Section, the computation of liquidated damages for purposes of this section is based on the following data:

(a) The average length of stay on public assistance in San Francisco's County Adult Assistance Program is approximately 41 months at an average monthly grant of \$348 per month, totaling approximately \$14,379; and

(b) In 2004, the retention rate of adults placed in employment programs funded under the Workforce Investment Act for at least the first six months of employment was 84.4%. Since qualified individuals under the First Source program face far fewer barriers to employment than their counterparts in programs funded by the Workforce Investment Act, it is reasonable to conclude that the average length of employment for an individual whom the First Source Program refers to an employer and who is hired in an entry level position is at least one year;

therefore, liquidated damages that total \$5,000 for first violations and \$10,000 for subsequent violations as determined by FSHA constitute a fair, reasonable, and conservative attempt to quantify the harm caused to the City by the failure of a contractor to comply with its first source referral contractual obligations.

(6) That the failure of contractors to comply with this Chapter, except property contractors, may be subject to the debarment and monetary penalties set forth in Sections 6.80 et seq. of the San Francisco Administrative Code, as well as any other remedies available under the contract or at law; and

Violation of the requirements of Chapter 83 is subject to an assessment of liquidated damages in the amount of \$5,000 for every new hire for an Entry Level Position improperly withheld from the first source hiring process. The assessment of liquidated damages and the evaluation of any defenses or mitigating factors shall be made by the FSHA.

F. **Subcontracts.** Any subcontract entered into by Contractor shall require the subcontractor to comply with the requirements of Chapter 83 and shall contain contractual obligations substantially the same as those set forth in this Section.

**46. Prohibition on Political Activity with City Funds.** In accordance with San Francisco Administrative Code Chapter 12.G, Contractor may not participate in, support, or attempt to influence any political campaign for a candidate or for a ballot measure (collectively, "Political Activity") in the performance of the services provided under this Agreement. Contractor agrees to comply with San Francisco Administrative Code Chapter 12.G and any implementing rules and regulations promulgated by the City's Controller. The terms and provisions of Chapter 12.G are incorporated herein by this reference. In the event Contractor violates the provisions of this section, the City may, in addition to any other rights or remedies available hereunder, (i) terminate this Agreement, and (ii) prohibit Contractor from bidding on or receiving any new City contract for a period of two (2) years. The Controller will not consider Contractor's use of profit as a violation of this section.

**47. Preservative-treated Wood Containing Arsenic.** Contractor may not purchase preservative-treated wood products containing arsenic in the performance of this Agreement unless an exemption from the requirements of Chapter 13 of the San Francisco Environment Code is obtained from the Department of the Environment under Section 1304 of the Code. The term "preservative-treated wood containing arsenic" shall mean wood treated with a preservative that contains arsenic, elemental arsenic, or an arsenic copper combination, including, but not limited to, chromated copper arsenate preservative, ammoniacal copper zinc arsenate preservative, or ammoniacal copper arsenate preservative. Contractor may purchase preservative-treated wood products on the list of environmentally preferable alternatives prepared and adopted by the Department of the Environment. This provision does not preclude Contractor from purchasing preservative-treated wood containing arsenic for saltwater immersion. The term

“saltwater immersion” shall mean a pressure-treated wood that is used for construction purposes or facilities that are partially or totally immersed in saltwater.

**48. Modification of Agreement.** This Agreement may not be modified, nor may compliance with any of its terms be waived, except by written instrument executed and approved in the same manner as this Agreement. Contractor shall complete and submit an Airport Federal Contract Modification – Federal Form 4 with every Modification of the Agreement.

**49. Administrative Remedy for Agreement Interpretation.** Should any question arise as to the meaning and intent of this Agreement, the question shall, prior to any other action or resort to any other legal remedy, be referred to Purchasing who shall decide the true meaning and intent of the Agreement.

**50. Agreement Made in California; Venue.** The formation, interpretation and performance of this Agreement shall be governed by the laws of the State of California. Venue for all litigation relative to the formation, interpretation and performance of this Agreement shall be in San Francisco.

**51. Construction.** All paragraph captions are for reference only and shall not be considered in construing this Agreement.

**52. Entire Agreement.** This contract sets forth the entire Agreement between the parties, and supersedes all other oral or written provisions. This contract may be modified only as provided in Section 48, “Modification of Agreement.”

**53. Compliance with Laws.** Contractor shall keep itself fully informed of the City’s Charter, codes, ordinances and regulations of the City and of all state, and federal laws in any manner affecting the performance of this Agreement, and must at all times comply with such local codes, ordinances, and regulations and all applicable laws as they may be amended from time to time.

**54. Services Provided by Attorneys.** Any services to be provided by a law firm or attorney must be reviewed and approved in writing in advance by the City Attorney. No invoices for services provided by law firms or attorneys, including, without limitation, as subcontractors of Contractor, will be paid unless the provider received advance written approval from the City Attorney.

**55. Supervision of Minors: Left Blank by Agreement of the Parties – Contract Does Not Involve Supervision of Minors.**

**56. Severability.** Should the application of any provision of this Agreement to any particular facts or circumstances be found by a court of competent jurisdiction to be invalid or unenforceable, then (a) the validity of other provisions of this Agreement shall not be affected or impaired thereby, and (b) such provision shall be enforced to the maximum extent possible so as to effect the intent of the parties and shall be reformed without further action by the parties to the extent necessary to make such provision valid and enforceable.

**57. Protection of Private Information.** Contractor has read and agrees to the terms set forth in San Francisco Administrative Code Sections 12M.2, “Nondisclosure of Private Information,” and 12M.3, “Enforcement” of Administrative Code Chapter 12M, “Protection of Private Information,” which are incorporated herein as if fully set forth. Contractor agrees that any failure of Contractor to comply with the requirements of Section 12M.2 of this Chapter shall be a material breach of the Contract. In such an event, in addition to any other remedies available to it under equity or law, the City may terminate the Contract, bring a false claim action against the Contractor pursuant to Chapter 6 or Chapter 21 of the Administrative Code, or debar the Contractor.

**58. Graffiti Removal.** Graffiti is detrimental to the health, safety and welfare of the community in that it promotes a perception in the community that the laws protecting public and private property can be disregarded with impunity. This perception fosters a sense of disrespect of the law that results in an increase in crime; degrades the community and leads to urban blight; is detrimental to property values, business opportunities and the enjoyment of life; is inconsistent with the City's property maintenance goals and aesthetic standards; and results in additional graffiti and in other properties becoming the target of graffiti unless it is quickly removed from public and private property. Graffiti results in visual pollution and is a public nuisance. Graffiti must be abated as quickly as possible to avoid detrimental impacts on the City and County and its residents, and to prevent the further spread of graffiti. Contractor shall remove all graffiti from any real property owned or leased by Contractor in the City and County of San Francisco within forty eight (48) hours of the earlier of Contractor's (a) discovery or notification of the graffiti or (b) receipt of notification of the graffiti from the Department of Public Works. This section is not intended to require a Contractor to breach any lease or other agreement that it may have concerning its use of the real property. The term "graffiti" means any inscription, word, figure, marking or design that is affixed, marked, etched, scratched, drawn or painted on any building, structure, fixture or other improvement, whether permanent or temporary, including by way of example only and without limitation, signs, banners, billboards and fencing surrounding construction sites, whether public or private, without the consent of the owner of the property or the owner's authorized agent, and which is visible from the public right-of-way. "Graffiti" shall not include: (1) any sign or banner that is authorized by, and in compliance with, the applicable requirements of the San Francisco Public Works Code, the San Francisco Planning Code or the San Francisco Building Code; or (2) any mural or other painting or marking on the property that is protected as a work of fine art under the California Art Preservation Act (California Civil Code Sections 987 et seq.) or as a work of visual art under the Federal Visual Artists Rights Act of 1990 (17 U.S.C. §§ 101 et seq.).

Any failure of Contractor to comply with this section of this Agreement shall constitute an Event of Default of this Agreement.

**59. Food Service Waste Reduction Requirements.** Effective June 1, 2007, Contractor agrees to comply fully with and be bound by all of the provisions of the Food Service Waste Reduction Ordinance, as set forth in San Francisco Environment Code Chapter 16, including the remedies provided, and implementing guidelines and rules. The provisions of Chapter 16 are incorporated herein by reference and made a part of this Agreement as though fully set forth. This provision is a material term of this Agreement. By entering into this Agreement, Contractor agrees that if it breaches this provision, City will suffer actual damages that will be impractical or extremely difficult to determine; further, Contractor agrees that the sum of one hundred dollars (\$100) liquidated damages for the first breach, two hundred dollars (\$200) liquidated damages for the second breach in the same year, and five hundred dollars (\$500) liquidated damages for subsequent breaches in the same year is reasonable estimate of the damage that City will incur based on the violation, established in light of the circumstances existing at the time this Agreement was made. Such amount shall not be considered a penalty, but rather agreed monetary damages sustained by City because of Contractor's failure to comply with this provision.

**60. Slavery Era Disclosure: Left Blank by Agreement of the Parties – Contract Not for Insurance or Applicable Financial Services or Textiles.**

**61. Cooperative Drafting.** This Agreement has been drafted through a cooperative effort of both parties, and both parties have had an opportunity to have the Agreement reviewed and revised by legal counsel. No party shall be considered the drafter of this Agreement, and no presumption or rule that an ambiguity shall be construed against the party drafting the clause shall apply to the interpretation or enforcement of this Agreement.

**62. Dispute Resolution Procedure: Left Blank by Agreement of the Parties – Contract Not with Health or Human Services Nonprofit.**

**63. Airport Intellectual Property**

Pursuant to Resolution No. 01-0118, adopted by the Airport Commission on April 18, 2001, the Airport Commission affirmed that it will not tolerate the unauthorized use of its intellectual property, including the SFO logo, CADD designs, and copyrighted publications. All proposers, bidders, contractors, tenants, permittees, and others doing business with or at the Airport (including subcontractors and subtenants) may not use the Airport intellectual property, or any intellectual property confusingly similar to the Airport intellectual property, without the Airport Director's prior consent.

**64. Labor Peace / Card Check Rule**

Without limiting the generality of other provisions herein requiring Contractor to comply with all Airport Rules, Contractor shall comply with the Airport's Labor Peace / Card Check Rule, adopted on February 1, 2000, pursuant to Airport Commission Resolution No. 00-0049 (the "Labor Peace / Card Check Rule"). Capitalized terms not defined in this provision are defined in the Labor Peace/Card Check Rule. To comply with the Labor Peace/Care Check Rule, Contractor shall, among other actions: (a) Enter into a Labor Peace/Care Check Rule Agreement with any Labor Organization which requests such an agreement and which has registered with the Airport Director or his / her designee, within thirty (30) days after Labor Peace/Care Check Rule Agreement has been requested; (b) Not less than thirty (30) days prior to the modification of this Agreement, Contractor shall provide notice by mail to any Labor Organization or federation of labor organizations which have registered with the Airport Director or his / her designee (registered labor organization"), that Contractor is seeking to modify or extend this Agreement; (c) Upon issuing any request for proposals, invitations to bid, or similar notice, or in any event not less than thirty (30) days prior to entering into any Subcontract, Contractor shall provide notice to all registered Labor Organizations that Contractor is seeking to enter into such Subcontract; and (d) Contractor shall include in any subcontract with a Subcontractor performing services pursuant to any covered Contract, a provision requiring the Subcontractor performing services pursuant to any covered Contract, a provision requiring the Subcontractor to comply with the requirements of the Labor Peace/Card Check Rule. If Airport Director determines that Contractor violated the Labor Peace/Card Check Rule, Airport Director shall have the option to terminate this Agreement, in addition to exercising all other remedies available to him / her.

**65. FEDERAL CONTRACT PROVISIONS**

**The following provisions included in subparts A-J below in this section 65 are clauses that shall be included without modification in this Agreement**

**A. PROMPT PAYMENT**

**Prompt Payment** - The prime contractor agrees to pay each subcontractor under this prime contract for satisfactory performance of its contract no later than 30 days from the receipt of each payment the prime contractor receives from the City and County of San Francisco. The prime contractor agrees further to return retention payments to each subcontractor within 10 days after the subcontractor's work is satisfactorily completed. Any delay or postponement of payment from the above referenced time frame may occur only for good cause following written approval of the City and County of San Francisco.



## B. CIVIL RIGHTS ACT OF 1964, TITLE VI – CONTRACTOR CONTRACTUAL REQUIREMENTS

During the performance of this contract, the Contractor, for itself, its assignees and successors in interest (hereinafter referred to as the "Contractor") agrees as follows:

**1. Compliance with Regulations.** The contractor shall comply with the Regulations relative to nondiscrimination in federally assisted Projects of the Department of Transportation (hereinafter, "DOT") Title 49, Code of Federal Regulations, Part 21, as they may be amended from time to time (hereinafter referred to as the Regulations), which are herein incorporated by reference and made a part of this contract.

**2. Nondiscrimination.** The contractor, with regard to the work performed by it during the contract, shall not discriminate on the grounds of race, color, or national origin in the selection and retention of subcontractors, including procurements of materials and leases of equipment. The contractor shall not participate either directly or indirectly in the discrimination prohibited by section 21.5 of the Regulations, including employment practices when the contract covers a Project set forth in Appendix B of the Regulations.

**3. Solicitations for Subcontracts, Including Procurements of Materials and Equipment.** In all solicitations either by competitive bidding or negotiation made by the contractor for work to be performed under a subcontract, including procurements of materials or leases of equipment, each potential subcontractor or supplier shall be notified by the contractor of the contractor's obligations under this contract and the Regulations relative to nondiscrimination on the grounds of race, color, or national origin.

**4. Information and Reports.** The contractor shall provide all information and reports required by the Regulations or directives issued pursuant thereto and shall permit access to its books, records, accounts, other sources of information and its facilities as may be determined by the Airport or the Transportation Security Administration (TSA) to be pertinent to ascertain compliance with such Regulations, orders, and instructions. Where any information required of a contractor is in the exclusive possession of another who fails or refuses to furnish this information, the contractor shall so certify to the Airport or the TSA, as appropriate, and shall set forth what efforts it has made to obtain the information.

**5. Sanctions for Noncompliance.** In the event of the contractor's noncompliance with the nondiscrimination provisions of this contract, the Airport shall impose such contract sanctions as it or the TSA may determine to be appropriate, including, but not limited to:

a. Withholding of payments to the contractor under the contract until the contractor complies, and/or

b. Cancellation, termination, or suspension of the contract, in whole or in part.

**6. Incorporation of Provisions.** The contractor shall include the provisions of paragraphs 1 through 5 in every subcontract, including procurements of materials and leases of equipment, unless exempt by the Regulations or directives issued pursuant thereto. The contractor shall take such action with respect to any subcontract or procurement as the Airport or the TSA may direct as a means of enforcing such provisions including sanctions for noncompliance. Provided, however, that in the event a contractor becomes involved in, or is threatened with, litigation with a subcontractor or supplier as a result of such direction, the contractor may request the Airport to enter into such litigation to protect the

interests of the Airport and, in addition, the contractor may request the United States to enter into such litigation to protect the interests of the United States.

**C. AIRPORT AND AIRWAY IMPROVEMENT ACT OF 1982, SECTION 520 - GENERAL CIVIL RIGHTS PROVISIONS**

The contractor assures that it will comply with pertinent statutes, Executive orders and such rules as are promulgated to assure that no person shall, on the grounds of race, creed, color, national origin, sex, age, or handicap be excluded from participating in any activity conducted with or benefiting from Federal assistance. This provision obligates the tenant/concessionaire/lessee or its transferee for the period during which Federal assistance is extended to the airport a Project, except where Federal assistance is to provide, or is in the form of personal property or real property or interest therein or structures or improvements thereon. In these cases the provision obligates the party or any transferee for the longer of the following periods: (a) the period during which the property is used by the Airport or any transferee for a purpose for which Federal assistance is extended, or for another purpose involving the provision of similar services or benefits or (b) the period during which the Airport or any transferee retains ownership or possession of the property. In the case of contractors, this provision binds the contractors from the bid solicitation period through the completion of the contract. This provision is in addition to that required of Title VI of the Civil Rights Act of 1964.

**D. LOBBYING AND INFLUENCING FEDERAL EMPLOYEES**

1. No Federal appropriated funds shall be paid, by or on behalf of the contractor, to any person for influencing or attempting to influence an officer or employee of any agency, a Member of Congress, an officer or employee of Congress, or an employee of a Member of Congress in connection with the making of any Federal grant and the amendment or modification of any Federal grant.

2. If any funds other than Federal appropriated funds have been paid or will be paid to any person for influencing or attempting to influence an officer or employee of any agency, a Member of Congress, an officer or employee of Congress, or an employee of a Member of Congress in connection with any Federal grant, the contractor shall complete and submit Standard Form-LLL, "Disclosure of Lobby Activities," in accordance with its instructions.

**E. ACCESS TO RECORDS AND REPORTS**

The Contractor shall maintain an acceptable cost accounting system. The Contractor agrees to provide the Airport, the TSA and the Comptroller General of the United States or any of their duly authorized representative's access to any books, documents, papers, and records of the contractor which are directly pertinent to the specific contract for the purpose of making audit, examination, excerpts and transcriptions. The Contractor agrees to maintain all books, records and reports required under this contract for a period of not less than three years after final payment is made and all pending matters are closed.

**F. BREACH OF CONTRACT TERMS**

Any violation or breach of terms of this contract on the part of the contractor or their subcontractors may result in the suspension or termination of this contract or such other action that may be necessary to enforce the rights of the parties of this agreement. The duties and obligations imposed by the Agreement and the rights and remedies available thereunder shall be in addition to and not a limitation of any duties, obligations, rights and remedies otherwise imposed or available by law.

## G. RIGHTS TO INVENTIONS

All rights to inventions and materials generated under this contract are subject to regulations issued by the TSA and the Sponsor of the Federal grant under which this contract is executed.

## H. TRADE RESTRICTION CLAUSE

1. The contractor or subcontractor, by submission of an offer and/or execution of a contract, certifies that it:

a. Is not owned or controlled by one or more citizens of a foreign country included in the list of countries that discriminate against U.S. firms published by the Office of the United States Trade Representative (USTR);

b. Has not knowingly entered into any contract or subcontract for this project with a person that is a citizen or national of a foreign country on said list, or is owned or controlled directly or indirectly by one or more citizens or nationals of a foreign country on said list;

c. Has not procured any product nor subcontracted for the supply of any product for use on the project that is produced in a foreign country on said list.

2. Unless the restrictions of this clause are waived by the Secretary of Transportation in accordance with 49 CFR 30.17, no contract shall be awarded to a contractor or subcontractor who is unable to certify to the above. If the contractor knowingly procures or subcontracts for the supply of any product or service of a foreign country on said list for use on the project, the TSA may direct through the Airport cancellation of the contract at no cost to the Government.

3. Further, the contractor agrees that, if awarded a contract resulting from this solicitation, it will incorporate this provision for certification without modification in each contract and in all lower tier subcontracts. The contractor may rely on the certification of a prospective subcontractor unless it has knowledge that the certification is erroneous.

4. The contractor shall provide immediate written notice to the Airport if the contractor learns that its certification or that of a subcontractor was erroneous when submitted or has become erroneous by reason of changed circumstances. The subcontractor agrees to provide written notice to the contractor if at any time it learns that its certification was erroneous by reason of changed circumstances.

a. This certification is a material representation of fact upon which reliance was placed when making the award. If it is later determined that the contractor or subcontractor knowingly rendered an erroneous certification, the TSA may direct through the Airport cancellation of the contract or subcontract for default at no cost to the Government.

5. Nothing contained in the foregoing shall be construed to require establishment of a system of records in order to render, in good faith, the certification required by this provision. The knowledge and information of a contractor is not required to exceed that which is normally possessed by a prudent person in the ordinary course of business dealings.

6. This certification concerns a matter within the jurisdiction of an agency of the United States of America and the making of a false, fictitious, or fraudulent certification may render the maker subject to prosecution under Title 18, United States Code, Section 1001.

## **I. TERMINATION OF CONTRACT**

1. The Airport may, by written notice, terminate this contract in whole or in part at any time, either for the Airport's convenience or because of failure to fulfill the contract obligations. Upon receipt of such notice services shall be immediately discontinued (unless the notice directs otherwise) and all materials as may have been accumulated in performing this contract, whether completed or in progress, delivered to the Airport.

2. If the termination is for the convenience of the Airport, an equitable adjustment in the contract price shall be made, but no amount shall be allowed for anticipated profit on unperformed services.

3. If the termination is due to failure to fulfill the contractor's obligations, the Airport may take over the work and prosecute the same to completion by contract or otherwise. In such case, the contractor shall be liable to the Airport for any additional cost occasioned to the Airport thereby.



4. If, after notice of termination for failure to fulfill contract obligations, it is determined that the contractor had not so failed, the termination shall be deemed to have been effected for the convenience of the Airport. In such event, adjustment in the contract price shall be made as provided in paragraph 1.2 of this clause.

5. The rights and remedies of the Airport provided in this clause are in addition to any other rights and remedies provided by law or under this contract.

## **J. CERTIFICATION REGARDING DEBARMENT, SUSPENSION, INELIGIBILITY AND VOLUNTARY EXCLUSION**

The Proposer certifies, by submission of this proposal or acceptance of this contract, that neither it nor its principals is presently debarred, suspended, proposed for debarment, declared ineligible, or voluntarily excluded from participation in this transaction by any Federal department or agency. It further agrees by submitting this proposal that it will include this clause without modification in all lower tier transactions, solicitations, proposals, contracts, and subcontracts. Where the Proposer or any lower tier participant is unable to certify to this statement, it shall attach an explanation to this solicitation/proposal.

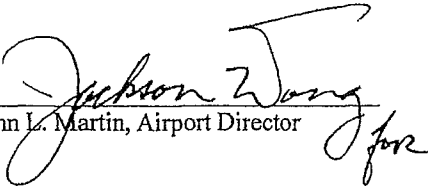
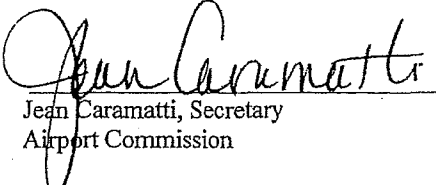
IN WITNESS WHEREOF, the parties hereto have executed this Agreement on the day first mentioned above.

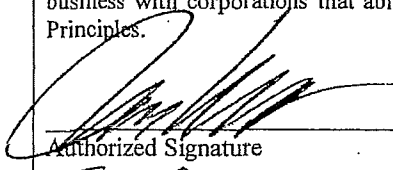
<p><b>CITY</b> AIRPORT COMMISSION CITY AND COUNTY OF SAN FRANCISCO</p> <p> John L. Martin, Airport Director</p> <p>Attest:</p> <p>By  Jean Caramatti, Secretary Airport Commission</p> <p>Resolution No: 11-0146</p> <p>Adopted on: June 30, 2011</p> <p>Approved as to Form:</p> <p>Dennis J. Herrera City Attorney</p> <p>By  Kathryn Luhe Deputy City Attorney</p>	<p><b>CONTRACTOR</b></p> <p>By signing this Agreement, I certify that I comply with the requirements of the Minimum Compensation Ordinance, which entitle Covered Employees to certain minimum hourly wages and compensated and uncompensated time off.</p> <p>I have read and understood paragraph 35, the City's statement urging companies doing business in Northern Ireland to move towards resolving employment inequities, encouraging compliance with the MacBride Principles, and urging San Francisco companies to do business with corporations that abide by the MacBride Principles.</p> <p> Authorized Signature</p> <p>John Boosie Printed Name</p> <p>PRESIDENT Title</p> <p>CAGE Professional Services, Inc. Company Name</p> <p>81238 City Vendor Number</p> <p>6303 Commerce Drive, Suite 150 Address</p> <p>Irving, Texas 75063 City, State, ZIP</p> <p>(972) 550-1001 Telephone Number</p> <p>75-2722503 Federal Employer ID Number</p>
--	--

**Appendices**

- A: Services to be provided by Contractor
- B: Calculation of Charges

- B.1: Provisional Cost Rate Agreement
- C.1: Approved Task 1 cost proposal and rates
- C.2: Approved staffing plan
- C.3: SFO 9024.9 FAR Rate Schedule
- D: Other Transaction Agreement (OTA)

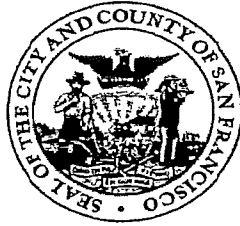

**Appendix A**  
**Services to be provided by Contractor**

**1. INTRODUCTION**

**PROJECT DESCRIPTION:**

The following is a general project description for the International Terminal and Terminal 3, Boarding Area F Checked Baggage Inspection System Modernization and International Terminal Baggage Handling System Improvements Project (Project), Task One. The Airport reserves the right to amend this description and intends to amend the Scope of Services for the Project to include Tasks Two and Three when and if funds are appropriated for those tasks.

- A. International Terminal Checked Baggage Inspection System (CBIS) Modernization.** The International Terminal common use terminal systems are shared by twenty six airlines and operated and maintained by an airline consortium contractor (SFOTEC), including the Baggage Handling System (BHS). Two existing checked baggage inspection system (CBIS) areas are not in compliance with the Transportation Security Administration's (TSA) current Planning Design Guidelines (PGDS), and the TSA screening equipment is at the end of its useful life. The CBIS improvements will include: new TSA screening equipment with higher throughput; new servers, new network and programmable logic controls (PLC); new distributed input/output (I/O) controls; new Human Machine Interface (HMI); new and reconfigured baggage conveyor equipment; and new and relocated Checked Bag Reconciliation Areas (CBRA's). The two CBRA's will be moved from the ground floor up to two existing structural mezzanines, and will be enclosed in new air conditioned rooms with vertical transportation.
- B. Terminal 3 Boarding Area F CBIS Modernization.** The Terminal 3 Boarding Area F BHS is operated and maintained by United Airlines (UA). UA has the largest operation at the Airport, with approximately 45% of all passengers. The existing CBIS area is not in compliance with the TSA's PGDS, and the TSA screening equipment is at the end of its useful life. The CBIS improvements will include: new TSA screening equipment with higher throughput; new servers, new network and PLC; new I/O controls; new HMI; new and reconfigured baggage conveyor equipment; and a new and relocated CBRA. The CBRA will be moved to a temporary building to be constructed on the airfield to allow for phasing. The permanent CBRA will be enclosed in a new air conditioned room within the existing Boarding Area F.
- C. International Terminal BHS Improvements.**

The common use International Terminal BHS includes twelve ticket islands, twenty four outbound makeup devices, and oversize and transfer bag systems. The common use inbound BHS

includes twelve drop off and claim carrousel. The common use terminal management system, baggage sortation system and airline tag readers were recently replaced. The Airport will consider adding RFID technology. Other portions of the BHS are obsolete and at the end of its useful life. The International Terminal BHS improvements will include: new servers, new network and PLC; new HMI; new I/O controls; new high speed/capacity diverters to replace pushers; variable frequency drives and other energy-saving equipment.

#### **D. General**

- 1) The Airport and the TSA have entered into an Other Transaction Agreement No. HSTS04-11-H-CT1149 (OTA), executed on March 23, 2011, to define roles and responsibilities and develop a budget and funding plan for the development of CBIS design documents and construction management design support services. Thereafter, these design documents will serve as bridging documents for the design-build portion of the International Terminal and Terminal 3, Boarding Area F CBIS modernization work. The executed OTA will become part of the Contractor's agreement (Appendix D) and the Contractor will be responsible for the management, reporting, implementation, and ensuring Airport compliance with the terms and conditions of the OTA. The TSA is committed to funding 90% of the costs for the International Terminal and Terminal 3, Boarding Area F CBIS modernization design bridging documents.
- 2) Following its completion and approval of the CBIS design bridging documentation, the TSA and Airport intend to enter into an additional OTA which will fund design-build services and the remaining construction management services. This subsequent OTA will define roles and responsibilities for the final design, construction and TSA's commissioning and acceptance of the Project

## **2. CONSTRUCTION MANAGEMENT SCOPE DESCRIPTION:**

### **Task 1 – Contractor Services for International Terminal and Terminal 3, Boarding Area F CBIS Modernization and International Terminal BHS Improvements Design.**

The Contractor will provide the following services for Task 1:

- A. Provide 30% and 70% design submittal technical reviews for constructability, functionality, value engineering, building code and PGDS compliance for the International Terminal and Terminal 3, Boarding Area F CBIS Modernization, including baggage handling systems, architectural, structural, vertical transportation, mechanical, electrical, fire protection and special systems.
- B. Provide 30% and 70% design submittal technical reviews for constructability, functionality, value engineering and building code compliance for the International Terminal BHS Improvements, including baggage handling systems, structural, mechanical, electrical, fire protection and special systems.
- C. Track and document all design review comments by the TSA, Airport, airlines and other stakeholders.
- D. Review and validate the Airport design consultant's cost estimates with current industry pricing.



- E. Provide scheduling analysis for the design, design-build contractor selection, and procurement, installation and certification process. Scheduling analysis will emphasize construction phasing in an operational environment.
- F. Provide monthly status, cost and schedule reports in accordance with TSA and Airport guidelines.
- G. Prepare invoice summaries, with a separate accounting system for all costs that are eligible for reimbursement by the TSA under the OTA. Assist the Airport in preparing invoices to the TSA.
- H. Provide technical assistance to the Airport in the preparation of a Request for Proposal (RFP) for the design-build contractor.
- I. Initiate meetings and communication with all stakeholders to achieve a collaborative process.
- J. Provide timely meeting reports and an issues/action log, with responsible party and due dates.
- K. Provide administrative support to the Airport Project Manager (PM). Initiate communication with the PM first as a pre-requisite to discussions with other Airport, airline and TSA management.

### **3. REPORTS**

Contractor shall submit written reports as requested by the Design & Construction. Format for the content of such reports shall be determined by the Design & Construction. The timely submission of all reports is a necessary and material term and condition of this Agreement. The reports, including any copies, shall be submitted on recycled paper and printed on double-sided pages to the maximum extent possible.

### **4. DEPARTMENT LIAISON**

In performing the services provided for in this Agreement, Contractor's liaison with the Design & Construction will be Tom Rodrigues.

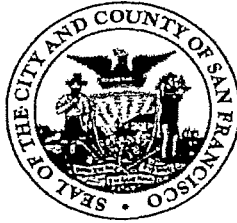

## Appendix B Calculation of Charges

This is Appendix B attached to, and incorporated by reference in the Agreement made on **June 30, 2011** between the City and County of San Francisco, acting by and through its Airport Commission (Commission), and **CAGE Professional Services Inc.** (Contractor) providing for construction management services for the International Terminal and Terminal 3, Boarding Area F Checked Baggage Inspection System Modernization and International Terminal Baggage Handling System Improvements Project, Task One

### A. General

1. For the compensation for complete and satisfactory performance of the **Task 1** services detailed in Section 2.A of Appendix A of this Agreement are set forth in paragraph 5.A. "Compensation" of the Agreement.
2. No charges shall be incurred under this Agreement nor shall any payments become due to the Contractor until reports, services, or both required under this Agreement are received from the Contractor and approved by the Commission as being in accordance with this Agreement. In no event shall the Commission be liable for interest or late charges for any late payments.
3. Compensation for work performed under this Agreement will be on a cost-plus-fee payment basis. Such compensation shall be allowable only to the extent that costs incurred, or otherwise established prices, are consistent with the Federal Cost Principles (Title 48, Code of Federal Regulations, Part 31).

### B. Method of Payment

1. Unless approved otherwise by the Commission, the Contractor's services shall be invoiced on a monthly basis and payment will be made within thirty (30) days of receipt of an acceptable invoice with satisfactory backup documentation, approved by the Project Manager. As used herein, the term "invoice" shall include the Contractor's bill or written request for payment under this Agreement for services performed. All invoices shall be made in writing.
2. Unless approved otherwise by the Commission's Project Manager, the Contractor shall, within three (3) days after receipt of payment by the Airport specified in this Agreement pay to all of its immediate subcontractors (or their respective assignees) the amounts to which they are entitled, after deducting any prior payments and any amounts due and payable to the Contractor by those subcontractors.

3. The Contractor shall invoice for the Work performed in conformance with procedures approved by the Commission.
  - a. Such invoices shall segregate current costs from previously invoiced costs.
  - b. Costs for individual labor shall be segregated by task and subtasks, if any.
  - c. Notwithstanding the above, in no case shall the Contractor invoice include costs which Airport has disallowed or otherwise indicated that it will not recognize.
4. Such invoices shall be as a minimum, (i) mechanically accurate, (ii) substantially vouchered and properly supported and (iii) in compliance with generally accepted accounting principles
5. The Contractor shall also certify, for each invoice, that (i) the hourly rates for direct labor, whether for Contractor or its subcontractor(s), to be reimbursed under this Agreement are not in excess of the actual hourly rates in effect for the Contractor or subcontractor employees engaged in the performance of services under this Agreement at that time, and (ii) that such hourly rates are in conformance with the Agreement.
6. The fee for the Contractor or any of its subcontractors shall be billed monthly on all direct labor and indirect costs for services provided in the current invoice at the percentage described in paragraph E below.
7. The Commission's Project Manager reserves the right to withhold payment(s) otherwise due the Contractor in the event of the Contractor's material non-compliance with any of the provisions of this Agreement, including, but not limited to, the requirements imposed upon the Contractor in Article 15, Insurance, and Article 16, Indemnification. The Airport shall provide notice of withholding, and may continue the withholding until the Contractor has provided evidence of compliance which is acceptable to the Airport.
8. All invoices shall be made in writing and delivered or mailed to the Airport as follows:

By US mail:                    **Tom Rodrigues**, Project Manager  
San Francisco International Airport  
Design and Construction (Contract 9024.9)  
P.O. Box 8097  
San Francisco, CA 94128

By Personal Delivery  
or Express Mail:            **Tom Rodrigues**, Project Manager  
San Francisco International Airport  
Delta/Singapore Building  
Design and Construction (Contract 9024.9)  
710 N. McDonnell Road, 2<sup>nd</sup> Floor  
San Francisco, CA 94128

**C. Direct Salary Rate and Direct Salary Rate Adjustment**

1. The direct labor rate shall not exceed **Ninety-three Dollars (\$93)** per hour. Any rate in excess of this cap will require prior written approval from the Commission's Project Manager.
2. Salaried personnel shall be paid on a maximum of 40 hours per week, with no overtime. Salaried personnel assigned to multiple projects shall be paid on a pro-rata share of a 40-hour week. Signed time cards shall be provided showing all assigned projects and the shared calculation.
3. The billing rates agreed upon (Appendix C.3, SFO 9024.9 FAR Rates of this Agreement) at the effective date of this Agreement shall remain effective until June 30, 2012.

#### **D. Billing Rates**

1. Subject to Appendix B.1, Provisional Indirect Cost Rate Agreement of this Agreement, billing rates and overhead rates shall be used for reimbursement of the cost portion of this cost plus fee Agreement as stipulated in Appendix C.3, SFO 9024.9 FAR Rates of this Agreement. Billing rates shall be the sum of direct salary rates plus indirect cost as stipulated in Appendix B.1. Billing rates may be adjusted on July 1<sup>st</sup> of each year when the direct labor rates are adjusted as stated in section C.3 above.
2. Whenever possible, billing rates shall be established for home office work using a home office indirect cost rate and field office work using a field office indirect cost rate. The home office indirect cost rate shall be used when staff works in an office provided by the Contractor. The field office indirect cost rate shall be used when staff is assigned full time to an office provided by the Commission. To qualify for the field office indirect cost rate the Commission shall also provide normal office equipment and materials for field office staff such as computers, printers, internet access, phone service, fax, copier, and other office materials such as paper, clips, pens, and pencils.

#### **E. Fee**

The Fee for Contractor's work effort, including any subcontractor work at any tier, shall be ten percent (10%) of estimated direct labor and indirect costs of the Contractor and any subcontractors at any tier. There shall be no additional fixed fee markup on the work of first and lower tier subcontractors.

#### **F. Other Direct Cost**

1. All travel expenses and cost for vehicle rentals, contractor meals, and per diem into or outside the San Francisco Bay Area shall be subject to prior written approval by SFO. No administration charge may be added to the amount to be reimbursed as other direct costs. No reimbursement shall be provided for faxing documents. No mileage reimbursement shall be provided for automobile trips within the San Francisco Bay Area (less than fifty (50) miles from SFO). No reimbursement shall be provided for contractor meals, accommodations, long distance, and cellular telephone charges within the San Francisco Bay Area (less than fifty (50) miles from SFO). Specialists, Project Executives, and others that are based out of town, who are not assigned to the jobsite office, must have prior written approval by SFO in order to be reimbursed for salary costs and travel expenses. Regional (remote) executive's travel expenses to visit the

local job office are not reimbursable. Part-time jobsite personnel who are shared with other out-of-town clients are not reimbursed for travel expenses.

2. Any ODC expenses in excess of \$500 shall be pre-approved by the Project Manager.
- G. The approved staffing plan and hourly rate schedule is detailed in Appendix C.1, C.2 and C.3 of this agreement.

---

**Appendix B.1, Compensation and Payment**

**FORM OF**  
**PROVISIONAL INDIRECT COST RATE AGREEMENT**

This is an Appendix attached to, and incorporated by reference in the Agreement made on **June 30, 2011** between the City and County of San Francisco, acting by and through its Airport Commission (Commission), and **CAGE Professional Services Inc.** (Contractor) providing for construction management services for the International Terminal and Terminal 3, Boarding Area F Checked Baggage Inspection System Modernization and International Terminal Baggage Handling System Improvements Project. Pursuant to Agreement No. 9024.9 between the parties, the Cost Principles contained in FAR, and practices required by the applicable Cost Accounting Standards in FAR, **CAGE Professional Services Inc.** (hereinafter referred to as "CONTRACTOR") and the CITY AND COUNTY OF SAN FRANCISCO, AIRPORT COMMISSION (hereinafter referred to as "City") agree as follows:

**I. DEFINITIONS**

A. Indirect Cost: Indirect costs shall consist of three indirect cost pools:

- 1) Overhead on direct labor, such as taxes or payments on direct labor charges required by law under Federal and State Social Security Acts, or by any other Federal, State or local law; and
- 2) Fringe benefits on direct labor, such as vacation, holiday and severance pay, and sick leave; bona fide pension, retirement, group health, accident and life insurance plans in operation as an established policy of the firm; and
- 3) General Administrative expenses.

B. Provisional Indirect Cost Rate: A temporary indirect cost rate which has been established for the purpose of reimbursement of indirect costs pending the completion of a formal audit. This rate shall be established through the provision of Contractor's and certain subcontractors' provision of historical and current financial information to the Contract Manager.

C. Audited Indirect Cost Rate: An indirect cost rate which is established by a cognizant United States Government Audit Agency or by an independent third party entity which shall be pre-approved by the City. The Audited Indirect Cost Rate shall be utilized to determine the Final Indirect Cost Rate and also to establish the Provisional Indirect Cost Rate for the current fiscal year of Agreement performance.

D. Final Indirect Cost Rate: An indirect cost rate which becomes the basis for determining the final basis for the application of indirect costs against direct labor costs.

**II. PROVISIONAL INDIRECT COST RATES**

This Agreement will employ a temporary provisional indirect cost rate which has been established for award of the Agreement and reimbursement of indirect cost pending the establishment of a final indirect cost rate for the period of time when the services were performed. The provisional indirect cost rates set forth in this Agreement are applicable to all services in the Services to be provided by Contractor identified in Appendix

A or in Modifications issued by the City, pending the determination of the final indirect cost rates for Contractor or certain subcontractors.

- A. Subcontractors at any tier with estimated total billings exceeding \$100,000 shall enter into a provisional indirect cost rate agreement with the Contractor. The provisional indirect cost rates for subcontractor indirect costs shall be as set forth below for the Services to be provided by Contractor or in any Change Order.
- B. The provisional indirect cost rate to be applied to Contractor's and subcontractor's direct labor as set forth in Contractor's and subcontractors' submissions shall be:

TABLE 1	
FIRM	PROVISIONAL OVERHEAD RATE
CAGE Professional Services, Inc.	129.11%
KPA Group	179.01%
Chaves & Assoc	112.20%
EPC Consultants	109.91%
M Lee Corp	131.96%
Apex Testing	76.44%

- C. The provisional indirect cost rate shall be applicable until the final indirect cost rate for the audited period is established. If negotiations are not conducted for the second or subsequent twelve (12) month periods within ninety (90) days after completion of the previous period, the provisional indirect cost shall be utilized for the subsequent period(s) until an actual indirect cost rate is mutually agreed upon between the Contractor and the City.
- D. The provisional indirect cost rates set forth in Table 1 shall be used for all new work performed under the Agreement or Modifications until such time that the final indirect cost rate for that new work is established.
- E. There shall be no indirect cost rate or general administrative expense (G&A) mark-up applied to materials, other direct costs (ODC's), nor for Facilities Capital Cost of Money for either the Contractor or any of its subcontractors at any tier.

III. AUDITED INDIRECT COST RATE

- A. Within one hundred eighty (180) days of either (a) the end of Contractor's and subcontractors' fiscal year or (b) the expiration or any earlier termination of this Agreement, Contractor shall submit to the Project Manager the Contractor's and certain subcontractors' audited indirect cost rates for the period(s) of time for which a final indirect cost rate has not yet been established. In the event Contractor or subcontractor does not have audited indirect cost rates determined by a cognizant United States Government Audit Agency, then such rates will be established by an independent, third party audit entity, subject to approval by the City.

- B. The audited indirect cost rate shall be used for both (a) developing the basis for the negotiation of the provisional indirect cost rate for those periods of time for which a final indirect cost rate has not yet been established, and (b) developing the final indirect cost rate.

III. FINAL INDIRECT COST RATE

- A. For Contractor and subcontractors (at any tier), the audited indirect cost rate shall be utilized to establish the final indirect cost rate for the billings of the previous fiscal year. This process shall be repeated for each subsequent fiscal year.
- B. For Contractor and subcontractors (at any tier), the audited indirect cost rate shall be utilized to negotiate the provisional indirect cost rate for the billings for the current fiscal year.
- C. Any compensation under this Agreement made prior to the determination of the final indirect cost rates will be recalculated if the provisional indirect cost rates differ from the final indirect cost rates, unless the City and Contractor or subcontractor mutually agree that recalculation will not be required, in which case the provisional indirect cost rates will be considered as the final indirect cost rates.
- D. The indirect cost rates identified above, including any adjustment to such indirect cost rates as provided for above or in Appendix B.1, *Compensation and Payment*, are subject to reimbursements as defined below:
1. Overpayment by City: For each final indirect cost rate of Contractor's or any subcontractor that is less than the provisional indirect cost rate paid to Contractor, the City shall withhold the overpaid amounts from subsequent payments to the Contractor if those payments are sufficient to cover the overpaid amount. In the event subsequent payments owed to the Contractor are less than the amount overpaid, Contractor shall reimburse to the City any overpayments made by applying the difference between the provisional indirect cost rate and the final indirect cost rate to the compensated direct labor costs. Contractor shall reimburse City within thirty (30) days of written notice from City seeking reimbursement.
  2. Underpayment by City: For each final indirect cost rate of Contractor or subcontractor that exceeds the provisional indirect cost rate paid to Contractor, City shall pay to Contractor the difference between the final indirect cost rate and the provisional indirect cost rate paid for the periods not previously adjusted during the term of the Agreement; City shall reimburse Contractor within sixty (60) days of City's receipt of all of Contractor's actual rates.
  3. Nothing in this paragraph shall limit City's right to audit and inspect Contractor's or subcontractors' rates under Section 28 of the Agreement.
- E. Contractor or subcontractor agrees to accept payment of the final indirect cost rates as its total compensation for all indirect costs for performing all services.

IV. OTHER



---

IV. OTHER

- A. Nothing herein shall be construed to prejudice, waive, or in any other way affect any rights of the City under the provisions of Agreement No. 9024.9, nor respecting limitation of the City's obligations thereunder.
- B. Contractor may bill for direct cost incurred in managing subcontractor effort provided the labor cost are included in the direct labor base. The Airport will re-evaluate the 3% limitation on overhead increase on Contractor only, if and only if historical data support a re-evaluation. Contractor agrees to provide actual cost data on a recurring quarterly basis.
- C. Contractor and subcontractor may not bill for fee until negotiated and agreed upon. Determination of fee shall strictly comply with FAR Part 15-4.



1770

TASK-1 -- Planning / Programming and Design																		
Position	CAGE Inc			KPA Group + Subs			EPC Consultants			CHAVES & Assoc			M Lee Corporation			APEX Testing Labs		
	Hours	Rate	Extended Cost	Hours	Rate	Extended Cost	Hours	Rate	Extended Cost	Hours	Rate	Extended Cost	Hours	Rate	Extended Cost	Hours	Rate	Extended Cost
Principal	0	\$ 225	\$ -	54	\$ 205	\$ 11,070												
Associate				124	\$ 173	\$ 21,452				120	\$ 181	\$ 21,720						
Construction Manager PH 1	805	\$ 138	\$ 111,090															
Construction Manager PH 2	100	\$ 160	\$ 16,000															
Cost Estimator													92	\$ 176	\$ 16,192			
Project Controls Manager							368	\$ 166	\$ 61,088									
Senior Project Manager	100	\$ 128	\$ 12,800															
Project Coordinator		\$ 140																
Senior Software Specialist	190	\$ 138	\$ 26,220															
Senior Controls Engineer	220	\$ 125	\$ 27,500															
Senior Mechanical Engineer	300	\$ 123	\$ 36,900	54	\$ 165	\$ 8,910												
Senior Engineer / Architect				80	\$ 195	\$ 15,600												
Engineer / Architect		\$ 105		54	\$ 150	\$ 8,100												
Document Controller										361	\$ 117	\$ 42,237						
Technical Writer	96	\$ 96	\$ 9,216															
PM Field Operations	192	\$ 132	\$ 25,344															
Site Manager/ Commissioning Specialist	384	\$ 102	\$ 39,168															
Testing/Check-out Specialist		\$ 94																
Project Analyst	40	\$ 81	\$ 3,240															
QA/QC	80	\$ 76	\$ 6,080															
First Source Hiring		\$ 25																
Office Engineer							336	\$ 81	\$ 27,216									
CADD																		
<b>SUBTOTALS</b>	<b>2507</b>	<b>\$ 313,558</b>		<b>366</b>	<b>\$ 65,132</b>		<b>704</b>	<b>\$ 88,304</b>		<b>481</b>	<b>\$ 63,957</b>		<b>92</b>	<b>\$ 16,192</b>		<b>0</b>	<b>\$ -</b>	
Reimbursable Expenses		\$ 19,331			\$ -			\$ -			\$ -			\$ -			\$ -	
<b>SUBTOTAL</b>		<b>\$ 332,889</b>			<b>\$ 65,132</b>			<b>\$ 88,304</b>			<b>\$ 63,957</b>			<b>\$ 16,192</b>			<b>\$ -</b>	
<b>Grand Total Labor</b>		<b>\$ 566,474</b>																
<b>Grand Total Expenses</b>		<b>\$ 19,331</b>																
<b>PROJECT TOTAL TASK 1</b>		<b>\$ 585,805</b>																
SFO First Source Hiring		\$ -																
<b>GRAND TOTAL</b>		<b>\$ 585,805</b>																

Rev 1 June 2, 2011

Construction Management Services For The International Terminal and Terminal 3 Boarding Area F CBIS Modernization and International Terminal BHS Improvements Project RFP No. 9024.9

### Management Staffing Plan --- Estimated Monthly Man-Loading Projections

Task #	Task Name	Month												Year Total	Peak	Total		
		1	2	3	4	5	6	7	8	9	10	11	12					
1197	Construction Manager III 1	40	40	40	40	40	40	40	40	40	40	40	40	40	40	480	40	480
1198	Construction Manager III 2	100	100	100	100	100	100	100	100	100	100	100	100	100	100	1200	100	1200
1199	Senior Software Specialist	50	50	50	50	50	50	50	50	50	50	50	50	50	50	600	50	600
1200	Senior Software Specialist	20	20	20	20	20	20	20	20	20	20	20	20	20	20	240	20	240
1201	Senior Civil Engineer	20	20	20	20	20	20	20	20	20	20	20	20	20	20	240	20	240
1202	Senior Mechanical Engineer	20	20	20	20	20	20	20	20	20	20	20	20	20	20	240	20	240
1203	Senior Electrical Engineer	20	20	20	20	20	20	20	20	20	20	20	20	20	20	240	20	240
1204	Senior Mechanical Engineer	20	20	20	20	20	20	20	20	20	20	20	20	20	20	240	20	240
1205	Senior Electrical Engineer	20	20	20	20	20	20	20	20	20	20	20	20	20	20	240	20	240
1206	Senior Mechanical Engineer	20	20	20	20	20	20	20	20	20	20	20	20	20	20	240	20	240
1207	Senior Electrical Engineer	20	20	20	20	20	20	20	20	20	20	20	20	20	20	240	20	240
1208	Senior Mechanical Engineer	20	20	20	20	20	20	20	20	20	20	20	20	20	20	240	20	240
1209	Senior Electrical Engineer	20	20	20	20	20	20	20	20	20	20	20	20	20	20	240	20	240
1210	Senior Mechanical Engineer	20	20	20	20	20	20	20	20	20	20	20	20	20	20	240	20	240
1211	Senior Electrical Engineer	20	20	20	20	20	20	20	20	20	20	20	20	20	20	240	20	240
1212	Senior Mechanical Engineer	20	20	20	20	20	20	20	20	20	20	20	20	20	20	240	20	240
1213	Senior Electrical Engineer	20	20	20	20	20	20	20	20	20	20	20	20	20	20	240	20	240
1214	Senior Mechanical Engineer	20	20	20	20	20	20	20	20	20	20	20	20	20	20	240	20	240
1215	Senior Electrical Engineer	20	20	20	20	20	20	20	20	20	20	20	20	20	20	240	20	240
1216	Senior Mechanical Engineer	20	20	20	20	20	20	20	20	20	20	20	20	20	20	240	20	240
1217	Senior Electrical Engineer	20	20	20	20	20	20	20	20	20	20	20	20	20	20	240	20	240
1218	Senior Mechanical Engineer	20	20	20	20	20	20	20	20	20	20	20	20	20	20	240	20	240
1219	Senior Electrical Engineer	20	20	20	20	20	20	20	20	20	20	20	20	20	20	240	20	240
1220	Senior Mechanical Engineer	20	20	20	20	20	20	20	20	20	20	20	20	20	20	240	20	240

Site CM Services - RFP# 9024.9

**LEGEND**

[Pattern]	Task # 1.0
[Pattern]	Task # 2.0
[Pattern]	Task # 3.0
[Pattern]	Task # 4.0



HOURLY BILLING RATES						
FAR Overhead Rate	129.11%	179.01%	112.20%	109.91%	131.96%	76.44%
Position	CAGE	KPA Group	CHAVES & Assoc	EPC Consultants	M Lee Corp	APEX Testing
Principal	\$ 225	\$ 221				\$ 125
Associate		\$ 150	\$ 181			
Construction Manager PH 1	\$ 138					
Construction Manager PH 2	\$ 160					
Lead/Chief Estimator					\$ 193	
Senior Estimator					\$ 167	
Estimator					\$ 144	
Project Controls Manager				\$ 169		
Senior Project Manager	\$ 128	\$ 175				
Project Coordinator	\$ 140					
Senior Software Specialist	\$ 138					
Senior Controls Engineer	\$ 125					
Senior Mechanical Engineer	\$ 123					
Senior Engineer / Architect		\$ 120				
Engineer / Architect / Designer	\$ 107	\$ 100				\$ 85
Document Controller			\$ 117			
Technical Writer	\$ 96					
PM Field Operations	\$ 132					
Commissioning Manager	\$ 125					
Site Manager/ Commissioning Specialist	\$ 102					
Testing/Check-out Specialist	\$ 94					
Project Analyst	\$ 81					
QA/QC	\$ 76					
First Source Hiring	\$ 25					
Office Engineer				\$ 83		
CADD		\$ 90				

Construction Management Services For The International Terminal and Terminal 3 Boarding Area F CBIS  
 Modernization and International Terminal BHS Improvements Project RFP No. 9024.9



**OTHER TRANSACTION AGREEMENT**

**BETWEEN**

**DEPARTMENT OF HOMELAND SECURITY  
TRANSPORTATION SECURITY ADMINISTRATION**

**AND**

**THE CITY AND COUNTY OF SAN FRANCISCO,  
RELATING TO**

**SAN FRANCISCO INTERNATIONAL AIRPORT  
Checked Baggage Screening Design Services Project**

---

**Negotiated by the TSA pursuant to  
Aviation and Transportation Security Act, Pub. L. 107-71, 115 Stat. 597  
49 U.S.C. §114(m)(1) and 106(l)(6)**

---

**HSTS04-11-H-CT1149**

## **ARTICLE I – PARTIES**

The parties to this Other Transaction Agreement (OTA or Agreement) are the U.S. Department of Homeland Security Transportation Security Administration (TSA) and the City and County of San Francisco Commission (CITY) as owner and operator of the San Francisco International (SFO Airport). The TSA and the CITY agree to cooperate in good faith and to perform their respective obligations in executing the purpose of this Agreement.

## **ARTICLE II – LEGAL AUTHORITY**

This Agreement is entered into under the authority of the Aviation and Transportation Security Act, Pub. L. 107-71, 115 Stat. 597, specifically 49 U.S.C. § 114(m)(1) and 106(l)(6), which authorizes other transactions.

## **ARTICLE III – SCOPE**

The purpose of this Agreement is to set forth the terms and conditions, as well as establish the respective cost-sharing obligations of the TSA and the CITY with respect to the design services and construction management design support services necessary to provide for the recapitalization of TSA Explosive Detection Systems (EDS) equipment within the Checked Baggage Inspection System (CBIS) at the International A, International G and Boarding Area F bag rooms at the San Francisco International Airport (the CBIS Project). The design services will be provided in accordance with the published TSA Planning Design Guidelines and Design Standards (PGDS) Version 3.0 dated November 2009 found at:  
[http://www.tsa.gov/research/checked\\_baggage\\_material.shtm](http://www.tsa.gov/research/checked_baggage_material.shtm)

This Design Services Project requires the CITY to provide the architect and engineering services to develop the design and construction specifications for the replacement of TSA EDS equipment in the International A, International G and the Boarding Area F bag rooms CBIS systems within the Airport Terminal buildings (hereinafter the Design Project). The design needs to identify the terminal modifications required to be made for the replacement of EDS units in the CBIS areas to include changes to baggage conveyor components and programming, mechanical, plumbing, electrical, structural, and telecommunications, or other infrastructure necessary to remove existing EDS units and replace them with new EDS units. The Design Project will also encompass any redesign of Checked Baggage Resolution Areas (CBRA) as required, as well as any required modifications to the multiplexed On Screen Resolution Room (OSR). The objective of the Design Services Agreement is to provide the necessary design deliverables and specifications to identify the necessary construction modifications required to replace obsolete EDS equipment with updated TSA EDS units while enhancing the security and baggage screening capabilities at the Airport. The detailed design deliverables for each Design Phase are identified in Appendix A of this Agreement. The Design Phases include:

1. Validation of Schematic/30% Design Package submittal, including pre-design Preliminary Alternative Analysis Report
2. Supplemental Preliminary Alternative Analysis Report to address increased load conditions identified with the Static Model Validation effort and incorporating the requirements of PGDS Version 3.0
3. TSA Briefing describing the Preferred Alternative

4. Updated TSA Basis of Design Report and Schematic Design upon reaching consensus with the TSA regarding the Preferred Alternative.
5. 30% TSA Design Package
6. 70% TSA Design Package
7. 100% TSA Design Package
8. Final Construction Drawings
9. Bid Phase Services
10. Construction Administration/Construction Phases Services
11. Construction Management Design Support Services

Any future allowable, allocable and reasonable costs for CBIS Project construction, project management, construction management, and commissioning/site acceptance testing is anticipated to be funded through a separate Agreement between the CITY and the TSA. This Design Agreement shall not be construed to obligate the TSA, in any manner, to provide construction cost funding or obligate the TSA to enter into an Agreement with the CITY for reimbursement of construction costs related to the CBIS Project. TSA funding for the construction portion of the CBIS Project is subject to the Congressional authorization and appropriation budget process.

#### **ARTICLE IV – COST SHARING AND OTHER RESPONSIBILITIES**

1. Capital Costs: The estimated cost of the Design Project refers to the design services to be completed by the CITY to design the modifications that need to be made to the Terminal CBIS systems to support the replacement of obsolete EDS units with new EDS units and associated TSA screening equipment. It does not include the costs of acquisition, delivery or installation of the EDS and ETD equipment itself. All work performed by the CITY pursuant to this Agreement shall be accomplished in accordance with the TSA PGDS in effect at the time this Agreement is executed and in accordance with the applicable local Airport Building Standards and Criteria. Recognizing the uniqueness of this Design Project, in the event of any conflicts between the provision of the PGDS and this Agreement, the Parties agree to resolve such conflicts through the design review and Alternative Analysis processes described in the TSA PGDS, Version 3.0.

2. The estimated cost for the design services for the Design Project is \$4,053,854.00. TSA agrees to reimburse the CITY for ninety percent (90%) of the allowable, allocable and reasonable costs of the design services for the Design Project, not to exceed a total reimbursement of \$3,648,469.00 (calculated as 90% of \$4,053,854.00). TSA reimburses ninety cents for every dollar of allowable, allocable and reasonable costs submitted by the CITY for reimbursement up to the TSA funded amount of \$3,648,469.00.

3. TSA will determine allowable and allocable costs in accordance with the OMB Circular A-87 "Cost Principles for State, Local and Indian Tribal Governments" codified at 2 C.F.R. Part 225 (together with Appendices A – D) and Appendix F of the TSA PGDS in effect upon the signing of this Agreement by both parties. TSA will reimburse the CITY on an actual expense basis supported by one or more invoices submitted by the CITY in accordance with Article X – Payment. The parties understand and agree that all design costs in excess of \$3,648,469.00, as well as any costs that are inconsistent with OMB A-87 and the guidance set forth in Appendix F of the TSA PGDS, shall be borne solely by the CITY unless otherwise agreed by the TSA in a modification in accordance with Article XIII – Changes and/or Modifications. Should the TSA

contributions of \$3,648,469.00 represent more than ninety percent of the total final TSA allowable, allocable, and reasonable design costs for the TSA baggage screening project, the CITY will refund TSA sufficient funds such that TSA's total reimbursement will be no more than 90% of the total allowable, allocable and reasonable costs submitted by the CITY.

4. The Design Project costs which TSA will reimburse are limited specifically to those costs associated with the Design Deliverables identified in Appendix A "TSA PGDS Design Deliverables Checklist" and outlined in Article III – Scope to address the replacement of EDS units and any commensurate changes in the OSR room, the CBRA(s), and the EDS network equipment rooms as applicable. The Design Services entail validation/finalization of Preferred Alternative Analysis, Basis of Design Report, schematics, 30%, 70% and 100% TSA design packages and preparation of 70% design documents for bidding, bid phase services, and construction/administration and construction phase services. The CITY's design-build Contractor will prepare the 100% construction documents and will be the final engineer of record.

5. Change orders shall not be considered authorization to exceed TSA's reimbursement limit of \$3,648,469.00 for the Design Project, unless the TSA Deployment Manager and TSA Contracting Officer have been notified in advance of the impact the Change Order has on the total cost of the design services for the Design Project, and TSA provides its written approval to proceed with the work identified in the Change Order. Use of contingency funds for the TSA baggage-screening project requires TSA's prior written approval.

#### **ARTICLE V: PROJECT RESPONSIBILITIES**

The primary Project responsibilities of the TSA and the CITY are outlined below. The Design Project will be overseen by the CITY.

##### **A. TSA Responsibilities**

1. Review and concur with the CBIS Project design, plans, and specifications for alternative analysis, schematic, 30%, 70% and 100% design packages for the installation of the replacement EDS units in the CBIS based upon the recommendations and guidelines in the TSA PGDS in effect at the time of execution of this Agreement.
2. The CITY must receive concurrence from TSA at each stage of the design review in order to proceed to the next design review stage.
3. Consider design alternatives during the design review process in order to achieve the most efficient screening solution for both TSA and CITY.
4. Provide the TSA PGDS as well as the EDS equipment specification(s) as required.
5. Advise the type of EDS equipment to be provided at each stage of the design.
6. Provide EDS Original Equipment Manufacturer Technical Advisory Support Services to the Airport regarding integration of the EDS units into the baggage handling system (BHS).
7. Review and consider requested changes to the design and associated costs.



## **B. CITY/Airport Responsibilities**

1. Except for the responsibilities of the TSA, as outlined above, the Design Project will be managed and overseen by the CITY. The CITY, acting through such contractors as it may engage, will provide the engineering and design services necessary for successful completion of the Design Project. The CITY will provide oversight of such contractor(s) to ensure the design of the CBIS Project conforms to the TSA design guidelines identified in the PGDS and is completed within the prescribed schedule, identified and incorporated herein as Appendix B.
2. The CITY must receive concurrence from TSA at each stage of the design review in order to proceed to the next design review stage.
3. Provide a budgetary construction cost estimate with the schematic, 30% design review and subsequent 70% and 100% design reviews for the CBIS Project.
4. Obtain all necessary licenses, insurance permits and approvals.
5. Ensure the EDS OEM site planning, installation, integration and networking guidelines are incorporated into the design to ensure operational, maintenance and environmental specifications are met.
6. Within the design, provide reasonable measures to protect the EDS and ETD equipment from harm, theft, and water intrusion in the screening area.
7. Incorporate heating, ventilation, air conditioning into the design as well as OSHA requirements for those spaces occupied by TSA personnel.
8. Submit monthly progress reports by the 10<sup>th</sup> of each month to the TSA Deployment Manager, OSTCBD@tsa.dhs.gov

## **ARTICLE VI - EFFECTIVE DATE AND TERM**

For purposes of establishing recognition of costs incurred for the Design Project, the effective date of this Agreement is established as March 1, 2011. Project completion is currently estimated to be on or about December 31, 2012 unless earlier terminated by the parties pursuant to Article XV "Termination" as provided herein or extended by mutual written agreement pursuant to Article XIII "Changes and/or Modifications." The period of performance for this effort is established as June 30, 2013 in order to allow the CITY time to submit a final invoice, close out the Design Project, and address any other issues.

The CITY will establish and provide Design Schedule Milestones to the TSA that allow objective measurement of progress toward completion. Design Schedule Milestones will be provided to the TSA within 30 days after the CITY has established their design services contract(s). TSA maintains the right to identify any additional milestones to be tracked.

## **ARTICLE VII - ACCEPTANCE AND TESTING**

TSA will deem the Design Project complete upon review and concurrency of the 100% design package for the CBIS, OSR and CBRA for each Terminal. The design must conform to the TSA PGDS in effect at the time that this Agreement is executed. Successful completion requires the correction of any non-conformances identified during the design review process.

**ARTICLE VIII - AUTHORIZED REPRESENTATIVES**

The authorized representative for each party shall act on behalf of that party for all matters related to this Agreement. Each party's authorized representative may appoint one or more personnel to act as an authorized representative for any administrative purpose related to this Agreement, provided written notice of such appointments is made to the other party to this Agreement. The authorized representatives for the parties are as follows:

A. TSA Points of Contact:

Deployment Manager/Contracting Officer Technical Representative:

Khalid Haider

Mail Stop TSIF #32

Transportation Security Administration

1 Post Office Road

Washington, DC 20528-6032

Phone: 571-227-1350

E-Mail: Khalid.haider@dhs.gov

Contracting Officer:

Connie Thornton

Office of Acquisition, TSA-25

Transportation Security Administration

4275 Airport Road, Suite C

Rapid City, SD 57703

Phone: 605-393-8191

E-Mail: Connie.Thornton@dhs.gov

Only the TSA Contracting Officer (CO) shall have the authority to bind the Federal government with respect to funding and liability. The TSA Regional Deployment Manager (RDM) is also the TSA Contracting Officer Technical Representative (COTR) and is responsible for the technical administration of this Agreement and technical liaison with the CITY and the SFO Airport. The TSA COTR is not authorized to change the scope of work, to make any commitment or otherwise obligate the TSA, or authorize any changes which affect the liability of the TSA such as amount or level of funding.

The CITY Airport must notify the TSA CO and COTR in the event that any TSA employee or TSA contracted agent takes any action that may be interpreted by the CITY and/or the SFO Airport as direction which could increase the Design Project costs and could cause the CITY and/or the SFO Airport to seek reimbursement from TSA in excess of the of the TSA's total reimbursement liability as defined in Articles IV and IX of this Agreement.

A. City of San Francisco Points of Contact:

The City and County of San Francisco Commission Point of Contact for all correspondence is:

Tom Rodrigues

Project Manager

San Francisco International Airport

Bureau of Design and Construction  
P.O. Box 8097  
San Francisco, California 94128  
(650) 867-5738  
tom.rodrigues@flysf.com

The City and County of San Francisco Commission Point of Contact for invoices is:

Geri Rayca  
Project Manager  
San Francisco International Airport  
Bureau of Design and Construction  
P.O. Box 8097  
San Francisco, California 94128  
(650) 821-5317  
geri.rayca@flysf.com

#### ARTICLE IX - FUNDING AND LIMITATIONS

TSA will provide funding to the CITY in an amount not to exceed \$3,648,469.00. Funds in the amount of \$3,648,469,000 are hereby obligated and made available for payment for performance of this Agreement. Expenses incurred in executing the work identified herein are chargeable to:

PR: 21-11-201CT1149

Accounting Code:

**5AV101B010D2011SWE044GE013723006200622CTO.5903001518010000.251B.TSA  
DIRECT/DEF. TASK Amount: \$3,648,469.00**

In the event of termination or expiration of this Agreement, any TSA funds that have not been spent or incurred for allowable expenses prior to the date of termination and are not reasonably necessary to cover termination expenses will be returned and/or de-obligated from this Agreement. TSA's liability to make payments to the CITY is strictly limited to the amount of funds obligated and available for payment hereunder, including written modifications to this Agreement.

Under no circumstances will TSA be responsible to reimburse the CITY for profit or the general costs of government. The CITY may recover the allowable direct costs of the CITY personnel performing work necessary under this Agreement, as well as the allowable and allocable costs of the contractors hired by the CITY to perform the necessary work under this Agreement. Profit and overhead costs for the CITY's contractors performing work on the TSA Project are allowable costs. Submission of a cost allocation plan is required to address any indirect costs, to include CITY employees, who work on multiple activities that will result in a request for reimbursement under this Agreement. TSA will not be responsible for costs incurred by the CITY, its contractors or agents to perform work not in compliance with the TSA requirements in this Agreement. The TSA has the right to recoup any payments made to the CITY if the TSA Contracting Officer determines that the invoices submitted by the CITY exceed the actual costs incurred, or if the work substantially deviates from the TSA-approved design requirements for the Project pursuant to this Agreement.

TSA will reimburse only for allowable, allocable and reasonable costs in accordance with the OMB Circular No. A-87 in effect on the Effective Date of the Agreement (codified at 2 C.F.R. Part 225) and the allowable/not-allowable costs identified in the TSA PGDS in effect as of the effective date of this Agreement.

#### ARTICLE X – PAYMENT

The United States Coast Guard Finance Center performs the payment function on behalf of the TSA. For purposes of submission to the Coast Guard Finance Center, the CITY must submit a completed Summary Invoice. Central Contractor Registration is mandatory for invoice payment; for information regarding the Central Contractor Registration, please refer to <http://www.ccr.gov>.

Invoices for reimbursable expenses will be submitted every thirty (30) days, as expenses are incurred. For periods in which the CITY has not incurred a reimbursable expense, an invoice is not required. Expenses are considered to accrue on the date that the CITY is invoiced from a subcontractor, supplier, or provider of services. Reimbursement by TSA is conditioned upon submission to TSA of an invoice identifying the Project costs that have been incurred and paid. The TSA intends to make payment to the CITY within 30 days of receipt of each properly prepared invoice for reimbursement of incurred costs.

In the event that an invoice for reimbursable expenses is not received by the TSA within a twelve (12) month period, the TSA reserves the right to terminate the Agreement per Article XV "Termination."

The TSA reimbursement process consists of two steps.

Step 1 – Summary Invoice Submittal to the U.S. Coast Guard Finance Center for Payment, and at a minimum should contain the following information:

- (1) Agreement Number HSTS04-11-H-CT1149
- (2) Invoice Number and Invoice Date
- (3) Complete Business Name and Remittance Address
- (4) Point of Contact with address, telephone, fax and e-mail address
- (5) Tax Identification Number and DUN's Number
- (6) Dollar Amount of Reimbursement requested
- (7) Signature of the CITY's authorized representative and the following certification language: *"This is to certify that the services set forth herein were performed during the period stated and that the incurred costs billed were actually expended for the Project."*

The Summary Invoice may be submitted by standard email or by electronic transmission to the following address(s):

Mailing Address: TSA Commercial Invoices  
 USCG Finance Center  
 P.O. Box 4111  
 Chesapeake, VA 23327

Email: FIN-SMB-TSAINVOICES@uscg.mil

**Step 2 – Submission of Summary Invoice and Supporting Documentation  
Submittal to TSA for Approval of Payment:**

The TSA CO and the COTR are required to review and approve all invoices prior to payment. To aid in this review, the Airport shall provide a copy of the Summary Invoice along with all receipts, contractor pay requests and other supporting information which specify the vendor, services provided, and products delivered as well as the appropriate identifications that the Airport has paid these obligations. The Airport should provide this supporting information simultaneously with Step 1 to expedite the payment process.

The Support Documentation should contain the following items:

- Summary Invoice from Step 1
- An executive summary project overview with the first invoice
- A summary spreadsheet providing a categorized breakdown of the amount invoiced.
- Signed, approved and legible copies of each individual contractor's invoice to include schedules of values statements of work.
  - Copies of contracts and change orders that provide support for the actual work being invoiced
  - Vendor and subcontractor invoices with specific details about services provided
  - Rationale for all allocations or unusual calculations or assumptions
  - Proof of delivery to the project sponsor
  - Copies of subcontractor's invoices if listed on a prime contractor's invoice as a single amount (copies of timesheets and detailed backup not required if descriptions are clear and specific).
- Proof of payment by the Airport for each invoice in the form of copies of check/warrants, bank wire transfers, or accounting systems transactions

The Summary Invoice and supporting documentation may be submitted by email or mail via CD or paper documents or electronic transmission to the below addresses. The final closeout invoice should include proof that all required deliverables have been provided.

Mr. Christopher Randall  
Mail Stop TSA TSIF - #32  
Transportation Security Administration  
1 Post Office Way  
Washington, D.C. 20528-6032

Email: OSTCBD@tsa.dhs.gov

Connie Thornton, TSA Contracting Officer  
C/O Mr. John Gebhart  
Faithful & Gould  
1725 Duke Street, Suite #200  
Alexandria, VA 22314  
Phone: 571-403-8777

Email: John.Gebhart@fgould.com

Upon completion of the review of the supporting documentation for the Summary Invoice, the TSA CO and the TSA RDM/COTR will advise the Coast Guard Finance Center regarding payment of the Summary Invoice.

## **ARTICLE XI - AUDITS**

The Federal Government, including the Comptroller General of the United States, has the right to examine or audit relevant financial records for a period not to exceed three (3) years after expiration of the terms of this Agreement. The CITY and its contractors must maintain an established accounting system that complies with generally accepted accounting principles. Records related to disputes arising out of this Agreement shall be maintained and made available until such disputes have been resolved. As used in this provision, "records" includes books, documents, accounting procedures and practices, and other data, regardless of type and regardless of whether such items are in written form, in the form of computer data, or in any other form.

The CITY shall maintain all records and other evidence sufficient to reflect costs claimed to have been incurred or anticipated to be incurred directly or indirectly in performance of this Agreement. The TSA CO or the authorized representative of the TSA CO shall have the right to examine and audit those records at any time, or from time to time. The right of examination shall include inspection at all reasonable times at the offices of the CITY or at the offices of the CITY's contractor(s) responsible for the Project. The CITY will be required to submit cost or pricing data and supporting information in connection with any invoice relating to this Agreement if requested by the TSA CO.

This Article XI shall not be construed to require the CITY or its contractors or subcontractors to create or maintain any record that they do not maintain in the ordinary course of business pursuant to a provision of law, provided that those entities maintain records which conform to generally accepted accounting practices.

The CITY shall insert a clause containing the terms of Article XI – Audits in all its contracts and subcontracts under this Agreement that exceed \$100,000.00 (One Hundred Thousand Dollars).

## **ARTICLE XII – REQUIRED FEDERAL PROCUREMENT PROVISIONS**

Competition in the award of contracts or procurements resulting from this Project is strongly encouraged and the CITY should promote competition to the maximum extent practicable. The CITY intends to select a Design-Build Contractor based on a competitive best value basis, including qualifications and cost. The CITY proposes to use a Federal Acquisition Regulation Cost Plus Fixed Fee contract arrangement with their Design-Build Contractor.

The CITY agrees to include in its contract(s) a provision that the Airport Terminal designs for this Project are required to comply with the TSA's Planning Guidelines and Design Standards.

## **ARTICLE XIII – CHANGES AND/OR MODIFICATIONS**

Changes and modifications to this Agreement shall be in writing and signed by the TSA CO and duly executed by the authorized representative of the CITY. Any modification shall cite this Agreement and shall state the exact nature of the change and/or modification. No oral statement by any person shall be interpreted as modifying or otherwise affecting the terms of this Agreement. The properly signed written modification shall be attached to this Agreement and thereby become a part of this Agreement.

**ARTICLE XIV – DISPUTES**

When possible, disputes will be resolved by informal discussion between the parties. All disputes arising under or related to this Agreement shall be resolved under this Article. Disputes, as used in this Agreement, mean a written demand or written assertion by one of the parties seeking, as a matter of right, the adjustment or interpretation of Agreement terms, or other relief arising under this Agreement. The dispute shall be made in writing and signed by a duly authorized representative of the CITY or the TSA. At a minimum, a dispute under this Agreement shall include a statement of facts, adequate supporting data. In the event that the parties are unable to resolve any disagreement through good faith negotiations, the dispute will be resolved by the TSA Assistant Secretary or his or her designee. The parties agree that the TSA Assistant Secretary's decision shall be final and not subject to further judicial or administrative review and shall be enforceable and binding upon the parties.

**ARTICLE XV – TERMINATION**

In addition to any other termination rights provided by this Agreement, either party may terminate this Agreement at any time prior to its expiration date, with or without cause, and without incurring any liability or obligation to the terminated party (other than payment of amounts due and performance of obligations accrued, in each case on or prior to the termination date) by giving the other party at least thirty (30) days prior written notice of termination. Upon receipt of a notice of termination, the receiving party shall take immediate steps to stop the accrual of any TSA additional obligations that might require payment.

In the event of termination or expiration of this Agreement, any TSA funds that have not been spent or incurred for allowable expenses prior to the date of termination and are not reasonably necessary to cover termination expenses will be returned and/or de-obligated from this Agreement.

**ARTICLE XVI – CONSTRUCTION OF THE AGREEMENT**

This Agreement is an "other transaction" issued under 49 U.S.C. § 106(l) and 114(m)(1) and is not a procurement contract, grant or cooperative agreement. Nothing in this Agreement shall be construed as incorporating by reference or implication any provision of Federal acquisition law or regulation. It is not intended to be, nor shall it be construed as creation of a partnership, corporation, or other business entity between the parties.

Each party acknowledges that all parties hereto participated equally in the negotiation and drafting of this Agreement and any amendments thereto, and that, accordingly, this Agreement shall not be construed more stringently against one party than against the other.

This Agreement constitutes the entire agreement between the parties with respect to the subject matter hereof and supersedes all prior agreements, understandings, negotiations and discussions, whether oral or written, of the parties.

In the event that any Article and/or parts of this Agreement are determined to be void or otherwise invalid or unenforceable, such Article or portions thereof shall lapse. No such lapse

will affect the rights, responsibilities, and obligations of the parties under this Agreement, except as provided therein. If either party determines that such lapse has or may have a material effect on the performance of the Agreement, such party shall promptly notify the other party, and shall negotiate in good faith a mutually acceptable amendment to the Agreement if appropriate to address the effect of the lapse.

#### **ARTICLE XVII - PROTECTION OF INFORMATION**

The parties agree that they shall take appropriate measures to protect all proprietary, privileged, confidential, or otherwise Sensitive Security Information (SSI) that may come into their possession as a result of this Agreement.

##### **A. RELEASE OF TECHNICAL DATA**

No Sensitive Security Information (SSI), as defined in 49 CFR Parts 15 and 1520, concerning the scope of this Agreement, shall be published or released to the public without prior written approval of the TSA Assistant Secretary or his or her designee. Guidance regarding SSI may be found in Appendix G, Checked Baggage Screening Equipment Sensitive Security Information Identification Guide", of the TSA PGDS.

##### **B. RECORDS AND RELEASE OF INFORMATION**

All Sensitive Security Information (SSI), as defined in 49 CFR Part 1520, shall be handled in accordance with TSA policies and regulations. All employees, contractors, and subcontractors assigned to work under this Agreement are subject to the provisions of 49 CFR Part 1520, Protection of Sensitive Security Information, because they act for, or carry out duties for, or on behalf of the TSA. SSI may not be disclosed except in accordance with the provisions of that rule or where TSA otherwise approves.

##### **C. MEDIA**

Neither the CITY nor the Airport shall make publicity or public affairs activities related to the subject matter of this Agreement unless written approval has been received from the TSA Office of Security Technology or the TSA Office of Strategic Communication and Public Affairs.

#### **ARTICLE XVIII - SURVIVAL OF PROVISIONS**

The following provision of this Agreement shall survive the termination of this Agreement: Article XII – Required Federal Procurement Provisions; Article XI – Audits; Article XIV – Disputes, Article XVII – Protection of Information and Article XVIII – Survival of Provisions.

**IN WITNESS WHEREOF**, the Parties have entered into this Agreement by their duly authorized officers this \_\_\_\_\_ day of \_\_\_\_\_, 2011.



U. S. Department of Homeland Security  
Transportation Security Administration

City and County of San Francisco  
Airport Commission

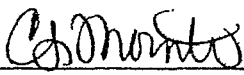
  
\_\_\_\_\_  
Connie Thornton  
TSA Contracting Officer

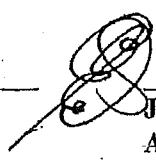
   
\_\_\_\_\_  
John L. Martin  
Airport Director

3/23/2011

3-11-11

Date

Date

Copy to:  
Office of Security Technology  
Federal Security Director

Authorized by Airport Commission

Resolution No. 11-0041

Adopted: March 1, 2011

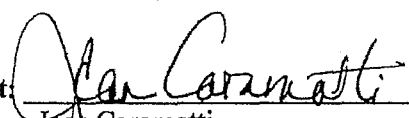
Attest:   
\_\_\_\_\_  
Jean Caramatti  
Secretary, Airport Commission

Approved as to Form  
Dennis J. Herrera, City Attorney

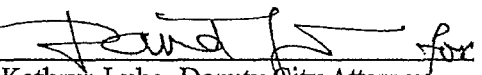
By:   
\_\_\_\_\_  
Kathryn Luhe, Deputy City Attorney

### Appendix A TSA Planning Guidelines and Design Standards Design Deliverables Checklist

Figure 2-4  
DELIVERABLES CHECKLIST

PROJECT PHASE DELIVERABLES		SECTION	Completed		PROJECT PHASE DELIVERABLES		SECTION	Completed	
			Yes	No				Yes	No
Pre-Design Phase	Final Preliminary Assessment Analysis Report	2.2.1	<input type="checkbox"/>	<input type="checkbox"/>	Detailed Design Phase (continued)	70% Design Submittals (continued)	2.2.3	<input type="checkbox"/>	<input type="checkbox"/>
	Preliminary Alternatives Analysis Report		<input type="checkbox"/>	<input type="checkbox"/>		Description of Operations		<input type="checkbox"/>	<input type="checkbox"/>
	Scenario Design Phase		<input type="checkbox"/>	<input type="checkbox"/>		Preliminary Contingency Plan		<input type="checkbox"/>	<input type="checkbox"/>
	Basis of Design Report		<input type="checkbox"/>	<input type="checkbox"/>		70% Specifications		<input type="checkbox"/>	<input type="checkbox"/>
	Detailed Program Requirements		<input type="checkbox"/>	<input type="checkbox"/>		Draft Site Specific Configuration Management Plan		<input type="checkbox"/>	<input type="checkbox"/>
	High-Level Flow-Based Modeling Assumptions and Results		<input type="checkbox"/>	<input type="checkbox"/>		Stakeholder Review and Approval Documentation		<input type="checkbox"/>	<input type="checkbox"/>
	Preliminary Concept Plans		<input type="checkbox"/>	<input type="checkbox"/>		70% Estimate of Probable Construction and O&M Costs		<input type="checkbox"/>	<input type="checkbox"/>
	Planning and Constructability Technical Memoranda		<input type="checkbox"/>	<input type="checkbox"/>		Final Schedule		<input type="checkbox"/>	<input type="checkbox"/>
	RAM Estimate of Probable Construction and O&M Costs		<input type="checkbox"/>	<input type="checkbox"/>		Conveyer Identifiers		<input type="checkbox"/>	<input type="checkbox"/>
	Stakeholder Review and Approval Documentation		<input type="checkbox"/>	<input type="checkbox"/>		Updated EIS Equipment List		<input type="checkbox"/>	<input type="checkbox"/>
Detailed Design Phase	Preliminary Project Schedule	2.2.2	<input type="checkbox"/>	<input type="checkbox"/>	100% Detail in Submittals	2.2.3.3	<input type="checkbox"/>	<input type="checkbox"/>	
	Updated Basis of Design Report		<input type="checkbox"/>	<input type="checkbox"/>	3rd Document		<input type="checkbox"/>	<input type="checkbox"/>	
	Operational Scenario Assessment		<input type="checkbox"/>	<input type="checkbox"/>	Final Description of Operations		<input type="checkbox"/>	<input type="checkbox"/>	
	Preliminary Plans		<input type="checkbox"/>	<input type="checkbox"/>	Contingency Plans		<input type="checkbox"/>	<input type="checkbox"/>	
	Gross Sections		<input type="checkbox"/>	<input type="checkbox"/>	Project Specifications		<input type="checkbox"/>	<input type="checkbox"/>	
	Description of Operations		<input type="checkbox"/>	<input type="checkbox"/>	Final Site Specific Configuration Management Plan		<input type="checkbox"/>	<input type="checkbox"/>	
	Baggage and Data Flow Diagrams		<input type="checkbox"/>	<input type="checkbox"/>	Stakeholder Review and Approval Documentation		<input type="checkbox"/>	<input type="checkbox"/>	
	Table of Contents for O&M		<input type="checkbox"/>	<input type="checkbox"/>	Final Estimate of Probable Construction and O&M Costs		<input type="checkbox"/>	<input type="checkbox"/>	
	Screening Equipment Installation Guidelines		<input type="checkbox"/>	<input type="checkbox"/>	Final Phasing Schedule		<input type="checkbox"/>	<input type="checkbox"/>	
	Division of Operating Capabilities		<input type="checkbox"/>	<input type="checkbox"/>	Updated EIS Equipment List		<input type="checkbox"/>	<input type="checkbox"/>	
70% Design Submittals	Stakeholder Review and Approval Documentation	2.2.3.1	<input type="checkbox"/>	<input type="checkbox"/>	Operations Training Materials and Documentation	2.2.4	<input type="checkbox"/>	<input type="checkbox"/>	
	30% Estimate of Probable Construction and O&M Costs		<input type="checkbox"/>	<input type="checkbox"/>	Construction Plans		<input type="checkbox"/>	<input type="checkbox"/>	
	Preliminary Phasing Schedule		<input type="checkbox"/>	<input type="checkbox"/>	Changes to Approved 100% Design Submittals		<input type="checkbox"/>	<input type="checkbox"/>	
	Conveyer Identifiers		<input type="checkbox"/>	<input type="checkbox"/>	Construction Schedule		<input type="checkbox"/>	<input type="checkbox"/>	
	EIS Equipment List		<input type="checkbox"/>	<input type="checkbox"/>	Queries/Copies of Shop and Installation Drawings		<input type="checkbox"/>	<input type="checkbox"/>	
	Updated Basis of Design Report		<input type="checkbox"/>	<input type="checkbox"/>	Training and Commissioning Plans		<input type="checkbox"/>	<input type="checkbox"/>	
	Updated Operational Standards Assessment		<input type="checkbox"/>	<input type="checkbox"/>	Preliminary Documentation		<input type="checkbox"/>	<input type="checkbox"/>	
	70% Design Drawings		<input type="checkbox"/>	<input type="checkbox"/>	ISAT Documentation		<input type="checkbox"/>	<input type="checkbox"/>	
	Gross Sections		<input type="checkbox"/>	<input type="checkbox"/>	Project Phasing Plans		<input type="checkbox"/>	<input type="checkbox"/>	
			<input type="checkbox"/>	<input type="checkbox"/>	As-Built O&M Documentation Submittal		<input type="checkbox"/>	<input type="checkbox"/>	
	<input type="checkbox"/>	<input type="checkbox"/>	Final Copy of the PLG Program with Drawings	<input type="checkbox"/>	<input type="checkbox"/>				
	<input type="checkbox"/>	<input type="checkbox"/>	Final Copy of Disaster Recovery Procedures	<input type="checkbox"/>	<input type="checkbox"/>				



**APPENDIX B, Project Milestone Schedule**

<b>Design Services Milestones</b>	<b>Estimated Completion Dates</b>
Items 1-4: Validation of Schematic/30% Design submittal, include pre-design Preliminary Alternative Analysis Report Supplemental Preliminary Alternative; TSA Briefing describing the Preferred Alternative; Updated TSA Basis of Design Report and Schematic Design	<b>Dates to Be Filled In</b>
Item 5: 30% TSA Design Package	June, 2011
Item 6: 70% TSA Design Package	August, 2011
Item 7: 100% TSA Design Package	November, 2011
Item 8: Final Construction Drawings	November, 2011
Item 9: Bid Phase Services	October, 2011
Item 10: Construction Administration/Construction Phases Services	December, 2013

**TSA Funding Amount for the Design OTA**

<b>TSA Funding Amount for Design OTA</b>		
Design Fee w/ Construction Admin	8%	\$3,243,063
Construction Management	2%	\$810,771
	<b>Subtotal</b>	<b>\$4,053,834</b>
X 50% Cost Share		<b>\$3,648,469</b>

**APPENDIX C, SCHEDULE OF DELIVERABLES**

The following deliverables are required to be submitted by the CITY/Airport.

Item	Submitted To:	Frequency or Due Date
Alternative Analysis, Schematic, 30%, 70% and 100% Design	TSA Deployment Manager, OSTCBD@tsa.dhs.gov	In accordance with the TSA PGDS Deliverables Checklist
Schedule to include Project Milestones (Design and proposed Construction)	TSA Deployment Manager, OSTCBD@tsa.dhs.gov	Within 30 days of the CITY awarding the design contract. Updates submitted with monthly TSA report.
Design Contract Schedule of Fees	TSA Deployment Manager, TSA Contracting Officer, OSTCBD@tsa.dhs.gov	Provide upon issuing Design Contract
Copies of the Design Contract(s) and Change Orders	TSA Deployment Manager, TSA Contracting Officer, OSTCBD@tsa.dhs.gov	Upon Award. Change Orders requiring advanced TSA approval.
Monthly Project Report	TSA Deployment Manager, OSTCBD@tsa.dhs.gov	By the 10 <sup>th</sup> of each month. Electronic submission is requested.
Requests for Information or Clarification	TSA Deployment Manager	As needed
Final Invoice	TSA Deployment Manager TSA Contracting Officer, OSTCBD@tsa.dhs.gov	No later than 90 days after completion of the CBIS Construction Project.

The Monthly Project Report is to be submitted by the 10th of each month to the TSA Deployment Lead, and OSTCBD@tsa.dhs.gov and shall address the following:

- Design Schedule in both PDF and "live"/usable format to depict the critical path, baseline and actual date information; predecessors/successors. The Design Schedule will be used for all planned TSA activities.

AIRPORT COMMISSION

CITY AND COUNTY OF SAN FRANCISCO

RESOLUTION NO. 11-0146

AWARD PROFESSIONAL SERVICES AGREEMENT FOR CONTRACT NO. 9024.9, CONSTRUCTION MANAGEMENT SERVICES FOR THE INTERNATIONAL TERMINAL AND BOARDING AREA F CHECKED BAGGAGE INSPECTION SYSTEM MODERNIZATION PROGRAM, AND THE INTERNATIONAL TERMINAL BAGGAGE HANDLING SYSTEM IMPROVEMENTS PROJECT IN AN AMOUNT NOT TO EXCEED \$585,805.

WHEREAS, on March 1, 2011, by Resolution No. 11-0045, the Commission authorized the Director to execute an Other Transaction Agreement with the Transportation Security Administration (TSA) for 90% reimbursement of design costs, including construction management services during design, for the International Terminal and Boarding Area F Checked Baggage Inspection System Modernization Program under the TSA's Recapitalization Program, in an amount not to exceed \$3,279,870; and

WHEREAS, on March 1, 2011, by Resolution No. 11-0047, the Commission authorized Staff to issue a request for proposal (RFP) to provide construction management services for the International Terminal and Boarding Area F Checked Baggage Inspection System Modernization Program, and the International Terminal Baggage Handling System Improvements Project (Project); and

WHEREAS, on June 7, 2011, by Resolution No. 11-0150, the Commission accepted the Selection Panel's recommendation of CAGE Inc. (Consultant) as the highest ranked construction management consultant for the Project, and authorized Staff to enter into negotiations and prepare a professional services contract for Commission consideration and award; and

WHEREAS, the initial award of Contract 9024.9 provides for Task 1: Construction Management Services during Design of the International Terminal and Boarding Area F Checked Baggage Inspection System Modernization Program (Program); and

WHEREAS, the TSA's intent is to issue a separate follow-on OTA for the construction phase of the Program, once the construction estimate has been developed and approved, and 90% funding for the CM services during the construction phase will be included in the follow-on OTA; and

WHEREAS, the Airport's BHS Improvements are integrated with the TSA Program, and should be installed concurrently, and by the same contractor to avoid issues with coordination, phasing and potential scope gap; and

WHEREAS, Staff will return to the Commission for award of Tasks 2 and 3 related to the construction phase services following approval by the Commission of the OTA with the TSA for the construction phase of the Program; now, therefore be it

RESOLVED, that the Commission hereby awards a Professional Services Agreement, Contract No. 9024.9, Construction Management Services for the International Terminal and Boarding Area F Checked Baggage Inspection System Modernization Program, and the International Terminal Baggage Handling System Improvements Project, to CAGE Inc., for an amount not to exceed \$585,805, for a contract duration of six months, for the Task 1 scope of services.

*I hereby certify that the foregoing resolution was adopted by the Airport Commission*

*at its meeting of* \_\_\_\_\_

JUN 30 2011

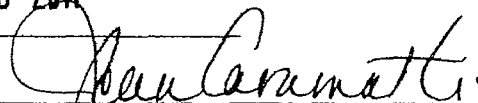

1789

Secretary



San Francisco International Airport

**MEMORANDUM**  
June 30, 2011

**TO:** AIRPORT COMMISSION  
 Hon. Larry Mazzola, President  
 Hon. Linda S. Crayton, Vice President  
 Hon. Eleanor Johns  
 Hon. Richard J. Guggenhime  
 Hon. Peter A. Stern

**FROM:** Airport Director

**SUBJECT:** Award Professional Services Agreement, Contract No. 9024.9, Construction Management Services for the International Terminal and Boarding Area F Checked Baggage Inspection System Modernization Program, and the International Terminal Baggage Handling System Improvement Project, to CAGE, Inc., in an amount not to exceed \$585,805.

**DIRECTOR'S RECOMMENDATION:** AWARD PROFESSIONAL SERVICES AGREEMENT, CONTRACT NO. 9024.9, CONSTRUCTION MANAGEMENT SERVICES FOR THE INTERNATIONAL TERMINAL AND BOARDING AREA F CHECKED BAGGAGE INSPECTION SYSTEM MODERNIZATION PROGRAM, AND THE INTERNATIONAL TERMINAL BAGGAGE HANDLING SYSTEM IMPROVEMENT PROJECT, TO CAGE, INC., IN AN AMOUNT NOT TO EXCEED \$585,805.

**Executive Summary**

On June 7, 2011, by Resolution No. 11-0150, the Commission approved the selection of CAGE, Inc. as the highest ranked firm to provide construction management services for the International Terminal and Boarding Area F Checked Baggage Inspection System Modernization Program, and the International Terminal Baggage Handling System Improvement Project (Project), and authorized the Director to enter into negotiations and prepare a professional services agreement.

Transmitted herewith for your approval, is a proposed Resolution to award Contract No. 9024.9, to CAGE Inc. for Construction Management Services for the Project. The proposed award amount is \$585,805, with a contract duration of six months, for the Task 1 scope of services to be provided under this initial award.

**Background**

On March 1, 2011, by Resolution No. 11-0045, the Commission authorized the Director to execute an Other Transaction Agreement with the Transportation Security Administration (TSA) for 90% reimbursement of design costs, including construction management support services during design only, for the International Terminal and Boarding Area F Checked Baggage Inspection System Modernization Program under the TSA's Recapitalization Program, in an amount not to exceed \$3,279,870.

THIS PRINT COVERS CALENDAR ITEM NO. 5

AIRPORT COMMISSION CITY AND COUNTY OF SAN FRANCISCO

EDWIN M. LEE MAYOR	LARRY MAZZOLA PRESIDENT	LINDA S. CRAYTON VICE PRESIDENT	ELEANOR JOHNS	RICHARD J. GUGGENHIME	PETER A. STERN	JOHN L. MARTIN AIRPORT DIRECTOR
-----------------------	----------------------------	------------------------------------	---------------	-----------------------	----------------	------------------------------------

The Airport will pay for 10% of the total design cost of \$3,644,300 for the Program from existing FY 10/11 capital funds, in the amount not to exceed \$364,430. The Airport has an existing Board of Supervisors authorization to enter into the OTA with the TSA for the design of the Program.

On March 1, 2011, by Resolution No. 11-0047, the Commission authorized Staff to issue a request for proposal (RFP) to provide construction management (CM) services for the International Terminal and Boarding Area F Checked Baggage Inspection System Modernization Program, and the International Terminal Baggage Handling System Improvement project (Project). Two firms responded with proposals and a selection panel was convened to review and score the proposals. CAGE Inc. was determined to be the highest ranking respondent.

On June 7, 2011, by Resolution No. 10-0150, the Commission approved the selection of CAGE Inc., and authorized staff to enter into negotiations and prepare a professional services agreement. Staff and Consultant have reached agreement on the scope and fee, and have developed an appropriate staffing plan.

The proposed Contract 9024.9 would include the following tasks:

#### Task 1

TSA and SFO staffs agreed that the OTA for the design of the Program would include the scope and funding for CM support services during design only. These CM support services will include estimating, scheduling, phasing alternatives development, constructability analysis, project controls and reports. The estimated cost is in an amount not to exceed \$585,805, for six months of services.

#### Task 2

The TSA's intent is to issue a separate follow-on OTA for the construction phase of the Program, once the construction estimate has been developed and approved. The 90% funding for the CM services during the construction phase will be included in the follow-on OTA. The CM will provide for a construction manager, resident engineers, project controls personnel, construction administration support, materials testing and special inspection and any other specialty construction management services required. The CM will not be authorized by the Airport to proceed with Task 2 unless the Airport first enters into an OTA with the TSA for the construction phase of the Program. The estimated cost is in an amount not to exceed \$3,237,597, for twenty four months of services.

#### Task 3

The Airport has budgeted for the International Terminal Baggage Handling System (BHS) Improvements under the Airport's capital plan to replace equipment and systems that are beyond their useful life and impact the reliability of the BHS. These improvements include mechanical equipment, as well as computer equipment and programming that are outside the Checked Baggage Inspection System (CBIS) area and are not included in the TSA Program. However, the Airport's BHS Improvements are integrated with the TSA Program, and should be installed concurrently, and by the same

contractor to avoid issues with coordination, phasing and potential scope gap. The proposed RFP for CM services would include the Airport's BHS Improvements, and will require separate cost accounting. The CM scope for Task 3 is similar to Tasks 1 and 2. The estimated cost is in an amount not to exceed \$1,175,512, for twenty-four months of services, concurrently with Task 2.

This initial award is for the Task 1 scope of services only. Staff will return to the Commission to award Tasks 2 and 3 to Cage at the appropriate time, following approval of the construction OTA for the Program.

The estimated total value of the construction to be managed by Airport staff and Consultant, including contingency, is \$60,800,000. The total project budget for construction management services, including materials testing and special inspection, is \$4,998,914. The construction management services budget for the Project is 8.2% which is not within the Airport's overall goal of achieving 15% for project "soft cost" performance (design, construction management, administrative, and materials testing/special inspection). However, Staff has determined that the scope of CM services for this Project should include 24 hour CM oversight to cover the various work areas, which will likely require double or triple shifting to minimize the impact on operations during construction.

Due to the federal funding component for these services, there are no HRC LBE subconsultant participation goals for the contract. The Airport encouraged proposers to utilize "best efforts" to subcontract at least 10% of the work to certified small and disadvantaged businesses (SDB). There is no specific DBE subconsultant goal for this contract, but the Airport's overall 3-year DBE goal is 12%. Due to the specialized nature of the services, CAGE Inc. was able to achieve 5.8% SDB and DBE subconsultant participation.

### Recommendation

Based upon the foregoing, I recommend your approval of the proposed resolution to award a professional services agreement to CAGE Inc., for Contract No. 9024.9, Construction Management Services for the International Terminal and Boarding Area F Checked Baggage Inspection System Modernization Program, and the International Terminal Baggage Handling System Improvement Project, in the amount not to exceed \$585,805, for a contract duration of six months, for the Task 1 scope of services.

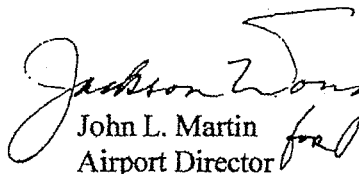
  
John L. Martin  
Airport Director

Prepared by: Ivar Satero  
Deputy Airport Director  
Design and Construction

Attachment



AIRPORT COMMISSION

CITY AND COUNTY OF SAN FRANCISCO

RESOLUTION NO. 11-0047

AUTHORIZATION TO ISSUE A REQUEST FOR PROPOSAL FOR PROFESSIONAL SERVICES FOR CONTRACT 9024.9 CONSTRUCTION MANAGEMENT SERVICES FOR THE INTERNATIONAL TERMINAL AND BOARDING AREA F CHECKED BAGGAGE INSPECTION SYSTEM MODERNIZATION PROGRAM, AND THE INTERNATIONAL TERMINAL BAGGAGE HANDLING SYSTEM IMPROVEMENTS

- WHEREAS, the TSA has initiated a Recapitalization Program for the purpose of funding the modernization of the TSA's Explosive Detection Systems (EDS) equipment within airport bag room Checked Baggage Inspection Systems (CBIS); and,
- WHEREAS, the TSA has approved the Airport's application and has issued a proposed Other Transaction Agreement (OTA) for reimbursement of 90% of the design cost of the International Terminal and Boarding Area F Checked Baggage Inspection System Modernization Program (Program); and,
- WHEREAS, Task 1 for the proposed RFP would include CM support services during design of the Program; and,
- WHEREAS, the TSA's intent is to issue a separate follow-on OTA for the construction phase of the Program, once the construction estimate has been developed and approved, with the follow-on OTA providing for 90% funding for CM services during the construction phase; and,
- WHEREAS, Task 2 for the proposed RFP would include CM services during the construction phase of the Program and would be deferred until the Airport entered into the follow-on construction phase OTA; and,
- WHEREAS, Task 3 for the proposed RFP would include CM services for the International Terminal Baggage Handling System (BHS) Improvements, budgeted under the Airport's capital plan to replace equipment and systems that are beyond their useful life and impact the reliability of the BHS; and,
- WHEREAS, the total cost estimate for the three CM services tasks is \$2,996,580; and
- WHEREAS, the duration of the proposed Contract 9024.9 is 30 months; now, therefore be it
- RESOLVED, that the Commission approves this resolution authorizing Staff to issue a Request for Proposal for Contract 9015.9, Construction Management Services for Contract 9024.9, Construction Management Services for International Terminal and Boarding Area F Checked Baggage Inspection System Modernization Program, and the International Terminal Baggage Handling System Improvements, conditioned on the separate Commission authorization of the Transportation Security Administration's Other Transaction Agreement for the Program design.

*I hereby certify that the foregoing resolution was adopted by the Airport Commission*

*at its meeting of* \_\_\_\_\_

MAR 01 2011



Secretary



San Francisco International Airport

**MEMORANDUM**

March 1, 2011

TO: Members, Airport Commission  
 Hon. Larry Mazzola, President  
 Hon. Linda S. Crayton, Vice President  
 Hon. Eleanor Johns  
 Hon. Richard J. Guggenlime  
 Hon. Peter A. Stern

11-0047

MAR 01 2011

FROM: Airport Director

SUBJECT: Authorization to Issue a Request for Proposal for Professional Services for Contract 9024.9, Construction Management Services for the International Terminal and Boarding Area F Checked Baggage Inspection System Modernization Program, and the International Terminal Baggage Handling System Improvements

DIRECTOR'S RECOMMENDATION: APPROVE RESOLUTION AUTHORIZING A REQUEST FOR PROPOSAL FOR PROFESSIONAL SERVICES, FOR CONTRACT 9024.9, CONSTRUCTION MANAGEMENT SERVICES FOR THE INTERNATIONAL TERMINAL AND BOARDING AREA F CHECKED BAGGAGE INSPECTION SYSTEM MODERNIZATION PROGRAM, AND THE INTERNATIONAL TERMINAL BAGGAGE HANDLING SYSTEM IMPROVEMENTS

Executive Summary

Staff is seeking Commission authorization to issue a Request for Proposal (RFP) to select a Construction Management Team to provide professional services on Contract 9024.9, Construction Management Services for the International Terminal and Boarding Area F Checked Baggage Inspection System Modernization Program (Program), and the International Terminal Baggage Handling System Improvements. The total estimated cost for these services is \$2,996,580.

Background

The TSA has initiated a Recapitalization Program for the purpose of funding the modernization of the TSA's Explosive Detection Systems (EDS) equipment within airport bag room Checked Baggage Inspection Systems (CBIS). The Airport submitted an application for an Other Transaction Agreement (OTA) under the TSA's Recapitalization Program. The TSA has approved the Airport's application and has issued a proposed OTA for reimbursement of 90% of the design cost of the Program. A proposed Commission resolution to approve the OTA is submitted under a separate Agenda item on this Commission calendar.

THIS PRINT COVERS CALENDAR ITEM NO. 4

AIRPORT COMMISSION CITY AND COUNTY OF SAN FRANCISCO

EDWIN M. LEE MAYOR	LARRY MAZZOLA PRESIDENT	LINDA S. CRAYTON VICE PRESIDENT	ELEANOR JOHNS	RICHARD J. GUGGENHIME	PETER A. STERN	JOHN L. MARTIN AIRPORT DIRECTOR
-----------------------	----------------------------	------------------------------------	---------------	-----------------------	----------------	------------------------------------

1794

The proposed RFP for Contract 9024.9 for construction management (CM) services would include the following tasks:

Task 1

TSA and SFO staffs agreed that the OTA for the design of the Program would include the scope and funding for CM support services during design only. These CM support services will include estimating, scheduling, phasing alternatives development, constructability analysis, project controls and reports. Estimated cost is \$807,000.

Task 2

The TSA's intent is to issue a separate follow-on OTA for the construction phase of the Program, once the construction estimate has been developed and approved. The 90% funding for the CM services during the construction phase will be included in the follow-on OTA. The CM will provide for a construction manager, resident engineers, project controls personnel, construction administration support, materials testing and special inspection and any other specialty construction management services required. The CM would not be authorized by the Airport to proceed with Task 2 unless the Airport first entered into an OTA with the TSA for the construction phase of the Program. Estimated cost is \$1,379,580.

Task 3

The Airport has budgeted for the International Terminal Baggage Handling System (BHS) Improvements under the Airport's capital plan to replace equipment and systems that are beyond their useful life and impact the reliability of the BHS. These improvements include mechanical equipment, as well as computer equipment and programming that are outside the CBIS area and are not included in the TSA Program. However, the Airport's BHS Improvements are integrated with the TSA Program, and should be installed concurrently, and by the same contractor to avoid coordination, phasing and scope gap issues. The proposed RFP for CM services would include the Airport's BHS Improvements, and will require separate cost accounting. The CM scope for Task 3 is similar to Tasks 1 and 2. Estimated cost is \$810,000.

The duration for the proposed Contract 9024.9 is 30 months.

The RFP for Contract 9024.9 will contain minimum qualification requirements appropriate for the anticipated size and complexity of the proposed scope. Upon determining which proposals meet the minimum qualifications, Staff will convene a selection committee to evaluate the technical content of the accepted proposals and develop a ranking. The Airport will then shortlist the highest ranked responsive teams and the Selection Committee will interview the teams and key personnel. Staff will perform reference checks of past clients of the firms. Based upon the results of the proposals, interviews and reference checks, Staff will determine the highest ranked proposer, and enter into negotiations with that CM Team. Upon successfully negotiating scope, staffing and fees, Staff will return to the Commission with a recommendation that the Commission award a contract to the highest ranked team.

Due to the federal funding component for these services, Staff will work with Airport Small Business Affairs staff to develop a small business program for these services to ensure the participation of local, small, and disadvantaged businesses.

Recommendation

I recommend the Commission approve this Resolution authorizing Staff to issue an RFP for professional services for Contract 9024.9, Construction Management Services for the International Terminal and Boarding Area F Checked Baggage Inspection System Modernization Program, and the International Terminal Baggage Handling System Improvements, conditioned on the separate Commission authorization of the Transportation Security Administration's Other Transaction Agreement for the Program design.



John L. Martin  
Airport Director

Prepared by:

Ivar Satero  
Deputy Airport Director  
Bureau of Design and Construction

Attachment

RECEIVED  
BOARD OF SUPERVISORS  
SAN FRANCISCO

San Francisco International Airport

July 14, 2017

2017 SEP 25 PM 1:30

Ms. Angela Calvillo

Clerk of the Board: 

Board of Supervisors

City Hall

1 Dr. Carlton B. Goodlett Place, Room 244

San Francisco, CA 94102-4689

**Subject: Contract Amendment – CAGE Professional Services, Inc. – Construction Management Services for the International Terminal Checked Baggage Inspection System Modernization and Baggage Handling System Improvements Project – Not-to-Exceed \$14,500,000**

Dear Ms. Calvillo:

Pursuant to Section 9.118 of the City Charter, I am forwarding for the Board of Supervisor's approval, a contract between the City and County of San Francisco, by and through its Airport Commission ("Commission") and CAGE Professional Services, Inc., for Construction Management Support Services. This contract was originally estimated to be under \$10 million, but will now exceed the threshold of Section 9.118.

The Commission awarded this contract by Resolution 11-0146 on June 30, 2011 to CAGE, Inc.; approved the First Modification by Resolution 11-0221 on October 4, 2011; approved the Second Modification by Resolution 12-0158 on July 17, 2012; approved the Third Modification by Resolution 13-0248 on December 3, 2013; approved the Fourth Modification by Resolution 14-0124 on June 17, 2014; approved the Fifth Modification by Resolution 14-0249 on December 2, 2014; approved the Sixth Modification by Resolution 15-0171 on September 1, 2015; approved the Eighth Modification by Resolution 16-0221 on August 9, 2016. The Seventh Modification and Ninth Modification were administrative in nature.

By Resolution 17-0155, dated June 20, 2017; the Commission approved the Tenth Modification to this contract. The Commission authorized a not-to-exceed amount of \$10,695,000 for services through September 30, 2018. The Airport Director estimates that the total value of this contract will not exceed \$14,500,000 for services through December 31, 2020.

Three (3) sets of the following documents are enclosed for review:

- Proposed Board of Supervisors Resolution;
- Adopted Airport Commission Resolution No. 11-0047;
- Memorandum recommending Resolution No. 11-0047;
- Adopted Airport Commission Resolution No. 11-0140;
- Memorandum recommending Resolution No. 11-0140;
- Adopted Airport Commission Resolution No. 11-0146;
- Memorandum recommending Resolution No. 11-0146;
- Adopted Airport Commission Resolution No. 11-0221;
- Memorandum recommending Resolution No. 11-0221;



San Francisco International Airport

- Adopted Airport Commission Resolution No. 12-0158;
- Memorandum recommending Resolution No. 12-0158;
- Adopted Airport Commission Resolution No. 13-0248;
- Memorandum recommending Resolution No. 13-0248;
- Adopted Airport Commission Resolution No. 14-0124;
- Memorandum recommending Resolution No. 14-0124;
- Adopted Airport Commission Resolution No. 14-0249;
- Memorandum recommending Resolution No. 14-0249;
- Adopted Airport Commission Resolution No. 15-0171;
- Memorandum recommending Resolution No. 15-0171;
- Adopted Airport Commission Resolution No. 16-0221;
- Memorandum recommending Resolution No. 16-0221;
- Adopted Airport Commission Resolution No. 17-0155;
- Memorandum recommending Resolution No. 17-0155;
- Form SFEC-126 for the Board of Supervisors;
- Form SFEC-126 for Mayor Lee; and
- Copy of Airport Contract No. 9024.9 with CAGE, Inc. for Construction Management Support Services
- Certified First Amendment
- Certified Second Amendment
- Certified Third Amendment
- Certified Fourth Modification
- Certified Fifth Modification
- Certified Sixth Modification
- Certified Seventh Modification
- Certified Eighth Modification
- Certified Ninth Modification
- Tenth Modification

Please contact Cathy Widener, Airport Governmental Affairs Manager at (650) 821-5023 if you have questions or concerns regarding this matter.

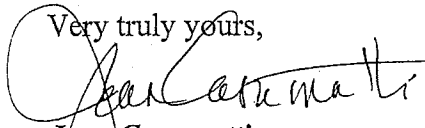
Very truly yours,  
  
**Jean Caramatti**  
 Commission Secretary

Enclosures

Cc: Cathy Widener  
 Greg McCarthy  
 Geri Rayca

**FORM SFEC-126:**  
**NOTIFICATION OF CONTRACT APPROVAL**  
(S.F. Campaign and Governmental Conduct Code § 1.126)

<b>City Elective Officer Information</b> <i>(Please print clearly.)</i>	
Name of City elective officer(s): Members, Board of Supervisors	City elective office(s) held: Members, Board of Supervisors

<b>Contractor Information</b> <i>(Please print clearly.)</i>	
Name of contractor: <b>CAGE Professional Services, Inc.</b>	

*Please list the names of (1) members of the contractor's board of directors; (2) the contractor's chief executive officer, chief financial officer and chief operating officer; (3) any person who has an ownership of 20 percent or more in the contractor; (4) any subcontractor listed in the bid or contract; and (5) any political committee sponsored or controlled by the contractor. Use additional pages as necessary.*

**CAGE, Inc.**

(1) Members of the contractor's board of directors;

Carl Clause, David Sinclair, Jeff Plant

(2) The contractor's chief executive officer, chief financial officer and chief operating officer;

Carl Clause, David Sinclair, Jeff Plant

(3) Any person who has an ownership of 20 percent or more in the contractor;

Carl Clause

(4) Any subcontractor listed in the bid or contract;

KPA Group  
Chaves & Associates  
EPC Consultants  
M Lee Corporation  
Apex Testing  
Grindstone Group, LLC  
Cooper Pugaeda Management, Inc.  
Brock Solutions  
Innovation Technology Partners, Inc.  
Faith Group, LLC

(5) Any political committee sponsored or controlled by the contractor

None

Contractor address:

CAGE Professional Services, Inc.: 6440 North Beltline Road, Suite 125, Irving, Texas 75063  
The KPA Group: 1 Kaiser Plaza, Suite 445, Oakland, California 94612  
Chaves & Associates: One Hallidie Plaza, Suite 220, San Francisco, California 94102  
EPC Consultants: 655 Davis Street, San Francisco, California 94111  
M Lee Corporation: 500 Suiter Street, Suite 923, San Francisco, California 94102  
Apex Testing Laboratories: 3450 3<sup>rd</sup> Street, Suite 3E, San Francisco, California 94124  
Grindstone Group, LLC: 6440 North Beltline Road, Suite 125-D, Irving, Texas 75063  
Cooper Pugaeda Management, Inc.: 65 McCoppin Street, San Francisco, California  
Brock Solutions: 86 & 88 Ardel Avenue, Kitchener, Ontario, Canada N2C 2C9  
Innovation Technology Partners, Inc.: 1679 Geary Road, Walnut Creek, CA 94597  
Faith Group, LCC: 3101 S Hanley Road, St Louis, MO 63143

Date that contract was approved: <i>(By the SF Board of Supervisors)</i>	Amount of contract: <b>Not-to-exceed \$10,695,000</b>
Describe the nature of the contract that was approved: The contractor will provide construction management services to assist the Airport for the International Terminal Checked Baggage Inspection System Modernization Program and Baggage Handling Systems Improvements Project ("Project") in a coordinated and methodical manner. Specific areas of expertise required include: baggage handling systems and Transportation Security Administration (TSA) design, program planning and phasing, program-level cost/schedule controls, solicitations and contract preparation, alternative project delivery processes, construction management coordination, cost estimating, industry outreach/workshops, document control, program management systems, and other administrative support functions and operations.	
Comments: Requesting Board of Supervisors to approve the Professional Services Agreement for Airport Contract 9024.9 – Construction Management Services for the International Terminal Checked Baggage Inspection System Modernization Program and Baggage Handling Systems Improvements Project and the City and County of San Francisco for a contract end date through September 30, 2018 with a not-to-exceed amount of \$10,695,000. Since a new design-build contract has been awarded, Staff recommended continuing this contract to provide general contract administration and project management support services for the full duration of the new design-build contract which may extend this contract through December 2020 with a final contract amount of \$14,500,000.	

This contract was approved by (check applicable):

the City elective officer(s) identified on this form

a board on which the City elective officer(s) serves: San Francisco Board of Supervisors  
Print Name of Board

the board of a state agency (Health Authority, Housing Authority Commission, Industrial Development Authority Board, Parking Authority, Redevelopment Agency Commission, Relocation Appeals Board, Treasure Island Development Authority) on which an appointee of the City elective officer(s) identified on this form sits

Print Name of Board

<b>Filer Information</b> <i>(Please print clearly.)</i>	
Name of filer: Angela Calvillo, Clerk of the Board	Contact telephone number: ( 415 ) 554-5184
Address: City Hall, Room 244, 1 Dr. Carlton B. Goodlett Pl., San Francisco, CA 94102	E-mail: Board.of.Supervisors@sfgov.org

\_\_\_\_\_  
Signature of City Elective Officer (if submitted by City elective officer)

\_\_\_\_\_  
Date Signed

\_\_\_\_\_  
Signature of Board Secretary or Clerk (if submitted by Board Secretary or Clerk)

\_\_\_\_\_  
Date Signed