

File No. 180985

Committee Item No. 3

Board Item No. 39

COMMITTEE/BOARD OF SUPERVISORS

AGENDA PACKET CONTENTS LIST

Committee: Government Audit and Oversight
Board of Supervisors Meeting:

Date: November 7, 2018
Date: Nov. 13, 2018

Cmte Board

- | | | |
|-------------------------------------|-------------------------------------|--|
| <input type="checkbox"/> | <input type="checkbox"/> | Motion |
| <input checked="" type="checkbox"/> | <input checked="" type="checkbox"/> | Resolution |
| <input type="checkbox"/> | <input type="checkbox"/> | Ordinance |
| <input type="checkbox"/> | <input type="checkbox"/> | Legislative Digest |
| <input type="checkbox"/> | <input type="checkbox"/> | Budget and Legislative Analyst Report |
| <input type="checkbox"/> | <input type="checkbox"/> | Youth Commission Report |
| <input type="checkbox"/> | <input type="checkbox"/> | Introduction Form |
| <input type="checkbox"/> | <input type="checkbox"/> | Department/Agency Cover Letter and/or Report |
| <input type="checkbox"/> | <input type="checkbox"/> | MOU |
| <input type="checkbox"/> | <input type="checkbox"/> | Grant Information Form |
| <input type="checkbox"/> | <input type="checkbox"/> | Grant Budget |
| <input type="checkbox"/> | <input type="checkbox"/> | Subcontract Budget |
| <input checked="" type="checkbox"/> | <input checked="" type="checkbox"/> | Contract/Agreement |
| <input checked="" type="checkbox"/> | <input checked="" type="checkbox"/> | Form 126 – Ethics Commission |
| <input type="checkbox"/> | <input type="checkbox"/> | Award Letter |
| <input type="checkbox"/> | <input type="checkbox"/> | Application |
| <input type="checkbox"/> | <input type="checkbox"/> | Public Correspondence |

OTHER

- | | | |
|-------------------------------------|-------------------------------------|--|
| <input checked="" type="checkbox"/> | <input checked="" type="checkbox"/> | <u>Planning Presentation - November 7, 2018</u> |
| <input checked="" type="checkbox"/> | <input checked="" type="checkbox"/> | <u>Case Report - 2018 Mills Act Applications</u> |
| <input checked="" type="checkbox"/> | <input checked="" type="checkbox"/> | <u>HPC Reso. No. 991 - October 3, 2018</u> |
| <input checked="" type="checkbox"/> | <input checked="" type="checkbox"/> | <u>Rehabilitation and Maintenance Plans</u> |
| <input checked="" type="checkbox"/> | <input checked="" type="checkbox"/> | <u>Assessor's Mills Act Valuation</u> |
| <input checked="" type="checkbox"/> | <input checked="" type="checkbox"/> | <u>Mills Act Application Documents</u> |

Prepared by: John Carroll

Date: November 2, 2018

Prepared by: John Carroll

Date: November 8, 2018

1 [Mills Act Historical Property Contract - 465-467 Oak Street]

2
3 **Resolution approving an historical property contract between Joseph E and Jennifer A**
4 **Laska Joint Living Trust, the owner of 465-467 Oak Street, and the City and County of**
5 **San Francisco, under Administrative Code, Chapter 71; and authorizing the Planning**
6 **Director and the Assessor-Recorder to execute and record the historical property**
7 **contract.**

8
9 WHEREAS, The California Mills Act (Government Code, Section 50280 et seq.)
10 authorizes local governments to enter into a contract with the owners of a qualified historical
11 property who agree to rehabilitate, restore, preserve, and maintain the property in return for
12 property tax reductions under the California Revenue and Taxation Code; and

13 WHEREAS, The Planning Department has determined that the actions contemplated in
14 this Resolution comply with the California Environmental Quality Act (California Public
15 Resources Code, Sections 21000 et seq.), and

16 WHEREAS, Said determination is on file with the Clerk of the Board of Supervisors in
17 File No. 180985, is incorporated herein by reference, and the Board herein affirms it; and

18 WHEREAS, San Francisco contains many historic buildings that add to its character
19 and international reputation and that have not been adequately maintained, may be
20 structurally deficient, or may need rehabilitation, and the costs of properly rehabilitating,
21 restoring, and preserving these historic buildings may be prohibitive for property owners; and

22 WHEREAS, Administrative Code, Chapter 71 was adopted to implement the provisions
23 of the Mills Act and to preserve these historic buildings; and

24
25

1 WHEREAS, 465-467 Oak Street is designated as a Contributor to the California
2 Register of Historical Places-listed Hayes Valley Residential Historic District and thus qualifies
3 as an historical property as defined in Administrative Code, Section 71.2; and

4 WHEREAS, A Mills Act application for an historical property contract has been
5 submitted by Joseph E & Jennifer A Laska Joint Living Trust, the owners of 465-467 Oak
6 Street, detailing rehabilitation work and proposing a maintenance plan for the property; and

7 WHEREAS, As required by Administrative Code Section 71.4(a), the application for the
8 historical property contract for 465-467 Oak Street was reviewed by the Assessor's Office and
9 the Historic Preservation Commission; and

10 WHEREAS, The Assessor-Recorder has reviewed the historical property contract and
11 has provided the Board of Supervisors with an estimate of the property tax calculations and
12 the difference in property tax assessments under the different valuation methods permitted by
13 the Mills Act in its report transmitted to the Board of Supervisors on October 10, 2018, which
14 report is on file with the Clerk of the Board of Supervisors in File No. 180985 and is hereby
15 declared to be a part of this Resolution as if set forth fully herein; and

16 WHEREAS, The Historic Preservation Commission recommended approval of the
17 historical property contract in its Resolution No. 991, including approval of the Rehabilitation
18 Program and Maintenance Plan, attached to said Resolution, which is on file with the Clerk of
19 the Board of Supervisors in File No. 180985 and is hereby declared to be a part of this
20 Resolution as if set forth fully herein; and

21 WHEREAS, The draft historical property contract between Joseph E & Jennifer A
22 Laska Joint Living Trust, the owners of 465-467 Oak Street, and the City and County of San
23 Francisco is on file with the Clerk of the Board of Supervisors in File No. 180985 and is
24 hereby declared to be a part of this Resolution as if set forth fully herein; and
25

1 WHEREAS, The Board of Supervisors has conducted a public hearing pursuant to
2 Administrative Code, Section 71.4(d) to review the Historic Preservation Commission's
3 recommendation and the information provided by the Assessor's Office in order to determine
4 whether the City should execute the historical property contract for 465-467 Oak Street; and

5 WHEREAS, The Board of Supervisors has balanced the benefits of the Mills Act to the
6 owner of 465-467 Oak Street with the cost to the City of providing the property tax reductions
7 authorized by the Mills Act, as well as the historical value of 465-467 Oak Street and the
8 resultant property tax reductions, and has determined that it is in the public interest to enter
9 into a historical property contract with the applicants; now, therefore, be it

10 RESOLVED, That the Board of Supervisors hereby approves the historical property
11 contract between Joseph E & Jennifer A Laska Joint Living Trust, the owners of 465-467 Oak
12 Street, and the City and County of San Francisco; and, be it

13 FURTHER RESOLVED, That the Board of Supervisors hereby authorizes the Planning
14 Director and the Assessor-Recorder to execute the historical property contract and record the
15 historical property contract.

**Recording Requested by, and
when recorded, send notice to:**
City and County of San Francisco
Planning Department
Attn: Shannon Ferguson
1650 Mission Street, Suite 400
San Francisco, CA 94103-2414

**CALIFORNIA MILLS ACT
HISTORIC PROPERTY AGREEMENT
465-467 OAK STREET
SAN FRANCISCO, CALIFORNIA**

THIS AGREEMENT is entered into by and between the City and County of San Francisco, a California municipal corporation ("City") and Joseph E & Jennifer A Laska Jnt Lvg Trust ("Owners").

RECITALS

Owners are the owners of the property located at 465-467 Oak Street, in San Francisco, California (Block 0840, Lot 017). The building located at 465-467 Oak Street is designated as a Contributor to the California Register of Historical Places-listed Hayes Valley Residential Historic District (the "Historic Property"). The Historic Property is a Qualified Historic Property, as defined under California Government Code Section 50280.1.

Owners desire to execute a rehabilitation and ongoing maintenance project for the Historic Property. Owners' application calls for the rehabilitation and restoration of the Historic Property according to established preservation standards, which it estimates will cost three hundred sixty-nine thousand, six hundred dollars (\$369,600.00). (See Rehabilitation Plan, Exhibit A.) Owners' application calls for the maintenance of the Historic Property according to established preservation standards, which is estimated will cost approximately two thousand dollars (\$2,000) annually (See Maintenance Plan, Exhibit B).

The State of California has adopted the "Mills Act" (California Government Code Sections 50280-50290, and California Revenue & Taxation Code, Article 1.9 [Section 439 et seq.]) authorizing local governments to enter into agreements with property Owners to reduce their property taxes, or to prevent increases in their property taxes, in return for improvement to and maintenance of historic properties. City has adopted enabling legislation, San Francisco Administrative Code Chapter 71, authorizing it to participate in the Mills Act program.

Owners desire to enter into this Agreement (also referred to as a Mills Act Agreement or a Historic Property Agreement) with City to help mitigate anticipated expenditures to restore and maintain the Historic Property. City is willing to enter into this Agreement to mitigate these expenditures and to induce Owners to restore and maintain the Historic Property in excellent condition in the future.

NOW, THEREFORE, in consideration of the mutual obligations, covenants, and conditions contained in this Agreement, the parties hereto do agree as follows:

1. Application of Mills Act. The benefits, privileges, restrictions, and obligations provided for in the Mills Act will be applied to the Historic Property during the Term (as defined in Paragraph 7 below), commencing on the date that this Agreement is recorded.
2. Rehabilitation of the Historic Property. Owners will undertake and complete the work set forth in Exhibit A ("Rehabilitation Plan") according to certain standards and requirements. Those standards and requirements include, but are not limited to: the Secretary of the Interior's Standards for the Treatment of Historic Properties ("Secretary's Standards"); the rules and regulations of the Office of Historic Preservation of the California Department of Parks and Recreation ("OHP Rules and Regulations"); the State Historical Building Code as determined applicable by City; all applicable building safety standards; and the requirements of the Historic Preservation Commission, the Planning Commission, and the Board of Supervisors, including but not limited to any Certificates of Appropriateness approved under Planning Code Article 10. Owners will (a) apply for any necessary permits no more than six (6) months after the date this Agreement is recorded, (b) commence the work within six (6) months of receipt of necessary permits, and (c) complete the work within three (3) years from the date of receipt of permits. Upon written request by Owners, the Zoning Administrator, at his or her discretion, may grant an extension of the time periods set forth in this paragraph. Owners may apply for an extension by a letter to the Zoning Administrator, and the Zoning Administrator may grant the extension by letter without a hearing. The work will be deemed complete when the Director of Planning determines that the Historic Property has been rehabilitated in accordance with the standards set forth in this Paragraph. Failure to timely complete the work may result in cancellation of this Agreement as set forth in Paragraphs 11 and 12 below.
3. Maintenance. Owners will maintain the Historic Property during the time this Agreement is in effect in accordance with the standards for maintenance set forth in Exhibit B ("Maintenance Plan"), the Secretary's Standards; the OHP Rules and Regulations; the State Historical Building Code as determined applicable by City; all applicable building safety standards; and the requirements of the Historic Preservation Commission, the Planning Commission, and the Board of Supervisors, including but not limited to any Certificates of Appropriateness approved under Planning Code Article 10.
4. Damage. If fifty percent (50%) or less of the Historic Property is damaged by any cause whatsoever, Owners will replace and repair the damaged area(s) of the Historic Property. For repairs that do not require a permit, Owners will commence the repair work within thirty (30) days after the date of the damage and will diligently perform and complete the repair work within a reasonable time, as determined by City. Where specialized services are required due to the nature of the work and the historic character of the features damaged, "commence the repair work" within the meaning of this paragraph may include contracting for repair services. For repairs that require a permit(s), Owners will apply for any necessary permits for the work within sixty (60) days after the date of the damage, commence the repair work within one hundred twenty (120) days of receipt of the required permit(s), and diligently perform and complete the repair work within a reasonable period of time, as determined by City. Upon written request by Owners, the Zoning Administrator, at his or her discretion, may grant an extension of the time periods set forth in this paragraph. Owners may apply for an extension by a letter to the Zoning Administrator, and the Zoning Administrator may grant the extension by letter without a hearing. All repair work must comply with the design and standards established for the Historic Property in Exhibits A and B attached hereto and Paragraph 3 above. If twenty percent (20%) or more of the Historic Property is damaged due to a catastrophic event, such as an earthquake, or if more than fifty percent (50%) of the Historic Property is destroyed from any cause whatsoever, then City and Owners may mutually agree to terminate this Agreement and Owners will not be obligated to pay the cancellation fee set forth in Paragraph 12 below. Upon the termination, City will assess the full value of the Historic Property without regard to any restriction imposed upon

the Historic Property by this Agreement and Owners will pay property taxes to City based upon that valuation as of the date of termination.

5. Insurance. Owners will obtain and maintain adequate property insurance to meet Owners' repair and replacement obligations under this Agreement and will submit evidence of that insurance to City upon request.

6. Inspections and Compliance Monitoring. Before entering into this Agreement Owners have allowed, and every five years during the Term (defined in Paragraph 7 below) upon seventy-two (72) hours advance notice Owners will allow any representative of City, the Office of Historic Preservation of the California Department of Parks and Recreation, or the State Board of Equalization, to inspect of the interior and exterior of the Historic Property, to determine Owners' compliance with this Agreement. Throughout the term of this Agreement, Owners will provide all reasonable information and documentation about the Historic Property demonstrating compliance with this Agreement, as requested by any of the above-referenced representatives.

7. Term. This Agreement will be effective on the recording date for a term of ten years from that date ("Term"), as it may be extended. As provided in Government Code section 50282, one year will be added automatically to the Term on each anniversary date of this Agreement, unless notice of nonrenewal is given as set forth in Paragraph 9 below.

8. Valuation. Pursuant to Section 439.4 of the California Revenue and Taxation Code, as amended from time to time, this Agreement must have been signed, accepted and recorded on or before the lien date (January 1) for a fiscal year (the following July 1-June 30) for the Historic Property to be valued under the taxation provisions of the Mills Act for that fiscal year.

9. Notice of Nonrenewal. If in any year of this Agreement either Owners or City desire not to renew this Agreement, then that party will serve written notice on the other party before the annual renewal date. Owners must serve the written notice of nonrenewal to City at least ninety (90) days before the date of renewal. City must serve the written notice of non-renewal to Owners at least sixty (60) days before the date of renewal. If City elects not to renew the Agreement, then the Board of Supervisors must make City's determination that this Agreement will not be renewed and send a notice of nonrenewal to Owners. Upon receipt by Owners of a notice of nonrenewal from City, Owners may make a written protest. At any time before the renewal date, the City's Board of Supervisors may withdraw its notice of nonrenewal. If either party serves a notice of nonrenewal of this Agreement, this Agreement will remain in effect for the remaining balance of the Term. If either party elects not to renew this Agreement, then the electing party may cause a notice of nonrenewal in the form attached as Exhibit C to this Agreement to be completed and recorded. Upon the expiration of this Agreement, City will assess the full value of the Historic Property without regard to any restriction imposed upon the Historic Property by this Agreement and Owners will pay property taxes to City based upon that valuation as of the date of expiration.

10. Payment of Fees. As provided for in Government Code Section 50281.1 and San Francisco Administrative Code Section 71.6, upon filing an application to enter into a Mills Act Agreement with City, Owners will pay City the reasonable costs related to the preparation and approval of the Agreement. In addition, Owners will pay City for the actual costs of inspecting the Historic Property, as set forth in Paragraph 6 above.

11. Default. If City determine that any of the following have occurred, City will give Owners written notice by registered or certified mail specifying the failure:

(a) Owners' failure to timely complete the rehabilitation work set forth in Exhibit A, in accordance with Paragraph 2 above;

- (b) Owners' failure to maintain the Historic Property as set forth in Exhibit B, in accordance with Paragraph 3 above;
- (c) Owners' failure to repair any damage to the Historic Property in a timely manner, as provided in Paragraph 4 above;
- (d) Owners' failure to allow any inspections or requests for information, as provided in Paragraph 6 above;
- (e) Owners' failure to pay any fees requested by City as provided in Paragraph 10 above;
- (f) Owners' failure to maintain adequate insurance for the replacement cost of the Historic Property, as required by Paragraph 5 above; or
- (g) Owners' failure to comply with any other provision of this Agreement.

If Owners do not undertake and diligently pursue corrective action to the reasonable satisfaction of City within thirty (30) days after the date of the notice, then the Board of Supervisors will conduct a public hearing to determine whether an event of default has occurred. Notice of the public hearing will be mailed to the last known address of each owner of property in the Hayes Valley Residential Historic District and published under Government Code section 6061. If the Board of Supervisors determines that an event of default has occurred, City will either cancel this Agreement as set forth in Paragraph 12 below or bring an action to enforce this contract, including, but not limited to, an action for specific performance or injunction.

12. Cancellation. If the Board of Supervisors determines that an event of default has occurred and elects to cancel the contract, then Owners will pay a cancellation fee of twelve and one-half percent (12.5%) of the fair market value of the Historic Property at the time of cancellation. The City Assessor will determine fair market value of the Historic Property without regard to any restriction imposed on the Historic Property by this Agreement. The Cancellation Fee will be paid to the City Tax Collector at such time and in such manner as City may prescribe. As of the date of cancellation, Owners will pay property taxes to City without regard to any restriction imposed on the Historic Property by this Agreement and based upon the Assessor's determination of the fair market value of the Historic Property as of the date of cancellation.

13. Enforcement of Agreement. No failure by City to cancel this Agreement or file an action will be deemed to be a waiver of this Agreement or any claim for an event of default under this Agreement.

14. Indemnification. Owners will indemnify, defend, and hold harmless City and all of its boards, commissions, departments, agencies, agents, and employees (individually and collectively, the "Indemnitees") from and against any and all liabilities, losses, costs, claims, judgments, settlements, damages, liens, fines, penalties, and expenses incurred in connection with or arising in whole or in part from: (a) any accident, injury to or death of a person, loss of or damage to property occurring in or about the Historic Property; (b) the use or occupancy of the Historic Property; (c) the condition of the Historic Property; (d) any construction or other work undertaken on the Historic Property; or (e) any claims by unit or interval Owners for property tax reductions in excess those provided for under this Agreement. This indemnification will include, without limitation, reasonable fees for attorneys, consultants, and experts and related costs that may be incurred by the Indemnitees and the Indemnitees' cost of investigating any claim. In addition to Owners' obligation to indemnify the Indemnitees, Owners specifically acknowledge and agree that they have an immediate and independent obligation to defend the Indemnitees from any claim that actually or potentially falls within this indemnification provision, even if the allegations are or may be groundless, false, or fraudulent, which obligation arises at the time such claim is tendered to Owners, and continues at all times thereafter. Owners' obligations under this Paragraph survive termination of this Agreement.

15. Eminent Domain. In the event that a the Historic Property is acquired in whole or part by eminent domain or other similar action, this Agreement will be cancelled and no cancellation fee will be imposed, as provided by Government Code Section 50288.

16. Binding on Successors and Assigns. The covenants, benefits, restrictions, and obligations contained in this Agreement will run with the land and be binding upon and inure to the benefit of all successors in interest and assigns of Owners. Successors in interest and assigns have the same rights and obligations under this Agreement as the original Owners who entered into the Agreement.

17. Legal Fees. If either City or Owners fail to perform any of their obligations under this Agreement or if a dispute arises concerning the meaning or interpretation of any provision of this Agreement, the prevailing party may recover all costs and expenses incurred in enforcing or establishing its rights under this Agreement, including reasonable attorneys' fees, in addition to court costs and any other relief ordered by a court of competent jurisdiction. Reasonable attorneys' fees of the City's Office of the City Attorney will be based on the fees regularly charged by private attorneys with the equivalent number of years of experience who practice in the City of San Francisco in law firms with approximately the same number of attorneys as employed by the Office of the City Attorney.

18. Governing Law. This Agreement will be construed and enforced in accordance with the laws of the State of California.

19. Recordation. Within 20 days after the date of execution of this Agreement, the parties will cause this Agreement to be recorded with the Office of the Recorder of the City and County of San Francisco.

20. Amendments. This Agreement may be amended in whole or in part only by a written recorded instrument executed by the parties hereto in the same manner as this Agreement.

21. No Implied Waiver. No failure by City to insist on the strict performance of any obligation of Owners under this Agreement or to exercise any right, power, or remedy arising out of an event of default or breach of this Agreement will constitute a waiver of the event of default or breach or of City's right to demand strict compliance with any terms of this Agreement.

22. Authority. If Owners sign as a corporation or a partnership, each of the persons executing this Agreement on behalf of Owners covenants and warrants that the entity is a duly authorized and existing entity, that the entity has and is qualified to do business in California, that Owners have full right and authority to enter into this Agreement, and that each and all of the persons signing on behalf of Owners are authorized to do so.

23. Severability. If any provision of this Agreement is determined to be invalid or unenforceable, the remainder of this Agreement will not be affected thereby, and each other provision of this Agreement will be valid and enforceable to the fullest extent permitted by law, except to the extent that enforcement of this Agreement without the invalidated provision would be unreasonable or inequitable under all the circumstances or would frustrate a fundamental purpose of this Agreement.

24. Tropical Hardwood Ban. City urges companies not to import, purchase, obtain, or use for any purpose, any tropical hardwood or tropical hardwood product.

25. MacBride Principles. City urges companies doing business in Northern Ireland to move toward resolving employment inequities and encourages them to abide by the MacBride Principles as expressed in San Francisco Administrative Code Section 12F.1 et seq. City also

urges San Francisco companies to do business with corporations that abide by the MacBride Principles. Owners acknowledge that it has read and understands the above statement of City concerning doing business in Northern Ireland.

26. Sunshine. Owners understand and agree that under the San Francisco Sunshine Ordinance (San Francisco Administrative Code, Chapter 67) and the State Public Records Law (Gov't Code Section 6250 et seq.), this Agreement and any and all records, information, and materials submitted to City under this Agreement or the Mills Act are public records subject to public disclosure.

27. Conflict of Interest. Through its execution of this Agreement, Owners acknowledge that it is familiar with the provisions of Section 15.103 of the City's Charter, Article III, Chapter 2 of the San Francisco Campaign and Governmental Conduct Code, and California Government Code section 87100 et seq. and section 1090 et seq., and certifies that it does not know of any facts that constitute a violation of those provisions and agrees that it will immediately notify City if it becomes aware of any such fact during the Term.

28. Notification of Limitations on Contributions. Through execution of this Agreement, Owners acknowledge that it is familiar with Section 1.126 of City's Campaign and Governmental Conduct Code, which prohibits any person who contracts with City, whenever such transaction would require approval by a City elective officer or the board on which that City elective officer serves, from making any campaign contribution to the officer at any time from the commencement of negotiations for the contract until three (3) months after the date the contract is approved by City elective officer or the board on which that City elective officer serves. San Francisco Ethics Commission Regulation 1.126-1 provides that negotiations are commenced when a prospective contractor first communicates with a City officer or employee about the possibility of obtaining a specific contract. This communication may occur in person, by telephone or in writing, and may be initiated by the prospective contractor or a City officer or employee. Negotiations are completed when a contract is finalized and signed by City and the contractor. Negotiations are terminated when City and/or the prospective contractor end the negotiation process before a final decision is made to award the contract.

29. Nondiscrimination. In the performance of this Agreement, Owners agree not to discriminate on the basis of the fact or perception of a person's, race, color, creed, religion, national origin, ancestry, age, height, weight, sex, sexual orientation, gender identity, domestic partner status, marital status, disability or Acquired Immune Deficiency Syndrome or HIV status (AIDS/HIV status), or association with members of such protected classes, or in retaliation for opposition to discrimination against such classes, against any City employee, employee of or applicant for employment with Owners, or against any bidder or contractor for public works or improvements, or for a franchise, concession or lease of property, or for goods or services or supplies to be purchased by Owners. A similar provision must be included in all subordinate agreements let, awarded, negotiated, or entered into by Owners for the purpose of implementing this Agreement.

30. Exhibits. Exhibits A, B, and C attached to this Agreement are incorporated and made a part of this Agreement by reference.

31. Charter Provisions. This Agreement is governed by and subject to the provisions of the City Charter.

32. Signatures. This Agreement may be signed and dated in counterparts, and when all counterparts are assembled, will be considered one document.

IN WITNESS WHEREOF, the parties hereto have executed this Agreement as follows:

CITY AND COUNTY OF SAN FRANCISCO:

By: _____ (signature) DATE: _____
_____ (name), Assessor-Recorder

By: _____ (signature) DATE: _____
_____ (name), Director of Planning

APPROVED AS TO FORM:
DENNIS J. HERRERA
CITY ATTORNEY

By: _____ (signature) DATE: _____
_____ (name), Deputy City Attorney

OWNERS

By: _____ (signature) DATE: _____
Joseph E. Laska, 465-467 Oak Street Owner

By: _____ (signature) DATE: _____
Jennifer A. Laska, 465-467 Oak Street Owner

OWNER(S) SIGNATURE(S) MUST BE NOTARIZED.
ATTACH PUBLIC NOTARY FORMS HERE.

Exhibit A: Rehabilitation/Restoration Plan for 467 Oak Street

#1 Building Feature: Windows

Rehab/Restoration Maintenance Completed Proposed

Contract Year Work Completion: 2017

Total Cost: \$1,848.28

Description of Work:

Repaired original windows (glass, ropes, and weights).

#2 Building Feature: Wood Siding and Trim

Rehab/Restoration Maintenance Completed Proposed

Contract Year Work Completion: 2017

Total Cost: \$4,200

Description of Work:

Patched and painted exterior wood siding and trim.

#3 Building Feature: Chimneys

Rehab/Restoration Maintenance Completed Proposed

Contract Year Work Completion: 2017

Total Cost: \$915

Description of Work:

Repaired interior and exterior of chimneys and sealed roof around chimneys.

#4 Building Feature: Seismic structural upgrade of ground floor and foundation

Rehab/Restoration Maintenance Completed Proposed

Contract Year Work Completion: 2020

Total Cost: \$210,000

Description of Work:

Upgrade ground floor and foundation to current seismic standards and San Francisco Building Code.

#5 Building Feature: Roof

Rehab/Restoration Maintenance Completed Proposed

Contract Year Work Completion: 2022

Total Cost: \$73,700

Description of Work:

Repair substructure of roof, replace current roof, and, instead of conventional shingles, install durable Tesla solar shingles and a home battery, which will allow us to extend the life of the roof and make the house energy self-sufficient without adding large, visible solar panels. The Tesla solar shingles are far more durable than conventional shingles and come with a warranty for the lifetime of the house.

#6 Building Feature: Rear staircase and balcony

Rehab/Restoration Maintenance Completed Proposed

Contract Year Work Completion: 2023

Total Cost: \$48,900

Description of Work:

Replace rear wood staircase and balcony (original to the house) and add period-appropriate railing.

#7 Building Feature: Wood Siding and Trim

Rehab/Restoration Maintenance Completed

Proposed

Contract Year Work Completion: 2023

Total Cost: \$37,000

Description of Work:

Prepare, repair, and repaint entire exterior of house.

Exhibit B: Maintenance Plan for 467 Oak Street

#8 Building Feature: Roof

Rehab/Restoration Maintenance Completed Proposed

Contract Year Work Completion: Annually

Total Cost: \$400

Description of Work:

Inspect roof for leaks and make roof repairs as necessary.

#9 Building Feature: Gutters and downspouts

Rehab/Restoration Maintenance Completed Proposed

Contract Year Work Completion: Annually

Total Cost: \$400

Description of Work:

Clean gutters and direct downspouts away from foundation.

#10 Building Feature: Windows and doors

Rehab/Restoration Maintenance Completed Proposed

Contract Year Work Completion: Annually

Total Cost: \$400

Description of Work:

Inspect windows and doors for leaks, failing paint or deteriorated wood, and make any necessary repairs in kind.

#11 Building Feature: Front steps and porch

Rehab/Restoration Maintenance Completed Proposed

Contract Year Work Completion: Annually

Total Cost: \$400

Description of Work:

Inspect front steps and porch for failing paint or deteriorated wood, and make any necessary repairs in kind.

#12 Building Feature: Wood siding and trim

Rehab/Restoration Maintenance Completed Proposed

Contract Year Work Completion: Annually

Total Cost: \$400

Description of Work:

Inspect wood siding and trim for failing paint or deteriorated wood, and make any necessary repairs in kind.

2018 Mills Act Contracts

Government Audit and Oversight Committee Review

November 7, 2018

4049

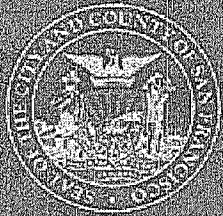

**SAN FRANCISCO
PLANNING DEPARTMENT**

What is the Mills Act?

- California's leading financial incentive program for historic preservation since 1972.
- Contract between the City and property owner that allows for a potential reduction in property taxes.
- Tax savings will be used to offset cost of rehabilitation, restoration, and maintenance work in conformance with the Secretary's Standards.
- Only local financial incentive program for restoring, rehabilitating, and maintaining eligible properties to promote appreciation of the City's architecture, history, and culture.



Active Mills Act Contracts

4051

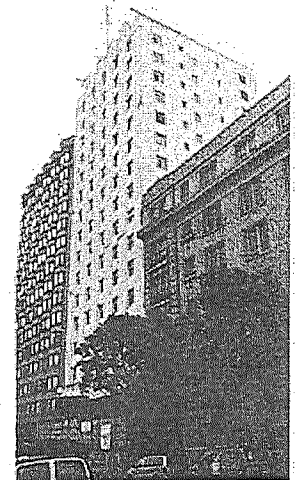
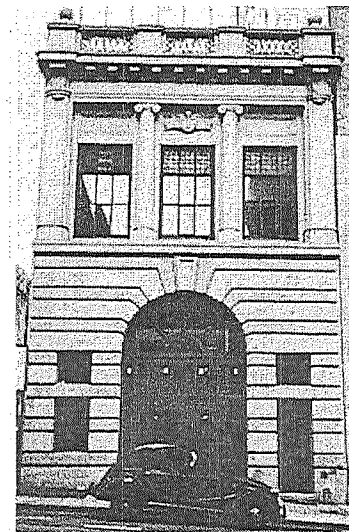
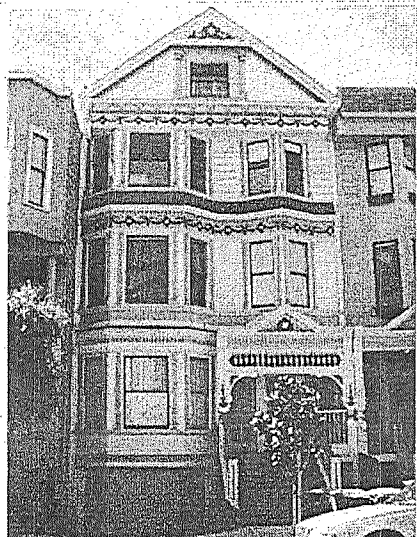
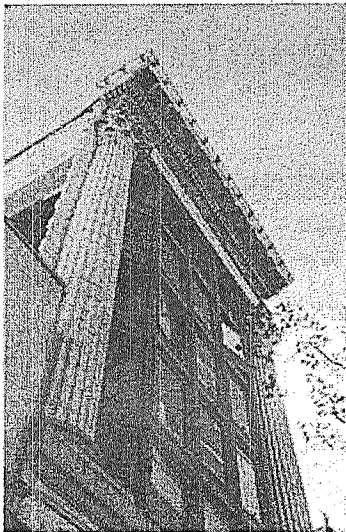
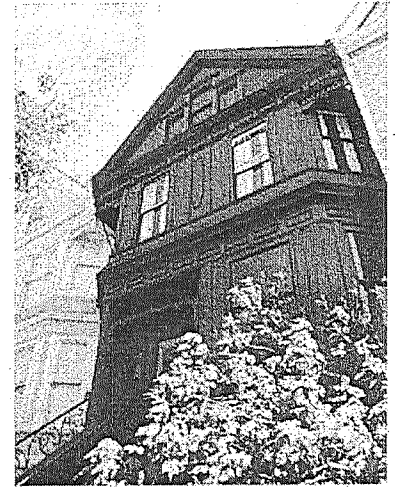
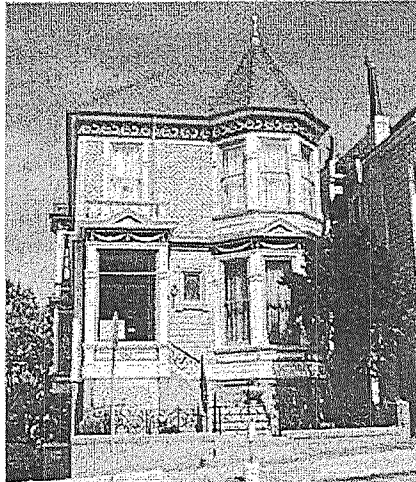
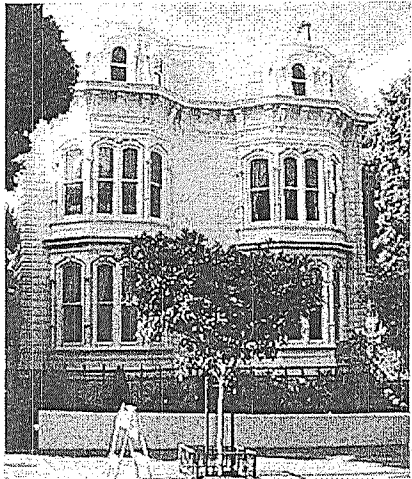

2019 Mills Act Application Changes

1. Qualified historic properties must also meet **Priority Consideration Criteria** in order to be considered for a Mills Act Contract:
 - (a) Necessity
 - (b) Investment
 - (c) Distinctiveness
 - (d) Legacy Business
 - (e) Recently Designated City Landmarks (requires amendment to Administrative code)
2. Properties with **outstanding violations are not eligible to apply** for the Mills Act.
3. Mills Act Contracts must include **minimum scopes of work**, such as seismic work, accessibility, and life safety improvements.



4. Scopes of work may be completed in the calendar year the Mills Act application is made.
5. All proposed scopes of completed during the first ten years of the contract.
6. A Certificate of Appropriateness (COA) for scopes of work must be filed and approved during the Mills Act application process.

*Most of these policy changes may be made at the staff level.***



2253 Webster Street (built c. 1900)
Contributor to Webster Street Historic District



4054

District 2



353 Kearny Street (built 1907)

Category IV – Contributory Building to Kearny-Market-Mason-Sutter Conservation District



District 3



465-467 Oak Street (built 1899)
Hayes Valley Residential California Register Historic District



District 5

4056



587 Waller Street (built c. 1900)
Duboce Park Historic District

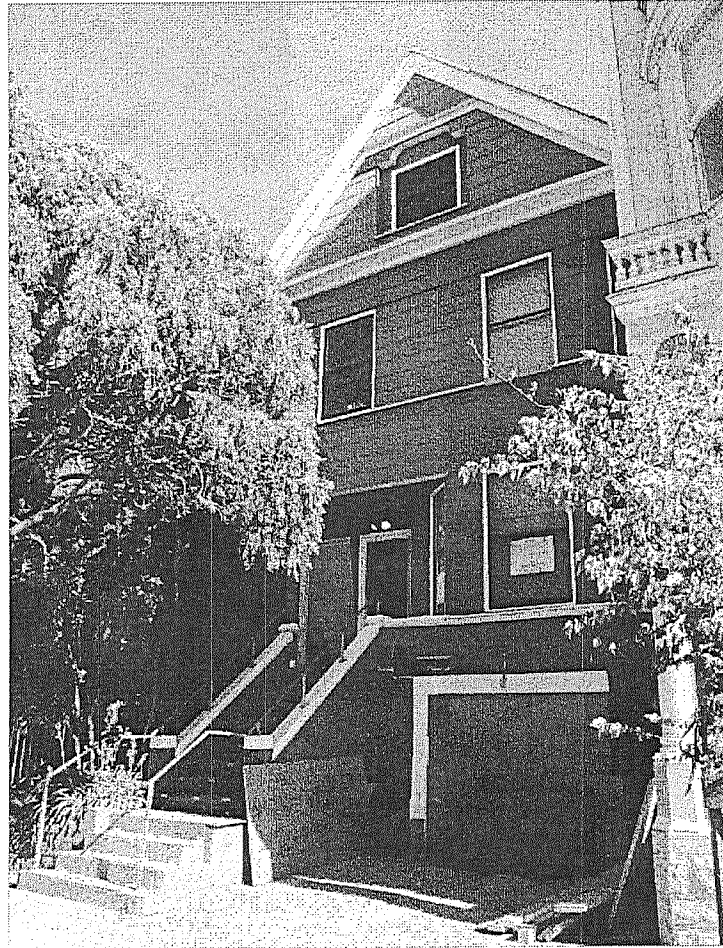

District 8

4057



354-356 San Carlos (built 1877)
Liberty Hill Historic District (District 9)

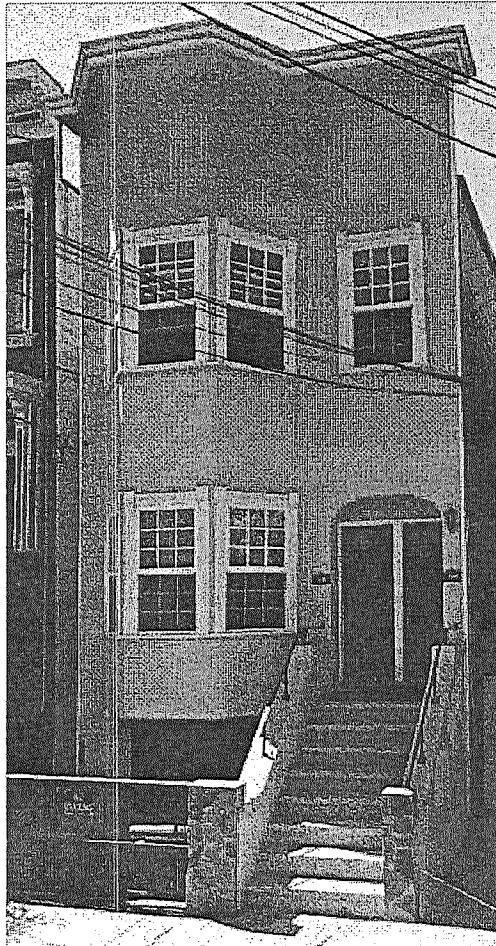

Prior to rehabilitation.

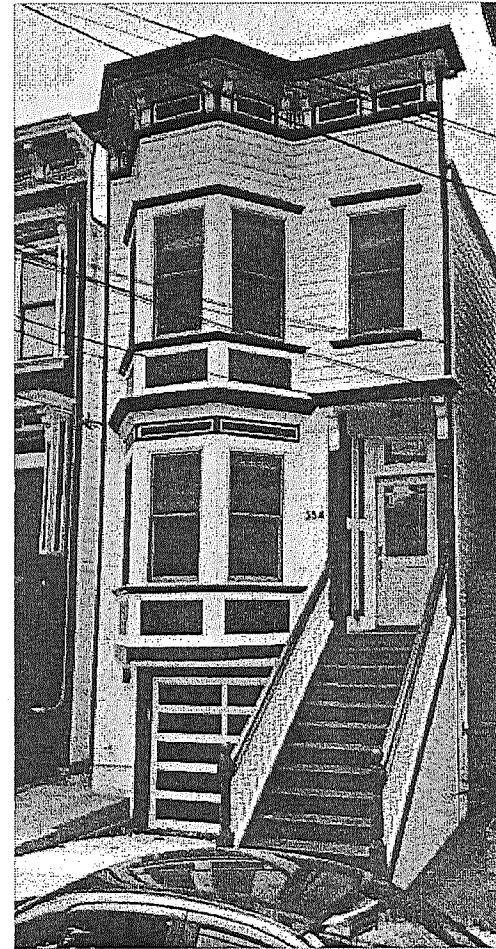

Existing condition.
Rehabilitation completed 2015-2016.



811 Treat Avenue (built c. 1882)
National Register of Historic Places



4059

District 9



A	B	C	D	E	F	G H I Three Way Value Comparison			J Lesser of the 3 Comparisons	K	L	M	N
APN	Address	Property Type	Owner Occupied	Year Built	Square Feet	Factored Base Year Value	Restricted Value by Income	Market Value	Taxable Mills Act Value	Reduction in Assessed Value	Percentage % Reduction From FBV	2018 Property Tax Rate	Estimated Property Tax Savings
03-0270-001	353 Kearny (a)	Office/Retail	No	1907	9,729	\$ 6,800,000	\$ 4,500,000	\$ 7,200,000	\$ 4,500,000	\$ (2,300,000)	-33.82%	1.1630%	(\$26,749)
05-0612-001	2253 Webster	SFR	Yes	1880	1,604	\$ 2,142,872	\$ 970,000	\$ 2,150,000	\$ 970,000	\$ (1,172,872)	-54.73%	1.1630%	(\$13,641)
06-0840-017	465 Oak	2-units	Yes/No	1875	2,394	\$ 2,616,162	\$ 1,230,000	\$ 2,625,000	\$ 1,230,000	\$ (1,386,162)	-52.98%	1.1630%	(\$16,121)
06-0865-021	587 Waller (b)	SFR	Yes	1900	2,785	\$ 2,400,000	\$ 1,000,000	\$ 2,750,000	\$ 1,000,000	\$ (1,400,000)	-58.33%	1.1630%	(\$16,282)
24-3609-093	354-356 San Carlos	2-units	Yes/No	1900	2,070	\$ 1,543,282	\$ 1,156,661	\$ 1,650,100	\$ 1,156,661	\$ (386,621)	-25.05%	1.1630%	(\$4,496)
24-3613-053	811 Treat (b)(c)	7-units	No	1900	5,793	\$ 1,424,030	\$ 1,392,679	\$ 3,260,000	\$ 1,392,679	\$ (31,351)	-2.20%	1.1630%	(\$365)

(a) Income value is \$7,500,000 with temporary lease-up value of \$4,500,000

Market value is \$10,250,000 with temporary lease-up value of \$7,200,000

(b) Current condition of property warrants a lesser remaining economic life and improvement allocation

(c) Lease-up \$140,000

4060

Interest Rate 4.00% for 2018 (BOE LTA 9/13/2017)
+ Risk Rate 4.00% for owner occupied and 2.00% for non-owner occupied
+ Property Tax Rate 1.1723% (used 2017 tax rate because 2018 tax rate will not be announced until late Sept. 2018)
+ Amortization Rate for Improvements (1/REL) x % of total property value allocated to improvements
= **Restricted Capitalization Rate**

353 Kearny Retail occupied and Offices vacant. Office space to undergo significant renovation - windows, roof, elevator, exterior repair, interior flooring, ceiling lighting, HVAC, bathroom upgrades, and tenant improvements. Anticipated to take 2-years at an estimated cost of \$2.7 million

811 Treat Two buildings on one lot with a total of 7 units. The front building consisting of 5 units is subject to the Mills Act Contract. The rear building containing 2 units is not part of the contract.



SAN FRANCISCO PLANNING DEPARTMENT

Mills Act Historical Property Contracts Case Report

1650 Mission St.
Suite 400
San Francisco,
CA 94103-2479

Reception:
415.558.6378

Fax:
415.558.6409

Planning
Information:
415.558.6377

Hearing Date: October 3, 2018
Staff Contact: Shannon Ferguson – (415) 575-9074
shannon.ferguson@sfgov.org
Reviewed By: Tim Frye – (415) 575-6822
tim.frye@sfgov.org

a. *Filing Date:* May 1, 2018
Case No.: 2018-006629MLS
Project Address: 2253 Webster Street (District 2)
Landmark District: Contributor to the Webster Street Historic District
Zoning: RH-2 (Residential-House, Two-Family District)
Height & Bulk: 40-X
Block/Lot: 0612/001
Applicant: Virginia Hong Revoc Living Trust
2253 Webster Street
San Francisco, CA 94115

b. *Filing Date:* May 1, 2018
Case No.: 2018-006717MLS
Project Address: 353 Kearny Street (District 3)
Landmark District: Category IV–Contributory Building to Kearny-Market-Mason-Sutter
Conservation District
Zoning: C-3-O – Downtown-Office
Height and Bulk: 80-130-F
Block/Lot: 0270/001
Applicant: Pine Kearny LLC
590 Pacific Avenue
San Francisco, CA 94133

c. *Filing Date:* May 1, 2018
Case No.: 2018-006796MLS
Project Address: 465-467 Oak Street (District 5)
Landmark District: Contributor to the California Register of Historical Places-listed
Hayes Valley Residential Historic District
Zoning: RTO (Residential Transit Oriented District)
Height and Bulk: 40-X
Block/Lot: 0840/017
Applicant: Joseph E & Jennifer A Laska Jnt Lvg Trust
467 Oak Street
San Francisco, CA 94102

www.sfplanning.org

Mill Act Applications
October 3, 2018

2018-006629MLS (2253 Webster Street); 2018-006717MLS (353 Kearny Street);
2018006796MLS (465-467 Oak Street); 2018-006690MLS (587 Waller Street); 2018-
006794MLS (354-356 San Carlos Street); 2018-007338MLS (811 Treat Avenue)

- d. *Filing Date:* May 1, 2018
Case No.: 2018-006690MLS
Project Address: 587 Waller Street (District 8)
Landmark District: Contributing building to Duboce Park Historic District
Zoning: RTO (Residential Transit Oriented District)
Height and Bulk: 40-X
Block/Lot: 0865/021
Applicant: Christopher Hansten & June Kwon
4658 18th St. PH
San Francisco, CA 94114
- e. *Filing Date:* May 1, 2017
Case No.: 2018-006794MLS
Project Address: 354-356 San Carlos Street (District 9)
Landmark District: Contributor to Liberty Hill Historic District
Zoning: RTO-M – Residential Transit Oriented - Mission
Height and Bulk: 40-X
Block/Lot: 3609/093
Applicant: Joyjit & Preetha Nath
354 San Carlos Street
San Francisco, CA 94110
- f. *Filing Date:* May 1, 2017
Case No.: 2018-007338MLS
Project Address: 811 Treat Avenue (District 9)
Landmark District: Individually listed on the National Register of Historic Places
Zoning: RH-3 – Residential-House, Three Family
Height and Bulk: 40-X
Block/Lot: 3613/053
Applicant: Golden Gate Properties LLC
2170 Sutter Street
San Francisco, CA 94115

PROPERTY DESCRIPTIONS

- a. 2253 Webster Street: The subject property is located on the west side of Webster Street between Washington and Clay streets, Assessor's Block 0612, Lot 001. The subject property is located within a RH-2 (Residential-House, Two-Family District) zoning district and a 40-X Height and Bulk district. The subject property is a contributing building to the Webster Street Historic District. It is a two-story, plus basement, wood-frame, single-family dwelling designed in the Italianate style and built in circa 1900.

Mill Act Applications.

October 3, 2018

2018-006629MLS (2253 Webster Street); 2018-006717MLS (353 Kearny Street);
2018006796MLS (465-467 Oak Street); 2018-006690MLS (587 Waller Street); 2018-
006794MLS (354-356 San Carlos Street); 2018-007338MLS (811 Treat Avenue)

- b. 353 Kearny Street: The subject property is located on the southwest corner of Kearny and Pine streets, Assessor's Block 0270, Lot 001. The subject property is located within the C-3-O – Downtown–Office zoning district and a 80-130-F Height and Bulk district. The subject property is a Category IV – Contributory Building to Kearny-Market-Mason-Sutter Conservation District. It is a five-story over basement, brick masonry, commercial building designed in the Renaissance-Revival style by San Francisco architectural firm Salfield & Kohlberg and was built in 1907.
- c. 465 Oak Street: The subject property is located on the south side of Oak Street between Buchanan and Laguna streets, Assessor's Block 0840, Lot 017. The subject property is located within a RTO (Residential Transit Oriented District) zoning district and a 40-X Height and Bulk district. The subject property is a contributing building to the California Register of Historical Places- listed Hayes Valley Residential Historic District. It is a two-story plus basement, wood-frame, two-family dwelling designed in the flat-front Italianate style and built in circa 1900.
- d. 587 Waller Street: The subject property is located on the south side of Waller Street between Pierce and Potomac streets, Assessor's Block 0865 Lot 021. The subject property is located within a RTO (Residential Transit Oriented District) zoning district and a 40-X Height and Bulk district. The subject property is a contributing building to the Duboce Park Historic District. It is a two-and-half-story plus basement, wood-frame, single-family dwelling designed in the Queen Anne style and built in circa 1900.
- e. 354-356 San Carlos Street: The subject property is located on the west side of San Carlos Street between 20th and 21st streets, Assessor's Block 3609, Lot 093. The subject property is located within the RTO-M – Residential Transit Oriented - Mission zoning district and 40X Height and Bulk district. The subject property is a potential contributor to Liberty Hill Historic District. It is a three-story wood-frame, two-family residential building originally designed in the Italianate style and was built in 1877 by The Real Estate Associates (T.R.E.A.). The front façade was altered with stucco cladding, stuccoed front steps, and vinyl windows at an unknown date. Rehabilitation work was completed in 2015-2016.
- f. 811 Treat Avenue: The subject property is located on the east side of San Carlos Street between 21st and 22nd streets, Assessor's Block 3613, Lot 053. The subject property is located within the RH-3 – Residential-House, Three Family zoning district and 40X Height and Bulk district. The subject property is individually listed on the National Register of Historic Places. Known as the Henry Geilfuss House, the property comprises an Italianate main residence designed by local master architect Henry Geilfuss circa 1882 as his personal residence; a raised room (c. 1882, altered c. 1900); a workshop (c. 1920) and a garage (c. 1940). The main residence and raised room are contributing features; the workshop and garage are non-contributing features that were added after Geilfuss moved from the property.

PROJECT DESCRIPTION

This project is a Mills Act Historical Property Contract application.

Mill Act Applications
October 3, 2018

2018-006629MLS (2253 Webster Street); 2018-006717MLS (353 Kearny Street);
2018006796MLS (465-467 Oak Street); 2018-006690MLS (587 Waller Street); 2018-
006794MLS (354-356 San Carlos Street); 2018-007338MLS (811 Treat Avenue)

MILLS ACT REVIEW PROCESS

Once a Mills Act application is received, the matter is referred to the Historic Preservation Commission (HPC) for review. The HPC shall conduct a public hearing on the Mills Act application, historical property contract, and proposed rehabilitation and maintenance plan, and make a recommendation for approval or disapproval to the Board of Supervisors.

The Board of Supervisors will hold a public hearing to review and approve or disapprove the Mills Act application and contract. The Board of Supervisors shall conduct a public hearing to review the Historic Preservation Commission recommendation, information provided by the Assessor's Office, and any other information the Board requires in order to determine whether the City should execute a historical property contract for the subject property.

The Board of Supervisors shall have full discretion to determine whether it is in the public interest to enter into a Mills Act contract and may approve, disapprove, or modify and approve the terms of the contract. Upon approval, the Board of Supervisors shall authorize the Director of Planning and the Assessor-Recorder's Office to execute the historical property contract.

MILLS ACT REVIEW PROCEDURES

The Historic Preservation Commission is requested to review and make recommendations on the following:

- The draft Mills Act Historical Property Contract between the property owner and the City and County of San Francisco.
- The proposed rehabilitation and maintenance plan.

The Historic Preservation Commission may also comment in making a determination as to whether the public benefit gained through restoration, continued maintenance and preservation of the property is sufficient to outweigh the subsequent loss of property taxes to the City.

APPLICABLE PRESERVATION STANDARDS

Ordinance No. 191-96 amended the San Francisco Administrative Code by adding Chapter 71 to implement the California Mills Act, California Government Code Sections 50280 *et seq.* The Mills Act authorizes local governments to enter into contracts with private property owners who will rehabilitate, restore, preserve, and maintain a "qualified historical property." In return, the property owner enjoys a reduction in property taxes for a given period. The property tax reductions must be made in accordance with Article 1.9 (commencing with Section 439) of Chapter 3 of Part 2 of Division 1 of the California Revenue and Taxation Code.

TERM

Mills Act contracts must be made for a minimum term of ten years. The ten-year period is automatically renewed by one year annually to create a rolling ten-year term. One year is added automatically to the initial term of the contract on the anniversary date of the contract, unless notice of nonrenewal is given or

Mill Act Applications
October 3, 2018

2018-006629MLS (2253 Webster Street); 2018-006717MLS (353 Kearny Street);
2018006796MLS (465-467 Oak Street); 2018-006690MLS (587 Waller Street); 2018-
006794MLS (354-356 San Carlos Street); 2018-007338MLS (811 Treat Avenue)

the contract is terminated. If the City issues a notice of nonrenewal, then one year will no longer be added to the term of the contract on its anniversary date and the contract will only remain in effect for the remainder of its term. The City must monitor the provisions of the contract until its expiration and may terminate the Mills Act contract at any time if it determines that the owner is not complying with the terms of the contract or the legislation. Termination due to default immediately ends the contract term. Mills Act contracts remain in force when a property is sold.

ELIGIBILITY

San Francisco Administrative Code Chapter 71, Section 71.2, defines a "qualified historic property" as one that is not exempt from property taxation and that is one of the following:

- (a) Individually listed in the National Register of Historic Places;
- (b) Listed as a contributor to an historic district included on the National Register of Historic Places;
- (c) Designated as a City landmark pursuant to San Francisco Planning Code Article 10;
- (d) Designated as contributory to a landmark district designated pursuant to San Francisco Planning Code Article 10; or
- (e) Designated as significant (Categories I or II) or contributory (Categories III or IV) to a conservation district designated pursuant to San Francisco Planning Code Article 11.

All properties that are eligible under the criteria listed above must also meet a tax assessment value to be eligible for a Mills Act Contract. The tax assessment limits are listed below:

Residential Buildings

Eligibility is limited to a property tax assessment value of not more than \$3,000,000.

Commercial, Industrial or Mixed Use Buildings

Eligibility is limited to a property tax assessment value of not more than \$5,000,000.

Properties may be exempt from the tax assessment values if it meets any one of the following criteria:

- The qualified historic property is an exceptional example of architectural style or represents a work of a master architect or is associated with the lives of persons important to local or national history; or
- Granting the exemption will assist in the preservation and rehabilitation of a historic structure (including unusual and/or excessive maintenance requirements) that would otherwise be in danger of demolition, deterioration, or abandonment;

Properties applying for a valuation exemption must provide evidence that it meets the exemption criteria, including a historic structure report to substantiate the exceptional circumstances for granting the exemption. The Historic Preservation Commission shall make specific findings in determining whether to recommend to the Board of Supervisors that the valuation exemption should be approved. Final approval of this exemption is under the purview of the Board of Supervisors.

PUBLIC/NEIGHBORHOOD INPUT

The Department has not received any public comment regarding the Mills Act Historical Property Contract.

STAFF ANALYSIS

The Department received six Mills Act applications by the May 1, 2018 filing date. The Project Sponsors, Planning Department Staff, and the Office of the City Attorney have negotiated the six attached draft historical property contracts, which include a draft rehabilitation and maintenance plan for the historic building. Department Staff believes the draft historical property contracts and plans are adequate. Please see below for complete analysis.

- a. 2253 Webster Street: As detailed in the Mills Act application, the applicant proposes to rehabilitate and maintain the historic property. Staff determined that the proposed work, detailed in the attachments, is consistent with the Secretary of Interior's Standards for Rehabilitation.

The subject property is currently valued by the Assessor's Office as under \$3,000,000 (see attached Market Analysis and Income Approach reports) and did not require a Historic Structure Report.

The applicant completed some rehabilitation of the building in 2017, including dry rot repair and painting with an estimated cost of \$75,270. The proposed Rehabilitation Plan includes flashing replacement, roof repair and replacement, additional dry rot repair, installing new compatible handrail, replacing the front door in-kind. Rehabilitation work is estimated to cost \$87,364.31 over ten years.

The proposed Maintenance Plan includes annual inspection of the wood siding, windows, roof, front porch and door. Maintenance work is estimated to cost \$3,500 annually. Any needed repairs will be made in kind and will avoid altering, removing or obscuring character-defining features of the building.

No changes to the use of the property are proposed. Please refer to the attached Rehabilitation and Maintenance Plan for a full description of the proposed work. The attached draft historical property contract will help the applicant mitigate these expenditures and will induce the applicant to maintain the property in excellent condition in the future.

- b. 353 Kearny Street: As detailed in the Mills Act application, the applicant proposes to rehabilitate and maintain the historic property. Staff determined that the proposed work, detailed in the attachments, is consistent with the Secretary of Interior's Standards for Rehabilitation.

The subject property is currently valued by the Assessor's Office at over \$3,000,000 (see attached Market Analysis and Income Approach reports). The subject property qualifies for an exemption as it is designated as a Category IV – Contributory Building to Kearny-Market-Mason-Sutter Conservation District under Article 11 of the Planning Code. A Historic Structure Report was

required in order to demonstrate that granting the exemption would assist in the preservation of a property that might otherwise be in danger of demolition or substantial alterations

The proposed Rehabilitation Plan includes roof replacement, parapet bracing, elevator penthouse repair, brick repair and repointing at the façade and basement under sidewalk, repair and in-kind replacement of wood windows, plaster repair at rear façade, sheet metal cornice repair or in-kind replacement, fire escape repair, historic elevator and stair repair, storefront repair and replacement. Rehabilitation work is estimated to cost \$1,091,077 over ten years.

The proposed Maintenance Plan includes annual inspection of roof, parapet bracing, elevator penthouse, basement, wood windows, brick and plaster facades, storefronts, sheet metal cornice,, and fire escape with in-kind repair of any deteriorated elements as necessary. Maintenance work is estimated to cost \$23,694 annually. Any needed repairs will be made in kind and will avoid altering, removing or obscuring character-defining features of the building.

No changes to the use of the property are proposed. Please refer to the attached Rehabilitation and Maintenance Plan for a full description of the proposed work. The attached draft historical property contract will help the applicant mitigate these expenditures and will induce the applicant to maintain the property in excellent condition in the future.

- c. 465-467 Oak Street: As detailed in the Mills Act application, the applicant proposes to rehabilitate and maintain the historic property. Staff determined that the proposed work, detailed in the attachments, is consistent with the Secretary of Interior's Standards for Rehabilitation.

The subject property is currently valued by the Assessor's Office as under \$3,000,000 (see attached Market Analysis and Income Approach reports) and did not require a Historic Structure Report.

The applicant completed rehabilitation work to the building in 2017, including wood window repair, exterior painting, brick chimney repair at an estimated cost of \$6963.28. The proposed Rehabilitation Plan includes seismic upgrade, roof replacement, rear stair and balcony replacement, and exterior repainting. Rehabilitation work is estimated to cost \$369,600 over ten years.

The proposed Maintenance Plan includes annual inspection of roof, gutters and downspouts, windows, doors, front steps and porch, and wood siding a trim. Any needed repairs will be made in kind and will avoid altering, removing or obscuring character-defining features of the building. Maintenance work is estimated to cost approximately \$2,000 annually.

No changes to the use of the property are proposed. Please refer to the attached Rehabilitation and Maintenance Plan for a full description of the proposed work. The attached draft historical property contract will help the applicant mitigate these expenditures and will induce the applicant to maintain the property in excellent condition in the future.

- d. 587 Waller Street: As detailed in the Mills Act application, the applicant proposes to rehabilitate and maintain the historic property. Staff determined that the proposed work, detailed in the attachments, is consistent with the Secretary of Interior's Standards for Rehabilitation.

The subject property is currently valued by the Assessor's Office as under \$3,000,000 (see attached Market Analysis and Income Approach reports) and did not require a Historic Structure Report.

The proposed Rehabilitation Plan includes seismic and foundation work, roof replacement, front façade restoration, window replacement, and front steps and porch restoration. Rehabilitation work is estimated to cost \$337,400 over ten years.

The proposed Maintenance Plan includes annual inspection of gutters and downspouts, windows, front steps and porch, front façade, and roof. Any needed repairs resulting from inspection will be made in kind and will avoid altering, removing or obscuring character-defining features of the building. Maintenance work is estimated to cost approximately \$1,300 annually.

No changes to the use of the property are proposed. Please refer to the attached Rehabilitation and Maintenance Plan for a full description of the proposed work. The attached draft historical property contract will help the applicant mitigate these expenditures and will induce the applicant to maintain the property in excellent condition in the future.

- e. 354-356 San Carlos Street: As detailed in the Mills Act application, the applicant proposes to rehabilitate and maintain the historic property. Staff determined that the proposed work, detailed in the attachments, is consistent with the Secretary of Interior's Standards for Rehabilitation and Preservation.

The subject property is currently valued by the Assessor's Office as under \$3,000,000 (see attached Market Analysis and Income Approach reports) and did not require a Historic Structure Report.

The applicant completed substantial rehabilitation work to the property in 2016, including front façade restoration, window replacement, exterior painting, front stair replacement, and foundation and structural work at an estimated cost of \$317,000. The proposed Rehabilitation Plan includes roof replacement. Rehabilitation work is estimated to cost \$50,000 over ten years.

The proposed Maintenance Plan includes annual inspection of the roof, gutters and drains, windows, foundation and structure, stairs. Annual inspection of the siding and trim will occur every five years. Any needed repairs resulting from inspection will be made in kind and will avoid altering, removing or obscuring character-defining features of the building. Maintenance work is estimated to cost approximately \$1,600 annually.

No changes to the use of the property are proposed. Please refer to the attached Rehabilitation and Maintenance Plan for a full description of the proposed work. The attached draft historical

property contract will help the applicant mitigate these expenditures and will induce the applicant to maintain the property in excellent condition in the future.

- f. 811 Treat Avenue: As detailed in the Mills Act application, the applicant proposes to rehabilitate and maintain the historic property. Staff determined that the proposed work, detailed in the attachments, is consistent with the Secretary of Interior's Standards for Rehabilitation and Preservation.

The subject property is currently valued by the Assessor's Office as under \$3,000,000 (see attached Market Analysis and Income Approach reports) and did not require a Historic Structure Report.

The proposed Rehabilitation Plan includes siding and trim repair and repainting, incompatible garage door replacement, door repair and decorative glass replacement, and roof replacement. Rehabilitation work is estimated to cost \$67,000 over ten years.

The proposed Maintenance Plan includes annual inspection of the foundation, roof, gutters, drains, windows, doors, and stairs and porch. Inspection of the siding and trim will occur every five years. Any needed repairs resulting from inspection will be made in kind and will avoid altering, removing or obscuring character-defining features of the building. Maintenance work is estimated to cost approximately \$2,100 annually.

No changes to the use of the property are proposed. Please refer to the attached Rehabilitation and Maintenance Plan for a full description of the proposed work. The attached draft historical property contract will help the applicant mitigate these expenditures and will induce the applicant to maintain the property in excellent condition in the future.

ASSESSOR-RECORDER INFORMATION

Based on information received from the Assessor-Recorder, the following properties will receive an estimated first year reduction as a result of the Mills Act Contract. Please refer to the attached Preliminary Valuation spreadsheet prepared by the Assessor for detailed information about each property.

- a) 2253 Webster Street: Estimated Property Tax Savings of \$13,750 (a 54.73% reduction from factored base year value)
- b) 353 Kearny Street: Estimated Property Tax Savings of \$26,963 (a 33.82% reduction from factored base year value)
- c) 465 Oak Street: Estimated Property Tax Savings of \$16,250 (a 52.98% reduction from factored base year value)
- d) 587 Waller Street: Estimated Property Tax Savings of \$16,412 (a 58.33% reduction from factored base year value)

Mill Act Applications
October 3, 2018

2018-006629MLS (2253 Webster Street); 2018-006717MLS (353 Kearny Street);
2018006796MLS (465-467 Oak Street); 2018-006690MLS (587 Waller Street); 2018-
006794MLS (354-356 San Carlos Street); 2018-007338MLS (811 Treat Avenue)

- e) 354-356 San Carlos Street: Estimated Property Tax Savings: \$4,532 (a 25.05% reduction from factored base year value).
- f) 811 Treat Avenue: Estimated Property Tax Savings: \$368 (a 2.20% reduction from factored base year value).

PLANNING DEPARTMENT RECOMMENDATION

- The Planning Department recommends that the Historic Preservation Commission adopt a resolution recommending **approval** of the Mills Act Historical Property Contracts and Rehabilitation and Maintenance Plans to the Board of Supervisors for the following properties:
 - a. 2253 Webster Street
 - b. 353 Kearny Street
 - c. 465 Oak Street
 - d. 587 Waller Street
 - e. 354-356 San Carlos Street
 - f. 811 Treat Avenue

ISSUES AND OTHER CONSIDERATIONS

Mills Act Contract property owners are required to submit an annual affidavit demonstrating compliance with Rehabilitation and Maintenance Plans.

HISTORIC PRESERVATION COMMISSION ACTIONS

Review and adopt a resolution for each property:

1. Recommending to the Board of Supervisors approval of the proposed Mills Act Historical Property Contract between the property owner(s) and the City and County of San Francisco;
2. Approving the proposed Mills Act Rehabilitation and Maintenance Plan for each property.

Attachments:

- a. **2253 Webster Street:**
 - Draft Resolution
 - Draft Mills Act Historical Property Contract
 - Draft Rehabilitation Program & Maintenance Plan
 - Draft Mills Act Valuation provided by the Assessor-Recorder's Office
 - Pre-Approval Inspection Report
 - Mills Act Application

Mill Act Applications

October 3, 2018

2018-006629MLS (2253 Webster Street); 2018-006717MLS (353 Kearny Street);
2018006796MLS (465-467 Oak Street); 2018-006690MLS (587 Waller Street); 2018-
006794MLS (354-356 San Carlos Street); 2018-007338MLS (811 Treat Avenue)

b. 353 Kearny Street:

Draft Resolution
Draft Mills Act Historical Property Contract
Draft Rehabilitation Program & Maintenance Plan
Draft Mills Act Valuation provided by the Assessor-Recorder's Office
Pre-Approval Inspection Report
Mills Act Application
Historic Structure Report

c. 465-467 Oak Street:

Draft Resolution
Draft Mills Act Historical Property Contract
Draft Rehabilitation Program & Maintenance Plan
Draft Mills Act Valuation provided by the Assessor-Recorder's Office
Pre-Approval Inspection Report
Mills Act Application

d. 587 Waller Street:

Draft Resolution
Draft Mills Act Historical Property Contract
Draft Rehabilitation Program & Maintenance Plan
Draft Mills Act Valuation provided by the Assessor-Recorder's Office
Pre-Approval Inspection Report
Mills Act Application

e. 354-356 San Carlos Street:

Draft Resolution
Draft Mills Act Historical Property Contract
Draft Rehabilitation Program & Maintenance Plan
Draft Mills Act Valuation provided by the Assessor-Recorder's Office
Pre-Approval Inspection Report
Mills Act Application

f. 811 Treat Avenue:

Draft Resolution
Draft Mills Act Historical Property Contract
Draft Rehabilitation Program & Maintenance Plan
Draft Mills Act Valuation provided by the Assessor-Recorder's Office
Pre-Approval Inspection Report
Mills Act Application



SAN FRANCISCO PLANNING DEPARTMENT

Historic Preservation Commission Resolution No. 991 HEARING DATE OCTOBER 3, 2018

1650 Mission St.
Suite 400
San Francisco,
CA 94103-2479

Reception:
415.558.6378

Fax:
415.558.6409

Planning
Information:
415.558.6377

Case No.: 2018-006796MLS
Project Address: 465-467 Oak Street (District 5)
Landmark District: Contributor to the California Register of Historical Places-listed
 Hayes Valley Residential Historic District
Zoning: RTO (Residential Transit Oriented District)
Height and Bulk: 40-X
Block/Lot: 0840/017
Staff Contact: Shannon Ferguson – (415) 575-9074
 shannon.ferguson@sfgov.org
Reviewed By: Tim Frye – (415) 575-6822
 tim.frye@sfgov.org

ADOPTING FINDINGS RECOMMENDING TO THE BOARD OF SUPERVISORS APPROVAL OF THE MILLS ACT HISTORICAL PROPERTY CONTRACT, REHABILITATION PROGRAM, AND MAINTENANCE PLAN FOR 465-467 OAK STREET:

WHEREAS, The Mills Act, California Government Code Sections 50280 et seq. (“the Mills Act”) authorizes local governments to enter into contracts with owners of private historical property who assure the rehabilitation, restoration, preservation and maintenance of a qualified historical property; and

WHEREAS, In accordance with Article 1.9 (commencing with Section 439) of Chapter 3 of Part 2 of Division 1 of the California Revenue and Taxation Code, the City and County of San Francisco may provide certain property tax reductions, such as those provided for in the Mills Act; and

WHEREAS, Ordinance No. 191-96 amended the San Francisco Administrative Code by adding Chapter 71, to implement Mills Act locally; and

WHEREAS, The Planning Department has determined that the actions contemplated in this Resolution are categorically exempt from with the California Environmental Quality Act (California Public Resources Code Sections 21000 et seq.) under section 15331; and

WHEREAS, The existing building located at 465-467 Oak Street is listed as a Contributor to the California Register of Historical Places-listed Hayes Valley Residential Historic District and thus qualifies as a historic property; and

WHEREAS, The Planning Department has reviewed the Mills Act Application, Historical Property Contract, Historical Property Contract, Rehabilitation Program, and Maintenance Plan for 465-467 Oak

Street, which are located in Case Docket No. 2018-006796MLS. The Planning Department recommends approval of the Mills Act historical property contract, rehabilitation program, and maintenance plan; and

WHEREAS, The Historic Preservation Commission (HPC) recognizes the historic building at 465-467 Oak Street as an historical resource and believes the Rehabilitation Program and Maintenance Plan are appropriate for the property; and

WHEREAS, At a duly noticed public hearing held on October 3, 2018, the Historic Preservation Commission reviewed documents, correspondence and heard oral testimony on the Mills Act Application, Historical Property Contract, Rehabilitation Program, and Maintenance Plan for 465-467 Oak Street, which are located in Case Docket No. 2018-006796MLS.

THEREFORE BE IT RESOLVED that the Historic Preservation Commission hereby recommends that the Board of Supervisors approve the Mills Act Historical Property Contract, including the Rehabilitation Program, and Maintenance Plan for the historic building located at 465-467 Oak, attached herein as Exhibits A and B, and fully incorporated by this reference.

BE IT FURTHER RESOLVED That the Historic Preservation Commission hereby directs its Commission Secretary to transmit this Resolution, the Mills Act Historical Property Contract, including the Rehabilitation Program, and Maintenance Plan for 465-467 Oak, and other pertinent materials in the case file 2018-006796MLS to the Board of Supervisors.

I hereby certify that the foregoing Resolution was **ADOPTED** by the Historic Preservation Commission on October 3, 2018.

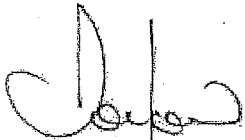

Jonas P. Ionin
Commissions Secretary

AYES: Wolfram, Hyland, Black, Johns, Matsuda, Pearlman

NOES: None

ABSENT: Johnck

ADOPTED: October 3, 2018

Exhibit A: Rehabilitation/Restoration Plan for 467 Oak Street

#1 Building Feature: Windows

Rehab/Restoration Maintenance Completed Proposed

Contract Year Work Completion: 2017

Total Cost: \$1,848.28

Description of Work:

Repaired original windows (glass, ropes, and weights).

#2 Building Feature: Wood Siding and Trim

Rehab/Restoration Maintenance Completed Proposed

Contract Year Work Completion: 2017

Total Cost: \$4,200

Description of Work:

Patched and painted exterior wood siding and trim.

#3 Building Feature: Chimneys

Rehab/Restoration Maintenance Completed Proposed

Contract Year Work Completion: 2017

Total Cost: \$915

Description of Work:

Repaired interior and exterior of chimneys and sealed roof around chimneys.

#4 Building Feature: Seismic structural upgrade of ground floor and foundation

Rehab/Restoration Maintenance Completed Proposed

Contract Year Work Completion: 2020

Total Cost: \$210,000

Description of Work:

Upgrade ground floor and foundation to current seismic standards and San Francisco Building Code.

#5 Building Feature: Roof

Rehab/Restoration Maintenance Completed Proposed

Contract Year Work Completion: 2022

Total Cost: \$73,700

Description of Work:

Repair substructure of roof, replace current roof, and, instead of conventional shingles, install durable Tesla solar shingles and a home battery, which will allow us to extend the life of the roof and make the house energy self-sufficient without adding large, visible solar panels. The Tesla solar shingles are far more durable than conventional shingles and come with a warranty for the lifetime of the house.

#6 Building Feature: Rear staircase and balcony

Rehab/Restoration Maintenance Completed Proposed

Contract Year Work Completion: 2023

Total Cost: \$48,900

Description of Work:

Replace rear wood staircase and balcony (original to the house) and add period-appropriate railing.

#7 Building Feature: Wood Siding and Trim

Rehab/Restoration Maintenance Completed

Proposed

Contract Year Work Completion: 2023

Total Cost: \$37,000

Description of Work:

Prepare, repair, and repaint entire exterior of house.

Exhibit B: Maintenance Plan for 467 Oak Street

#8 Building Feature: Roof

Rehab/Restoration Maintenance Completed Proposed

Contract Year Work Completion: Annually

Total Cost: \$400

Description of Work:

Inspect roof for leaks and make roof repairs as necessary.

#9 Building Feature: Gutters and downspouts

Rehab/Restoration Maintenance Completed Proposed

Contract Year Work Completion: Annually

Total Cost: \$400

Description of Work:

Clean gutters and direct downspouts away from foundation.

#10 Building Feature: Windows and doors

Rehab/Restoration Maintenance Completed Proposed

Contract Year Work Completion: Annually

Total Cost: \$400

Description of Work:

Inspect windows and doors for leaks, failing paint or deteriorated wood, and make any necessary repairs in kind.

#11 Building Feature: Front steps and porch

Rehab/Restoration Maintenance Completed Proposed

Contract Year Work Completion: Annually

Total Cost: \$400

Description of Work:

Inspect front steps and porch for failing paint or deteriorated wood, and make any necessary repairs in kind.

#12 Building Feature: Wood siding and trim

Rehab/Restoration Maintenance Completed Proposed

Contract Year Work Completion: Annually

Total Cost: \$400

Description of Work:

Inspect wood siding and trim for failing paint or deteriorated wood, and make any necessary repairs in kind.

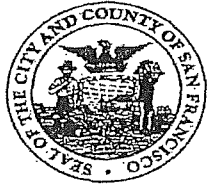

Office of the Assessor / Recorder - City and County of San Francisco
Mills Act Valuation

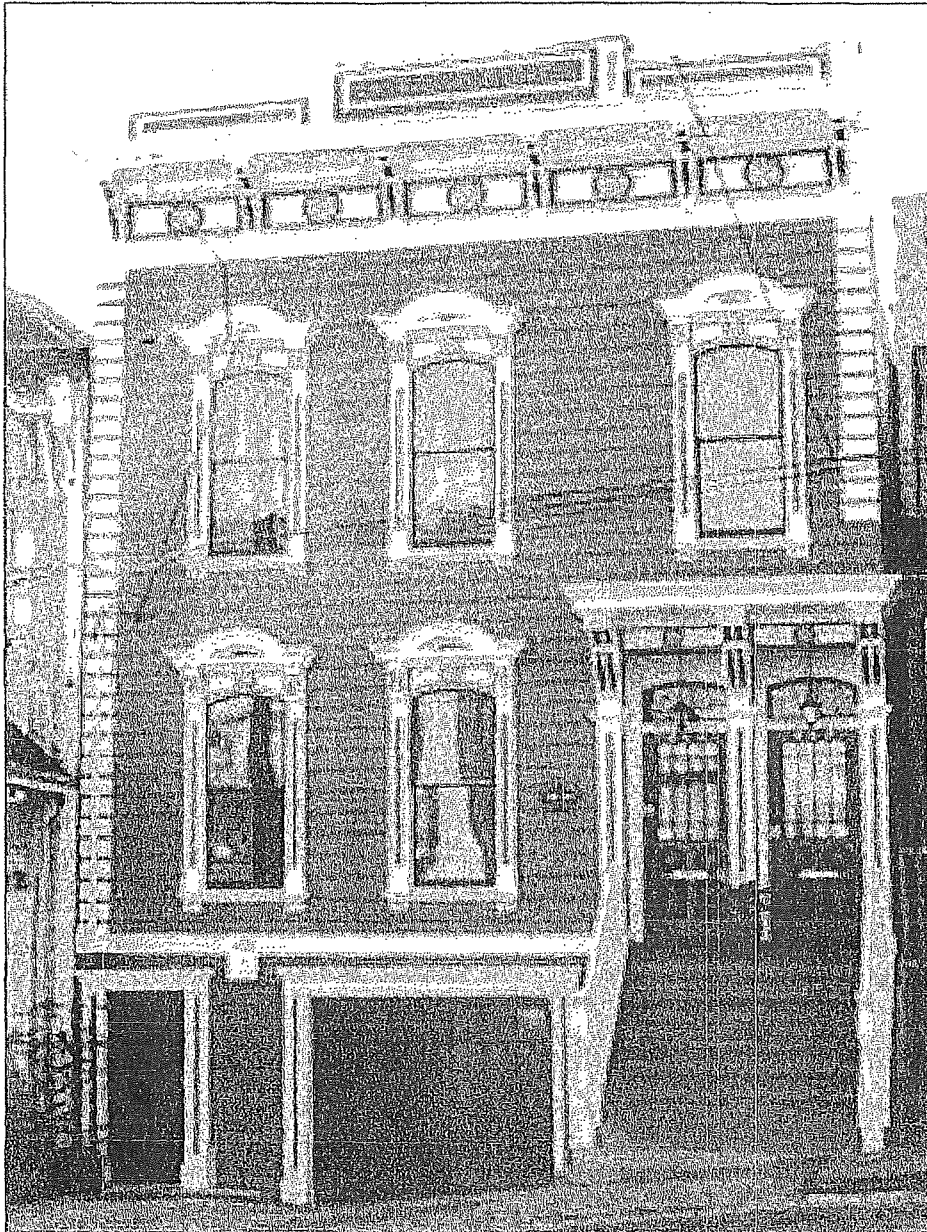

465-467 Oak Street
The Russell Warren House

4077

OFFICE OF THE ASSESSOR-RECORDER - CITY & COUNTY OF SAN FRANCISCO
MILLS ACT VALUATION

APN:	0840 017	Lien Date:	7/1/2018
Address:	465-467 Oak Street	Application Date:	4/27/2018
SF Landmark Title:	Russell Warren House	Valuation Date:	7/1/2018
Applicant's Name:	Joseph E. & Jennifer A. Laska	Valuation Term:	12 Months
Agt./Tax Rep./Atty:	None	Last Sale Date:	1/6/2017
Fee Appraisal Provided:	No	Last Sale Price:	\$2,500,000

FACTORED BASE YEAR (Roll) VALUE		INCOME CAPITALIZATION APPROACH		SALES COMPARISON APPROACH	
Land	\$1,785,000	Land	\$738,000	Land	\$1,575,000
Imps.	\$831,162	Imps.	\$492,000	Imps.	\$1,050,000
Personal Prop	\$0	Personal Prop	\$0	Personal Prop	\$0
Total	\$2,616,162	Total	\$1,230,000	Total	\$ 2,625,000

Property Description

Property Type:	Multi-Family	Year Built:	1875	Neighborhood:	Hayes Valley
Type of Use:	Multi-Family	(Total) Rentable Area:	2394	Land Area:	2,006
Owner-Occupied:	Yes	Stories:	2	Zoning:	RH-3
Unit Type:	Residential	Parking Spaces:	2 Car Garage		

Total No. of Units: 2

Special Conditions (Where Applicable)

	Per Unit	Per SF	Total
Factored Base Year Roll Value	\$1,308,081	\$1,093	\$ 2,616,162
Income Approach - Direct Capitalization	\$615,000	\$514	\$ 1,230,000
Sales Comparison Approach	\$1,312,500	\$1,096	\$ 2,625,000
Recommended Value Estimate	\$ 615,000	\$ 514	\$ 1,230,000

Appraiser: Bryan Bibby **Principal Appraiser:** James Bias **Date of Report:** 8/13/2018

SUBJECT PHOTOGRAPHS AND LOCATOR MAP

Address: 465-467 Oak Street

APN: 0840 017

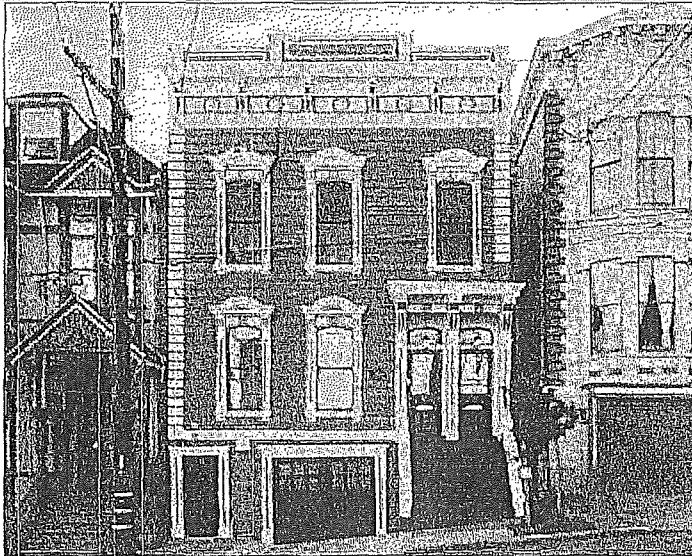

465-467 Oak Street Building Frontage

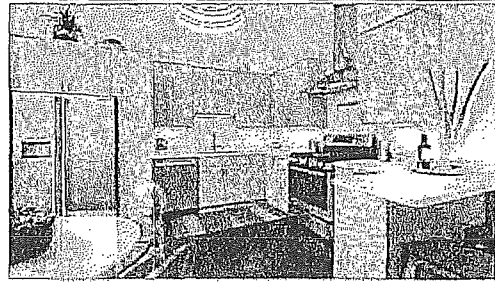

465 Oak Street Unit Kitchen

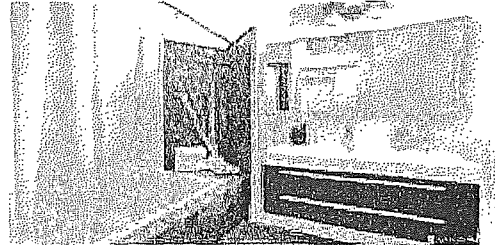

465 Oak Street Unit Bathroom

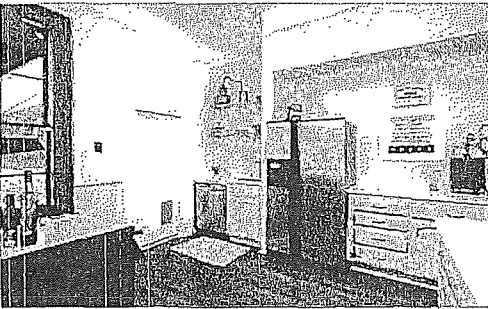

467 Oak Street Unit Kitchen (Before Updates)



467 Oak Street Unit Bathroom (Before Updates)

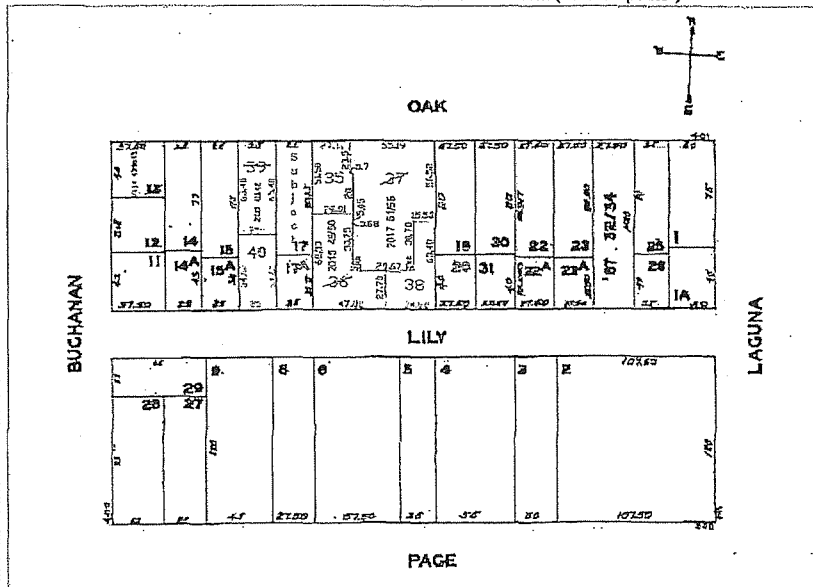
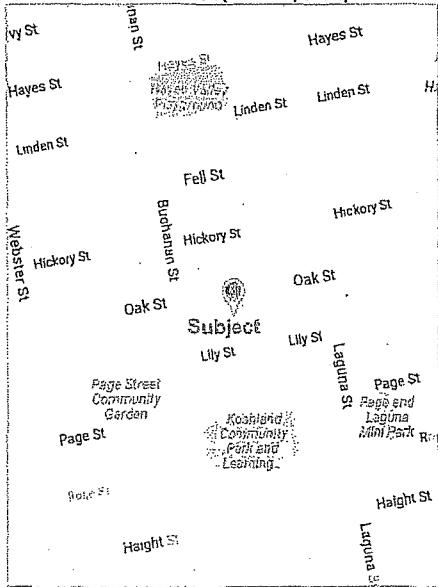

INCOME APPROACH

Address: 465-467 Oak Street
Lien Date: 7/1/2018

	<u>Monthly Rent</u>		<u>Annualized</u>	
Potential Gross Income	\$11,000	x	12	\$132,000
Less: Vacancy & Collection Loss			3%	<u>(\$3,960)</u>
Effective Gross Income				\$128,040
Less: Anticipated Operating Expenses (Pre-Property Tax)*			15%	<u>(\$19,206)</u>
Net Operating Income (Pre-Property Tax)				\$108,834

Restricted Capitalization Rate

2018 interest rate per State Board of Equalization			4.0000%	
Risk rate (4% owner occupied / 2% all other property types)			3.0100%	
2017 property tax rate **			1.1723%	
Amortization rate for improvements only				
Remaining economic life (Years)	60	0.0167	0.6667%	
Improvements constitute % of total property value	40%			8.8490%

RESTRICTED VALUE ESTIMATE **\$1,229,903**

ROUNDED TO **\$1,230,000**

Rent Roll as of 7/1/2018

<u>Unit</u>	<u>Bdrm/Ba</u>	<u>SF</u>	<u>Move In Date</u>	<u>Monthly Rent***</u>	<u>Annual Rent</u>	<u>Annual Rent / Foot</u>
465	2/2	1,185	8/1/2017	\$5,500	\$66,000	\$55.70
467	2/2	1,209	Owner Occupied	\$5,500	\$66,000	\$54.59
Total:		2,394		\$11,000	\$132,000	\$55.14

Notes:

* Annual operating expenses include water service, refuse collection, insurance, and regular maintenance items. Assumes payment of PG&E bill for in-unit power to be paid by lessee.

** The 2018 property tax rate will be determined in September, 2018. The 2017 tax rate is the most recent established tax rate as of the reporting date and was used for this analysis.

<u>Unit #</u>	<u>SF GLA</u>	<u>Occupancy</u>	<u>Weight</u>	<u>Risk Factor</u>	<u>Overall</u>
---------------	---------------	------------------	---------------	--------------------	----------------

Address: 465-467 Oak Street

Lien Date: 7/11/2018

Rental Comp #1

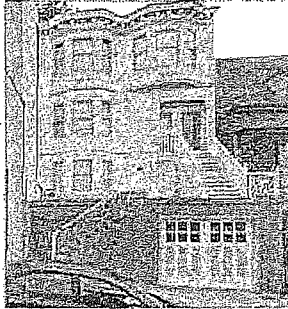

Property Rental Type: 2 Unit Entire Building
 Listing Agent: Keller Williams
 Address: 4307-4309 20th Street
 Cross Streets: Collingwood Street
 SF: 2,800
 Layout: 2 units: 1/2/1; 1/3/2, 2 car parking
 Monthly Rent: \$13,750
 Rent/Foot/Mo: \$4.91
 Annual Rent/Foot: \$58.93

Rental Comp #2

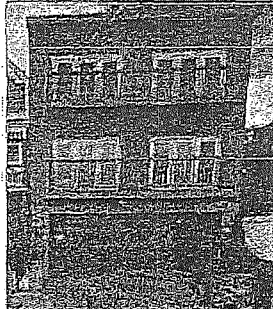

Property Rental Type: 2 Unit Entire Building
 Listing Agent: Keller Williams
 Address: 404-406 Hoffman Avenue
 Cross Streets: 24th Street
 SF: 2,745
 Layout: 2 units: 1/3/2, 1/2/2; 4 car parking
 Monthly Rent: \$12,000
 Rent/Foot/Mo: \$4.37
 Annual Rent/Foot: \$52.46

Rental Comp #3



Property Rental Type: 2 Unit Entire Building
 Listing Agent: Keller Williams
 Address: 2388-2390 Bryant Street
 Cross Streets: 22nd Street
 SF: 2,335
 Layout: 2 units: 1/3/2, 1/2/1, no car parking
 Monthly Rent: \$10,200
 Rent/Foot/Mo: \$4.37
 Annual Rent/Foot: \$52.42

Rental Comp #4

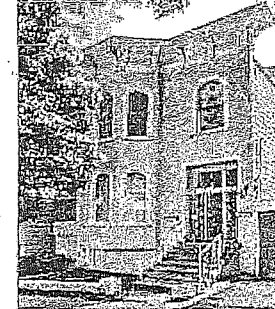

Property Rental Type: 2 Unit Entire Building
 Listing Agent: Vanguard Properties
 Address: 653-655 Fell Street
 Cross Streets: Webster Street
 SF: 1,760
 Layout: 2 units: 2/2/1, no car parking
 Monthly Rent: \$9,000
 Rent/Foot/Mo: \$5.11
 Annual Rent/Foot: \$61.36

Rental Comp #5



Property Rental Type: Individual Unit
 Listing Agent: Zillow Rental Network
 Address: 310 Scott Street
 Cross Streets: Oak Street
 SF: 1,047
 Layout: Condo Unit: 2/2, 1 car parking

Rental Comp #6



Property Rental Type: Individual Unit
 Listing Agent: Zillow Rental Network
 Address: 51 Alblon Street #A
 Cross Streets: 15th Street
 SF: 1,100
 Layout: Apartment Unit: 2/2, no car parking

Rental Comp #7

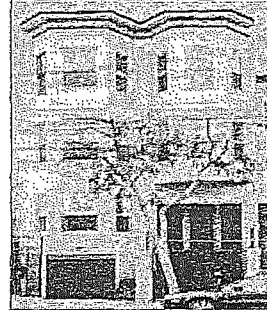

Property Rental Type: Individual Unit
 Listing Agent: Zillow Rental Network
 Address: 752 South Van Ness Avenue
 Cross Streets: 18th Street
 SF: 1,508
 Layout: Condo Unit: 3/1.5, 1 car parking

Rental Comp #8

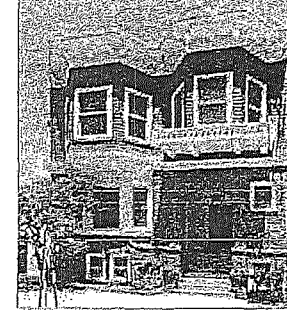



Property Rental Type: Individual Unit
 Listing Agent: Zillow Rental Network
 Address: 4882 17th Street
 Cross Streets: Shrader Street
 SF: 1,250
 Layout: Apartment Unit: 2/1.5, 1 car parking

4081

RESIDENTIAL INCOME PROPERTY MARKET ANALYSIS

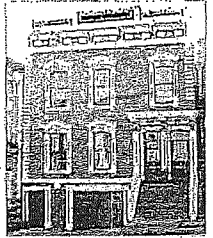
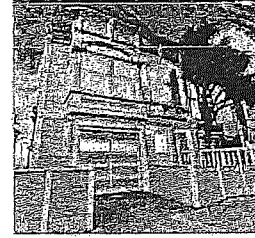
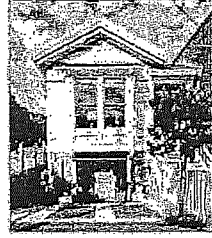
4082

APN	SUBJECT-A	COMPARABLE SALE 1-B	COMPARABLE SALE 2-C	COMPARABLE SALE 3-D													
	0040 017	0887 021	2601 005	3024 025													
																	
Address	485-487 Oak Street	110 Steiner Street	244-248 Douglas Street	1015 Castro Street													
Sales Price		\$2,600,000	\$2,600,000	\$2,400,000													
\$ / GBA		\$992	\$1,184	\$1,185													
\$ / Unit		\$1,300,000	\$1,250,000	\$800,000													
Annual Gross Income (PGI)		N/A	N/A	N/A													
GIM		N/A	N/A	N/A													
Avg Monthly Rent/Unit		N/A	N/A	N/A													
	DESCRIPTION	DESCRIPTION	DESCRIPTION	DESCRIPTION													
Lien Date / Date of Sale	07/01/18	03/16/18	11/09/17	06/04/18													
Neighborhood	Hayes Valley	Hayes Valley	Eureka Valley/Dolores Heights	Noe Valley													
Proximity to Subject	-	Within Reasonable Proximity	Within Reasonable Proximity	Within Reasonable Proximity													
Site (sq.ft.)	2,006	1,920	2,247	2,026													
Year Built	1876	1900	1900	1905													
Condition	Good/Updates	Good/Updates	Good/Updates	Good/Updates													
Traffic	Busy Street	Typical	Typical	Arterial Street													
Gross Bldg. Area	2,394	2,620	2,111	2,099													
Residential Unit Breakdown	Room Count				Room Count				Room Count				Room Count				
	No. of Units	GLA	Total	Bed	Bath	No. of Units	Total	Bed	Bath	No. of Units	Total	Bed	Bath	No. of Units	Total	Bed	Bath
	1	1185	4	2	2	1	5	3	2	1	5	2	2	1	5	2	2
	1	1209	5	2	2	1	4	2	1	1	3	1	1	1	4	2	1
Total	2	2394	9	4	4	2	9	5	3	2	9	3	2	3	10	4	4
Parking Spaces	2/Garage	1/Garage	60,000	1/Uncovered	75,000	1/Garage	50,000										
Net Adj. (total)																	
ADJ. SALES PRICE	\$2,625,000	\$2,625,000	\$2,625,000	\$2,658,000	\$2,658,000	\$2,658,000	\$2,658,000	\$2,658,000	\$2,658,000	\$2,658,000	\$2,658,000	\$2,658,000	\$2,658,000	\$2,658,000	\$2,658,000	\$2,658,000	\$2,658,000
Adj. \$ Per Foot	\$1,088	\$1,085	\$1,085	\$1,101	\$1,101	\$1,101	\$1,047	\$1,047	\$1,047	\$1,047	\$1,047	\$1,047	\$1,047	\$1,047	\$1,047	\$1,047	\$1,047
REMARKS:																	
The subject's property features were based on listing data, recent building permits and plans with completed DBI permits as of the subject's valuation date. The lower unit showed recent kitchen and baths updates per listing history. The upper unit had recent kitchen & bath alterations done per building plans submitted to DBI with a completion date of 8/1/2017.																	
Site size adj. warranted for all comps and was adj. at \$30/sf; Traffic adj. warranted for all comps to account for the busy street attributes of the subject. Comps #1 and 2 were adj. at 3% of the sales price. Comp #3 was adj. at 1% of the sales price to account for its arterial street attributes. GBA was adj. at \$400/sf. Unpermitted attic level area for Comp #2 was based on a flat \$50,000 adj. Unwarranted garden unit noted for Comp #3. Adj. at a flat \$75,000 to account for this unwarranted area with bath. Full bath adj. based on \$40,000 each. Parking space adj. was based on \$50,000 for each garage space variance. Uncovered parking spaces were given a value of \$25,000 per space.																	
All comparables were given consideration in the final value conclusion. The adj. sales prices of the comps listed above bracketed the subject's FMV conclusion.																	
THE ESTIMATED MARKET VALUE AS OF, 1-Jul-18 IS Land Improvements \$1,575,000 TOTAL \$2,625,000																	



SAN FRANCISCO PLANNING DEPARTMENT

PRE-APPROVAL INSPECTION REPORT

Report Date: May 22, 2018
Inspection Date: May 22, 2018, 9:00am
Filing Date: May 1, 2018
Case No.: 2018006796MLS
Project Address: 465-467 Oak Street
Block/Lot: 0840/017
Eligibility: Contributor to California Register of Historical Resources Historic District, Hayes Valley Residential Historic District
Zoning: RTO – Residential Transit Oriented District
Height & Bulk: 40-X
Supervisor District: District 5 (London Breed)
Project Sponsor: Joseph E & Jennifer A Laska Jnt Lvg Trust
Address: 467 Oak Street
San Francisco, CA 94102
310-497-8118, 310-709-2230
joelaska@me.com, jennlaska@me.com
Staff Contact: Shannon Ferguson – (415) 575-9074
shannon.ferguson@sfgov.org
Reviewed By: Tim Frye – (415) 575-6822
tim.frye@sfgov.org

1650 Mission St.
Suite 400
San Francisco,
CA 94103-2479

Reception:
415.558.6378

Fax:
415.558.6409

Planning
Information:
415.558.6377

PRE-INSPECTION

Record of calls or e-mails to applicant to schedule pre-approval inspection

4/30/2018: email applicant to confirm receipt of application

5/14/2018: email applicant to schedule site visit

5/15/2018: email applicant to confirm site visit date and time

INSPECTION OVERVIEW

Date and time of inspection:

Parties present:

- Provide applicant with business cards
- Inform applicant of contract cancellation policy
- Inform applicant of monitoring process

Inspect property. If multi-family or commercial building, inspection included a:

- Thorough sample of units/spaces
- Representative
- Limited

- Review any recently completed and in progress work to confirm compliance with Contract.
- Review areas of proposed work to ensure compliance with Contract.
- Review proposed maintenance work to ensure compliance with Contract.
- Identify and photograph any existing, non-compliant features to be returned to original condition during contract period. n/a

Yes No Does the application and documentation accurately reflect the property's existing condition? If no, items/issues noted:

Yes No Does the proposed scope of work appear to meet the Secretary of the Interior's Standards? If no, items/issues noted: See below

Yes No Does the property meet the exemption criteria, including architectural style, work of a master architect, important persons or danger of deterioration or demolition without rehabilitation? If no, items/issues noted: n/a

Yes No Conditions for approval? If yes, see below.

NOTES

465 Oak Street (District 5) is located on the south side of Oak Street between Buchanan and Laguna streets, Assessor's Block 0840, Lot 017. The subject property is located within a RTO (Residential Transit Oriented District) zoning district and a 40-X Height and Bulk district. The subject property is a contributing building to the California Register of Historical Places- listed Hayes Valley Residential Historic District. It is a two-story plus basement, wood-frame, two-family dwelling designed in the Edwardian style and built in circa 1900.

The subject property is currently valued by the Assessor's Office at under \$3,000,000. Therefore, an exemption from the tax assessment value is not required.

The applicant has completed rehabilitation work including, window repair, wood siding and trim repair and painting, and chimney repair in 2017. The rehabilitation plan proposes seismic structural upgrade, roof replacement, replacement of rear stair and balcony, and repainting. The estimated cost of rehabilitation work is \$369,600.

The maintenance plan proposes to inspect the roof, gutters, downspouts, windows, doors, front steps, wood siding, and wood trim for leaks, failing paint or deterioration and make any necessary repairs in kind. The estimated cost of maintenance work is \$2,000 annually.

PHOTOGRAPHS

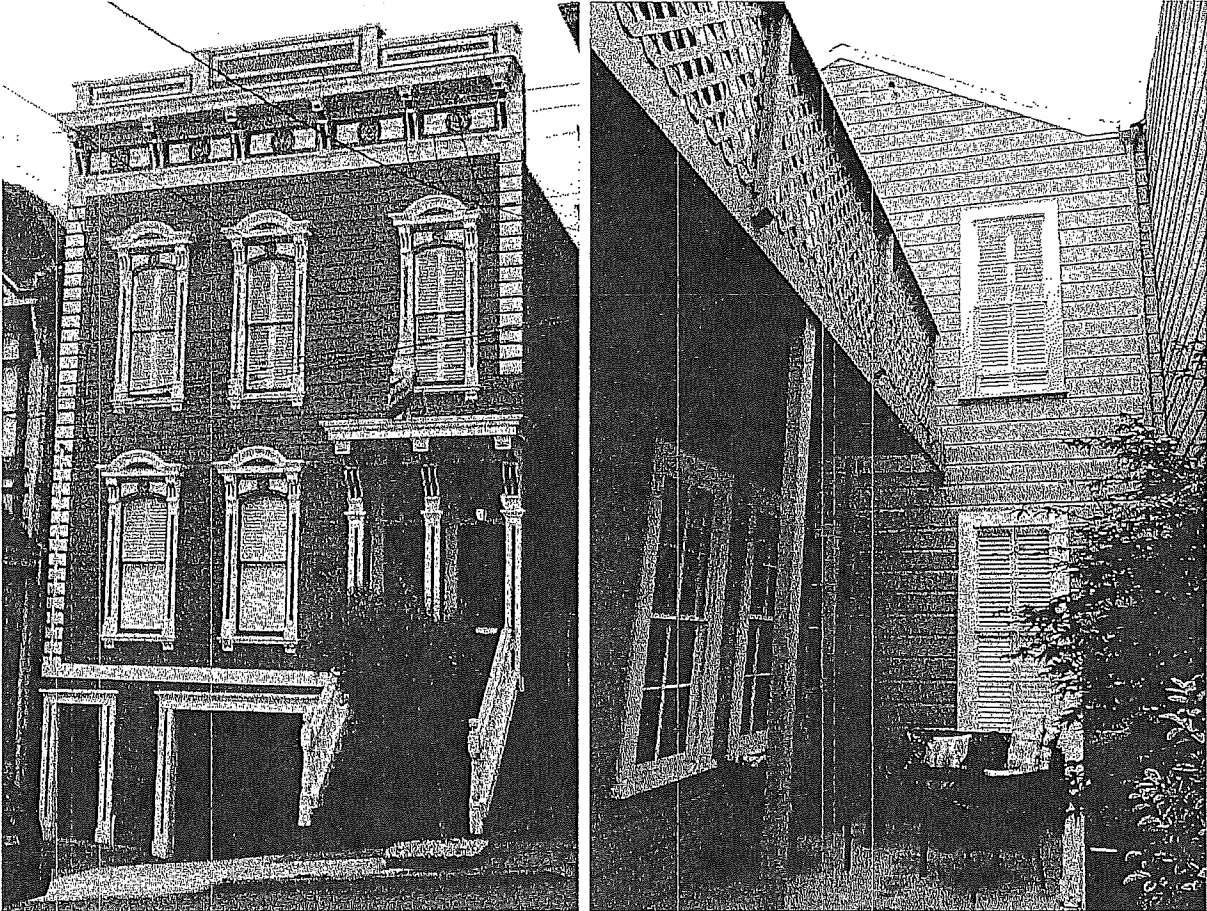

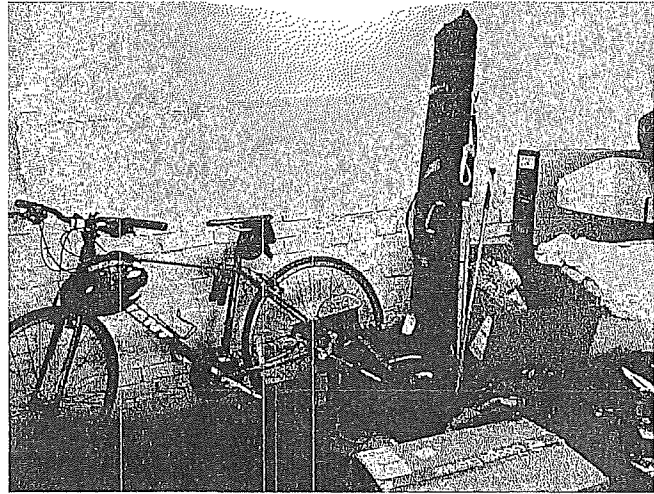
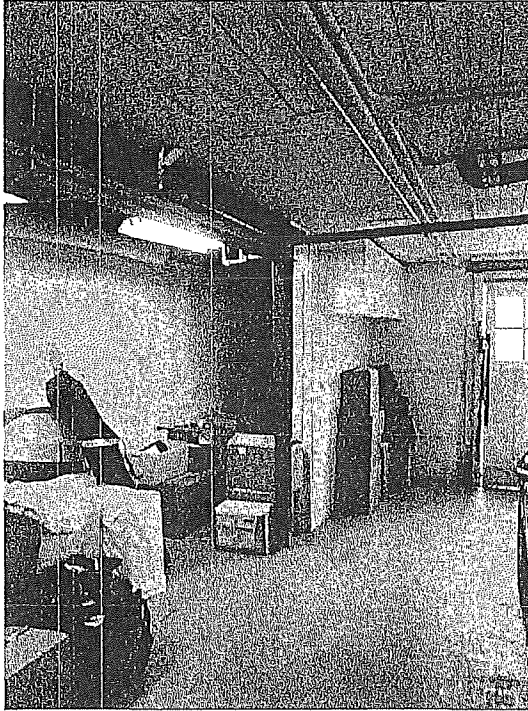

Application for
Mills Act Historical Property
Contract

Property:
Russell Warren House
465-467 Oak. St.
San Francisco, CA 94102

Submitted April 30, 2018
by Joseph and Jennifer Laska
467 Oak St.
San Francisco, CA 94102

MILLS ACT HISTORICAL PROPERTY CONTRACT Application Checklist:

Applicant should complete this checklist and submit along with the application to ensure that all necessary materials have been provided. Saying "No" to any of the following questions may nullify the timelines established in this application.

1	Mills Act Application Has each property owner signed? Has each signature been notarized?	YES <input type="checkbox"/> NO <input type="checkbox"/>
2	High Property Value Exemption Form & Historic Structure Report Required for Residential properties with an assessed value over \$3,000,000 and Commercial/Industrial properties with an assessed value over \$5,000,000. Have you included a copy of the Historic Structures Report completed by a qualified consultant?	YES <input type="checkbox"/> NO <input type="checkbox"/> N/A <input type="checkbox"/>
3	Draft Mills Act Historical Property Contract Are you using the Planning Department's standard "Historical Property Contract?" Have all owners signed and dated the contract? Have all signatures been notarized?	YES <input type="checkbox"/> NO <input type="checkbox"/>
4	Notary Acknowledgement Form Is the Acknowledgement Form complete? Do the signatures match the names and capacities of signers?	YES <input type="checkbox"/> NO <input type="checkbox"/>
5	Draft Rehabilitation/Restoration/Maintenance Plan Have you identified and completed the Rehabilitation, Restoration, and Maintenance Plan organized by contract year, including all supporting documentation related to the scopes of work?	YES <input type="checkbox"/> NO <input type="checkbox"/>
6	Photographic Documentation Have you provided both interior and exterior images (either digital, printed, or on a CD)? Are the images properly labeled?	YES <input type="checkbox"/> NO <input type="checkbox"/>
7	Site Plan Does your site plan show all buildings on the property including lot boundary lines, street name(s), north arrow and dimensions?	YES <input type="checkbox"/> NO <input type="checkbox"/>
8	Tax Bill Did you include a copy of your most recent tax bill?	YES <input type="checkbox"/> NO <input type="checkbox"/>
9	Rental Income Information Did you include information regarding any rental income on the property, including anticipated annual expenses, such as utilities, garage, insurance, building maintenance, etc.?	YES <input type="checkbox"/> NO <input type="checkbox"/>
10	Payment Did you include a check payable to the San Francisco Planning Department? Current application fees can be found on the Planning Department Fee Schedule under Preservation Applications.	YES <input type="checkbox"/> NO <input type="checkbox"/>
11	Recordation Requirements A Board of Supervisors approved and fully executed Mills Act Historical Property contract must be recorded with the Assessor-Recorder. The contract must be <u>accompanied</u> by the following in order to meet recording requirements: – All approvals, signatures, recordation attachments – Fee: Check payable to the Office of the Assessor-Recorder" in the appropriate recording fee amount Please visit www.sfassessor.org for an up-to-date fee schedule for property contracts. – Preliminary Change of Ownership Report (PCOR). Please visit www.sfassessor.org for an up-to-date PCOR (see example on page 20).	YES <input type="checkbox"/> NO <input type="checkbox"/>

APPLICATION AND PLAN

APPLICATION FOR Mills Act Historical Property Contract

Applications must be submitted in both hard copy and digital copy form to the Planning Department at 1650 Mission St., Suite 400 by May 1st in order to comply with the timelines established in the Application Guide. Please submit only the Application and required documents.

1. Owner/Applicant Information (If more than three owners, attach additional sheets as necessary.)

PROPERTY OWNER 1 NAME:	TELEPHONE:
Joseph E. Laska	(310) 497-8118
PROPERTY OWNER 1 ADDRESS:	EMAIL:
467 Oak St., San Francisco, CA 94102	joclaska@mc.com
PROPERTY OWNER 2 NAME:	TELEPHONE:
Jennifer A. Laska	(310) 709-2230
PROPERTY OWNER 2 ADDRESS:	EMAIL:
467 Oak St., San Francisco, CA 94102	jennlaska@mc.com
PROPERTY OWNER 3 NAME:	TELEPHONE:
	()
PROPERTY OWNER 3 ADDRESS:	EMAIL:

2. Subject Property Information

PROPERTY ADDRESS:	ZIP CODE:
465-467 Oak St., San Francisco, CA	94102
PROPERTY PURCHASE DATE:	ASSESSOR'S BLOCK/LOT(S):
January 6, 2017	Block 0840 / Lot 017
MOST RECENT ASSESSED VALUE:	ZONING DISTRICT:
\$2,500,000	RTO Dist. 6 Bucna Vista

- Are taxes on all property owned within the City and County of San Francisco paid to date? YES NO
- Is the entire property owner-occupied? YES NO
If No, please provide an approximate square footage for owner-occupied areas vs. rental income (non-owner-occupied areas) on a separate sheet of paper.
- Do you own other property in the City and County of San Francisco? YES NO
If Yes, please list the addresses for all other property owned within the City of San Francisco on a separate sheet of paper.
- Are there any outstanding enforcement cases on the property from the San Francisco Planning Department or the Department of Building Inspection? YES NO
If Yes, all outstanding enforcement cases must be abated and closed for eligibility for the Mills Act.

I/we am/are the present owner(s) of the property described above and hereby apply for an historical property contract. By signing below, I affirm that all information provided in this application is true and correct. I further swear and affirm that false information will be subject to penalty and revocation of the Mills Act Contract.

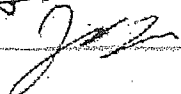
Owner Signature:  Date: 4/27/2018
 Owner Signature:  Date: 4/27/2018
 Owner Signature: _____ Date: _____

CALIFORNIA JURAT WITH AFFIANT STATEMENT

GOVERNMENT CODE § 8202

- See Attached Document (Notary to cross out lines 1-6 below)
- See Statement Below (Lines 1-6 to be completed only by document signer[s], *not* Notary)

1 _____
 2 _____
 3 _____
 4 _____
 5 _____
 6 _____

Signature of Document Signer No. 1 *Signature of Document Signer No. 2 (if any)*

A notary public or other officer completing this certificate verifies only the identity of the individual who signed the document to which this certificate is attached, and not the truthfulness, accuracy, or validity of that document.

State of California
 County of San Francisco

Subscribed and sworn to (or affirmed) before me
 on this 27 day of April, 2018,
 by Date Month Year

(1) Joseph Edward Loska III
 (and (2) Jennifer Amanda Loska),
 Name(s) of Signer(s)

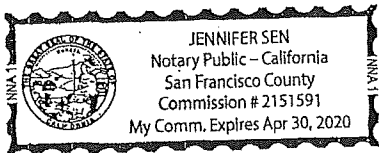

proved to me on the basis of satisfactory evidence
 to be the person(s) who appeared before me.

Place Notary Seal Above

Signature Jennifer Sen
 Signature of Notary Public

OPTIONAL

Though this section is optional, completing this information can deter alteration of the document or fraudulent reattachment of this form to an unintended document.

Description of Attached Document

Title or Type of Document: _____ Document Date: _____

Number of Pages: _____ Signer(s) Other Than Named Above: _____

3. Property Value Eligibility:

Choose one of the following options:

- The property is a Residential Building valued at less than \$3,000,000. YES NO
- The property is a Commercial/Industrial Building valued at less than \$5,000,000. YES NO

*If the property value exceeds these options, please complete the following: Application of Exemption.

Application for Exemption from Property Tax Valuation

If answered "no" to either question above please explain on a separate sheet of paper, how the property meets the following two criteria and why it should be exempt from the property tax valuations.

1. The site, building, or object, or structure is a particularly significant resource and represents an exceptional example of an architectural style, the work of a master, or is associated with the lives of significant persons or events important to local or natural history; or
2. Granting the exemption will assist in the preservation of a site, building, or object, or structure that would otherwise be in danger of demolition, substantial alteration, or disrepair. (A Historic Structures Report, completed by a qualified historic preservation consultant, must be submitted in order to meet this requirement.)

4 Property Tax Bill

All property owners are required to attach a copy of their recent property tax bill.

PROPERTY OWNER NAMES
Joseph E. and Jennifer A. Laska

MOST RECENT ASSESSED PROPERTY VALUE
\$2,500,000

PROPERTY ADDRESS
465-467 Oak St., San Francisco, CA 94102

5. Other Information

All property owners are required to attach a copy of all other information as outlined in the checklist on page 7 of this application.

By signing below, I/we acknowledge that I/we am/are the owner(s) of the structure referenced above and by applying for exemption from the limitations certify, under the penalty of perjury, that the information attached and provided is accurate.

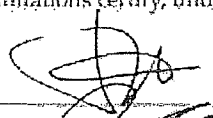
Owner Signature:  Date: 4/27/2018

Owner Signature:  Date: 4/27/2018

Owner Signature: _____ Date: _____

CALIFORNIA JURAT WITH AFFIANT STATEMENT

GOVERNMENT CODE § 8202

- See Attached Document (Notary to cross out lines 1-6 below)
- See Statement Below (Lines 1-6 to be completed only by document signer[s], *not* Notary)

1 _____

2 _____

3 _____

4 _____

5 _____

6 _____

Signature of Document Signer No. 1 *Signature of Document Signer No. 2 (if any)*

A notary public or other officer completing this certificate verifies only the identity of the individual who signed the document to which this certificate is attached, and not the truthfulness, accuracy, or validity of that document.

State of California
 County of San Francisco

Subscribed and sworn to (or affirmed) before me
 on this 27 day of April, 2018,
 by Date Month Year

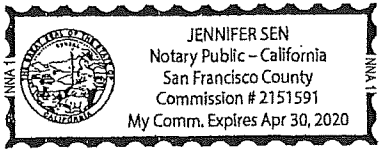

(1) Joseph Edward Laska III
 (and (2) Jennifer Amanda Laska),
 Name(s) of Signer(s)

proved to me on the basis of satisfactory evidence to be the person(s) who appeared before me.

Place Notary Seal Above

Signature Jennifer Sen
 Signature of Notary Public

OPTIONAL

Though this section is optional, completing this information can deter alteration of the document or fraudulent reattachment of this form to an unintended document.

Description of Attached Document

Title or Type of Document: _____ Document Date: _____

Number of Pages: _____ Signer(s) Other Than Named Above: _____

Exhibit A: Rehabilitation/Restoration Plan for 467 Oak Street

#1 Building Feature: Windows

Rehab/Restoration Maintenance Completed Proposed

Contract Year Work Completion: 2017

Total Cost: \$1,848.28

Description of Work:

Repaired original windows (glass, ropes, and weights).

#2 Building Feature: Wood Siding and Trim

Rehab/Restoration Maintenance Completed Proposed

Contract Year Work Completion: 2017

Total Cost: \$4,200

Description of Work:

Patched and painted exterior wood siding and trim.

#3 Building Feature: Chimneys

Rehab/Restoration Maintenance Completed Proposed

Contract Year Work Completion: 2017

Total Cost: \$915

Description of Work:

Repaired interior and exterior of chimneys and sealed roof around chimneys.

#4 Building Feature: Seismic structural upgrade of ground floor and foundation

Rehab/Restoration Maintenance Completed Proposed

Contract Year Work Completion: 2020

Total Cost: \$210,000

Description of Work:

Upgrade ground floor and foundation to current seismic standards and San Francisco Building Code.

#5 Building Feature: Roof

Rehab/Restoration Maintenance Completed Proposed

Contract Year Work Completion: 2022

Total Cost: \$73,700

Description of Work:

Repair substructure of roof, replace current roof, and, instead of conventional shingles, install durable Tesla solar shingles and a home battery, which will allow us to extend the life of the roof and make the house energy self-sufficient without adding large, visible solar panels. The Tesla solar shingles are far more durable than conventional shingles and come with a warranty for the lifetime of the house.

#6 Building Feature: Rear staircase and balcony

Rehab/Restoration Maintenance Completed Proposed

Contract Year Work Completion: 2023

Total Cost: \$48,900

Description of Work:

Replace rear wood staircase and balcony (original to the house) and add period-appropriate railing.

#7 Building Feature: Wood Siding and Trim

Rehab/Restoration Maintenance Completed

Proposed

Contract Year Work Completion: 2023

Total Cost: \$37,000

Description of Work:

Prepare, repair, and repaint entire exterior of house.

Exhibit B: Maintenance Plan for 467 Oak Street

#8 Building Feature: Roof

Rehab/Restoration Maintenance Completed Proposed

Contract Year Work Completion: Annually

Total Cost: \$400

Description of Work:

Inspect roof for leaks and make roof repairs as necessary.

#9 Building Feature: Gutters and downspouts

Rehab/Restoration Maintenance Completed Proposed

Contract Year Work Completion: Annually

Total Cost: \$400

Description of Work:

Clean gutters and direct downspouts away from foundation.

#10 Building Feature: Windows and doors

Rehab/Restoration Maintenance Completed Proposed

Contract Year Work Completion: Annually

Total Cost: \$400

Description of Work:

Inspect windows and doors for leaks, failing paint or deteriorated wood, and make any necessary repairs in kind.

#11 Building Feature: Front steps and porch

Rehab/Restoration Maintenance Completed Proposed

Contract Year Work Completion: Annually

Total Cost: \$400

Description of Work:

Inspect front steps and porch for failing paint or deteriorated wood, and make any necessary repairs in kind.

#12 Building Feature: Wood siding and trim

Rehab/Restoration Maintenance Completed Proposed

Contract Year Work Completion: Annually

Total Cost: \$400

Description of Work:

Inspect wood siding and trim for failing paint or deteriorated wood, and make any necessary repairs in kind.

CONTRACT

6. Draft Mills Act Historical Property Agreement

Please complete the following Draft Mills Act Historical Property Agreement and submit with your application. A final Mills Act Historical Property Agreement will be issued by the City Attorney once the Board of Supervisors approves the contract. The contract is not in effect until it is fully executed and recorded with the Office of the Assessor-Recorder.

Any modifications made to this standard City contract by the applicant or if an independently-prepared contract is used, it shall be subject to approval by the City Attorney prior to consideration by the Historic Preservation Commission and the Board of Supervisors. This will result in additional application processing time and the timeline provided in the application will be nullified.

Recording Requested by,
and when recorded, send notice to:
Director of Planning
1650 Mission Street
San Francisco, California 94103-2414

California Mills Act Historical Property Agreement

PROPERTY NAME (IF ANY)

PROPERTY ADDRESS
San Francisco, California

THIS AGREEMENT is entered into by and between the City and County of San Francisco, a California municipal corporation ("City") and _____ ("Owner/s").

RECITALS

Owners are the owners of the property located at _____, in San Francisco, California

_____/_____. The building located at _____

_____ is designated as _____ (e.g. "a City Landmark pursuant to Article 10 of the Planning Code") and is also known as the _____

Owners desire to execute a rehabilitation and ongoing maintenance project for the Historic Property. Owners' application calls for the rehabilitation and restoration of the Historic Property according to established preservation standards, which it estimates will cost approximately _____ (\$_____). See Rehabilitation Plan, Exhibit A.

Owners' application calls for the maintenance of the Historic Property according to established preservation standards, which is estimated will cost approximately _____ (\$_____) annually. See Maintenance Plan, Exhibit B.

The State of California has adopted the "Mills Act" (California Government Code Sections 50280-50290, and California Revenue & Taxation Code, Article 1.9 [Section 439 et seq.] authorizing local governments to enter into agreements with property owners to potentially reduce their property taxes in return for improvement to and maintenance of historic properties. The City has adopted enabling legislation, San Francisco Administrative Code Chapter 71, authorizing it to participate in the Mills Act program.

Owners desire to enter into a Mills Act Agreement (also referred to as a "Historic Property Agreement") with the City to help mitigate its anticipated expenditures to restore and maintain the Historic Property. The City is willing to enter into such Agreement to mitigate these expenditures and to induce Owners to restore and maintain the Historic Property in excellent condition in the future.

NOW, THEREFORE, in consideration of the mutual obligations, covenants, and conditions contained herein, the parties hereto do agree as follows:

Mills Act Application

1. Application of Mills Act.

The benefits, privileges, restrictions and obligations provided for in the Mills Act shall be applied to the Historic Property during the time that this Agreement is in effect commencing from the date of recordation of this Agreement.

2. Rehabilitation of the Historic Property.

Owners shall undertake and complete the work set forth in Exhibit A ("Rehabilitation Plan") attached hereto according to certain standards and requirements. Such standards and requirements shall include, but not be limited to: the Secretary of the Interior's Standards for the Treatment of Historic Properties ("Secretary's Standards"); the rules and regulations of the Office of Historic Preservation of the California Department of Parks and Recreation ("OHP Rules and Regulations"); the State Historical Building Code as determined applicable by the City; all applicable building safety standards; and the requirements of the Historic Preservation Commission, the Planning Commission, and the Board of Supervisors, including but not limited to any Certificates of Appropriateness approved under Planning Code Article 10. The Owners shall proceed diligently in applying for any necessary permits for the work and shall apply for such permits not less than six (6) months after recordation of this Agreement, shall commence the work within six (6) months of receipt of necessary permits, and shall complete the work within three (3) years from the date of receipt of permits. Upon written request by the Owners, the Zoning Administrator, at his or her discretion, may grant an extension of the time periods set forth in this paragraph. Owners may apply for an extension by a letter to the Zoning Administrator, and the Zoning Administrator may grant the extension by letter without a hearing. Work shall be deemed complete when the Director of Planning determines that the Historic Property has been rehabilitated in accordance with the standards set forth in this Paragraph. Failure to timely complete the work shall result in cancellation of this Agreement as set forth in Paragraphs 13 and 14 herein.

3. Maintenance.

Owners shall maintain the Historic Property during the time this Agreement is in effect in accordance with the standards for maintenance set forth in Exhibit B ("Maintenance Plan"), the Secretary's Standards; the OHP Rules and Regulations; the State Historical Building Code as determined applicable by the City; all applicable building safety standards; and the requirements of the Historic Preservation Commission, the Planning Commission, and the Board of Supervisors, including but not limited to any Certificates of Appropriateness approved under Planning Code Article 10.

4. Damage.

Should the Historic Property incur damage from any cause whatsoever, which damages fifty percent (50%) or less of the Historic Property, Owners shall replace and repair the damaged area(s) of the Historic Property. For repairs that do not require a permit, Owners shall commence the repair work within thirty (30) days of incurring the damage and shall diligently prosecute the repair to completion within a reasonable period of time, as determined by the City. Where specialized services are required due to the nature of the work and the historic character of the features damaged, "commence the repair work" within the meaning of this paragraph may include contracting for repair services. For repairs that require a permit(s), Owners shall proceed diligently in applying for any necessary permits for the work and shall apply for such permits not less than sixty (60) days after the damage has been incurred, commence the repair work within one hundred twenty (120) days of receipt of the required permit(s), and shall diligently prosecute the repair to completion within a reasonable period of time, as determined by the City. Upon written request by the Owners, the Zoning Administrator, at his or her discretion, may grant an extension of the time periods set forth in this paragraph. Owners may apply for an extension by a letter to the Zoning Administrator, and the Zoning Administrator may grant the extension by letter without a hearing. All repair work shall comply with the design and standards established for the Historic Property in Exhibits A and B attached hereto and Paragraph 3 herein. In the case of damage to twenty percent (20%) or more of the Historic Property due to a catastrophic event, such as an earthquake, or in the case of damage from any cause whatsoever that destroys more than fifty percent (50%) of the Historic Property, the City and Owners may mutually agree to terminate this Agreement. Upon such termination, Owners shall not be obligated to pay the cancellation fee set forth in Paragraph 14 of this Agreement. Upon such termination, the City shall assess the full value of the Historic Property without regard to any restriction imposed upon the Historic Property by this Agreement and Owners shall pay property taxes to the City based upon the valuation of the Historic Property as of the date of termination.

5. Insurance.

Owners shall secure adequate property insurance to meet Owners' repair and replacement obligations under this Agreement and shall submit evidence of such insurance to the City upon request.

6. Inspections.

Owners shall permit periodic examination of the exterior and interior of the Historic Property by representatives of the Historic Preservation Commission, the City's Assessor, the Department of Building Inspection, the Planning Department, the Office of Historic Preservation of the California Department of Parks and Recreation, and the State Board of Equalization, upon seventy-two (72) hours advance notice, to monitor Owners' compliance with the terms of this Agreement. Owners shall provide all reasonable information and documentation about the Historic Property demonstrating compliance with this Agreement as requested by any of the above-referenced representatives.

7. Term.

This Agreement shall be effective upon the date of its recordation and shall be in effect for a term of ten years from such date ("Initial Term"). As provided in Government Code section 50282, one year shall be added automatically to the Initial Term, on each anniversary date of this Agreement, unless notice of nonrenewal is given as set forth in Paragraph 10 herein.

8. Valuation.

Pursuant to Section 439.4 of the California Revenue and Taxation Code, as amended from time to time, this Agreement must have been signed, accepted and recorded on or before the lien date (January 1) for a fiscal year (the following July 1-June 30) for the Historic Property to be valued under the taxation provisions of the Mills Act for that fiscal year.

9. Termination.

In the event Owners terminates this Agreement during the Initial Term, Owners shall pay the Cancellation Fee as set forth in Paragraph 15 herein. In addition, the City Assessor-Recorder shall determine the fair market value of the Historic Property without regard to any restriction imposed on the Historic Property by this Agreement and shall reassess the property taxes payable for the fair market value of the Historic Property as of the date of Termination without regard to any restrictions imposed on the Historic Property by this Agreement. Such reassessment of the property taxes for the Historic Property shall be effective and payable six (6) months from the date of Termination.

10. Notice of Nonrenewal.

If in any year after the Initial Term of this Agreement has expired either the Owners or the City desires not to renew this Agreement that party shall serve written notice on the other party in advance of the annual renewal date. Unless the Owners serves written notice to the City at least ninety (90) days prior to the date of renewal or the City serves written notice to the Owners sixty (60) days prior to the date of renewal, one year shall be automatically added to the term of the Agreement. The Board of Supervisors shall make the City's determination that this Agreement shall not be renewed and shall send a notice of nonrenewal to the Owners. Upon receipt by the Owners of a notice of nonrenewal from the City, Owners may make a written protest. At any time prior to the renewal date, City may withdraw its notice of nonrenewal. If in any year after the expiration of the Initial Term of the Agreement, either party serves notice of nonrenewal of this Agreement, this Agreement shall remain in effect for the balance of the period remaining since the execution of the last renewal of the Agreement.

11. Payment of Fees.

Within one month of the execution of this Agreement, City shall tender to Owners a written accounting of its reasonable costs related to the preparation and approval of the Agreement as provided for in Government Code Section 50281.1 and San Francisco Administrative Code Section 71.6. Owners shall promptly pay the requested amount within forty-five (45) days of receipt.

12. Default.

An event of default under this Agreement may be any one of the following:

- (a) Owners' failure to timely complete the rehabilitation work set forth in Exhibit A in accordance with the standards set forth in Paragraph 2 herein;
- (b) Owners' failure to maintain the Historic Property in accordance with the requirements of Paragraph 3 herein;
- (c) Owners' failure to repair any damage to the Historic Property in a timely manner as provided in Paragraph 4 herein;
- (d) Owners' failure to allow any inspections as provided in Paragraph 6 herein;
- (e) Owners' termination of this Agreement during the Initial Term;
- (f) Owners' failure to pay any fees requested by the City as provided in Paragraph 11 herein;
- (g) Owners' failure to maintain adequate insurance for the replacement cost of the Historic Property; or
- (h) Owners' failure to comply with any other provision of this Agreement.

An event of default shall result in cancellation of this Agreement as set forth in Paragraphs 13 and 14 herein and payment of the cancellation fee and all property taxes due upon the Assessor's determination of the full value of the Historic Property as set forth in Paragraph 14 herein. In order to determine whether an event of default has occurred, the Board of Supervisors shall conduct a public hearing as set forth in Paragraph 13 herein prior to cancellation of this Agreement.

13. Cancellation.

As provided for in Government Code Section 50284, City may initiate proceedings to cancel this Agreement if it makes a reasonable determination that Owners have breached any condition or covenant contained in this Agreement, has defaulted as provided in Paragraph 12 herein, or has allowed the Historic Property to deteriorate such that the safety and integrity of the Historic Property is threatened or it would no longer meet the standards for a Qualified Historic Property. In order to cancel this Agreement, City shall provide notice to the Owners and to the public and conduct a public hearing before the Board of Supervisors as provided for in Government Code Section 50285. The Board of Supervisors shall determine whether this Agreement should be cancelled. The cancellation must be provided to the Office of the Assessor-Recorder for recordation.

14. Cancellation Fee.

If the City cancels this Agreement as set forth in Paragraph 13 above, Owners shall pay a cancellation fee of twelve and one-half percent (12.5%) of the fair market value of the Historic Property at the time of cancellation. The City Assessor shall determine fair market value of the Historic Property without regard to any restriction imposed on the Historic Property by this Agreement. The cancellation fee shall be paid to the City Tax Collector at such time and in such manner as the City shall prescribe. As of the date of cancellation, the Owners shall pay property taxes to the City without regard to any restriction imposed on the Historic Property by this Agreement and based upon the Assessor's determination of the fair market value of the Historic Property as of the date of cancellation.

15. Enforcement of Agreement.

In lieu of the above provision to cancel the Agreement, the City may bring an action to specifically enforce or to enjoin any breach of any condition or covenant of this Agreement. Should the City determine that the Owners has breached this Agreement, the City shall give the Owners written notice by registered or certified mail setting forth the grounds for the breach. If the Owners do not correct the breach, or if it does not undertake and diligently pursue corrective action, to the reasonable satisfaction of the City within thirty (30) days from the date of receipt of the notice, then the City may, without further notice, initiate default procedures under this Agreement as set forth in Paragraph 13 and bring any action necessary to enforce the obligations of the Owners set forth in this Agreement. The City does not waive any claim of default by the Owners if it does not enforce or cancel this Agreement.

16. Indemnification.

The Owners shall indemnify, defend, and hold harmless the City and all of its boards, commissions, departments, agencies, agents and employees (individually and collectively, the "City") from and against any and all liabilities, losses, costs, claims, judgments, settlements, damages, liens, fines, penalties and expenses incurred in connection with or arising in whole or in part from: (a) any accident, injury to or death of a person, loss of or damage to property occurring in or about the Historic Property; (b) the use or occupancy of the Historic Property by the Owners, their Agents or Invitees; (c) the condition of the Historic Property; (d) any construction or other work undertaken by Owners on the Historic Property; or (e) any claims by unit or interval Owners for property tax reductions in excess those provided for under this Agreement. This indemnification shall include, without limitation, reasonable fees for attorneys, consultants, and experts and related costs that may be incurred by the City and all indemnified parties specified in this Paragraph and the City's cost of investigating any claim. In addition to Owners' obligation to indemnify City, Owners specifically acknowledge and agree that they have an immediate and independent obligation to defend City from any claim that actually or potentially falls within this indemnification provision, even if the allegations are or may be groundless, false, or fraudulent, which obligation arises at the time such claim is tendered to Owners by City, and continues at all times thereafter. The Owners' obligations under this Paragraph shall survive termination of this Agreement.

17. Eminent Domain.

In the event that a public agency acquires the Historic Property in whole or part by eminent domain or other similar action, this Agreement shall be cancelled and no cancellation fee imposed as provided by Government Code Section 50288.

18. Binding on Successors and Assigns.

The covenants, benefits, restrictions, and obligations contained in this Agreement shall be deemed to run with the land and shall be binding upon and inure to the benefit of all successors and assigns in interest of the Owners.

19. Legal Fees.

In the event that either the City or the Owners fail to perform any of their obligations under this Agreement or in the event a dispute arises concerning the meaning or interpretation of any provision of this Agreement, the prevailing party may recover all costs and expenses incurred in enforcing or establishing its rights hereunder, including reasonable attorneys' fees, in addition to court costs and any other relief ordered by a court of competent jurisdiction. Reasonable attorneys fees of the City's Office of the City Attorney shall be based on the fees regularly charged by private attorneys with the equivalent number of years of experience who practice in the City of San Francisco in law firms with approximately the same number of attorneys as employed by the Office of the City Attorney.

20. Governing Law.

This Agreement shall be construed and enforced in accordance with the laws of the State of California.

21. Recordation.

The contract will not be considered final until this agreement has been recorded with the Office of the Assessor-Recorder of the City and County of San Francisco.

22. Amendments.

This Agreement may be amended in whole or in part only by a written recorded instrument executed by the parties hereto in the same manner as this Agreement.

23. No Implied Waiver.

No failure by the City to insist on the strict performance of any obligation of the Owners under this Agreement or to exercise any right, power, or remedy arising out of a breach hereof shall constitute a waiver of such breach or of the City's right to demand strict compliance with any terms of this Agreement.

24. Authority.

If the Owners sign as a corporation or a partnership, each of the persons executing this Agreement on behalf of the Owners does hereby covenant and warrant that such entity is a duly authorized and existing entity, that such entity has and is qualified to do business in California, that the Owner has full right and authority to enter into this Agreement, and that each and all of the persons signing on behalf of the Owners are authorized to do so.

25. Severability.

If any provision of this Agreement is determined to be invalid or unenforceable, the remainder of this Agreement shall not be affected thereby, and each other provision of this Agreement shall be valid and enforceable to the fullest extent permitted by law.

26. Tropical Hardwood Ban.

The City urges companies not to import, purchase, obtain or use for any purpose, any tropical hardwood or tropical hardwood product.

27. Charter Provisions.

This Agreement is governed by and subject to the provisions of the Charter of the City.

28. Signatures.

This Agreement may be signed and dated in parts

IN WITNESS WHEREOF, the parties hereto have executed this Agreement as follows:

CARMEN CHU
ASSESSOR-RECORDER
CITY & COUNTY OF SAN FRANCISCO

Date

JOHN RAHAIM
DIRECTOR OF PLANNING
CITY & COUNTY OF SAN FRANCISCO

Date

APPROVED AS PER FORM:
DENNIS HERRERA
CITY ATTORNEY
CITY & COUNTY OF SAN FRANCISCO

Signature

Date

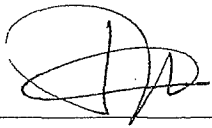

Signature

4/27/2018
Date

Print name
DEPUTY CITY ATTORNEY

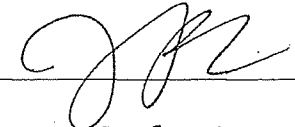

Signature

4/27/2018
Date

JOSEPH E. LASKA

Print name
OWNER

JENNIFER A. LASKA

Print name
OWNER

Owner/s' signatures must be notarized. Attach notary forms to the end of this agreement.
(If more than one owner, add additional signature lines. All owners must sign this agreement.)

7. Notary Acknowledgment Form

The notarized signature of the majority representative owner or owners, as established by deed or contract, of the subject property or properties is required for the filing of this application. (Additional sheets may be attached.)

State of California

County of: San Francisco

On: 4/27/18 before me, Jennifer Sen,
DATE INSERT NAME OF THE OFFICER

NOTARY PUBLIC personally appeared: Joseph E. Laska and Jennifer A. Laska
NAME(S) OF SIGNER(S)

who proved to me on the basis of satisfactory evidence to be the person(s) who name(s) ~~is~~/are subscribed to the within instrument and acknowledged to me that ~~he~~/she/they executed the same in his/her/their authorized capacity(ies), and that by his/her/their signature(s) on the instrument the person(s), or the entity upon behalf of which the person(s) acted, executed the instrument.

I certify under PENALTY OF PERJURY under the laws of the State of California that the foregoing paragraph is true and correct.

WITNESS my hand and official seal.

Jennifer Sen
SIGNATURE

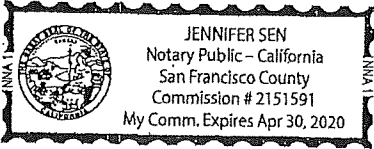

(PLACE NOTARY SEAL ABOVE)

ELLIOTTBUILD

elliottbuild@yahoo.com - (415) 377-9009 - www.elliottbuild.com

Payment Schedule**10/20/17**

Joseph and Jenn Laska
465-467 Oak Street
San Francisco, CA 94102

Total project cost prior to city permit fees and homeowner change orders \$133,155.00
(please note that the line items below are time markers, not direct comparisons to the estimate)

-Due when contract is signed	PAID	\$1,000.00
-Due when cabinets are ordered	PAID	\$16,000.00
-Due when window and door are ordered	PAID	\$7,000.00
-Due when demo complete	PAID	\$8,000.00
-Due when rough framing begins	PAID	\$5,000.00
-Due when rough plumbing complete	PAID	\$11,000.00
-Due when rough electrical complete	PAID	\$13,500.00
-Due when rough framing complete	PAID	\$5,000.00
-Due when ready to drywall	PAID	\$15,000.00

-Due when drywall is complete	PAID	\$15,000.00
-Due when tile prep is complete	PAID	\$5,000.00
-Due when tiling is complete	PAID	\$7,000.00
-Due when cabinets are installed	PAID	\$5,000.00
-Due when counters are installed	PAID	\$5,000.00
-Due when finish carpentry is complete	PAID	\$8,000.00
-Due when finish plumbing is complete	PAID	\$2,000.00
-Due when finish electrical is complete	PAID	\$2,000.00
-Due when ready for final inspection	PAID	\$1,000.00
-Due after final inspection	PAID	\$1,655.00

Please make all checks payable to
 Elliottbuild Remodel
 P.O. Box 2746
 Berkeley, CA 94702

City Permit Fees and Approved Change Orders Billed as Accrued

-Permit and parking fees	PAID	\$2,374.37
--------------------------	------	------------

-3 hours at SFDBI pulling permits	PAID	\$360.00
-Add L shape to cabinet in corner of kitchen. Add cabinet between windows.	PAID	\$926.00
-Add for wall hung toilet installation	PAID	\$350.00
-Relocate plumbing and electrical to accommodate framing for 2 recessed medicine cabinets	PAID	\$1,200.00
-Frame master closet, purchase and install barn door hardware and 2 reclaimed doors from site, purchase and install 2 pre-hung flush panel doors with oil rubbed bronze finish hinges and touch latches, run custom baseboard to match, drywall. Add \$1400 to this line item if the picture rail has to be matched. If picture rail can be cast from a match, no added cost to this line item. Closet interior will be blank canvas for homeowner to finish with built ins.	PAID	\$7,300.00
-Match the picture rail with cast material instead of wood.	PAID	\$1,400.00
-Cost of barn door hardware	PAID	\$350.00
-Abate asbestos and haul away existing heating duct for kitchen, strip asbestos back for clean connection of new heating duct. Run new heating duct to kitchen ceiling near chimney.	PAID	\$2,500.00
-Purchase, create hatch and frame for, and install 10' telescoping access ladder	PAID	\$1,450.00
-Upgrade master closet doors to concealed hinge doors @ \$400 each	PAID	\$800.00
-Frame for, run electrical, wire, trim out, and install homeowner provided		\$750.00

electric fireplace. Add \$200 to this line item if the inspector requires us to build a firebox behind it.

-Electrical rewire all outlets and lights throughout unit except in kitchen and bathroom. Kitchen and bathroom electrical included with their respective ballpark estimates. Includes cleaning up miscellaneous low volt phone wire and cable	PAID	\$15,000.00
-Small bathroom install surface mount medicine cabinet over sink	PAID	\$125.00
-Sand, stain and refinish existing hardwood floors throughout unit \$5500-\$6500 depending on transitions and repair work.	PAID	\$6,200.00
-Change border and repair kitchen floor.	PAID	\$1,050.00
-Prep and paint throughout interior \$12,000 - \$16,000. Add \$5000 \$10,000 to this line item to refinish bannisters and railing.	PAID	\$16,000.00
-Miscellaneous vent and register covers, door knob replacement throughout \$2000 - \$4000.	PAID	\$3,700.00
-Run copper plumbing supply line for future irrigation.	PAID	\$375.00
-Paint touch-up where wires were removed. Paint all new EMT conduit on exterior. touch-up Paint at front of the house where boxes were removed.	PAID	\$1,600.00
-Remove all cable and telephone lines in back.	PAID	\$250.00
-Remove old electrical conduit outside of master bedroom window.	PAID	\$250.00

-Add (2) outdoor lights with outdoor switch on ground level (one to the left of sliding door, one under stairs).	PAID	\$900.00
-Add (2) outlets on ground level (one below new light under stairs, one on cement wall at the base of the stairs in garden bed). All electrical to be run through EMT conduit.	PAID	\$700.00
-Remove (1) outdoor light on ground level by placing cover plate over box (the one centered over sliding door.)	PAID	\$25.00
-Replace rotting boards on deck. Paint match as close as possible.	PAID	\$1,050.00
-Remove Satellite and dead power cords from roof.	PAID	\$500.00
-Remove speaker brackets under deck.	PAID	\$50.00
-Remove lights from over garage and breezeway doors.	PAID	\$200.00
-Install (1) light between garage and breezeway door. Wire/EMT to be run inside garage and stubbed out so exterior looks clean.	PAID	\$900.00
-Relocate cable box to inside breezeway. We will have to see if this is possible.	PAID	\$250.00
-Remove ADT box.	PAID	\$75.00
-Remove old security, cable and telephone lines and boxes.	PAID	\$550.00
-New wood is needed around framing of property line kitchen windows that we just had replaced. We will need access to neighbor's yard for this.	PAID	\$1,500.00

-Fix dead outlet in living room. We will troubleshoot this. \$50 - \$200.	PAID	\$25.00
-Install wall mounted Robern medicine cabinet in guest bathroom. If there is no electrical and the cabinet is either surface mounted or fits exactly in an existing recess \$150. If additional work is needed, cost will be assessed.	PAID	\$150.00
-Credit for kitchen shelves	PAID	\$1,900.00
-Paint back fence wall	PAID	\$1,300.00
-Sand, prep, and paint (2) front doors	PAID	\$1,100.00
-Prep and paint front landings and stairs	PAID	\$1,250.00

Custom kitchen shelves		\$1,900.00
-----------------------------------	--	-----------------------

Golden Gate Glass & Mirror Co., Inc.

2011 Folsom Street
San Francisco, CA 94110

Phone # 415-552-0220

Fax # 415-552-6135

Contractor License #228354

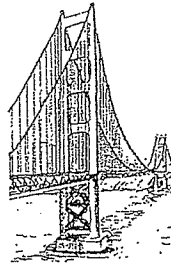

Invoice

Date	Invoice #
4/25/2017	66234

Bill To
Jennifer Laska 467 Oak St San Francisco, CA

Ship To

P.O. Number	Terms
	25% Deposit, COD at c...

Quantity	Description	Price Each	Amount
2	Replace glass in customer's wood windows		
2	26 x 37 - 1/8" Double Glue Chip	139.48	278.96
1	12 x 18 - Clear 1/8" glass - top sash	18.75	18.75
2	15 x 18 - Clear 1/8" glass - bottom sash	18.75	37.50
8	15 x 18 - 1/8" Double Glue Chip - bottom sash	40.66	325.28
1	Rope	7.20	7.20
	Subtotal		667.69
	15% Discount	-15.00%	-100.15
	Subtotal		567.54
	Sales Tax - San Francisco	8.50%	48.24
	Labor	1,650.00	1,650.00
		Total	\$2,265.78

Payments/Credits	-\$500.00
Balance Due	\$1,765.78

Golden Gate Glass & Mirror Co., Inc

2011 Folsom Street
 San Francisco, CA 94110

Phone # 415-552-0220

Fax # 415-552-6135

Contrator License #228354

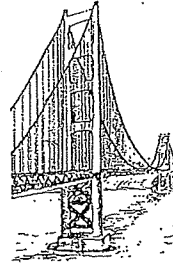

Invoice

Date	Invoice #
5/19/2017	66335

Bill To
Jennifer Laska 467 Oak St San Francisco, CA

Ship To

P.O. Number	Terms
	25% Deposit, COD at c...

Quantity	Description	Price Each	Amount
8	Add weights to Double Hung Window - this was not included in the original estimate		
	8 lbs of weight	13.75	110.00
	25% Discount	-25.00%	-27.50
	Subtotal		82.50
Total			\$82.50

Payments/Credits	\$0.00
Balance Due	\$82.50

2598247

MISTER CHIMNEY
 CLEANING AND REPAIRS INC
 90 GLENN WAY, SUITE #1
 SAN CARLOS, CA 94070
 (650) 631-4531 FAX (650) 632-1612
 LIC. #C29 989096

- No. of Stories: (1) 2 3 4 • No. of Appliances: (1) 2 3 4
- Type of Appliance: Prefab Masonry Stove Insert Furnace.
- Fuel Type: Wood Pellet Oil Gas
- Type of Wood Used: Soft Hard Wet Dry
- Last Cleaned: _____ Year(s) Ago Never
- Amount of fuel burned per season: _____
- Flue Size: 8"x8" 8"x13" 13"x13" 8"x17" 13"x17"
 6" Round 8" Round 5 X 8
- Outside Chimney Dimensions: 20" x 13"
- Fireplace Opening Size: 24" x 27"
- How did you hear about us? TV Radio Website
 Newspaper Yellow Pages Direct Mail Social Media
 Referral Repeat Customer Internet Ad. _____

Customer JENNIFER LASKA
 Address 4125 - 4607 DAK ST
 City SF State CA Zip 94114
 Phone (310) 709 2230
 E-mail _____
 Date 02-16-17 Time 11:15am
 Directions to Home _____

CONDITION REPORT

	Satisfactory	Unsatisfactory	Not Applicable
CHIMNEY			
1. Height	X		
2. Chimney Cap / Spark Arrestor	X		
3. Crown / Wash		X	
4. Brickwork / Mortar	X		
5. Flashing	X		
6. Flue Liner	X		
7. Moisture Resistance	X		
FIREPLACE			
8. Smoke Chamber		X	
9. Damper		X	
10. Firebox / Grate	X		
11. Ash Container			X
12. Spark Screen / Doors	X		
13. Tools / Gloves	X		
14. Hearth Protection			
15.			
STOVE OR FIREPLACE INSERT			
16. Connector Pipe Condition			
17. NFPA/IRC Approved Flue Connection			
18. Installation / Thimble / Clearances			
OTHER SAFETY CONSIDERATIONS			
19. Fire Ext. / Smoke Detectors / CO Alarms			
20. Gas / Oil Furnace Flue Liner			
21. Fire Escape Plan			

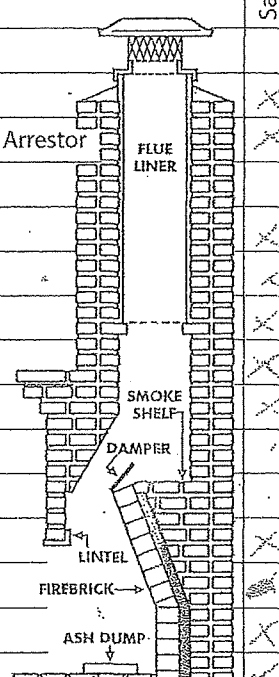

COMMENTS: Recommend
S. Chamber reline 250
RESURFACE CROWN - 325

SOLD

OK TO USE

CUSTOMER VERIFICATION

I have read this form and now understand which areas of my chimney system appear to be satisfactory and which areas are not satisfactory.

Signed [Signature] Date 2/16/17

NEXT SERVICING SCHEDULED

on _____ month _____ day _____ year, at _____ time

The National Fire Protection Association Standard states the fireplace and chimney should be inspected yearly for any structural faults.

Chimney Professional's Signature Guardo

RECEIPT / INVOICE

DESCRIPTION	PRICE
<u>2) Cleaning / inspect</u>	<u>118</u>
	<u>-10</u>
	<u>\$170</u>
<u>CK #105</u>	<u>X2</u>
	SUBTOTAL
DATE COMPLETED	TOTAL <u>#340</u>

Note: This sheet is the result of a visual inspection done at the time of cleaning. It is intended as a convenience to our customer, not as certification of fire worthiness of safety. Since conditions of use and hidden construction defects are beyond our control, we make no warranty of the safety or function of any appliance and none is to be implied.



PROPOSAL FOR CONSTRUCTION SERVICES

The agreement:

This Agreement ("Contract") is made this _____ day of _____ between **A.J.O. Group Build Inc.** ("Contractor") and **JOE LASKA** ("Owner") in **SAN FRANCISCO, CALIFORNIA**.

The Work described in Section 1 below shall be performed in accordance with all plans, specifications and other Contract documents for the project known as: **SEISMIC/STRUCTURAL UPGRADE OF GROUND FLOOR AND FOUNDATIONS**.

Project property address: **463-467 OAK ST, SAN FRANCISCO, CALIFORNIA**
Project property block/lot: **0840/017**

Section 1. Scope:

The Contractor agrees to furnish all labor, materials, equipment and other facilities required to complete the following Work: **SEISMIC/STRUCTURAL UPGRADE OF GROUND FLOOR AND FOUNDATION** including:

- Building survey to produce "as built" plans of the existing conditions;
- Engineering analysis and design to bring building in compliance with San Francisco Existing Building Code, Chap. 4D.
- Permit processing through City competent departments until final sign off of plans and specifications.
- Construction services until a City Certificate of Final Completion is obtained.

Expected work:

- Upgrade/replacement of existing brick foundation;
- Upgrade of sections of existing walls in the north-south direction;
- Construction of 4 to 5 new shear (seismic) lines in the east-west direction including two new steel frames and two new walls or upgrade of existing walls, including new foundation elements as required.
- Upgrade of existing ground floor ceiling steel beam in the north-south direction.

Section 2. Price and Payments

This quote represents a preliminary quote to be amended once an engineering analysis is completed and project construction documents have been reviewed and approved by the City competent authorities.

The Owner agrees to pay the Contractor for the strict performance of the Work, the sum of **\$210,000 (TWO HUNDRED TEN THOUSAND DOLLARS)** subject to adjustments for changes in the Work as may be agreed to by the Owner and the Contractor, or as may be required under this Contract.

The Owner agrees to pay the Contractor at project phases as indicated below.

- Agreement (at signing of this contract): 5% of total
- Mobilization (at starting of Work): 5% of total
- At project phases upon receipt of work progress report and invoice
- Completion of Work (final sign off by Building official on structural work): 10% of total

Additional expenses:

- we expect the City permit fees listed hereinafter to be in the \$3,000 to \$5,000 range.
- We expect the Special Inspection fees listed hereinafter to be in the \$2,000 to \$4,000 range.

Section 3. Entire Agreement

This agreement represents the entire agreement between the Contractor and the Owner regarding the Work described in Section 1, and supersedes any prior written or oral agreements or representations as to that work.



Section 4. Time

The duration of the Work is estimated in **EIGHT TO TEN WEEKS**. The Contractor shall conform to this schedule, including any changes to that schedule agreed to between the Owner and the Contractor or required by circumstances beyond Contractor's control.

This quote is valid for Work contracted within three months from the date of this document.

Section 5. Differing Site Conditions

Contractor shall promptly, and before the following conditions are disturbed, notify the Owner in writing of any:

Hazardous Material that, because of its quantity, concentration or physical or chemical characteristics, is deemed by any federal, state or local governmental authority to pose a present or potential future hazard to human health or safety or to the environment, or that the handling of which may subject Contractor to legal liability as asbestos and other such materials.

Subsurface or latent physical conditions at the site materially different from those indicated in the Contract Documents.

Unknown physical or other conditions at the site of an unusual nature, materially different from those ordinarily encountered and generally recognized as inherent to work of the character provided for in the Contract.

The Owner shall promptly investigate such conditions. If the Owner finds that the worksite conditions do materially differ, or involve Hazardous Material, the Owner shall make an equitable adjustment in the Contract Price and the Contract Time for such work by issuing a change order under Article 6.

The Owner shall formally inform the Contractor before commencement of work of any hazardous condition or material present within the property that he/she is aware of and share copies of any and all past documents related to such condition with the Contractor.

Section 6. Changes in Work

The Work shall be subject to changes by additions, deletions or revisions by the Owner. The Owner shall notify Contractor of such changes by delivery of additional and/or revised drawings, specifications, exhibits or written orders.

Whenever an adjustment in the Contract price or Contract time is required because of Owner's change request, differing site conditions, errors in the plans and specifications, or other circumstances beyond the control of Contractor (including acts of any governmental authority; acts of a public enemy, fire, flood, unusual delay in transportation, abnormal weather conditions, labor disputes, strikes, lack of worksite access, acts of God, natural disasters, or acts of third parties), the Contractor shall submit to the Owner, within a reasonable time, a detailed estimate with supporting calculations and pricing, together with any adjustments to the Contract price and the Contract time. Pricing of the adjustment shall be in general accordance with the pricing structure of this Contract. However, to the extent that such pricing is inapplicable, cost of the change or the amount of the adjustment shall be determined based on the cost to the Contractor plus reasonable amounts for overhead and profit.

The Contractor shall not be obligated to perform changes in the Work or additional work until the Owner has approved, in writing, the changes to the Contract price and the Contract time.

Section 7. Suspension of Work

The Contractor, at its option, may suspend work under the Contract as a result of the following: (1) Owner's failure to timely pay sums due to the Contractor, until such payment is made; (2) a dispute over payment for extra work, differing site conditions, changes by Owner or other circumstances beyond Contractor's control if such circumstance will cause the Contractor to suffer substantial financial hardship if Contractor is required to continue the Work; or (3) Owner's failure to provide Owner's ability to pay Contractor for the work remaining to be performed by Contractor.

Any suspension of Work under this Contract will also suspend the progress and completion dates set forth in Section 4.

**Section 8: Inspection of Work**

The Contractor shall make the Work accessible at all reasonable times for inspection by the Owner. The Contractor shall inspect all material and equipment delivered to the job site by others to be used or incorporated in the Contractor's work.

Section 9: Site Access and Rights of Way

The Owner shall provide, no later than the date when needed by the Contractor, all necessary access to the site or sites upon which the Work is to be performed, including convenient access to the site or sites and any other site or sites designated in the Contract Documents for use by the Contractor. Owner shall continue to provide such access until completion of the Contract.

Particularly the entire ground floor (excluded the main entrance) shall be delivered clear of all vehicles, stored items, personal belongings and such for the entire length of the project. No access to the construction area shall be permitted for the entire length of the project if not for inspecting the construction progress.

Any delay in providing such access shall entitle the Contractor to an equitable adjustment in the Contract price and the Contract time.

Section 10: Surveys and Reports

The Owner shall furnish to Contractor for the Work, prior to the start of the Work, all necessary surveys and reports describing the physical characteristics, soil, geological and subsurface conditions, legal limitations, utility locations and legal descriptions that might assist the Contractor in properly evaluating the extent and character of the work required. The Owner shall provide all site surveys and baselines necessary for the Contractor to locate the principal parts of the Work and perform the Work.

Section 11: Permits, Licenses, Regulations

The Owner and Contractor shall assist the other in obtaining all permits and licenses. Unless otherwise provided, the Owner shall secure and pay for all permits and licenses of a temporary nature necessary for the prosecution of the Work and for all permits, licenses and easements for permanent structures or permanent changes in existing facilities.

The Contractor shall give all notices and comply with all laws, ordinances, rules and regulations bearing on the performance of the Work.

Particularly the Owner shall pay any City fee related to the project and any required Special Inspection Fees.

Section 12: Insurance

12.1 The Contractor shall, at its expenses, procure and maintain insurance of its operations under this Contract consisting of the following coverages:

- a) Workers' Compensation.
- b) Commercial General Liability Insurance covering Contractor's operations; and,
- c) Automobile Liability Insurance, including coverage for Contractor's owned, hired and non-owned automobiles.

12.2. Waiver of Subrogation. Owner and Contractor waive all rights against each other and against all other subcontractors and Owner for loss or damage to the extent reimbursed by any property or equipment insurance applicable to the work, except such rights as they may have to the proceeds of such insurance. If any applicable policies of insurance require an endorsement or consent of the insurance company to provide for continued coverage where there is a waiver of subrogation, the owners of such policies will cause them to be so endorsed or obtain such consent.

Section 13: Arbitration

Any controversy or claim arising out of or relating to this Contract or its alleged breach, which cannot be resolved by mutual agreement, shall be settled by arbitration in accordance with Construction Industry Rules of the American Arbitration Association in effect on the date of the Contract, and judgment upon the award rendered by the arbitrator(s) may be entered in any court having jurisdiction. Owner and Contractor agree that, should Contractor be potentially or actually a party to a lawsuit or arbitration arising out of or connected to this Contract, Owner shall appear in, and be bound by the decision in, that



lawsuit or arbitration. The prevailing party in any action or proceeding to enforce this Contract shall recover its reasonable attorneys' fees and costs (including expert witnesses) in that action or proceeding.

Section 14. Warranty

The Contractor warrants to the Owner that all materials and equipment furnished under this Contract shall be new unless otherwise specified and that all work under this agreement will be performed in a good and workmanlike manner, shall be of good quality, free from faults and defects, and in conformance with Contract documents.

Section 15. Special provisions

15.1 Work hours will be 8:00 AM to 5:00 PM, Monday through Saturday.

15.2 The construction work might create minor movements and vibrations throughout the building during construction hours due to the use of mechanical equipment and the nature of the work. The Contractor waves any responsibility for damage to the Owner's personal belonging (as vehicles, furniture, art objects, electronic equipment, etcetera) left in the construction area or anywhere in the property, that have not been properly protected nor secured. **The Contractor waves any responsibility for cracks in existing finishes appearing as a result of the construction work in areas not directly affected by the work.** Minor settlements are expected throughout the building during and after large structural work/upgrades; such settlements might affect existing doors and windows; **any repair work to doors and windows is not part of this contract and it will be billed on a Time & Material basis. Owner initials**

15.3 All electrical and water supply for the project shall be provided by the owner.

15.4 Any electrical, water, gas, mechanical systems that may need to be moved or rerouted is not included here and will be offered on a separate quote.

15.5 No temporary or permanent removal and/or relocation of existing fixtures as boilers, washer/driers, water heaters is included in this quote unless explicitly noted otherwise in this document.

15.6 This agreement does not include any additional work that might be requested by the building officials/inspectors due to pre-existing non-complying items found in the property during construction that are not strictly related to and explicitly specified in the scope of work described in the architectural and engineering plans referenced in Section 1.

15.7 Unless noted otherwise in this document, this agreement includes all finishes of the areas directly affected by the project to match the existing conditions as best possible (**excluded wall paper, moldings and other detail features, particularly dated decorations**). It shall be understood that matching exactly old finishing patterns and paint is basically impossible. This agreement does not cover the re-finishing and painting of existing entire areas (like rooms, walls, ...) in order to guarantee the exact same look. This, if desired, can be discussed and will be object of a different agreement. **Walls and ceiling in garage, storage areas, mechanical rooms where work is performed currently finished with plaster, drywall or metal sheeting, will be re-finished with currently standard 5/8" drywall, fire-tape finish, no painting. Areas of walls with currently exposed wall framing where work is performed will be covered with structural plywood; no drywall installation for these areas is included here.**

15.8 This proposal assumes that any excavation is on sandy, silty or clayey soil. If hard sedimentary or crystalline rock is found during excavation, such excavation work will be billed on a Time & Material basis.

15.9 No underpinning of existing foundation is included in this quote unless explicitly noted otherwise in this document.

15.10 Verification of elements marked on approved plans with "Verify In Filed" or equivalent is included in this agreement; any additional work related to conditions found on site differing from what is specified on the approved plans will be billed as per Section 6 of this agreement.

15.11 If hired AJO Group is authorized to install and maintain one sign of our choice in the front of the building for the entire duration of the project.

Acceptance

Owner

A.J.O. Group Build Inc (CA Lic. #: 1035097)

Giuseppe Sircana (President)

May 27, 2018

Date

Date

Signature

Signature

ELLIOTTBUILD

elliottbuild@yahoo.com - (415)377-9009 - www.elliottbuild.com

Estimate

4/27/18

Joseph and Jenn Laska
465-467 Oak Street
San Francisco, CA 94102

- Demo and haul away existing balcony, stairs, concrete footings. \$3100

- Erect/dismantle scaffold to be used throughout project. \$3500

- Dig footing for concrete piers according to engineer's specification.
Form, rebar and pour concrete footings with Simpson post bases. \$5700

- Construct new balcony/stairs/railing according to architect/engineer specifications. Understructure to be pressure treated, decking and railing to be redwood/cedar. Railing interior frame finish to be cable with tensioners. Handrail to be 1.5" continuous from balcony to patio with returns at each end. Replace one lateral run of siding and install flashing behind new board for waterproofing. \$32,500

- Options to stain all finished wood. Please note this requires maintenance/reapplication every 2-3 years. \$4100

General

- Portable toilet @\$175 per month, billed as accrued. \$TBD

-This estimate includes all labor and materials unless otherwise stated.

-Permit fees are not included and are billed in exact amounts for reimbursement as accrued.

-Special inspections and associated fees are not included and are billed in exact amounts for reimbursement as accrued.

From: Tesla EnergyOrdersNA@tesla.com ✉
Subject: Your Solar Roof Order is Confirmed
Date: December 1, 2017 at 5:20 PM
To: jennlaska@me.com

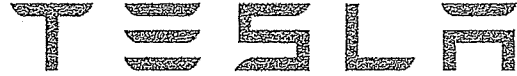

Thank you
Your order is complete

What's Next?

We will contact you when installations begin in your area. For the latest information, please check out our frequently asked questions.

Order Number:

EN6204126

Order Summary:

Textured glass tiles
1 Powerwall
Reservation payment \$1,000

Installation Address:

467 Oak St
SF, CA 94102

Payment Information:

AMEX ending in: 3023
Expires: 11/2022

Privacy Policy



Solar Roof Order Agreement

1. Solar Roof Order

Thank you for placing a Solar Roof Order. Your Order will become effective when we receive your Order Payment.

2. Purchase Agreement

You will receive a purchase and installation agreement indicating the final specifications of your Solar Roof and the final purchase price, including installation cost. Depending on your installation location, the entity that signs your purchase and installation agreement may be Tesla, one of our affiliates, or one of our approved third party installers.

3. Your Order Payment; Cancellation

The Tesla entity that holds your Order Payment may vary depending on your location. We will not hold your Order Payment in a separate account or in an escrow or trust fund, or pay any interest on your Order Payment. Until you enter into a purchase and installation agreement, your Order may be cancelled at any time by you or by Tesla, in which case you will receive a full refund of your Order Payment. If you enter into a purchase and installation agreement, your Order Payment will be applied towards the final purchase price of your Solar Roof.

4. Non-Transferable

Your Order is not transferable or assignable to another party without the prior written approval of Tesla.

5. Your Details

From time to time we will ask you to provide information so that we can perform our obligations under this Solar Roof Order Agreement. We will maintain your personal information in accordance with our Customer Privacy Policy, which is available at <https://www.tesla.com/about/legal>.

6. Status of your Order

While this Order secures approximate delivery priority within your region, it does not constitute the purchase of a Solar Roof or guarantee that Tesla will sell you a Solar Roof. The timing for delivery and installation of your Solar Roof will depend on your queue position and when the Solar Roof is ready for your region.

Finance

Cash

Customize your Solar Roof

We recommend 50% solar coverage to meet your home's energy needs. Solar and non-solar tiles appear the same from street level.

\$117,100 Value of energy

-\$66,300 Cost of roof

-\$7,400 Cost of Powerwall battery

+\$14,400 Tax credit



Choose your Powerwall Quantity

We recommend 1 Powerwall battery to realize the value of energy produced by your Solar Roof and keep your home running during an outage.

1 Powerwall

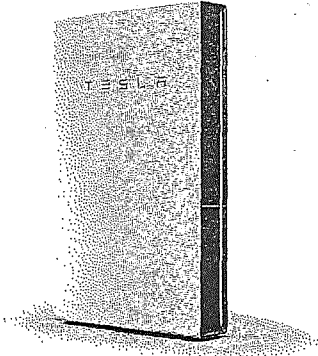

2500 Roof square footage
Reset default

\$ 253 Current electric bill

\$57,800 Net earned over 30 years

A traditional roof starts at about \$12,500 in comparison

Close

[Learn more about your estimate](#)

Calculations are based on an estimated 2,500 square foot roof. Data provided by Google Project Sunroof.

4125

SOLAR ROOF ▾

RESERVE NOW

REQUEST A CALL

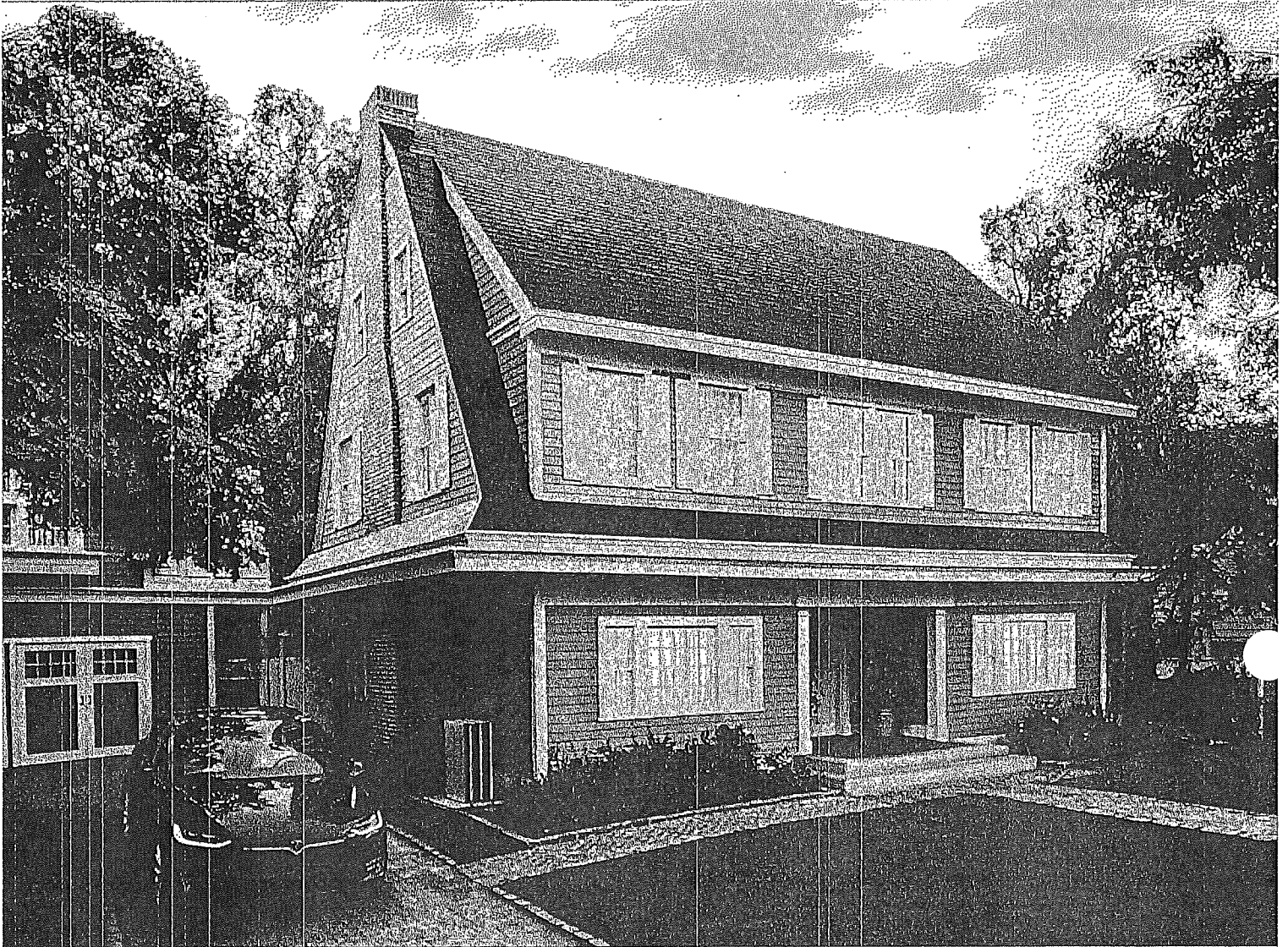

TEXTURED

SMOOTH

TUSCAN

SLATE

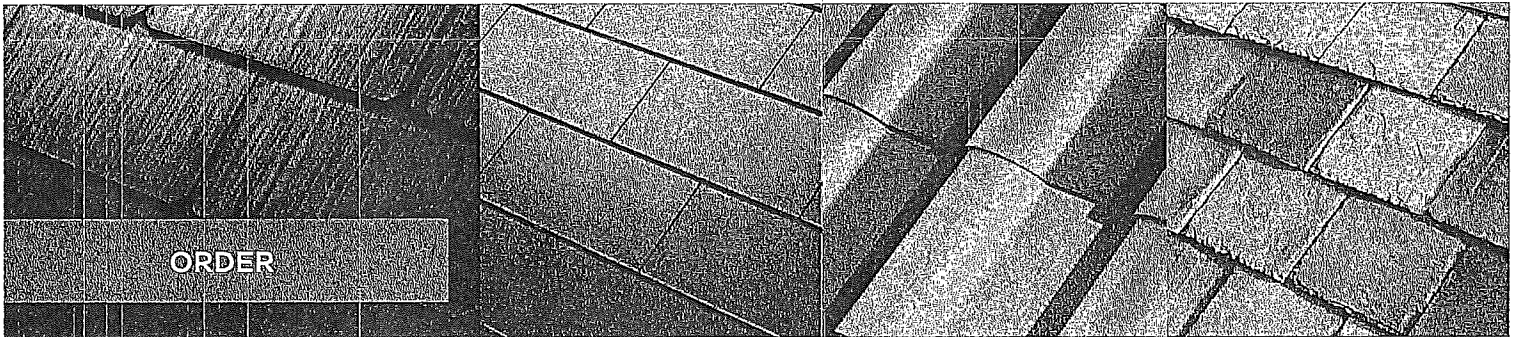

ORDER

Solar Roof

Solar Roof complements your home's architecture while turning sunlight into electricity. With an integrated Powerwall battery, energy collected during the day is stored and made available any time, effectively turning your home into a personal utility. Glass solar tiles are so durable they are warranted for the lifetime of your house, or infinity, whichever comes first. Enter your address below to get started.

Enter your home address

GET STARTED

Invisible Solar Cells

Customize the amount of electricity your Solar Roof produces to fit your energy needs. This feature is made possible by using two types of glass tile, solar tile and non-solar tile. Both appear the same from street level.

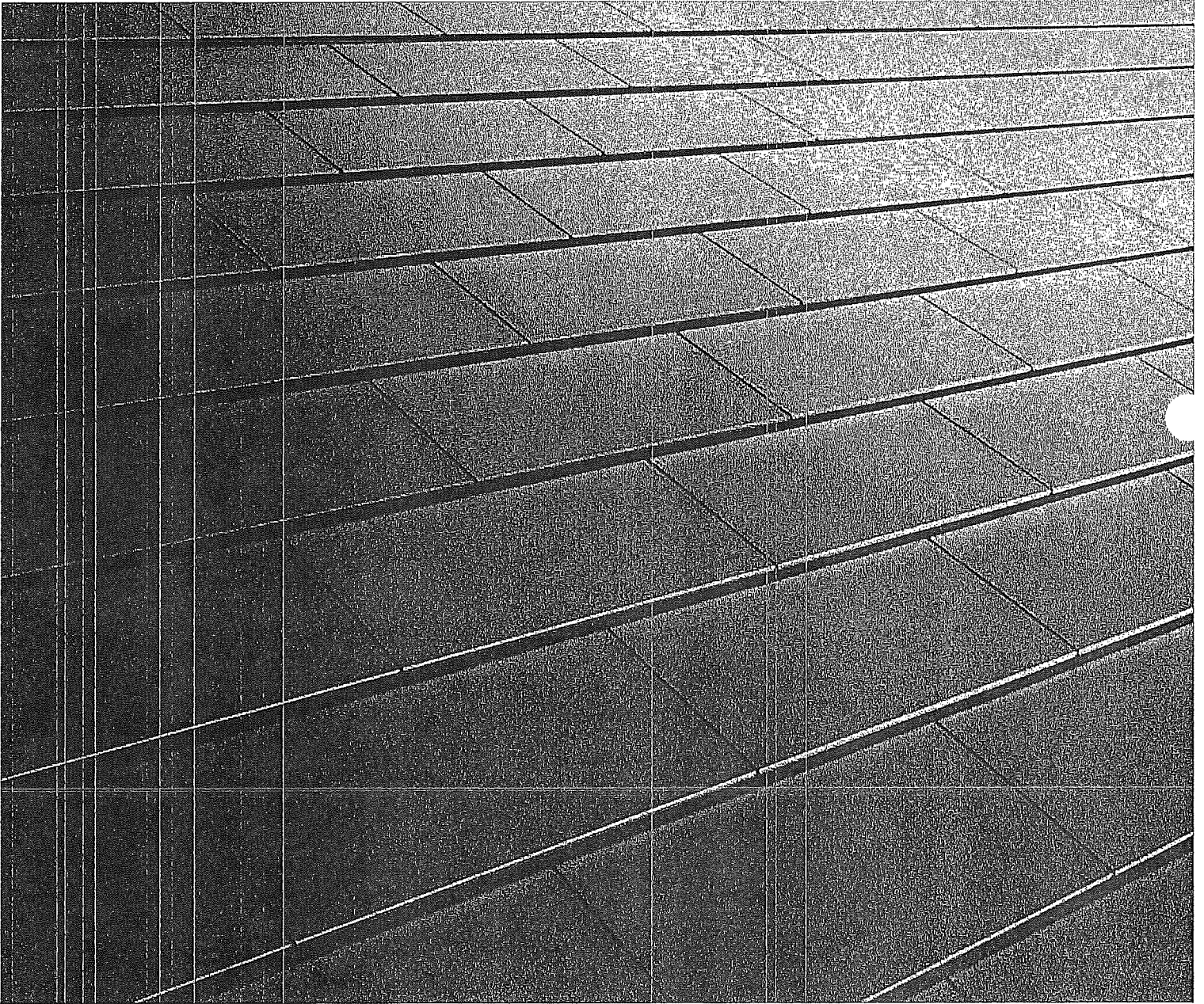

Infinite Tile Warranty

4128

Made with tempered glass, Solar Roof tiles are more than three times stronger than standard roofing tiles. That's why we offer the best warranty in the industry - the lifetime of your house, or infinity, whichever comes first. Watch our hail test video to see how we take durability to a whole new level.

TESLA SOLAR GLASS

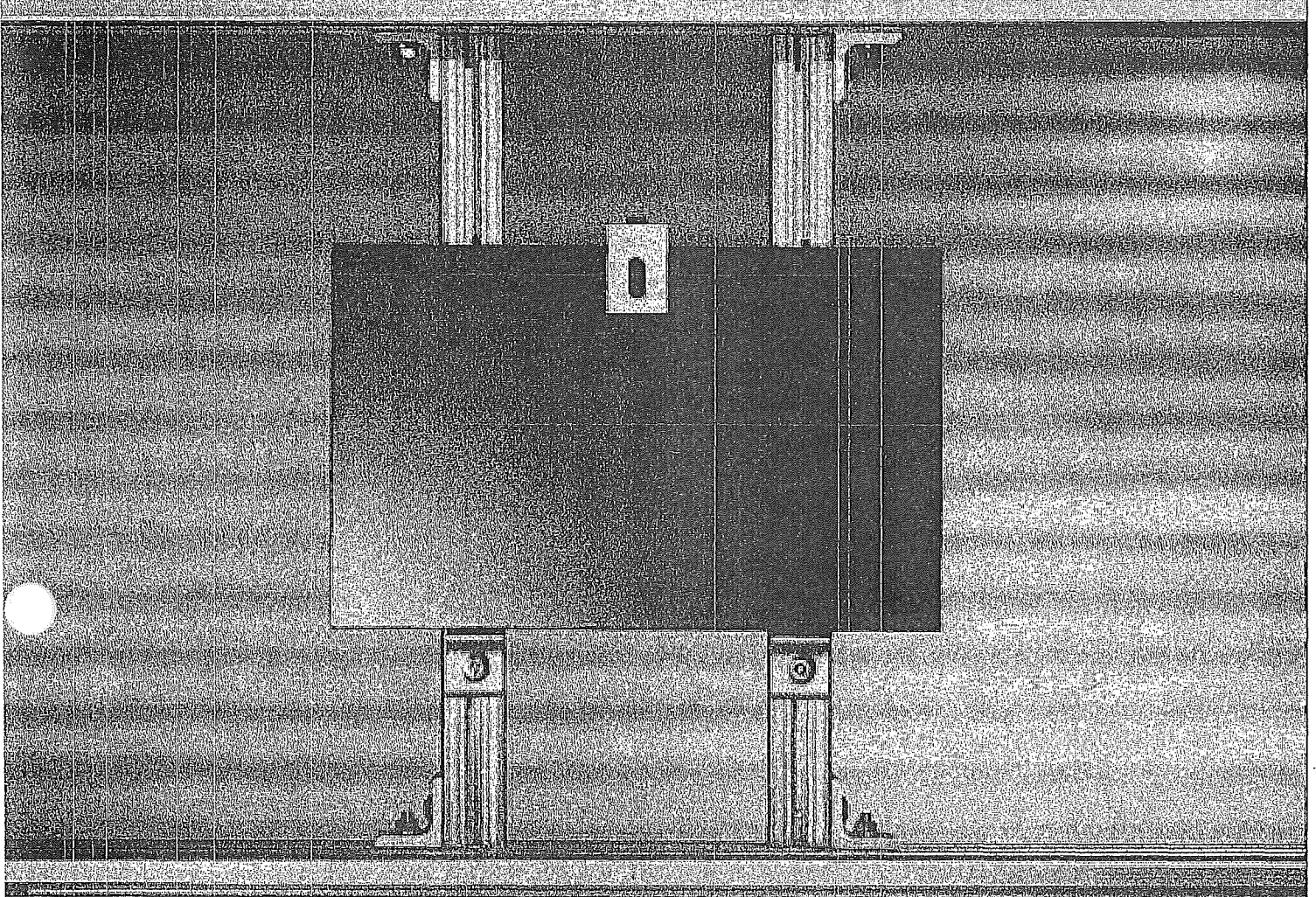

TRADITIONAL ROOF TILES

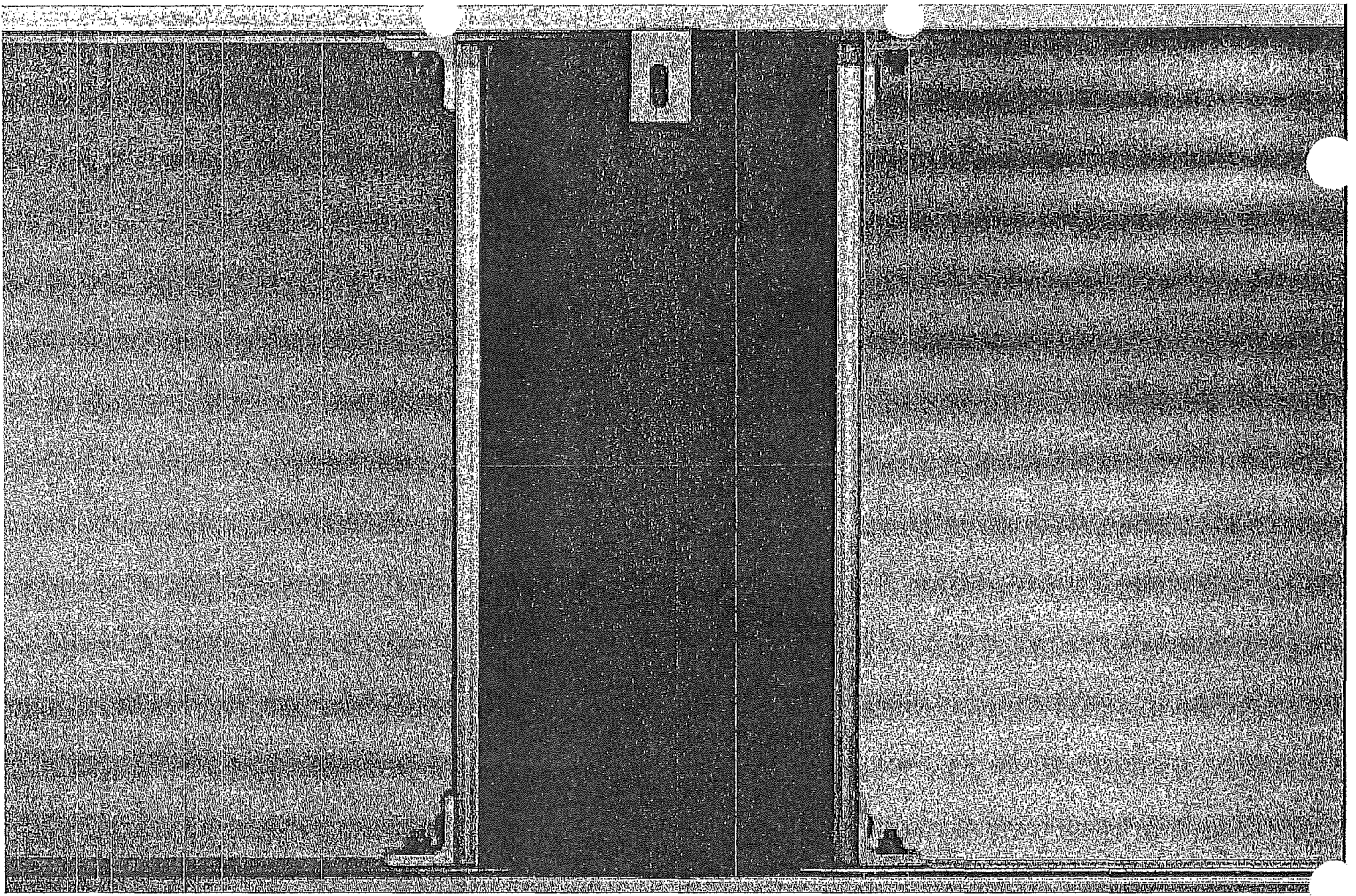

Test video for the highest (class 4) hail rating, filmed at 2,500 frames per second. Each 2" hailstone is travelling 100 mph on impact.

Off-Grid Reliability

Solar Roof integrates with the Powerwall home battery, allowing you to use solar energy whenever you choose and providing uninterrupted electricity during grid outages.

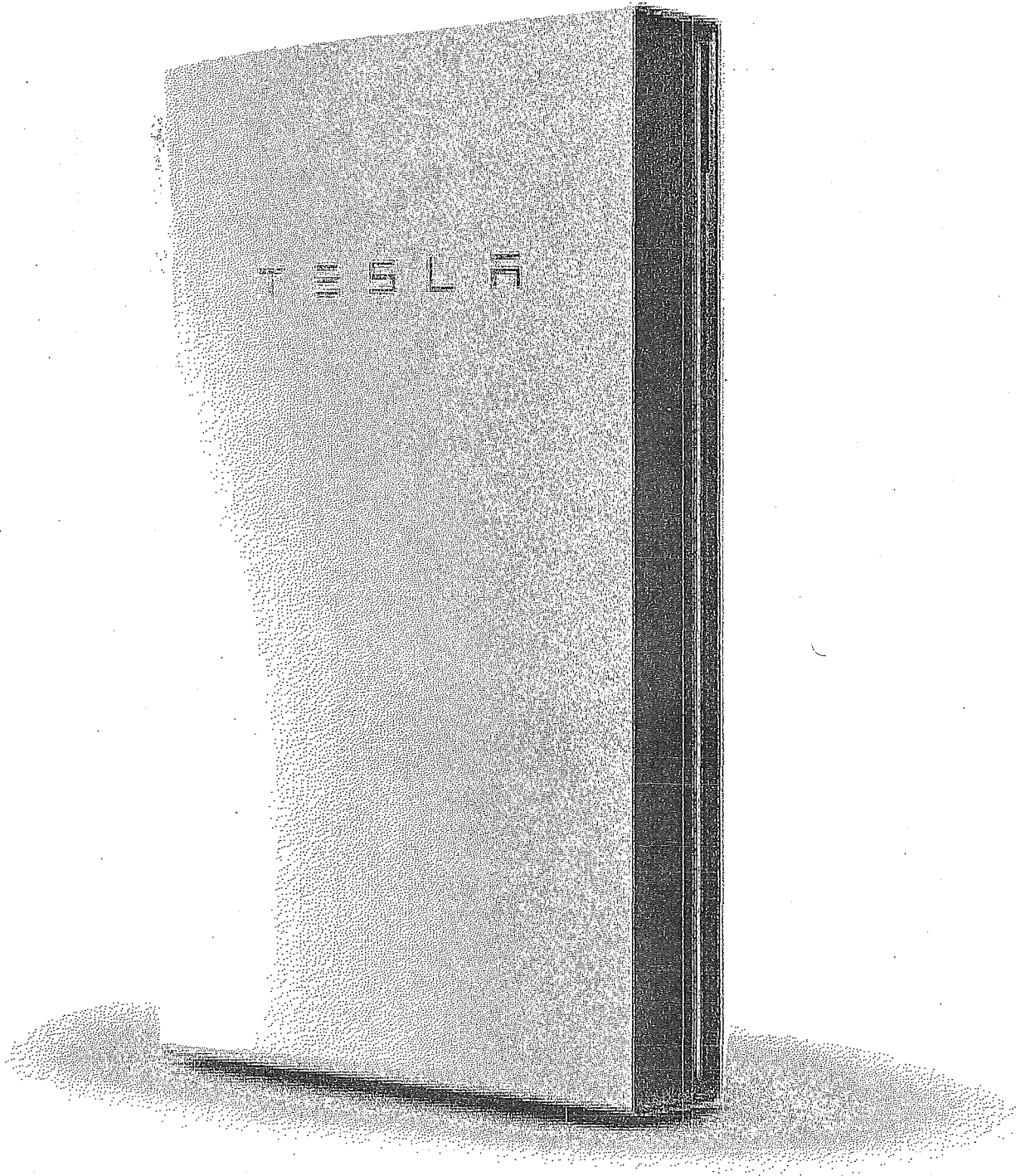

Warranty and Specs

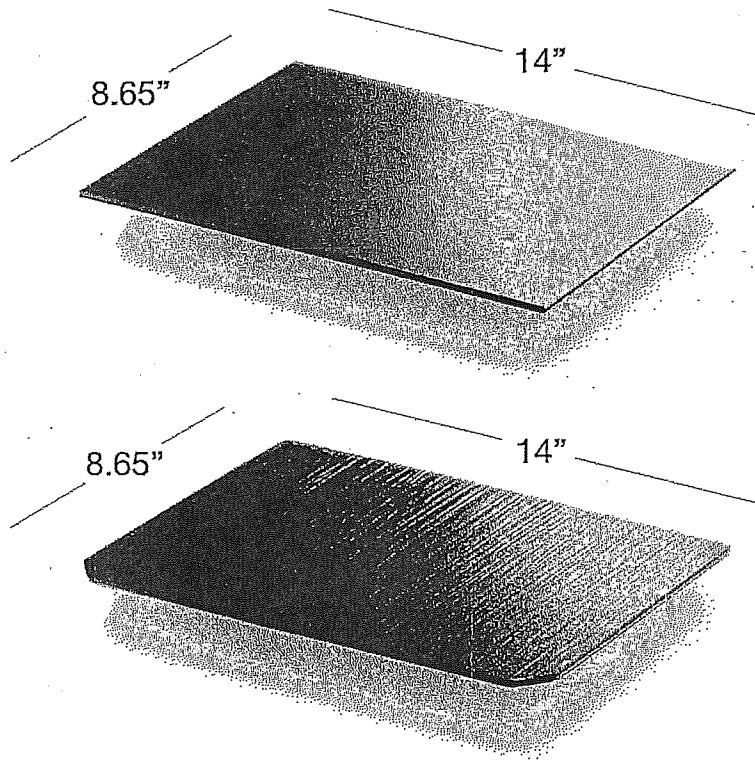

Tile warranty

Infinity, or the lifetime of your house, whichever comes first

Power warranty

30 years

Weatherization warranty

30 years

Roof Pitch

3:12 to vertical

Hail rating

Class 4 ANSI FM 4473 (best hail rating)

Wind rating

Class F ASTM D3161 (best wind rating)

Fire rating

Class A UL 790 (best fire rating)

Questions about reserving a Solar Roof? Find your answers here.

Interested in learning about traditional solar panels? Find out more here.

Value of energy

The value of energy your Solar Roof is expected to produce over 30 years is based on the average price of electricity in your area, adjusted for inflation by 2% annually. Your ability to realize the full value depends on your home's electricity usage, amount of energy storage available, and utility regulations on solar in your area. Electricity price estimates are sourced from the Energy Information Administration and solar production estimates are based on irradiance data from NASA.

Cost of roof

The estimated cost of your Solar Roof includes materials, installation, and the removal of your old roof. Taxes, permit fees and additional construction costs such as significant structural upgrades, gutter replacement, or skylight replacements are not included. The Solar Roof cost is based on estimated roof square footage for your home, provided by Google Project Sunroof where available, and the portion of your roof covered with solar tiles.

Cost of Powerwall battery

The estimated cost of your Powerwall includes the battery, supporting hardware and installation cost. We recommend that every Solar Roof be installed with a Powerwall battery to enable you to use more of the solar power your roof produces and keep your home running during a grid outage. In states that do not have Net Energy Metering policies, we estimate and recommend a number of Powerwalls that will enable you to realize the full benefit of the energy your Solar Roof produces.

Tax credit

The 30% Solar Investment Tax Credit applies to the cost of the solar tiles and associated solar energy equipment as well as the cost of the Powerwall batteries. To receive the full tax credit, you must have federal income tax liability that's at least equal to the value of the tax credit. This credit may be carried over to future tax years. Additional state, local or utility solar incentives may apply but are not included in this calculation.

Monthly loan payment

Customers can choose to finance their Solar Roof through their home mortgage. The loan amount is equal to the total Solar Roof cost, less the estimated 30% federal tax credit. The monthly loan payment is amortized over the selected loan term at the selected interest rate. Tesla is not a mortgage lender. Values depicted above are for

illustrative purposes only.

Mortgage interest deduction

A benefit of financing a Solar Roof through a home mortgage is the tax deduction customers may receive on their mortgage interest. This value decreases over time as the mix of principal and interest paid per month shifts. The value of the mortgage interest deduction will vary depending on customers' tax rates and individual financial information. This is not tax advice. Please consult your tax advisor.

Traditional roof cost

A typical asphalt shingle roof cost starts at \$5 per square foot. The monthly loan payment for a traditional roof is estimated using the same loan term and interest rate as is selected for the Solar Roof for a given roof size.

Recommended solar tile coverage for your home

We recommend the portion of solar tiles for your roof that we estimate will produce enough electricity to cover your home energy usage. To customize your usage, enter your average monthly electric bill. If you choose to increase the portion of your roof covered with solar tiles, your home may generate more electricity than it needs. In this case, you may not realize the full value of energy your Solar Roof produces. Your entire roof is not eligible to be covered with solar tiles due to building regulations and obstructions. Recommended solar tile coverage is based on estimated eligible roof area for solar.

Warranty and specs

All warranties and ratings apply to the United States only. Similar warranties and ratings will be developed for other markets. Our tile warranty covers the glass in the tiles. The power warranty covers the output capability of the solar tiles. Weatherization means that there will be no water leaks or other weather intrusions during the warranty period that result from our installation.

Installation timing

Initial trial installations are complete and customer installations are underway with plans to ramp up in 2018. When Solar Roof is rolled out in a particular market, Solar Roof customers will be installed based on when their order was placed. Installations performed by Tesla, Inc.'s wholly owned subsidiary SolarCity Corporation. CA CSLB 888104, MA HIC 168572/EL-1136MR. View our full list of contractor licenses online.

DESIGN - REMODEL - HOME REPAIR License#931480

ELLIOTTBUILD

elliottbuild@yahoo.com - (415)377-9009 - www.elliottbuild.com

Estimate

5/22/18

Joseph and Jenn Laska
465-467 Oak Street
San Francisco, CA 94102

-Sand, fill, prep and paint exterior siding, eaves, windows, trim, doors. Erect scaffold. \$37,000

General

-Portable toilet @\$175 per month, billed as accrued. \$TBD

-This estimate includes all labor and materials unless otherwise stated.

-Permit fees are not included and are billed in exact amounts for reimbursement as accrued.

-Special inspections and associated fees are not included and are billed in exact amounts for reimbursement as accrued.

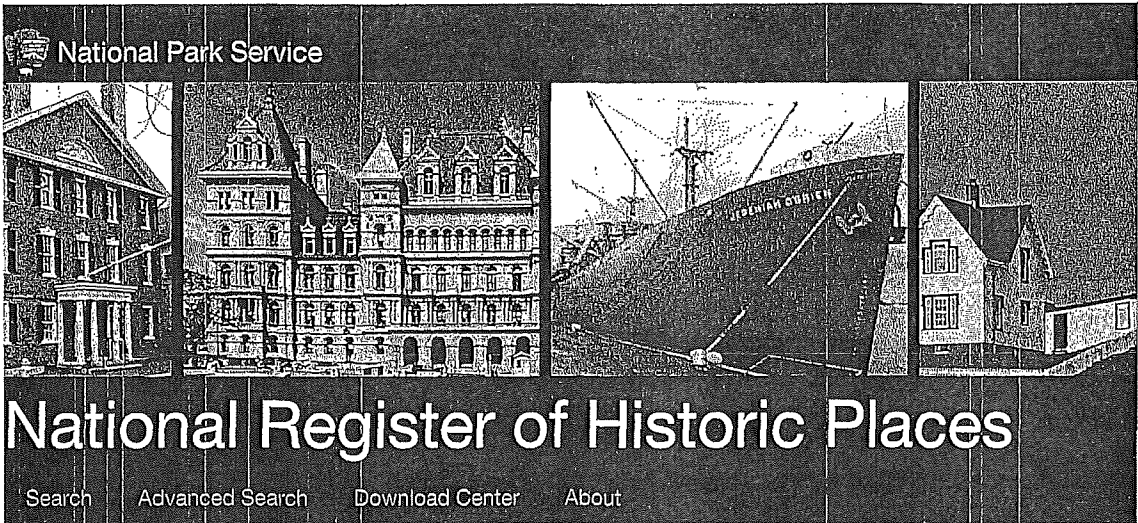

Your search returned 1 results, Showing page 1 of 1, Items 1 through 1

List View ▾

Photos

Text

Name

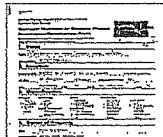
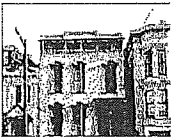

Warren, Russell, House

List View ▾

EXPERIENCE YOUR AMERICA™

[ACCESSIBILITY](#) | [PRIVACY POLICY](#) | [FOIA](#) | [NOTICES](#) | [DISCLAIMER](#)

[FREQUENTLY ASKED QUESTIONS](#) | [NO FEAR ACT](#) | [CONTACT US](#) | [USA.GOV](#)

National Park Service
 U.S. Department of the Interior



[f FACEBOOK](#) [TWITTER](#)
[NEWS RELEASES](#) [YOUTUBE](#)
[INSTAGRAM](#) [FLICKR](#)
[ITUNES](#)

United States Department of the Interior
National Park Service

National Register of Historic Places
Inventory—Nomination Form

See instructions in How to Complete National Register Forms
Type all entries—complete applicable sections

RECEIVED
MAY 24 1983
OHP
Find

1. Name

historic *House* 465-467 Oak Street (Russell Warren Residence) *House*
and/or common 465-467 Oak Street

2. Location

street & number 465-467 Oak Street & 368 Lily Street n/a not for publication
city, town San Francisco n/a vicinity of ~~Congressional District~~ 5th.
state California code 06 county San Francisco code 075

3. Classification

Category	Ownership	Status	Present Use
<input type="checkbox"/> district	<input type="checkbox"/> public	<input checked="" type="checkbox"/> occupied	<input type="checkbox"/> agriculture
<input checked="" type="checkbox"/> building(s)	<input checked="" type="checkbox"/> private	<input type="checkbox"/> unoccupied	<input type="checkbox"/> commercial
<input type="checkbox"/> structure	<input type="checkbox"/> both	<input type="checkbox"/> work in progress	<input type="checkbox"/> educational
<input type="checkbox"/> site	Public Acquisition	Accessible	<input checked="" type="checkbox"/> private residence
<input type="checkbox"/> object	<input type="checkbox"/> in process	<input type="checkbox"/> yes: restricted	<input type="checkbox"/> religious
	<input checked="" type="checkbox"/> being considered	<input checked="" type="checkbox"/> yes: unrestricted	<input type="checkbox"/> scientific
	<input checked="" type="checkbox"/> n/a	<input type="checkbox"/> no	<input type="checkbox"/> transportation
			<input type="checkbox"/> other:

4. Owner of Property

name Bryan Hillstrom
street & number 147 W. 15th Street #701
city, town New York n/a vicinity of state New York 10011

5. Location of Legal Description

courthouse, registry of deeds, etc. Office of County Recorder, Room 167
street & number San Francisco City Hall
city, town San Francisco state California 94102

6. Representation in Existing Surveys

title Historic Sites Survey, Junior (Tax Certification, Part I, 1-19-82)
League of San Francisco (published as Here Today) has this property been determined eligible? yes no
date 1968 federal state county local
depository for survey records San Francisco Room, San Francisco Main Public Library
city, town San Francisco state Calif. 94102

7. Description

Condition		Check one	Check one	
<input checked="" type="checkbox"/> excellent	<input type="checkbox"/> deteriorated	<input checked="" type="checkbox"/> unaltered	<input checked="" type="checkbox"/> original site	
<input type="checkbox"/> good	<input type="checkbox"/> ruins	<input type="checkbox"/> altered	<input type="checkbox"/> moved	date
<input type="checkbox"/> fair	<input type="checkbox"/> unexposed			N/A

Describe the present and original (if known) physical appearance

465-467 Oak St. Present Condition; This Victorian building is two stories with a garage and full basement. Its structure is of redwood balloon frame, redwood V-rustic siding and gable roof hidden from front view by a false front facade. This front facade, facing the street, features arched pediments and arched windows with nicely moulded outside window casings and door casings. The facade also has quoins, corner beads, and elaborate wooden trim mouldings below the entryway cornice and roof cornice. The roof cornice appears as a multi-level moulded horizontal "Cap" and is echoed by lesser horizontal lines over the window, front doorway, garage and service entrance. Overall, the building has a strong vertical emphasis, well suited to construction in a densely built city and it is nestled in a row of six other Victorians of about the same era, some of which are also listed in various Victorian architectural publications. The facade and interior have been restored during the renovation period, 6-1-77 to 7-27-81, by the replacement of mouldings, preparation of surfaces and application of paint. The restoration has been certified as meeting the Secretary of the Interior's Standards for Rehabilitation.

465-467 Oak St. Original Condition; (Historical Building Date) This building is listed as standing in the 1875 Sanborn Insurance map. The map, begun in 1875 and finished in Dec. 1885, was periodically updated by pasting over old lots and buildings with outlines of new ones. In examining the original map, the outline of 465-467 Oak St. (then 427 Oak) exists on the earliest drawn main sheet. The outline of 368 Lily St., however, is a paste over, so that structure could have been built anytime up until 1886. However, this author feels that because the mouldings, siding, interior detail and above all the "L" shaped floor plan correspond so closely to the main Oak St. building, that it was constructed perhaps just a few years after 1875. It is also important to view the map as to the social use of the neighborhood of the time. The aspect of a modest set of flats facing a main street with a through lot backed by an alley is a plan quite indicative of the entire Mint Hill area, one of San Francisco's oldest surviving intact neighborhoods. Where higher on the hill one finds larger mansion style homes with servants quarters in the rear, it is evident from the Sanborn Map the Oak-Lily St. area imitated this style, but with stables and rental income property in the rear substituting for servants quarters; i.e. a working class version of the grand design. Thus 368 Lily St. was most probably rental income property or was used to house inlaws or other family members.

(Structure) This building was built as a set of flats, one over the other, and had a simple floorplan consisting of an "L" shape, the block of which measures 25 x 30" and the arm 12 x 27". The other 12 x 27" of the lot is a yard. Housed in the block of the "L" each flat consisted of two bedrooms, side by side, with the larger bedroom opening onto the living room via large four panel sliding doors. Each of the flat's living rooms had a nicely banded ceiling and a marble face coal burning fireplace, however the marble of the lower flat's fireplace was replaced with brick probably about 1940. Each flat also had an "S" wall between the small bedroom and the hallway which leads from the front entrance to the rear "arm" portion of the "L". The "arm" portion of the building contains the dining room and kitchen of each flat and a plain brick chimney stack lies in the wall between the rooms providing ventilation for each.

United States Department of the Interior
National Park Service

National Register of Historic Places
Inventory—Nomination Form



Continuation sheet

Item number 7

Page 1

(Decks) Outside the "arm" portion of the "L" and running parallel to it are two wooden decks, one on the ground level for the lower flat and one elevated for the upper flat. The lower deck remains essentially as it was, having no handrail, but it has been refloored with new wood in 1977. The elevated deck is supported by floor joists extending out of the building and was actually what was then termed a "wash porch". This was a long narrow walkway, 27 feet long, of 1 x 3" tongue and groove fir tilted for drainage. Access to the decks was provided by doors from each dining room and kitchen. The rear of the wash porch abutted the back stairway to the yard. Two alterations have been made to the wash porch. At a time unknown, it was reduced by half its length, the front half near the dining room being eliminated. One can still see the cut off floor joists supports flush with the siding of the building in that area. The access door from the dining room was closed up and made into a window, in the same style but not quite the same size as the other dining room window. The second alteration to the wash porch was made in August 1978 when the flooring and handrails were replaced and it was joined to a newly constructed rear stairway. It is notable that the floor joist support system and original dimensions of the older deck remain the same after this renovation, (see photo #14).

(Plumbing) Water service was connected to 465-467 Oak St. on April 28, 1876. The original supply ran in galvanized pipe through the basement of the main residence to both properties and the drainage of each property ran to the street facing them. As can be seen from the Sanborn Map, there was a small structure between the two houses that contained the toilets and waste lines for the main residence. This structure also contained a poorly constructed rear stairway abutted to the wash porch mentioned above. It was constructed on a 4" concrete slab with its 4" x 4" vertical support posts embedded directly into the cement. This structure was not of the same construction as the main house, did not have the same exterior siding, brick foundation or roofline, and in fact used the buildings on either end for its own interior walls, having no interior walls of its own. With the support posts completely rotted away and with the structure in unrestorable condition because of age and poor initial construction, it was removed in 1978 (see photo #15). The existing waste line, attached to the rear existing siding of the main residence, was revented and attached to fixtures in the renovated kitchens. The lavatory and tub area, originally in the center of the house next to the bedrooms both upstairs and downstairs, was enlarged by taking up what once was the second smaller bedroom of each flat. Toilets and a new plumb chase were installed in these new areas in 1977. Also new copper supply replaced the old galvanized pipe throughout the building. In sum, this author feels that 465-467 Oak St. had no original plumbing facility integrated into the building's design when constructed in 1875, and that both the rear plumbing structure and the crudely adapted plumb chase in the central house lavatory area were afterthoughts upon the advent of plumbing being connected in 1876.

(Garage) The garage in the building has a separate brick foundation which supports its walls. These are constructed of lath and plaster and have a 1" x 3" redwood tongue and groove wainscoating. The ceiling is made of the same wainscoat material. So the room is a freestanding room in the bottom

United States Department of the Interior
National Park Service

National Register of Historic Places
Inventory—Nomination Form

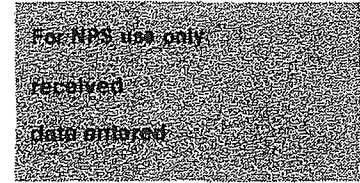

Continuation sheet

Item number 7

Page 2

of the building, with hallways on either side, one ending at the service entrance, the other ending under the front stairs. As the interior trim, wainscoat and ceiling material are identical to the wainscoat material used in the kitchen and dining room of each flat and because the garage has its own brick ring foundation for its walls, it can be assumed that this area is integral to the building's design and is in fact an original room. As the building next door was a stable and carriage house, the garage probably housed a carriage. Inquiries to the City and County of San Francisco, Department of Public Works, Bureau of Building Inspection reveal no construction or alteration permits for a garage at this address.

368 Lily St. Present & Original Condition; This building is a one story cottage with partial basement and has street level floor area of 850 sq. ft. Probably built soon after the main Oak Street residence, it is on the rear of the original 120' lot and faces Lily St., an alley which runs between Oak and Page Streets. The structure is of redwood balloon frame construction, has 1" x 10" V-rustic siding, fir flooring and a gable roof protected from street view by a raised flat front Italianate facade. This facade uses similar mouldings and has a similar architectural effect as the main building however it is smaller, more simplified, and more modest in scale. It is completely original and needs no moulding replacement. The interior is comprised of two rooms and a hallway. Again as with 465-467 Oak St., the building has an "L" floorplan. The living room, dining room, kitchen, and bathroom comprise the block of the "L" while the bedroom is the "arm". There appears to have been a fire in the basement under the bedroom in the very rear of the building sometime before 1966. Portions of the rear exterior siding, and a small portion of flooring in the bedroom was consumed by the fire. A previous owner, Christopher Layton, drew permits from the city, repaired lower rear wall and mudsill damage and redid portions of the foundation. He also shingled over the existing remaining rear siding of the building to cosmeticize it. This author, upon gaining possession of the residence replaced the entire bedroom floorint with new 1" x 3" fir, thereby restoring it to its original state. Thus, the fire has only cosmetically altered the building and has not affected the interior mouldings, walls or roof. The fireplace and chimney stack have been removed, time unknown. The cottage lies in a row of other small one and two story Victorians, most of which appear also to be standing on the 1875 and 1886 Sanborn Maps.

1. D. A. Sanborn, Sanborn Insurance Map of San Francisco 1875, Vol. 2. Sheet 59, Block 995. Original in New York City Main Public Library Annex, 521 W. 43rd. St. N.Y. N.Y. 10036. Also on microfilm in the Bancroft Library, Univ. of Calif. Berkeley, Berkeley Calif.
2. City and County of San Francisco, Department of Public Works, Bureau of Building Inspection, Building Permit # 438981, August 2, 1978, 450 McAllister St., San Francisco, Calif. 94102.
3. San Francisco Water Department, Service Information, 425 Mason St. San Francisco, Calif. 94102.

United States Department of the Interior
National Park Service

National Register of Historic Places
Inventory—Nomination Form

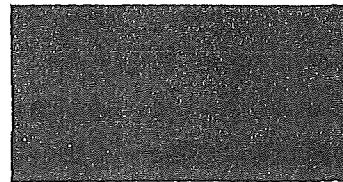

Continuation sheet

Item number 7

Page 3

4. D.A. Sanborn, 10c. Cit., and D.A. Sanborn, Sanborn Insurance Map of San Francisco 1886, Vol. 2. Sheet 59, Block 995. Original in New York City Main Public Library Annex, 521 W. 43rd. St. N.Y. N.Y. 10036. Also on microfilm in the Bancroft Library, Univ. of Calif. Berkeley, Berkeley Calif.

5. City and County of San Francisco, Department of Public Works, Bureau of Building Inspection, Building Permit #291450, March 3, 1966 and Building Permit #323672, August 28, 1968, 450 McAllister St. San Francisco, Calif. 94102.

6. D.A. Sanborn, Loc. Cit.

United States Department of the Interior
National Park Service

National Register of Historic Places
Inventory—Nomination Form

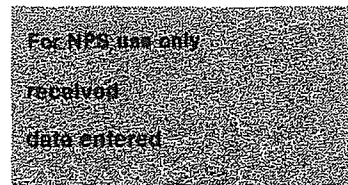

Continuation sheet

Item number 8

Page 4

6. Clark W. Bryan, The Directory of Architects 1885, Page 3, Copy at the Society of California Pioneers, 456 McAllister St. San Francisco.

7. Clark W. Bryan, The Directory of Architects 1887, Page 3. microfilm copy at the Avery Library, Columbia University, N.Y. N.Y.

WARREN, R.

CABR V.II, n.9, September 1881, p. 96:

Two 1 story frame cottages, Scott between Pine & Bush, P.H. Vey.
\$2,300.

CABN V.III, n.6, June 1882, p. 92:

2 story & basement frame building, Buchanan & Webster. Higgins.
\$4,500.

CABN V.III, n.8, August 1882, p. 123:

2 story & basement frame dwelling, corner Scott & O'Farrell.
J. Dowling. \$7,000.

Two 2 story & basement frame buildings, southeast corner Scott & O'Farrell. J. Dowling. \$7,500.

CABN V.III, N.11, November 1882, p. 166:

2 story frame building, Wildey between Fillmore & Steiner.
Walcome. \$1,300.

CABN V.III, n.12, December 1882, p. 182:

1 story & basement frame building, Lyon between Clay & Washington.
L.P. Rixford. \$2,000.

CABN V.IV, n.3, March 1883, p.52:

2 story frame building, 17th & Sanchez. E. Duane. \$3,400.

CABN V.IV, n.4, April 1883, p. 66:

Two story & basement frame buildings, Guerrero & Fair Oaks.
J. Cronigal. \$3,300.

CABN V,IV, n.7, July 1883, p. 122:

2 story & basement frame building, Waller between Steiner & Fillmore. N.C. Taft. \$2,500.

CABN V.IV, n.9, September 1883, p. 158:

2 story frame building, Valencia between 26th & 27th.
Mrs. E. O'Brien. \$4,100.

CABN V.V, n.7, July 1884, p. 136:

2 story frame building, Ridley near Guerrero. T.E. Smith. \$4,100.

United States Department of the Interior
National Park Service

National Register of Historic Places
Inventory—Nomination Form

For NPS use only
received
date entered

Continuation sheet

Item number 8

Page 5.

CABN V.V, n.10, October 1884, p.190:

Alterations to building; 1 story building, & addition, 21st near Valencia. M. Plover. \$2,450.

2 story frame building, Bush between Steiner & Fillmore. Jacob Walcom. \$4,500.

Alterations to building, corner 7th & Jessie. J. Nunan. \$4,200.

Additions to building, 21st near Valencia. Miss Plover. \$2,500.

CABN V.VI, n.1, January 1885, p.18:

2 story frame building, Hayes between Octavia & Gough.

J.E. McGrath. \$4,100.

2 story frame building, Hayes near Octavia. J.E. McGrath. \$4,000.

CABN V.VI, n.3, March 1885, p.53:

2 story & basement building, corner Buchanan & Ivy. William Murz. \$3,800.

3 story frame building with brick basement, Geary between Jones & Taylor. P. Gordon. \$6,000.

- Building, 5th between Harrison & Bryant. E. Sharkey. \$3,500.

CABN V.VI, n.7, July 1885, p. 125:

1 story frame building, Hickory near Octavia. J. Riley. \$1,500.

CABN V.VI, n. 10, October 1885, p. 178:

Two 2 story frame buildings, corner Eddy & Scott. H. Dorscher. \$5,000.

1 story frame building, Fell near Devisadero. M. Carrick. \$1,800.

Two 2 story frame buildings, northwest corner Octavia & Fell. P.J. Gallagher. \$7,500.

CABN V.VII, n.5, May 10, 1886, p. 79:

2 story frame building, 15th between Castro & Noe. J. Healing. \$4,800.

2 story frame building for two flats, Ridley between Valencia & Guerrero. D. O'Neill. \$4,000.

CABN V.VII, n.11, November 15, 1886, p. 169:

2 story frame building, Fell between Laguna & Buchanan. Patrick Parrell. \$4,500.

CABN V.VIII, n.6, June 15, 1887, p. 83:

2 story frame building, corner Church & 29th. Henry Beuttner. \$4,800.

2 story frame building, corner 29th & Church. H. Beuttner. \$3,500.

CABN V.IX, n.10, October 15, 1888, p. 138:

Building, Oak near Gough. Madden. \$1,275.

CABN V.IX, n.12, December 15, 1888, p. 166:

Frame building, Dolores near 23rd. James Thorn. \$2,780.

8. Significance

Period	Areas of Significance—Check and justify below			
<input type="checkbox"/> prehistoric	<input type="checkbox"/> archeology-prehistoric	<input type="checkbox"/> community planning	<input type="checkbox"/> landscape architecture	<input type="checkbox"/> religion
<input type="checkbox"/> 1400-1499	<input type="checkbox"/> archeology-historic	<input type="checkbox"/> conservation	<input type="checkbox"/> law	<input type="checkbox"/> science
<input type="checkbox"/> 1500-1599	<input type="checkbox"/> agriculture	<input type="checkbox"/> economics	<input type="checkbox"/> literature	<input type="checkbox"/> sculpture
<input type="checkbox"/> 1600-1699	<input checked="" type="checkbox"/> architecture	<input type="checkbox"/> education	<input type="checkbox"/> military	<input type="checkbox"/> social/
<input type="checkbox"/> 1700-1799	<input type="checkbox"/> art	<input type="checkbox"/> engineering	<input type="checkbox"/> music	<input type="checkbox"/> humanitarian
<input checked="" type="checkbox"/> 1800-1899	<input type="checkbox"/> commerce	<input type="checkbox"/> exploration/settlement	<input type="checkbox"/> philosophy	<input type="checkbox"/> theater
<input type="checkbox"/> 1900-	<input type="checkbox"/> communications	<input type="checkbox"/> industry	<input type="checkbox"/> politics/government	<input type="checkbox"/> transportation
		<input type="checkbox"/> invention		<input type="checkbox"/> other (specify)

Specific dates 1875 Builder/Architect Russell Warren

Statement of Significance (In one paragraph)

This building is one of the best examples in scale and detail of a flat-front Italianate Victorian set of flats in San Francisco. It was built about 1875 by a noted San Francisco architect and builder of post Gold Rush era, Russell Warren. With an elegant and simple facade, the building makes the point of permanence by recalling the glory of modified Renaissance and Mannerist Italian palaces. As a residence it fits the close functional and fashion relationship of buildings made high and narrow because of lot limitations and because of regard for high-ceiling interiors at this time, with high and narrow door and window openings related to the basic building shape. Few flat front Italianate residences remain in San Francisco as most were East of Van Ness Avenue and did not survive the 1906 earthquake and fire.

Originally having the address of 427-427½ Oak Street, the building was built and occupied by Russell Warren and his wife Laranetta. He ran his architect and contracting business from the premises for ten years, 1878 to 1888. A native of Vermont, Warren began as a carpenter in San Francisco about 1864 and is credited with building 36 buildings in the city from 1881 to 1888. Records of his building activities prior to that time have been lost. He is listed in "The Directory of Architects" 1885 and 1887 published by Clark W. Bryan & Co., Holyoke Mass. & N.Y.C., a trade publication of the time.

1. D.A. Sanborn, Sanborn Insurance Map of San Francisco 1875, Vol. 2. Sheet 59, Block 995. Original in New York City Main Public Library Annex, 521 W. 43rd. St. N.Y. N.Y. 10036. Also on microfilm in the Bancroft Library, Univ. of California Berkeley, Berkeley, California.
2. Joseph A. Baird, 1962, Times Wonderous Changes, San Francisco Architecture 1776-1915, Calif. Historical Society, Publisher, Library of Congress # 62-21821.
3. Structure listed as architect's office, D.A. Sanborn, Sanborn Insurance Map of San Francisco 1886, Vol. 2. Sheet 59, Block 995. Original in New York City Public Library Annex, 521 W. 43rd. St. N.Y. N.Y. 10036. Also on microfilm in the Bancroft Library, Univ. of California Berkeley, Berkeley, California.
4. San Francisco Directory 1864, San Francisco Main Public Library.
5. John William Snyder, Index to San Francisco Buildings 1879-1900, 1975, a graduate thesis accepted for Master of Art, Art History, Univ. of California, Davis. Copy to be found at the California Historical Society Library, 2099 Pacific Ave. San Francisco, and list enumerated below.

9. Major Bibliographical References

Here Today, Junior League of San Francisco, Chronicle Books, S.F., p. 283; Library of Congress #68-57180.

A Gift to the Street, Carol Olwell & Judith Lynch Waldhorn, Angelope Press, S.F., p. 8; Library of Congress #NA 7238 S35048.

10. Geographical Data

Acreeage of nominated property 0.06887 (Less than one)

Quadrangle name San Francisco North, California

Quadrangle scale 1:24000

UMT References

A	<u>10</u>	<u>5</u> <u>50</u> <u>5</u> <u>80</u>	<u>4</u> <u>18</u> <u>0</u> <u>74</u> <u>0</u>	B					
	Zone	Easting	Northing		Zone	Easting	Northing		
C				D					
E				F					
G				H					

Verbal boundary description and justification 465-467 Oak St. Beginning at a point on the Southerly line of Oak Street, distant there on 112 feet 6 inches Easterly from the Easterly line of Buchanan Street; running thence Easterly and along said line of Oak Street 25 feet; (please see continuation sheet page 6.)

List all states and counties for properties overlapping state or county boundaries

state n/a code NA county n/a code NA

state n/a code NA county n/a code NA

11. Form Prepared By

name/title Bryan Hillstrom, Owner

organization n/a

date May 16, 1983

street & number 147 West 15th. St. #701

telephone (212) 242-4052

city or town New York

state New York 10011

12. State Historic Preservation Officer Certification

The evaluated significance of this property within the state is:

national state local

As the designated State Historic Preservation Officer for the National Historic Preservation Act of 1966 (Public Law 89-665), I hereby nominate this property for inclusion in the National Register and certify that it has been evaluated according to the criteria and procedures set forth by the National Park Service.

State Historic Preservation Officer signature

R. M. Ellis

title State Historic Preservation Officer

date AUG 9, 1983

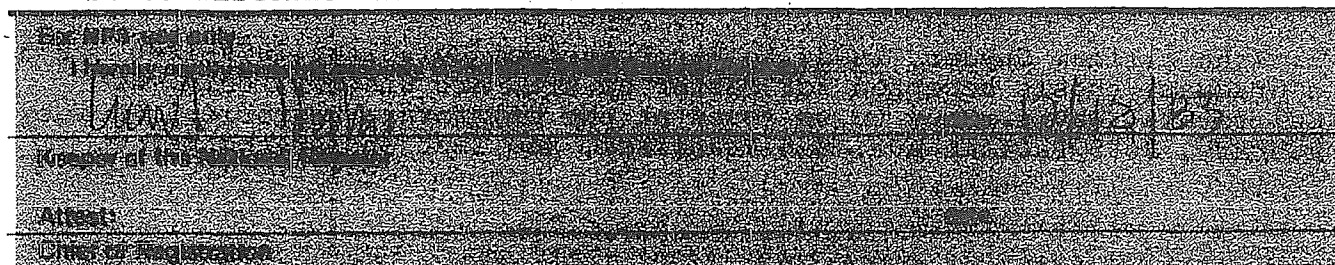

United States Department of the Interior
National Park Service

**National Register of Historic Places
Inventory—Nomination Form**

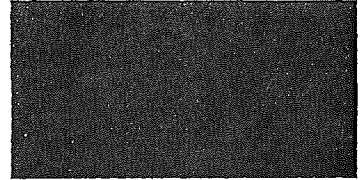

Continuation sheet

Item number 10

Page 6

thence at a right angle Southerly 80 feet 3 inches; thence at a right angle Westerly 25 feet; and thence at a right angle Northerly 80 feet 3 inches to the point of beginning.

BEING part of Western Addition Block No. 219.

Assessor's Parcel No. Lot 17, Block 840.

368 Lily St; Commencing at a point on the Northerly line of Lily Street, distant there on 112 feet 6 inches Easterly from the Easterly line of Buchanan Street; running thence Easterly along said line of Lily Street 25 feet; thence at a right angle Northerly 39 feet 9 inches; thence at a right angle Westerly 25 feet; thence at a right angle Southerly 39 feet 9 inches to the point of commencement.

BEING a portion of Western Addition Block No. 219.

Assessor's Parcel No. Lot 17A, Block 840.

The boundaries are drawn along historic lot lines to encompass the original 25' x 120' lot and its two original building (the flats at 465-467 Oak and the rear cottage at 368 Lily).

United States Department of the Interior
Heritage Conservation and Recreation Service

National Register of Historic Places
Inventory—Nomination Form

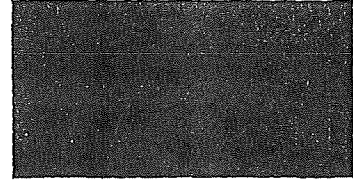

Continuation sheet

Item number

Page

Scale: 1/16" = 1'

Lot sizes taken from S.F. Assessors map, Block 840.

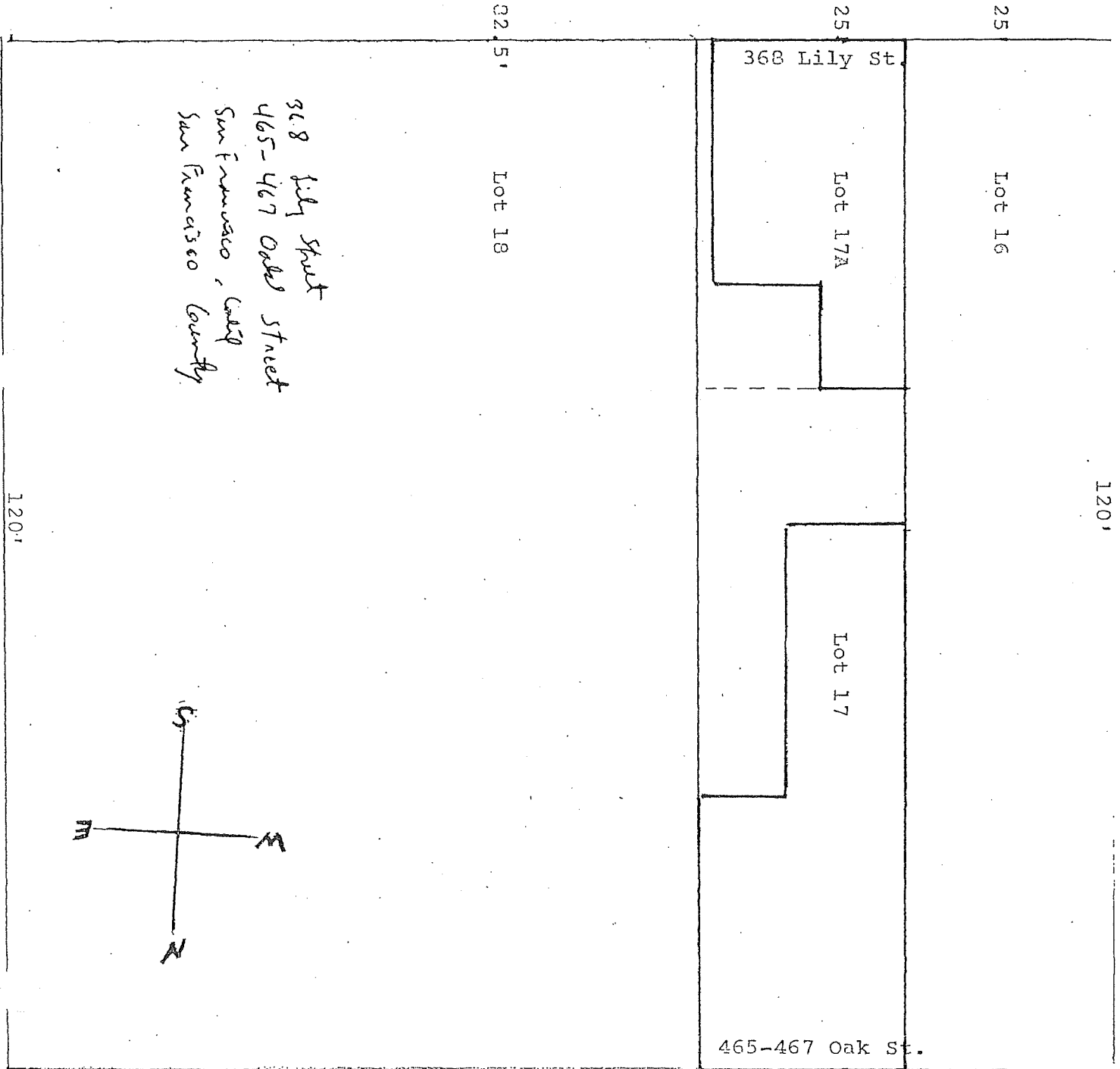

Tracing taken from 1886
 Sanborn Insurance Map of
 S.F. Vol. 2. Sheet 59, Blk
 995. Original in N.Y.C.
 Main Public Library.
 427 Oak & 320 Lily Sts.
 are original addresses.
 ☒ = stables.

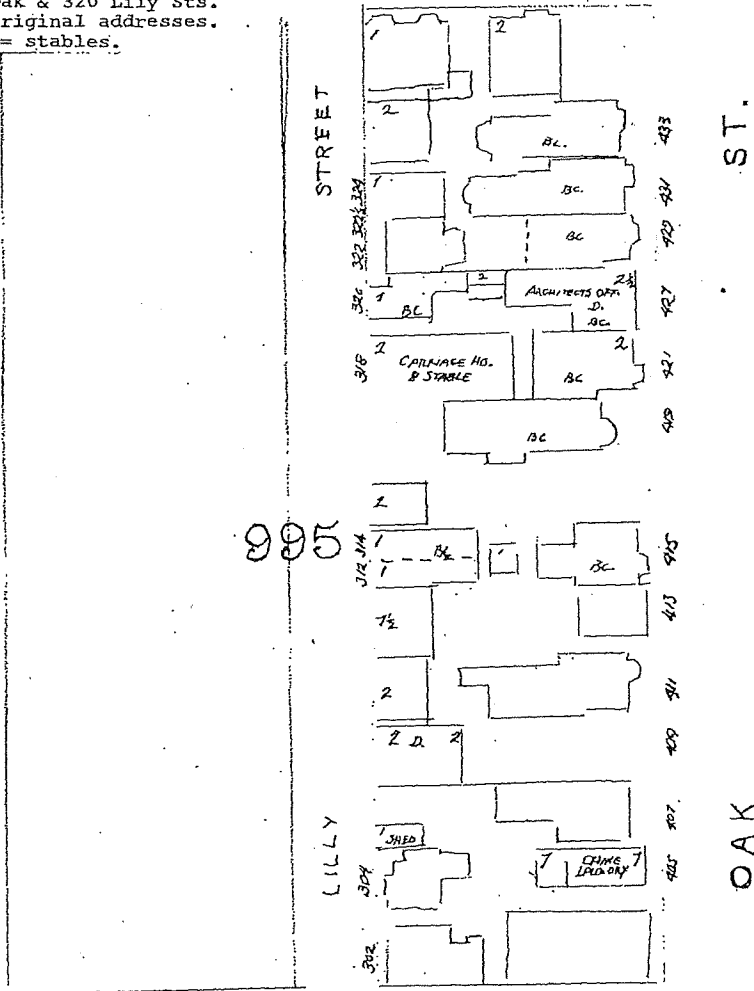

Tracing taken from 1875
 Sanborn Insurance Map of
 S.F. Vol. 2. Sheet 59, Blk.
 995. Original in N.Y.C.
 Main Public Library.
 427 Oak & 320 Lily Sts. are
 original addresses.
 ☒ = stables

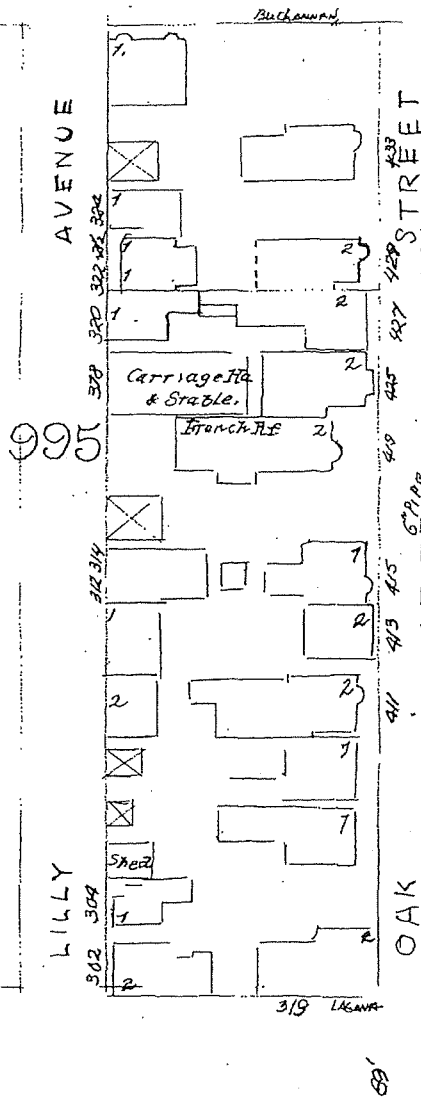

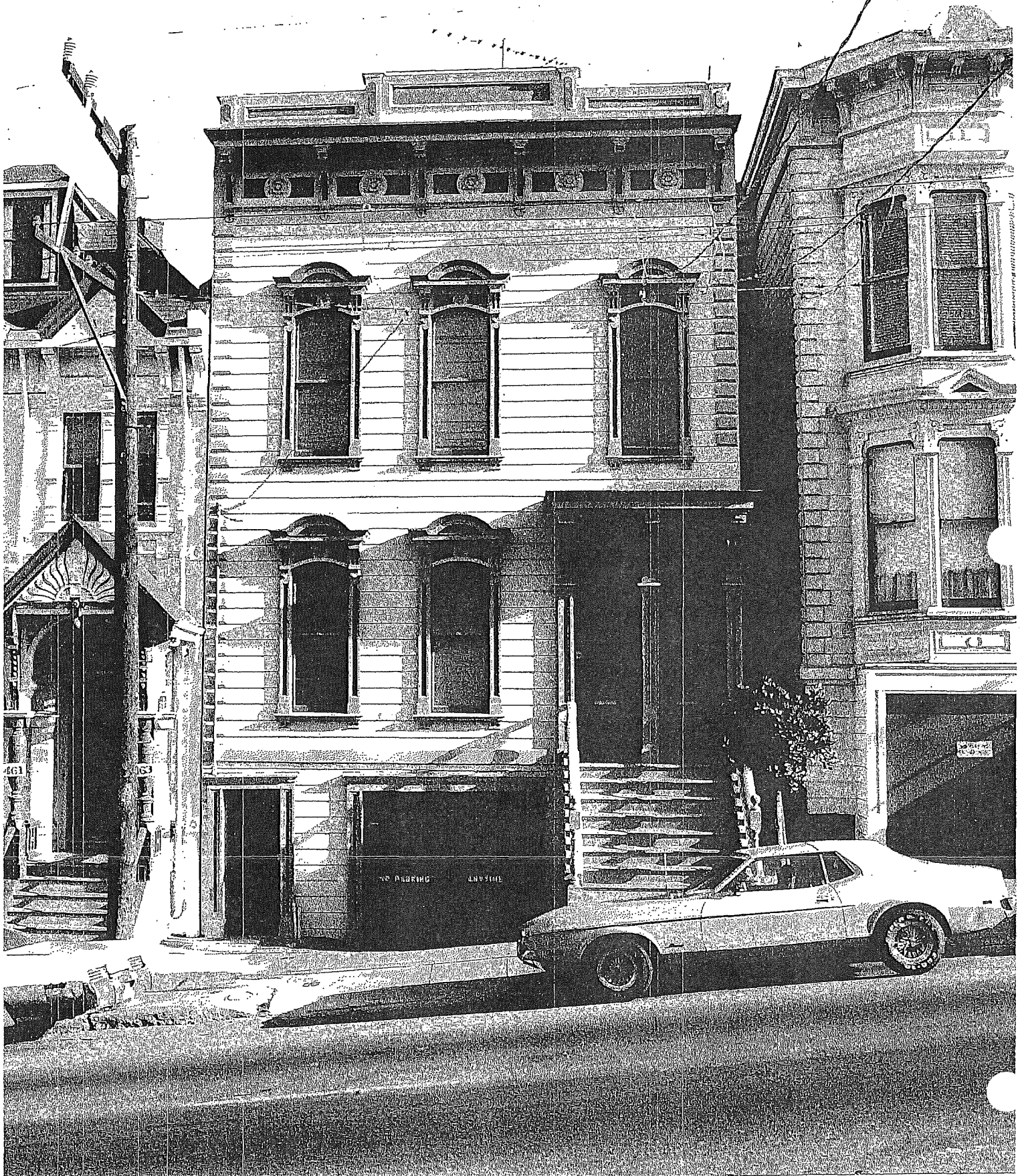

RECEIPT FOR
PAYMENT OF
\$2,866 FEE

Planning Department
City and County of San Francisco
1650 Mission Street
San Francisco, CA 94103-2414

RECEIPT		DATE <u>4/30/18</u>	No. <u>805115</u>
RECEIVED FROM <u>Joseph E Laska III, Jennifer A Laska</u>		\$ <u>2866.00</u>	
<u>Two thousand eight hundred sixty six and 00/100</u> DOLLARS			
<input type="radio"/> FOR RENT		<input type="radio"/> FOR <u>Mills Act 465 - 467 Oak</u>	
ACCOUNT		<input type="radio"/> CASH	FROM _____ TO _____
PAYMENT	<u>#162</u>	<input checked="" type="radio"/> CHECK	
BAL DUE		<input type="radio"/> MONEY ORDER	
		<input type="radio"/> CREDIT CARD	
		BY <u>Melisse</u>	3-11



SAN FRANCISCO PLANNING DEPARTMENT

October 10, 2018

Ms. Angela Calvillo, Clerk
Board of Supervisors
City and County of San Francisco
City Hall, Room 244
1 Dr. Carlton B. Goodlett Place
San Francisco, CA 94102

1650 Mission St.
Suite 400
San Francisco,
CA 94103-2479

Reception:
415.558.6378

Fax:
415.558.6409

Planning
Information:
415.558.6377

Re: Transmittal of Planning Department Case Numbers: 2018-006629MLS; 2018-006717MLS; 2018-006796MLS; 2018-006690MLS; 2018-006794MLS; 2018-007338MLS

Six Individual Mills Act Historical Property Contract Applications for the following addresses: 2253 Webster Street; 353 Kearny Street; 465-467 Oak Street; 587 Waller Street; 354-356 San Carlos Street; 811 Treat Avenue

BOS File Nos: _____ (pending)

Historic Preservation Commission Recommendation: Approval

RECEIVED
BOARD OF SUPERVISORS
SAN FRANCISCO
2018 OCT 10 PM 3:54

Dear Ms. Calvillo,

On October 3, 2018 the San Francisco Historic Preservation Commission (hereinafter "Commission") conducted a duly noticed public hearing at a regularly scheduled meeting to consider the proposed Mills Act Historical Property Contract Applications. At the October 3, 2018 hearing, the Commission voted to approve the proposed Resolutions.

The Resolutions recommend the Board of Supervisors approve the Mills Act Historical Property Contracts as each property is a historical resource and the proposed Rehabilitation and Maintenance plans are appropriate and conform to the *Secretary of the Interior's Standard for the Treatment of Historic Properties*. Please refer to the attached exhibits for specific work to be completed for each property.

The Project Sponsors submitted the Mills Act applications on May 1, 2018. As detailed in the Mills Act application, the Project Sponsors have committed to Rehabilitation and Maintenance plans that will include both annual and cyclical scopes of work. The Mills Act Historical Property Contract will help the Project Sponsors mitigate these expenditures and will enable the Project Sponsors to maintain the properties in excellent condition in the future.

The Planning Department will administer an inspection program to monitor the provisions of the contract. This program will involve a yearly affidavit issued by the property owner verifying compliance with the approved Maintenance and Rehabilitation plans as well as a cyclical 5-year site inspection.

Transmittal Materials
Mills Act Historical Property Contracts

The Mills Act Historical Property Contract is time sensitive. Contracts must be recorded with the Assessor-Recorder by December 30, 2018 to become effective in 2019. Your prompt attention to this matter is appreciated.

If you have any questions or require further information please do not hesitate to contact me.

Sincerely,



Aaron D. Starr
Manager of Legislative Affairs

cc: Erica Major, Office of the Clerk of the Board
Andrea Ruiz-Esquide, City Attorney's Office

Attachments:

Mills Act Contract Case Report, dated October 3, 2018

2253 Webster Street

Historic Preservation Commission Resolution
Draft Mills Act Historical Property Contract
Draft Rehabilitation & Maintenance Plans
Draft Mills Act Valuation provided by the Assessor-Recorder's Office
Mills Act Application

353 Kearny Street

Historic Preservation Commission Resolution
Draft Mills Act Historical Property Contract
Draft Rehabilitation & Maintenance Plans
Draft Mills Act Valuation provided by the Assessor-Recorder's Office
Mills Act Application
Historic Structure Report

465-467 Oak Street

Historic Preservation Commission Resolution
Draft Mills Act Historical Property Contract
Draft Rehabilitation & Maintenance Plans
Draft Mills Act Valuation provided by the Assessor-Recorder's Office
Mills Act Application

587 Waller Street

Historic Preservation Commission Resolution
Draft Mills Act Historical Property Contract

Transmittal Materials
Mills Act Historical Property Contracts

Draft Rehabilitation & Maintenance Plans

Draft Mills Act Valuation provided by the Assessor-Recorder's Office

Mills Act Application

Historic Structure Report

354-356 San Carlos Street

Historic Preservation Commission Resolution

Draft Mills Act Historical Property Contract

Draft Rehabilitation & Maintenance Plans

Draft Mills Act Valuation provided by the Assessor-Recorder's Office

Mills Act Application

811 Treat Avenue

Historic Preservation Commission Resolution

Draft Mills Act Historical Property Contract

Draft Rehabilitation & Maintenance Plans

Draft Mills Act Valuation provided by the Assessor-Recorder's Office

Mills Act Application

**FORM SFEC-126:
NOTIFICATION OF CONTRACT APPROVAL**
(S.F. Campaign and Governmental Conduct Code § 1.126)

City Elective Officer Information <i>(Please print clearly.)</i>	
Name of City elective officer(s): Members, Board of Supervisors	City elective office(s) held: Members, Board of Supervisors
Contractor Information <i>(Please print clearly.)</i>	
Name of contractor: Joseph E & Jennifer A Laska Jnt Lvg Trust	
<i>Please list the names of (1) members of the contractor's board of directors; (2) the contractor's chief executive officer, chief financial officer and chief operating officer; (3) any person who has an ownership of 20 percent or more in the contractor; (4) any subcontractor listed in the bid or contract; and (5) any political committee sponsored or controlled by the contractor. Use additional pages as necessary.</i> Joseph E and Jennifer A Laska	
Contractor address: 467 Oak Street San Francisco, CA 94102	
Date that contract was approved: <i>(By the SF Board of Supervisors)</i>	Amount of contracts: \$16,250 (estimated property tax savings)
Describe the nature of the contract that was approved: Mills Act Historical Property Contract	
Comments:	

This contract was approved by (check applicable):

the City elective officer(s) identified on this form

a board on which the City elective officer(s) serves: San Francisco Board of Supervisors
Print Name of Board

the board of a state agency (Health Authority, Housing Authority Commission, Industrial Development Authority Board, Parking Authority, Redevelopment Agency Commission, Relocation Appeals Board, Treasure Island Development Authority) on which an appointee of the City elective officer(s) identified on this form sits

Print Name of Board

Filer Information <i>(Please print clearly.)</i>	
Name of filer: Angela Calvillo, Clerk of the Board	Contact telephone number: (415) 554-5184
Address: City Hall, Room 244, 1 Dr. Carlton B. Goodlett Pl., San Francisco, CA 94102	E-mail: Board.of.Supervisors@sfgov.org

Signature of City Elective Officer (if submitted by City elective officer)

Date Signed

Signature of Board Secretary or Clerk (if submitted by Board Secretary or Clerk)

Date Signed