

File No. 200544

Committee Item No. 1

Board Item No. 11

COMMITTEE/BOARD OF SUPERVISORS

AGENDA PACKET CONTENTS LIST

Committee: Budget & Finance Committee

Date June 17, 2020

Board of Supervisors Meeting

Date June 23, 2020

Cmte Board

- Motion
- Resolution
- Ordinance
- Legislative Digest
- Budget and Legislative Analyst Report
- Youth Commission Report
- Introduction Form
- Department/Agency Cover Letter and/or Report
- MOU
- Grant Information Form
- Grant Budget
- Subcontract Budget
- Contract/Agreement
- Form 126 – Ethics Commission
- Award Letter
- Application
- Public Correspondence

OTHER (Use back side if additional space is needed)

<input type="checkbox"/>	<input type="checkbox"/>	_____
<input type="checkbox"/>	<input type="checkbox"/>	_____
<input type="checkbox"/>	<input type="checkbox"/>	_____
<input type="checkbox"/>	<input type="checkbox"/>	_____
<input type="checkbox"/>	<input type="checkbox"/>	_____
<input type="checkbox"/>	<input type="checkbox"/>	_____
<input type="checkbox"/>	<input type="checkbox"/>	_____
<input type="checkbox"/>	<input type="checkbox"/>	_____
<input type="checkbox"/>	<input type="checkbox"/>	_____
<input type="checkbox"/>	<input type="checkbox"/>	_____
<input type="checkbox"/>	<input type="checkbox"/>	_____
<input type="checkbox"/>	<input type="checkbox"/>	_____

Completed by: Linda Wong

Date June 12, 2020

Completed by: Linda Wong

Date June 19, 2020

1 [Real Property Lease - New Cingular Wireless PCS, LLC - 260 Golden Gate Avenue -
2 \$92,352 Annual Initial Base Rent]

3 **Resolution authorizing and approving the lease of telecommunications facilities on a**
4 **portion of the roof at 260 Golden Gate Avenue with New Cingular Wireless PCS, LLC,**
5 **for a ten-year term at an initial annual rent of \$92,352 or the monthly base rent of**
6 **\$7,696, with 4% annual adjustments thereafter, and two five-year options to extend,**
7 **with tenant responsible for all services and utilities, to commence upon execution after**
8 **approval by the Board of Supervisors and Mayor, in their respective sole and**
9 **absolution discretion.**

10
11 WHEREAS, The City and County of San Francisco (“City”) owns real property at 260
12 Golden Gate Avenue (“Building”), formerly under the San Francisco Fire Department’s
13 jurisdiction, currently under the jurisdiction of the Department of Homelessness and
14 Supportive Housing; and

15 WHEREAS, In 1996, the City entered into a telecommunications lease for a portion of
16 the roof and a portion of the north side of the Building with the Bay Area Cellular Telephone
17 Company aka AT&T Wireless; and

18 WHEREAS, AT&T Wireless, now New Cingular Wireless PCS, LLC, desires to upgrade
19 and replace a portion of its telecommunications equipment at 260 Golden Gate Avenue; and

20 WHEREAS, The City, through its Real Estate Division and with consultation from the
21 Office of the City Attorney, and New Cingular Wireless PCS, LLC (“Cingular”), formerly AT&T
22 Wireless (“Tenant”) have negotiated the proposed lease (“Lease”), which provides an initial
23 Base Rent of \$92,352 per year (\$7,696 per month) with an annual adjustment of 4% each
24 January 1st and includes two five-year options to extend the Lease; and

25

1 WHEREAS, Tenant is currently responsible for reimbursement to City for utilities and
2 will continue to reimburse City for utilities; and

3 WHEREAS, Tenant warrants that it has or will have acquired all licenses, permits, and
4 other regulatory approvals required for the upgrades and revisions to its telecommunications
5 equipment on the rooftop, side of building and inside equipment room, for the operation of the
6 Tenant's telecommunications facilities; and

7 WHEREAS, Individual cellular company network needs typically make competitive
8 bidding impractical, especially where a company has already placed equipment, but approval
9 of this Lease shall not preclude another cellular carrier from installing facilities atop the same
10 property in the future; and

11 WHEREAS, Tenant shall be responsible for all utilities and services for the use of the
12 telecommunications site within the Premises; and

13 WHEREAS, The term of the lease shall be for ten (10) years commencing upon
14 approval by the Board of Supervisors and Mayor; and

15 WHEREAS, Tenant shall have two five-year option terms to extend the Lease unless
16 Tenant is in default; now, therefore, be it

17 RESOLVED, That in accordance with the recommendation of the Director of the
18 Department of Homelessness and Supportive Housing, the Director of Property and the City
19 Attorney, the Director of Property on behalf of the City, as Landlord, be and is hereby
20 authorized to take all actions necessary to execute the Lease (a copy of which is on file with
21 the Clerk of the Board of Supervisors in File No. 200544) at 260 Golden Gate Avenue, at a
22 Base Rent of \$92,352 per year, with annual escalation of 4%, for an initial ten year term and
23 two five-year options to extend; and, be it

24 FURTHER RESOLVED, The Board of Supervisors approves the Lease in substantially
25 the form in the Board's File and authorizes the Director of Property to take all actions, on

1 behalf of City, to enter into any amendments or modifications (including without limitation, the
2 exhibits) to the Lease that the Director of Property determines, in consultation with the City
3 Attorney, are in the best interests of the City, do not materially increase the obligations or
4 liabilities of the City, and are necessary or advisable to complete the transaction and
5 effectuate the purposes and intent of this resolution and are in compliance with all applicable
6 laws, including City's Charter; and, be it

7 FURTHER RESOLVED, That the Lease contains language indemnifying and holding
8 harmless the City from, and agreeing to defend the City against, any and all claims, costs and
9 expenses, including, without limitation, reasonable attorney's fees, incurred as a result of
10 Tenant's use of the Premises; and, be it

11 FURTHER RESOLVED, That the Competitive Bidding Procedures would be impractical
12 or impossible due to Federal law and individual cellular company network needs, including the
13 existing Tenant equipment on the roof and building; and, be it

14 FURTHER RESOLVED, That any action heretofore taken by any City employee or
15 official with respect to the exercise of the Lease as set forth herein is hereby approved,
16 confirmed and ratified; and, be it

17 FURTHER RESOLVED, That within thirty (30) days of the Lease agreement being fully
18 executed by all parties, the Director of Property shall provide a copy of the Lease agreement
19 to the Clerk of the Board to include into the official file.

20
21
22
23
24
25

1
2
3
4
5
6
7
8
9
10
11
12
13
14
15
16
17
18
19
20
21
22
23
24
25

RECOMMENDED:

 /S/
Andrico Q. Penick
Director of Property
Real Estate Division

COMMUNICATIONS SITE LEASE

between

CITY AND COUNTY OF SAN FRANCISCO,
as Landlord

and

NEW CINGULAR WIRELESS PCS, LLC, a Delaware limited liability company,
as Tenant

For the lease of

a Site at 260 Golden Gate Avenue,
San Francisco, California

April 20, 2020

TABLE OF CONTENTS

	<u>Page</u>
1. BASIC LEASE INFORMATION	1
2. CO-LOCATION OF TELECOMMUNICATIONS FACILITIES	4
2.1 Prohibition on Co-location Without Landlord's Consent	4
2.2 Required Co-location	4
3. PREMISES; AS IS LEASE	5
3.1 Lease Premises; License Area	5
3.2 As Is Lease	5
3.3 Energy Consumption Disclosure	6
4. TERM	6
4.1 Term of Lease	6
4.2 Confirmation of Commencement Date and Expiration Date	6
4.3 Termination of 1996 Lease	7
5. RENT; ADDITIONAL CHARGES	7
5.1 Base Rent	7
5.2 Adjustments in Base Rent	7
5.3 Additional Charges	7
5.4 Late Charges	7
5.5 Default Interest	8
6. USE	8
6.1 Permitted Use	8
6.2 No Illegal Uses, Nuisances, or Advertising	8
7. INSTALLATION OF TENANT IMPROVEMENTS	8
7.1 Tenant Improvement Work	8
7.2 Working Requirements	9
7.3 Air-Conditioning and Fire Suppression	9
8. ALTERATIONS	9
8.1 Tenant's Alterations	9
8.2 Title to and Removal of Tenant's Equipment	10
8.3 Taxes on Tenant's Property	11
8.4 Working Requirements	11
9. CITY'S ALTERATIONS OF THE BUILDING AND BUILDING SYSTEMS	11
10. REPAIRS AND MAINTENANCE	11

10.1	City's Repairs	11
10.2	Tenant's Repairs	12
11.	LIENS	12
12.	UTILITIES AND SERVICES	13
12.1	Utilities and Services	13
12.2	Mandatory or Voluntary Restrictions	14
12.3	Floor Load.....	14
13.	COMPLIANCE WITH LAWS AND RISK MANAGEMENT REQUIREMENTS	14
13.1	Compliance with Laws	14
13.2	Licenses and Approvals	15
13.3	Radiofrequency Radiation and Electromagnetic Fields.....	15
13.4	Compliance with City's Risk Management Requirements	16
14.	SUBORDINATION.....	16
15.	DAMAGE OR DESTRUCTION.....	16
16.	EMINENT DOMAIN	17
16.1	Eminent Domain	17
16.2	Temporary Takings.....	17
17.	ASSIGNMENT AND SUBLETTING	18
17.1	Restriction on Assignment and Subletting.....	18
17.2	Notice of Proposed Transfer	18
17.3	City's Response	18
17.4	Effect of Sublease or Assignment.....	18
17.5	Assumption by Transferee	19
17.6	Permitted Assignment.....	19
18.	DEFAULT	19
18.1	Events of Default	19
18.2	Remedies.....	20
19.	TENANT'S INDEMNITY	21
20.	INSURANCE.....	21
20.1	Tenant's Insurance.....	21
20.2	Tenant's Property	22
20.3	City's Self Insurance.....	22
20.4	Waiver of Subrogation Rights.	22

21.	LIMITATION OF CITY'S LIABILITY	22
21.1	Limitation on City's Liability.....	22
21.2	Consequential Damages.....	23
21.3	No Relocation Assistance	23
22.	ACCESS TO PREMISES	23
22.1	Tenant's Access to the Premises	23
22.2	City's Access to the Premises.....	24
22.3	Emergency Access	24
22.4	No Liability	24
22.5	No Abatement	25
22.6	Minimize Disruption.....	25
23.	ESTOPPEL CERTIFICATES	25
24.	RULES AND REGULATIONS	25
25.	SECURITY DEPOSIT.....	25
26.	SURRENDER OF PREMISES	26
27.	HAZARDOUS MATERIALS.....	26
27.1	Definitions.....	26
27.2	Hazardous Materials in Premises.....	27
27.3	Tenant's Environmental Indemnity	27
28.	SPECIAL PROVISIONS.....	28
28.1	Extension Option	28
28.2	Tenant's Right to Terminate.....	28
28.3	City's Right to Terminate Due to Finding by Board of Supervisors.....	29
28.4	City's Protection Against Interference.....	29
28.5	Tenant's Protection Against Interference	29
29.	GENERAL PROVISIONS	30
29.1	Notices	30
29.2	No Implied Waiver	30
29.3	Amendments	31
29.4	Authority	31
29.5	Interpretation of Lease	31
29.6	Successors and Assigns.....	31
29.7	Brokers.....	32
29.8	Severability	32

29.9 Governing Law32

29.10 Entire Agreement.....32

29.11 Attorneys' Fee32

29.12 Holding Over33

29.13 Time of Essence.....33

29.14 Cumulative Remedies33

29.15 Survival of Indemnities.....33

29.16 Signs.....33

29.17 Light and Air.....33

29.18 Recording.....33

29.19 Taxes, Assessments, Licenses, Permit Fees and Liens.....33

29.20 Non-Liability of City Officials, Employees and Agents34

29.21 Prevailing Wages and Local Hiring Requirements.....34

29.22 Non-Discrimination in City Contracts and Benefits Ordinance.35

29.23 Requiring Health Benefits for Covered Employees.....36

29.24 MacBride Principles - Northern Ireland37

29.25 Drug-Free Workplace38

29.26 Tropical Hardwood and Virgin Redwood Ban38

29.27 Restrictions on the Use of Pesticides.....38

29.28 Prohibition of Tobacco Sales and Advertising38

29.29 Prohibition of Alcoholic Beverage Advertising38

29.30 Preservative-Treated Wood Containing Arsenic39

29.31 Conflicts of Interest.....39

29.32 Notification of Limitations on Contributions39

29.33 Sunshine Ordinance40

29.34 Food Service and Packaging Waste Reduction40

29.35 Compliance with San Francisco Business and Tax Regulations Code.....40

29.36 Counterparts.....40

29.37 Effective Date40

29.38 Cooperative Drafting40

LIST OF EXHIBITS

- EXHIBIT A – Description and Depiction of Premises
- EXHIBIT B – List of Tenant's Existing and Proposed Equipment in Antenna Area and Wall Equipment Area
- EXHIBIT B-1 – Description of Tenant's Equipment in Antenna Area and Wall Equipment Area as of Commencement Date
- EXHIBIT B-2 – Description of Tenant's Equipment in Antenna Area and Wall Equipment Area after the Tenant Improvement Work
- EXHIBIT C – Approved Plans/100% Construction Drawings (Description of Tenant's Equipment in Antenna Area and Wall Equipment Area after Tenant Improvement Work)
- EXHIBIT D – Conditional Use Permit
- EXHIBIT E – Access Requirements
- EXHIBIT F - Final Revised Construction Plans (if any)

COMMUNICATIONS SITE LEASE

THIS COMMUNICATIONS SITE LEASE (this "**Lease**") dated for reference purposes only as of April 20, 2020, is made between the CITY AND COUNTY OF SAN FRANCISCO, a municipal corporation ("**City**" or "**Landlord**"), and NEW CINGULAR WIRELESS PCS, LLC, a Delaware limited liability company ("**Tenant**").

City and Tenant hereby covenant and agree as follows:

1. BASIC LEASE INFORMATION

The following is a summary of basic lease information (the "**Basic Lease Information**"). Each item below shall be deemed to incorporate all of the terms set forth in this Lease pertaining to such item. In the event of any conflict between the information in this Section and any more specific provision of this Lease, the more specific provision shall control.

- Lease Reference Date: April 20, 2020
- Landlord: CITY AND COUNTY OF SAN FRANCISCO
- Tenant: NEW CINGULAR WIRELESS PCS, LLC
- Building (Section 3.1): Building located on the property commonly known as 260 Golden Gate Avenue, San Francisco, California, and also known as APN 0345-007 (the "**Building**").
- Premises (Section 3.1): The "**Premises**" shall be defined as the portions of the Building described and depicted on Exhibit A and consisting of: (i) approximately two hundred forty-three (243) square feet of space located on the roof of the Building ("**Rooftop Equipment Room**") where Tenant's communications equipment is installed, (ii) those certain vertical footprint areas located on the existing penthouse walls comprising approximately two hundred sixteen (216) square feet in the aggregate (collectively "**Wall Equipment Area**") where Tenant's communications equipment can be installed after the Commencement Date (the Rooftop Equipment Room and the Wall Equipment Area are collectively referred to as the "**Equipment Area**"), and (iii) approximately one hundred fifty (150) square feet (from an aerial view) of space on the Building's roof and facades ("**Antenna Area**") where Tenant's antennas are installed and mounted.

In connection with this Lease and during the term of the Lease, Tenant shall have a non-exclusive license for the placement and use of cables, conduits, wires, cables, cable trays and other connecting hardware reasonably necessary to connect Tenant's Equipment (as defined below) together and to a power source (collectively, "**Connecting Equipment**") in the portions of the Building (the "**License Area**") between the Equipment Area and the Antenna Area and between the Equipment Area and City's utility

connection locations, including its main point of entry, in and upon the Building as shown on Exhibit C. The Building is under the jurisdiction of the City's Department of Homelessness and Supportive Housing.

Term (Section 4.1):

Ten (10) years, commencing on the full execution of this Lease (the "**Commencement Date**") and expiring on the tenth (10th) anniversary of the Commencement Date.

Extension Option (Section 28.1):

Two (2) additional terms of five (5) years, exercisable on the terms specified in Section 28.1.

Base Rent (Section 5.1):

Initial Annual Base Rent: \$92,352

Initial monthly payments: \$7,696

Adjustment Dates (Section 5.2):

Annually on January 1 of each year, beginning January 1, 2021, four percent (4%) adjustment per year

Use (Section 6.1):

Tenant shall use the Premises for the installation, construction, maintenance, operation, and repair of the Tenant's Equipment (as defined below) as an unmanned telecommunication facility for the transmission and reception of radio communication signals on various frequencies as one of Tenant's communications sites (a "**Communications Site**"). Tenant shall not use the Premises for any other purposes without the written consent of Landlord.

Tenant's Equipment (Section 7):

As of the Commencement Date, the "**Tenant's Equipment**" means the equipment listed in the yellow column of Exhibit B and more particularly described in the attached Exhibit B-1, together with related Connecting Equipment in and on the Building and all equipment in the Rooftop Equipment Room. The equipment in the Rooftop Equipment Room shall be comprised of equipment and materials typically used to support the equipment in the Wall Equipment Area and the Antenna Area.

Following the completion of the Tenant Improvement Work (as defined in Section 7.1) as described in the Approved Plans (as defined in Section 7.1 and attached hereto as Exhibit C (100% Construction Drawings), the "**Tenant's Equipment**" will mean the equipment listed in the green column of Exhibit B and more particularly described in the attached Exhibit B-2, together with related Connecting Equipment in and on the Building and all equipment in the Rooftop Equipment Room. The equipment in the Rooftop Equipment Room shall be comprised of equipment and materials typically used to support the equipment in the Wall Equipment Area and the Antenna Area.

Tenant has the right to install the Tenant's Equipment and the Connecting Equipment in the Premises at its sole cost.

Tenant has the right to install and maintain the following items in the License Area at its sole cost: (i) Connecting Equipment; (ii) innerducts for fiber and DC power on rooftop sleepers; (iii) coax located in cable trays; and (iv) FRP screen wall surrounding some portions of the Antenna Area.

Utilities and Services (Section 12.1):

All utilities and services necessary for use of the Premises as a Communications Site shall be provided by Tenant at its sole cost. City has no responsibility for any utilities or services to the Premises, the Building common areas, or the License Area, except to the extent Tenant requires minimal and temporary access to existing Building utilities to install future equipment installations permitted under this Lease.

Tenant has the right to sub-meter power from City's existing power supply in the Building. Each month Tenant sub-meters power from City, Tenant shall pay the sum of Six Hundred Dollars (\$600.00) to the City as Additional Charges (Section 5.3) subject to adjustment and reconciliation as set forth in Section 12.1.

Security Deposit (Section 25):

\$14,800

Notice Address of Landlord (Section 29.1):

SF Department of Homelessness and Supportive Housing
PO COX 427400
San Francisco, CA 94127-7400
Re: 260 Golden Gate Ave.

with a copy to:

City and County of San Francisco
Real Estate Division
25 Van Ness Avenue, Suite 400
San Francisco, CA 94102
Attn: Andrico Penick, Director of Property
Re: 260 Golden Gate Ave.

and to:

Office of the City Attorney
City and County of San Francisco
City Hall, Room 234
1 Dr. Carlton B. Goodlett Place
San Francisco, CA 94102
Attn: Special Projects Team
Re: 260 Golden Gate Ave.

Key Contact for Landlord:

Gigi Whitley, Deputy Director for Administration and Finance, San Francisco Department of Homelessness and Supportive Housing

Telephone No.:

415-355-5210

Notice Address for Tenant
(Section 29.1):

New Cingular Wireless PCS, LLC
Attn: Tower Asset Group Lease Administration
Re: Cell Site No.: CNU0096
Search Ring Name: SF Civic Center
Cell Site Name: SF Civic Center (CA)
Fixed Asset No.: 10087996
1025 Lenox Park Blvd. NE, 3rd Floor
Atlanta, GA 30319

With a mandatory copy to:

New Cingular Wireless PCS, LLC
Attn: AT&T Legal Dept.—Network Ops
Re: Cell Site No.: CNU0096
Search Ring Name: SF Civic Center
Cell Site Name: SF Civic Center (CA)
Fixed Asset No.: 10087996
208 S. Akard Street
Dallas, TX 75202
Melissa Murphree

Key Contact for Tenant:

Telephone No.:

925-963-8027

Other Noteworthy Provisions:

Tenant has the right to terminate this Lease if it loses its permits to operate a Communications Site at the Premises in spite of its reasonable efforts to maintain such permits (Section 28.2).

2. CO-LOCATION OF TELECOMMUNICATIONS FACILITIES

2.1 Prohibition on Co-location Without Landlord's Consent

Co-location of facilities is prohibited except with the express written approval of Landlord. A "co-located telecommunication facility" means a telecommunication facility comprised of one or more antennas, dishes, or similar devices owned or used by more than one public or private entity that does not control, or is not controlled by or under common control with, Tenant. The meaning of "control" in the foregoing sentence shall be as set forth in Section 17.6.

2.2 Required Co-location

Notwithstanding the foregoing, Tenant acknowledges that Landlord may require Tenant to co-locate its facilities on the Premises with other facilities or providers or require Tenant to permit other facilities or providers to co-locate on Tenant's facilities.

Tenant shall cooperate and use commercially reasonable efforts to facilitate co-location of future telecommunications facilities upon the Premises; provided, however, that Tenant shall not be under any such obligation if a proposed co-location causes interference with Tenant's existing use of the Premises. If no such interference would occur upon installation of a co-locator's equipment as reasonably determined by Landlord, then the proposed co-locator in each instance shall, as a condition precedent to any proposed co-location: (i) execute and deliver a co-location agreement prepared in commercially reasonable form by the proposed co-locator;

(ii) pay all costs arising from or related to the co-location, including but not limited to any and all costs incurred by Tenant to accommodate such co-location; and (iii) reimburse Tenant a commercially reasonable percentage of costs and expenses (including capital expenditures) incurred by Tenant in connection with the development, use, or occupancy of the Premises prior to the co-location.

3. PREMISES; AS IS LEASE

3.1 Lease Premises; License Area

Subject to the terms, covenants and conditions set forth in this Lease, City leases to Tenant and Tenant leases from City those premises specified in the Basic Lease Information and shown on the plans attached hereto as Exhibit A (the "Premises"). Tenant shall have access to the Premises and portions of the common areas of the Building as provided in Section 22.1 (Tenant's Access to Premises).

In connection with its use of the Premises as a Communications Site and for the Term of this Lease, City grants Tenant a nonexclusive license (which license shall not be revoked by City except upon the expiration or earlier termination of this Lease) to place, install, use, maintain, repair, replace, and remove the Connecting Equipment in the License Area. City, in its reasonable discretion, may relocate the License Area, at its sole cost, with reasonable notice to Tenant, and subject to all necessary and required regulatory or other permits and approvals. Except as otherwise expressly permitted in this Lease, all Connecting Equipment shall pass through existing openings in the Building's walls, floors, ceilings, and roof unless Tenant reasonably determines that such existing openings are not usable. In such event, Tenant shall obtain Landlord's prior written consent to make any new penetrations through the Building walls, floors, ceilings, and roof for any Connecting Equipment, which consent will not be unreasonably withheld, conditioned or delayed.

To request Landlord's consent to new penetrations, Tenant shall deliver such request to Landlord in writing, together with any information reasonably requested by Landlord to analyze whether such proposed penetrations would negatively impact the Building's safety or structural integrity (a "Request Notice"). Such Landlord-requested information may include an analysis of the impact of the proposed penetrations, prepared by a California-licensed structural engineer with reasonable experience in analyzing such issues. If the cost of making any such new penetrations is more than Five Thousand Dollars (\$5,000), Tenant shall pay Landlord the administrative fee described in Section 8.1. If the cost of making any such new penetrations is Five Thousand Dollars (\$5,000) or less, at Landlord's election, Tenant shall pay Landlord a reasonable administrative review fee before Landlord is required to review such new penetration request. Such administrative review fee shall be based on Landlord's estimated costs in reviewing the proposed penetrations. Landlord shall notify Tenant in writing if Landlord will charge such an administrative review fee and the amount of such fee within thirty (30) days' of receiving Tenant's Request Notice. Tenant shall have the right to withdraw its Request Notice at any time; provided, however, that if Tenant withdraws such Request Notice after delivering the administrative review fee or a Section 8.1 administrative fee, Landlord shall have no obligation to reimburse such fee to Tenant.

3.2 As Is Lease

TENANT EXPRESSLY ACKNOWLEDGES AND AGREES THAT THE PREMISES ARE BEING LEASED AND ACCEPTED IN THEIR "AS IS, WITH ALL FAULTS" CONDITION, WITHOUT REPRESENTATION OR WARRANTY OF ANY KIND, AND SUBJECT TO ALL APPLICABLE LAWS, RULES AND ORDINANCES, INCLUDING, WITHOUT LIMITATION, ZONING ORDINANCES AND REGULATIONS GOVERNING THE USE, OCCUPANCY OR POSSESSION OF THE PREMISES OR LICENSED AREAS. TENANT REPRESENTS AND WARRANTS TO LANDLORD THAT TENANT HAS CONDUCTED A REASONABLY DILIGENT INVESTIGATION, EITHER

INDEPENDENTLY OR THROUGH AGENTS OF TENANT'S CHOOSING, OF THE CONDITION OF THE PREMISES AND OF THE SUITABILITY OF THE PREMISES FOR TENANT'S INTENDED USE, AND TENANT IS RELYING SOLELY ON ITS INDEPENDENT INVESTIGATION. TENANT FURTHER REPRESENTS AND WARRANTS THAT ITS INTENDED USE OF THE PREMISES IS THE USE DESCRIBED IN THE BASIC LEASE INFORMATION. TENANT AGREES THAT NEITHER CITY NOR ANY OF ITS AGENTS HAVE MADE, AND CITY DISCLAIMS, ANY REPRESENTATIONS OR WARRANTIES, EXPRESS OR IMPLIED, WITH RESPECT TO THE PHYSICAL, STRUCTURAL OR ENVIRONMENTAL CONDITION OF THE PREMISES OR THE PRESENT OR FUTURE SUITABILITY OF THE PREMISES OR LICENSED AREAS FOR THE CONDUCT OF TENANT'S BUSINESS, OR ANY OTHER MATTER WHATSOEVER RELATING TO THE PREMISES, INCLUDING, WITHOUT LIMITATION, ANY IMPLIED WARRANTIES OF MERCHANTABILITY OR FITNESS FOR A PARTICULAR PURPOSE.

For purposes of California Civil Code Section 1938, to the extent applicable to this Lease, neither the Premises nor the License Area have been inspected by a certified access specialist ("CASp"). A CASp can inspect the Premises and determine if they comply with all the applicable construction-related accessibility standards under state law. Although state law does not require a CASp inspection of the Premises, City may not prohibit Tenant from obtaining a CASp inspection of the Premises for the occupancy or potential occupancy of Tenant if requested by Tenant. City and Tenant shall mutually agree on the arrangements for the time and manner of such CASp inspection, the payment of the CASp inspection fee, and the cost of making any repairs necessary to correct violations of construction-related accessibility standards within the Premises

3.3 Energy Consumption Disclosure

Tenant consents to utility service providers disclosing energy use data for the Premises to City for use under California Public Resources Code Section 25402.10, as implemented under California Code of Regulations Sections 1680-1685, and San Francisco Environment Code Chapter 20, as each may be amended from time to time ("Energy Consumption Reporting Laws"), and for such data to be publicly disclosed under the Energy Consumption Reporting Laws.

4. TERM

4.1 Term of Lease

The Premises are leased for a term (the "**Term**") of ten (10) years, commencing and terminating as set forth below. The Term of this Lease shall end on the Expiration Date specified in the Basic Lease Information, or such earlier date on which this Lease terminates pursuant to the terms hereof. No delay in the commencement of this Lease beyond the Estimated Commencement Date specified in the Basic Lease Information shall serve to extend the Initial Term beyond the Expiration Date. Tenant shall have the right to extend the Term for two (2) additional terms of five (5) years each on the terms provided in Section 28.1(a) (Options to Extend Term). As used below, the "**Term**" shall include the initial term of ten (10) years, and any of the Extended Terms if Tenant duly exercises its Extension Options with respect to such Extended Terms pursuant to Section 28.1 of this Lease.

4.2 Confirmation of Commencement Date and Expiration Date

The Term of this Lease shall commence on the date (the "**Commencement Date**") this Lease is fully executed by the parties (which execution by City shall require the approval of a resolution as set forth in Section 23.30 of San Francisco Administrative Code). The Term shall terminate on the Expiration Date unless earlier terminated pursuant to the terms hereof or extended as provided in Section 28.1(a).

4.3 Termination of 1996 Lease

Immediately prior to the Commencement Date, Tenant leased the Premises from City pursuant to a certain Cell Site Lease dated as of April 30, 1996, between Bay Area Cellular Telephone Company, a California general partnership ("BACTC"), Tenant's predecessor-in-interest, and City (the "1996 Lease"). Tenant succeeded to all of the right, title and interest of BACTC in and to the 1996 Lease by merger. The term of the 1996 Lease expired on May 31, 2011, and Tenant continued to occupy the Premises pursuant to the Lease with City's consent on a month to month holdover basis pursuant to Section 28.12 of the 1996 Lease. Tenant represents that all equipment and property at the Premises described in the 1996 Lease immediately prior to the Commencement Date is owned by Tenant, and acknowledges that the security deposit described in the 1996 Lease was never delivered to City.

Tenant and City agree that the 1996 Lease, and Tenant's lease of the Premises under the 1996 Lease, shall automatically terminate as of 12:01 a.m. of the Commencement Date.

5. RENT; ADDITIONAL CHARGES

5.1 Base Rent

Beginning on the Commencement Date, Tenant shall pay to City during the Term the annual Base Rent specified in the Basic Lease Information as the same may be increased pursuant to Section 5.2 (Adjustments in Base Rent) (the "**Base Rent**"). The Base Rent shall be payable in equal consecutive monthly payments on or before the first day of each month, in advance, by good check to the City and County of San Francisco at the address for the Director of Property specified in the Basic Lease Information, or such other place as City may designate in writing upon thirty (30) days advance notice. Tenant shall pay the Base Rent without any prior demand and without any deduction or setoff. If the Commencement Date occurs on a day other than the first day of a calendar month, or the Expiration Date occurs on a day other than the last day of a calendar month, then the Base Rent for such fractional month shall be prorated based on a thirty (30)-day month.

5.2 Adjustments in Base Rent

On each date specified in the Basic Lease Information for the adjustment of Base Rent (an "**Adjustment Date**") during the Term, the Base Rent payable by Tenant under Section 5.1 (Base Rent) above shall be increased by an amount equal to Four Percent (4%) over the Base Rent paid immediately prior to the applicable Adjustment Date.

5.3 Additional Charges

Tenant shall promptly pay to City any and all Utility Charges under Section 12.1 (Utilities and Services), and other amounts, if any, required under any other provision of this Lease, as additional rent (herein called "**Additional Charges**"). Such Additional Charges shall be payable to City at the same place and in the same manner as the Base Rent is payable. City shall have the same remedies for a default in the payment of any Additional Charges as for a default in the payment of Base Rent. As used in this Lease, the term "**Rent**" shall include the Base Rent and any Additional Charges.

5.4 Late Charges

If Tenant fails to pay any Rent within ten (10) days after Tenant's receipt of written notice that the same is due and payable, such unpaid amounts will be subject to a late payment charge equal to six percent (6%) of the unpaid amounts in each instance. The late payment charge has been agreed upon by City and Tenant, after negotiation, as a reasonable estimate of the additional administrative costs and detriment that will be incurred by City as a result of any such failure by Tenant, the actual costs thereof being extremely difficult if not impossible to

determine. The late payment charge constitutes liquidated damages to compensate City for its damages resulting from such failure to pay and shall be paid to City together with such unpaid amounts.

5.5 Default Interest

Any Rent, if not paid within ten (10) days following the due date, shall bear interest from the due date until paid at the rate of six percent (6%) per year or, if a higher rate is legally permissible, at the highest rate an individual is permitted to charge under law. However, interest shall not be payable on late charges incurred by Tenant nor on any amounts on which late charges are paid by Tenant to the extent this interest would cause the total interest to be in excess of that which an individual is lawfully permitted to charge. Payment of interest and late charges shall not excuse or cure any default by Tenant.

6. USE

6.1 Permitted Use

Tenant shall use the Premises during the Term of this Lease solely for such uses as are specified in the Basic Lease Information and for no other use. Tenant acknowledges that this prohibition on the change in use is expressly authorized by California Civil Code Section 1997.230 and is fully enforceable. Tenant shall not interfere with the use and operation of the Building as a homeless shelter with homeless support services.

6.2 No Illegal Uses, Nuisances, or Advertising

Without limiting the foregoing, Tenant shall not use or occupy any of the Premises, or permit the use or occupancy thereof, in any unlawful manner or for any illegal purpose, or permit to be carried on any offensive, immoral, noisy, or hazardous use. Tenant shall take all precautions to eliminate any nuisances or hazards in connection with its activities within the Premises. Tenant shall not advertise in any manner in areas outside the Premises or on or about the Building; provided, however that Tenant may (i) place one identification plate on each antenna, and base station equipment component that comprises the Tenant's Equipment, which plate shall be no larger than two (2) inches by two (2) inches and shall be reasonably approved in advance by City, in order to identify the Tenant's Equipment as belonging to Tenant, and (ii) install all signage required by federal, state and local laws, rules and regulations, codes and ordinances.

7. INSTALLATION OF TENANT IMPROVEMENTS

7.1 Tenant Improvement Work

As of the Commencement Date, the Tenant's Equipment in the Wall Equipment Area and Antenna Area is as listed in the yellow column of Exhibit B and more particularly described in Exhibit B-1. City, in its proprietary interest as owner of the Premises, approves of Tenant's proposed modification to the Tenant's Equipment after the Commencement Date to be as listed in the green column of Exhibit B and more particularly described in Exhibit B-2 and the construction drawings prepared by Nuwave Communications dated as of May 29, 2018, as updated November 11, 2019, and attached as Exhibit C (the "**Approved Plans**"). The work described in the Approved Plans is called the "**Tenant Improvement Work**" or "**Tenant Improvements**". Tenant represents it has received a conditional use permit from City's Planning Department that allows for the Tenant Improvement Work (the "**CUP**"). If Tenant commences the Tenant Improvement Work, then within three (3) business days of completing the Tenant Improvement Work, Tenant shall notify City in writing of Tenant's completion of the Tenant Improvement Work and confirm that the Tenant's Equipment in the Antenna Area and Wall Equipment Area on the date of such notice is as listed in the green column of Exhibit B and more particularly described in Exhibit B-2 and in the Approved Plans. If Tenant commences,

but does not complete, the Tenant Improvement Work, Tenant shall deliver written notice to City within three (3) business days of such suspension and describe the existing Tenant's Equipment in the Antenna Area and Wall Equipment Area as of the date of such notice. Tenant shall notify City in writing before resuming any suspended Tenant Improvement Work, and the foregoing notice requirements shall apply to the resumed Tenant Improvement Work.

Except for the Tenant Improvement Work, Tenant shall not alter, replace, modify, or add to any of Tenant's Equipment without City's prior written consent; provided, however, that Tenant may perform maintenance, repairs, like-for-like exchanges or similar replacements of Tenant's Equipment and may make modifications within the interior of any of Tenant's Equipment without prior approval of City so long as the like-for-like exchanges or similar replacements of Tenant's Equipment are substantially similar in size and weight to the previous item of Tenant's Equipment, do not pose any greater danger to the Building than the Tenant's Equipment to be so exchanged or replaced, will comply with Section 12.3 (Floor Load), and Tenant obtains all regulatory approvals required for such exchanges, replacements, or modifications. If Tenant wishes to make any exchange or replacement of Tenant's Equipment within the Premises that requires City's prior written consent, City will not unreasonably withhold, condition or delay its approval. Tenant acknowledges that City, in its capacity as a landlord, shall have the sole discretion in deciding whether to approve any proposed addition to the Tenant's Equipment within the Premises or any proposed exchange or replacement of Tenant's Equipment that would result in any expansion of the Premises, including the right to condition such approval on an increase in Base Rent.

Tenant shall be responsible, at its cost, for performing the Tenant Improvement Work in accordance with the Approved Plans and otherwise in compliance with the standards contained in Section 8.1 (Tenant's Alterations). Tenant shall further be responsible, at its cost, for obtaining all permits and licenses required in connection with the Tenant Improvements and satisfy any conditions or mitigation measures approved in connection therewith. No Tenant Improvement Work shall commence until Tenant has first obtained all necessary permits and approvals for Tenant to be legally entitled to perform it.

7.2 Working Requirements

Tenant and its subtenants shall comply with the applicable requirements of San Francisco Administrative Code Sections 23.61 and 23.62 in the performance of the Tenant Improvement Work, as further set forth in Section 29.21 (Prevailing Wages and Local Hiring Requirements) below.

7.3 Air-Conditioning and Fire Suppression

Tenant shall have the right (but not the obligation) to install and maintain at its own cost and expense a self-contained air-conditioning system and fire protection system within the Premises, as shown on the Approved Plans. Installation of such systems, which shall not connect to any of the heating, ventilating, air conditioning, plumbing, electrical, fire protection, life safety, security and other mechanical, electrical, and communications systems of the Building (collectively, "**Building Systems**"), shall be in compliance with Section 7.1 (Tenant Improvement Work) and Section 8.1 (Tenant's Alterations).

8. ALTERATIONS

8.1 Tenant's Alterations

(a) Tenant shall not make or permit any alterations, installations, additions or improvements, structural or otherwise (collectively, "**Alterations**") to the Building or any of the Building Systems, except with City's prior written consent in each instance which may be withheld in City's sole discretion. All Alterations shall be done at Tenant's sole expense in accordance with plans and specifications approved by City, only by duly licensed and bonded

contractors or mechanics, and subject to all other conditions which City may reasonably impose. If the cost of any Alterations to the Building (excluding any shown on the Approved Plans) is in excess of Five Thousand Dollars (\$5,000), then Tenant shall pay City an administrative fee equal to ten percent (10%) of the total "hard" costs of the work. "Hard costs" shall include the cost of materials and installation, but shall exclude any costs associated with design, such as architectural fees

(b) Without limiting Section 27.2 (Hazardous Materials in Premises) below, if asbestos-containing materials ("ACM") are determined to exist in or about the Premises, Tenant shall ensure that all Tenant Improvement Work, Alterations and any asbestos related work, as defined in California Health & Safety Code Section 25914.1(b), is performed in compliance with all laws relating to asbestos, including but not limited to California Occupational Safety and Health (OSHA) regulations found in Title 8 of the California Code of Regulations, Sections 1502 and 1529. Additionally, Tenant shall distribute notifications to all employees and contractors as required pursuant to California Health & Safety Code Section 25915 *et seq.* informing them of the existence of ACM and that moving, drilling, boring, or otherwise disturbing ACM may present a health risk and should not be attempted by an unqualified employee. No Alterations affecting ACM-containing areas or any asbestos related work shall be performed without City's prior written consent in each instance.

(c) Tenant, on behalf of itself and its Agents or Invitees, shall comply with all requirements of the San Francisco Building Code, Section 3407, and all other applicable present or future federal, state, local and administrative laws, rules, regulations, orders and other governmental requirements, the requirements of any board of fire underwriters or other similar body, any directive or occupancy certificate issued pursuant to any law by any public officer or officers acting in their regulatory capacity, including, without limitation, the California and United States Occupational Health and Safety Acts and their implementing regulations, when the work of improvement or alteration disturbs or removes exterior lead-based or "presumed" lead-based paint (as defined below). Tenant and its Agents or Invitees shall give to City three (3) business days' prior written notice of any disturbance or removal of exterior lead-based or presumed lead-based paint. Further, Tenant and its Agents or Invitees, when disturbing or removing exterior lead-based or presumed lead-based paint, shall not use or cause to be used any of the following methods: (a) acetylene or propane burning and torching; (b) scraping, sanding or grinding without containment barriers or a High Efficiency Particulate Air filter ("HEPA") local vacuum exhaust tool; (c) hydroblasting or high-pressure wash without containment barriers; (d) abrasive blasting or sandblasting without containment barriers or a HEPA vacuum exhaust tool; and (e) heat guns operating above 1,100 degrees Fahrenheit. Paint on the exterior of buildings built before December 31, 1978, is presumed to be lead-based paint unless lead-based paint testing, as defined in Section 3407 of the San Francisco Building Code, demonstrates an absence of lead-based paint on the exterior surfaces of such buildings. Under this Section, lead-based paint is "disturbed or removed" if the work of improvement or alteration involves any action that creates friction, pressure, heat or a chemical reaction upon any lead-based or presumed lead-based paint on an exterior surface so as to abrade, loosen, penetrate, cut through or eliminate paint from that surface. Notice to City under this Lease shall not constitute notice to the City's Department of Building Inspection required under Section 3407 of the San Francisco Building Code.

8.2 Title to and Removal of Tenant's Equipment

Title to the Tenant's Equipment, Tenant Improvements, all permitted improvements or equipment installed at and affixed to the Premises by Tenant and all of Tenant's personal property (collectively, "**Tenant's Property**") shall remain the property of Tenant; provided, however, that any structural improvements to the Building or any new openings made in the Building pursuant to Section 3.1 that are made by Tenant with City's consent shall become City's property and remain on the Premises. City hereby acknowledges that Tenant may grant to the vendor of the equipment to be installed at and affixed to the Premises a security interest in all equipment and fixtures owned by Tenant now or hereafter located at or on the Premises;

provided no such security interest shall cover any portion of the Premises or the Building or City's property in, on or about the Building and further provided that any removal of such equipment or fixtures by the holder of any such security interest must be in compliance with the provisions of Section 26 (Surrender of Premises). Tenant may at any time, including any time it vacates the Premises (excluding the structural improvements referenced above), remove all of Tenant's Property from the Premises, subject to the provisions of Section 26 (Surrender of Premises). Notwithstanding anything to the contrary in this Lease, and subject to Tenant's timely exercise of the Extension Option, City can elect at any time prior to the Expiration Date or within thirty (30) days after termination of this Lease to require Tenant to remove on the Expiration Date or any earlier termination of this Lease in accordance with Section 26 (Surrender of Premises) at Tenant's sole expense, all or part of any structural improvements to the Premises or the common areas of the Building made by City or Tenant, which were made in order to provide sufficient support for Tenant's equipment, and any antenna or tower supports, foundations, or base plates. In the event Tenant has timely exercised the Extension Option, then City's election in the preceding sentence shall apply as of the expiration date of the Extended Term.

8.3 Taxes on Tenant's Property

At least ten (10) days prior to delinquency, Tenant shall pay all taxes levied or assessed upon Tenant's Property and shall deliver reasonably satisfactory evidence of such payment to City promptly upon request.

8.4 Working Requirements

Tenant and its subtenants shall comply with the applicable requirements of San Francisco Administrative Code 23.61 and 23.62 in the performance of the Tenant Improvement Work, as further set forth in Section 29.21 (Prevailing Wages and Working Requirements) below.

9. CITY'S ALTERATIONS OF THE BUILDING AND BUILDING SYSTEMS

City reserves the right at any time to make alterations, additions, repairs, deletions or improvements to all or any part of the Building, the Building Systems or the common areas of the Building, for any purpose including compliance with mandatory or voluntary controls or guidelines, subject to the following terms and conditions. In performing any such work, City shall make good faith efforts to give Tenant prior notice of such work and shall make reasonable efforts not to disrupt Tenant's normal use of Tenant's Equipment in the Premises. The making of any such alterations, additions, repairs, deletions or improvements shall in no event entitle Tenant to any damages, relieve Tenant of the obligation to pay the full Base Rent and Additional Charges reserved hereunder or to perform each of its other covenants hereunder or constitute or be construed as a constructive or other eviction of Tenant, provided that Tenant can still operate the Premises as a Communications Site. During the period of any such alterations by City which materially impair Tenant's use of the Premises as a Communications Site, Tenant shall have the right at no additional charge to bring into the Building and operate a portable generator and mobile Communications Site and telescopic antennae or tower, in a mutually acceptable location and on the other terms and conditions provided with respect to such equipment in Section 15 (Damage or Destruction).

10. REPAIRS AND MAINTENANCE

10.1 City's Repairs

City shall not be responsible for any maintenance of any portion of the Building, except that City agrees (i) to correct any immediately life-threatening or hazardous condition that affects any portion of the Building necessary for Tenant's use of the Premises as a Communications Site, so long as such condition is not the result of damage or destruction discussed in Section 15 (Damage or Destruction), the acts, omissions or negligence of Tenant or its Agents, such repair is

not otherwise the responsibility of Tenant under Section 10.2 (Tenant's Repairs), and such condition is not disclosed to Tenant under any provision of this Lease or would not have otherwise been discovered by Tenant through a reasonably diligent inspection of the Premises prior to the reference date hereof, and (ii) to repair any condition caused by City or its tenants of the Building other than Tenant, which condition materially affects any portion of the Building necessary for Tenant's use of the Premises as a Communications Site and is not caused by damage or destruction discussed in Section 15 (Damage or Destruction). Upon becoming aware of any such condition, Tenant shall give the City written notice of the need for any repair for which the City is responsible under the preceding sentence; provided, however, that Tenant's agreement to provide written notice shall in no event be interpreted as an assumption of liability for such life-threatening or hazardous conditions unless Tenant would otherwise be responsible for such conditions hereunder. In the event that the costs of making the corrections or repairs described in subsections (i) or (ii) above exceed Twenty-Five Thousand Dollars (\$25,000.00), City may elect to terminate this Lease within thirty (30) days of the condition requiring correction or repair in lieu of making such corrections or repairs, provided however, that Tenant may elect to pay the portion of such costs in excess of Twenty-Five Thousand Dollars (\$25,000.00) necessary in order to make such correction or repairs, in which case City will proceed with the correction or repair.

10.2 Tenant's Repairs

Tenant shall maintain all parts of its Premises at its sole expense, including without limitation, the floors, electrical wiring, fixtures and equipment, in good repair and working order and in a clean, safe and sanitary condition. Tenant shall repair all damage to the Building to the extent such damage results from any Tenant Alterations, Tenant's use of the Premises, or Tenant's entry on the Building pursuant to this Lease. Tenant shall make all repairs and replacements: (a) at Tenant's expense and at such time and, when required hereunder, in such manner as reasonably approved by City, (b) by duly licensed and bonded contractors or mechanics, (c) in a manner and using equipment and materials which will not interfere with or impair City's operations, use or occupation of the Building or the Building Systems, and (d) in accordance with any Building Rules and Regulations (as defined in Section 24 (Rules and Regulations)) and all applicable Laws (as defined in Section 13.1 (Compliance with Laws)).

Tenant hereby waives any right it may have to make repairs at City's expense under Sections 1941 and 1942 of the California Civil Code (Lessor to make dwelling-house fit for its purpose, and Repairs by lessee, respectively) or under any similar law, statute or ordinance now or hereafter in effect.

11. LIENS

Tenant shall keep the Premises and the Building free from any liens arising out of any work performed, material furnished or obligations incurred by or for Tenant. In the event Tenant shall not, within thirty (30) days following the imposition of any such lien, cause the lien to be released of record by payment or posting of a proper bond, City shall have in addition to all other remedies provided herein and by law or equity the right, but not the obligation, to cause the same to be released by such means as it shall deem proper, including, but not limited to, payment of the claim giving rise to such lien. All such sums paid by City and all expenses incurred by it in connection therewith (including, without limitation, reasonable attorneys' fees) shall be payable to City by Tenant upon demand. City shall have the right at all times to post and keep posted on the Premises any notices permitted or required by law or that City shall deem proper for the protection of City, the Premises, and the Building, from mechanics' and material supplier's liens. Tenant shall give to City at least fifteen (15) days' prior written notice of commencement of any repair or construction on the Premises except for minor and routine repair and maintenance for which Tenant is responsible hereunder. Tenant shall not create, permit or suffer any other encumbrances affecting any portion of the Premises or the Building except as expressly permitted under this Lease or without first obtaining the written consent of City, which City may give or withhold in its sole discretion.

12. UTILITIES AND SERVICES

12.1 Utilities and Services

Tenant shall furnish, at its sole cost, any and all utilities or services, including but not limited to, electric and telephone service and fees, necessary or appropriate for Tenant's Equipment and Tenant's use of the Premises; provided, however, that that Tenant shall only receive electric service from the San Francisco Public Utilities Commission ("SFPUC") if the SFPUC determines that such services is feasible and Tenant must obtain the prior written approval of City, acting in its proprietary capacity as the Building owner, to the plans for the installation of a separate meter. Should any governmental entity promulgate or revise any statute, ordinance or building, fire or other code or impose mandatory or voluntary controls or guidelines on City or the Building or any part thereof, relating to the use or conservation of energy or electricity, or in the event City is required or elects to make Alterations to any part of the Building in order to comply with such mandatory or voluntary controls or guidelines, Tenant shall be responsible for the difference in the utility or service charge, if any, due to any such Alterations.

(a) Separately Metered

Tenant shall keep separate utility meters at the Premises and, when permitted by serving utilities, Tenant shall be responsible directly to the serving utilities for all utilities required for Tenant's Equipment and Tenant's use of the Premises. Tenant agrees to promptly pay for all such metered utilities.

(b) Sub-Metered

If Tenant is unable to secure separate utility service for Tenant's Equipment and Tenant's use of the Premises, then Tenant shall have the right to sub-meter and use City's electrical service at the Building, including the right to upgrade such utility service at Tenant's sole cost and in a manner reasonably acceptable to City, as Landlord, provided Tenant has any and all required permits and regulatory approvals. Tenant shall reimburse City the actual cost of utility service used by Tenant. Commencing upon the Commencement Date, and monthly thereafter until the expiration of this Lease or Tenant is able to secure a separate meter, Tenant shall pay to City concurrently with each installment of the Base Rent a total monthly estimated amount of Six Hundred Dollars (\$600) per month ("Utility Charge") subject to a three (3%) percent increase annually on the anniversary date of each Adjustment Date. The Utility Charge shall be subject to annual reconciliation every six (6) months (or any shorter or longer period selected by City) based on the actual amount of electricity used by Tenant as charged by PG&E or SFPUC without additional City mark-up or administrative fee. Tenant will remit any underpayment within forty-five (45) days of receipt of the reconciliation and any overpayment will be subtracted from the next payment(s) of Utility Charges until reconciled.

(c) Interruption

City shall exercise best efforts to maintain electrical service to the Building at all times, and shall exercise good faith efforts under the circumstances to provide Tenant with notice at least twenty-four (24) hours prior to any planned interruptions, shut-down or disablement via telephone and email as set forth in the Basic Lease Information.

City acknowledges that Tenant provides a communication service which requires electrical power to operate and must operate twenty-four (24) hours per day, seven (7) days per week. If an interruption in electrical power service occurs for more than twenty-four (24) consecutive hours, City agrees to allow Tenant the right to bring into the Building and operate a portable generator and mobile Communications Site and telescopic antennae or tower, in a mutually acceptable location and on the other terms and conditions provided in this Section 12, Section 7 (Installation of Tenant Improvements) and Section 15 (Damage or Destruction).

Tenant shall not: (a) connect or use any electrical equipment that exceeds the capacity of the Building electrical system; or (b) connect any apparatus, machine or device through electrical outlets except in the manner for which such outlets are designed, except for such modifications as may be shown on the Approved Plans and for any other such modifications at Tenant's sole cost as are reasonably approved in writing in advance by City.

12.2 Mandatory or Voluntary Restrictions

In the event City provides any utilities pursuant to Section 12.1 (Utilities and Services), and any governmental entity promulgates or revises any statute, ordinance or building, fire or other code or imposes mandatory or voluntary controls or guidelines on City or the Building or any part thereof, relating to the use or conservation of energy or electricity, or in the event City is required or elects to make alterations to any part of the Building in order to comply with such mandatory or voluntary controls or guidelines, such compliance and the making of such alterations shall in no event entitle Tenant to any damages, relieve Tenant of the obligation to pay the full Base Rent and Additional Charges reserved hereunder or to perform each of its other covenants hereunder or constitute or be construed as a constructive or other eviction of Tenant, provided that Tenant can still operate the Premises as a Communications Site. During the period of any such alterations by City which materially impair Tenant's use of the Premises as a Communications Site, Tenant shall have the right, at no additional charge, to bring into the Building and operate a portable generator and mobile Communications Site and telescopic antennae or tower, in a mutually acceptable location and on the other terms and conditions provided with respect to such equipment in Section 15 (Damage or Destruction).

12.3 Floor Load

Without the prior written consent of City, which City may give or refuse in City's sole discretion, Tenant shall not place or install in the Premises any machine, equipment, structure or other improvement the weight of which shall exceed the normal loadbearing capacity of the floors or roof of the Building, except as may be shown in the Approved Plans. If City consents to the placement or installation of any such machine or equipment in the Premises, Tenant at its sole expense shall reinforce the floor or roof of the Premises in the area of such placement or installation, pursuant to plans and specifications reasonably approved by City and otherwise in compliance with Section 8.1 (Tenant's Alterations), to the extent necessary to assure that no damage to the Premises or the Building or weakening of any structural supports will be occasioned thereby.

13. COMPLIANCE WITH LAWS AND RISK MANAGEMENT REQUIREMENTS

13.1 Compliance with Laws

Tenant, at Tenant's expense, shall promptly maintain the Premises, any Tenant Improvements and Tenant's Alterations, the Tenant's Equipment, and any other improvements and equipment permitted hereunder, and Tenant's use and operations thereon, in strict compliance with all present and future laws, orders and regulations of federal, state, county and municipal authorities (collectively, "Laws") relating to the Premises or the use or occupancy thereof, whether foreseen or unforeseen, ordinary as well as extraordinary. Such Laws shall include, without limitation, all Laws relating to health and safety and disabled accessibility including, without limitation, the Americans with Disabilities Act, 42 U.S.C. Section 12101 et seq. (insofar as such Act relates to Tenant's unique use) and Title 24 of the California Code of Regulations, all present and future Environmental Laws (as defined in Section 27.1 (Definitions)), and all present and future life safety, fire sprinkler, seismic retrofit and other building code requirements. Notwithstanding the foregoing, Tenant shall not be responsible for bringing any non-complying conditions in the Premises into compliance with Laws unless such compliance is triggered directly or indirectly as a result of work or installations made by or on behalf of Tenant in the Premises. Tenant further acknowledges City shall have no obligation to bring any non-complying conditions in the Premises or elsewhere in the Building into

compliance with Laws; provided, however, that if Tenant is not reasonably able to use the Premises for its permitted uses under this Lease due to non-complying conditions that are not triggered directly or indirectly as a result of work or installations made by or on behalf of Tenant in the Premises, Tenant shall have the right to terminate this Lease by delivering at least thirty (30) days prior written notice of such termination to City. Any work or installations made or performed by or on behalf of Tenant or any person or entity claiming through or under Tenant pursuant to the provisions of this Section shall be made in conformity with and subject to the provisions of Section 10.2 (Tenant's Repairs). In making any application to City's Planning Department for the Communications Site, Tenant agrees to act as both "Applicant" and "Project Sponsor." A summary of the conditional use permits authorizing use of the Premises as a Communications Site is attached hereto as Exhibit D.

The parties acknowledge and agree that Tenant's obligation to comply with all Laws as provided herein is a material part of the bargained-for consideration under this Lease. Tenant's obligation under this Section shall include, without limitation, the responsibility of Tenant to make substantial or structural repairs and alterations to the Premises (including any of the Tenant Improvements or any of Tenant's Alterations), regardless of, among other factors, the relationship of the cost of curative action to the Rent under this Lease, the length of the then remaining Term hereof, the relative benefit of the repairs to Tenant or City, the degree to which the curative action may interfere with Tenant's use or enjoyment of the Premises, the likelihood that the parties contemplated the particular Law involved, and whether the Law involved is related to Tenant's particular use of the Premises; provided, however, that if any future Law requires such substantial or structural repairs and alterations, and such future Law is not triggered by Tenant's particular use of the Premises or any Tenant Improvements or Tenant's Alterations, Tenant shall have the right to terminate this Lease in lieu of performing such substantial or structural repairs and alterations by delivering written notice of such termination to City within the thirty (30) day period immediately following the date that Tenant receives written notice from City of any such non-complying condition arising due to any such future Law. If Tenant timely delivers such a termination notice to City pursuant to the foregoing sentence, this Lease shall terminate as of the thirtieth (30th) day immediately following City's receipt of such termination notice. Except as expressly provided herein, no occurrence or situation arising during the Term, nor any present or future Law, whether foreseen or unforeseen, and however extraordinary, shall relieve Tenant from its obligations hereunder, or shall give Tenant any right to otherwise seek redress against City, and Tenant waives any rights now or hereafter conferred upon it by any existing or future Law to receive any abatement, diminution, reduction or suspension of payment of Rent, or to compel City to make any repairs to comply with any such Laws, on account of any such occurrence or situation.

Tenant understands and agrees that City is entering into this Lease in its capacity as a property owner with a proprietary interest in the Premises and not as a regulatory agency with police powers. Nothing in this Lease shall limit in any way Tenant's obligation to obtain any required regulatory approvals from City departments, boards or commissions having jurisdiction over the Premises. By entering into this Lease, City is in no way modifying or limiting Tenant's obligation to cause the Premises to be used and occupied in accordance with all Laws as provided above.

13.2 Licenses and Approvals

Tenant represents and warrants that it has acquired all licenses, permits, and other approvals required under all federal, state, and local laws for the operation of Tenant's Equipment on the Premises. Tenant shall maintain all such licenses, permits or other approvals throughout the Term of this Lease.

13.3 Radiofrequency Radiation and Electromagnetic Fields

Without limiting Section 13.1 above, Tenant shall comply with all present and future laws, orders and regulations of federal, state, county and municipal authorities relating to

allowable presence of or human exposure to Radiofrequency Radiation ("RFs") or Electromagnetic Fields ("EMFs") on or off the Premises, including without limitation, all applicable standards adopted by the Federal Communications Commission ("FCC"), whether such RF or EMF presence or exposure results from Tenant's equipment alone or from the cumulative effect of Tenant's equipment added to all other sources in the Building. City shall not agree to allow any third party entering into an occupancy or use agreement after the Commencement Date to cause an increase in RF or EMF levels in the Building such that the cumulative levels exceed allowable levels. If the cumulative effect of City's use of the Building taken together with Tenant's use hereunder and other tenant(s) whose use predated the Commencement Date exceeds such standards, Tenant shall have the right to terminate this Lease without penalty upon ninety (90) days' prior written notice to City. Without limiting the provisions of Tenant's indemnity contained in Section 19 (Tenant's Indemnity), Tenant, on behalf of itself and its successors and assigns, shall indemnify the "Indemnified Parties," and each of them, from and against all "Claims" incurred in connection with or arising in whole or in part from the presence of or exposure to RFs or EMFs resulting from Tenant's use of the Premises.

13.4 Compliance with City's Risk Management Requirements

Tenant shall not do anything, or permit anything to be done, in or about the Premises which would create any unusual fire risk, and shall take commercially reasonable steps to protect City from any potential premises liability by reason of any business operation being conducted by Tenant in the Premises. Tenant, at Tenant's expense, shall comply with all reasonable rules, orders, regulations or requirements of City's Risk Manager.

14. SUBORDINATION

This Lease shall be subordinate to any reciprocal easement agreements, ground leases or underlying leases and the lien of any mortgage or deed of trust (collectively, "**Encumbrance**"), which may now exist or hereafter be executed affecting any of the Building, the real property upon which the Building is located or City's interest therein and all renewals, extensions, modifications, and replacements of such Encumbrance. Notwithstanding the foregoing, City shall have the right to subordinate any such Encumbrances to this Lease. If any ground lease or underlying lease terminates for any reason or any mortgage or deed of trust is foreclosed or a conveyance in lieu of foreclosure is made for any reason, Tenant shall attorn to the successor-in-interest to City, at the option of such successor-in-interest, provided that so long as Tenant is not in default hereunder, such successor-in-interest shall recognize this Lease and shall not disturb Tenant in its possession of the Premises for any reason other than one that would entitle City to terminate this Lease or otherwise dispossess Tenant of the Premises in accordance with the terms hereof. No further instrument shall be required to make the provisions hereof operative except that City shall give Tenant written notice of such subordination. Tenant agrees, however, to execute and deliver, upon demand by City and in the form requested by City, any additional documents evidencing the priority or subordination of this Lease provided such documents contain a non-disturbance and recognition agreement executed by the holder of such Encumbrance.

15. DAMAGE OR DESTRUCTION

The parties recognize that the Premises are a small portion of a building used as, among other things, a homeless shelter. In the event of damage to the Premises or the Building by any cause, City shall have no obligation to rebuild or repair. If City, in City's sole and absolute discretion, determines to repair or rebuild, City shall give Tenant written notice of its determination and its good faith estimate of the amount of time to repair or rebuild, within thirty (30) days of the date of such damage or destruction. If such repairs or rebuilding cannot be completed within two hundred ten (210) days after the date of such damage or destruction, or if City elects not to repair or rebuild as provided above, then Tenant shall have the right, at its election, to terminate this Lease upon sixty (60) days prior written notice to City.

During the period of any repair or rebuilding provided for hereunder, Tenant shall have the right, at its sole expense, to bring onto the Building in a location mutually acceptable to Tenant and City and to operate a portable generator and mobile Communications Site and telescopic antennae or tower in order to provide for continuous service to Tenant's customers during such period. Neither the placement nor use of such generator or equipment shall interfere with City's operations or business in the Building or, if City has elected to repair or rebuild the Premises or the Building as provided above, with such repair or reconstruction.

The parties hereto understand and agree that the provisions of this Section are intended to govern fully the rights and obligations of the parties in the event of damage or destruction, and Tenant and City each hereby waives and releases the provisions of Section 1932, subdivision 2, and Section 1933, subdivision 4, of the Civil Code of California (When hirer may terminate the hiring) or under any similar law, statute or ordinance now or hereafter in effect.

16. EMINENT DOMAIN

16.1 Eminent Domain

If all or any part of the Premises shall be taken as a result of the exercise of the power of eminent domain or any transfer in lieu thereof, this Lease shall terminate as to the part so taken as of the date of taking. In the case of a partial taking, Tenant shall have the right to terminate this Lease as to the balance of the Premises by written notice to City within thirty (30) days after such date; provided, however, that a condition to the exercise by Tenant of such right to terminate shall be that the portion of the Premises taken shall be of such extent and nature as to materially impair Tenant's use of the balance of the Premises as a Communications Site. In the event of a partial taking of the Premises which does not result in a termination of this Lease, the Base Rent and Additional Charges thereafter to be paid shall be equitably reduced.

If any material part of the Building shall be taken as a result of the exercise of the power of eminent domain or any transfer in lieu thereof, City shall have the right to terminate this Lease by written notice to Tenant within thirty (30) days of the date of the taking.

In the event of any taking, City shall be entitled to any award which may be paid or made in connection therewith. Tenant shall have no claim against City for the value of any unexpired term of this Lease or otherwise except that Tenant may claim any portion of the award that is specifically allocable to Tenant's relocation expenses or the interruption of or damage to Tenant's business or loss or damage to Tenant's Property.

The parties understand and agree that the foregoing provisions of this Section are intended to govern fully the rights and obligations of the parties in the event of a taking. Tenant and City each hereby waives and releases any right to terminate this Lease in whole or in part under Sections 1265.120 and 1265.130 of the California Code of Civil Procedure (partial termination of lease and Court order terminating lease, respectively) or under any similar law, statute or ordinance now or hereafter in effect.

16.2 Temporary Takings

Notwithstanding the foregoing, if a taking occurs with respect to all or any portion of the Premises for less than ninety (90) days, this Lease shall remain unaffected thereby, and Tenant shall continue to perform all of the terms, conditions and covenants of this Lease, except that Tenant shall be entitled to an abatement in Base Rent to the extent that its use of the Premises as a Communications Site is materially impaired. In the event of any such temporary taking, Tenant shall be entitled to receive that portion of any award which represents compensation for the use or occupancy of the Premises during the Term up to the total Base Rent and Additional Charges owing by Tenant for the period of the taking, and City shall be entitled to receive the balance of any award.

17. ASSIGNMENT AND SUBLETTING

17.1 Restriction on Assignment and Subletting

Tenant shall not directly or indirectly (including, without limitation, by merger, acquisition, or other transfer of any controlling interest in Tenant), voluntarily or by operation of law, sell, assign, encumber, pledge or otherwise transfer any part of its interest in or rights with respect to the Premises or its leasehold estate hereunder (collectively, "Assignment"), or permit any portion of the Premises to be occupied by anyone other than itself, or sublet any portion of the Premises (collectively, "Sublease"), without City's prior written consent. City's consent shall not be unreasonably withheld in each instance, as provided hereinbelow and subject to the exception for certain permitted transfers as provided in Section 17.6 (Permitted Assignment). Notwithstanding anything to the contrary contained in this Lease, in no event shall Tenant have the right to encumber by a mortgage, deed of trust, security agreement, or otherwise, any part of the Premises, the Building or City's interest therein.

17.2 Notice of Proposed Transfer

If Tenant desires to enter into an Assignment or a Sublease, then it shall give written notice (a "Notice of Proposed Transfer") to City of its intention to do so. The Notice of Proposed Transfer shall provide in detail the terms and conditions for such proposed Assignment or Sublease and complete information, including financial statements, business history, and references about the Assignee or Sublessee and such other information about the proposed assignee or subtenant (collectively, "Transferee") as is reasonably requested by City to make a fully informed decision about consent to Tenant's request.

17.3 City's Response

City shall make its election to approve or disapprove such Assignment or Sublease within twenty (20) business days after City's receipt of the Notice of Proposed Transfer (the "Response Period"). If City approves the proposed Sublease or Assignment in writing, then Tenant shall be entitled for a period of ninety (90) days following such date to enter into the proposed Assignment or Sublease. However, any Rent or other consideration realized by Tenant under any such Assignment or Sublease in excess of the Base Rent and Additional Charges payable hereunder (or the amount thereof proportionate to the portion of the Premises subject to such Sublease) shall be paid to City after Tenant has recovered any reasonable broker's commissions and the reasonable cost of any improvements that Tenant has actually incurred in connection with such Sublease or Assignment.

Notwithstanding anything to the contrary in this Section, if any monetary or other material event of default by Tenant is outstanding hereunder at the time of Tenant's Notice of Proposed Transfer (or if any event shall have occurred which with the giving of notice or the passage of time or both would constitute such a default), then City may elect by notice to Tenant to refuse to consent to Tenant's proposed Transfer and pursue any of its right or remedies hereunder or at law or in equity.

17.4 Effect of Sublease or Assignment

No Sublease or Assignment by Tenant nor any consent by City thereto nor any Assignment or Sublease by Tenant permitted hereunder without City's consent shall relieve Tenant of any obligation on its part under this Lease. Any Sublease or Assignment that is not in compliance with this Section shall be void and, at City's option, shall constitute a material default by Tenant under this Lease. The acceptance of any Base Rent or other payments by City from a proposed Transferee shall not constitute consent to such Sublease or Assignment by City or a recognition of any Transferee, or a waiver by City of any failure of Tenant or other transferor to comply with this Section.

17.5 Assumption by Transferee

Each Transferee shall assume all obligations of Tenant under this Lease and shall be and remain liable jointly and severally with Tenant for the payment of the Base Rent and Additional Charges, and for the performance of all of the terms, covenants, conditions and agreements herein contained on Tenant's part to be performed. No Assignment shall be binding on City unless Tenant or Transferee shall deliver to City evidence satisfactory to City that it has obtained all permits, licenses, or other approvals required to operate as a wireless telecommunications service provider on the Premises, a counterpart of the Assignment (or other document reasonably satisfactory to the City in the event of an assignment permitted under Section 17.6 (Permitted Assignment)) and an instrument in recordable form that contains a covenant of assumption by such Transferee satisfactory in substance and form to City, and consistent with the requirements of this Section. However, the failure or refusal of such Transferee to execute such instrument of assumption shall not release such Transferee from its liability as set forth above. Except for a permitted assignment to a general partner or affiliate of Tenant as provided in Section 17.6, Tenant shall reimburse City on demand for any reasonable costs that may be incurred by City in connection with any proposed Sublease or Assignment, including, without limitation, the costs of making investigations as to the acceptability of the proposed Transferee and legal costs incurred in connection with the granting of any requested consent.

17.6 Permitted Assignment

City agrees that Tenant shall be permitted to enter into an Assignment of this Lease or Sublease of the Premises, without City's prior consent but with notice to City as provided below, to any entity which directly or indirectly controls, is controlled by or is under the common control with, Tenant, and has a net worth of at least Ten Million Dollars (\$10,000,000.00), will use the Premises in the same manner as Tenant under this Lease and holds all licenses, permits, and other approvals necessary to lawfully operate a Communications Site on the Premises. As used above, the term "control" shall mean (a) as to a corporation, the ownership of stock having the right to exercise more than fifty percent (50%) of the total combined voting power of all classes of stock of the controlled corporation, issued and outstanding, and (b) as to partnerships and other forms of business associations, ownership of more than fifty percent (50%) of the beneficial interest and voting control of such association. Tenant shall use its best efforts to provide City with notice in advance of any such permitted Assignment and in any event shall provide City with written notice no later than ten (10) days after the effective date of such permitted Assignment.

18. DEFAULT

18.1 Events of Default

Any of the following shall constitute an event of default by Tenant hereunder:

(a) any failure to pay any Base Rent or Additional Charges as and when due, provided Tenant shall have a period of ten (10) days from Tenant's receipt of written notice from City within which to cure any default in the payment of Rent; provided, however, that City shall not be required to provide such notice regarding Tenant's failure to make such payments when due more than two (2) times during any consecutive twelve (12) month period during the Term, and any such failure by Tenant after Tenant has received two (2) such notices in any calendar year from City shall constitute a default by Tenant hereunder without any requirement on the part of City to give Tenant notice of such failure except for a three (3)-day notice to pay or quit as required by law;

(b) any failure to perform or comply with any other covenant, condition or representation made under this Lease, provided Tenant shall have a period of thirty (30) days from the date of Tenant's receipt of written notice from City within which to cure such default under this Lease, or, if such default is not capable of cure within such thirty (30)-day period,

Tenant shall have a reasonable period to complete such cure if Tenant promptly undertakes action to cure such default within such thirty (30)-day period and thereafter diligently prosecutes the same to completion and Tenant uses its best efforts to complete such cure within sixty (60) days after Tenant's receipt of written notice of default from City;

(c) any vacation or abandonment of the Premises for more than fourteen (14) consecutive days such that the Premises are no longer being used for the purposes set forth in Section 6.1; City acknowledges that the Premises are to be used as an unoccupied transmission facility and, accordingly, lack of on-site personnel shall not, in and of itself, be deemed to indicate vacation or abandonment; and

(d) the appointment of a receiver due to Tenant's insolvency to take possession of all or substantially all of the assets of Tenant, or an assignment by Tenant for the benefit of creditors, or any action taken or suffered by Tenant under any insolvency, bankruptcy, reorganization, moratorium or other debtor relief act or statute, whether now existing or hereafter amended or enacted, if any such receiver, assignment or action is not released, discharged, dismissed or vacated within sixty (60) days.

18.2 Remedies

Upon the occurrence of an event of default by Tenant which is not cured by Tenant within the applicable grace period, if any, specified in Section 18.1 (Events of Default), City shall have the following rights and remedies in addition to all other rights and remedies available to City at law or in equity:

(a) the rights and remedies provided by California Civil Code Section 1951.2 (damages on termination for breach), including, but not limited to, the right to terminate Tenant's right to possession of the Premises and to recover the worth at the time of award of the amount by which the unpaid Base Rent and Additional Charges for the balance of the Term after the time of award exceeds the amount of rental loss for the same period that Tenant proves could be reasonably avoided, as computed pursuant to subsection (b) of such Section 1951.2.

(b) the rights and remedies provided by California Civil Code Section 1951.4 (continuation of lease after breach and abandonment), which allows City to continue this Lease in effect and to enforce all of its rights and remedies under this Lease, including the right to recover rent as it becomes due, for so long as City does not terminate Tenant's right to possession. Acts of maintenance or preservation, efforts to relet the Premises or the appointment of a receiver upon City's initiative to protect its interest under this Lease shall not constitute a termination of Tenant's right to possession. If City exercises its right under California Civil Code Section 1951.4, City may from time to time sublet the Premises or any part thereof for such term or terms (which may extend beyond the Term) and at such rent and upon such other terms as City in its sole discretion may deem advisable, with the right to make alterations and repairs to the Premises. Upon each such subletting, Tenant shall be immediately liable for payment to City of, in addition to Base Rent and Additional Charges due hereunder, the cost of such subletting and such alterations and repairs incurred by City and the amount, if any, by which the Base Rent and Additional Charges owing hereunder for the period of such subletting (to the extent such period does not exceed the Term) exceeds the amount to be paid as Base Rent and Additional Charges for the Premises for such period pursuant to such subletting. No action taken by City pursuant to this Subsection shall be deemed a waiver of any default by Tenant and, notwithstanding any such subletting without termination, City may at any time thereafter elect to terminate this Lease for such previous default.

(c) the right to have a receiver appointed for Tenant upon application by City to take possession of the Premises and to apply any rental collected from the Premises and to exercise all other rights and remedies granted to City pursuant to this Lease.

19. TENANT'S INDEMNITY

Tenant, on behalf of itself and its successors and assigns, shall indemnify, defend and hold harmless ("**Indemnify**") City, its Agents and Invitees, and their respective heirs, legal representatives, successors and assigns (individually and collectively, the "**Indemnified Parties**"), and each of them, from and against any and all liabilities, losses, costs, claims, judgments, settlements, damages, liens, fines, penalties and expenses, including, without limitation, direct and vicarious liability of every kind (collectively, "**Claims**"), incurred in connection with or arising in whole or in part from: (a) injury to or death of a person, including, without limitation, employees of Tenant, or loss of or damage to property, occurring on or about the Premises or License Area or arising in connection with the use of the Premises or License Area under this Lease; (b) any default by Tenant in the observation or performance of any of the terms, covenants or conditions of this Lease to be observed or performed on Tenant's part; (c) the use or occupancy or manner of use or occupancy of the Premises by Tenant, its Agents or Invitees or any person or entity claiming through or under any of them; (d) the condition of the Premises or any occurrence on the Premises from any cause attributable to the events described in clauses (a), (b) or (c) of this Section; or (e) any acts, omissions or negligence of Tenant, its Agents or Invitees in, on or about the Premises or the Building; all regardless of the negligence of, and regardless of whether liability without fault is imposed or sought to be imposed on, the Indemnified Parties, except to the extent that such Indemnity is void or otherwise unenforceable under applicable Law in effect on or validly retroactive to the date of this Lease and further except to the extent such Claim is caused by the willful misconduct or active negligence of the Indemnified Parties. The foregoing Indemnity shall include, without limitation, reasonable fees of attorneys, consultants and experts and related costs and City's costs of investigating any Claim. Tenant specifically acknowledges and agrees that it has an immediate and independent obligation to defend City and the other Indemnified Parties from any claim which actually or potentially falls within this indemnity provision even if such allegation is or may be groundless, fraudulent or false, which obligation arises at the time such claim is tendered to Tenant by City and continues at all times thereafter. Tenant's obligations under this Section shall survive the termination of the Lease.

20. INSURANCE

20.1 Tenant's Insurance

(a) During the Term, Tenant will carry, at its own cost and expense, the following insurance: (i) workers' compensation insurance that complies with applicable Laws; and (ii) commercial general liability ("**CGL**") insurance with respect to its activities on the Property, such insurance to afford protection of up to Five Million Dollars (\$5,000,000) per occurrence and Six Million Dollars (\$6,000,000) annual aggregate, based on Insurance Services Office (ISO) Form CG 00 01, or a substitute form, providing substantially equivalent coverage. Tenant's CGL insurance shall contain a provision including and naming the Indemnified Parties as additional insureds. Such additional insured coverage:

(i) shall be limited to bodily injury, property damage or personal and advertising injury caused, in whole or in part, by Tenant, its employees, agents or independent contractors;

(ii) shall not extend to claims for punitive or exemplary damages arising out of the acts or omissions of City, its employees, agents or independent contractors or where such coverage is prohibited by law or to claims arising out of the gross negligence of City, its employees, agents or independent contractors; and

(iii) shall not exceed Tenant's indemnification obligation under this Lease, if any.

(b) Notwithstanding the foregoing, Tenant shall have the right to self-insure the coverages required in subsection (a). In the event Tenant elects to self-insure its obligation to include City as an additional insured, the following provisions shall apply (in addition to those set forth in subsection (a)):

(i) City shall promptly and no later than thirty (30) days after notice thereof provide Tenant with written notice of any claim, demand, lawsuit, or the like for which it seeks coverage pursuant to this Section and provide Tenant with copies of any demands, notices, summonses, or legal papers received in connection with such claim, demand, lawsuit, or the like;

(ii) City shall not settle any such claim, demand, lawsuit, or the like without the prior written consent of Tenant; and

(iii) City shall cooperate with Tenant in the defense of the claim, demand, lawsuit, or the like by promptly providing information that is in City's possession and reasonably requested by Tenant for such defense, but City shall have no obligation to incur any costs or provide any services as part of such cooperation.

20.2 Tenant's Property

Tenant shall be responsible, at its sole expense, for separately insuring Tenant's Property.

20.3 City's Self Insurance

Tenant acknowledges that City self-insures against casualty, property damage and public liability risks and agrees that City may at its sole election, but shall not be required to, carry any third party insurance with respect to the Building, the Premises or otherwise.

20.4 Waiver of Subrogation Rights.

Notwithstanding anything to the contrary contained herein, City and Tenant (each a "**Waiving Party**") each hereby waives any right of recovery against the other party for any loss or damage sustained by such other party with respect to the Building or the Premises or any portion thereof or the contents of the same or any operation therein, whether or not such loss is caused by the fault or negligence of such other party, to the extent such loss or damage is covered by third party insurance which is required to be purchased by the Waiving Party under this Lease or is actually then carried by the Waiving Party. Each Waiving Party agrees to cause its third party insurers to issue appropriate waiver of subrogation rights endorsements to all policies relating to the Building or the Premises; provided, the failure to obtain any such endorsement shall not affect the above waiver.

21. LIMITATION OF CITY'S LIABILITY

21.1 Limitation on City's Liability

City shall not be responsible for or liable to Tenant, and Tenant hereby waives all Claims against City and its Agents and releases City and its Agents from, all Claims for any injury, loss or damage to any person or property in or about the Premises or any License Area created under this Lease by or from any cause whatsoever (other than to the extent caused by the active negligence or willful misconduct of City and its Agents), including, without limitation, acts or omissions of persons occupying adjoining premises or any part of the Building adjacent to or connected with the Premises; theft; burst, stopped or leaking water, gas, sewer or steam pipes; or gas, fire, oil or electricity in, on or about the Premises or the Building.

21.2 Consequential Damages

Tenant expressly acknowledges and agrees that the Rent payable hereunder does not take into account any potential liability of City for any consequential or incidental damages including, but not limited to, lost profits arising from the disruption to Tenant Improvements or the Tenant's Equipment. City would not be willing to enter into this Lease in the absence of a complete waiver of liability, to the fullest extent permitted by Law, for consequential or incidental damages due to the acts or omissions of City or its Agents, and Tenant expressly assumes the risk with respect thereto. Accordingly, without limiting any indemnification obligations of Tenant or other waivers contained in this Lease and as a material part of the consideration for this Lease, Tenant fully releases, waives and discharges forever any and all claims, demands, rights, and causes of action against City for consequential and incidental damages (including without limitation, lost profits) arising out of this Lease, including, without limitation, any interference with uses conducted by Tenant pursuant to this Lease, regardless of the cause, and whether or not due to the active or passive negligence or willful misconduct of City or its Agents, and covenants not to sue for such damages City, its departments, commissions, officers, directors and employees, and all persons acting by, through or under each of them.

21.3 No Relocation Assistance

This Lease creates no right in Tenant to receive any relocation assistance or payment for any reason under the Relocation Assistance Act (California Government Code Section 7260 et seq.), the Uniform Relocation Assistance Act (42 U.S.C. Section 4602 et seq.) as such acts may be amended or revised or under any existing or future law upon any termination of tenancy except as provided in Section 16 (Eminent Domain) hereof.

Tenant fully waives, releases and relinquishes forever any and all claims, demands, rights and causes of action that it may have against the city under any existing or future laws, for any compensation from City not otherwise provided for herein, upon any termination of tenancy hereunder.

In connection with the releases under Sections 21.1 (Limitation on City's Liability), 21.2 (Consequential Damages), and 21.3 (No Relocation Assistance), Tenant acknowledges that it is familiar with Section 1542 of the California Civil Code, which reads:

A GENERAL RELEASE DOES NOT EXTEND TO CLAIMS WHICH THE CREDITOR DOES NOT KNOW OR SUSPECT TO EXIST IN HIS OR HER FAVOR AT THE TIME OF EXECUTING THE RELEASE, WHICH IF KNOWN BY HIM OR HER MUST HAVE MATERIALLY AFFECTED HIS OR HER SETTLEMENT WITH THE DEBTOR.

Tenant acknowledges that the releases contained herein include all known and unknown, disclosed and undisclosed, anticipated and unanticipated claims. Tenant realizes and acknowledges that it has agreed upon this Lease in light of this realization and, being fully aware of this situation, it nevertheless intends to waive the benefit of Civil Code Section 1542, or any statute or other similar law now or later in effect. The releases contained herein shall survive any termination of this Lease.

22. ACCESS TO PREMISES

22.1 Tenant's Access to the Premises

City hereby grants to Tenant during the Term of this Lease and for the limited purposes and subject to the terms and conditions set forth below, a nonexclusive license in and over the following common areas of the Building to the Premises: areas providing physical access by personnel and equipment including ramps, loading docks, walkways, staircases, and ladders; and the roof of the elevator room on which Tenant's Equipment is installed as shown on

Exhibit A. Use of such common areas shall be subject to City's rights under Section 9 (City's Alterations of Building and Building Systems). The license granted to Tenant hereunder is for the sole purpose of constructing, maintaining, restoring, replacing and operating Tenant's Equipment located within the Premises and the Connecting Equipment in the License Area, including any necessary electrical and telephone conduits, in accordance with the use permitted under this Lease. Such rights shall include the right of ingress and egress through the Building during non-business hours for access to or from Tenant's Equipment located within the Premises or the Connecting Equipment located in the License Area, provided that Tenant shall notify City or a designee, as designated by City, at least twenty-four (24) hours in advance of any requested access and shall comply with the access requirements set forth in Exhibit E and any other reasonable requirements of such designated City person with respect to Tenant's requested access. In the event of an emergency, Tenant shall have the right to enter the Premises and the License Area provided it makes good faith efforts to notify City, or City's designated person, in advance of such entry. The foregoing license is irrevocable until this Lease expires or sooner terminates as provided herein.

22.2 City's Access to the Premises

City and its designated Agents shall have the right to enter the Premises at all reasonable times upon not less than twenty-four (24) hours advance notice (except in the event of an emergency) for any of the following purposes:

- (a) To determine whether the Premises are in good condition and to inspect the Premises;
- (b) To determine whether Tenant is in compliance with its obligations hereunder and to cure or attempt to cure any default in accordance with the provisions of Section 18.2 (Remedies) hereof;
- (c) To serve, post or keep posted any notices required or allowed under any provisions of this Lease or required under any applicable Law;
- (d) To do any maintenance or repairs to the Premises that City has the right or the obligation, if any, to perform hereunder; and
- (e) To show the Premises to any prospective purchasers, brokers, encumbrancers or officials, or, during the last year of the Term of this Lease, to exhibit the Premises to prospective tenants or other occupants, and to post any "for sale" or "for lease" signs in connection therewith.

22.3 Emergency Access

In the event of any emergency, as determined by City, City may, at its sole option and without notice (provided that City shall make reasonable efforts to provide Tenant with notice when feasible in light of the exigent circumstances) enter the Premises and alter or remove Tenant's Property on or about the Premises. City shall have the right to use any and all means City considers appropriate to gain access to any portion of the Premises in an emergency. In such case, City shall not be responsible for any damage or injury to any such property, nor for the replacement of any such property and any such emergency entry shall not be deemed to be a forcible or unlawful entry onto or a detainer of, the Premises, or any eviction, actual or constructive, of Tenant from the Premises or any portion thereof.

22.4 No Liability

City shall not be liable in any manner, and Tenant hereby waives any claims, for any inconvenience, disturbance, loss of business, nuisance or other damage arising out of City's entry onto the Premises, except damage resulting directly and exclusively from the gross negligence or willful misconduct of City or its Agents and not contributed to by the acts, omissions or

negligence of Tenant, its Agents or Invitees. During any City access to the Premises pursuant to this Section 22 (Access to Premises), City will not unreasonably (i) interfere with the Tenant's Equipment in any way; (ii) move or remove the Tenant's Equipment; (iii) disconnect the power or any other utilities or services serving the Tenant's Equipment; or (iv) make any repairs to the Tenant's Equipment. As soon as reasonably possible following any such action by City, City must notify Tenant orally and followed promptly by written notice, that City entered the Premises and describe the action taken by City at the Premises in default of its obligations under the foregoing sentence.

22.5 No Abatement

Tenant shall not be entitled to any abatement in Rent if City exercises any rights reserved in this Section 22.

22.6 Minimize Disruption

City shall use its reasonable good faith efforts to conduct any activities on the Premises allowed under this Section 22 in a manner that, to the extent practicable, will minimize any disruption to Tenant's use hereunder.

23. ESTOPPEL CERTIFICATES

Tenant, at any time and from time to time upon not less than ten (10) days' and after receipt of written notice from City, shall execute, acknowledge and deliver to City or to any party designated by City, a certificate of Tenant stating: (a) that Tenant has accepted the Premises (or, if Tenant has not done so, that Tenant has not accepted the Premises and specifying the reasons therefor), (b) the Commencement Date and Expiration Date of this Lease, (c) that this Lease is unmodified and in full force and effect (or, if there have been modifications, that the Lease is in full force and effect as modified and stating the modifications), (d) whether or not there are then existing any defenses against the enforcement of any of the obligations of Tenant under this Lease (and if so, specifying the same), (e) whether or not there are then existing obligations of City under this Lease (and if so specifying the same), (f) the dates, if any, to which the Base Rent and Additional Charges have been paid, and (g) any other information that may be requested by the City pertaining to the status of the Lease.

24. RULES AND REGULATIONS

Tenant shall faithfully comply with any and all reasonable rules, regulations and instructions, written or oral which may be established during the Term by City with respect to use of any part of the Building.

25. SECURITY DEPOSIT

Upon execution of this Lease, Tenant shall deposit with City the sum specified as the security deposit in the Basic Lease Information (the "**Security Deposit**"), in cash or by check, to secure Tenant's faithful performance of all terms, covenants and conditions of this Lease. Tenant agrees that City may (but shall not be required to) apply the Security Deposit in whole or in part to remedy any damage to the Premises caused by Tenant, its Agents or Invitees, or any failure of Tenant to perform any other terms, covenants or conditions in this Lease (including, but not limited to, the payment of Rent or other sum due hereunder either before or after a default), without waiving any of City's other rights and remedies under this Lease or under applicable Laws. Tenant waives the provisions of Section 1950.7 of the California Civil Code or any similar Laws now or hereafter in effect and agrees that Landlord may retain any portion of Security Deposit reasonably necessary to compensate Landlord for any foreseeable or unforeseeable loss or damage caused by the acts or omissions of Tenant, its Agents, or Invitees. Without limiting the foregoing, Tenant understands and agrees that Landlord may apply some or all of the Security Deposit to the payment of future Rent following a Tenant default.

If City uses any portion of the Security Deposit to cure any default by Tenant under this Lease, Tenant will immediately replenish the Security Deposit to the original amount within ten (10) business days following Tenant's receipt of a written request from the City for same accompanied by reasonable substantiation of the City's use of the Security Deposit or any portion thereof. If the Base Rent is increased under any of the provisions of this Lease, Tenant will increase the amount of the Security Deposit by the same amount. City's obligations with respect to the Security Deposit are solely that of debtor and not trustee. City shall not be required to keep the Security Deposit separate from its general funds, and Tenant shall not be entitled to interest on the Security Deposit. The amount of the Security Deposit shall in no way limit the liabilities of Tenant under any provision of this Lease. Provided Tenant is not in default under the Lease, City will return any remaining portion of the Security Deposit within the applicable period required under California law following the expiration or earlier termination of this Lease.

26. SURRENDER OF PREMISES

Upon the Expiration Date or other termination of this Lease, Tenant shall peaceably quit and surrender to City the Premises in good order and condition, normal wear and tear excepted, free of debris and hazards, after having made the last necessary repair required by Tenant under this Section (and damage caused by casualty or condemnation excepted). The Premises shall be surrendered free and clear of all liens and encumbrances caused by Tenant. Tenant shall, immediately before the Expiration Date or other termination of this Lease, remove all of Tenant's Property and repair any damage resulting from the removal; subject to City's exercise of its rights under Section 8.2 (Title to and Removal of Tenant's Equipment). Tenant's removal and repair work pursuant to this Section, if any, shall be performed (a) at Tenant's expense and at such time and, when required hereunder, in such manner as reasonably approved by City, which City approval shall not be unreasonably withheld, conditioned or delayed, (b) by duly licensed and bonded contractors or mechanics, (c) in a manner and using equipment and materials which will not interfere with or impair City's operations, use or occupation of the Building or the Building Systems, and (d) in accordance with any Building Rules and Regulations and all applicable Laws. Tenant's obligations under this Section shall survive the Expiration Date or other termination of this Lease. Any items of Tenant's Property which shall remain in the Premises after the Expiration Date of this Lease may, at the option of City, be deemed abandoned and in such case may be disposed of by City in accordance with Civil Code Section 1980 et seq. or any other manner allowed by law.

Concurrently with the surrender of the Premises as provided above, Tenant agrees, if requested by City, to execute, acknowledge and deliver to City a quitclaim deed to the Premises and any other instrument reasonably requested by City to evidence or otherwise effect the termination of Tenant's leasehold estate hereunder and to effect such transfer or vesting of title to the Tenant Improvements or other improvements or equipment which are to remain part of the Premises as provided herein.

27. HAZARDOUS MATERIALS

27.1 Definitions

As used herein, the following terms shall have the meanings set forth below:

(a) **"Environmental Laws"** shall mean any federal, state, local or administrative law, rule, regulation, order or requirement relating to industrial hygiene, environmental conditions or Hazardous Materials, whether now in effect or hereafter adopted.

(b) **"Hazardous Material"** shall mean any material that, because of its quantity, concentration or physical or chemical characteristics, is at any time now or hereafter deemed by any federal, state or local governmental authority to pose a present or potential hazard to human health, welfare or safety or to the environment. Hazardous Material includes, without

limitation, any material or substance defined as a "hazardous substance," or "pollutant" or "contaminant" pursuant to the Comprehensive Environmental Response, Compensation and Liability Act of 1980 ("CERCLA", also commonly known as the "Superfund" law), as amended, (42 U.S.C. Section 9601 et seq.) or pursuant to Section 25316 of the California Health & Safety Code; any "hazardous waste" listed pursuant to Section 25140 of the California Health & Safety Code; and petroleum, including crude oil or any fraction thereof, natural gas or natural gas liquids.

(c) **"Investigate and Remediate"** shall mean the undertaking of any activities to determine the nature and extent of Hazardous Material that may be located in, on, under or about the Premises, the Building and the real property upon which the Building is located and all other improvements and appurtenances to such real property (collectively, the "**Property**") or that has been, is being or threatens to be Released into the environment, and to clean up, remove, contain, treat, stabilize, monitor or otherwise control such Hazardous Material.

(d) **"Release"** when used with respect to Hazardous Material shall include any actual or imminent spilling, leaking, pumping, pouring, emitting, emptying, discharging, injecting, escaping, leaching, dumping, or disposing into or inside the Building, or in, on, under or about the Property or the environment.

27.2 Hazardous Materials in Premises

Tenant covenants and agrees that neither Tenant nor any of its Agents or Invitees shall cause or permit any Hazardous Material to be brought upon, kept, used, stored, generated, disposed of or Released in, on or about the Premises or any other part of the Property, or transported to or from the Property in violation of Environmental Laws, except that Tenant may use small quantities of Hazardous Materials, including backup batteries, as needed for backup power and routine cleaning and maintenance of Tenant's Equipment which are customarily used for backup power and routine cleaning and maintenance of such equipment and so long as all such materials are handled and used in compliance with Environmental Laws. Tenant shall immediately notify Landlord if and when Tenant learns or has reason to believe there has been any Release of Hazardous Material on or about the Premises or the Property.

27.3 Tenant's Environmental Indemnity

If Tenant breaches any of its obligations contained in this Section, or if any act, omission or negligence of Tenant or any of its Agents or Invitees results in any contamination of the Premises or any other part of the Property or in a Release of Hazardous Material from, on, about, in, or beneath any part of the Premises or the Property or the violation of any Environmental Law, then in any such event Tenant, on behalf of itself and its successors and assigns, shall Indemnify City, its Agents and Invitees, and their respective successors and assigns, and each of them, from and against any and all Claims (including, without limitation, damages for decrease in value of the Premises or the Property, the loss or restriction of the use of rentable or usable space or of any amenity of the Premises or the Property and sums paid in settlement of claims, attorneys' fees, consultants' fees and experts' fees) arising during or after the Term of this Lease relating to such Release or violation of Environmental Laws; provided, however, Tenant shall not be liable for any Claims to the extent such Release was caused by the active negligence or willful misconduct of City or its Agents. The foregoing Indemnity includes, without limitation, costs incurred in connection with any activities required to Investigate and Remediate any Hazardous Material brought onto the Premises or the Property by Tenant or any of its Agents or Invitees and to restore the Property to its condition prior to Tenant's introduction of such Hazardous Material or the correction of any violation of Environmental Laws. Tenant specifically acknowledges and agrees that it has an immediate and independent obligation to defend City and the other Indemnified Parties from any claim which actually or potentially falls within this indemnity provision even if such allegation is or may be groundless, fraudulent or false, which obligation arises at the time such claim is tendered to Tenant by City and continues at all times thereafter. Without limiting the foregoing, if Tenant or any of its Agents or Invitees

cause the Release of any Hazardous Material on , about, in, or beneath the Premises or Property, then in any such event Tenant shall, immediately, at no expense to City, take any and all necessary actions to return the Premises or the Property, as applicable, to the condition existing prior to the Release of any such Hazardous Materials on the Property or otherwise abate the Release in accordance with all Environmental Laws, except to the extent such Release was caused by the active negligence of City or its Agents. Tenant shall afford City a full opportunity to participate in any discussions with governmental regulatory agencies regarding any settlement agreement, cleanup or abatement agreement, consent decree, or other compromise or proceeding involving Hazardous Material.

28. SPECIAL PROVISIONS

28.1 Extension Option

(a) Options to Extend Term

(1) Subject to City's rights under Section 28.3 (City's Right to Terminate) and Section 28.5 (City's Protection Against Interference), City grants to Tenant two (2) options to extend the Term of this Lease (the "**Extension Option**"), each extension for an additional five (5) years (the "**Extended Term**"). This Lease shall automatically renew for the Extended Term upon the same terms and conditions unless Tenant notifies City in writing of Tenant's intention not to renew this Lease at least two hundred seventy (270) days prior to the then-scheduled expiration of the Term. Any such automatic exercise by Tenant shall be irrevocable by Tenant except as provided in Section 28.1(b) (Base Rent and Other Terms). If any monetary event of default by Tenant is outstanding hereunder beyond the applicable cure period on the date which is ninety (90) days prior to the expiration of the Term, then City may elect by notice to Tenant to reject Tenant's automatic exercise of the Extension Option, whereupon the Extension Option shall be null and void.

(2) Notwithstanding the foregoing, City and Tenant acknowledge and agree that the automatic exercise feature of the Extensions Options in Section 28.1(a)(1) is subject to the approval of both the Board of Supervisors and the Mayor of the City. If the Board of Supervisors and the Mayor adopt a resolution that authorizes City to execute this Lease, but does not expressly approve the automatic exercise feature of the Extension Options, then Tenant shall be required to notify City in writing of Tenant's intention to renew this Lease for the applicable Extended Term at least two hundred seventy (270) days prior to the then-scheduled expiration of the Term.

(b) Base Rent and Other Terms

If Tenant elects to exercise an Extension Option pursuant to the terms and conditions set forth in Section 28.1(a) above, then the lease for the Extended Term shall cover the entire Premises and shall be upon all of the terms, covenants and conditions of this Lease, except that upon the commencement of the Extended Term the Base Rent due and payable hereunder shall be increased by an amount equal to four percent (4%) over the Base Rent amount due during the year immediately preceding the Extended Term hereunder, notwithstanding Section 5.2 (Adjustments in Base Rent).

28.2 Tenant's Right to Terminate

In the event Tenant loses its permits necessary to operate the Communications Site due to reasons other than its failure to comply with the conditions of the permit and in spite of reasonable efforts by Tenant to maintain its permits, Tenant may terminate this Lease with ninety (90) days' prior written notice to City. The parties do not intend that Tenant's right to terminate be used to relocate to a better site.

28.3 City's Right to Terminate Due to Finding by Board of Supervisors

City shall have the right to terminate this Lease without penalty upon ninety (90) days' written notice to Tenant if, after notice and public hearing and a reasonable time (not to exceed sixty (60) days) for Tenant to effect a remedy, the San Francisco Board of Supervisors determines that Tenant's continued use of the Premises will adversely affect public health and safety.

28.4 City's Protection Against Interference

City shall not grant a lease for the Building if such use would materially adversely interfere with Tenant's normal operation of the Communications Site. Any such future lease of the Building to a third party that permits the installation of communication equipment shall be conditioned upon such tenant not causing measurable interference which materially impairs Tenant's ability to utilize the Premises for its intended purpose.

28.5 Tenant's Protection Against Interference

(a) Tenant will not permit its equipment or use of the Premises as a Communications Site to cause interference with or impairment of City's 911 Public Communications Safety System or Citywide 800 MHz Radio System or any other communication or computer equipment used by City or any of its Agents or tenants on the Property. Subject to City's obligations under Section 28.4 (City's Protection Against Interference), Tenant will not use the Premises or the Tenant's Equipment located on the Premises in any way which interferes with any existing use of the Building prior to this Lease or any future use of the Building by City or its successors (including, without limitation, City's use of the Building as a homeless shelter with related radio, telephone and other communications transmission and reception), and such interference shall be deemed a material breach of this Lease by Tenant, which shall, upon notice from City, be responsible for terminating such interference. In the event any such interference does not cease promptly, the parties acknowledge that continuing interference may cause irreparable injury and, therefore, City shall have the right (i) to bring an action to enjoin such interference and/or pursue any other remedy available at law or in equity to cause the interference to cease, other than the termination of the Lease, and, (ii) if such interference continues for more than two (2) consecutive days after Tenant's receipt of written notice from City, to cause Tenant's Equipment to temporarily cease operation by means of operating a power shut-off or other equipment shut-off device pursuant to standing instructions provided by Tenant, in which event City shall immediately notify Tenant's representative as noted in this Lease that a shut-off of Tenant's Equipment has occurred.

(b) If City plans to make any Alteration to the Building or change in the nature of City's use of the Building during the Term that is reasonably anticipated to result in measurable interference which materially and adversely impairs Tenant's normal operation of Tenant's Equipment located on the Premises, and as a result of such interference, it would be necessary to either (1) alter all or any portion of the Tenant's Equipment located in the Premises, or (2) to relocate all or any portion of Tenant's Equipment located in any portion of the Premises (each such alteration and relocation is referred to as an "Interference Change"), then City shall notify Tenant in writing ("Change Notice") as far as reasonably possible in advance of the implementation of an Interference Change, but in no event (absent a bona fide emergency) less than one hundred and eighty (180) days in advance of the date that City reasonably anticipates the need to commence the work required. In the event of a bona fide emergency, City shall provide the Change Notice as much in advance as is reasonably practicable in light of the existence of the bona fide emergency. Following Tenant's receipt of a Change Notice from City or Tenant's delivery of written notice to City that an Interference Change has occurred or appears to be imminent, City and Tenant shall (i) promptly and reasonably communicate and cooperate with reasonable diligence and continuity to identify (A) the alterations of Tenant's Equipment on the Premises that may be required in light of the Interference Change, and/or (B) an alternate location of comparable size in and/or on the Building ("Relocation Premises") to

which the affected portion(s) of Tenant's Equipment may be relocated, so that Tenant's Equipment, following any such alterations and/or relocation to the Relocation Premises, will provide reasonably comparable operational coverage, capacity and service to Tenant's customers based on a reasonable and objective evaluation of the technical performance of Tenant's Equipment. As part of the communication/cooperation process with City, Tenant shall provide City with a written description of the work and a good faith cost estimate concerning Tenant's Equipment and/or the Building that would be required to effect the necessary alterations and/or relocation, for City's review and approval, which approval shall not be unreasonably withheld, conditioned or delayed.

(c) If Tenant elects to make such alterations to Tenant's Equipment in the Premises and/or to relocate Tenant's Equipment to the Relocation Premises due to an Interference Change, then such work shall be at Tenant's sole cost and expense, provided, however, that Tenant shall have the right to offset the actual, documented cost incurred by Tenant to complete such alterations or relocation of Tenant's Equipment against Base Rent as it comes due, up to a maximum amount equal to the lesser of (i) the cost estimate contained in Tenant's notice to City described above or (ii) Ten Thousand and No/100 Dollars (\$10,000.00).

(d) If Tenant determines, in Tenant's sole discretion, that making the necessary alterations to Tenant's Equipment in the Premises and/or completing the necessary relocation of Tenant's Equipment to the Relocation Premises for an Interference Change are infeasible for either technological and/or economic reasons, then in lieu of undertaking the necessary alterations to Tenant's Equipment and/or completing the relocation of Tenant's Equipment to the Relocation Premises, Tenant shall have the right to terminate the Lease without further liability upon written notice to City.

(e) In the event that after compliance by City and Tenant with the process identified in Section 28.5(b) to address and resolve the Interference Change, City is unable, after using reasonable efforts to do so, to identify Relocation Premises in the Building that would be available to resolve the Interference Change, then City shall have the right to terminate the Lease upon written notice to Tenant to accomplish the City's paramount purpose of undertaking an Alteration to the Building or change in the nature of City's use of the Building during the Term that is reasonably anticipated to result in an Interference Change.

29. GENERAL PROVISIONS

29.1 Notices

Any notice given under this Lease shall be effective only if in writing and given by delivering the notice in person, by sending it first class mail or certified mail with a return receipt requested or overnight mail, return receipt requested, with postage prepaid, to: (a) Tenant at Tenant's address set forth in the Basic Lease Information, or at any place where Tenant or any agent, officer or employee of Tenant may be personally served if sent subsequent to Tenant's vacating, deserting, abandoning or surrendering the Premises; or (b) Landlord at City's address set forth in the Basic Lease Information; or (c) to such other address as either City or Tenant may designate as its new address for such purpose by notice given to the other in accordance with the provisions of this Section. All notices hereunder shall be deemed to have been given or received five (5) days after the date when it shall have been deposited with the U.S. Post Office if sent by first class or certified mail, or the next business day following deposit with an overnight courier service, or upon the date personal delivery is made. Neither party may give official or binding notice by facsimile.

29.2 No Implied Waiver

No failure by either party to insist upon the strict performance of any obligation of the other under this Lease or to exercise any right, power or remedy arising out of a breach thereof, irrespective of the length of time for which such failure continues, shall constitute a waiver of

such breach. No acceptance by any Agent of City of full or partial Base Rent or Additional Charges during the continuance of any such breach, and no acceptance of the keys to or possession of the Premises prior to the expiration of the Term by any Agent of City, shall constitute a waiver of such breach or of City's right to demand strict compliance with such term, covenant or condition or operate as a surrender of this Lease. No express written waiver by either party of any default or the performance of any provision hereof shall affect any other default or performance, or cover any other period of time, other than the default, performance or period of time specified in such express waiver. One or more written waivers of a default or the performance of any provision hereof by either party shall not be deemed to be a waiver of a subsequent default or performance. The consent of City given in any instance under the terms of this Lease shall not relieve Tenant of any obligation to secure the consent of City in any other or future instance under the terms of this Lease.

29.3 Amendments

Neither this Lease nor any term or provisions hereof may be changed, waived, discharged or terminated orally, and no breach thereof shall be waived, altered or modified, except by a written instrument signed by both parties hereto.

29.4 Authority

If Tenant signs as a corporation or a partnership, each of the persons executing this Lease on behalf of Tenant does hereby covenant and warrant that Tenant is a duly authorized and existing entity, that Tenant is qualified to do business in California, that Tenant has full right and authority to enter into this Lease, and that each and all of the persons signing on behalf of Tenant are authorized to do so. Upon City's request, Tenant shall provide City with evidence reasonably satisfactory to City confirming the foregoing covenants and warranties.

29.5 Interpretation of Lease

The words "City" or "Landlord" and "Tenant" as used herein shall include the plural as well as the singular. If there is more than one Tenant, the obligations and liabilities under this Lease imposed on Tenant shall be joint and several. As used herein, the term "Agents" when used with respect to either party shall include the agents, employees, officers, contractors, subcontractors and representatives of such party, and the term "Invitees" when used with respect to either party shall include the clients, customers, invited guests, licensees, assignees or subtenants of such party. The captions preceding the articles and sections of this Lease and in the table of contents have been inserted for convenience of reference and such captions in no way define or limit the scope or intent of any provision of this Lease. This Lease has been negotiated at arm's length and between persons sophisticated and knowledgeable in the matters dealt with herein. Provisions in this Lease relating to number of days shall be calendar days, unless otherwise specified, provided that if the last day of any period to give notice, reply to a notice or to undertake any other action occurs on a Saturday, Sunday or a bank or City holiday, then the last day for undertaking the action or giving or replying to the notice shall be the next succeeding business day. All approvals, consents or other determinations permitted or required by City hereunder shall be made by or through City's Director of Property or his or her designee unless otherwise provided in this Lease, by City's Charter or City Ordinance.

29.6 Successors and Assigns

The terms, covenants and conditions contained in this Lease shall bind and inure to the benefit of City and Tenant and, except as otherwise provided herein, their personal representatives and successors and assigns; provided, however, that upon the sale, assignment or transfer by City named herein (or by any subsequent landlord) of its interest in the Building as owner or lessee, including any transfer by operation of law, City (or any subsequent landlord) shall be relieved from all subsequent obligations and liabilities arising under this Lease subsequent to such sale, assignment or transfer.

29.7 Brokers

Neither party has had any contact or dealings regarding the leasing of the Premises, or any communication in connection therewith, through any licensed real estate broker or other person who could claim a right to a commission or finder's fee in connection with this Lease except as identified in the Basic Lease Information, whose commission, if any is due, shall be paid pursuant to a separate written agreement between such broker and the party through which such broker contracted. In the event that any broker or finder perfects a claim for a commission or finder's fee based upon any such contact, dealings or communication in connection with the lease contemplated herein, the party through whom the broker or finder makes his claim shall be responsible for such commission or fee and shall indemnify and hold harmless the other party from all claims, costs, and expenses (including, without limitation, reasonable attorneys' fees and disbursements) incurred by the indemnified party in defending against the same. The provisions of this Section shall survive any termination of this Lease.

29.8 Severability

If any provision of this Lease or the application thereof to any person, entity or circumstance shall, to any extent, be invalid or unenforceable, the remainder of this Lease, or the application of such provision to persons, entities or circumstances other than those as to which it is invalid or unenforceable, shall not be affected thereby, and to each provision of this Lease shall be valid and be enforced to the full extent permitted by law.

29.9 Governing Law

This Lease shall be construed and enforced in accordance with the laws of the State of California and City's Charter.

29.10 Entire Agreement

This instrument, including the exhibits hereto, which are made a part of this Lease, contains the entire agreement between the parties and all prior written or oral negotiations, understandings and agreements are merged herein. The parties further intend that this Lease shall constitute the complete and exclusive statement of its terms and that no extrinsic evidence whatsoever (including prior drafts hereof and changes therefrom) may be introduced in any judicial, administrative or other legal proceeding involving this Lease. Tenant hereby acknowledges that neither City nor City's Agents have made any representations or warranties with respect to the Premises, the Building or this Lease except as expressly set forth herein, and no rights, easements or licenses are or shall be acquired by Tenant by implication or otherwise unless expressly set forth herein.

29.11 Attorneys' Fee

In the event that either City or Tenant fails to perform any of its obligations under this Lease or in the event a dispute arises concerning the meaning or interpretation of any provision of this Lease, the defaulting party or the non-prevailing party in such dispute, as the case may be, shall pay the prevailing party reasonable attorneys' and experts' fees and costs, and all court costs and other costs of action incurred by the prevailing party in connection with the prosecution or defense of such action and enforcing or establishing its rights hereunder (whether or not such action is prosecuted to a judgment). For purposes of this Lease, reasonable attorneys' fees of the City's Office of the City Attorney shall be based on the fees regularly charged by private attorneys with the equivalent number of years of experience in the subject matter area of the law for which the City Attorney's services were rendered who practice in the City of San Francisco in law firms with approximately the same number of attorneys as employed by the Office of the City Attorney. The term "attorneys' fees" shall also include, without limitation, all such fees incurred with respect to appeals, mediations, arbitrations, and bankruptcy proceedings, and whether or not any action is brought with respect to the matter for which such fees were incurred.

The term "costs" shall mean the costs and expenses of counsel to the parties, which may include printing, duplicating and other expenses, air freight charges, hiring of experts, and fees billed for law clerks, paralegals, and others not admitted to the bar but performing services under the supervision of an attorney.

29.12 Holding Over

Any holding over after the expiration of the Term with the express consent of City shall be construed to automatically extend the Term of this Lease for a period of one (1) year at a Base Rent equal to one hundred fifty percent (150%) of the latest Base Rent payable by Tenant hereunder prior to such expiration, and shall otherwise be on the terms and conditions herein specified so far as applicable (except for those pertaining to the Term and any Extension Options). Any holding over without City's consent shall constitute a default by Tenant and entitle City to exercise any or all of its remedies as provided herein, notwithstanding that City may elect to accept one or more payments of Base Rent and Additional Charges from Tenant.

29.13 Time of Essence

Time is of the essence with respect to all provisions of this Lease in which a definite time for performance is specified.

29.14 Cumulative Remedies

All rights and remedies of either party hereto set forth in this Lease shall be cumulative, except as may otherwise be provided herein.

29.15 Survival of Indemnities

Termination of this Lease shall not affect the right of either party to enforce any and all indemnities and representations and warranties given or made to the other party under this Lease, nor shall it affect any provision of this Lease that expressly states it shall survive termination hereof.

29.16 Signs

Tenant agrees that it will not erect or maintain, or permit to be erected or maintained, any signs, notices or graphics upon or about the Premises which are visible in or from public corridors or other portions of any common areas of the Building or from the exterior of the Premises, without obtaining the prior written consent and approval of City, which City may withhold or grant in its sole discretion.

29.17 Light and Air

Tenant covenants and agrees that no diminution of light, air or view by any structure that may hereafter be erected (whether or not by City) shall entitle Tenant to any reduction of the Base Rent or Additional Charges under this Lease, result in any liability of City to Tenant, or in any other way affect this Lease or Tenant's obligations hereunder, except as described in Section 28.4 (City's Protection Against Interference).

29.18 Recording

Tenant agrees that it shall not record this Lease nor any memorandum or short form hereof in the Official Records of the City and County of San Francisco.

29.19 Taxes, Assessments, Licenses, Permit Fees and Liens

(a) Tenant recognizes and understands that this Lease may create a possessory interest subject to property taxation and that Tenant may be subject to the payment of property taxes levied on such interest. Tenant further recognizes and understands that any sublease or assignment permitted under this Lease and any exercise of any option to renew or extend this Lease may constitute a change in ownership for purposes of property taxation and therefore may result in a revaluation of any possessory interest created hereunder.

(b) Tenant agrees to pay taxes of any kind, including possessory interest taxes, that may be lawfully assessed on the leasehold interest hereby created and to pay all other taxes, excises, licenses, permit charges and assessments based on Tenant's usage of the Premises that may be imposed upon Tenant by law, all of which shall be paid when the same become due and payable and before delinquency. Tenant agrees not to allow or suffer a lien for any such taxes to be imposed upon the Premises or upon any equipment or property located thereon without promptly discharging the same, provided that Tenant, if so desiring, may have reasonable opportunity to contest the validity of the same.

(c) San Francisco Administrative Code Sections 23.38 and 23.39 require that City report certain information relating to the creation, renewal, extension, assignment, sublease, or other transfer of this Lease to the County Assessor within sixty (60) days after any such transaction, and that Tenant report certain information relating to such matters to City within sixty (60) days after the applicable transaction. Tenant agrees to provide such information as may be requested by City to enable the City to comply with this requirement.

29.20 Non-Liability of City Officials, Employees and Agents

No elective or appointive board, commission, member, officer, employee or agent of City shall be personally liable to Tenant, its successors and assigns, in the event of any default or breach by City or for any amount which may become due to Tenant, its successors and assigns, or for any obligation of City under this Lease.

29.21 Prevailing Wages and Local Hiring Requirements

(a) Any undefined, initially-capitalized term used in this subsection shall have the meaning given to such term in San Francisco Administrative Code Section 23.61. Tenant shall require its Contractors and Subcontractors performing (i) labor in connection with a "public work" as defined under California Labor Code Section 1720 *et seq.* (which includes certain construction, alteration, maintenance, demolition, installation, repair, carpet laying, or refuse hauling work if paid for in whole or part out of public funds) or (ii) Covered Construction, at the Premises to (1) pay workers performing such work not less than the Prevailing Rate of Wages, (2) provide the same hours, working conditions and benefits as in each case are provided for similar work performed in San Francisco County, and (3) employ Apprentices in accordance with San Francisco Administrative Code Section 23.61 (collectively, "Prevailing Wage Requirements"). Tenant agrees to cooperate with the City in any action or proceeding against a Contractor or Subcontractor that fails to comply with the Prevailing Wage Requirements.

Tenant shall include, and shall require its subtenants, and Contractors and Subcontractors (regardless of tier) to include, the Prevailing Wage Requirements and the agreement to cooperate in City enforcement actions in any Construction Contract with specific reference to San Francisco Administrative Code Section 23.61. Each such Construction Contract shall name the City and County of San Francisco, affected workers, and employee organizations formally representing affected workers as third party beneficiaries for the limited purpose of enforcing the Prevailing Wage Requirements, including the right to file charges and seek penalties against any Contractor or Subcontractor in accordance with San Francisco Administrative Code Section 23.61. Tenant's failure to comply with its obligations under this Section shall constitute a material breach of this Lease. A Contractor's or Subcontractor's failure to comply with this Section will enable the City to seek the remedies specified in San Francisco Administrative Code Section 23.61 against the breaching party. For the current

Prevailing Rate of Wages, see www.sfgov.org/olse/prevailingwages or call the City's Office of Labor Standard Enforcement at 415-554-6235.

(b) Any undefined, initially-capitalized term used in this subsection shall have the meaning given to such term in San Francisco Administrative Code Section 23.62 (the "Local Hiring Requirements"). Improvements and Alterations are subject to the Local Hiring Requirements unless the cost for such work is (i) estimated to be less than \$750,000 per building permit or (ii) meets any of the other exemptions in the Local Hiring Requirements. Tenant agrees that it shall comply with the Local Hiring Requirements to the extent applicable. Before starting any Tenant Improvement Work or any Alteration, Tenant shall contact City's Office of Economic Workforce and Development ("OEWD") to verify if the Local Hiring Requirements apply to the work (i.e., whether the work is a "Covered Project").

Tenant shall include, and shall require its subtenants to include, a requirement to comply with the Local Hiring Requirements in any contract for a Covered Project with specific reference to San Francisco Administrative Code Section 23.62. Each such contract shall name the City and County of San Francisco as a third party beneficiary for the limited purpose of enforcing the Local Hiring Requirements, including the right to file charges and seek penalties. Tenant shall cooperate, and require its subtenants to cooperate, with the City in any action or proceeding against a contractor or subcontractor that fails to comply with the Local Hiring Requirements when required. Tenant's failure to comply with its obligations under this subsection shall constitute a material breach of this Lease. A contractor's or subcontractor's failure to comply with this Section will enable the City to seek the remedies specified in San Francisco Administrative Code Section 23.62 against the breaching party.

29.22 Non-Discrimination in City Contracts and Benefits Ordinance.

(a) Covenant Not to Discriminate

In the performance of this Lease, Tenant agrees not to discriminate against any employee of, any City employee working with Tenant, or applicant for employment with Tenant, or against any person seeking accommodations, advantages, facilities, privileges, services, or membership in all business, social, or other establishments or organizations, on the basis of the fact or perception of a person's race, color, creed, religion, national origin, ancestry, age, height, weight, sex, sexual orientation, gender identity, domestic partner status, marital status, disability or Acquired Immune Deficiency Syndrome or HIV status (AIDS/HIV status), or association with members of such protected classes, or in retaliation for opposition to discrimination against such classes.

Tenant further acknowledges that the Americans with Disabilities Act requires that programs, services and other activities provided by a public entity to the public, whether directly or through a contractor, must be accessible to the disabled public. Subject to Section 13.1 (Compliance with Laws) hereof, Tenant acknowledges its obligation to comply with such Act and any other federal, state or local disability rights legislation. Tenant warrants that it will fulfill that obligation. Tenant also warrants that it will not discriminate against disabled persons in the provision of services, benefits or activities.

(b) Subleases and Other Subcontracts

Tenant shall include in all Subleases and other subcontracts relating to the Premises a non-discrimination clause applicable to such Subtenant or other subcontractor in substantially the form of Subsection (a) above. In addition, Tenant shall incorporate by reference in all subleases and other subcontracts the provisions of Sections 12B.2(a), 12B.2(c)-(k), and 12C.3 of the San Francisco Administrative Code and shall require all subtenants and other subcontractors to comply with such provisions. Tenant's failure to comply with the obligations in this Subsection shall constitute a material breach of this Lease.

(c) Non-Discrimination in Benefits

Tenant does not as of the date of this Lease and will not during the term of this Lease, in any of its operations in San Francisco, on real property owned by City, or where the work is being performed for the City or elsewhere within the United States, discriminate in the provision of bereavement leave, family medical leave, health benefits, membership or membership discounts, moving expenses, pension and retirement benefits or travel benefits, as well as any benefits other than the benefits specified above, between employees with domestic partners and employees with spouses, and/or between the domestic partners and spouses of such employees, where the domestic partnership has been registered with a governmental entity pursuant to state or local law authorizing such registration, subject to the conditions set forth in Section 12B.2(b) of the San Francisco Administrative Code.

(d) CMD Form

As a condition to this Lease, Tenant shall execute the "Chapter 12B Declaration: Nondiscrimination in Contracts and Benefits" form (Form CMD-12B-101) with supporting documentation and secure the approval of the form by the San Francisco Contract Monitoring Division ("CMD"). Tenant hereby represents that prior to execution of this Lease, (i) Tenant executed and submitted Form CMD-12B-101 with supporting documentation to the CMD, and (ii) the CMD approved such form.

(e) Incorporation of Administrative Code Provisions by Reference

The provisions of Chapters 12B and 12C of the San Francisco Administrative Code relating to non-discrimination by parties contracting for the lease of City property are incorporated in this Section by reference and made a part of this Lease as though fully set forth herein. Tenant shall comply fully with and be bound by all of the provisions that apply to this Lease under such Chapters of the Administrative Code, including but not limited to the remedies provided in such Chapters. Without limiting the foregoing, Tenant understands that pursuant to Section 12B.2(h) of the San Francisco Administrative Code, a penalty of Fifty Dollars (\$50) for each person for each calendar day during which such person was discriminated against in violation of the provisions of this Lease may be assessed against Tenant and/or deducted from any payments due Tenant.

29.23 Requiring Health Benefits for Covered Employees

Unless exempt, Tenant agrees to comply fully with and be bound by all of the provisions of the Health Care Accountability Ordinance (HCAO), as set forth in San Francisco Administrative Code Chapter 12Q, including the remedies provided, and implementing regulations, as the same may be amended from time to time. The provisions of Chapter 12Q are incorporated herein by reference and made a part of this Lease as though fully set forth. The text of the HCAO is available on the web at <http://www.sfgov.org/olse/hcao>. Capitalized terms used in this Section and not defined in this Lease shall have the meanings assigned to such terms in Chapter 12Q.

(a) For each Covered Employee, Tenant shall provide the appropriate health benefit set forth in Section 12Q.3 of the HCAO. If Tenant chooses to offer the health plan option, such health plan shall meet the minimum standards set forth by the San Francisco Health Commission.

(b) Notwithstanding the above, if the Tenant is a small business as defined in Section 12Q.3(d) of the HCAO, it shall have no obligation to comply with Subsection (a) above.

(c) Tenant's failure to comply with the HCAO shall constitute a material breach of this Lease. City shall notify Tenant if such a breach has occurred. If, within thirty (30) days after receiving City's written notice of a breach of this Lease for violating the HCAO, Tenant fails to cure such breach or, if such breach cannot reasonably be cured within such period of thirty (30)

days, Tenant fails to commence efforts to cure within such period, or thereafter fails diligently to pursue such cure to completion, City shall have the right to pursue the remedies set forth in Section 12Q.5(f)(1-5). Each of these remedies shall be exercisable individually or in combination with any other rights or remedies available to City.

(d) Any Subcontract entered into by Tenant shall require the Subcontractor to comply with the requirements of the HCAO and shall contain contractual obligations substantially the same as those set forth in this Section. Tenant shall notify City's Purchasing Department when it enters into such a Subcontract and shall certify to the Purchasing Department that it has notified the Subcontractor of the obligations under the HCAO and has imposed the requirements of the HCAO on Subcontractor through the Subcontract. Each Tenant shall be responsible for its Subcontractors' compliance with this Chapter. If a Subcontractor fails to comply, the City may pursue the remedies set forth in this Section against Tenant based on the Subcontractor's failure to comply, provided that City has first provided Tenant with notice and an opportunity to obtain a cure of the violation.

(e) Tenant shall not discharge, reduce in compensation, or otherwise discriminate against any employee for notifying City with regard to Tenant's compliance or anticipated compliance with the requirements of the HCAO, for opposing any practice proscribed by the HCAO, for participating in proceedings related to the HCAO, or for seeking to assert or enforce any rights under the HCAO by any lawful means.

(f) Tenant represents and warrants that it is not an entity that was set up, or is being used, for the purpose of evading the intent of the HCAO.

(g) Tenant shall keep itself informed of the current requirements of the HCAO.

(h) Tenant shall provide reports to the City in accordance with any reporting standards promulgated by the City under the HCAO, including reports on Subcontractors and Subtenants, as applicable.

(i) Tenant shall provide City with access to records pertaining to compliance with HCAO after receiving a written request from City to do so and being provided at least five (5) business days to respond.

(j) City may conduct random audits of Tenant to ascertain its compliance with HCAO. Tenant agrees to cooperate with City when it conducts such audits.

(k) If Tenant is exempt from the HCAO when this Lease is executed because its amount is less than Twenty-Five Thousand Dollars (\$25,000), but Tenant later enters into an agreement or agreements that cause Tenant's aggregate amount of all agreements with City to reach Seventy-Five Thousand Dollars (\$75,000), all the agreements shall be thereafter subject to the HCAO. This obligation arises on the effective date of the agreement that causes the cumulative amount of agreements between Tenant and the Contracting Department to be equal to or greater than Seventy-Five Thousand Dollars (\$75,000) in the fiscal year.

29.24 MacBride Principles - Northern Ireland

The City and County of San Francisco urges companies doing business in Northern Ireland to move toward resolving employment inequities and encourages them to abide by the MacBride Principles as expressed in San Francisco Administrative Code Section 12F.1 et seq. The City and County of San Francisco also urges San Francisco companies to do business with corporations that abide by the MacBride Principles. Tenant acknowledges that it has read and understands the above statement of the City and County of San Francisco concerning doing business in Northern Ireland.

29.25 Drug-Free Workplace

Tenant acknowledges that pursuant to the Federal Drug-Free Workplace Act of 1989, the unlawful manufacture, distribution, possession or use of a controlled substance is prohibited on City premises. Tenant agrees that any violation of this prohibition by Tenant, its employees, agents or assigns shall be deemed a material breach of this Lease.

29.26 Tropical Hardwood and Virgin Redwood Ban

The City and County of San Francisco urges companies not to import, purchase, obtain or use for any purpose, any tropical hardwood or tropical hardwood wood product, virgin redwood or virgin redwood wood product except as expressly provided by the application of Sections 802(b) and 803(b) of the San Francisco Environment Code.

29.27 Restrictions on the Use of Pesticides

Chapter 3 of the San Francisco Environment Code (the Integrated Pest Management Program Ordinance or "IPM Ordinance") describes an integrated pest management ("IPM") policy to be implemented by all City departments. Tenant shall not use or apply or allow the use or application of any pesticides on the Premises or contract with any party to provide pest abatement or control services to the Premises without first receiving City's written approval of an IPM plan that (i) lists, to the extent reasonably possible, the types and estimated quantities of pesticides that Tenant may need to apply to the Premises during the term of this Lease, (ii) describes the steps Tenant will take to meet the City's IPM Policy described in Section 300 of the IPM Ordinance, and (iii) identifies, by name, title, address and telephone number, an individual to act as the Tenant's primary IPM contact person with the City. Tenant shall comply, and shall require all of Tenant's contractors to comply, with the IPM plan approved by the City and shall comply with the requirements of Sections 300(d), 302, 304, 305(f), 305(g), and 306 of the IPM Ordinance, as if Tenant were a City department. Among other matters, such provisions of the IPM Ordinance: (a) provide for the use of pesticides only as a last resort, (b) prohibit the use or application of pesticides on property owned by the City, except for pesticides granted an exemption under Section 303 of the IPM Ordinance (including pesticides included on the most current Reduced Risk Pesticide List compiled by City's Department of the Environment), (c) impose certain notice requirements, and (d) require Tenant to keep certain records and to report to City all pesticide use at the Premises by Tenant's staff or contractors.

If Tenant or Tenant's contractor will apply pesticides to outdoor areas at the Premises, Tenant must first obtain a written recommendation from a person holding a valid Agricultural Pest Control Advisor license issued by the California Department of Pesticide Regulation ("CDPR") and any such pesticide application shall be made only by or under the supervision of a person holding a valid, CDPR-issued Qualified Applicator certificate or Qualified Applicator license. City's current Reduced Risk Pesticide List and additional details about pest management on City property can be found at the San Francisco Department of the Environment website, <http://sfenvironment.org/ipm>.

29.28 Prohibition of Tobacco Sales and Advertising

Tenant acknowledges and agrees that no advertising or sale of cigarettes or tobacco products is allowed on the Premises. This advertising prohibition includes the placement of the name of a company producing cigarettes or tobacco products or the name of any cigarette or tobacco product in any promotion of any event or product.

29.29 Prohibition of Alcoholic Beverage Advertising

Tenant acknowledges and agrees that no advertising or sale of alcoholic beverages is allowed on the Premises. For purposes of this section, "alcoholic beverage" shall be defined as set forth in California Business and Professions Code Section 23004, and shall not include

cleaning solutions, medical supplies and other products and substances not intended for drinking. This advertising prohibition includes the placement of the name of a company producing alcoholic beverages or the name of any alcoholic beverage in any promotion of any event or product.

29.30 Preservative-Treated Wood Containing Arsenic

Tenant may not purchase preservative-treated wood products containing arsenic in the performance of this Lease unless an exemption from the requirements of Environment Code Chapter 13 is obtained from the Department of Environment under Section 1304 of the Environment Code. The term "preservative-treated wood containing arsenic" shall mean wood treated with a preservative that contains arsenic, elemental arsenic, or an arsenic copper combination, including, but not limited to, chromated copper arsenate preservative, ammoniac copper zinc arsenate preservative, or ammoniacal copper arsenate preservative. Tenant may purchase preservative-treated wood products on the list of environmentally preferable alternatives prepared and adopted by the Department of Environment. This provision does not preclude Tenant from purchasing preservative-treated wood containing arsenic for saltwater immersion. The term "saltwater immersion" shall mean a pressure-treated wood that is used for construction purposes or facilities that are partially or totally immersed in saltwater.

29.31 Conflicts of Interest

Through its execution of this Lease, Tenant acknowledges that it is familiar with the provisions of Article III, Chapter 2 of City's Campaign and Governmental Conduct Code, and Section 87100 et seq. and Section 1090 et seq. of the Government Code of the State of California, and certifies that it does not know of any facts which would constitute a violation of said provisions, and agrees that if Tenant becomes aware of any such fact during the term of this Lease, Tenant shall immediately notify the City.

29.32 Notification of Limitations on Contributions

For the purposes of this Section, a "City Contractor" is a party that contracts with, or seeks to contract with, the City for the sale or leasing of any land or building to or from the City whenever such transaction would require the approval by a City elective officer, the board on which that City elective officer serves, or a board on which an appointee of that individual serves. Through its execution of this Agreement, Tenant acknowledges that it is familiar with Section 1.126 of the San Francisco Campaign and Governmental Conduct Code, which prohibits a City Contractor from making any campaign contribution to (1) the City elective officer, (2) a candidate for the office held by such individual, or (3) a committee controlled by such individual or candidate, at any time from the commencement of negotiations for the contract until the later of either the termination of negotiations for that contract or twelve (12) months after the date that contract is approved. Tenant acknowledges that the foregoing restriction applies only if the contract or a combination or series of contracts approved by the same individual or board in a fiscal year have a total anticipated or actual value of \$100,000 or more. Tenant further acknowledges that (i) the prohibition on contributions applies to Tenant, each member of Tenant's board of directors, Tenant's chief executive officer, chief financial officer and chief operating officer, any person with an ownership interest of more than ten percent (10%) in Tenant, any subcontractor listed in the contract, and any committee that is sponsored or controlled by Tenant, and (ii) within thirty (30) days of the submission of a proposal for the contract, the City department seeking to enter into the contract must notify the Ethics Commission of the parties and any subcontractor to the contract. Additionally, Tenant certifies it has informed each of the persons described in the preceding sentence of the prohibitions contained in Section 1.126 by the time it submitted a proposal for the contract to the City, and has provided the names of the persons required to be informed to the City department seeking to enter into that contract within thirty (30) days of submitting its contract proposal to the City department receiving that submittal, and acknowledges the City department receiving that submittal was required to notify the Ethics Commission of those persons.

29.33 Sunshine Ordinance

In accordance with Section 67.24(e) of the San Francisco Administrative Code, contracts, contractors' bids, leases, agreements, responses to Requests for Proposals, and all other records of communications between City and persons or firms seeking contracts will be open to inspection immediately after a contract has been awarded. Nothing in this provision requires the disclosure of a private person's or organization's net worth or other proprietary financial data submitted for qualification for a contract, lease, agreement or other benefit until and unless that person or organization is awarded the contract, lease, agreement or benefit. Information provided which is covered by this Section will be made available to the public upon request.

29.34 Food Service and Packaging Waste Reduction

Tenant agrees to comply fully with and be bound by all of the provisions of the Food Service and Packaging Waste Reduction Ordinance, as set forth in the San Francisco Environment Code, Chapter 16, including the remedies provided therein, and implementing guidelines and rules. The provisions of Chapter 16 are incorporated herein by reference and made a part of this Lease as though fully set forth herein. Tenant acknowledges that City lessees may not use Disposable Food Service Ware that contains Polystyrene Foam in City Facilities and while performing under a City lease, and shall instead use suitable Biodegradable/Compostable or Recyclable Disposable Food Service Ware. This provision is a material term of this Lease. By entering into this Lease, Tenant agrees that if it breaches this provision, City will suffer actual damages that will be impractical or extremely difficult to determine. Without limiting City's other rights and remedies, Tenant agrees that the sum of One Hundred Dollars (\$100.00) liquidated damages for the first breach, Two Hundred Dollars (\$200.00) liquidated damages for the second breach in the same year, and Five Hundred Dollars (\$500.00) liquidated damages for subsequent breaches in the same year is a reasonable estimate of the damage that City will incur based on the violation, established in light of the circumstances existing at the time this Lease was made. Such amounts shall not be considered a penalty, but rather agreed monetary damages sustained by City because of Tenant's failure to comply with this provision.

29.35 Compliance with San Francisco Business and Tax Regulations Code

Tenant acknowledges that under Section 6.10-2 of the San Francisco Business and Tax Regulations Code, the City Treasurer and Tax Collector may require the withholding of payments to any vendor that is delinquent in the payment of any amounts that the vendor is required to pay the City under the San Francisco Business and Tax Regulations Code. If, under that authority, any payment City is required to make to Tenant under this Lease is withheld, then City will not be in breach or default under this Lease, and the Treasurer and Tax Collector will authorize release of any payments withheld under this paragraph to Tenant, without interest, late fees, penalties, or other charges, upon Tenant coming back into compliance with its San Francisco Business and Tax Regulations Code obligations.

29.36 Counterparts

This Lease may be executed in two or more counterparts, each of which shall be deemed an original, but all of which taken together shall constitute one and the same instrument.

29.37 Effective Date

This Lease shall become effective on the date upon which the parties hereto have duly executed this Lease.

29.38 Cooperative Drafting

This Lease has been drafted through a cooperative effort of both parties, and both parties have had an opportunity to have the Lease reviewed and revised by legal counsel. No party shall

be considered the drafter of this Lease, and no presumption or rule that an ambiguity shall be construed against the party drafting the clause shall apply to the interpretation or enforcement of this Lease.

[BALANCE OF PAGE LEFT INTENTIONALLY BLANK]

City and Tenant have executed this Lease as of the date first written above.

TENANT:

NEW CINGULAR WIRELESS PCS, LLC,
a Delaware limited liability company

By: AT&T Mobility Corporation
Its: Manager

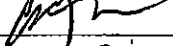
By: 
Name: Courtney Tanna Perillo
Its: Area Mgr Construction & Engr
Date: April 22, 2020

CITY:

CITY AND COUNTY OF SAN FRANCISCO,
a municipal corporation

By: _____
Andrico Q. Penick
Director of Property

Date: _____

APPROVED AS TO FORM:

DENNIS J. HERRERA
City Attorney

By: _____
Carol Wong, Deputy City Attorney

LIST OF EXHIBITS

- EXHIBIT A – Description and Depiction of Premises
- EXHIBIT B – List of Tenant's Existing and Proposed Equipment in Antenna Area and Wall Equipment Area
- EXHIBIT B-1 – Description of Tenant's Equipment in Antenna Area and Wall Equipment Area as of Commencement Date
- EXHIBIT B-2 – Description of Tenant's Equipment in Antenna Area and Wall Equipment Area after the Tenant Improvement Work
- EXHIBIT C – Approved Plans/100% Construction Drawings (Description of Tenant's Equipment in Antenna Area and Wall Equipment Area after Tenant Improvement Work)
- EXHIBIT D – Conditional Use Permit
- EXHIBIT E – Access Requirements
- EXHIBIT F - Final Revised Construction Plans (if any)

LIST OF EXHIBITS

- EXHIBIT A – Description and Depiction of Premises
- EXHIBIT B – List of Tenant's Existing and Proposed Equipment in Antenna Area and Wall Equipment Area
- EXHIBIT B-1 – Description of Tenant's Equipment in Antenna Area and Wall Equipment Area as of Commencement Date
- EXHIBIT B-2 – Description of Tenant's Equipment in Antenna Area and Wall Equipment Area after the Tenant Improvement Work
- EXHIBIT C – Approved Plans/100% Construction Drawings (Description of Tenant's Equipment in Antenna Area and Wall Equipment Area after Tenant Improvement Work)
- EXHIBIT D – Conditional Use Permit
- EXHIBIT E – Access Requirements
- EXHIBIT F - Final Revised Construction Plans (if any)

EXHIBIT A

Description and Depiction of Premises

Antenna Area (given in 3 dimensions because of stealth boxing: W-D-H)

Sector A - 18' x 3' x 5'-6"

Sector B - 14' x 3' x 5'-6"

Sector C - 18' x 3' x 5'-6"

Wall Equipment Area (W-H-D)

Sector A - 1 @ 10' x 6" x 1'-6"

Sector B - 1 @ 10' x 6" x 1'-6"

Sector C - 2 @ 8' x 6" x 1'-6"

Rooftop Equipment Room (shelter)

13'-4" x 18'-1"

Exhibit A (cont.) - Rooftop Equipment Room

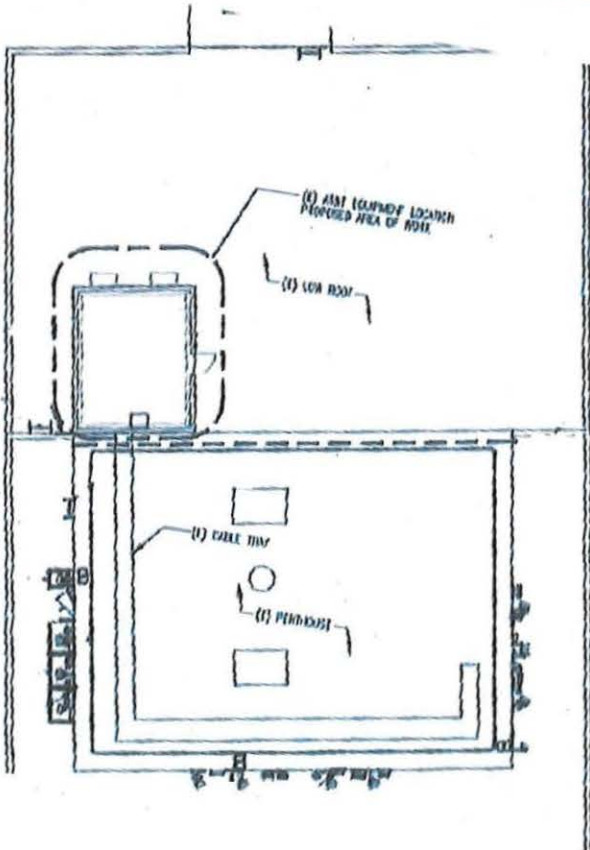
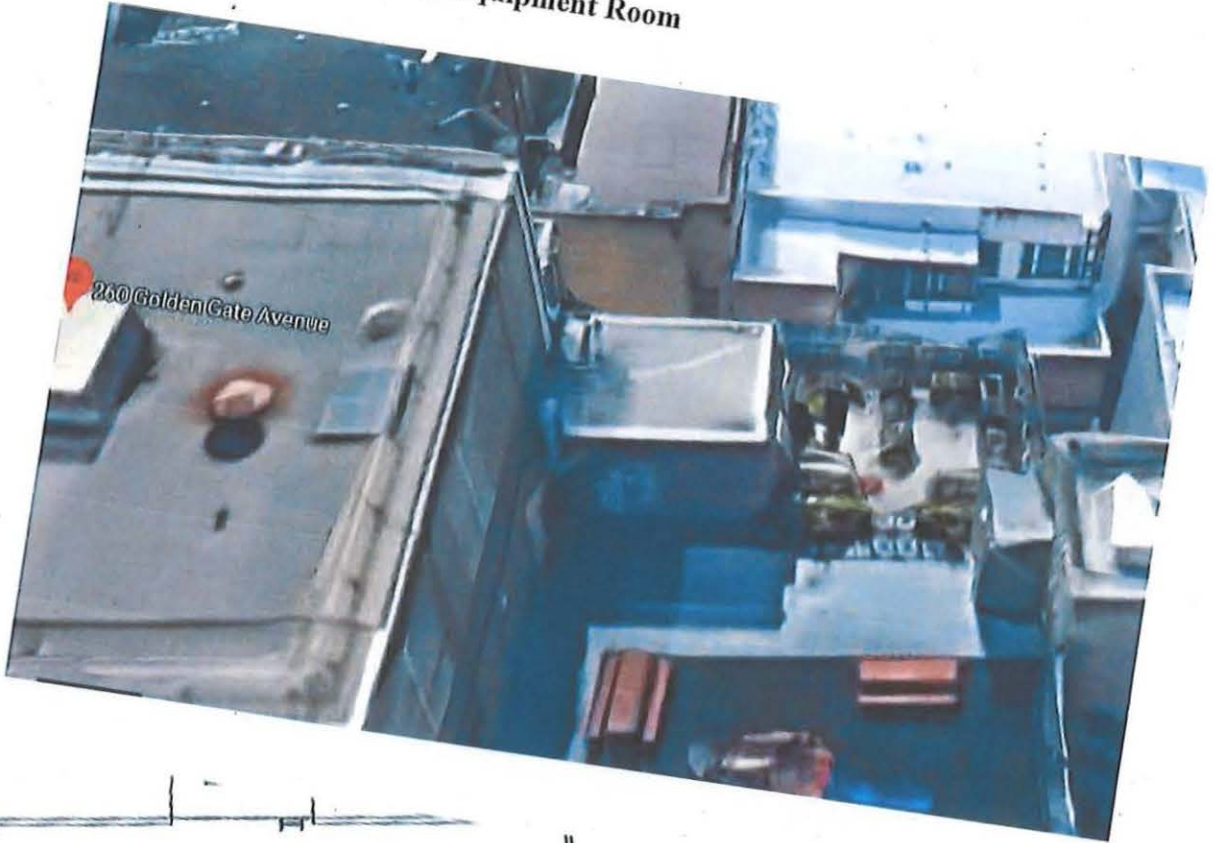

Exhibit A (cont.): Sector A – Antenna Area and Wall Equipment Area



Exhibit A (cont.): Sector B – Antenna Area and Wall Equipment Area

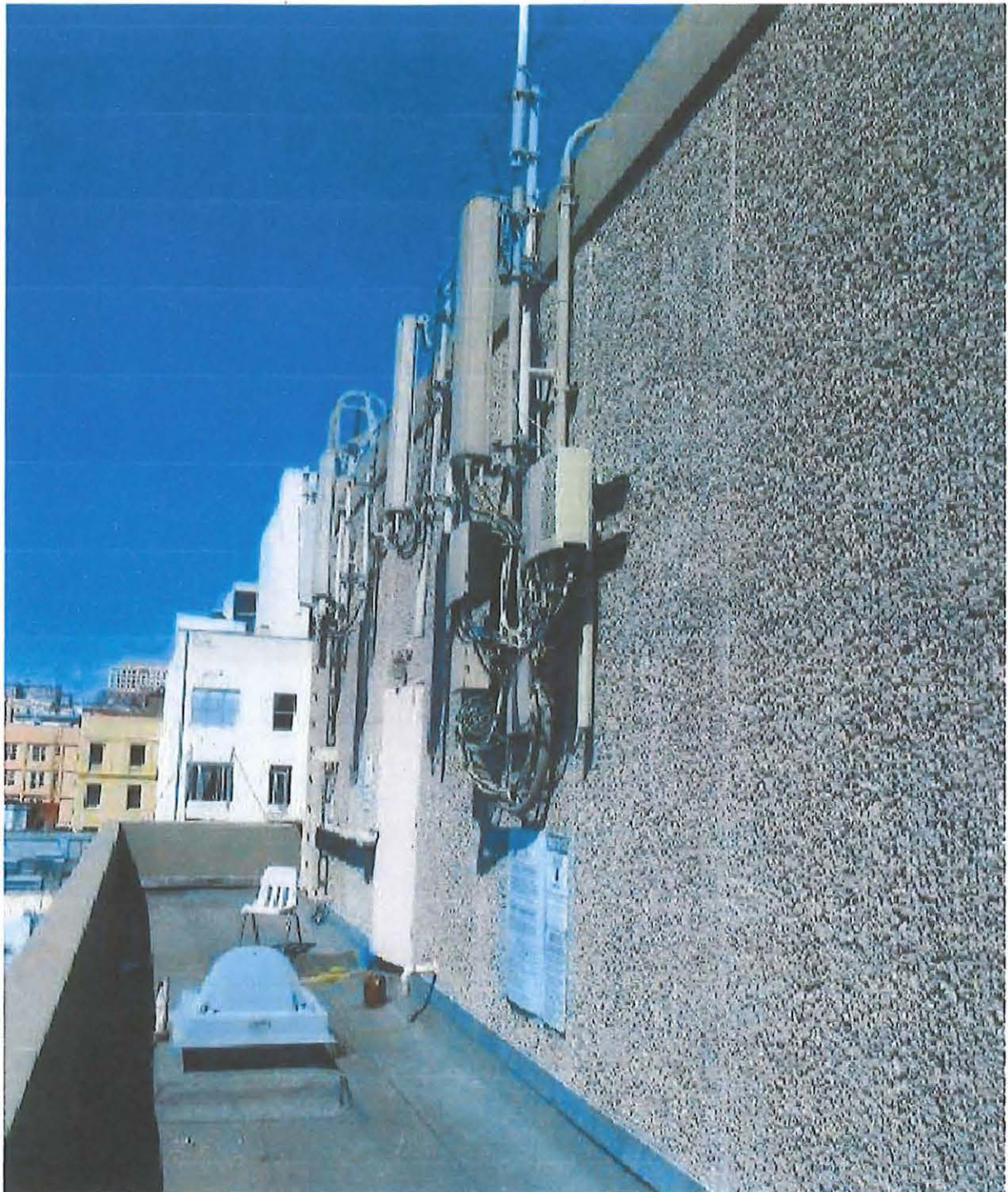

Exhibit A (cont.): Sector C – Antenna Area and Wall Equipment Area



EXHIBIT B

Count of Existing and Proposed Tenant Equipment in Wall Equipment Area and Antenna Area

Sector A		
	Tenant Equipment as of Commencement Date	Tenant Equipment After All Improvement Work
Antennas	4	4
RRUs	2	5
DC2	1	0
Fiber box	1	1
TMA	2	-
DC6	--	1
	Ant & Equip: 18' x 3' x 5'-6" Site: 54 sq.ft Elev: 99 sq.ft	Ant: 18' x 3' x 5'-6" Equip: 6' x 10' = 60 sq.ft
Sector B		
	Tenant Equipment as of Commencement Date	Tenant Equipment After All Improvement Work
Antennas	4	4
RRUs	2	5
DC2	1	0
Fiber box	1	1
TMA	2	-
DC6	--	1
	Ant & Equip: 14' x 3' x 5'-6" Site: 42 sq.ft Elev: 77 sq.ft	Ant: 14' x 3' x 5'-6" Equip: 6' x 10' = 60 sq.ft
Sector C		
	Tenant Equipment as of Commencement Date	Tenant Equipment After All Improvement Work
Antennas	4	4
RRUs	2	5
DC2	1	0
Fiber box	1	1
TMA	2	-
DC6	--	1
	Ant & Equip: 18' x 3' x 5'-6" Site: 54 sq.ft Elev: 99 sq.ft	Ant: 18' x 3' x 5'-6" Equip: (2) 6' x 8' = 96 sq.ft

EXHIBIT B-1

**Description of Tenant's Equipment in Wall Equipment Area and
Antenna Area as of Commencement Date**

Count	Equipment	Model	Dimensions	Weight (lbs)
6	Kathrein (antenna)	742 264	51.8X10.3X5.5	33
3	Kathrein (antenna)	800 10764	55.2X11.8X6	40.8
3	Antel (antenna)	LPD7905_4	47.2"x5.1"x9.6"	22.1
3	RRU	RRUS-12	19.68x16.96x7.16	52.91
3	RRU	RRUS-11	20.5 x 18.5 x 7.5	50.7
3	TMA	KRY 112 89/4	11.2 x 11 x 4.2	17
6	TMA	KRY 112 72	12.5 x 5.6 x 3.7	13.2
3	Raycap (surge suppressor)	DC2	16x16,4x6.3	5
3	Box	Fiber winder	14x14x9	2

EXHIBIT B-2

**Description of Tenant's Equipment in Wall Equipment Area and
Antenna Area after Tenant Improvement Work**

Count	Equipment	Model	Dimensions	Weight (lbs)
3	Kathrein (antenna)	742 264	51.8X10.3X5.5	33
9	CommScope (antenna)	JAHH-65A-R3B	55X13.8X8.2	52
3	RRU	B14 4478	15 x 13.2 x 7.4	59.52
3	RRU	RRUS-32 B66	27.2 x 12.1 x 7	60
3	RRU	RRUS-32	27.2 x 12.1 x 7	60
3	RRU	4415 B25	15 x 13.2 x 7.4	59.52
3	RRU	RRUS-11	20.5 x 18.5 x 7.5	50.7
3	Raycap (surge suppressor)	DC6	18.28 x 10.24 x 31.4	26.2
3	Box	Fiber winder	14x14x9	2

EXHIBIT C

**Approved Plans/100% Construction Drawings and Depiction of Tenant's Equipment in
Wall Equipment Area and Antenna Area After Tenant Improvement Work**

[100% Construction Drawings last updated November 11, 2019, prepared by NuWave Communications, and consisting of fifteen (15) pages, appears on following pages, provided; however, that if altered with the prior written and reasonable approval of City's Director of Property pursuant to Section 7.1, the altered drawings will be attached at Exhibit F once approved by the City Planning Department]



SITE NUMBER: CCL00096/CNU0096
FA NUMBER: 10087996, USID NUMBER: 12733
RFDS ID 1789794, v6.00, DATED 05/29/2018
LTE 4C MRSFR041524, LTE 5C MRSFR040170
ANT-MOD MRSFR032357
PTN# 3701A0BKXS, PTN# 3701A0BNG2
PTN# 3701A07GAA
SITE NAME: SF CIVIC CENTER
260 GOLDEN GATE AVENUE, SAN FRANCISCO CA 94102
ROOFTOP/INDOOR

ENGINEERING
2019 CALIFORNIA BUILDING CODE 2019 CALIFORNIA TITLE 24 2019 CALIFORNIA FIRE CODE 2019 CALIFORNIA ENERGY CODE 2019 CALIFORNIA MECHANICAL CODE TIA/EA-222-F OR LATEST EDITION

GENERAL NOTES
THE FACILITY IS UNMANNED AND NOT FOR HUMAN HABITATION. A TECHNICIAN WILL VISIT THE SITE AS REQUIRED FOR ROUTINE MAINTENANCE. THE PROJECT WILL NOT RESULT IN ANY SIGNIFICANT DISTURBANCE OR EFFECT ON DRAINAGE, NO SANITARY SEWER SERVICE, POTABLE WATER, OR TRASH DISPOSAL IS REQUIRED AND NO COMMERCIAL SIGNAGE IS PROPOSED.

SITE INFORMATION	
PROPERTY OWNER: CITY & COUNTY OF SAN FRANCISCO REAL ESTATE DIVISION 25 VAN NESS AVENUE, SUITE 400 SAN FRANCISCO, CA 94102	SITE ADDRESS: 260 GOLDEN GATE AVENUE SAN FRANCISCO, CA 94102
APPLICANT: AT&T ADDRESS: 5001 EXECUTIVE PARKWAY SAN RAMON CALIFORNIA 94583	
LATITUDE (NAD 83): 37° 46' 55.09992" N LONGITUDE (NAD 83): 122° 24' 53.09992" W LONGITUDE/LATITUDE TYPE: NAD 83 GROUND ELEVATION: N/A APN #: 0345-007 ZONING JURISDICTION: CITY OF SAN FRANCISCO CURRENT ZONING: C-3-C POWER COMPANY: PG&E TELCO COMPANY: AT&T PROPOSED USE: UNMANNED TELECOMM FACILITY LEASE AREA (SF): - CONSTRUCTION TYPE: I	

PROJECT TEAM	
PROJECT MANAGER: ERICSSON 6140 STONERIDGE MALL RD. SUITE 350 PLEASANTON, CA 94508 CONTACT: NIKESH SHAH PH: (918) 602-8530 FAKESH.SHAH@ERICSSON.COM	A/E/C: NUWAVE COMMUNICATIONS INC. BULLDOCK, LLC 1875 CORONADO AVE. SUNVALE HILL, CALIFORNIA 94705 CONTACT: SAM VANNI PH: 925-230-2519 SAM.VANNI@TELECOM.CA
SITE ACQUISITION: ERICSSON 6140 STONERIDGE MALL RD. SUITE 350 PLEASANTON, CA 94508 CONTACT: ARTAL GENCER PH: (925) 918-8127 EMAIL: ARTAL.GENCER@ERICSSON.COM	ZONING: ERICSSON 6140 STONERIDGE MALL RD. SUITE 350 PLEASANTON, CA 94508 CONTACT: TOM BERKAS PH: (925) 202-3333 TOM@THCCORPORATION.COM
RF ENGINEER: AT&T 5001 EXECUTIVE PARKWAY, SAN RAMON, CALIFORNIA 94503 CONTACT: EMAIL:	CONSTRUCTION MANAGER: ERICSSON 6140 STONERIDGE MALL RD. SUITE 350 PLEASANTON, CA 94508 CONTACT: JEREMY VOBRACER PH: (925) 202-2620 EMAIL: JVOBRAC@ERICSSON.COM

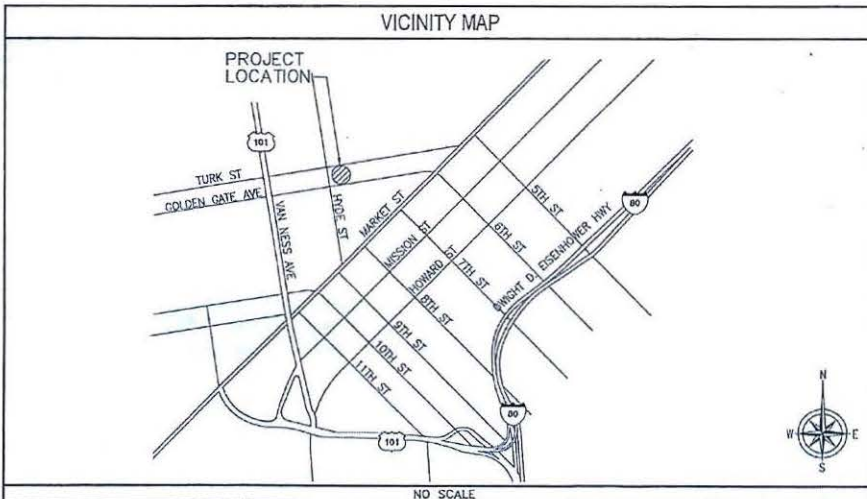

DRIVING DIRECTIONS

DIRECTIONS FROM AT&T OFFICE:
 GET ON I-680 N FROM BOLLINGER CANYON RD, HEAD NORTHEAST ON BISHOP DR TOWARD SUNSET DR, TURN RIGHT ONTO SUNSET DR, TURN RIGHT ONTO BOLLINGER CANYON RD, MERGE ONTO I-680 N VIA THE RAMP TO SACRAMENTO, CONTINUE ON I-680 N, TAKE CA-24 W AND I-80 W TO HARRISON ST IN SAN FRANCISCO, TAKE EXIT 1C FROM I-80 W, MERGE ONTO I-680 N, TAKE EXIT 46A FOR STATE ROUTE 24 TOWARD OAKLAND/LAFAYETTE, CONTINUE ONTO CA-24 W, STAY ON CA-24 W, TAKE EXIT 2B FOR INTERSTATE 580 W, MERGE ONTO I-580 W, TAKE EXIT 19A TO MERGE ONTO I-80 W TOWARD SAN FRANCISCO PARTIAL TOLL ROAD, TAKE EXIT 1C TOWARD CIVIC CENTER, TAKE 9TH ST AND LARKIN ST TO GOLDEN GATE AVE, MERGE ONTO HARRISON ST, TURN RIGHT ONTO 9TH ST, PASS BY BURGER KING, TURN SLIGHTLY RIGHT AFTER WALGREENS, TURN RIGHT ONTO GOLDEN GATE AVE, DESTINATION WILL BE ON THE LEFT.

CONSTRUCTION DRAWINGS
 IF USING 11"X17" PLOT, DRAWINGS WILL BE HALF SCALE

PROJECT DESCRIPTION

AT&T WIRELESS PROPOSES TO MODIFY AN EXISTING WIRELESS INSTALLATION. THE SCOPE WILL CONSIST OF THE FOLLOWING:

- REMOVE AND REPLACE (9) EXISTING PANEL ANTENNAS WITH (9) NEW PANEL ANTENNAS.
- REMOVE (3) EXISTING RIUS-12.
- RELOCATE (1) EXISTING PANEL ANTENNA AND MOUNT AT SECTOR "B".
- RELOCATE ALL EXISTING PENTHOUSE WALL MOUNTED RIUS, SURGE SUPPRESSORS, AND FIBER WINDER BOXES LOW ON EXISTING WALL TO SHIELD FROM STREET VIEW.
- INSTALL (3) NEW RIUS-4478 B14 NEAR ANTENNA (1) PER SECTOR.
- INSTALL (3) NEW RIUS-4415 B25 NEAR ANTENNA (1) PER SECTOR.
- INSTALL (3) NEW RIUS-32 B55 NEAR ANTENNA (1) PER SECTOR.
- INSTALL (3) NEW RIUS-32 B30 NEAR ANTENNA (1) PER SECTOR.
- INSTALL (3) NEW DC-6 SURGE SUPPRESSORS.
- INSTALL NEW INNERDUT FOR FIBER AND DC POWER.
- INSTALL (2) NEW FRP SCREENS AROUND SECTOR "B" ANTENNAS. PAINT AND TEXTURE TO MATCH EXISTING PENTHOUSE WALL.
- INSTALL (1) NEW 19" RACK W/ (3) DC12 SURGE SUPPRESSOR.
- REMOVE & REPLACE (E) DUL UNIT W/ (N) DUS41 UNIT INSIDE (E) 19" RACK.
- ADD (1) NEW XMJ D3 INSIDE EXISTING V2 CHASSIS WITHIN EXISTING RACK.
- PAINT ALL NEW EQUIPMENT TO MATCH BUILDING WALL COLOR.

DRAWING INDEX

SHEET NO:	TITLE SHEET
T-1	TITLE SHEET
GN-1	GENERAL NOTES
F-1	FIRE DEPARTMENT CHECKLIST
EME-1	EME REPORT
PS-1	PHOTOS/MS
PS-2	PHOTOS/MS
PS-3	PHOTOS/MS
A-1	SITE PLAN
A-2	ENLARGED SITE PLAN AND EQUIPMENT PLANS
A-3	EXISTING AND NEW ANTENNA LAYOUTS
A-4	ELEVATIONS
A-5	ELEVATIONS
A-6	ELEVATIONS
D-1	DETAILS
D-2	DETAILS

DO NOT SCALE DRAWINGS

SUBCONTRACTOR SHALL VERIFY ALL PLANS & EXISTING DIMENSIONS & CONDITIONS ON THE JOB SITE & SHALL IMMEDIATELY NOTIFY THE ENGINEER IN WRITING OF ANY DISCREPANCIES BEFORE PROCEEDING WITH THE WORK OR BE RESPONSIBLE FOR SAME.

UNDERGROUND SERVICE ALERT OF CALIFORNIA
 800-642-2444
 48 HOURS BEFORE YOU DIG

CCL00096/CNU0096
 SF CIVIC CENTER
 260 GOLDEN GATE AVENUE
 SAN FRANCISCO, CA 94102
 ROOFTOP/INDOOR



REV	DATE	DESCRIPTION	BY
5	11/11/19	100% CD	SA
4	11/06/19	100% CD	SA
3	11/05/19	100% CD REVISION	MR
2	08/22/19	CLERK COORDINATOR	LT
1	06/22/19	100% CONSTRUCTION DRAWING	AM
0	06/18/19	90% CONSTRUCTION DRAWING	CA



IT IS A VIOLATION OF LAW FOR ANY PERSON, UNLESS THEY ARE ACTING UNDER THE DIRECTION OF A LICENSED PROFESSIONAL ENGINEER, TO ALTER THIS DOCUMENT.

SHEET TITLE
TITLE SHEET

SHEET NUMBER
T-1

GENERAL CONSTRUCTION NOTES

- FOR THE PURPOSE OF CONSTRUCTION DRAWINGS, THE FOLLOWING DEFINITIONS SHALL APPLY:
GENERAL CONTRACTOR - OVERLAND CONTRACTING INC. (BAY)
SUBCONTRACTOR - CONTRACTOR (CONSTRUCTION)
OWNER - AT&T
- ALL SITE WORK SHALL BE COMPLETED AS INDICATED ON THE DRAWINGS AND AT&T PROJECT SPECIFICATIONS.
- GENERAL CONTRACTOR AND SUBCONTRACTOR SHALL VISIT THE SITE AND SHALL FAMILIARIZE HIMSELF WITH ALL CONDITIONS AFFECTING THE PROPOSED WORK AND SHALL MAKE PROVISIONS. GENERAL CONTRACTOR AND SUBCONTRACTOR SHALL BE RESPONSIBLE FOR FAMILIARIZING HIMSELF WITH ALL CONTRACT DOCUMENTS, FIELD CONDITIONS, DIMENSIONS, AND CONFIRMING THAT THE WORK MAY BE ACCOMPLISHED AS SHOWN PRIOR TO PROCEEDING WITH CONSTRUCTION. ANY DISCREPANCIES SHALL BE BROUGHT TO THE ATTENTION OF THE ENGINEER PRIOR TO THE COMMENCEMENT OF WORK.
- ALL MATERIALS FURNISHED AND INSTALLED SHALL BE IN STRICT ACCORDANCE WITH ALL APPLICABLE CODES, REGULATIONS, AND ORDINANCES. GENERAL CONTRACTOR SHALL ISSUE ALL APPROPRIATE NOTICES AND COMPLY WITH ALL LAWS, ORDINANCES, RULES, REGULATIONS, AND LAWFUL ORDERS OF ANY PUBLIC AUTHORITY REGARDING THE PERFORMANCE OF WORK.
- ALL WORK CARRIED OUT SHALL COMPLY WITH ALL APPLICABLE MUNICIPAL AND UTILITY COMPANY SPECIFICATIONS AND LOCAL JURISDICTIONAL CODES, ORDINANCES, AND APPLICABLE REGULATIONS.
- UNLESS NOTED OTHERWISE, THE WORK SHALL INCLUDE FURNISHING MATERIALS, EQUIPMENT, APPURTENANCES, AND LABOR NECESSARY TO COMPLETE ALL INSTALLATIONS AS INDICATED ON THE DRAWINGS.
- PLANS ARE NOT TO BE SCALED. THESE PLANS ARE INTENDED TO BE A DIAGRAMMATIC OUTLINE ONLY UNLESS OTHERWISE NOTED. DIMENSIONS SHOWN ARE TO FINISH SURFACES UNLESS OTHERWISE NOTED. SPACING BETWEEN EQUIPMENT IS THE MINIMUM REQUIRED CLEARANCE. THEREFORE, IT IS CRITICAL TO FIELD VERIFY DIMENSIONS, SHOULD THERE BE ANY QUESTIONS REGARDING THE CONTRACT DOCUMENTS, THE SUBCONTRACTOR SHALL BE RESPONSIBLE FOR OBTAINING A CLARIFICATION FROM THE ENGINEER PRIOR TO PROCEEDING WITH THE WORK. DETAILS ARE INTENDED TO SHOW DESIGN INTENT. MODIFICATIONS MAY BE REQUIRED TO SUIT JOB DIMENSIONS OR CONDITIONS AND SUCH MODIFICATIONS SHALL BE INCLUDED AS PART OF WORK AND PREPARED BY THE ENGINEER PRIOR TO PROCEEDING WITH WORK.
- THE SUBCONTRACTOR SHALL INSTALL ALL EQUIPMENT AND MATERIALS IN ACCORDANCE WITH MANUFACTURER'S RECOMMENDATIONS UNLESS SPECIFICALLY STATED OTHERWISE.
- IF THE SPECIFIED EQUIPMENT CANNOT BE INSTALLED AS SHOWN ON THESE DRAWINGS, THE SUBCONTRACTOR SHALL PROPOSE AN ALTERNATIVE INSTALLATION SPACE FOR APPROVAL BY THE ENGINEER PRIOR TO PROCEEDING.
- GENERAL CONTRACTOR SHALL BE RESPONSIBLE FOR THE SAFETY OF WORK AREA, ADJACENT AREAS AND BUILDING OCCUPANTS THAT ARE LIKELY TO BE AFFECTED BY THE WORK UNDER THIS CONTRACT. WORK SHALL CONFORM TO ALL OSHA REQUIREMENTS AND THE LOCAL JURISDICTION.
- GENERAL CONTRACTOR SHALL COORDINATE WORK AND SCHEDULE WORK ACTIVITIES WITH OTHER DISCIPLINES.
- ERECTOR SHALL BE DONE IN A WORKMANLIKE MANNER BY COMPETENT EXPERIENCED WORKMAN IN ACCORDANCE WITH APPLICABLE CODES AND THE BEST ACCEPTED PRACTICE. ALL MEMBERS SHALL BE LAID PLUMB AND TRUE AS INDICATED ON THE DRAWINGS.
- SEAL PENETRATIONS THROUGH FIRE RATED AREAS WITH UL LISTED MATERIALS APPROVED BY LOCAL JURISDICTION. SUBCONTRACTOR SHALL KEEP AREA CLEAN, HAZARD FREE, AND DISPOSE OF ALL DEBRIS.
- WORK PREVIOUSLY COMPLETED IS REPRESENTED BY LIGHT SHADED LINES AND NOTES. THE SCOPE OF WORK FOR THIS PROJECT IS REPRESENTED BY DARK SHADED LINES AND NOTES. SUBCONTRACTOR SHALL NOTIFY THE GENERAL CONTRACTOR OF ANY EXISTING CONDITIONS THAT DEVIATE FROM THE DRAWINGS PRIOR TO BEGINNING CONSTRUCTION.
- SUBCONTRACTOR SHALL PROVIDE WRITTEN NOTICE TO THE CONSTRUCTION MANAGER 48 HOURS PRIOR TO COMMENCEMENT OF WORK.
- THE SUBCONTRACTOR SHALL PROTECT EXISTING IMPROVEMENTS, PAVEMENTS, CURBS, LANDSCAPING AND STRUCTURES. ANY DAMAGED PARTY SHALL BE REPAIRED AT SUBCONTRACTOR'S EXPENSE TO THE SATISFACTION OF THE OWNER.
- THE SUBCONTRACTOR SHALL CONTACT UTILITY LOCATING SERVICES PRIOR TO THE START OF CONSTRUCTION.
- GENERAL CONTRACTOR SHALL COORDINATE AND MAINTAIN ACCESS FOR ALL TRADES AND SUBCONTRACTORS TO THE SITE AND/OR BUILDING.
- THE GENERAL CONTRACTOR SHALL BE RESPONSIBLE FOR SECURITY OF THE SITE FOR THE DURATION OF CONSTRUCTION UNTIL JOB COMPLETION.
- THE GENERAL CONTRACTOR SHALL MAINTAIN IN GOOD CONDITION ONE COMPLETE SET OF PLANS WITH ALL REVISIONS, ADDENDA, AND CHANGE ORDERS ON THE PREMISES AT ALL TIMES.
- THE GENERAL CONTRACTOR AND SUBCONTRACTOR SHALL PROVIDE PORTABLE FIRE EXTINGUISHERS WITH A RATING OF NOT LESS THAN 2-A OR 2-A10-BC AND SHALL BE WITHIN 25 FEET OF TRAVEL DISTANCE TO ALL PORTIONS OF WHERE THE WORK IS BEING COMPLETED DURING CONSTRUCTION.
- ALL EXISTING ACTIVE SEWER, WATER, GAS, ELECTRIC, AND OTHER UTILITIES SHALL BE PROTECTED AT ALL TIMES, AND WHERE REQUIRED FOR THE PROPER EXECUTION OF THE WORK, SHALL BE RELOCATED AS DIRECTED BY THE ENGINEER. EXTREME CAUTION SHOULD BE USED BY THE SUBCONTRACTOR WHEN EXCAVATING OR DRILLING PIERS AROUND OR NEAR UTILITIES. SUBCONTRACTOR SHALL PROVIDE SAFETY TRAINING FOR THE WORKING CREW. THIS SHALL INCLUDE BUT NOT BE LIMITED TO A) FALL PROTECTION, B) CONFINED SPACE, C) ELECTRICAL SAFETY, AND D) TRENCHING & EXCAVATION.
- ALL EXISTING INACTIVE SEWER, WATER, GAS, ELECTRIC, AND OTHER UTILITIES WHICH INTERFERE WITH THE EXECUTION OF THE WORK, SHALL BE REMOVED, CAPPED, PLUGGED OR OTHERWISE DISCONNECTED AT POINTS WHICH WILL NOT INTERFERE WITH THE EXECUTION OF THE WORK, AS DIRECTED BY THE RESPONSIBLE ENGINEER, AND SUBJECT TO THE APPROVAL OF THE OWNER AND/OR LOCAL UTILITIES.
- THE AREAS OF THE OWNER'S PROPERTY DISTURBED BY THE WORK AND NOT COVERED BY THE TOWER, EQUIPMENT OR DRIVEWAY, SHALL BE GRADED TO A UNIFORM SLOPE, AND STABILIZED TO PREVENT EROSION.
- SUBCONTRACTOR SHALL MINIMIZE DISTURBANCE TO THE EXISTING SITE DURING CONSTRUCTION. EROSION CONTROL MEASURES, IF REQUIRED DURING CONSTRUCTION, SHALL BE IN CONFORMANCE WITH THE FEDERAL AND LOCAL JURISDICTION FOR EROSION AND SEDIMENT CONTROL.
- NO FILL OR EMBANKMENT MATERIAL SHALL BE PLACED ON FROZEN GROUNDING, FROZEN MATERIALS, SNOW OR ICE SHALL NOT BE PLACED IN ANY FILL OR EMBANKMENT.
- THE SUBGRADE SHALL BE BROUGHT TO A SMOOTH UNIFORM GRADE AND COMPACTED TO 95 PERCENT STANDARD PROCTOR DENSITY UNDER STRUCTURES AND 80 PERCENT STANDARD PROCTOR DENSITY IN OPEN SPACE. ALL TRENCHES IN PUBLIC RIGHT OF WAY SHALL BE BACKFILLED WITH FLOWABLE FILL OR OTHER MATERIAL PRE-APPROVED BY THE LOCAL JURISDICTION.
- ALL NECESSARY RUBBERISH, STUMPS, DEBRIS, STICKS, STONES, AND OTHER REFUSE SHALL BE REMOVED FROM THE SITE AND DISPOSED OF IN A LAWFUL MANNER.
- ALL BROCHURES, OPERATING AND MAINTENANCE MANUALS, CATALOGS, SHOP DRAWINGS, AND OTHER DOCUMENTS SHALL BE TURNED OVER TO THE GENERAL CONTRACTOR AT COMPLETION OF CONSTRUCTION AND PRIOR TO PAYMENT.
- SUBCONTRACTOR SHALL SUBMIT A COMPLETE SET OF AS-BUILT RESOLINES TO THE GENERAL CONTRACTOR UPON COMPLETION OF PROJECT AND PRIOR TO FINAL PAYMENT.

- SUBCONTRACTOR SHALL LEAVE PREMISES IN A CLEAN CONDITION.
- THE PROPOSED FACILITY WILL BE UNMANNED AND DOES NOT REQUIRE POTABLE WATER OR SEWER SERVICE, AND IS NOT FOR HUMAN HABITAT (NO HANDICAP ACCESS REQUIRED).
- OCCUPANCY IS LIMITED TO PERIODIC MAINTENANCE AND INSPECTION, APPROXIMATELY 2 TIMES PER MONTH BY AT&T TECHNICIANS.
- NO OUTDOOR STORAGE OR SOLID WASTE CONTAINERS ARE PROPOSED.
- ALL MATERIAL SHALL BE FURNISHED AND WORK SHALL BE PERFORMED IN ACCORDANCE WITH THE LATEST REVISION AT&T MOBILITY GROUNDING STANDARD "TECHNICAL SPECIFICATION FOR CONSTRUCTION OF GSA/CPRS WIRELESS SITES" AND "TECHNICAL SPECIFICATION FOR FACILITY GROUNDING", IN CASE OF A CONFLICT BETWEEN THE CONSTRUCTION SPECIFICATION AND THE DRAWINGS, THE DRAWINGS SHALL GOVERN.
- SUBCONTRACTORS SHALL BE RESPONSIBLE FOR OBTAINING ALL PERMITS AND INSPECTIONS REQUIRED FOR CONSTRUCTION. IF SUBCONTRACTOR CANNOT OBTAIN A PERMIT, THEY MUST NOTIFY THE GENERAL CONTRACTOR IMMEDIATELY.
- SUBCONTRACTOR SHALL REMOVE ALL TRASH AND DEBRIS FROM THE SITE ON A DAILY BASIS.
- INFORMATION SHOWN ON THESE DRAWINGS WAS OBTAINED FROM SITE VISITS AND/OR DRAWINGS PROVIDED BY THE SITE OWNER. CONTRACTORS SHALL NOTIFY THE ENGINEER OF ANY DISCREPANCIES PRIOR TO ORDERING MATERIAL OR PROCEEDING WITH CONSTRUCTION.
- NO WHITE STROBE LIGHTS ARE PERMITTED. LIGHTING IF REQUIRED, WILL MEET FAA STANDARDS AND REQUIREMENTS.
- ALL COAXIAL CABLE INSTALLATIONS TO FOLLOW MANUFACTURER'S INSTRUCTIONS AND RECOMMENDATIONS.
- NO NOISE, SMOKE, DUST, ODOR OR VIBRATIONS WILL RESULT FROM THIS FACILITY. (DELETE THIS NOTE IF THE SITE WILL HAVE A GENERATOR)
- NO ADDITIONAL PARKING TO BE PROPOSED. EXISTING ACCESS AND PARKING TO REMAIN. (REVISE THIS NOTE ACCORDING TO THE SITE CONFIGURATION)
- NO LANDSCAPING IS PROPOSED AT THIS SITE. (REVISE THIS NOTE ACCORDING TO THE SITE CONFIGURATION)

EMERGENCY SHUT DOWN

FOR IMMEDIATE SHUT DOWN OF ALL RADIO FREQUENCY EMISSIONS OF THIS SITE:

1. CALL CONTACT NUMBER AND GIVE SITE IDENTIFICATION INFO. CONTACT PHONE NUMBER: 1-800-832-6662 SITE IDENTIFICATION NUMBER: CCL00096

2. DISCONNECT POWER AT MAIN SERVICE DISCONNECT: (CHECK LEVELS, IDENTIFY EQUIPMENT ROOM)

3. DISCONNECT BACKUP POWER AT BATTERY DISCONNECT: (WHERE EXISTING EQUIPMENT IS)

THIS SIGN SHALL BE A PREFERRED LABEL WITH WHITE BACKGROUND AND BLACK LETTERING. THE TITLE BLOCK SHALL BE A RED BACKGROUND AND 1" HIGH WHITE LETTERING.

NOTE: SIGN TO BE PERMANENTLY MOUNTED AT THE FOLLOWING LOCATIONS:

- CALL SITE EQUIPMENT ROOM DOOR
- BATTERY LOCATION WITHIN PROXIMITY OF BATTERY DISCONNECT
- FCC (FEDERAL COMMUNICATIONS COMMISSION) ROOM WITHIN PROXIMITY OF THE FIRE ALARM PANEL
- BUILDING'S MAIN ELECTRICAL ROOM WITHIN PROXIMITY OF THE MAIN SHUTOFF
- THE CELL SITE MAIN ELECTRICAL DISCONNECT

EMERGENCY SHUT DOWN SIGN

1

NOTICE TO WORKERS

RADIO FREQUENCY ANTENNAS ON THIS ROOF. PLEASE EXERCISE CAUTION AROUND ANTENNAS AND OBEY POSTED SIGNS AND/OR MARKINGS. FOR ACCESS TO RESTRICTED AREAS OR FOR FURTHER INFORMATION, PLEASE CALL 1-800-832-6662 (SITE NUMBER: CCL00096)

IN ACCORDANCE WITH FCC RULES 47 CFR 1.1310

AVISO A TRABAJADORES

EXISTEN ANTENAS DE RADIOFRECUENCIA EN ESTE TECHO. POR FAVOR USE PRECAUCION AL REDOR DE LAS ANTENAS Y OBEDEZCA A LAS ZONAS RESTRINGIDAS O PARA OBTENER MAS INFORMACION, LLAME AL TELEFONO 1-800-832-6662 (NUMERO DE SITIO: CCL00096)

DE ACUERDO A LAS REGLAS DE FCC 47 CFR 1.1310

工作人員注意

此屋宇房頂有射頻天線裝置
在天線周圍四周需請小心,並遵照各已張貼之標示及/或標識行事
如需進入禁區範圍或索取更多資料
請致電+1-800-832-6662 此站區號: (CCL00096)

依據 FCC 條例第 47 CFR 1.1310 條執行

NOTES:

- WARNING SIGN TO BE MOUNTED AT ANTENNA LOCATIONS.
- SIGN SHALL COMPLY WITH ANSI Z53.2 COLOR, SYMBOL, AND CONTENT CONVENTIONS.
- SIGNAGE SHALL BE CLEARLY LABELED IN A PREFERRED LABEL WITH A WHITE BACKGROUND AND BLACK LETTERING, AND SHALL BE READABLE FROM AT LEAST (15) FEET FROM THE SIGN.
- PROPOSED 12"X20" PLASTIC SIGN

MULTI-LANGUAGE SIGN

6

CAUTION

Beyond This Point you are entering a controlled area where RF emissions may exceed the FCC Occupational Exposure Limits

Obey all posted signs and other guidelines for working in a RF environment.

Call 1-800-832-6662 for more information.

Ref: FCC-47CFR 1.1307(b)

CAUTION SIGN

INFORMATION

ACTIVE ANTENNAS ARE MOUNTED

- ON THE OUTSIDE SURFACE OF THIS BUILDING
- BEHIND THIS PANEL
- ON THE STRUCTURE

STAY BACK A MINIMUM OF 3 FEET FROM THESE ANTENNAS

Contact AT&T Mobility at 800-832-2822 and follow their instructions prior to performing any maintenance or repairs closer than 3 feet from the antenna.

This is AT&T Mobility site

INFORMATION SIGNAGE

2

NOTICE

AT&T operates antennas at this site.

Beyond This Point you are entering an area where radio frequency (RF) fields may exceed the FCC General Population Exposure Limits.

Follow safety guidelines for working in an RF environment.

Contact AT&T at 800-832-2822 and follow their instructions prior to performing any maintenance or repairs above this point.

This is AT&T site

NOTICE SIGN

CAUTION

AT&T operates antennas at this site.

Beyond This Point you are entering an area where radio frequency (RF) fields may exceed the FCC Occupational Exposure Limits.

Follow safety guidelines for working in an RF environment.

Contact AT&T at 800-832-2822 and follow their instructions prior to performing any maintenance or repairs beyond this point.

This is AT&T site

CAUTION SIGNAGE

3

CCL00096/CNU0096
SF CIVIC CENTER
260 GOLDEN GATE AVENUE
SAN FRANCISCO, CA 94102
ROOFTOP/INDOOR



5001 EXECUTIVE PARKWAY,
SAN RAMON, CA 94583



ERICSSON
6140 STONERIDGE MALL ROAD, SUITE 350
PLEASANTON, CA 94588

PLANS PREPARED BY:

1875 CORONADO AVE
SIGAL HILL, CA 95745

REV	DATE	DESCRIPTION	BY
5	11/11/18	ISSUE CHG	SA
4	11/06/18	ISSUE CHG	SA
3	11/05/18	ISSUE CHG REVISION	MB
2	08/29/18	CLIENT COMMENTS	LT
1	05/28/18	ISSUE CONSTRUCTION DRAWINGS	AM
0	05/16/18	ISSUE CONSTRUCTION DRAWINGS	GA



IF IT IS A VIOLATION OF LAW FOR ANY REASON, UNLESS THEY ARE ACTING UNDER THE DIRECTION OF A LICENSED PROFESSIONAL ENGINEER, TO ALTER THE DOCUMENT.

SHEET TITLE
GENERAL NOTES

SHEET NUMBER
GN-1

2.06 SUBMITTAL REQUIREMENTS FOR CELLULAR ANTENNA SITES (2016)

2.06 SUBMITTAL REQUIREMENTS FOR CELLULAR ANTENNA SITES (2016)

REFERENCE: 2016 SFBC, 2016 SFFC, 2016 SFMC AND FCC DET BULLETIN (97-01)

I. SUBMITTAL REQUIREMENTS

- SEE SHEET T-1 — 20 A. PROVIDE A DESCRIPTION OF WORK ON THE PLANS.
- SEE SHEET A-1, A-2, A-3, A-4, A-5 — 20 B. PLANS SHALL INCLUDE PLAN VIEWS AND ELEVATIONS SHOWING ALL EQUIPMENT LOCATIONS AND CABLE RUNS.
- SEE SHEET A-3, D-1, D-2 — 20 C. PLANS SHALL INCLUDE ANTENNA MANUFACTURER SPECIFICATION SHEETS AND EQUIPMENT LIST ON A DRAWING.
- SEE SHEET EME-1 — 20 D. INCLUDE A COPY OF THE SIGNED AND STAMPED RF REPORT ON A DRAWING SHEET AS A REFERENCE TO IDENTIFY THE EXCLUSION AREA REQUIRED TO PREVENT OCCUPATIONAL EXPOSURES IN EXCESS OF THE FCC GUIDELINES (47CFR1.1310 AND FCC DET BULLETIN 99 EDITION 97-01).
- SEE SHEET EME-1 — 20 E. THE RF REPORT SHALL INDICATE WHETHER OR NOT THE SITE UNDER REVIEW IS A PART OF A MULTIPLE TRANSMITTER SITE AND SHALL SHOW COMPLIANCE WITH FCC 47CFR1.1307 (B) (3), AS AMENDED - ALL TRANSMITTERS SHALL NOT EXCEED 5% OF THE POWER DENSITY EXPOSURE LIMIT.
- SEE SHEET EME-1 AND SHEET A-2 — 20 F. DRAWINGS SHALL REFLECT THE STRIPPED/EXCLUSION AREAS FOR WORKERS PER THE ABOVE RF REPORT WITH A MINIMUM RADIUS OF 1-FOOT.
- N/A — 20 G. PLANS SHALL INCLUDE A QUANTITATIVE THREE-DIMENSIONAL IMAGE OF THE RF LEVELS FROM EACH ANTENNA LOCATED NEAR AN EGRESS POINT (E.G. PENTHOUSE STAIR, FIRE ESCAPE, ROOF WALKING PATHS, SKYLIGHTS, ETC.).
- SEE SHEET GN-1, EME-1 AND A-2 — 20 H. "NOTICE TO WORKERS" WARNING SIGNAGE, AS APPLICABLE PER THE ABOVE RF REPORT, SHALL BE PERMANENTLY MOUNTED AT THE STARWELL SIDE OF THE ROOF-ACCESS DOOR (ANSI C95.2-1982 (REFERENCE [3]) - YELLOW OR MORE DURABLE COLOR FOR OUTDOOR LONGEVITY).
- SEE SHEET EME-1 AND SHEET A-2 — 20 I. CAMOUFLAGED ANTENNAS SHALL HAVE 4-INCH X 4-INCH SIGNAGE PERMANENTLY MOUNTED TO THE EXTERIOR OF THE RF SCREEN AS PROVIDED BELOW. THE SIGN SHALL BE WEATHERPROOF WITH CONTRASTING BACKGROUND COLOR AND SHALL CONTAIN THE YELLOW TRIANGLE AROUND THE ANTENNA SYMBOL (ANSI C95.2-1982 (REFERENCE [3]) - YELLOW OR MORE DURABLE COLOR FOR OUTDOOR LONGEVITY). SIGNAGE LOCATION(S) AND DETAIL OF THE SIGN SHALL BE INCLUDED ON THE PLANS.
- N/A — 20 J. CABLES/WIRING SHALL NOT BE ALLOWED IN EXIT ENCLOSURES, SMOKE-PROOF TOWERS, ELEVATOR SHAFTS, OR IN FRONT OF DRY STANDPIPES. 2016 SFBC 1023.5 AND 509.2.
- SEE SHEET A-2 — 20 K. ANTENNAS SHALL NOT BE MOUNTED CLOSER THAN THE EXCLUSION ZONE PLUS 4- FEET FOR INSTALLATIONS NEAR FIRE ESCAPES, STAIR PENTHOUSE DOORS, EXTERIOR STANDPIPE OUTLETS, SKYLIGHTS, OR OTHER FIRE DEPARTMENT OPERATIONS CONSIDERATION.

SEC SHEET A-1 — SEE SHEET GN-1 AND SHEET A-2

- 20 L. STATIONARY STORAGE BATTERY SYSTEMS SHALL COMPLY WITH 2016 CFC, SECTION 608.
- 20 M. THE FIRE DEPARTMENT MAY NEED TO SHUT DOWN THE POWER TO THE CELL SITE IN AN EMERGENCY SITUATION. IN ORDER TO REDUCE THE SITE OPERATOR'S POSSIBLE LOSS OF SERVICE, PERMANENT EMERGENCY SHUTDOWN PROCEDURE SIGNAGE SHALL BE PROVIDED AT THE EQUIPMENT ROOM ENTRANCE.
1. THE SIGN SHALL INCLUDE THE FOLLOWING:
- EMERGENCY 24-HOUR/7 DAY A WEEK NETWORK OPERATIONS CENTER (NOC) / FIELD TECHNICIAN TELEPHONE NUMBER FOR RF SHUT-DOWN
 - CELL SITE IDENTIFICATION NUMBER
 - MAP SHOWING LOCATION OF ELECTRICAL MAIN SHUT-OFF (ELECTRICAL MAIN SHALL BE CLEARLY IDENTIFIED WITH A PERMANENT RED LABEL AND WHITE LETTERING).
 - MAP SHOWING LOCATION OF BATTERY CABINETS AND BREAKERS (CABINETS AND BREAKERS SHALL BE CLEARLY IDENTIFIED WITH A PERMANENT RED LABEL AND WHITE LETTERING).
 - ANY OTHER RELEVANT INFORMATION OR PROCEDURES AS REQUIRED FOR THE INDIVIDUAL CELLULAR SITE.
2. THE SIGN SHALL BE CLEARLY LABELED IN A PHENOLIC LABEL WITH A WHITE BACKGROUND AND BLACK LETTERING. THE TITLE BLOCK SHALL BE A RED BACKGROUND AND 1-INCH HIGH WHITE LETTERING. MULTIPLE SIGNS MAY NEED TO BE INSTALLED BASED UPON THE CELLULAR SITE CONFIGURATION.
3. A COPY OF THE SIGNAGE SHALL BE INCLUDED ON A DRAWING SHEET. SEE ATTACHED SAMPLE.

II. DRAWING NOTES

- A. SIGN SHALL BE A PHENOLIC LABEL WITH WHITE BACKGROUND AND BLACK LETTERING. THE TITLE BLOCK SHALL BE A RED BACKGROUND AND 1-INCH HIGH WHITE LETTERING.
- B. CONTRACTOR TO PLACE SIGNS IN FOLLOWING LOCATIONS:
- CELL SITE EQUIPMENT ROOM DOOR
 - BATTERY LOCATION WITHIN PROXIMITY OF BATTERY DISCONNECT
 - FCC ROOM WITHIN PROXIMITY OF THE FIRE ALARM PANEL
 - BUILDING'S MAIN ELECTRICAL ROOM WITHIN PROXIMITY OF THE MAIN SHUTOFF AND/OR AT THE CELL SITE MAIN ELECTRICAL DISCONNECT

CCL00096/CNU0096
SF CIVIC CENTER
260 GOLDEN GATE AVENUE
SAN FRANCISCO, CA 94102
ROOFTOP/INDOOR



5001 EXECUTIVE PARKWAY,
SAN RAMON, CA 94583



ERICSSON

6140 GTONERIDGE MALL ROAD, SUITE 350
PLEASANTON, CA 94566

PLANS PREPARED BY:



1875 CORONADO AVE
SIGNAL HILL, CA 92745

REV	DATE	DESCRIPTION	INT
5	11/11/19	100% CIP	SA
4	11/09/19	100% CIP	SA
3	11/09/19	100% CIP 10/15/19	MB
2	08/20/19	CLIENT COMMENTS	LT
1	08/29/18	NOTE CONSTRUCTION BRANCHED	AM
0	03/16/18	NOTE CONSTRUCTION BRANCHED	CA



IT IS A VIOLATION OF LAW FOR ANY PERSON, UNLESS THEY ARE ACTING UNDER THE DIRECTION OF A LICENSED PROFESSIONAL ENGINEER, TO ALTER THIS DOCUMENT.

SHEET TITLE
FIRE DEPT CHECKLIST

SHEET NUMBER

F-1

PROPOSED SITE LOCATION

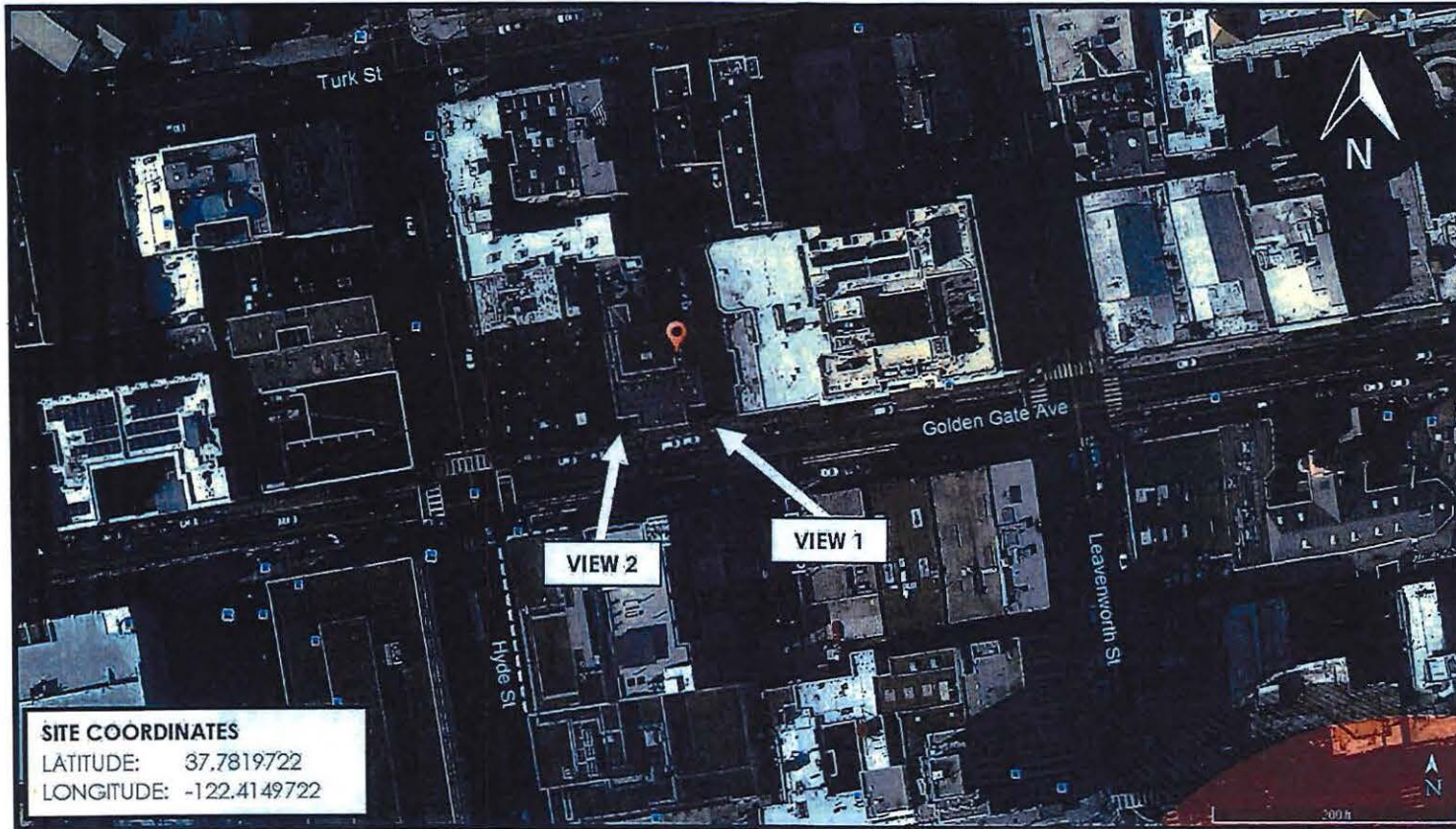

SITE COORDINATES

LATITUDE: 37.7819722
 LONGITUDE: -122.4149722

CCL00096
SF CIVIC CENTER
 260 Golden Gate Avenue
 San Francisco, CA 94102

SHOT MAP
 AT&T Node: CCL00096
 SF CIVIC CENTER



The CBR Group
 841 Arnold Dr., Suite A
 Martinez, CA 94553
 info@thecbrgroup.com

CCL00096/CNU0096
 SF CIVIC CENTER
 260 GOLDEN GATE AVENUE
 SAN FRANCISCO, CA 94102
 ROOFTOP/INDOOR



5001 EXECUTIVE PARKWAY,
 SAN RAMON, CA 94583



ERICSSON

8140 STONERIDGE MALL ROAD, SUITE 350
 PLEASANTON, CA 94588

PLANS PREPARED BY:



1875 CORONADO AVE
 SIGNAL HILL, CA 91081

REV	DATE	DESCRIPTION	INT
5	11/11/19	100% CD	SA
4	11/06/19	100% CD	SA
3	11/05/19	100% CD REVISION	MD
2	09/20/19	CLIENT COMMENTS	LT
1	08/29/18	100% CONSTRUCTION DRAWINGS	ALL
0	03/19/18	90% CONSTRUCTION DRAWINGS	CA



IT IS A VIOLATION OF LAW FOR ANY PERSON, UNLESS THEY ARE ACTING UNDER THE DIRECTION OF A LICENSED PROFESSIONAL ENGINEER, TO ALTER THIS DOCUMENT.

SHEET TITLE
PHOTOSIMS

SHEET NUMBER
PS-1

VIEW 2

EXISTING

SECTOR "B" EXISTING WIRELESS ANTENNAS TO BE REPLACED

SECTOR "C" EXISTING WIRELESS ANTENNAS TO BE REPLACED



PROPOSED

PURPOSED WIRELESS ANTENNAS NO VISIBLE CHANGE

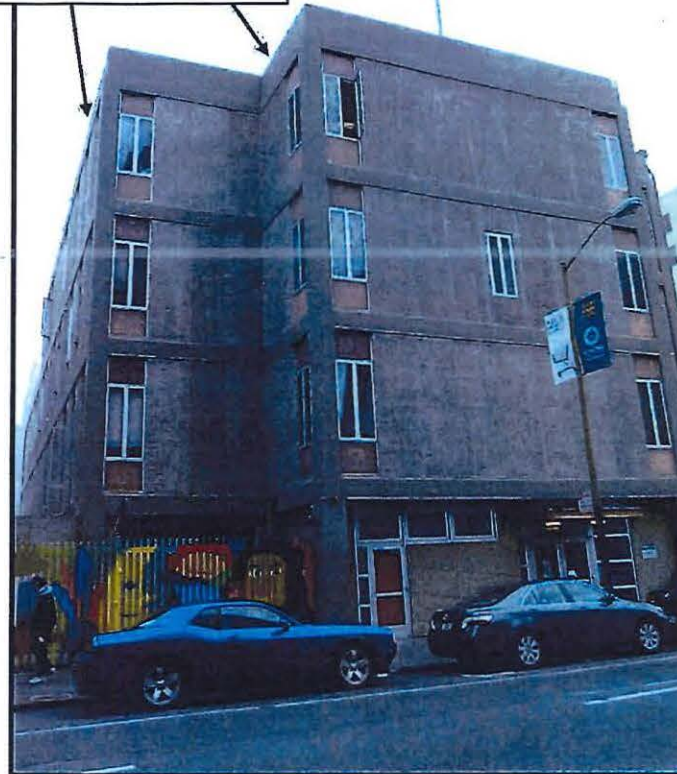

CCL00096/CNU0096
SF CIVIC CENTER
260 GOLDEN GATE AVENUE
SAN FRANCISCO, CA 94102
ROOFTOP/INDOOR



5001 EXECUTIVE PARKWAY,
SAN RAMON, CA 94583



ERICSSON

8140 STONERIDGE MALL ROAD, SUITE 350
PLEASANTON, CA 94589

PLANS PREPARED BY:



1875 CORDONADO AVE
SIGNAL HILL, CA 92408

5	11/11/10	ISSUE CDR	SA
4	11/06/10	ISSUE CDR	SA
3	11/05/10	ISSUE CDR REVISION	MR
2	08/20/10	CLIENT COMMENTS	LT
1	08/20/10	ISSUE CONSTRUCTION DRAWINGS	AM
0	06/18/10	ISSUE CONSTRUCTION DRAWINGS	CA
REV	DATE	DESCRIPTION	BY



IT IS A VIOLATION OF LAW FOR ANY PERSON, UNLESS THEY ARE ACTING UNDER THE DIRECTION OF A LICENSED PROFESSIONAL ENGINEER, TO ALTER THIS DOCUMENT.

SHEET TITLE
PHOTOSIMS

SHEET NUMBER

PS-2

CCL00096
SF CIVIC CENTER
260 Golden Gate Avenue
San Francisco, CA 94102

**VIEW 2: LOOKING NORTHEAST ACROSS
GOLDEN GATE AVE**

PHOTOSIMS PRODUCED 2/06/2018



The CBR Group
841 Arnold Dr., Suite A
Martinez, CA 94553
info@thecbrgroup.com

VIEW 1

EXISTING

SECTOR "C" EXISTING WIRELESS ANTENNAS TO BE REPLACED

SECTOR "A" EXISTING WIRELESS ANTENNAS TO BE REPLACED

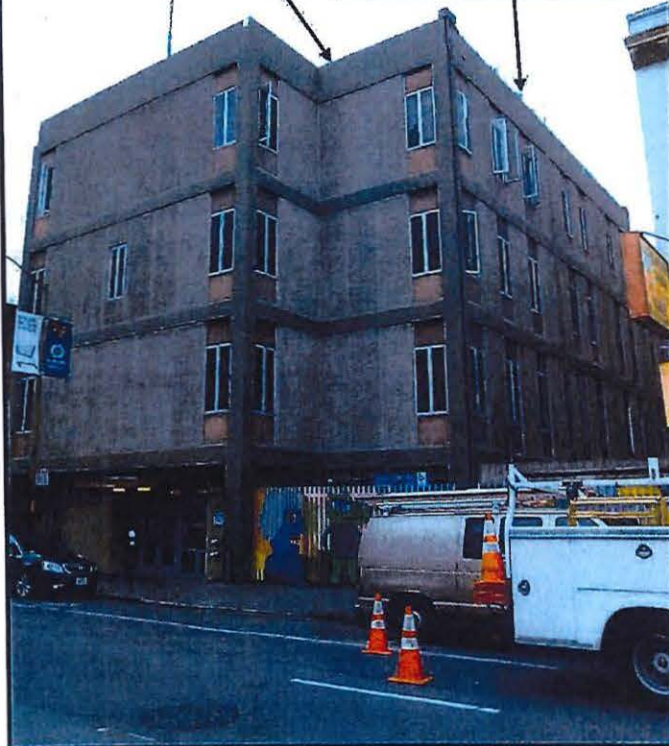

PROPOSED

PURPOSED WIRELESS ANTENNAS NO VISIBLE CHANGE

PURPOSED WIRELESS ANTENNAS

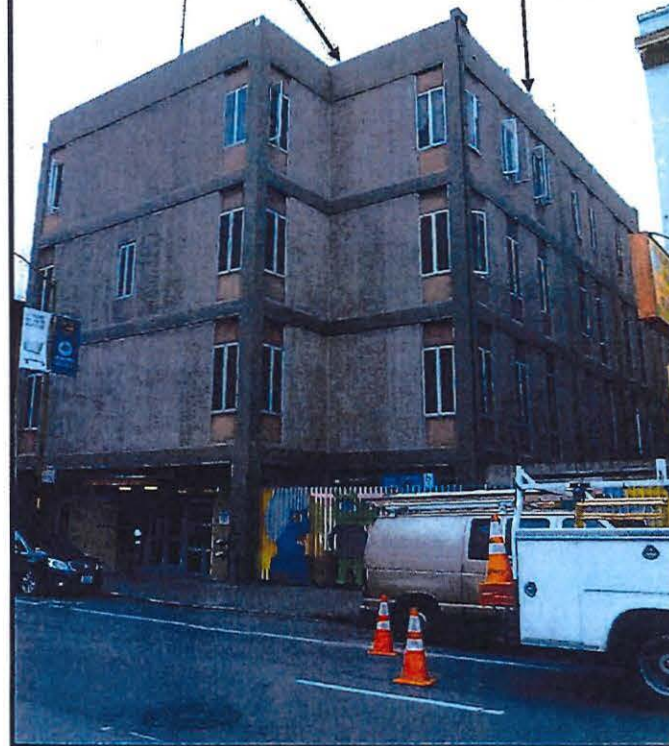

CCL00096
SF CIVIC CENTER
 260 Golden Gate Avenue
 San Francisco, CA 94102

VIEW 1: LOOKING NORTHWEST ACROSS
 GOLDEN GATE AVE
 PHOTOSIMS PRODUCED 2/06/2018



The CBR Group
 841 Arnold Dr., Suite A
 Martinez, CA 94553
 info@thecbrgroup.com

CCL00096/CNU0096
 SF CIVIC CENTER
 GOLDEN GATE AVENUE
 SAN FRANCISCO, CA 94102
 ROOFTOP/INDOOR



5001 EXECUTIVE PARKWAY,
 SAN RAMON, CA 94583



ERICSSON

8140 STONERIDGE MALL ROAD, SUITE 350
 FOLSOM, CA 95630

PLANS PREPARED BY:



1875 CORONADO AVE
 SIGNAL HILL, CA 90783

3	11/11/19	ISSUE 01A	JA
4	11/06/19	ISSUE 01A	JA
3	11/05/19	ISSUE 01A REVISION	MB
2	08/20/19	CLIENT COMMENTS	LT
1	08/28/18	ISSUE CONSTRUCTION DRAWINGS	AM
0	08/16/18	ISSUE CONSTRUCTION DRAWINGS	GA
REV	DATE	DESCRIPTION	INT



IT IS A VIOLATION OF LAW FOR ANY PERSON, UNLESS THEY ARE ACTING UNDER THE DIRECTION OF A LICENSED PROFESSIONAL ENGINEER, TO ALTER THIS DOCUMENT.

SHEET TITLE
 PHOTOSIMS

SHEET NUMBER

PS-3

BATTERY STORAGE SYSTEM THRESHOLD QUANTITIES	
BATTERY TECHNOLOGY	LEAD ACID
QUANTITY OF EXISTING BATTERIES	24
QUANTITY OF NEW BATTERIES	0
QUANTITY OF TOTAL BATTERIES	24
EXISTING BATTERY STORAGE SYSTEM CAPACITY	150AH PER BATTERY
NEW BATTERY STORAGE SYSTEM CAPACITY	N/A
TOTAL BATTERY STORAGE SYSTEM CAPACITY	44.64MWH

TOTAL VOLUME IS LESS THAN 70MWH.

EXISTING BATTERIES

BATTERY TYPE: GNB-ABSOLYTE IP
 NUMBER OF UNITS W/BATTERIES: 2
 NUMBER OF BATTERIES: 24
 MATERIAL: ACID
 ELECTROLYTE VOLUME: 2.2 GALLONS
 WEIGHT: 7.5 LBS
 BATTERY TOTAL: 53 GALLONS
 BATTERY TOTAL: 180 LBS
 MATERIAL: LEAD
 WEIGHT: 76.92 LBS
 BATTERY TOTAL: 1,846 LBS

NOTE: NO NEW BATTERIES ARE PROPOSED FOR THIS MODIFICATION
 NOTE: A SEPARATE PERMIT SHALL BE REQUIRED FROM S.F.F.D. IF BATTERY ELECTROLYTE EXCEEDS 50 GALLONS

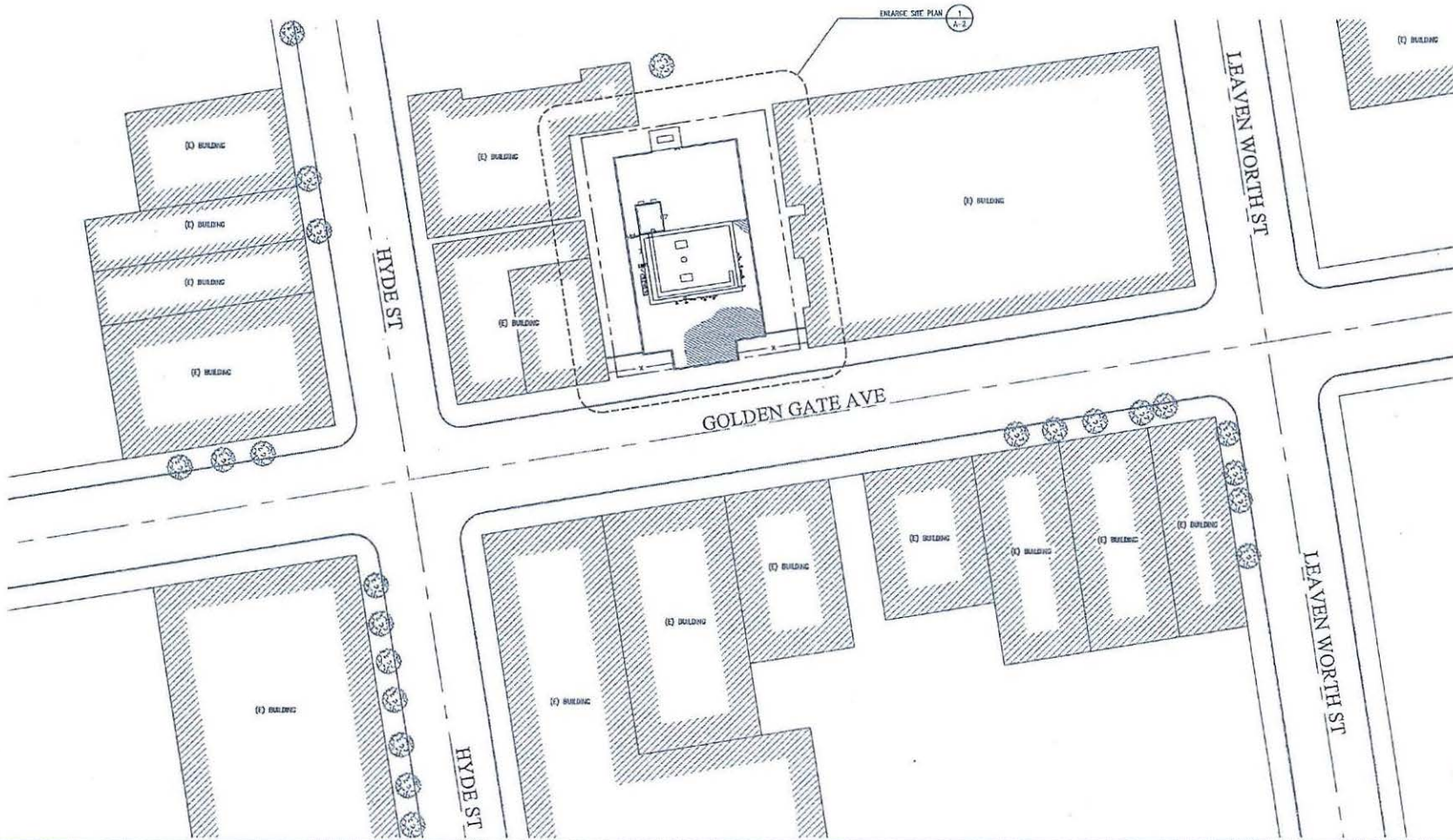

SITE PLAN

SCALE: 1"=30'-0"
 1

CCL00096/CNU0096
 SF CIVIC CENTER
 260 GOLDEN GATE AVENUE
 SAN FRANCISCO, CA 94102
 ROOFTOP/INDOOR



5001 EXECUTIVE PARKWAY,
 SAN RAMON, CA 94583



ERICSSON

9140 STONERIDGE MALL ROAD, SUITE 350
 PLEASANTON, CA 94589

PLANS PREPARED BY:



1875 CORONADO AVE
 SIGNAL HILL, CA 92705

REV	DATE	DESCRIPTION	INT
5	11/1/19	ISSUE CDV	SA
4	11/06/19	ISSUE CDV	SA
3	11/05/19	ISSUE CDV REVISION	MB
2	08/20/19	CLIENT COMMENTS	LT
1	04/29/18	ISSUE CONSTRUCTION DRAWINGS	AM
0	04/18/18	ISSUE CONSTRUCTION DRAWINGS	GA



IT IS A VIOLATION OF LAW FOR ANY PERSON, UNLESS THEY ARE ACTING UNDER THE DIRECTION OF A LICENSED PROFESSIONAL ENGINEER, TO ALTER THIS DOCUMENT.

SHEET TITLE
 SITE PLAN

SHEET NUMBER
 A-1

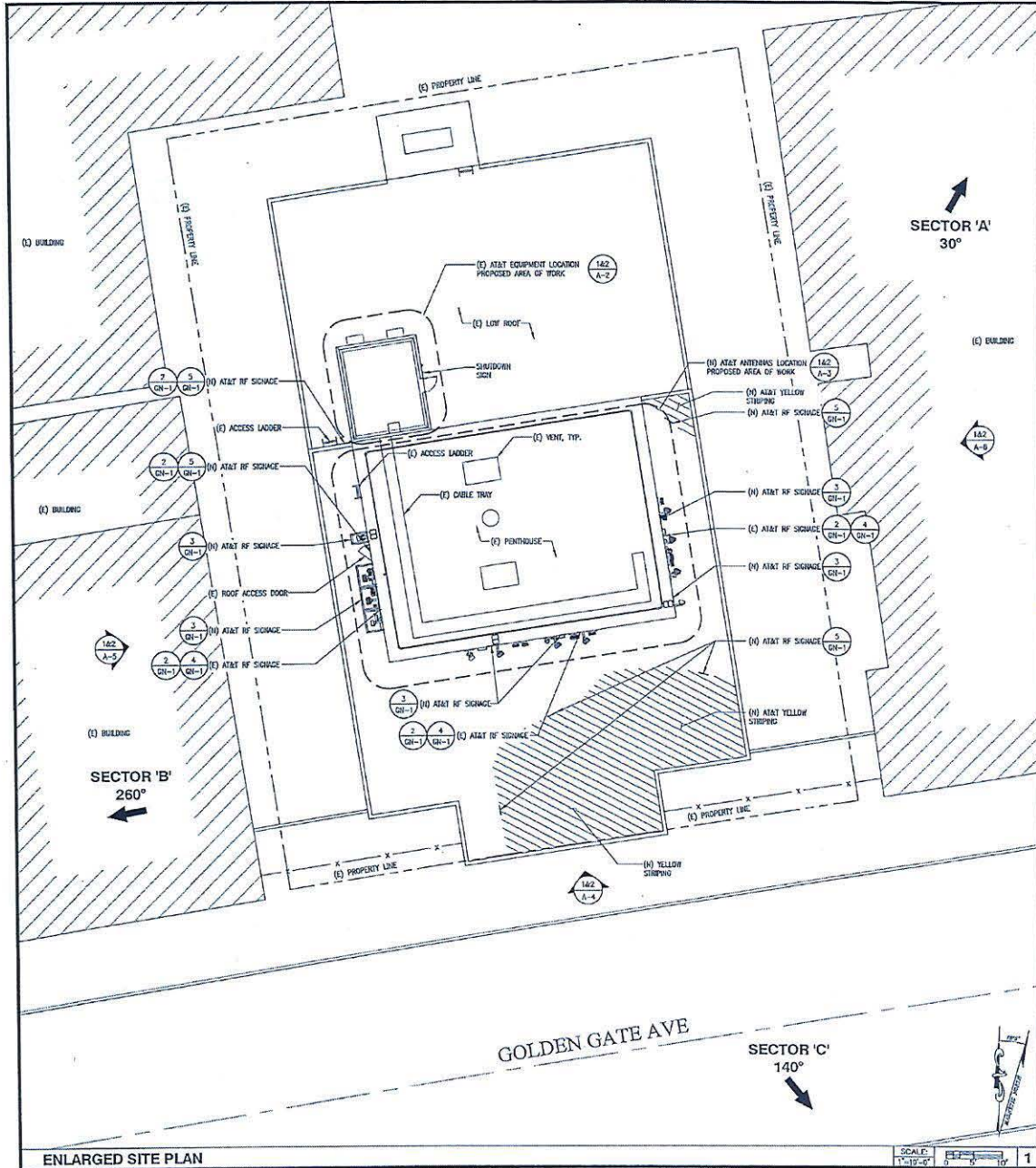

EXISTING EQUIPMENT LAYOUT KEY NOTES

- 1 (E) AT&T RIBS 2209 CABINET, TYP. OF 2
- 2 (E) AT&T RIBS 3209 CABINET, TYP. OF 2
- 3 (E) AT&T DC POWER PLANT
- 4 (E) AT&T CLEM CABINET
- 5 (E) COAX ENTRY POINT
- 6 (E) AT&T FIBER EQUIPMENT
- 7 (E) AT&T TELCO EQUIPMENT
- 8 (E) FAN
- 9 (E) MAIN BREAKER
- 10 (E) BATTERY DISCONNECT SWITCH
- 11 (E) BATTERY RACK
- 12 (E) AT&T 15" RF RACK
- 13 (E) BATTERY BOX
- 14 (E) MAJOR FIRE SUPPRESSION SYSTEM
- 15 (E) VENT
- 16 (E) INTERFACE PANEL
- 17 (E) TRANSFER SWITCH
- 18 (E) ELECTRICAL PANEL
- 19 (E) HVAC UNIT
- 20 (E) ENDR BENCH
- 21 (E) SHUT/DOWN SIGN

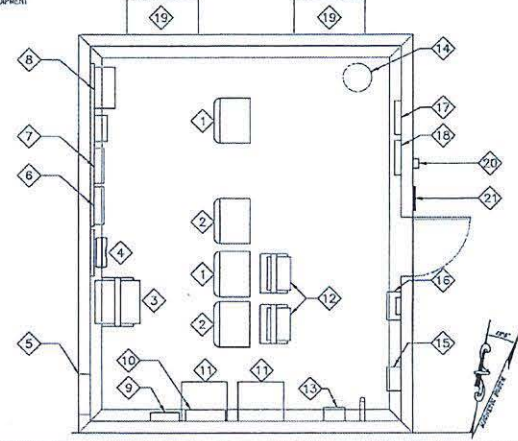

EXISTING EQUIPMENT LAYOUT

PROPOSED EQUIPMENT LAYOUT KEY NOTES

- 1 INSTALL (1) NEW AT&T 14U 03 INSIDE V2 CHASSIS WITHIN EXISTING RF RACK
- 2 INSTALL (1) NEW 5218 BR INSIDE V2 CHASSIS WITHIN EXISTING RF RACK
- 5 (E) 100E CDU
- 6 (E) 100E CDU
- 9 (E) 180X CDU REMOVED

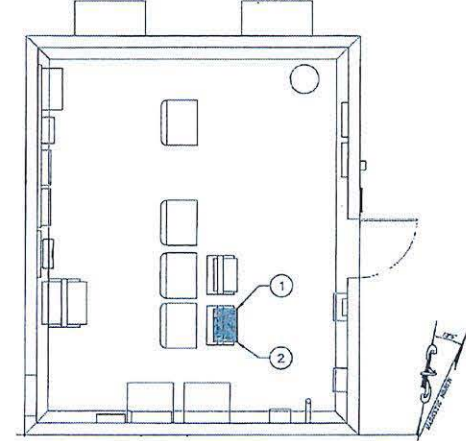

CCL00095/CNU0096
SF CIVIC CENTER
260 GOLDEN GATE AVENUE
SAN FRANCISCO, CA 94102
ROOFTOP/INDOOR



PLANS PREPARED BY:

1875 CORONADO AVE
SIGNAL HILL, CA 92476

REV	DATE	DESCRIPTION	BY
5	11/11/19	100E CDU	SA
4	11/06/19	100E CDU	SA
3	11/05/19	180X CDU REMOVED	MD
2	04/25/19	CLIENT COMMENTS	LT
1	04/25/19	ISSUE CONSTRUCTION DRAWINGS	AM
0	04/18/19	ISSUE CONSTRUCTION DRAWINGS	CA



IT IS A VIOLATION OF LAW FOR ANY PERSON, UNLESS THEY ARE ACTING UNDER THE DIRECTION OF A LICENSED PROFESSIONAL ENGINEER, TO ALTER THIS DOCUMENT.

SHEET TITLE
ENLARGED SITE PLAN AND EQUIPMENT LAYOUTS

SHEET NUMBER
A-2

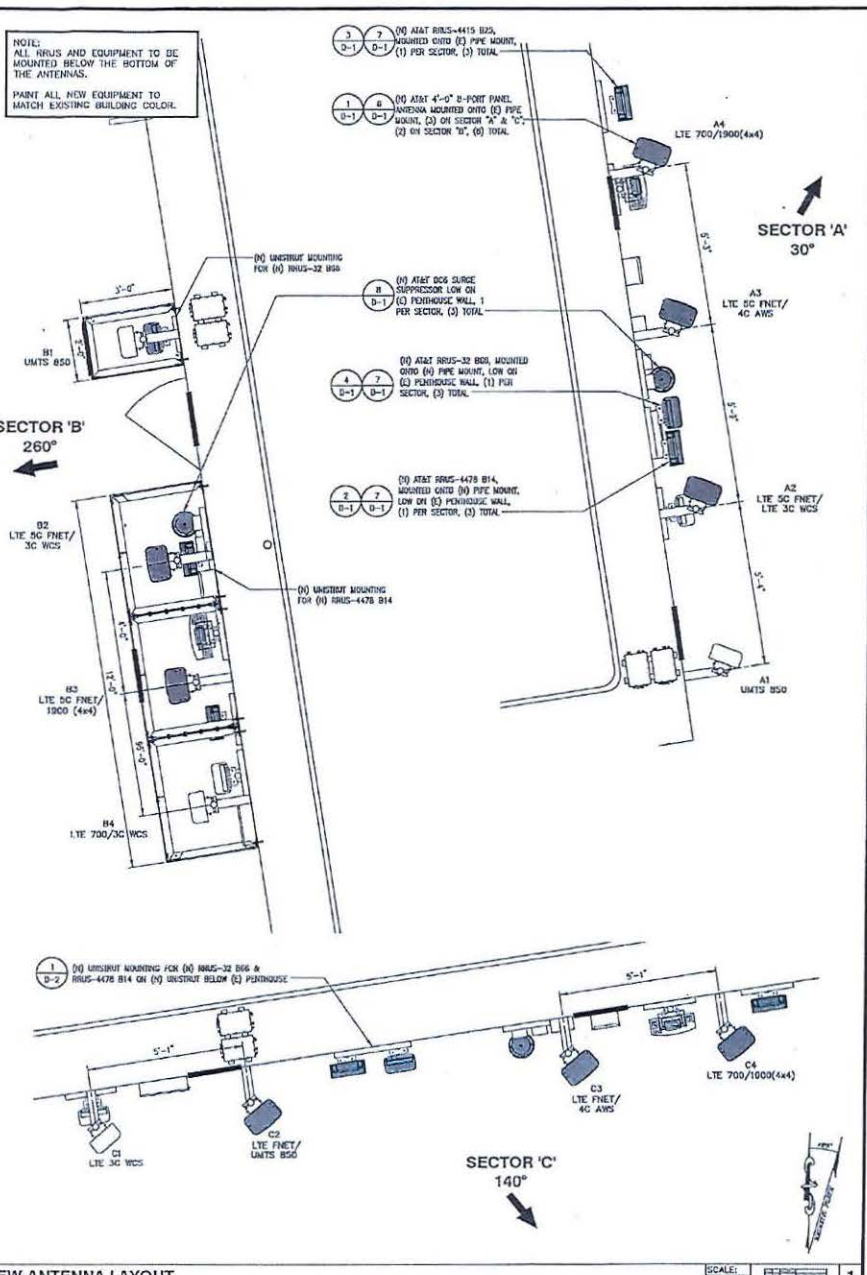
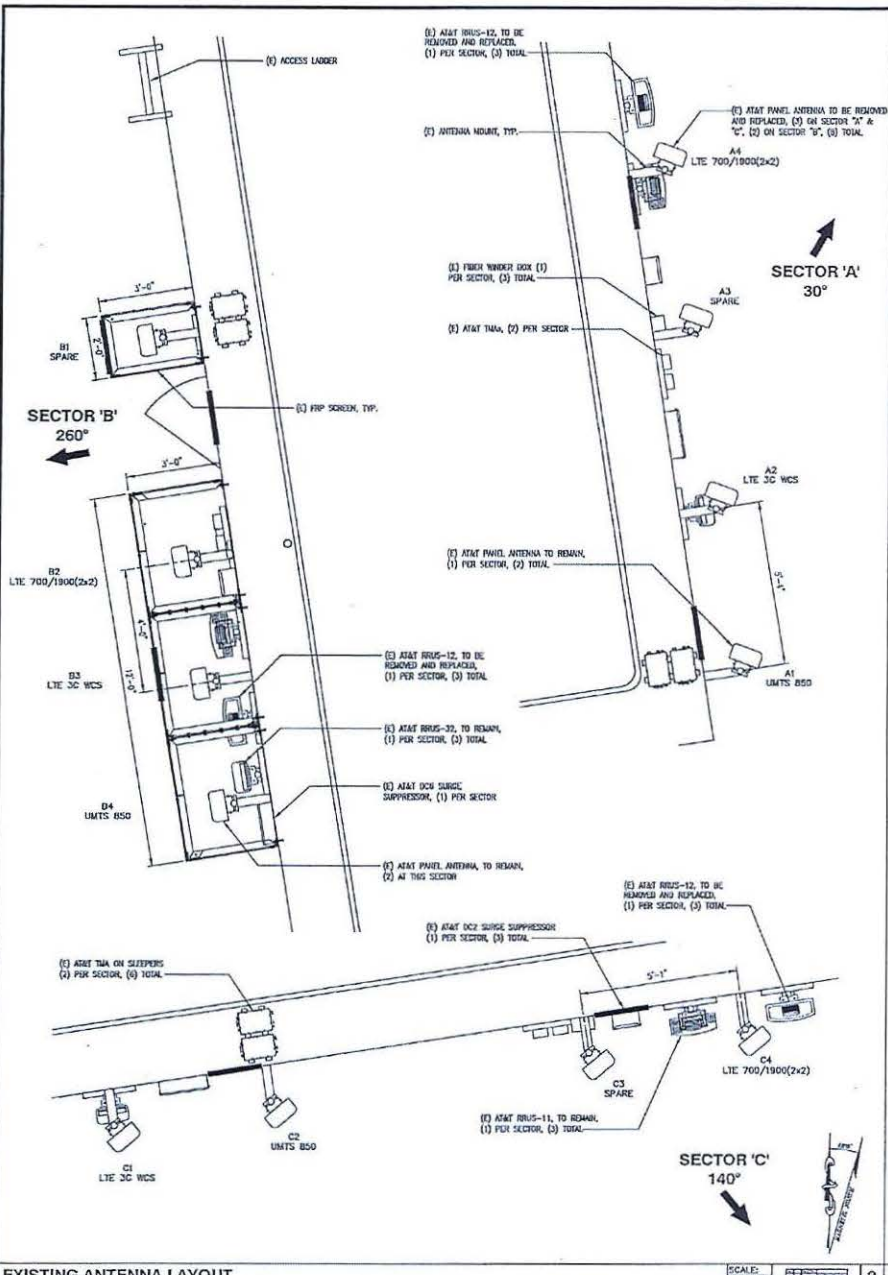

NOTE:
ALL RRUS AND EQUIPMENT TO BE MOUNTED BELOW THE BOTTOM OF THE ANTENNAS.
PAINT ALL NEW EQUIPMENT TO MATCH EXISTING BUILDING COLOR.

CCL00096/CNU0096
SF CIVIC CENTER
260 GOLDEN GATE AVENUE
SAN FRANCISCO, CA 94102
ROOFTOP/INDOOR



5001 EXECUTIVE PARKWAY,
SAN RAMON, CA 94583



6140 STONERIDGE MALL, ROAD, SUITE 350
PLEASANTON, CA 94588

PLANS PREPARED BY:



1875 CONORAH AVE
SIGNAL HILL, CA 94745

REV	DATE	DESCRIPTION	INT
5	11/11/18	ISSUE CDW	SA
4	11/09/18	ISSUE CDW	SA
3	11/05/18	ISSUE CDW REVISION	MB
2	06/20/18	CLIENT COMMENTS	LT
1	06/29/18	ISSUE CONSTRUCTION DRAWINGS	AM
0	06/18/18	ISSUE CONSTRUCTION DRAWINGS	DA



IT IS A VIOLATION OF LAW FOR ANY PERSON, UNLESS THEY ARE ACTING UNDER THE DIRECTION OF A LICENSED PROFESSIONAL ENGINEER, TO ALTER THIS DOCUMENT.

SHEET TITLE
EXISTING AND PROPOSED
ANTENNA LAYOUTS

SHEET NUMBER
A-3

EXISTING ANTENNA LAYOUT

SCALE: 1/2"=1'-0"

2 NEW ANTENNA LAYOUT

SCALE: 1/2"=1'-0"

1

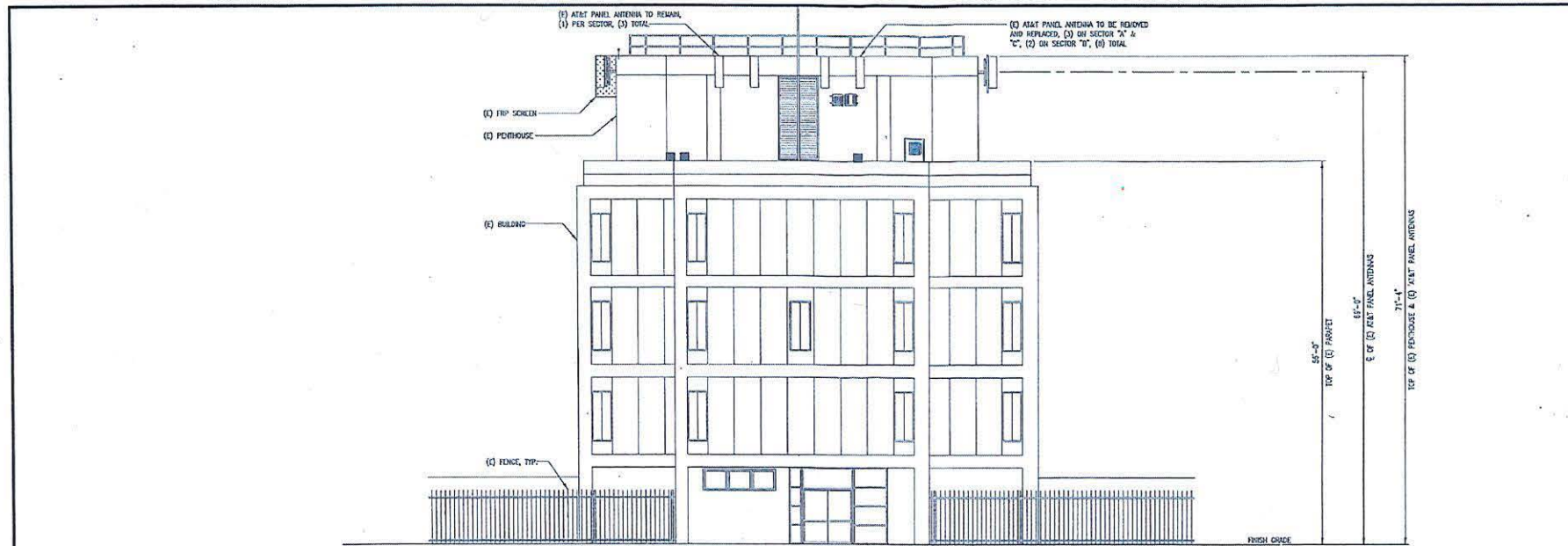

EXISTING SOUTH ELEVATION

SCALE: 1/8"=1'-0" 2

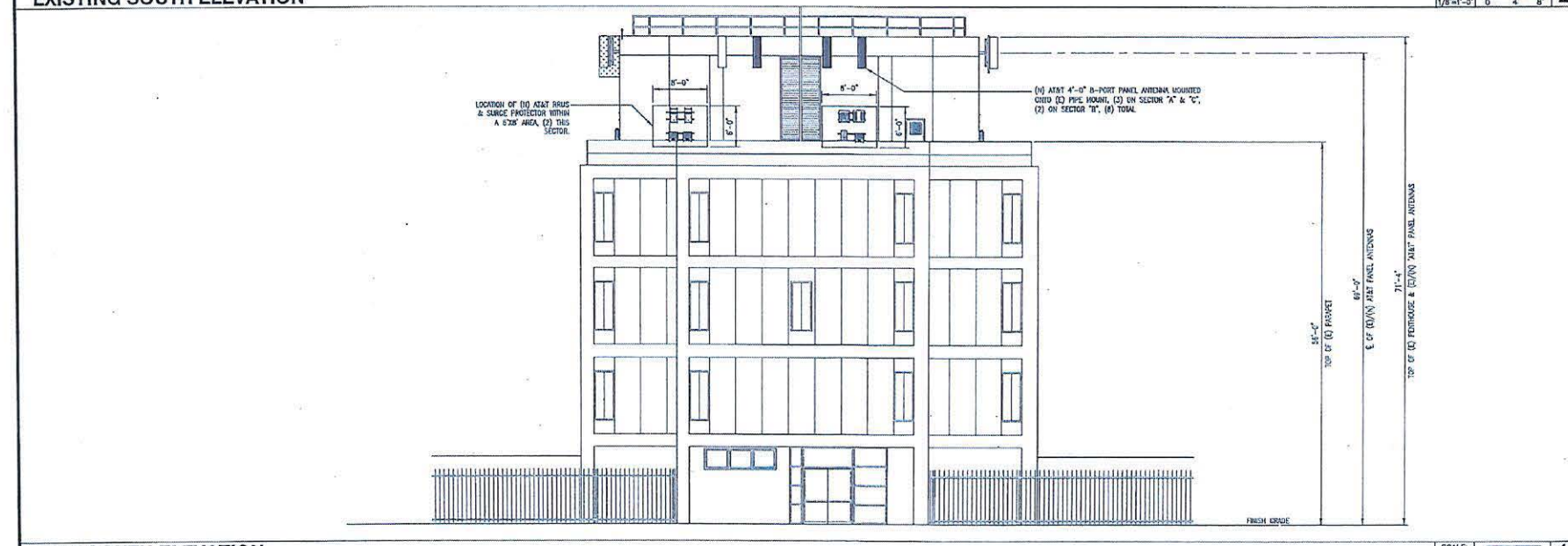

NEW SOUTH ELEVATION

SCALE: 1/8"=1'-0" 1

CCL00096/CNU0096
 SF CIVIC CENTER
 260 GOLDEN GATE AVENUE
 SAN FRANCISCO, CA 94102
 ROOFTOP/INDOOR



5001 EXECUTIVE PARKWAY,
 SAN RAMON, CA 94583



6140 STONERIDGE MALL ROAD, SUITE 350
 PLEASANTON, CA 94588

PLANS PREPARED BY:



1875 CORONADO AVE
 SERRA HILL, CA 94565

3	11/11/19	100% CD	SA
4	11/06/19	100% CD	SA
3	11/05/19	100% CD REVISION	MB
2	08/20/19	CLIENT COMMENTS	LT
1	06/29/18	100% CONSTRUCTION DRAWINGS	AM
0	09/18/18	50% CONSTRUCTION DRAWINGS	CA
REV	DATE	DESCRIPTION	BY



IT IS A VIOLATION OF LAW FOR ANY PERSON, UNLESS THEY ARE ACTING UNDER THE DIRECTION OF A LICENSED PROFESSIONAL ENGINEER, TO ALTER THIS DOCUMENT.

SHEET TITLE
 ELEVATIONS

SHEET NUMBER
 A-4

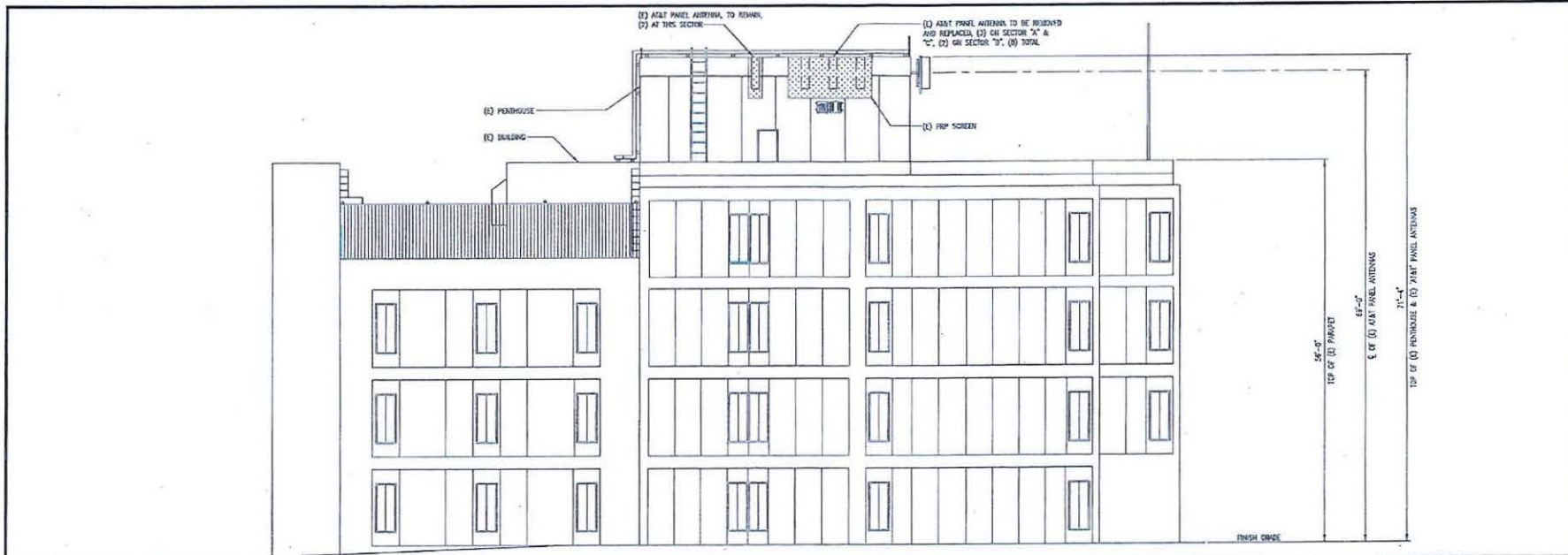

EXISTING WEST ELEVATION

SCALE: 1/8"=1'-0" 2

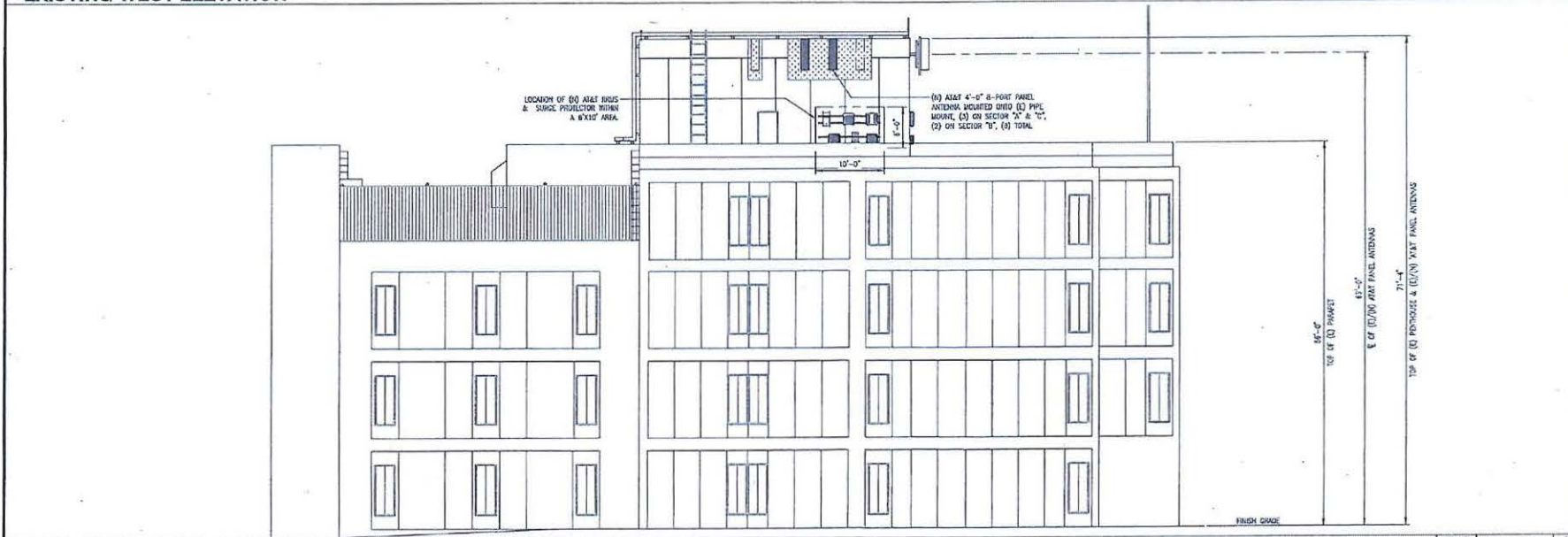

NEW WEST ELEVATION

SCALE: 1/8"=1'-0" 1

CCL00096/CHU0096
SF CIVIC CENTER
260 GOLDEN GATE AVENUE
SAN FRANCISCO, CA 94102
ROOFTOP/INDOOR



5001 EXECUTIVE PARKWAY,
SAN RAMON, CA 94583



ERICSSON

5140 STONERIDGE MALL ROAD, SUITE 350
PLEASANTON, CA 94590

PLANS PREPARED BY:



1975 CORONADO AVE
SIGNAL HILL, CA 94049

REV	DATE	DESCRIPTION	INT
5	11/11/19	100% CD#	SA
4	11/09/19	100% CD#	SA
3	11/05/19	100% CD# REVISION	MB
2	08/20/19	CLIENT COMMENTS	LT
1	06/29/18	100% CONSTRUCTION DRAWINGS	AM
0	05/18/18	SET CONSTRUCTION DRAWINGS	CA



IT IS A VIOLATION OF LAW FOR ANY PERSON, UNLESS THEY ARE ACTING UNDER THE DIRECTION OF A LICENSED PROFESSIONAL ENGINEER, TO ALTER THIS DOCUMENT.

SHEET TITLE
ELEVATIONS

SHEET NUMBER
A-5

CCL00096/CHU0096
 SF CIVIC CENTER
 260 GOLDEN GATE AVENUE
 SAN FRANCISCO, CA 94102
 ROOFTOP/INDOOR



5001 EXECUTIVE PARKWAY,
 SAN RAMON, CA 94583



ERICSSON

6140 DITCHBERRY ROAD, SUITE 350
 PLEASANTON, CA 94589

PLANS PREPARED BY:



1875 CORONADO AVE
 SIGNAL HILL, CA 91405

REV	DATE	DESCRIPTION	INT
5	11/11/19	100% CDR	SA
4	11/06/19	100% CDR	SA
3	11/05/19	100% CDR REVISION	MB
2	08/20/19	CLIENT COMMENTS	LT
1	06/29/18	100% CONSTRUCTION DRAWINGS	AM
0	08/19/18	90% CONSTRUCTION DRAWINGS	GA



IT IS A VIOLATION OF LAW FOR ANY PERSON, UNLESS THEY ARE ACTING UNDER THE DIRECTION OF A LICENSED PROFESSIONAL ENGINEER, TO ALTER THIS DOCUMENT.

SHEET TITLE

ELEVATIONS

SHEET NUMBER

A-6

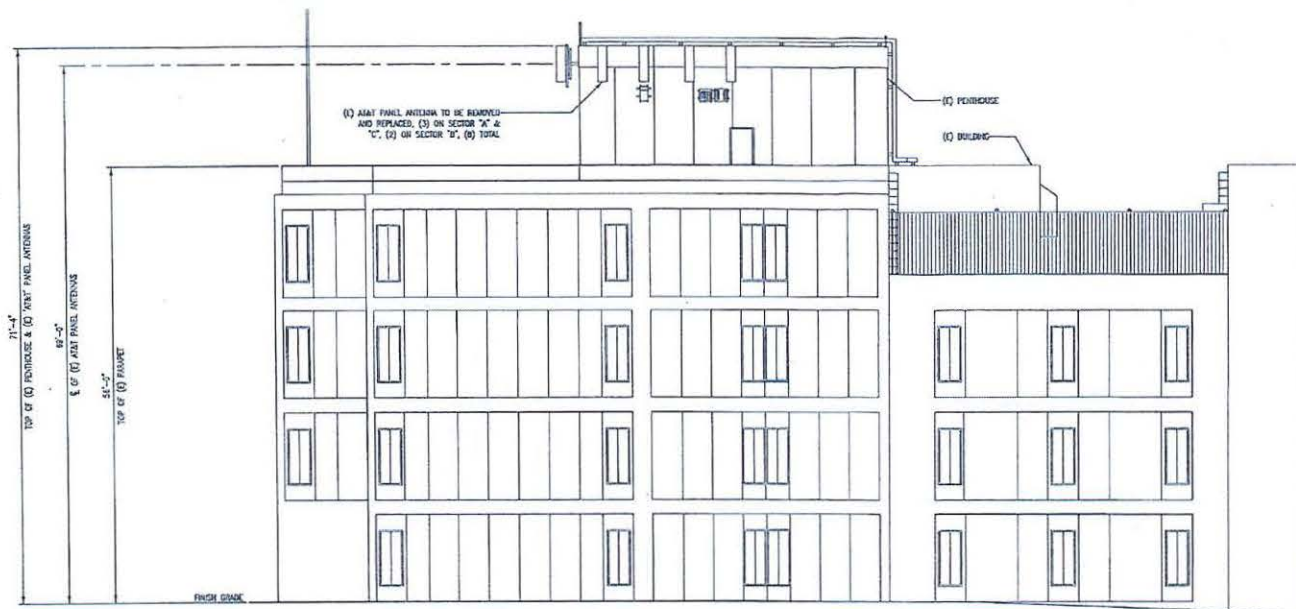

EXISTING EAST ELEVATION

SCALE: 1/8"=1'-0" 2

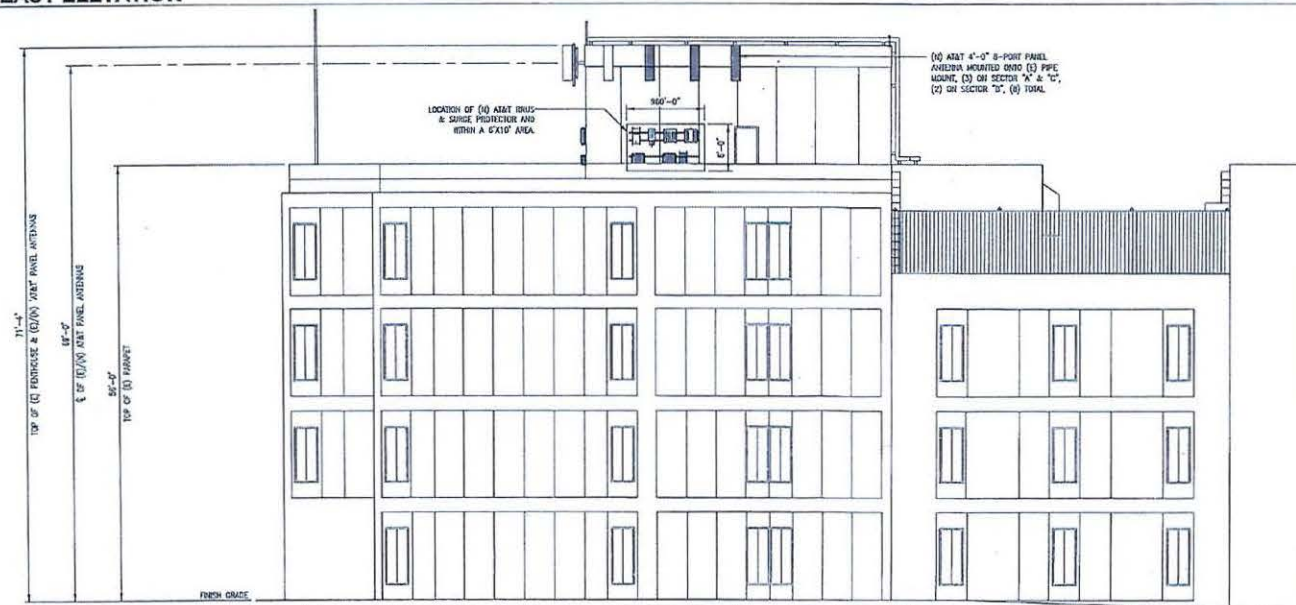

NEW EAST ELEVATION

SCALE: 1/8"=1'-0" 1

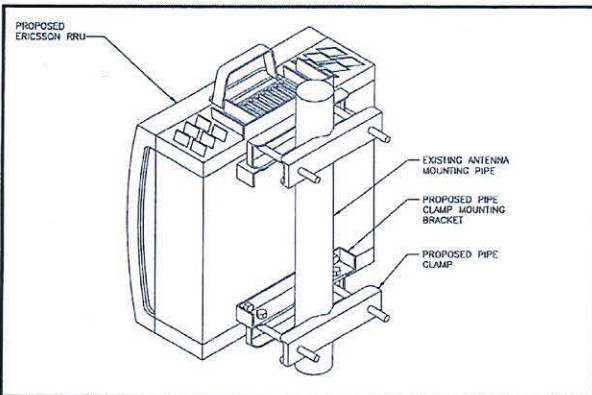

TYPICAL RRU MOUNTING DETAIL

NO SCALE

7

ERICSSON RRUS-32 B66

DIMENSIONS, HxWxD: (27.2"x12.1"x7.0")
 DC LOAD VALUE: 850W
 TOTAL WEIGHT: 53 lbs
 AWS: TX = 2110 - 2180 MHz
 RX = 1710 - 1780 MHz

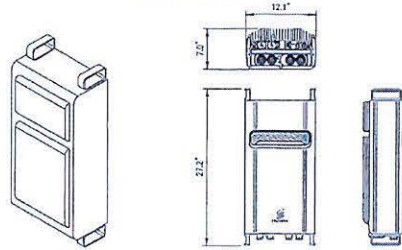

RRUS-32 B66 SPECIFICATIONS

NO SCALE

4

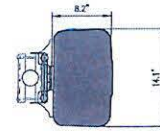

COMMSCOPE 4'-0" 8 PORT ANTENNA: J4HH-85A-R3R
 DIMENSIONS (H X W X D): 55.1" X 14.1" X 8.2"

WEIGHT: 52.9 LBS.
 W/O RET OR MOUNTING HARDWARE

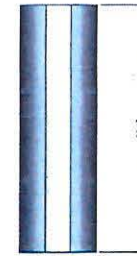

COMMSCOPE 4'-0" 8 PORT ANTENNA

NO SCALE

1

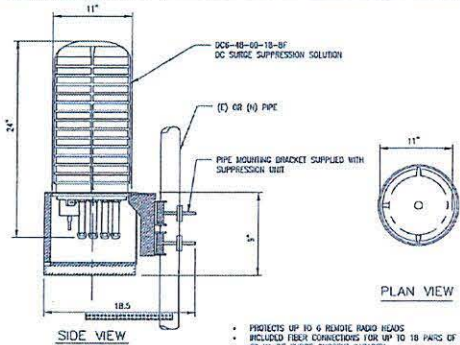

SIDE VIEW

PLAN VIEW

- PROTECTS UP TO 6 REMOTE RADIO HEADS
- INCLUDES FIBER CONNECTIONS FOR UP TO 18 Pairs OF FIBER
- 60 KA OF SURGE CURRENT CAPACITY
- IT IS RECOMMENDED THAT UNIT BE INSTALLED WITHIN 6 FEET OF THE RAZO
- TOTAL WEIGHT IS UNDER 20 LBS.

DC 6 SURGE PROTECTION DETAIL

NO SCALE

8

XMU_03

DIMENSIONS, WxDxH: (13.8"x11"x1.22")
 MAX POWER CONSUMPTION: 80 W
 BREAKER SIZE: MIN 15 A, MAX 20 A
 TOTAL WEIGHT: ± 5 lbs

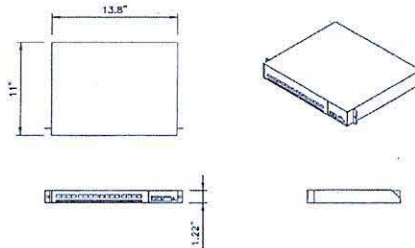

XMU_03 DETAIL

NO SCALE

5

ERICSSON RRUS-4478 B14

DIMENSIONS, HxWxD: 18.5"x13.4"x7.7"
 POWER CONSUMPTION: 4x40 WATTS
 TOTAL WEIGHT: 59.9 lbs
 TEMPERATURE: -40° TO 55° C

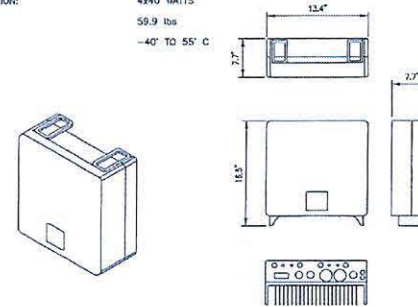

RRUS-4478 B14 SPECIFICATIONS

NO SCALE

2

5216 BASEBAND

DIMENSIONS, WxDxH: (13.8"x11"x1.22")
 MAX POWER CONSUMPTION: 80 W
 BREAKER SIZE: MIN 15 A, MAX 20 A
 TOTAL WEIGHT: ± 9 lbs

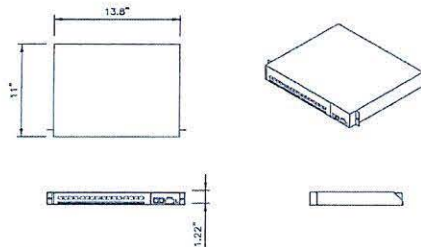

BASEBAND 5216

NO SCALE

9

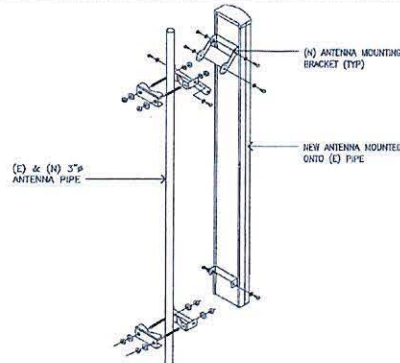

ANTENNA MOUNTING DETAIL

NO SCALE

6

ERICSSON RRUS-4415 B25

DIMENSIONS, HxWxD: 15"x13.2"x6.8"
 POWER CONSUMPTION: 4x40 WATTS
 TOTAL WEIGHT: 48.5 lbs
 TEMPERATURE: -40° TO 55° C

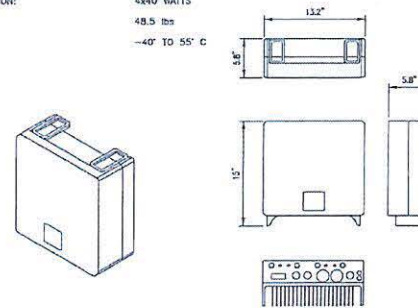

RRUS-4415 B25 SPECIFICATIONS

NO SCALE

3

CCL00096/CNU0096
 SF CIVIC CENTER
 260 GOLDEN GATE AVENUE
 SAN FRANCISCO, CA 94102
 ROOFTOP/INDOOR



5001 EXECUTIVE PARKWAY,
 SAN RAMON, CA 94583



ERICSSON
 6140 STONERIDGE MALL ROAD, SUITE 250
 PLEASANTON, CA 94589

PLANS PREPARED BY:

 1875 CORONADO AVE
 SIGNAL HILL, CA 90755

REV	DATE	DESCRIPTION	INT
5	11/11/10	100% COV	SA
4	11/06/10	100% COV	SA
3	11/05/10	100% COV REVISION	MB
2	08/20/10	CLIENT COMMENTS	LF
1	05/29/10	100% CONSTRUCTION SERVICES	AM
0	04/18/10	BIDD CONSTRUCTION SERVICES	CA



IT IS A VIOLATION OF LAW FOR ANY PERSON, UNLESS THEY ARE ACTING UNDER THE DIRECTION OF A LICENSED PROFESSIONAL ENGINEER, TO ALTER THIS DOCUMENT.

SHEET TITLE
 DETAILS

SHEET NUMBER
 D-1

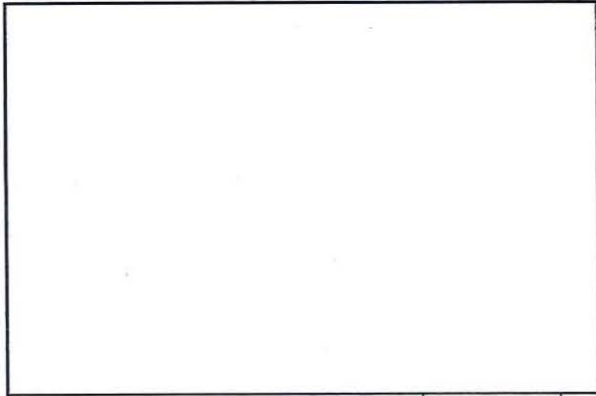

NOT USED

NO SCALE

7

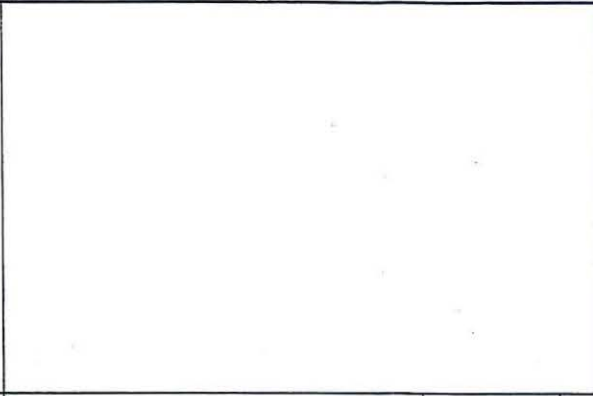

NOT USED

NO SCALE

4

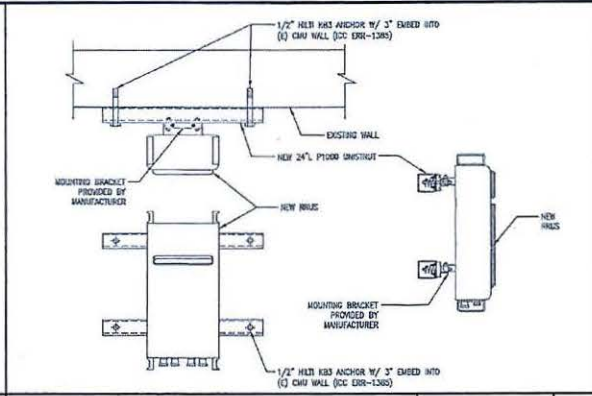

RRU WALL MOUNT DETAIL

NO SCALE

1

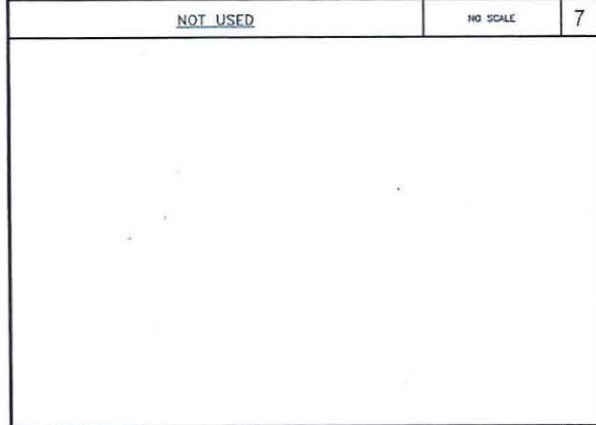

NOT USED

NO SCALE

8

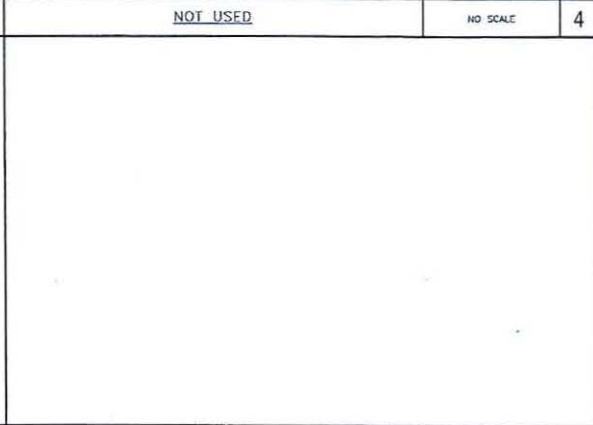

NOT USED

NO SCALE

5

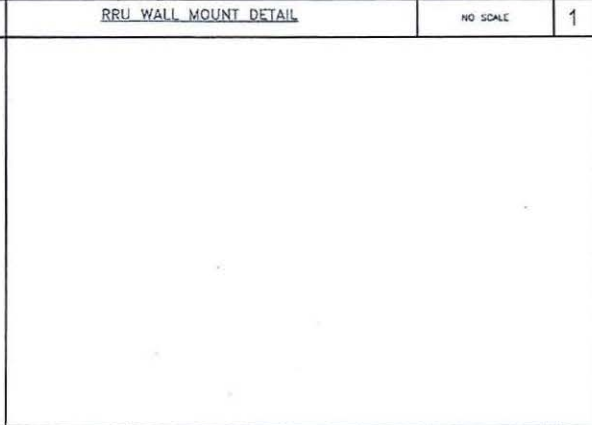

NOT USED

NO SCALE

2

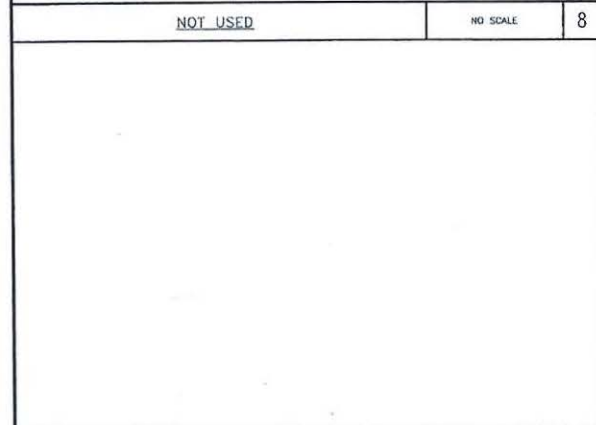

NOT USED

NO SCALE

9

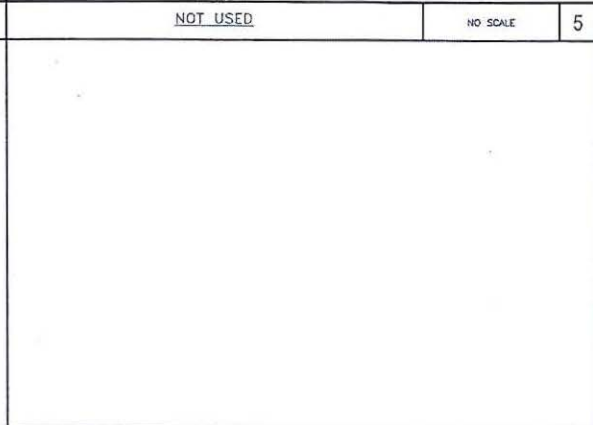

NOT USED

NO SCALE

6

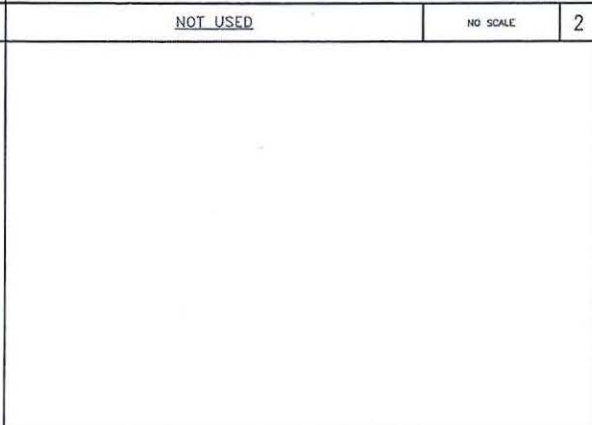

NOT USED

NO SCALE

3

CL00096/CNU096
SF CIVIC CENTER
280 GOLDEN GATE AVENUE
SAN FRANCISCO, CA 94102
ROOFTOP/INDOOR



5001 EXECUTIVE PARKWAY,
SAN RAMON, CA 94583



6140 STONEBRIDGE MALL ROAD, SUITE 300
PLEASANTON, CA 94586

PLANS PREPARED BY:



1875 CORONADO AVE
SIGNAL HILL, CA 92681

REV	DATE	DESCRIPTION	INT
5	11/11/19	ISSUE CD	SA
4	11/06/19	ISSUE CD	SA
3	11/05/19	ISSUE CD REVISION	MB
2	08/20/19	CLIENT COMMENTS	LT
1	06/29/18	ISSUE CONSTRUCTION DIMENSIONS	AH
0	06/18/18	ISSUE CONSTRUCTION DIMENSIONS	CA



IT IS A VIOLATION OF LAW FOR ANY PERSON, UNLESS THEY ARE ACTING UNDER THE DIRECTION OF A LICENSED PROFESSIONAL ENGINEER, TO ALTER THIS DOCUMENT.

SHEET TITLE
DETAILS

SHEET NUMBER
D-2

EXHIBIT D

Conditional Use Permits

2016 (Phase 1) scope permit

Permit Details Report

Report Date: 6/23/2016 5:25:52 PM
Application Number: 201601126876
Form Number: 8
Address(es): 0345 / 007 / 0 260 GOLDEN GATE AV
Description: MODIFICATION TO E ATT FACILITY INCLUDING REMOVE AND REPLACE 3 E ANTENNAS. INSTALL 3 NEW RRUS, E N SURGE SUPPRESSORS, N INNERDUCT FOR FIBER/POWER. INSTALL 1 NEW SURGE SUPPRESSOR IN N 19 IN RACK AND 2 NEW DVS 4/2 IN E RACKS IN EQUIPMENT ROOM
Cost: \$25,000.00
Occupancy Code: B
Building Use: 10 - OFFICE

Disposition / Stage:

Action Date	Stage	Comments
1/12/2016	TRIAGE	
1/12/2016	FILEING	
1/12/2016	FILED	

Contact Details:

Contractor Details:

Addenda Details:

Description:

Step	Station	Arrive	Start	In Hold	Out Hold	Finish	Checked By	Phone	Hold Description
1	417-86							415-558-6070	
2	INTAKE	1/12/16	1/12/16			1/12/16	BUFKA SUSAN	415-999-9999	
3	CP-ZOC	6/17/16	6/17/16			6/17/16	ADINA SEENA	415-558-6377	NOTE: Update building permit info to encompass new scope of work. Update estimated cost of construction to encompass new scope of work. Approved over the counter, removing and replacing three antennas. Adding six RRUs and other supplemental equipment. Installation of FRP screening.
4	BLDG	6/20/16	6/20/16			6/20/16	YU CYRIL	415-558-6133	
5	SFFD	1/12/16	1/12/16			1/12/16	O'KEEFE TRACY	415-558-6177	revision stamped and APPROVED etc
6	HEALTH	1/13/16	1/13/16			1/13/16	FOSDAHL PATRICK	415-252-3800	
7	CPB							415-558-6070	

Appointments:

Appointment Date	Appointment AM/PM	Appointment Code	Appointment Type	Description	Time Slots

Inspections:

Activity Date	Inspector	Inspection Description	Inspection Status

EXHIBIT D (cont.)

Conditional Use Permits

2019 (Phase 2) scope permit

Permit Details Report

Report Date: 2/11/2020 1:38:31 PM

Application Number: 201911187555
Form Number: 8
Address(es): 0345 /007 /0 260 GOLDEN GATE AV
Description: ATF MODIFICATION: R/R 8 EXTG ANTENNAS WITH 8 NEW ANTENNAS, REMOVE 3 EXTG RRUS, INSTALL 9 NEW RRUS. INSTALL OTHER SMALL EQUIP, PAINT EXPOSAL EQUIPMENT TO MATCH, NO CHANGE TO EXGT BATTERIES.
Cost: \$49,000.00
Occupancy Code: B
Building Use: 10 - OFFICE

Disposition / Stage:

Action Date	Stage	Comments
11/18/2019	TRIAGE	
11/18/2019	FILING	
11/18/2019	FILED	

Contact Details:

Contractor Details:

Addenda Details:

Description:

Step	Station	Arrive	Start	In Hold	Out Hold	Finish	Checked By	Phone	Hold Description
1	INTAKE	11/18/19	11/18/19			11/18/19	SHAWL HAREGGEWAIN	415-999-9999 ⁽⁸⁾	
2	CP-ZOC							415-558-6377 ⁽⁸⁾	
3	BLDG	1/30/20	1/30/20			1/30/20	YU CYRIL	415-558-6133 ⁽⁸⁾	
4	SFFD	1/30/20	1/30/20			1/30/20	MCCORMACK MARCELLA	415-558-6177 ⁽⁸⁾	APPROVED
5	HEALTH							415-252-3800 ⁽⁸⁾	
6	CPB							415-558-6070 ⁽⁸⁾	

Appointments:

Appointment Date	Appointment AM/PM	Appointment Code	Appointment Type	Description	Time Slots

Inspections:

Activity Date	Inspector	Inspection Description	Inspection Status

Special Inspections:

Addenda No.	Completed Date	Inspected By	Inspection Code	Description	Remarks
0			18B	BOLTS INSTALLED IN EXISTING MASONRY	

EXHIBIT D (cont.)

Conditional Use Permits

Job Card

2020-000274PRL w

PERMIT APPLICATION CONTROL SLIP

ADDRESS: 260 Golden Gate Ave

APPLICATION #

STATION	CP	ROV	MECH	PRE	OSM	STPUC	DPH	SEMTA	DFCU	PPC	CPB
ACCEPT											
APPR'D	WAK		WAK		WAK		AS				
DATE	1/20		1/20		1/20		2/20				
STATION	PLAN REVIEWER	DATE LOG-IN	DATE START	DATE HOLD	DATE APPR'D	COMMENTS					
BLDG											
SIR											
MECH											
COMMENTS:	M.L. - 1										

COMPLAINTS: NO YES DIVISION

SITE PERMIT SOFT STORY PREMIUM PARALLEL

APPRO DATE

FORM 3/8 APPLICATION NUMBER 2019-11-19-255 APPROVAL NUMBER 0581 APPROVAL RECEIVED

FORM 2 NUMBER OF PLAN SETS

ACCORDING TO THE DESCRIPTION AND FOR THE PURPOSE HEREINAFTER SET FORTH

DATE FILED: 11/18/2019 PLUMBING RECEIPT NO. (1) STREET ADDRESS OF JOB: 260 Golden Gate Ave, 0345/007 BLOCK & LOT

PERMIT NO. (2) ESTIMATED COST OF JOB: \$47,000 (3) MEMBER COST: \$49K DATE: 1/20/20

INFORMATION TO BE FURNISHED BY ALL APPLICANTS

LEGAL DESCRIPTION OF EXISTING BUILDING

(1A) TYPE OF CONSTR.	(2A) NO. OF STORIES OF OCCUPANCY: <u>4</u>	(3A) NO. OF BASEMENTS AND CELLARS: <u>0</u>	(4A) PRESENT USE: <u>office</u>	(5A) OCCUP. CLASS: <u>5</u>	(6A) NO. OF DWELLING UNITS: <u>0</u>
(4) TYPE OF CONSTR.	(5) NO. OF STORIES OF OCCUPANCY: <u>4</u>	(6) NO. OF BASEMENTS AND CELLARS: <u>0</u>	(7) PROPOSED USE (LEGAL USE): <u>office</u>	(8) OCCUP. CLASS: <u>(10)</u>	(9) NO. OF DWELLING UNITS: <u>0</u>

(10) IS AUTO RAMPWAY TO BE CONSTRUCTED OR ALTERED? YES NO

(11) WILL STREET SPACE BE USED OUTSIDE CONSTRUCTION? YES NO

(12) ELECTRICAL WORK TO BE PERFORMED? YES NO

(13) PLUMBING WORK TO BE PERFORMED? YES NO

(14) GENERAL CONTRACTOR ADDRESS: ZIP: PHONE: CALIF. LIC. NO.: EXPIRATION DATE:

(15) OWNER - LESSEE (CROSS OUT ONE) ADDRESS: ZIP: STREET: PHONE (FOR CONTACT BY DEPT.):

ATT Mobility 430 Bldg, 5th A SF, CA 94108 805-895-4894

(16) WRITE IN DESCRIPTION OF ALL WORK TO BE PERFORMED UNDER THIS APPLICATION (REFERENCE TO PLANS IS NOT SUFFICIENT)

ATT modification: Rt R (8)(E) antennas w/ (8)(N) antennas; Remove (3)(E) RRUs; Install (9)(N) RRUs; Install other small equip; Paint exposed equip to match; No change to (6) batteries.

ADDITIONAL INFORMATION

(17) DOES THIS ALTERATION CREATE ADDITIONAL HEIGHT OR STORY TO BUILDING? YES <input type="checkbox"/> NO <input checked="" type="checkbox"/>	(18) IF (17) IS YES, STATE NEW HEIGHT AT CENTER LINE OF FRONT: <u>N/A</u>	(19) DOES THIS ALTERATION CREATE DECK OR PORCH, EXTENSION TO BUE, DUNE? YES <input type="checkbox"/> NO <input checked="" type="checkbox"/>	(20) IF (19) IS YES, STATE NEW GROUND FLOOR AREA: <u>N/A</u> SQ. FT.
(21) WILL SIDEWALK OVER SUB-SIDEWALK SPACE BE REPAIRED OR ALTERED? YES <input type="checkbox"/> NO <input checked="" type="checkbox"/>	(22) WILL BUILDING EXTEND BEYOND PROPERTY LINE? YES <input type="checkbox"/> NO <input checked="" type="checkbox"/>	(23) ANY OTHER EXISTING OLDS. ON LOT? OF YES, SHOW ON PLOT PLAN: YES <input type="checkbox"/> NO <input checked="" type="checkbox"/>	(24) DOES THIS ALTERATION CONSTITUTE A CHANGE OF OCCUPANCY? YES <input type="checkbox"/> NO <input checked="" type="checkbox"/>

(25) ARCHITECT OR ENGINEER (DESIGN OR CONSTRUCTION) ADDRESS: CALIF. CERTIFICATE NO.:

Newwave 1875 Coronado Ave, Signal Hill, CA 90745 # 76549

(26) CONSTRUCTION LEADER (ENTER NAME AND BRANCH DESIGNATION IF ANY. IF THERE IS NO KNOWN CONSTRUCTION LEADER, ENTER 'UNKNOWN') ADDRESS:

N/A

IMPORTANT NOTICES No change shall be made in the character of the occupancy or use without first obtaining a Building Permit authorizing such change. See San Francisco Building Code and San Francisco Housing Code.

NOTICE TO APPLICANT HOLD YOURSELF (LAURE). The permit(s) by acceptance of the permit contract is automatically voided by...

EXHIBIT E

Access Requirements

1. All parties must sign in and show credentials (business card or ID) at the front desk upon arriving at 260 Golden Gate Avenue and shall receive a visitor's pass. Upon exiting the building/facility grounds, it would be appreciated if the visitor also sign-outs at the front desk.
2. Staff escorts are available, however a party will not require an escort **unless they will need to access participant rooms.**

Contact information:

Tonya Allen, Operations Manager

Hamilton Families Shelter

415-292-9930x327

tallen@hamiltonfamilies.org

EXHIBIT F

(IF NEEDED)



London N. Breed, Mayor
Naomi M. Kelly, City Administrator



Andrico Q. Penick
Director of Real Estate

May 6, 2020

Through City Administrator Naomi Kelly

Honorable Board of Supervisors
City and County of San Francisco
City Hall, Room 244
1 Carlton B. Goodlett Place
San Francisco, CA 94102

Subject: Communications Site Lease Between City and County of San Francisco (Landlord) and New Cingular Wireless PCS, LLC (aka AT&T) (Tenant) at 260 Golden Gate

Dear Board Members:

Attached for your consideration is a Resolution approving and authorizing a Communications Site Lease between the City and County of San Francisco (Landlord) and New Cingular Wireless PCS, LLC (aka AT&T) at 260 Golden Gate which is currently under the jurisdiction of the Department of Homelessness and Supportive Housing. The Lease permits the installation and replacement of upgraded antennas and equipment by AT&T which is currently on the site under holdover of an existing Lease.

Background

In 1996, the Board of Supervisors approved a "Cell Site Lease" between the City and Bay Area Cellular Telephone Company (BACTC). The lease term was for a total of 15 years (initial five-year term and two five-year options) or until May 31, 2011.

In 2011, the Real Estate Division (RED) commenced negotiations with the Tenant to enter into a new lease. In 2012, the former Real Property Director forwarded a letter of intent to AT&T Wireless (which purchased BACTC). During this time period, the facility, originally the SFFD's Headquarters, changed uses and the SFFD relocated. Currently, the building houses Hamilton Families, a non-profit, providing assistance to and housing for the homeless.

Negotiations stalled for numerous reasons including changes in staffing both on the City side and the tenant side; revisions to the planned upgrades and permitting of same; and, the City's decisions regarding reuse of the building.

In or about 2016, AT&T indicated they had "finalized" plans for upgrades to several of the antennas on site. Approval of the plans took some time. In April 2020, the two parties agreed to the proposed lease which includes the approved plans for the equipment upgrades.

Resolution

Specifically, the Resolution approves:

- (A) An initial Lease term of ten years through 2030;
- (B) Two additional option terms of five years each to extend the lease;
- (C) A base monthly rent of \$7,696.00 commencing upon approval by the Board of Supervisors and Mayor, subject to annual adjustments of 4%; and
- (D) The Tenant to pay to City \$600.00 monthly for utilities and services which increases 3% annually.

Both the Department of Homelessness and Supportive Housing and the Real Estate Division recommend approval of the proposed Resolution.

If you have any questions regarding the lease, please contact Claudia Gorham of Real Estate at 415.554.9871 or Claudia.gorham@sfgov.org.

Respectfully,



Andrico Q. Penick
Director of Property

From: [Quetone, Tal \(ART\)](#)
To: [BOS Legislation, \(BOS\)](#)
Cc: [Gorham, Claudia \(ADM\)](#); [Gosiengfiao, Rachel \(ADM\)](#); [Barnes, Bill \(ADM\)](#)
Subject: ADM -- [Resolution] -- [Resolution authorizing and approving the lease of telecommunications facilities on the roof at 260 Golden Gate Avenue]
Date: Friday, May 15, 2020 1:23:37 PM
Attachments: [260 Golden Gate Ltr to BOS fr RED.pdf](#)
[Exhibits to Proposed Lease.260 Golden Gate.pdf](#)
[Form 126 - 260 Golden Gate.pdf](#)
[Lease 260 Golden Gate.signed by tenant.pdf](#)
[Resolution.260 Golden Gate.pdf](#)
[Resolution.260 Golden Gate.doc](#)

Hello,

Attached for introduction to the Board of Supervisors is a **resolution authorizing and approving the lease of telecommunications facilities on a portion of the roof at 260 Golden Gate Avenue with New Cingular Wireless PCS, LLC, for a ten-year term at an initial annual rent of \$92,352 or the monthly base rent of \$7,696, 4% annual adjustments thereafter, and two five-year options to extend, tenant responsible for all services and utilities, to commence upon execution after approval by the Board of Supervisors and Mayor, in their respective sole and absolute discretion.**

Best,

Tal Quetone
Office of the City Administrator
City and County of San Francisco
City Hall, Room 362
(415) 554-4928



San Francisco Ethics Commission

25 Van Ness Avenue, Suite 220, San Francisco, CA 94102

Phone: 415.252.3100 . Fax: 415.252.3112

ethics.commission@sfgov.org . www.sfethics.org

Received On:

File #:

200544

Bid/RFP #:

Notification of Contract Approval

SFEC Form 126(f)4

(S.F. Campaign and Governmental Conduct Code § 1.126(f)4)

A Public Document

Each City elective officer who approves a contract that has a total anticipated or actual value of \$100,000 or more must file this form with the Ethics Commission within five business days of approval by: (a) the City elective officer, (b) any board on which the City elective officer serves, or (c) the board of any state agency on which an appointee of the City elective officer serves. For more information, see: <https://sfethics.org/compliance/city-officers/contract-approval-city-officers>

1. FILING INFORMATION

TYPE OF FILING	DATE OF ORIGINAL FILING (for amendment only)
Original	
AMENDMENT DESCRIPTION – Explain reason for amendment	

2. CITY ELECTIVE OFFICE OR BOARD

OFFICE OR BOARD	NAME OF CITY ELECTIVE OFFICER
Board of Supervisors	Members

3. FILER'S CONTACT

NAME OF FILER'S CONTACT	TELEPHONE NUMBER
Angela Calvillo	415-554-5184
FULL DEPARTMENT NAME	EMAIL
office of the clerk of the Board	Board.of.Supervisors@sfgov.org

4. CONTRACTING DEPARTMENT CONTACT

NAME OF DEPARTMENTAL CONTACT	DEPARTMENT CONTACT TELEPHONE NUMBER
Claudia Gorham	554.9871
FULL DEPARTMENT NAME	DEPARTMENT CONTACT EMAIL
ADM RED	claudia.gorham@sfgov.org

5. CONTRACTOR	
NAME OF CONTRACTOR New Cingular Wireless PCS, LLC a Delaware LLC	TELEPHONE NUMBER 916.943.5045
STREET ADDRESS (including City, State and Zip Code) 1025 Lenox Park Blvd. NE, 3rd Fl Atlanta, GA 30319	EMAIL g46945@att.com

6. CONTRACT		
DATE CONTRACT WAS APPROVED BY THE CITY ELECTIVE OFFICER(S)	ORIGINAL BID/RFP NUMBER	FILE NUMBER (If applicable) 200544
DESCRIPTION OF AMOUNT OF CONTRACT \$92,352		
NATURE OF THE CONTRACT (Please describe) Telecommunication lease for rooftop, outside wall and Antenna Area located at 260 Golden Gate.		

7. COMMENTS

8. CONTRACT APPROVAL	
This contract was approved by:	
<input type="checkbox"/>	THE CITY ELECTIVE OFFICER(S) IDENTIFIED ON THIS FORM
<input checked="" type="checkbox"/>	A BOARD ON WHICH THE CITY ELECTIVE OFFICER(S) SERVES Board of Supervisors
<input type="checkbox"/>	THE BOARD OF A STATE AGENCY ON WHICH AN APPOINTEE OF THE CITY ELECTIVE OFFICER(S) IDENTIFIED ON THIS FORM SITS

9. AFFILIATES AND SUBCONTRACTORS

List the names of (A) members of the contractor’s board of directors; (B) the contractor’s principal officers, including chief executive officer, chief financial officer, chief operating officer, or other persons with similar titles; (C) any individual or entity who has an ownership interest of 10 percent or more in the contractor; and (D) any subcontractor listed in the bid or contract.

#	LAST NAME/ENTITY/SUBCONTRACTOR	FIRST NAME	TYPE
1	AT&T Mobility Corporation		Board of Directors
2	Biry	Jennifer S.	Board of Directors
3	Christopher	David	CEO
4	Biry	Jennifer S.	CFO
5			
6			
7			
8			
9			
10			
11			
12			
13			
14			
15			
16			
17			
18			
19			

9. AFFILIATES AND SUBCONTRACTORS

List the names of (A) members of the contractor’s board of directors; (B) the contractor’s principal officers, including chief executive officer, chief financial officer, chief operating officer, or other persons with similar titles; (C) any individual or entity who has an ownership interest of 10 percent or more in the contractor; and (D) any subcontractor listed in the bid or contract.

#	LAST NAME/ENTITY/SUBCONTRACTOR	FIRST NAME	TYPE
20			
21			
22			
23			
24			
25			
26			
27			
28			
29			
30			
31			
32			
33			
34			
35			
36			
37			
38			

9. AFFILIATES AND SUBCONTRACTORS

List the names of (A) members of the contractor’s board of directors; (B) the contractor’s principal officers, including chief executive officer, chief financial officer, chief operating officer, or other persons with similar titles; (C) any individual or entity who has an ownership interest of 10 percent or more in the contractor; and (D) any subcontractor listed in the bid or contract.

#	LAST NAME/ENTITY/SUBCONTRACTOR	FIRST NAME	TYPE
39			
40			
41			
42			
43			
44			
45			
46			
47			
48			
49			
50			

Check this box if you need to include additional names. Please submit a separate form with complete information. Select “Supplemental” for filing type.

10. VERIFICATION

I have used all reasonable diligence in preparing this statement. I have reviewed this statement and to the best of my knowledge the information I have provided here is true and complete.

I certify under penalty of perjury under the laws of the State of California that the foregoing is true and correct.

<p>SIGNATURE OF CITY ELECTIVE OFFICER OR BOARD SECRETARY OR CLERK</p> <p>BOS Clerk of the Board</p>	<p>DATE SIGNED</p>
---	---------------------------