

File No. 41100

Committee Item No. 5

Board Item No. 18

### COMMITTEE/BOARD OF SUPERVISORS

#### AGENDA PACKET CONTENTS LIST

Committee: Budget & Finance Committee

Date November 5, 2014

Board of Supervisors Meeting

Date November 18, 2014

#### Cmte Board

- |                                     |                                     |  |
|-------------------------------------|-------------------------------------|--|
| <input type="checkbox"/>            | <input type="checkbox"/>            | Motion                                       |
| <input checked="" type="checkbox"/> | <input checked="" type="checkbox"/> | Resolution                                   |
| <input type="checkbox"/>            | <input type="checkbox"/>            | Ordinance                                    |
| <input type="checkbox"/>            | <input type="checkbox"/>            | Legislative Digest                           |
| <input type="checkbox"/>            | <input type="checkbox"/>            | Budget and Legislative Analyst Report        |
| <input type="checkbox"/>            | <input type="checkbox"/>            | Youth Commission Report                      |
| <input checked="" type="checkbox"/> | <input checked="" type="checkbox"/> | Introduction Form                            |
| <input type="checkbox"/>            | <input type="checkbox"/>            | Department/Agency Cover Letter and/or Report |
| <input type="checkbox"/>            | <input type="checkbox"/>            | MOU  |
| <input type="checkbox"/>            | <input type="checkbox"/>            | Grant Information Form                       |
| <input checked="" type="checkbox"/> | <input checked="" type="checkbox"/> | Grant Budget                                 |
| <input type="checkbox"/>            | <input type="checkbox"/>            | Subcontract Budget                           |
| <input checked="" type="checkbox"/> | <input checked="" type="checkbox"/> | Contract/Agreement                           |
| <input checked="" type="checkbox"/> | <input checked="" type="checkbox"/> | Form 126 – Ethics Commission                 |
| <input type="checkbox"/>            | <input type="checkbox"/>            | Award Letter                                 |
| <input type="checkbox"/>            | <input type="checkbox"/>            | Application                                  |
| <input type="checkbox"/>            | <input type="checkbox"/>            | Public Correspondence                        |

#### OTHER (Use back side if additional space is needed)

<input type="checkbox"/>	<input type="checkbox"/>	
<input type="checkbox"/>	<input type="checkbox"/>	
<input type="checkbox"/>	<input type="checkbox"/>	
<input type="checkbox"/>	<input type="checkbox"/>	
<input type="checkbox"/>	<input type="checkbox"/>	
<input type="checkbox"/>	<input type="checkbox"/>	
<input type="checkbox"/>	<input type="checkbox"/>	
<input type="checkbox"/>	<input type="checkbox"/>	
<input type="checkbox"/>	<input type="checkbox"/>	
<input type="checkbox"/>	<input type="checkbox"/>	
<input type="checkbox"/>	<input type="checkbox"/>	
<input type="checkbox"/>	<input type="checkbox"/>	
<input type="checkbox"/>	<input type="checkbox"/>	
<input type="checkbox"/>	<input type="checkbox"/>	
<input type="checkbox"/>	<input type="checkbox"/>	
<input type="checkbox"/>	<input type="checkbox"/>	
<input type="checkbox"/>	<input type="checkbox"/>	
<input type="checkbox"/>	<input type="checkbox"/>	
<input type="checkbox"/>	<input type="checkbox"/>	
<input type="checkbox"/>	<input type="checkbox"/>	
<input type="checkbox"/>	<input type="checkbox"/>	
<input type="checkbox"/>	<input type="checkbox"/>	

Completed by: Linda Wong Date October 31, 2014  
 Completed by: L.W. Date 11/10/14

1 [Accept and Expend Grant - Racial and Ethnic Approaches to Community Health - Heart  
2 Healthy SF- \$799,159]

3 **Resolution retroactively authorizing the Department of Public Health to accept and**  
4 **expend a grant in the amount of \$799,159 from Centers for Disease Control and**  
5 **Prevention to participate in a program entitled “Racial and Ethnic Approaches to**  
6 **Community Health - Heart Healthy SF” for the period of September 30, 2014, through**  
7 **September 29, 2015.**

8  
9 WHEREAS, Centers for Disease Control and Prevention has agreed to fund  
10 Department of Public Health (DPH) in the amount of \$799,159 for the period of September 30,  
11 2014, through September 29, 2015; and

12 WHEREAS, The full project period of the grant starts on September 30, 2014, and  
13 ends on September 29, 2017, with years two and three subject to availability of funds and  
14 satisfactory progress of the project; and

15 WHEREAS, As a condition of receiving the grant funds, Centers for Disease Control  
16 and Prevention requires the City to enter into an agreement (Agreement), a copy of which is  
17 on file with the Clerk of the Board of Supervisors in File No. 141100; which is hereby declared  
18 to be a part of this Resolution as if set forth fully herein; and

19 WHEREAS, The purpose of this project will adapt and implement the national Million  
20 Hearts Initiative in SF, focusing on Latinos and African Americans who have or are at risk for  
21 cardiovascular disease. Healthy Hearts SF will expand upon the Million Hearts initiative to  
22 incorporate the addition of alcohol and diabetes to the campaign’s focus in order to meet the  
23 health and cultural needs of San Francisco; and

24 WHEREAS, An Annual Salary Ordinance amendment is not required as the grant  
25 partially reimburses DPH for three existing positions, one Epidemiologist II (Job Class No.

1 2803) at .20 FTE, one Health Program Coordinator III (Job Class No. 2593) at .20 FTE, and  
2 one Senior Administrative Analyst (Job Class No. 1823) at .05 FTE for the period of  
3 September 30, 2014 through, September 29, 2015; and

4 WHEREAS, The budget includes a provision for indirect costs in the amount of  
5 \$10,392; now, therefore, be it

6 RESOLVED, That DPH is hereby authorized to retroactively accept and expend a grant  
7 in the amount of \$799,159 from Centers for Disease Control and Prevention; and

8 FURTHER RESOLVED, That DPH is hereby authorized to retroactively accept and  
9 expend the grant funds pursuant to San Francisco Administrative Code section 10.170-1; and,  
10 be it

11 FURTHER RESOLVED, That the Director of Health is authorized to enter into the  
12 Agreement on behalf of the City.

16 RECOMMENDED:

17   
18 \_\_\_\_\_  
19 Barbara A. Garcia, MPA  
20 Director of Health

APPROVED:

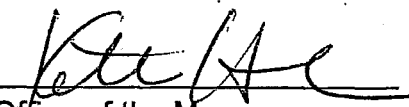
  
\_\_\_\_\_   
Office of the Mayor

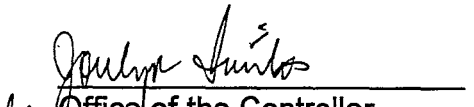
  
\_\_\_\_\_   
Office of the Controller



Edwin M. Lee  
Mayor

Barbara A. Garcia, MPA  
Director of Health

**TO:** Angela Calvillo, Clerk of the Board of Supervisors

**FROM:** Barbara A. Garcia, MPA  
Director of Health *cmc for*

**DATE:** September 29, 2014

**SUBJECT:** Grant Accept and Expend

**GRANT TITLE:** Racial and Ethnic Approaches to Community Health - Heart Healthy SF- \$799,159

Attached please find the original and 4 copies of each of the following:

- Proposed grant resolution, original signed by Department
- Grant information form, including disability checklist -
- Budget and Budget Justification
- Grant application
- Agreement / Award Letter
- Other (Explain):

**Special Timeline Requirements:**

**Departmental representative to receive a copy of the adopted resolution:**

Name: Richelle-Lynn Mojica

Phone: 255-3555

Interoffice Mail Address: Dept. of Public Health, Grants Administration for  
Community Programs, 1380 Howard St.

Certified copy required Yes

No

File Number: \_\_\_\_\_  
(Provided by Clerk of Board of Supervisors)

**Grant Resolution Information Form**  
(Effective July 2011)

Purpose: Accompanies proposed Board of Supervisors resolutions authorizing a Department to accept and expend grant funds.

The following describes the grant referred to in the accompanying resolution:

1. Grant Title: **Racial and Ethnic Approaches to Community Health - Heart Healthy SF**
2. Department: **Department of Public Health  
Population Health Division**
3. Contact Person: **Tomas Aragon, MD** Telephone: **415-554-2898**

4. Grant Approval Status (check one):

Approved by funding agency

Not yet approved

5. Amount of Grant Funding Approved or Applied for:

**\$2,397,477 in the 3-year project period (Year1 = \$799,159; Year2 = \$799,159; Year3 = \$799,159)**

6a. Matching Funds Required: **\$0**

b. Source(s) of matching funds (if applicable):

7a. Grant Source Agency: **Centers for Disease Control and Prevention**

b. Grant Pass-Through Agency (if applicable):

8. Proposed Grant Project Summary: **The proposed program will adapt and implement the national Million Hearts Initiative in SF, focusing on Latinos and African Americans who have or are at risk for cardiovascular disease, particularly in census tracts where more than 30% of residents live below 200% of the FPL. Healthy Hearts SF will expand upon the Million Hearts initiative to incorporate the addition of alcohol and diabetes to the campaign's focus in order to meet the health and cultural needs of San Francisco; we will focus on primary prevention and management of the ABCDS – Aspirin when appropriate/Alcohol moderation, Blood pressure control, Cholesterol management, Diabetes management, and Smoking cessation.**

9. Grant Project Schedule, as allowed in approval documents, or as proposed:

**Approved Year one project: Start-Date: 09/30/2014 End-Date: 09/29/2015**

**Full project period: Start-Date: 09/30/2014 End-Date: 09/29/2017**

10a. Amount budgeted for contractual services: **\$695,465 in year 1**  
**\$2,086,395 in the 3-year project period**

b. Will contractual services be put out to bid? **No**

c. If so, will contract services help to further the goals of the Department's Local Business Enterprise (LBE) requirements? **N/A**

d. Is this likely to be a one-time or ongoing request for contracting out? **N/A**

11a. Does the budget include indirect costs?  Yes  No

b1. If yes, how much? **\$10,392 in Year 1**  
**\$31,176 in the 3-year project period**

b2. How was the amount calculated? **24.03% of total salaries**

c1. If no, why are indirect costs not included?

- Not allowed by granting agency
- Other (please explain):

To maximize use of grant funds on direct services

c2. If no indirect costs are included, what would have been the indirect costs?

12. Any other significant grant requirements or comments:

We respectfully request for approval to accept and expend these funds retroactive to September 30, 2014. The Department received the subaward agreement on September 22, 2014.

Grant Code: HCAO77/1500

**\*\*Disability Access Checklist\*\* (Department must forward a copy of all completed Grant Information Forms to the Mayor's Office of Disability)**

13. This Grant is intended for activities at (check all that apply):

- |  |   |  |
|--|---|--|
| <input checked="" type="checkbox"/> Existing Site(s) | <input type="checkbox"/> Existing Structure(s)      | <input type="checkbox"/> Existing Program(s) or Service(s) |
| <input type="checkbox"/> Rehabilitated Site(s)       | <input type="checkbox"/> Rehabilitated Structure(s) | <input type="checkbox"/> New Program(s) or Service(s)      |
| <input type="checkbox"/> New Site(s)                 | <input type="checkbox"/> New Structure(s)           |  |

14. The Departmental ADA Coordinator or the Mayor's Office on Disability have reviewed the proposal and concluded that the project as proposed will be in compliance with the Americans with Disabilities Act and all other Federal, State and local disability rights laws and regulations and will allow the full inclusion of persons with disabilities. These requirements include, but are not limited to:

1. Having staff trained in how to provide reasonable modifications in policies, practices and procedures;
2. Having auxiliary aids and services available in a timely manner in order to ensure communication access;
3. Ensuring that any service areas and related facilities open to the public are architecturally accessible and have been inspected and approved by the DPW Access Compliance Officer or the Mayor's Office on Disability Compliance Officers.

If such access would be technically infeasible, this is described in the comments section below:

Comments:

**Departmental ADA Coordinator or Mayor's Office of Disability Reviewer:**

Ron Weigelt  
\_\_\_\_\_  
(Name)

Director of Human Resources and Interim Director, EEO, and Cultural Competency Programs  
\_\_\_\_\_  
(Title)

Date Reviewed: 10-3-14

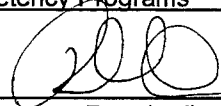
  
\_\_\_\_\_  
(Signature Required)

**Department Head or Designee Approval of Grant Information Form:**

Barbara A. Garcia, MPA  
\_\_\_\_\_  
(Name)

Director of Health  
\_\_\_\_\_  
(Title)

Date Reviewed: 10/2/14

  
\_\_\_\_\_  
(Signature Required)

CATEGORY/LINE ITEM				Annual Salary	42.00% Annual Frin Ben	% OF TIME	% OF FTE	Monthly Rate	Mth	Salary Budget	Frin Ben Budget	Total Budget	Comments
PERSONNEL													In Kind Staff: T.Aragon, I.Nieves, M.Kirin, C.Chan, P.Erwin, D.Smith, H.Hammer
1.	Ngoc Trang Nguyen			93,935	39,453	20%	0.20	7,828	12	18,787	7,891	26,678	
2.	J. McCright			98,371	41,316	20.0%	0.20	8,198	12	19,674	8,263	27,937	
3.										0	0	0	
21	Sr. Administrative Analyst												
	1823	S.	Shalkh	95,654	40,175	5%	0.05	7,971	12	4,783	2,009	6,791	
							0.00	0	12	0	0	0	
							0.00	0	12	0	0	0	
<b>TOTAL SALARY/FRINGE</b>				<b>287,960</b>	<b>120,943</b>		<b>0.4500</b>			<b>43,244</b>	<b>18,162</b>	<b>61,406</b>	
					FTE City and PHFE		4.1500						
00101 SALARIES												43,244	
00103 FRNG BN												18,162	
<b>SUB TOTAL</b>												<b>61,406</b>	
TRAVEL													
1. Local Travel (02301)													
2. Out-of-Jurisdiction Travel (02101)													
<b>Sub Total TRAVEL</b>												<b>1,450</b>	
EQUIPMENT													
<b>Sub Total EQUIPMENT</b>												<b>0</b>	
MATERIALS AND SUPPLIES													
<b>Sub Total SUPPLIES</b>												<b>0</b>	
CONTRACTUAL SERVICES (02789)													
1. PHFE													
2. Public Health Foundation													
<b>Sub Total CONTRACTS</b>												<b>695,465</b>	
OTHER													
1. Rent support/mtg fac (081RR/03011)													
2. Telephone/Com (03241)													
5. Reproduction/Photocopy													
<b>Sub TOTAL OTHER</b>												<b>30,447</b>	
<b>TOTAL DIRECT COST</b>												<b>788,768</b>	
H. INDIRECT COST (24.03% of total salaries)												<b>10,392</b>	
<b>TOTAL BUDGET</b>												<b>799,159</b>	
<b>AWARD</b>												<b>799,159</b>	
<b>SURPL/(DEFICIT)</b>												<b>(0)</b>	

**San Francisco Department of Public Health**  
**Community Health Equity and Promotion Branch**  
**REACH**

A. Salaries and Wages	\$43,244
B. Mandatory Fringe	\$18,162
C. Consultant Costs	\$0
D. Equipment	\$0
E. Materials and Supplies	\$0
F. Travel	\$1,450
G. Other Expenses	\$30,447
H. Contractual	\$695,465
I. Total Direct Costs	\$788,768
J. Indirect Costs (24.03% of Total Salaries)	\$10,392
<b>TOTAL BUDGET</b>	<b>\$799,159</b>



The program and work plan will be accomplished through collaboration between the San Francisco Department of Public Health (SFDPH) and the San Francisco Health Improvement Partnership (SFHIP). The core team as SFDPH will be supported by the Public Health Foundation Enterprises, Inc. (PHFE). PHFE has provided fiscal, human resource, and contract administration services to SFDPH for over 15+ years. PHFE is a licensed California non-profit that has served the non-profit, education, and research communities for over 39 years. As a Fiscal Intermediary, PHFE currently serves over 250 programs with combined budgets totaling more than \$120 million dollars.

In order to meet the benchmark of allocating a minimum of 10% of our resources towards evaluation, we are allocating resources as shown in the table below. For more information please refer to the details in the justification.

Resource	Resource Cost	% Evaluation	Total \$ Evaluation
Program Manager	\$27,937	10%	\$2,794
Epidemiologist	\$26,678	100%	\$26,678
Project Coordinator	\$98,250	20%	\$19,650
REACH Coordinators	\$170,300	20%	\$34,060
Data Manager	\$26,646	100%	\$26,646
Focus Group Costs	\$16,000	100%	\$16,000
Assessment Costs	\$4,000	100%	\$4,000
Community Mini Grants	\$150,000	10%	\$15,000
<b>Total Funding Allocated To Evaluation Activities (approximately 18%)</b>			<b>\$144,828</b>

**A. SALARIES AND WAGES**

**\$43,244**

**Salaries and Wages: City and County of San Francisco Personnel**

Position Title and Name	Annual	Time	Months	Amount Requested
PI and Director, Population Health Division T. Aragon	NA	10%	12 months	In-Kind
Community Health Equity and Promotion Branch Deputy Director and Program Manager J. McCright	\$98,371	20%	12 months	\$19,674
Epidemiologist N.T. Nguyen	\$93,935	20%	12 months	\$18,787
Sr. Administrative Analyst S. Shaikh	\$95,654	5%	12 months	\$4,783
Director, Community Health and Equity Promotion Branch T. Packer	NA	5%	12 months	In-Kind

Community Health Equity and Promotion Branch Deputy Director P. Erwin	NA	10%	12 months	In-Kind
Epidemiologist M. Kirian	NA	5%	12 months	In-Kind
Tobacco Free Project Health Educator D. Smith	NA	5%	12 months	In-Kind
Director of Food Systems Environmental Health Branch P. Jones	NA	5%	12 months	In-Kind
Tobacco Free Project Health Planner S. Hennessey-Lavery	NA	5%	12 months	In-Kind
Director, Office of Equity and Quality Improvement I. Nieves	NA	5%	12 months	In-Kind
Coordinator Feeling Good Project L. Brainin-Rodriguez	NA	5%	12 months	In-Kind
Program Manager, Children's Environmental Health Promotion K. Cohen	NA	5%	12 months	In-Kind
Maternal, Child and Adolescent Health Medical Director C. Chan	NA	5%	12 months	In-Kind
Director of Primary Care H. Hammer	NA	5%	12 months	In-Kind

Job Description: PI and Director, Population Health Division (T. Aragon) – Dr. Tomas Aragón will provide leadership for the project. Dr. Aragón is the San Francisco Health Officer, and the Director of the Population Health and Prevention Division of SFDPH. Dr. Aragón will be responsible for overall planning, implementation, monitoring, and reporting of the program.

Job Description: Program Manager (J. McCright) – Jacqueline McCright is a Deputy Director of Community Health Equity & Promotion Branch at SFDPH. Ms. McCright will serve as the Program Manager for this program. She has over 10 years' experience in Community-based participatory research; developing, planning, implementing, and evaluating community-based services with the African American and Latino populations of all ages. Ms. McCright is also the team lead for the pilot Quality Improvement African American Hypertension Project with Southeast Health Center, linking patients to physical activity at the YMCA via green prescriptions. Ms. McCright will be responsible for monitoring all short-term outcomes with the support of other project staff, managing the Communication Plan and maintaining smooth implementation of all project strategies on a day-to-day basis. Ms. McCright will supervise the

REACH coordinators and program assistant for this project. She is also responsible for tracking and reporting all activities to CDC annually, under the close supervision of Dr. Aragón.

Job Description: Epidemiologist II (N.T. Nguyen) – Dr. Nguyen will assist in analyzing the clinical and community prevention resource data for the project and synthesizing the information that will be used for the REACH reports and dissemination of information materials.

Job Description: Senior Administrative Analyst (S. Shaikh) – Mr. Shaikh will provide fiscal and administrative support to the program. He prepares funding notification letters, manages section budgets and prepares statistical reports on contracts. He will work with program staff and contractors to resolve issues related to invoicing.

Job Description: Director, Community Health Equity and Promotion Branch (T. Packer) – This position is in-kind. Ms. Packer provides oversight to all work in the Branch and direct supervision to the Program Manager. She also provides linkages to other Branches and Divisions of the Department on REACH and other initiatives.

Job Description: Deputy Director of Community Health Equity & Promotion (P. Erwin) – This position is in-kind and will provide leadership and technical assistance on the physical activity and community linkages strategies of the REACH Project, as well as linkages to the SFHIP Coalition.

Job Description: CHI Epidemiologist (M. Kirian) – This position is in-kind. Ms. Kirian will head the evaluation for REACH. She is an epidemiologist with 9 years of experience in the design and implementation of qualitative and quantitative data collection and analyses.

Job Description: Tobacco Free Project Health Educator (D. Smith) – This position is in-kind and will provide leadership and technical assistance on all tobacco control initiatives and linkages to the Tobacco Free Coalition and other tobacco control work in San Francisco.

Job Description: Director of Food Systems Environmental Health Branch (P. Jones) – This position is in-kind and will provide linkages to the Food Security Task Force and other linkages to food security work in SF.

Job Description: Tobacco Free Project Health Planner (S. Hennessey-Lavery) – This position is in-kind and will provide leadership and technical assistance on all tobacco control initiatives and linkages to the Tobacco Free Coalition and other tobacco control work in San Francisco.

Job Description: Office of Equity & Quality Improvement Director (I. Nieves) – This position is in-kind, and will provide leadership and technical assistance on quality improvement efforts with the SFDPH primary care medical homes and performance measures.

Job Description: Program Coordinator Feeling Good Project (L. Brainin-Rodriguez) – This position is in-kind and will provide linkages and technical assistance to healthy retail efforts in the Tenderloin as well as for community engagement efforts.

Job Description: Program Manager, Children’s Environmental Health Promotion (K. Cohen) – This position is in-kind and will provide technical assistance to the Media Broker/PR Firm and REACH team to support the planning, implementing, and evaluating communication activities, with the support of Ms. Kirian for evaluation.

Job Description: Maternal, Child and Adolescent Health Medical Director (C. Chan) – This position is in-kind, and will provide leadership and technical assistance on Healthy Eating Active Living initiatives and linkages to other Healthy Eating Active Living work in San Francisco, primarily those focused on youth, children, and parents as well as linkages to the Childhood Obesity TaskForce.

Job Description: Director of Primary Care (H. Hammer) –This position is in-kind and will provide leadership and technical assistance for access to the patients and clinical teams at the SFPDH primary care medical homes and facilitate implementation of the REACH Project at the priority clinics.

<b>B.</b>	<b>FRINGE BENEFITS</b>	<b>\$18,162</b>
	42% of total salaries	
<b>C.</b>	<b>CONSULTANT COSTS</b>	<b>\$0</b>
<b>D.</b>	<b>EQUIPMENT</b>	<b>\$0</b>
<b>E.</b>	<b>MATERIALS AND SUPPLIES</b>	<b>\$0</b>
<b>F.</b>	<b>TRAVEL</b>	<b>\$1,450</b>

Meeting	Rate	Cost
CDC Meetings	Airfare	\$800 x 1 traveler x 1 trip = \$800
	Lodging	\$250 per night x 2 nights x 1 traveler x 1 trip = \$500
	Transportation	\$150/traveler x 1 traveler x 1 trips = \$150
		<b>\$1,450</b>

CDC Meetings: Staff will travel to Atlanta annually as needed for the annual CDC REACH meeting.

<b>G.</b>	<b>OTHER</b>	<b>\$30,447</b>
-----------	--------------	-----------------

Item	Rate	Cost

Office Rent	\$2/sq.ft./month x 250 sq.ft./FTE x 4.15 FTE x 12 months	\$24,900
Telephone/Communication	Average monthly cost \$15/FTE/month x 4.15 FTE x 12 months	\$747
Photocopier lease/maintenance	Approximately \$400/month x 12 months	\$4,800

Office Rent: Office rent covers expenses of office space rental and maintenance for all FTE included in the budget. Calculations are based on the number of FTE from the City and County of San Francisco (SFDPH) as well as the FTE from fiscal sponsor contract with Public Health Foundations Enterprises (PHFE).

Telephone/Communication: Funds cover expenses for all means necessary to communicate with contractors, partners, health departments, and grantors, including local and long distance telephone calls, fax usage, Internet, voicemail and replacement/maintenance of phones for program staff and administrative staff. Calculations are based on the number of FTE from the City and County of San Francisco (SFDPH) as well as the FTE from fiscal sponsor contract with PHFE.

Photocopier Lease/Maintenance: Funds cover expenses for office photocopier lease and maintenance for program staff.

**H. CONTRACTUAL**

**\$695,465**

Contractor Name (see below for details)	Total Funding
Public Health Foundation Enterprises, Inc.	\$695,465

1. Name of Contractor: **Public Health Foundation Enterprises, Inc.**

Method of Selection: PHFE was selected through a Request for Qualifications process held in 2013 by the SFDPH Contracts Unit. PHFE acts as a fiscal intermediary for SFDPH.

Period of Performance: 09/30/2014 - 09/29/2015

Scope of Work: Fiscal intermediary services to the SFDPH Population Health Division. PHFE pays for staff members and travel that support the goals and objectives of the project. The staff supports all programmatic activities, including but not limited to coordination and administrative support.

Method of Accountability: Annual program and fiscal and compliance monitoring.

Itemized budget and justification:

a. Salaries and Wages \$255,101

Position Title and Name	Annual	Time	Months	Amount Requested
Project Coordinator (TBD)	\$75,000	100%	12 months	\$75,000
REACH Coordinator (TBD)	\$65,000	100%	12 months	\$65,000
REACH Coordinator (TBD)	\$65,000	100%	12 months	\$65,000
Project Assistant L. Bristow	\$50,000	25%	12 months	\$12,500
Finance & Operations Manager Arfana Sogal	\$95,481	10%	12 months	\$9,548
Project Manager J. Balido	\$77,123	10%	12 months	\$7,712
Data Manager J. White	\$81,363	25%	12 months	\$20,341

Job Description: Project Coordinator (TBD) – The Project Coordinator will be responsible for the day to day activities for the grant. This person will serve as the main point of contact for all communication and evaluation activities. In addition, the Project Coordinator will be responsible for all programmatic administration and monitoring of the mini-grants including managing the request for proposal process and providing technical assistance to those who receive the mini-grants.

Job Description: 2 REACH Coordinators (TBD) – The REACH Coordinators will be the point of contact for our target clinics. They will be responsible for developing and coordinating the priority patient assessment and focus groups. They will provide assistance to the primary care medical home (PCMH) clinics on aspects of implementing this project. They will convene meetings monthly with key integrated clinical team members to share information, facilitate communication, and maintain and update an inventory of high quality, effective resources available to support patients in the community by serving as a primary contact with 2-1-1.org. The REACH Coordinators will also work with the PCMH clinics to implement a clinic-wide system to provide non-pharmaceutical prescriptions to further support their patients in reducing their risk for heart attack and stroke. The REACH Coordinators will also provide support for all data tracking, evaluation and communication activities as needed.

Job Description: Project Assistant (L. Bristow) – The Project Assistant will provide overall administrative support to the project including scheduling meetings, answering calls from community partners, media, providers, and the distribution of program materials.

Job Description: Finance and Operations Manager (A. Sogal) – Arfana Sogal is responsible for the fiscal management, policy development, and financial reporting of projects at SFDPH's Population Health Division. She will monitor the budget, establish contracts and

sub-contracts in addition to managing FTEs, benefits, budget estimates, and monthly reports to assist with the execution of activities. These reports will be used to make staffing, space, and other logistically based decisions to ensure capacity, and to meet program requirements. Ms. Sogal will collaborate with PHFE and SFDPH (Accounts Payable, Payroll, Human Resources, and Fiscal) on a regular basis to facilitate project activities.

Job Description: Project Manager (J. Balido) – Ms. Balido will be responsible for working with the Program Manager to develop the project charter, which will include the roles and responsibilities chart, identification of project stakeholders, identify key assumptions and risks, development of the project timeline and scope.

Job Description: Data Manager (J. White) – Mr. White will be responsible for extracting data from the San Francisco Health Network (SFHN) clinical health information technology system of African American & Latino patients with cardiovascular disease from the priority clinics of their primary care medical homes. This data will be used to track ongoing progress and heart health outcomes for the REACH Project.

- b. Fringe Benefits \$79,081  
31% of total salaries
- c. Consultant Costs \$0
- d. Equipment \$0
- e. Materials and Supplies \$13,130

Item	Rate	Cost
Office Supplies	\$75/month/FTE x 3.7 FTE x 12 months = \$3,330	\$5,130
	\$150/month x 12 months for meetings = \$1,800	
IT Supplies	4 computers/software x \$2000 = \$8,000	\$8,000

Office Supplies: This line item includes general office supplies required for daily work for project staff including, but not limited to pens, paper, binders and files. In addition, this includes supplies for meetings/conferences conducted by the program. Meeting supplies include, but are not limited to, folders, pens, handouts and recording devices for focus groups.

IT Supplies: Including but not limited to 4 desktop computers including all appropriate software.

- f. Travel \$5,823

Meeting		Rate	Cost
Local Travel	Muni Card	\$66 x 12 months x 2 REACH Coordinators	\$1,584

CDC Meetings	Airfare	\$550 x 3 travelers x 1 trip = \$1,650	\$4,239
	Lodging	\$250 per night x 2 nights x 3 travelers x 1 trip = \$1,500	
	Per diem	\$71 per day x 3 days x 3 travelers x 1 trip = \$639	
	Transportation	\$150/traveler x 3 travelers x 1 trips = \$450	

Local Travel: Public transit muni cards will be purchased to cover local travel for the field REACH coordinators.

CDC Meetings: Staff will travel to Atlanta annually as needed for the annual CDC REACH meeting, as well other CDC meetings as needed.

g. Other Expenses \$39,540

Item	Rate	Cost
Printing	Approximately \$100/month x 12 months	\$1,200
Shipping	Approximately \$20/month x 12 months	\$240
Communication	\$50/ month x 12 months	\$600
Kick-off Meeting	Approximately \$125/person x 100 attendees	\$12,500
Patient Focus Group Incentives	8 groups x 10 participants x \$50/participant x 2/year = \$8,000	\$8,000
Patient Focus Group Transcription	\$50/hr. x 10 hrs. transcription x 8 groups x 2/year = \$8,000	\$8,000
Priority Patient Assessment Survey	2 clinics x 200 participants x \$10/participant = \$4,000	\$4,000
2-1-1 Services	Up to 50 hours x \$100 per hour	\$5,000

Printing: Funds for costs of printing project materials to provide to clinic and other partners as well as project staff. This includes but is not limited to flyers, manuals, and binders.

Shipping: Funds for shipping project materials for meetings and general project management and grant administration.

Communication: Funds for programmatic conference calls with collaborators, community members, and funders.

Kick-off Meeting: Funds will be used to cover costs associated with the kick-off meeting planned for February of 2015. Costs will include but are not limited to location rental, materials production and event coordination. Costs are estimated on a per participant basis.



Focus Group Incentives: Funds will cover the costs of providing a \$50 stipend to focus group participants. Costs are based on 8 groups with 10 participants each, conducted twice in year one.

Focus Group Transcription: Funds will cover the cost of transcribing the information gathered at the above mentioned focus groups. Costs are estimated based on each group requiring 10 hours of transcription services at \$50/hour.

Priority Patient Assessment Survey Incentives: Funds will cover the costs of a \$10 gift card for all who participate in the needs assessment survey. Costs are calculated based on conducting the survey with 200 people at two clinics.

2-1-1 Services: To support the identification and active referral of valuable community resources that promote good cardiovascular health for AA and Latinos in San Francisco, the REACH Coordinators will work closely with SF's existing agency 2-1-1. 2-1-1 currently runs the website <http://211bayarea.org/find-help/>, which is a community resource database to assist SF residents with food security, healthcare, housing, legal aid, senior services, and other supportive services at no cost. It is confidential and available in 150 languages, 24 hours a day, with the information also available via a phone call to 2-1-1. This information can be accessed by patients directly but also by healthcare providers while they are being seen at the clinic. It can be searched by zip code, helping to find resources in close proximity to a patient's home, work, or the clinic itself if desired. This 2-1-1 data is also part of the HealthyCity lookup database, which provides data and mapping tools to help public health professionals and community members build a better community. Therefore REACH Coordinators will partner with 2-1-1 staff to request the addition of community resources identified from our patient assessments and throughout the course of the project.

h. Contractual \$235,000

Contractor Name (see below for details)	Total Funding
Media Broker Consultant	\$85,000
Community Mini-Grants	\$150,000

i. Media broker Consultant

Method of Selection: We will conduct a request for proposal (RFP) process through PHFE. A RFP review committee (consisting of: REACH Program Manager, SFHIP Coalition member, CHEP staff and the SFDPH Communication Officer) will develop criteria and a scoring sheet for the selection of the Media broker agency.

Period of Performance: 11/01/2014 - 09/29/2015

Scope of Work: The contractor will be responsible for the development and implementation of the communication plan. The contractor will work closely with

SFHIP, the SFDPH core REACH team and the SFDPH Public Information Officer. Please refer to the narrative for key strategies and components of the Healthy Hearts SF communication plan.

Method of Accountability: Annual program and fiscal and compliance monitoring.

Itemized budget and justification: Estimated budget is \$85,000. Once contractor is selected, budget and justification will be sent to CDC for approval.

ii. Community Mini-Grants

Method of Selection: We will release a request for applications for community-based organization.

Period of Performance: 02/01/2015 - 09/29/2015

Scope of Work: To address the ABCDs in the community, we will be providing mini-grants to conduct activities in support of the Million Hearts® Initiative. Proposals will be required to include a communication plan, to engage African Americans and Latinos who have or are at high risk for cardiovascular disease, encourage widespread, equitable utilization of community activities, and to support evaluation activities. For more information on this please refer to narrative.

Method of Accountability: Annual program and fiscal and compliance monitoring.

Itemized budget and justification: We estimate 4-5 grants will be awarded ranging from \$10,000 to \$50,000. Once proposals are selected, a budget and justification will be sent to CDC for approval.

Total PHFE Direct Costs	\$627,676	
i. Total PHFE Indirect Costs (10.8% of Modified Total Direct Costs)	\$67,789	
Total PHFE Costs	\$695,465	
<b>TOTAL DIRECT COSTS:</b>		<b>\$788,768</b>
<b>I. INDIRECT COSTS (24.03% of total salaries)</b>		<b>\$10,392</b>
<b>TOTAL BUDGET:</b>		<b>\$799,159</b>



**Grant Number:** 1U58DP005794-01  
**FAIN:** U58DP005794

**Principal Investigator(s):**  
TOMAS ARAGON, MD

**Project Title:** RACIAL AND ETHNIC APPROACHES TO COMMUNITY HEALTH - HEART HEALTHY SF

SAN FRANCISCO DEPT OF PUBLIC HEALTH  
Director of Sponsored Programs  
101 GROVE ST  
RM 408  
SAN FRANCISCO, CA 94102

**Budget Period:** 09/30/2014 – 09/29/2015  
**Project Period:** 09/30/2014 – 09/29/2017

Dear Business Official:

The Centers for Disease Control and Prevention hereby awards a grant in the amount of \$799,159 (see "Award Calculation" in Section I and "Terms and Conditions" in Section III) to SAN FRANCISCO DEPARTMENT OF PUBLIC HEALTH in support of the above referenced project. This award is pursuant to the authority of 301A,311BC,317K2(42USC241A,243BC247BK2) and is subject to the requirements of this statute and regulation and of other referenced, incorporated or attached terms and conditions.

Acceptance of this award including the "Terms and Conditions" is acknowledged by the grantee when funds are drawn down or otherwise obtained from the grant payment system.

If you have any questions about this award, please contact the individual(s) referenced in Section IV.

Sincerely yours,

Tracey M Sims  
Grants Management Officer  
Centers for Disease Control and Prevention

Additional information follows

---

**SECTION I – AWARD DATA – 1U58DP005794-01**

---

**Award Calculation (U.S. Dollars)**

Salaries and Wages	\$43,244
Fringe Benefits	\$18,162
Personnel Costs (Subtotal)	\$61,406
Travel Costs	\$1,450
Other Costs	\$40,838
Consortium/Contractual Cost	\$695,465

Federal Direct Costs	\$799,159
Approved Budget	\$799,159
Federal Share	\$799,159
<b>TOTAL FEDERAL AWARD AMOUNT</b>	<b>\$799,159</b>

**AMOUNT OF THIS ACTION (FEDERAL SHARE) \$799,159**

Recommended future year total cost support, subject to the availability of funds and satisfactory progress of the project.

02 \$799,159  
03 \$799,159

**Fiscal Information:**

CFDA Number: 93.738  
EIN: 1946000417A8  
Document Number: 005794CH14

IC	CAN	2014	2015	2016
DP	939ZMPN	\$799,159	\$799,159	\$799,159

SUMMARY TOTALS FOR ALL YEARS		
YR	THIS AWARD	CUMULATIVE TOTALS
1	\$799,159	\$799,159
2	\$799,159	\$799,159
3	\$799,159	\$799,159

Recommended future year total cost support, subject to the availability of funds and satisfactory progress of the project

**CDC Administrative Data:**

PC: / OC: 4151 / Processed: ERAAPPS 09/17/2014

---

**SECTION II – PAYMENT/HOTLINE INFORMATION – 1U58DP005794-01**

---

For payment information see Payment Information section in Additional Terms and Conditions.

**INSPECTOR GENERAL:** The HHS Office Inspector General (OIG) maintains a toll-free number (1-800-HHS-TIPS [1-800-447-8477]) for receiving information concerning fraud, waste or abuse under grants and cooperative agreements. Information also may be submitted by e-mail to [hhstips@oig.hhs.gov](mailto:hhstips@oig.hhs.gov) or by mail to Office of the Inspector General, Department of Health and Human Services, Attn: HOTLINE, 330 Independence Ave., SW, Washington DC 20201. Such reports are treated as sensitive material and submitters may decline to give their names if they choose to remain anonymous. This note replaces the Inspector General contact information cited in previous notice of award.

---

**SECTION III – TERMS AND CONDITIONS – 1U58DP005794-01**

---

This award is based on the application submitted to, and as approved by CDC on the above-titled project and is subject to the terms and conditions incorporated either directly or by reference in the following:

- a. The grant program legislation and program regulation cited in this Notice of Award.
- b. The restrictions on the expenditure of federal funds in appropriations acts to the extent those restrictions are pertinent to the award.
- c. 45 CFR Part 74 or 45 CFR Part 92 as applicable.
- d. The HS Grants Policy Statement, including addenda in effect as of the beginning date of the budget period.
- e. This award notice, INCLUDING THE TERMS AND CONDITIONS CITED BELOW.

This award has been assigned the Federal Award Identification Number (FAIN) U58DP005794. Recipients must document the assigned FAIN on each consortium/subaward issued under this award.

**Treatment of Program Income:**  
Additional Costs

---

**SECTION IV – DP Special Terms and Conditions – 1U58DP005794-01**

**Funding Opportunity Announcement (FOA) Number:** PPHF 2014: Racial and Ethnic Approaches to Community Health (REACH) – Financed in Part by Prevention and Public Health Funding

**Award Number:** 1 U58 DP005794

**Award Type:** Cooperative Agreement

**Applicable Cost Principles:** 2 CFR Part 225 Cost Principles for State, Local, and Indian Tribal Governments (OMB Circular A-87)

**AWARD INFORMATION**

**CLARIFICATION:** The Statutory Authority of 42 USC 241 42 CFR 52 cited on the first page of this Notice of Award is incorrect. The correct statutory authority for this award is: Section 317(k)(2) of the Public Health Service Act, 42 U.S.C. 247b(k)(2) and Title IV, Section 4002 of the Affordable Care Act, Prevention and Public Health Fund.

**Incorporation:** The Centers for Disease Control and Prevention (CDC) hereby incorporates Funding Opportunity Announcement number *CDC-RFA-DP14-1419PPHF14, entitled PPHF 2014: Racial and Ethnic Approaches to Community Health (REACH) – Financed in Part by Prevention and Public Health Funding*, and application dated **July 22, 2014**, as may be amended, which are hereby made a part of this Non-Research award hereinafter referred to as the Notice of Award (NoA). The Department of Health and Human Services (HHS) grant recipients must comply with all terms and conditions outlined in their NoA, including grants policy terms and conditions contained in applicable HHS Grants Policy Statements, and requirements imposed by program statutes and regulations and HHS grant administration regulations, as applicable; as well as any requirements or limitations in any applicable appropriations acts. The term grant is used throughout this notice and includes cooperative agreements.

**Approved Funding:** Funding in the amount of **\$799,159** is approved for the Year 01 budget period, which is **September 30, 2014** through **September 29, 2015**. All future year funding will be based on satisfactory programmatic progress and the availability of funds.

Note: Refer to the Payment Information section for draw down and Payment Management System (PMS) subaccount information.

**Award Funding:** Funded in part by the Prevention and Public Health Fund

**Objective Review Summary Statement Response Requirement:** The review comments on the strengths and weaknesses of the proposal are provided as part of this award. A response to the

weaknesses in these statements must be submitted to and approved, in writing, by the Grants Management Specialist/Grants Management Officer (GMS/GMO) noted in the Staff Contacts section of this NoA, no later than **October 30, 2014**. Failure to submit the required information by the due date, October 31, 2014, will cause delay in programmatic progress and will adversely affect the future funding of this project.

**Budget Revision Requirement:** By **October 30, 2014** the grantee must submit a revised budget with a narrative justification. Use the CDC Guidelines for budget preparation to assist in the formulation of your revised budget. You may access this document at: <http://www.cdc.gov/od/pgo/funding/grants/foamain.shtm>.

**Your revised budget must specifically address the following proposed items of cost:**

**Travel** - Dollars requested in the Travel category should be for **recipient staff travel only**. Travel for consultants should be shown in the Consultant category. Travel for other participants (e.g., advisory committees, review panel, volunteers, etc.) should be itemized as specified below and placed on the *Other* category. List where travel will be undertaken, number of trips planned, **who will be making the trips**, and approximate dates. If mileage is to be paid, provide the number of miles and the cost per mile. Recipients can provide their established policy plan or following the GSA.Gov rates.

**Other** – Provide indirect rate agreement or cost allocation plan. This cooperative agreement will only cover the recipient's FTE costs for rent and telecommunication costs.

**Restrictions and redirection are recommended for the following proposed cost items:**

**Other:**

- Maintenance cost disallowed until further discussion and/or supporting documentation can be provided
- FTE expenses from the fiscal sponsor contract (Public Health Foundations Enterprises (PHFE) for rent and telecommunication cost are disallowed

**Contractual** - Public Health Foundations Enterprises (PHFE) is restricted in the amount of \$695,465 until further discussion and/or supporting documentation can be provided as to how the proposed cost supports the programmatic plan.

Failure to submit the required information in a timely manner may adversely affect the future funding of this project. If the information cannot be provided by the due date, you are required to contact the GMS/GMO identified in the Staff Contacts section of this notice before the due date.

**Program Income:** Any program income generated under this grant or cooperative agreement will be used in accordance with the Addition alternative.

**Addition alternative:** Under this alternative, program income is added to the funds committed to the project/program and is used to further eligible project/program objectives.

Note: The disposition of program income must have written prior approval from the GMO.

**FUNDING RESTRICTIONS AND LIMITATIONS**

**Funding Opportunity Announcement (FOA) Restrictions:**

- Awardees may not use funds for research.
- Awardees may not use funds for clinical care.
- Awardees may use funds only for reasonable program purposes, including personnel, travel, supplies, and services.
- Generally, awardees may not use funds to purchase furniture or equipment. Any such proposed spending must be clearly identified in the budget.
- Reimbursement of pre-award costs is not allowed.
- Other than for normal and recognized executive-legislative relationships, no funds may be used for:
  - (1) Publicity or propaganda purposes, for the preparation, distribution, or use of any

material designed to support or defeat the enactment of legislation before any legislative body.

- (2) The salary or expenses of any grant or contract recipient, or agent acting for such recipient, related to any activity designed to influence the enactment of legislation, appropriations, regulation, administrative action, or Executive order proposed or pending before any legislative body.

See Additional Requirement (AR) 12 for detailed guidance on this prohibition and additional guidance on lobbying for CDC awardees

- The direct and primary recipient in a cooperative agreement program must perform a substantial role in carrying out project outcomes and not merely serve as a conduit for an award to another party or provider who is ineligible.

#### **Indirect Costs:**

Indirect costs are approved based on the Indirect Cost Rate Agreement dated **06/09/2014**, which calculates indirect costs as follows, a provisional rate is approved at a rate of **32.68%** of the base, which includes, direct salaries and wages including vacation, holiday, sick pay and other paid absences but excluding all other fringe benefits. The effective dates of this indirect cost rate are from **01/01/2014 until 12/31/2015**.

Type: Provisional

Rate: 32.68%

Base: Modified total direct costs as described in rate agreement dated June 09, 2014.

#### **Cost Limitations as Stated in the Consolidated Appropriations Act, 2014, (Items A through G)**

A. Cap on Salaries (Div. H, Title II, Sec. 203): None of the funds appropriated in this title shall be used to pay the salary of an individual, through a grant or other extramural mechanism, at a rate in excess of Executive Level II.

Note: The salary rate limitation does not restrict the salary that an organization may pay an individual working under an HHS contract or order; it merely limits the portion of that salary that may be paid with Federal funds.

B. Gun Control Prohibition (Div. H, Title II, Sec. 217): None of the funds made available in this title may be used, in whole or in part, to advocate or promote gun control.

C. Proper Use of Appropriations - Publicity and Propaganda (LOBBYING) FY2012 (Div. H, Title V, Sec. 503):

- 503(a): No part of any appropriation contained in this Act or transferred pursuant to section 4002 of Public Law 111-148 shall be used, other than for normal and recognized executive-legislative relationships, for publicity or propaganda purposes, for the preparation, distribution, or use of any kit, pamphlet, booklet, publication, electronic communication, radio, television, or video presentation designed to support or defeat the enactment of legislation before the Congress or any State or local legislature or legislative body, except in presentation of the Congress or any State or local legislature itself, or designed to support or defeat any proposed or pending regulation, administrative action, or order issued by the executive branch of any State or local government itself.
- 503 (b): No part of any appropriation contained in this Act or transferred pursuant to section 4002 of Public Law 111-148 shall be used to pay the salary or expenses of any grant or contract recipient, or agent acting for such recipient, related to any activity designed to influence the enactment of legislation, appropriations, regulation, administrative action, or Executive order proposed or pending before the Congress or any State government, State legislature or local legislature or legislative body, other than normal and recognized executive legislative relationships or participation by an agency or officer of an State, local or tribal government in policymaking and administrative processes within the executive branch of that government.

- 503(c): The prohibitions in subsections (a) and (b) shall include any activity to advocate or promote any proposed, pending or future Federal, State or local tax increase, or any proposed, pending, or future requirement or restriction on any legal consumer product, including its sale or marketing, including but not limited to the advocacy or promotion of gun control.

For additional information, see Additional Requirement 12 at [http://www.cdc.gov/od/pgo/funding/grants/additional\\_req.shtm](http://www.cdc.gov/od/pgo/funding/grants/additional_req.shtm) and Anti Lobbying Restrictions for CDC Grantees at [http://www.cdc.gov/od/pgo/funding/grants/Anti-Lobbying\\_Restrictions\\_for\\_CDC\\_Grantees\\_July\\_2012.pdf](http://www.cdc.gov/od/pgo/funding/grants/Anti-Lobbying_Restrictions_for_CDC_Grantees_July_2012.pdf).

D. Needle Exchange (Div. H, Title V, Sec. 522): Notwithstanding any other provision of this Act, no funds appropriated in this Act shall be used to carry out any program of distributing sterile needles or syringes for the hypodermic injection of any illegal drug.

E. Restricts dealings with corporations with recent felonies (Div. E, Title VI, Sec. 623): None of the funds made available by this Act may be used to enter into a contract, memorandum of understanding, or cooperative agreement with, make a grant to, or provide a loan or loan guarantee to any corporation that was convicted (or had an officer or agent of such corporation acting on behalf of the corporation convicted) of a felony criminal violation under any Federal or State law within the preceding 24 months, where the awarding agency is aware of the conviction, unless the agency has considered suspension or debarment of the corporation, or such officer or agent, and made a determination that this further action is not necessary to protect the interests of the Government.

F. Restricts dealings with corporations with unpaid federal tax liability (Div. E, Title VI, Sec. 622, Div. H, Title V, Sec. 518): None of the funds made available by this Act may be used to enter into a contract, memorandum of understanding, or cooperative agreement with, make a grant to, or provide a loan or loan guarantee to, any corporation that any unpaid Federal tax liability that has been assessed, for which all judicial and administrative remedies have been exhausted or have lapsed, and that is not being paid in a timely manner pursuant to an agreement with the authority responsible for collecting the tax liability, where the awarding agency is aware of the unpaid tax liability, unless the agency has considered suspension or debarment of the corporation and made a determination that this further action is not necessary to protect the interests of the Government.

G. Blocking access to pornography (Div. H, Title V, Sec. 528): (a) None of the funds made available in this Act may be used to maintain or establish a computer network unless such network blocks the viewing, downloading, and exchanging of pornography; (b) Nothing in subsection (a) shall limit the use of funds necessary for any Federal, State, tribal, or local law enforcement agency or any other entity carrying out criminal investigations, prosecution, or adjudication activities.

**Rent or Space Costs:** Grantees are responsible for ensuring that all costs included in this proposal to establish billing or final indirect cost rates are allowable in accordance with the requirements of the Federal award(s) to which they apply, including 2 CFR Part 200, Uniform Administrative Requirements, Cost Principles, and Audit Requirements for Federal Awards; 2 CFR Part 225, Cost Principles for State, Local, and Indian Tribal Governments (OMB Circular A-87); and 2 CFR Part 230, Cost Principles for Non-Profit Organizations (OMB Circular A-122). The grantee also has a responsibility to ensure sub-recipients expend funds in compliance with applicable federal laws and regulations. Furthermore, it is the responsibility of the grantee to ensure rent is a legitimate direct cost line item, which the grantee has supported in current and/or prior projects and these same costs have been treated as indirect costs that have not been claimed as direct costs. If rent is claimed as direct cost, the grantee must provide a narrative justification, which describes their prescribed policy to include the effective date to the assigned Grants Management Specialist (GMS) identified in the CDC Contacts for this award.

**Trafficking In Persons:** This award is subject to the requirements of the Trafficking Victims Protection Act of 2000, as amended (22 U.S.C. Part 7104(g)). For the full text of the award terms and conditions, see, [http://www.cdc.gov/od/pgo/funding/grants/Award\\_Term\\_and\\_Condition\\_for\\_Trafficking\\_in\\_Persons](http://www.cdc.gov/od/pgo/funding/grants/Award_Term_and_Condition_for_Trafficking_in_Persons)



.shtm

**Cancel Year:** 31 U.S.C. Part 1552(a) Procedure for Appropriation Accounts Available for Definite Periods states the following, On September 30<sup>th</sup> of the 5<sup>th</sup> fiscal year after the period of availability for obligation of a fixed appropriation account ends, the account shall be closed and any remaining balances (whether obligated or unobligated) in the account shall be canceled and thereafter shall not be available for obligation or expenditure for any purpose. An example is provided below:

Fiscal Year (FY) 2014 funds will expire September 30, 2019. All FY 2014 funds should be drawn down and reported to Payment Management Services (PMS) prior to September 30, 2019. After this date, corrections or cash requests will not be permitted.

## REPORTING REQUIREMENTS

**Annual Federal Financial Report (FFR, SF-425):** The Annual Federal Financial Report (FFR) SF-425 is required and must be submitted through eRA Commons no later than 90 days after the end of the calendar quarter in which the budget period ends. The FFR for this budget period is due to the GMS/GMO by **December 31, 2015**. Reporting timeframe is **September 30, 2014** through **September 29, 2015**.

The FFR should only include those funds authorized and disbursed during the timeframe covered by the report. The final FFR must indicate the exact balance of unobligated funds and may not reflect any unliquidated obligations. There must be no discrepancies between the final FFR expenditure data and the Payment Management System's (PMS) cash transaction data. All Federal reporting in PMS is unchanged.

Failure to submit the required information in a timely manner may adversely affect the future funding of this project. If the information cannot be provided by the due date, the grantee is required to contact the Grants Officer listed in the contacts section of this notice before the due date.

FFR (SF-425) instructions for CDC Grantees are available at <http://grants.nih.gov/grants/forms.htm>. For further information, contact GrantsInfo@nih.gov. Additional resources concerning the eFSR/FFR system, including a User Guide and an on-line demonstration, can be found on the eRA Commons Support Page: <http://www.cdc.gov/od/pgo/funding/grants/eramain.shtm>.

**Performance Reporting:** The Annual Performance Report is due no later than 120 days prior to the end of the budget period, **June 3, 2015**, and serves as the continuing application. This report should include the information specified in the FOA.

### Audit Requirement:

**Domestic Organizations (including US-based organizations implementing projects with foreign components):** An organization that expends \$500,000 or more in a fiscal year in Federal awards shall have a single or program-specific audit conducted for that year in accordance with the provisions of OMB Circular A-133. The audit period is an organization's fiscal year. The audit must be completed along with a data collection form (SF-SAC), and the reporting package shall be submitted within the earlier of 30 days after receipt of the auditor's report(s), or nine (9) months after the end of the audit period. The audit report must be sent to:

Federal Audit Clearing House Internet Data Entry System

Electronic Submission:

[https://harvester.census.gov/facides/\(S\(0vkw1zaelyzjibnahocga5i0\)\)/account/login.aspx](https://harvester.census.gov/facides/(S(0vkw1zaelyzjibnahocga5i0))/account/login.aspx)

AND

Procurement & Grants Office, Risk Management & Compliance Activity

Electronic Copy to: [PGO.Audit.Resolution@cdc.gov](mailto:PGO.Audit.Resolution@cdc.gov)

After receipt of the audit report, the National External Audit Review Center will provide audit resolution instructions. CDC will resolve findings by issuing Final Determination Letters.

**Audit requirements for Subrecipients:** The grantee must ensure that the subrecipients receiving CDC funds also meet these requirements. The grantee must also ensure to take appropriate corrective action within six months after receipt of the subrecipient audit report in instances of non-compliance with applicable Federal law and regulations (2 CFR 200 Subpart F and HHS Grants Policy Statement). The grantee may consider whether subrecipient audits necessitate adjustment of the grantee's own accounting records. If a subrecipient is not required to have a program-specific audit, the grantee is still required to perform adequate monitoring of subrecipient activities. The grantee shall require each subrecipient to permit the independent auditor access to the subrecipient's records and financial statements. The grantee must include this requirement in all subrecipient contracts.

Note: The standards set forth in 2 CFR Part 200 Subpart F will apply to audits of fiscal years beginning on or after December 26, 2014.

**Federal Funding Accountability and Transparency Act (FFATA):** *FFATA applies to new awards that have been made and noncompeting continuations that were issued as new awards on or after October 1, 2010.* In accordance with 2 CFR Chapter 1, Part 170 Reporting Sub-Award And Executive Compensation Information, Prime Awardees awarded a federal grant are required to file a FFATA sub-award report by the end of the month following the month in which the prime awardee awards any sub-grant equal to or greater than \$25,000.

Pursuant to A-133 (see Section .205(h) and Section .205(i)), a grant sub-award includes the provision of any commodities (food and non-food) to the sub-recipient where the sub-recipient is required to abide by terms and conditions regarding the use or future administration of those goods. If the sub-awardee merely consumes or utilizes the goods, the commodities are not in and of themselves considered sub-awards.

2 CFR Part 170: [http://www.ecfr.gov/cgi-bin/text-idx?SID=62c0c614004c0ada23cb6552e0adcdc6&node=2:1.1.1.1.4&rgn=div5#\\_top](http://www.ecfr.gov/cgi-bin/text-idx?SID=62c0c614004c0ada23cb6552e0adcdc6&node=2:1.1.1.1.4&rgn=div5#_top)

FFATA: [www.fsrs.gov](http://www.fsrs.gov).

#### Reporting of First-Tier Sub-awards

**Applicability:** Unless you are exempt (gross income from all sources reported in last tax return is under \$300,000), you must report each action that obligates \$25,000 or more in Federal funds that does not include Recovery funds (as defined in section 1512(a)(2) of the American Recovery and Reinvestment Act of 2009, Pub. L. 111-5) for a sub-award to an entity.

**Reporting:** Report each obligating action of this award term to <http://www.fsrs.gov>. For sub-award information, report no later than the end of the month following the month in which the obligation was made. (For example, if the obligation was made on November 7, 2010, the obligation must be reported by no later than December 31, 2010). You must report the information about each obligating action that the submission instructions posted at <http://www.fsrs.gov> specify.

**Total Compensation of Recipient Executives:** You must report total compensation for each of your five most highly compensated executives for the preceding completed fiscal year, if:

- The total Federal funding authorized to date under this award is \$25,000 or more;
- In the preceding fiscal year, you received—
  - 80 percent or more of your annual gross revenues from Federal procurement contracts (and subcontracts) and Federal financial assistance subject to the Transparency Act, as defined at 2 CFR Part 170.320 (and sub-awards); and
  - \$25,000,000 or more in annual gross revenues from Federal procurement contracts (and subcontracts) and Federal financial assistance subject to the Transparency Act, as defined at 2 CFR Part 170.320 (and sub-awards); and
  - The public does not have access to information about the compensation of the executives through periodic reports filed under section 13(a) or 15(d) of the Securities Exchange Act of 1934 (15 U.S.C. Part 78m(a), 78o(d)) or section 6104 of the Internal Revenue Code of 1986. (To determine if the public has access to the compensation information, see the U.S. Security and Exchange

Commission total compensation filings at  
<http://www.sec.gov/answers/execomp.htm>).

Report executive total compensation as part of your registration profile at <http://www.sam.gov>. Reports should be made at the end of the month following the month in which this award is made and annually thereafter.

**Total Compensation of Sub-recipient Executives:** Unless you are exempt (gross income from all sources reported in last tax return is under \$300,000), for each first-tier sub-recipient under this award, you must report the names and total compensation of each of the sub-recipient's five most highly compensated executives for the sub-recipient's preceding completed fiscal year, if:

- In the sub-recipient's preceding fiscal year, the sub-recipient received—
  - 80 percent or more of its annual gross revenues from Federal procurement contracts (and subcontracts) and Federal financial assistance subject to the Transparency Act, as defined at 2 CFR Part 170.320 (and sub-awards); and
  - \$25,000,000 or more in annual gross revenues from Federal procurement contracts (and subcontracts), and Federal financial assistance subject to the Transparency Act (and sub-awards); and
  - The public does not have access to information about the compensation of the executives through periodic reports filed under section 13(a) or 15(d) of the Securities Exchange Act of 1934 (15 U.S.C. Part 78m(a), 78o(d)) or section 6104 of the Internal Revenue Code of 1986. (To determine if the public has access to the compensation information, see the U.S. Security and Exchange Commission total compensation filings at <http://www.sec.gov/answers/execomp.htm>).

You must report sub-recipient executive total compensation to the grantee by the end of the month following the month during which you make the sub-award. For example, if a sub-award is obligated on any date during the month of October of a given year (i.e., between October 1st and 31st), you must report any required compensation information of the sub-recipient by November 30th of that year.

**Definitions:**

- Entity means all of the following, as defined in 2 CFR Part 25 (Appendix A, Paragraph(C)(3)):
  - Governmental organization, which is a State, local government, or Indian tribe;
  - Foreign public entity;
  - Domestic or foreign non-profit organization;
  - Domestic or foreign for-profit organization;
  - Federal agency, but only as a sub-recipient under an award or sub-award to a non-Federal entity.
- Executive means officers, managing partners, or any other employees in management positions.
- Sub-award: a legal instrument to provide support to an eligible sub-recipient for the performance of any portion of the substantive project or program for which the grantee received this award. The term does not include the grantees procurement of property and services needed to carry out the project or program (for further explanation, see Sec. \_\_210 of the attachment to OMB Circular A-133, Audits of States, Local Governments, and Non-Profit Organizations). A sub-award may be provided through any legal agreement, including an agreement that the grantee or a sub-recipient considers a contract.
- Sub-recipient means an entity that receives a sub-award from you (the grantee) under this award; and is accountable to the grantee for the use of the Federal funds provided by the sub-award.

- Total compensation means the cash and non-cash dollar value earned by the executive during the grantee's or sub-recipient's preceding fiscal year and includes the following (for more information see 17 CFR Part 229.402(c)(2)):
  - Salary and bonus
  - Awards of stock, stock options, and stock appreciation rights. Use the dollar amount recognized for financial statement reporting purposes with respect to the fiscal year in accordance with the Statement of Financial Accounting Standards No. 123 (Revised 2004) (FAS 123R), Shared Based Payments.
  - Earnings for services under non-equity incentive plans. This does not include group life, health, hospitalization or medical reimbursement plans that do not discriminate in favor of executives, and are available generally to all salaried employees.
  - Change in pension value. This is the change in present value of defined benefit and actuarial pension plans.
  - Above-market earnings on deferred compensation which is not tax-qualified.
  - Other compensation, if the aggregate value of all such other compensation (e.g. severance, termination payments, value of life insurance paid on behalf of the employee, perquisites or property) for the executive exceeds \$10,000.

**Prevention Fund Reporting Requirements:** This award requires the grantee to complete projects or activities which are funded under the Prevention and Public Health Fund (PPHF) (Section 4002 of Public Law 111-148) and to report on use of PPHF funds provided through this award. Information from these reports will be made available to the public.

Grantees awarded a grant, cooperative agreement, or contract from such funds with a value of \$25,000 or more shall produce reports on a semi-annual basis with a reporting cycle of January 1 - June 30 and July 1 - December 31; and email such reports to the CDC website (template and point of contact to be provided after award) no later than 20 calendar days after the end of each reporting period (i.e. July 20 and January 20, respectively). Grantee reports must reference the NoA number and title of the grant, and include a summary of the activities undertaken and identify any sub-awards (including the purpose of the award and the identity of each sub-recipient).

Responsibilities for Informing Sub-recipients: Grantees agree to separately identify each sub-recipient, document the execution date sub-award, date(s) of the disbursement of funds, the Federal award number, any special CFDA number assigned for PPHF fund purposes, and the amount of PPHF funds. When a grantee awards PPHF funds for an existing program, the information furnished to sub-recipients shall distinguish the sub-awards of incremental PPHF funds from regular sub-awards under the existing program.

## GENERAL REQUIREMENTS

**Travel Cost:** In accordance with HHS Grants Policy Statement, travel costs are only allowable where such travel will provide direct benefit to the project or program. There must be a direct benefit imparted on behalf of the traveler as it applies to the approved activities of the NoA. To prevent disallowance of cost, the grantee is responsible for ensuring that only allowable travel reimbursements are applied in accordance with their organization's established travel policies and procedures. Grantees approved policies must meet the requirements of 2 CFR Parts 200, 225 and 230, as applicable and 45 CFR Parts 74 and 92, as applicable.

**Food and Meals:** Costs associated with food or meals are allowable when consistent with OMB Circulars and guidance, HHS Federal regulations, Program Regulations, HHS policies and guidance. In addition, costs must be proposed in accordance with grantee approved policies and a determination of reasonableness has been performed by the grantees. Grantee approved policies must meet the requirements of 2 CFR Parts 200, 225 and 230, as applicable and 45 CFR Parts 74 and 92, as applicable.

**Prior Approval:** All requests, which require prior approval, must bear the signature of an authorized official of the business office of the grantee organization as well as the principal investigator or program or project director named on this NoA. The grantee must submit these

requests by **June 3, 2014** or no later than 120 days prior to this budget period's end date. Any requests received that reflect only one signature will be returned to the grantee unprocessed. Additionally, any requests involving funding issues must include an itemized budget and a narrative justification of the request.

The following types of requests require prior approval.

- Use of unobligated funds from prior budget period (Carryover)\*
- Lift funding restriction, withholding, or disallowance
- Redirection of funds
- Change in scope
- Implement a new activity or enter into a sub-award that is not specified in the most recently approved budget
- Apply for supplemental funds
- Response to the Objective/Technical Review Statement
- Change in key personnel
- Extensions
- Conferences or meetings that exceed cost threshold

Note: Awardees may request up to 75 percent of their estimated unobligated funds to be carried forward into the next budget period.

Templates for prior approval requests can be found at:

<http://www.cdc.gov/od/pgo/funding/grants/granteeguidance.shtm>

**Key Personnel:** In accordance with 2 CFR Parts 200.308 and 215.25(c)(2) & (3); CDC grantees must obtain prior approval from CDC for (1) change in the project director/principal investigator, business official, authorized organizational representative or other key persons specified in the FOA, application or award document; and (2) the disengagement from the project for more than three months, or a 25 percent reduction in time devoted to the project, by the approved project director or principal investigator.

**Inventions:** Acceptance of grant funds obligates grantees to comply with the standard patent rights clause in 37 CFR Part 401.14.

**Publications:** Publications, journal articles, etc. produced under a CDC grant support project must bear an acknowledgment and disclaimer, as appropriate, for example:

This publication (journal article, etc.) was supported by the Grant or Cooperative Agreement Number, **DP005794**, funded by the Centers for Disease Control and Prevention. Its contents are solely the responsibility of the authors and do not necessarily represent the official views of the Centers for Disease Control and Prevention or the Department of Health and Human Services.

**Acknowledgment Of Federal Support:** When issuing statements, press releases, requests for proposals, bid solicitations and other documents describing projects or programs funded in whole or in part with Federal money, all awardees receiving Federal funds, including and not limited to State and local governments and grantees of Federal research grants, shall clearly state:

- percentage of the total costs of the program or project which will be financed with Federal money
- dollar amount of Federal funds for the project or program, and
- percentage and dollar amount of the total costs of the project or program that will be financed by non-governmental sources.

**Copyright Interests Provision:** This provision is intended to ensure that the public has access to the results and accomplishments of public health activities funded by CDC. Pursuant to applicable grant regulations and CDC's Public Access Policy, Recipient agrees to submit into the National Institutes of Health (NIH) Manuscript Submission (NIHMS) system an electronic version of the final, peer-reviewed manuscript of any such work developed under this award upon acceptance for publication, to be made publicly available no later than 12 months after the official date of publication. Also at the time of submission, Recipient and/or the Recipient's submitting author must specify the date the final manuscript will be publicly accessible through PubMed Central (PMC). Recipient and/or Recipient's submitting author must also post the manuscript

through PMC within twelve (12) months of the publisher's official date of final publication; however the author is strongly encouraged to make the subject manuscript available as soon as possible. The recipient must obtain prior approval from the CDC for any exception to this provision.

The author's final, peer-reviewed manuscript is defined as the final version accepted for journal publication, and includes all modifications from the publishing peer review process, and all graphics and supplemental material associated with the article. Recipient and its submitting authors working under this award are responsible for ensuring that any publishing or copyright agreements concerning submitted articles reserve adequate right to fully comply with this provision and the license reserved by CDC. The manuscript will be hosted in both PMC and the CDC Stacks institutional repository system. In progress reports for this award, recipient must identify publications subject to the CDC Public Access Policy by using the applicable NIHMS identification number for up to three (3) months after the publication date and the PubMed Central identification number (PMCID) thereafter.

**Disclaimer for Conference/Meeting/Seminar Materials:** Disclaimers for conferences/meetings, etc. and/or publications: If a conference/meeting/seminar is funded by a grant, cooperative agreement, sub-grant and/or a contract the grantee must include the following statement on conference materials, including promotional materials, agenda, and internet sites:

Funding for this conference was made possible (in part) by the Centers for Disease Control and Prevention. The views expressed in written conference materials or publications and by speakers and moderators do not necessarily reflect the official policies of the Department of Health and Human Services, nor does the mention of trade names, commercial practices, or organizations imply endorsement by the U.S. Government.

**Logo Use for Conference and Other Materials:** Neither the Department of Health and Human Services (HHS) nor the CDC logo may be displayed if such display would cause confusion as to the funding source or give false appearance of Government endorsement. Use of the HHS name or logo is governed by U.S.C. Part 1320b-10, which prohibits misuse of the HHS name and emblem in written communication. A non-federal entity is unauthorized to use the HHS name or logo governed by U.S.C. Part 1320b-10. The appropriate use of the HHS logo is subject to review and approval of the HHS Office of the Assistant Secretary for Public Affairs (OASPA). Moreover, the HHS Office of the Inspector General has authority to impose civil monetary penalties for violations (42 CFR Part 1003). Accordingly, neither the HHS nor the CDC logo can be used by the grantee without the express, written consent of either the CDC Project Officer or the CDC Grants Management Officer. It is the responsibility of the grantee to request consent for use of the logo in sufficient detail to ensure a complete depiction and disclosure of all uses of the Government logos. In all cases for utilization of Government logos, the grantee must ensure written consent is received from the Project Officer and/or the Grants Management Officer.

**Equipment and Products:** To the greatest extent practicable, all equipment and products purchased with CDC funds should be American-made. CDC defines equipment as tangible non-expendable personal property (including exempt property) charged directly to an award having a useful life of more than one year AND an acquisition cost of \$5,000 or more per unit. However, consistent with grantee policy, a lower threshold may be established. Please provide the information to the Grants Management Officer to establish a lower equipment threshold to reflect your organization's policy.

The grantee may use its own property management standards and procedures, provided it observes provisions of in applicable grant regulations and OMB circulars.

**Federal Information Security Management Act (FISMA):** All information systems, electronic or hard copy, that contain federal data must be protected from unauthorized access. This standard also applies to information associated with CDC grants. Congress and the OMB have instituted laws, policies and directives that govern the creation and implementation of federal information security practices that pertain specifically to grants and contracts. The current regulations are pursuant to the Federal Information Security Management Act (FISMA), Title III of the E-Government Act of 2002, PL 107-347.

FISMA applies to CDC grantees only when grantees collect, store, process, transmit or use

information on behalf of itself or any of its component organizations. In other cases, FISMA is not applicable to recipients of grants, including cooperative agreements. Under FISMA, the grantee retains the original data and intellectual property, and is responsible for the security of these data, subject to all applicable laws protecting security, privacy, and research. If/When information collected by a grantee is provided to HHS, responsibility for the protection of the HHS copy of the information is transferred to HHS and it becomes the agency's responsibility to protect that information and any derivative copies as required by FISMA. For the full text of the requirements under Federal Information Security Management Act (FISMA), Title III of the E-Government Act of 2002 Pub. L. No. 107-347, please review the following website:

[http://frwebgate.access.gpo.gov/cgi-bin/getdoc.cgi?dbname=107\\_cong\\_public\\_laws&docid=f:publ347.107.pdf](http://frwebgate.access.gpo.gov/cgi-bin/getdoc.cgi?dbname=107_cong_public_laws&docid=f:publ347.107.pdf)

**Pilot Program for Enhancement of Contractor Employee Whistleblower Protections:**

Grantees are hereby given notice that the 48 CFR section 3.908, implementing section 828, entitled "Pilot Program for Enhancement of Contractor Employee Whistleblower Protections," of the National Defense Authorization Act (NDAA) for Fiscal Year (FY) 2013 (Pub. L. 112-239, enacted January 2, 2013), applies to this award.

**Federal Acquisition Regulations**

As promulgated in the Federal Register, the relevant portions of 48 CFR section 3.908 read as follows (note that use of the term "contract," "contractor," "subcontract," or "subcontractor" for the purpose of this term and condition, should be read as "grant," "grantee," "subgrant," or "subgrantee"):

3.908 Pilot program for enhancement of contractor employee whistleblower protections.

3.908-1 Scope of section.

(a) This section implements 41 U.S.C. 4712.

(b) This section does not apply to-

(1) DoD, NASA, and the Coast Guard; or

(2) Any element of the intelligence community, as defined in section 3(4) of the National Security Act of 1947 (50 U.S.C. 3003(4)). This section does not apply to any disclosure made by an employee of a contractor or subcontractor of an element of the intelligence community if such disclosure-

(i) Relates to an activity of an element of the intelligence community; or

(ii) Was discovered during contract or subcontract services provided to an element of the intelligence community.

3.908-2 Definitions.

As used in this section-

"Abuse of authority" means an arbitrary and capricious exercise of authority that is inconsistent with the mission of the executive agency concerned or the successful performance of a contract of such agency.

"Inspector General" means an Inspector General appointed under the Inspector General Act of 1978 and any Inspector General that receives funding from, or has oversight over contracts awarded for, or on behalf of, the executive agency concerned.

3.908-3 Policy.

(a) Contractors and subcontractors are prohibited from discharging, demoting, or otherwise discriminating against an employee as a reprisal for disclosing, to any of the entities listed at paragraph (b) of this subsection, information that the employee reasonably believes is evidence of gross mismanagement of a Federal contract, a gross waste of Federal funds, an abuse of authority relating to a Federal contract, a substantial and specific danger to public health or safety, or a violation of law, rule, or regulation related to a Federal contract (including the competition for or negotiation of a contract). A reprisal is prohibited even if it is undertaken at the request of an executive branch official, unless the request takes the form of a non-discretionary directive and is within the authority of the executive branch official making the request.

(b) Entities to whom disclosure may be made.

(1) A Member of Congress or a representative of a committee of Congress.

(2) An Inspector General.

- (3) The Government Accountability Office.
- (4) A Federal employee responsible for contract oversight or management at the relevant agency.
- (5) An authorized official of the Department of Justice or other law enforcement agency.
- (6) A court or grand jury.
- (7) A management official or other employee of the contractor or subcontractor who has the responsibility to investigate, discover, or address misconduct.

(c) An employee who initiates or provides evidence of contractor or subcontractor misconduct in any judicial or administrative proceeding relating to waste, fraud, or abuse on a Federal contract shall be deemed to have made a disclosure.

**3.908-9 Contract clause.**

**Contractor Employee Whistleblower Rights and Requirement to Inform Employees of Whistleblower Rights (Sept. 2013)**

(a) This contract and employees working on this contract will be subject to the whistleblower rights and remedies in the pilot program on Contractor employee whistleblower protections established at 41 U.S.C. 4712 by section 828 of the National Defense Authorization Act for Fiscal Year 2013 (Pub. L. 112-239) and FAR 3.908.

(b) The Contractor shall inform its employees in writing, in the predominant language of the workforce, of employee whistleblower rights and protections under 41 U.S.C. 4712, as described in section 3.908 of the Federal Acquisition Regulation.

(c) The Contractor shall insert the substance of this clause, including this paragraph (c), in all subcontracts over the simplified acquisition threshold.

**PAYMENT INFORMATION**

**Automatic Drawdown (Direct/Advance Payments):** Payment under this award will be made available through the Department of Health and Human Services (HHS) Payment Management System (PMS). PMS will forward instructions for obtaining payments.

PMS correspondence, mailed through the U.S. Postal Service, should be addressed as follows:

Director, Division of Payment Management  
 P.O. Box 6021  
 Rockville, MD 20852  
 Phone Number: (877) 614-5533  
 Email: [PMSSupport@psc.gov](mailto:PMSSupport@psc.gov)  
 Website: <http://www.dpm.psc.gov/help/help.aspx>

**Note:** To obtain the contact information of PMS staff within respective Payment Branches refer to the links listed below:

- University and Non-Profit Payment Branch:  
[http://www.dpm.psc.gov/contacts/dpm\\_contact\\_list/univ\\_nonprofit.aspx?explorer.event=true](http://www.dpm.psc.gov/contacts/dpm_contact_list/univ_nonprofit.aspx?explorer.event=true)
- Governmental and Tribal Payment Branch:  
[http://www.dpm.psc.gov/contacts/dpm\\_contact\\_list/gov\\_tribal.aspx?explorer.event=true](http://www.dpm.psc.gov/contacts/dpm_contact_list/gov_tribal.aspx?explorer.event=true)
- Cross Servicing Payment Branch:  
[http://www.dpm.psc.gov/contacts/dpm\\_contact\\_list/cross\\_servicing.aspx](http://www.dpm.psc.gov/contacts/dpm_contact_list/cross_servicing.aspx)
- International Payment Branch:  
 Bhavin Patel (301) 443-9188

If a carrier other than the U.S. Postal Service is used, such as United Parcel Service, Federal Express, or other commercial service, the correspondence should be addressed as follows:

U.S. Department of Health and Human Services



Division of Payment Management  
7700 Wisconsin Avenue, Suite 920  
Bethesda, MD 20814

To expedite your first payment from this award, attach a copy of the Notice of Grant/Cooperative Agreement to your payment request form.

**Payment Management System Subaccount:** Effective October 1, 2013, a new HHS policy on subaccounts requires the CDC setup payment subaccounts within the Payment Management System (PMS) for all grant awards. Funds awarded in support of approved activities have been obligated in a newly established subaccount in the PMS, herein identified as the "P Account". A P Account is a subaccount created specifically for the purpose of tracking designated types of funding in the PMS.

All award funds must be tracked and reported separately. Funds must be used in support of approved activities in the FOA and the approved application.

The grant document number and subaccount title (below) must be known in order to draw down funds from this P Account.

**Grant Document Number: 005794CH14**  
**Subaccount Title: DP14-1419PPHF14**

**Acceptance of the Terms of an Award:** By drawing or otherwise obtaining funds from the grant Payment Management Services, the grantee acknowledges acceptance of the terms and conditions of the award and is obligated to perform in accordance with the requirements of the award. If the recipient cannot accept the terms, the recipient should notify the Grants Management Officer within thirty (30) days of receipt of this award notice.

**Certification Statement:** By drawing down funds, the grantee certifies that proper financial management controls and accounting systems, to include personnel policies and procedures, have been established to adequately administer Federal awards and funds drawn down. Recipients must comply with all terms and conditions outlined in their NoA, including grant policy terms and conditions contained in applicable HHS Grant Policy Statements, and requirements imposed by program statutes and regulations and HHS grants administration regulations, as applicable; as well as any regulations or limitations in any applicable appropriations acts.

#### **CLOSEOUT REQUIREMENTS**

Grantees must submit closeout reports in a timely manner. Unless the Grants Management Specialist/Grants Management Officer (GMS/GMO) approves a deadline extension the grantee must submit all closeout reports within 90 days after the last day of the final budget period. Reporting timeframe is **September 30, 2014** through **September 29, 2017**. Failure to submit timely and accurate final reports may affect future funding to the organization or awards under the direction of the same Project Director/Principal Investigator (PD/PI).

All manuscripts published as a result of the work supported in part or whole by the cooperative grant must be submitted with the progress reports.

An original plus two copies of the reports must be mailed to the GMS for approval by the GMO by the due date noted. Ensure the Award and Program Announcement numbers shown above are on the reports.

The final and other programmatic reports required by the terms and conditions of the NoA are the following.

**Final Performance Report:** An original and two copies are required. At a minimum, the report should include the following:

- Statement of progress made toward the achievement of originally stated aims.
- Description of results (positive or negative) considered significant.
- List of publications resulting from the project, with plans, if any, for further

publication.

**Final Federal Financial Report (FFR, SF-425):** The FFR should only include those funds authorized and actually expended during the timeframe covered by the report. The Final FFR, SF-425 is required and must be submitted through eRA Commons no later than 90 days after the end of the project period. This report must indicate the exact balance of unobligated funds and may not reflect any unliquidated obligations. Should the amount not match with the final expenditures reported to the Department of Health and Human Services' Payment Management Services (PMS), you will be required to update your reports to PMS accordingly. Remaining unobligated funds will be de-obligated and returned to the U.S. Treasury.

If the final reports (FFR and Final Progress Report) cannot be submitted within 90 days after the end of the project period, in accordance with 2 CFR Parts 200.343 (Closeout), 225 and 230, the grantee must submit a letter requesting an extension that includes the justification for the delay and state the expected date the CDC Procurement and Grants Office will receive the reports. All required documents must be mailed to the business contact identified in Staff Contacts.

**Equipment Inventory Report:** An original and two copies of a complete inventory must be submitted for all major equipment acquired or furnished under this project with a unit acquisition cost of \$5,000 or more. The inventory list must include the description of the item, manufacturer serial and/or identification number, acquisition date and cost, percentage of Federal funds used in the acquisition of the item. The grantee should also identify each item of equipment that it wishes to retain for continued use in accordance with 2 CFR Parts 200, 215.37 or 2 CFR Part 215.71. These requirements do apply to equipment purchased with non-federal funds for this program. The awarding agency may exercise its rights to require the transfer of equipment purchased under the assistance award referenced in the cover letter. CDC will notify the grantee if transfer to title will be required and provide disposition instruction on all major equipment. Equipment with a unit acquisition cost of less than \$5,000 that is no longer to be used in projects or programs currently or previously sponsored by the Federal Government may be retained, sold, or otherwise disposed of, with no further obligation to the Federal Government. If no equipment was acquired under this award, a negative report is required.

**Final Invention Statement:** An original and two copies of a Final Invention Statement are required. Electronic versions of the form can be downloaded by visiting <http://www.hhs.gov/forms/hhs568.pdf>. If no inventions were conceived under this assistance award, a negative report is required. This statement may be included in a cover letter.

## CDC ROLES AND RESPONSIBILITIES

**Roles and Responsibilities:** Grants Management Specialists/Officers (GMO/GMS) and Program/Project Officers (PO) work together to award and manage CDC grants and cooperative agreements. From the pre-planning stage to closeout of an award, grants management and program staff have specific roles and responsibilities for each phase of the grant cycle. The GMS/GMO is responsible for the business management and administrative functions. The PO is responsible for the programmatic, scientific, and/or technical aspects. The purpose of this factsheet is to distinguish between the roles and responsibilities of the GMO/GMS and the PO to provide a description of their respective duties.

**Grants Management Officer:** The GMO is the federal official responsible for the business and other non-programmatic aspects of grant awards including:

- Determining the appropriate award instrument, i.e.; grant or cooperative agreement
- Determining if an application meets the requirements of the FOA
- Ensuring objective reviews are conducted in an above-the-board manner and according to guidelines set forth in grants policy
- Ensuring grantee compliance with applicable laws, regulations, and policies
- Negotiating awards, including budgets
- Responding to grantee inquiries regarding the business and administrative aspects of an award
- Providing grantees with guidance on the closeout process and administering the closeout of grants
- Receiving and processing reports and prior approval requests such as changes in funding, carryover, budget redirection, or changes to the terms and conditions of an award

- Maintaining the social grant file and program book

The GMO is the only official authorized to obligate federal funds and is responsible for signing the NoA, including revisions to the NoA that change the terms and conditions. The GMO serves as the counterpart to the business officer of the recipient organization.

**GMO Contact:** See Staff Contacts below for the assigned GMO

**Grants Management Specialist:** The GMS is the federal staff member responsible for the day-to-day management of grants and cooperative agreements. The GMS is the primary contact of recipients for business and administrative matters pertinent to grant awards. Many of the functions described above are performed by the GMS on behalf of the GMO.

**GMS Contact:** See Staff Contacts below for the assigned GMS

**Program/Project Officer:** The PO is the federal official responsible for the programmatic, scientific, and/or technical aspects of grants and cooperative agreements including:

- The development of programs and FOAs to meet the CDC's mission
- Providing technical assistance to applicants in developing their applications e.g. explanation of programmatic requirements, regulations, evaluation criteria, and guidance to applicants on possible linkages with other resources
- Providing technical assistance to grantees in the performance of their project
- Post-award monitoring of grantee performance such as review of progress reports, review of prior approval requests, conducting site visits, and other activities complementary to those of the GMO/GMS

#### **Business and Grants Policy Contact**

**Grants Management Officer (GMO):** Tracey M. Sims  
Centers for Disease Control and Prevention  
Procurement and Grants Office  
Koger Center, Colgate Building  
2920 Brandywine Road, Mailstop E-09  
Atlanta, GA 30341  
**Telephone:** (770) 488-2739  
**Fax:** 770-488-2778  
**Email:** atu9@cdc.gov

**Grants Management Specialist (GMS):** Ferrinnia (Toni) Augustus-High, MSA  
Centers for Disease Control, PGO, Branch III  
2920 Brandywine Road, Mail Stop E-09  
Atlanta, GA 30341  
**Telephone:** 770.488.2906  
**Fax:** 770-488-2778  
**Email:** wef9@cdc.gov

#### **Programmatic and Technical Contact**

**Project Officer (PO):** Shannon White  
National Center for Chronic Disease Prevention and Health Promotion (NCCDPHP)  
Centers for Disease Control and Prevention  
4770 Buford Hwy., NE Mail Stop F-79  
Atlanta, Georgia 30341  
**Telephone:** (770) 488-5295  
**Email:** [snw4@cdc.gov](mailto:snw4@cdc.gov)

#### **STAFF CONTACTS**

**Grants Management Specialist:** Ferrinnia Augustus-high  
Center for Disease Control and Prevention  
PGO  
2920 Brandywine Road MS E-09

Atlanta, GA 30341  
Email: wef9@cdc.gov Phone: 770-488-2906

**Grants Management Officer:** Tracey M Sims  
Centers for Disease Control and Prevention  
Procurement and Grants Office  
Koger Center, Colgate Building  
2920 Brandywine Road, Mail Stop E-09  
Atlanta, GA 30341  
Email: tsims3@cdc.gov Phone: 770-488-2739 Fax: 770-488-2777

**SPREADSHEET SUMMARY**  
**GRANT NUMBER:** 1U58DP005794-01

**INSTITUTION:** SAN FRANCISCO DEPT OF PUBLIC HEALTH

Budget	Year 1	Year 2	Year 3
Salaries and Wages	\$43,244		
Fringe Benefits	\$18,162		
Personnel Costs (Subtotal)	\$61,406		
Travel Costs	\$1,450		
Other Costs	\$40,838	\$799,159	\$799,159
Consortium/Contractual Cost	\$695,465		
TOTAL FEDERAL DC	\$799,159	\$799,159	\$799,159
TOTAL FEDERAL F&A			
TOTAL COST	\$799,159	\$799,159	\$799,159

Application for Federal Assistance SF-424

Version 02

* 1. Type of Submission: <input type="checkbox"/> Preapplication <input checked="" type="checkbox"/> Application <input type="checkbox"/> Changed/Corrected Application	* 2. Type of Application: <input checked="" type="checkbox"/> New <input type="checkbox"/> Continuation <input type="checkbox"/> Revision	* If Revision, select appropriate letter(s): _____ * Other (Specify) _____
--	--	---

* 3. Date Received: Completed by Grants.gov upon submission.	4. Applicant Identifier: FOA DP14-1419PPHF14
---	---

5a. Federal Entity Identifier: _____	* 5b. Federal Award Identifier: _____
---	--

State Use Only:

6. Date Received by State: _____	7. State Application Identifier: _____
----------------------------------	--

8. APPLICANT INFORMATION:

* a. Legal Name: San Francisco Department of Public Health
--

* b. Employer/Taxpayer Identification Number (EIN/TIN): 94-6000417	* c. Organizational DUNS: 103717336
---	--

d. Address:

* Street1: 101 Grove, Rm408
Street2: _____
* City: San Francisco
County: _____
* State: CA: California
Province: _____
* Country: USA: UNITED STATES
* Zip / Postal Code: 94102

e. Organizational Unit:

Department Name: _____	Division Name: _____
------------------------	----------------------

f. Name and contact information of person to be contacted on matters involving this application:

Prefix: _____	* First Name: Christine
Middle Name: _____	
* Last Name: Siador	
Suffix: _____	
Title: _____	
Organizational Affiliation: _____	

* Telephone Number: 415-554-2832	Fax Number: _____
* Email: christine.siador@sfdph.org	

Application for Federal Assistance SF-424

Version 02

9. Type of Applicant 1: Select Applicant Type:

B: County Government

Type of Applicant 2: Select Applicant Type:

Type of Applicant 3: Select Applicant Type:

\* Other (specify):

\* 10. Name of Federal Agency:

Chronic Disease Prevention and Health Promotion

11. Catalog of Federal Domestic Assistance Number:

93.738

CFDA Title:

PPHF 2012: Racial and Ethnic Approaches to Community Health Program financed solely by 2012 Public Prevention and Health

\* 12. Funding Opportunity Number:

CDC-RFA-DP14-1419PPHF14

\* Title:

PPHF 2014: Racial and Ethnic Approaches to Community Health (REACH) - financed in part by Prevention and Public Health Funding

13. Competition Identification Number:

NCCDPHF-NR

Title:

14. Areas Affected by Project (Cities, Counties, States, etc.):

\* 15. Descriptive Title of Applicant's Project:

Racial and Ethnic Approaches to Community Health - Heart Healthy SF

Attach supporting documents as specified in agency instructions.

Add Attachments

Delete Attachments

View Attachments

<b>Application for Federal Assistance SF-424</b>		<b>Version 02</b>
<b>16. Congressional Districts Of:</b>		
* a. Applicant	<input type="text" value="CA-008"/>	* b. Program/Project <input type="text" value="CA-008"/>
Attach an additional list of Program/Project Congressional Districts if needed.		
<input type="text"/>	<input type="button" value="Add Attachment"/>	<input type="button" value="Delete Attachment"/> <input type="button" value="View Attachment"/>
<b>17. Proposed Project:</b>		
* a. Start Date:	<input type="text" value="09/30/2014"/>	* b. End Date: <input type="text" value="09/29/2017"/>
<b>18. Estimated Funding (\$):</b>		
* a. Federal	<input type="text" value="2,397,477.00"/>	
* b. Applicant	<input type="text" value="0.00"/>	
* c. State	<input type="text" value="0.00"/>	
* d. Local	<input type="text" value="0.00"/>	
* e. Other	<input type="text" value="0.00"/>	
* f. Program Income	<input type="text" value="0.00"/>	
* g. TOTAL	<input type="text" value="2,397,477.00"/>	
<b>* 19. Is Application Subject to Review By State Under Executive Order 12372 Process?</b>		
<input type="checkbox"/> a. This application was made available to the State under the Executive Order 12372 Process for review on <input type="text"/>		
<input checked="" type="checkbox"/> b. Program is subject to E.O. 12372 but has not been selected by the State for review.		
<input type="checkbox"/> c. Program is not covered by E.O. 12372.		
<b>* 20. Is the Applicant Delinquent On Any Federal Debt? (If "Yes", provide explanation.)</b>		
<input type="checkbox"/> Yes <input checked="" type="checkbox"/> No <input type="text" value="Explanation"/>		
<b>21. *By signing this application, I certify (1) to the statements contained in the list of certifications** and (2) that the statements herein are true, complete and accurate to the best of my knowledge. I also provide the required assurances** and agree to comply with any resulting terms if I accept an award. I am aware that any false, fictitious, or fraudulent statements or claims may subject me to criminal, civil, or administrative penalties. (U.S. Code, Title 218, Section 1001)</b>		
<input checked="" type="checkbox"/> ** I AGREE		
** The list of certifications and assurances, or an internet site where you may obtain this list, is contained in the announcement or agency specific instructions.		
<b>Authorized Representative:</b>		
Prefix:	<input type="text"/>	* First Name: <input type="text" value="Tomas"/>
Middle Name:	<input type="text"/>	
* Last Name:	<input type="text" value="Aragon"/>	
Suffix:	<input type="text"/>	
* Title:	<input type="text" value="Director, Population Health Division (PHD)"/>	
* Telephone Number:	<input type="text" value="415-787-2583"/>	Fax Number: <input type="text"/>
* Email:	<input type="text" value="tomas.aragon@sfdph.org"/>	
* Signature of Authorized Representative:	<input type="text" value="Completed by Grants.gov upon submission."/>	* Date Signed: <input type="text" value="Completed by Grants.gov upon submission."/>

## Project Abstract Summary

**Program Announcement (CFDA)**

93.738

**Program Announcement (Funding Opportunity Number)**

CDC-RFA-DP14-1419PPHF14

**Closing Date**

07/22/2014

**Applicant Name**

San Francisco Department of Public Health

**Length of Proposed Project**

3

**Application Control No.**

**Federal Share Requested (for each year)**

**Federal Share 1st Year**

\$ 799,159

**Federal Share 2nd Year**

\$ 799,159

**Federal Share 3rd Year**

\$ 799,159

**Federal Share 4th Year**

\$ 0

**Federal Share 5th Year**

\$ 0

**Non-Federal Share Requested (for each year)**

**Non-Federal Share 1st Year**

\$ 0

**Non-Federal Share 2nd Year**

\$ 0

**Non-Federal Share 3rd Year**

\$ 0

**Non-Federal Share 4th Year**

\$ 0

**Non-Federal Share 5th Year**

\$ 0

**Project Title**

Racial and Ethnic Approaches to Community Health - Heart Healthy SF



## Project Abstract Summary

### Project Summary

#### PROJECT ABSTRACT

San Francisco is known as a diverse and vibrant city with a population of more than 800,000, where African Americans and Latinos have contributed rich influence and cultural history. There are over 50,000 African Americans and 128,000 Latinos in San Francisco, and both groups have maintained strong positive influences through their values, cultures, spirituality, food, dance and music. They have also demonstrated strong multi-generational family ties and resiliency, which have held these groups together despite life challenges and discrimination. Through the REACH grant, the San Francisco Department of Public Health (SFPDH) will address health inequities in these two populations through a community-based approach, which aims to not only reduce cardiovascular disease but also enhance community engagement around chronic disease, improve social connectedness, and improve quality of life.

In San Francisco, our campaign will be called "Healthy Hearts SF: Million Hearts® Initiative Plus." Our proposed program will adapt and implement the national Million Hearts® Initiative in SF, focusing on Latinos and African Americans who have or are at risk for cardiovascular disease, particularly in census tracts where more than 30% of residents live below 200% of the Federal Poverty Level. Healthy Hearts SF will incorporate the addition of alcohol and diabetes to the campaign's focus in order to meet the health and cultural needs of San Francisco; we will focus on primary prevention and management of the ABCDS - Aspirin when appropriate / Alcohol moderation, Blood pressure control, Cholesterol management, Diabetes management, and Smoking cessation.

Healthy Hearts SF is built upon a specific framework designed to identify, improve, and link community prevention resources (CPRs) to patients' primary care medical homes (PCMHs). It does this through three major strategies: I) Identifying and ensuring the QUALITY of CPRs for patients from our PCMHs, II) Improving the ACCESS to CPRs and the FLOW of patients between CPRs and PCMHs, and III) Improving the QUALITY of referrals and PCMH processes to refer patients to CPRs.

Heart Healthy SF activities are designed to improve heart health and address the ABCDS in a variety of ways. Proposed activities include assessing the target population to determine the best systems of linkage to CPRs, hiring REACH Coordinators who will attend monthly quality improvement meetings at each PCMH, partnering with 211.org to improve the public database of CPRs, using Health IT to track patient engagement with CPRs and progress with ABCDS outcomes, offering tailored heart healthy activities (physical activity, nutrition, smoking cessation, etc.) by the community and for the community through REACH mini-grants, executing a communication plan to support these activities, and conducting ongoing evaluation and performance management to ensure high-impact of all Heart Healthy SF activities. These activities will improve the flow of patients between PCMHs and CPRs via quality linkages; increase access to environments that are tobacco-free, have healthy food and beverages, and/or have opportunities for physical activity; as well as creating positive changes in attitudes, beliefs, knowledge, awareness, and behavioral intentions for relevant strategies. These short-term outcomes will lead to reduced exposure to secondhand smoke, increased daily consumption of fruit, vegetables, and healthy beverages, improved social cohesion, and increased use of community-based resources related to better control of cardiovascular health.

Estimated number of people to be served as a result of the award of this grant.

30000

BUDGET INFORMATION - Non-Construction Programs

OMB Number: 4040-0006  
Expiration Date: 06/30/2014

SECTION A - BUDGET SUMMARY

Grant Program Function or Activity (a)	Catalog of Federal Domestic Assistance Number (b)	Estimated Unobligated Funds		New or Revised Budget		
		Federal (c)	Non-Federal (d)	Federal (e)	Non-Federal (f)	Total (g)
1. SF - Reach	93.738, 93.304	\$ 799,159.00	\$	\$	\$	\$ 799,159.00
2.						
3.						
4.						
5. Totals		\$ 799,159.00	\$	\$	\$	\$ 799,159.00

**SECTION B - BUDGET CATEGORIES**

6. Object Class Categories	GRANT PROGRAM, FUNCTION OR ACTIVITY				Total (5)
	(1)	(2)	(3)	(4)	
	SF - Reach				
a. Personnel	\$ 43,244.00	\$	\$	\$	\$ 43,244.00
b. Fringe Benefits	18,162.00				18,162.00
c. Travel	1,450.00				1,450.00
d. Equipment	0.00				
e. Supplies					
f. Contractual	695,465.00				695,465.00
g. Construction					
h. Other	30,446.00				30,446.00
i. Total Direct Charges (sum of 6a-6h)	788,767.00				\$ 788,767.00
j. Indirect Charges	10,392.00				\$ 10,392.00
k. TOTALS (sum of 6i and 6j)	\$ 799,159.00	\$	\$	\$	\$ 799,159.00
7. Program Income	\$	\$	\$	\$	\$

Page 7 of 29

Authorized for Local Reproduction

Standard Form 424A (Rev. 7-97)  
Prescribed by OMB (Circular A -102) Page 1A

SECTION C - NON-FEDERAL RESOURCES					
(a) Grant Program	(b) Applicant	(c) State	(d) Other Sources	(e) TOTALS	
8. <input style="width: 95%;" type="text"/>	\$ <input style="width: 95%;" type="text"/>	\$ <input style="width: 95%;" type="text"/>	\$ <input style="width: 95%;" type="text"/>	\$ <input style="width: 95%;" type="text"/>	
9. <input style="width: 95%;" type="text"/>	<input style="width: 95%;" type="text"/>	<input style="width: 95%;" type="text"/>	<input style="width: 95%;" type="text"/>	<input style="width: 95%;" type="text"/>	
10. <input style="width: 95%;" type="text"/>	<input style="width: 95%;" type="text"/>	<input style="width: 95%;" type="text"/>	<input style="width: 95%;" type="text"/>	<input style="width: 95%;" type="text"/>	
11. <input style="width: 95%;" type="text"/>	<input style="width: 95%;" type="text"/>	<input style="width: 95%;" type="text"/>	<input style="width: 95%;" type="text"/>	<input style="width: 95%;" type="text"/>	
<b>12. TOTAL (sum of lines 8-11)</b>	\$ <input style="width: 95%;" type="text"/>	\$ <input style="width: 95%;" type="text"/>	\$ <input style="width: 95%;" type="text"/>	\$ <input style="width: 95%;" type="text"/>	
SECTION D - FORECASTED CASH NEEDS					
	Total for 1st Year	1st Quarter	2nd Quarter	3rd Quarter	4th Quarter
13. Federal	\$ <input style="width: 95%;" type="text"/>	\$ <input style="width: 95%;" type="text"/>	\$ <input style="width: 95%;" type="text"/>	\$ <input style="width: 95%;" type="text"/>	\$ <input style="width: 95%;" type="text"/>
14. Non-Federal	\$ <input style="width: 95%;" type="text"/>	<input style="width: 95%;" type="text"/>	<input style="width: 95%;" type="text"/>	<input style="width: 95%;" type="text"/>	<input style="width: 95%;" type="text"/>
<b>15. TOTAL (sum of lines 13 and 14)</b>	\$ <input style="width: 95%;" type="text"/>	\$ <input style="width: 95%;" type="text"/>	\$ <input style="width: 95%;" type="text"/>	\$ <input style="width: 95%;" type="text"/>	\$ <input style="width: 95%;" type="text"/>
SECTION E - BUDGET ESTIMATES OF FEDERAL FUNDS NEEDED FOR BALANCE OF THE PROJECT					
(a) Grant Program	FUTURE FUNDING PERIODS (YEARS)				
	(b) First	(c) Second	(d) Third	(e) Fourth	
16. SF Reach	\$ 799,159.00	\$ 799,159.00	\$ 799,159.00	\$ <input style="width: 95%;" type="text"/>	
17. <input style="width: 95%;" type="text"/>	<input style="width: 95%;" type="text"/>	<input style="width: 95%;" type="text"/>	<input style="width: 95%;" type="text"/>	<input style="width: 95%;" type="text"/>	
18. <input style="width: 95%;" type="text"/>	<input style="width: 95%;" type="text"/>	<input style="width: 95%;" type="text"/>	<input style="width: 95%;" type="text"/>	<input style="width: 95%;" type="text"/>	
19. <input style="width: 95%;" type="text"/>	<input style="width: 95%;" type="text"/>	<input style="width: 95%;" type="text"/>	<input style="width: 95%;" type="text"/>	<input style="width: 95%;" type="text"/>	
<b>20. TOTAL (sum of lines 16 - 19)</b>	\$ 799,159.00	\$ 799,159.00	\$ 799,159.00	\$ <input style="width: 95%;" type="text"/>	
SECTION F - OTHER BUDGET INFORMATION					
21. Direct Charges: <input style="width: 95%;" type="text" value="788,768"/>		22. Indirect Charges: <input style="width: 95%;" type="text" value="10,392"/>			
23. Remarks: <input style="width: 95%;" type="text" value="24.03% of Total Salaries"/>					

CHECKLIST

Public Burden Statement:

Public reporting burden of this collection of information is estimated to average 4 hours per response, including the time for reviewing instructions, searching existing data sources, gathering and maintaining the data needed, and completing and reviewing the collection of information. An agency may not conduct or sponsor, and a person is not required to respond to a collection of information unless it displays a currently valid OMB control number. Send comments regarding this burden estimate or any other aspect of this collection of information, including suggestions for reducing this burden to CDC,

Clearance Officer, 1600 Clifton Road, MS D-24, Atlanta, GA 30333, ATTN: PRA (0920-0428). Do not send the completed form to this address.

NOTE TO APPLICANT:

This form must be completed and submitted with the original of your application. Be sure to complete both sides of this form. Check the appropriate boxes and provide the information requested. This form should be attached as the last page of the signed original of the application. This page is reserved for PHS staff use only.

Type of Application:  NEW  Noncompeting Continuation  Competing Continuation  Supplemental

PART A: The following checklist is provided to assure that proper signatures, assurances, and certifications have been submitted.

- 1. Proper Signature and Date [X] Included [ ] NOT Applicable
2. Proper Signature and Date on PHS-5161-1 "Certifications" page [X] Included [ ] NOT Applicable
3. Proper Signature and Date on appropriate "Assurances" page [X] Included [ ] NOT Applicable
4. If your organization currently has on file with DHHS the following assurances, please identify which have been filed by indicating the date of such filing on the line provided. (All four have been consolidated into a single form, HHS Form 690)
[ ] Civil Rights Assurance (45 CFR 80)
[ ] Assurance Concerning the Handicapped (45 CFR 84)
[ ] Assurance Concerning Sex Discrimination (45 CFR 86)
[ ] Assurance Concerning Age Discrimination (45 CFR 90 & 45 CFR 91)
5. Human Subjects Certification, when applicable (45 CFR 46) [ ] Included [X] NOT Applicable

PART B: This part is provided to assure that pertinent information has been addressed and included in the application.

- 1. Has a Public Health System Impact Statement for the proposed program/project been completed and distributed as required? [ ] YES [X] NOT Applicable
2. Has the appropriate box been checked on the SF-424 (FACE PAGE) regarding intergovernmental review under E.O. 12372 ? (45 CFR Part 100) [X] YES [ ] NOT Applicable
3. Has the entire proposed project period been identified on the SF-424? [X] YES [ ] NOT Applicable
4. Have biographical sketch(es) with job description(s) been attached, when required? [X] YES [ ] NOT Applicable
5. Has the "Budget Information" page, SF-424A (Non-Construction Programs) or SF-424C (Construction Programs), been completed and included? [X] YES [ ] NOT Applicable
6. Has the 12 month detailed budget been provided? [X] YES [ ] NOT Applicable
7. Has the budget for the entire proposed project period with sufficient detail been provided? [ ] YES [X] NOT Applicable
8. For a Supplemental application, does the detailed budget address only the additional funds requested? [ ] YES [X] NOT Applicable
9. For Competing Continuation and Supplemental applications, has a progress report been included? [ ] YES [X] NOT Applicable

PART C: In the spaces provided below, please provide the requested information.

Business Official to be notified if an award is to be made

Name: Prefix: [ ] \* First Name: Christine Middle Name: [ ]
\* Last Name: Siador Suffix: [ ]

Title: [ ]

Organization: [ ]

Address: \* Street 1: 101 Grove St, Rm408

Street 2: [ ]

\* City: San Francisco

\* State: CA: California Province: [ ]

\* Country: USA: UNITED STATES \* Zip / Postal Code: 94102

\* Telephone Number: 415-554-2832

E-mail Address: christine.siador@sfph.org

Fax Number: [ ]

APPLICANT ORGANIZATION'S 12-DIGIT DHHS EIN (if already assigned)

[ ] 94-6006417 [ ]

**PART C (Continued): In the spaces provided below, please provide the requested information.**

Program Director/Project Director/Principal Investigator designated to direct the proposed project

Name: Prefix: [ ] \* First Name: Tomas Middle Name: [ ]  
 \* Last Name: Aragon Suffix: [ ]  
 Title: [ ]  
 Organization: [ ]  
 Address: \* Street1: 101 Grove St, Rm308  
 Street2: [ ]  
 \* City: San Francisco  
 \* State: CA: California Province: [ ]  
 \* Country: USA: UNITED STATES \* Zip / Postal Code: 94102  
 \* Telephone Number: 415-787-2583  
 E-mail Address: tomas.aragon@sfdph.org  
 Fax Number: [ ]

SOCIAL SECURITY NUMBER [ ] HIGHEST DEGREE EARNED [ ]

**PART D: A private, nonprofit organization must include evidence of its nonprofit status with the application. Any of the following is acceptable evidence. Check the appropriate box or complete the "Previously Filed" section, whichever is applicable.**

- (a) A reference to the organization's listing in the Internal Revenue Service's (IRS) most recent list of tax-exempt organizations described in section 501(c)(3) of the IRS Code.
- (b) A copy of a currently valid Internal Revenue Service Tax exemption certificate.
- (c) A statement from a State taxing body, State Attorney General, or other appropriate State official certifying that the applicant organization has a nonprofit status and that none of the net earnings accrue to any private shareholders or individuals.
- (d) A certified copy of the organization's certificate of incorporation or similar document if it clearly establishes the nonprofit status of the organization.
- (e) Any of the above proof for a State or national parent organization, and a statement signed by the parent organization that the applicant organization is a local nonprofit affiliate.

If an applicant has evidence of current nonprofit status on file with an agency of PHS, it will not be necessary to file similar papers again, but the place and date of filing must be indicated.

Previously Filed with: \* (Agency) [ ] on \* (Date) [ ]

**INVENTIONS**

If this is an application for continued support, include: (1) the report of inventions conceived or reduced to practice required by the terms and conditions of the grant; or (2) a list of inventions already reported, or (3) a negative certification.

**EXECUTIVE ORDER 12372**

Effective September 30, 1983, Executive Order 12372 (Intergovernmental Review of Federal Programs) directed OMB to abolish OMB Circular A-95 and establish a new process for consulting with State and local elected officials on proposed Federal financial assistance. The Department of Health and Human Services implemented the Executive Order through regulations at 45 CFR Part 100 (Intergovernmental Review of Department of Health and Human Services Programs and Activities). The objectives of the Executive Order are to (1) increase State flexibility to design a consultation process and select the programs it wishes to review, (2) increase the ability of State and local elected officials to influence Federal decisions and (3) compel Federal officials to be responsive to State concerns, or explain the reasons.

The regulations at 45 CFR Part 100 were published in *Federal Register* on June 24, 1983, along with a notice identifying the

Department's programs that are subject to the provisions of Executive Order 12372. Information regarding PHS programs subject to Executive Order 12372 is also available from the appropriate awarding office.

States participating in this program establish State Single Points of Contact (SPOCs) to coordinate and manage the review and comment on proposed Federal financial assistance. Applicants should contact the Governor's office for information regarding the SPOC, programs selected for review, and the consultation (review) process designed by their State.

Applicants are to certify on the face page of the SF-424 (attached) whether the request is for a program covered under Executive Order, 12372 and, where appropriate, whether the State has been given an opportunity to comment.

**Table of Contents**  
**San Francisco Department of Public Health**  
**Population Health Division**  
**Racial and Ethnic Approaches to Community Health**  
**Heart Healthy SF**  
**FOA DP14-1419PPHF14**

**I. Project Narratives**

A. Background.....	1
B. Approach.....	2
i. Problem Statement.....	2
<i>Chronic Disease Burden in San Francisco</i> .....	2
ii. Purpose.....	3
iii. Outcomes.....	4
iv. Strategy and Activities.....	4
<i>Collaborations</i> .....	5
<i>Target Populating</i> .....	5
<i>Activities</i> .....	6
<i>Assessment</i> .....	6
<i>Team Based Care</i> .....	7
<i>Health Information Technologies</i> .....	8
<i>Communication and Community Engagement</i> .....	9
<i>Dissemination and Sustainability</i> .....	11
C. Applicant Evaluation and Performance Measurement Plan.....	11
i. Evaluation Methods.....	12
ii. Key Evaluation Questions.....	13
iii. Data Sources.....	13
D. Organizational Capacity of Applicants to Implement the Approach.....	13
i. Program Infrastructure and Organizational Capacity.....	15
ii. Fiscal Management.....	16
iii. Coalition.....	17
E. Community Action Plan.....	18

**II. Budget Narrative..... B-1**

**III. Appendices**

A. Demographic and Socioeconomic Characteristics of SF Residents and SF Census Tracts.....	A-1
B. Strategic Media for Use with Communication Plan.....	A-2
C. Key Resources for Communication Plan.....	A-3
D. Key Program Partners for Evaluation.....	A-4
E. Clinical Quality Measures for the ABCDS.....	A-5
F. Potential Data Sources for Evaluation.....	A-6
G. HEAL Zone Highlights.....	A-7
H. San Francisco Health Improvement Partnership.....	A-8
I. San Francisco Health Improvement Partnership Council Roles and Responsibilities.....	A-12

J. Narrative References.....	A-13
K. Organizational Charts .....	A-14
L. Staffing Plan .....	A-16
M. Resumes.....	A-20
N. Letters of Involvement.....	A-93
O. Letters of Support.....	A-99

Note: CDC Form 0.1113 Assurance of Compliance and the Indirect Cost Rate Agreement are not included in the Table of Contents but are included with the application.



## PROJECT NARRATIVE

### A. BACKGROUND

Heart disease and stroke are two of the leading causes of death in the US, with 1.5 million heart attacks and strokes occurring annually.<sup>1</sup> However, many of the risk factors for heart attack and stroke are preventable or can be managed with appropriate medical care, including identification and management of high blood pressure, high cholesterol, diabetes, obesity, and smoking.<sup>2</sup> These risk factors are far more prevalent among African Americans (AAs) and Latinos in the U.S., leading to significant health inequity for cardiovascular disease in these populations.<sup>3</sup>

In September of 2011, the Department of Health and Human Services launched the Million Hearts® Initiative, with the goal of preventing one million heart attacks and strokes in the U.S. by 2017. This national campaign focuses on evidence-based strategies to address the “ABCS” – Aspirin when appropriate, Blood pressure control, Cholesterol management, and Smoking cessation. Million Hearts® unites federal agencies, private-sector partners, local health departments, nonprofit organizations, and communities to fight heart attack and stroke through clinical and community prevention, including innovative team-based care and health information technology (IT).

San Francisco (SF) is known as a diverse and vibrant city with a population of more than 800,000, where African Americans and Latinos have contributed rich influence and cultural history. There are over 50,000 AAs and 128,000 Latinos in SF,<sup>4</sup> and both groups have maintained strong positive influences through their values, cultures, spirituality, food, dance and music. They have also demonstrated strong multi-generational family ties and resiliency, which have held these groups together despite life challenges and discrimination. Through the REACH grant, the SF Department of Public Health (SFDPH) will address health inequities in these two populations through a community-based approach, which aims to not only reduce cardiovascular disease but also enhance community engagement around chronic disease, improve social connectedness, and improve quality of life.

In SF, our campaign will be known as “Healthy Hearts SF: Million Hearts® Initiative Plus.” Healthy Hearts SF will incorporate the addition of alcohol and diabetes to the campaign’s focus in order to meet the health and cultural needs of San Francisco; we will focus on primary prevention and management of the ABCDS – Aspirin when appropriate / Alcohol moderation, Blood pressure control, Cholesterol management, Dibabetes management, and Smoking cessation. Our campaign framework is designed to identify, improve, and link community prevention resources (CPRs) to patients’ primary care medical homes (PCMHs).

By design, this community-based initiative connects with our healthcare-based Black/AA Health Initiative (BAAHI), which was launched by SFDPH leadership in April 2014. The Director of Health recognized that in order to effectively address and significantly impact the health inequities and disparities among AAs, a focused and deliberate process must be prioritized across the SFDPH, so that appropriate staffing and resources can be aligned with key strategic activities. The BAAHI has identified and convened meetings with an internal SFDPH “Think Tank”, comprised of 50+ representatives from every Branch within the SF Health Network and the Population Health Division. The BAAHI is a department-wide initiative that will provide recommendations for action to SFDPH leadership and the SF Health Commission to focus specifically on reducing the percentage of AAs with heart disease.

## B. APPROACH

### i. PROBLEM STATEMENT

The City and County of San Francisco is a densely populated urban area of 837,441 residents within 49 square miles.<sup>4</sup> There are marked income, social, and health disparities across the County. The higher-income workforce generally lives in the western half of the County; new immigrants, those working in low-income jobs, and most public housing units are in the eastern half. About 45% of residents speak a language other than English at home.<sup>4</sup>

Healthy Hearts SF will be implemented countywide; however, our efforts will be focused in the Census Tracts and surrounding areas where at least 30% of the population has an income below 200% of the Federal Poverty Level (FPL) and at least 25% of adults over 25 years of age do not have a high school education (see Figure 1). The income cutoff of 200% FPL was chosen as a better indicator of poverty and need in SF than 100% FPL due to the high cost of living resulting from, in part, high housing costs; 37.3% households spend more than 35% of their income on rent.<sup>5</sup> The Insight Center for Community Economic Development estimates that a family of two adults and two children would need to earn at least \$54,222 and as much as \$97,472 to be self-sufficient depending on the age of their children.<sup>6</sup> Furthermore, inclusion of those with an income under 200% FPL also aligns with local initiatives such as the Lifeline Transportation Program by Metropolitan Transportation Commission which uses a threshold of 200% FPL in defining their populations of concern.<sup>7</sup> Access to social programs such as the Supplemental Food Program for Women, Infants and Children (WIC) and free and reduced meals at school are also available to those earning up to 185% of the FPL.

The priority census tracts are contained within six contiguous areas. (A list of priority populations for Healthy Hearts SF and selected demographic data is provided in Appendix A). These priority populations represent 12% of the county's population but more than 30% of SF's African American and Latino populations. The median per capita income for 25/26 of the priority population census tracts ranges from \$10,796 to \$35,419, which is only 23% to 75% of SF's overall per capita income. In four of these census tracts, per capita income is below \$15,000. About 50% of this priority population does not speak English fluently.<sup>5</sup>

#### ***Chronic Disease Burden in San Francisco***

SF has stark health inequities in mortality rates by ethnicity. Disparity ratios for heart attack and stroke, calculated by dividing the highest race-specific age-adjusted death rate by the lowest, range from 1.3 to almost 4.9 among males and from 1.6 to 5.6 among women. Overall, AA men and women have the highest death rates in SF; death rates among AAs are about 2.5 times higher than rates among the ethnic groups with the lowest rates the same causes of death.<sup>8</sup>

Smoking is still too prevalent in SF, where approximately 14% of adults smoke. Prevalence is higher among AAs (21%) than other ethnic groups, and almost 20% of AAs who smoke report smoking indoors.<sup>9</sup> Smoking prevalence is also higher among the lowest-income adults in households earning less than 200% of the FPL.<sup>10</sup>

Figure 1. Map of priority census tracts for Healthy Hearts SF

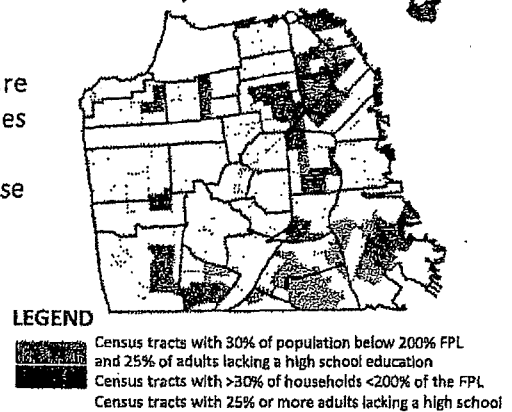

More than 20% of adults in SF have been diagnosed with high blood pressure at some point. This percentage is more than double among AAs. SF households with incomes under 200% of the FPL are more likely to have high blood pressure than those with higher income. High blood pressure prevalence is highest for AAs with incomes below 300% of the FPL.<sup>10</sup>

Population levels of obesity in SF are high among both youth and adults: 41.8% of adults and over 30% of youth are overweight or obese. There are also large inter-ethnic disparities in this burden. For example, AAs (33%) and Latinos (37%) are significantly more likely to be obese than whites (11%) and Asians (21%). Households earning less than the FPL are more likely to have obese members than those earning an income at least 200% of the FPL.<sup>9,10</sup>

Physical activity and healthy eating are powerful protective factors against obesity. Almost 40% of San Franciscans reported living a sedentary lifestyle. When including walking, only 23% of adults reported getting moderate physical activity for at least 30 minutes/day for 5 days/week. Only 18% of Latinos and 27% of AAs reported regular exercise. Households earning less than 300% of the FPL are less likely to get regular exercise than those who make more.<sup>9,11</sup> Fifty-two percent of Latino children ages 5-11 report no days of being physically active for a least one hour the week before being interviewed, compared to 14% of white children.<sup>9,10</sup>

Many San Franciscans regularly eat unhealthy food. Forty percent of San Franciscans eat fast food in a typical week, compared to 57% of AAs, 63% of Latinos and 50% of Asians. Only 41% of children and 24% of teens eat 5 or more servings of fruits and vegetables per day.<sup>10</sup>

The table below highlights some of the most relevant health inequities for AAs and Latinos in SF related to the focus of this proposed campaign.

<b>Stroke</b>
7% of AAs in SF report ever having a stroke compared to 1% of Latinos, 1% of Whites and 0.3% of Asians. <sup>10</sup>
1.8% of those living below 100% of the FPL have had a stroke. <sup>10</sup>
<b>Heart Disease</b>
More AAs (15%) in SF have been diagnosed with heart disease than Whites(7%), Asians (4%), and Latinos (2%). <sup>10</sup>
<b>Diabetes</b>
The prevalence of self-reported diabetes is higher among AAs (16%), Latinos (5%) and Asians (7%) than whites in SF (1%). <sup>10</sup>
More AAs (14%) report having pre-diabetes than Latinos (3%), Whites (4%) and Asians (11%). <sup>10</sup>
From 2007 to 2011 the rate of gestational diabetes increased for all San Franciscans; increases were greater among Latinas (5% to 8.2% of live births) and AAs (1.5% to 5.5% of live births). <sup>12</sup>

**ii. PURPOSE**

Our proposed program will adapt and implement the national Million Hearts® Initiative in SF, focusing on Latinos and African Americans who have or are at risk for cardiovascular disease, particularly in census tracts where more than 30% of residents live below 200% of the FPL. Healthy Hearts SF will expand upon the Million Hearts® Initiative to incorporate the addition of alcohol and diabetes to the campaign's focus in order to meet the health and cultural needs of San Francisco; we will focus on primary prevention and management of the ABCDS – Aspirin when appropriate / Alcohol moderation, Blood pressure control, Cholesterol management, Diabetes management, and Smoking cessation.

iii. OUTCOMES

The table below explains how our proposed activities will address each of the outcomes required by the FOA.

ACTIVITIES	OUTCOMES										
	Short-term*					Intermediate†					
	a	b	c	d	e	a	b	c	d	e	f
Assessment of target pop. to determine best system of linkage to CPRs											
Monthly quality improvement meetings at each PCMH											
Partnership with 211.org to improve CPR database											
Implementation of non-pharmaceutical prescription system											
Enhancement of EMR and tracking of patient engagement with CPRs and ABCDs outcomes using Health IT											
Tailored heart healthy activities (physical activity, nutrition, smoking cessation, etc.), by the community and for the community, funded through REACH mini-grants											
Execution of communication plan											
Ongoing evaluation and performance management											

\*Short-term outcomes per the REACH FOA:

- a) Increased access to smoke-free or tobacco-free environments
- b) Increased access to environments with healthy food or beverage options
- c) Increased access to physical activity opportunities
- d) Increased opportunities for chronic disease prevention, risk reduction or management through clinical and community linkages
- e) Positive changes in attitudes, beliefs, knowledge, awareness, and behavioral intentions for relevant strategies

†Intermediate outcomes per the REACH FOA:

- a) Reduced exposure to secondhand smoke
- b) Increased daily consumption of fruit
- c) Increased daily consumption of vegetables
- d) Increased consumption of healthy beverages
- e) Increased physical activity
- f) Increased use of community-based resources related to better control of chronic disease

iv. STRATEGY AND ACTIVITIES: This proposal is for a Comprehensive Implementation Award.

Healthy Hearts SF is built upon a specific framework designed to identify, improve, and link CPRs to patients' PCMHs. It does this through three major strategies:

- I. Identifying and ensuring the **QUALITY** of CPRs for patients from our PCMHs
- II. Improving the **ACCESS** to CPRs and the **FLOW** of patients between CPRs and PCMHs
- III. Improving the **QUALITY** of referrals and PCMH processes to refer patients to CPRs.

Figure 2 illustrates how these 3 strategies work in practice. In this illustration, SF Health Network patients that live in Community A seek medical care at PCMH 2 and 3. Looking at it another way, patients at PCMH 2 live in Communities A, B, C, and D. Given that SF patients do not have a linear relationship with PCMHs in their own communities, addressing the access and referral of patients between their PCMH and their CPRs is an essential part of supporting their health and wellness.

Figure 2.

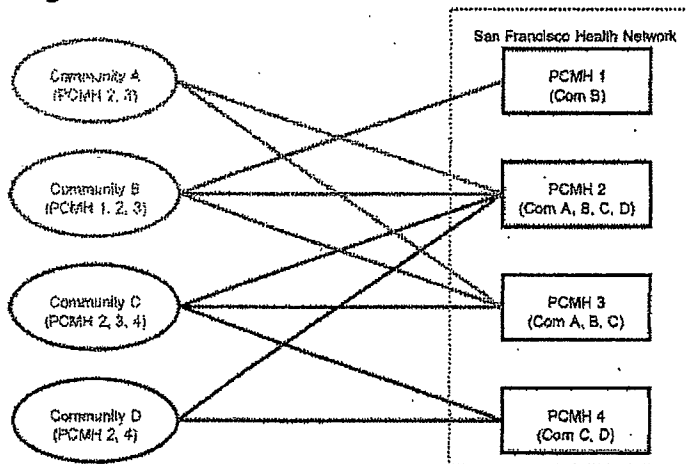

## 1. Collaborations

The Activities described in the remainder of this section and in the work plan will be accomplished through collaboration between the SFDPH and the SF Health Improvement Partnership (SFHIP). A Letter of Involvement from SFHIP members as well as a number of other community organizations and coalitions that will support the project is included in this grant package.

## 2. Target Population

San Francisco is a large city and urban county with a population of over 500,000. Our target population is Latino and AAs who currently have or are at high risk for cardiovascular disease (CVD), particularly those who reside in 26 census tracts where more than 30% of population has an income less than 200% FPL and 25% adults are without a high school education.

Given the scope of the REACH grant, we have decided to focus our clinic-based interventions on select PCMHs within the SF Health Network, with the ultimate goal of scaling our program citywide after opportunities for improvement have been addressed. The SF Health Network is comprised of PCMHs providing direct health services to thousands of insured and uninsured residents of SF, including those most socially and medically vulnerable. To determine the most appropriate PCMHs on which to focus, we conducted a systematic analysis of patient-level data at all SFDPH-run PCMHs throughout the city. Across all PCMHs, the greatest number of current smokers and people with high blood pressure (>140/90) were ages 45 – 64. Therefore, our interventions will be targeted toward AAs and Latinos in that age group. The majority of patients with diabetes, hypertension, high cholesterol, and/or active tobacco exposure seek care at the Southeast Health Center, as well as the Family Health Center and General Medicine Clinic at San Francisco General Hospital (SFGH). These PCMHs also see the highest percentage of AA and Latino patients across the SF Health Network.

Additionally, we analyzed the residential location of PCMH patients. Typically clinical teams have expertise in CPRs nearest to their PCMH, based on the assumption that patients seek medical care near to their home and would benefit from services in that same area. Rather than finding that patients were likely to access PCMHs based on their home location, however, we discovered that in fact, these four PCMHs routinely see patients from throughout the city – and that they are particularly concentrated in the same 26 priority census tracts discussed earlier. Figures 2-4 display maps pinpointing residential locations for each AA and Latino patients of the priority PCMHs (indicated by the black dots), overlaid on the priority census tract areas, identified in red, orange, and yellow.

Figure 2. Southeast Health Center



### LEGEND



-  Census tracts with 30% of population below 200% FPL and 25% of adults lacking a high school education
-  Census tracts with 30% or more of households under 200% of the FPL
-  Census tracts with 25% or more adults lacking a high school education

Figure 3. Family Health Center (SFGH)

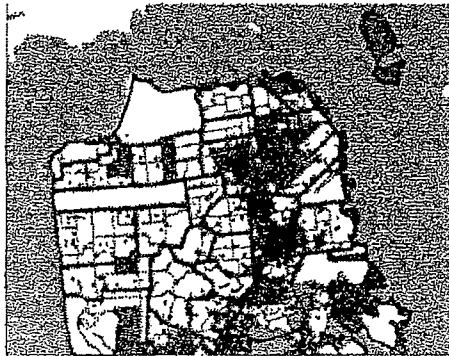
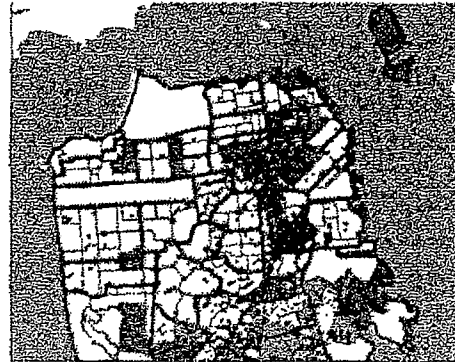





Figure 4. General Medicine Clinic (SFGH)



LEGEND

-  Census tracts with 30% of population below 200% FPL and 25% of adults lacking a high school education
-  Census tracts with 30% or more of households under 200% of the FPL
-  Census tracts with 25% or more adults lacking a high school education

### 3. Activities

To implement our strategies, we will conduct a number of specific activities. The first step will be to hire two full-time “REACH Coordinators”, and identify members of an integrated team at each participating PCMH, which will include key clinical team members the patients may interact with during their visit – i.e., medical providers, behaviorists (social workers who support patients in meeting needs and changing behaviors to support their health), community health workers, medical assistants, phlebotomists, social workers, and registration staff. These teams will work collaboratively and partner with SFDPH staff to execute the following activities:

#### ***Assessment of African American and Latino Patients with Cardiovascular Disease***

A critical lesson learned from the residential analysis by PMCH is that we cannot make assumptions about where people are most likely to seek services, and what services they may be interested in accessing. Simply placing a focus on providing community prevention resources (CPRs) nearby participating PCMHs may not be appropriate. Given this, we will spend much of the first 6 months of the REACH project period assessing priority patients – asking them where they would be most likely to participate in programs to improve their heart health, and what their barriers might be to accessing the CPRs. Would it be where they work? Where they play? Where their kids go to school? What would be critical features of the service? Once we have a better understanding of the geographic and programmatic needs of our priority patients, we will be in a greatly improved position to identify and support effective, culturally competent interventions.

With the input and support of the integrated PCMH teams, the REACH Coordinators will:

1. Recruit priority patients for focus groups and coordinate all of focus group logistics.
2. Assist in setting up the procedures for implementation of the PCMH-based surveys, including working with the PCMH staff to determine who will best implement the surveys.
3. Facilitate the Spanish translation of the assessment instrument with Spanish-speaking patients, coalition members, SFDPH staff, and other community partners.
4. Field test the assessment instrument for both AA and Latino patients, specifically testing literacy and cultural appropriateness as well as overall user friendliness.
5. Conduct the assessments simultaneously at each PCMH, and supervise data collection.

The form of the assessment—written survey, face-to-face interview, or other— will be determined through consultation with the integrated clinical teams and designed to suit the target population. REACH coordinators will collect, analyze and distribute the results of the assessment, which will be used to identify and ensure the QUALITY of CPRs, and better understand how best to successfully REFER patients from PCMHs to CPRs, per our project framework. The information will also be used to enhance the existing CPR database hosted by 211.org, a program of United Way of the Bay Area (see the next section for more information).

To supplement the findings of this assessment, staff epidemiologists from the Community Health Assessment and Impact (CHAI) Unit of SFDPH will conduct a thorough analysis of participating PCMH data, to examine which health conditions and behavioral risk factors most affect AA and Latino patients, including but not limited to the ABCDS. Results of this analysis will be shared with clinical leadership and REACH staff, and used by PCMH teams to improve care.

#### ***Using Team-Based Care to Boost Linkages and Address the ABCDS***

Once the assessment period is complete, the REACH coordinator role will transition to facilitating our team-based care strategy. Simply, the REACH coordinators will improve the FLOW of patients between CPRs and PCMHs; they will work with the PCMH-based integrated teams to improve QUALITY of referrals and PCMH processes to refer patients to CPRs for improved cardiovascular health (a continuous quality improvement process), per our project framework.

To do this, REACH Coordinators will attend existing monthly quality improvement meetings with key PCMH staff to share chronic disease data of their patients and provide them with updates about CPRs available to support their patients. Each PCMH will use time in these meetings to determine how they will incorporate referrals to new CPRs into their clinic flow.

In addition to the monthly quality improvement meetings, staff from the SFDPH Community Health Equity and Promotion (CHEP) Branch and the Office of Equity and Quality Improvement (OEQI) will support REACH Coordinators in working with PCMHs to identify and support improved QUALITY of PCMH processes to REFER patients to the rich network of CPRs available to promote health for San Franciscans at low to no cost to individuals. This integrated team will meet quarterly to discuss clinical guidelines, review practice-based evidence, and recognize best practices. At these meetings, clinical staff at each PCMH will be presented with feedback on continuous quality improvements to address the ABCDS among AA and Latino patients.

At the same time, REACH staff will work with at least 5 CPRs per year to support program participants without a PCMH to access health coverage options of the Affordable Care Act (ACA), through Covered California or with our local program, Healthy San Francisco. Having access to regular medical care through a PCMH is critical to successful management of chronic disease, including CVD. Yet many of the patients with highest need do not have health insurance and are not connected to regular medical care. To this end, REACH staff will work with CPRs to develop protocols for referral to ACA resources and tracking of linkage to health care access programs. With the support of SFHIP and the OEQI, REACH staff will develop and provide a tailored series of 3 trainings for CPR staff on ACA options and health care access opportunities, including barriers and supportive factors for accessing PCMHs in SF. They will meet with CPRs on a regular basis to discuss and adjust protocols as needed.

To support the identification and *active referral* of valuable CPRs that promote good cardiovascular health for AA and Latinos in SF, the REACH Coordinators will work closely with the

United Way of the Bay Area, which runs the website <http://211bayarea.org/find-help/>. This website features a CPR database to assist SF residents with food security, healthcare, housing, legal aid, senior services, and other supportive services at no cost. It is confidential and available in 150 languages, 24 hours a day, with the information also available via a phone call to 2-1-1. This information can be accessed by patients directly and also by healthcare providers while they are being seen at the PCMH. It can be searched by zip code, helping to find resources in close proximity to a patient's home, work, or the PCMH itself if desired. This 211.org data is also part of the *HealthyCity* lookup database, which provides data and mapping tools to help public health professionals and community members build a better community.<sup>13</sup> A part of this activity will involve REACH Coordinators partnering with 211.org staff (See Letter of Support) to update or complete missing resource information based on information received from AA or Latino patients or the PCMHs' integrated teams through this project, particularly for CPRs related to the ABCDS. REACH Coordinators will also regularly use the information found in 211.org to inform clinical teams about available resources in the monthly PCMH quality improvement meetings.

Finally, the REACH Coordinators will also work with each PCMH to implement a clinic-wide system to provide non-pharmaceutical prescriptions to further support their patients in reducing their risk for heart attack and stroke. This process would be tailored for each PCMH, but based on a model already piloted at Southeast Health Center, where a quality improvement team comprised of SFDPH managers and staff, community health workers, and clinicians provided physical activity prescriptions to AA patients diagnosed with hypertension, and referred those patients to the nearby YMCA to participate in free exercise classes. Patients were then tracked through follow up phone calls and clinic appointments to assess blood pressure outcomes. After just two months post-implementation, the pilot showed consistent physical activity participation among most participants. In addition, systems were created to establish a strong referral and feedback loop from PCMH to community site and back to the PCMH. We plan to build upon the successes and lessons learned from this pilot, to expand this strategy to all priority patients in our participating PCMHs (and ultimately to all SFDPH PCMHs citywide), aligning the non-pharmaceutical prescriptions with CPR agencies in each neighborhood.

#### ***Using Health Information Technology to Track Outcomes and Strategize Improvements***

After the initial 6-month assessment period is complete, we recognize that it is important to continue assessing the health conditions and behaviors of AA and Latino patients, including where they live, seek medical and psychosocial care, and engage in health-promoting activities. This information is useful not only to track project outcomes but also to improve and adjust our strategies and activities as needed to maximize health impact during the project period. Through the REACH grant, we plan to develop systems for using health information technology (IT) to conduct this ongoing assessment. Activities within this strategy include:

- A staff epidemiologist in the SFDPH CHAI Unit will work with the IT staff of the OEQI to routinely extract data from SFDPH PCMHs to assess where AAs and Latinos seek healthcare, and where those patients reside.
- The REACH Coordinators, 211.org staff, and the CHAI epidemiologist will work together to conduct a quarterly environmental scan using SFDPH PCMH and CPR data in the 211.org database, to identify what CPRs are available near the PCMH and where PCMH patients live. This information will be shared with providers in the monthly quality improvement meetings.



- The REACH Coordinators will work with key IT staff at the SFDPH and participating PCMHs to systematically identify patients who need support to improve their ABCDS, and track their progress over time. For example, using the electronic medical record system to flag patients with ABCDS needs at the time of the visit and remind the clinician to refer to appropriate CPRs will support clinical teams in effectively linking patients to heart healthy CPRs.
- With the support of the REACH Coordinators, PCMH integrated teams, SFDPH OEQI, and SFHIP, the CHAI epidemiologist will use and develop IT systems within SFDPH to track patients' engagement with clinical services and CPRs, and will provide an ongoing status report each quarter for key project and PCMH staff.

### ***Communications and Community Engagement***

We are especially excited about our final strategy: the REACH Coordinators will coordinate provision of tailored CPRs for the AA and Latino communities. These will have a focus on physical activity, healthy eating and smoking cessation, as well as social cohesion. This will be accomplished by the REACH Coordinators working with SFHIP to execute a Request for Applications (RFA) process for community-based organizations to address the ABCDs in their community through mini-grants to conduct activities in support of the Million Hearts® Initiative. Almost 20% of the Healthy Heart SF budget will be distributed through the mini-grants process, which will be conducted annually. Ideas for activities to be funded by mini-grants will come from the community. However, some examples of activities we anticipate may be proposed are: "Wear Red Day," creating awareness and dialogue throughout the community about heart disease and high blood pressure; "a multi-generational "Dance a thon" event to inspire physical activity; and a "Cultural Food Cook Off," with healthy food options. We will leverage the expertise of the SFDPH Tobacco Free Project, Shape Up San Francisco, and other community organizations and coalitions to provide technical assistance on these programs, though the main point of this strategy is to promote community engagement and social cohesion through supporting heart-healthy activities by the community, for the community.

The SFDPH has a long history of mini-grant programs in the community, with established processes to ensure that community-based organizations have the necessary infrastructure and support to implement the programming and administrative requirements. To ensure that nonprofits of all sizes can apply, the RFA is a straightforward process; the RFA is distributed to existing CBOs, announced on local and neighborhood listservs, and distributed through City partner agencies. SFDPH staff conduct a technical review to ensure submissions meet criteria, then guide a diverse review panel comprised of residents and content experts to review and score mini-grant proposals. Once agencies are selected, SFDPH staff provides programmatic and fiscal technical assistance to ensure grantees succeed in conducting proposed activities.

Integrated with the programs resulting from the mini-grants will be a citywide communication strategy to engage AAs and Latinos who have or are at high risk for CVD and encourage widespread, equitable utilization of community activities to encourage heart health. This plan is intended to support the mini-grant recipients and encourage success of their planned activities. The communication plan will be designed and implemented by the Media Broker/PR Firm, in partnership with a Communication Advisory Board comprised of members of the target population, award recipient staff, SFHIP coalition members, and the SFDPH Communications Director. The following table outlines the details of the plan.

**Key strategies and components of the Healthy Hearts SF communication plan:**

Strategies
1. Build AA and Latino community engagement and ownership of Million Hearts® Initiative activities, using culturally competent, clear communication approaches to overcome barriers to health literacy about prevention of heart attack and stroke and to empower individuals to act as heart health-promoting communicators to their loved ones
2. Support Million Hearts® Initiative efforts and sustainability by capturing successes in a storytelling format to increase awareness in key audience, strengthen coalitions, create and sustain partnerships, and to educate and advocate with funders and policymakers
3. Promote the Healthy Hearts SF kick-off event in February 2015. This event will be developed in collaboration with the BAAHI team and a PR firm hired to coordinate event advertising
4. Convey unified, accurate and time-sensitive key messages to key audiences (see below)
5. Link abstract heart health concepts to action steps and specific CPRs
6. Monitor, track and report bi-annually on all communication activities and effectiveness
Key Messages
1. Heart attack and stroke are two of the leading causes of death and disability in SF's AA and Latino populations.
2. Scientific evidence shows that heart attacks and strokes <i>can be prevented</i> .
3. Healthy Hearts SF exists to create equal opportunity for and empowerment of SF AAs and Latinos to have access and to utilize " <i>healthy choices for healthy hearts.</i> "
Components
1. Conduct gender-specific focus group-based formative research with AAs and Latinos to measure attitude, awareness and health beliefs, as well as to assess health literacy abilities
2. Using the formative research findings: <ul style="list-style-type: none"> <li>a. Prepare and field test Healthy Hearts SF and Million Hearts® Initiative branding, key messages, plain language presentations and talking points for campaign spokespersons to brief AA and Latino community leaders and decision makers,</li> <li>b. Plan content and design of strategic and integrated paid, earned and partner media over the project period to communicate Healthy Hearts SF and Million Hearts® Initiative objectives, activities and successes to key audiences, and</li> <li>c. Prepare Healthy Hearts SF written materials with plain language and low-literate elements to make health information easier to understand and ensure culturally competent communication strategies.</li> </ul>
2. Track and evaluate communication effectiveness bi-annually, and use findings for quality improvement of communication products
4. Report all paid, earned and partner media and communication activities twice yearly and complete online submittal of at least two success stories per year over the course of the project period. Success stories will also be highlighted in the quarterly reports as well as in meetings with clinical teams, coalition members and community partners; during quarterly presentations at brown bags lunch sessions; and through conference presentations.

Appendix B provides detail of the strategic media to be used in the communications plan, and Appendix C identifies resources for key message and material development.

### ***Dissemination and Sustainability***

We believe strongly in the importance of disseminating findings about best practices and impact of activities developed as a result of Healthy Hearts SF. To disseminate information about the outcomes of the REACH grant, we will:

- Present updates at least annually at SF Health Network meetings (meetings of all SFDPH PCMHs), SFHIP meetings, SFDPH Leadership meetings, and meetings of the SF BAAHI, as well as semi-annually at integrated team meetings at each participating PCMH
- Display visuals (e.g. a thermometer with a goal at the top) in various clinical and community locations that are most frequented by AAs and Latinos, such as Southeast Health Center, Family Health Center, Instituto de la Raza, and Bayview YMCA, of a) the number of patients participating in CPRs, and b) percent improvement in ABCDS for AA and Latino patients
- Share key project updates on SFDPH Monthly “Fast Facts” web-based announcements
- Present findings quarterly through the Public Health Division “Brown Bag Workshop Series”
- Identify two community-based locations frequented by the target population and engage community partners to present project findings/updates in non-scientific, simple language
- Write up the findings and submit abstracts for presentation at professional health conferences and articles to be published in high-impact peer-reviewed journals

We also recognize that the momentum built by the REACH grant will be valuable and it is critical to have a plan to sustain successful activities well after funding has ended. SFDPH leadership is committed to using REACH funding as a seed for expansion of the pilot project throughout the SF Health Network. During the project period, external funding will be sought to support the hiring of additional REACH Coordinators, who will be assigned to clinics not participating in the original REACH pilot and will oversee the expansion into those new locations, tailoring activities culturally and linguistically for each neighborhood and patient population they serve. REACH project staff duties will be eventually absorbed into the tasks performed by existing SFDPH behaviorists and community health workers. We expect a smooth transition, since they will be part of the team-based approach of the Healthy Hearts SF project.

### **C. APPLICANT EVALUATION AND PERFORMANCE MEASUREMENT PLAN**

In collaboration with program partners, REACH Coordinators and staff of the SFDPH CHEP Branch, SFDPH staff epidemiologists and the OEQI will plan and conduct the evaluation and performance management plans for Healthy Hearts SF. The CDC’s Framework for Program Evaluation in Public Health<sup>14</sup> – Engage stakeholders, describe the program, focus the evaluation design, gather credible evidence, justify conclusions, and ensure use and share lessons learned – will be employed to organize the evaluation process. The first step in our process will be the assembly of work groups comprised of key program partners who will play a role in activities for Healthy Hearts SF, including identification of appropriate indicators, development of data collection tools, as well as data collection and analysis. Following initial planning sessions, REACH Coordinators will lead monthly meetings for the duration of the grant. Appendix D lists key program partners for evaluation planning and implementation.

Healthy Hearts SF performance monitoring and evaluation will include both process and outcome components. Process monitoring will be focused on improving the quality, effectiveness, reach, and efficiency of program activities and will generally be used to

determine: (1) if the program is being implemented as intended and reaching the target populations (and adjusted to overcome barriers over their course), (2) what aspects of each program are working and for whom, and (3) delivery of short term objectives. Outcome evaluation will be informed by community partner data generated by Healthy Hearts SF and clinical measures designed to align with the Million Hearts® Clinical Quality Measures. All findings will be disseminated quarterly to all REACH community and clinical partners via email and changes made as needed to the process.

Specific measures will be developed for each Healthy Hearts SF activity based on resources, activities, outputs and outcomes identified in the activities' logic models, which will be required by the mini-grants RFA. Performance indicators may include meeting attendance logs and notes, and quantitative elements such as the percentage of patients with CVD receiving a non-pharmaceutical prescription, and of those, the percentage who reported actually participating in a heart healthy activity.

### ***Evaluation Methods***

Needs Assessment and Gap Analysis: Within six months of project start, a needs assessment will be completed identifying the patients' wants and needs near their PCMH or where they live, and any assets or barriers to participation in quality physical activity and nutrition opportunities. The needs assessment will also include questions on frequency and type of health behaviors, such as physical activity and nutrition, which are associated with cardiovascular health. This self-reported data will be used to define the baseline health behaviors of our target population. REACH Coordinators will collaborate with PCMH partners to identify patients for participation in the needs assessment as well as the methods for dissemination/participation and distribution of incentives (all patients who participate in the survey will receive a giftcard or other incentive for their time). To complement the needs assessment and further enhance the 211.org CPR database, a gap analysis will be completed by the REACH Coordinators in cooperation with project partners. The gap analysis will review the overall availability of services in regards to needs identified in the needs assessment and evaluate the quality of those services. The findings will be used to support the development of appropriate services by community partners.

Ongoing Assessment of ABCDS: Ongoing assessment of the gaps in availability, access to heart health activities, and the cultural and linguistic proficiency of materials and resources will occur through focus groups. Separate groups each including 8 to 10 participants will be formed for men and women and African Americans and Latinos (total 4 groups). Each focus group will be held at 6 month intervals for the first year and a half and annually thereafter.

Non-Pharmaceutical Prescription Issuance and Use and Clinical Outcomes: Through partnership with the SF Health Network, we will have the ability to routinely track the health outcomes of target population patients. REACH coordinators, with input from SFDPH epidemiologists, will work with the participating PCMHs to develop plans and protocols for the collection and analysis of clinical measures related to the REACH objectives. Clinical data will be collected at baseline and every six months thereafter. Tools will also be developed to track frequency of planned and actual appointment attendance. Clinical measures will be aligned with the Million Hearts Clinical Quality Measures (see Appendix E) for Aspirin use among those with Ischemic Vascular Disease, Blood pressure Screening and control, Cholesterol screening

and control, and Smoking cessation and be enhanced with the addition of Alcohol and Diabetes to address the health and cultural needs of the local jurisdiction. Non-clinical setting methods of obtaining biometric data and supporting self-measured blood pressure monitoring, such as placing blood pressure machines in public locations will also be considered.

Community Engagement Activity (Mini-Grant) Participation Tracking: In collaboration with coalition members and CPR partners, REACH Coordinators will develop methods to monitor programmatic data which indicates in which heart healthy activities AAs and Latinos participate. Particular attention will be paid to community members who participated as a result of one or more elements of the Heart Healthy SF communication plan. Options to track participation may include registration forms, health passport books, collection of non-pharmaceutical prescription referrals and follow-throughs, and barcode scanning. Association between clinical outcomes and participation in heart healthy activities will be assessed by SFDPH epidemiologists in coordination with the integrated clinical teams and the SF Health Network, for SFDPH Network Patients. However, these community level projects are not limited to our PCMH patients, because we want to improve the health of the community as a whole. For non-SFDPH Network patients, only measures of participation will be collected.

#### ***Key Evaluation Questions***

Key evaluation questions to be answered by the Healthy Hearts Evaluation will be refined through collaboration with SFHIP. Key questions may focus on the following:

- Is the program being implemented as intended?
- What are the assets and barriers to participation in heart healthy activities for our patients?
- How can this work be sustained (policy change, capacity of partners)?
- What is the baseline ABCDS health status of the AA and Latino patients with cardiovascular disease at participating PCMHs and how does it change throughout the project?
- What CPRs (e.g. exercise classes, smoking cessation) do our patients use and how frequently?
- How many CPRs are available, what proportion of services are culturally and linguistically appropriate, and how does this change over time?
- What is the participation by African American and Latino patients and other community members in programs supported by REACH-funded mini-grants?

#### ***Data Sources***

The performance management and evaluation team will collect organizational-level information from quarterly project reports, tracking forms used by key community partners, surveys with stakeholders (including on-site implementation staff), and data generated by the Healthy Hearts SF evaluation. There are a series of possible data sources for the evaluation, and details of those sources as well as the feasibility of collecting each are listed in Appendix F.

#### **D. ORGANIZATIONAL CAPACITY OF APPLICANT TO IMPLEMENT THE APPROACH**

The applicant and lead agency for the project is the SFDPH, the sole health department in San Francisco – the only consolidated city and county in the state of California. SFDPH is recognized as a public health leader with a track record of success in implementing innovative, effective, evidence-based strategies and enacting policies to build healthy, safe and equitable communities.

SFDPH has an extensive track record of developing and implementing policy, environmental, programmatic and infrastructure initiatives to promote health and prevent disease and reduce health inequities, including the ones detailed below:

Childhood Asthma: SFDPH has worked with the SF Asthma Task Force and Community Action to Fight Asthma to implement structural changes to reduce rates of asthma in SF over the last decade. Strategies include making school improvements using the EPA Tools for School Indoor Air Quality Program; screening out asthma-causing and asthma-exacerbating janitorial products purchased by the City and the SF Unified School District; building capacity of the SF Housing Authority, Department of Building Inspection, and Mayor's Office of Housing to use thermographic cameras to detect mold and moisture problems; and raising community awareness through television and internet video messaging. SFDPH has also administered six projects funded through SF Ordinance No. 217-11, appropriating \$1,000,000 of Mirant Potrero LLC Settlement Funds for neighborhood improvement and mitigation in the neighborhoods most impacted by the Potrero Power Plant. Projects funded with this money include Asthma & Preventive Developmental Health Education and an Asthma Case Management and Education Program at SF General Hospital's Pediatric Asthma Clinic. These projects have led to an increase in over 477 lung health appointments for low-income residents with asthma by April 2014.

Healthy Eating and Active Living: The Bayview Hunters Point neighborhood was funded by Kaiser Permanente as a HEAL Zone in 2004. HEAL stands for "Healthy Eating Active Living," and the Bayview HEAL Zone promotes healthy eating and active living by focusing on a) Lowering calorie consumption, b) increasing fresh fruit and vegetable consumption, c) increasing physical activity in community settings such as parks and safe routes for walking and biking, and d) increasing physical activity in institutional settings such as schools and work sites. (See Appendix G for more on the Bayview HEAL Zone, including outcomes achieved). In addition to the HEAL Zone program, the SFDPH Nutrition Education and Obesity Prevention Branch has funded the *Feeling Good Project* for more than a decade. The Feeling Good Project develops and provides nutrition education materials and classes in English, Spanish, and Chinese, and supports local cultural and community events that promote healthy eating and physical activity. Feeling Good staff also collaborate with SNAP-Ed-funded local implementing agencies to improve fruit and vegetable intake, physical activity, and food security for SF residents who receive CalFresh (EBT). Through Shape Up SF, SFDPH also runs the Southeast Food Access Coalition (SEFA), a collaborative of residents, community based organizations, city agencies, and others working to achieve a vibrant and robust food system for all residents of the Bayview Hunters Point neighborhood.<sup>15</sup> SEFA's Food Guardian program is a group of Bayview Hunters Point residents trained to educate, advocate, and mobilize to promote nutrition education and awareness, support urban agriculture, and address community food security and justice. And finally, from 2013 to 2014, the SFDPH Quality and Leadership Academy piloted a program with Southeast Health Center to reduce systolic blood pressure among AA patients with hypertension by an average of 3mm Hg by program end. This program worked to routinely refer AA patients to YMCA physical activity or nutrition classes, and as of April 2014 the average number of patients referred to these programs had jumped from 22/month to 52/month.

Violence Prevention: From 2000-2003, SFDPH staff worked in collaboration with members of the AA and Latino communities in SF to create a Violence Prevention Plan, which grew into the 501(c)3 agency now known as *Peace It Together*. Peace It Together offers affordable individual

counseling services to children, teens, and adults and provides community outreach programs to prevent violence. SFDPH has also been funded by the Substance Abuse and Mental Health Services Administration to implement YouthPOWER in the Bayview and Mission neighborhoods, providing mini-grants to community groups to conduct Community Action Teams to prevent violence – much in the same way the Healthy Hearts SF mini-grants will function.

Tobacco Use: SFDPH's Tobacco Free Project partnered with the SF Health Network to establish a system to assess tobacco use among PCMH patients, document the assessment in the system, and provide a referral if indicated through the electronic referral system. For patients participating in cessation classes at SFGH, the results of their participation are fed back to the clinical teams through the electronic system. That system and the process used to set it up to meet needs of the clinical team is a key foundational piece for the tracking and referral loop of REACH, and will be used as a model for programs of Healthy Hearts SF.

#### ***Program Infrastructure and Organizational Capacity***

Healthy Hearts SF will be led by Tomás Aragón, MD, DrPH. Dr Aragón is the Health Officer of the City and County of San Francisco, and the Director of the Population Health Division (PHD) of SFDPH. As Health Officer, he exercises leadership and legal authority to protect and promote health; as PHD Director he directs public health services (environmental health, community health promotion, disease prevention and control, and epidemiology, surveillance, and research). Dr. Aragón will be responsible for overall planning, implementation, monitoring, and reporting of the program. Dr. Aragón is trained in primary care Internal medicine (MD), epidemiology (DrPH), and research (UCSF fellowship). He teaches epidemiology at the UC Berkeley School of Public Health where he also directed a CDC public health research and training center for 10 years. He was Principal Investigator of San Francisco's Community Transformation Grant, and has extensive experience leading CDC program and research grants.

Dr. Aragón will be supported by Jacqueline McCright, MPH, who will serve as the Program Manager at .20 FTE. Ms. McCright is highly knowledgeable and experienced in Community-Based Participatory Approaches (CBPA), with 10+ years of experience conducting CBPA, focus groups and community needs assessments with AA and Latino populations of all ages. She most recently was part of the SFDPH Quality Improvement Academy Team that was developed and implemented the pilot AA Hypertension Project that provided non-pharmaceutical prescriptions for physical activity to reduce patients' blood pressure. Ms. McCright will be responsible for supervising and training and Project Coordinator and the REACH Coordinators; for monitoring all short-term outcomes with the support of other project staff, and maintaining smooth implementation of all project strategies. She will also be responsible for tracking and reporting all activities to CDC annually, under the supervision of Dr. Aragón.

Both Dr. Aragón and Ms. McCright will be supported by a .25 FTE Program Assistant that will provide overall administrative support to the project including scheduling meetings; answering calls from community partners, media, and providers; and materials distribution. There will also be a 1.0 FTE Project Coordinator, who will be responsible for the day-to-day activities of the grant. S/he will work with the Principal Investigator and Program Manager to develop the project charter, including the roles and responsibilities chart, identification of key stakeholders, programmatic administration and monitoring of the mini-grants including management the RFA

process and providing technical assistance to those who receive mini-grants. The Project Coordinator will be the main point of contact for all communication and evaluation activities.

Evaluation for Healthy Hearts SF will be headed by Michelle Kirian, MPH, REHS, an epidemiologist with nine years of experience in design and implementation of data collection and analysis. Ms. Kirian will be responsible for revising the original evaluation plan and sending it to CDC for review and approval within 30 days after the CAP is finalized with CDC. 18% of the annual project budget is allocated for evaluation.

Communication activities (See *Communications* in Section iv.3), will be overseen by Karen Cohn. Ms. Cohn has over 10+ years of experience in developing, implementing and evaluating communication plans for the SF Lead Prevention Program, and will provide technical assistance to the Media Broker/PR Firm and REACH team to support the planning, implementing, and evaluating communication activities, with the support of Ms. Kirian for evaluation. Over 15% of the annual project budget is allocated for strategic and integrated media and communication activities to help advance our program efforts.

SFDPH staff key to Healthy Hearts SF already have extensive, productive relationships with partners in SFHIP and the other coalitions that will collaborate on these activities. Coalition partners have been actively involved in the development of this proposal (including the development of the strategies and activities of the CAP) through in-person meetings, conference calls, and collaborative document sharing; these currently successful strategies will continue in order to facilitate the active participation of all partners in the implementation and evaluation of CAP strategies and activities through the three year REACH funding period.

Resumes of key coalition members and organizational staff, an organizational chart for the SFDPH, and a staffing plan that describes position titles, lines of supervision, and roles and responsibilities of all program staff are available as attachments to this application package.

Together, members of Healthy Hearts SF will work to develop a draft sustainability plan by year 2 of the award. The plan will be developed with SFHIP, and will include how accomplishments will be maintained and future improvements will be made. It may also include funding from other sources, such as other government, foundations, and the private sector.

### ***Fiscal Management***

SFDPH has extensive experience managing large government grants in the areas of health services, prevention, and transportation. Responsibility for fiscal monitoring and oversight of government grants lies with a six member team based in the SFDPH Grants Unit and led by the Accounting Manager. The Accounting Manager is supported by five Senior Systems accountants, each of whom supervises numerous accounting staff and oversees a range of program related grants and contracts. The Grant Unit's specific duties include analyzing and implementing grant accounting policies and procedures; supervising and directing grant staff; monitoring grant budget, revenue and expenditure accounts, preparing complex financial reports; and performing timely reconciliation of grant revenues, expenditures, and general ledger and other supporting documentation. The Accounting Manager establishes, evaluates and reviews fiscal procedures to ensure internal control and compliance with federal, state and local requirements and oversees and manages fiscal audits of Federal, State and private grants.

As stated in the *Activities* section of this grant, a major part of the Healthy Hearts SF strategy includes the provision of \$150,000 worth of mini-grants to local entities or coalitions



who propose activities that will positively contribute to the goals and objectives of Healthy Hearts SF and the Million Hearts® Initiative. Recipients will be required by SFDPH to work closely with the Grant Unit to be sure they track and report expenditures in accordance with CDC Procurement and Grants Office federal guidelines and procedures.

### **Coalition**

SF has been a home to many successful collaborative efforts designed to improve community health and wellness. However, these efforts have largely functioned independently of one another, resulting in missed opportunities for alignment and maximum impact. The SF Health Improvement Partnership (SFHIP) is a cross sector collaboration designed to improve the health and wellness of all San Franciscans by minimizing disconnected efforts. SFHIP combines the efforts of three successful community health improvement collaborators into one aligned framework: 1) SF's non-profit hospitals; 2) the Clinical and Translational Science Institute at UCSF, which supported the first phase of SFHIP; and 3) the SFDPH's process for community health improvement. SFHIP's current formal structure is designed to ensure better coordination, accountability, community engagement, and improved community health and wellness:

- The **Vision Council** provides governance and vision to SFHIP;
- The **Steering Committee** oversees SFHIP strategy;
- **Work Groups** are open, participatory, action-oriented bodies that focus on specific health issues or programs related to San Francisco's Identified health priorities; and
- **Partners** are those who will actively align with and participate in the collaboration.

An information sheet about SFHIP as well as a current membership list as evidence of the wide representation of members is available in Appendix H. Evidence that the coalition has been in existence for 2 or more years is available in Appendix I.

Throughout the 3 years of Healthy Hearts SF, SFHIP will (1) serve as our advisory committee, (2) guide and promote the community mini-grant program, and (3) promote citywide expansion of Healthy Hearts SF. As can be seen in Appendix H, SFHIP members have already been working in partnership with the priority populations addressed through this proposal. Each of the organizations represented within SFHIP have many years of experience working with the Black/AA and Latino communities of SF, particularly in the priority census tracts identified in this proposal. SFHIP also brings representation from other coalitions such as the AA Community Health Equity Council and Chicano/Latino/Indígena Health Equity Coalition.

One of the key accomplishments in mobilizing partners to implement local policy, strategy, and environmental change improvements that address the priority areas of the REACH grant is the SFHIP-driven community health assessment (CHA) and Community Health Improvement Plan (CHIP). SFHIP partners engaged in a 14-month CHA process between July 2011 and August 2012. Through the CHA, SFHIP and SFDPH and its partners strove to foster a community-driven and transparent assessment aligned with community values.

The core method for our community based participatory approach was conducted by using a method called the Technology of Participation.<sup>16</sup> The Technology of Participation facilitation methods are practical tools that enable groups to have highly energized, productive, inclusive and meaningful participation. This kind of participation leads to follow-through and quality outcomes, as well as more effective team work. These methods are ideal for engaging teams, organizations and communities to identify, clarify, plan for and implement change.

Print Form

# Introduction Form

By a Member of the Board of Supervisors or the Mayor

Time stamp  
or meeting date

I hereby submit the following item for introduction (select only one):

- 1. For reference to Committee. (An Ordinance, Resolution, Motion, or Charter Amendment)
- 2. Request for next printed agenda Without Reference to Committee.
- 3. Request for hearing on a subject matter at Committee.
- 4. Request for letter beginning "Supervisor [ ] inquires"
- 5. City Attorney request.
- 6. Call File No. [ ] from Committee.
- 7. Budget Analyst request (attach written motion).
- 8. Substitute Legislation File No. [ ]
- 9. Reactivate File No. [ ]
- 10. Question(s) submitted for Mayoral Appearance before the BOS on [ ]

Please check the appropriate boxes. The proposed legislation should be forwarded to the following:

- Small Business Commission       Youth Commission       Ethics Commission
- Planning Commission       Building Inspection Commission

**Note: For the Imperative Agenda (a resolution not on the printed agenda), use a Imperative Form.**

**Sponsor(s):**

Cohen

**Subject:**

Accept and Expend Grant- Racial and Ethnic Approaches to Community Health

**The text is listed below or attached:**

Accept and Expend Grant- Racial and Ethnic Approaches to Community Health - Heart Healthy SF - \$799,159.00

Signature of Sponsoring Supervisor:

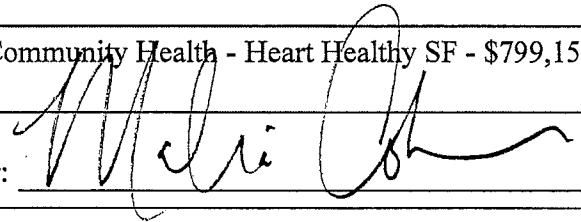

**For Clerk's Use Only:**