



April 17, 2017

Hon. London Breed
San Francisco Board of Supervisors
City Hall Room 244
1 Dr. Carlton B. Goodlett Place
San Francisco, CA 94102

Re: 2675 Folsom Street
File No. 161146 (CEQA Appeal)
Hearing Date: April 18, 2017

Dear President Breed and Supervisors,

On behalf of Axis Development Group (Axis), the Respondent in the 2675 Folsom Street CEQA Appeal (Board of Supervisors File No. 161146), attached please find supplemental information for inclusion in the Administrative Record. The attachment consists of a displacement study recently completed.

If you have any questions, please do not hesitate to contact me at (415) 273-9670.

Very truly yours,

A handwritten signature in blue ink that reads "Alexis M. Pelosi".

Alexis M. Pelosi

Developing a New Methodology for Analyzing Potential Displacement

University of California, Berkeley

Principal Investigator:

Karen Chapple

Co-Principal Investigators:

Paul Waddell

Daniel Chatman

With Miriam Zuk

University of California, Los Angeles

Principal Investigator:

Anastasia Loukaitou-Sideris

Co-Principal Investigator:

Paul Ong

With Silvia R. Gonzalez, Chhandara Pech, and Karolina Gorska

*Prepared for the California Air Resources Board and the California Environmental Protection Agency
By the University of California, Berkeley and the University of California, Los Angeles*

ARB Agreement No. 13-310

March 24, 2017

The statements and conclusions in this Report are those of the contractor and not necessarily those of the California Air Resources Board. The mention of commercial products, their source, or their use in connection with material reported herein is not to be construed as actual or implied endorsement of such products.

Acknowledgements

This Report was submitted in fulfillment of ARB Agreement No. 13-310 by the University of California, Berkeley under the partial sponsorship of the California Air Resources Board. Work was completed as of 10/9/15.

Chapter 2 and 5:

The UC-Berkeley team is grateful for the advice of its advisory committee at MTC/ABAG, including Vikrant Sood, Carlos Romero, Peter Cohen, Gen Fujioka, Wayne Chen, Bob Allen, Duane Bay, Jennifer Martinez, and Johnny Jaramillo. Our case study research (groundtruthing and policy) in East Palo Alto, Chinatown, Marin City, the Mission, and San Jose benefited deeply from the participation of local community groups, including San Francisco Organization Project/Peninsula Interfaith Action, Chinatown Community Development Center, Marin Grassroots, PODER, and Working Partnerships.

Chapter 3:

Development of UrbanSim has been previously supported by the National Science Foundation Grants CMS-9818378, EIA-0090832, EIA-0121326, IIS- 0534094, IIS-0705898, IIS-0964412, and IIS-0964302 and by grants from the U.S. Federal Highway Administration, U.S. Environmental Protection Agency, European Research Council, Maricopa Association of Governments, Puget Sound Regional Council, Oahu Metropolitan Planning Organization, Lane Council of Governments, Southeast Michigan Council of Governments, Metropolitan Transportation Commission and the contributions of many users. The application of UrbanSim to the San Francisco Bay Area was funded by the Metropolitan Transportation Commission (MTC).

The following persons participated in the development of the research to adapt UrbanSim to address displacement issues in its application to the San Francisco Bay Area:

Paul Waddell, City and Regional Planning, University of California Berkeley
Samuel Maurer, City and Regional Planning, University of California Berkeley
Samuel Blanchard, City and Regional Planning, University of California Berkeley

This project has been done in close collaboration with the staff of the Metropolitan Transportation Commission (MTC) and of the Association of Bay Area Governments (ABAG). In particular, we wish to acknowledge the leadership of Mike Reilly at MTC, with additional assistance from Aksel Olsen at ABAG. Many other staff at MTC and at ABAG have participated in the development of the data, the scenarios and the analysis described in this report.

Chapter 4:

Many thanks to those who provided assistance with NHTS and CHTS confidential data, and the remote system for using the CHTS, including Brennan Borlaug, Evan Burton, Jeff Gonder, Susan Liss, Jasmy Methipara, and Adella Santos. Thanks also to Karen Chapple for helpful comments that improved the paper, and for a large set of comments from numerous anonymous reviewers, organized by the California Air Resources Board.

Table of Contents

List of Tables.....	i
List of Figures.....	iii
Abstract.....	v
Executive Summary.....	vi
Introduction.....	1
Chapter 1: Literature Review of Gentrification, Displacement, and the Role of Public Investment.....	3
Chapter 2: Analysis of Historic Patterns of Neighborhood Change.....	45
Chapter 3: Developing Tools for Analyzing Potential Displacement Impacts in SCS.....	93
Chapter 4: Effects on Auto Use of Household Displacement from Rail Station Areas.....	156
Chapter 5: Anti-Displacement Policy Analysis.....	181
Conclusions.....	262
References.....	263
Appendices.....	285
Appendix A: Summary of Racial Transition and Succession Studies.....	285
Appendix B: Summary of the Impact of Rail Transit Facilities on Residential and Commercial Property Values.....	291
Appendix C: Summary of Studies on TOD and Gentrification.....	295
Appendix D: TOD Impacts in Los Angeles.....	297
Appendix E: Summary of Simulation Models of Gentrification.....	302
Appendix F: Census Tract Datasets.....	304
Appendix G: Parcel-Level Datasets.....	308
Appendix H: Data Cleaning Protocol for DataQuick Assessor and Transaction Data.....	314

Appendix I: Sources and Definitions of Affordable Housing Data for Section 2E.2.....	317
Appendix J: Ground-Truthing Methodology for the SF Bay Area..	318
Appendix K: Los Angeles Ground-Truthing Neighborhoods.....	333
Appendix L: Detailed Ground-Truthing Methodology for Los Angeles.....	336
Appendix M: Survey Instruments in Los Angeles.....	339
Appendix N: Interview Protocol for Los Angeles.....	348
Appendix O: Detailed Assessments for LA Ground-Truthing Case Studies.....	352
Appendix P: Bay Area UrbanSim Models as Used in Plan Bay Area.....	361
Appendix Q: SCAG PECAS Estimated Aggregated TOD Impacts.....	381
Appendix R: In- and Out-Migration Regression Results.....	389
Appendix S: Average Daily VMT by Income and Rail Access.....	391
Appendix T: Anti-Displacement Strategies and Sources.....	399
Appendix U: Policies adopted by each LA County City.....	401
Appendix V: Challenges Facing Inclusionary Zoning.....	402

List of Tables

Table 1.1 Indicators and Data Sources for Analyzing Gentrification and Displacement 36

Table 2A.1: Common Neighborhood-level Datasets Collected for Both Regions..... 49

Table 2A.2: Common Address-level Datasets Collected for Both Regions..... 49

Table 2C.1: Summary Statistics for Transit Station Types in the Bay Area (Means)..... 53

Table 2C.2: TOD Tracts, Gentrified With/Without Development for Los Angeles County 54

Table 2C.3: Summary Statistics for Transit Station Types in the Bay Area (Means)..... 55

Table 2C.4: TODs, Gentrification, and Residential Development for the 9-County Bay Area 56

Table 2D.1: In-Out Migration, Parsimonious Multivariate Regressions 61

Table 2D.2: Bivariate Analysis by Subgroups, LA County and the Bay Area, 2009-2013..... 62

Table 2D.3: Modeling Share of In-Movers by Subgroups, Multivariate Regressions for Los Angeles County, 2009-2013 63

Table 2D.4: Modeling Share of In-Movers by Subgroups, Multivariate Regressions for the Bay Area, 2009-2013 64

Table 2E.1: Gentrification Criteria for Los Angeles, County Averages 65

Table 2E.2: Gentrification Criteria, Medians for the Nine-County Bay Area..... 67

Table 2E.3: Logit Regressions of Gentrification, 1990-2000 and 2000-2013, Los Angeles 70

Table 2E.4: Logit Regressions of Gentrification, 1990-2000 and 2000-2013, Bay Area 71

Table 2E.5: Changes in Affordable Housing¹, Linear Regressions (Los Angeles), 72

Table 2E.6: Changes in Affordable Housing, Linear Regressions (Bay Area) 73

Table 2E.7: Evictions and Condominium Conversions, Linear Regressions, San Francisco..... 73

Table 2E.8: Change of Low-income Households, Linear Regressions (Bay Area) 75

Table 2F.1: Changes in Neighborhood Characteristics, LA County, 2000-2013*..... 76

Table 2F.2: Table 2F.2: Neighborhood Change Multivariate Regressions, LA County, 2000-2013*... 77

Table 2F.3: Changes in Neighborhood Characteristics, SF Bay Area, 2000-2013*..... 78

Table 2F.4: Neighborhood Change Multivariate Regressions, SF Bay Area, 2000-2013 79

Table 2G.1: Regression Results for Los Angeles 81

Table 2H.1: Comparisons of Secondary Data and Ground-truthing Data in Three Case Study Areas 84

Table 2H.2: Count of Parcels and Blocks Surveyed in Los Angeles..... 85

Table 2H.3: Comparison of Indicators of Neighborhood Change in Los Angeles Case Studies..... 87

Table 2H.4: Percent land use matched in Los Angeles Case Study Areas 88

Table 2H.5: Estimated Housing Units from Assessor and Census Data in Los Angeles Study..... 89

Table 2H.6: Percent of Major improvements for Observed and Assessor Parcels in Los Angeles Study Areas 89

Table 2H.7: Percent of Constructions for Observed and Assessor Parcels in Los Angeles Study 90

Table 3A.1: Key Features of UrbanSim..... 102

Table 3A.2: Specification of UrbanSim Model Components Using Parcel Data Structure..... 103

Table 3A.3: Data Inputs and Outputs of UrbanSim..... 106

Table 3A.4: Hedonic Regression Estimation Results for Rental Listings 110

Table 3A.5: Relocation Choice Model Estimation Results for Renters 113

Table 3A.6: Location Choice Model Estimation Results for Renters in Income Quartile 1 114

¹ We ran an analysis looking at the change in public housing units in TOD and non-TOD areas and found that changes in TOD areas are essentially the same as in non-TOD areas (the difference in proportion is not statistically different). From 2000 to 2013, non-TOD areas lost 5.8% of their public housing units, whereas non-TOD areas lost 6%.

Table 3A.7: Location Choice Model Estimation Results for Renters in Income Quartile 2	115
Table 3A.8: Location Choice Model Estimation Results for Renters in Income Quartile 3	115
Table 3A.9: Location Choice Model Estimation Results for Renters in Income Quartile 4	116
Table 3B.1: Dwelling type categories in the SCAG PECAS Model.....	124
Table 3B.2: Household Categories in the SCAG PECAS Model	125
Table 3B.3: Rent modifier Coefficients in the SCAG PECAS model for the distance to Transit Station	128
Table 3B.4: Effects of neighborhood characteristics on neighborhood change	133
Table 3B.5: Legend of measured effects from Table 3B.4.....	134
Table 3B.6: Metrics used to calibrate TOD scenario	136
Table 3B.7: Results of the parameter test scenarios.....	138
Table 3B.8: Effect of parameter changes compared to the empirical targets	138
Table 3B.9: Change resulting from the optimal parameters	139
Table 3B.10: Changes in Zone Constants	139
Table 3B.11: SCAG PECAS Enhancement Options.....	147
Table 3C.1: Actual versus Predicted Gentrification in Los Angeles Tracts	152
Table 3C.2: Actual versus Predicted Gentrification in Bay Area Tracts.....	154
Table 3C.3: Actual versus Predicted Loss of Low Income Households in Bay Area Tracts	155
Table 4.1: Average Daily VMT by Income Category and Rail Access, metropolitan areas only, NHTS 2009, and CHTS 2010-2012	166
Table 4.2: Tobit Model of Household Daily VMT for NHTS 2009 Data and CHTS 2010-2012 Data (Metropolitan areas, San Francisco Bay Area, and Los Angeles Area)	170
Table 4.3: Tobit Model of Household Daily VMT for all Metropolitan Areas, Bay Area, LA Area (NHTS and CHTS data)	174
Table 4.4: Example scenarios showing estimated change in VMT in selected gentrifying census tracts.....	178
Table 5.1: Affordable Housing and Anti-Displacement Strategies.....	187
Table 5.2: Federal and State Funding Available for Affordable Rental	197
Table 5.3: Anti-Displacement Policies in the Bay Area and Los Angeles.....	201
Table 5.4: Anti-Displacement Policies/Programs by County	202
Table 5.5: Annual Average Housing Unit Construction per 10,000 People, Bay Area Cities, by Affordable Housing Production Strategy.....	203
Table 5.6: Projected housing demand, supply, and shortfall for the nine-county	204
Table 5.7: LA County Cities that have instigated 3 or more Anti-Displacement and Housing Affordability Policies.....	205
Table 5.8: Existing Los Angeles Plans with TOD sections.....	213
Table 5.9: Inclusionary Housing Units Produced (1999-2006)	220
Table 5.10: Inclusionary Housing Units Produced (1998-2005).....	221
Table 5.11: Cities in the Bay Area with Rent Stabilization/Control Ordinances.....	226
Table 5.12: Chinatown, LA Demographics	248
Table 5.13: Hollywood/Western Demographics.....	252
Table 5.14: 103rd St/Watts Towers Demographics	257

List of Figures

Figure 1.1 “Some Conditions Resulting in Displacement in Urban Neighborhoods”	26
Figure 2C.1: Map of 2010 TOD tracts	51
Figure 2C.2: TOD Areas in the Bay Area.....	52
Figure 2C.3: Development Tracts in LA County (L) and Gentrified Tracts in LA County (R).....	54
Figure 2C.4: Development Tracts in the Bay Area (L) and Gentrified Tracts in the Bay Area (R)	56
Figure 2D.1: In- and Out-Migration Rates Calculations	58
Figure 2D.2: Bivariate Analysis, In- and Out-Migration Rates for Los Angeles, 2009-2013	59
Figure 2D.3: Bivariate Analysis, In- and Out-Migration Rates for Los Angeles (L) and the SF Bay Area (R), 2009-2013.....	59
Figure 2D.4: Per-Capita Income, LA County and 9-County Bay Area (adjusted to 2013 dollars)	63
Figure 2E.1: Gentrified/Gentrifying census Tracts, LA County 1990-2013.....	66
Figure 2E.2: Gentrified/Gentrifying census Tracts, SF Bay Area 1990-2013	68
Figure 2G.1: Estimated Number of Housing Units for LA County	82
Figure 2H.1: Gentrifying and Gentrified Census Tracts, Los Angeles County, 1990-2013	86
Figure 3A.1: UrbanSim Model Flow: Employment Focus	104
Figure 3A.2: UrbanSim Model Flow: Household Focus.....	104
Figure 3A.3: UrbanSim Model Flow: Real Estate Focus.....	105
Figure 3A.4: Computation Process in UrbanSim Choice Models.....	108
Figure 3A.5: Rent per Square Foot from Craigslist Rental Listings	110
Figure 3A.6: Square Footage per Unit from Craigslist Rental Listings.....	111
Figure 3A.7: Rent Burdens for Bay Area Households.....	112
Figure 3B.1: Information flows in the PECAS framework	123
Figure 3B.2: Shifted Exponential Function used in Transit Local Rent Modifier.....	127
Figure 3B.3: Change in number of households <10k, 2 or less person	141
Figure 3B.4: Change in Households by Category and Zone.....	142
Figure 3B.5: Relative change in rent in Luxury Single Family Dwelling space (ResType 3).....	143
Figure 3B.6: Relative change in rent in Economy Single Family Dwelling space (ResType 4)	143
Figure 4.1: Average Daily VMT by Income and Rail Access in All Californian Metropolitan Areas (NHTS data)	167
Figure 4.2: Average Daily VMT by Income and Rail Access in All Californian Metropolitan Areas (CHTS data).....	167
Figure 4.3: Net Effect of Household Income on VMT (NHTS, Based on Models in Table 4.2).....	172
Figure 4.4: Net effect of rail proximity on VMT, by income category – threshold models.....	175
Figure 5.1: State and Federal Investment in Affordable Housing (from the California Housing Partnership Corporation)	198
Figure 5.2: Number of Anti-Displacement Policies by City	202
Figure 5.3: Comparison of the Proportion of Bay Area and Los Angeles Cities with Anti- Displacement Policies.....	206
Figure 5.4: Per Capita Opportunity Bay Area Grant Funding By Number of Anti-Displacement Policies, Bay Area Cities.....	211
Figure 5.5: Distribution of Units by Income Level and Age of Inclusionary Program.....	217
Figure 5.6: Inclusionary-Development Units by Income Target.....	217
Figure 5.7: Inclusionary Zoning in Bay Area Cities.....	219
Figure 5.8: Condominium Conversion Policies in Bay Area Cities	224
Figure 5.9: Rent Control Policies in the Bay Area	227

Figure 5.10: Census Tracts at Risk for Gentrification/Displacement in 1990 and 2000, but did not experience gentrification between 2000 2013	230
Figure 5.11: Tract 113, Chinatown, and Greater Chinatown.....	231
Figure 5.12: Change in Median Rent in Chinatown (Tract 113) and Surrounding Tracts	233
Figure 5.13: Instances of No-Fault Evictions and Percentage of Rent-Controlled Units in San Francisco by Census Tract and Chinatown and Surroundings	235
Figure 5.14: East Palo Alto and Case Study Area.....	237
Figure 5.15: Case Study Area Map (Census Tract 5019).....	242
Figure 5.16: Race/Ethnicity and Population Change, 1990-2013.....	244
Figure 5.17: Rent Stabilized Units in Tract 5019, San Jose	245
Figure 5.18: Chinatown, LA Study Area by Census Tract (2010 Boundaries).....	247
Figure 5.19: Hollywood/Western Study Area by Census Tract (2010 Boundaries)	251
Figure 5.20: 103rd St/Watts Towers Study Area by Census Tract (2010 Boundaries).....	256

Abstract

In 2008, California passed Senate Bill 375, requiring metropolitan planning organizations to develop Sustainable Communities Strategies as part of their regional transportation planning process. While the implementation of these strategies has the potential for environmental and economic benefits, there are also potential negative social equity impacts, as rising land costs in infill development areas may result in the displacement of low-income residents. This report examines the relationship between fixed-rail transit neighborhoods and displacement in Los Angeles and the San Francisco Bay Area, modeling patterns of neighborhood change in relation to transit-oriented development, or TOD. Overall, we find that TOD has a significant impact on the stability of the surrounding neighborhood, leading to increases in housing costs that change the composition of the area, including the loss of low-income households. We found mixed evidence as to whether gentrification and displacement in rail station areas would cause an increase in auto usage and vehicle miles traveled (VMT). The report also examines the effectiveness of anti-displacement strategies. The results can be adapted into existing regional models (PECAS and UrbanSim) to analyze different investment scenarios. The project includes an off-model tool that will help practitioners identify the potential risk of displacement.

Executive Summary

Background

To comply with state climate change legislation, regions across California are pursuing more compact, transit-oriented development as a key strategy to achieve greenhouse gas reductions through their sustainable communities strategy (SCS). Concern has been raised that such development and investment patterns may result in heightened property values and the displacement of low income households. This report examines the relationship between fixed-rail transit in neighborhoods and gentrification and displacement in California, specifically in the Los Angeles and San Francisco metro areas.

Objectives and Methods

This report examines the relationship between fixed-rail transit neighborhoods and displacement in California by modeling past patterns of neighborhood change in relation to transit-related investment (also called transit-oriented development, or TOD). It identifies anti-displacement strategies in use and examines their effectiveness in different neighborhood contexts. The report also analyzes the relationship between displacement and travel behavior, including mode choice and vehicle miles traveled (VMT). It develops an off-model tool to examine gentrification and displacement around TODs and explores the feasibility of using the UrbanSim and PECAS modeling tools to predict likely displacement outcomes around TODs.

We use a mixture of quantitative and qualitative data and methods to compensate for the inadequacy of existing secondary datasets, supplementing neighborhood-level census data with parcel-level and address-based data while also conducting extensive key informant interviews.

Results

Fixed-rail transit has a significant impact on the stability of the surrounding neighborhood. In transit neighborhoods, housing costs tend to increase, changing the demographic composition of the area and resulting in the loss of low-income households. We find that low-income households both near and farther away from rail stations have lower VMT than high-income households, but that higher-income households either reduce their driving more in response to being near rail, or that there is no difference in VMT impacts between income categories when considered at a regional level. Our findings generally confirm earlier research on gentrification and displacement, but extend previous work by explicitly linking transit investment to gentrification and displacement, and investigating how income and proximity to transit influence VMT. Implications for board. The study results have implications for how ARB monitors and supports affordable housing goals via SB 375.

Conclusions

We find a significant and positive relationship between TOD and gentrification, particularly in downtown areas and core cities, and in some cases the loss of affordable housing or low-income households as well. Yet, the timeframe of impacts, as well as the role of intervening variables, is less clear and warrants additional research. Given the lack of appropriate data, it is hard to predict how households will alter their VMT with displacement, for instance as high-income households replace

low-income households near transit. More research is needed to understand the dynamic impacts that occur as residents adjust their travel behavior in new locations. Finally, the effectiveness of policy solutions varies by context, and it is unclear whether any of the existing approaches are sufficient to address displacement in the core neighborhoods where it is most prevalent. More research is needed to develop responsive policy tools, as well as to understand better the trade-offs between anti-displacement and VMT reduction goals. Despite these remaining concerns, it is not too soon to begin incorporating these results into existing regional models (PECAS and UrbanSim) to analyze different investment scenarios and market conditions. We also recommend that practitioners begin to use our off-model tool to help identify the potential risk of displacement.

Introduction

The impetus for this study lies in state climate change legislation. Recognizing the role good planning can play in achieving our AB32 goals, California passed Senate Bill 375, requiring the California Air Resources Board (ARB) to set regional greenhouse gas reduction targets for passenger vehicles. The bill also requires metropolitan planning organizations (MPOs) to develop Sustainable Communities Strategies (SCSs) as part of their regional transportation planning process to illustrate how integrated land use, transportation, and housing planning will achieve these targets. Regions are pursuing more compact, transit-oriented development as a key strategy to achieve these reductions.

While the implementation of these strategies has the potential to bring environmental, health, and economic benefits, planning for SCSs across the state has raised awareness of the potential social equity effects of land-use-based greenhouse gas reduction strategies. Locals are likely to benefit from improved mobility, neighborhood revitalization, reduced transportation costs, and other amenities that spill over from the new development (Cervero et al. 2004). However, more disadvantaged communities may fail to benefit, if the new development does not bring appropriate housing and job opportunities, or if there is gentrification that displaces low-income and minority residents (Pollack, Bluestone, and Billingham 2010, Chapple 2009). Specifically, there is concern that new transit investment and development may increase housing costs, forcing low-income communities, often of color, to move to more affordable locations, preventing these communities from sharing in the benefits of this type of development. Replacing low-income households in transit-oriented developments with higher-income residents more likely to own a car may reshape travel behavior, including vehicle-miles traveled (VMT).

This report examines the relationship between fixed-rail transit neighborhoods and displacement in California, modeling past patterns of neighborhood change in relation to transit-related investment (also called transit-oriented development, or TOD).ⁱ After establishing the relationship between TOD and displacement, the report identifies anti-displacement strategies in use and examines their effectiveness in different neighborhood contexts. The report also analyzes the relationship between displacement and travel behavior, including mode choice and VMT. We find that low-income households both near and farther away from rail stations have lower VMT than high-income households, but that higher-income households either reduce their driving more in response to being near rail, or that there is no difference in VMT impacts between income categories. When gentrification is accompanied by densification, these results imply it will reduce regional VMT on net. However, when displacement is significant enough and population density declines, regional VMT is expected to increase.

The results of this analysis form the basis of a predictive model that can be adapted into existing regional models (PECAS and UrbanSim) to analyze different investment scenarios and market conditions. We also produce an off-model tool that will help practitioners quantify the potential magnitude of displacement.

In total, this study produces the strongest evidence to date of the relationship between TOD and displacement. Surprisingly little research has addressed the relationship between transit neighborhoods and social equity, outside of an advocacy literature has focused largely on the importance of affordable housing near transit stations to reduce transportation cost burdens for low-income households (CTOD 2004; Great Communities Collaborative 2007; CHPC 2013). One reason for the relative lack of research on equity issues related to transit neighborhoods is the

challenge of operationalizing displacement, due to lack of appropriate data. Further, most studies neglect to examine the role of private or public investment in spurring gentrification, examining it as a purely demographic phenomenon, i.e., the influx of higher-income households into low-income neighborhoods. They also generally fail to examine the possibility that rather than rent increases pushing households out, the key displacement mechanism is rent increases preventing minority households from moving in. Studies typically investigate only a 10-year period; however, given the length of time it takes to plan, fund, and build transportation improvements, examining a longer period of time may be more appropriate.

Several innovations distinguish our approach from previous and related work. First, we use a mixture of quantitative and qualitative data and methods to compensate for the inadequacy of existing secondary datasets, supplementing neighborhood-level census data with parcel-level and address-based data on property transactions, building permits, building characteristics, and affordable housing subsidies, along with field observations. We develop the neighborhood change models in close collaboration with regional agency officials, with the idea that they will begin to integrate displacement effects into their regional models. Second, the report complements the neighborhood change analysis with an extensive inventory and key informant interviews to identify policies supporting transit neighborhoods and mitigating displacement. Finally, using data from household travel surveys, we link neighborhood types and displacement to VMT.

This report focuses on the San Francisco Bay Area and Los Angeles County. Though both regions have experienced significant levels of transit investment, they have different development trajectories. Much of the Bay Area's transit development occurred with the development of the BART system in the 1970s and 1980s, while Los Angeles developed fixed rail much more recently. Moreover, urban form and land markets function very differently in the two places, and the San Francisco region remains a stronger real estate market than most of Los Angeles County. As a result, in the analysis of neighborhood change, we take slightly different analytic approaches in the two regions. While both models analyze gentrification and loss of affordable housing, the San Francisco model adds an analysis of the displacement of low-income households. However, the newness of transit development in Los Angeles, as well as its weaker housing market (outside of Downtown), may make it most comparable to the many other areas of California with new rail systems.

The remainder of this report is organized by analytic tasks, as follows. Chapter 1 provides an in-depth review of the literature to date on neighborhood change, gentrification, public investment, displacement, urban simulation models, and change assessment tools. Chapter 2 analyzes historic patterns of neighborhood change in both regions in both transit and other neighborhoods. Different sections describe the construction of the neighborhood and parcel-level databases; the typologies of transit neighborhoods and displacement; the models of neighborhood mobility, displacement, and change; and the groundtruthing of our findings (through neighborhood observation). Chapter 3 describes how the UrbanSim and PECAS models can incorporate displacement, through adding anti-displacement policies and incorporating housing affordability into real estate development models. It also provides a methodology to assess displacement "off-model," i.e., in an Excel tool readily accessible by practitioners. Chapter 4 analyzes the VMT and auto ownership impacts of displacement; and Chapter 5 examines strategies to minimize displacement from transit investment and TOD. A conclusion summarizes the major findings of each task.

ⁱ We define TOD here broadly to include any form of development, from new construction to rehabilitation of older structures, within a half-mile radius of a fixed-rail transit station. We use the term TOD interchangeably with "transit neighborhood."

Chapter 1: Literature Review of Gentrification, Displacement, and the Role of Public Investment

Miriam Zuk¹, Ariel H. Bierbaum¹, Karen Chapple¹, Karolina Gorska²,
Anastasia Loukaitou-Sideris², Paul Ong², Trevor Thomas²

¹ University of California, Berkeley

² University of California, Los Angeles

Acronyms Used in This Chapter

- ACS (American Community Survey)
- BRT (Bus Rapid Transit)
- CCI (Center for Community Innovation)
- HOV (High-Occupancy-Vehicle)
- HUD (Department of Housing and Urban Development)
- LISC (Local Initiative Support Corporation)
- NYCHVS (New York City Housing and Vacancy Survey)
- PSID (Panel Survey of Income)
- PSRC (Puget Sound Regional Council)
- TOD (Transit-Oriented Districts/Development)

Chapter 1 Table of Contents

- Chapter 1 Introduction..... 6
- Historical Perspectives on Neighborhoods and Change..... 7
- Trends in Mobility and Neighborhood Segregation..... 8
 - Economic Segregation..... 9
 - Racial Transition and Succession 10
- Dimensions of Neighborhoods and Change..... 12
 - Neighborhood Decline..... 12
 - Neighborhood Ascent and Gentrification..... 13
 - The Role of Public Investments in Neighborhood Ascent 18
- Understanding Negative Impacts of Gentrification: Displacement 24
 - Defining Residential Displacement..... 25
 - Measuring Residential Displacement..... 28
 - Challenges to Understanding Displacement 33
 - Indicators for Analyzing Residential Displacement..... 35
- Implications for Strong versus Weak Markets 36
- Urban Simulation Models and Neighborhood Change 37
- Moving from Research to Praxis: Prediction and Mitigation..... 39
- Chapter 1 Conclusions..... 43

A significant body of work examines neighborhood change, gentrification, and displacement. This chapter assesses this research, beginning with accounts of neighborhood change from the Chicago School in the 1920s. After summarizing research that examines trends in economic and racial segregation, the chapter turns to the literature on neighborhood decline and ascent, with a focus on the state of knowledge about gentrification and the role of public investment. The heart of the chapter addresses the literature on displacement, describing the methodologies used to understand displacement – and how they fall short. The next section addresses how neighborhood change dynamics differ in strong versus weak markets. After an assessment of how urban simulation models treat neighborhood change, the chapter concludes with a description of the rise of early warning systems for gentrification and displacement.

Chapter 1 Introduction

The ever-changing economies, demographics, and morphologies of the metropolitan areas of the United States have fostered opportunity for some and hardship for others. These differential experiences “land” in place, and specifically in neighborhoods. Generally, three dynamic processes can be identified as important determinants of neighborhood change: movement of people, public policies and investments, and flows of private capital. These influences are by no means mutually exclusive. In fact, they are very much mutually dependent, and they each are mediated by conceptions of race, class, place, and scale. How scholars approach the study of neighborhood change and the relative emphasis that they place on these three influences shapes the questions asked and attendant interventions proposed.

These catalysts result in a range of transformations—physical, demographic, political, economic—along upward, downward, or flat trajectories. In urban studies and policy, scholars have devoted volumes to analyzing neighborhood decline and subsequent revitalization at the hands of government, market, and individual interventions. One particular category of neighborhood change is gentrification, definitions and impacts of which have been debated for at least 50 years. Central to these debates is confronting and documenting the differential impacts on incumbent and new residents, and questioning who bears the burden and who reaps the benefits of changes. Few studies have addressed the role of public investment, and more specifically transit investment, in gentrification. Moreover, little has been written about how transit investment may spur neighborhood disinvestment and decline. Yet, at a time when so many United States regions are considering how best to accommodate future growth via public investment, developing a better understanding of its relationship with neighborhood change is critical to crafting more effective public policy.

This literature review will document the vast bodies of scholarship that have sought to examine these issues. First, we contextualize the concept and study of neighborhood change. Second, we delve into the literature on neighborhood decline and ascent (gentrification). The third section examines the role of public investment, specifically transit investment, on neighborhood change. Next, we examine the range of studies that have tried to define and measure one of gentrification’s most pronounced negative impacts: displacement. After describing the evolution of urban simulation models and their ability to incorporate racial and income transition, we conclude with an examination of gentrification and displacement assessment tools.

Historical Perspectives on Neighborhoods and Change

neighborhoods have been changing since the beginning of time—people move in and out, buildings are built and destroyed, infrastructure and amenities are added and removed, properties are transferred, and so on. Despite the constancy of change, our current paradigms for understanding and studying neighborhoods and change stem from the early 20th century when urban America experienced dramatic change due to rapid industrialization, extensive flows of immigrants from Europe, and mass migration of African-Americans from the rural south. In this time of great transition, emergent social problems, and heightened middle class anxiety about the ills of urban society, new ideas were formulated to understand urban growth, neighborhood change, and attendant tensions.

We review these ideas here because they continue to be prominent in today's scholarship and current understandings about neighborhoods and change. Three key ideas that took shape were: 1) the primacy of neighborhood as the unit of analysis in studying the city; 2) specific concepts of the substantive nature of neighborhoods, including: theories of a social ecology, cycles of equilibrium to disequilibrium, ideas of social disorganization, and assimilation; and 3) attention to race and ethnicity and their association with persistent neighborhood poverty.

While today the notion of the “neighborhood” is one that practitioners, scholars, and laypersons alike take for granted, its definitions vary, and not all assign equal importance to its role in social processes. The neighborhood has come to be understood as the physical building block of the city for both “social and political organization” (Sampson 2011, 53), conflating physical and non-physical attributes. Early scholars hypothesized that cities' physical elements like size and density, as well as their heterogeneous demographics, influenced the mechanisms and processes of neighborhood change (Park 1936; Park 1925; Wirth 1938). Theorists suggested that there were natural areas in the city for specific types of land uses and people, such as the concentric zone model with a central business district at the center, transitional zones of light industrial and offices next, followed by worker housing, and finally newer housing for the middle class in the outer ring (Burgess 1925).

These ideas about neighborhoods and urban morphology presented a deterministic model in which neighborhoods were considered a closed ecosystem, and neighborhood change had a natural tendency toward social equilibrium. New residents—distinguished by ethnicity and class—would enter the ecosystem and disrupt the equilibrium. Competition for space followed, and neighborhood succession occurred when less dominant populations were forced to relocate. The dominant groups that stayed established a new equilibrium. In these conceptualizations of neighborhood change, competition for space drove locational decisions of different groups in a natural and inevitable way. Observed deviant behavior was thought to be a natural reaction to urbanization; new arrivals to the city fostered social disorganization, which would return to equilibrium once the immigrants assimilated (Park 1936; Park 1925; Wirth 1938).

This “ecological” model also naturalized segregation. New arrivals to the city—specifically the “poor, the vicious, the criminal”—would separate themselves from the “dominant moral order” (Park 1925, 43) into segregated neighborhoods to live among people with a similar moral code of conduct. Like disorganization, this “voluntary segregation would eventually break down as acculturation brought assimilation” (Hall 2002, 372). These concepts set the foundation for subsequent study and policy premised on notions of marginality in which immigrants, African-Americans, and low-income people were assumed to operate based on logics divergent from

mainstream, middle-class society, and of assimilation as a key mechanism to mitigate social disorganization.

Although early researchers were most concerned with immigrant influx and increasing ethnic diversity among white populations, others—notably black sociologists—observed that neighborhoods with burgeoning African-American populations seemed to experience neighborhood succession differently than the model of naturalized assimilation would predict. Unlike white ethnic immigrant in-movers to Chicago, the African-American population was involuntarily contained in specific neighborhoods (DuBois 2003).

These approaches to neighborhoods and neighborhood change have been widely adopted in today's policy and research agendas, perhaps understandably, since about half of all United States metropolitan areas conform to the concentric zone model (Dwyer 2010). Yet, these early ideas have their weaknesses. The deterministic and ecological theories naturalize the transition process and leave very little room for politics. The conflation of geographic units (neighborhoods) with social and political units masks other processes in cities. Public institutions also remain notably absent in these early theories, and these approaches fail to take into account larger city and regional forces that influence neighborhood-level change. Subsequent research has improved upon these weaknesses by de-naturalizing market phenomena, incorporating the role of public sector actors and public policy, and by embedding neighborhood in other macro- and meso-scale processes (Goetz 2013; Jargowsky 1997).

Finding: Influential early models of neighborhood change present processes of succession and segregation as inevitable, underemphasizing the role of the state.

Trends in Mobility and Neighborhood Segregation

Despite the emphasis that urban models place on change, what is perhaps most startling about this literature is how slowly neighborhood change happens. Analysis of change over time suggests that neighborhoods are surprisingly stable (Wei and Knox 2014). Over individual decades, the change that researchers are discussing amounts to a few percentage points; neighborhood transformation takes decades to complete. And, in fact, overall, Americans have become significantly more rooted over time; just 12% of United States residents moved in 2008, the lowest rate since 1948 and probably long before (C. S. Fischer 2010). Sociologist Claude Fischer credits growing security, as well as technology, for the shift, but adds: “Americans as a whole are moving less and less. But where the remaining movers—both those forced by poverty and those liberated by affluence—are moving is reinforcing the economic and, increasingly, the cultural separations among us” (Fischer 2013). For many at the lower end of the economic spectrum, stability means imprisonment: even though many families have left, researchers estimate that some 70% of families in today's impoverished neighborhoods were living there in the 1970s as well (Sharkey 2012).

Questions of urban morphology and neighborhood change have continued to capture academic and popular imagination because of the perceived and real impacts of neighborhoods on residents. Scholars writing on the “geographies of opportunity” (Briggs 2005) argue that the spatial relationships between high-quality housing, jobs, and schools structure social mobility. Patterns of urban development in the United States have resulted in uneven geographies of opportunity, in which low-income households and people of color experience limited access to affordable housing, high quality schools, and good-paying jobs. A range of studies have found that living in poor neighborhoods negatively impacts residents, particularly young people, who are more likely than

their counterparts in wealthier neighborhoods to participate in and be victims of criminal activity, experience teen pregnancy, drop out of high school, and perform poorly in school, among a multitude of other negative outcomes (Crane 1991; Ellen and Turner 1997; Galster 2010; P. A. Jargowsky 1997; Jencks et al. 1990; Ludwig et al. 2001; Sampson, Morenoff, and Gannon-Rowley 2002; Sharkey 2013). However, geographic proximity does not affect opportunity in the same way for all variables; living next door to a toxic waste site may impact life chances more than living next to a major employer (Chapple 2014).

Economic Segregation

Economic segregation has increased steadily since the 1970s, with a brief respite in the 1990s, and is related closely to racial segregation (i.e., income segregation is growing more rapidly among black families than white) (Fischer et al. 2004; Fry and Taylor 2015; P. Jargowsky 2001; Lichter, Parisi, and Taquino 2012; Reardon and Bischoff 2011; Watson 2009; Yang and Jargowsky 2006). Increases are particularly pronounced in more affluent neighborhoods: between 1980 and 2010, the share of upper-income households living in majority upper-income tracts doubled from 9 to 18 percent, compared to an increase from 23 to 25 percent in segregation of lower-income households living in majority lower-income tracts (Fry and Taylor 2012).

The sorting of the rich and poor is even more pronounced between jurisdictions than between neighborhoods in the same city (Reardon and Bischoff 2011). Over time, the poor are increasingly concentrated in high-poverty places, while the non-poor shift to non-poor cities (Lichter, Parisi, and Taquino 2012). Upper-income households in metropolitan areas like Houston or Dallas are much more likely to segregate themselves than those in denser older regions like Boston or Philadelphia or Chicago (Fry and Taylor 2012). This suggests that segregation is related to metropolitan structure and suburbanization. The concentric zone model is particularly strongly associated with the segregation of the affluent (Dwyer 2010). In other words, in metropolitan areas where the affluent are most separated from the poor, they are living on land further from the center.

Metropolitan areas that conform to the concentric zone model (for example, places like Chicago, Los Angeles, and Philadelphia) tend to be larger and more densely populated, often with a higher degree of both affluence and inequality, a larger African-American population, and a greater share of population in the suburbs. In the remaining metropolitan areas, there is greater integration between the affluent and the poor (Dwyer 2010). In these places, such as Seattle, Charleston, and Boulder, the rich concentrate in the urban core, allowing more opportunity for interaction with the poor. Growing racial/ethnic diversity may be reshaping some of these areas, with suburban immigrant enclaves creating more fragmented, checkerboard patterns of segregation (Coulton et al. 1996).

Public choice theorists, most prominently Charles Tiebout (1956), have long understood economic segregation to result from the preference of consumers for distinct baskets of public goods (e.g., schools, parks, and the like); local jurisdictions provide these services at different levels, attracting residents of similar economic means (Peterson 1981). However, the causality here is unclear: government policies shape free markets and preferences, as well as respond to them. Thus, transportation policies favoring the automobile, discrimination and redlining in early federal home ownership policies, mortgage interest tax deductions for homeowners, and other urban policies have actively shaped or reinforced patterns of racial and economic segregation, while severely constraining choices for disadvantaged groups (Dreier, Mollenkopf, and Swanstrom 2004).

But we also now understand that neighborhood income segregation within metropolitan areas is influenced mostly by income inequality, in particular, higher compensation in the top quintile and the lack of jobs for the bottom quintile (Reardon and Bischoff 2011; Watson 2009). Income inequality leads to income segregation because higher incomes, supported by housing policy, allow certain households to sort themselves according to their preferences – and control local political processes that continue exclusion (Reardon and Bischoff 2011). Other explanatory factors include disinvestment in urban areas, suburban investment and land use patterns, and the practices generally of government and mortgage underwriters (Hirsch 1983; Levy, McDade, and Dumlao Bertumen 2011). Nonetheless, were income inequality to stop rising, the number of segregated neighborhoods would decline (Reardon and Bischoff 2011, Watson 2009).

Finding: Neighborhoods change slowly, but over time are becoming more segregated by income, due in part to macro-level increases in income inequality.

Racial Transition and Succession

In the United States, income segregation is highly correlated with racial/ethnic segregation, which has a long history. As many scholars have documented, African-American segregation peaked in 1960 and 1970, and has declined since then (Logan 2013; Vigdor 2013). The growth of Asian and Hispanic populations in the last several decades has led to more diverse, multi-ethnic neighborhoods. Ellen and coauthors (2012) find both the increase of previously white neighborhoods that became integrated through the growth of non-white populations, as well as a smaller but accelerating number of previously non-white neighborhoods that became integrated through the growth of white populations. It is important to note two countervailing trends, however. First, while the number of integrated neighborhoods increased from 1990 to 2010, the large majority of non-integrated neighborhoods remained so over each decade. Furthermore, African-American-white segregation has persisted in major metropolitan areas, especially in the Northeast and Midwest, and a large share of minorities still live in neighborhoods with virtually no white residents (Logan 2013). Second, a significant number of integrated neighborhoods reverted to non-integration during each decade, though the stability of integration increased after 2000. These findings of increasing integration over time, persistence of non-integration in a majority of neighborhoods, and instability of some integrated neighborhoods are corroborated by a number of other researchers (Farrell and Lee 2011; Quercia and Galster 2000; Chipman et al. 2012; Sampson and Sharkey 2008; Logan and Zhang 2010).

Looking at the neighborhood and metropolitan correlates of these demographic shifts, Ellen et al. (2012) find a number of interesting patterns. Focusing on a case pertinent to the study of gentrification – the integration of African-American neighborhoods by white in-movers – the authors find that neighborhoods that become integrated start off with lower income and rates of homeownership and higher rates of poverty than those that remain non-integrated. Additionally, these neighborhoods are more likely to be located in central cities of metropolitan areas with growing populations. Looking at rates of transition to integration by racial and ethnic category, the researchers contradict previous work (Logan and Zhang 2010; Reibel and Regelson 2011; Lee and Wood 1991) by finding that multi-racial or multiethnic neighborhoods integrate with white in-movers at a relatively infrequent rate. This contradiction may be explained, however, by the lack of nuance employed by the various authors in categorizing race and ethnicities, as various subgroups can display markedly different residential movement patterns (Charles 2003).

Several main theories have been put forward to account for both the persistence and change of neighborhood racial compositions over time. With respect to the integration of formerly white neighborhoods, a primary mechanism described by Charles (2003) is that of “spatial assimilation,” which argues that as the gap between socioeconomic status of racial and ethnic groups narrows, so too does their spatial segregation. While this mechanism may help explain the integration of Hispanic and Asian households into previously white neighborhoods, it does not help explain the experience of African-American households (Charles 2003). For these groups, a theory of “place stratification” is a better fit, incorporating discriminatory institutions that limit residential movement of African-Americans into white neighborhoods and factors such as, biased residential preferences among non-Hispanic whites and discriminatory practices in the real estate market (Charles 2003; Krysan et al. 2009; Turner et al. 2013).

The converse neighborhood process, the transition from integration back to segregation, has been explained by economists through theories of neighborhood “tipping,” which hold that as the neighborhood proportion of non-white racial and ethnic groups increases past a certain threshold, a rapid out-migration of other (white) groups will ensue (Schelling 1971; Charles 2000; Bruch and Mare 2006). The precise threshold at which neighborhoods “tip” varies according to a number of metropolitan-level attributes, and researchers have found that places with small non-white populations, high levels of discrimination, large homicide rates, and a history of racial riots tip at lower thresholds than other places (Quercia and Galster 2000; Card, Mas, and Rothstein 2008).

A number of other macro-level and institutional influences have been attached to racial transition. For instance, rates of macro-level population movement are seen to have a substantial impact on neighborhood racial compositions, with the movements of the Great Migration out of the South and into metropolitan areas of the Northeast, Midwest, and West leading to greater degrees of black segregation in urban neighborhoods (Ottensmann, Good, and Gleeson 1990) and more recent movements of immigrants into neighborhoods leading to greater rates of out-migration among native-born residents (Crowder, Hall, and Tolnay 2011).

Finally, a number of studies have gone beyond place-level analyses of neighborhood racial change to examine the determinants of individual household movements. For instance, (Hipp 2012) has found a strong correlation between the race of the prior resident of a housing unit and the race of the in-moving resident, a phenomenon that he attributes to a signaling mechanism for neighborhood belonging. (Sampson 2012) similarly finds that Hispanic and black residents overwhelmingly move to predominantly Hispanic and black neighborhoods of Chicago, respectively. Additionally, he finds strong effects of spatial proximity on selection of destination neighborhoods, as well as strong associations with similarities in income, perceptions of physical disorder, and social network connectedness between origin and destination neighborhoods. These findings may help explain results from other researchers that have found limited impact of housing policies and programs such as inclusionary zoning and housing choice vouchers to reduce neighborhood racial segregation (Glaeser 2003; Kontokosta 2013; Chaskin 2013). The literature on gentrification, discussed below, revisits this question of how in-migration patterns reshape neighborhoods. For further detail on racial transition and succession studies, see Appendix A.

Finding: Racial segregation persists due to patterns of in-migration, “tipping points,” and other processes; however, racial integration is increasing, particularly in growing cities.

Dimensions of Neighborhoods and Change

In general, studies of neighborhood change began with preoccupations about decline and have evolved into concerns about the impacts of neighborhood ascent, variously defined. Public investment – and disinvestment – has played a role in both types of change.

Neighborhood Decline

The story of neighborhood decline in the United States is oft-told. While early researchers naturalized processes of neighborhood transition and decline, the drivers of decline are anything but natural and stem from a confluence of factors including: federal policy and investments, changes in the economy, demographic and migration shifts, and discriminatory actions. Neighborhood conditions and patterns of physical investment (or disinvestment) have been conflated with challenges of poverty (Katz 2012). Given this conflation, our review examines not only studies concerned with physical change but also research that investigates demographic and social dynamics that accompany neighborhood-level transitions.

Between the 1920s and 1950s, the African-American population in northern cities swelled due to the mechanization of agricultural production in the South and Jim Crow laws, even as deindustrialization started to take hold and jobs began moving out of central cities (Sugrue 2005). Simultaneously federal programs, (e.g., the Federal-Aid Highway Program and Home Owners Loan Corporation) provided quick automobile access (in the case of the former) and large subsidies for home ownership in the suburbs (in the case of the latter). The confluence of government subsidy and investment in infrastructure and regulation with private lending practices led to subsidies for racial segregation, with restrictive covenants on deeds and lending practices governed by racially discriminatory stipulations, i.e., redlining (K. Jackson 1987).

The demographic shifts enabled by these public policies and private actions left cities with a severely depleted tax base to support the more disadvantaged communities who did not have options to leave the city (Frieden and Sagalyn 1989). Ostensibly to address the persistent poverty in cities, urban renewal sought to revive downtown business districts and provide adequate housing for all. However, the divergent interests of stakeholders including developers, mayors, and affordable housing advocates resulted in a diluted policy that prioritized downtown redevelopment at the expense of primarily low-income communities and particularly African-American communities, leading many to refer to urban renewal as “Negro Removal.” Meanwhile, public housing development served as a tool to physically and socially buffer central business districts from neighborhoods of poverty, which were predominantly African-American (Halpern 1995; Hirsch 1983). These efforts emphasize the approach of “solving” social, economic, and political problems with spatial and physical solutions. In essence, this period conflated urban policy with anti-poverty policy, due in part to the real policy challenges of addressing structural poverty (O’Connor 2002).

By the late 1980s, inner city poverty and metropolitan inequality were cemented. Wilson (1987), drawing on some of the earlier notions of neighborhood succession, argued that the key mechanisms driving inner-city poverty were: structural economic shifts; shifting migration flows; changes in the age structure; and the out-migration of middle-class blacks as a result of Civil Rights gains. These shifts resulted in “concentration effects,” leaving residents even more isolated from

mainstream institutions, labor markets, and politics, which manifested spatially in the creation of the black ghetto neighborhood. Beyond Wilson's focus on class, Massey and Denton (1993) argued that neighborhood decline is caused by systems of discrimination pervasive in the housing market, and that "racial segregation...and the black ghetto - are the key structural factors responsible for the perpetuation of black poverty" (Massey and Denton 1993, 9). They suggest a "culture of segregation" forms from geographic isolation, resulting in limited political power, less resilience available to respond to economic shifts, and little or no access to job opportunities and mainstream institutions.

Sociologist Loic Wacquant offers another way of understanding the relationship between race, poverty, and space, extending Massey and Denton's focus on residential segregation. For Wacquant (1997), racial enclosure is a critical component to understanding urban decline. Analyses and proposed interventions focused only on poverty will never mitigate and deconstruct the ghetto, since it is, in fact, the racial and ethnic enclosure and control that creates poverty, not the other way around. He argues that the shift to class-based segregation at the expense of an analysis of race is a "tactical" choice by scholars, given the politics of influencing policy: "[scholars] have diligently effaced from their analytical framework the one causal nexus that the American state stubbornly refuses to acknowledge, confront, and mitigate when dealing with disparity and destitution: race" (1998, 149).

Complicating the issue of segregation for policymakers is the need to distinguish between the ghetto and the enclave (Marcuse 1997). In contrast to the ghetto, where society segregates residents involuntarily in a process of exclusion, the enclave is a spatial cluster where residents choose to congregate in order to achieve economic goals (such as Chinatown) or social cohesion (such as Hasidic Williamsburg, Brooklyn). The urban enclave may strengthen social groups or subcultures and more effectively provide the resources to prosper than an integrated neighborhood does (Fischer 1984).

More recently, scholars using quantitative methods have broadened analyses from the neighborhood level to metropolitan, county, and state geographies (Fischer et al. 2004; Massey, Rothwell, and Domina 2009; Reardon et al. 2008). Jargowsky's (1997) empirical work links ghetto poverty with metropolitan economies and finds that changes in economic opportunity at the metropolitan level impact the levels of inner city poverty. Further, Jargowsky's work raises questions about the concept of neighborhood as a self-contained ecosystem, highlighting neighborhoods' interdependency and their dependence on broader metropolitan economies and infrastructures. Neighborhood decline and disinvestment may reflect regional economic distress, but may also be related to the shift of investment elsewhere in the metropolitan area.

Finding: Neighborhood decline results from the interaction of demographic shifts, public policy, and entrenched segregation, and is shaped by metropolitan context.

Neighborhood Ascent and Gentrification

Following decades of public and private initiatives to regenerate the inner city, scholars are increasingly paying attention to the causes and consequences of the upward trajectories of neighborhoods, also known as neighborhood ascent or upgrading. Much like decline, neighborhood ascent exhibits a variety of trajectories, which depend greatly on their starting points. Owens (2012), for instance, identified nine different types of neighborhoods that are all experiencing some form of upgrading in the United States: minority urban neighborhoods, affluent neighborhoods,

diverse urban neighborhoods, no population neighborhoods, new white suburbs, upper-middle-class white suburbs, booming suburbs, and Hispanic enclave neighborhoods. While different actors and catalysts may be at play in these different types of neighborhood ascent, Owens does not suggest any causality, and does not investigate the role of investment or public policies on these trajectories. In this section we provide an overview of the literature on gentrification, the most commonly studied form of neighborhood ascent involving the racial and economic transformation of low-income neighborhoods.

The first documented use of the term “gentrification” (Glass 1964) describes the influx of a “gentry” in lower-income neighborhoods in London during the 1950s and 60s.¹ Today, gentrification is generally defined as simultaneously a spatial and social practice that results in “the transformation of a working-class or vacant area of the central city into middle-class residential or commercial use” (Loretta Lees, Slater, and Wyly 2008, xv).² Often, gentrification has been understood as a tool of revitalization for declining urban neighborhoods, defined primarily by their physical deterioration. However, revitalization, as first noted by Clay (1979) can take two forms: incumbent upgrading and gentrification. Incumbent upgrading, whereupon existing residents improve the conditions of their neighborhood, is catalyzed by the cost of housing, the rise of neighborhood consciousness, demographic pressure, and reduced pressures from migrants to the city. Gentrification, on the other hand, draws middle-class residents to the city, attracted by job and recreational opportunities, low and appreciating housing prices, stabilization of negative social conditions (such as crime), and lifestyle or aesthetic considerations. Displacement, a negative outcome of gentrification, is not present in incumbent upgrading.

Gentrification literature conceptualizes neighborhoods as terrains not of isolated pockets of decline and abandonment, but rather as sites of exploration, potential investment, and emergent identity construction that are manifestations of larger city, metropolitan, and global forces. Gentrification is not driven by a singular cause. It may emerge when three conditions are present: the existence of a potential pool of gentrifiers, a supply of inner-city housing, and a cultural preference for urban living (Hamnett 1991). It is arguably a “chaotic” process, which does not lend itself to binary or linear analysis (Beauregard 1986; Freeman 2006; L. Lees 1996). Early debates, however, relied strongly on binaries to identify the causes of gentrification. Scholars argued that either macro-forces of capital accumulation or micro-sociological processes of individual preferences drive gentrification processes. Today, the overarching debate has generally drawn a line between the flows of capital versus flows of people to neighborhoods. This dichotomous narrative has spawned many analyses focused on either production and supply-side or consumption and demand-side catalysts. Flows of capital focus on profit-seeking and the work of broader economic forces to make inner city areas profitable for in-movers. Flows of people refer to individual gentrifiers who enter inner city areas, drawn by cultural and aesthetic preferences.

From the production or supply-side perspective, private capital investment, public policies, and public investments are the main mechanisms of gentrification. Smith (1979) argues that the return of capital from the suburbs to the city drives gentrification; the change in neighborhoods is the spatial manifestation of the restructuring of capital through shifting land values and housing development. Gentrification occurs in disinvested neighborhoods where there is the greatest “rent

¹ While Glass offers the first use of the term, the phenomenon predates this naming. For example, Osman (2011) documents earlier instances of class-based movement into inner city areas in the United States; his history of “brownstoning” in Brooklyn dates gentrifying neighborhood change to the 1940s.

² An early definition by London and Palen (1984) quoting the Urban Land Institute names gentrification as a “private-market non-subsidized housing renovation.”

gap” between the cost of purchasing property and the price at which gentrifiers can rent or sell (1979). Smith (1979) sees individual gentrifiers as important, but places a greater emphasis on a broader nexus of actors – developers, builders, mortgage lenders, government agencies, real estate agents – that make up the full political economy of capital flows into urban areas. His focus goes so far as to obscure individual ascriptive characteristics (e.g., race or ethnicity) in favor of a more macro analysis of gentrification and urban land markets as a function of the capitalist economy.

Another “supply-side” actor is government – at the local, state, and federal levels – which through public subsidy and policy measures sets the conditions for and catalyzes gentrification processes. As mentioned previously, Smith (1979; 1996) sees government as part of a larger political economy that aims to accumulate capital through land use management and city development, echoing the idea of the city as a “growth machine” (Logan and Molotch 1987). Others (Freeman 2006; Wilson and Taub 2006; Pattillo 2008; powell and Spencer 2002) have clearly tied gentrification to historical patterns of residential segregation. Segregated neighborhoods experience the “double insult – a ‘one-two’ knock” (powell and Spencer 2002, 437) of neglect and white flight in the 1950s through 1970s and then the forces of displacement in the 1980s through today. These scholars highlight the role of policy in structuring the differential and inequitable spatial distributions of risks and resources by race and class across metropolitan areas. Gentrification represents merely the latest imprint of these efforts by the state. In subsequent sections we will review the literature on the specific role of government investment in infrastructure in housing prices and subsequent neighborhood change.

For those who explain gentrification as flows of people (rather than capital), two threads persist, both grounded in consumer-driven, demand-side principles. One thread focuses on aesthetic and lifestyle preferences of gentrifiers, who desire a gritty, authentically “urban” experience (Caulfield 1994; Ley 1994; Ley 1996; Zukin 1982), or who see themselves as agents to preserve some nostalgic, authentic character of a place (Brown-Saracino 2009). The second thread is embedded in neoclassical economics and links land values to housing location choice connected to shifts in the labor market (Hamnett 2003).

Ethnographic accounts have examined middle- and upper-class, primarily white, childless in-movers and their motivations to move to inner city neighborhoods. These studies have identified political persuasions and identity construction vis-à-vis their housing choices into declining neighborhoods as the primary catalysts (Brown-Saracino 2009; Caulfield 1994; Ley 1996; Ley 2003). Others also consider broader economic forces (Rose 1984; Zukin 1987), which point to the connections between the theories on macro flows of capital described above and these more micro-sociological processes of individuals.

These earlier studies on in-movers have focused primarily in inter-racial/ethnic gentrification, with white in-movers and incumbent communities of color. More recently, scholars have examined cases of middle-class black in-movers into predominantly low-income black neighborhoods (Boyd 2005; Freeman 2006; Hyra 2008; Moore 2009; Pattillo 2008; Taylor 2002). These studies tie neighborhood-specific processes to larger structural issues of residential segregation and exclusion, arguing that in some cases black in-movers feel more comfortable relocating to predominantly African-American neighborhoods because of a history of housing discrimination in predominantly white neighborhoods and the suburbs (Freeman 2006; Moore 2009; Taylor 2002). African-American in-movers also become connected to a set of cultural practices and aesthetics that link to their racial identities (Freeman 2006). Further, black gentrifiers may see their relocation in inner cities as a project of “racial uplift” for their lower-income black counterparts (Boyd 2005).

Additional work has also shown substantial racial diversity specifically among higher-income gentrifying households (Bostic and Martin 2003).

Looking at neighborhood racial transition through the lens of gentrification, existing evidence is mixed. Research has found trends of greater white movement into poor, non-white neighborhoods (Crowder and South 2005; McKinnish, Walsh, and Kirk White 2010), resulting in shifting racial compositions in the face of gentrification. Other research, however, presents a picture of less sharp differences in race among households moving into and out of gentrifying and non-gentrifying neighborhoods (Ellen and O'Regan 2011). Finally, Hwang and Sampson (2014) recently found that Chicago neighborhoods with higher proportions of black and Latino residents gentrified at a slower pace than predominantly white neighborhoods, indicating that gentrifiers have less of a taste for integrated neighborhoods than previously believed.

Finding: Gentrification results from both flows of capital and people. The extent to which gentrification is linked to racial transition differs across neighborhood contexts.

Cultural Strategies and Gentrification

An analysis of the built environment unveils a range of cultural strategies undertaken in many cities, from large- to micro-scale, that can be linked to processes of gentrification. In order to stand out and take part in inter-urban competition, cities make use of “starchitects,” innovative design, and “cultural” institutions/developments to give them a competitive edge (Zukin 1995). Flagship developments, including entertainment and business-oriented facilities such as festival marketplaces and entertainment districts (Boyer 1992; Hannigan 1998), sports arenas (Chapin 2004; Noll and Zimbalist 1997), convention centers (Sanders 2002), and office complexes (Fainstein 2011) play an influential and catalytic role in urban regeneration (Bianchini et al. 1992). Many cities have undertaken these types of development strategies as tools for city boosterism and economic revitalization.

These cultural strategies are considered essential in attracting the “creative class” (Florida 2002), as well as stimulating consumer spending. While certain theorists find that cities with a high level of these amenities have grown the fastest and see this as a positive development (Glaeser 2003); others argue that these strategies are predominantly aimed at elite and gentrifying areas or those seeking to attract tourists and thus promote greater social stratification (Zukin 1995; N. Smith 1996).

Critics also argue that the cultural economy drives redevelopment strategies toward the production of commercialized urban spaces, which are in turn geared primarily toward entertainment and tourism (Zukin 1995; Zukin 2009). The consequences of these strategies can be increased property values, gentrification, displacement, and inauthentic places.³ Additionally, Zukin believes that “culture is [...] a powerful means of controlling cities” (Zukin 1995: 1). Controlling cities in this sense refers to deciding who belongs in specific areas of cities and who doesn't. Nevertheless, the aesthetic improvements, city marketing, and economic growth that are associated with cultural development strategies are often touted as the necessary benefits in successful redevelopment projects (Florida 2002; Landry 2008).

Noting the increasing emphasis on the economic benefits of cultural initiatives, scholars have also

³ Susan Fainstein (2001) questions whether “inauthentic” is an appropriate term to criticize new development; arguably, if it reflects underlying social forces, as for instance does Disneyland, then it is genuine.

pointed to the ever-increasing creation of commodified public spaces (Smith 1996; Zukin 1995). Zukin sees the production of cultural spaces in cities as a result of an organized effort among real estate interests, public-private partnerships, and community organizations. Zukin is implying that “middle class tastes” for cultural offerings—artist galleries, ethnic restaurants and shops, historic preservation, and mixed uses—are essentially part of a scripted program designed to increase city revenues and create spaces where the middle class will want to spend their disposable income, perhaps leading to gentrification. The prevalence of ethnic retail has also been shown to catalyze gentrification in Los Angeles and Toronto, where ethnic commodification attracted larger city audiences and served to revalorize local real estate markets (Loukaitou-Sideris 2002; Hackworth and Rekers 2005). Even when the change is ostensibly organic, as in emergent arts districts, planners are often working in tandem with artists and others to create economic development (Chapple, Jackson, and Martin 2010).

Finding: Cultural strategies can transform places, creating new economic value but at the same time displacing existing meanings.

Commercial and Retail Gentrification

Changes in the commercial environment of gentrifying neighborhoods have been seen as both an instigator and consequence of residential demographic change (Chapple and Jacobus 2009). Researchers have shown that retail and commercial amenities signal to middle-class residents that a low-income neighborhood is changing, consequently attracting new residents (Brown-Saracino 2004). On the other side, the shifting buying power and cultural preferences of new residents in gentrifying neighborhoods may influence the mix of retail in nearby commercial corridors (Chapple and Jacobus 2009).

At first, residents may have a positive response if new retail and services provide desired goods that were previously not available (such as Starbucks, CVS, etc.) and if that provokes only minimal displacement of other retail (Sullivan and Shaw 2011; Freeman 2006). However, new commercial amenities in gentrifying neighborhoods also imply rising property values, as well as an influx of white and middle-class residents, creating conditions for direct displacement through competition or rising rent (Zukin 2009). This association seems appropriate as local amenities, such as retail businesses, have been found to play an important role in household residential choice (Fischel 1985; Kolko, 2011).

Generally, commercial gentrification of urban areas involves complex issues of social class, cultural capital, and race (Zukin 2009: 48). Besides responding to a different consumer base, changes in the retail landscape reflect structural changes in the retail industry. Many scholars believe that commercial gentrification results in the disappearance of small, mom-and-pop stores and the arrival of national chains, such as CVS, Starbucks, Target (Loretta Lees 2003; Zukin et al. 2009; Fishman 2006; Bloom n.d.). Chains are usually interested in commercial districts at the mature end of any revitalization timeline: places with high foot traffic and strong demographics (Bloom, n.d.). Overall commercial rents increase because as local retail spending increases, more businesses compete to capture it (Kennedy and Leonard 2001; Chapple and Jacobus 2009).

The increase in rents can push out local businesses that are not drawing the same traffic as the chain stores and not generating similarly high sales volume. These local businesses may have had higher multiplier effects on the area, due to reliance on local suppliers and the recirculation of business owner profits (Civic Economics 2012). However, chains can also create their own customer traffic and that additional traffic can have positive effects on nearby businesses: as more

customers come into the commercial district, they encounter other businesses along the way (Bloom, n.d.). Moreover, they benefit consumers by offering goods and services at lower prices, likely offsetting any losses in the local multiplier. Others suggest that an influx of national chains can also indicate the changing corporate views of the commercial viability of the inner city (Porter 1995). Still, when Walmart or other big-box retailers come to town, there is net job and business loss, as well as decreases in retail wages (Dube, Lester, and Eidlin 2007; Ficano 2013; Haltiwanger, Jarmin, and Krizan 2010; Neumark, Zhang, and Ciccarella 2008).

Empirical studies on the nature of commercial change in gentrifying neighborhoods are mixed and scarce. Koebel (2002) measured the factors influencing changes in the number of neighborhood retail and service businesses in six cities, finding little relationship with neighborhood economic (e.g., median income) factors. Instead, he found that a substantial amount of the change in neighborhood commerce was related to property and location characteristics (such as redevelopment or revitalization projects). In contrast, Chapple and Jacobus (2009) found that overall retail establishment growth in the San Francisco Bay Area was associated with neighborhoods becoming middle- or upper-income rather than those that became bipolar. Meltzer and Schuetz (2011) analyzed changes among neighborhood businesses in New York City, finding that retail access improved rapidly in low-home-value neighborhoods that experienced upgrading or gentrification. The authors suggest that these results indicate that retail is quite sensitive to changes in neighborhood economic and demographic characteristics (Meltzer and Schuetz 2011). Finally, a study comparing retail change in California found that in gentrifying neighborhoods, new businesses grew more (in employment) than existing businesses in the 1990s, but not in the 2000s (Plowman 2014). This suggests the importance of extending the timeframe for the analysis of neighborhood change.

The relationship between transit-oriented districts and retail gentrification is similarly understudied. Recently, Schuetz (2014) asked if new rail transit stations in California resulted in changes in retail employment, finding little support for such relationships. However, the absence of parking was found to be significantly associated with a decline in retail employment. Finally, in their analysis of the effects of TOD investments on small and ethnically owned businesses in Los Angeles County, Paul Ong and collaborators found that growth in Asian and small commercial establishments in TODs lagged behind the county average, despite the fact that real estate activity was higher in the TODs than for the county (Ong, Pech, and Ray 2014).

Finding: Commercial gentrification can also transform a neighborhood's meaning, but research is mixed on whether it is positive or negative for existing residents and businesses.

The Role of Public Investments in Neighborhood Ascent

The vast majority of gentrification literature has focused on private actors and capital. However, the public sector plays an important role in neighborhood transformation. While we have detailed the study of urban renewal and federal programs as part of the discourse on neighborhood decline, government has had a strong hand in neighborhood improvement as well, investing in physical infrastructure such as rail transit, schools, parks, and highways, as well as neighborhood-based organizations. These initiatives date from at least the 1950s urban renewal and public housing development and include more recent interventions like the Empowerment Zones of the 1980s and 90s, HOPE VI in the 1990s and early 2000s, and today's Choice Neighborhoods and Promise Zones programs, among many others.

As described above, in the 1980s persistent poverty in inner-city areas, particularly among the African-American community, led to extensive scholarly inquiry, and federal housing policy realigned to focus on the deconcentration of poverty through the development of mixed-income housing and housing mobility programs (Goetz 2003). This shift in federal policy “to encourage deconcentration is based on the consensus among policy makers and scholars that high concentrations of very-low-income households in housing” is detrimental (Popkin et al. 2000, 928). Federal programs promoting mixed-income housing development aimed to alleviate poverty, however have had mixed results (Joseph 2006).

Recently, critics of these programs have raised concerns that mixed-income developments displace those living in poverty rather than supporting their social mobility by catalyzing other upgrades and development (Bridge et al. 2012). These critiques have placed government policy and programs at the center of longstanding debates about the catalysts and consequences of neighborhood ascent, suggesting that certain housing policies represent “state-sponsored gentrification” (Bridge, Butler, and Lees 2012).

In addition to federal housing policy, numerous other federal, state, and local government investments have the potential to significantly alter the physical and social makeup of low-income neighborhoods.

Although few studies have looked at the impact of public investments on neighborhood demographic change, there is a significant body of literature on the impact of transit on property values, which is intimately tied to the social status of the people who live there. In the next section we review the relevant body of literature to begin to relate public investments in infrastructure to neighborhood demographic change, with a specific focus on transit.

Rail Transit

Transit and transit-oriented districts (TODs) are viewed as desirable amenities in urban neighborhoods due to their accessibility. Scholars have found that areas adjacent to transit stops often experience thriving commercial activity with the introduction of shops, restaurants, and other businesses that attract commuters and non-commuters (Bluestone, Stevenson, and Williams 2008). However, disadvantages also exist from being “too close” to transit, which can result in heightened noise, congestion, pollution, and traffic (Cervero 2006; Kilpatrick et al. 2007).

In a review of existing research on the topic, (Giuliano and Agarwal 2010) state that, “the literature does not establish unambiguously whether or not rail transit investments get capitalized in property values.” They attribute inconsistent findings in part to differences in research methods and in the local conditions in which transit investments are made. They note that transit systems have an appreciable impact on accessibility only where road networks are insufficient for handling travel demands (i.e., where congestion is severe). Other researchers, however, argue that the accessibility benefits of living near transit outweigh the potential nuisance effects, and that proximity to public transit often leads to higher home values and rents (Wardrip 2011).

Most empirical studies on the impact of transportation investments focus on changes in property values rather than land use, household, or racial transition. (Landis et al. 1995) suggest this may be due to the fact that property value data is more widely available than data such as land use. In general, the literature agrees that transport investments (new stations, TODs) have economic benefits primarily if they improve access significantly. Households with easy access to public transit

are able to spend less on transportation and can thus afford to spend more on housing (Kilpatrick et al. 2007). Economic theory suggests that the value of decreased travel time should be reflected in home prices, as reviewed in Hess and Almeida (2007). Benefits tend to be the highest near, but not too near, network access points such as rail stations or freeway ramps.

Several recent literature reviews have summarized research related to the home price premiums that come with proximity to transit. These premiums vary significantly. (Cervero and Duncan 2004) found that the premium for home prices ranged from 6 percent to 45 percent (2004). Another literature review set the range between 3 percent and 40 percent (Diaz 1999). A third review, involving heavy and light rail systems only, found a maximum premium of 32 percent, although some studies found no effect, while others found negative effects (Hess and Almeida 2007). Summarizing the available research is difficult, because as (Duncan 2008, 121) argues, generalization is problematic owing to different methodologies and contexts. He concludes: “The most that one might safely generalize from the body of literature is that properties near stations sell at small to modest premiums (somewhere between 0% and 10%).”

There are two common methods to study the effect of transit proximity on housing costs. One is to compare residential prices near transit with similar homes farther away, using a hedonic price model to separate out the effects of housing characteristics from the impact of location.⁴ The other method, “Pre/Post studies,” which examines prices in an area before and after the initiation of transit, represents another, albeit less utilized, method to examine the effect of transit on housing costs.

In hedonic price models, the independent variable for modeling the price effects of transit is most often the distance from the nearest transit station (Chatman, Tulach, and Kim 2012; Duncan 2008; Cervero and Duncan 2002a), measured along streets or in terms of distance rings. Two earlier studies from Toronto have utilized weighted travel-time-based measures as an alternative to distance travelled (Bajic 1983; Dewees 1976). Hedonic price models may also use monetary savings⁵ as an independent variable, inquiring how travelers respond when faced with a tradeoff between time and money, for example, when offered the option to pay extra for a faster trip (Nelson 1992; Lewis-Workman and Brod 1997; Chen, Rufolo, and Dueker 1998; Gatzlaff and Smith 1993; Wardman 2004). “Pre/Post” studies, although less commonly used because they require access to longitudinal data (Chatman et al. 2012), are considered “more optimal” because they make it easier to establish causal links (Duncan 2010: 5). A summary of the literature using hedonic price models and “Pre/Post” studies is included in the Appendix B.

Overall, the impact of transit on home values can vary depending on a number of mediating factors. Wardrip (2011) outlines several reasons, which include: housing tenure and type, the extent and reliability of the transit system, the strength of the housing market, the nature of the surrounding development, and so on. In an area with a strong housing market and a reliable transit system, the price premium may be much higher than the average. Additionally, effects may vary for different stations within a single market. For instance, averages can hide a lot of variation, and transit

⁴ The basic premise of the hedonic pricing method is that the price of a marketed good is related to its characteristics. In the case of housing, this relates to square footage, number of rooms, amenities, etc. (http://www.ecosystemvaluation.org/hedonic_pricing.htm).

⁵ Total travel time costs are the product of the amount of time (minutes or hours) multiplied by unit costs (measured as cents per minute or dollars per hour). Generally, travel time unit costs are calculated relative to average wages (Litman, 2011: 4). Personal travel time unit costs are usually estimated at 25-50% of prevailing wage rates, with variations due to factors such as age, income, or length of commute (Waters 1992; Litman 2007).

stations may have little or no impact on housing prices in some neighborhoods but a significant impact in others (Wardrip 2011). Some studies have also found that transit expansion plans may drive increases in property values before anything is built (Knaap, Ding, and Hopkins 2001). Finally, research suggests that heavy rail systems have a greater impact on property values than light rail systems. This is likely due to heavy rail's greater frequency, speed, and scope of service as compared to most light rail networks, as reviewed by (Brinckerhoff 2001; Lewis-Workman and Brod 1997; Landis et al. 1995).

Rail impacts on Commercial Land Values

Most studies have focused on the impact of transit investment on residential properties. However, a few studies have examined the relationship between transit and commercial property values. A study of Northern California's Santa Clara County light-rail system found that properties within a half-mile of stations experienced rent premiums, and those that were a quarter- to a half-mile away were worth even more (Weinberger 2001). In another study of Santa Clara, (Cervero and Duncan 2002b) found that the commercial property land values were higher for commuter rail access than for light-rail access, which is the opposite result observed for apartments in the same city (Cervero and Duncan 2002c). In a meta-analysis of existing studies, Debrezion, Pels, and Rietveld (2007) found that commercial properties within a quarter-mile of the station were 12.2% more expensive than residential properties located the same distance away. Farther away from the station, residential properties received a higher premium than commercial properties.

Finding: New fixed-rail transit has a generally positive effect on both residential and commercial property values, but its impact varies substantially according to context.

Bus and Bus Rapid Transit

Several scholars have described Bus Rapid Transit (BRT) as an attractive modal transit option (R. B. Diaz and Schneck 2000; Levinson et al. 2002; Polzin and Baltes 2002; Vuchic 2002). The attributes favoring BRT are its lower capital cost relative to other modes (such as fixed rail) (US GAO 2001) as well as its flexibility in implementation and operation (Jarzab, Lightbody, and Maeda 2002).

There is limited evidence about the relationship between land values and BRT (Rodriguez and Targa 2004; Johnson 2003). Similarly, traditional bus service is rarely considered when discussing the impact of transit on housing costs. In their review of the literature, Hess and Almeida (2007, 1043) explain that "...property values near bus routes have only modest gains, if any, from transit proximity, because most bus routes lack the permanence of fixed infrastructure."

Much attention and research has been focused on Bogota, Colombia's BRT TransMilenio. What makes TransMilenio an interesting case study is that affordable transport was coupled with affordable housing initiatives. This has been made possible with an innovative land-banking/poverty-alleviation program, called Metrovivienda, which was introduced in 1999 (Cervero 2005). Under this program, the city acquires land and provides public utilities, roads, and open space. Afterwards property is sold to developers with the stipulation that average prices be kept under a certain price and affordable to families with incomes of US\$200 per month. An important aspect of the Metrovivienda program is the acquisition of land well in advance of the arrival of the BRT services. This has enabled the organization to acquire land before prices become inflated by the arrival of the BRT. This is important because, as a recent study found, those residing close to TransMilenio stations pay higher monthly rents: on average, housing prices fell between 6.8 and 9.3 percent for every five minutes' increase in walking time to a station (Cervero 2005).

Thus, acquiring land in advance has kept prices affordable for low-income households. However, more recent work has shown that by failing to leverage development around BRT stations, the TransMilenio system has created regional mobility at the expense of accessibility for the poor (Cervero 2013).

In North America, the relationship between accessibility to BRT and land values is only examined by a handful of studies focusing on bus priority treatments (high-occupancy-vehicle (HOV)-bus lanes) and transit ways. In an early study, (Knight and Trygg 1977) examined HOV-bus lanes in Washington, D.C.; California; Seattle; and Florida. They relied on previously published reports, interviews, aerial photographs, and other secondary sources available at the time to conclude that exclusive bus lanes incorporated into highways appear to have no impact on either residential or commercial development. A later study by Mullins, Washington, and Stokes (1990) found that the BRT in Ottawa, Canada, appeared to have some effect on land development in areas surrounding stations. A review of studies from Houston, Pittsburgh, Pennsylvania; and San Francisco conducted by Rodriguez and Targa (2004) revealed that bus transit had no impact on either residential or commercial development. A hedonic analysis applied to Los Angeles's BRT, one year after its initiation, did not detect any evidence of benefits to nearby multi-family parcels (Cervero and Duncan 2002a). More recent work, however, found that Los Angeles' Orange BRT Line had an effect on the neighborhood real estate market. Between 2000 and 2012, areas near the Orange Line saw median rent increase by 25% compared to 15% in the control area. Renter occupancy increase by 9% compared to 0% in the control area, and home value increase by 47% compared to 34% in the control area (Brown 2014). No significant differences in median income or household vehicle ownership were found; however, other demographic characteristics (growth, education, and race) were found to significantly change.

Rodriguez and Targa (2004) suggest that these mixed results could be partially explained by the BRT's lack of fixed guideways, as well as the cross-sectional research design and the newness of the service. Indeed, a study of a 25-year-old BRT system in Pittsburgh found a significant price premium for homes selling near it (Perk and Catala 2009). The implication is that where a BRT system can bring lasting improvements in accessibility on par with a fixed-rail transit system, housing markets may respond accordingly.

Finding: Preliminary evidence suggests that BRT has limited or no effects on local property values.

Transit-Induced Gentrification

Although the vast majority of the literature has focused on the impacts of transit investments and planning on real estate value, a number of scholars are beginning to investigate the relationship between transit investments and the demographic shifts common in gentrifying neighborhoods as well (Lin 2002; Chapple 2009; Kahn 2007; Pollack, Bluestone, and Billingham 2010; Dominie 2012; see Appendix D for a summary of L.A.-specific TOD studies and policy reports). Studies have also found that the real estate premiums associated with rail investment can alter the demographic composition of the surrounding neighborhood (R. Diaz 1999; Cervero and Duncan 2004; Lin 2002).

There are several factors that scholars cite as the likely cause of gentrification near transit. The demand-side argument claims that transit is likely to spur gentrification when the new transit modes (rail, bus, etc.) provide a viable alternative to the car, thereby attracting higher-income

households. The reduction in transportation costs for residents is also thought to increase land values, attracting higher-value uses and higher-income residents (TCRP 2004).

The supply-side argument claims that transit is likely to cause gentrification when it counters pre-existing patterns of disinvestment. Thus, gentrification around transit investments is likely to occur when there is a credible commitment to large-scale investment: reinvestment in a disinvested neighborhood is likely when it appears that an actor (a state agency, financial institution, or large landowner) demonstrates a commitment to refurbish the physical environment at a scale capable of influencing the area's land or housing market (Knaap, Ding, and Hopkins 2001; N. Smith 1979). Large transit investments appear to have been used successfully and intentionally to demonstrate this type of commitment (Pollack, Bluestone, and Billingham 2010).

Pollack and coauthors (2010) affirm that transit can be a catalyst for neighborhood renewal, and that such improvements to neighborhood accessibility could potentially “price out” current residents because of rising property values. Despite the connections between improved accessibility, higher property values, and gentrification, only a few studies address these issues explicitly, and few look at issues of income and race (Lin 2002; Kahn 2007; Pollack et al. 2010; Dominie 2012). Thus, while Lin (2002) and Kahn (2007) develop models to explain the relationship between neighborhood gentrification and transit, they do not take into account race and ethnicity. See Appendix C for further detail on these studies.

Other Public Investments

Government investment in a wide range of neighborhood infrastructure and services can also have significant impacts on property values and neighborhood change. In this section we outline the literature on the impact of schools, parks and open spaces, and highways on housing prices.

Schools

The quality of public schools is widely believed to be a key determinant of housing prices (Max 2004). A number of studies employ hedonic regression models to examine this relationship. In 1969, Oates documented a positive relationship between school expenditures and housing values in 53 northern New Jersey municipalities. Following Oates' work, a number of researchers have estimated similar relationships. Most of these studies have produced similar findings. For instance Dubin and Goodman (1982) estimated the impact of school performance and crime measures on housing prices in Baltimore, finding a significant relationship between real estate value and school characteristics such as the pupil-to-staff ratio, average teacher experience, percent of staff with a graduate degree, and third and fifth grade test scores. In Minnesota, Reback (2005) identified the capitalization effects of a school choice program, finding that the adoption of an inter-district open enrollment policy weakened the link between local school quality and property values.

Parks and Open Spaces

Extensive research has tried to value urban parks, forests, and open space through analysis of property data and stated preferences. The majority of these studies use hedonic analysis of property sales data, finding that home values increase with proximity to a park (Bolitzer and Netusil 2000; Acharya and Bennett 2001; Lutzenhiser and Netusil 2001; Troy and Grove 2008; V. K. Smith, Poulos, and Kim 2002) looked specifically at the price effects of urban greenways, or linear

areas of open space along rivers, streams, or abandoned railroad corridors in Austin, finding such adjacency resulted in significant increases in property values. Studies often distinguish broadly between protected open space, such as public parks and land under conservation easement, and developable open space, such as privately owned agricultural land (Irwin and Bockstael 2001; Irwin 2002; Geoghegan 2002; Bucholtz, Geoghegan, and Lynch 2003). This difference is relevant because studies have found that preserved open space surrounding a home increases home value, while developable open space has a lesser, insignificant, or negative effect on home value (Anderson and West 2006). Finally, in a study of Baltimore, Troy and Grove (2008) found that crime is a critical factor conditioning how residents perceive parks and how this is reflected in the housing market.

Highways

Studies of the impact of highways on nearby land and housing values date to the beginnings of the Interstate Highway Program (Adkins 1959; Mohring 1961). Huang (1994) reviewed the hedonic price literature, finding that studies from the 1950s and 1960s usually revealed large land price increases near major highway projects. Later studies, from the 1970s and the 1980s, typically showed smaller and often statistically insignificant land price effects from highway projects. Both Giuliano (1989) and Huang (1994) argued that this happens because as the highway system was developed in many urban areas, the value of access to any particular highway was reduced because accessibility was then generally good throughout the network. Huang (1994) also noted that for residential properties, noise and other disamenities reduce the value of locating close to a highway. Finally, using access rather than distance, Voith (1993) found that highway access (measured by travel time by highway to downtown) influenced housing prices in the Philadelphia area and that the magnitude of that effect increased during the 1980s.

Finding: Proximity to high quality schools and parks, as well as access to highways, increases home values.

Understanding Negative Impacts of Gentrification: Displacement

Gentrification scholarship has used primarily qualitative research methods to uncover the causes and reveal the motivations of individual actors in neighborhoods. Unlike scholarly discourse on decline and revitalization in the 1950s and 1960s, the gentrification debates since the 1970s have largely neglected the public sector. Attention is shifting today, however, as increasingly, particular kinds of federal investments – specifically in mixed-income housing – have raised questions about state-sponsored or -catalyzed gentrification. The primary concern of gentrification is one of its negative outcomes: displacement⁶. Given today's landscape of public investment, advocates and scholars are increasingly concerned that public investments may create a situation in which incumbent residents have fewer options than they did before and are forced out or cannot move in.

To fully understand this concern, we now turn to review the literature on displacement. This literature has dominated much discussion by gentrification scholars since the early 1990s, and represents a departure from the methods employed until then. As we will describe, scholars

⁶ Other negative consequences of gentrification that are not reviewed here include a sense of loss of place and belonging and erosion of social networks, community resources, and political power, among others.

became increasingly concerned with measuring displacement, assessing its extent, and predicting it as a result of first public and then private revitalization efforts.

Consistently activists, residents, and social justice actors identify displacement as the biggest impact of concern resulting from neighborhood revitalization and gentrification. Anxieties about residential, retail, and job displacement reflect the lived experience of neighborhood change and the social memory of displacements past. Yet social science research attempting to quantify the scale and nature of residential displacement has come up short. Why the discrepancy?

In this section we review the body of research on residential displacement related to gentrification, neighborhood investment, and revitalization. By tracing attempts to define and measure displacement, we highlight significant methodological limitations including data availability and narrow definitions of displacement and explore specific interpretations of the significance of displacement, which potentially mask the impacts on communities.

Defining Residential Displacement

The Federal Urban Renewal program, local redevelopment efforts, and interstate highway construction of the 1950s and 60s forcibly displaced communities of color and low-income communities in urban neighborhoods en masse. Following these policy efforts, urban activists were particularly sensitive to the risks of displacement and the role of government in facilitating displacement. However, the nature of this displacement in the 1970s was no longer solely driven by forced removal by public action. Instead, a growing “back to the city” trend perceived to be largely driven by private actions and individual preferences, albeit with significant yet perhaps more subtle influences from the public sector⁷, began to dominate the public concerns with neighborhood change and residential displacement (Clay 1979).

In 1978 the United States Department of Housing and Urban Development (HUD) sponsored the first of a series of reports on revitalization and displacement called “Urban Displacement: A Reconnaissance” (Grier and Grier 1978). In this report, authors Eunice and George Grier listed 25 factors that might lead to the involuntary movement of people from their place of residence (Figure 1.1). These factors imply a diverse set of actors: natural disasters; building owners who initiate condominium conversion or rent increases; local government conducting proactive code enforcement and planning decisions; federal government initiating large-scale urban renewal; and banks engaging in redlining practices, to name a few.

⁷ Although large-scale urban renewal has dominated the social imagination about the ways in which the public sector can influence neighborhood change and displacement, myriad public interventions can influence the composition of neighborhoods: from tax abatement programs to zoning decisions and pro-active code enforcement.

- Abandonment
- Accidental fire
- Airport construction or expansion
- Arson
- Code enforcement (incl. overcrowding)
- Conversion of rental apartments to condominiums
- Demolition to make way for new housing
- Demolition for safety/health reasons
- Foreclosure
- Highway or transit constructions/ expansion
- Historic area designation
- Institutional expansion (universities/hospitals, etc)
- Military base expansion
- Natural disaster
- Partition sales
- Planning and zoning decisions
- Public building construction
- Redlining
- Rehabilitation (private market)
- Rehabilitation (publicly aided)
- Renovation of public housing
- Rising market prices and rents
- School construction
- Urban renewal
- Withdrawal of private services from neighborhood or structure

Figure 1.1 “Some Conditions Resulting in Displacement in Urban Neighborhoods”

Source: (Grier and Grier 1978, 2)

In an effort to provide a definition of displacement that encompasses these various drivers, Grier and Grier proposed the following definition, which has been adopted by numerous researchers and agencies in subsequent decades:

“Displacement occurs when any household is forced to move from its residence by conditions which affect the dwelling or immediate surroundings, and which:

- 1) are beyond the household’s reasonable ability to control or prevent;
 - 2) occur despite the household’s having met all previously-imposed conditions of occupancy; and
 - 3) make continued occupancy by that household impossible, hazardous or unaffordable.”
- (Grier and Grier 1978, 8)

Although they use the term “forced” in their definition of displacement, Grier and Grier do not equate “forced” with involuntary. In fact, they describe the fact that many who are displaced are subject to a variety of actions or inactions that can be frank or subtle, therefore concluding:

“For most residents to move under such conditions is about as ‘voluntary’ as is swerving one’s car to avoid an accident. By the time the landlord issues notices of eviction, or the code inspector posts the structure as uninhabitable, few occupants may be left. Therefore we cannot define displacement simply in terms of legal or administrative actions – or even draw a clear-cut line between ‘voluntary’ and ‘involuntary’ movement.” (p.3)

Newman and Owen (1982) extend the critique of the false distinction between voluntary and involuntary moves to moves driven by economic reasons when stating that “low-income households who experience extremely large rent increases may technically ‘choose’ to move, but the likelihood that they had any real alternative is very small” (p.137).

In an effort to categorize the causes of displacement, Grier and Grier distinguish between disinvestment displacement, reinvestment displacement, and displacement caused by enhanced housing market competition, despite their obvious inter-connections. Disinvestment-related displacement describe the conditions under which the value of a property does not justify investing in its maintenance, thereby resulting in decay and abandonment. Reinvestment-related displacement refers to the case where investments in a neighborhood result in increased rent to a point where it’s profitable to sell or raise the rent, and tenants are forced to leave. The authors are

careful to note that “unrelated as they seem, these two conditions of displacement may be successive stages in the cycle of neighborhood change” (p.3). Finally, enhanced housing market competition referred to broad shifts in the national and regional housing market, which they argue have an even larger impact than disinvestment or reinvestment forces, although again acknowledging the inter-relationship among the three. As an example they discuss the needs of the then-young baby boom generation that were not being met by housing production of mostly single-family suburban homes, thus resulting in pressures on the pre-existing urban housing stock.

The distinctions in these three types of displacement pressures resurfaced eight years later when Peter Marcuse analyzed displacement in New York City (Marcuse 1986). Marcuse argued that when looking at the relationship between gentrification and displacement one must first consider the disinvestment of urban neighborhoods and subsequent displacement, which makes land ripe for investment with gentrification of “vacant” land. From this perspective gentrification can happen long after abandonment-induced displacement. Therefore, he argues, most gentrification-induced displacement studies significantly underestimated the magnitude of the problem and therefore “chains” of displacement must be considered. He further distinguishes between displacement caused by physical reasons (e.g., water is turned off, evictions, rehab, etc.) and economic causes (e.g., rising rent). In addition, Marcuse introduces the concept of exclusionary displacement, modifying Grier and Grier’s definition of displacement to define exclusionary displacement as:

“Exclusionary displacement from gentrification occurs when any household is not permitted to move into a dwelling, by a change in conditions, which affect that dwelling or its immediate surroundings, which:

- a) is beyond the household’s reasonable ability to control or prevent;
- b) occur despite the household’s being able to meet all previously-imposed conditions of occupancy;
- c) differs significantly and in a spatially concentrated fashion from changes in the housing market as a whole; and
- d) makes occupancy by that household impossible, hazardous or unaffordable.” (p. 156)

Although Marcuse’s four categories of displacement (e.g., direct/physical, direct/economic, chains of displacement, and exclusionary) provide the most comprehensive definition available, he warns that to sum across the categories would lead to an over-estimate of displacement as there is considerable overlap between them; yet to exclude any source could produce an underestimate.

Despite these early attempts to define displacement and the fact that most authors have formally adopted one or the other definition, in operationalizing the term for the means of study, most researchers have narrowly defined displacement as evictions or unaffordable price increases. This narrow focus stems from two factors. Researchers have access to limited data and are challenged to impute the motivation behind household moves. Tracking which exits from a neighborhood are displacement-motivated is difficult; measuring displacement is akin to “measuring the invisible” as the population under question has moved away from the place of study (Atkinson 2000). Perhaps because of this, definitions and operationalization of displacement is often driven by the data available. Furthermore, scholars often define displacement based on the scope and sponsor of their research agenda. For instance, many of the early HUD-funded studies on displacement were specifically concerned with the role of HUD programs in residential displacement and therefore narrowly defined it as displacement resulting from public action (US HUD 1979). Another study (Schill, Nathan, and Persaud 1983) that focused on revitalization-induced displacement defined displacement as that occurring as a result of “neighborhood reinvestment or upgrading” (p.47).

For the purposes of this literature review we do not adopt a singular definition of displacement. In our effort to review and evaluate the disparate literature on residential displacement, however, we adopt the framework of Marcuse (1986) and Grier and Grier to classify the types of displacement studies analyzed. As each of the studies reviewed below utilizes slightly different definitions of displacement in their analysis, we make a point to highlight their operating definitions in addition to the methods and results of their study.

Finding: Displacement takes many different forms—direct and indirect, physical or economic, and exclusionary—and may result from either investment or disinvestment.

Measuring Residential Displacement

Researchers have varied in their approaches to studying gentrification/revitalization-induced displacement. Studies use qualitative and quantitative methods to answer a variety of questions ranging from the nature of displacement (e.g., how many and who gets displaced, where they move to, who is most vulnerable, and so on) to the causes (e.g., changes in rent, conversions to condos, disinvestment, and the like.) and consequences of displacement (e.g., neighborhood destabilization, re-segregation, crowding, disparities in rent burdens, satisfaction with new neighborhoods, and so on). For most of the studies reviewed, a number of questions are addressed in each, making it challenging to categorize studies by the questions they seek to answer. Instead, we review the studies on residential displacement chronologically; because of shifts in understanding and interests, data availability, and statistical methods, the timing of the study largely coincides with methodological approaches.

In the following sections, we review specific studies and then compare across studies to identify common methodological challenges, persistent gaps in inquiry, and promising indicators to include in our research. We proceed by summarizing relevant studies on displacement along the following dimensions: a) the context in which the studies were undertaken and the resultant questions that preoccupied them, b) the research approach, c) the source and type of data used, d) their working definition of displacement and gentrification/revitalization, e) their results, and f) the strengths and shortcomings of the study.

As mentioned above, quantitative studies on displacement found their origins in the late 1970s as urban America was witnessing a wave of downtown reinvestment following the urban crises. Because of the newness of the phenomenon, many early studies on displacement were concerned with quantifying its magnitude to determine if it was a “significant” phenomenon. In the late 1970s, for instance, HUD was actively considering the adoption of policies to address displacement associated with HUD’s programs. In the 1979 “Displacement Report” they reviewed a series of case studies and national datasets to evaluate the nature and magnitude of the “displacement problem.” Although it cited Grier and Grier’s definition of displacement, the report mostly focused on displacement occurring as a result of eminent domain related to federal, state, or local government activity. Emphasis was placed on the results from the nationally representative American Housing Survey from which the report estimated that nationally, independent of neighborhood or city of residence and independent of the vulnerability of the household (i.e., income or race) over half a million households were displaced each year. When evaluated in light of the fact that 20% of all United States households move each year and in conjunction with data on the scale of urban revitalization the HUD report concluded that “the population and economic trends represented by ‘revitalization’ in urban areas are far too small to slow significantly or to reverse the movement to the suburbs and the loss of economic activity by central cities” (US HUD 1979, iii). These

conclusions were reached despite citing evidence from case studies in revitalizing neighborhoods in Seattle and Washington, D.C., which showed that nearly 20% of people moving out of revitalizing neighborhoods were displaced. This early study and its ambiguous criteria against which it evaluated the “significance” of the displacement phenomenon would prove to be a common theme in future studies that have displayed a lack of transparency and little consistency in how to assess displacement’s significance.

One of the outcomes of HUD’s initiative, however, was to invest in a series of research studies to better understand and quantify the magnitude and impacts of neighborhood revitalization and displacement. Two HUD-funded studies stand out for their methodological rigor. These studies identified and surveyed displaced households from revitalizing neighborhoods to find out their reasons for moving out. The first, a study of “Market Generated Displacement” (NIAS 1981), was concerned with the rapid revitalization of San Francisco’s Hayes Valley neighborhood and the potential impacts on pre-existing residents. The researchers conducted a survey of previous residents who left the neighborhood, new residents who moved in, and residents who remained. They found that from 1975-1979, one out of four of the out- and intra-neighborhood movers from their sample were displaced, which they defined as any non-voluntary reason for moving except lifecycle factors (i.e., divorce, unemployment). They also found that displacees of Hayes Valley were more likely to be black, less educated, poor, renters, elderly, and living alone in comparison to in-movers and stayers. Displacees moved out for a variety of reasons, including investment-related causes (i.e., rising rent, eviction, condo-conversion), but also disinvestment-related reasons (i.e., crime, poor housing quality, poor schools.), calling into question both the nature and timing of neighborhood revitalization, disinvestment, and displacement, making it hard to identify a linear relationship or a before and after period. They did not, however, explicitly link information on the public or private revitalization investments in the neighborhood with displacement, and their study lacked any comparison to non-revitalizing neighborhoods, thereby limiting their ability to contextualize their results on the displacement impacts of revitalization.

Asking similar questions about the impacts of revitalization on residential displacement, in 1983 Michael Schill and coauthors published a study on displacement trends in nine revitalizing neighborhoods of five cities⁸ (Schill, Nathan, and Persaud 1983). They surveyed and interviewed out-movers from these neighborhoods to better understand the frequency and effects of neighborhood reinvestment. From this sample, they found that 23% of out-movers in 1978-80 were displaced, which they defined as the following reasons for moving out of their neighborhood: 1) the rent was increased too much, 2) they were evicted or 3) the house they were renting was sold. Using statistical regression, Schill and coauthors found that crowding, frequency of previous moves, unemployment, and marital status predicted displacement. Although they conclude that the “advantages of neighborhood reinvestment outweighed its disadvantages” (p.7), their research also suffered from data limitations given the potential under-sampling of the most vulnerable and more transient households, since they were less likely to be detected by the door-to-door canvass used to construct the list of out-movers, as well as the absence of control neighborhoods. Furthermore, these authors look only at a two-year timeframe and do not define the stage of revitalization each of the neighborhoods were experiencing, thereby potentially missing what Marcuse would describe as chains of displacement, in addition to ignoring exclusionary displacement effects of revitalization.

In one of the first studies to try to estimate the national displacement rate associated with urban revitalization, Newman and Owens (1982) used longitudinal data from the Panel Study on Income Dynamics to estimate the scale, nature, and impacts of displacement. They considered people to be

⁸ Boston, Cincinnati, Richmond, Virginia, Seattle, and Denver

displaced if they moved out of their previous residence because of: the conditions of the house/neighborhood, public action, and eviction by the landlord because of sale or reoccupation. Newman and Owens found that the average annual rate of displacement between 1970 and 1977 was roughly 1 percent, however when calculated as a fraction of all families who moved, the proportion was 5 percent and of urban families 8.2 percent. Using this dataset the authors were able to follow people over time, yet they lacked information on neighborhood conditions, thereby limiting their ability to make inferences about revitalization-induced displacement.

Research on gentrification and displacement waned in the late 1980s and early 1990s. However, in many respects the economic boom of the 1990s reinvigorated both the revitalization of downtown areas and the study of gentrification-induced displacement. Although sharing in some of the questions and methodologies of the previous literature, the new wave of displacement studies capitalized on larger, more detailed datasets, allowing for the introduction of control neighborhoods and the use of more advanced statistical techniques in an attempt tease out the independent effects of gentrification on residential displacement. Many of these studies also pay much closer attention to the impacts on disadvantaged households rather than studying displacement of the general population.

In one of the first attempts to use more detailed, disaggregate data to understand the displacement impacts of gentrification, Rowland Atkinson (2000) combined cross-sectional and disaggregate longitudinal census data for London. To proxy gentrification, he used increases in the number of professionals and managers in the neighborhood and approximated displacement by decreases in the number of residents from the following vulnerable groups: working class, unskilled labor, renters, unemployed, people of color, elderly and single-parent households. From this analysis he found a clear link between the rise in gentrification and displacement of vulnerable groups. Atkinson was one of the first to focus on specific vulnerable populations in his operationalized definition of displacement. Yet he cautioned that the study at the large ward- and district-scale with “noisy” data does little to provide a deeper understanding about the impacts of displacement, for which he suggests more qualitative research.

In response to the growing negative perception about the impacts of gentrification, in 2001 Jacob Vigdor asked if low-status households were more likely to exit housing units in gentrifying zones relative to other parts of the Boston metropolitan area. He analyzed aggregate census data and the American Housing Survey data by running a regression of residential stability on location in a gentrified zone, which had populations of roughly 100,00-200,000 people. Although he did not limit his analysis to this, he generally defined preference-driven gentrification as increased educational attainment and income-driven gentrification as increased owner-occupied housing values. In addition, he did not specify what constitutes displacement, but rather proxied it as any exit from a neighborhood that falls within a general “gentrifying region.” Vigdor found that housing turnover was greater in gentrifying zones; however, educational attainment, which he used as an indicator of poverty, appeared to predict housing stability rather than turnover when interacted with location in a gentrified zone. Furthermore, he found that a poor household was more likely to exit poverty than to be replaced by a non-poor household. Vigdor’s study emphasized the difficulties in characterizing the counterfactual: what would have happened to low-income residents if gentrification had not occurred? He chose to compare the moves of low-status households in gentrifying zones to non-gentrifying zones; however, the large size of the zones could significantly smooth over neighborhood variability, thereby limiting his ability to answer the question he asked. Lance Freeman and Frank Braconi (2004) hailed the potential benefits of affluent households moving back to central cities and sought to help governments evaluate the potential negative consequences of policies to promote gentrification. Applying similar methodologies as Vigdor for

New York City, with the distinct advantage of having a higher spatial resolution and disaggregate data available from the New York City Housing and Vacancy Survey (NYCHVS), the authors compared the exit rates of poor households in gentrifying sub-boroughs (roughly 47,000 households) to the exit rates of the poor in low-income neighborhoods that did not gentrify. They classified a sub-borough as gentrifying based on higher rates of growth in white populations, monthly rent, educational attainment, and median income in contrast to other New York City neighborhoods. They did not, however, include an operational definition of displacement beyond neighborhood exits.

Controlling for life-cycle variables (e.g., age, marital status, children) and housing unit characteristics (e.g., rent, tenure, overcrowding in their regression, they found that poor households residing in gentrifying neighborhoods were less likely to move than poor households residing elsewhere. They do note, however, people moving into gentrifying neighborhoods were of a higher socio-economic status than those leaving. Despite these indications of exclusionary displacement, however, Freeman and Braconi state “a neighborhood could go from a 30% poverty population to 12% in as few as 10 years without any displacement whatsoever, providing that all vacated units are rented by non-poor households” (p.50). The authors also note that their findings could be due to the large spatial area and that the lower rates of residential mobility could be due to a lack of affordable housing in familiar nearby locations. In their later study, Newman and Wyly (2006) critiqued Freeman and Braconi’s findings, pointing to the “chain of displacement” arguments that the “gentrified” neighborhoods had already seen the displacement of poor households in decades earlier. Furthermore, they argue, the non-gentrifying poor neighborhood control groups included residents of some of the poorest areas of the city with respective high turnover rates, creating an artificially high standard to use as a control.

Building off this analysis with a nationally representative sample, in his 2005 analysis of data from the Panel Study on Income Dynamics, Freeman compared displacement in poor gentrifying census tracts to poor census tracts that did not gentrify. He defined gentrifying census tracts as those disinvested, low-income central city tracts that experienced increased investment and educational attainment. Freeman considered displacement-motivated moves as those where residents wanted to consume less space, pay less rent, were evicted, got divorced, joined the armed forces, or other involuntary reasons. Freeman found that rental inflation was a significant predictor of mobility, and displacement was higher in gentrifying as opposed to non-gentrifying tracts. He also found that for in-movers the poverty rates declined and educational levels increased more sharply in gentrifying than in non-gentrifying neighborhoods. Freeman also found that moves originating in gentrifying neighborhoods were more likely to end outside of the neighborhood when compared to the counterfactual non-gentrifying neighborhoods. He defined this pattern, however, as succession (or reverse filtering), rather than exclusionary displacement. Despite his significant findings, Freeman concluded that the overall rate of displacement was very small, since the probability of a household in a gentrifying neighborhood being displaced was “only” 1.3% (Freeman 2005). Given the fact that this data is nationally, not locally representative, the results likely mask a great deal of heterogeneity between metropolitan areas and even within Census tracts.

In response to the media’s interpretation of the previous studies that gentrification benefits all, Newman and Wyly (2006) reanalyzed the NYCHVS data, adding a qualitative component to their research. Given the limitations from the dataset, they were only able to look at the sub-borough in their quantitative analysis. Narrowing their analysis of displacement to households that moved for reasons of housing expense, landlord harassment, and displacement by private action (condo conversion, for example), they found between 6-10% of all moves in New York City from 1989 to 2002 were due to displacement. They argued that this could be a significant underestimate,

however, due to the inability of the NYCHVS data to capture “doubling up” or staying with relatives, which they found from their qualitative analysis to be an important coping strategy. For the qualitative component of their study, the authors interviewed 33 key informants to assess the catalysts for physical, demographic, political, and economic change. Their interviews revealed tremendous displacement pressures resulting in crowding, homelessness, or people moving out of the neighborhood or even city. None of these dynamics, the authors note, were captured in the NYCHVS. Despite the significance of their modeled results, the authors emphasize the low predictive power of the model, which they attribute to deficiencies in the dataset. Furthermore, and similar to the limitations of previous studies, their spatial unit of the sub-borough was too large to fully understand neighborhood dynamics.

In a more recent analysis, McKinnish et al. (2010) analyzed the confidential national Census Long Form data from 1990 and 2000 to understand who moves into and out of gentrifying neighborhoods, which they defined as low-income tracts in 1990 where the average household income increased by more than \$10,000. They did not explicitly define displacement, although they did look at exit rates of specific vulnerable population groups. The authors found that migrants into gentrifying tracts were more likely to be higher-income, college-educated, younger, white, and black, and less likely to be Hispanic, have children, and be immigrants when compared to non-gentrifying low-income tracts. McKinnish and coauthors also found that 33% of the income gains in gentrifying neighborhoods were due to the in-migration of middle-income black households. They found little difference in the in-migration rates of non-college-educated black households between gentrifying and non-gentrifying neighborhoods, leading them to conclude that exclusionary displacement was not occurring. They also found “modestly” high exit of low-education and retention of high-education households in gentrifying neighborhoods. Although this study improved upon previous studies with its access to household-level data, it suffered from methodological limitations of the Census sample size (one in six) that could differ from the census tract populations, the narrow definition of gentrification (including an influx of higher-income residents but not capital, i.e., higher property values), the possibility that neighborhood change may occur at a smaller geography than the census tract, and the masking of geographical variability (e.g., differences between strong- versus weak-market cities).

Wyly and coauthors (2010) updated their 2006 study using more recent NYCHVS data (2002-2008), asking if recent changes in housing assistance and rent regulations altered the choices available to displaced renters. Using slightly modified methods, the authors compared the number of people moving out of a neighborhood to the number of people moving into a neighborhood as a means of analyzing displacement pressures, maintaining their definitions of gentrification and displacement from their previous study. The authors found that annualized displacement rates ranged from a minimum of about 10,000-20,000 households per year; however, they emphasized the considerable uncertainty in these estimates. When comparing their results to local eviction data, the authors estimate that the NYCHVS misses 12 out of 13 displacements. Wyly and coauthors also ran a regression model finding that poor households with high rent burden were nearly twice as likely to have been displaced in comparison to other groups. While their statistical analysis did not find any significant relationship between household composition (for example, race) and displacement, the authors note that “the interwoven relations of urban life should not be obscured by the illusory cleanliness of a multivariate test... Insignificant estimates do not mean that race, gender, or family structure are irrelevant just that they are inextricably bound up with other circumstances” (pg. 2615). Furthermore, they explained that household composition is determined partly by how people and families cope with high housing costs and displacement; that is, the variable is endogenous. Despite certain innovations, this study suffered from some of the same

methodological limitations as their previous study, namely those relating to the geographic resolution of their dataset.

Finally, Ellen and O'Regan (2011) used a nationwide dataset from the American Housing Survey to compare characteristics of households that moved into or out of gentrifying neighborhoods to better understand how and why neighborhoods experience income gains. The longitudinal nature of this dataset, which follows housing units over time, allowed for the researchers to identify the characteristics of households that moved both out of and into gentrifying neighborhoods, which they defined as neighborhoods experiencing a 5% gain in income relative to the metropolitan area. For displacement rates they calculated 2-year exit rates and modeled them as a function of neighborhood income gains controlling for a series of household life-cycle characteristics. They found that neighborhood income gains did not predict household exit rates, even among vulnerable groups. Age, renter, and minority status did predict exit rates for the overall sample, including gentrifying and non-gentrifying tracts. As opposed to other authors (e.g., Newman et al.), Ellen and O'Regan make no mention of the low predictive power of their models (R^2 of 0.122). Instead they take their results to indicate that there is "no evidence that original residents – even renters and poor households – exited these communities at elevated rates" (p.94). The authors suggested that selective entry and exit among homeowners were key drivers of neighborhood change. To some, however, such selective entry would be an indicator of displacement. The most significant shortcomings of this study were the narrow definitions of gentrification (not including private investment), the lack of information about reasons for moving, as well as the masking of geographic variability.

Although varied in their approaches, questions, and results, one consistent finding across these studies is that in-movers to gentrifying neighborhoods are wealthier, whiter, and of higher educational attainment, and out-movers are more likely to be renters, poorer, and people of color. The research also consistently shows that rent appreciation predicts displacement. A number of the above studies also found that government intervention in the housing market through rent stabilization and public housing programs are protective factors limiting the displacement effects of gentrification. However, the studies are not consistent in their finding that gentrification induces displacement. Why the discrepancy? One possible explanation for the unexpected residential stability is that in neighborhoods that are gaining new amenities (along with new residents), the normal neighborhood transition process slows; residents try harder to stay in the neighborhood, even if it means paying more rent in exchange (Chapple 2014). Yet, these higher rent burdens are unlikely to be sustainable over the long term, resulting in displacement in a longer term framework than is typically measured. In the following section we review some of the methodological limitations discussed above as a means to consolidate and advance future research directions.

Finding: Despite severe data and analytic challenges in measuring the extent of displacement, most studies agree that gentrification at a minimum leads to exclusionary displacement and may push out some renters as well.

Challenges to Understanding Displacement

Most studies reviewed here suffer from significant data limitations and consequently limited advances in understanding what drives displacement and how to predict it. In this section we review the most common methodological limitations contributing to the conflicting and ambiguous understanding about the relationship between revitalization/gentrification and residential displacement. Among other limitations, we review the following four below: 1) inconsistent definitions and operationalization of the terms gentrification and displacement, 2) differences in

the definitions of a comparison group and controls to calculate and compare displacement rates, 3) the time-scale of analysis that may not capture the full processes of neighborhood change, 4) ambiguous criteria against which to determine the significance and meaning of research results. Together, these challenges limit the ability of researchers to adequately capture the full magnitude and impact of gentrification and displacement.

Each of the above reviewed studies defined and operationalized the concepts of gentrification and displacement in slightly different ways, not only making it difficult to compare across studies, but also significantly impacting the results achieved. For some, displacement only encompasses evictions, whereas others include such concepts as exclusionary displacement and even chains of displacement (i.e., Millard et al. not reviewed here). The vast majority of studies narrowly define displacement under what Marcuse would classify as physical or economic displacement, but ignore or dismiss exclusionary displacement as simply succession and replacement. This limitation results not only from data and methodological limitations, but also normative understandings of what constitutes forced displacement. Where one study may claim to find evidence of displacement (at least of the exclusionary kind) because in-movers are becoming whiter and more affluent, other authors may define such phenomena as merely succession or replacement. How we define the phenomenon matters for how we interpret the results. Furthermore, the definition and operationalization of gentrification is highly varied, and very few authors attempted to systematically capture the many dimensions of gentrification. In almost all of these studies (with the exception of Freeman), gentrification is proxied for by income change rather than private or public investment. However, an influx of capital into a neighborhood might have much stronger impacts on resident stability than simply higher-income households moving next door. Furthermore, the link between what predicts gentrification and subsequently displacement has not been made. It is important to not only understand if gentrification predicts displacement, but what dimensions of gentrification and what factors spurring gentrification also cause displacement.

Another key limitation is a lack of a consistent and clear identification of a comparison group. While some argue we should be comparing displacement from poor gentrifying neighborhoods to poor non-gentrifying neighborhoods (i.e., Freeman 2005 and Vigdor 2001), others believe we should be comparing to city-wide averages or more stable neighborhoods in general (i.e., Newman and Wyly 2006). Furthermore, some studies calculate displacement as a percentage of all movers or as a percentage of all households, either citywide or by neighborhood. These comparison groups are important because they not only provide a context against which to evaluate results, but also reveal belief systems about our normative understandings of how neighborhoods should function. More and more, researchers are becoming more transparent about the reference population and control groups, which is a trend that needs to continue.

Further obscuring the relationship between gentrification and displacement are the issues of timing. Neighborhood change is a long process, and many of the studies examined above only look at relatively short time periods. In its early phases, gentrification may not result in displacement, but over time, in the absence of protections, tenants may be forced to move. As a result, the principal barrier to studying the relationship is the lack of appropriate panel data to determine the extent of mobility and displacement. Furthermore, if one is to consider the full chains of displacement, as suggested by Marcuse, it would be important to extend our analysis to the period prior to gentrification to carefully consider disinvestment-related displacement as part of the gentrification-displacement phenomenon.

Finally, the review of this literature highlights the lack of any consistent measure or criteria against which to interpret study results. Whereas some studies highlight the low predictive power and

limited interpretability of their modeling results (i.e., Wyly et al. 2010) others barely even report on the statistical significance of their results or, when statistically significant (i.e., Vigdor 2001), minimize the relevance of findings based on the statistical magnitude of the effect. These inconsistencies are not unique to studies of gentrification and displacement, but rather social scientific inquiry in general. This likely highlights the underlying subjective nature of belief systems of social science research. For instance, some authors interpret their statistically significant results of the higher rates of displacement in gentrifying neighborhoods to be too small to be of concern (Freeman 2005). But for other researchers, such results are of concern because they significantly impact real people in real neighborhoods. Whether the impact is large or small is a relative interpretation that lies in the eyes of the beholder. This limitation, which mirrors the differences in the definition of the reference population and control groups, should be carefully examined, made transparent, and its implications should be discussed in any study that has the potential to impact real lives.

Much of the methodological limitations discussed above are ultimately data-driven. Where more detailed disaggregate data exist, it lacks information about households' reasons for moving (i.e., Panel Survey of Income Dynamics (PSID) or the Census long form) and does not have sufficient spatial resolution or coverage to contribute to local knowledge (i.e., National Household Survey). Where local data is available, it may not contain information about where displaced households are displaced from (i.e., NYHVS). Without panel data, it is not possible to understand the nature of turnover in a neighborhood (i.e., whether neighborhood household income changes are occurring to existing residents or newcomers). But even when datasets such as the American Housing Survey (the confidential panel version) or the PSID allow tracking of individual households, their responses to questions about reasons for moving are not precise enough to measure displacement (e.g., there is no answer option for "the landlord raised the rent"). For this reason it is important to not only compare and combine datasets as much as possible but to carefully understand and explore the implications of the data limitations as much as possible.

Finding: Previous studies have failed to build a cumulative understanding of displacement because they have utilized different definitions, compared different populations, and adopted a relatively short timeframe; there is not even agreement on what constitutes a significant effect.

Indicators for Analyzing Residential Displacement

As is evidenced from the above review, researchers have used myriad indicators and sources of data for characterizing residential displacement, each with its own set of advantages and disadvantages. In this section we summarize the types of indicators and data used to analyze such indicators, highlighting the typical sources of such data. Table 1.1 summarizes quantitative data sources only. As discussed above, data on many of the drivers and impacts of gentrification and displacement are not regularly gathered or are hard to quantify. It is therefore important to consider qualitative sources of information to better understand the drivers and impacts of neighborhood change.

Table 1.1 Indicators and Data Sources for Analyzing Gentrification and Displacement

Indicator Type	Indicators	Data sources
Change in property values and rents	Sales value, property value	County tax assessor's office, Department of finance, data aggregator
	Rent	Data aggregators, apartment operating licenses, craigslist
	Changes in availability of restricted affordable housing	HUD, housing departments
Investment in the neighborhood	Building permits, housing starts, renovation permits, absentee ownership	Jurisdiction's building or planning departments
	Mortgage lending and characteristics	HMDA and assessor data
	Sales (volume and price)	County assessor's office, data aggregators
	Condo conversions	Assessor office, housing department, department of public works
	Change in community and business orgs (#, membership, nature of activities, etc.)	Chamber of commerce, NETS, neighborhood or local business associations, etc.
	Public investments (transit, streets, parks, etc.)	Public works departments, transit agencies, parks and rec, etc.
Disinvestment	Building conditions, tenant complaints, vacancies, fires, building condemnation,	Surveys, Census, maps, building departments, utility shut-offs, fire department
	School quality, crime, employment rates, neighborhood opportunity	Department of Education, Police Departments/crime maps, Census, Bureau of Labor Statistics
	Neighborhood quality	Local Surveys
Change in tenure and demographic changes	Tenure type, change in tenancy	Building department, assessor's office, census
	Evictions	Rent board, superior court
	Foreclosure	HUD, proprietary data sources
	Demographics data on in- vs. out-movers (race, ethnicity, age, income, employment, educational achievement, marital status, etc.)	Census, voter registration, real estate directories, surveys, American Housing Survey, DMV
Investment potential	Neighborhood and building characteristics (e.g., age and square footage, improvement-to-land ratio)	Tax assessor, Census, Deeds, etc.
	Neighborhood perceptions	Surveys of residents, realtors, lenders, neighborhood businesses, Newspapers, TV, blogs, etc.
Reasons that people move in/out of 'hood	Reason for move	Surveys of in- and out- movers, HCD housing discrimination complaints database.
Coping strategies / displacement impacts	Crowding/doubling up	Census, utility bills, building footprint
	Increased travel distance and time	Census

Implications for Strong versus Weak Markets

The intensity of gentrification, as well as how it is experienced by local residents, will differ according to market context. Where economic growth is above average and demand for land is strong, new private and public investment can accelerate neighborhood change and push up

property values. This process likely transforms neighborhood meanings and crowds out existing residents. Where the economy is more tepid, the new investment will also transform neighborhoods, but may not have the same displacement effects. The Center for Transit-Oriented Development (2013) has illustrated this market variation: new fixed-rail investments have transformed some neighborhoods while leaving others essentially unchanged.

Yet, the existing literature on gentrification and displacement fails to acknowledge these market differences. Many studies examine strong market cities such as New York, San Francisco, and London, with findings that may not be at all applicable to weaker market regions or even neighboring cities. Although these case studies provide some of the most methodologically rigorous analyses of neighborhood change processes, they do not provide systematic comparisons across market types. Where studies do look across market types, they typically try to predict change across many different metropolitan areas without controlling for local economies. As a result, these more systematic models likely have poor predictive value for individual metros. This in turn raises questions of the utility of these analyses for local policymakers.

Finding: Existing studies rarely account or proxy for regional market strength, which undermines their relevance to particular contexts.

Urban Simulation Models and Neighborhood Change

In recent years, a number of computational models have sought to simulate aspects of neighborhood change associated with gentrification. The models discussed here fall into two broad categories: those that address the phenomenon of gentrification explicitly, and those that focus primarily on processes of residential choice and residential segregation, patterned after Schelling's early model of neighborhood "tipping" along racial lines (Schelling 1971). Roughly following the same division, the simulation models in the literature can also be grouped according to their structure. Models focusing on representing the movement of individuals and households into spatial patterns of settlement tend to be specified through "agent-based models," also referred to in the literature as "multi-agent systems," while models that focus on capturing inter-related patterns of change among spatially fixed entities (such as housing units or entire neighborhoods) tend to be specified through cellular automata (Torrens and Nara 2007). Additionally, a number of hybrid model specifications contain both spatially fixed automata and spatially mobile agents (Torrens and Nara 2007; Diappi and Bolchi 2013). The integrated land use and transportation models utilized by metropolitan planning organizations (e.g., UrbanSim and PECAS) simulate the individual decisions and interactions of agents (e.g., households, businesses), fixed physical characteristics of urban environments (e.g., buildings and transit), as well as larger structural constraints (e.g., land use regulations) (Johnston and McCoy 2006).

Despite their compatibility with the study of residential spatial dynamics, relatively few simulation models have been specified to focus explicitly on gentrification. One explanation for this paucity is the difficulty of adequately incorporating the breadth of social theory needed to account for the range of gentrifying mechanisms (Torrens and Nara 2007). Here we analyze four studies that attempt to simulate neighborhood economic and racial change. In developing the first widely published work on gentrification-based computational models, O'Sullivan (2002) relies heavily on Smith's rent gap theory for specifying the structure of his cellular automata model of gentrification in a region of East London. Specifically, O'Sullivan sets out to model the role of neighborhood status in determining the "gap" in a given parcel's potential and capitalized rents and the gap's impact on states of "for sale," "owner-occupied," "for rent," and "rented" (O'Sullivan 2002; p. 260). In assessing

the performance of the model, O'Sullivan suggests to nest the neighborhood within a broader urban structure, allowing neighborhood status to better reflect position within a wider city hierarchy.

Diappi and Bolchi (2013) model gentrification in Milan through a specification of "active agents," including real estate investors, housing owners and housing tenants; and "passive agents," which they specify as individual buildings. Within this general structure, investor agents choose to develop housing based on citywide assessments of rent gaps, housing owner agents make housing upkeep decisions based on localized market conditions, and tenant agents sort themselves into different housing units based on housing conditions, rents, and their (heterogeneous income-based) ability to pay. Additionally, potential rents are shaped by local amenities and proximity to the city center. Finally, the amount of capital that investor agents have to spend is shaped by exogenous business cycles (Diappi and Bolchi 2013; 89-90).

Similarly, Torrens and Nara, in a simulation of gentrifying change in Salt Lake City, specify properties and aggregations of properties as "fixed automata" and residential households as "mobile automata," which they liken to agents. Torrens and Nara (2007) reference the importance of capital-driven, supply-based approaches to modeling gentrification and include demand-based drivers of gentrification. Within this general framework, they generate nested patterns of behavior between household agents, large neighborhood markets that they chose to either enter or stay in, and specific housing properties within the market of choice. A number of variables drive the dynamics of these moves including spatial amenities and economic prosperity at the market level; price, housing quality, and spatial amenities at the property level; and economic status, amenity preferences, and moving thresholds at the household level. Notably, ethnicity (Latino or non-Latino) is also included as a state variable for both households and properties.

Finally, Jackson and coauthors (2008) utilize an agent-based model to study gentrifying patterns in Boston. While the structure of their model is similar to those of Diappi and Bolchi (2013) and Torrens and Nara, they operationalize gentrifying change as being driven by demand-side consumer decisions, rather than by supply-side development decisions, justifying this approach by pointing to the absence of an observed relationship between large-scale neighborhood investment projects and changes in nearby rents in Boston between 2003 and 2007. The residential dynamics simulated by Jackson et al. are driven by the interactions of four classes of agents: professionals, students, non-professionals, and elderly, each of whom are motivated by varying abilities to pay and preferences for neighborhood composition and amenity access.

The above four models (see Appendix E for further details), while exemplars of computational modeling approaches to gentrification, all suffer from a related set of limitations. First, each of the above models is constrained in its ability to theoretically ground mechanisms of neighborhood change. While the work of O'Sullivan (2002) and Diappi and Bolchi (2013) is well-grounded in Smith's rent gap theory, it does not incorporate competing theories of the drivers of gentrification, notably those focusing on the housing demand of gentrifying populations and their particular set of locational preferences. Similarly, all four models are limited by a lack of important empirical detail, both in their specifications of agent attributes (such as agent incomes and baseline parcel rents), as well as in their specification of neighborhood choice and parcel change mechanisms. An important example of the latter drawback is in the incorporation (or lack thereof) of race and ethnicity in the models. Despite empirical work demonstrating the importance of race above and beyond income in shaping housing decisions (see Charles 2003; Pais, South, and Crowder 2012), the majority of the models covered here do not include any measure of race or ethnicity.

Looking beyond models that explicitly simulate gentrification, a number of computational models examine processes of neighborhood segregation. The seminal model on which much of this work draws upon was specified by Schelling (1971) in an attempt to account for the dynamics of residential segregation between whites and blacks. In his model of residential movement on a simple grid, Schelling demonstrates that when whites and blacks are ascribed thresholds of same-race neighborhood preference, they can generate very sharp patterns of segregation, even when their preference thresholds are relatively innocuous.

More recent efforts have extended on this model in a number of ways (summarized by Huang et al. 2013). For instance, various extensions have modified the structure of neighborhood composition preferences and attached them to empirical estimates of residential preference (Bruch and Mare 2006; Xie and Zhou 2012), situated models in realistic and empirically grounded urban environments (Crooks 2010; Yin 2009), gone beyond binary racial distinctions to include interactions among a greater diversity of agents (Ellis et al. 2012; Clark and Fossett 2008), and incorporated competing sets of non-racial preferences (K. Chen et al. 2005). The range of residential choice mechanisms explored in these model extensions hold the potential to help refine and improve the incorporation of race in simulations of gentrification.

Finally, researchers are beginning to use integrated land use and transportation models to simulate neighborhood composition and gentrification. Using the Simple Integrated Land-Use Orchestrator (SILO) model, Dawkins and Moeckel (2014) analyzed the impact of an inclusionary housing program and more compact development for Washington, D.C., on neighborhood gentrification. The SILO model accounts for household relocation constraints, housing costs, transportation costs, and travel times, but not race and ethnicity. No simulation model to date has been used to explicitly study residential displacement.

Finding: Urban simulation models are guided by consumer decision-making, rather than the development decisions – flows of people rather than capital – and have neglected the role of race; thus they may not capture complex gentrification dynamics.

Moving from Research to Praxis: Prediction and Mitigation

A number of researchers have developed models and analyses to aid activists and governments to better understand, predict, and plan for neighborhood change. One of the earlier iterations of work predicting gentrification is a presentation by researchers from the Urban Institute (Austin Turner and Snow 2001). Analyzing data for the Washington, D.C., area, they identified the following five leading indicators as predictive of future gentrification (defined as sales prices that are above the District's average) as low-priced areas that are: 1) adjacent to higher-priced areas, 2) have good Metro access, 3) contain historic architecture, 4) have large housing units, and 5) experience over 50% appreciation in sales prices between 1994 and 2000. Census tracts were scored for each indicator and then ranked according to the sum of indicators with a maximum value of 5. This ranking system is one of the first recorded attempts to create a policy-relevant tool to analyze and predict gentrification; however, the presentation did not include their methodology nor an evaluation of the results.

In a 2001 discussion paper prepared for the Brookings Institution and PolicyLink, Kennedy and Leonard conducted a literature review, case studies, and stakeholder interviews to determine the

predictors, impacts, and responses to neighborhood gentrification (Kennedy and Leonard 2001). From this research they identified the following factors to be predictive of gentrification:

- | | |
|---|---|
| a) high rate of renters, | h) large rent gap, |
| b) ease of access to job centers, | i) urban amenities, |
| c) high and increasing levels of metropolitan congestion, | j) targeted public sector policies (e.g., tax incentives, public housing revitalization, construction of transit facilities, disposition of city-owned properties, code enforcement, etc.), |
| d) high architectural value, | k) growing preference for urban amenities. |
| e) comparatively low housing values, | |
| f) high job growth, | |
| g) constrained housing supply, | |

In addition, they characterized the following factors as indicative that the process of gentrification was already underway: a) shift in tenure, b) increase in down payment and decrease in FHA financing, c) influx of households interested in urban living, and d) increase in high-income serving amenities such as music clubs, coffee shops, galleries, and the like.

In 2009, sponsored by the Association of Bay Area Governments, Karen Chapple at the Center for Community Innovation (CCI) at UC Berkeley conducted an analysis of neighborhood change in the San Francisco Bay Area from 1990 to 2000 and used the results of this analysis to predict neighborhood susceptibility to gentrification (Chapple 2009). Chapple adopted Freeman's (2005) definition of gentrifying neighborhoods as low-income census tracts in central city locations in 1990 that by 2000 experienced housing appreciation and increased educational attainment above the average of the nine counties in the Bay Area. The author then constructed a multivariate statistical model that had gentrification as the dependent variable, and a set of 19 socio-economic, locational, and built environment factors for 1990 as independent variables⁹. Based on the outcome of the regression, Chapple determined the direction, significance, and rank of the variables. The author assigned a value of 1 if census tracts scored above the regional average for each of the 19 predictive variables and summed across the variables. With a maximum score of 19, tracts were determined highly susceptible if they scored 16 or higher and of moderate susceptibility with scores between 13 and 15. No analysis or prediction of displacement or exit rates was included in this study, as neighborhood gentrification and change was the object of analysis.

The Dukakis Center for Urban and Regional Policy (2010) conducted an analysis transit oriented development and its association with neighborhood gentrification and displacement (Pollack, Bluestone, and Billingham 2010). Analyzing 42 neighborhoods (block groups within a half-mile of a transit station) near rail stations in 12 metro areas across the United States, they studied changes between 1990 and 2000 for neighborhood socio-economic and housing characteristics (e.g., number of units, racial composition, household income, auto ownership, and the like) and compared it to the metropolitan area to determine if patterns in transit-oriented neighborhoods differed significantly (i.e., over 20%) from non-transit-oriented neighborhoods. They found that rail-served neighborhoods were more likely to experience higher rates of growth in population, production of housing units, household incomes, housing costs, in-migration, and car ownership

⁹ % of workers taking transit, density of youth facilities, density of public space, density of small parks, % non-family households, % of dwelling units in buildings with 5+ units, % of dwelling units in buildings with 3-4 units, % renter-occupied, Public housing units, income diversity, % of renters paying > 0.35 of income, distance to San Jose, % of dwelling units with three or more cars available, density of recreational facilities, % married couples with children, % non-Hispanic white, median gross rent, % of owners paying > 0.35 of income, Distance to San Francisco

when compared to the averages for the respective metropolitan areas. To discern whether gentrification occurred more often in neighborhoods with initially high proportions of renters rather than homeowners, they looked for a correlation between the rate of homeownership in 1990 (before the transit station opened) on the one hand and both the percentage change in the non-Hispanic white population between 1990 and 2000 and the percentage change in median household income between 1990 and 2000 on the other. In both cases they found that a higher initial proportion of renters was correlated with a larger change in racial and ethnic composition and larger increases in median household income.

Applying the same methodology he used to study gentrification and displacement in London, in 2011 Atkinson and coauthors characterized household vulnerability to displacement from neighborhoods that gentrified between 2001 and 2006 in the Melbourne and Sydney greater metropolitan areas. A vulnerability score (from 1-13) was measured based on tenure, number of employed persons per household, and occupation, ranking owner-purchaser, two-income, professional households at the least vulnerable end of the scale (1) and working-age private renters not in the labor force at the most vulnerable (13). Displacement rates were calculated by dividing the number of out-migrants with vulnerability characteristics by the number of households with these characteristics exposed to the likelihood of moving in 2001. Gentrified neighborhoods were defined by projecting the population for various sub-groups (e.g., low-income) and comparing projected to actual populations. Neighborhoods that had higher-than-projected numbers of high-income, occupied, and professional populations were designated gentrified.

Building off the same methodology as Chapple (2009), researchers from the Local Initiative Support Corporation (LISC) constructed a model predicting gentrification in neighborhoods of Houston (Winston and Walker 2012). They created a narrower definition of gentrifying neighborhoods by restricting the label to those that experience increases in a neighborhood's median incomes, median housing values, and educational attainment that are at least 10 percent higher than for all Houston neighborhoods. They began with the same list of independent variables (excluding the locational and income diversity ones), and added several others such as percent poverty, vacancy rates as well as dis-amenity variables such as industrial land uses for 1990. In addition, they included in the regression changes in the variables between 1990 and 2000. From this original list of 32 only seven variables¹⁰ were significantly associated with gentrification rates and were included in the susceptibility model. Rather than scoring tracts like CCI, the LISC researchers used the regression coefficients and continuous independent variables in predicting the rate of gentrification, resulting in higher predictive accuracy. Validating their model using 2007 (2005-2009) American Community Survey (ACS) data, they found 86% accuracy for highly susceptible tracts (i.e. those that the model predicted were 75% likely to gentrify) and 60% accuracy for moderate susceptibility (i.e., between 50% and 75% likelihood).

A recent study in Portland by Lisa Bates (2013) set out to predict market changes based on a small set of indicators (vulnerability to displacement, demographic changes, and housing market conditions). She defined tracts as vulnerable to displacement in 2010 when they had higher-than-average populations of renters, communities of color, a lack of college degrees, and lower incomes. For housing market conditions Bates defines neighborhood market typologies as 1) adjacent tracts (low/moderate 2010 value, low-moderate appreciation, touch boundary of high value/appreciation tract), accelerating tracts (low/moderate in 2010 with high appreciation rates), and appreciated

¹⁰ % of non-family households 1990, % of dwelling units in buildings with 5+ units 1990, % of dwelling units with three or more cars available 1990, number of youth facilities, Δ in % of married couples with children 1990 – 2000, Δ in % of non-family households 1990 – 2000, Δ in % of renter-occupied units 1990 – 2000

tracts (low or moderate 1990 values, high 2010 value, high 1990-2010 appreciation). Combining this information with demographic shifts for vulnerability factors (see above) between 2000 and 2010, she identified the following neighborhood typologies:

1. Susceptible tracts: are near high-value and/or high-appreciation tracts, but still have low or moderate home values and appreciation rates. They have vulnerable populations and are not yet experiencing demographic change indicative of gentrification.
2. Early: Type 1 tracts experienced high appreciation rates over the last decade, but still have low or moderate home values. Their populations are vulnerable but no gentrification-related demographic change has occurred.
3. Early: Type 2 tracts are near high-value and/or high-appreciation tracts but still have low or moderate home values and appreciation rates. They have vulnerable populations and have experienced demographic change indicative of gentrification.
4. Dynamic tracts experienced high appreciation rates over the last decade but still have low or moderate home values. They exhibit demographic change indicative of displacement but still have vulnerable populations.
5. Late tracts had low or moderate median home values in 1990, but experienced high appreciation over the last two decades and are now high-value tracts. They have experienced gentrification-related demographic change, but still have populations that are vulnerable.
6. Continued loss tracts are also high-value areas that experienced high appreciation over the last two decades starting from low or moderate 1990 values. They no longer have above-average levels of vulnerable populations, but exhibited high levels of demographic change over the previous period, and remaining vulnerable households may be in a precarious situation.

Bates then uses these typologies to recommend how to tailor policy approaches to the specific characteristics and needs of neighborhoods.

Finally, the Puget Sound Regional Council (PSRC) together with the Center for Transit Oriented Development created a typology of neighborhoods as part of their “Growing Transit Communities” Strategy (PSRC 2013). They constructed a “people profile” and “place profile” matrix and aligned policy responses according to neighborhood typology. The people profile consisted of a social infrastructure/access-to-opportunity axis comprised of a composite indicator of education, economic health, housing and neighborhood quality, mobility and transportation, and health and environment. The other axis - change/displacement - measured risk of displacement due to recent neighborhood change, current community risk factors, and current and future market pressure. Data used to quantify these factors relate to income, education, race and ethnicity, household type, housing tenure, and residential market strength measured at the block group level and were categorized into low, potential, and immediate risk. Low-risk communities tend to be moderate- to higher-income communities and/or communities with lower market pressures. Immediate-risk communities tend to have indications that displacement of lower-income populations has begun, higher current market strength, and/or high number of community risk factors. Potential-risk communities are those that have a weak market strength and therefore do not face imminent displacement risk; however, they also exhibit numerous community risk factors that suggest needs for community stabilization efforts to avoid future displacement risk should market forces change.

The place profile also consisted of two dimensions: the degree to which a transit community’s physical form and activity support a dense and walkable transit community (the physical form+activity/transit orientation axis) and the likelihood that the community will change due to real estate market strength (the change/market strength axis). The physical form+activity/transit

orientation axis measures the degree to which a community's place characteristics are transit-oriented—with a form and activity level that support a dense and walkable community served by high-capacity transit. The composite index includes five sub-measures: pedestrian infrastructure, transit performance, physical form, population, and proximity of a mix of uses. The change/market strength axis measures the strength of the residential transit-oriented development market, which was intended to evaluate the potential demand for residential transit-oriented development, includes measures related to the real estate market, employment patterns, density, and household income and size. Combining the people and place typologies, they identify eight general typologies, for each of which they identified implementation and policy approaches.

Finding: Many different descriptive toolkits offer typologies of neighborhood change, but few have analyzed the causality behind it, limiting the usefulness of such tools to predict and mitigate change.

Chapter 1 Conclusions

Scholarly interest in the relationship between investment and displacement dates back to the 1970s, in the aftermath of displacement related to urban renewal. More recently, a new wave of scholarship examines gentrification, primarily in strong-market cities, and its relationship to public investment, particularly in transit. The results of these studies are mixed, due in part to methodological shortcomings. However, the following findings emerge across the literature:

- Influential early models of neighborhood change present processes of succession and segregation as inevitable, underemphasizing the role of the state.
- Neighborhoods change slowly, but over time are becoming more segregated by income, due in part to macro-level increases in income inequality.
- Racial segregation harms life chances and persists due to patterns of in-migration, “tipping points,” and other processes; however, racial integration is increasing, particularly in growing cities.
- Neighborhood decline results from the interaction of demographic shifts, public policy, and entrenched segregation, and is shaped by metropolitan context.
- Gentrification results from both flows of capital and people. The extent to which gentrification is linked to racial transition differs across neighborhood contexts.
- Cultural strategies can transform places, creating new economic value but at the same time displacing existing meanings.
- Commercial gentrification can also transform a neighborhood's meaning, but research is mixed on whether it is positive or negative for existing residents and businesses.
- New fixed-rail transit has a generally positive effect on both residential and commercial property values, but its impact varies substantially according to context.
- Preliminary evidence suggests that BRT has limited or no effects on local property values.

- Proximity to high-quality schools and parks, as well as access to highways, increases home values.
- Displacement takes many different forms—direct and indirect, physical or economic, and exclusionary—and may result from either investment or disinvestment.
- Despite severe data and analytic challenges in measuring the extent of displacement, most studies agree that gentrification at a minimum leads to exclusionary displacement and may push out some renters as well.
- Previous studies have failed to build a cumulative understanding of displacement because they have utilized different definitions, compared different populations, and adopted a relatively short timeframe; there is not even agreement on what constitutes a significant effect.
- Existing studies rarely account or proxy for regional market strength, which undermines their relevance to particular contexts.
- Urban simulation models are guided by consumer decision-making, rather than development decisions – flows of people rather than capital – and have neglected the role of race; thus they may not capture complex gentrification dynamics.
- Many different descriptive toolkits offer typologies of neighborhood change, but few have analyzed the causality behind it, limiting the usefulness of such tools to predict and mitigate change.

In sum, previous work on neighborhood change has showed that income segregation is generally increasing. Gentrification, or the influx of capital and higher-income, higher-educated residents into working-class neighborhoods, is transforming some areas. Displacement, which includes moves out of neighborhood that are for reasons beyond a households control (e.g., rent increase) as well as exclusion or the prevention of households from moving into neighborhoods where they could have previously afforded to live, may result from disinvestment as well as investment in neighborhoods. The impacts of gentrification are mixed, at a minimum leading to exclusionary displacement and most likely pushing out some renters as well. New fixed-rail transit, inasmuch as it has a positive effect on residential and commercial property values, may also affect neighborhood stability and composition.

Chapter 2: Analysis of Historic Patterns of Neighborhood Change

Paul Ong², Miriam Zuk¹, Chhandara Pech², Karen Chapple¹,
Mitchell Crispell¹, Silvia R. Gonzalez²

¹ University of California, Berkeley

² University of California, Los Angeles

Acronyms Used in This Chapter

- ACS (American Community Survey – U.S. Census)
- AIN (Assessor Identification Number)
- APN (Assessor Plat Number)
- CASP (Cornfield Arroyo Seco Specific Plan)
- CBO (Community-Based Organization)
- CTCAC (California Tax Credit Allocation Commission)
- HCD (California Department of Housing and Community Development)
- HUD (U.S. Department of Housing and Urban Development)
- JD (Joint Development – Los Angeles Metro)
- LIHTC (Low-Income Housing Tax Credits – HUD)
- LTDB (Longitudinal Tract Data Base)
- NCDB (Neighborhood Change Database)
- OLS (Ordinary Least Squares)
- PUMA (Public Use Microdata Area)
- PUMS (Public Use Microdata Sample)
- SEACA (Southeast Asian Community Alliance)
- SUR (Seemingly Unrelated Regressions)
- SNAP (Station Neighborhood Area Plan)
- TOD (Transit-Oriented Development or Transit-Oriented District)
- VTA (Santa Clara Valley Transportation Authority)

Chapter 2 Table of Contents

Chapter 2 Introduction.....	48
Section 2A: Development of a Neighborhood Database	48
2A.1: Census-Tract Datasets.....	48
2A.2: Address-Level Datasets	49
Section 2B: Development of a Parcel-Level Database	50
Section 2C: Developing Typologies of Transit Neighborhoods	50
Section 2D: Modeling Neighborhood Mobility	57
2D.1: In-/Out- Migration.....	57
2D.2: Composition of In-Movers.....	61
Section 2E: Modeling Neighborhood Displacement.....	64
2E.1: Gentrification	64
2E.2: Changes in Affordable Housing	71
2E.3: Loss of Low-income Households	74
Section 2F: Modeling Neighborhood Change	75
2F.1: Neighborhood Change in Los Angeles County.....	75
2F.2: Neighborhood Change in San Francisco Bay Area.....	77
Section 2G. Sensitivity Analyses	79
Section 2H. Ground-Truthing Secondary Data	83
2H.1: Bay Area Ground-Truthing	83
2H.2: Los Angeles Ground-Truthing	84
Part I: Assessment of Data Ground-Truthing in Los Angeles.....	85
Part II: Comparison of Model, Street and Observations, and Interviews.....	90
Los Angeles Ground-Truthing Conclusions.....	91
Chapter 2 Conclusion.....	91

Chapter 2 Introduction

In Chapter 2, we present a series of quantitative and qualitative analyses to examine if key characteristics associated with gentrification and displacement are driving neighborhood change in fixed-rail transit neighborhoods in Los Angeles County and the San Francisco Bay Area. The sections in this chapter provide the following: 1) a summary of steps taken to construct the quantitative databases for each area, which are used to model neighborhood change; 2) a description of the typologies of transit neighborhoods we encounter in these regions; 3) a series of multivariate regression models on mobility, displacement, and neighborhood change; 4) sensitivity analyses of the models; and 5) the methods and findings used to ground-truth our quantitative models through an extensive inventory of neighborhood observations and interviews with key informants.

We find that gentrification in Los Angeles and the Bay Area TODs cannot be attributed to new development, as both areas experienced relatively little residential development during the period of observation. We also find that transit neighborhoods in both areas are experiencing similar demographic shifts, including new residents with higher-income in Los Angeles and new residents with higher levels of educational attainment in the Bay Area. Further, we see an increase in the use of housing development tax credits as well as an increase in eviction rates near fixed-rail transit in both regions. Spatial variations within the two areas exist in terms of race and measures of affordable housing. The findings of the field observations were generally consistent with the secondary data; however, observations and interviews also reflected processes currently underway that have the potential for displacement but are not captured in our neighborhood change databases. We conclude that proximity to a rail station impacts neighborhood change patterns associated with gentrification and displacement.

Section 2A: Development of a Neighborhood Database

This section summarizes the data sources and general methods used to construct a customized database for Los Angeles and the Bay Area at the neighborhood level. We use Census tracts as a proxy for neighborhoods¹. For Los Angeles we analyze all tracts within Los Angeles County. For the Bay Area we analyze all tracts within the 9-county region as defined by the Metropolitan Transportation Commission: Alameda, Contra Costa, Marin, Napa, San Francisco, San Mateo, Santa Clara, Solano and Sonoma counties. The database is used to model neighborhood change from 1990-2013 at the Census tract level. While we strived to ensure consistency in the variables and indicators used in both regions, each site had access to varying data sources; however, the database for each region is consistent in use of key demographic, socioeconomic, and housing variables. Detailed information on methods used, and challenges faced when processing the datasets for the two regions can be found in Appendix F and Appendix G.

2A.1. Census-Tract Datasets

The primary datasets used to construct the databases for each region are derived from the Census Bureau's decennial Census and American Community Survey (ACS). The ACS is conducted annually but only the 5-year estimates provide data at small geographies such as the tract. In addition to

¹ There is much debate and research into the definitions and analytical proxies for neighborhoods that is beyond the scope of this research. Due to data availability, we use the Census tract as a proxy for neighborhood scale for the purposes of this study.

Census datasets, a wide variety of other data were collected and analyzed for exploratory purposes. Table 2A.1 shows the common datasets and variables collected for both regional databases.

Decennial Census and ACS data were used to derive information on demographics of the population, socioeconomic status of households and individuals, and housing characteristics. These data are from the 1990 and 2000 decennial Censuses, and the 2009-2013 ACS 5-year estimates. Due to shifting Census tract boundaries, it is necessary to harmonize tract-level data to the same tract boundaries to be able to compare them over time. We analyzed two datasets that harmonize tract boundaries, Geolytics’ 2010 Neighborhood Change Database and Brown University’s Longitudinal Tract Data Base (LTDB), and compared them to our own population estimates. We determined that the LTDB was the most accurate of the two datasets we assessed. As such, most of the Census-based variables were derived from Brown University’s LTDB or downloaded from the U.S. Census and converted to 2010 Census geography using LTDB free conversion scripts. Detailed information on the assessment, methods used, and challenges faced when processing the datasets for the two regions can be found in Appendix F.

Table 2A.1: Common Neighborhood-level Datasets Collected for Both Regions

Dataset	Variables	Data Source
Decennial Census and ACS	Demographic, housing, and socioeconomic characteristics	Brown University Census’ American Fact Finder
PUMS	Movement in/out of neighborhood (with race, income, education)	Census’ American Fact Finder
HUD Picture of Subsidized Housing	# Section 8 voucher recipients # public housing units	HUD

2A.2. Address-Level Datasets

When we encountered address-level data, we geocoded these data to the corresponding Census tracts and spatially joined them to the 2010 Census tract data to calculate tract-level indicators which were then added to the neighborhood database. Table 2A.2 shows the common datasets and variables collected for both regional databases at the address level.

Table 2A.2: Common Address-level Datasets Collected for Both Regions

Dataset	Variables	Data Source
Low-Income Housing Tax Credit (LIHTC)	# housing units constructed	HUD
NETS	# jobs, establishments, sales	Walls & Associates
Evictions	# fault/no-fault evictions (SF), # Ellis Act evictions (LA)	SF Rent Board, HCIDLA
Transit Stations	Presence of rail station	Various; respective metropolitan transportation agencies

Section 2B: Development of a Parcel-Level Database

In an attempt to build a finer grain understanding of neighborhood change in the Bay Area and Los Angeles County, various indicators of changes to the residential housing stock were constructed at the parcel-level. Parcel-level data provide information on the changes associated with a plot of land, including transaction history, land-use changes, new construction of a residential structure in a parcel, major renovations of existing structures, and conversions of apartments to condos. These data allowed us to develop proxies to assess different types of displacement (economic, physical, and exclusionary). The parcel datasets were purchased from Dataquick, a lead provider of county assessor data (Dataquick has since been acquired by CoreLogic). Data was also acquired directly from the county assessor for the Los Angeles database. The parcel-level data were then aggregated to the tract-level and integrated to the neighborhood database. The methods used and challenges faced when processing the parcel-level datasets for the two regions can be found in Appendix G.

Section 2C: Developing Typologies of Transit Neighborhoods

In this section we analyze neighborhood-type clusters to answer questions related to transit-oriented development (TOD) neighborhoods, gentrification, and displacement. Specifically, we created TOD neighborhood (Census tracts that intersect within a half-mile station buffer) typologies based on new development and transit investment types, where data is available. We used cluster analysis to group transit neighborhoods based on their shared characteristics. For the analysis in this section, new development includes data on new residential units, renovations of single-family homes, condo conversions, and the change in the number of low-income housing tax credit (LIHTC) units for Los Angeles County. As data for renovations and condominium conversions were only available for San Francisco, the analysis for the entire Bay Area is limited to new market-rate housing development, new and rehabbed subsidized housing units, and new transit stations. For further discussion of data and variable construction for the above, please see Appendices F and G.

New residential units, renovations, and condo conversions all represent private investments, while LIHTC is a combination of both public and private investment. Data on transit investment for Los Angeles include the number of Metro Joint Development (JD) projects in a tract. JD represents a public-private partnership and occurs when a transit agency collaborates with a private developer to develop property that is owned by the transit agency and located near a transit station. No such data was available for the entire Bay Area. Four main cluster types emerged from this analysis for Los Angeles and three for the Bay Area.

As of 2014, the Los Angeles Metro Rail system was comprised of 80 transit stations. Using the half-mile definition, 387 Census tracts were classified as TOD tracts. Figure 2C.1 below displays all 387 TOD tracts in Los Angeles.



Figure 2C.1: Map of 2010 TOD tracts, Los Angeles

As of 2014, there were 548 Census tracts that intersected with the half-mile buffers around rail stations (Figure 2C.2). In 2000 there were only 422 rail stations, and their half-mile buffers intersected with 488 Census tracts, and in 1991 there were 302 rail stations, covering 418 Census tracts. Thus, while the number of rail stations has more than doubled since 1990, they have clustered in heavily populated areas, and the Census tract coverage has only increased by 31%.



Figure 2C.2: TOD Areas in the Bay Area

The following describes the four main cluster types for Los Angeles and Table 2C.1 reports their summary statistics:

1. *Private-driven* – On average, have a greater number of new residential units and condo conversions.
2. *Mixed without joint Metro development* – Generally have more newly constructed residential units, an increase in LIHTC units, and condo conversions, but on average, no joint development and no renovations to single-family homes.
3. *Mixed with joint Metro development* – Characterized by a combination of newly constructed residential units, an increase in LIHTC units, condo conversions, joint development, and renovations to single-family homes.
4. *Subsidy-driven* – On average, have experienced an increase in the number of LIHTC units.

Table 2C.1: Summary Statistics for Transit Station Types in Los Angeles (Means)

	Private-Driven	Mixed w/o Joint Metro Development	Subsidized-Driven	Mixed w/ Joint Metro Development
New Residential Units, 2005-12	538.5	1,237.5	64.8	450.2
SFH Renovations, 2007-13	2.5	0.0	2.0	13.2
Condo Conversions, 2003-13	483.5	58.0	35.0	36.6
Δ LIHTC Units, 2000-13	0.0	224.5	782.3	149.5
Joint Development, 2014	1.0	0.0	1.0	1.2
n	2	2	4	13

Source: 2000 Decennial Census, 2009-13 ACS, LA County Assessor, TCAC

Figure 2C.1 displays the typologies alongside tracts that have gentrified between 2000 and 2013. Broadly speaking, gentrified neighborhoods are defined as socioeconomically disadvantaged tracts that are at risk of displacement due to influx of higher income, better educated, increasing rent and loss of affordable rental housing. For further discussion of the methodology used to calculate gentrification, see Section 2E.

When we compare the two maps side by side for Los Angeles (Figure 2C.3), we see the existence of both development-driven gentrification and gentrification without extensive development. For example, if a place suddenly becomes attractive, it can attract more affluent, higher educated, and non-Hispanic whites who might just use the existing built environment. Gentrification can also overlap with high levels of development as we see in the two maps. For example, there seems to be a lot of overlap in the areas around Downtown, particularly around the Staples Center and Arts District. Both of these areas have gentrified or are in the process of gentrifying, and both are experiencing high levels of development, but the types of development occurring are different. The area around the Staples Center is experiencing more mixed development (with and without Metro’s joint development), and the Arts District is being driven primarily by private development. We also see tracts that are adjacent to development and gentrified tracts experiencing changes, indicating some sort of spillover effect.

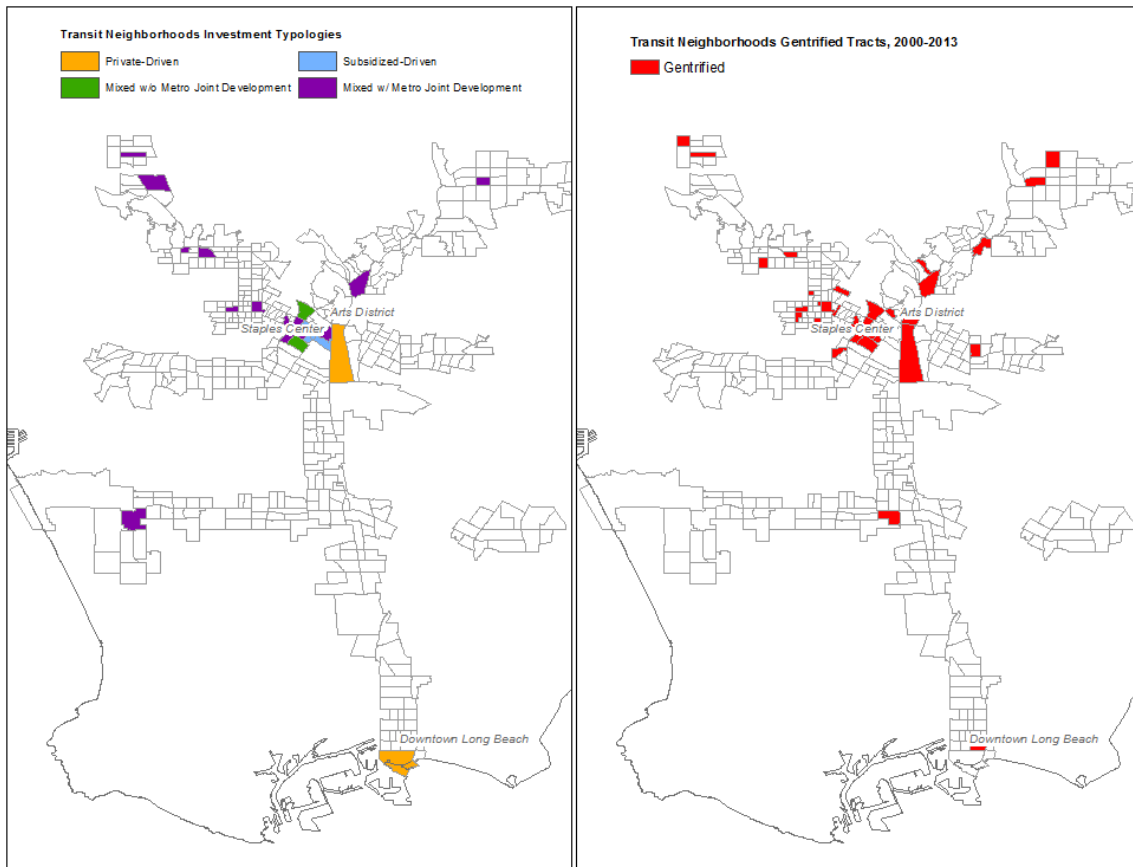

Figure 2C.3: Development Tracts in LA County (L) and Gentrified Tracts in LA County (R)

The tracts that experienced extensive development but did not cross the threshold of gentrification are also interesting. The southern part of Long Beach provides an example. The tract gentrified in the 1990s to the extent where it is no longer eligible (i.e., it no longer housed sufficient low income or other vulnerable population per the criteria listed in section 2E.1) to be included in our assessment in the 2000s. The gentrification that occurred in the 1990s seems to have precipitated a wave of development in the following decade. Table 2C.2 provides a breakdown of all 387 TOD tracts by whether or not they gentrified and whether it was with or without housing development.

Table 2C.2: TOD Tracts, Gentrified With/Without Development for Los Angeles County

	# of TOD Tracts
Gentrified w/ Development	11
Gentrified w/o Development	20
Development Only	7
Not Gentrified/No Development	349

Source: 2000 Decennial Census, 2009-13 ACS

For the Bay Area, the three typologies that emerged (Table 2C.3) were:

1. *Private-driven* – On average, have a greater number of new market rate residential units and more new transit stations.
2. *Little development* – Characterized by few new market-rate or subsidized residential developments with some new transit
3. *Subsidy-driven* – On average, have experienced an increase in the number of LIHTC units with little new transit.

Table 2C.3: Summary Statistics for Transit Station Types in the Bay Area

	Private-Driven Development	Little Development	Subsidy-Driven Development
Average Number of New Market Rate Units, '00-'13	65.8	109.1	1997.6
Average Number of New and Rehabbed Subsidized Units, '00-'14	417.9	20.8	150.3
Average Number of New Transit Stations '00-'14	0.3	0.8	2.3
n (# of tracts)	24	510	14

Source: 2000 Decennial Census, 2009-13 ACS, TCAC, MTC, HUD

In the Bay Area, we see a similar mix of non-development-driven gentrification and some development-driven gentrification of different types (Table 2C.4 and Figure 2C.4). Of the 125 Census tracts that gentrified between 2000 and 2013, half (63) were in TOD areas. Yet, the vast majority of these TODs (58) that gentrified did not experience much development. Only five of these tracts experienced housing development, including two subsidy-driven neighborhoods. One of these gentrifying TODs that witnessed a significant amount of subsidized residential development is in San Francisco's South of Market neighborhood, where 438 units were developed in five different projects between 2002 and 2013. The other is in Downtown Oakland, where 313 subsidized units (along with 400 market-rate units) were developed in three different projects. The three TOD neighborhoods that experienced privately driven development and gentrified between 2000 and 2013 were: 1) the Jack London Square neighborhood of Oakland where 1,301 market-rate units were developed as well as 103 subsidized units, 2) Milpitas near the Santa Clara Valley Transportation Authority (VTA) Great Mall Station where 2,904 new market-rate units were developed and no subsidized housing was built, and 3) the Midtown neighborhood in San Jose near the VTA light-rail stations, where 1,087 market-rate units were developed and no subsidized housing was built.

While many TOD tracts experienced housing development, they did not undergo gentrification either because they were not low-income to begin with, or because there was not sufficient demographic change during the time period analyzed.

Table 2C.4: Number of tracts that gentrified and did not gentrify in the 9-County Bay Area, Categorized by TOD Typology

	Gentrified '00-'13	Did not Gentrify '00-'13
Subsidized Housing Driven Development	2	22
Little Development	58	452
Private Development w/New Transit	3	11

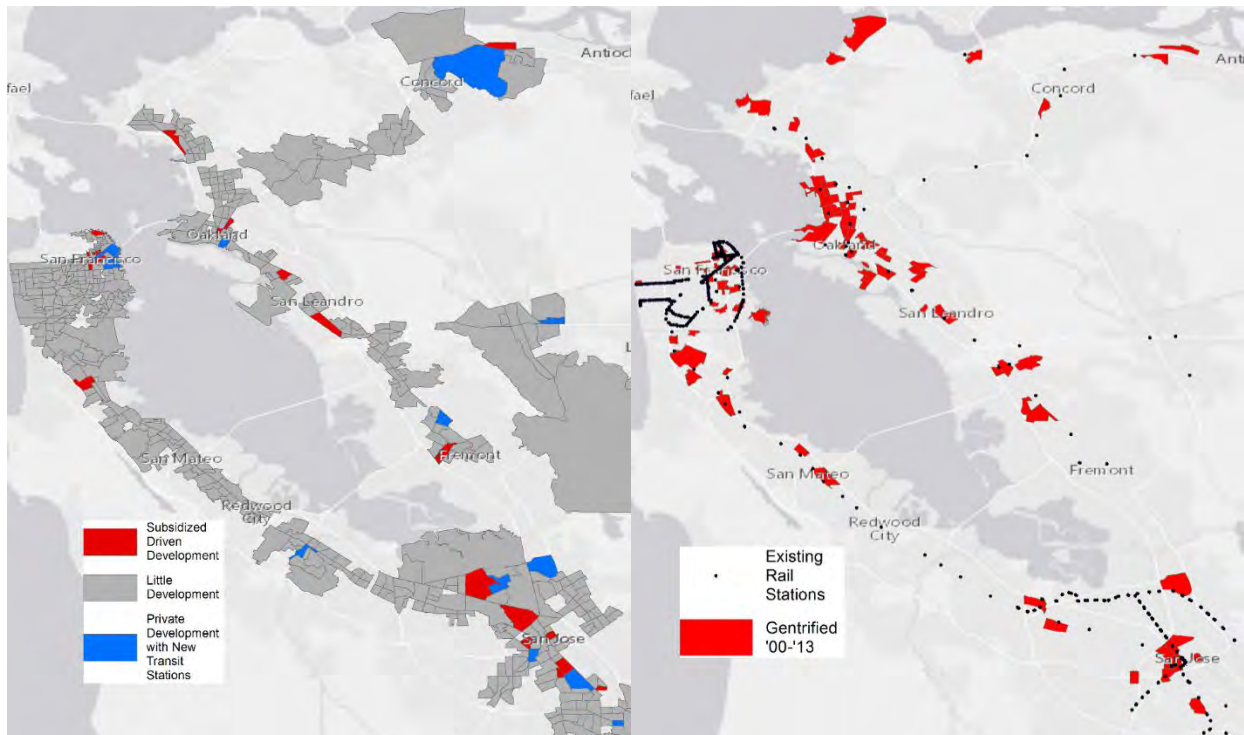

Figure 2C.4: Development Tracts in the Bay Area (L) and Gentrified Tracts in the Bay Area (R)

The relationship between gentrification and development is complex. The analysis depends on creating mutually exclusive categories, which may over-simplify complex phenomena (such as the changes in and around Downtown Long Beach, described on page 54). However, we find in general that the vast majority of tracts experienced relatively little development during the time period of analysis. In the Bay Area, most development occurred in tracts that did not gentrify. In contrast, in Los Angeles, development occurred in both gentrifying and non-gentrifying areas — but with most gentrification occurring in the absence of development.

Section 2D: Modeling Neighborhood Mobility

To assess neighborhood mobility patterns and the effects of proximity to rail transit stations, we developed models controlling for demographic characteristics, income, housing price appreciation, and other covariates. Our analysis of neighborhood mobility is done in two parts. The first part models both in-migration and out-migration rates for overall movers who reported moving within the last year. Part two examines the demographic and socioeconomic characteristics of in-movers. We attempted to estimate the numbers out-movers and examine their demographic and socioeconomic characteristics but it did not produce any robust results. Our main finding is that higher-income and better-educated persons make up a higher share of in-movers in TOD areas for both the Bay Area and Los Angeles. Additionally, non-Hispanic whites also make up a higher share of in-movers to TODs adjusting for all other factors for both regions. These findings are consistent with the gentrification thesis: that is, TODs are associated with demographic and socioeconomic change.

For the dependent variable of household mobility, we relied on the American Community Survey's (ACS) tract-level data. The five-year ACS now includes information on in-migration by race/ethnicity and income levels.

2D.1. In-/Out- Migration

This section examines both the in- and out-migration rates using data from the 2009-13 five-year ACS estimate. We use ordinary least squares (OLS) regressions to model residential mobility. The dependent variables are the calculated in- and out-migration rates. We include a series of independent variables related to socioeconomic, demographic, and housing characteristics. Additionally, variables related to residential mobility choice (e.g., proximity to amenities, housing cost burden, and the like) are included. The key variables of interest are the downtown and non-downtown TOD variables, which were included to measure whether or not TOD had an impact on the likelihood of people moving into or out of a neighborhood.

For Los Angeles, TOD neighborhoods are grouped into two separate categories: TODs that are located in Downtown Los Angeles ("Downtown TOD") and TODs that are located elsewhere ("Other TODs"). In recent decades, Downtown has gone through a major revitalization process with a surge in private investments and new developments. While it is important to control for these effects, the problem lies with the fact that all of the Downtown Los Angeles tracts are also TOD tracts, making it difficult to tease out the individual effects. The Downtown variable can only be interpreted as a subset of TOD areas that just happens to be in Downtown. In the Bay Area, there is no such obvious "downtown." However, we did separate out TODs in the three largest cities — San Francisco, Oakland and San Jose — and labeled them as "downtown" to determine if different dynamics are at play in the region's major cities in contrast to other TODs.

In order to calculate in-migration rates, we first calculated the number of in-movers. This was done by subtracting the number of non-movers or "stayers" (lived in the same house 1 year ago) from the total number of persons in that tract. We then divided this number by the tract's total population in the previous year, in this case 2012, and multiplied this by 100. We relied on the 2008-2012 ACS for the total population counts in the previous year, since it is the only available source of information to include population counts in 2012 at the tract level. To calculate the out-movers, we subtracted the total population in the previous year (2012) and total number of estimated in-movers from the

total population in 2013. The numerator of the rate is the number of out-movers, while the denominator is the population in the previous year. Figure 2D.1 provides the formulas utilized in calculating migration rates.

In-movers = total number of persons – lived in same house 1 year ago
Out-movers = Total Pop ₂₀₁₃ – Total Pop ₂₀₁₂ – In-Movers
In-Migration Rate = $\left(\frac{\text{Number of In-Movers to Tract X in 2013}}{\text{Total Population in Tract X in 2012}} \right)$
Out-Migration Rate = $\left(\frac{\text{Number of Out-Movers to Tract X in 2013}}{\text{Total Population in Tract X in 2012}} \right)$

Figure 2D.1: In- and Out-Migration Rates Calculations

We begin with a simple bivariate analysis of the relationship between TODs and in-/out- migration rates. Figures 2D.2 and 2D.3 compare the rates for TOD and non-TOD areas. From the bivariate analysis, we do observe that TOD neighborhoods have higher rates of in- and out-migration than non-TOD areas in Los Angeles. This is consistent with the literature that TODs have an impact on residential mobility. TODs can make a neighborhood more desirable and attractive to those who want to be closer to transit, leading to in-migration. Conversely, the neighborhood’s proximity to transit can also lead to price escalation, pricing out those who can no longer afford to live in the neighborhood, and thus exiting.

The effect is less dramatic in the Bay Area, where TOD areas have in- and out-migration rates that are only slightly higher than non-TOD areas. The bivariate analysis, however, does not account for other neighborhood characteristics that may influence in- and out-migration. For example, low-income and renter households generally have higher mobility rates. A TOD neighborhood with a larger share of low-income or renter households might exhibit higher rates of in- and out-migration because of other factors in the neighborhood, not due to TOD per se. We used multivariate regression models to determine if this relationship holds after controlling for all other factors related to the neighborhood’s characteristics.

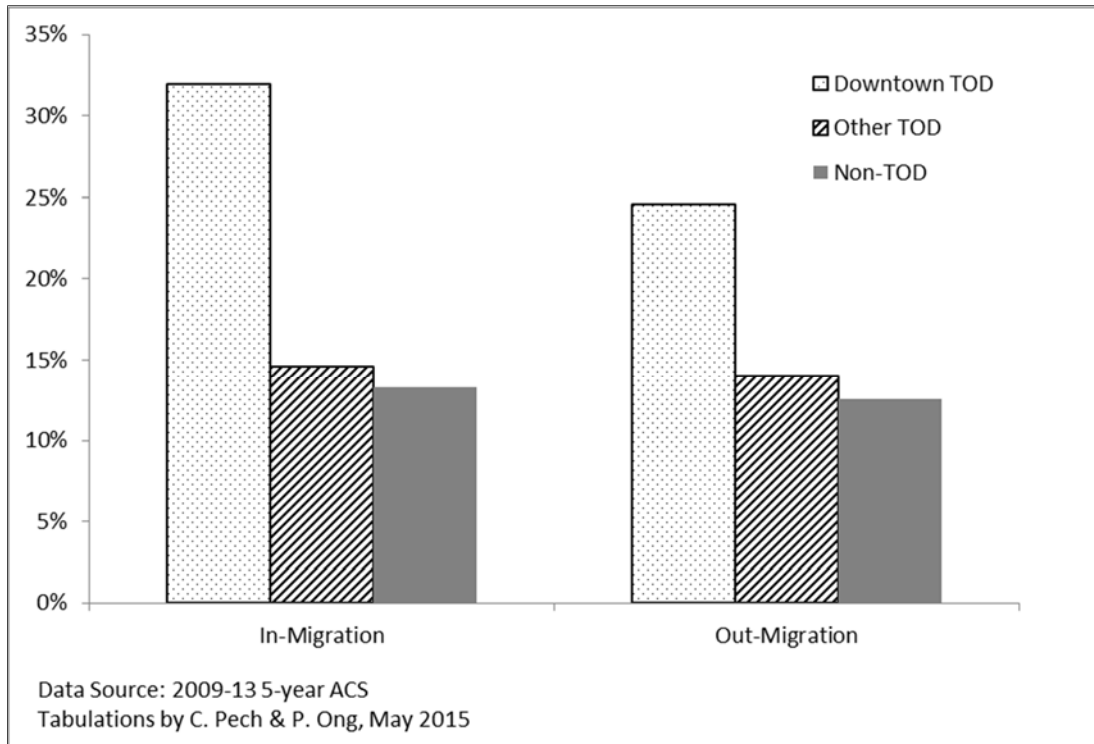

Figure 2D.2: Bivariate Analysis, In- and Out-Migration Rates for Los Angeles, 2009-2013

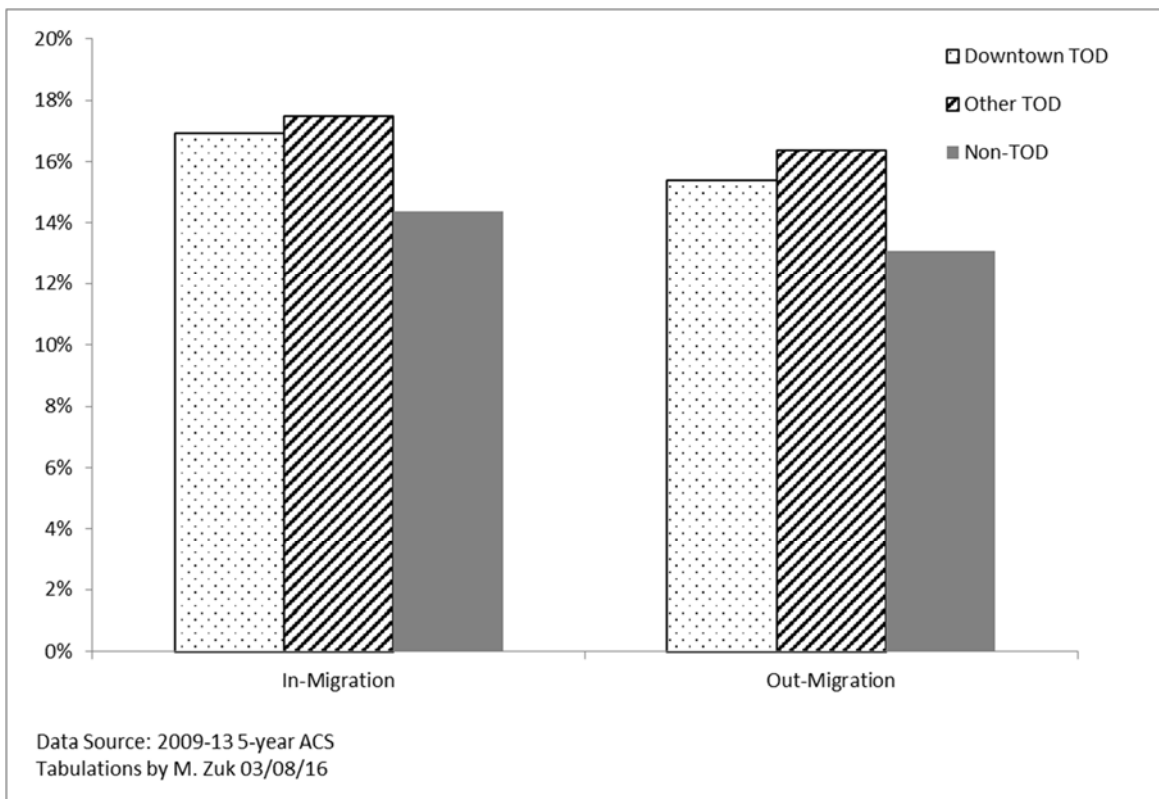

Figure 2D.3: Bivariate Analysis, In- and Out-Migration Rates for the SF Bay Area, 2009-2013

We initially ran regressions for both in- and out-migration that included an extensive list of control variables, many of which were collinear, producing problems of multi-collinearity and endogeneity. The results are presented in Appendix R. To reduce multi-collinearity, we ran more parsimonious models to include a more limited set of key variables. The key independent variables are lagged (that is, from the previous period), thus reducing endogeneity. Data for the independent variables come from the 2006-2010 five-year ACS, the earliest available in which the tract boundary is consistent with the 2009-2013 five-year ACS (the previous five-year ACS uses the 2000 boundary). We acknowledge that this method is not perfect since the 2009-2013 and 2006-2010 five-year ACS both include the 2009 and 2010 individual ACS.

Results for the parsimonious migration models are presented in Table 2D.1 In Los Angeles, with the exception of Downtown TODs, we do not see TODs having any effect on mobility in Los Angeles. In comparison, proximity to rail outside of the three major cities in the Bay Area (San Francisco, Oakland, and San Jose) is positively associated with in-migration, and negatively associated with out-migration. In the three main cities of the Bay Area, the pattern is reverse, with higher out-migration rates and lower in-migration rates.

In Los Angeles, TODs seem to accelerate change in locations that are going through transitions. The transit system going through Downtown Los Angeles was meant to bring people in and out of Downtown. It contributes to making Downtown more accessible and more susceptible to neighborhood change and development. The other changes occurring in Downtown (e.g. Grand Avenue project, Staples Center) are not the consequence of TOD; instead, TODs may help serve them.

For the Bay Area, the variability in TODs and development seems to be too great to draw any general conclusions. For instance, when including a variable for TODs, without differentiating between those in the major cities, we find positive, but not significant association for both in- and out-migration. When we differentiate between TODs in the three major cities versus other TODs, we find greater in-migration and less out-migration in non-central TODs, and the reverse in central TODs. This non-intuitive relationship may result from the wide variability in land use types among the TODs in the three major cities: some actually have more suburban land use characteristics (e.g., low density), despite being in a major city. This could also result from the timing of construction, which we don't control for – if the "Other TODs" are built more recently than the "Downtown TODs", and construction is a nuisance, out-migration rates may temporarily be higher than in-migration.

Table 2D.1: In-Out Migration, Parsimonious Multivariate Regressions

	In-Migration		Out-Migration	
	Los Angeles	Bay Area	Los Angeles	Bay Area
Constant	0.0909 ***	0.1122 ***	0.0348 *	-0.1123 ***
Median Household Income (/10,000)	0.0061 ***	-0.0033	0.0115 ***	0.005996 **
Income Squared	-0.0003 ***	0.00014	-0.0005 ***	-0.00026 **
% non-Hispanic black	-0.0002 **	0.037 **	-0.0001	-0.0015
% Asian	-0.0007 ***	-0.0278 ***	-0.0004 ***	0.023764 **
% Hispanic	-0.0011 ***	-0.0579 ***	-0.0009 ***	0.065866 ***
Downtown TOD	0.1219 ***	-0.0107 **	0.0558 **	0.015904 ***
Other TOD	-0.0046	0.0129 ***	-0.0043	-0.01239 **
% Renters	0.0016 ***	0.18276 ***	0.0018 ***	-0.19257 ***
Adj R-Squared	0.3411	0.3256	0.2576	0.268
n	2,315	1578	2,315	1578

*** P<.01, ** p<.05, *p<.10

Source: 2006-10, 2009-13 ACS

Tabulations by C.Pech & P. Ong, May 2015, M. Zuk Aug 2015

2D.2. Composition of In-Movers

Our second analysis of residential mobility looks at the composition of the in-movers by income and demographic characteristics. Specifically, we focus on the share of in-movers who are low-income, high-income, non-Hispanic white, individuals with less than a high school diploma, and persons with a bachelor’s degree or higher. In part due to differences in the income distributions between the two regions (and high intra-region variability in the Bay Area), we use slightly different categories for low and high income. For Los Angeles we define low-income as persons who move with less than \$10,000 annual income, and for the Bay Area we use the Census calculated incomes below the Federal Poverty level (~\$11,500 for a one-person household in 2013). For high income in Los Angeles, we use \$65,000 annual individual income as the cutoff and for the Bay Area we use 120% of each county’s median per capita income for that year (between ~\$35,000 and \$68,000) and rounded to the closest Census income category.

We attempted to estimate the number of out-movers by subgroup using the method presented in Figure 2D.1, but the small sample size of the ACS resulted in uncertain estimates that made the models unreliable. We therefore only report results for in-movers by subgroup. We use the following equations to estimate the share of in-movers for each sub-population (example shown for low-income):

$$\begin{aligned} \# \text{ In-Movers}_{\text{low-income}} &= (\text{Total Persons Age 15+} - \text{Non-Movers}_{\text{low-income}}) \\ \% \text{ In-Movers}_{\text{low-income}} &= (\# \text{ In-Movers}_{\text{low-income}} / \text{Total In-Movers}) * 100 \end{aligned}$$

Table 2D.2 contains the bivariate analysis by subgroup. The bivariate analysis shows mixed results for the gentrification hypothesis. Data for both TOD and non-TOD areas show that in-movers are lower income than stayers ($\Delta = \% \text{ in-movers} - \% \text{ stayers}$). This, however, may be confounded by the Great Recession which depressed overall income. Figure 2D.4 shows the decline in per-capita income (adjusted to 2013 dollars) following the Great Recession. The changes in TOD by educational levels in Los Angeles show an increase at the two extremes; that is, in-movers are more likely to have less than a high school diploma and more likely to have at least a bachelor’s degree. In

the Bay Area, while in-movers to TODs are more likely to have bachelor's degrees, they are less likely to have less than a high school diploma. The analysis for non-Hispanic white is unambiguous in Los Angeles. In-movers in TOD areas are more likely to be of that group than stayers. This is also true for the Bay Area, except for TOD areas outside of the three major cities, where in-movers are less likely to be non-Hispanic white.

Table 2D.2: Bivariate Analysis by Subgroups, LA County and the Bay Area, 2009-2013

	Los Angeles				Bay Area			
	Not TOD	All TOD	Down-town TOD	Other TOD	Not TOD	All TOD	Down-town TOD	Other TOD
Low Income (LT 10K)¹								
Stayers (% Below 10K)	15.8	17.7	21.2	17.5	9.3	12	14.8	9.2
In-Movers (% Below 10K)	18.4	19.3	21.9	19.2	15.8	18.8	22.1	15.5
Δ (% In-Movers-% Stayers)	2.7	1.7	0.6	1.7	6.5	6.7	7.2	6.3
Δ Δ (Δ TOD-Δ Non-TOD)	0	-1.0	-2.0	-0.9	0	4.0	4.5	3.6
High Income (65K+)²								
Stayers (% Above 65K)	15.8	9.5	14.7	9.3	22	21.2	20.5	21.9
In-Movers (% Above 65K)	12.7	9.1	15.8	8.8	4	5.1	5	5.3
Δ (% In-Movers-% Stayers)	-3.1	-0.5	1.1	-0.5	-18	-16.1	-15.5	-16.6
Δ Δ (Δ TOD-Δ Non-TOD)	0	2.6	4.2	2.6	0	-13.0	-12.4	-13.5
non-Hispanic white								
Stayers (% non-Hispanic White)	30.8	17.1	25.9	16.7	46.6	38.7	34.5	42.8
In-Movers (% non-Hispanic White)	28.4	19.4	28.4	19.0	43.2	39.5	39.2	39.7
Δ (% In-Movers-% Stayers)	-2.3	2.3	2.4	2.3	-3.5	0.9	5	-3.1
Δ Δ (Δ TOD-Δ Non-TOD)	0	4.6	4.8	4.6	0	3.2	7.3	-0.8
Less than High School								
Stayers (% w/ LT HS)	23.5	28.6	29.3	35.5	29.9	32.1	34.3	29.9
In-Movers (% w/ LT HS)	20.9	35.2	25.0	28.8	28.8	27.9	28	27.8
Δ (% In-Movers-% Stayers)	-2.6	6.6	-4.3	-6.7	-1	-4.1	-6.4	-1.8
Δ Δ (Δ TOD-Δ Non-TOD)	0	9.2	-1.7	-4.1	0	-1.5	-3.8	0.8
Bachelor's Degree or Higher								
Stayers (% w/ BA+)	28.8	22.0	32.7	21.6	41.6	43.2	42.1	44.3
In-Movers (% w/ BA+)	32.0	28.4	40.3	28.0	44	49.1	48.2	49.9
Δ (% In-Movers-% Stayers)	3.3	6.4	7.7	6.4	2.3	5.9	6.3	5.5
Δ Δ (Δ TOD-Δ Non-TOD)	0	3.1	4.4	3.1	0	2.6	3.0	2.2
n	1,960	387	15	372	1,029	551	276	275

¹ In the Bay Area, people in poverty that moved in or stayed was used for this category

² Because of the higher incomes in the Bay Area, this category was calculated as in-movers and stayers that had incomes greater than 120% of the county median income

Source: 2009-13 ACS

Tabulations by C.Pech & P. Ong, May 2015, M. Zuk, Aug 2015

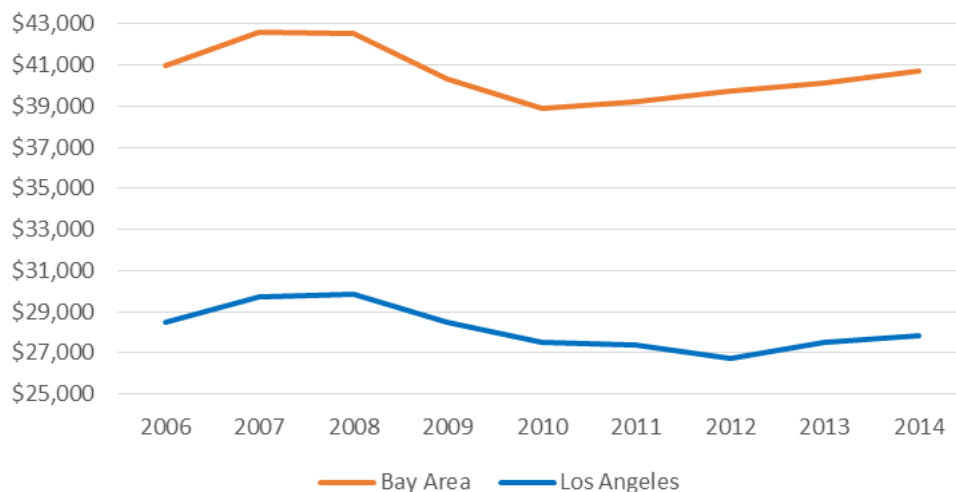

Figure 2D.4: Per-Capita Income, LA County and 9-County Bay Area (adjusted to 2013 dollars)

We ran also multivariate regressions to see whether or not we find the same results even after controlling for neighborhood demographics. Tables 2D.3 and 2D.4 report the results of the OLS regressions for each of the subgroups. After accounting for the demographic and socioeconomic characteristic (race/ethnicity and income), Downtown location, and tenure, we find that low-income and less-educated persons make up a lower share of in-movers in TOD areas than in non-TOD areas for Los Angeles. In the Bay Area, individuals in poverty actually make up a higher share of in-movers into downtown TODs, but not into non-downtown TODs. This may be related to the location of subsidized housing opportunities for very-low-income households. Conversely, higher-income and better-educated persons make up a higher share of in-movers in TOD areas for both the Bay Area and Los Angeles. Finally, non-Hispanic whites make up a higher share of in-movers to TODs after adjusting for all other factors for both regions. The multivariate results are consistent with the gentrification thesis: that is, TODs are associated with the a priori hypothesis of demographic and socioeconomic change.

Table 2D.3: Modeling Share of In-Movers by Subgroups, Multivariate Regressions for Los Angeles County, 2009-2013

	Low-Income (<10K)	High-Income (65K+)	Less than High School	Bachelor Degree or Higher	non-Hispanic white
Constant	19.233 ***	2.561	5.992 *	0.744	51.633 ***
Median Household Income	-1.642 ***	0.633 **	-0.677	1.472 ***	0.002
Income Squared	0.064 ***	0.011	0.024	-0.052 ***	0.296 ***
% non-Hispanic black	0.020	-0.041 ***	0.078 ***	-0.114 ***	-0.560 ***
% Asian	-0.033 **	-0.048 ***	-0.016	0.007	-0.551 ***
% Hispanic	0.005	-0.076 ***	0.130 ***	-0.101 ***	-0.546 ***
Downtown TOD	-0.316	4.225 *	2.970	2.700	4.821
Other TOD	-1.599 **	1.315 ***	-1.175	2.798 ***	1.440 *
% Renters	-0.024 *	0.030 ***	-0.060 ***	0.105 ***	0.066 ***
n	2,307	2,307	2,307	2,307	2,307
Adj. R-Squared	0.1206	0.5915	0.5698	0.677	0.7639

*** P<.01, ** p<.05, *p<.10

Source: 2009-13 ACS

Tabulations by C.Pech & P. Ong, May 2015

Table 2D.4: Modeling Share of In-Movers by Subgroups, Multivariate Regressions for the Bay Area, 2009-2013

	In Poverty	High-Income (> 120% County Median Income)	Less than High School	Bachelor Degree or Higher	non-Hispanic white
Constant	0.412 ***	-0.055 ***	0.496 ***	0.078 *	0.898 ***
Median Household Income	-0.053 ***	0.013 ***	-0.051 ***	0.055 ***	-0.001
Income Squared	0.002 ***	0.000 ***	0.001 ***	-0.001 ***	0.000
% non-Hispanic black	0.171 ***	-0.013 *	0.198 ***	-0.345 ***	-0.794 ***
% Asian	0.016	-0.014 ***	0.132 ***	-0.043 *	-0.933 ***
% Hispanic	0.077 ***	-0.048 ***	0.684 ***	-0.671 ***	-0.959 ***
Downtown TOD	0.019 **	0.004 *	-0.024 **	0.045 ***	0.048 ***
Other TOD	-0.014	0.008 ***	-0.015 **	0.048 ***	0.002
% Renters	0.020	0.091 ***	-0.258 ***	0.410 ***	0.066 ***
n	1,575	1,578	1,575	1,575	1,576
Adj. R-Squared	0.328	0.3922	0.5685	0.579	0.7169

*** P<.01, ** p<.05, *p<.10

Source: 2009-13 ACS

Tabulations by M. Zuk, Aug 2015

Section 2E: Modeling Neighborhood Displacement

To better understand the relationship between TODs, gentrification, and displacement, we develop dichotomous and multinomial logit models. We conduct two primary analyses, one on gentrification and the other on changes affordable rental housing. We first construct gentrification measures, which can include both direct and exclusionary displacement, for both Los Angeles and the Bay Area. Due to the unique conditions of each region and access to different data sources, gentrification is defined differently for each region. The second analysis focuses on a more direct measure of displacement, the loss of affordable housing which includes changes in affordable rental units, condo conversion, Section 8 housing, Low-Income Housing Tax Credit units, and evictions. For the San Francisco Bay Area we also explore the decline in low-income households, an indicator of displacement that is particularly salient in the region due to rising income inequality. Our main findings are that there is evidence of neighborhood change and gentrification in TOD areas. The magnitude of change varies by the type of TOD. Additionally, we find that relative to non-TOD areas, transit neighborhoods are experiencing greater losses in affordable rental housing.

2E.1. Gentrification

The method used to develop the gentrification index for this study incorporates several methods of gentrification from previous studies. These include the work done by Lance Freeman (2005) for the U.S., Lisa Bates for Portland (2013), the Bay Area (CJJC 2014; Haas Institute 2015), and the recent analysis of the largest 50 cities in the United States by *Governing Magazine* (Maciag 2015). We made some modifications to reflect the unique conditions of Los Angeles. We use the following criteria to define a neighborhood (Census tract) as having gentrified between years 1 and 2.

For Los Angeles, a tract was vulnerable to gentrification (or eligible to gentrify) if it met all of the following criteria:

1. The tract had a population of at least 500 residents in year 1
2. Vulnerable, meeting 3 out of 4 of the following indicators:
 - a. % low-income households (household income below 80% of the county median) > county median
 - b. % college educated < county median
 - c. % renters > county median
 - d. % nonwhite > county median

A tract is said to be gentrified or gentrifying if it meets eligibility and all of the following criteria:

1. Demographic change between years 1 and 2
 - o Change in % college educated > county (percentage points)
 - o Change in % non-Hispanic white > county (percentage points)
 - o Change in median household income > county (absolute value)
2. Change in Median Gross Rent > Change County Median Gross Rent (absolute value)

For Los Angeles, two major modifications were made to the index that makes it different from the previous work on gentrification. One, instead of focusing on homeowners and property values (e.g., change in home values), we focused on the rental housing market. Renters are more susceptible to gentrification and displacement due to increase in rent (e.g., generally, homeowners benefit from rising property values). Second, we included change in non-Hispanic whites into the demographic change criteria. As noted in the literature review, gentrification involves racial changes, particularly the replacement of minority population with the dominant social group. In Los Angeles, the dominant social group, in terms of political power and socioeconomic status, are non-Hispanic whites.

For Los Angeles, we were unable to estimate the number of changes in market and non-market units (e.g., affordable, below market rate, subsidized) because we did not have information on affordable units that were negotiated with private developers in exchange for concession. Table 2E.1 reports the county averages and changes for the three decades in Los Angeles.

Table 2E.1: Gentrification Criteria for Los Angeles, County Averages

	1990	2000	2013	Δ 1990-2000	Δ 2000-2013
% non-Hispanic white	41%	31%	28%	-10%	-4%
% with bachelor's degree or higher	22%	25%	30%	3%	5%
Median Household Income (2013 dollars)	\$63,423	\$58,982	\$55,909	-\$4,441	-\$3,073
Median Gross Rent (2013 dollars)	\$1,082	\$952	\$1,204	-\$130	\$252

Source: 1990 and 2000 Decennial Census, 2009-2013 five-yr ACS

Using the above definition for Los Angeles, we find that 81 tracts gentrified between 1990 and 2000, and 82 tracts gentrified between the years 2000 and 2013. Of these 82 tracts that gentrified between 2000 and 2013, eight also gentrified in the previous decade. We estimate that a total of 155 tracts gentrified between 1990 and 2013 in Los Angeles. The tracts that gentrified are displayed in Figure 2E.1. It includes tracts that gentrified *in each* of the time period and those that gentrified in *both* time periods. Additionally, vulnerable tracts (see above criteria) are also displayed, regardless of the time period of when they were vulnerable.

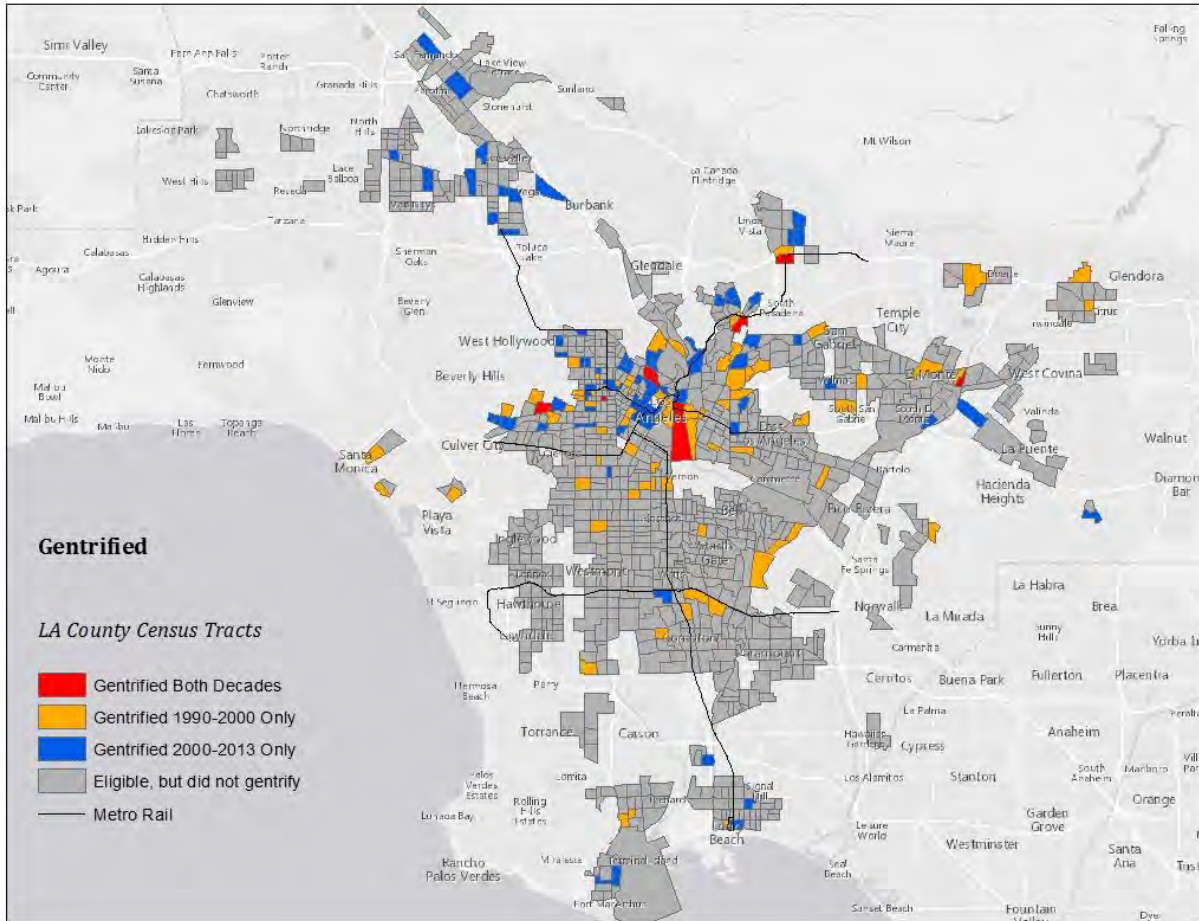

Figure 2E.1: Gentrified/Gentrifying Census Tracts, LA County 1990-2013

For the Bay Area, this index was modified slightly to reflect the conditions of the region. First, all measures were compared to the regional median that includes nine counties. Second, we did not use change in non-Hispanic white in the demographic change criteria, as considerable research has emerged on the nature of black- and Asian-driven gentrification in strong markets like the Bay Area. Finally, because of the role of the influx of global capital into the housing market, we used a combination of housing price increases and new market-rate units for the second criteria of change.

For the Bay Area, a tract was vulnerable to gentrification if it met all of the following criteria:

1. The tract had a population of at least 500 residents in year 1
2. Vulnerable, meeting 3 out of 4 of the following indicators:
 - a. % low-income households (household income below 80% of the county median) > regional median
 - b. % college educated < regional median
 - c. % renters > regional median
 - d. % nonwhite > regional median

A tract is said to be gentrified or gentrifying if it meets eligibility and all of the following criteria:

1. Demographic change between years 1 and 2
 - a. Change in % college educated > region
 - b. Change in median household income > region

2. Investment between years 1 and 2:
 - a. % market rate units built > regional median
 - b. Growth in of the following
 - % increase of single-family sales price per square foot > regional median
 - % increase of multi-family sales price per square foot > regional median
 - % increase of home value > regional median (where sales value is unavailable = 57 tracts)

Table 2E.2 reports the regional medians used for the Bay Area.

Table 2E.2: Gentrification Criteria, Medians for the 9-County Bay Area

	1990	2000	2013	Δ 1990-2000	Δ 2000-2013
% low-income	37%	37%	39%	0%	2%
% with bachelor's degree or higher	27%	35%	41%	8%	6%
% renter	38%	37%	41%	-1%	4%
% non-white	33%	46%	57%	13%	11%
Δ with bachelor's degree or higher	-	-	-	6%	5%
Δ in median household income	-	-	-	\$9,925	-\$5,719
% of market-rate units built	-	-	-	3%	3%
% increase in single-family sales price per square foot	-	-	-	22%	8%
% increase multi-family sales price per square foot	-	-	-	23%	5%
% increase home value for owner-occupied units	-	-	-	2%	15%

Source: 1990 and 2000 Decennial Census, 2009-2013 five-yr ACS, and Dataquick (2014)

Using the above criteria for the Bay Area, we find that 83 tracts gentrified between 1990 and 2000 and 85 tracts gentrified between the years 2000 and 2013 (Figure 2E.2). Of these 83 that gentrified between 2000 and 2013, 19 were tracts that gentrified between 1990 and 2000 as well. In total we estimate that 149 tracts gentrified between 1990 and 2013. The fact that a tract has gentrified between two years does not preclude them from continued change. In fact, of the 149 tracts that we estimate to have gentrified between 1990 and 2013, 71 had lower rates of growth of low-income households than the rest of the region, 105 lost naturally occurring affordable housing, and 100 had lower rates of in-migration of low-income residents in 2013 than they did in 2009. Furthermore, 88 of the gentrified tracts continue to have higher proportions of low-income households than the region (39%).

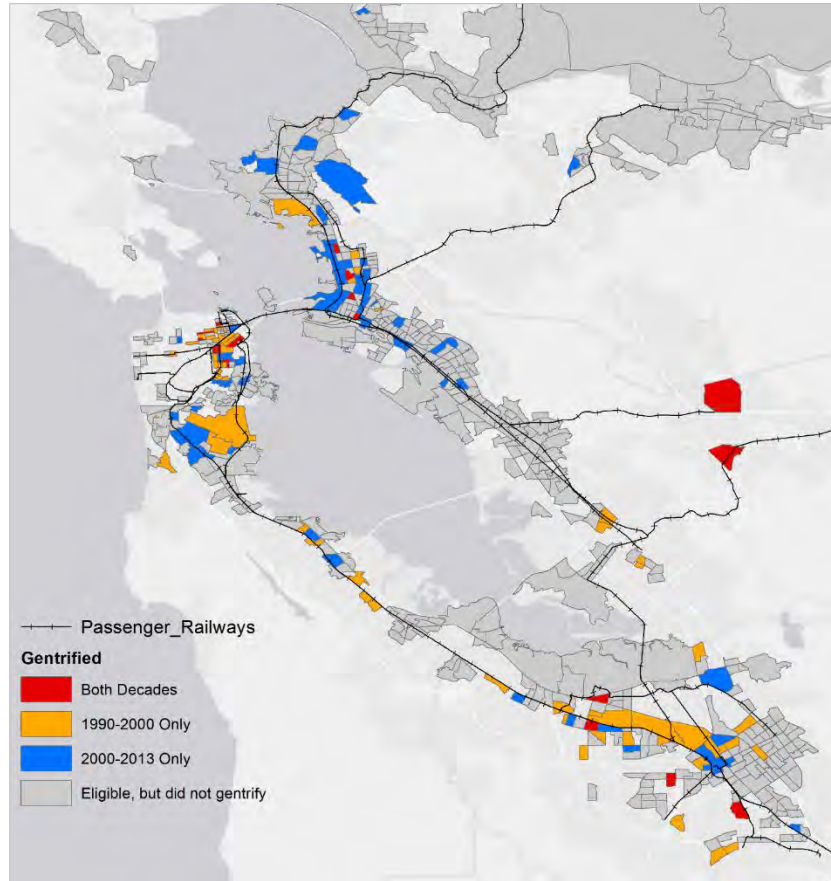

Figure 2E.2: Gentrified/Gentrifying Census Tracts, SF Bay Area 1990-2013

Our finding that tracts that gentrified in the first decade from 1990-2000 had a higher risk of gentrifying again from 2000-2013 is also shown with a simple bivariate analysis. In the Bay Area, the probability to continue gentrifying from 1990-2000 to 2000-2013 were over twice as likely as newly gentrifying areas from 2000-2013 (23% vs. 11%). In Los Angeles, a neighborhood that gentrified in the previous time period was over three times as likely to gentrify again in the following decade (10% vs. 3%). To test whether or not the findings hold true after controlling for the characteristics of the neighborhood, we ran a logit model for the 2000-2013 period to include a variable indicating whether the tract was gentrifying in the previous decade (1990-2000). After controlling for the characteristics of the neighborhood, we did not find any independent significance for Los Angeles; however, the relationship in the Bay Area was highly significant after controlling for neighborhood characteristics. The results for Los Angeles are likely due to the fact that the same variables that compelled the neighborhood to gentrify in the first period are compelling it to gentrify again, making it difficult to capture the independent effects. If a tract gentrifies in the first time period, it has much the same chance of gentrifying again, because the neighborhood has the same characteristics that led it to gentrify.

Although the chance of a tract potentially gentrifying again may be small, the fact of higher risk means that we should give additional consideration to these tracts relative or other potentially eligible tracts. Moreover, it is expected that changes that lead to gentrification would slow in the second decade, in part because some of the changes are reaching a “ceiling.” What is worth noting is that another half of these tracts continued to change in the second decade in a direction that is partially related to gentrification.

Overall, we see that, if a tract started gentrifying, it will have a much higher risk of continuing down the path of gentrifying and/or upscaling. In some ways, if we project this forward, starting with the tracts that gentrified between 2000 and 2013, we can expect that a majority of these tracts will either continue to gentrify or upscale, thus putting them at a higher risk. In some ways, the methodology used to construct the gentrification index obscures some of the upscaling that continues to go on in some of these neighborhoods. Additionally, we need to look at other key factors that make an area gentrify. The next section uses logit and multinomial logit regression models to examine this.

Logit Regressions

Gentrification can include both direct displacement (socially and economically disadvantaged residents who are forced out) and exclusionary displacement (barriers that make it difficult for disadvantaged residents to move in). It is difficult to separate these two elements in the regression model. In this section, we begin by modeling gentrification for two individual time periods: 1990-2000 and 2000-2013.

For Los Angeles and the Bay Area, we use a logit regression model with two types of regression results (Tables 2E.3 and 2E.4). The first two models (I & II) only look at tracts that are eligible to gentrify, whereas the second set of models looks at all tracts (III & IV). The dependent variable is a dichotomous variable indicating whether or not a tract has gentrified. The independent variables include key factors related to gentrification (race and income), a tenure variable (percent renters), and two place variables (TOD neighborhoods and Downtown TOD). In this analysis, we separated TOD neighborhoods into three categories depending on the year the transit station opened: TOD 1990s (opened in the 1990s), TOD 2000s (opened in the 2000s), and TOD Recent (opened in 2012 or later *for LA only*, since there has been a lot of recent station development in LA compared to the Bay Area). Additionally, we include a built environment variable (percent of housing units in pre-WWII buildings, defined as those constructed before 1950) and an accessibility variable (# jobs/square mile). The baseline year data for the independent variables are either 1990 or 2000 depending on the period examined.

For Los Angeles, we find that when a station opens, there is a measurable statistical impact. In the first model, the transit stations that opened in the 1990s are associated with a significant positive impact on the tract gentrifying in that decade (Model I), but not in the following decade (Model II). Furthermore, for stations that opened in the 2000s, they negatively predict gentrification in that decade (Model II), and for stations that opened after 2012, they had a significant positive impact on the gentrification outcome. Downtown TODs positively predicted gentrification in all models. For the Bay Area, while new stations appear to influence gentrification positively between 1990 and 2000, they do not seem to have an impact on gentrification from 2000 to 2013. TODs in the three major cities (Oakland, San Francisco, and San Jose, labeled downtown) were more likely to gentrify than TODs in other cities for both time periods, however only downtown TODs were significant for the more recent model.

The role of race remains significant, but its impact changes from one decade to the next. For Los Angeles, the first model tells us that gentrification is occurring in minority areas. Model I (which covers 1990-2000) indicates that neighborhoods with a higher share of non-white population were more likely to gentrify, while Model II (which covers 2000-2013) implies the opposite. In other words, gentrification was initially concentrated in minority areas and then shifted to others. This may be due in part to the possibility that some areas continued to gentrify even after losing much of their minority population. When comparing the eligible and non-eligible models for Los Angeles, we

see a flip in the signs on the race variables, particularly for the 1990-2000 models (Model I and Model III). This would indicate that while gentrification is occurring more in predominantly minority neighborhoods, overall upscaling is more likely to occur in predominantly white neighborhoods. The changes in the estimated coefficients indicate that some patterns of gentrification/upscaling are time- and location-specific, perhaps due to changes in unobserved factors that alter the relative attractiveness for development. In the Bay Area, African-American neighborhoods were more likely to experience gentrification during the later time period (2000-2013), but not the earlier (1990-2000), possibly reflecting shifts in neighborhood preferences or housing availability.

With respect to non-demographic drivers of gentrification, in Los Angeles, the percent of all units that were built prewar is statistically significant, indicating that neighborhoods with a higher share of older units are more likely to experience gentrification. The same was true for the Bay Area model from 2000-2013, again potentially reflecting shifts in neighborhood and housing preferences. While the impact of the access variable (job density) was positive and significant in all of the Los Angeles models, it was only significant and positive in the Bay Area in the 2000-2013 model when including all of the Census tracts, possibly indicating that accessible neighborhoods have become more attractive to gentrifiers over time.

Table 2E.3: Logit Regressions of Gentrification, 1990-2000 and 2000-2013, Los Angeles

	<i>Eligible Tracts</i>				<i>All Tracts</i>			
	Model I LA		Model II LA		Model III LA		Model IV LA	
	1990-2000		2000-2013		1990-2000		2000-2013	
Intercept	-3.2807	***	2.6899	***	-5.7477	***	-4.5411	***
Median Household Income (/10000)	-0.2130	**	-0.8161	***	0.4623	***	0.2741	***
Income Squared	0.0208	*	0.0852	***	-0.0111	***	-0.0240	***
% non-Hispanic black	0.0065	***	-0.0756	***	-0.0069	***	-0.0124	***
% Asian	0.0273	***	-0.0296	***	-0.0157	***	0.0015	
% Hispanic	0.0126	***	-0.0538	***	-0.0106	***	-0.0160	***
% Renters	-0.0065	***	0.0026		0.0214	***	0.0247	***
Downtown TOD	0.5736	***	0.4838	***	0.7406	***	0.6822	***
TOD 1990s	0.1327	**	-0.0381		0.3575	***	-0.0193	
TOD 2000s	-		-0.2962	***	-		-0.2677	***
TOD Recent	-		1.0297	***	-		0.3971	***
% of Housing Units Prewar (<1950)	0.0178	***	0.0345	***	0.0259	***	0.0309	***
Employment Density (# jobs / square mile)	0.0001	***	0.0006	***	0.0001	***	0.0002	***
N	937		929		2,273		2,306	
Likelihood Ratio	493.110	***	2157.547	***	7822.79	***	6436.391	***
***<.01 **<.05 *<.10								

Source: 1990 and 2000 Decennial Censuses, 2009-13 5-year ACS, NETS (1990, 2000)
 Tabulations by C.Pech & P. Ong, July 2015

Table 2E.4: Logit Regressions of Gentrification, 1990-2000 and 2000-2013, Bay Area

	<i>Eligible Tracts</i>				<i>All Tracts</i>			
	<i>Model I BA</i>		<i>Model II BA</i>		<i>Model III BA</i>		<i>Model IV BA</i>	
	1990-2000		2000-2013		1990-2000		2000-2013	
Intercept	-6.690	***	-4.861	***	-8.060	***	-7.191	***
Median Household Income (/10000)	0.692	**	0.332		0.765	**	0.698	**
Income Squared	-0.032		-0.011		-0.059	**	-0.057	**
% non-Hispanic black	0.012		2.030	**	1.383	*	3.772	***
% Asian	-0.890		-0.362		0.256		1.385	
% Hispanic	-0.711		-0.242		1.800	**	2.216	***
% Renters	2.373	***	0.598		3.524	***	1.412	*
Downtown TOD	1.906	***	0.782	**	1.363	***	0.366	
Non-Downtown TOD	0.841	**	-0.269		1.058	***	0.087	
TOD 1990s	0.823	**	-0.465		0.883	***	-0.179	
TOD 2000s	-		0.354		-		0.372	
% of Housing Units Prewar (<1950)	0.438		1.783	***	-0.143		1.039	*
Employment Density (# jobs / square mile)	0.000		0.000		0.000		0.000	*
N	640		626		1576		1579	
Likelihood Ratio	219.9	***	229.9	***	262.5	***	266.7	***
***<.01 **<.05 *<.10								

Source: 1990 and 2000 Decennial Censuses, 2009-13 5-year ACS
Tabulations by M. Zuk Aug 2015

2E.2. Changes in Affordable Housing

In this section, we look at the loss of affordable housing, which serves as proxy for displacement. This is measured by the change in affordable rental units, condo conversions (cities of Los Angeles and San Francisco only), Housing Choice Vouchers (Section 8), Low-Income Housing Tax Credit (LIHTC) units, Ellis Act evictions (city of Los Angeles only) and fault/no fault evictions (city of San Francisco only).

In Los Angeles, we define affordable rental units as units with median gross rent of less than 80% of the county median. For the Bay Area, we define these units as those where low-income households are paying less than 30% of their income on rent and we subtract out subsidized units. Details on data sources and definitions can be found in Appendix I.

Table 2E.5 presents the results for each of the regression models for Los Angeles. We begin by first examining the change in affordable rental units and condo conversions, which is presented in the first two columns. The market as a whole is facing some losses of affordable rental units and of apartments converted to condos, particularly in Downtown. TOD neighborhoods outside of Downtown are also experiencing loss in affordable rental units and conversions from apartments to condos. The next two columns – changes in Section 8 and LIHTC units – look specifically at subsidized housing. While Los Angeles county overall has seen an increase in the number of Section 8 units within the last decade, TOD areas are not experiencing increases in Section 8 units, and TODs outside of Downtown are actually losing them. LIHTC seems to help offset some of the loss because there is an increase of them in both TOD areas, much more so for the Downtown. The increase in LIHTC in TOD areas, however, has not been large enough to offset the total loss of affordable rental units that are occurring in the area. The final model looks at Ellis Act evictions, which are only available for the City of Los Angeles. Because of these data limitations, the results should be interpreted cautiously. They indicate that there are not many Ellis Act evictions occurring in TOD areas. The negative coefficient on the Downtown TOD variable indicates that Ellis Act

evictions are occurring less in the Downtown area. Other types of evictions, which are not Ellis Act, can be occurring in TOD areas, but because this data is unavailable, it is hard to capture this.

Table 2E.5: Changes in Affordable Housing², Linear Regressions (Los Angeles)

	Model I		Model II		Model III		Model IV		Model V	
	Δ Affordable Rental (00-13)	Units	Condo Conversions (03-13)		Δ Section 8 (00-13)		Δ LIHTC (00-13)		Ellis Act Evictions (07-14)	
Intercept	-2.353	**	1.556	***	3.284	***	4.071	***	1.137	***
Median Household Income (/10000)	0.634	***	-0.055		-0.494	***	-0.664	***	-0.100	***
Income Squared	-0.028	***	-0.001		0.017	***	0.023	***	0.002	**
% non-Hispanic black	0.027	***	-0.010	***	0.013	***	0.003		-0.008	***
% Hispanic	0.021	***	-0.015	***	-0.008	***	-0.002		-0.008	***
% Asian	0.008		-0.008	**	-0.005	*	0.001		-0.003	
Downtown TOD	-18.966	***	4.486	***	-0.678		12.945	***	-0.290	*
Other TOD	-2.551	***	0.341	***	-0.365	***	0.392	*	0.050	
Adj. r-squared	0.091		0.052		0.112		0.147		0.0704	
N	2,316		2,317		2,316		2,316		993	

***<.01 **<.05 *<.10

Ellis Act Evictions Data Are Only for LA City, All Other Data are for the County

Source: 2000 Decennial Census, 2006-10 & 2009-13 5-year ACS, 2000 & 2013 HUD's Picture of Subsidized Households, CTCAC, Housing Authority of the City of Los Angeles, Tabulations by C.Pech & P. Ong, July 2015

For the Bay Area (Table 2E.6), we find that being in a TOD predicts the loss of non-subsidized affordable housing and use of Section 8 vouchers; however, the effect is not significant. Similar to Los Angeles, we find that being in a TOD in one of the Bay Area's three major cities – San Francisco, Oakland, and San Jose – positively predicts the addition of federally subsidized housing (LIHTC). However, being in a TOD outside of these three cities predicts fewer new subsidized units. For the entire region, an increase in affordable housing is predicted for minority neighborhoods through both naturally occurring rental units and the use of housing choice vouchers; however, only Hispanic neighborhoods see new federally subsidized units.

² We ran an analysis looking at the change in public housing units in TOD and non-TOD areas and found that changes in TOD areas are essentially the same as in non-TOD areas (the difference in proportion is not statistically different). From 2000 to 2013, non-TOD areas lost 5.8% of their public housing units, whereas non-TOD areas lost 6%.

Table 2E.6: Changes in Affordable Housing, Linear Regressions (Bay Area)

	Model I	Model II	Model III
	Δ Affordable Rental Units (00-13)	Δ Section 8 (00-13)	Δ Federally Subsidized (00-14)
Intercept	-142.541 ***	34.043 ***	96.232 ***
Median Household Income, 2000	14.112 ***	-3.880 ***	-14.105 ***
Income Squared, 2000	-0.365 ***	0.086 *	0.4716 ***
% Asian, 2000	40.256 ***	36.249 ***	3.703
% non-Hispanic Black, 2000	92.624 ***	14.739 *	-18.857
% Hispanic, 2000	95.357 ***	16.762 **	43.516 ***
% Renter, 2000	-119.277 ***	-0.453	11.843
Downtown TOD, 2000	-2.978	-0.964	21.084 ***
Non-downtown TOD, 2000	-6.507	-2.744	-23.961 ***
adjusted R squared	0.189	0.184	0.082
n	1,579	1,579	1,579
***<.01 **<.05 *<.10			
Source: 2000 Decennial Census, 2006-10 & 2009-13 5-year ACS, 2000 & 2013 HUD's Picture of Subsidized Households, CHPC			

Taking advantage of the unique datasets available for San Francisco, we ran linear regressions on the rates of evictions (both fault and no-fault) as well as condominium conversions at the finer geography of the Census block group. Data on condominium conversions, building renovation permits, and code violations were all derived from San Francisco departmental data (Planning, Buildings, and the Rent Control Board). *For these models, TOD neighborhoods are defined as Census block groups that intersect with a quarter-mile buffer of a rail-transit station.*

In Table 2E.7, we show that Hispanic neighborhoods were more likely to experience higher eviction rates than other neighborhoods, whereas Asian neighborhoods were less likely to experience fault evictions. Location near rail transit appears to increase fault evictions rates, but not no-fault rates. Condominium conversions, on the other hand, appear to be less likely to occur in minority neighborhoods, and the impact of TODs is not significant.

Table 2E.7: Evictions and Condominium Conversions, Linear Regressions, San Francisco*

	Fault Evictions Rate, '10-'15	No Fault Evictions Rate, '10-'15	All Evictions Rate, '10-'15	Condo Conversion Rate, 10-15
Intercept	0.018 ***	0.002	0.021 **	0.029 ***
Median Household Income, 2010	-1.8E-04	1.0E-03	8.3E-04	1.9E-03 ***
Income Squared, 2010	-2.9E-05	-4.5E-05	-7.4E-05	-8.5E-05 **
% non-Hispanic black, 2010	-0.006	-0.003	-0.009	-0.042 ***
% Asian, 2010	-0.014 ***	-0.002	-0.016 *	-0.058 ***
% Hispanic, 2010	0.027 ***	0.018 ***	0.045 ***	-0.009
TOD	0.004 **	0.001	0.005 *	-0.001
Adj. r-squared	0.071	0.001	0.043	0.287
n	576	576	576	578

**Note: This analysis differs from previous analyses in that TOD neighborhoods are defined as Census block groups, rather than Census tracts and we look at the quarter mile buffer around the rail station rather than half mile...*

2E.3. Loss of Low-income Households

Another approach to estimating displacement is to use the loss of low-income households as a proxy. For the Bay Area, we take this approach as another way to model displacement effects of TODs. Researchers have found that neighborhood composition in the United States is considerably stable (Wei and Knox 2014; Landis 2015). In fact, on average, Bay Area Census tracts' low-income population grew by 59 households between 2000 and 2013. Therefore, we may assume that any neighborhood that experienced a net loss of low-income households while stable in overall population is a result of displacement pressures. Although the change in low-income households could be due to income mobility (e.g., low-income households moving into middle- or upper-income categories, or vice versa), from our analysis of data from the Panel Study on Income Dynamics we estimate that the Great Recession would have caused a net increase in low-income households in most places. In Table 2E.8, we find that TODs outside of the three major cities had an increase in the likelihood of losing low-income households, which is consistent with the lower rates of low-income in-migration and higher rates of higher-income in-migration found in Section 2D. In TOD neighborhoods in the three major cities, we found an increase in the likelihood of gaining low-income households, which may be related to the growth in subsidized housing found in these neighborhoods (see table 2E.6).

Neighborhoods with a high proportion of renters were more likely to lose low-income households, whereas minority neighborhoods were more likely to gain. In an alternative scenario we consider characteristics related to the built environment such as the percent of housing units in prewar buildings, and find that neighborhoods with a high proportion of historic, pre-war housing stock were more likely to lose low-income households, whereas development of any kind, both market-rate and subsidized, predicted a gain in low-income households. Finally, neighborhoods that had a high proportion of housing stock in public housing were more likely to gain low-income households, whereas neighborhoods where low-income residents were living in naturally affordable rental units were more likely to lose low-income households.

Table 2E.8: Change of Low-Income Households, Linear Regressions (Bay Area)

	Change in Low Income Households, 2000-2013	Change in Low Income Households, 2000-2013 ALT
Intercept	-33.829	96.519 ***
Median Household Income (/10000), 2000	9.850 *	
Income Squared, 2000	-0.326 *	
% Asian, 2000	108.805 ***	
% non-Hispanic Black, 2000	14.670	
% Hispanic, 2000	234.995 ***	
% Renters, 2000	-74.772 ***	
Downtown TOD, 2000	17.886	48.539 ***
Non-Downtown TOD, 2000	-44.087 ***	-73.647 ***
% of housing units prewar (<1950), 2000		-140.675 ***
Employment Density (/1000), 2000		0.000
% increase in property sales value per square foot, 1990-2000		-15.782
% increase in rent paid, 1990-2000		-6.582
New market rate units, 1990-2000		0.052 ***
New subsidized units, 1990-2000		0.378 ***
% of housing units in Public Housing, 2000		167.638 *
% of low income households paying less than 30% in rent in non-subsidized units, 2000		-67.788 **
Adj. r-squared	0.065	0.105
n	1569	1524

Section 2F: Modeling Neighborhood Change

Given the shortcomings of the data available to analyze mobility and displacement, we conducted a third set of analyses to look at changes in neighborhood composition by income classes, income inequality, racial/ethnic groups, racial diversity, and rent burden. First we present the findings for Los Angeles County, followed by those for the Bay Area.

2F.1. Neighborhood Change in Los Angeles County

Our analysis of neighborhood change is broken into two parts. We begin with a simple bivariate analysis, comparing the changes in neighborhood characteristics between TOD and non-TOD areas using the characteristics previously described pertaining to income, race, education, and tenure. TOD neighborhoods are grouped into two separate categories: TODs that are located in Downtown Los Angeles (“Downtown TOD”) and TODs that are located elsewhere (“Other TODs”).

Table 2F.1 reports the average (both mean and median) tract level changes for TOD and non-TOD areas. Our analysis looks specifically at the changes in: 1) population with less than a high school diploma; 2) population with a bachelor’s degree or higher; 3) non-Hispanic white; 4) rent burden (paying 30 percent or more of income on rent); 5) low-income households (households with less than \$10K); 6) high income-households (households with \$125K or more); 7) median household income (adjusted to 2013 dollars); and 8) gross rent (adjusted to 2013 dollars). With the exception

of the change in median household income and gross rent (which are absolute changes), all changes represent percentage point change.

It is evident from the table that TOD tracts are changing more in the direction of gentrification than non-TOD areas. In terms of demographic and socioeconomic changes, TODs, on average, experienced greater increase in white, college-educated, and higher-income households. While the county overall experienced declines in median household income from 2000 to 2013 (-\$3,460), largely a result of the recent recession, the impact on TOD areas was smaller. Surprisingly, Downtown TODs on average saw a gain in median household income during this period (+\$1,405). Increases in gross rent are also higher in TOD tracts than non-TOD areas.

Table 2F.1: Changes in Neighborhood Characteristics, LA County, 2000-2013*

	<i>Downtown TOD</i>		<i>Other TOD</i>		<i>non-TOD</i>	
	Mean	Median	Mean	Median	Mean	Median
Δ Less than High School	-16.41	-16.6	-10.8	-10.27	-6.98	-5.59
Δ Bachelor's Degree or Higher	16.98	15.97	5.77	4.17	4.9	4.3
Δ non-Hispanic white	12.37	13.04	0.21	-0.1	-4.76	-3.56
Δ Rent Burden	8.29	7.37	12.7	13.36	11.64	12.55
Δ Low-Income Households (<10K)	-4.74	-0.42	-0.23	-0.01	1.00	0.89
Δ High Income Households (125K+)	3.85	3.25	-0.57	-0.99	-2.1	-2.06
Δ Gross Rent	\$358.75	\$247.98	\$246.95	\$226.39	\$223.87	\$233.34
Δ Median Household Income	\$8,864.43	\$1,405.51	\$327.72	-\$824.07	-\$4,110.56	-\$3,460.36
% Asian, 2000	35.08	32.23	10.7	7.03	13.01	8.21
% non-Hispanic black, 2000	15.02	8.57	14.62	6.82	8.92	3.45
% Hispanic, 2000	35.47	26.61	56.47	57.83	41.78	36.81
% Renter, 2000	92.87	93.66	70.78	72.99	48.46	48.9
n	12		367		1,884	

Data Source: 2000 Census, 2009-2013 5-year ACS

**With the exception of change in gross rent and median household income, all changes represent percentage point change. Values for gross rent and median household income are adjusted to 2013 dollars.*

While the patterns seem to be consistent with the literature on gentrification, we ran multivariate models to test whether the relative changes for TOD tracts hold after accounting for other neighborhood characteristics that can also influence change (Table 2F.2). The dependent variables (in column headings) include the change in: population with less than a high school diploma (LTHS), those with a bachelor's degree or higher (BA+), non-Hispanic white (NHW), rent burden, low-income households, high-income households, median household income, and gross rent. The control variables are the 2000 baseline data presented in each row.

Table 2F.2: Neighborhood Change Multivariate Regressions, LA County, 2000-2013*

	Δ LTHS	Δ BA+	Δ NHW	Δ Renter Burden	Δ Low-Income HHs (<10K)	Δ High Income HHs (125K+)	Δ Median HH Income	Δ Median Gross Rent
Constant	-5.544 ***	3.230 *	-19.657 ***	-4.181	2.129	2.938 *	6,007 *	266.135 ***
Median Household Income (/10,000)	1.212 ***	0.137	0.106	1.333 ***	0.366 **	-0.841 ***	-410.652	28.163 ***
Median Household Income Squared	-0.049 ***	-0.003	0.030 ***	-0.049 ***	-0.022 ***	0.016 **	-75.488 ***	-2.745 ***
% Asian	-0.034 ***	0.021 **	0.078 ***	0.024	-0.039 ***	0.001	-40.271 **	-1.875 ***
% NHBK	-0.006	-0.036 ***	0.116 ***	0.055 ***	-0.024 ***	-0.038 ***	-88.725 ***	-1.246 ***
% Hispanic	-0.108 ***	-0.055 ***	0.087 ***	0.120 ***	-0.011 *	-0.044 ***	-95.379 ***	-1.240 ***
Downtown TOD	-4.975 ***	9.028 ***	11.312 ***	-3.361	-4.596 ***	1.591	7,703 **	166.895 ***
Other TOD	-0.440	0.897 **	1.422 ***	-1.186	-0.696 **	0.611 *	2,679 ***	17.775
% Renters	-0.023 **	0.045 ***	0.131 ***	0.057 ***	-0.008	0.017 **	0.671	0.184
Δ Gross Rent	-0.003 ***	0.005 ***	0.002 **	0.006 ***	-0.003 ***	0.004 ***	9.520 ***	
Adjusted R-Squared	0.359	0.133	0.258	0.071	0.055	0.144	0.279	0.156
n	2,224	2,224	2,224	2,224	2,224	2,224	2,224	2,224

***<.01 **<.05 *<.10

Data Source: 2000 Census, 2009-2013 5-year ACS

*With the exception of change in gross rent and median household income, all other changes represent percentage point changes. Values for gross rent and median household income are in 2013 dollars.

Not surprisingly, we find similar results to what was discussed in the previous sections. Relative to non-TOD areas, TOD tracts are changing more into the direction of gentrification. Focusing specifically on Downtown TOD and Other TOD, we see that relative to non-TOD areas, TOD neighborhoods are more likely to see a decline in people with less than a high school diploma (significant only for Downtown TOD) and low-income households. Conversely, TOD tracts are more likely to see an increase in the share of people with a bachelor's degree or higher, a gain in non-Hispanic white population, a gain in higher-income households (significant only for Other TOD neighborhoods), an increase in median household income, and a rise in gross rent relative to non-TOD areas. The multivariate results are consistent with the gentrification thesis, that is, TODs are associated with the a priori hypothesis of demographic and socioeconomic change.

We found no significance in terms of rent burden, although the negative coefficients do indicate that relative to non-TOD tracts, TOD neighborhoods are more likely to see a drop in burden households. One explanation for this could be the increase in higher-income households. In early gentrifying neighborhoods, rents are cheaper and, according to existing literature on gentrification, they often attract higher-income and educated young professionals. Hoping to take advantage of the cheaper rent (cheaper relative to their income), these newcomers might displace lower-income families who can no longer afford to live in the neighborhood. The low-income family's higher housing burden status is now replaced with the new higher-income households for whom the rent is not a burden (i.e., they pay less than 30% of their income on housing). Although declining rent burden is not proof of gentrification, it certainly is consistent with what is known about early stages of gentrification.

2F.2. Neighborhood Change in San Francisco Bay Area

Using similar datasets and procedures as in Los Angeles County, Table 2F.3 reports the average (both mean and median) tract-level changes for TOD and non-TOD areas for indicators in the San Francisco Bay Area. For rent burden, we only look at low-income households that are rent burdened, defined as households earning less than 80% of the county median income that spend more than 30% of their household income on rent. Because of the high variability in incomes across

the region, we define low-income households as those earning less than 80% of the county median income and high-income households as those earning more than 120% of the county median income.

It is evident from the table that TOD tracts in the Bay Area are changing more in the direction of gentrification than non-TOD areas. In terms of demographic and socioeconomic changes, TODs, on average, lost fewer non-Hispanic whites and adults with less than a high school education than non-TODs. In contrast, TODs experienced greater increases in college-educated and higher-income households. While the region overall experienced declines in median household income from 2000 to 2013, largely a result of the recent recession, the impact on TOD areas was about half as much as on non-TOD areas. While the patterns seem to be consistent with the literature on gentrification, we ran multivariate models to test whether the relative changes for TOD tracts hold after accounting for other neighborhood characteristics that can also influence change.

Table 2F.3: Changes in Neighborhood Characteristics, SF Bay Area, 2000-2013*

	Non-TOD		Downtown TOD		Non-Downtown TOD	
	Mean	Median	Mean	Median	Mean	Median
Δ Less than High School	-3.40	-3.28	-6.29	-4.66	-3.23	-3.55
Δ Bachelor's Degree or Higher	5.29	4.72	8.02	7.14	5.84	5.54
Δ non-Hispanic white	-8.51	-8.09	-2.43	-2.64	-8.53	-9.11
Δ Rent Burden	-6.45	-8.02	-3.87	-5.39	-10.54	-11.71
Δ Low Income Households (<80% County median Income)	2.31	2.41	1.80	1.88	-0.02	-0.29
Δ High Income Households (>120% County Median Income)	0.02	-0.16	0.83	0.51	2.61	2.65
Δ Median Rent	\$145.61	\$170.95	\$192.97	\$194.15	\$133.25	\$144.82
Δ Median Household Income	-\$6,688.40	-\$6,946.20	-\$1,986.81	-\$4,124.38	-\$2,460.94	-\$3,033.15
% Asian, 2000	18.73	13.14	28.41	22.97	23.10	19.76
% non-Hispanic Black, 2000	7.97	3.00	12.05	4.83	7.03	3.12
% Hispanic, 2000	17.09	12.41	21.74	15.92	20.32	15.92
% Renter, 2000	35.32	31.90	56.80	59.65	47.99	46.04

Data Source: 2000 Census, 2009-2013 5-year ACS

**With the exception of change in gross rent and median household income, all other changes represent percentage point changes. Values for gross rent and median household income are in 2013 dollars.*

Focusing specifically on the one TOD variable for the Bay Area (Table 2F.4), we see that relative to non-TOD areas, TOD neighborhoods are more likely to see a decline in those with less than a high school diploma and low-income households. Conversely, TOD tracts are more likely to see an increase in the share of those with a bachelor's degree or higher, a gain in non-Hispanic white population, more higher-income households, and an increase in median household income and median gross rent relative to non-TOD areas. The multivariate results are consistent with the gentrification thesis, that is, TODs are associated with the a priori hypothesis of demographic and socioeconomic change.

Table 2F.4: Neighborhood Change Multivariate Regressions, SF Bay Area, 2000-2013*

	Δ Less than High School	Δ Bachelor Degree or Higher	Δ non-Hispanic White	Δ Rent Burden of Low Income Households	Δ Low income Households	Δ High Income Households	Δ Median Household Income	Δ Median Gross Rent
Constant	-0.03	0.01	-0.14 ***	0.01	-0.07 ***	0.07 ***	959.01	493.59 ***
Median Household Income	0.00	0.00	0.00	-0.02 ***	0.01 ***	-0.01 ***	-30.20	1.58
Income Squared	0.00	0.00	0.00 **	0.00 ***	0.00 ***	0.00 ***	-30.87	-2.15 ***
% Asian	0.02	-0.01	0.02 ***	0.08 ***	0.08 ***	-0.08 ***	-11314.17 ***	-204.25 ***
% non-Hispanic black	-0.05 ***	0.03 *	0.20 ***	0.13 ***	0.06 ***	-0.08 ***	-6834.32 *	110.26 *
% Hispanic	-0.02 *	-0.03 **	0.06 ***	0.05	0.14 ***	-0.11 ***	-28243.65 ***	-106.73 **
% Renters	-0.03 **	0.04 ***	0.08 ***	-0.08 **	-0.04 ***	0.03 ***	4813.04 **	-269.02 ***
TOD	-0.01 **	0.02 ***	0.01 ***	0.00	-0.01 ***	0.02 ***	4416.09 ***	26.48 *
Δ Median Gross Rent	-3.4E-05 ***	4.09E-05 ***	3.33E-05 ***	4.28E-05 **	-5.5E-05 ***	5.33E-05 ***	11.00 ***	
n	1,575	1,575	1,575	1,546	1,567	1,567	1,574	1,575
Adj. R-Squared	0.0633	0.0414	0.1765	0.028	0.1436	0.1301	0.146	0.2109

*** p<.01, ** p<.05, *p<.10

Data Source: 2000 Census, 2009-2013 5-year ACS

*With the exception of change in gross rent and median household income, all other changes represent percentage point changes. Values for gross rent and median household income are in 2013 dollars.

Section 2G. Sensitivity Analyses

For Sections 2D, 2E, and 2F, we report the results for the regression models that are both conceptually sound and empirically reasonable. There are two different methods of comparing the model results for the sensitivity analyses. One is a pure statistical comparison. We look at the estimated parameters to see if they are statistically different from or similar to each other across models. This includes conducting a simple t-test of the coefficients. The second is a more qualitative comparison of the outcomes. For example, are the directions of the impacts in the same (e.g., positive coefficients in all models), and are they roughly of the same relative magnitude?

The sensitivity analyses to test the robustness and reliability of our models can be grouped into four broad categories: 1) alternative specifications; 2) alternative data construction; 3) identifying outliers; and 4) other types of robustness testing.

Alternative Specifications

This essentially consists of purposely running a number of alternative specifications to determine whether particular results are robust to a change in specification. For example, while we ran mostly ordinary least square regressions (OLS), we also explored other types of regression models. For the research task described in section 2D, we ran both OLS and seemingly unrelated regressions (SUR) to model neighborhood mobility. SUR accounts for possible correlation of the error terms across equations. We ran the model using both techniques and found them to produce similar results, which confirmed our original conclusion derived from the OLS model. Other modeling techniques employed include logit models, both binary and multinomial, which we used to model neighborhood displacement in Section 2E, and censored regression models, specifically Tobit models, which we used to deal with datasets with a high number of zero values. On the whole, they produced similar results.

In addition to the type of regressions adopted, we also made modifications to the method itself. For example, we had to decide whether or not to apply weights to the models. We acknowledge that

they generally do not produce the same results, but conceptually, we know that the greatest inaccuracies lie within tracts with very small numbers or sample sizes. These tracts often overly influence the regression results because they often have extreme values. By applying weights to the models, we could counteract this undue influence. Changes were also made to the sets of independent variables. This process involved using different types of independent variables by adding or swapping out individual variables that either have or do not have a major impact on the estimated equation.

Alternative Data Construction

Another sensitivity analysis employed includes the construction of the same variables using different types of methods or definitions. In the analysis presented in Section 2F, for example, we ran a series of linear regressions to measure housing affordability using different definitions of rent burden. The most widely accepted definition is that a household should spend no more than 30 percent of their income towards housing costs. As part of our sensitivity analysis, we also model households paying 35 percent or more. Additionally, we ran models to include, as the dependent variable, all households (both homeowners and renters), and separately, homeowners and renters who are paying at these different levels.

Another alternative data construction test involved varying our estimates of the number of residential units. While we relied on the assessor's parcel data for information about individual properties, the parcel data had incomplete information on the number of residential units in a given parcel, as noted earlier. For properties classified as "Five or More Units", for example, we estimated the number of units in the structure by dividing the property's square footage by 900 square feet, the average size for a multi-family unit in Los Angeles County. We compared our estimated numbers to those reported by DataQuick, the Bureau of Census's 2010 Decennial Census, and the 2009-2013 American Community Survey (ACS). DataQuick reports the number of units for each property but has some missing information, which is why we decided to develop a methodology to estimate the number of units for each individual parcel for Los Angeles. The Bureau of Census does not report the number of units at the individual parcel level but does report it at the Census block (contain in the Decennial Census) and at the block group level (contained in the ACS). We compared each of these data sources for the number units within the half-mile radius of a transit station. The results are displayed in Figure 2G.1, Estimated Number of Housing Units for LA County. Our estimated numbers of units are similar to those reported by the other two sources, which allows us to have some confidence in our developed methodology and data construction. However, we do see some discrepancy, particularly in the station areas with the greatest number of housing units. One reason may be temporal, that is inconsistencies in year for the various datasets. The County Assessor's parcel data are for 2012, DataQuick is for 2014, Census block data is for 2010, and the ACS data is the average for years 2009-2013. We also use an average size of a unit across all areas to estimate the number of units for a given parcel; however, certain neighborhoods may have homes with significantly greater or smaller area footprints.

Identifying and Addressing Outliers

Outliers can distort the regression results. When an outlier is included in the analysis, it pulls the regression line towards itself. This can result in a solution that is more accurate for the outlier, but less accurate for all of the other cases in the dataset. Prior to removing them, we first had to make the decision about what would be considered unreasonable outliers. First, those identified as being too extreme on either end were removed. We determined this by looking at the distribution of the variable. Next, we looked at how changing the parameters might affect the sample size and

regression results. For example, as described in Section 2F “Modeling Neighborhood Change”, we ran our regressions using three different cutoffs to eliminate outliers. Table 2G.1 reports the results for Los Angeles and only includes the coefficients for the variables of interest – Downtown TOD and Other TOD – and the sample size for each. The patterns are fairly consistent, but the level of significance for specific variables and overall sample sizes changes when different parameters are applied. For example, by applying a higher cutoff, the coefficient for the change in less than high school education becomes significant for Downtown TOD, and we are able to get a larger sample size for the Downtown area.

Table 2G.1: Regression Results for Los Angeles County

Parameters		Δ LTHS	Δ BA+	Δ NHW	Δ Renter Burden	Δ Low-Income HH (<10K)	Δ High Income HH (<125K)	Δ Median HH Income	Sample Size w/ Cutoffs	Sample Size w/o Cutoffs
30 pp, 300% Change	Downtown TOD	-3.07	7.81 ***	9.57 ***	-3.81	-3.31 **	0.64	6,677.86 **	11	15
	Other TOD	-0.52	1.02 ***	1.46 ***	-0.96	-0.81 ***	0.65 *	2,842.51 ***	352	387
40 pp, 300% Change	Downtown TOD	-5.42 ***	10.17 ***	11.61 ***	-2.45	-5.16 ***	2.33	9,232.68 ***	12	15
	Other TOD	-0.47	1.04 ***	1.46 ***	-1.11	-0.76 **	0.69 **	2,854.13 ***	365	387
40 pp, 350% Change	Downtown TOD	-6.60 ***	12.19 ***	12.09 ***	-2.03	-8.36 ***	2.81 *	10,460.00 ***	13	15
	Other TOD	-0.46	1.04 ***	1.46 ***	-1.11	-0.74 **	0.69 **	2,848.70 ***	365	387

Percentage points (PP) difference for the following variables: LTHS, NHW, Rent Burden, and Low-Income HHS
Percent change for the following variables: Gross Rent (2013 dollars), and Median HH income

*** p<.01, ** p<.05, *p<.10

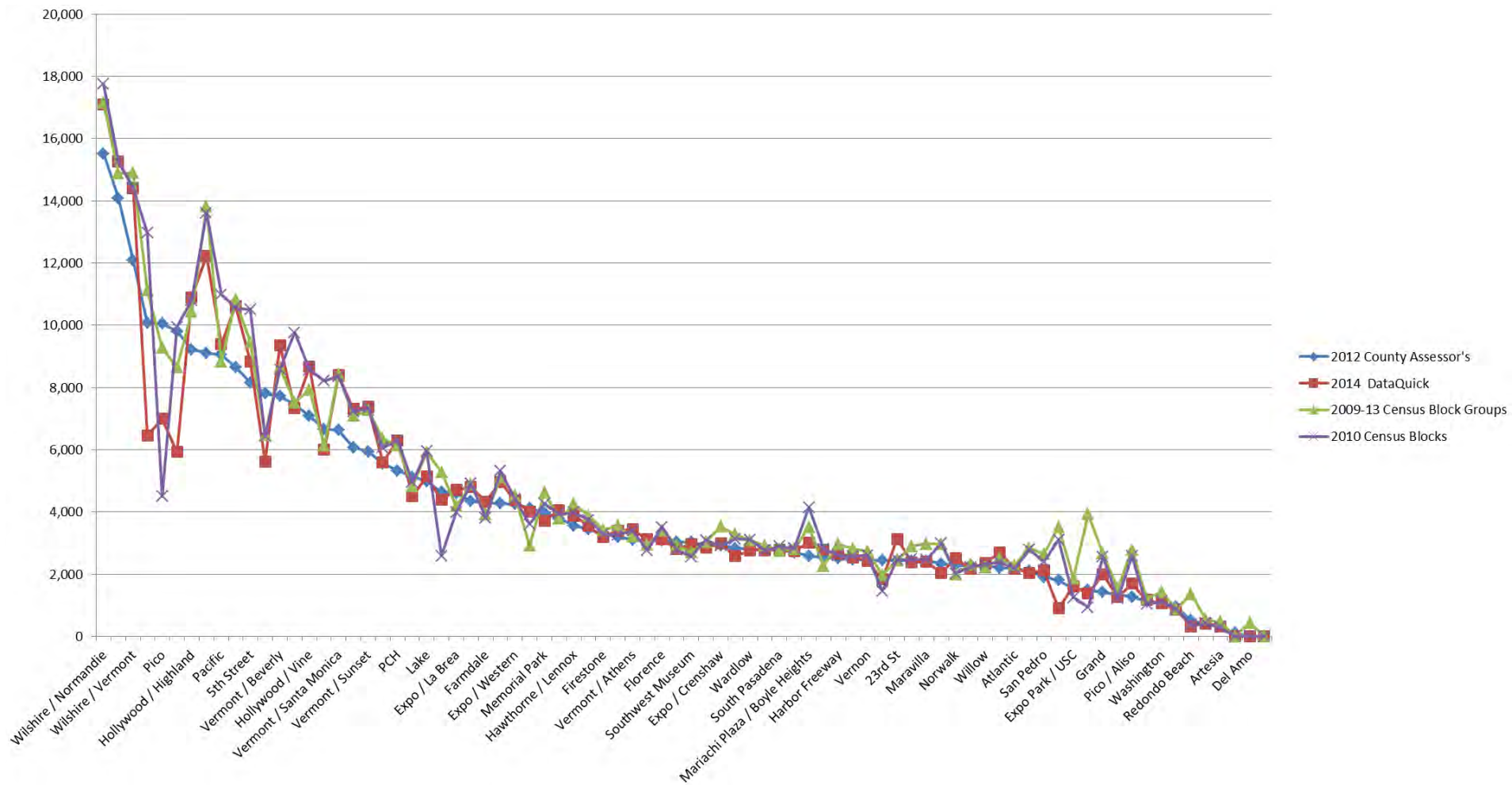

Figure 2G.1: Estimated Number of Housing Units for LA County

Section 2H: Ground-Truthing Secondary Data

The above analyses rely on secondary datasets (e.g. Census), some of which are derived from samples rather than full inventories of the population in question (e.g., people, housing units, jobs, etc.). Because of this as well as delays in data collection, reporting, etc., secondary data may not accurately depict what is currently observed on the ground. We conducted a ground-truthing exercises to assess the level of consistency between real-world observations and secondary datasets. Interviews and visual observation provide a way to verify secondary data. These methods also allow us to garner more firsthand knowledge about the processes at work in gentrification and displacement. We use these ground-truthing methods in three case studies in the SF Bay Area (East Palo Alto, Marin City, and the Mission District of San Francisco) and three case study neighborhoods in Los Angeles (Chinatown, 103rd St/Watts Tower, and Hollywood/Western).

We developed similar visual inspection tools for the two regions with some variation to account for regional differences. Both methodologies involve walking on sample blocks and, using a written checklist, noting signs of investment, disinvestment, and other features of each building on the street. For example, we note the number of units a building appears to have (by counting doorbells, mailboxes, electric boxes, and so on), the apparent use of the building (single-family, multi-family, commercial, and the like), whether the building is well-maintained (through indicators like whether it is recently painted), and how stable or transient the population appears (through indicators like whether curtains/drapes are permanent or temporary). These results are compared on a parcel-by-parcel basis to secondary parcel data, and on an aggregate block-by-block level to Census and other secondary data.

Besides this visual inspection, we also conducted interviews with stakeholders (primarily non-profit advocates) who are familiar with the history and ongoing patterns of change of the case study areas. In some cases, they accompanied us on our block-walking. This insider knowledge helped us to make sense of ambiguous visual indicators. These stakeholders also helped us “ground-truth” our overall understanding of how the area is changing.

2H.1. Bay Area Ground-Truthing

The ground-truthing exercise conducted on sample blocks in East Palo Alto, Marin City, and the Mission District of San Francisco showed us that, broadly speaking, secondary data and on-the-ground visual observation tell the same story of neighborhood change. We find, however, that there is greater divergence between the stories emerging from the secondary data analysis and the stakeholders’ perceptions of change, than there is between the secondary data and the neighborhood observation.

This process reveals the relative strengths of different datasets: secondary data provides rich descriptions of demographic change, sales turnover, and changes in home values (based on assessed versus sales values). However, unlike secondary data, ground-truthing reveals perceived safety, levels of maintenance (a proxy for investment), and newer trends in investment and change not reflected in secondary data. Finally, stakeholder interviews reveal resident concerns and perceptions, historical context, and also trends too recent for secondary data to capture.

In general, the “broad” story of a block’s change as told by primary data is about the same as that told by secondary data. Though there are some discrepancies in parcels’ land use and numbers of units between the datasets, these are not significant enough to change the story.

In East Palo Alto, the datasets are generally aligned, and there is minimal variation among the blocks surveyed. However, stakeholders viewed the city as undergoing more displacement than our secondary data analysis indicated.

In Marin City, the same dynamic was at play: while our secondary data analysis would lead us to believe that the neighborhood was not losing low-income households, stakeholders are very concerned about gentrification and displacement. The visual observation generally aligned with secondary data here. A challenge to the methodology on one block was that almost all the homes were identical in design, upkeep, security signage, and more. Assessing the level of investment and perceiving any nuance here was difficult.

In the Mission District, the number of units per building varied considerably from the secondary datasets. The Mission has experienced significant condominium conversion and general turnover. This is a concern for modeling displacement in areas that are rapidly changing: the secondary datasets we often rely on miss a great deal of the changes happening especially in the recent past. This underscores the importance of stakeholder engagement and on-the-ground observation to ascertain the extent of development.

There is a range of accuracy in parcel data’s land use and number of units (Table 2H.1). However, even with these discrepancies, the overall story from visual observation was the same as secondary data.

Table 2H.1: Comparisons of Secondary Data and Ground-truthing Data in Three Case Study Areas

Case	Land Use Match Percentages for Blocks	Unit Number Match Percentages for Blocks	Discrepancy in Total number of Units on Blocks
East Palo Alto	87% - 100%	94% - 100%	5-60 units
Marin City	74% - 97%	65% - 100%	1-28 units
Mission District	71% - 96%	32% - 44%	0-46 units

In Appendix J, we outline the basic methodology and the visual survey tools used, followed by a basic overview of each case study’s history and recent changes, secondary and visual observation data for each case, and a comparison of the results of our quantitative models with stakeholder perceptions. Overall we find alignment between the secondary data analysis and the observations on the ground. Interviews, however, reveal perceptions of change or anticipation and anxiety about gentrification and displacement in response to more subtle observations on the ground and in surrounding neighborhoods.

2H.2. Los Angeles Ground-Truthing

There are 80 Metro rail stations in Los Angeles County. Metro also operates buses. Our analysis, however, focuses on three Metro station areas: Chinatown, Hollywood/Western, and 103rd St./Watts Towers. These areas were selected with input from our Southern California Advisory

Board, and each is on a different Metro rail line. Diversity of station-area conditions also influenced the selection of the three case studies, as each of the case studies represents a different typology, as described below.

- (1) Chinatown is a mixed-use, ethnic neighborhood at risk of gentrification with few formal transit-specific planning efforts to mitigate the changes taking place;
- (2) Hollywood/Western is a mixed-use, regional destination at risk of gentrification but mediated by formal planning efforts; and
- (3) 103rd St./Watts Towers is a residential commuter neighborhood that is not gentrifying.

We focus on the area within a half-mile radius of each station. When possible, we present secondary data for the 80 stations as an aggregate group. Our analysis is done in two parts. Using results from field observations, Part I examines the validity of underlying Census and assessor data that was used to model gentrification and displacement as described in Section 2E. Part II compares the results of models in 2E with information gathered from interviews with community-based organizations (CBOs) and public agencies.

Part I: Assessment of Data Ground-Truthing in Los Angeles

The team selected parcels for observation based on land use and recent sale transactions or activity requiring a permit. A total of 123 residential and commercial parcels were observed in the three case study areas (See Table 2H.2). Detailed description of the methodology can be found in Appendix L.

Table 2H.2: Count of Parcels and Blocks Surveyed in Specific Los Angeles Neighborhoods

	Chinatown	Hollywood/Western	103rd/Watts
Total Parcels	26	48	49
Residential	19	46	46
Commercial	7	2	3
Total Block Segments	21	20	31

Source: Tabulated by authors from observational data collected between March and August 2015.

Model Results for All Three Case Studies in Los Angeles

Figure 2H.1 presents the results of our gentrification model at the Census tract level from 1990 to 2013. Tracts were classified as either eligible or not eligible for gentrification based on population size and indicators of vulnerability (income, educational attainment, rentership rate and rent costs, race). The eligible tracts were then classified into one of four categories: (1) experiencing gentrification between 1990 and 2000; (2) experiencing gentrification between 2000 and 2013; (3) experiencing gentrification in both decades (1990-2000, and 2000-2013); or (4) eligible (disadvantaged communities) but not gentrifying. For more information on the model and tract classification, see Section 2E.

As shown in Figure 2H.1, the 103rd St./Watts area is "eligible" for gentrification as defined in section 2E.1. However, while the area is a disadvantaged community, not much development has occurred. For Chinatown and Hollywood/Western, our model indicates that the areas have undergone significant changes in the past decade. Most of the change in Chinatown can be seen along the

outskirts of the half-mile buffer. On the other hand, change in the Hollywood/Western TOD area has occurred in close proximity to the transit station.

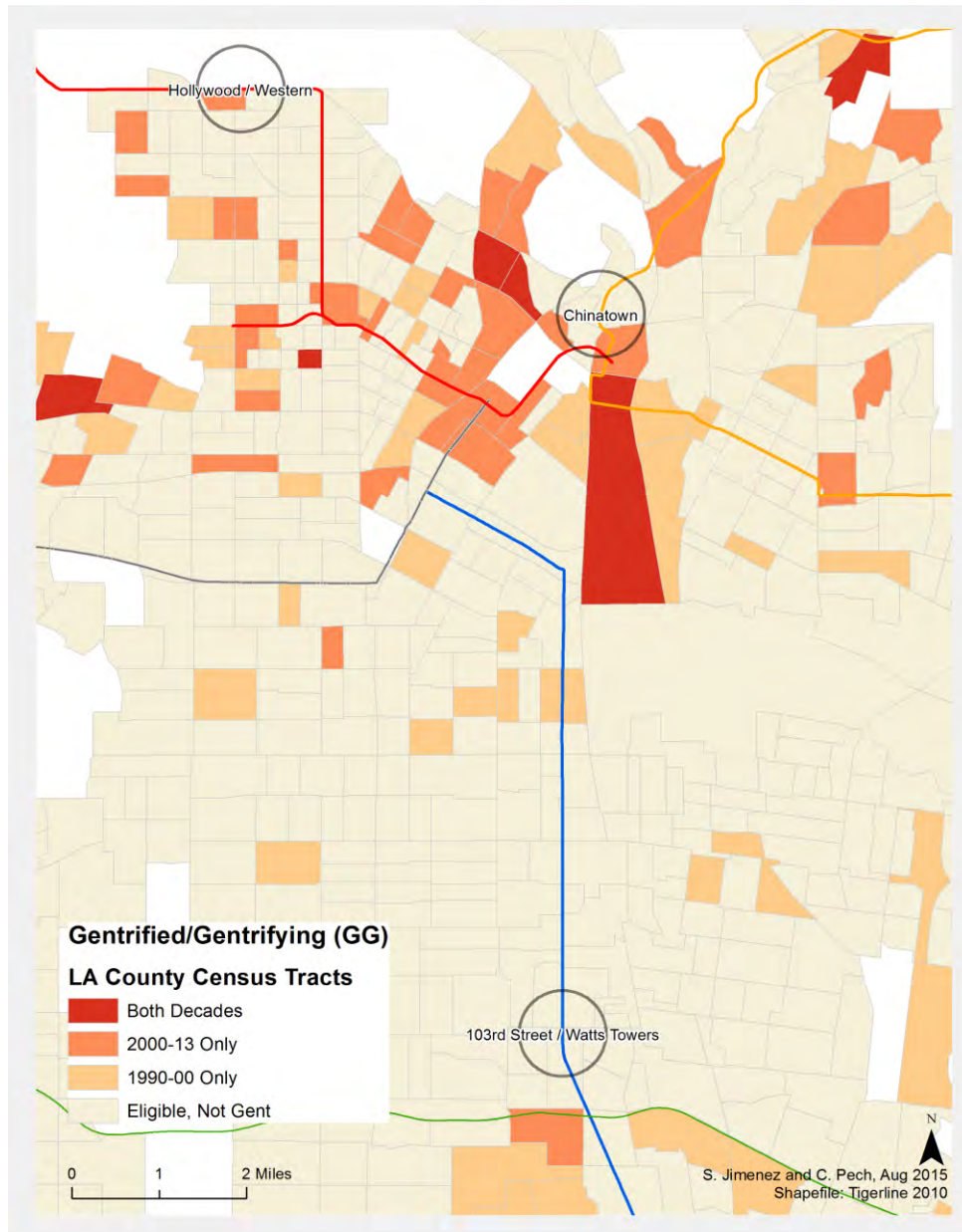

Figure 2H.1: Gentrifying and Gentrified Census Tracts, Los Angeles County, 1990-2013

Assessment Results

Table 2H.3 ranks the three case studies along four composite indicators of neighborhood change: 1. sociodemographic changes, 2. job changes, 3. physical signs of residential change, and 4. physical signs of commercial change. The ranking allows us to compare the results of the gentrification model to what is happening on the ground. For the most part, we find moderate consistency when comparing the secondary data, field observations, and model results, particularly in areas where there is little development.

The sociodemographic indicators are derived from readily available Census data used in the model discussed in Section 2E. They measure greater-than-expected change (or z-score)³ in each case study area relative to all TOD areas in Los Angeles County.⁴ The higher and more positive the z-score for an individual station, the higher the signs of gentrification. Three variables are used for this indicator: average household income, average rent, and number of non-Hispanic whites. For each station, we examined the change for each variable from 1990 to 2013. Greater changes in income, rent, and number of non-Hispanic whites correlate with more signs of development.

Table 2H.3: Comparison of Indicators of Neighborhood Change in Los Angeles Case Studies

Station	Rank (from most change to least)			
	Δ Sociodemographic	Δ Jobs	Δ Residential	Δ Commercial
Chinatown	1	3	2	2
Hollywood/Western	2	2	1	1
103rd St/Watts Towers	3	1	3	3

Source: Tabulated by authors from 1990 decennial Census data and 2013 ACS; LEHD 2002-2012; and observational data collected in March and June, 2015.

For Chinatown, the z-score total is -0.247, while for Hollywood/Western it is -0.437 and for 103rd St./Watts Towers -0.561. The negative scores indicate that the three case study areas are gentrifying less than all TODs as a whole, with the Watts station showing the least indication of gentrification of the study areas.

We use job growth to measure changes in economic activity and commercial gentrification.⁵ Chinatown had a 12.3% increase in jobs from 2002-2012, Hollywood/Western a 115.1% increase, and 103rd St./Watts a 194.4% increase. While Watts ranks first, its base is the lowest of the case study areas, having started in 2002 with only 484 jobs. In absolute numbers, Watts and Chinatown

³ A z-score is essentially a standardized score that indicates how many standard deviations an observation or a data point is from the mean.

⁴ To compare a specific station's change in each variable relative to all TOD stations, we compute a z-score for each of the three variables (income, rent, and race) to see how much it deviates from the average of all stations. This z-score is calculated by taking the specific station's change (in household income, for example), subtracting it by the mean change for all TOD stations, and dividing it by the standard deviation of change for all TOD stations. After finding the z-score for each of income, rent, and race, we add these z-scores to create a composite z-score.

Where

$$zscore\ composite = zinc + zrent + zrace$$

$$zinc = \frac{\Delta income\ for\ specific\ station - mean\ \Delta income\ of\ all\ TOD\ stations}{standard\ deviation\ in\ \Delta income\ of\ all\ TOD\ stations}$$

$$zrent = \frac{\Delta rent\ for\ specific\ station - mean\ \Delta rent\ of\ all\ TOD\ stations}{standard\ deviation\ in\ \Delta rent\ of\ all\ TOD\ stations}$$

$$zrace = \frac{\Delta nhw * for\ specific\ station - mean\ \Delta nhw\ for\ all\ TOD\ stations}{standard\ deviation\ in\ \Delta nhw\ for\ all\ TOD\ stations}$$

*nhw = non-Hispanic whites

⁵ The percent change in jobs is from the 2002 – 2012 Longitudinal Employer-Household Dynamics (LEHD) survey for “all jobs” in blocks within ½ mile of the TOD station.

experienced similar growth in jobs while the increase in Hollywood/Western was more than four times that of the other two areas (an increase of 941,995, and 4,292 jobs, respectively).

The data on residential and commercial gentrification is based on observed signs of “upscaling” and physical signs of gentrification collected as part of ground-truthing.⁶ Upscaling includes extensive renovations, changes in building characteristics, as well as a building appearance that looks more “upscale” and dissimilar to the surrounding parcels. Ground-truthing observations indicate that Hollywood/Western has undergone the most residential and commercial upscaling, followed by Chinatown, with 103rdSt./Watts last.

For the most part, we find moderate consistency amongst the four indicators, particularly in areas where there is little development. However, there are mixed results in areas undergoing development. For example, while the observations rank Hollywood/Western as having the most physical changes, Chinatown has experienced the greatest sociodemographic shift.

Assessed land-use vs. observed (at parcel level)

Land use designations between assessor data and ground-truth observations are for the most part consistent: about a 90% match for residential uses (See Table 2H.4). Chinatown had the highest consistency at 95%. The only large discrepancy is in the single-family units in the Hollywood/Western TOD area.⁷

One limitation of the land-use comparison is that it is not possible to visually distinguish whether a unit is a condo or part of a larger apartment complex. Additionally, commercial parcel matches were not noted because commercial properties comprised less than 10% of the surveyed parcels.

Table 2H.4: Percent land use matched in Los Angeles Case Study Areas

	Chinatown	Hollywood/Western	103rd St/Watts Towers
Single Family	89%	50%	100%
Condo	100%	100%	None surveyed
Multi-family	100%	88%	95%
Total Residential	95%	93%	89%

Source: Tabulated by authors from County Assessor’s data; and observations collected in March and June, 2015.

Local Roll Housing Unit Counts vs. Census Counts

We compare housing units estimated from the County Assessor’s data (See Appendix L for methodology) with the total housing units reported in the 2009-2013 five-year ACS. We focused on parcels with a residential land-use for this comparison.

⁶ For residential, we used questions 4, 6, and 7 from survey instruments (shown in Appendix M). For commercial, we used questions 5, 7, and 8.

⁷ As part of the 2015 UCLA Master’s in Urban and Regional Planning Capstone project, observations in three other case studies also took place. Of the 193 total residential parcels surveyed in all 6 areas, 165 of the parcels (or about 85%) matched with the assessor data. See Appendix J.

Table 2H.5 shows some differences in housing units between assessor and Census data. The difference between the two datasets in Chinatown is about 600 units. For 103rd St./Watts, the difference is about 400 housing units. The greatest discrepancy appears in the housing unit counts between the datasets for Hollywood/Western. The Census estimates more than 2,000 units more than the assessor data does.

Table 2H.5: Estimated Housing Units from Assessor and Census Data in Los Angeles Study Areas

	Assessor Data					ACS 2009-2013 Data	
	Total Parcels	Total Residential Parcels	Total SF Parcels	Total Other Residential	Estimated Residential Units	Total Housing Units	Total Households
Chinatown	1,498	644	139	505	2,337	2,965	2,700
Hollywood / Western	1,515	1,262	591	671	8,656	10,818	9,937
103rd St / Watts Towers	2,129	1,946	1,468	478	2,828	3,269	2,894
Total	5,142	3,852	2,198	1,654	13,821	17,052	15,531

Source: Tabulated by authors from ACS 2009 – 2013 and County Assessor’s data

Reported Recent Major Improvements vs. Observed Major Investments

A “major improvement” in our field observations was defined as an improvement where extensive renovation was apparent, which would have likely required a building permit; for instance, a structural improvement.⁸ Reported improvements are those reported to the County Assessor.⁹ We focused on residential parcels for the comparison.

Table 2H.6 shows that the percent of major improvements is similar to each other in the two datasets. For Chinatown and 103rd St./Watts Towers, the percentages only differ by about 1%. The greater discrepancy is for Hollywood/Western, where the observations found only about 2% (51 parcels out of 591) with major improvements while the assessor data indicates about 9%.

Table 2H.6: Percent of Major improvements for Observed and Assessor Parcels In Los Angeles Study Areas

	Observed Parcels	Assessor Data for All Parcels in Area	
	% with Major Improvements	% Reported Improvements [2007 - 2012]	Median Improvement Value, 2013\$
Chinatown	0.0%	1%	\$64,291
Hollywood / Western	2.2%	9%	\$238,742
103rd Street / Watts Towers	2.2%	3%	\$93,398

Source: Tabulated by authors from County Assessor’s data; and observations collected in March and June, 2015.

Note: Data are for single family parcels

⁸ For our observations, this refers to Question 6 on the Residential Parcel Observations form (See Appendix M for instrument). Percentages for % major improvements for each study area were calculated by taking the total numbers of parcels marked with “extensive” recent renovations and dividing it by the total number of observed parcels.

⁹ Extensive rehabilitation work may involve “substantial changes to the plumbing system, electrical system, framing, or foundation and can extend the usable life of a building.” Only when a building becomes “substantially equivalent to new” does it become categorized as new construction. See <http://assessor.lacounty.gov/bwl-faq/>.

Reported Recent Constructions vs. Observed Construction (at parcel level)

Table 2H.7 shows the match between reported and observed construction for single-family parcels.¹⁰ Within both datasets, there is consistency in the Hollywood/Western station, whereby there is no reported or observed new constructions for single-family homes. There appears to be a larger inconsistency in Chinatown (31.6% observed new construction compared to 4% in secondary data), but this inconsistency is likely due to the methodology of selecting areas with above-average transaction activity. More importantly, we looked at matches between our observed data and the assessor data in terms of new construction. Of the parcels that we selected to observe, all that were marked as having new construction were also reported similarly in the assessor data.

Table 2H.7: Percent of Constructions for Observed and Assessor Parcels in Los Angeles Study Areas

	Observed Parcels	Assessor Data for All SFH Parcels in Area	
	%New SF Construction	% Reported New SF Construction	Observed vs. Reported Match
Chinatown	31.6%	4%	100%
Hollywood / Western	0.0%	0%	100%
103rd Street / Watts Towers	13.0%	5%	100%

Source: Tabulated by authors from County Assessor's data; and observations collected in March and June, 2015.

Part II: Comparison of Model, Street and Observations, and Interviews

Research on neighborhood change often relies on quantitative demographic and real estate data to evaluate trends and the trajectory of neighborhoods. However, subtle changes that may point to gentrification are rarely captured by quantitative data. Often times, it is the local community-based organizations and groups that notice the small changes that are difficult to quantify and track. The following compares the results of the models described in Section 2E with information gathered through street observations as well as interviews with representatives from CBOs and public agencies.

Overview of Street Observation Method

A similar method of ground-truthing as the one reported in Part I was also employed to observe physical changes of gentrification at the Census block/street segment level. We selected Census blocks that were directly adjacent to (or within a quarter-mile radius of) the rail station regardless of their land use. We also chose blocks within a half-mile radius that had above-average transaction activity even if these were not directly adjacent to the rail station. The boundaries for most Census blocks coincided with street block segments. A total of 72 block segments were observed in the

¹⁰ New constructions are defined for the assessor data as any new structures; area added to existing structures; new items added to an existing structure such as bathroom or fireplace; physical changes that result in a change in use; "rehabilitation, renovation, or modernization that converts an improvement to the substantial equivalent of a new improvement"; or land development. See assessor.co.la.ca.us/extranet/list/faqFull.aspx. The percentage of new construction is calculated by taking the number of reported single family home constructions and dividing it by the total number of observed parcels for each station. New constructions are based on Question 1 (if "new constructed") and Question 5 (if "new construction") from the Residential ground-truthing form (See Appendix M). For the percent of reported new construction based off of assessor data, we take the number of reported of single family new constructions & divide it by the total number of single family parcels for each station.

three case study neighborhoods. Detailed description of the methodology can be found in Appendix L.

A semi-structured interview approach was used to guide a series of interviews with representatives of various CBOs and public agencies. Organizations and agencies were selected because of their location and activity in a study area or their previous experience with other aspects of TODs in Los Angeles. We identified and contacted planners, elected officials, and CBO staff. More information on the interview protocol can be found in Appendix N and detailed results comparing the street observation method with interviews and secondary data analysis can be found in Appendix O.

Los Angeles Ground-Truthing Conclusions

In general, we found a higher consistency among data sources in areas that have not experienced major changes such as in 103rd St./Watts Towers, and a lower consistency in areas experiencing more changes such as in Hollywood/Western.

This assessment indicated that the quantitative models reported in other sections of this report do not capture all the complexities and nuances of neighborhood change. At the same time, the quantitative models do identify factors and patterns that cannot be observed through primary fieldwork. Researchers and analysts should not assume, however, that secondary data are precise. Ideally, secondary data should be carefully evaluated for anomalies and other problems (e.g., discrepancies in housing unit counts) before being incorporated into models.

There are clear discrepancies in indicators and beliefs about the nature and extent of neighborhood change. This can be due in part to differences in the sources of information. Those on the ground may see patterns not captured by secondary data. Data from observations and interviews are also subjective and may reflect some of the biases, priorities, and broader concerns of the observer, interviewer, and interviewees. For all the above reasons, the utilization of multiple data sources that involve both secondary data as well as empirical work such as direct field observations and stakeholder interviews complement each other and give a more complete picture of neighborhood change.

Chapter 2 Conclusions

This chapter developed a series of analyses that examine gentrification and displacement in fixed-rail transit neighborhoods. Gentrification in Los Angeles and the Bay Area TODs cannot be attributed to new residential development, as the vast majority of transit neighborhoods in both Los Angeles and the Bay Area experienced relatively little residential development from 2000 to 2013. In the Bay Area, over half of market rate residential development occurred in tracts that did not gentrify.

Analyzing household moves into and out of neighborhoods, we find that transit neighborhoods in Los Angeles have higher rates of high income in-movers and lower rates of low income in-movers, consistent with previous findings on the relationship between proximity to transit and higher housing prices. A similar relationship is found when analyzing the education level of in-movers to transit neighborhoods in the Bay Area, who are more likely to have a bachelor's degree or higher and less likely to have less than a high school diploma. Yet, in the Bay Area, people in poverty were more likely to move into transit neighborhoods in the core cities (San Francisco, Oakland, and San Jose), but not in other cities. For Los Angeles, in-movers to transit neighborhoods were more likely

to be non-Hispanic white, which is only true in the Bay Area for transit neighborhoods located in the core cities.

Our models of neighborhood gentrification suggest that proximity to transit matters in both regions, but effects vary across time periods. In Los Angeles, proximity to transit is most clearly associated with gentrification in Downtown, and proximity to recently opened transit stations seems to have the most significant effect. The Bay Area results also indicate that proximity to fixed rail transit stations has a significant impact on gentrification.

When we look at less aggregate demographic measures and zoom in specifically on affordable housing, we find a much stronger effect of proximity to rail transit. For Los Angeles we find that proximity to rail transit significantly predicts a loss of affordable rental units and an increase in condominium conversions. For the downtown rail transit neighborhoods, we also find a significant increase in Ellis Act evictions and for transit neighborhoods outside of the downtown we find a significant decline in Section 8 vouchers. There was, however, an increase in subsidized units using the Low-Income Housing Tax Credit (LIHTC) program for transit neighborhoods both in and outside of Downtown Los Angeles. For the Bay Area, the impact of rail transit neighborhoods was not significant for the change in affordable rental units and Section 8 vouchers. Similar to Los Angeles, however, rail transit neighborhoods were more likely to increase the number of LIHTC units in the Bay Area's core cities, but less likely in other Bay Area cities. Rail transit neighborhoods outside of the core cities were more likely to lose low-income households. In San Francisco, proximity to rail transit was positively related to increased eviction rates.

Another set of analyses looks at changes in neighborhood composition by income classes, racial/ethnic groups, and rent burden. Confirming the analysis of gentrification, the results for both Los Angeles and the Bay Area showed a decline in the share of low-income residents and residents with a bachelor's degree were higher in transit neighborhoods.

To verify the secondary data analyzed in our models and to learn more about the process of change, we used visual observation in the field as well as in-depth interviews with key informants. The findings of the field observations were generally consistent with the secondary data, except that there was often a discrepancy between the number of housing units found in the County Assessor's database and those observed in the field. Often, local observers pointed to displacement processes currently underway that are not reflected in the secondary data. At the same time, interviews occasionally suggested a level of anxiety about displacement that is not supported by empirical data.

Chapter 3: Developing Tools for Analyzing Potential Displacement Impacts in Sustainable Community Strategies (SCS)

Sections 3A authors: Paul Waddell¹ and Sam Maurer¹

Section 3B authors: Sungbin Cho³, John Abraham⁴, and Graham Hill⁴

Section 3C authors: Paul Ong², Miriam Zuk¹, Chhandara Pech², and Karen Chapple¹

¹University of California, Berkeley

²University of California, Los Angeles

³Southern California Association of Governments

⁴HBA Specto, Inc.

Acronyms Used in This Chapter

- AA (Activity Allocation)
- ABAG (Association of Bay Area Governments)
- ACS (American Community Survey, U.S. Census)
- ARB (California Air Resources Board)
- AMI (Area Median Income)
- BMR (Below Market Rate)
- CSA (Community Statistical Area)
- FAR (Floor Area Ratio)
- ED (Economic/Demographic)
- EIR (Environment Impact Report)
- GIS (Geographic Information System)
- GHG (Greenhouse Gas)
- HCD (California Department of Housing and Community Development)
- HUD U.S. Department of Housing and Urban Development)
- LIHTC (Low-Income Housing Tax Credit)
- MNL (Multinomial Logit)
- MPO (Metropolitan Planning Organization)
- MTC (Metropolitan Transportation Commission)
- NPH (Non-Profit Housing Association of Northern California)
- PECAS (Production Exchange Consumption Allocation System)
- PUMS (Public Use Microdata Sample, U.S. Census)
- RHNA (Regional Housing Needs Allocation)
- ROI (Return on Investment)
- RTP (Regional Transportation Plan)
- SCAG (Southern California Association of Governments)
- SCS (Sustainable Communities Strategy)
- SD (Space Development)
- TAZ (Transportation Analysis Zone)
- TOD (Transit-Oriented Development)
- TR (Transportation)
- VMT (Vehicle Miles Traveled)

Chapter 3 Table of Contents

- Chapter 3 Introduction..... 96
 - Effects of Transit Investments and Upzoning on Prices and Rents..... 96
 - Effects of Increased Prices and Rents on Displacement..... 97
 - Requirements for Regional Models to Represent Displacement..... 98
- Section 3A: Addressing Displacement in the Bay Area UrbanSim Application 101
 - 3A.1. Introduction 101
 - Prior Use of UrbanSim in Plan Bay Area..... 101
 - 3A.2. Overview of UrbanSim..... 101
 - Design Objectives and Key Features 101
 - Model System Design..... 102
 - Policy Scenarios 105
 - Discrete Choice Models..... 106
 - 3A.3. Adapting UrbanSim to Address Displacement..... 108
 - Representation of Individual Households and Housing Units..... 108
 - Representation of Renter and Owner Markets Separately 108
 - Representation of Income and Race/Ethnicity..... 111
 - Representation of the Influence of Rent Burdens on Moving Out 111
 - Representation of the Influence of Rent Burdens on Moving In..... 113
 - Representation of Parcel-Level Demand and Supply..... 116
 - Representation of Affordable Housing Development Feasibility..... 116
 - Summary of Status and Next Steps 119
- Section 3B: Addressing Displacement in the SCAG PECAS Model..... 120
 - 3B.1. Introduction 120
 - 3B.2. PECAS and SCAG PECAS Model Overview..... 121
 - 3B.3. Modeling TOD and Displacement in PECAS 123
 - Rent in Modeling TOD using PECAS 123
 - Modeling of Displacement in PECAS 129
 - Representing Displacement Mitigation Measures in PECAS..... 132
 - 3B.4. Representation of Empirical Research Findings in PECAS 133
 - Findings Reported..... 133
 - Implications of Findings on PECAS Model Scenarios 134
 - Scenario Development and Calibration 135
 - Displacement Impact..... 140
 - 3B.5. Findings and Conclusions 144
- Section 3C: Development of an Off-Model Displacement Assessment Methodology 148
 - Defining a Predictive Model..... 148
 - Specifications of the Off-Model Tool for Los Angeles..... 148
 - Specifications of the Off-Model Tool for the Bay Area..... 153
- Chapter 3 Conclusions..... 155

Chapter 3 Introduction

In Chapter 3, we first present our analysis on what we believe are requirements for regional models to represent displacement, and we use this information along with findings presented in previous chapters to evaluate the suitability of the integrated land use and transportation models used by the metropolitan planning organizations (MPOs) in the Bay Area (the Metropolitan Transportation Commission, MTC) and Los Angeles (the Southern California Association of Governments, SCAG) to address displacement. To adapt the urban simulation model used in the Bay Area—UrbanSim—researchers analyzed the role of race, income, household size, rent, and rent burden on household location decisions and made adjustments to it. Researchers are working with MTC to integrate these modifications into their modeling for the next sustainable communities strategy (SCS). After analyzing how the integrated land use and transportation model used in Los Angeles—PECAS—could analyze displacement, researchers concluded that the current version is not capable of analyzing displacement issues at the desired level of detail.

In an effort to provide more streamlined and less resource-intensive modeling options, we present several different approaches to an off-model displacement assessment methodology. The off-model approaches build on the modeling results found in Chapter 2. All of the models are able to predict gentrification with results ranging from 50% to 86% accuracy.

Effects of Transit Investments and Upzoning on Prices and Rents

There is growing concern that there may be unwanted side effects of well-intentioned planning efforts to intensify development around transit stations, often referred to as transit-oriented development (TOD). The added transit accessibility from new stations, lines, and improved levels-of-service represents a local amenity that is of value to households and firms that are able to locate in close proximity to those amenities. In fact, accessibility is one of the primary influences on land values, and consequently on housing prices and rents, as well as on rents and prices of non-residential buildings.

The reason accessibility translates to higher property values is that amenities such as accessibility translate to higher willingness-to-pay for locations with such amenities. In short, increased transit accessibility increases demand for locations whose accessibility has increased as a result of public investment, and this increased demand is capitalized into land and property values. This is both intuitively obvious, and backed by a large empirical and theoretical literature.

If the real estate market were able to respond to increases in demand for those locations with new construction, one might expect that it could offset this increase in demand, pushing prices downward at least partially. Several factors tend to prevent that from happening. First, local governments may not zone for high enough intensity of development to enable developers to profitably build sufficient new housing and non-residential space to offset the demand effect. This is often due to community resistance to increased density, which pressures the municipality to keep zoning constrained considerably, compared to what the market would support in high-demand locations.

A further consideration on the supply side of the market is that higher-density development, at certain thresholds, increases construction cost substantially. Once developers move from a frame-on-podium construction appropriate for low-rise construction of two to three stories to higher

densities, it may precipitate numerous changes in construction technology, such as structure parking, steel frame construction, and elevators, all of which increase costs considerably. The end result is that, in order to realize sufficient profit to attract investment capital for construction loans, developers have to target a higher price segment of consumers, by moving to higher-quality materials and amenities. The result of these changes can be reasonably expected to put upward pressure on prices and rents.

A third factor that can contribute to both a diminished supply response to increased demand is that any upzoning done by the local jurisdiction to enable higher-density development might in fact drive up development costs for developers by increasing the reservation prices of current property owners. This arises because the zoning on each parcel confers an entitlement to the property owner to develop the parcel up to the limits imposed by the zoning. When the city upzones selected parcels around transit, the current property owners essentially receive a windfall of increased entitlement value. Assuming that these property owners are aware of this change in zoning, they are likely to demand a higher price for their property when a developer seeks to acquire it for development, since they fully appreciate that the developer could build to a higher intensity based on the change in zoning. Some jurisdictions have implemented value capture or community benefits policies to attempt to redirect some of this entitlement windfall from the public investment in transit towards public objectives. But most jurisdictions have not implemented such policies, which means that the full entitlement value gain is transferred to current property owners and translates to a higher cost for developers in these locations.

Effects of Increased Prices and Rents on Displacement

Through a combination of increased demand, constrained supply, and increased development costs, it is not unreasonable to anticipate upward pressure on prices and rents associated with transit investments and localized upzoning intended to stimulate TOD around these investments. The next issue to consider is how these pressures translate to risks of displacement and a consideration of who is at risk of such displacement.

The first, essential distinction to consider when considering the issue of displacement is how households in different circumstances might be affected. Households fortunate enough to own property, whether still paying a mortgage or owning it in full, will derive a windfall benefit of increased property values. Equity in housing is one of the main sources of wealth accumulation by households, notwithstanding the devastating effects of the global housing recession that began in 2007 and the large number of foreclosures that ensued. Still, on the whole, any amenity value that is generated by public investments such as transit, or any increases in entitlement value generated by increases in zoned development capacity, translate to increases in equity value for current property owners. As a result, the current project does not need to be concerned about any harmful effects of transit investments on the current property owners in those locations receiving additional transit service, or being upzoned to increase denser development.

These price pressures raise concerns about the potential impacts on renter households. For these households, price pressure could result in increased rents and therefore increases in the rental cost burden or potential eviction if building owners decide to convert apartments to condominiums. We would refer to these two circumstances as involuntary displacement, though the term involuntary might be subject to interpretation in the event that a household's rent increases to the point of being intolerable, and they "voluntarily" decide to relocate to a lower-cost location. We still consider this to be a hardship, and relevant to consider, so will use the term involuntary to include

those who would have preferred to stay, but either were evicted or chose to move out due to an excessive cost burden.

Another relevant population who could be harmed are low-income renters who might be able to consider moving into these locations before the transit investment or upzoning, but whose income constraints prevent them from locating there once rents increase. We could refer to this circumstance as exclusionary displacement. It is more nuanced, in the sense that we cannot directly observe which households would have considered specific neighborhoods before and after a change in rents. Nevertheless, the combination of exclusionary and involuntary displacement could combine to rapidly change the composition of transit-oriented neighborhoods toward the elimination of low-income households.

Requirements for Regional Models to Represent Displacement

Models used by MPOs were initially designed almost exclusively to address the evaluation of alternative packages of transportation projects, in order to develop a regional transportation plan (RTP) under assumptions that land use patterns should be considered as fixed, exogenous inputs. Later, these models evolved to evaluate the of potential induced demand effects that could arise from transportation projects influencing real estate markets — increasing demand for locations advantaged by increased accessibility, and increased supply in response to the demand and price effects, and subsequent increases in household and firm travel resulting from new development and new household and firm locations. UrbanSim is one of the model innovations that emerged to address this induced demand effect (Waddell 2011).

Concerns about housing affordability have only recently begun to intersect the regional transportation planning process. In particular, SB375 is one of the first legal tools to require coordination of the regional housing needs allocation (RNHA) process with the transportation and land use plans in the SCS planning process. The current project extends the consideration of housing affordability to more directly address the question of displacement associated with transit investments.

From the foregoing discussion, several requirements can be identified for making regional models responsive to displacement-related concerns.

Representation of Renter and Owner Markets Separately

As discussed above, displacement is a concern for low-income households who rent, rather than own, their homes. While homeowners receive a windfall from increasing property values, renters receive a higher rent bill, or worse, an eviction notice. Regional land use models have often used a simplification of the housing market to generalize over, or abstract away, this difference between renter and owner housing markets, often relying on a rule-of-thumb “cap rate” (capitalization rate) conversion between rents and prices, to enable a representation in the models of only one tenure type. For purposes of analyzing displacement risks, it is a fundamental requirement that rental and owner markets be treated separately. Without this distinction, it would be meaningless to attempt to discuss impacts of any market or policy change on displacement.

So the first and most essential requirement for regional models is to represent the housing stock as two fundamental market types: rental and owner. Building types, such as multi-family and single-family, townhouse, duplex, and the like, are useful in understanding the market, but do not

substitute for the tenure distinction. Single-family houses can be in the rental or the owner market, and the outcomes will be very different for the occupants when prices and rents increase.

Representation of the Influence of Rent Burdens on Moving Out

A second fundamental requirement for these models to be useful for analyzing displacement is the representation of the cost burden for renters in a model component reflecting the probability that a household will move out of their current unit. As already mentioned, this is less relevant for owner-occupants since they generally acquire a mortgage to finance their home purchase, thus payments are not influenced by market pressures on prices.

Some land use models do not attempt to represent the probability that a household will move. These models do not represent the way cities evolve over time through annual changes in the movement of households and firms and the construction of new buildings.. While a static equilibrium approach like that used in PECAS is plausible for some kinds of questions, it is not particularly well-suited to address dynamic questions such as how transit investments and upzoning might conspire to increase rents, and induce low-income renters to move out. Representing the renter market as a distinct market is a prerequisite, as is a representation of the decision to move out during a specific time frame such as over the following year.

Representation of the Influence of Rent Burdens on Moving In

A third requirement relates to the rent burdens of households who might be able to consider a neighborhood prior to increased transit services or upzoning, but are unable to afford the location after such changes. This is the exclusionary displacement circumstance.

This is a challenging issue to address since it requires making assumptions about how binding budget constraints are in households' choices of a residence. As we explore in a subsequent section, the empirical data on rent burdens suggests that this is not as simple as assuming that housing units above a specific rent burden would never be an option for locating households, since in fact, we observe large numbers of low-income households in units that impose an extremely high cost-burden.

Representation of Parcel-Level Demand and Supply

TOD involves increasing the zoning capacity for higher-density and often more mixed-use development in locations within close proximity (usually walking distance, e.g., one-quarter to one-half mile), of transit stations. The zoning changes are generally implemented in a special area plan that applies upzoning on a parcel-by-parcel level of detail, based on proximity and connectivity to the transit station. Models cannot capture the effects of these policies if they are not working at a parcel level of detail to represent, in a consistent way, both the demand side and the supply side of the models.

Some modeling approaches abstract the demand side considerably and use very large zones or districts, much larger than walking scale, to simulate market demand. They may or may not represent the supply side of the model at a parcel level or at a more aggregate level, but often encounter internal inconsistencies if the models are not structured to work consistently at the same scale and in close coordination. In order to capture localized policies and the micro-scale effects of walk access to transit, models need a consistent representation of both demand and supply at the parcel level of geography.

Representation of Affordable Housing Development Feasibility

Representing the influences of market demand on rents, and the interaction of these with zoning constraints and other policies (such as inclusionary housing), can be best represented using a financial model that mimics the decision analysis used by real estate developers. This model enables a parcel-level assessment of how increased rents, increased prices, and changes in development costs influence return on investment (ROI) as a result of the following:

- zoning constraints,
- the building program on a site,
- building technology, and
- the effects of policies such as inclusionary housing, which require developers to incorporate some fraction of affordable units into a project on site, or pay an in-lieu fee to the city to support the construction of affordable housing elsewhere in the city.

Representation of Individual Households and Housing Units

To analyze the impacts of housing affordability challenges on households, it is important to distinguish between many characteristics of households, including their income, household size, and stage of life. For example, a small unit may be inappropriate for a large family, even if the rent appears to be affordable. Our assessment is that it is necessary to represent not only individual households in the model, but also individual housing units, so that the characteristics of both can be used to analyze how households with different characteristics choose housing units with different characteristics.

Moving toward full-scale microsimulation on both the household and the housing supply sides of the model also makes the model much more transparent and reflective of the real world.

Representation of Income and Race/Ethnicity

Housing markets are heavily segregated by income, race and ethnicity, and other forms of clustering characteristics like household size and stage of life. Models tend to suppress consideration of race and ethnicity, in spite of a large body of theoretical and empirical research that documents how important these dimensions are to understanding the nature of housing markets. Common sense and experience generally confirm the magnitude of these influences in large, diverse metropolitan areas such as the San Francisco Bay Area. Further, federal and local environmental justice and equity policy mandates motivate the need to at least assess how displacement pressures might disproportionately impact low-income households and households containing black or Hispanic individuals.

Based on prior research and the need to be sensitive to equity concerns, it is therefore a final requirement that models reflect the influences of race and ethnicity on location outcomes of households.

Section 3A: Addressing Displacement in the Bay Area

UrbanSim Application

3A.1. Introduction

In this section we explore the potential of the UrbanSim model system to better address displacement concerns and to provide new capacity for MPOs to consider these effects and policies to mitigate them, as part of their operational planning process. We begin by describing the prior application of UrbanSim (Waddell 2011) in the San Francisco Bay Area, as a foundation for the current project. Following this is a discussion of the requirements for adapting UrbanSim to effectively meet the research objectives of the current project to address displacement concerns related to transit investments, and a discussion of the overall strategy for making these adaptations in UrbanSim. We turn next to a more detailed discussion of the design and implementation of UrbanSim and to the changes in model structure, data, and model specification and estimation to address the current research objectives. We close with an assessment of the status of these innovations and a summary of next steps. For a detailed description of the models used in the Bay Area application of UrbanSim that were modified for this project, see Appendix P.

Prior Use of UrbanSim in Plan Bay Area

This effort builds on the prior development and application of UrbanSim in the San Francisco Bay Area, and its deployment and operational use by MTC and the Association of Bay Area Governments (ABAG). UrbanSim was used in coordination with the MTC activity-based travel model system to analyze the Environmental Impact Report (EIR) alternatives for the Plan Bay Area Sustainable Communities Strategy planning process, which ended in 2013 and is now being updated for use in the next SCS planning process.

UrbanSim is designed to support analysis of the potential effects of land use policies and infrastructure investments on the development and character of cities and regions. Its application in the Bay Area was used to update land use forecasts under alternative EIR scenarios, with differing assumptions such as aggregate economic growth targets, transportation system investments and policies, and local land use plans and policies to focus development around transit. UrbanSim was adapted to run at a parcel level and to interface with the MTC travel model. UrbanSim is designed to run as a microsimulation, at the individual household and person level of detail, so that it consistently represents choices of individuals and housing market and local land use policies at the building and parcel levels.

3A.2. Overview of UrbanSim

Design Objectives and Key Features

UrbanSim is an urban simulation system developed over the past several years to better inform deliberation on public choices with long-term, significant effects.¹ A key motivation for developing such a model system is that the complexity of the urban environment makes it is infeasible to

¹This chapter draws in part on reference (Waddell et al. 2008).

anticipate the cause-and-effect interactions that could have both intended and possibly unintended consequences.

UrbanSim was designed to reflect the interdependencies in dynamic urban systems, focusing on the real estate market and the transportation system, initially, and on the effects of individual interventions, and combinations of them, on patterns of development, travel demand, and household and firm location. The basic features of the UrbanSim model and software implementation are highlighted in Table 3A.1. The model is unique in that it departs from prior operational land use models based on cross-sectional, equilibrium, aggregate approaches to adopt an approach that models individual households, jobs, buildings, and parcels (or gridcells), and their changes from one year to the next as a consequence of economic changes, policy interventions, and market interactions.

Table 3A.1: Key Features of UrbanSim

<p>Key Features of the UrbanSim Model System</p>	<ul style="list-style-type: none"> • The model simulates the key decision makers and choices impacting urban development; in particular, the mobility and location choices of households and businesses, and the development choices of developers • The model explicitly accounts for land, structures (houses and commercial buildings), and occupants (households and businesses) • The model simulates urban development as a dynamic process over time and space, as opposed to a cross-sectional or equilibrium approach • The model simulates the land market as the interaction of demand (locational preferences of businesses and households) and supply (existing vacant space, new construction, and redevelopment), with prices adjusting to clear market • The model incorporates governmental policy assumptions explicitly, and evaluates policy impacts by modeling market responses • The model is based on random utility theory and uses logit models for the implementation of key demand components • The model is designed for high levels of spatial and activity disaggregation, with a zonal system identical to travel model zones • The model presently addresses both new development and redevelopment, using parcel-level detail
<p>Key Features of the UrbanSim Software Implementation</p>	<ul style="list-style-type: none"> • The model and user interface is currently compatible with Windows, Linux, Apple OS X, and other platforms supporting Python • The software is implemented in the Open Platform for Urban Simulation • The software is open-source, using the GPL license • The system is downloadable from the web at www.urbansim.org • The user interface focuses on configuring the model system, managing data, running, and evaluating scenarios • The model is implemented using object-oriented programming to maximize software flexibility • The model inputs and results can be displayed using ArcGIS or other GIS software such as PostGIS • Model results are written to binary files, but can be exported to database management systems, text files, or geodatabases

Model System Design

The overall architecture of the UrbanSim model system is depicted in Figures 3A.1, 3A.2, and 3A.3. Most of the early applications of UrbanSim used gridcells of 150 by 150 meters in resolution as the

basic unit of spatial analysis. More recent applications have adopted the use of parcels and buildings, but the overall logic remains intact. What differs is the configuration of specific models.

The models used in the parcel version of UrbanSim differ in some obvious respects from the earlier gridcell versions, and these differences are summarized in Table 3A.2. In addition to the substitution of parcels for gridcells as the unit of analysis, the real estate development model was completely restructured to take advantage of the availability of parcel geography in representing actual development projects, which do vary in size and shape in the real world, in ways that are difficult to reconcile with gridcell geography. The explicit use of buildings is also fairly new in UrbanSim, and allows a clear mapping of occupants to buildings and buildings to parcels.

Table 3A.2: Specification of UrbanSim Model Components Using Parcel Data Structure

Model	Agent	Dependent Variable	Functional Form
Household Location Choice	Household (New or Moving)	Residential Building With Vacant Space	Multinomial Logit
Employment Location Choice	Establishment (New or Moving)	Non-residential Building With Vacant Space	Multinomial Logit
Building Location Choice	Building	Parcel (With Vacant Land)	Multinomial Logit
Real Estate Price	Parcel	Price	Multiple Regression

UrbanSim simulates the real-world actions of agents in the urban system. Developers construct new buildings or redevelop existing ones. Buildings are located on land parcels that have particular characteristics such as value, land use, slope, and other environmental characteristics. Governments set policies that regulate the use of land, through the imposition of land use plans, urban growth boundaries, and environmental regulations, or through pricing policies such as development impact fees. Governments also build infrastructure, including transportation infrastructure, which interacts with the distribution of activities to generate patterns of accessibility at different locations that in turn influence the attractiveness of these sites for different consumers. Households have particular characteristics that may influence their preferences and demands for housing of different types at different locations. Businesses also have preferences that vary by industry and size of business (number of employees) for alternative building types and locations.

The model system contains a large number of components, so in order to make the illustrations clearer, there are three “views” of the system. In Figure 3A.1, the focus is on the flow of information related to jobs. Figure 3A.2 provides a household-centric view of the model system. Finally, Figure 3A.3 provides a view with a focus on real estate.

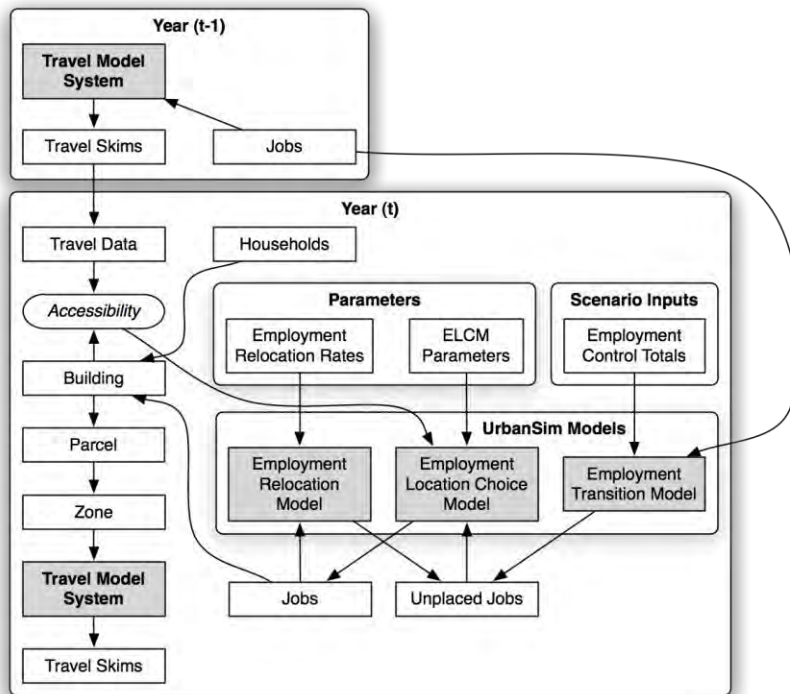

Figure 3A.1: UrbanSim Model Flow: Employment Focus

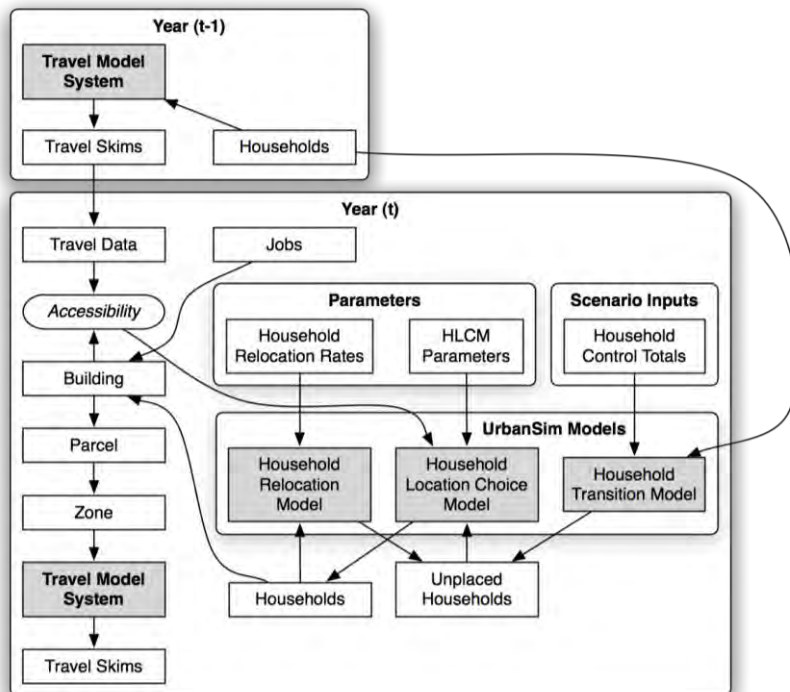

Figure 3A.2: UrbanSim Model Flow: Household Focus

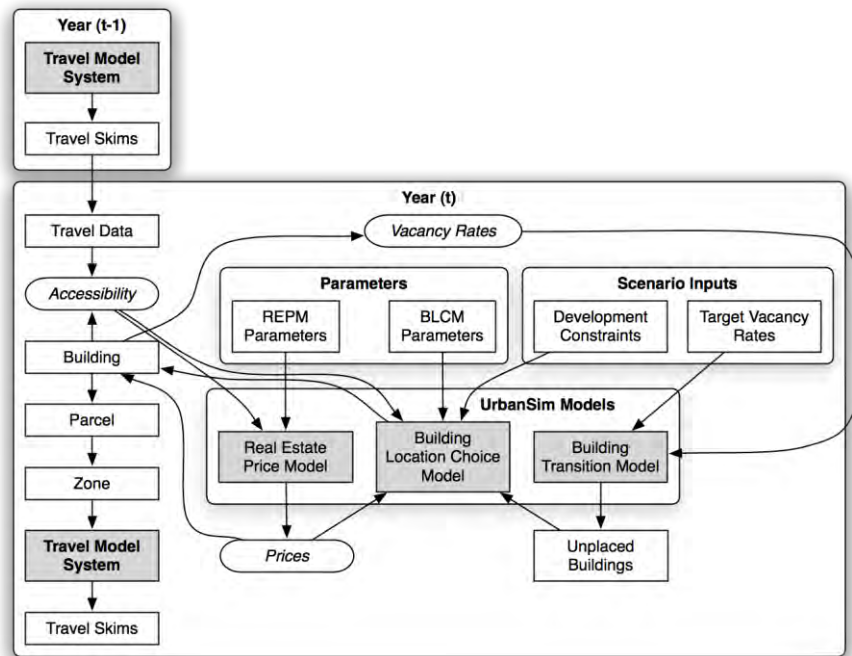

Figure 3A.3: UrbanSim Model Flow: Real Estate Focus

UrbanSim predicts the evolution of these entities (employment, households, and real estate) and their characteristics over time, using annual steps to predict the movement and location choices of businesses and households, the development activities of developers, and the impacts of governmental policies and infrastructure choices. The land use model is interfaced with a metropolitan travel model system (e.g., an MPO’s travel demand model) to deal with the interactions of land use and transportation. Access to opportunities, such as employment or shopping, are measured by travel time or cost of accessing these opportunities via all available modes of travel.

The data inputs and outputs for operating the UrbanSim model are shown in Table 3A.3. Developing the input database is challenging, owing to its detailed data requirements. A geographical information system (GIS) is typically used to manage and combine these data into a form usable by the model, and can also be used to visualize the model results. Fortunately, freely available open-source GIS tools such as Quantum GIS and PostGIS are now generally robust enough to handle these needs. Once the database is compiled, the model equations must be calibrated and entered into the model. A final step before actual use of the model is a validation process that tests the operation of the model over time and makes adjustments to the dynamic components of the model. The steps of data preparation, model estimation, calibration, and validation will be addressed in later sections. In the balance of this chapter the design and specification of UrbanSim, using a parcel-based approach adapted for use in the Bay Area, is presented in more detail.

Policy Scenarios

UrbanSim is designed to simulate and evaluate the potential effects of multiple scenarios. We use the term “scenario” in the context of UrbanSim in a very specific way: a scenario is a combination of input data and assumptions to the model system, including macroeconomic assumptions regarding

the growth of population and employment in the study area, the configuration of the transportation system assumed to be in place in specific future years, and general plans of local jurisdictions that will regulate the types of development allowed at each location.

In order to facilitate comparative analysis, a model user such as an MPO will generally adopt a specific scenario as a base of comparison for all other scenarios. This base scenario is generally referred to as the ‘baseline’ scenario, and this is usually based on the adopted or most likely to be adopted regional transportation plan, accompanied by the most likely assumptions regarding economic growth and land use policies. Table 3A.3 summarizes both the inputs and the outputs of UrbanSim.

Table 3A.3: Data Inputs and Outputs of UrbanSim

UrbanSim Inputs	<ul style="list-style-type: none"> • Employment data, usually in the form of geocoded business establishments, but alternatively from zonal employment by sector • Household data, merged from multiple census sources • Parcel database, with acreage, land use, housing units, non-residential square footage, year built, land value, improvement value, city and county • City and County General Plans and zoning • GIS overlays for environmental features such as wetlands, floodways, steep slopes, or other sensitive or regulated lands • Traffic Analysis Zones • GIS overlays for any other planning boundaries • Travel model outputs • Development costs • Real estate transactions
UrbanSim Outputs (by Building, Parcel or Gridcell), Generally Summarized by Zone	<ul style="list-style-type: none"> • Households by income, age, size, and presence of children • Employment by industry and land use type • Acreage by land use • Dwelling units by type • Square feet of nonresidential space by type • Real estate prices
Travel Model Outputs (Zone-to-Zone) Used in UrbanSim	<ul style="list-style-type: none"> • Travel time by mode, by time of day, by purpose • Trips by mode, by time of day, by purpose • Composite utility of travel using all modes by purpose • Generalized costs (time + time equivalent of tolls) by purpose

Discrete Choice Models

UrbanSim makes extensive use of models of individual choice. A path breaking approach to modeling individual actions using discrete choice models emerged in the 1970s, with the pioneering work of McFadden on Random Utility Maximization theory (McFadden 1974, 1981). This approach derives a model of the probability of choosing among a set of available alternatives based on the characteristics of the chooser and the attributes of the alternative, and proportional to the relative utility that the alternatives generate for the chooser. Maximum likelihood and simulated maximum likelihood methods have been developed to estimate the parameters of these choice models from data on revealed or stated preferences, using a wide range of structural specifications (see Train 2003). Early applications of these models were principally in the transportation field, but also included work on residential location choices (Quigley 1976; Lerman 1977; McFadden 1978), and on residential mobility (Clark and Lierop 1986).

Choice models are implemented in UrbanSim in a modular way, to allow flexible specification of models to reflect a wide variety of choice situations. Figure 3A.4 shows the process both in the form of the equations to be computed, and from the perspective of the tasks implemented as methods in software.

For each model component within the UrbanSim model system, the choice process proceeds as shown in Figure 3A.4. The first steps of the model read the relevant model specifications and data. Then a choice set is constructed for each chooser. Currently this is done using random sampling of alternatives, which has been shown to generate consistent, though not efficient, estimates of model parameters (Ben-Akiva and Lerman 1987).

The choice step in this algorithm warrants further explanation. Choice models predict choice probabilities, not choices. In order to predict choices given the predicted probabilities, we require an algorithm to select a specific choice outcome. A tempting approach would be to select the alternative with the maximum probability, but unfortunately this strategy would have the effect of selecting only the dominant outcome, and less frequent alternatives would be completely eliminated. In a mode choice model, for illustration, the transit mode would disappear, since the probability of choosing an auto mode is almost always higher than that of choosing transit. Clearly this is not a desirable or realistic outcome. In order to address this problem, the choice algorithm used for choice models uses a sampling approach. As illustrated in Figure 3A.4, a choice outcome can be selected by sampling a random number from the uniform distribution in the range 0 to 1, and comparing this random draw to the cumulative probabilities of the alternatives. Whichever alternative the sampled random number falls within is the alternative that is selected as the “chosen” one. This algorithm has the property that it preserves in the distribution of choice outcomes a close approximation of the original probability distribution, especially as the sample size of choosers becomes larger.

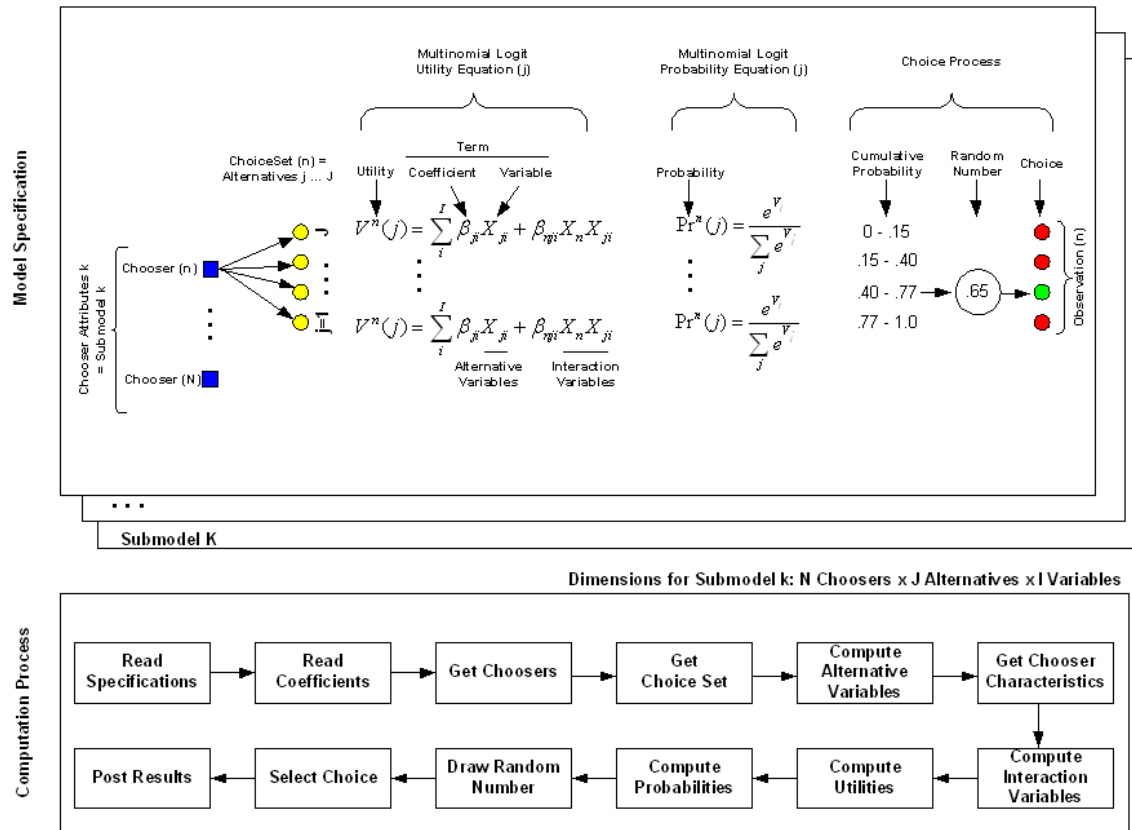

Figure 3A.4: Computation Process in UrbanSim Choice Models

3A.3. Adapting UrbanSim to Address Displacement

Representation of Individual Households and Housing Units

A prerequisite for many of the enhancements to UrbanSim required for this project was to represent individual households and individual housing units. While UrbanSim already used individual households (and persons) in the previous implementation for the Bay Area, it used parcels and buildings as the smallest representations of housing supply. In this project, we have extended the data schema to represent each residential unit in the region, in addition to buildings and parcels. The combination of microsimulating households and residential units simplifies the accounting of which units are for rent (and which households are renting) as well as enabling more detailed tracking of households of different incomes, household structures, and racial and ethnic composition, which are found to be important in exploring the core questions in this research project.

Representation of Renter and Owner Markets Separately

In order to separately represent renter and owner housing markets, several changes have been implemented in data structures and model specifications.

Model structures were modified in the following ways:

- Household relocation models were modified to separately model the move-out probabilities of renters and owners
- Hedonic regression models were modified to separately predict owner-occupied housing sales prices and rental rates for rental housing
- Household location choice models were modified to separate renters from owners, with renters only choosing from vacant rental units, and owners only choosing from among vacant owner units
- Supply-demand price adjustment models were adapted to separately treat the adjustment of rents and prices in the respective components of the housing market
- The real estate development model was modified to evaluate pro forma return on investment for both rental and owner options for relevant housing types, using prices and rents from the relevant hedonic regressions

Data structures were changed in the following ways:

- A housing-unit-level table was added, disaggregating from parcels and buildings, representing each individual housing unit in the region
- Tenure status (rent or own) was imputed for each housing unit from census-block-level tenure composition
- Tenure status was added to each household record in the synthetic population, from the relevant Public Use Microdata Sample (PUMS) record

These changes to models and data structures capture the most essential changes to address the requirement of separately representing the owner and renter markets.

We used rental listings from Craigslist to estimate the rental hedonic model presented in Table 3A.4, using the log of monthly asking rent per square foot as the dependent variable. Housing rents were collected by scraping rental listings from the Bay Area Craigslist website over a period of several months. Only records that were sufficiently complete, and included a geocoded location, were used.

Figure 3A.5 shows the distribution of rent per square foot for the collected listings. We tested a combination of structural, neighborhood, and accessibility variables as independent variables in the model. Neighborhood variables were computed as queries of parcels that were within a half-kilometer along the local street network, to better reflect the localized nature of neighborhood effects. The accessibility variables are from the MTC Travel Model, and reflect composite utilities (logsums) that are intended to capture the full set of influences on accessibility to specific modes, across destinations. The estimation results for the rental hedonic model reflect that not only do standard structural characteristics such as square footage and structure type influence rents per square foot, but so too do socioeconomic characteristics of the neighborhood around the units, including their income and racial composition, as well as broader accessibility from the location by auto and transit.

Table 3A.4: Hedonic Regression Estimation Results for Rental Listings

Dependent Variable: Log of Price Per Sq. Ft.	coef	std err	z	P> z
Intercept	6.6031	0.079	84.012	0.000
Log of average sq. ft. per unit	-0.3266	0.002	-148.469	0.000
Average lot size per unit	-0.0406	0.001	-34.985	0.000
Average income	0.0473	0.001	32.935	0.000
Poverty rate	-0.5245	0.013	-39.223	0.000
% Black	-0.0068	9.46e-05	-71.538	0.000
% Hispanic	-0.0028	0.000	-27.751	0.000
% Asian	0.0057	9.77e-05	58.724	0.000
% Renters	0.0009	0.000	5.159	0.000
Single family dwelling unit	-0.0718	0.001	-79.909	0.000
Auto Peak Total Accessibility	-0.5061	0.014	-36.533	0.000
Transit Peak Total Accessibility	0.0166	0.001	30.635	0.000
Auto Off Peak Retail Accessibility	0.2103	0.015	14.046	0.000
Total non-residential units	0.0279	0.001	41.777	0.000
Total residential units	0.1467	0.002	82.811	0.000
Observations	73,134			
Adj R-squared.:	0.562			
<i>Data Sources: Bay Area UrbanSim Synthetic Population (derived from PUMS), MTC Travel Model, Craigslist</i>				
<i>Note: Neighborhood variables are averages within 0.5 to 3 km</i>				

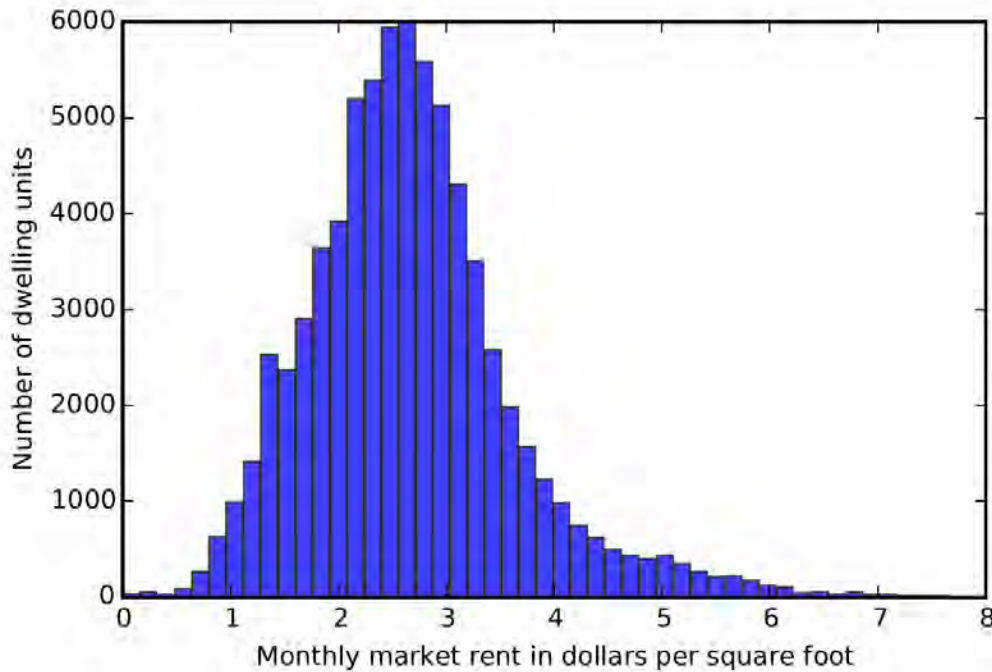

Figure 3A.5: Rent per Square Foot from Craigslist Rental Listings

Size of units is of course relevant to housing affordability, and the size distribution of the rental listings is shown in Figure 3A.6.

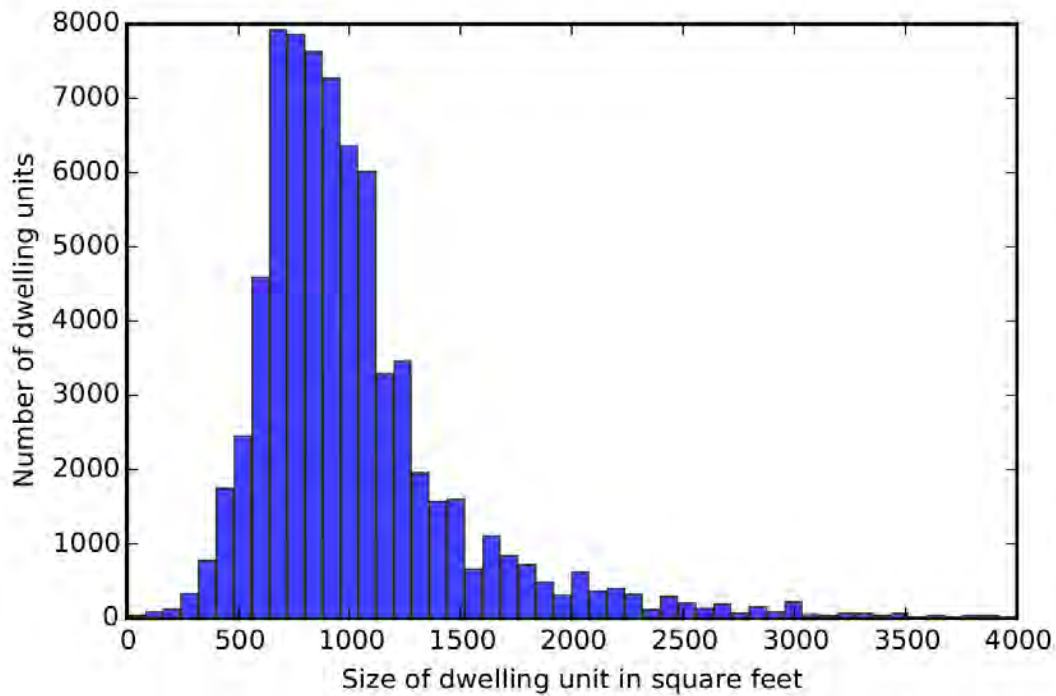

Figure 3A.6: Square Footage per Unit from Craigslist Rental Listings

Representation of Income and Race/Ethnicity

Income, racial and ethnic composition of households was incorporated into the data and several models. It was added to the hedonic regression models as shown above in Table 3A.4, in addition to the move-out models and the location choice models. Results were mainly significant in the location choice models (housing demand), and not surprisingly, therefore also in the hedonic models of housing rents and prices. Income and race/ethnicity were not generally found to be significant in the decision to move out.

Representation of the Influence of Rent Burdens on Moving Out

UrbanSim's household relocation choice model prior to this project was a rate-based model in which the probability that a household moves out of its residence in a given year (independent of housing tenure) depended on the age of the head of the household and household income. This model was modified to a binary logit model, with the probability of moving as the outcome variable.

The hedonic regression for rents was used to predict rents for all units. For renters in the synthetic population, the rental cost burden was calculated as the annualized rent divided by household income, and used as an independent variable and presented in Figure 3A.7.

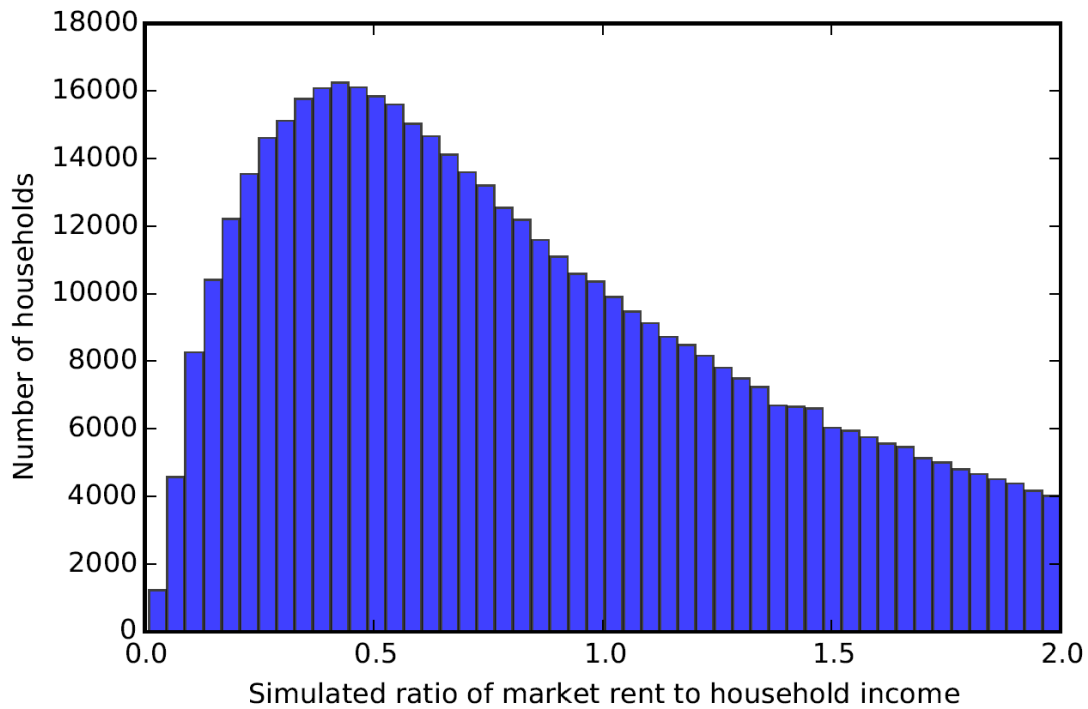

Figure 3A.7: Rent Burdens for Bay Area Households

These estimation results in Table 3A.5 show that there is a systematic change in the coefficients on rent burden as the income of the household increases, with higher coefficients for higher-income households. While this might initially appear counter-intuitive, it is entirely consistent with the observed data: households with lower incomes are forced to spend a higher fraction of their incomes on housing. We also test for any impacts of race of household on move-out propensity, but find these to be largely insignificant, with only Asian households having a measurable difference in their propensity to move. The lack of race effects on move-out behavior is also consistent with the hypothesis that the move-out decision is mostly driven by the economics of rent burdens and other factors such as age, household size, and the presence of children.

Table 3A.5: Relocation Choice Model Estimation Results for Renters

Dependent. Variable: Moved During Last Year	coef	std err	z	P> z
Intercept	0.3159	0.134	2.365	0.018
Rent Burden (\$10,000 income bracket)	0.0121	0.001	8.707	0.000
Rent Burden (\$20,000 income bracket)	0.0114	0.001	7.679	0.000
Rent Burden (\$40,000 income bracket)	0.0176	0.002	9.873	0.000
Rent Burden (\$60,000 income bracket)	0.0257	0.003	9.593	0.000
Rent Burden (\$80,000 income bracket)	0.0379	0.003	11.099	0.000
Rent Burden (\$100,000 income bracket)	0.0432	0.004	10.253	0.000
Rent Burden (\$120,000 income bracket)	0.0566	0.005	11.064	0.000
Rent Burden (\$150,000 income bracket)	0.0582	0.006	9.545	0.000
Rent Burden (\$200,000 income bracket)	0.0803	0.008	10.575	0.000
Rent Burden (\$300,000 income bracket)	0.0976	0.012	8.317	0.000
Rent Burden (top income bracket)	0.1607	0.029	5.553	0.000
Income\(\$ thousands)	0.0003	0.001	0.442	0.659
Age of householder	-0.0429	0.002	-23.155	0.000
Persons in household	-0.2380	0.020	-11.727	0.000
Presence of Young Child	0.1953	0.081	2.424	0.015
Hispanic householder	-0.0927	0.072	-1.294	0.196
Black householder	0.0337	0.094	0.357	0.721
Asian householder	0.1312	0.064	2.047	0.041
Public assistance income (\$ thousands)	-0.0087	0.030	-0.288	0.774
San Francisco householder	-0.8309	0.073	-11.458	0.000
Observations	10,014			
Pseudo R-squared:	0.09712			

Data Source: American Community Survey 2013

Representation of the Influence of Rent Burdens on Moving In

The effects of rent burdens on households considering a location to move into are captured in the household location choice models in UrbanSim. These have been structured for this project to segment households by income quartile, with separate model estimation for each income quartile, from 1 (lowest) to 4 (highest)². The models are estimated using PUMS. The models are also segmented by owner and renter households. Table 3A.6 displays the results are for renters in income Quartile 1.

These estimation results still require further calibration in order to adjust for the potential influence of variables not measured in the model. In particular, we do not observe numerous internal quality characteristics of housing units, and as a result of this omission, the coefficients on rent are positive rather than negative, though this must be interpreted in the context of other variables such as income, which is a powerful variable in these location choice models. Note that the coefficient for average nearby income increases from -1.45 for quartile 1 (Table 3A.6), to -0.839 for quartile 2 (Table 3A.7), -0.155 for quartile 3 (Table 3A.8), and finally to 1.197 for quartile 4 (Table 3A.9). Rents and average incomes are of course correlated, so in this case the income coefficient for renters is negative for low income renters since they cannot afford to locate in higher income neighborhoods. As incomes for renters increase, this negative correlation is reduced, and

² Quartile 1: \$0-\$30,000, Quartile 2: \$30,000-\$60,000, Quartile 3: \$60,000-\$100,000, Quartile 4: \$100,000 +

Table 3A.6: Location Choice Model Estimation Results for Renters in Income Quartile 1

Dep. Var: Location Choice	Coefficient	Std. Error	Z-Score
Log of rent	0.488	0.076	6.396
Log of nearby sq. ft. per unit	0.084	0.024	3.554
Log of nearby lot size per unit	1.063	0.117	9.059
Average nearby income	-1.454	0.032	-46.069
Log(persons * avg. household size)	0.198	0.020	9.965
White * Log(1 + % White)	9.169	0.007	1318.078
Black * Log(1 + % Black)	5.386	0.009	619.337
Hispanic * Log(1 + % Hispanic)	6.267	0.006	1001.648
Asian * Log(1 + % Asian)	5.374	0.008	641.331
Nearby Jobs	0.022	0.008	2.685
Auto Peak Total Accessibility	0.463	0.054	8.634
Transit Peak Total Accessibility	0.048	0.006	8.139
Auto Off Peak Retail Accessibility	-0.437	0.059	-7.425
Pseudo R-squared:	0.077		

Data Sources: Bay Area UrbanSim Synthetic Population (derived from PUMS), MTC Travel Model

Note: Neighborhood variables are averages within 0.5 to 3 km

The comparison of the rent coefficients across income quartiles reveals that it drops slightly from 0.488 for quartile 1 (Table 3A.6), to 0.174 for quartile 2 (Table 3A.7), before climbing to 0.768 for quartile 3 (Table 3A.8), and to 1.011 for quartile 4 (Table 3A.9). Taken as relative measures, this indicates that from quartile 2-4, there is declining sensitivity to rents, which is consistent with households at higher incomes being more willing and able to pay for amenities and higher-quality finishes. Why the lowest income quartile is slightly less sensitive to rents than the second income quartile is less obvious, but most likely is due to an inability to escape higher rent burdens due to the absence of lower-cost housing options.

Aside from control variables for accessibility and neighborhood job density, the interaction of household characteristics with the socioeconomic characteristics of neighborhoods also appears to be very important in understanding spatial segregation patterns. We find very significant clustering effects when interacting the characteristics of households making a location choice with the fraction of households in a neighborhood that share the same characteristic. This applies for household size, with larger households preferring locations in which other households are also larger (more children, generally). It also applies to the racial and ethnic composition of households independent of the income effect. Clustering of whites, blacks, Hispanics, and Asians is clearly evident in the coefficients for these location choice models. One intriguing pattern emerges when comparing across income quartiles: the coefficient on same-race interaction decreases markedly from the lowest to higher income quartiles for blacks, and declines somewhat less for Hispanics, whereas it does not decline much at all for whites or Asian renter households. This suggests that as their income increases, blacks and Hispanics are more likely to move into more integrated neighborhoods.

Table 3A.7: Location Choice Model Estimation Results for Renters in Income Quartile 2

Dep. Var: Location Choice	Coefficient	Std. Error	Z-Score
Log of rent	0.174	0.076	2.276
Log of nearby sq. ft. per unit	-0.017	0.024	-0.721
Log of nearby lot size per unit	0.202	0.106	1.908
Average nearby income	-0.839	0.032	-26.212
Log(persons * avg. household size)	0.474	0.019	24.471
White * Log(1 + % White)	9.244	0.006	1464.798
Black * Log(1 + % Black)	3.924	0.009	448.839
Hispanic * Log(1 + % Hispanic)	5.820	0.006	965.782
Asian * Log(1 + % Asian)	4.598	0.008	587.814
Nearby Jobs	-0.000	0.008	-0.037
Auto Peak Total Accessibility	0.459	0.054	8.422
Transit Peak Total Accessibility	0.015	0.006	2.794
Auto Off Peak Retail Accessibility	-0.359	0.059	-6.067

Pseudo R-squared:

0.041

Data Sources: Bay Area UrbanSim Synthetic Population (derived from PUMS), MTC Travel Model

Note: Neighborhood variables are averages within 0.5 to 3 km

Table 3A.8: Location Choice Model Estimation Results for Renters in Income Quartile 3

Dep. Var: Location Choice	Coefficient	Std. Error	Z-Score
Log of rent	0.768	0.082	9.404
Log of nearby sq. ft. per unit	0.130	0.025	5.222
Log of nearby lot size per unit	-0.758	0.111	-6.846
Average nearby income	-0.155	0.039	-4.005
Log(persons * avg. household size)	0.940	0.020	47.245
White * Log(1 + % White)	8.908	0.008	1182.424
Black * Log(1 + % Black)	3.636	0.010	349.770
Hispanic * Log(1 + % Hispanic)	5.094	0.007	762.927
Asian * Log(1 + % Asian)	4.854	0.009	565.542
Nearby Jobs	-0.027	0.008	-3.506
Auto Peak Total Accessibility	0.934	0.058	16.201
Transit Peak Total Accessibility	-0.019	0.005	-3.657
Auto Off Peak Retail Accessibility	-0.617	0.063	-9.762

Pseudo R-squared:

0.032

Data Sources: Bay Area UrbanSim Synthetic Population (derived from PUMS), MTC Travel Model

Note: Neighborhood variables are averages within 0.5 to 3 km

Table 3A.9: Location Choice Model Estimation Results for Renters in Income Quartile 4

Dep. Var: Location Choice	Coefficient	Std. Error	Z-Score
Log of rent	1.011	0.075	13.517
Log of nearby sq. ft. per unit	0.175	0.024	7.451
Log of nearby lot size per unit	-1.132	0.109	-10.389
Average nearby income	1.197	0.036	33.641
Log(persons * avg. household size)	0.030	0.020	1.448
White * Log(1 + % White)	8.032	0.009	928.342
Black * Log(1 + % Black)	3.253	0.013	258.123
Hispanic * Log(1 + % Hispanic)	3.792	0.008	486.235
Asian * Log(1 + % Asian)	4.310	0.010	449.356
Nearby Jobs	-0.028	0.007	-3.917
Auto Peak Total Accessibility	1.622	0.061	26.596
Transit Peak Total Accessibility	-0.008	0.005	-1.673
Auto Off Peak Retail Accessibility	-1.268	0.069	-18.390
Pseudo R-squared:	0.06		
<i>Data Sources: Bay Area UrbanSim Synthetic Population (derived from PUMS), MTC Travel Model</i>			
<i>Note: Neighborhood variables are averages within 0.5 to 3 km</i>			

Representation of Parcel-Level Demand and Supply

As noted in the above section, “Requirements for Regional Models to Represent Displacement,” the need to reflect detailed zoning and walk-scale access to transit imposes a requirement that parcel- and building-level representation be used to capture these effects. In this application of UrbanSim, we have exploited the use of local street network-based accessibility, and moved to a representation not only of parcels, but of individual residential units within buildings. This enables appropriate measurement of localized policies and amenity effects in the location choice models (demand), real estate development models (supply), and hedonic models (prices).

Representation of Affordable Housing Development Feasibility

We have explored alternative strategies to address affordable housing construction in the real estate development model using pro forma analysis. The affordable housing component is made up of two subcomponents, inclusionary housing development and multi-family housing built with assistance from the Low-Income Housing Tax Credit (LIHTC) program, which we believe will capture a majority of all new subsidized affordable housing developed in the coming decades. We have developed a working add-on to the developer model to simulate inclusionary housing development, using San Francisco as a prototype. This can be expanded to the rest of the Bay Area with some data collection about the particular aspects of different jurisdictions’ inclusionary housing ordinances. After pursuing several options of how to operationalize a model of LIHTC-assisted developments, we have developed a potential blueprint for how to address this in the UrbanSim developer model.

Inclusionary Housing

For the past 10 years or so, recognizing the difficulty of providing housing at prices affordable to low and moderate-income households, the City and County of San Francisco, among other

jurisdictions in the Bay Area, have required developers of market-rate housing to provide housing affordable to low-income households. The developer can choose to:

- Provide affordable housing on site;
- Provide affordable housing off site;
- Pay an in-lieu fee on a per-unit basis, providing funds the Mayor's Office of Housing can use to support affordable housing development.

The program applies to all housing development above 10 units, which is the vast majority of development projects (counted in terms of units provided) in San Francisco.

Affordability levels:

- Per Planning Code Sections 415.6 (c) and 415.7 (d), initial rental below market rate (BMR) Rental Units will be priced to be Affordable to Qualifying Households at 55% of area median income (AMI).
- Per Planning Code Section 415.6 (c), initial sale BMR Ownership Units that are provided on the site of the Principal Project will be priced to be Affordable to Qualifying Households 90% of AMI on average.
- Off-site BMR Ownership Units must be affordable to Qualifying Households earning no more than 70 percent of AMI.
- Off-site BMR Rental Units must be affordable to Qualifying Households earning no more than 55 percent of AMI.

UrbanSim has a ROI-type developer model which is separated into the following: a) a feasibility calculation for all parcels for a number of building types, and b) a model selecting the most promising projects. The feasibility model returns a list of parcels where projects could pencil out. When the simulation is actually run, development is randomly chosen among such feasible projects, weighted by profitability, favoring financially stronger projects.

We incorporate inclusionary housing into the developer model on the feasibility side, such that jurisdictions whose planning codes contain inclusionary housing would be, all other things being equal, more expensive places in which to develop, assuming some portion of the cost for renting or selling units at less than their market value is carried by the developer. The implication from a policy perspective would be that the geography of development would, all other things equal, be impacted by the presence or absence of inclusionary ordinances, allowing for somewhat explicit testing of the effect of their introduction, and the provisions they contain. From a modeling perspective, adjusting the feasibility calculation is a quite direct and explicit way of achieving this end.

An important component in the feasibility calculation is the revenue side of potential development projects, which, compared with the cost estimate, make up the basics of the feasibility. Potential revenues come from an aggregation of hedonic sales prices for nearby or similar projects. The basic idea behind the implementation of inclusionary housing is to enter the calculation where expected sales prices are calculated. This takes place in the variable function known as "parcel-average-price." Instead of relying strictly on zone-level hedonic quantiles for expected sale price, the parcel-average-price function now performs a county-level lookup of a U.S. Department of Housing and Urban Development (HUD)-derived table on low-income limits, which is used to calculate upper threshold values for how much housing can cost and remain affordable to households earning 50% of the AMI. The developer must be able to break even, while providing these units at these much lower levels of revenue.

The following lists assumptions made to simulate inclusionary housing development in UrbanSim for the San Francisco prototype:

- We assume inclusionary units are built for this target income level, which is true for the San Francisco program but not necessarily for other jurisdictions.
- We assume inclusionary units are only built in jurisdictions with actual ordinances on the books, ignoring any voluntary arrangements.
- Placeholder values exist at the jurisdiction level (city-id), assuming 12% for all jurisdictions with an inclusionary ordinance.
- We also assumed a two-person household for the purpose of determining the target rent level, which is the closest integer to the average San Francisco household size. It may be advisable to parameterize this choice as a constant, or allow it to vary geographically to better fit actual local variations.
- We have set aside for now the complexities of off-site provision, as well as in-lieu fees.
- Concretely, this would mean that while a hedonic model may provide \$600 per square foot as a revenue assumption, 12 percent of the units now come with a much smaller, around \$200-per-square-foot assumption. The overall project revenue is then the weighted sum of the two.
- A significant deficiency here is that no accounting is done of BMR units produced pursuant to the program. Ideally, there would be explicit accounting of any BMR units produced, over time changing the geography of affordable housing as the simulation progresses. The reason for this is mainly because of a pending migration of the unit of analysis to individual housing units away from the current square footage representation of built space. Once that is in effect, individual units should be flagged as deed-restricted units, and, importantly, the household location choice model should be segmented to select BMR vs non-BMR units. This would entail schema changes as well as model changes.

LIHTC-Assisted Projects

We have explored several possibilities for modeling 100% affordable multi-family units, which make up a majority of all income-restricted housing units in the Bay Area, developing rough conceptual models for each, and discussing their plausibility with specialists from the San Francisco Mayor's Office of Housing, ABAG, the San Francisco-based Non-Profit Housing Association of Northern California (NPH), and Mercy Housing California (a large statewide developer of non-profit housing).

The initial concept was a "layering" approach, whereby affordable housing projects would compete with market-rate development for land in the developer model. Their ability to compete would be based on layers of subsidies from various public sources (LIHTC, remaining redevelopment funds, and other sources) as well as streamlined entitlement processes that would reduce friction and allow these projects to be completed in less time. Housing practitioners acknowledged that affordable housing would be developed in this manner in an ideal world, but in reality, land in San Francisco has become so expensive that it only gets set aside for affordable developments if it is dedicated by public agencies, donated by developers through one-off agreements with elected officials, or is made available through other types of arrangements that would be impossible to model.

The next iteration was based on an assumption that the vast majority of 100% affordable multi-family developments would receive LIHTCs, which is supported by our interviews with housing experts. Based on this assumption, if we could model the location of LIHTC-assisted projects (in

addition to the inclusionary housing units) we could approximate locations of the new income-restricted units that will be built in the region. Although we have a dataset of all of the developments built in past years with tax credits, our goal was to use the locational criteria established by the California Tax Credit Allocation Committee to forecast where future developments might go. Unfortunately, this approach proved infeasible as locational criteria have a relatively small effect on the likelihood that a proposed project will receive 9% LIHTC, which are competitively allocated by the California Tax Credit Allocation Committee. The official 2015 regulations for assessing 9% LIHTC applications, for example, provide applicants with a maximum of 15 points for neighborhood amenities, a small percentage of the total possible score of over 120 points.²

We have, however, come up with a filtering mechanism that may allow us to narrow the range of total possible parcels to one in which affordable housing developments may be located. Municipalities are required to submit their housing elements to the California Department of Housing and Community Development (HCD). Housing elements must include a listing of parcels already entitled for residential development that will allow cities to meet their Regional Housing Needs Allocation (RHNA). ABAG intends to compile this list of suitable housing sites from all Bay Area jurisdictions in the near future. We believe that the combination of sites deemed suitable through the housing elements (which will have already cleared the political hurdles of public hearings and entitlement process) and the locational criteria of LIHTC may give a reasonable approximation of where 100% affordable multi-family housing developments are likely to occur.

Summary of Status and Next Steps

This project has explored strategies for addressing questions around displacement related to transit investment and has made substantial progress in first, identifying requirements for making such adjustments in the modeling, and second, implementing these requirements. Significant changes have been made in the data structures and models to address the challenges of modeling displacement and modeling the impacts of alternative policies intended to mitigate these problems. We have not fully incorporated these changes into the operational models at MTC and ABAG, though most are in a condition that they could be easily incorporated at this point. This should be the case for the changes in data structures, household relocation model, hedonic models, and household location choice models. Estimation for these models has been completed.

What remains before full implementation and operational use is the following:

- Completion of proposed changes to the real estate supply model to simulate alternative policies designed to address affordable housing supply
- Testing and calibration of the combined changes to ensure reasonable predictions with the fully integrated model system
- Sensitivity testing of the updated, calibrated model system
- Running alternative scenarios with the calibrated model system to compare the effects of alternative policy strategies on displacement outcomes

As of early 2017, MTC has begun integrating most of the research innovations added to UrbanSim as part of this project and through a separate project funded by the MacArthur Foundation into their operational version of UrbanSim. The UrbanSim modeling methodology and platform has also recently been adopted for operational use by SANDAG, and efforts are now underway to generalize

² See <http://www.treasurer.ca.gov/ctcac/programreg/regulations.asp> for details on the regulations.

these changes to make them readily usable by any metropolitan area without extensive customization.

Section 3B: Addressing Displacement in the SCAG PECAS Model

3B.1. Introduction

In this section we present enhancements to the land use model used in the Los Angeles by the Southern California Association of Governments (SCAG) known as the PECAS Land Use Model. First, we review the types of displacement categorized by previous research (Chapple, Chatman, and Waddell 2014) and assess how to implement the causality within PECAS's general equilibrium framework (Hunt and Abraham 2005). Second, given empirical findings concerning the displacement near TOD areas outlined in Chapter 2, the SCAG PECAS model was updated to incorporate incomes and rents. This update allows the analysis of the regional economic benefit of TOD that took place in Los Angeles County, which is presented in the Appendix Q. Lastly, it provides possible options for further enhancement.

The SCAG PECAS model is designed as a sketch tool to provide an overview of the impact of planning alternatives for the SCAG region, which consists of six counties with over 5 million households and 18 million people. The SCAG PECAS model was developed from 2008-2010 via a cooperative arrangement with the UC Davis Team charged with developing the statewide PECAS version. The SCAG region was "carved" out from the statewide database as a sub-regional model. Then, the model was recalibrated with available data for the SCAG region at that time, including travel skim matrices and land use inventory. Its relevancy was somewhat compromised by not fully being calibrated with genuine SCAG regional data. However, by taking such an expedited development path, SCAG was able to operate the model internally to produce cursory impact analyses for the 2012 RTP/SCS.

In its core, PECAS estimates the amount of goods, services, labor, and building floor space produced and consumed. As an output, it generates snapshots of household and job allocation in the region at 302 zones defined by Community Statistical Areas (CSA). While PECAS estimates land use transition for 4.5 million individual parcels in the SCAG region in its space development (SD) model (described in more detail in Section 3B.2), the model's main focus is to summarize regional economic performance of various policy assumptions at a manageable scale.

Given this modeling framework, the SCAG PECAS model is equipped to answer the question, "how does the region look when TOD is implemented compared to when TOD is not implemented?" It is not, however, equipped to answer the question, "what are the characteristics of the residents or households that move into or out of the TOD area?" This is because the sketch model searches for a spatial equilibrium state and uses relatively coarse geographic units of analysis (the CSA zone) and simplified stratification of economic agents (e.g., categories of households, not individual households). This simple model specification allows SCAG to review various planning alternatives in a relatively short analysis period and on a small budget.

The SCAG PECAS model is only partially adequate to explain the dynamic and disaggregated nature of displacement presented in the discussions in previous chapters and sections of this report. The SCAG PECAS model is a quasi-dynamic model in which a momentary state depends on the previous state, and it calculates the “changes” by comparing the two states at different times. Thus, it presents the net changes instead of identifying individual effects separately. The current SCAG PECAS model is without a mechanism that associates individual agents (e.g., households) to residential units at parcel level. Thus, the current SCAG PECAS model is not capable of analyzing potential displacement at the level of detail desired for this project.

Without major investment planned for the foreseeable future, this project gives SCAG an opportunity to review the new requirements for modeling potential displacement and to consider how these requirements compare to the SCAG PECAS model’s current capabilities. It also gives SCAG the opportunity to evaluate methods that could be used in the future to incorporate additional information and to marginally update the model with the latest statistical findings related to TOD investment.

Modification of modeling dimensions, like reclassification of households/industrial sectors or changing zone systems, is considered a major update. In the general equilibrium states on which the PECAS is formulated, every variable is inter-related. Changing the model’s dimension means almost all model coefficients should be re-estimated for the new structure. The current project does not aim for such a major update. The updating process summarized in the following sections demonstrates a possible method for enhancing existing PECAS-like land use models that represent economic actors and activities in aggregated form with very limited resources.

The following discussion consists of three sections: 1) an overview of the SCAG PECAS model, 2) a review of how it can be updated to model the types of displacement under consideration by recalibrating the zonal utility constant (but without radically re-framing the model structure) and applied to show the impact of TOD, and 3) a summary and recommendation with options for further enhancement, including major updates.

3B.2. PECAS and SCAG PECAS Model Overview

PECAS (Hunt and Abraham 2005) is a land use forecasting and policy analysis system used for comprehensive planning and transportation planning. It is a time-series (year-by-year) simulation of the evolution of the spatial form and the contribution of the transportation system to the future development of the economy and spatial patterns.

It consists of two internal modules—activity allocation (AA) and space development (SD)—and two external modules—economic/demographic (ED) and transportation (TR) (J.E. Abraham and Hunt 2007).

The AA module represents two elements: (1) the relationships between the people of the region—their interaction with businesses and other establishments in the region (and in the world) through markets for labor, goods, and services and (2) the relationships between businesses and establishments. The module allocates the region’s households and production (employment) (called “activities”) to the region’s buildings (and other land improvements). It uses the region’s travel demand models (TDM) to allocate “activities” according land uses and “skims” the TDM for travel conditions between transportation analysis zones (TAZs). The word “PECAS” is an acronym for “Production Exchange Consumption Allocation System,” since AA represents the production of

goods, services, and labor (collectively called “commodities”) in one location, and the exchange (and transportation) of these items to consuming entities in other locations, with a spatial price search mechanism at the point of exchange in order to clear the markets for each commodity in each short-term equilibrium time period (each year of the simulation).

PECAS’ AA module estimates the production and consumption of commodities and building floor space, with consideration of three types of equilibrium states: 1) given the regional control of households and jobs, the estimated regional production is identical to consumption, and there is a set of market clearing prices in zones; 2) each type of household and business has a set of substitution technology, which determines the amount of input and output to maximize their gain at a given set of commodity prices according to the technology; 3) given the transportation system (and its capacity) as supply for transportation activity, the zone-to-zone travel demand for exchange of commodities from the produced zone to the finally consumed zone determines travel time and travel cost. The market clearing commodity price includes this endogenously determined travel cost.

The SD module represents developers (private or public) as they change the built form of the region (Hunt et al. 2007; Hunt and Abraham 2009). SD represents the land and buildings in the region via a parcel database; development conditions are represented via construction costs, zoning regulations, fees, servicing costs, etc. SD also represents the detailed appropriateness of specific parcels for specific uses through proximity functions, and is thus able to respond to the price signals (received from AA) indicating neighborhood demand/supply in a way that respects and responds to the specific arrangement of developable land, roads, buildings, transit stations, etc. SD inputs are largely GIS files that describe the land and parameters that represent developer behavior and ROI functions.

An aggregate version of SD is often developed in complex regions with missing or inconsistent data. This aggregate version contains a simplified inventory of the quantity of developed and vacant land in each land use zone, categorized by current development and zoning category. The aggregate version of SD converts quantities of vacant land into quantities of developed land in each TAZ in each year of the simulation, in response to the price signals from the AA module (higher rents indicating unsatisfied demand), and other demand signals that are region specific. In the SCAG region, there is both an aggregate SD model and a disaggregate SD model, with the disaggregate SD model not yet fully calibrated.

AA and SD work together with a spatial economic forecasting model of ED and TR to represent the state of a spatial economy over time.

Figure 3B.1 depicts the flow of information in the PECAS system. The system runs year-by-year. The ED module forecasts the size of the total economy given outputs from the AA module. Note that AA allocates by TAZ based on transportation system performance and the inventory of buildings and other space. Within the SD module, the inventory of buildings and space is modified per AA’s price signals. The TR model develops measures of transportation system performance given the locations of business and household activity from AA.

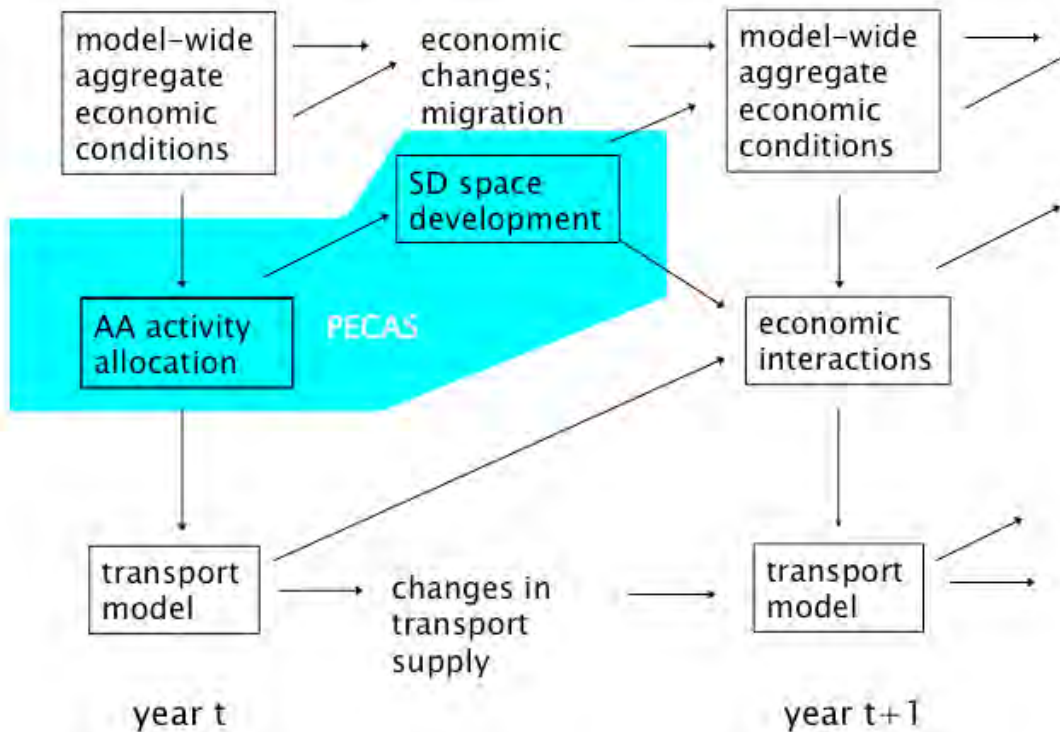

Figure 3B.1: Information flows in the PECAS framework

In the SCAG region, the PECAS model is currently operational with a simplified TR model, which relies on the skim matrices (average zone-to-zone travel time and distance by all modes including bus and rail transit, weighted by the ridership) produced by the regional travel demand model. The ED model is represented by forecasts, guided by a group of experts' economic outlook. The feedback process from PECAS to ED has not yet been established since, in SCAG's practice, the regional forecast is considered to be fixed during an RTP cycle.

3B.3. Modeling TOD and Displacement in PECAS

Rent in Modeling TOD using PECAS

In the context of TOD, it is generally expected that the lower-density and older uses will be replaced by newer, higher-density uses. Each of the housing categories shown in Table 3B.1 represents a range of densities, with the upper (and lower) value of floor area ratio constrained by both 1) the definition of the category, and 2) the zoning regulations that prohibit or allow specific ranges of densities.

Real estate developers modeled in the PECAS SD module are motivated by future profit, and thus are blind to specific social issues (e.g., race and ethnicity) and spatial issues (e.g., proximity to transit), *unless* those factors are included in the calculation of rent or construction costs. Such issues are more directly related to households' decision process and housing demand, which is modeled in the AA module. Within PECAS's general framework, TOD should directly impact rent in two ways: (1) in the AA module, via the estimation of the zonal average rent as the equilibrium market

clearing price, and (2) via the SD module, whereby parcel-specific rents are determined within a zone, depending on the local condition where the parcel is located.

Table 3B.1: Dwelling type categories in the SCAG PECAS Model

Dwelling Type	Description
ResType1-VL Luxury	Very low-density (acreage style homes, high value)
ResType2-VL Economy	Very low-density (acreage style homes, low value), includes rural mobile homes
ResType3-L Luxury	Low-density (subdivision style homes), high value
ResType4-L Economy	Low-density (subdivision style homes), low value
ResType5-MD Separate Entrance	Duplexes, attached single-family, townhomes
ResType6-MD Shared Entrance	3,4,5 or 6 units per structure
ResType7-Higher Density	More than 6 units per structure, but not high rise
ResType8-Highrise	More than 6 units per structure, high rise
ResType9-Urban MH	Mobile home in an urban area

Zonal Rent Impacts

The zonal average rent for each of the space types in each zone is calculated in the PECAS AA module (J. Abraham and Hunt 2007), based on the ability of people to depart from (or arrive to) the zone to exchange labor, goods, services, or other items of tangible or intangible value. The travel attributes are calculated in the SCAG transportation demand model and are used by PECAS to represent “how travel on the transportation system fulfills economic needs,” such as travel to work to sell labor, travel to schools to obtain an education, and so on.

The zonal rent is established through a supply/demand relationship in the housing market, with households in the PECAS categories making location and housing choices to optimize their access to the labor markets (to sell their labor as a product of the household) and to goods, services, and other PECAS commodities (to buy and to consume), based on their chosen economic interactions. In their choice process, the “zonal attractiveness factor” is considered as representing a base attractiveness of a zone to the household based on the zone’s categorization. This factor includes both economic and non-economic terms, but the existing SCAG PECAS model does not include any non-economic attractiveness term at this time. Typical economic terms—which are included in the SCAG PECAS model—are price of goods and services, travel impedance, and amount and variety of available commodities including transit services.

The economic terms for the PECAS’s “zonal attractiveness factor” have been developed using two key data sources: (1) economic input-output tables, which show household consumption relationships, (2) and Census micro-sample data, which show labor force participation and housing choices in terms of dwelling size and type. It is not expected that an analysis of displacement data and literature will significantly contradict the spatial economic interactions that drive spatial behavior in the SCAG PECAS model. Therefore, further analysis of displacement data is not expected to add much value to improve rent estimation from an economic aspect. Of course, recalibration of the model upon the availability of better and more recent data should enhance the model.

However, as new data and information emerges, model updates may be warranted to reflect non-economic aspects of household choice behavior, particularly if these new findings might affect PECAS’s rent model. In PECAS, the “zonal attractiveness factor” represents how certain types of households are drawn to certain neighborhoods independent of the housing and the accessibility provided by the transportation system, which is considered part of economic attractiveness. Social proximity effects, whereby households more attracted to neighborhoods with matching or desirable attributes of current residents, can be represented in these factors.

In the current SCAG PECAS model, household categories—denoted by income range and household size—are shown in the Table 3B.2. The empirical findings could be included as a zone-by-zone modifier to the zonal attractiveness measures to target households with certain characteristics as long the findings are in a form of specific quantitative metrics about how neighborhood attractiveness changes for households as a function of household attributes and neighborhood attributes.

Table 3B.2: Household Categories in the SCAG PECAS Model

Household Category	Income Range	Household Size
INC0010 2 or less	Less than \$10K	2 or less
INC0010 3 or more	Less than \$10K	3 or more
INC1025 2 or less	\$10K ~ \$25K	2 or less
INC1025 3 or more	\$10K ~ \$25K	3 or more
INC2550 2 or less	\$25K ~ \$50K	2 or less
INC2550 3 or more	\$25K ~ \$50K	3 or more
INC5075 2 or less	\$50K ~ \$75K	2 or less
INC5075 3 or more	\$50K ~ \$75K	3 or more
INC75100 2 or less	\$75K ~ \$100K	2 or less
INC75100 3 or more	\$75K ~ \$100K	3 or more
INC100150 2 or less	\$100K ~ \$150K	2 or less
INC100150 3 or more	\$100K ~ \$150K	3 or more
INC150m 2 or less	\$150K or more	2 or less
INC150m 3 or more	\$150K or more	3 or more

In the PECAS model, neighborhood attractiveness influences would have to be treated as average amounts for each of the above household categories, either model-wide or zone-by-zone. The method of aggregation could make use of the relationship between PECAS household categories and household attributes in the measured relationships. There are few data options to support the method. The census PUMS data provides the information to enable an aggregation based on regional relationships, or the synthetic population representation could be used to aggregate within specific TOD zones. Individual households and population were synthesized based on the controls of household size/income/housing type distributions, as well as population age/race/worker status at 11,268 TAZs for the base and planning years (2012, 2020, 2035 and 2040) of the 2016 RTP/SCS in various land use scenarios.

The most important aspect of using observed neighborhood attractiveness in the PECAS model is the monetization of attractiveness into an annual willingness-to-pay measure, since zonal attractiveness households in PECAS are currently measured dollars of annual expenditure. Statistical estimations in location choice models should include, as a variable, a measure of housing

cost as annual rent. Otherwise, the units will be ambiguous and not translatable into the PECAS context. There is currently no explicit representation of race or ethnicity in the SCAG PECAS model, and a statistically sound relationship of race/ethnicity composition to the annual willingness-to-pay as rent has not yet been established.

The SCAG PECAS model is being developed using an “agile and incremental” development approach (Beck et al. 2001). This means that SCAG is continuously interested in potential improvements to the PECAS model. Recommendations regarding adjustments or enhancements to the system of categorization of households in Table 3B.2 could result from the displacement study described throughout this report, especially as quantifiable measures of neighborhood desirability are produced. A microsimulation version of the PECAS AA module is also planned, allowing additional socioeconomic variables or location variables to be included in utility functions, removing the need for zonal based variables. The study could recommend that SCAG adopt this PECAS enhancement.

Within-Zone Parcel Rent Adjustments (Local Level Effects)

Within each zone, certain parcels are more desirable for certain uses. PECAS uses a two-level hedonic model to modify parcel-level expected rents by development type to account for the characteristics of each parcel. This allows PECAS to represent particular parcel-specific development probabilities.

An example in the statewide model (as well as in the SCAG PECAS model) is the rent modifier that considers the distance to the nearest transit station. The average zonal rent estimated in the AA module based on economic and non-economic terms of attractiveness is further modified for each parcel and each space type, based on the distance to a major transit stop by multiplying factors from the shifted exponential function shown in Figure 3B.2.

Using the same distance to the transit station example, the distance to the transit service would have both positive and negative influences on rent, when all other factors are controlled. With ease of access to the transit service, the shorter distance from a residential parcel should be a positive impact on rent. But if the distance is too far, its influence diminishes. On the other hand, due to nuisance factors such as noise from train operation, shorter distance could negatively affect rent, but this negative influence also diminishes with distance. The adjustment factor to a parcel is 1 when the rent of the parcel is exactly the same as the zonal average, and its distance from the station is the “reference distance value” for local effect of g , $RefDValue_g$. The local effect factors are then modeled as increasing functions for positive influences and decreasing functions for negative influences of observable measures, such as distance to certain amenity or age of property ($DValue_g$) with one known point on the Figure 3B.2 of $(RefDValue_g, 1)$. Negative values for θ_g in the exponential function result in values of $LEFac_{g,h}$ that decrease from 1 as $DValue_g$ decreases from $RefDValue_g$ to 0. Thus, rents decrease down from the zonal-level value as the effect gets closer to the parcel.

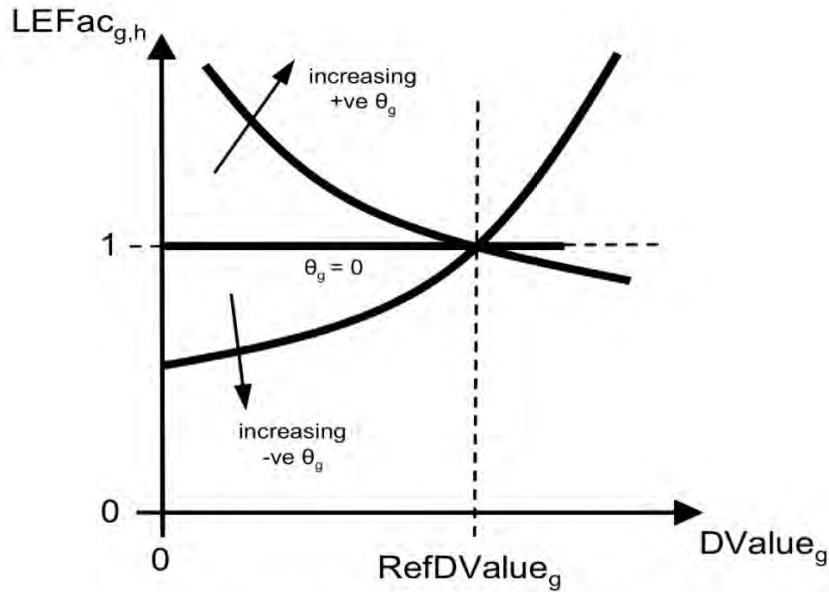

Shifted Exponential: $LEFac_{g,h} = \exp (\theta_g \cdot [1 - \{ DValue_g / RefDValue_g \}])$

Figure 3B.2: Shifted Exponential Function used in Transit Local Rent Modifier

$LEFac_{g,h}$: Factor adjusting proportional change in rent for space type h as a function of values on dimension relevant for local-level effect g

$DValue_g$: Values on dimension relevant for local-level effect g. Typically this represents the distance from the parcel to the source of the local-level effect, the local-level density for the parcel, or the age of the space on the parcel

$RefDValue_g$: Reference value on dimension relevant for local-level effect g

θ_g : Parameter for function calculating values for $LEFac_{g,h}$

g : Index of local-level effects on rent

In the SCAG PECAS model, the coefficients were estimated locally, using Orange County data. Table 3B.3 shows the empirically estimated rent modifier function coefficient by household categories. Higher-density housing shows increased value within the zone when it is located closer than one mile from a major transit stop, while non-residential uses increase even more substantially. Within the single-family housing categories, the nuisance effects of proximity to major transit (noise, litter, traffic) at the sub-zone level causes rents to decrease (although rents could still increase in total due to the zonal average impact). See (Wang et al. 2011) for details regarding the technique and the estimations that were performed using 58,000 residential parcels, and statewide (California) GIS representations.

These local rent coefficients could be updated based on the findings from the literature review and analysis of this project that provides additional information about the localized impact on the desirability of developments (separate from the neighborhood effect). Any analysis of changing rent patterns that occur due to major transit development should be careful to separate neighborhood uplift effects from parcel-specific effects, and should attempt to classify rental properties using the above categorical definitions. In this way, the displacement study could provide a major enhancement to the SCAG PECAS model, by improving this representation of rental proximity effects, and hence improving the representation of housing demolition and reconstruction. In

general, the *a priori* expectation is as follows, and these hypotheses should be tested and confirmed with a rigorous statistical analysis.

Table 3B.3: Rent Modifier Coefficients in the SCAG PECAS Model for Distance to a Transit Station

Space type	RefDValue	θ
ResType1-VL Luxury	5280	-0.116
ResType2-VL Economy	5280	-0.116
ResType3-L Luxury	5280	-0.116
ResType4-L Economy	5280	-0.116
ResType5-MD Separate Entrance	5280	-0.116
ResType6-MD Shared Entrance	5280	0.056
ResType7-Higher Density	5280	0.056
ResType8-Highrise	5280	0.056
ResType9-Urban MH	5280	0.056
Manufacturing space	1320	0.993
Commercial High space	5280	0.713
Commercial Low space	2640	0.252

- Multi-family residents are protected from nuisance effects by the structure type (they may live on higher stories, do not have to maintain a yard, and can secure the outside entrance to the building in addition to the entrance to their own residential unit) and have already chosen housing that causes them to interact with others as they come and go from their residence. Thus, the households bidding for multi-family housing will place a much higher value on the reduced walking time to transit, over the privacy and nuisance effects of transit stations and multi-family dwellings near transit will have an increased value.
- Single-family residents are more affected by the nuisance effects of transit, yet still value the reduced walk time of the closer locations, so the effect of major transit station proximity on rent could be positive or negative depending on which element is stronger.
- Users of commercial space value the visibility and access to pedestrian and change-mode (park-n-ride, bus transfers) users, and, all other things being equal, should bid the rents in the closest locations higher.

The other local effect modifiers in the current SCAG PECAS model are:

- Distance from schools
- Distance from coastline
- Distance from major roads
- Distance from freeway link (negative effect primarily due to noise)
- Distance from freeway access ramp (positive effect, especially for commercial uses, due to access)
- Distance from parks (positive effect for residential uses)

Analysis of parcel-specific rents or parcel-specific desirability for specific uses should attempt to include (or control for) the proximity effects of these other variables. For instance, if a major transit facility is built on an existing road right-of-way, turning a former major road into a local road,

commercial rents along the right-of-way could decrease, as the positive impact of the transit stop could be more than offset by the negative impact of the loss of a major road.

Analysis of parcel-specific rents or desirability could also suggest additional proximity measures affecting rents, for eventual inclusion in an enhanced PECAS model. Adding or changing these local-level effect modifiers in the PECAS SD module is a potential stand-alone enhancement that could have high modeling value for a potentially reasonable cost.

Modeling of Displacement in PECAS

This section reviews types of displacement in focusing on the possible methods to incorporate in PECAS model. According to the previous research referenced in the project scope (Chapple, Chatman, and Waddell 2014):

“Transit investment and TOD may result in either direct displacement, when residents are forced to move when new development replaces their housing units, or indirect displacement, which may occur as property values in the area increase due to its new desirability. Indirect displacement may be voluntary, if property owners elect to sell their residences (typically for a profit), or involuntary, occurring in any of three forms: (1) economic, in which housing becomes prohibitively costly (because of high rent or, outside of California, property tax increases); (2) physical, in which the landlord evicts the tenant or induces departure through harassment or persuasion; and (3) exclusionary, in which low-income and/or minority households no longer have the opportunity to move into the neighborhood.”

This categorization of displacement provides the organizational framework for this section, explaining how the PECAS model in Southern California can represent displacement.

Direct Displacement

Direct displacement is defined as “when residents are forced to move when new development replaces their housing units.” In PECAS, this category represents the demolition of existing housing units, potentially for two reasons: government demolition and private demolition.

Direct Displacement due to Government Demolition

Housing could be purchased for civic use and demolished by government authority. For example, housing can be demolished so the land can be used as a right-of-way for transit, for new access roads to transit stations, for park-n-ride transit lots, or for a new school provided together with new transit.

Since PECAS is designed to represent how the spatial economic and social economic system responds to government policy, the impact of forced displacement by direct government policy should be understood directly, analyzed outside of PECAS. Instead of letting the model decide future land use of the parcels in the TOD area, it is directly edited into the database for the SD module. In this situation, PECAS could be used to help understand how the system may adapt by the externally given land use change through second-order effects.

Direct Displacement due to Private Demolition

Housing can be demolished and replaced by private developers, who are pursuing the *Highest and Best Use* of existing land. The PECAS model for SCAG provides a direct representation of this

phenomenon, especially if the microsimulation SD module is calibrated and used. It contains a parcel-by-parcel representation of developer decisions, with developers motivated by expected future rent streams by type, age, and intensity of development. The space types in the SCAG PECAS model, representing types of development, are the same as in the California statewide PECAS model, and as Table 3B.1 shows. Within each category, the cost of constructing new space is calculated based on a commercial construction costing model, adjusted for zip code and for the slope of land (Circella et al. 2011).

Voluntary Indirect Displacement

Voluntary indirect displacement occurs if property owners elect to sell their residences. This category involves owner-occupied residences being sold for the benefit of the owner. The representation of this phenomenon in PECAS relates to the specific representation of rents, as already discussed in the previous section, direct displacement due to private demolition. The opportunities discussed in the section to better understand the TOD-related rent impacts in the context of demolition and redevelopment also apply to the understanding of voluntary displacement.

The PECAS model represents housing value as a rent stream regardless of whether housing is owner- or tenant-occupied, representing the direct rent paid by tenants and the opportunity cost of not renting forgone by owners. Typically, tenant vs owner analysis in PECAS has relied on the segregation by household income (Table 3B.2). Given the strong tendency of higher-income households to own their own homes, prior analysis along this dimension has been appropriately successful. Analysis of data for this category of displacement should attempt to understand the characteristics of households choosing to sell their homes to take advantage of upward rent pressures, to help assess the appropriateness of the existing income- and size-based classification system.

Owners usually have a longer-term mortgage with payments set based on purchase price. This allows them to make longer-term decisions, but they are less mobile in searching for a new residence than renters. The opportunity of increased revenue due to selling (or renting out) a residence with increased desirability may not be something that households are initially aware of, or initially consider, and because it represents an increase in value (rather than an increase in costs subject to a budget constraint), it does not force immediate lifestyle changes, or immediate decisions in a general equilibrium state of the economic system. The PECAS model has terms (called “inertia terms”) that serve to adjust the rate of locational response, if it is shown through the displacement research that households who own their dwellings respond more slowly to increased housing value, the PECAS inertia terms could be adjusted.

Analysis of displacement data could support this household categorization, as long as the rates of response are highly correlated with income or household size in the manner represented in the current SCAG PECAS model. Or it could suggest a more detailed categorization, or supplementary variables to be included in a future microsimulation version of PECAS AA, when the rates of response are highly correlated with many different variables, which are not part of the current SCAG PECAS household classification variables. Statistical analysis presented in Chapter 2 show that race/ethnicity and housing tenure are important variables in the explanation of demographic changes near TOD areas of Los Angeles County. Unfortunately, the current SCAG PECAS model does not include those variables to represent households explicitly.

Involuntary Displacement due to Rent Impacts

This category of displacement is economically similar to the category above, “Voluntary Indirect Displacement,” with the difference being that the residents of the household are not the owners of the residence. It is implied in the literature that this displacement is less desirable than voluntary displacement, because the displaced households do not themselves receive the benefit of property uplift.

In the current SCAG PECAS model, no tenure distinction is included. The location choice and space consumption behavior is mainly modeled by rent or rent-related accessibility, assuming the household mobility is already incorporated implicitly in the model by the income category as a proxy, owing to the high correlation between the proportions of renters and income category (from ACS PUMS 2007-2011 in SCAG region, it is 0.995). Such an assumption might be reasonable for the purpose of the current SCAG PECAS model, in which specificities are aggregated into totals or averages. But, if the model should be revised in a way to maintain the individual specificities, it would be desirable to expand the household classification given by Table 3B.2.

Involuntary Displacement due to Physical Evictions / Harassment / Persuasion

This category of displacement refers to non-market-based representations of displacement, with some person or entity forcing people out of the home. The general assumption is that landlords would be the ones trying to force out existing tenants, so that they can increase rents on new tenants or redevelop the property to a higher-profit use. From an economic theory perspective, this implies one of following:

- an “economic agent” who, by definition, acts on profit motivation, would simply increase the rent on existing tenants, and let them decide whether to leave or stay,
- an attempt by monopolistic landlords (or a landlord cartel) to change the character of the neighborhood due to perceived benefits (and eventual higher rents) associated with a dominant socioeconomic characteristic, or
- an undesirable tenant, whether due to landlord discrimination or tenant behavior.

The empirical research should explore, or potentially identify, situations where individuals felt compelled to leave. In the case when the compeller was a landlord, the research could explore why the landlord didn’t simply raise rents. As this category of displacement is identified as a common one, different possible constrained choice frameworks should be investigated for future inclusion in an enhanced PECAS model. It can only be represented in the current SCAG PECAS model in a calculation (for calibration) of adjusted zonal specific constants, as discussed in the context of neighborhood rent in the section on Zonal Rent Impacts. This could be adequate to represent the non-economic attractiveness, but may not be adequate to represent the non-free-market motivations of this category of displacement.

Exclusionary Displacement

“Exclusionary Displacement” refers to situations where households no longer have opportunities to move into the neighborhood. This could be due to overly high rents as already discussed in previous sections, or characteristics of the neighborhood that make it less desirable to future residents. If this is not related to high rent, then the observed rent does not explain the composition of household characteristics in a certain community. Thus, the mechanisms for neighborhood desirability and exclusivity should be explored and quantified in terms of willingness-to-pay to

convert the effect of non-economic terms to economic. Any measures of willingness-to-pay in equivalent annual rent can be included in the PECAS zone specific attractiveness measures. For example, if an exclusionary characteristic of a zone causes low-income households to avoid the zone to the same degree as a \$500 higher annual rent, this can be represented in PECAS directly for zones that acquire the characteristic, through a modification of the zonal attractiveness variable for low-income households by -\$500.

Representing Displacement Mitigation Measures in PECAS

There are policies that can be undertaken to mitigate displacement by allowing existing residents (or new residents matching the income, ethnicity, or other characteristics of existing residents) to live in areas that are affected by improved transit service. Some examples are listed in this section, but other possibilities should be further identified to determine how they can be best represented in the PECAS model.

Low-Income Housing Tax Credit (LIHTC)

SCAG may consider a future enhancement to PECAS that adjusts the housing types in the model (Table 3B.1) to separate LIHTC properties from other properties. In general, space types in PECAS represent physically different types of space, but the LIHTC works through the investment and capital formation phases of development. Since abandoning LIHTC status in favor of renting to higher-income households affects developer profitability as represented through the corporation or investor syndicate, this program is also best represented in PECAS's SD module.

Any program under consideration that impacts developers' costs in a conditional-use way, so that the housing is classified and its use or tenancy is restricted in the future based on the payments or fees at the time of development, are best represented as enhancements to the housing categorization in the SD module. However, this must be balanced against the availability of data to accurately represent such housing.

Changes to Rent Stabilization Ordinance, Ellis Act, and the like

Rent controls in a city affect the ability of landlords to increase rents. This limits the response of the market to changes in desirability induced by the improved transit services. The Ellis Act allows building owners to evict tenants if they wish to demolish their building or change its use. Any proposed changes to these or similar ordinances could be analyzed with the existing PECAS model as they are targeted towards housing types in Table 3B.1 or household types in Table 3B.2.

Future enhancements to PECAS's household categorizations (Table 3B.2) should be necessary as housing is built that restricts particular households from occupancy. For instance, if a program of providing housing without any on-site parking in the vicinity of major transit stops is being considered, further household category segmentation based on auto ownership should be included. Programs based on racial or ethnic characteristics are unlikely to be proposed due to anti-discrimination laws, so housing supply policies are unlikely to suggest further segmentation of household categories based on race and ethnicity variables. Despite this, however, the effectiveness of the policy may not be diminished due to the certain existing conditions. To better analyze impact of policy, future versions of the SCAG PECAS model need to be flexible enough to incorporate various household types.

Enhancements to housing type categories (Table 3B.1) could reflect any revealed market segmentation variables that cause differences in rents and opportunity costs. For example, dwellings that can freely and easily be converted from owner-occupied to tenant-occupied dwellings could continue to share a category (since owner-occupiers are clearly foregoing a rent stream through their occupation) while dwellings that are required, through agreement or legislation, to remain tenant-occupied, could be included in a separate categorization.

3B.4. Representation of Empirical Research Findings in PECAS

This section describes the use of the model to represent displacement in the SCAG region, in the context of the empirical research findings. The method presented in this section demonstrates the possibility of further calibration of the SCAG PECAS model to better represent the impact of TODs on displacement when new findings are available without requiring a major re-framing of the model.

Findings Reported

The PECAS modeling team was tasked with incorporating the empirical results from Chapter 2 into the existing regional forecasting and policy analysis models. It was also tasked with considering adjustments and enhancements for future model versions.

For the Southern California region, the primary empirical research made available to the PECAS modeling team took the form of a regression equation relating the changes in 2,224 census tract-level attributes in Los Angeles County between the years 2000 and 2013, to census tract attributes from the year 2000. These results are shown in Table 2F.2. We present them again in Table 3B.4 below, since the remainder of this section relies heavily on the regression coefficients presented. Table 3B.5 defines terms shown in Table 3B.4.

Table 3B.4: Effects of neighborhood characteristics on neighborhood change

	Δ LTHS	Δ BA+	Δ NHW	Δ Renter Burden	Δ Low-Income HH (<10K)	Δ High Income HH (<125K)	Δ Median HH Income	Δ Gross Rent
Constant	-5.544 ***	3.230 *	-19.66 ***	-4.181	2.129	2.938	6006.842 *	266.135 ***
Median Household Income (/10,000)	1.212 ***	0.137	0.11	1.333 ***	0.366 **	-0.841 ***	-410.652	28.163 ***
Median Household Income Squared	-0.049 ***	-0.003	0.03 ***	-0.049 ***	-0.022 ***	0.016 **	-75.488 ***	-2.745 ***
% Asian	-0.034 ***	0.021 **	0.08 ***	0.024	-0.039 ***	0.001	-40.271 **	-1.875 ***
% NHBLK	-0.006	-0.036 ***	0.12 ***	0.055 ***	-0.024 ***	-0.038 ***	-88.725 ***	-1.246 ***
% Hispanic	-0.108 ***	-0.055 ***	0.09 ***	0.120 ***	-0.011 *	-0.044 ***	-95.379 ***	-1.240 ***
Downtown TOD	-4.975 ***	9.028 ***	11.31 ***	-3.361	-4.596 ***	1.591	7703.347 **	166.895 ***
Other TOD	-0.440	0.897 **	1.42 ***	-1.186	-0.696 **	0.611 *	2679.065 ***	17.775
% Renters	-0.023 **	0.045 ***	0.13 ***	0.057 ***	-0.008	0.017 **	0.671	0.184
Δ Gross Rent	-0.003 ***	0.005 ***	0.00 **	0.006 ***	-0.003 ***	0.004 ***	9.520 ***	-
Adjusted R-Squared	0.359	0.133	0.258	0.071	0.055	0.144	0.279	0.156
n	2,224	2,224	2,224	2,224	2,224	2,224	2,224	2,224

***<.01 **<.05 *<.10

Parameters with a p-value of >= .10 are not denoted with asterisks

With the exception of change in gross rent and median household income, all other changes represent percentage point changes

Values for gross rent and median household income are in 2013 dollars

Data Source: 2000 Census, 2009-2013 5-year ACS

Tabulations by P. Ong & C. Pech

Table 3B.5: Legend of measured effects from Table 3B.4

Effect	Meaning
Δ LTHS	Change of proportion in individuals with less than high school education
Δ BA+	Change in percent non-Hispanic black
Δ NHW	Change in percent non-Hispanic white
Δ Renter Burden	See Chapter 2 Sections E and F for the definition
Δ Low-Income HH (<10K)	Change in percent low-income households, adjusted to inflation to less \$10,000/year 2013 dollars income
Δ High-Income HH (>125K)	Change in percent high-income households, adjusted to inflation to more than \$125,000/year 2013 dollars income *
Δ Median HH Income	Change in median household income, inflation-adjusted to 2013 dollars
Δ Gross Rent	Change in average gross rent paid per month, inflation-adjusted to 2013 dollars

The regressions controlled for accessibility via a variable that measured location within a transit station area. However, they did not analyze changes in accessibility provided by the transportation network operations over time, and so have a limited ability to explain how transportation infrastructure and services impact the socioeconomic arrangement of households in the region. Also, PECAS would benefit from information on real estate development for recalibration of the SD. Overall, however, the very strong statistical significance of some of the coefficients shows correlations that could be represented in regional land use models, in particular, as the causal nature of the correlations can be explained through further investigation.

Implications of Findings on PECAS Model Scenarios

For modeling TOD and possible subsequent displacement in the SCAG PECAS model, it was anticipated that the fine representation of the detailed development pattern would focus on the PECAS SD module, representing developers' attempt to provide appropriate housing types and densities in desirable locations, within the constraints of zoning, to maximize profits (J.E. Abraham et al. 2015b). However, the empirical analysis presented in Table 3B.4 is more focused on neighborhood-level changes over 13 years. As a result, the PECAS AA module is more appropriate to be updated.

Households are represented in the PECAS model using an aggregate categorical system, as shown in Table 3B.2. Categorizing households in this way—by income and size—makes it possible to link them to economic information via economic input-output tables, which is why this categorization method was chosen for both the SCAG PECAS model and the statewide version of PECAS. The division into income categories is based on the earnings and expenditure patterns of households, as well as their participation in different labor markets according to the predominant wages paid in different occupational categories. The partition into size categories is done specifically to represent the consumption of different housing types/rates in the real estate model, the differing trip rates per household in the travel model, and to further support the spending and consumption patterns on a per-capita (rather than per-household) basis.

Mechanism for Representing Displacement in PECAS

We stated above that the quantitative metrics about how neighborhood attractiveness changes for households is a function of household attributes and neighborhood attributes and could be included as a zone-by-zone modifier to the zonal attractiveness measures in the PECAS AA module.

Instead of the empirical results that are presented as zonal attractiveness measures, it showed the changes in the rent and income distribution around TOD zones (separated into Downtown and Other TOD zones), controlling for other influences, and thus implying that the TOD nature of the zone caused such changes. Changes in zone-by-zone modifiers for each household category were planned to best reproduce the reported shift in neighborhood characteristics.

Scenario Development and Calibration

Parameter Change Methodology

The overall approach was to develop a small set of parameters for the SCAG PECAS model that represent the effect of TOD on housing location choice in a simple but realistic way. This was done using linear relationships that modify the utility constants on each zone for each household type (distinguished by income level and household size). These parameters were then calibrated so that they reproduced the currently representable findings from the empirical research.

The pool of parameters to calibrate was based on the following conceptual relationships:

- TOD makes neighborhoods more attractive in general because of the improved accessibility.
- TOD has a greater attractive effect on higher-income households when expressed as a monetary value because money is less valuable to them. They are willing to pay more for amenity value because they can afford it, e.g., they have a higher value of time in transportation.
- In addition, households with fewer members could be more or less attracted to TOD than those with more members, due, for example, to differing preferences for housing types and different labor force participation rates.

To represent these relationships, three types of parameters were examined:

- a constant utility adjustment applied to all household types equally,
- an income-sensitive utility adjustment applied to each household type in proportion to its income, and
- a “small household” utility adjustment that applied only to household types with one or two members.

Each of these parameter types had one variant for downtown TOD and another for non-downtown TOD, for a total of six parameters.

Thirteen model scenarios were formulated with different combinations of these parameters to test their ability to help match the correlations in the metrics from Table 3B.4. Based on the results of these test runs, the “small household” utility adjustments were dropped because they had a minimal impact on the metrics, while the income adjustments were coalesced into one parameter for both downtown and non-downtown TOD areas. This left three parameters to calibrate:

- a downtown TOD constant for all household types,

- a non-downtown TOD constant for all household types, and
- a household income TOD adjustment.

Once the values of the three parameters are chosen, the following formula produced the changes in the utility constants for each zone needed to represent the effect in the SCAG PECAS input files:

$$K_{zh} = p_{DTz}k_{DT} + p_{NDz}k_{ND} + (p_{DTz} + p_{NDz})i_h s$$

where K_{zh} is the value added to the zonal utility constant for household type h in zone z ;
 p_{DTz} is the percentage of zone z that is in a downtown TOD area, while p_{NDz} is the percentage that is in a non-downtown TOD area, to translate census tract TOD binary categorical variables into portions of PECAS LUZ Zones;
 i_h is the midpoint of the income range represented by household category h ;
 k_{DT} , k_{ND} , and s are the downtown constant, non-downtown constant, and income adjustment.

The calibration runs were then made and the differences in various metrics from the base condition were calculated. Table 3B.6 shows the metrics used in the calibration process.

Table 3B.6: Metrics used to calibrate TOD scenario

Metric	Description
DT % low-income	Change in the percentage of the households that are low-income in the downtown TODs
DT % high-income	Change in the percentage of the households that are high-income in the downtown TODs
DT median income	Change in the median income of households in the downtown TODs
DT average rent	Change in annual rent in the downtown TODs
ND % low-income	Change in the percentage of the households that are low-income in the other TODs
ND % high-income	Change in the percentage of the households that are high-income in the other TODs
ND median income	Change in the median income of households in the other TODs
ND average rent	Change in annual rent in the other TODs

The differences in these metrics were compared to the changes found by the empirical research. By changing one parameter at a time, the approximate effect of each parameter on the metrics could be calculated. A least-squares optimization was then solved for the best set of parameter values to use. Each metric was weighted according to its statistical significance in Table 3B.4. The metrics with a correlation significant at $p < 0.01$ were given the highest weight, while those at $p > 0.1$ were given the lowest weight. In addition, the “average rent” metrics were given lesser weights than their significance would imply, since a price investigation revealed unreasonably high residential space prices for some uncommon space types in many zones of the SCAG PECAS model. Insisting on an accurate match on the rent metrics would distract from matching the more reliable income-based metrics.

Description of Calibration Scenarios

Six of the 13 calibration scenarios are described here. They are the ones that were relevant to finding the final set of parameter values. The scenarios are:

- **The constrained base scenario.** This scenario was done in the way that is normal for the base year in a SCAG PECAS time series run: the number of households in each zone was constrained to be equal to the observed amounts to establish the zonal constants. It represents the control case that does not account for TOD and its effects on the neighborhood income mix.
- **“SDBU”, the unconstrained base scenario.** This model run was designed to reproduce identical results to the constrained base scenario, but without the option to constrain the allocation to the controls. Instead, the zonal constants found in the constrained base scenario were given to the SCAG PECAS model as a direct input, to open up the possibility of changing these constants in future scenarios. Since no adjustments were made to the zonal constants in this run, it represented the case where all three parameters were zero ($k_{DT} = 0, k_{ND} = 0, s = 0$).
- **Test scenario 1: downtown TOD constant.** This run was the same as the unconstrained base scenario, but with a constant of \$10,000 added to each zone containing the downtown TOD, in proportion to the fraction of the zone that is located in the downtown TOD. This constant would make all households willing to spend an extra \$10,000 per year on living expenses in order to gain the accessibility benefits of locating in a downtown TOD neighborhood. The choice of this number was somewhat arbitrary, since it served only for exploration purposes and was not intended to be realistic. The other two parameters were zero ($k_{DT} = 10,000, k_{ND} = 0, s = 0$).
- **Test scenario 2: non-downtown TOD constant.** This scenario had a constant of \$10,000 added to zones containing non-downtown TOD zones, in proportion to the fraction of the zone located in the non-downtown TOD. The other two parameters were zero ($k_{DT} = 0, k_{ND} = 10,000, s = 0$).
- **Test scenario 3: income adjustment.** This scenario had an income adjustment of 0.2, representing each household being willing to pay an extra 20% of its income to locate in a TOD neighborhood. The other two parameters were zero ($k_{DT} = 0, k_{ND} = 0, s = 0.2$).
- **“SD10”: Scenario with optimal parameters.** This scenario used the parameter values found from the least-squares optimization; as discussed below, these values were $k_{DT} = -3,110, k_{ND} = 2,530$, and $s = 0.0176$.

Parameter Exploration

For each of the above scenarios, the eight metrics were calculated, with the differences between the metrics for each test scenario and those for the unconstrained base scenario. Table 3B.6 defines the metrics for the unconstrained base scenario and the test scenario. Table 3B.7 shows the changes caused by the parameter values in the test scenarios, i.e., the difference between the metric in the test scenario and that in the base scenario. With the addition of \$10,000 to downtown TOD zones, Test Scenario 1 shows an increase of high-income households to 6.56% from 4.93% in the same zones. Interestingly, this additional utility in the downtown TOD area also affects the proportion of high-income households and median income, as well as the average rent in the non-downtown TOD zones. On the other hand, the SCAG PECAS model responded very little to the additional utility in the non-downtown TOD zones of Test Scenario 2.

These differences are compared to the empirical values, which are derived from Table 3B.4. Since all of the scenarios were run for one year, while the targets were calculated from changes between 2000 and 2013, the targets were divided by 13 for the comparisons. It would be desirable to extend this approach to a run over time, so that the parameters could be increased in each successive year to simulate the long-term effects captured by the empirical findings.

Table 3B.7: Results of the parameter test scenarios

Metric	Unconstrained base	Test Scenario 1: Downtown constant	Test Scenario 2: Non-downtown constant	Test Scenario 3: Income adjustment
DT % low-income	32.69%	30.22%	32.86%	32.71%
DT % high-income	4.93%	6.56%	4.69%	4.89%
DT median income	\$15,003	\$18,049	\$14,780	\$15,007
DT average rent	\$4,149	\$4,408	\$4,232	\$4,170
ND % low-income	14.29%	13.45%	14.29%	14.39%
ND % high-income	14.16%	15.85%	14.15%	13.79%
ND median income	\$41,704	\$44,844	\$42,217	\$41,986
ND average rent	\$5,237	\$5,502	\$5,239	\$5,329

The size of the effects from Table 3B.8 provides an estimate of the derivative (or marginal differences) of each metric with respect to each parameter. From these results, a set of optimal parameters were derived using a least-squares optimization. In this optimization process, the targets were given tolerances (desired closeness of match) based on the statistical significance of the correlation found between that outcome and the presence of TOD.

Table 3B.8: Effect of parameter changes compared to the empirical targets

Metric	Unconstrained base	Test Scenario 1: Downtown constant	Test Scenario 2: Non-downtown constant	Test Scenario 3: Income adjustment
DT % low-income	-2.48%	+0.17%	+0.01%	-0.35%
DT % high-income	+1.63%	-0.24%	-0.03%	+0.12%
DT median income	+\$3,046	-\$223	+\$3	+\$593
DT average rent	+\$259	+\$84	+\$21	+\$13
ND % low-income	-0.84%	-0.01%	+0.09%	-0.05%
ND % high-income	+1.69%	-0.00%	-0.36%	+0.05%
ND median income	+\$3,139	+\$513	+\$282	+\$206
ND average rent	+\$265	+\$2	+\$93	+\$1

The approach for the weights was to assume that the parameter effect was a Gaussian random variable with a mean equal to the target and a standard deviation equal to the tolerance. A tolerance was chosen so that the chance of this random variable reaching zero (and therefore the correlation does not actually exist) was equal to the stated p value. For example, at the $p < 0.01$ statistical significance level of the empirical study, the tolerance was set to about 43% of the

absolute value of the target, since at that standard deviation, the probability of the target reaching zero was about 1%. The targets that showed no statistical significance were assumed to have a p value of 0.3.

In addition, the tolerances on the rent targets were multiplied by 15, since the rents produced by the current SCAG PECAS model were not believed to be reliable. The resulting tolerances are shown in Table 3B.9.

Table 3B.9: Change resulting from the optimal parameters

Metric	Empirical target	Tolerance	Actual change
DT % low-income	-0.35%	0.15%	-0.27%
DT % high-income	+0.12%	0.23%	+0.21%
DT median income	+\$593	\$360	+\$338
DT average rent	+\$13	\$83	+\$2
ND % low-income	-0.05%	0.03%	-0.05%
ND % high-income	+0.05%	0.04%	+0.06%
ND median income	+\$206	\$125	+\$188
ND average rent	+\$1	\$39	+\$46

The actual changes in the metrics produced by these parameters are also shown in Table 3B.9. As expected, the changes of rent were not close to the targets, although they had the correct sign. However, the other metrics showed a good match to the targets. Therefore, the method outlined in this section is a viable way to reproduce the empirical effects of TOD on neighborhood change.

The optimal parameters derived from this approach were: $k_{DT} = -3,110$, $k_{ND} = 2,530$, and $s = 0.0176$. Households, in general, were willing to spend \$2,530 per year to locate in a non-downtown TOD, \$3,110 to *avoid* a downtown TOD, and 1.7% of their income to locate in any TOD.

The parameters in the PECAS AA model inputs are constants by zone type (TOD, Downtown TOD), which are then modified in an alternative scenario based on the optimal “meta parameters” discussed above. The changes in the PECAS model inputs are shown in Table 3B.10.

Table 3B.10: Changes in Zone Constants

Household Category	DT TOD Mod	Other TOD Mod
INC0010 2 or less	-3,019.27	2,616.29
INC0010 3 or more	-3,019.27	2,616.29
INC1025 2 or less	-2,799.27	2,836.29
INC1025 3 or more	-2,799.27	2,836.29
INC2550 2 or less	-2,447.28	3,188.28
INC2550 3 or more	-2,447.28	3,188.28
INC5075 2 or less	-2,007.29	3,628.27
INC5075 3 or more	-2,007.29	3,628.27
INC75100 2 or less	-1,567.30	4,068.26
INC75100 3 or more	-1,567.30	4,068.26
INC100150 2 or less	-907.32	4,728.24
INC100150 3 or more	-907.32	4,728.24
INC150m 2 or less	-27.34	5,608.22
INC150m 3 or more	-27.34	5,608.22

In this section, a set of parameters was estimated for the SCAG PECAS model to best reproduce the empirical findings on changes of households by income category, median household income and gross rent in downtown TOD and non-downtown TOD areas. For the zones identified as TOD zones, the zonal accessibility factors in the AA module were updated during its run with the parameters in Table 3B.10 for each household category. For downtown TOD zones, the annual changes of low and high-income households are -0.3% and +0.2%, respectively. For non-downtown TOD area, the annual changes of low and high-income households are -0.05% and +0.06% respectively, as Table 3B.9 shows.

This study did not attempt to incorporate the existing conditions, such as proportion of Asian or black, or proportion of renters. It could be possible to calculate the willingness-to-pay rent depending on the zonal conditions with racial/ethnic proportion in year 2000, just as demonstrated in this section. However, it would be more desirable to be able to update such conditions with endogenous variables and express displacement through the relationship between variables, rather than keep referring to a fixed set of input data. To make this possible, fine-scaled household/population segmentation is required.

In spite of the limitation of being incapable of dealing with existing conditions, the updated SCAG PECAS model with the optimized parameters still gives an opportunity to examine system-wide changes. Although the SCAG PECAS model is not able to pinpoint the origin of the 0.2% high-income households who relocate in the downtown TOD area, it shows changes of households by income/size categories and cascading effects from all of the zones in the region. The following section briefly summarizes the zonal differences created by inclusion of the TOD-related parameters. Appendix Q summarizes the region-wide impact of TOD by household types, industries, and housing types.

Displacement Impact

This section analyzes the region-wide zonal changes of household location and rent estimated by the updated SCAG PECAS model with and without the TOD-related parameters. The model run with this optimized set of parameters is labeled “SD10.” The equilibrium state estimated by the SD10 scenario is compared to the unconstrained base scenario, called “SDBU.” The difference of the two states is caused by the parameters estimated from the empirical findings of Table 3B.4, which shows the displacement as the changes of household proportion by income group.

Location Changes

The calibration of model behavioral constants described in the previous section was able to reproduce the change in income that occurred in the TOD zones. Average incomes in TODs went up compared to the model run SDBU, without TOD consideration, and the percentage of people in TODs who are low-income went down, as Table 3B.9 shows in the “Actual Change” column. However, Table 3B.4 also shows that the absolute number of low-income households in TODs generally went up, even though the percentage went down, with the exception of the low- to middle-income groups (0 to \$75K). They are being reduced in the downtown TOD zone, as Figure 3B.4 shows. It is also shown that the reduction in the downtown TOD zone is severe (colored by dark red) for households with less than \$10K income and of small size, and \$10K-\$25K income and of large size.

Note that SDBU, the “without” TOD version of the SCAG PECAS model, is also calibrated to the zonal household statistics by income and size categories. In the calibrated “with” TOD version (SD10 in the previous section), the estimated household location deviates from the target statistics. Two separate attempts were made to get the SCAG PECAS model to calibrate, one with targeting of a snapshot of household location in the region, and another one to match the marginal changes in the TOD zones. And the latter one contradicts the former effort. In the ideal situation, the introduction of the TOD-related parameters should maintain the previously calibrated household location, and still should be able to show the marginal changes over simulation time. Along with an “agile and incremental” approach, a comprehensive strategy should be devised to calibrate the model to reproduce not only a static snapshot, but also marginal changes.

Spatial Changes in Rent

The spatial changes in rent for the “L Luxury” category (ResType3) and “L Economy” (ResType4) are shown in Figures 3B.5 and 3B.6. There are increases in rent in most of the TOD zones, but decreases in rent in the non-TOD zones.

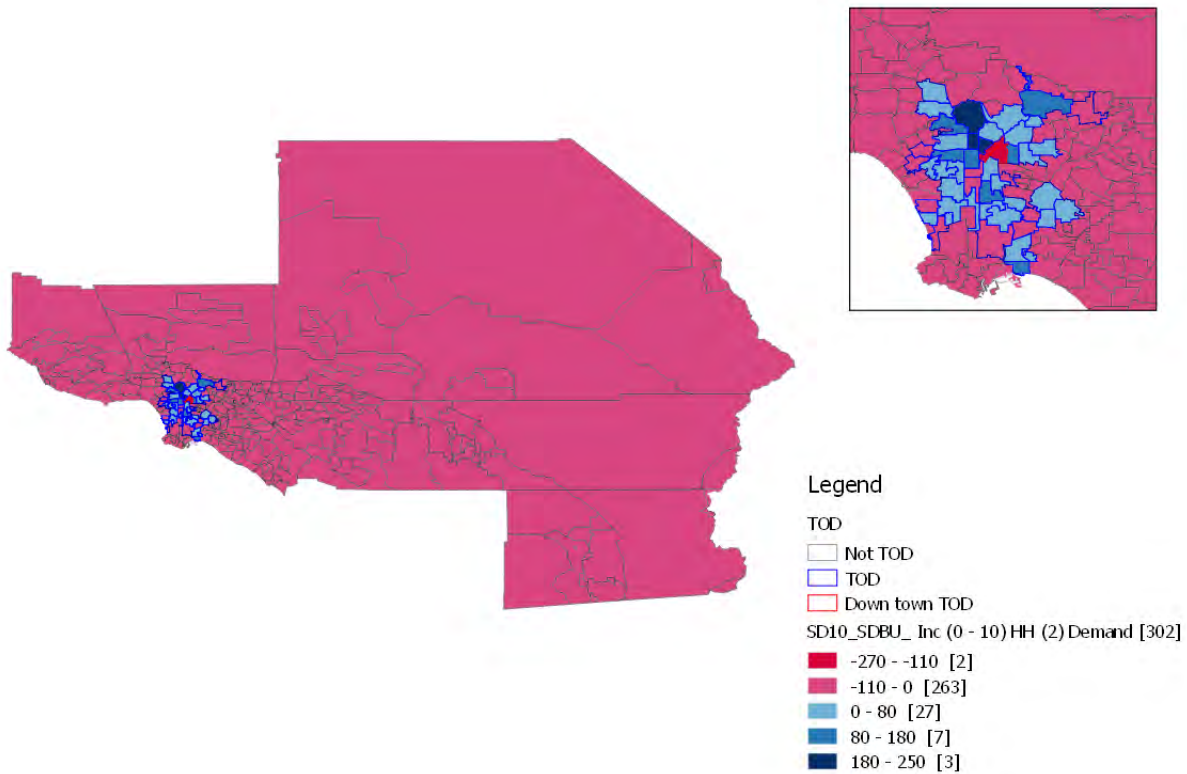

Figure 3B.3: Change in number of households <10k, 2 or less person

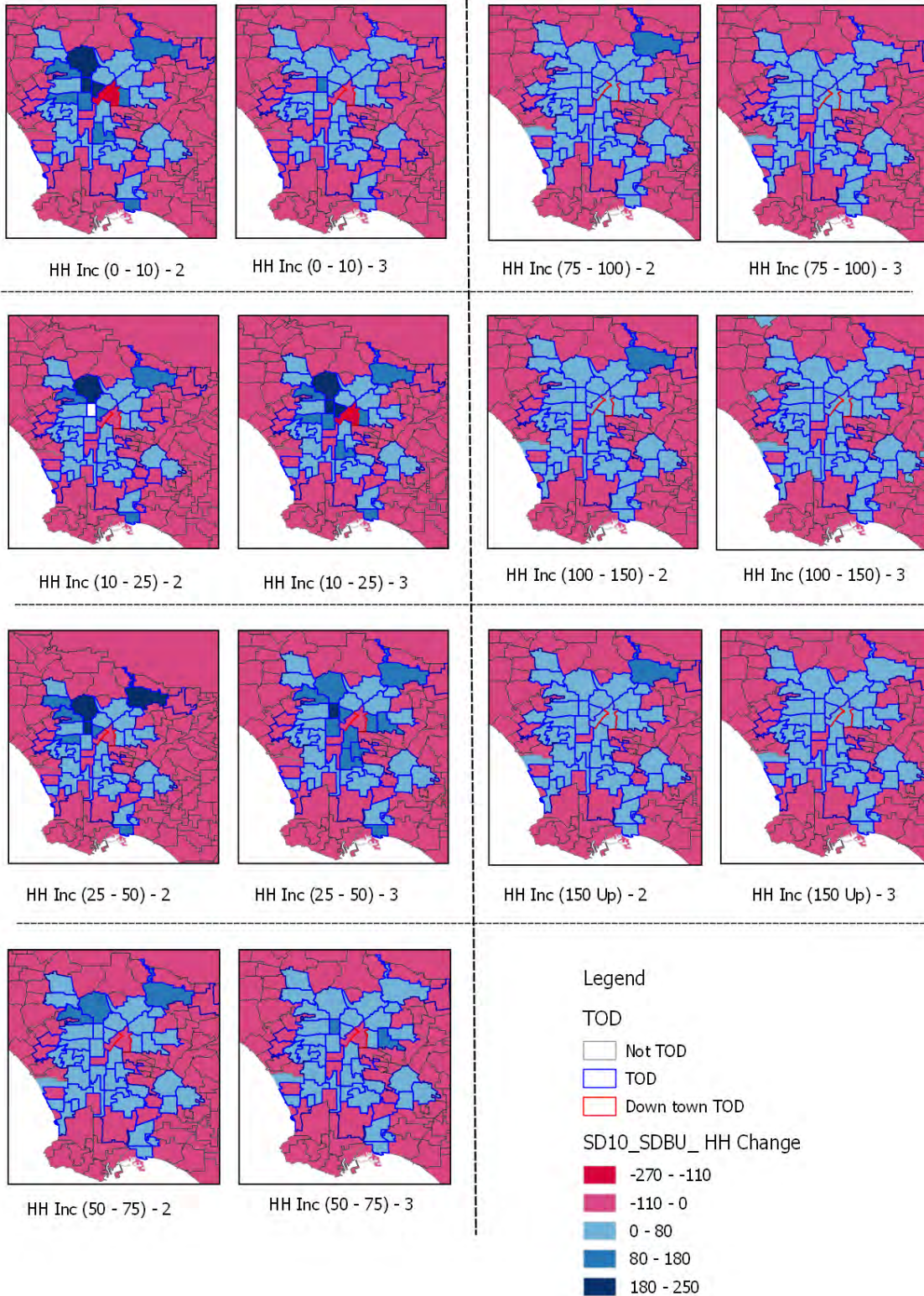

Figure 3B.4: Change in Households by Category and Zone

The shift in the demand for location towards TOD zones allows for an overall decrease in housing prices in the region with a corresponding benefit to residents and loss to landowners. However, the increase in some TOD zones is much larger than the decreases elsewhere, and hence much more likely to be measurable and noticed. When TODs are envisioned and developed, the region-wide impacts on rent must also be considered, since they mitigate the TOD-specific changes in rent, and may be larger in aggregate to the region but smaller in each location.

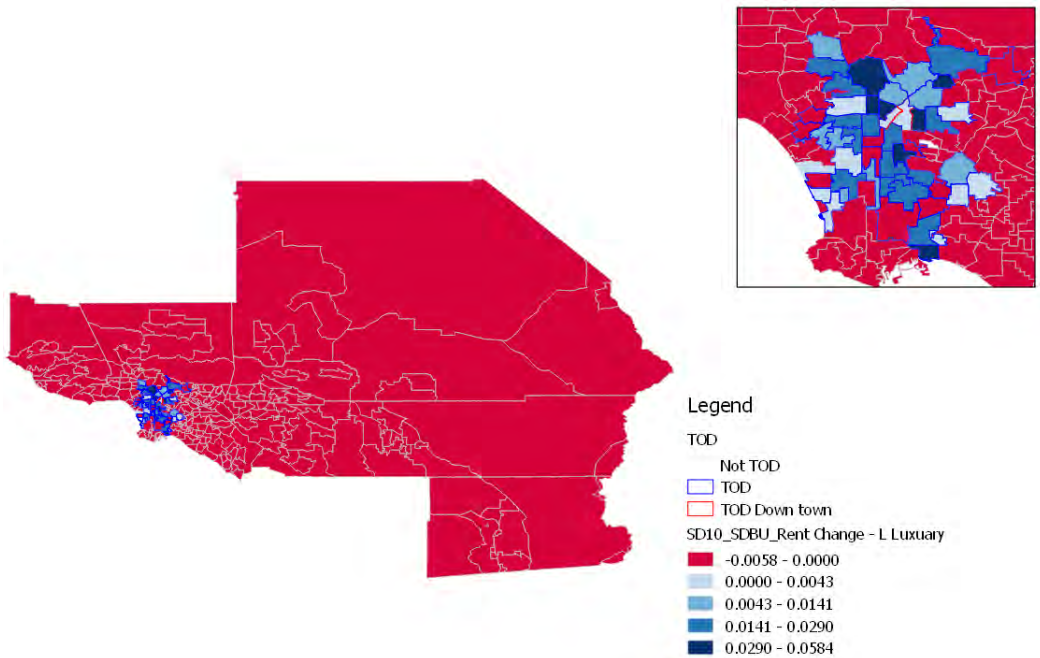

Figure 3B.5: Relative change in rent in Luxury Single Family Dwelling space (ResType 3)

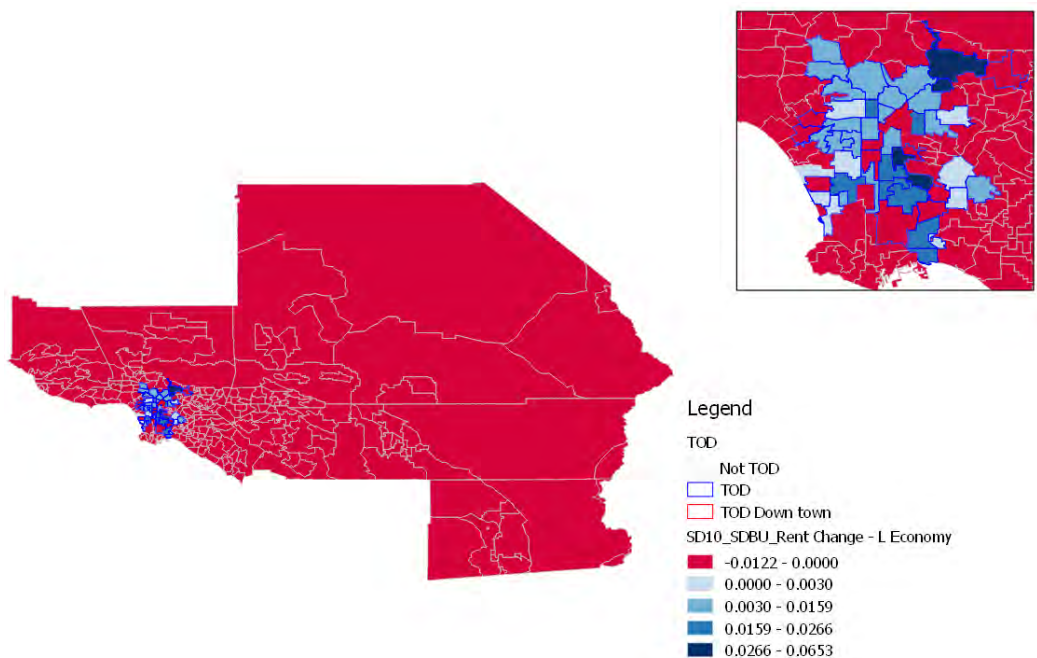

Figure 3B.6: Relative change in rent in Economy Single Family Dwelling space (ResType 4)

3B.5. Findings and Conclusions

SCAG PECAS Update and Findings from TOD Scenario

This work explored possibilities for representing TOD and displacement in the SCAG PECAS model, and it proved challenging. The current model design could best represent the real estate development nature relating to TOD as developers demolish, convert, and build housing (or non-residential space) near major transit stations. PECAS, then, represents displacement as the difference of states estimated from with and without TOD-related parameters. Further empirical research on real estate development, especially with a behavioral framework analysis of developer profit motive, could lead to a very rich representation of displacement in the SCAG region in terms of physical changes anticipated in planned TOD areas.

The SCAG PECAS model was modified to best represent the empirical findings regarding displacement around TOD zones that occurred between 2000 and 2013. The attractiveness of the TOD zones was changed for households, with a search process determining the optimum set of parameter shift strategies to represent observed changes (divided by 13 to annualize) in TOD zones in the percentage of low-income households, percentage of high-income households, median household income, and gross (and then) average rent. This scenario was compared to the base scenario to determine the impacts on the spatial economy.

A shift in the desirability of TOD zones brings about changes in the distribution of households in the region. As Figures 3B.5 and 3B.6 show, rent outside of TOD zone decreases as the demand for housing in TOD zones is generally increased. The increase of rent in TOD zones and the decrease in non-TOD zones result in positive net change in rent; in other words, regional net rent increases. In the updated model, the TOD-related parameters work as an increasing factor of rent in the TOD. Within the closed economic system (aka, the input-output analysis framework) that characterizes the SCAG PECAS model, the rent increase in TOD zones is interpreted as a positive direct impact without any leakage to outside the region. Also, its multiplied impact (again, as of Input-Output framework) cascades to every household in the region. Analysis of aggregated economic impact has been traditionally used as one of the most important measures in evaluation of various facility or land use plans. The current SCAG PECAS model shows that TOD in Los Angeles County is economically desirable to every household in the region.

However, this may be an overly simplified assertion in the modeling of displacement. Even at the zonal aggregated level, households of certain types are moving out from the downtown TOD zone, and the resulting rent of certain type of residence decreases as modeled with fixed real estate inventory. Although the total of their surplus or composite utility might be increased, this is not the case for a small group of households, and the degree of negative impact to them might be very acute. Parting from its initial design specification, the SCAG PECAS model might need a radical update so that it can scrutinize the difference in susceptibility to policy at the micro level.

Caveats and Cautions in Interpreting the TOD Scenario

The scenarios developed here do not include a representation of shifts in developer behavior. The magnitude of observed change in the empirical study was reproduced in the cross sectional portion of the SCAG PECAS model through attractiveness measures to draw households into TOD zones. Without the enabling effect of shifts in development, the attractiveness measures would be too

high. Thus, the total benefit measures calculated may be too high, and the absolute magnitude of those benefits may be overstated.

The proper consideration of transport costs requires a time-series scenario run with full integration with one of the SCAG travel models. This study approximated the improved desirability of TOD zones through a constant neighborhood effect, but the direct travel improvements from transit services would be better represented in changes in the “skims” calculated from the travel demand model. The suggestion in the scenarios that TOD development could lead to higher travel costs for obtaining household services is based on location (home and destination) changes only; a travel model is the appropriate tool for further investigating this concern.

Consideration for Next Steps

The monitoring and future empirical analysis of TOD in the SCAG region should be expanded to incorporate the motivating factors of developers: notably the costs and profitability of different types of buildings on land with different conditions such as land classified by spatial regulations, fees, and physical geography effects influencing construction costs. Housing desirability, and hence developer profitability, of different building options vary with the exact location. The analysis should include a numerically specific representation of the impact on rent (or willingness pay for housing) of proximity to transit station entrances, transit infrastructure noise effects, and other statistically important effects such as proximity to freeways, parks, beaches, and major arterial roadways. The specific approaches described in (Wang et al. 2011), where California statewide data was used, should be expanded into a time-series analysis with a focus (or oversampling) on changes in the vicinity of transit stations.

The model scenarios developed here show that the undesirable displacement of low-income people from around TOD stations could be the result of changes that are beneficial at the aggregate level to other households. Wealthy people have more freedom and economic power, and so they can take advantage of changes in situations more easily. Their shifts in behavior, however, may open up other opportunities, which low-income people who are sensitive to price changes may be able to take advantage of. Displacement of people of certain ethnic groups could not be analyzed with the current SCAG PECAS model.

The empirical research and the model categorize households by their income. It was found that TODs tend to be associated with higher incomes in the future. This modeling result could happen due to higher-income households moving into TODs, lower income households moving out, or upward mobility. Future empirical research in the SCAG region should attempt to address these possibilities, through panel analysis of TOD residents, or through retrospective surveys of current residents. Time-series census tract data is not generally adequate to identify these possibilities (although the ACS geographic mobility question has proven somewhat useful).

The household-level categorization in the SCAG PECAS model should be refined to add representation of race and ethnicity. The empirical findings showed correlations between race and ethnicity variables over time, and causal hypotheses could be explored using a PECAS model that includes race/ethnicity and housing tenure. Even though current empirical study suggests adding these variables, a more vital improvement would be focusing on making the SCAG PECAS model more flexible. Its tight theoretical structure and use of input-output (and social accounting) matrix makes it hard to expand PECAS to include non-economic variables. Enhancing the flexibility of

PECAS requires fundamental change in the model structure, which would require considerable time and resources.

A few options for expanding the household classification could be explored, including options to incorporate the variables suggested by the empirical study, and options for restructuring the model. Table 3B.11 summarizes the pros and cons to be considered.

The first option is to expand the dimension of household classification in the SCAG PECAS model to three or more from the current 2 dimensions of [7 income group]-by- [2 size group]. In addition to 4 to 7 groups for race/ethnic variables, 2 housing tenure groups (owner/renter) can be considered. Although this is one explicit way to incorporate the empirical findings' variables, the model's flexibility is not improved. In the case when a new finding points to another important variable, the same discussion should be repeated. In the incorporation of the variables mentioned above, the model should be recalibrated for at least 112 ($= 7 * 2 * 4 * 2$) household types; the scope of that task would be virtually identical to a fresh development of PECAS for the region. Another aspect to be considered is that a change in household classification from the current version also means that the SCAG version would diverge from the statewide one, and there would be no more direct cooperative relationship in its development.

A microsimulation version of the PECAS AA module is the one of the options, respecting the same PECAS utility function, to enable specific coefficient modifiers in the PECAS utility functions for different races and ethnicities, without drastically expanding the number of categories represented in the model. However, adopting microsimulation without caution and respect for the type of analysis undertaken here, and the economic foundations of PECAS, could weaken the ability to show comprehensive distributions of benefit measures by type of household, interaction, location, housing type, etc. Since this option radically changes the model structure as well as the software implementation, existing microsimulation tools should be considered with an open mind. Even though the model structure would be different from the existing one, a new microsimulation model could use data similar to what is already collected for PECAS. Therefore, instead of developing new software with an updated model formulation of PECAS, a fresh start with an existing tool might a way to increase the chance of success.

Recalibration of the hedonic price model and complete development of the disaggregated version of the SCAG PECAS SD module is another option. Since the current SD module includes the zone ID as a dummy variable to capture unexplained price factors, it is also possible to include other neighborhood variables, such as ethnicity. This is not performed in this project, because the empirical finding does not include sufficient evidence to support recalibrating the hedonic model. However, this might be the most feasible among the options examined as additional parcel-level real estate data, including price, becomes available.

Another option in modeling ethnic change is to apply a household joint distribution of income, size, and ethnic composition to the current SCAG PECAS output of household by income and size. This approach assumes that the current ethnic composition is determined by income and size composition at the TAZ level and the relationship is fixed. However, that method just matches the empirical findings without making much economic sense. The ethnic proportion is just calculated without clear causality with TOD and displacement.

As the method demonstrated in the previous section of the recalibration of SCAG PECAS based on the empirical finding, the last option is to recalibrate the zonal utility constant with ethnic variables and the proportion of owners. It could be possible to match more coefficients provided from the

empirical findings shown in Table 3B.4. However, this option still does not improve the flexibility of the ultimate model.

Table 3B.11: SCAG PECAS Enhancement Options

Option	Description	Pro	Con
Expand household classification for AA	<p>Currently household is in [7 income group] X [2 size]. Expand to [7 income group] X [2 size] X [4 to 7 ethnic group]</p> <p>Re-estimate model within general equilibrium framework.</p> <ul style="list-style-type: none"> - Consumption (commodity and housing by location) pattern for each household type - Labor supply (occupation) pattern for each type of household. 	Explicit modeling of the household by ethnic group	<p>Divert from the State-wide PECAS model</p> <p>Requires significant resources and time for data compilation and recalibration.</p> <p>Model is still inflexible to add other important/significant variables that are found.</p>
Microscopic version of AA	<p>Current model structure is in matrix-represented aggregated form, and calculates the market clearing prices in a closed mathematic way.</p> <p>Restructuring it into simulation based model with representation of individual households and business, model resulted from random drawings</p>	Individual representation of economic entities allows flexible model expansion	<p>Details are in discussion. Hard to make a decision to go with it without further estimation of development time and budget.</p> <p>Need more concrete evidence of “success” to choose this option</p>
Ethnic composition as neighborhood condition for SD (Hedonic price model)	<p>Current model uses ZONE ID as dummy variable to compensate for all of the unexplained price factors.</p> <p>Use the ethnic composition in the price model along with the ZONE ID dummy.</p> <p>It was has to be done in separate study for the empirical study in this project does not provide the necessary parameters</p>	Technically feasible to incorporate additional zonal level variables to price estimation.	<p>Space development is partially calibrated for the SCAG land use.</p> <p>It can be incorporated when the SD is fully calibrated with the proper value data.</p>
Ethnic composition comparison before-and-after the calibration with TOD binary variables	<p>Using joint distribution of household [income] X [size] X [ethnic composition], calculating the difference in the ethnic composition before and after the calibration (with TOD variables).</p> <p>Further adjust the model to match the estimated parameter (changes of NHW at TOD area)</p>	Technically feasible with relatively small budget and resources.	Ad-hoc application of TOD variables to estimate ethnic composition as DV, not IV.
Ethnic composition as neighborhood condition for AA	<p>Adjust AA model further to incorporate ethnic variable as neighborhood condition, as the method described in this chapter.</p> <p>Given estimated parameters, adjust the location choice constant to match the gross rent change by proportion of Asian, NHBLK and Hispanic</p>	Technically feasible with relatively small budget and resources	<p>Model is still inflexible to add other important/significant variables that are found.</p> <p>Model will depend on 2000 ethnic composition. Then why not the time period out of recession?</p>

Section 3C: Development of an Off-Model Displacement Assessment Methodology

In this section we identify neighborhood indicators that significantly predict types of neighborhood change associated with displacement in the models developed in Chapter 2 as related to transit investment. We construct neighborhood indicators from readily available, tract-level ACS data in order to facilitate assessment of displacement risk by city or regional agency staff in a simple spreadsheet analysis. For the Bay Area and Los Angeles cases, we will calibrate these indicators to the extent possible with the findings of the UrbanSim and PECAS models.

The following presents several different approaches to an off-model displacement assessment methodology, reflecting in part the differences between the model structure and results for the Bay Area and Los Angeles. The Los Angeles model builds on the logit regression of gentrification in Chapter 2, section 2E, adding variables to represent change in rent and density. The tool assesses risk by totaling the significant coefficients using data from each tract; to assess future risk, SCAG will need to provide additional inputs that project rent and density. For the Bay Area, we provide two models: one to assess gentrification risk based on risk factors from the built environment and the second to predict displacement specifically (since it is occurring in all types of neighborhoods, not just gentrifying neighborhoods). The tool identifies whether a tract is at risk for each factor, and totals the risk factors to determine the level of risk. All of the variables used can be predicted by UrbanSim in order to assess future risk. All of the models demonstrate a robust ability to predict gentrification and/or displacement, with results ranging from 50% to 86% accuracy.

Defining a Predictive Model

A predictive model should have the ability to predict future outcomes, and a quantitative predictive model uses a set of observed or anticipated indicators (variables) that influence the projected results. For this task, the objective is to identify neighborhoods (defined as tracts) that will be at risk of gentrification and displacement in the future so that the relevant governments (e.g. counties and cities) and their agencies (e.g. MPOs, housing, transportation, and environmental departments) can take appropriate action to offset negative effects. A predictive model can be based on causal or descriptive models of past patterns and dynamics. A causal model uses causal independent variables or factors, while a descriptive model may also include independent variables that are not necessarily causal but nonetheless correlated with the variable (outcome) of interest. For predictive purposes, we do not necessarily require knowing causal relationships since correlated indicators may be sufficient to forecast the outcome. (An example is the canary in the coal mine, where the bird does not cause poisonous gases but merely serves as an early warning.)

Specifications of the Off-Model Tool for Los Angeles

The key challenge of creating a predictive model is the availability of input data for the future time period of analysis. We explored whether SCAG's PECAS model can help fill in some of the required projected variables. We focused on three key variables from SCAG's previous efforts, which include: (1) household by income by size, (2) housing types, and (3) land prices. In terms of household by income by size, for Los Angeles, we find that SCAG's projected patterns are not consistent with recent trends. For example, SCAG projects growth of low-income households on the Westside of Los Angeles County, an area of moderate to higher income. We examined the changes in the spatial patterns of low-income households in the past decade using 2000 and 2013 data and find

inconsistencies with SCAG's trajectory of low-income households in the future. We believe that part of the discrepancy is the way SCAG models the spatial distribution of future changes in total housing units and households, and then translates into household by income by size. Unfortunately, we do not have enough information to understand their modeling approach.

The second variable that we examined is SCAG's housing type category. The challenge is that it does not correspond to available ACS information. Perhaps the biggest issue is the fact that the housing type variable does not differentiate between renters and homeowners. This is a severe limitation because displacement mainly affects renters, and renters comprise an overwhelming majority of households around transit stations. We recommend that SCAG should have projections by tenure. This includes building a bridge between housing type and tenure. A related issue is the lack of information on households by race and ethnicity, which is a key element in the debate regarding gentrification and displacement. Our analyses reported in Chapter 2 show that race and ethnicity have an independent effect and could not be captured by mere differences.

The third variable that we assessed is land prices. Land price is the value of the land per square foot. The idea behind looking at land value is that changes in land price, whether historical or projected, can help us understand changes in rent level, which is highly related to displacement and gentrification. SCAG has stated that it has done very preliminary work on land prices in the previous RTP. This work has only been done at the TAZ level, which makes it problematic if we are to focus on smaller-level geographies such as TOD neighborhoods. As part of our assessment of SCAG's land-price data, we did our own estimate of baseline land prices using the county assessor's parcel data. Here, we find discrepancy with the land price data that SCAG provided to us. Upon further investigation and inquiry with SCAG, SCAG responded that they did not estimate land prices but instead were estimating improvement prices (built structure price per square feet). In our opinion, improvement prices are not an adequate proxy for land prices, and thus have limited usefulness in projecting future rent changes.

We also examined what SCAG is planning to do with land prices in their current PECAS model. They stated that they will use different techniques (e.g. hedonic pricing) to estimate land prices and that they will use micro simulation of the market to project market-clearing land prices in the future. SCAG uses an equilibrium approach rather than a marginal change approach. An equilibrium approach maybe appropriate if the time period is very long, but for shorter time periods, a partial adjustment model is more appropriate. Because this effort is ongoing, SCAG has been reluctant to share any preliminary numbers with us, and we did not receive any of the information for our assessment. As such, we cannot assess its current work. We do believe, however, that if it is able to estimate land prices for the base year and adequately project land prices in the future, then there also needs to be a serious effort to determine how land prices are related to rent levels, and how changes to land prices are related to changes in rent levels.

A possible feasible alternative is an off-model module to identify potential areas at risk of gentrifying. The key missing values (e.g., projected changes in rent) can be filled in later when SCAG finalizes its PECAS land price model and estimates how changes in land prices affect rent levels.

Off-Model Module: Identifying Potential Areas at Risk of Gentrification

As previously mentioned, a predictive model should have the ability to predict future outcomes, and a quantitative predictive model uses a set of observed or anticipated indicators that influence the projected results. Below is a basic predictive model that forecast for outcome “O” into the future (time = t +1) from today (time = t).

$$\mathbf{O(t+1)} = \mathbf{a} + \mathbf{b*X(t-1)} + \mathbf{c*Y(t)} + \mathbf{d*Z(t,t+1)} + \mathbf{g*V(t+1)} + \mathbf{error}$$

In this model, a, b, c, d, and g are vectors of parameters (usually based on some cause or descriptive model or models). X is a vector of past factors that have persistent influences on the future (For example, major features of the built environment inherited from the past, which are not likely to change over time). Y is a vector of current factors, Z is a vector of factors that will materialize between today and tomorrow, and V is a vector of factors that will be present in the future. The error term denotes the degree of uncertainty in the prediction. Z can only contain factors that themselves can be predicted over the projection period. This can include policy decisions or major actions within the control of an agency, such as major investments in new infrastructure. Z can also contain variables that have been predicted through other means. For example, some regional economic models use national economic projections as drivers (e.g., the projected growth in GDP). Similarly, V can only contain factors that are predicted at the end of the projection period.

We calibrated the model by examining observed recent trajectory. This is based on analyses reported in Tasks 2D, 2E and 2F. Below is a stylized example model, where t is the current period and t-1 is the previous (baseline) period. The model parallels the above predictive model:

$$\mathbf{O(t)} = \mathbf{a} + \mathbf{b*X(t-2)} + \mathbf{c*Y(t-1)} + \mathbf{d*Z(t-1,t)} + \mathbf{g*V(t)} + \mathbf{error}$$

For example, we estimated whether a neighborhood (tract) was defined as gentrified or gentrifying by 2009-13 (the most recent period with ACS data at the tract level). The baseline year is 2000. X(t-2) includes whether the tract was gentrifying in an earlier period and whether it had pre-existing transit stations (e.g., during the 1990s, prior to the 2000 baseline year). Y(t-1) includes variables for the demographic (race/ethnicity), socioeconomic (income), and housing (tenure) characteristics during the baseline year (2000). Z(t-1,t) also includes the opening of transit stations after 2000. It is important to note that we do not include variables denoting changes in the population between t-1 and t. We exclude them because they are potentially endogenous and because we cannot predict their values in the future. The model does not include V(t). Which factors are important is determined empirically (i.e., the variables that are statistically significant).

We use the empirical results to develop the off-model module, which predicts the risk of gentrifying. Gentrifying includes both direct displacement (socially and economically disadvantaged residents who are forced out) and exclusionary displacement (barriers that make it difficult for disadvantaged residents to move in). Our goal is to identify tracts at risk of being gentrified in the future (roughly 10 years from the base year since our analysis of past trends is roughly by decades). We aim to use only data that are readily available to the public and MPOs (ACS) and outputs from PECAS. In our analysis and spreadsheet, we do the following:

1. We determine which tracts are eligible for possible gentrification in 2000 (baseline), and which have gentrified/gentrifying (G/G) by 2013 (future).
2. We develop a list of variables (based on the data restrictions described above) that can be used to model the odds of gentrifying during the 2000-13 period. This is not a causal model,

but a descriptive one including changes (possibly endogenous) during the period. We also include TOD by type to capture its effects.

3. We estimate the influence/association of the right-hand side variables on the probability of gentrifying using a logit regression with available data. We use only eligible tracts. We only use statistically significant right-hand side variables, determined interactively by eliminating insignificant variables.
4. We then run some basic robustness and efficacy analysis on predicted odds of gentrifying, looking at consistency of actual versus predicted G/G. We have decided on three categories: (1) high predicted odds [predicted>.666]; (2) moderate predicted odds; and low predicted odds [predicted<.333]. We examine the absolute and relative numbers of false positives and false negatives.
5. We incorporate the logit regression model results into a spreadsheet that can be used to calculate the predicted odds and the three categories. We do not know if the estimated coefficients are applicable outside of Los Angeles. If not, then each region would need to run a logit model. The values in the spreadsheet can be replaced with new baseline and predicted data from SCAG when these become available.

Limitations

The accuracy of a predictive model varies with a number of factors. For example, the predictive power can be low if the model relies on a causal or descriptive model with little explanatory power (e.g., a multivariate linear model with a low adjusted R-square). The prediction may also be systematically biased if there are fundamental changes in circumstances not captured by the causal/descriptive/predictive models. The accuracy of a predictive model also diminishes when examining detailed outcomes or outcomes further into the future. Because of the inherent variance around a prediction, there will be false positives and false negatives, whose prevalence increases with decreases in predictive accuracy.

Very few models accurately capture the variance and precisely estimate outcomes that are consistent with the actual world. For example, many causal multivariate models have very low r-square which is roughly the percent of the variance explained by the model. Quite often we find r-squares between .10 and .30 which means we are only explaining 10 to 30% of the variance, leaving 70-90% of the variance unexplained. The same is true with a dichotomous model which predicts something happening or not happening. In other words, it can predict false positives and false negatives even if the model overall is statistically significant. For example, our model as a whole is significant but we still have a fair number of false positives and false negatives. Therefore, we should be very cautious on how to use these models. The model, nonetheless, is the best that can be done within the scope of the work that is being funded.

Table 3C.1 displays the crosstabs between the actual and predicted tracts that gentrified or are in the process of gentrifying. Overall, the model is able to predict roughly 93% (867 of the 932) of eligible tracts into their actual category (either did not gentrify or actually gentrified and were predicted as having moderate to high risk). Forty tracts fall into the “false negative” category, that is, these tracts actually gentrified but the model predicts them having a low risk of gentrifying. Fifteen tracts would be considered “false positives,” tracts that did not actually gentrify but the model predicts that they did. In terms of predicting tracts that are at risk of gentrifying, the model has about a 50/50 percent chance of doing so.

Table 3C.1: Actual versus Predicted Gentrification in Los Angeles Tracts

Actual, GG 2000-13	Predicted			Total
	Low (<.33)	Moderate (.33-.66)	High (.66+)	
No	825	18	7	850
Yes	40	22	20	82
	865	40	27	932

Organization of Off-Model Module Spreadsheet

The off-model module includes four different spreadsheets where data can be inputted. The purpose of the first (“County Avg”) and second (“Gentrification Calcs”) spreadsheets is to identify tracts that are susceptible to gentrifying and tracts that actually gentrified between 2000 and 2013. For the first spreadsheet, county-level data are inputted and for the second spreadsheet, individual tract data are inputted. The following definitions from Task 2E are used to define eligible and gentrified/gentrifying tracts:

A tract was eligible if it met all of the following criteria:

1. The tract had a population of at least 500 residents in Year 1
2. Vulnerable (eligible) in year 1 (at least 3 out of 4 of the following indicators):
 - o % low-income households (household income below 80% of the county median) is above the county median
 - o % college-educated (bachelor’s degree or higher) below county median
 - o % renters above county median
 - o % nonwhite above county median

A tract is said to be gentrified or gentrifying if it meets eligibility and all of the follow criteria:

1. Demographic change between years 1 and 2
 - o Change in % college-educated > county (percentage points)
 - o Change in % non-Hispanic white > county (percentage points)
 - o Change in median household income > county (absolute value)
2. Change in median gross rent > change county median gross rent (absolute value)

The third (“Risk Factors”) and fourth (“Predicted Value”) spreadsheets are used to predict areas that are at risk of gentrifying. Only tracts that are eligible (determined from the two previous spreadsheets) are included in the calculations. The current spreadsheets use 2000 data as the starting point and the 2009-2013 ACS as the endpoint. Once the necessary data becomes available from SCAG, the values can be replaced with new baseline and projected data. The following variables are to be inputted into the “Risk Factors” spreadsheet:

- **Median Household Income (2013)**
- **% non-Hispanic black (2013)**
- **% Hispanic or Latino (2013)**
- **% Asian (2013)**
- **% Renters (2013)**
- **Employment Density (2013)**
- **Downtown TOD (Dummy variable)**
- **Pre-2000 TODs (Dummy Variable)**
- **Post-2000 TODs Including any Future Transit Stations (Dummy Variable)**

- **Change in Median Gross Rent** (to be projected based on SCAG's predicted changes in land prices)
- **Change in Household Density** (to be projected based on SCAG's allocation of new housing units and households)

Projected data are needed to calculate the change in gross rent and household density. Once all data are inputted, the last spreadsheet, "predicted value," calculates and categorizes eligible tracts into one of the three categories: (1) high predicted odds [predicted>.666]; (2) moderate predicted odds; and low predicted odds [predicted<.333].

Concluding Remarks

Given the current state of SCAG's regional models (still in development), future work will be needed to develop, test, and refine an off-model predictive module that identifies neighborhoods at risk of gentrification and displacement in the near future. It is important to incorporate insights and understandings based on empirical evidence. This includes explicitly modeling the dynamics as they relate to economic class, tenure status, and race and ethnicity, both for recent developments and future projections. SCAG can benefit by seeking outside advice from those with expertise on these topics.

Specifications of the Off-Model Tool for the Bay Area

The Bay Area Off-Model tool uses the variables that we found to be significant in predicting gentrification and displacement in the Bay Area. Instead of using the coefficients from the regressions of Section 2E, however, we construct risk indices similar to the gentrification index used in that section. Again, we focus on variables that the regional model (UrbanSim) can predict, and give an example of calculating risk for present-day (2013) data, although we believe such data can easily be replaced with future projections from the models. We develop two different models, one to assess gentrification and the second to assess displacement, specifically, the loss of low-income households. We separate the two, as our ongoing research has shown that low-income households can be displaced from many different types of neighborhoods, not just poor, gentrifying ones.

Gentrification and Displacement Risk

Recall from Section 2E, the gentrification index was assessed using the following index, which was used in models to determine what kinds of neighborhood characteristics predicted gentrification.

1. Tracts with at least 500 people in year 1 and less than 25% of their population in college (college towns)
2. Vulnerable in year 1 (at least 3 out of 4 of the following indicators):
 - % low-income households > regional median
 - % college-educated < regional median
 - % renters > regional median
 - % nonwhite > regional median
3. Demographic change between years 1 and 2:
 - Growth in % college-educated > region
 - Growth in median household income > region
4. Investment between years 1 and 2:
 - % market-rate units built between year 1 and 2 > regional median

- Growth in either:
 - Single-family sales price per square foot > regional median
 - Multi-family sales price per square foot > regional median
 - Home value > regional median (where sales data is unavailable)

Using the results from the logit models in Section 2, we then assessed future risk of gentrification by first determining if a tract was eligible (criteria 1 and 2 above), and then assess risk based on the presence of the following risk factors:

1. Within a half-mile of a rail transit station
2. % of units in buildings built pre-1950 > regional median
3. Employment density (# jobs/square mile) > regional median

Eligible tracts that had only 1 out of the 3 risk factors above were given a risk level of low. Tracts with a composite score of 2 were assigned a risk level of moderate, and tracts with all 4 risk factors were assigned a high level of risk.

We then applied the same method to data from 2000 and the previous decade to compare predicted risk values to the actual gentrification index for the period of 2000-2013. These are summarized in Table 3C.2.

Table 3C.2: Actual versus Predicted Gentrification in Bay Area Tracts

Actual, 2000-13	Predicted			Total
	Low	Moderate	High	
No	109	353	50	512
Yes	12	57	16	85
	121	419	66	597

Thus, for the gentrification model, the Bay Area tool predicts moderate or high risk of gentrification for 73 of the 85 tracts that actually gentrified (86%). However, it also predicts a moderate or high risk for 383 of 512 tracts (75%) that did not actually gentrify.

A similar procedure was used to assess displacement risk, except most tracts were deemed eligible to experience displacement if they were home to more than 100 low-income households, had over 500 people living in them and less than 25% of the population in college. Based on the results from section 2E, we added prewar neighborhoods, TODs outside of the three largest cities and percentage of low-income households living in naturally occurring affordable units as risk factors for displacement. Tracts with a composite score of 2 or 3, were assigned a risk level of high, and tracts with a score of 1 were considered moderate.

As shown in Table 3C.3, the displacement prediction tool predicts moderate or high risk of displacement for 470 of the 537 tracts that experienced a loss of low-income households (88%).

Table 3C.3: Actual versus Predicted Loss of Low-income Households in Bay Area Tracts

Actual, 2000-13	Predicted			Total
	Low	Moderate	High	
No	240	472	297	1009
Yes	67	259	211	537
	307	731	508	1546

Chapter 3 Conclusions

In this chapter, we explain our findings that the integrated transportation land use and transportation models used by the state's MPOs have varying ability to address displacement. Researchers successfully adapted UrbanSim to address how race, income, household size, rent, and rent burden shape household location decisions and thus displacement. These modifications will ultimately be integrated into MTC's Sustainable Communities Strategy. However, PECAS, the model used by SCAG, could not be adapted to analyze displacement.

We also present several different approaches to an off-model displacement assessment methodology, designed for use by practitioners. All of the models are able to predict gentrification with results ranging from 50% to 86% accuracy.

Chapter 4: The Effects on Auto Use of Household Displacement from Rail Station Areas

Daniel G. Chatman, Ruoying Xu, Janice Park, Anne Spevack

University of California, Berkeley

Acronyms Used in This Chapter

- ACE (Altamont Corridor Express)
- ACS (American Community Survey)
- BART (Bay Area Rapid Transit)
- CHTS (California Household Travel Survey)
- CNT (Center for Neighborhood Technology)
- GHG (Greenhouse Gases)
- GPS (Geographic Positioning System)
- NHTS (National Household Travel Survey (NHTS))
- OLS (Ordinary Least Square)
- ORNL (Oak Ridge National Laboratory)
- TOD (Transit-Oriented Development)
- TSDC (Transportation Security Data Center)
- VMT (Vehicle-Miles Traveled)
- VTA (Santa Clara Valley Regional Transportation Authority)

Chapter 4 Table of Contents

Chapter 4 Introduction and Summary	159
Study Motivation.....	161
Literature Review.....	162
Data and Methodology	163
Results.....	165
Descriptive analysis.....	165
Controlled analysis.....	169
Discussion	179

This chapter addresses the question of whether gentrification and displacement affect regional auto use, and greenhouse gas emissions. We use travel survey data for metropolitan areas within California, focusing on the 9-county Bay Area region¹ and the 5-county Los Angeles region², to analyze whether low-income households reduce their auto use more than high-income households when locating near transit, as measured by their vehicle miles traveled (VMT). We find that low-income households both near and farther away from rail stations have lower VMT than high-income households, but that higher income households either reduce their driving more in response to being near rail, or that there is no difference in VMT impacts across income categories. When gentrification is accompanied by densification, these results imply it will reduce regional VMT on net. However, when displacement is significant enough and population density declines, regional VMT is expected to increase.

Chapter 4 Introduction

Transit-oriented development (TOD) policies are intended to reduce auto use by increasing dense, mixed-use development near high-frequency transit stations. But there is a growing concern that TOD policies or new transit investments may cause gentrification and displacement. In addition to disrupting the lives of displaced households, gentrification and displacement might also increase driving and associated problems such as greenhouse gas (GHG) emissions.

Depending on the neighborhood context and the details of implementation, TOD policies could certainly result in rent hikes and increases in home sales prices. This could cause poorer, transit-using households to seek lower-cost housing elsewhere while being replaced by wealthier households more likely to own cars and to drive. Under these circumstances, auto use in the rail station area would surely go up. But if such a displacement scenario were to occur, would regional auto use increase? And do actual patterns of population change in gentrifying neighborhoods near rail stations suggest that gentrification contributes to regional increases in auto use?

Previous research on this topic has neglected to explicitly take a regional perspective. It has focused instead on the fact that household VMT is likely to increase in station areas when gentrification occurs, without attempting to estimate travel patterns of displaced households, or what travel patterns would have been if planners and policy makers succeeded in forestalling gentrification.

In this study we analyzed how household auto use, as measured by VMT, is correlated with access to rail stations, household income, and the interaction of income and rail access, and we explicitly accounted for spatial population shifts using a simple method described below. We used multiple data sources and carried out a variety of regression models. We used data from the California subsample of the confidential version of the National Household Travel Survey of 2009, and from the California Household Travel Survey of 2010-12, merging these household-level travel data with spatial information on the location of rail stations across the state. We then used regression analysis to estimate how rail access reduces VMT differentially according to different levels of income when controlling for variations in household size and other factors. Finally, we used these estimates to simulate hypothetical displacement of poorer by richer households, as well as to model the VMT impacts of observed population changes in a set of four census tracts located near rail stations in

¹ We define the 9-county Bay Area region as Alameda, Contra Costa, Marin, Napa, San Francisco, San Mateo, Santa Clara, Solano, and Sonoma counties

² We define the 5-county Los Angeles region as Los Angeles, Orange, Riverside, San Bernadino, and Ventura counties.

California that experienced gentrification between 1990 and 2013, as defined elsewhere in this report.

Our estimates are based on calculating differences in VMT between households of different income levels located near and far from rail. Similar to all previous analysis on this topic, we relied on cross-sectional data. Longitudinal surveys, following the same households over time and repeatedly collecting data on VMT and spatial characteristics, as respondents move into or out of rail station areas, are unavailable and would require significant new resources for survey data collection. Without longitudinal data we must make reasonable assumptions in our scenarios, such as assuming that the average displaced low-income household moves to an average location in the region outside a rail station area.

We found little evidence that gentrification and displacement in rail station areas would cause auto use to increase, across multiple data sources and model specifications. This is for two reasons. First, rail access is associated with either a greater VMT difference for high-income than for low-income households, or no difference in VMT comparing high- and low-income households, in uncontrolled and controlled results. An average high-income household living within a rail station area has much lower VMT than an average high-income household living outside a rail station area. The difference in VMT for low-income households is substantially smaller when comparing those living within and outside rail station areas. This fact is largely robust to controlling for other factors including household size. However, we also find that in some controlled models, moderate-income households have a smaller VMT reduction associated with rail than do either low-income or high-income households. This latter finding, though not consistent across data sources, does complicate matters because it implies that the specific pattern of household turnover could influence whether gentrification increases auto use regionally, decreases it, or has no effect.

Second, in most census tracts located near rail stations that experienced gentrification (as defined elsewhere in this report), there was either no loss of low-income households or there was an increase in higher-income households exceeding that loss, so that the total number of households in most gentrifying station-area census tracts has increased. In fact, in many gentrifying tracts over the study period there was a quite significant increase in population density. Under our assumptions, this feature of gentrification means that more households were able to live near rail rather than far away, with concomitant VMT reduction benefits. Based on our analysis, the most plausible scenario in which gentrification and displacement in any particular neighborhood would cause VMT increases regionally would be one in which displaced low-income households were replaced by a smaller number of moderate- or higher-income households. A relatively small number of census tracts appears to fit this criterion. For example, based on our analysis of the census tract data described elsewhere in this report, between the years 2000 and 2013 there were 87 newly gentrifying tracts in the Bay Area. Of the 87, just two tracts had both a reduction in the number of low-income households and a net decline in the number of households as a whole.

Thus, in our simulated gentrification scenarios (described below), regional VMT declines or is not statistically significantly affected, except in a stylized scenario in which 1,000 low-income households are replaced by 500 high-income households; in this case, one estimate method suggests an increase in regional VMT. One can easily imagine additional but less common scenarios for which our analysis implies increases in regional VMT – mainly neighborhoods where gentrification is accompanied by significant displacement of poor households without a simultaneous increase in local population density.

Our results vary depending on the region and the data used, but they generally imply the following:

- If higher-income households (making more than \$100,000 per year) displace moderate-income households (with income in the range of \$25,000 to \$75,000) on a one-to-one basis, regional VMT will decrease.
- Regional VMT will likely increase if gentrification results in a reduction of the population living near rail and if those rail station areas have good transit service, high density, and other well-known features of supportive TOD.
- Regional VMT may increase (the results are not consistent) if lower-income households are displaced by households of moderate income, and if population density remains the same or falls.

Study Motivation

How would regional auto use and GHG emissions be affected if transit investments or TOD programs displaced core transit users with higher-income, car-owning residents? Regional reductions in auto use that are assumed to be achieved through the pursuit of smart growth, transit-focused development, and similar urban planning strategies are called into question if such displacement occurs. Urban planners would benefit from a better understanding of how transit investments, and policies to intensify development near rail, may affect the net auto use of households in a region if they also induce spatial population shifts.

Gentrification can cause substantial disruption and harm to lower-income households. It also has the potential to provide benefits to low-income households who are able to remain in gentrifying areas. This study does not address those issues. Rather, we explore whether, if gentrification or displacement does occur, this would result in a global (regional) increase in auto use, as measured by VMT.

If a TOD strategy leads to the displacement of lower-income households near transit stops, replacing those households with those of higher income, the effects on VMT are theoretically uncertain. They partly depend on the nature of residential choice by different household types, which in turn is likely to be influenced heavily by the particular policies adopted to encourage TOD, and they partly depend on whether and how housing supply is constrained, including by policies influencing housing production or renovation elsewhere in the region, as well as physical and environmental conditions affecting the cost of housing production (Chatman 2014, Cao and Chatman 2016). Households seeking new housing are strongly influenced by its spatial distribution and price.

On the one hand, there is reason to believe that displacement caused by TOD would increase auto use. Lower-income households are more likely than higher-income households to take advantage of transit services, and using transit services may decrease auto use. Under such assumptions, regional travel modeling for the San Francisco Bay Area resulted in projections of more net auto use when income increased near transit stops (Kanner and Niemeyer 2012). But the opposite is also possible: the auto use of lower-income households may not be highly dependent on proximity to rail or bus service. Public transit is by no means the only alternative to driving alone. There are alternative modes like walking and bicycling. Since more than three-quarters of auto mileage in U.S. urban areas is for non-work purposes, much daily travel can be thought of as discretionary. Lower-income

households are more likely than those of higher income to travel less, to rely on alternative modes more, and to own and use autos less, regardless of where they live (Chatman 2009). But whether people of different income groups respond differently to transit accessibility and the built environment is a question that has rarely been studied in the literature.

Literature Review

If TOD leads to the displacement of low-income households, we may expect a change in travel behavior of households living near rail stations. The mobility of richer households is far more likely to depend on automobiles than that of poorer households. Minorities and low-income households also account for a large share of the nation's transit riders (Pucher and Renee 2003). Therefore, if TOD programs caused gentrification, transit ridership might be expected to fall due to the displacement of low-income households, and in turn, auto use might be expected to increase.

Previous research has argued that the travel patterns of households living in TODs are primarily affected by two factors: accessibility and income (Danyluk and Ley 2007, Lund et al. 2004). It has also been argued that increased transit accessibility (such as a new rail line) might not increase transit ridership very much if it is associated with an influx of high-income households into the newly transit-served area accompanied by a loss of lower-income households who were frequent transit users (Lund et al. 2004, Dominic 2012, Pollack et al. 2010). One Canadian study showed that although households living in gentrified districts often cycled to work, they used public transportation less and automobile commuting more than those in non-gentrified districts (Danyluk and Ley 2007). A study of 42 neighborhoods and 12 metropolitan areas in the U.S. in which one or more transit lines were developed between 1990 and 2000 showed that transit development was associated with increased rent burden and an influx of automobile-owning households (Pollack et al. 2010).

However, such studies have failed to consider regional VMT. Almost by definition, gentrifying rail station areas experience an increase of high-income households who are more likely to drive cars and use transit less. From a regional perspective, the outcome of such an influx, whether accompanied by displacement or not, is unclear. Understanding the regional VMT impact of gentrification and displacement requires explicitly accounting for any change in auto use by higher-income households moving into the station area, along with any change in auto use by displaced, lower-income households.

Understanding the regional VMT impact of displacement ideally also relies on a better understanding of travel behavior before and after a move for households of these types. Previous evidence on this question has not shown that transit mode choice increased significantly among TOD residents compared to their travel patterns in their previous neighborhoods. Respondents to one California survey reported small increases in transit trips that were not large enough to be statistically significant (Lund et al. 2004). Those who had changed both work location and residential location indicated a variety of mode changes; 11.5% switched from automobile to rail transit, but an almost equal number switched from transit to automobile. The researchers concluded that the pattern of mode change that occurs when a resident move to a TOD is complex, because TODs provide good accessibility of all kinds, not just rail transit. Another study found that the VMT produced by more affluent, newly moved-in households (defined as income 25% above regional median, and living in their current home for less than 10 years) decreased over time, and residents who had been in their current location for less than a year had the highest auto VMT

(Kushto and Shofer). This suggests that recent movers may be less indicative of equilibrium VMT patterns.

One fundamental question, implicit in understanding the net VMT and GHG effects of any displacement coincident with transit investments or development near transit, is how households of different income levels respond to transit availability or the built environment. The combined effect of built environment and income has rarely been studied. One study of residential location choice and activities found no significant difference in the effect of transit access on activity participation among those of differing income (Pinjari et al. 2009). A recent report by the Center for Neighborhood Technology (CNT) investigated whether transit and employment density had different effects on households of different income levels, using different methods and measures than those used here, and similarly found no statistically significant differences in transit responsiveness among low- and high-income households (Newmark and Haas 2015)³. The same report argued that large GHG reductions can be achieved by preserving low-income housing in TOD areas because low-income households emit less VMT when living in TOD areas than high-income households do. But by focusing only on households living in TODs, this conclusion neglects to consider the impacts of TOD on auto use regionally.

Data and Methodology

We focused on household travel in the major California metropolitan areas—the San Francisco Bay Area, the Los Angeles region, Sacramento, and San Diego—and also estimated separate models for the Bay Area and the Los Angeles region. We relied on two sources of confidential, spatially precise microdata. The first was the National Household Travel Survey (NHTS) of 2009, with 16,575 households residing in California metropolitan areas. The second was the California Household Travel Survey (CHTS) of 2010-2012, with 25,246 metro area households.⁴ The NHTS 2009 confidential data were obtained with approvals from the NHTS committee of the U.S. Federal Highway Administration. We accessed the CHTS data through a remote system maintained by the Transportation Secure Data Center (TSDC), with approval from the National Renewable Energy Laboratory.⁵

Our dependent variable in the analysis was average daily VMT. Due to differences in surveying methods between the two datasets, we used a different calculation to arrive at this figure for the CHTS and the NHTS. The CHTS dataset contains detailed travel behavior information using two data collection methods: self-reported trips and GPS tracking. For trip reports, respondents reported the locations they visited over a 24-hour period using an online travel diary, and the travel distance for

³ The CNT report used data from the California Household Travel Survey and calculated average VMT estimates for five different income groups of households throughout California living within a quarter-mile of TOD areas (including rail, ferry and high-frequency buses), within a half-mile of these areas, and households beyond these thresholds (non-TOD households). The built environment factors used were whether the household was in a major metropolitan region, small city, or rural setting; residential and job density; and commute distance. Demographic control variables included the number of adult students, workers, preschoolers, school children, adults, and seniors, as well as whether any member of the household had a disability, and whether the travel diary day was a Saturday, Sunday, or holiday.

⁴ We used NHTS 2001 as well but do not share the results in this paper since the sample size was too small.

⁵ The application and approval process for access to confidential CHTS data took several weeks. Additionally, since confidential data cannot be moved or copied from TSDC's servers, we connected remotely in order to access and work with the data on their servers. In doing so we were limited to the software programs available to TSDC, which were QGIS and R statistical package.

each trip was calculated by the system as the shortest network distance between origin and destination for each trip. Since trips are represented at the person-level in the CHTS, we calculated a corrected estimate of VMT for each trip taken by the household by dividing the trip distance in miles by the number of occupants in the vehicle (including both household and non-household members). We then summed the VMT per trip over all trips taken on the travel day for each unique household.

The NHTS dataset includes an odometer reading for each household vehicle, as reported by survey respondents. For the 2009 version of the NHTS, only one odometer reading was collected. Annual mileage per household vehicle was estimated from the total odometer reading, as follows. Using the NHTS 2001 data, which showed a negative correlation between vehicle age and the annual odometer VMT calculation, the Oak Ridge National Laboratory (ORNL) developed regression models for three vehicle types (new vehicles, used vehicles, and used/new status unknown) to estimate the most recent year's VMT based on total VMT and vehicle age (ORNL 2001). We summed this estimate for all household vehicles, and then divided by 365 to get the average daily VMT per household.

The VMT calculation for each dataset has its advantages and drawbacks. Odometer estimates represent aggregated VMT for an entire year, which is less sensitive to noise from atypical travel behavior on the survey day. But odometer estimates neglect any auto trips taken without using household vehicles, such as borrowed vehicles or rental cars. The relatively accurate trip distance calculations in the CHTS dataset include all trips, such as auto trips taken without a household-owned vehicle. But for most respondents these distances are calculated under assumptions about least-path, rather than being directly measured. And the fact that they are measured only for a survey day means there will be much more statistical noise in the CHTS estimate.

The spatial specificity of the two datasets also varied somewhat. The confidential version of the NHTS provides the location of the census block group, allowing us to join the household spatial data, represented here at the block group centroid, to accurate spatial data on rail station locations that we created from a variety of sources (mainly from previous research projects of the first author). The confidential CHTS data included the latitude and longitude of each household, allowing us to calculate a more precise rail proximity measure than for the NHTS data. The CHTS dataset also provides information on each household's most recent move, and the zip code and city of the previous address, if the move was within five years of the survey date. As described below, we investigated these data but did not find statistically significant results due to small sample sizes of households living near rail.

Transit accessibility is represented in this study as being located within a half-mile of a rail station, which is highly predictive of rail ridership (Guerra et al. 2012). Transit access of all kinds, including bus service, tends to be highest near rail stations. Rail-station areas are also where most TOD programs are focused. In California, TOD is defined as being within a half-mile of transit stations with transit services having a headway of not more than 15 minutes (SB 375 2008). The rail stations included are those from the San Diego Trolley, North County Transit District, Metrolink (Orange County), LA Metro, Caltrain, Santa Clara Valley Transportation Authority (VTA), Altamont Corridor Express (ACE) Train, Bay Area Rapid Transit (BART), San Francisco Muni, and Sacramento light rail. This yields a total of 765 rail stations. Of the 16,575 households in the metropolitan areas in the California NHTS 2009 data, 847 are within a half-mile of a rail station. Of the 25,246 metropolitan households in the CHTS data, 2,263 households are within a half-mile of a rail station. For each dataset, we estimated a Tobit model of average daily household VMT as a function of rail station access, income, the interaction between rail proximity and income, and control variables.

The Tobit model is a more appropriate model than ordinary least squares (OLS) because it accounts for the fact that, in the case of the CHTS, a substantial fraction of respondent households did not drive on the survey day (either because they did not have access to a vehicle, or for some other reason), or, in the case of the NHTS, did not own household vehicles and therefore did not report a yearly odometer reading. The Tobit model allows for the auto ownership effect of transit access to be incorporated into the model, providing an appropriate functional form for the left-truncated distribution of the dependent variable. (We also estimated OLS models and did not find large differences such as changes in sign.) We considered other functional forms including count models (Poisson, negative binomial) and zero-inflated count models, but the Tobit is more appropriate for a continuously distributed variable like VMT. The use of sample selection models is another option that we did not test, and in future research plan to do so. However, we strongly suspect that the results will be consistent with the Tobit model results.

Results

Descriptive analysis

Table 4.1 shows summaries of average daily household VMT by income categories and rail access using the NHTS and CHTS data. Figures 4.1 and 4.2 show a graphical representation of the data. In order to ensure comparability between the two datasets, which have somewhat different income category reporting, we used four categories of income for the descriptive analysis: less than \$50,000 per year, between \$50,000 and \$75,000, between \$75,000 and \$100,000, and over \$100,000 per year per household. Household income of \$100,000 is not considered particularly high-income in most parts of metropolitan areas in California, but this is the highest income category in the NHTS data.

In both datasets, households of different income categories living near a rail station have lower VMT than those living farther away (although in the NHTS dataset, there is no statistically significant difference for the \$50,000 to \$75,000 range of household income). In the NHTS data, the percent and absolute VMT difference is higher for the \$75,000-\$100,000 and \$100,000+ income groups than the less-than-\$50,000 group. In the CHTS data, although the VMT difference is higher in percentage for the lowest-income group, the absolute value of the VMT difference is higher for households with income exceeding \$75,000, while the middle-income groups have smaller differences in VMT.

We conducted the same descriptive analysis for the entire state of California, for the San Francisco Bay Area only, and for the Los Angeles region only (see appendix S, Tables S.1 to S.3 and Figures S.1 to S.6). The statewide California descriptive statistics are similar to those for metropolitan areas within California. Comparing average VMT by income category within the Bay Area and Los Angeles region reduces the sample size considerably, which in the NHTS data results in low sample sizes (less than 100 respondents) for households in middle-income categories living near station areas, and reduces statistical reliability (see Appendix, upper half of Tables S2 and S3).

Table 4.1: Average Daily Household VMT by Income Category and Rail Access, metropolitan areas only, NHTS 2009, and CHTS 2010-2012

National Household Travel Survey (NHTS) 2009							
	In rail station area		Outside rail station area		VMT difference		t-test
Income categories	VMT	N	VMT	N	Percent difference	Absolute difference	
<\$50k	31.08	444	37.84	6,220	17.86%	6.76	2.8
\$50k-\$75k	49.03	140	55.87	2,571	12.24%	6.84	2.02
\$75k - \$100k	49.69	104	71.24	2,207	30.25%	21.55	5.44
>\$100k	60.86	159	79.86	4,730	23.79%	19	5.79
Total	41.86	847	57.89	15,728	27.69%	16.03	9.71
California Household Travel Survey (CHTS), 2010-2012							
	Near Rail		Away Rail		VMT difference		t-test
Income categories	VMT	N	VMT	N	% of VMT difference	Absolute VMT difference	
<\$50k	16.81	846	26.67	6,855	36.97%	9.86	7.55
\$50k-\$75k	28.09	386	39.02	3,923	28.01%	10.93	3.48
\$75k - \$100k	29.77	323	45.93	3,661	35.18%	16.16	5.53
>\$100k	35.17	708	55.64	8,544	36.79%	20.47	11.34
Total	25.61	2,263	43.65	22,983	41.33%	18.04	15.85

¹ This difference is not statistically significant

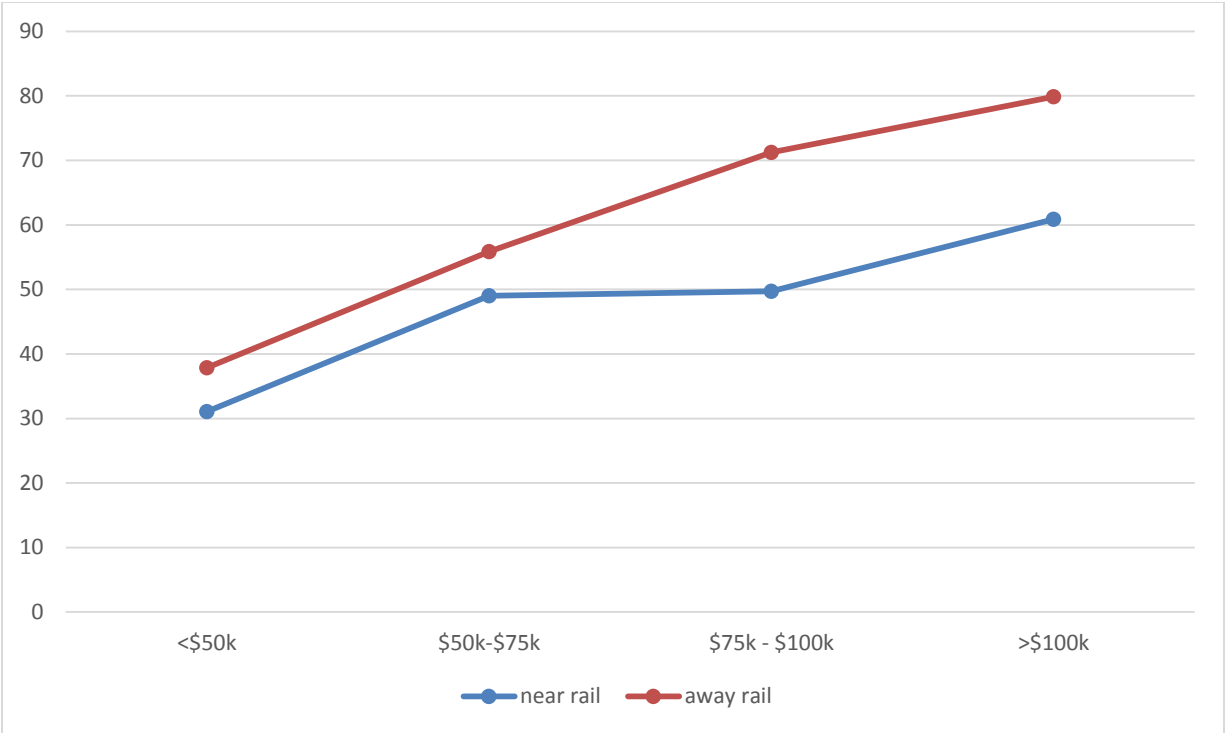

Figure 4.1: Average daily household VMT by income category and rail access, NHTS data, all California metro areas

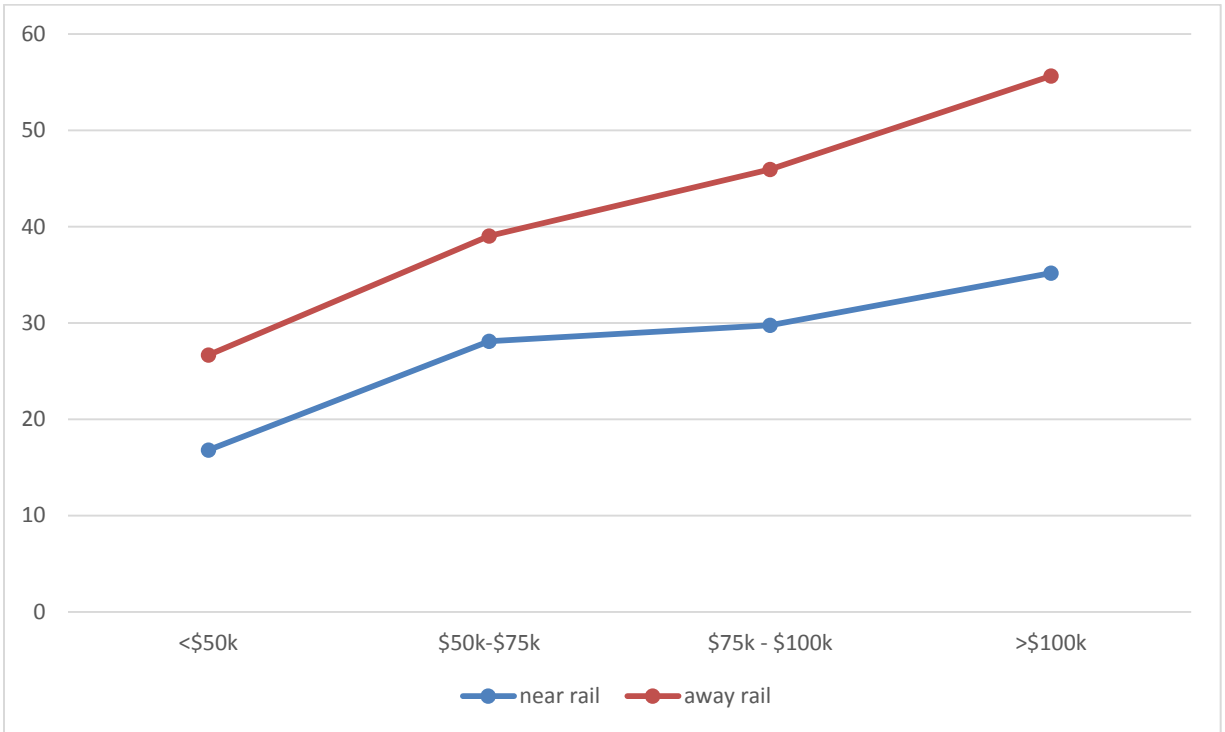

Figure 4.2: Average daily household VMT by income and rail access, CHTS data, all California metro areas

In the NHTS data for the San Francisco Bay Area, the decrease in VMT is larger for each successively higher income category, while in the CHTS data the VMT difference is smallest for the \$50,000 to \$75,000 income range (and not highly statistically significant), somewhat larger for households with less than \$50,000 in income, and largest for the \$75,000 to \$100,000 and “\$100,000 or more” income ranges. In NHTS data for the Los Angeles region, partly due to small sample sizes of households living near rail stations in the Los Angeles region sample, we found no statistically significant differences in VMT by rail access (see Appendix S; Table S.3). In the CHTS data for Los Angeles, we found that only among the lowest-income households was there a VMT difference associated with rail access. Differences in the other income categories were large but not statistically significant due to the small number of households in the sample who live near rail stations.

Thus in both the CHTS and the NHTS data, uncontrolled descriptive differences tend to suggest that displacement might not increase auto use, but might instead have no effect on regional VMT, or even decrease it. The statistically significant evidence suggests the absolute difference in VMT associated with rail access is either larger for higher-income households or there is no difference by income.

We also looked at data about recent movers in the CHTS, although unfortunately the number of respondents is small. Data about households moving near to and away from TOD areas would be a better way than cross-sectional data to determine how rail access influences VMT in a gentrification and displacement scenario, because moving households are likely different from those that stay in place, particularly if travel habits from the previous location influence their travel in their subsequent neighborhood. In the CHTS dataset, the respondent’s previous zip code or city is provided when the respondent moved within five years of the survey date. We used data for the entire state of California (not just metro areas), which has 8,426 households that moved recently. Then we excluded households that only reported a city and no zip code, leaving 6,922 households. Of these, 5,878 households had moved within California and were retained for this analysis. We determined the transit accessibility of the respondent’s previous address by checking whether the respondent’s previous zip code had at least one rail station. We subdivided the movers into three income categories: \$0 to \$49,999, \$50,000 to \$99,999, and \$100,000 or more, and then we categorized these recent movers into one of four mover profiles, based on whether the household moved as follows:

- From a zip code with no rail access to an address within a half-mile of a rail station (“away to near”);
- From a zip code with no rail access to an address farther than a half-mile from a rail station (“away to away”),
- From a zip code with a rail station to an address within a half-mile of a rail station (“near to near”); or
- From a zip code with a rail station to an address farther than a half-mile from a rail station (“near to away”).

Within each mover profile, higher-income respondents had higher VMT, as expected. Unlike the cross-sectional descriptive analysis just described, the difference in VMT associated with rail access was smaller for high-income than for low-income respondents among those who had moved into or out of zip codes with rail stations. But most differences were not statistically significant, since as few as 18 respondents are found in the subgroups (see Appendix, Table S.4). Thus while the mover data might appear to suggest that low-income households increase their VMT when moving out of a station area to a degree exceeding the reduction in VMT by high-income households moving into a station area, this pattern is not statistically reliable. Without a larger set of longitudinal data, we can only work in controlled analysis with the relatively robust set of cross-sectional data available to us,

which is the analysis we turn to next.

Controlled analysis

While the cross-sectional data show that VMT differences associated with rail access in the major metropolitan areas in California tend to be larger for higher-income households, factors other than rail access may play a role. Household size, age, sex, race/ethnicity, and other observed factors also influence auto use, and those factors may be correlated with both rail access and income. For example, higher-income households who live near rail may also have smaller household sizes and may be less likely to have children in the household than lower-income households living near rail. Larger households with children tend to travel more.

Regression analysis that includes control variables is therefore helpful in establishing whether the differences we observe in VMT levels near and far from rail access are actually attributable to rail access. We conducted regression analyses controlling for household size, whether the household has one adult, whether the household has children, and if the home is rented. We also controlled for census tract population density and employment density. These variables have been found to be highly significant determinants for VMT in previous studies (e.g., Chatman 2003). We also carried out models with additional control variables (including the number of drivers, as well as an endogenous variable, the number of household vehicles); results were consistent with the more parsimonious models presented here, which are also more statistically reliable given small sample sizes in certain income categories near rail. We were not able to include additional variables such as parking availability or workplace characteristics in this analysis. Parking availability is likely quite important but not available in the NHTS or CHTS data. Workplace characteristics were not available in the data that we had confidential access to even though they exist in the confidential data held by data steward agencies that may be made available under confidentiality agreements to us or other researchers in the future.

A relatively large percentage of respondents did not report household income (7.1% in the NHTS and 8.6% in the CHTS). We tested three different approaches to address this problem: we excluded households that did not report their income; we included them in the analysis by adding a dummy missing income variable; and we estimated their income using an imputation technique applied with non-missing data on demographics, using the multiple imputation routine in R. The estimation results for the three different outputs were very similar, so we only present models using imputed income.

Table 4.2 shows a first set of estimation results for all California metropolitan areas, as well as the San Francisco Bay Area only, and the Los Angeles region only, using both NHTS and CHTS data. This set of models uses household income represented with two variables: as a continuous (numeric) variable, and as the square of that variable. Representing income as a continuous variable using NHTS or CHTS data requires re-coding categories of income as the midpoint value for the category (e.g., the “\$0 to \$10,000” income category is recoded as “5” to represent \$5,000). For the top-coded income category we arbitrarily assigned a value of \$110,000 for the NHTS “\$100,000 or more” category, and a value of \$250,000 for the CHTS “\$200,000 or more” category, consistent with other studies. As noted previously, the other independent variables include rail proximity (a dummy variable representing whether there is a rail station within a half-mile of the residence), and the interactions between rail proximity and income. These interactions between rail proximity and income are of most interest because they help answer whether households in different income categories are more or less likely to reduce their driving in response to living near a rail station.

Significant coefficients on these variables imply that people of different income levels are more or less responsive to rail access in terms of their auto use, and therefore, that displacement would influence regional VMT in some way.

Table 4.2: Household daily VMT regressed on rail proximity, numeric income, income squared, interaction of income and rail proximity, and demographic controls

	Metropolitan areas		SF Bay Area		LA Region	
	NHTS (1)	CHTS (2)	NHTS (3)	CHTS (4)	NHTS (5)	CHTS (6)
Household VMT per day						
(Constant)	-2.16	-7.90**	-5.36	-3.03	-4.11	-12.55**
Near rail	-11.89**	-7.91**	-5.14	-15.43**	-25.28**	-4.66
Income (1000s)	0.69**	0.47**	0.66**	0.38**	0.76**	0.53**
Income (1000s) + near rail	0.38*	0.03	-0.03	0.09	0.86*	0.08
Income ² (100 millions)	-0.23**	-0.12**	-0.26**	-0.10**	-0.25**	-0.15**
Income ² (100 millions) + near rail	-0.34**	-0.03	-0.02	-0.05	-0.70*	-0.03
Census tract housing. density (1000 /sq mi)	-1.00**	-0.35	-1.20**	-0.43	-0.97**	0.51
Census tract pop. density (1000 /sq mi)	-0.22**	-0.68**	-0.04	-0.72**	-0.27*	-0.93**
Household size	12.62**	9.23**	13.39**	9.91**	12.49**	9.79**
One-adult household	-10.63**	-9.03**	-9.25**	-10.01**	-9.93**	-6.89**
Household with children	4.13**	-1.76	7.62**	-1.69	4.11**	-3.20*
Rental house	-9.13**	-5.48**	-9.37**	-6.06**	-9.14**	-5.05**
N	16,575	25,246	3,986	9,251	6,616	12,869
Log (scale)	3.8	4.16	3.76	4.12	3.86	4.18
Log-likelihood	-8,835	-11800	-19,670	-39160	-32,940	-55120

Note: ***: 99% significant; **: 95% significant; *: 90% significant

The first relevant finding from the models shown in Table 4.2 is that rail proximity is not always associated with a reduction in daily VMT controlling for other factors. In the metropolitan area models (columns 1-2), the rail proximity indicators are statistically significant; being near a rail station is associated with 11.89 fewer VMT per day in the model using NHTS data, and 7.91 fewer VMT in the model using CHTS data. But there is inconsistency in the models restricted to respondent households living in the San Francisco Bay Area and Los Angeles region (Table 4.2, columns 3 to 6). Rail proximity is not significantly associated with VMT in the Bay Area-specific model when using NHTS data, but it is significant and large when using CHTS data, implying a reduction of 15.43 miles per day (Table 4.2, columns 3-4). Apparently this is not merely a function of the different dataset characteristics, because the finding reverses between data sources for household respondents in the Los Angeles region. Rail proximity is significant and large when using NHTS data (rail access is associated with a reduction of 25 VMT per day), but the relationship is statistically insignificant with CHTS data (Table 4.2, columns 5-6). Note that we control for both population and housing density in these models, and our other published research has argued that rail access by itself may be less important than such factors as those, which may be correlated with rail access (Chatman 2013). Thus this finding is not new or particularly surprising, but its inconsistency is somewhat remarkable.

Both numeric income and income squared are statistically significant in the expected direction in all models. That is, across income categories, while there is increasing VMT with income, the effect decreases at higher levels of income. But the focus of this analysis is on the interaction of rail access and income, which provides evidence to help answer the question of whether higher-income households are different from lower-income households in how they reduce their vehicle use when near a rail station. The models show significant relationships only with the NHTS data, and when looking at all metropolitan areas and at Los Angeles (Table 4.2, columns 1 and 5), but not in the San Francisco Bay Area. In other words, four of the six models (Table 4.2, columns 2-4 and 6) imply that rail access has the same effect on VMT regardless of income level, and therefore that a one-to-one displacement of poorer by richer households has no effect on regional VMT.

In the other two models (Table 4.2, columns 1 and 5), the results imply that higher-income households and lower-income households decrease their VMT in response to rail access more than middle-income households do. For all metropolitan areas, there is a positive statistically significant coefficient on the interaction of rail access and income of 0.38, and a negative coefficient on the interaction of rail access and income squared of -0.34. For Los Angeles, the coefficients are 0.86 and -0.7. These coefficients are somewhat difficult to interpret in numerical form so we have graphed them (Figure 4.3, below). Within rail proximity areas in both regions, higher income is associated with higher VMT, but the incremental effect of income decreases when income is higher. Controlling for other factors, in Los Angeles specifically and in the major metro areas in the state, the VMT reduction associated with rail access in the NHTS data declines steadily in the income range from \$0 to \$60,000 and increases again at higher levels of income until becoming largest at levels of household income exceeding \$100,000 per year (Figure 4.3, below). In other words, in the models using NHTS data, the highest-income households have the largest VMT reduction associated with rail access; households with incomes less than \$25,000 are not far behind; and households in the \$50,000 to \$75,000 range have the smallest VMT reduction (in fact, the NHTS model for Los Angeles implies that rail access leads to a small VMT increase for the middle range of income; however, as noted previously, the number of middle-income households living near rail in the Los Angeles subsample of the NHTS data is quite small so the results are somewhat suspect). It is important to reiterate here that the preponderance of evidence, from the larger and more recent CHTS dataset, implies there is no difference by household income in how much VMT declines in response to rail access. In fact, in two of the models, there is no evidence that rail is associated with VMT levels at all.

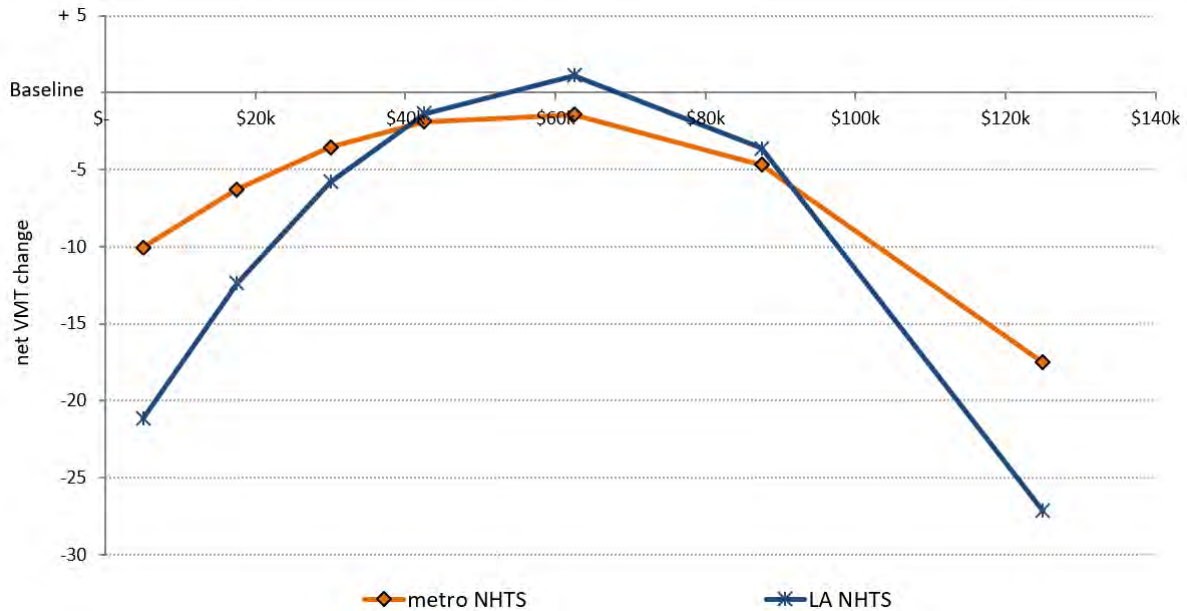

Figure 4.3: Net Effect of Household Income on Household Daily VMT (NHTS, Based on Models in Table 4.2)

A more flexible and potentially more accurate way to represent how VMT is affected by household income and rail access is to specify the income variables and their interactions with rail access as threshold variables for successively higher levels of income (Table 4.3, below), along with a linear coefficient for the effect of income represented numerically (with category midpoints). Using income thresholds is complicated by the relatively small sample sizes for income categories, particularly in the NHTS data as we elaborate upon below, but it is nevertheless instructive to compare this way of representing income effects, and we therefore do so.

In these models, each income threshold is represented by a dummy variable. For instance, the variable “Income > \$10,000” equals 1 if household income is above \$10,000, and zero otherwise. The remaining variables are specified the same way, so that the coefficient on each threshold variable measures the marginal difference in VMT associated with that additional household income increment. We removed those variables representing the interaction of rail proximity and income categories when they were not statistically significant, which accounts for the blanks in Table 4.3. Calculating the net effects for each income category requires summing the coefficient for “near rail,” the product of the midpoint of the income category and the coefficient for “Income (1000s) + near rail,” and, where present, the coefficient for the “Income > + [income threshold] + rail” variable. Since interpretation of Table 3 results is therefore complex, we also represent the results graphically (Figure 4, below). The figure uses dashed lines to represent NHTS model results (reflecting their lower sample size and therefore lower reliability), and uses solid lines to represent CHTS model results.

These models again find some evidence that rail proximity has different effects for households with different income levels, but again, not in the San Francisco Bay Area. In NHTS data for the major metros, the regression model finds a monotonic increase in VMT associated with rail access as household income increases (a reduction of 0.38 VMT per \$1,000 in income), but with positive VMT increments associated with exceeding \$10,000 in income and exceeding \$35,000 in income (Table 3, column 1; Figure 4.4, dashed orange line). In this model, households with income between \$35,000 and \$50,000 increase their VMT when near a rail station. But with the CHTS data, though the shape

of the function is similar, there are no positive VMT effects of rail access. The CHTS model results imply that the reduction of rail access on VMT increases modestly with household income though there is a narrowing of the VMT reduction when income exceeds \$25,000 (Table 3, column 2; Figure 4, solid orange line).

The San Francisco models with NHTS and CHTS data are completely consistent with the models shown in Table 4.2 in that there is no statistical significance of income interactions with rail (Table 4.3, columns 3 and 4; not represented in Figure 4.4). Thus we find no evidence in controlled models that the VMT impacts of TOD have different effects depending on household income in the San Francisco Bay Area.

Finally, we turn to the models for Los Angeles, where results vary based on the data being used. We begin with the model that uses NHTS data (Table 4.3, column 5; Figure 4.4, dashed blue line). At the lowest level of income, rail access is associated with a reduction of 19.77 VMT (see coefficient on “near rail”), but each additional \$1,000 in income beyond that increases VMT by 0.42 miles (see coefficient on “Income (1000s) + near rail”) until, when income exceeds \$75,000, there is a reduction of an additional 19.67 VMT associated with rail access (see coefficient on “Income>\$75,000 + near rail”). The additive effects of these coefficients means that between about \$45,000 and about \$70,000 in income, this model predicts an increase in VMT associated with rail access, and that the income category having with the biggest VMT reduction due to rail access is households earning between about \$70,000 and \$80,000. However, as noted previously, we view the NHTS results with some skepticism due to the very small number of households living near rail in each of the income categories, particularly since above \$50,000 in income there are a total of only 51 such households.

The model using CHTS data for the Los Angeles region had reasonable numbers of households in the different income categories, with 276 households living near rail with household income exceeding \$50,000 per year. This model shows no independent significance of rail access on VMT (the “Near rail” coefficient is small and statistically insignificant) and no significant continuous relationship between income and rail access (the coefficient on “Income (1000s) + near rail” is also small and statistically insignificant). But one variable, the interaction between having income exceeding \$75,000 and living near rail, is large and statistically significant, implying that, controlling for other factors, households earning more than \$75,000 per year, and living near rail, have fewer VMT per day than households in the same income category who live far from rail (Table 4.3, column 6; Figure 4.4, solid blue line).

Across the metro California and Los Angeles region models, the VMT reduction associated with rail access is greater for high-income households than for moderate-income households; moderate-income households have a smaller VMT reduction than the lowest-income households; and high-income households tend to have the same VMT reduction associated with rail access as the lowest income category for the CHTS data, while for the NHTS, which has lower reliability due to sample size issues, high-income households have a smaller VMT reduction associated with rail than lower-income households.

Table 4.3: Household daily VMT regressed on rail proximity, numeric income, income thresholds, interaction of numeric income and income thresholds with rail proximity; and demographic controls (NHTS and CHTS data)

	Metropolitan areas		SF Bay Area		LA Region	
	NHTS	CHTS	NHTS	CHTS	NHTS	CHTS
(Constant)	-1.62	-	-5.63	-7.45	-1.12	-
Near Rail	-13.54**	14.61**	-4.67	-9.79**	19.77**	-4.47
Income (1000s)	0.41**	0.07**	0.25	0.05**	0.55**	0.04*
Income (1000s) + near rail	-0.38**	-0.07**	-0.06	-0.03	0.42**	0.14
Income > \$10,000	2.95	9.41**	7.64	0.58	-0.86	13.15**
Income > \$25,000	7.04**	7.75**	4.51	11.79**	4.79	7.17**
Income > \$35,000	-3.11*	7.65**	-0.41	10.25**	-4.34	7.12**
Income > \$50,000	-0.29	5.33**	1.17	0.88	-0.08	7.52**
Income > \$75,000	0.99	2.38	6.35	2.94	-2.12	2.69
Income > \$100,000	-4.43**	3.08*	-5.98	2.91	-7.64**	5.62**
income>10,000 + near rail	16.71**					
income>25,000 + near rail		8.22*				
income>35,000 + near rail	16.65**					
income>50,000 + near rail						
income>75,000 + near rail					36.10**	-
income>100,000 + near rail	13.75*					19.67**
Census tract housing. density (1000 /sq mi)	-1.00**	9.20**	-1.18**	-0.45	-0.99**	0.35
Census tract pop. density (1000 /sq mi)	-0.22**	-9.16**	-0.05	-0.70**	-0.26**	-0.88**
Household size	12.59**	-1.44	13.44**	9.93**	12.45**	9.76**
One-adult household	-10.81**	-4.78**	-9.38**	-9.95**	-9.97**	-7.09**
Household with children	4.20**	-0.45	7.95**	-1.42	4.11**	-2.82
Rental house	-9.14**	-0.63**	-9.53**	-5.58**	-9.19**	-4.56**
N	16,575	25,246	3,986	9,251	6,616	12,869
Log(scale)	3.8	4.16	3.76	4.12	3.86	4.18
Loglikelihood	-88350	-	-19640	-43330	-32920	-60540
		118600				

Note: ***: 99% significant; **: 95% significant; *: 90% significant

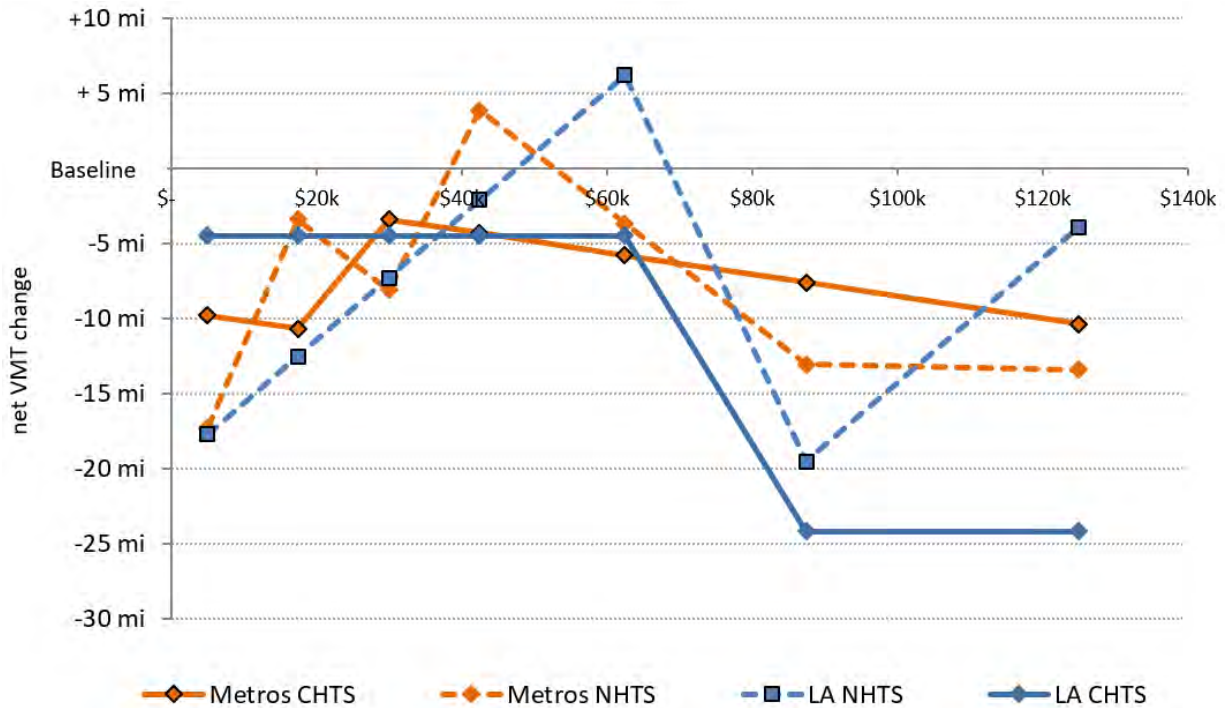

Figure 4.4. Net effect of rail proximity on household daily VMT, by income category - threshold models

Hypothetical gentrification and displacement illustrations

What seems likely to happen to regional VMT when a neighborhood gentrifies, given these findings? We begin our discussion of hypothetical gentrification and displacement scenarios with two simple illustrations and end with data on population change by income for four actual census tracts near rail stations in California that experienced an increase in the share of higher-income households.

For the sake of our first simple illustration, let us assume that there is an influx of 1,000 high-income households with an income level exceeding \$100,000, who previously lived away from rail. Let us assume that they displace the same number of low-income households, with an income level below \$50,000, from TODs to somewhere away from rail. What is the net impact on VMT of the richer households moving near rail, and the poorer households moving farther away? We used two different methods for the two data sets, thus calculating four results:

1. **Compare the near-station and outside-station average VMT figures from Table 4.1 for the lowest- and highest-income household categories.** This method does not control for other features of households that vary between households living inside and outside station areas. This uncontrolled method is arguably appropriate if self-selection is at work and if households require both motive and opportunity to reduce VMT, so that their self-selection, including their different demographic characteristics, is part of what enables a reduction in auto use (Chatman 2014).
2. **Use the Tobit estimation results shown in Table 4.2 (using the model for metropolitan areas) to predict net VMT change controlling for other factors.** We set the average income for low-income households at \$25,000 (the midpoint of the lowest income group), and for high-

income households at \$125,000. Note that the control variables do not need to be fixed at any particular value because the Tobit model is linear in parameters. In other words, there is no need to assume anything about household size or other characteristics of movers, given the model form.

With these assumptions and methods, we estimate the impact of displacement on regional VMT to range between zero effect (using a Tobit model on the CHTS data) and a reduction of 22% (using a Tobit model on the NHTS data) (see Appendix S, Table S.5). These results illustrate that a displacement of this type (of an equal number of higher income households moving in, and poorer households moving out) would not result in an increase in VMT regionally if the model results are generalizable.

However, note that a different kind of displacement in which a smaller number of high-income households displaced a larger number of low-income households, could in fact increase VMT on net simply by decreasing the total number of households with access to rail. This could happen if higher-income households took more space in new developments that consolidated or replaced denser housing near a rail station. Thus in a second stylized scenario, we assume that 1,000 low-income households are displaced by 500 high-income households (Appendix S, Table S.6). In this case the net regional VMT impact estimate ranges from a reduction of 7% to an increase of 23%. Clearly, the actual pattern of displacement will play a potentially large role in whether gentrification leads to a decrease or increase in regional VMT. In the next section we consider four additional scenarios of neighborhood change using census data to illustrate this point more explicitly.

Gentrification/displacement scenarios based on census data

We applied the same method to four census tracts near rail stations, three in the Bay Area and one in Los Angeles. Instead of using the continuous income models shown in Table 4.2, we used the threshold income models shown in Table 4.3, because these models had greater statistical significance for Los Angeles and because we wanted to apply region-specific estimates to carry out the scenarios. We identified the four census tracts using an online tool created as part of this research project (and described elsewhere in this report) which enabled us to find examples of census tracts with rail stations that experienced increases in the share of higher-income households between 1990 and 2013.

For the purpose of this next set of estimates we used numeric income midpoint values to generate average VMT. “Low-income households” are defined as those earning below 80% of the county median household income, according to 1990 Decennial census data and the 2009-2013 American Community Survey (ACS) (see Appendix S, Table S.7). We defined the income of this group of people as the midpoint between \$0 and the dollar amount representing 80% of median household income (this midpoint was about \$20,000 in both metro areas). We defined higher-income (or “non-low-income”) households as having income equal to 50% above the 2013 county median adjusted to 2010 dollars (which was about \$80,000 in both metro areas). For the San Francisco Bay Area estimates, however, the household income assumption is irrelevant because in the Bay Area models we did not find any evidence of any difference in the VMT impact of rail access according to household income. But for Los Angeles the assumptions matter, since as we showed above, the VMT impacts of changes in population in the Los Angeles model results are partly dependent on the particular income levels of the population shifted in and out of rail station areas.

For our scenario analysis, we made the simplifying assumption that the added households in a tract moved from a location far from rail to a location close to rail, and that any reduction in the number

of households in the tract moved to a location far from rail. In other words, changes in the number of households by income category are considered moves into or out of a rail-proximate area, rather than as changes in income among resident households. We estimated regional changes in VMT between 1990 and 2013 assuming that 1990 travel patterns are consistent with findings from the contemporary CHTS and NHTS data. Because in actual fact vehicle use was substantially lower in 1990, our estimates could arguably be better understood as likely region-wide VMT impacts that would be caused by rapid gentrification in such a census tract in the region between, for example, 2008 and 2013.

Our first example is the census tract adjacent to the Hollywood/Western metro station, census tract 1905.10, in Los Angeles County (Table 4.4, part 1). The share of low-income households in the tract decreased between 1990 and 2013, from 78% to 69%, with an absolute reduction of 48 low-income households and an increase of 172 higher-income households. This neighborhood is a mixed-use area and had median household income below the county average in 2013, but a greater share of non-Hispanic whites and fewer households with children compared to county-wide shares. Table 5 shows the rough estimated change in aggregate VMT between 1990 and 2013 using the assumptions described above, and this change ranges from a VMT decrease of between 16% and 33%.

Our second example is census tract 5019 in San Jose, which has experienced increased densification around a transit station, for both low-income and higher-income households. San Jose has experienced an all-time high for housing costs while wages for low-income workers remain stagnant. New residents are more likely to be single or not have children, be highly educated, and earn higher salaries, but the tract has not experienced displacement, which is sometimes attributed to San Jose's anti-displacement policies and rent-stabilized units. From 1990 to 2013, this gentrifying tract gained 411 low-income households and 931 higher-income households. The VMT scenario estimates range from a reduction of 30% to a reduction of 36%, with one estimated reduction of 16.3% being statistically insignificant.

Our third example is a census tract (5003), also located in San Jose, which lost 190 low-income households and gained 447 higher-income households. Table 4.4 suggests that regional VMT would decrease about 19% to 25% overall after such displacement (with one estimated decrease of 10.32% being statistically insignificant). An increase in VMT due to lower-income households moving away from the rail station is more than made up for the decreases in VMT by higher-income households moving near rail. Note that in the case of San Jose specifically, given the low level of rail service available here, it is possible that VMT may not be much affected by rail access. But our sample sizes with these data do not allow us to estimate VMT impacts below the metropolitan area level.

Our final example is census tract 20,1 located in San Francisco's Mission District, a neighborhood that is often used as the face of gentrification. Despite the decreasing share of low-income groups between 1990 and 2013, over that period of time the tract gained low-income households, as well as higher-income households. Like the densification story of our second example (tract 5019), this example results in an estimated decrease in regional VMT ranging from 31% to 41% , with one reduction of 15.4% being statistically insignificant.

Table 4.4: Example scenarios showing estimated change in VMT in selected gentrifying census tracts

Census Tract 1905.10, Los Angeles County, California				
Change in Low-Income Households Near Transit (1990-2013)			-48	
Change in Non-Low-Income Households Near Transit (1990-2013)			172	
Aggregate VMT	Uncontrolled Analysis		Tobit Models ¹	
	NHTS	CHTS	NHTS	CHTS
1990	14,136.80	8,824.36	12,097.56	6,454.07
2013	10,470.08	7,366.20	8,652.68	4,262.90
% VMT changes	-25.94%	-16.52%	-28.48%	-33.95%
Census Tract 5019, Santa Clara County, California				
Change in Low-Income Households Near Transit (1990-2013)			411	
Change in Non-Low-Income Households Near Transit (1990-2013)			931	
Aggregate VMT	Uncontrolled Analysis		Tobit Models	
	NHTS	CHTS	NHTS	CHTS
1990	81,712.99	62,762.21	82,369.33	47,167.75
2013	56,446.20	39,652.18	68,927.32	29,958.65
% VMT changes	-30.92%	-36.82%	-16.32%	-36.48%
Census Tract 5003, Santa Clara County, California				
Change in Low-Income Households Near Transit (1990-2013)			-190	
Change in Non-Low-Income Households Near Transit (1990-2013)			447	
Aggregate VMT	Uncontrolled Analysis		Tobit Models	
	NHTS	CHTS	NHTS	CHTS
1990	36,816.18	28,064.98	37,974.69	20,438.55
2013	29,088.84	20,788.29	34,054.04	16,378.64
% VMT changes	-20.99%	-25.93%	-10.32%	-19.86%
Census Tract 201, San Francisco County, California				
Change in Low-Income Households Near Transit (1990-2013)			600	
Change in Non-Low-Income Households Near Transit (1990-2013)			440	
Aggregate VMT	Uncontrolled Analysis		Tobit Models	
	NHTS	CHTS	NHTS	CHTS
1990	52,799.60	40,483.60	54,341.95	29,769.24
2013	36,244.80	25,560.80	45,980.12	17,599.44
% VMT changes	-31.35%	-36.86%	-15.39%	-40.88%

¹ VMT estimates come from income category regression coefficients by the household income values and rail proximity, holding other independent variables at mean values (see article text). Note that the difference in values drives the net effect of each scenario. Since the regression models are linear in parameters, this difference does not depend on values of the other independent variables in the model.

These stylized displacement scenarios certainly fail to account for more complex real-world phenomena. For example, perhaps displaced households drive more after they move, at least for a while, in order to maintain social ties and participate in activities in their previous neighborhoods. And the dynamics of displacement go beyond income and include other factors that we cannot easily control for here. But we know of no strong reason to know whether such phenomena lead to either underestimation or overestimation of likely VMT impacts of gentrification and displacement. The direction of error is uncertain.

Chapter 4 Discussion and Conclusions

The central question of this chapter was to determine whether the presence of rail reduced VMT more or less for lower-income households than for higher-income households, and to provide an informed discussion of how neighborhood gentrification and displacement might therefore influence regional VMT. The limited amount of previous research on this question had not found much evidence that households of different income levels were more or less responsive to transit access. Such evidence would provide a new reason to fear gentrification and displacement, because it would imply that the intended environmental benefits of TOD programs are precarious. But our results suggest this fear is largely unwarranted, though further research would be helpful.

We used two different data sources and looked at pooled data for the major metropolitan areas in California as well as looking at the 9-county San Francisco Bay Area and the 5-county Los Angeles metropolitan area separately. Almost all results suggest that rail access affects VMT about the same regardless of income, if it affects VMT at all. In about half of the models, using mainly the less-reliable of the two datasets, we find a differential effect of rail access by income. Regardless of dataset or region, the results suggest that one-to-one displacement of middle-income households (between \$25,000 and \$75,000 in income) by high-income households (those earning more than \$100,000) will either reduce VMT or have no significant effect on VMT. We also found some evidence that very-low-income households (below \$25,000 in income) reduce their VMT in response to rail access more than middle-income households do, but this evidence is from the NHTS dataset which has small numbers of middle-income households living near rail. Finally, it is important to note that some of our model results implied that rail access has no independent impact on VMT, and therefore that gentrification and displacement near rail stations will have no impact on GHG reduction.

We note that concerns about TOD-caused gentrification may be over a much more spatially-specific and policy-specific phenomenon than simply rail proximity, our focus here. But the policy landscape in California and elsewhere does privilege proximity to rail or other high-quality transit, making these results clearly policy-relevant. Any more-narrowly tailored research question is also of smaller potential magnitude and importance than the question we have focused on here, and more difficult to empirically investigate because of sample size problems with existing data.

The second focus of the paper was to construct plausible scenarios of VMT changes associated with neighborhood change and displacement in specific rail-proximate census tracts between 1990 and 2013. In all of these scenarios, we found reductions in regional VMT, for two reasons. First, as already noted, most of the data analysis suggests that higher-income households reduce their VMT more in response to rail proximity than do lower-income households. Second, census tracts near rail stations that underwent gentrification in California between 1990 and 2013 also typically increased in population. Any increase in the number of households having proximity to rail will tend to reduce regional VMT, in cases where rail access is substantial enough to reduce household reliance on auto use, or in TOD areas that have low parking levels, high density, and other characteristics that support good transit access. Thus, we do not find evidence that most kinds of gentrification and displacement around rail stations would increase VMT regionally, even if it does increase local VMT generation within rail station areas.

As noted, the analysis also provides some evidence that some kinds of neighborhood change could cause regional VMT to increase. For example, in Los Angeles, a pattern of one-to-one displacement of low-income households (those making less than \$25,000 per year) by moderate-income

households (those making between \$25,000 and \$75,000 per year) could increase VMT. These statistical results, found in NHTS data only, are our most questionable due to a small sample size for moderate-income households living near rail stations. But the result is intuitively reasonable due to the built form and land use policies in the Los Angeles region. In particular, there has until recently been very little relaxation of parking standards in Los Angeles for either new development or redevelopment near rail stations, suggesting that proximity to rail may have little effect on auto use among households who can afford to own autos.

In some cases, anti-displacement policies may have helped rail station areas (particularly, areas with high transit accessibility and high driving costs) to retain lower-income households, or to densify rather than displacing households, without dampening housing production there. Our analysis suggests that such policies would have clear regional VMT benefits. However, given the likely household income profile in California urban areas, our analysis also suggests that a policy that reduced market-rate housing development in locations that encourage lower auto use, even if the policy reduced displacement and preserved affordable housing, would likely result in a net regional increase in VMT compared to a policy that increased the production of (dense) housing near transit.

Finally, the regional VMT impacts of population changes near rail stations critically depend on whether rail-proximate neighborhoods have low parking, high density, and other built environment factors that we were not able to control for in these data (Chatman 2013). Regardless of household income level, rail access is likely not the most critical factor in determining how much households reduce their auto use when they move into and out of rail station areas.

Future refinements to this analysis, which were not possible for us to complete given the scope and timeline of the larger research project for the California Air Resources Board, could include several tasks. First, it would be helpful to investigate a larger number of neighborhood-change scenarios to give a more context-specific sense of the conditions under which gentrification is likely to lead to regional increases in VMT, and even to estimate in what share of tracts statewide these results would predict VMT increases to occur. Second, our models allowed for an interaction of income and rail proximity but did not similarly investigate other interactions. Specifically, we did not investigate whether the effect of rail access varies according to household size, whether rail access effects are influenced by neighborhood population and employment density levels, or whether effects vary by rail service type. (We expect that some of these analyses would yield statistically insignificant results due to small subsample size.) Third, the use of “sample selection” models in addition to the Tobit and OLS estimates we carried out would provide an additional technical robustness check on the validity of these results. However, we expect such models to yield very similar results.

Chapter 5: Anti-Displacement Policy Analysis

Mitchell Crispell¹, Karolina Gorska², Miriam Zuk¹, Karen Chapple¹,
Anastasia Loukaitou-Sideris², Silvia R. González², Somaya Abdelgany¹

¹ University of California, Berkeley

² University of California, Los Angeles

Acronyms Used in This Chapter

- ABAG (Association of Bay Area Governments)
- ACE (Altamont Commuter Express)
- ACS (American Community Survey, U.S. Census)
- ACTC (Alameda County Transportation Commission)
- AMI (Area Median Income)
- CASP (Cornfield Arroyo Seco Specific Plan)
- CBA (Community Benefit Agreement)
- CBO (Community-Based Organization)
- CCDC (Chinatown Community Development Corporation)
- CHPC (California Housing Partnership Corporation)
- CMA (Community Management Association)
- CPIO (Community Plan Implementation Overlay)
- EIR (Environmental Impact Review)
- HCD (California Department of Housing and Community Development)
- HUD (U.S. Department of Housing and Urban Development)
- LAANE (Los Angeles Alliance for a New Economy)
- MTC (Metropolitan Transportation Commission)
- OBAG (One Bay Area Grant)
- PDA (Priority Development Area)
- RHNA (Regional Housing Needs Assessment)
- SCS (Sustainable Communities Strategies)
- SDC (System Development Charges)
- SEACA (Southeast Asian Community Association)
- SNAP (Station Neighborhood Area Plan)
- SRO (Single-Room Occupancy)
- Thai CDC (Thai Community Development Corporation)
- TIF (Tax Increment Financing)
- TLC (Transit for Livable Cities)
- UNIDAD (United Neighbors in Defense Against Displacement)

Chapter 5 Table of Contents

Chapter 5 Introduction and Methodology.....	184
Anti-Displacement and Housing Affordability Policies: Literature Review.....	185
Research Methodologies.....	185
Gaps in the Literature.....	186
Approaches to Evaluation.....	186
Discussion of Policies in the Literature.....	186
General Conditions for Implementation and Effectiveness in TOD Neighborhoods.....	194
Statewide Affordability and Anti-Displacement Policies.....	196
State Affordable Housing Funding.....	196
State Laws That Enable or Limit Localities' Anti-Displacement Policies.....	199
Housing Affordability and Anti-Displacement Policies in the Bay Area and Los Angeles County....	200
Bay Area.....	201
Los Angeles County.....	204
Comparison Between Bay Area and Los Angeles.....	205
Addressing Displacement in Transit-Oriented Development.....	206
Planning for Transit Oriented Development in the Bay Area.....	207
Los Angeles Station Neighborhood Area and Planning Guidelines.....	211
Prevalent Policies That Aid in Addressing Transit-related Displacement.....	214
Inclusionary Housing/Zoning.....	214
Condominium Conversion.....	221
Rent Control in the Bay Area.....	225
Mobile Home Rent Control in Los Angeles.....	228
Case Studies.....	229
Chinatown, San Francisco.....	231
East Palo Alto, San Mateo County.....	237
Diridon Station Area, San Jose.....	241
Chinatown, Los Angeles.....	246
Hollywood/Western, Los Angeles.....	250
103rd St./Watts Towers, Los Angeles.....	254
Chapter 5 Conclusion.....	259

Many different anti-displacement and affordable housing policies exist at the city, regional, and state level. This chapter first summarizes the policies and programs available to combat displacement and then assesses which Bay Area and Los Angeles cities offer them. It then examines the potential of regional planning, specifically, station area planning and incentive programs related to the Sustainable Communities Strategies, to mitigate displacement. The chapter concludes that although some mechanisms exist to mitigate displacement, little is known about their effectiveness and in any case, implementation is weak.

Chapter 5 Introduction and Methodology

Many different policies and programs can mitigate the displacement impacts of transit investment-induced gentrification. The following presents a discussion of different housing affordability and anti-displacement policies, as well as an inventory of the policies that exist in the 89 jurisdictions of Los Angeles County and the 109 jurisdictions of the 9 county Bay Area. The purpose of the inventory is to highlight and better understand the policies that can promote affordability or mitigate displacement of vulnerable populations in gentrifying neighborhoods. Where possible, we highlight policies that have been effective specifically in transit neighborhoods. We describe the most common housing affordability and anti-displacement policies and analyze, as well as compare, the policies of both regions.

In what follows, we first offer an overview of the multitude of anti-displacement policies encountered in cities across the country and a review of the literature on anti-displacement policies, as a way of introducing the policies and discussing how other scholars and practitioners write about them. Next, we provide an overview of anti-displacement policies in two metropolitan regions: the San Francisco Bay Area and Los Angeles. Given the potential for displacement around fixed-rail transit stations, we next include a section on anti-displacement policies specific to transit-oriented development (TOD), before turning our attention to specific policies that, while benefitting transit regions, are not explicitly targeted towards them.

We discuss four specific policies: inclusionary zoning and condominium conversion ordinances, because of their prevalence in Los Angeles and the Bay Area; rent control, because of its importance in the anti-displacement discourse, effectiveness, but lack of prevalence and state-imposed limitations; and mobile-home rent control ordinances, because of their prevalence in the Los Angeles region.

To understand how such strategies work at a finer grain, we provide six case studies of specific neighborhoods that, in most cases, have experienced gentrification pressures but less gentrification than expected (as determined by our analysis in Chapter 2)—three in each region. In the Bay Area, we discuss neighborhoods in Chinatown in San Francisco, East Palo Alto, and San Jose. In Los Angeles, we discuss Chinatown, Hollywood/Western, and 103rd St./Watts Towers. Our conclusions appear in the last section.

In terms of methods, this report relied on literature review and secondary data analysis, as well as primary data from surveys and stakeholder interviews. We reviewed both academic and practitioner literature on anti-displacement strategies. For secondary data, we used Decennial Census and American Community Survey (ACS) data from the U.S. Census as well as various other datasets. A survey on the effectiveness of anti-displacement strategies was sent to staff at all of the planning departments in the Bay Area as well as housing-related community-based organizations

(CBOs); we refer to responses from this survey as “stakeholder” comments. Finally, we conducted interviews with many stakeholders, including community advocates, staff of community organizations, and individuals involved with local, regional, and state policy.

Anti-Displacement and Housing Affordability Policies: Literature Review

The emphasis of this literature review is on residential anti-displacement and housing affordability policies.¹ While the existing literature does not provide a systematic assessment of the effectiveness of anti-displacement policies, the metrics, conditions needed for success, and methods of evaluation used in the various studies are useful to our analysis.

Research Methodologies

In general, the literature on anti-displacement policies can be classified into three categories of research methodologies: 1) policy toolkits; 2) case studies; and 3) analysis and evaluation of a specific policy.

The policy toolkit is a particularly popular format among practitioners, in which authors outline an array of policies that cities could implement, describing how they work and giving brief examples of their implementation in various neighborhoods or cities. (Allbee et al. with ChangeLabSolutions 2015; Great Communities Collaborative 2007; Policy Link 2008a). These inventories group certain policies together, often distinguishing between policies that preserve existing affordable housing (subsidized or market-rate affordable) and those that produce new affordable housing. Discussion around the different strategies considers how they are financed, what challenges they face, and where they are most appropriately applied.

A second category of research presents detailed case studies of cities or geographic contexts from which lessons can be drawn. Some focus on just one study area, providing a comprehensive list of anti-displacement policies that have been implemented there or highlighting one of its programs that was particularly successful. Another variation of the case study compares and contrasts policies in two or more places. Comparative studies may assess the performance of similar policies in two cities and pinpoint unique factors that affected their respective success rates. Other studies consider multiple neighborhoods experiencing gentrification pressures and draw conclusions about policy implementation more generally.

Finally, a third category of studies focuses on a specific policy. These studies tend to focus on places where the policy was implemented, and seek to provide a critical analysis of the effectiveness of the policy. This category is most useful in outlining the strengths and weaknesses of policies or sets of policies used in tandem.

¹ This literature review is focused on residential displacement; a separate suite of policies is available to address commercial displacement. While a wealth of studies have focused on residential gentrification and displacement, very few scholars have examined commercial gentrification. As a result, the literature on policies addressing commercial gentrification and displacement is largely nonexistent.

Gaps in the Literature

Gaps in the literature include the relative absence of discussion of unsuccessful policies (negative case studies) or examples of policy limitations or misapplications. This is probably due to the fact that most of the anti-displacement literature is action-oriented, and often written by policy centers to help policy makers with future implementation. Therefore, studies are often written prospectively—they diagnose an ongoing problem and propose solutions moving forward (for example, Pollack et al. 2010), as opposed to retrospectively, giving a critical analysis of a problem, the solutions put forward, and their effectiveness at addressing the problem.

Approaches to Evaluation

A number of quantitative metrics, or indicators, emerge from the literature that can be used to evaluate the effectiveness of certain policies. We discuss three here.

A common measure is the number of housing units preserved or developed, and is most useful for evaluating preservation and production strategies. Studies that present the numbers of units preserved or created as a proportion of the larger housing stock show the relative contribution of a specific policy given the scope of the problem. However, authors frequently present such data.

A second metric is the level of affordability of housing units. Different anti-displacement policies are targeted toward or end up benefitting households at different income levels; therefore, this metric estimates the number proportions or residents of different income levels benefitting from a specific policy. This is most useful for evaluating production strategies.

Other studies focus on qualitative approaches. Authors use qualitative sources, such as government records, focus groups, and interviews, to identify contributors and barriers to success and to detail recommendations for a particular study area. This is a good approach for improving a policy that has already been implemented, or has widespread support.

Lastly, several studies take a historical approach, tracing the impact of a certain set of policies, usually in a specific place (Calavita et al. 1997; Furman Center for Real Estate and Urban Policy 2006). These studies provide greater insight into the potential trajectory of certain policies over an extended period of time, distinguishing between short-term and long-term solutions.

Discussion of Policies in the Literature

Anti-displacement policies found in the literature can be grouped roughly into four categories: those that produce new affordable housing, those that preserve existing affordable housing, those that protect tenants, and those that build the assets of low-income residents (Table 5.1).

Table 5.1: Affordable Housing and Anti-Displacement Strategies

Affordable Housing Production Strategies
<i>Fiscal Strategies</i>
Affordable housing impact fees
Jobs-housing balance or commercial impact fees
Community benefits agreements
Housing production trust funds
<i>Taxing Powers</i>
Tax exemptions for non-profit affordable housing
Levying parcel taxes, tax-increment financing districts
Bonds
<i>Land Use Controls</i>
Expedited permitting processes for affordable housing
Reduced parking requirements for affordable housing
Inclusionary housing/zoning
Density bonus in exchange for building affordable units
Accessory dwelling units
<i>Assets and Investments</i>
Public land dedicated to affordable housing
Land banking
Preservation Strategies
Rent stabilization/control
Condominium conversion ordinances
No-net-loss, one-for-one replacement strategies
Single-room occupancy hotels rent and conversion controls
Mobile home rent controls
Tenant protections and support
Rental assistance
Tenant counseling
Proactive code enforcement
Just-Cause eviction policy
Tenant right to purchase laws
Asset Building and Local Economic Development
Minimum wage
Wage theft protections
Local or first source hiring ordinances
Individual development accounts
Homeowner assistance programs
Housing rehabilitation funds

Affordable Housing Production Strategies

Restricting the production of affordable housing are several factors. High land costs, exacerbated by competition among developers (market-rate and affordable), further drive up production costs. Infill development, while incentivized through state programs, is more expensive, and can be difficult in terms of navigating regulations. Further, according to a non-profit developer, staffing is “inelastic:” it’s hard to compete with market-rate developers with more money.

Cities have a number of tools at their disposal to influence the quantity of affordable housing in their neighborhoods, including fiscal strategies to generate resources for development, land use

policies to incentivize or prioritize certain types of developments, and public investments that can be tied to affordability requirements.

Fiscal Strategies

Numerous jurisdictions have used development fees and transaction fees to generate funds from the private housing market as a means to creating affordable housing. Examples of these include affordable housing impact fees, jobs-housing balance or commercial impact fees, community benefits agreements, and housing trust funds.

One Oakland expert sees impact fees as a policy that is “starting to catch on” given legal limitations on inclusionary zoning; impact fees provide an alternative way to generate affordable housing at a cost to market-rate developers. While less common, commercial impact fees are also emerging. One development fee program that has enjoyed notable success is Boston’s commercial linkage fee program (Kim 2011). This program raises about \$5-\$7 million a year for housing, funding the creation or preservation of more than 8,500 units of affordable housing in projects throughout Boston from 1983 to 2011 (Kim 2011). The strength of the program is attributed in part to its “breadth of coverage.” Tied to all private commercial development, “everything from university projects to hospital expansions trigger the linkage ordinance,” so the City of Boston has a steady revenue stream each year (Kim 2011 p. 42).

When impact fees are in place, jurisdictions can further facilitate production by granting developers an exemption from affordable housing projects. For example, the City of Portland requires that developers pay system development charges (SDCs) to help offset a project’s impact on the city’s parks and recreation facilities, storm water and sanitary sewer systems, water systems, and street infrastructure (Kim 2011). They offer exemptions to SDCs for affordable housing projects, and the cost savings can add up to hundreds of thousands of dollars. As of 2011, the exemption had “reduced development costs for more than 2,225 units of affordable housing” (Kim 2011 p.27).

Another key tool for affordable housing production are housing trust funds. These funds are created by local or state governments as a pool of fees and taxes derived from real estate development (or other sources) that can be drawn upon to provide gap financing for the preservation or new construction of affordable housing (Calavita and Grimes 1992). One of their useful features is that, once established with their criteria for distributing monies, new sources of revenue into the fund can be approved—and the resulting funds distributed—without a whole new advocacy push around what to spend the funds on.

The importance of a housing trust fund was underscored by an expert interviewed, who believes that, in terms of revenue-generating policies (like commercial impact fees), “it’s very rare that any of those fees or policies by themselves can really stimulate production. What you need is a trust fund that has multiple sources that feed into it.”

Taxing Powers

A city’s taxing powers can also be used to create an affordable housing fund or incentivize development, such as providing property tax exemptions for non-profit owners of affordable housing, levying a parcel tax or floating bonds to generate funding for affordable housing, or

creating tax increment financing (TIF) districts² to generate revitalization funds by borrowing against future improvements in land value.

One study looks at New York City's "Ten Year Plan" launched in 1985, which called for the building and rehabilitation of 100,000 units of affordable housing by non-profit and private developers, funded through bonds, the city's capital budget, and other state and federal sources (Furman Center for Real Estate and Urban Policy 2006). It was largely successful: by 2003, the city "had created over 34,000 affordable units through new construction, had restored nearly 49,000 affordable units through the gut rehabilitation of formerly vacant buildings, and had provided renovation subsidies to another 125,000 units of distressed and occupied buildings" (Furman Center for Real Estate and Urban Policy 2006 p.6). The authors find several factors to have enabled the plan's success: "the income mix of households; the focus on preservation and neighborhood revitalization; the cooperation with local institutions; and the overall level of public commitment" (Furman Center for Real Estate and Urban Policy 2006 p.8).

The City of Portland has also made significant gains by implementing TIF districts, which allocate 30% of funds to the city's designated urban renewal areas for the development and rehabilitation of affordable housing (ChangeLabSolutions et al. 2015, Kim 2011). The TIF funds have income guidelines that prioritize the city's most economically vulnerable populations. In the 2012-2013 fiscal year alone, the Portland Housing Bureau was able to use \$28 million of TIF funds in order to create or preserve 959 units throughout the city (ChangeLabSolutions et al. 2015).

Land Use Controls

Cities' land use control and zoning powers are often used to incentivize the production of affordable housing by reducing costs through expediting permitting processes, reducing parking ratios, and easing other requirements that increase development costs. Land use controls can also be used to create inclusionary housing requirements on market-rate developers, requiring that a certain fraction of the units they develop be affordable.

Our literature search using the key words "anti-displacement strategies" and other related terms turned up multiple studies on inclusionary housing—far more than for any other policy (Schuetz et al. with Furman Center for Real Estate and Urban Policy 2007; Hickey 2014; Non-Profit Housing Association of Northern California 2007; Hickey et al. 2014). This could indicate the effectiveness or ubiquity of inclusionary housing in light of the lack of other financing mechanisms for the production of affordable housing. However, it more likely indicates how intricately the policy is tied to anti-displacement work; municipalities tend to implement inclusionary housing in a real estate market experiencing significant growth and development, where households are at risk for displacement.

The Furman Center for Real Estate and Urban Policy (2007) has looked at inclusionary zoning policies across the United States and found that specific factors can predict the adoption of inclusionary zoning policies: "larger, more highly educated jurisdictions and those surrounded by neighbors with inclusionary zoning are more likely to adopt such policies." They find that the policies that produce the most units are those that have been in place the longest (Furman Center

² While the elimination of redevelopment agencies has made this strategy impossible to utilize in California, a recent law signed by Governor Brown enables localities to establish "community revitalization investment authorities" (Young 2015). These will allow tax increment financing districts, albeit in a more limited capacity than were allowed under the former redevelopment agencies.

for Real Estate and Urban Policy 2007, p.4). In some California cities, state legislation is the primary motivation for the adoption of inclusionary housing policies. For example, a survey by Calavita and Grimes (1998) found that eight jurisdictions in San Diego County implemented inclusionary housing programs to avoid actual or perceived threats of litigation due to noncompliance with the state's Housing Element Law.

Advocates of inclusionary housing often cite California as a success story because so many cities have adopted ordinances, but the data shows that the number of below-market units actually built resulting from the policy is modest in comparison to regional housing needs (Powell and Stringham 2006). For example, Powell and Stringham point out that the Association of Bay Area Governments estimated the need for 133,195 affordable units in the San Francisco Bay Area during the 2001-2006 period, but in the 30-plus years of inclusionary zoning leading up to 2006, the policy had resulted in the production of only 6,836 affordable units. Thus, much of the literature asserts that inclusionary housing should continue to be part of an overall affordable housing strategy but not necessarily the core of it (Calavita et al. 1997, Powell and Stringham 2006).

As opposed to requiring affordable units (either directly or through in-lieu fees), some cities choose to incentivize them through density bonuses. California's Density Bonus Law requires that municipalities allow developers to build at higher density in exchange for affordable units (APA 2006). Density bonuses act as a cost off-set and can increase the number of inclusionary units in new developments, specifically in cities where there is significant market interest in developing taller buildings (ChangeLabSolutions et al. 2015). For example, New York City rezoned a number of locations to allow for higher density and provided a strong density bonus for developers that agreed to meet specified affordability targets. The program generated about 2,700 permanently affordable rental units between 2005 and 2013 (ChangeLabSolutions et al. 2015).

However, without the proper market, incentives alone may not be enough to produce affordable units (Schwartz et al. 2012). For example, the City of Cambridge, Massachusetts, had a voluntary inclusionary zoning program that offered density bonuses, and over the course of a decade, the program failed to produce a single unit. In 1998, the program was made mandatory, and as a result, it produced 385 affordable rental and for-sale homes by 2010 (Schwartz et al. 2012).

For built-out areas that may lack sufficient developable land for new units, jurisdictions may consider allowing homeowners to create accessory dwelling units on their property, as enabled by the state Second Unit Law (AB 1866). Chapple et al. (2012) discuss how the creation of secondary units (known as "in-law" or "granny" units) helps increase the stock of very-low- and low-income housing units without dramatic increases in parking demand and with no government investment required. This in turn, "could help to free up such scarce (and dwindling) monies for the subsidization of the lowest-income affordable developments" (p. 12). Through a qualitative review of planning and zoning restrictions, they found that the regulatory environment, with its onerous parking requirements, is the most significant barrier to secondary unit development.

Assets and Investments

Finally, cities can use their assets and investments to generate new affordable housing. Affordable housing advocates are beginning to push jurisdictions to dedicate land they own for affordable housing (Hickey and Sturtevant 2015a; Lane and Seifel 2015). Cities can also invest in land that they later open up for affordable housing development, a process known as land banking. In addition to owning a lot of land, cities continually invest in infrastructure and operate other programs that can be leveraged to create affordable housing.

For example, Hickey and Sturtevant (2015b) discuss policies to use public lands for the development of affordable housing in the Washington, D.C., region. They find that the “strongest” policies have much community engagement and are conscious of the limits of the policy, namely that other subsidies will be necessary for affordable housing to be built beyond just providing the land. They offer recommendations of how to maximize policies’ effectiveness, admonishing policymakers to understand the “relationship between land values and the affordability gap” so that they are aware exactly what kind of difference the land donation would make for developers of affordable housing (Hickey and Sturtevant 2015b, p.1).

In another study prepared for HUD, Sage Computing (2009) discusses the successful use of land banks to simultaneously revitalize abandoned properties and provide affordable housing. The study describes the work of the Fulton County/City of Atlanta Land Banking Authority, which prioritizes the transfer of land for affordable housing development, enabling community development corporations and other affordable housing developers to acquire tax-delinquent properties with insurable title at below-market prices for affordable development. The authority facilitates the transfer of 50-100 properties per year, and as of 2009, affordable housing groups had identified over 140 parcels to bank for future development. The land bank is also part of the Atlanta TOD Collaborative, a 13-member partnership of local non-profits, developers, banks and government agencies aimed at promoting equitable TOD in the Atlanta region (“Atlanta TOD Collaborative,” n.d.). The group was established in 2011 to leverage their joint resources to create affordable homes for low-income residents near transit, and it has conducted strategic planning, market, and feasibility studies since then to guide their future development efforts (“Atlanta TOD Collaborative,” n.d.).

One expert interviewed saw a connection between community land trusts and the “tiny home” movement: holding land in a community trust and allowing the construction of cottages on that land could provide an “eco village” of affordable homes.

Recognizing that the boom period will likely be followed by a downturn, several stakeholders have said that cities should be ready to strike quickly when that downturn comes, buying up land for later development, or getting anti-displacement policies in place when the political temperature isn’t so high.

Preservation Strategies

In many built-out neighborhoods experiencing gentrification pressures, there may be little room for new developments. Therefore, strategies for preserving both deed-restricted affordable units and naturally occurring affordable rental units are needed to counteract displacement forces in these communities. Rent stabilization is perhaps the most well-known strategy used to control the price of non-subsidized rental units, often tying it to inflation rates. Other strategies used in high-demand markets are controls for condominium conversions, adopting no-net-loss or one-for-one replacement policies to ensure that the quantity of affordable units are maintained, and laws that aim to preserve single-room occupancy hotels and mobile homes.

Of the policies discussed in this report, rent control has yielded the most literature with critical analysis. Writing primarily from an economics framework, numerous scholars have undertaken analyses of rent control, generally concluding that it reduces the quality and quantity of rental housing (Keating et al. 1998). They argue that when landlords cannot earn a competitive return on

rents, they under-maintain their units and look for more profitable uses, exacerbating the rental housing shortage (Keating et al. 1998). The less rental housing and the greater the rent gap between regulated and unregulated units, the less mobility renters have (Freeman and Braconi 2004; Munch and Svarer 2002; Keating et al. 1998; Gyourko and Linneman 1989).

However, other scholars point out that the benefits of rent control may outweigh the cost of market distortions in the context of gentrification and displacement. Freeman and Braconi (2004) posit that the limited mobility caused by rent control may be a logical trade-off in gentrifying areas because it allows vulnerable residents to stay in their neighborhoods by moderating their rent burdens. For example, rents for unregulated units in gentrifying neighborhoods of New York between 1996 and 1999 increased by an average of 43.2%, while rents for regulated units increased by only 11.4% (Freeman and Braconi 2004). Ellen and O'Flaherty (2013) also suggest that rent control can contribute to population stability and security of tenure in the face of displacement pressures. For example, 35.2% of renting households in New York stayed in the same unit from 1990 to 2000, while nationally, 13.6% stayed in the same unit (Ellen and O'Flaherty 2013). Minton (1996) prospectively evaluates the potential of targeted rent control to limit displacement in soon-to-gentrify neighborhoods, finding that rent control, in the short run, would have winners and losers: helping low-income renters to afford to stay in their neighborhood while distorting the housing market, which in turn creates an incentive for landlords to use unsavory methods to remove tenants and win a higher return. He also considers the long-term effects, which range from halting gentrification entirely to full gentrification, when the policy fails to preserve a low-income community in a neighborhood.

Barton's (1998) historical account of strong rent control in Berkeley concludes that its undoing was less economic than political. The policy was established at a time of rapid rent increases in the Bay Area, and while Berkeley also suffered a decline in low-rent units, its decline was half the rate of the Bay Area as a whole and half the rate of Alameda County (Barton 1998). The initial strong policy successfully increased community stability and tenure for low-income households. However, Barton also takes note of its limitations: 70% of the lowest-income residents still shouldered rent burdens greater than 30% of their income, insufficient staff hindered efficient implementation, and controls were gradually loosened over time because of strong landlord resistance at the local and state levels.

The effectiveness of rent control laws depends significantly on the specifics of the policy and the market. For example, ordinances that include vacancy decontrol provisions "reduce the number of affordable units over time" because each time a tenant moves out, the rent can increase to the market rate (Levy et al. 2006, p.17).

In California, due to the Costa-Hawkins act, passed in 1995, all rent control ordinances must allow for vacancy decontrol. This gives landlords an "incentive to push out tenants, which can lead to unjust, or no-fault evictions" (Great Communities Collaborative 2007, p.4). The law also makes it impossible for jurisdictions to pass rent controls on any units built after 1995, on single-family homes, and on condominium units (Portman and Brown 2013).

Tenant Protections and Support

Another important tool to stabilize gentrifying communities is sufficient protections for tenants and homeowners to be able to stay in their homes. These can run the gamut from providing rental assistance and tenant counseling to proactive code enforcement and requiring landlords to have a “just cause” when trying to evict tenants.

The Harrison Institute for Public Law (2006) studied Washington, D.C.’s tenant purchase law, coming out generally in support of the policy: it has “been the catalyst for preserving thousands of affordable homes in Washington, D.C., often in neighborhoods that have been undergoing gentrification”, “has preserved hundreds of units” of low-rent housing, and has allowed “low-income residents to purchase homes” (p. 2). The authors also offer a detailed critique of the law’s shortcomings and a set of recommendations. Through qualitative research, they identify “areas of concern”, including poor data management, lack of resident familiarity with the policy, the availability of technical assistance, and availability of funding.

Winstead (2006) discusses barriers to the tenant protection movement in Richmond, CA. He concludes that the lack of hard evidence of a tightening in the rental market and the difficulty of obtaining evidence of unjust evictions pose the greatest obstacles. Because of the evidence gaps, there is no public sense of “crisis” around rental housing in Richmond, which makes it difficult to garner political support for greater tenant protections. Winstead argues that advocates should focus on the implementation of a well-written just-cause ordinance that would include record-keeping provisions to make further action to protect tenants much easier. He also notes that a tenant protection campaign in Richmond centered on just cause would receive less opposition from landlords and property owners than one pushing for rent control (Winstead 2006). In general, experts argue that without a just-cause evictions policy in place, other preservation strategies will not work, because landlords can remove tenants very easily. It is very difficult to win against landlords in places without these policies, because any challenge to the landlord could result in eviction—forced or through raised rent—and it is hard to prove retaliation.

Asset Building and Local Economic Development

In addition to working on maintaining a sufficient affordable housing stock, jurisdictions can also support their residents by increasing their capacity to obtain housing. A diverse array of asset building and local economic and workforce development programs have been implemented around the country. These include the ever-growing movement to increase the minimum wage, implementing strong wage theft protections, and local or first-source hire ordinances that require a certain percentage of workers to be from the local disadvantaged community (PolicyLink 2015). Other asset-building strategies such as individual development accounts, homeowner assistance programs, and housing rehabilitation funds, among many others, are necessary elements to a comprehensive community stabilization strategy.

Minimum wage as an asset-building strategy has many ends: improving personal well-being, enhancing economic security, increasing civic behavior, and more (Page-Adams and Sherraden 1997). As such, the literature on minimum wage and similar strategies is not explicitly focused on addressing displacement, but scholars writing inventories of anti-displacement policies frequently include minimum wage in their lists because it may allow residents to build sufficient assets to be able to stay in an ascending neighborhood. However, minimum-wage policies have also received scrutiny. For example, there are many studies that evaluate the effects of minimum-wage laws on

levels of employment (Doucouliagos and Stanley 2009), and others on the number of hours worked (Couch and Wittenburg 2001).

Lester's (2009) study challenges this criticism, finding that a living-wage law is unlikely to harm a city's economic development prospects and is the only tool that individual jurisdictions can effectively use to address rising income inequality. He finds that living-wage laws not only provide direct wage increases for workers, but they may also help raise wage standards across the sector due to competition among firms for workers. In San Francisco, living-wage advocates explicitly linked wages and with ongoing debates around land use and displacement. Pitching their argument in terms of the high cost of living in the city contributed to their success in passing legislation (Lester 2009).

Whatever the efficacy of income- and wealth-building strategies, stakeholders interviewed emphasized that they must be linked to anti-displacement policies that target housing costs in order to address the affordability crisis effectively.

General Conditions for Implementation and Effectiveness in TOD Neighborhoods

The conditions for policy effectiveness and implementation are an important component of policy analysis that several authors have undertaken. Levy (2006) discussed tactical barriers to policy implementation, such as the requirement that they be enacted by legislation, market considerations, like the importance of a strong housing market for certain policies, and barriers to effectiveness once implemented, like what level of affordability a policy creates. She provides a good precedent for analysis, as she first outlines the policy, describes "anticipated outcomes," "implementation challenges," and also includes "timing considerations" that focus on which policies are best suited to which market conditions and which gentrification phases.

In interviews, stakeholders pointed out that the context of the city matters tremendously in terms of which policies work best. For example, a production strategy in San Francisco with little available land for development will look different from one in San Jose that has more land available for development; renter protection policies are only useful in places with many renters; the effectiveness of a density bonus will depend on the density limits currently in place, as well as market demand in the locality. One stakeholder put it this way:

I think the more you try to drill down the more context-specific it gets. So in general terms rent control and tenant protection and condo controls, all those things make sense. But, well, what's the right condo policy to have? Or how exactly should you write your rent control ordinance? What Richmond just adopted is very different from what Oakland has, for example.

Most of the literature reviewed does not include a discussion of political barriers or a policy's likelihood of being implemented based on how liberal or conservative a city and its elected officials are. Ellen and O'Flaherty (2013) examined whether New York's progressive housing policies may be due to the city's more liberal electorate, but rejected that hypothesis on the basis that other similarly liberal cities are lacking similar policies. Levy (2006) also considered the political barriers to implementing various strategies, but more generally and less along a "liberal-conservative" spectrum.

Others, like Marcuse (2004), considered political forces broadly, discussing ideological barriers to reforming housing policy, such as a “tendency to focus on the market and ignore non-market participants’ concerns” (p. 3). Goetz (1994) finds that non-traditional economic development policies and progressive housing policies (defined as those that are not directly in line with business interests) are more widespread than previously believed, and are in place not only in strong market cities, but often “in an environment of uneven development. Cities that are characterized by the existence of both wealth and poverty are engaging in progressive policy” (Goetz 1994, p. 103). Political culture and community mobilization are also “positively associated with alternative development policy” (Goetz 1994, p. 100). These variables, plus a good bond rating, are correlated with progressive housing policies as well (Goetz 1994).

At the same time, an ideology that favors real estate interests may obstruct anti-displacement policies in many cities: as one stakeholder argued in an interview, “...people think that people should be able to make as much money as they want.” Besides this pervasive ideology, stakeholders described the “real money” of developers as an obstacle to winning more anti-displacement protections. Given the often-changing cast of elected officials, politicians are less likely to remember to enforce an old agreement than they are to focus on the next big campaign issue (“political memories are short”); slowing development is viewed unfavorably to say the least; and many of these policies invoke the specter of anti-capitalist intentions, which inflame the opposition.

Incentives (like density bonuses) are easier than requirements (like inclusionary zoning) to get through the political process. While some stakeholders believe that housing preservation policies (like rent control) are easier to pass because they require minimal public outlay of funds, others think it is easier to come out in favor of housing production strategies, since doing so does not challenge property rights and is not seen as anti-development like preservation strategies sometimes are.

Stakeholders agreed that some of the barriers to local anti-displacement policy implementation can only be resolved with a state-level legislative fix. Examples include the Ellis Act, vacancy decontrol, and inclusionary housing, the latter two of which we discuss in more detail later in this chapter.

Behind the policies and strategies listed above often lie an informed and organized resident base and a robust community engaged decision-making process. For example, Howell highlights the importance of a strong, engaged non-governmental sector in a case study of neighborhood change in the Washington, D.C. neighborhood of Columbia Heights (2013). Her results indicate that planners “seemingly nailed the punch list for redevelopment”—including ensuring that new housing included low-income units, helping tenants purchase their homes, preserving existing affordable housing, and more—all of which worked to some extent (Howell 2013, p. 11–12). However, even with the city’s many interventions, displacement has still occurred and “low income residents’ sense of community, political power, and access to amenities changed significantly” (Howell 2013, p. 11–12). Findings indicated that it was “the work of tenant organizers, affordable housing developers, policy advocates” and the like that have “driven the effort to preserve neighborhoods” (Howell 2013, p. 16). Another case study of Vancouver goes over several neighborhoods that should have experienced gentrification but did not because strong community resistance held off the market and “[denied] the opportunity for gentrification to occur on these development sites” (Ley and Dobson 2008, p.2484).

Anti-displacement efforts in the context of transit neighborhoods have a particular set of challenges. Although some housing production policies target the areas around transit stations, for instance by requiring inclusionary housing or purchasing land, it is rare to find targeted

preservation policies. One challenge specific to TOD is the way in which transit agencies interpret the Federal Transit Administration’s requirement that federal fund be used for the “highest and best transit use”(PolicyLink 2008). The common approach is to pursue development that generates the most revenue. However, advocates can make the case that low-income residents use transit more than high-income residents, so location affordable housing near transit can increase ridership, another element of the “highest and best” use (PolicyLink 2008). Also important is community engagement during all phases of the TOD planning process and the introduction of anti-displacement efforts early on before land prices around transit rise (Ibid.). Community development corporations can proactively lead TOD partnerships and develop projects of their own. For example, in Chicago, the community development organization Bethel New Life launched a series of development projects around the Lake Pulaski transit stop in partnership with the Chicago Transit authority, producing 50 homes for low- and moderate-income residents and planning for 66 more in the future (PolicyLink 2008). Community benefit agreements can also be used to achieve anti-displacement and affordable housing protection around TOD projects (Ibid.). For instance, the Ballpark Community Benefits Agreement (CBA) in San Diego includes a provision that requires and funds studies of how the development will impact land prices and low-income residents (Ibid.).

Statewide Affordability and Anti-Displacement Policies

Before discussing local policies, we provide an overview of the relevant statewide affordability and anti-displacement policies. The primary role the state plays in anti-displacement policy is in funding affordable housing and providing the policy backdrop against which local governments are able to act.

State Affordable Housing Funding

On the production side, the significant expense of building or rehabilitating a single unit of affordable housing means that it is very difficult to fund projects solely from local dollars. Instead, developers rely on state and federal low-income housing tax credits, which are both administered by the state. Wegmann estimates that “63% of the average affordable rental housing project” in an array of projects in the Bay Area he analyzed “is financed by state and federal sources, with the remainder coming from local, rent-supported, and philanthropic financing” (see Table 5.2; Wegmann 2012, p.8).

California has a variety of programs that fund affordable housing, including the Multifamily Housing Program (through the state’s Housing and Community Development department), the new Affordable Housing and Sustainable Communities funding (through the Strategic Growth Council), the Affordable Housing Program (through the Federal Home Loan Bank) and several other programs. In addition, it administers the federal Low-Income Housing Tax Credit Program—usually the largest source of funds in a project—through the Tax Credit Allocation Committee. Localities administer HUD programs, like Community Development Block Grants and HOME funds. A detailed discussion of these programs is beyond the scope of this chapter.

Table 5.2: Federal and State Funding Available for Affordable Rental Housing Development in the Bay Area

	2010 Estimated 9-county Bay Area share (mm)
Federal - off balance sheet	
4% Low Income Housing Tax Credits (includes CA state tax credits)	\$163
9% Low Income Housing Tax Credits (includes CA state tax credits)	\$176
Federal Home Loan Bank Affordable Housing Program (AHP)	\$14
Federal – appropriations	
Project-based Housing Choice Vouchers (HCV)	\$114
HUD Section 202 capital expansion	\$19
HUD Section 811 (Capital Advance and PRAC)	\$6
CDBG	\$37
HOME	\$64
State	
Multifamily Housing Program (MHP) from Prop 1C	\$15
Infill/Infrastructure program from Prop 1C	\$55
MHSA	\$9
CALReUSE	\$1
Total	\$673

Source: (Wegmann 2012)

The competitive 9% tax credit program (see Table 5.2 above) receives requests double the amount of funding available (Schwartz 2015). This means that, even if local governments dramatically increased their funding of affordable housing, more projects would not get built, since they rely so much on the tax credit funds.

The state’s investment in affordable housing has been decreasing steadily in recent years, even as the state faces a shortage of 1.5 million homes affordable to very- and extremely-low-income households (California Housing Partnership Corporation 2015).

As Figure 5.1 shows, the most dramatic change was the elimination of state funding for redevelopment agencies. These agencies managed redevelopment areas in which they were able to retain new property taxes generated as an area was revitalized, and use these funds to support affordable housing and other investments (Taggart 2012). The agencies were eliminated in 2012 after a legislative act and court decision. Almost every stakeholder we have spoken with has cited the loss of redevelopment as a major barrier to local cities’ funding affordable housing: of a sample of 27 projects in the Bay Area, “about 26% of the [non-state and federal] funds contributed...originated from redevelopment” (Wegmann 2012).

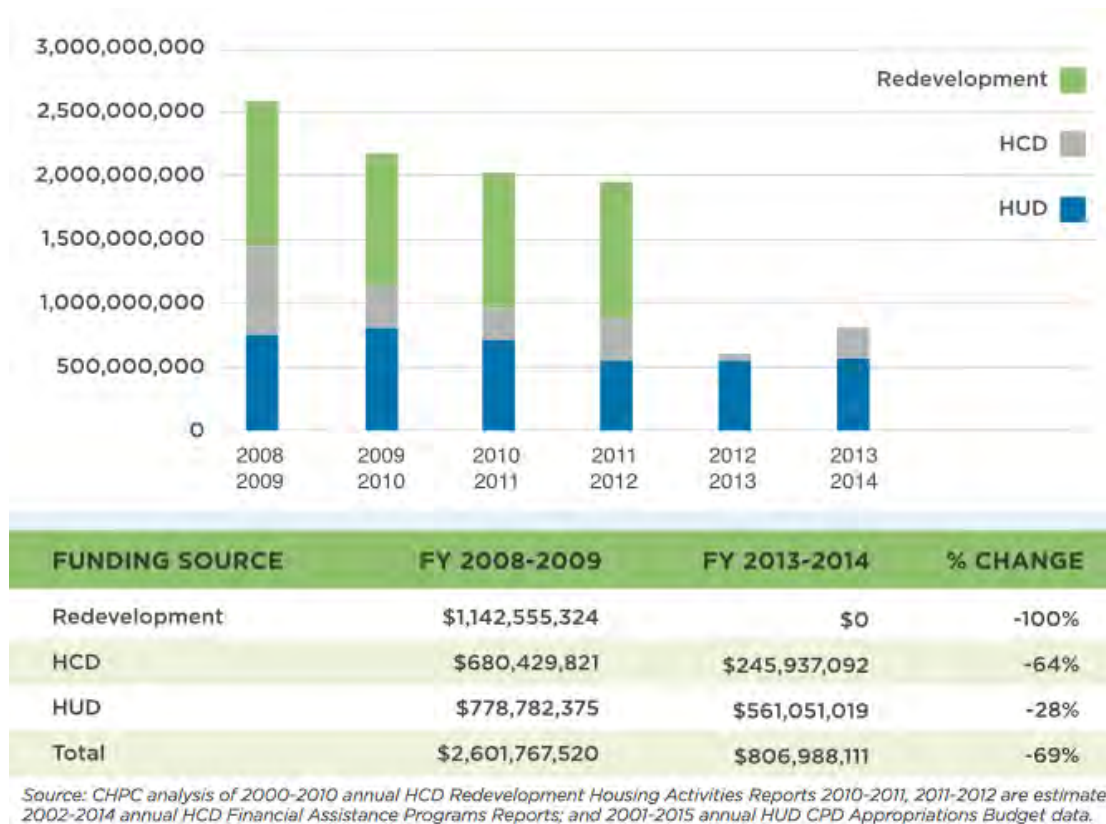

Figure 5.1: State and Federal Investment in Affordable Housing (from the California Housing Partnership Corporation (CHPC))
 Source:(CHPC 2015)

One example of the interplay between state and local governments in financing affordable housing is with the way tax credits are allocated. According to a long-time employee of state housing agencies, the City of Los Angeles is considered its own region and receives its own allocation of tax credits (interview with authors). This was motivated by the city’s construction of new transit stops, and its interest in targeting its affordable housing dollars towards those areas. The city and state tax credit agency worked together to create the new region (with “Balance of Los Angeles County” a region for the rest of the county besides the city). This arrangement allows the city to effectively control which projects its tax credit funds will flow to (through its control of the flow of predevelopment financing, which is essential for developers to have in order to be able to apply for tax credits). The decision was and is controversial, but could be effective as another tool to address transit-related displacement. Making decisions about the location of such developments and how those projects are integrated within the community is typically considered an appropriate role for localities.

The chief challenge at the state level, according to several experts, is the opposition of the incumbent governor, Jerry Brown, who has taken several steps in recent years to dismantle affordable housing programs, like the redevelopment agencies and an inclusionary zoning “fix” bill.

Ideas for state-level policy changes are numerous and beyond the scope of this project to detail. However, the CHPC suggests the following (2015, p.8):

- Create an “ongoing, predictable revenue source for the state housing trust fund with a \$75 document recording fee on real-estate transactions (excluding commercial and residential home sales).”
- Expand the state’s Low Income Housing Tax Credit by \$300 million per year and make it easier to use.
- Invest in the existing Multifamily Housing Program from the general fund.

These policies would not specifically target transit-oriented development areas, but they would help affordable housing developers who are attempting to develop affordable housing near transit; development in these areas is encouraged by other state affordable housing programs, like tax credits and the new Affordable Housing and Sustainable Communities program. Therefore, expanding these complementary programs indirectly helps produce affordable housing near transit.

State Laws That Enable or Limit Localities’ Anti-Displacement Policies

In terms of encouraging anti-displacement planning, the state requires that all local governments compose Housing Elements that include plans to address affordable housing needs. They must also report on prior progress towards reaching goals.

One aspect of these plans must be how the locality plans to preserve housing that is at-risk of conversion from affordable to market-rate—a major concern for the state (California Department of Housing and Community Development 2014).

On the other hand, several other aspects of state law limit localities’ ability to mitigate displacement. The Costa-Hawkins bill, passed in 1995, limits the scope of local governments’ rent control and inclusionary zoning policies; the effects of this bill on local anti-displacement policies are discussed more below (Great Communities Collaborative 2007).

Other barriers at the state level include changing voter thresholds for communities that want to raise their own funds. Currently, housing bonds must clear 67% of the vote. Since this is challenging for many cities, experts suggest reducing the threshold to 55%, the level required for school facility bond measures. However, this change has not yet succeeded at winning approval of the legislature (interview with authors).

To address the loss of subsidized housing to the market, the tax credit state agency is currently considering including a right of first refusal for the state in their regulatory agreements with owners of tax credit-funded projects. This would allow the state to have the first right to buy the property (at set prices, like the remaining debt on the project plus taxes owed) if ever the partnership that owns it wants to sell. That right would be assignable, allowing the state to allow a non-profit developer, for example, to step in and buy it to keep it affordable. According to a long-time state housing agency employee, this would allow the state to purchase the property at a reasonable price and then preserve the affordability of the housing in the future (interview with authors).

The federal Department of Housing and Urban Development (HUD) recently released a new rule on affirmatively furthering fair housing, which the state of California and local jurisdictions will have to comply with as they distribute affordable housing financing (Fluit 2015). Cities will have to submit detailed reports on their plans to, and progress in, addressing segregation and access to

high-quality affordable housing for low-income households (Semuels 2015). This has several implications for anti-displacement work. It could force localities to focus more on ensuring low-income households can stay in, or move to, moderate- and high-income areas. In terms of transit areas, if an affordable developer is proposing a new development before the area has gentrified, the new rules could make it more difficult for the city to grant that funding, since those funds would be going to build housing in a low-opportunity area. However, cities may be able to show how they expect the area to gentrify in coming years, and invest proactively to retain low-income households in the midst of that change. In sum, this rule change will probably encourage agencies that distribute HUD funds to focus their efforts in places that are experiencing displacement, either already high-income or gentrifying.

Housing Affordability and Anti-Displacement Policies in the Bay Area and in Los Angeles County

To construct an inventory of anti-displacement policies in the Bay Area and Los Angeles, we first reviewed anti-displacement toolkits and policy documents to generate a comprehensive list of strategies, considered by advocates, researchers, and policy makers as efforts to mitigate displacement (see Appendix T for sources). From an initial list of about 50 policies, we applied the following criteria to select policies to inventory:

1. Policies that are applied uniformly to the jurisdiction as a whole (i.e., not only restricted to specific neighborhoods).
2. Policies that have been implemented in at least two jurisdictions, but not all.³
3. Policies that have “teeth” and are being implemented.

A list of 14 anti-displacement policies was generated (Table 5.3)⁴. Researchers then analyzed municipal codes and housing elements for each of the jurisdictions in the Bay Area and Los Angeles County, which was complemented in the Bay Area with data from a survey of housing policies completed by the Association of Bay Area Governments (ABAG) (2015). Note that policies specific to transit-oriented development areas are discussed in a later section; these policies are citywide.

³ Policies that are required by all jurisdictions, such as the Density Bonus or Secondary Units, were not included because we wanted to focus on policies that went over and above the state law.

⁴ Neither the UC Berkeley nor ABAG inventories included Affordable Housing Trust Funds; an alternative data source was found to inventory these policies in the Bay Area and Los Angeles (*Center for Community Change 2015; Center for Community Change 2013*).

Table 5.3: Anti-Displacement Policies in the Bay Area and Los Angeles County

	Policy	Number of Bay Area Cities/ Counties with Policy	Percent of Bay Area Cities/ Counties (Total = 109)	Number of Los Angeles Cities/ Counties with Policy	Percent of LA Cities/ Counties (Total=89)
<i>Preservation Strategies</i>	Just-Cause Eviction Ordinance	7	6%	5	6%
	Rent Stabilization or Rent Control	9	8%	4	4%
	Rent Review/Mediation Boards	14	13%	2	2%
	Preservation of Mobile Homes (Rent Stabilization Ordinance)	34	31%	16	18%
	SRO Preservation Ordinance	28	26%	4	4%
	Condominium Conversion regulations	73	67%	24	27%
	Foreclosure Assistance	45	41%	1	1%
<i>Affordable Housing Production Strategies</i>	Housing Development Impact Fee (or Jobs-Housing Linkage Fee)	24	22%	3	3%
	Commercial Linkage Fee/Program	27	25%	3	3%
	Affordable Housing Trust Fund	15	14%	8	9%
	Inclusionary Zoning/Housing	78	72%	16	18%
	Local Density Bonus Ordinance (above state requirements)	19	17%	7	8%
	Community Land Trusts	26	24%	1	1%
<i>Asset-Building and Local Economic Development Strategies</i>	First Source Hiring Ordinances	17	16%	1	1%

Source: UC Berkeley and UCLA Internal Analysis; Association of Bay Area Governments 2015; Center for Community Change 2015; Center for Community Change 2013

Bay Area

Anti-displacement policies are found in roughly equal measure across the nine counties, with the exception of Solano and Sonoma Counties. Inclusionary zoning and regulation of condominium conversions are the most prevalent policies in the Bay Area. Most of these policies were adopted in the early 2000s, with some adopted in the 1980s and 1990s. On the other hand, rent control can be found in only nine jurisdictions in the Bay Area, which were all adopted in the early 1980s.⁵

One indicator of the extent of anti-displacement policies is the number of policies per city (Table 5.4). Alameda rises to the top as the county with the most policies per city, at six, after San Francisco (where the sole City of San Francisco has implemented 12 of the 14 policies). Besides San Francisco, the cities with the most policies in place are Berkeley and East Palo Alto (11 policies each), Oakland (10), Cupertino, Hayward, and Petaluma (nine each), and Alameda and San Jose (eight each).

⁵ The city of Richmond passed a rent control ordinance in August 2015 (Ioffe 2015).

Table 5.4: Anti-Displacement Policies/Programs by County

County	# Cities in County	# Policies - Total	Average # Policies per city (Total Policies/ # Cities)
San Francisco	1	12	12
Alameda	15	87	6
Sonoma	10	48	5
Santa Clara	16	74	5
Napa	6	24	4
Contra Costa	20	62	3
San Mateo	21	63	3
Marin	12	33	3
Solano	8	15	2

Source: UC Berkeley internal analysis. Note that policies in unincorporated parts of each county are also included in these figures.

Geographically, the cities with the most anti-displacement strategies cluster together: San Francisco, Berkeley, Oakland, Alameda, Hayward, and San Leandro, with two exceptions: Petaluma (7 policies) and East Palo Alto (12 policies) (Figure 5.2).

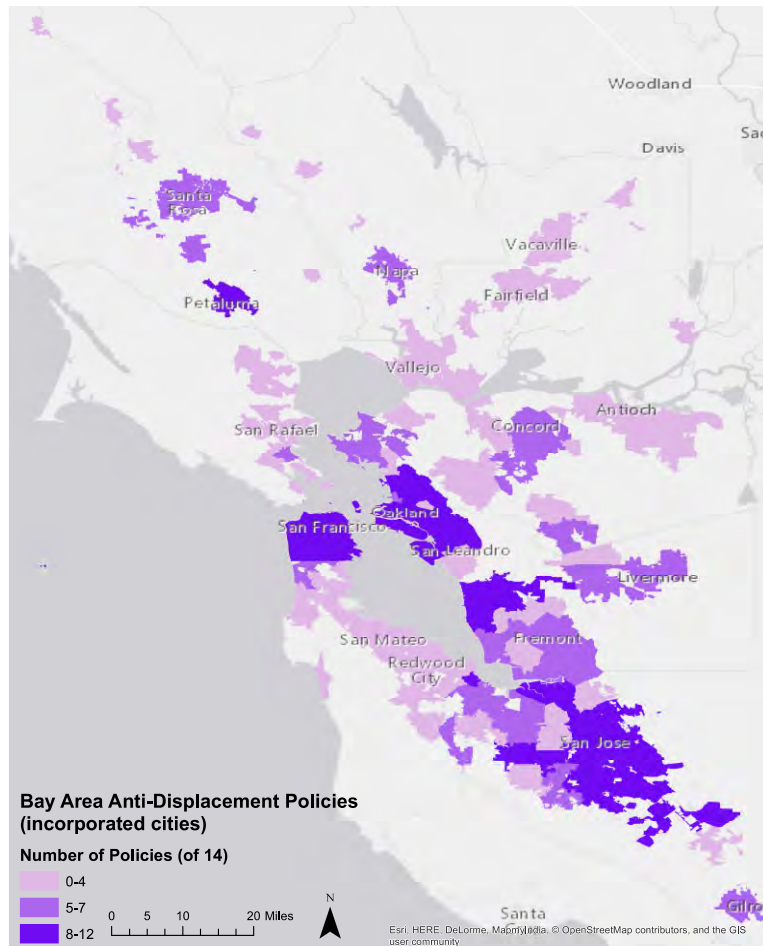

Figure 5.2: Number of Anti-Displacement Policies by City

Source: UC Berkeley Internal Analysis; Association of Bay Area Governments 2015; Center for Community Change 2015; Center for Community Change 2013

Nearly all these cities have BART stations. In terms of specific policies, most do not display a geographic pattern, with a few exceptions. There is a concentration of the following two policies in the South Bay: Community Land Trusts and Affordable Housing Impact Fees (or jobs-housing fees). Few peninsula cities have mobile home rent control policies in place, despite a need for them there, according to stakeholders.

Past and Future Affordable Housing Production

Using housing production figures that cities must report as part of their Regional Housing Needs Allocation (RHNA) requirements, it is possible to see how different cities perform based on whether they have each of the production policies considered here⁶. In terms of the production of very low-income (30-50% area median income (AMI)) housing, we found that, of Bay Area cities, those with each of the production strategies produce more total units (on average, and per capita) than those without each strategy (except for community land trusts) (Table 5.5). This could mean that cities that build more are then more likely to adopt production strategies, or that the causation is the reverse: cities with the strategies produce more affordable housing because the policies are working.

**Table 5.5: Annual Average Housing Unit Construction per 10,000 People, Bay Area Cities, by Affordable Housing Production Strategy
(Average of Constructed Units 2007-2013 / Population in 2010 * 10,000)**

		Housing Development Impact Fee (or Jobs-Housing Linkage Fee)	Commercial Linkage Fee/ Program	Affordable Housing Trust Fund	Inclusionary Zoning/ Housing	Local Density Bonus Ordinance (above state reqs)	Community Land Trusts
Very Low Income	Without Policy	9.78	9.17	11.50	10.19	10.61	11.97
	With Policy	19.17	19.90	15.21	12.42	18.80	11.39
Low Income	Without Policy	9.02	8.49	8.30	7.51	8.38	8.56
	With Policy	5.43	7.48	7.64	8.51	7.42	7.29
Moderate Income	Without Policy	10.33	9.40	9.69	3.98	9.32	10.26
	With Policy	7.99	11.10	11.16	11.95	12.66	8.48
Above Moderate Income	Without Policy	54.80	47.04	61.17	27.98	55.52	56.00
	With Policy	91.84	111.00	80.29	75.60	105.01	83.77

Numbers in bold are where cities with the policy have, on average, higher production. Source: Internal policy inventory, combined with Regional Housing Needs Assessment progress from Bay Area Legal Aid, EBHO, and NPH.

⁶ The Regional Housing Needs Allocation is a “state-mandated process to identify the total number of housing units (by affordability level) that each jurisdiction must accommodate in its Housing Element” (Association of Bay Area Governments 2015). The state tells the Bay Area regional planning agencies how many units of housing at each income level they need to produce in an eight-year period. These agencies then distribute those units among the various jurisdictions, who are in turn required to modify their Housing Elements to be in compliance with these allocations.

Interestingly, the same pattern does not apply to low-income (50-80% AMI) housing; except for inclusionary zoning, cities without the policy produce more low-income housing than cities with the policy.

Finally, it appears that moderate (80-120% AMI) and above-moderate income production is dramatically higher in places with each policy than in places without them. One hypothesis for this finding is that cities that have the hottest real estate markets, where developing market-rate homes affordable to low-income people is difficult, are also the cities most likely to implement production policies. Further research is needed to investigate this, and also to examine to what extent the adopted policies are also being implemented.

A projection of affordable housing supply and demand found large gaps between housing needed and likely to be supplied by current programs (Wegmann 2012). About 70% of the demand will not be met by the projected supply—a striking conclusion.

Table 5.6 summarizes the analysis, and provides insight into the relative housing production potential of the suite of financing programs and inclusionary zoning: 27% of the projected units would be built through affordable housing finance, while 11% would be constructed through inclusionary zoning. The number of units represented by these figures would probably be lower now, with decreases in affordable housing funding and the legal conscription of inclusionary zoning (discussed below). However, even so, this analysis provides evidence that inclusionary zoning, in general, is likely to produce fewer units than affordable housing finance.

Table 5.6: Projected housing demand, supply, and shortfall for the nine-county Bay Area region

	Very Low Income	Low Income	Moderate
<i>affordability metric</i>	<i>dwelling units</i>	<i>dwelling units</i>	<i>dwelling units</i>
Increase in region-wide housing demand, 2010-2040	231,142	164,216	115,286
<i>Demand absorbed by:</i>			
Affordable rental housing production, 2010-2040	(23,359)	(16,829)	
Inclusionary Zoning housing production, 2010-2040	(4,620)	(7,712)	(3,366)
Habitat for Humanity housing production, 2010-2040	(1,799)	(1,799)	
Foreclosed inventory, 2010-2020	(9,707)	(24,938)	(23,345)
Increase in tenant-based Housing Choice Vouchers, 2010-2040	(30,458)	(1,078)	
Housing demand not met by supply	161,200 dwelling units	111,859 dwelling units	88,576 dwelling units
<i>As % of total</i>	70%	68%	77%

Source: Wegmann 2012. Wegmann's report includes detailed methodology for arriving at each of these figures.

Los Angeles County

As observed in Table 5.3, few jurisdictions have anti-displacement policies and strategies in Los Angeles County, and the vast majority of the 14 policies have only been adopted by a handful of cities. The most prevalent policies in Los Angeles County are condo conversion ordinances (27% of

cities have adopted them), mobile home preservation ordinances (18%), and inclusionary zoning ordinances (18%).⁷ Condo conversion ordinances first appeared in the Los Angeles region in the late 1970s and early 1980s (the City of Los Angeles adopted such an ordinance in 1980), and continued to be adopted throughout the 2000s, with the most recent adoption in 2014 by La Canada Flintridge. Eleven out of the 24 jurisdictions that have condominium conversion ordinances adopted them after 2000.

Sixteen out of the 89 Los Angeles County municipalities (18%) have a mobile home preservation ordinance, but only four municipalities (4%) have a rent control ordinance and only two municipalities (2%) have rent mediation boards. The four cities that have rent control ordinances are Los Angeles, Beverly Hills, Santa Monica (adopting its ordinance in the mid-1970s), and West Hollywood (adopting its ordinance in the mid-1980s). Cities with a rent mediation ordinance are Gardena and Culver City (both adopting their ordinances in 1987).

Table 5.7 shows which cities have the highest number of anti-displacement policies (three or more). The cities with the highest proportion of anti-displacement policies are: Los Angeles that has adopted nine out of the 14 policies (64%), Santa Monica and West Hollywood (50%), as well as Calabasas and Pasadena that have adopted six out of 14 policies (43%). See Appendix U for a list of the policies adopted by each of Los Angeles County's 89 municipalities.

Table 5.7: LA County Cities that have instigated 3 or more Anti-Displacement and Housing Affordability Policies

City	# Total Policies	% of Policies Adopted
Los Angeles City	9	64%
Santa Monica	7	50%
West Hollywood	7	50%
Calabasas	6	43%
Pasadena	6	43%
Beverly Hills	5	36%
Glendale	5	36%
Huntington Beach	4	29%
La Verne	4	29%
Long Beach	4	29%
Malibu	4	29%
Agoura Hills	3	21%
Claremont	3	21%
Hermosa Beach	3	21%
Los Angeles County	3	21%
Rancho Palos Verdes	3	21%

Source: UCLA Internal Analysis

Comparison between Bay Area and Los Angeles

In comparison with the Bay Area, fewer Los Angeles cities have anti-displacement or affordable housing policies (Figure 5.3). The policy differences between the two regions can be explained by several other differences between these regions: the two regions are politically different, and

⁷ 16 Cities (18%) have Inclusionary Zoning and/or In-Lieu Fees. However, La Verne only has Inclusionary Zoning in its Old Town Community Plan, while Malibu only has In-Lieu Fees (Ordinance 375), but not Inclusionary Zoning.

progressive policies are more easily adopted in the Bay Area, due in part to pressures from affordable housing advocates in the Bay Area. Also, geography matters: the supply of land is more limited in the Bay Area; therefore, the development of housing is more constricted and the magnitude of the affordable housing problem is greater compared to Los Angeles (interview with authors).

Another reason cited is that, although Los Angeles is extremely expensive, San Francisco has been the “ground zero” for affordability issues (with rents only rivaled by those in Manhattan). However, given lower incomes in Los Angeles, it is actually relatively less affordable than the Bay Area at this time. Therefore, it is not a simple issue of greater need in the Bay Area. An expert in the Bay Area explained the discrepancy thus:

“...I think the existence of so much progressive housing and urban policy here is the legacy of volunteers...it was San Francisco and Berkeley that had really strong tenant movements in the 60s and early 70s...I think cities tend to look at their neighbors and see what their adopting and when you get to some sort of critical mass, you know half the city is in the county, half these policies. Now you’re not sticking your neck out, you’re just doing what everyone else does.”

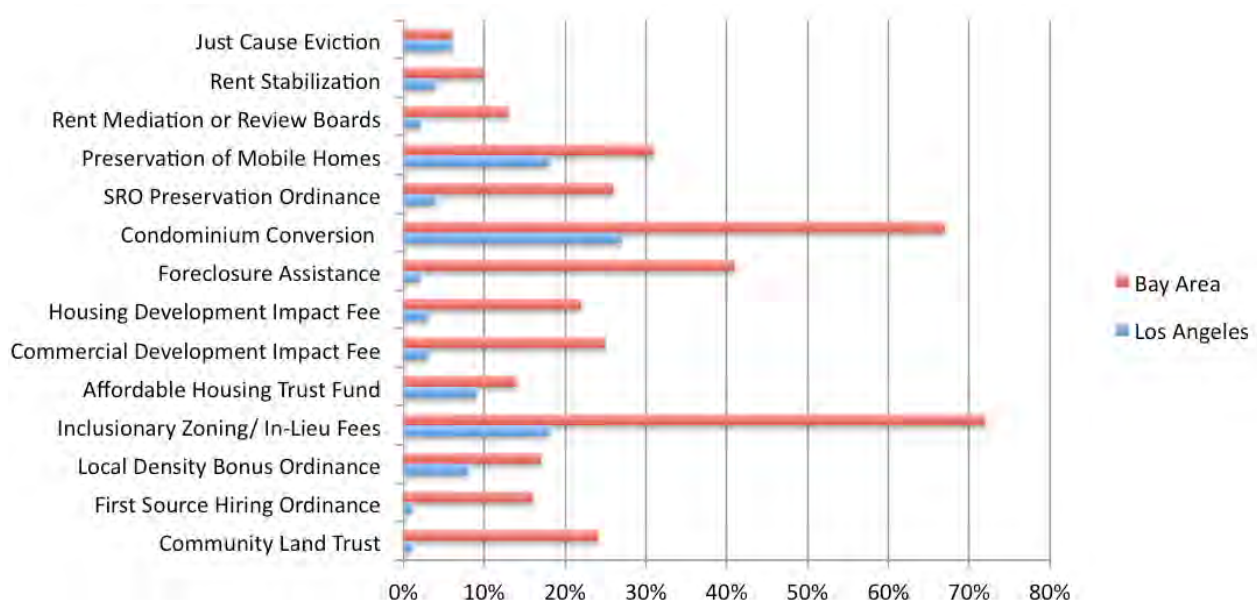

Figure 5.3: Comparison of the Proportion of Bay Area and Los Angeles Cities with Anti-Displacement Policies

Source: UC Berkeley and UCLA Internal Analysis; Association of Bay Area Governments 2015; Center for Community Change 2015; Center for Community Change 2013

Addressing Displacement in Transit-Oriented Development

Transit oriented development is defined as “a planning and design trend that seeks to create compact, mixed-use, pedestrian-oriented communities located around new or existing public transit stations” (PolicyLink 2008, p.1). A CHPC working paper clearly explains why there should be a focus on affordability near TODs (CHPC 2013).

1. Low-income people own fewer cars and use transit more.

- a. People with lower incomes are more likely to be transit riders, with households that earn less than \$20,000 per year using transit more than four times as much as higher-income groups.
 - b. Nationally, 48.5% of transit riders do not own a car, compared to the national average of only 6.1% of all American households that are carless, and low-income households are far less likely to own a car.
2. Proximity to transit is linked to increasing property values and rents, typically 10-20% above similar rental buildings that are further from transit.
3. New transit stations tend to attract new residents with higher incomes and higher car ownership.
4. Evaluations of smart growth plans that emphasize TOD and other infill development have found reduced affordability and loss of lower income households in TOD areas.

A common idea is to impose targeted policies in areas around transit stations. One expert is skeptical of this approach, however, unless the funds going to transit investments have anti-displacement provisions:

“Of course, then the question is what’s the radius that you want to define...I mean everybody let’s say oh within a mile or within a half-mile [of] the transit, and really the effects of our transit—it’s not a circle. It’s kind of...a snake that swallowed a rope with [a] big bulge and you go out along all the arterials that eat into the station. But however it gets defined, that could be one of the problems. Frankly, I think all of the money that’s tied into investments in transportation and close to transit stations needs to have strings attached to it that call for both some kind of anti-displacement policy (however those are defined) as well as some requirement for affordable housing (interview with authors).”

Planning for Transit Oriented Development in the Bay Area

The San Francisco Bay Area has a long history of developing policies to incentivize smart growth and TODs, some of which have explicitly addressed affordable housing and displacement. In this section we review some of these policies and how affordable housing and displacement risk have been incorporated into planning and project review, both at the local and regional level.

Background on Regional Smart Growth Planning in the Bay Area

Beginning in 1997, the Metropolitan Transportation Commission started the Transit for Livable Communities (TLC) program. TLC provided planning and capital grants for local transportation projects in downtowns, corridors, transit areas, and other activity centers, when they planned for higher-density housing and mixed-use development around transit. Since its inception, TLC has awarded over \$250 million in funds to better link land use and transportation decisions made by the region’s cities and transit operators (CTOD, CD+A, and Nelson Nygaard 2014).

In the early 2000s, ABAG, the Metropolitan Transportation Commission (MTC) and other regional agencies began to work together to formulate a regional Smart Growth strategy and developed the FOCUS program that promotes linkages between land use and transportation by encouraging development in key locations (CTOD, CD+A, and Nelson Nygaard 2014). In 2007, the regional agencies asked cities to select areas that they wished to prioritize for infrastructure grant funding, such as a downtown or a corridor, to promote infill development as part of the FOCUS program, which were called Priority Development Areas (PDAs). The criteria for identifying PDAs were that they be located in existing communities, where housing growth was expected, and near transit.

These areas, where cities had largely already planned future growth, then became eligible for planning grants, capital improvements, technical assistance, and other resources to support local governments and encourage TOD.

In 2008 California passed SB 375, directing regions to coordinate land use and transportation planning through the development of sustainable communities strategies (SCS) as part of its periodic Regional Transportation Plan. The SCS must also be consistent with state-mandated plans for ensuring that localities provide adequate housing for all income levels under the RHNA process. Grant funding and litigation provide the primary “carrots” and “sticks” for implementing these state goals.

When the Bay Area’s regional agencies set out to develop their SCS, known as Plan Bay Area and adopted in 2013, they used the pre-established PDAs as the guiding geography. Seventy-eight percent of future growth was directed towards PDAs. Although the implementation of the plan involves allocating transportation funding to projects consistent with the plan, they are largely coordinated through the county-level congestion management agencies that produce county transportation plans every two years and distribute funds to local jurisdictions (ABAG and MTC 2013).

Station Area Plans

Through MTC’s Station Area Planning program (which later became the Priority Development Area Planning), over 50 projects have been funded that include station area planning, funding for Environment Impact Reviews (EIRs) of plans, and in certain circumstances gap financing.

MTC began a station area planning program in 2005 in conjunction with the passage of the TOD policy that would apply to nine transit expansion projects covered under the Regional Transit Expansion Program, also known as Resolution 3434 of 2001 (MTC 2005). The TOD policy required that these plans include a minimum number of housing developments within a half-mile of the station along the corridors to ensure future growth in transit ridership, to make the investments cost-effective and to ease the Bay Area’s chronic housing shortage, among other goals. These housing thresholds were determined through a study of existing and potential levels of development in the corridors (CTOD, CD+A, and Nelson Nygaard 2014). If the corridors did not meet the thresholds (out of the nine, five projects did not meet them), they were required to conduct station area plans. Below-market-rate⁸ units were rewarded by receiving 50% bonus points toward the threshold minima. To be counted toward the threshold, planned land uses had to be adopted through general plans accompanied by the appropriate implementation processes, such as zoning codes.

In an evaluation of the TOD policy, consultants found through a stakeholder survey that despite the bonus points allocated to affordable housing “survey respondents did not feel that the Policy was effective in encouraging the inclusion of affordable housing opportunities within station areas. Most jurisdictions relied on their citywide affordable housing policies rather than making a specific effort to provide affordable housing within the station area plans” (CTOD, CD+A, and Nelson Nygaard 2014). In fact, the consultant team found that “Some jurisdictions feel that their citywide inclusionary ordinances are already near the tipping point of making housing development infeasible and imposing higher requirements for affordable housing in station areas would make transit-oriented housing infeasible. The City of San Jose actually exempted downtown areas from its

⁸ Defined in the policy as affordable to 60% AMI for rentals and 100% AMI for owner-occupied units.

citywide inclusionary housing ordinance, which had the effect of stimulating market-rate housing production around transit stations” (p.19).

In 2008, the station area planning program was expanded to allow areas participating in the FOCUS program to compete for funding. The FOCUS program was established by MTC and ABAG in 2007 to promote land use and transportation linkages by encouraging development in PDAs, which were defined by local jurisdictions as areas near transit that provided opportunities for future growth. At the same time MTC commissioned a Station Area Planning Manual from Reconnecting America in 2007 (Reconnecting America 2007). The manual identified different place types (e.g., city center and transit neighborhood) and attached suggested total housing unit targets for the half-mile radius around a station in each type of place, ranging from a low of 1,500 units for transit neighborhoods to 30,000 units for regional centers. According to stakeholders, these targets were very easy to reach as they were written very liberally to encompass a wide range of places. Also within the manual were suggestions for how to create opportunities for “affordable & accessible living” including a) the setting of affordable housing goals, b) consideration of inclusionary requirements, c) providing a range of housing options, and d) minimizing displacement of existing residents by analyzing and adopting policies where “appropriate and feasible” (p. 24). In addition, jurisdictions were encouraged to consider affordable housing financing mechanisms, including the targeting of existing programs to station areas.

The Station Area Planning program was later converted into the Priority Development Area program in 2012. Although MTC staff evaluated applicants based on the housing policies they required, it was not until 2012 that formal guidelines were distributed, which encompassed “Planning Elements” that MTC encouraged grant recipients to include (MTC 2012a). These elements included a section on “Affordable Housing and Anti-Displacement Strategy” (p.7-8), which involved the quantification of the affordable housing needs and identification of an affordable housing goal. In the identification of goals, jurisdictions were encouraged to consider “No net loss of affordability in the plan area”, to identify quantitative targets of affordable units, and to demonstrate consistency with RHNA numbers. Among the policies jurisdictions were encouraged to consider were: a) inclusionary housing, b) housing trust fund, c) reduced parking standards, d) rehabilitation programs, e) land trusts, f) foreclosure mitigation. To avoid displacing existing residents, the Plan Elements suggests the engagement of communities likely to be displaced, local economic development, and enhancement of community centers and facilities.

Of the 37 completed plans that were reviewed, 31 (84%) had quantified total housing unit targets, while 16 (43%) had quantitative affordable housing targets, usually in the form of a percentage of the total. In addition 14 (38%) plans mentioned displacement, some of which outlined potential efforts to mitigate it. The vast majority of plans, 31 (84%) included language on reduced or unbundled parking, either as a way to reduce costs, or increase transit ridership or non-motorized transit. In stakeholder interviews, MTC staff noted that although the plan elements were suggested to all grant recipients, they didn’t necessarily apply universally as some jurisdictions already covered many affordable housing policies through citywide policies or other plans. In addition, some of the funding went only to EIRs or partial grants for incomplete elements to pre-existing projects, making it difficult to modify plans that were already farther along.

Scoring Incentives through One Bay Area Grants

The One Bay Area Grant (OBAG) was the new funding approach to integrate the region’s federal transportation program with SB 375 to encourage land use and housing policies that support the production of housing with supportive transportation investments. In 2012, MTC established

criteria guidelines for how to allocate federal transportation money to the nine-county Congestion Management Associations (CMAs) (MTC 2012b). For FY2015-16, \$320 million was allocated to CMAs through the OBAG program, approximately 40% of total federal transportation funds that MTC distributed. With the guiding principle of “using transportation dollars to reward jurisdictions that accept housing allocation through the RHNA process and produce housing as well as promoting investments in PDAs” (MTC 2012d, p.2) the formula used to distribute OBAG funding to the counties takes into consideration the following factors weighted according to the percentages in parentheses: population (50%), past housing production (12.5%), future housing commitments as determined by the ABAG RHNA (12.5%) and added weighting to acknowledge very-low- and low-income housing production (12.5%) and future commitments (12.5%).

Each county CMA is then required to prepare a “PDA Growth and Investment Strategy” that includes selection criteria for OBAG grants. The purpose of the strategy is to ensure that CMAs have a transportation project priority-setting process for OBAG funding that supports and encourages development in the region’s PDAs. CMAs in larger counties were directed to spend at least 70% of their OBAG investments in PDAs or on projects connected to PDAs. In addition, jurisdictions were required to have an adopted and certified Housing Element to be eligible for OBAG grants. In developing their local funding guidelines for the competitive grants (accounting for approximately 50-75% of the OBAG grant money, which varied by county), MTC encouraged the CMAs to emphasize housing growth in PDAs, “favorably consider” projects located in Communities of Concern and in PDAs with “affordable housing preservation and creation strategies” (MTC 2012c, p.2). In a footnote, examples of such policies included: inclusionary housing requirements, city-sponsored land-banking for affordable housing production, just-cause eviction policies, policies or investments that preserve existing deed-restricted or “naturally” affordable housing, condo conversion ordinances that support stability and preserve affordable housing, and the like. (MTC 2012c, p.1)

Some CMAs used these suggestions from MTC directly when constructing their evaluation criteria for OBAG grants. For instance the Alameda County Transportation Commission (ACTC)’s first Investment and Growth Strategy of 2013 outlined a two-tier evaluation process. First projects were evaluated based on planning and development readiness, followed by a 100-point OBAG scoring and selection criteria. Projects could potentially receive nine out of 100 points for “Affordable Housing Preservation and Creation Strategies” such as “inclusionary zoning ordinance or in-lieu fee, land banking, housing trust fund, fast-track permitting for affordable housing, reduced deferred or waived fees for affordable housing, condo conversion ordinance regulating the conversion of apartments to condos, SRO conversion ordinance, demolition of residential structures ordinance, rent control, just cause eviction ordinance, or others” (ACTC 2013, pp. 3-13). In contrast the CMA of San Mateo awarded up to two out of 103 possible points for projects located in or near an “affordable housing PDA” (C/CAG 2014, p.46). Santa Clara County’s Santa Clara Valley Transportation Authority (VTA), on the other hand did not award any points for affordable housing (VTA 2014).

In a recent analysis of the first round of OBAG funding by the Great Communities Collaborative (Montejo 2015), researchers found that 61% of cities were allocated less funding than what was determined by their MTC formula share. Furthermore, Montejo found that on average, 51% of projects funded with OBAG grants were within a quarter-mile of affordable housing and only 21% were within a half-mile of both transit and affordable housing. According to the Great Communities Collaborative inventory of funding allocation and the number of anti-displacement policies we inventoried in each jurisdiction, the relationship appears weak at best. The jurisdiction with the highest number of anti-displacement policies (San Francisco) also received the largest amount of

OBAG grants. However, looking at the grant funding on a per-capita basis, there appears to be no correlation between the number of policies and funding received (Figure 5.4).

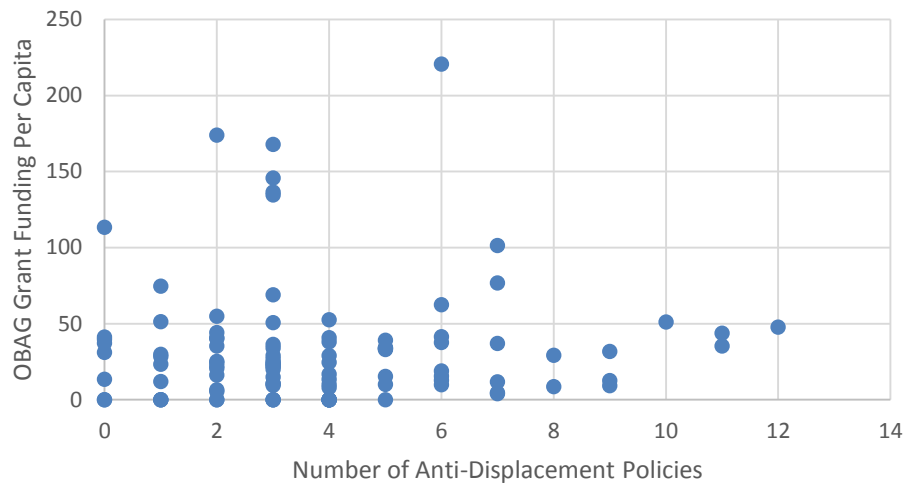

Figure 5.4: Per-Capita Opportunity Bay Area Grant Funding By Number of Anti-Displacement Policies, Bay Area Cities
Source: UC Berkeley Internal Analysis

Los Angeles Station Neighborhood Area and Planning Guidelines

The City of Los Angeles has created TODs or Station Neighborhood Area Plans (SNAPs) as a means of guiding development near existing or new transit stations. Various city documents have also incorporated transit sections into planning documents, including community plans and specific plans. The following section outlines how these types of plans address issues of affordability, and whether they mention the topics of gentrification or displacement. The emphasis of this section is not on the types of plans that have been created, rather how these documents propose development near transit and how/if they referred to affordability, displacement, or gentrification.

Before delving into these station area plans, consider a requirement of Los Angeles County Metropolitan Transportation Authority (LA Metro) when it enters into joint development agreements for construction on its land: the fifth listed goal is affordable housing⁹. The guidelines call for “35% of the total housing units in the Metro joint development portfolio [to be] affordable for residents earning 60% or less of the Area Median Income” (LA Metro 2015). One mechanism for achieving this is a policy of land discounting, whereby LA Metro may “discount joint development ground leases” by no more than 30% of fair market value. This is a promising addition (as of July 2015) to the guidelines, and is likely to help address displacement in transit neighborhoods by providing more affordable housing.

The planning documents are official statements of the local planning departments reflecting the government policy regarding the physical development of a community. However, the documents are not legally binding, but are instead a list of recommendations for interpreting those values into

⁹ Prior to the 2015, joint development agreements often included affordable housing requirements. The 2015 guidelines, however, institutionalized the 35% affordable housing requirement and also introduced the 30% discount limit on joint development ground leases.

future land use and development policies and decisions. The plans aim to be comprehensive in addressing how physical aspects of the community affect social, economic, and environmental issues. The plans can help shape future neighborhood plans, corridor plans, and other community improvements, but they do not guarantee a specific outcome. As with SNAPs, specific plans usually cover smaller geographical areas than the Community Plan. The goal of Specific Plans is to restrict development through regulatory controls and incentives that promote systematic and incremental neighborhood change to ensure orderly development and appropriate capacity off public facilities.¹⁰ Community Plans provide specific, neighborhood-level strategies necessary to achieve the General Plan objectives.

Table 5.8 lists the existing Los Angeles plans with TOD sections. None of the TOD plans¹¹ explicitly use the words gentrification or displacement, but there are references to the creation and preservation of affordable housing. The Northeast Los Angeles Community Plan mentions issues of displacement several times. The West Adams, Baldwin Hills, and Leimert Community Plan implies that gentrification is a concern and discusses preventing displacement.

There are 12 future Los Angeles County and City TOD plans. These future plans include five stations along the Crenshaw line, with additional five stations along the Exposition Line. Two future Los Angeles County TOD plans include Willowbrook and East Los Angeles 3rd St. Specific Plan.

¹⁰ A detailed description on community plans and specific plans can be found on the City of Los Angeles Planning website: <http://www.lacity.org/311-service-category/policy-planning>

¹¹ The three Los Angeles SNAP plans include 1) Vermont/Western 2) Avenue 57, and 3) Warner Center 2035 Plan. The five plans that include TOD sections include: 1) the Northeast Los Angeles Community Plan, 2) the West Adams, Baldwin Hills, Leimert Community Plan, 3) Cornfield Arroyo Seco Specific Plan, 4) Southeast L.A. Community Plan Implementation Overlay Zone, and 5) the South Community Plan Implementation Overlay Zone. There is also one report that is outlined in this summary that relates to the Vermont/Western Transit Plan—*Surveying East Hollywood: A Profile and Needs Assessment of the Business Community*.

Table 5.8: Existing Los Angeles Plans with TOD sections

Name	Type of Document	Year Adopted	Metro Line	Mention of Displacement or Gentrification	Affordability Policies Mentioned
Vermont/Western	SNAP/TOD	2001	Hollywood/Western, Vermont/Beverly, Vermont/Santa Monica, Vermont/Sunset (Red Line)	No	Mixed-Use Developments, Community Benefits, Homeownership, Exemptions from Park Fees
Avenue 57	SNAP/TOD	2002	Highland Park Station (Gold Line)	No	Homeownership support, Mixed-Use Development
Warner Center 2035	SNAP/TOD	2013	Warner Center Station (Orange Line)	No	Mixed-Use Development, Affordable Housing Requirement, Workforce Housing, Living Wage, Local Hiring, Exemptions from Development Fees.
Northeast Los Angeles	Community Plan w/ TOD	1999	Highland Park Station (Gold Line)	Yes, displacement concerns	Higher density near transit, Mixed-Use Development, Maximize opportunities for affordable housing adjacent to rail stations
West Adams, Baldwin Hills, Leimert	Community Plan w/ TOD	2007	Exposition (Phase I) and North-South Crenshaw/LAX	Yes, gentrification & displacement	Increase Homeownership, Affordable Housing Options, Accessory Dwelling Units, Infill Development, Parking Reductions, Condo Conversions.
Cornfield Arroyo Seco	Specific Plan w/ TOD	2013	Chinatown and Lincoln/Cypress Metro (Gold Line)	No	Affordable Housing Density Bonus, Unbundled Parking Exemption
Surveying East Hollywood	Report on Vermont/Western	2002	Hollywood/Western, Vermont/Beverly, Vermont/Santa Monica, Vermont/Sunset (Red Line)	Yes, displacement of businesses	Local Job Incentives, Lower Parking Standards, Love/Work Spaces

Source: UCLA Internal Analysis

The Los Angeles SNAP, Specific, and TOD Community plans vary in terms of if and how they mention gentrification and displacement, and how they propose to preserve or develop affordable housing. The older plans such as Vermont/Western or Avenue 57 do not directly speak to issues of displacement, but do refer to the need for housing affordability. The plans focus on maintaining the existing scale of the neighborhoods, as well as the need to promote homeownership. The plan encourages mixed-use and live-work spaces. Planners consider the development of mixed-use housing as an opportunity to provide affordable housing units. The Metro Joint Development Program: Policies and Processes, updated in 2016, states that “Metro will define affordable housing

as housing for residents earning 60% or less than AMI, and will prioritize units with even deeper affordability levels for very-low-income and extremely-low-income residents” (p. 7). There are also exemptions from standard parking requirements. The Vermont/Western Plan also mandates community benefit agreements. Although the Northeast Los Angeles Community Plan refers to displacement concerns, the Avenue 57 SNAP for the area does not speak to this issue directly.

The Warner Center Plan, which was adopted in 2013, speaks to a range of affordability policies such as workforce and affordable housing. Additionally the plan promotes anti-displacement policies such as living wage and local hiring. The Warner Center Plan does not directly refer to displacement or gentrification, but has an extensive list of policies that encourage both affordability and job opportunities for locals.

The West Adams, Baldwin Hills, Leimert Community Plan does refer to gentrification and displacement as a concern and provides numerous proposals to promote affordability. Numerous policies speak to affordable homeownership opportunities, the need to provide more affordable housing options built at the same scale as the neighborhood, the need to promote co-housing, and accessory dwelling units. The plan also promotes middle- and working-class homeownership and suggests that this could be done through condominium conversions.

The newest community plans, Cornfield Arroyo Seco (adopted 2013), the South and Southeast Los Angeles Plans (draft form), as well as the future Expo Line TOD plans, are more complex in their proposals. These plans create specific subareas where tiered zoning is encouraged as a means to promote denser development. The zoning scheme that would allow developers to build larger buildings if preferred uses, such as affordable housing, are included. These plans also have areas where single-family homes are prohibited, since the emphasis is on higher density as a means to provide more affordable housing options. The Expo Plan also incorporates public benefits as a part of development projects.

There is a significant distinction between the earlier and newer TOD plans. For instance, in the Vermont/Western Plan affordability is encouraged, but few incentives or guidelines are provided for developers when compared to the newer TOD plans, where a menu of incentives is provided to encourage different ways of achieving affordable housing.

Prevalent Policies that Aid in Addressing Transit-related Displacement

We will next consider four policies in depth, three production and one preservation. We focus on inclusionary housing and condominium conversions, because of their prevalence in the Bay Area and Los Angeles County. We then discuss rent control in the Bay Area, because it is a policy frequently discussed in the literature and believed to be effective in addressing displacement, yet few cities in in the Bay Area have implemented it. Finally, we discuss preservation of mobile homes in Los Angeles County since it is one of the more prevalent policies in Los Angeles.

Inclusionary Housing/Zoning

Many cities use inclusionary housing or inclusionary zoning policies to increase the stock of affordable housing at a minimal cost to the city and concurrent with development. Such policies

include requirements on developers to devote a certain portion of new development to below-market renters or owners or provide an in-lieu fee to develop affordable housing elsewhere. As can be expected, inclusionary zoning works best in robust housing markets (Hickey 2014) and mandatory policies produce more units than programs that are voluntary (those that have guidelines for including below-market rate units in new developments but where development is possible without meeting the requirements) (Hickey et al. 2014).

Inclusionary zoning programs are widespread—over 500 jurisdictions in 27 states and Washington, D.C. have policies in place, though they are particularly concentrated in California and New Jersey (Hickey et al. 2014). In the Bay Area 78 cities have some type of inclusionary zoning policy in place, but only 16 cities have inclusionary zoning in Los Angeles County. The policies vary considerably, both in their design and implementation and in how much housing they produce (Hickey et al. 2014). Overall, “larger, more highly educated jurisdictions, and those surrounded by more neighbors with inclusionary zoning are more likely to adopt” such policies (Schuetz Meltzer, and Been with Furman Center for Real Estate and Urban Policy 2007).

Inclusionary zoning policies have generated a significant number of units of affordable housing. Nationally, Mallach and Calavita estimate that between 129,000 and 150,000 units have been produced through these programs, mostly in California, Massachusetts, and New Jersey¹² (Mallach and Calavita 2010). In California, between 1999-2007, inclusionary housing programs generated 29,281 affordable units, or 2% of total units authorized for construction¹³ (Non-Profit Housing Association of Northern California 2007; California Department of Finance 2015).

A data limitation on inclusionary housing production figures is that units produced via now-shuttered California redevelopment agencies are left out. These redevelopment agencies had requirements that “15% of all production inside a project area has to be affordable, under state law,” which meant that “every community [using redevelopment dollars] had to have an inclusionary policy of some kind,” according to a policy expert (interview with authors). Therefore, other units developed in a similar manner as inclusionary zoning have been produced in the state and are not captured in these figures.

However, even with these potential data inaccuracies, the policy has only made a small contribution towards addressing the affordable housing shortage. A recent report from the CHPC finds a statewide need for 1.5 million rental homes affordable to extremely-low- and very-low-income households (CHPC 2015). In the Bay Area, just over 17,000 units of affordable housing (for moderate-, low-, and very-low-income households) are needed annually through 2040 (Wegmann 2012). Inclusionary zoning, on its own, is not enough to satisfy so large a demand.

¹² This estimate includes units produced “in whole or part with [in-lieu] fees,” paid by developers in place of building the below-market rate units in their developments.

¹³ 1,500,213 units of housing were authorized to be constructed in this period.

Statewide Characteristics of Inclusionary Housing Policies

In California, inclusionary zoning has been significantly circumscribed. In 2009, two Court of Appeal decisions, *Building Industry Ass'n of Cent. California v. City of Patterson* ("Patterson") and *Palmer/Sixth Street Properties L.P. v. City of Los Angeles* ("Palmer") together upended previous understandings about the validity of, and appropriate analysis applied to, inclusionary housing ordinances. *Palmer* found that an existing state law related to rent control precludes jurisdictions from forcing developers to include rent-restricted units in their market-rate, rental developments (Shigley 2009). More specifically, the two cases, taken together, have the following implications for inclusionary ordinances:

1. *Patterson* suggests that inclusionary housing ordinances should be viewed as "exactions" that must be justified by nexus studies.¹⁴
2. *Palmer* does not allow inclusionary housing ordinances to limit rents unless public assistance is provided (*Palmer* does not affect buildings that receive public funds, nor those that receive some regulatory incentive, such as a density bonus (21 Elements, Strategic Economics, and Vernazza Wolfe Associates, Inc. 2015).

Since these decisions, most California jurisdictions have ceased applying their inclusionary policy to market-rate rental developments to stay clear of legal trouble (Hickey 2013). This is significant because California is home to almost half of the nation's inclusionary policies (Hickey 2013). Others have instead required developers to pay fees in lieu of construction inclusionary units, which the city can then use for funding separate affordable housing. However, such policies require a nexus study to be completed showing that the fee imposed is equal to the contribution the development makes to the affordable housing project; therefore, the potential revenue that can be raised is lower (Jacobus 2015).

The inability to generate inclusionary rental units comes at a time when many California towns and cities are seeing rent levels nearing all-time highs, and fiscally strapped state and local governments have cut or fully spent public funds that subsidize affordable rental housing. The *Palmer* decision has highlighted the importance of finding new ways to address legal impediments to rental inclusionary housing; some of the challenges are outlined in Appendix V.

In 2013, a bill to reverse the *Palmer* decision was passed by the California legislature, but was vetoed by Governor Brown (Daniel 2013). Efforts are ongoing to pass a "*Palmer* fix."

Although the *Palmer* ruling did not restrict inclusionary zoning policies related to ownership units, a subsequent case in San Jose challenged those laws as well (*California Building Industry Ass'n ("BIA") v. City of San Jose*). In June 2015, the California Supreme Court ruled that inclusionary zoning ordinances for ownership units are allowed under jurisdictions' police powers and, importantly, "affordable housing ordinances are simply price controls on new homes" and therefore require no

¹⁴ Nexus studies must show that the construction of market-rate housing contributes to the need for affordable housing. They usually do so by showing the new market-rate housing will increase household spending in a community, which will create low-wage jobs, whose workers will need a place to live. An alternative nexus theory, more difficult to quantify, is that market-rate projects use up land that would otherwise be available for affordable housing. In a case involving commercial linkage fees, the Ninth Circuit discussed the "indirectness of the connection between the creation of new jobs and the need for low-income housing," but ultimately concluded that the fees bore a "*rational relationship* to a public cost closely associated with" new development. *Commercial Builders of Northern California v City of Sacramento*, 941 F.2d 872, 874-76 (9th Cir. 1991).

nexus studies or proof of “deleterious impact” to be passed, making their implementation much easier (Goldfarb Lipman LLP 2015).

Assessing the effectiveness and importance of inclusionary policies, one expert said: “No one has ever claimed that inclusionary is *the* policy...it’s one more tool in the toolbox...maybe between inclusionary and impact fees and this and that, you can cobble together enough” to create some level of affordable housing (interview with authors).

A different expert commented that inclusionary zoning might be so widespread because it is, from a fiscal standpoint, easy to pass: it requires no new tax funding nor allocation of general fund monies (interview with authors).

One of the most significant differences between older and newer programs is in the affordability of units produced (NPH 2007). According to the NPH report, newer programs (post-2000s) produce more rental housing and more housing for lower-income households, when compared with older programs (Figure 5.5).

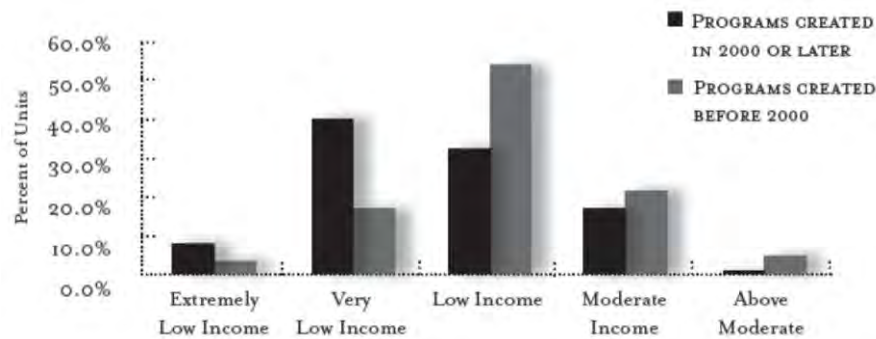

Figure 5.5: Distribution of Units by Income Level and Age of Inclusionary Program
 Source: (NPH 2007, 20)

The report also documented that almost none of the housing goes to extremely-low-income households, a quarter to very-low-income, nearly half to lo- income, and 21% to moderate-income (Figure 5.6) (NPH 2007, 14).

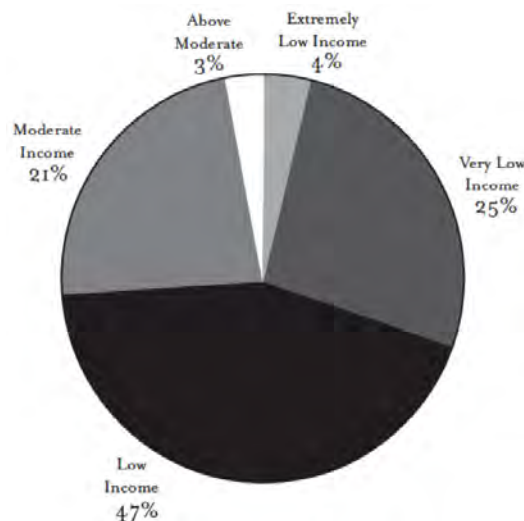

Figure 5.6: Inclusionary-Development Units by Income Target
 Source: (NPH 2007, 14).

Although 81% of programs in California offered payment of fees as an option (CCRH and NPH 2003), there are not many estimates of the total amount of in-lieu fees generated by inclusionary programs. The NPH report (2007) estimates the number of units created as a result of in-lieu fee: “nearly one-quarter of all the reported units (4,798)” (NPH 2007, 17). But the authors also claim that it is very likely the figure is higher. Such counts are inexact because most jurisdictions mingle in-lieu fees with other housing funds and do not track them separately. While most of the cities and counties with inclusionary housing allow in-lieu fees, the NPH study found that a smaller percentage of developers exercised this option.

Inclusionary Housing in the Bay Area

In the Bay Area, 72% of cities have inclusionary zoning policies in place (Figure 5.7). One expert thought the policy’s prevalence could be related to how easy the policy is to implement: “it doesn’t cost them money,” like funding affordable housing directly does. He believes that passing inclusionary laws allows cities to say “development is still happening, we’re getting housing built, and we’re still getting some affordable housing, aren’t we great. So I think at some point if enough cities are doing it the rest do it because it just becomes common sense” (interview with authors). On the other hand, the expert also speculated that some communities implement inclusionary housing as a “growth control measure...[such cities] were really interested in getting no more housing at all” as opposed to affordable housing (interview with authors).

Three policies were adopted between 1979 and 1989; 19 in the 1990s; 38 in the 2000s; and 11 between 2010 and 2014. The policies differ in terms of whether they target rental or ownership housing or both, and in regards to the specific proportion of affordable housing they require. Other differences include whether developers are allowed to construct their inclusionary units off-site from their market-rate development, and whether they may pay fees in lieu of providing the housing. There is no geographic pattern to which cities have inclusionary zoning policies.

Notably, Oakland, which has 10 of the 14 policies in place, does not have an inclusionary policy. A longtime advocate in Oakland believed this was because the city council is “just so eager to get development of any [kind]” given an “image problem” and a view that “people don’t want to invest in Oakland” and so are wary of placing any limitation on that, even negotiating with a developer to include community benefits or some affordable housing (interview with authors).

Most policies require developers to designate between 10-15% of their units as affordable, with others as high as 20% or as low as 4%. Nearly 70% of policies include an “in-lieu fee” provision that allows developers to pay a fee to the city instead of building the affordable units. Most policies specify a “minimum” number of units that triggers the law, around four-10.

Several cities include different requirements for different income levels. For example, in Richmond, developers must include either 17% of their units affordable to moderate-income households, 15% to low-income, 10% to very-low-income, or 12.5% to a combination of very-low-income and low-income. A plurality of policies explicitly target moderate-, low-, and very-low-income households (nearly 40%), while others focus on only low- and very-low-income households.

A very common feature of the policies is to include a prescribed breakdown of levels of affordability within the required below market-rate (BMR) units: for example, in San Bruno, 15% of units (in projects with 10 units or more) must be BMR; for rental buildings, 40% of those units are for very-low-income households, and the rest for low-income, while in ownership buildings, 40% are

reserved for low-income households and the rest for moderate-income. However, cities vary in terms of the income level qualifying for such affordable housing units—many cities also target moderate-income households, while other cities only focus on low-income households. Stakeholders from several cities in the Bay Area (Sonoma and Concord, for example) suggested changing the policies to shift the focus from moderate-income to lower-income households. Several other stakeholders suggested raising the in-lieu fees, which they said are currently too low. Many respondents also cited the *Palmer* case and the governor’s veto of a “*Palmer* fix” as challenges to the implementation of such policies.

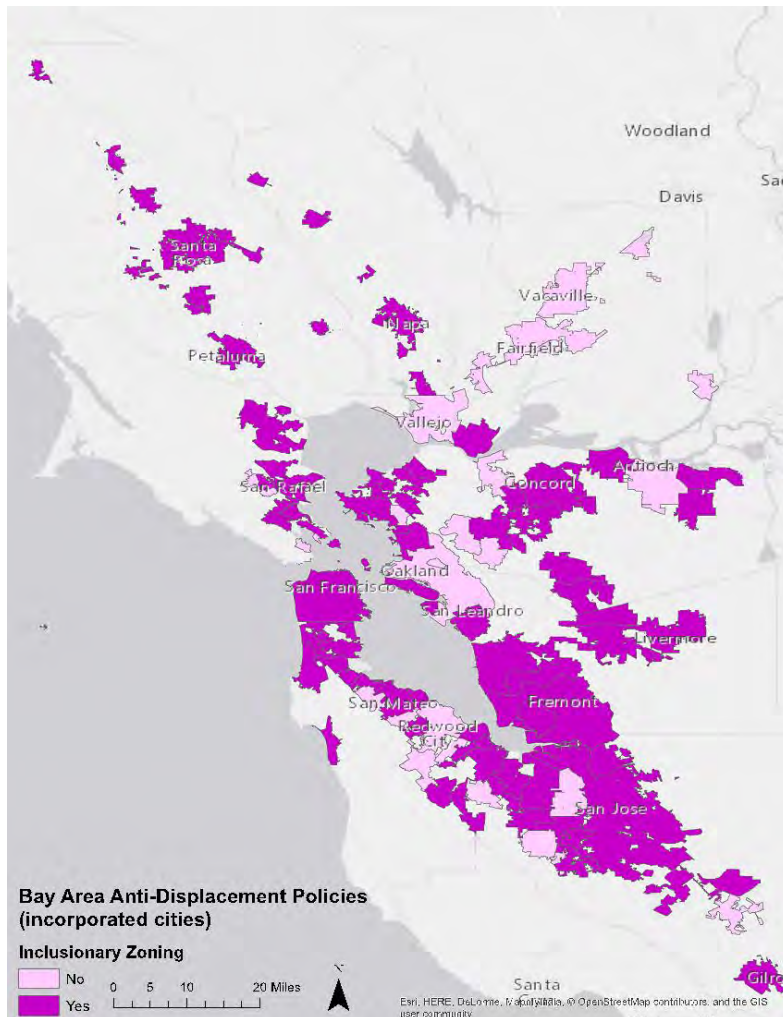

Figure 5.7: Inclusionary Zoning in Bay Area Cities
 Source: UC Berkeley Internal Analysis

The experience of two cities in the Bay Area (Colma and Walnut Creek) shows that inclusionary zoning does not work in cities without significant new housing investment. In these cities, stakeholders report that very few units (less than 10) have been developed as part of the ordinances, which were implemented in 2005 in Colma and 2004 in Walnut Creek.

These are both places that have experienced minimal development of any level: in Colma, which is comprised in large part of cemeteries, only two units of any kind have been built between 2007 and 2013, while in Walnut Creek, the figure is 75. However, in Walnut Creek, 47 of those units have

been for very-low-income households, even though no or very few units of inclusionary zoning have been developed. This indicates that other strategies besides inclusionary zoning are working to provide affordable housing.

Other cities have seen more success: in East Palo Alto, 80 units were developed through the policy between 1994-2013; in Sunnyvale, hundreds of units have been constructed since 1980; and in San Francisco, 1,214 on-site units and 346 off-site units have been constructed between 1992-2013 (San Francisco Mayor’s Office of Housing and Community Development 2014). These statistics are the exception to the rule: most cities do not track the numbers of units built through inclusionary ordinances, according to a stakeholder.

Inclusionary Housing in Los Angeles

In Los Angeles County, there are 14 cities with inclusionary housing policies. Three cities adopted inclusionary zoning in the 1980s, five in the 1990s, and six from 2000 to 2010. La Verne has inclusionary zoning in its Old Town Community Plan, while Malibu only has in-lieu fees (Ordinance 375), but not inclusionary zoning. Twelve of the 14 cities with inclusionary housing policies have mandatory inclusionary zoning, while the remaining two, Long Beach and Monrovia, have voluntary programs. Voluntary programs are based on the premise that cost offsets provide sufficient incentive for developers to participate in the arrangement (Mukhija et al. 2010, pp. 233–234). On the other hand, mandatory programs are likely to be based on the premise that revenue-neutral cost offsets are not necessary or that voluntary programs, even if financially neutral, are insufficient to motivate developers (Mukhija et al. 2010, pp. 233–234).

There are three recent papers or reports that provide numbers for how many units of affordable housing were produced through inclusionary zoning policies for some of the 14 Los Angeles cities. Although not all the cities are included and the time frames for when the information was collected varies, they provide a glimpse of how many affordable units have been produced using inclusionary zoning since the late 1990s.

The Non-Profit Housing Association of Northern California (NPH) report discussed above found that a total 659 affordable units were created through inclusionary zoning in the Los Angeles region from 1999 to 2006; however, this only accounts for inventories in six cities (Table 5.9). (NPH 2007, p. 7). Artesia is the only jurisdiction in the Los Angeles region that reported that 10% or more of the total housing in its jurisdiction was for affordable units as a result of local inclusionary housing programs (NPH 2007, 8).

Table 5.9: Inclusionary Housing Units Produced (1999-2006)

City	Affordable Units Completed	Units Created via In-lieu Fees	Total Units Created
Artesia	25	Not available	25
Calabasas	No response	No response	0
Glendale	No response	No response	0
Pasadena	348	178	526
Rancho Palos Verdes	No response	No response	0
West Hollywood	37	71	108
Total	410	249	659

Source: NPH, 2007

A Lincoln Institute paper that analyzed 20 inclusionary housing programs nationwide included one city in Los Angeles, Santa Monica (Hickey 2014). According to this report, up to 2006 Santa Monica had produced around 1,000 affordable housing units from inclusionary housing, 998 rental and two for-sale units (Hickey 2014, p. 23). These figures do not include affordable units developed by in-lieu fees. A more recent study by Mukhija et al. (2010) provides the numbers of affordable units created through inclusionary zoning for nine of the 14 Los Angeles cities from 1998 to 2005, as seen in Table 5.10.

Table 5.10: Inclusionary Housing Units Produced (1998-2005)

City	Affordable Units Completed	Affordable Units in Development	Units Created via In-lieu Fees	Total Units Created
Agoura Hills	36	0	Not available	36
Calabasas	0	0	0	0
Huntington Beach	428	78	111	617
Long Beach	0	0	N/A	0
Monrovia	0	0	N/A	0
Pasadena	346	357	128	831
Rancho Palos Verdes	0	9	0	9
Santa Monica	680	72	534	1,286
West Hollywood	91	50	224	365
Total	1581	566	997	3143

Source: Mukhija et al. 2010

Overall, studies have found that many cities do not have complete and accessible data on the number of affordable housing units produced (or the in-lieu fees generated) through inclusionary zoning (Mukhija et al. 2010; NPH 2007).

Condominium Conversion

The conversion of multifamily rental housing into condominiums is not a new phenomenon. The conversions of condominiums is a well-established trend that typically moves in waves (Chambers 2005; Pitarre 2005). “[Conversions were] popular in the late 1970s, and then [they] stopped completely. A mini wave happened again in the late 1980s, and now we’re seeing another wave” (Pitarre 2005 in Chambers 2005, p. 359). Historically, the most dramatic increases in conversions have occurred just before the real estate market peaks (LePage 2004 in Chambers 2005). For example, between 1970 and 1979, there were 366,000 conversions nationwide; 135,000 of those occurred in 1979 alone (Casazza 1982, p. 4).

There are several factors that fuel the condominium conversion trends in California: the lack of affordable homeownership options, an insufficient supply of undeveloped land, and developers’ financial motivation (Chambers 2005). Proponents of conversions emphasize that condos open the door to home ownership to people otherwise priced out of the housing market (LePage 2004, p. 29). Condominiums are typically much more affordable than detached, single-family homes. Thus, with affordable housing in California becoming increasingly scarce, “[c]onverted condominiums... are the only way for many residents to buy their first home” (Jones 2005a). The economic advantages of condominium ownership created a growth in both the demand and development of condominiums by the early 1980s (Vandever 1980; Judson 1983; Roback 1985).

The second component underlying the California boom of condominium conversions is the absence of available land for development (Hammer 2004). Thus, conversions are undertaken out of lack of alternative options. The last major factor fueling condominium conversions is the incentive for profit (Vandever 1980; Hammer 2004; Chambers 2005). The developer of a converted condominium project can realize returns from 15% to 30% in a matter of months (Pitarre 2005). Additionally, developers often save time and costs when they convert existing apartments instead of building new condominiums (Levy et al. 2006).

Together these incentives enable developers to pay substantial premiums for the apartment properties they acquire, often providing a high motivation for apartment building owners to sell their buildings (Gose 2004). Overall, this has resulted in a boom of converting existing apartments into condominiums in the 1980s and again in the early 2000s (Vandever 1980; Judson 1983; Roback 1985; Hofmann 2005; Ottens 2013).

While conversions have proven to be economically profitable to some building owners, the increasing frequency rate of conversions has sparked housing availability concerns. In recent years, the increase in conversions has resulted in the decrease of available rental units in many urban areas. For instance, by 1980, in California, the conversion of apartments to condominiums had doubled every year since 1976 (Vandever 1980, p. 467). The condominium surge returned in the mid-2000s.

Although no exact figures are available on how many renters are affected, the number of apartments sold to condominium redevelopers nationwide rose nearly tenfold from 7,800 in 2002 to 70,800 in 2004, according to Real Capital Analytics, a Manhattan-based research consulting firm (Jones 2005b). The condominium conversions are occurring most rapidly in Southern California, Northern Virginia, and the Miami and Las Vegas areas (Jones 2005b).

In addition to shrinking the supply of available rental units, condominium conversions also create numerous tenant-related problems (Committee on Government Operations, Commerce, Consumer, and Monetary Affairs Subcommittee, and U.S. Congress 1981). Tenants on fixed income such as the elderly, young families, couples, and individuals without operating capital are unable to purchase units they live in, or in some cases find replacement rental housing. Relocation becomes necessary and substantial moving costs can be incurred.

Condominium conversions are controlled primarily by local government regulations. In California as a whole, landowners must follow the Subdivision Map Act to convert rental property to condominiums, which includes applying for a tract map, attending a public hearing, and securing a public report from the State Department of Real Estate (Portman and Brown 2013). Tenants must be given sufficient notice if they are to be evicted, as well as the right to buy their unit (Portman and Brown 2013). However, even these provisions do not impose substantive restrictions on the ability of developers to convert (Bakker 2005). In addition, there are a number of ambiguities in state law provisions. Therefore, many cities have enacted condominium conversion ordinances that impose restrictions on the ability to convert and also deal with some of the ambiguities contained in the state law provisions. For example, under the California Subdivision Map Act, localities may establish social and economic criteria for regulating conversion in order to “make adequate provision for the housing needs of all economic segments of the community” (Cal. Gov Code § 65580(d)(West Supp. 1982)).

Local condominium conversion policies limit landlords' ability to turn multi-family rental housing into condominiums. These help existing tenants to stay in their housing as well preserving the overall stock of rental housing (Allbee, Johnson, and Lubell with ChangeLabSolutions 2015).

Bakker (2005) lists the most typical provisions found in procedural ordinances (ordinances that do not impose direct limits on conversions), which include a requirement that the initial notice of intention to convert contains a statement of tenant rights, a restriction on increasing rent during pendency of conversion process, and a requirement that the converter enters into extended leases (that will extend beyond the conversion).

Many local ordinances include provisions that require landlords to offer financial assistance to "elderly, disabled, or low-income tenants, and to families with minor children" as well as lifetime leases for elderly tenants (Portman and Brown 2013). Policies may also include specific notification requirements for tenants (such as 90 days or a year), relocation assistance, or offering residents the right to purchase their apartment (Allbee, Johnson, and Lubell with ChangeLabSolutions 2015).

In contrast to procedural ordinances, substantive ordinances typically limit the number of condo units that may be converted each year. The criteria for determining whether conversion is permitted or not is usually based on one or more of the following:

- Prohibiting conversions unless the city or regional vacancy rate is above a certain fixed amount.
- Prohibiting conversions unless the percent of total units rented is equal to or above a certain fixed number following the conversion. For example, the city might set its rental housing ratio at 30%, and conversions would be approved unless the conversion would push the proportion of rental units below 30%.
- Limiting annual conversions to a fixed percentage (such as 5%) of the total rental units in the community, or limiting them to a fixed number of units.

Condominium Conversion in the Bay Area

Seventy-three cities in the Bay Area have condominium conversion policies in place (67% of all cities/counties, see Figure 5.8), making this policy one of the most widespread of the 14 we considered. These policies were passed between 1974 and 2013: 11 in the 1970s, 24 in the 1980s (mostly 1980-1983), 12 in the 1990s, and 24 since 2000. Most prohibit conversion unless the vacancy rate in the city is above a certain level, usually around 3-5%. A few prohibit conversion of small buildings (such as fewer than 21 units in Burlingame). Others limit conversions based on the proportion of the housing stock that is rental: in Alameda and Santa Clara, conversion cannot occur if the percentage of units that are rented will drop below 40% due to conversion; in San Anselmo, the figure is 25%; in Mountain View and San Bruno, there is a floor of rental units as opposed to a percentage. Others set an annual limit on the number of units that may convert to condominiums: 200 in San Francisco, 100 in Fremont, 100 in Berkeley, 5% of units in Sausalito, 7% of units in Dublin. In Piedmont, apartments converted to condominiums must be replaced in kind by an equal number of equivalently priced rental units, with rents restricted for 55 years.

One stakeholder in Daly City believes "there is no need for the statute. Condominium conversions are not the trend in the housing market as they once were in the 1980s-1990s." Several other stakeholders around the Bay echoed a similar sentiment: while important at one time, condo conversions simply are not happening anymore. Yet many stakeholders around the Bay view these policies favorably: one in Sonoma noted "it has been effective;" and in South San Francisco, "no condominium conversions have occurred...to that extent, the current policy is very successful at

preventing the loss of rental units.” On the other hand, a stakeholder in San Francisco writes, “There are multiple problems with the ordinance. Existing tenants are pressured to accept buy-outs to move...[and it] also does not regulate [tenancy-in-common] conversions which would require state law reform to cover such conversions” (interviews with authors).

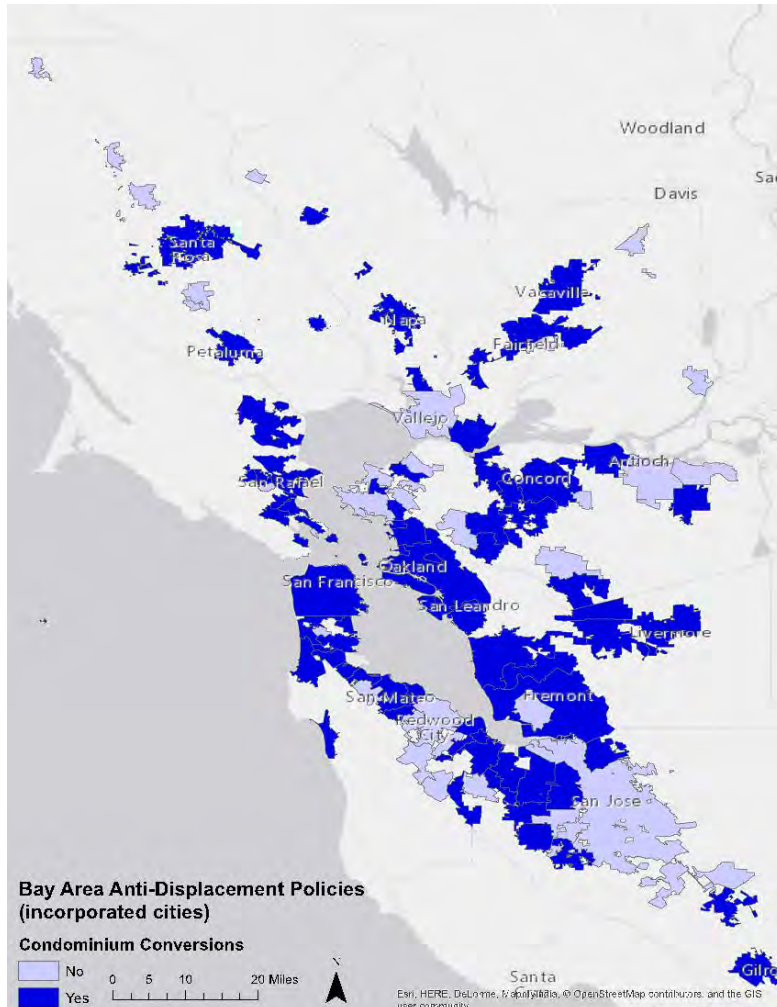

Figure 5.8: Condominium Conversion Policies in Bay Area Cities

Source: UC Berkeley Internal Analysis

One policy expert described many loopholes in Oakland’s condominium conversion policy that make it ineffective. The law’s intent is to ensure that any developer who takes rental units off the market must replace each one with rental housing someplace else. Developers can do this by building those units or buying “credits” from another developer for rental housing that another developer owns. However, developers can build a building as a condominium, rent out the units for seven years, and, through a provision in the law, that seven-year period generates conversion rights which can be sold to another developer. At the end of the seven-year period, the original developer can then sell the units, which means “there’s no permanent replacement housing.” Another loophole in the law, according to the expert, is that two- to four-unit buildings outside a certain zone in the city are exempt from the policy; most of the “close to 1,000” condo conversions in the last 10-15 years were in buildings this size (interview with authors).

One way developers avoid condominium conversion policies statewide is to evict tenants under the Ellis Act (which is by law a statement that they are exiting the rental housing business) and then sell the emptied building as condominiums later on, according to an expert (interview with authors).

These are but a few examples of how condominium conversion laws—and others, too—may seem effective on paper, but play out very differently.

Condominium Conversion in Los Angeles

In 2007, the City of Los Angeles issued 208 permits allowing apartment complexes to be converted to condominiums. Before the recession in 2008/2009, it was common for apartments to convert to condos when the market was hot. But when the housing bubble burst, the trend slowed down and declined every year afterwards. The city issued only 38 permits in 2010 (Ottens 2013). However, a 2013 *Los Angeles Times* article stated that, “Apartment building owners in Los Angeles and throughout California are once again converting to condos, but not at the torrid pace of 2007, when condo conversion peaked before the Great Recession” (Ottens 2013).

The Condominium Conversion Ordinance is the most prevalent anti-displacement policy in the Los Angeles region, with 27% of the jurisdictions having implemented it (24 jurisdictions). The majority of the cities in Los Angeles have procedural ordinances. The earliest condominium conversion ordinances date back to the late 1970s (two cities) and early 1980s (five cities). There were five cities that implemented condominium conversion ordinances in the 1990s and 12 from 2000 to the present. One of the cities, Pasadena, has imposed a Condominium Conversion Moratorium, which began in 2007. The use of these ordinances by cities may be reflective of condominium conversion booms from the 1980s and early to mid-2000s.

Rent Control in the Bay Area

Rent control refers to policies that limit the rent private landlords may charge tenants, either fixing it at a certain dollar amount, allowing it to increase by a specific percentage (often tied to the official rate of inflation) annually, or having the allowable increase set by a board each year. Some policies include restrictions on evictions and specific processes for landlords or tenants to petition for higher or lower increases, respectively.

Nationally, rent control was popular in the late 1960s through the early 1980s (Levy et al. 2006). By the late 1970s, 170 municipalities had put rent control laws in place, “mainly in the Northeast and California where the rent pressures were most severe and tenant organizations were strongest” (Keating and Kahn 2001, p.1). However, in the 1980s, an “emerging conservative onslaught” put tenants “on the defensive” and curtailed additional rent control ordinances, though cities that had passed rent control maintained a strong tenant voice (Keating and Kahn 2001). However, in Massachusetts and California, rent control was eliminated or limited, respectively, statewide; this is consistent with a national trend whereby opponents of rent control turn to the state level if they cannot roll back laws at the local level (Keating and Kahn 2001).

Nine cities in the Bay Area have rent stabilization/control policies in place, summarized in Table 5.11 and displayed in Figure 5.9.

Table 5.11: Cities in the Bay Area with Rent Stabilization/Control Ordinances

City	Year Introduced, Last Modified	Allowable Rent Increases	Type (according to California Tenants' Rights Guide)
Berkeley	1980, 2005	65% of the Consumer Price Index (CPI). Once per year.	Strict
Campbell	1983, 1998	No binding rule, but allows tenants to contest rent increases and includes dispute mediation.	N/A
East Palo Alto	1983, 2010	80% of the CPI but not exceeding 10%. Once a year.	Strict
Fremont	1997, 2001	No binding rule, but allows tenants to contest rent increases and includes dispute mediation.	N/A
Hayward	1980, 2003	5% max annual increase.	Weak
Los Gatos	1980, 2004	5% max annual increase or 70% of the increase in the CPI, whichever is greater. Once a year.	Weak
Oakland	1980, 2014	CPI; more if landlords have "banked" their rent increases. Once a year.	Weak
San Francisco	1970	60% of CPI, not exceeding 7%.	Strict
San Jose	1985	8% increase; 21% if the last increase was more than 24 months ago. Once a year.	Weak

Source: UC Berkeley Internal Analysis; (Portman and Brown 2013).

All the ordinances were passed between 1980-1985 except San Francisco's, which passed in 1970. Explaining the reason for the surge in rent control policies in the early 1980s, one stakeholder said these policies were in reaction to Prop 13. A policy expert mentioned that many rent control laws include a provision that if the vacancy rate is above a certain level (5 or 6%), the law does not apply, "because if you've got a really soft market it's harder to argue that there's a public purpose" (interviews with authors).

Most policies use the consumer price index, a measure of inflation, as the benchmark for the increase—such as East Palo Alto, where allowable rent increases are 80% of the consumer price index in that year—while others have a set increase of 5% or 8%. All policies allow only one increase per year.

Another way these policies vary is in which units they cover; statewide, no policy covers all rental housing (which is circumscribed under state law). For example, in San Francisco, units built after 1979 are exempt (Portman and Brown 2013). Most of the policies in the Bay Area exempt units built after they were passed.

All the cities listed here, with the exception of Los Gatos and San Jose, also have just-cause-for-evictions laws in place, which prohibit a landlord from evicting a tenant except for specific reasons. Such provisions are essential to make rent control effective because, without them, landlords can avoid rent control limits by evicting tenants for no reason, and then using vacancy decontrol to raise rent on the next tenant.

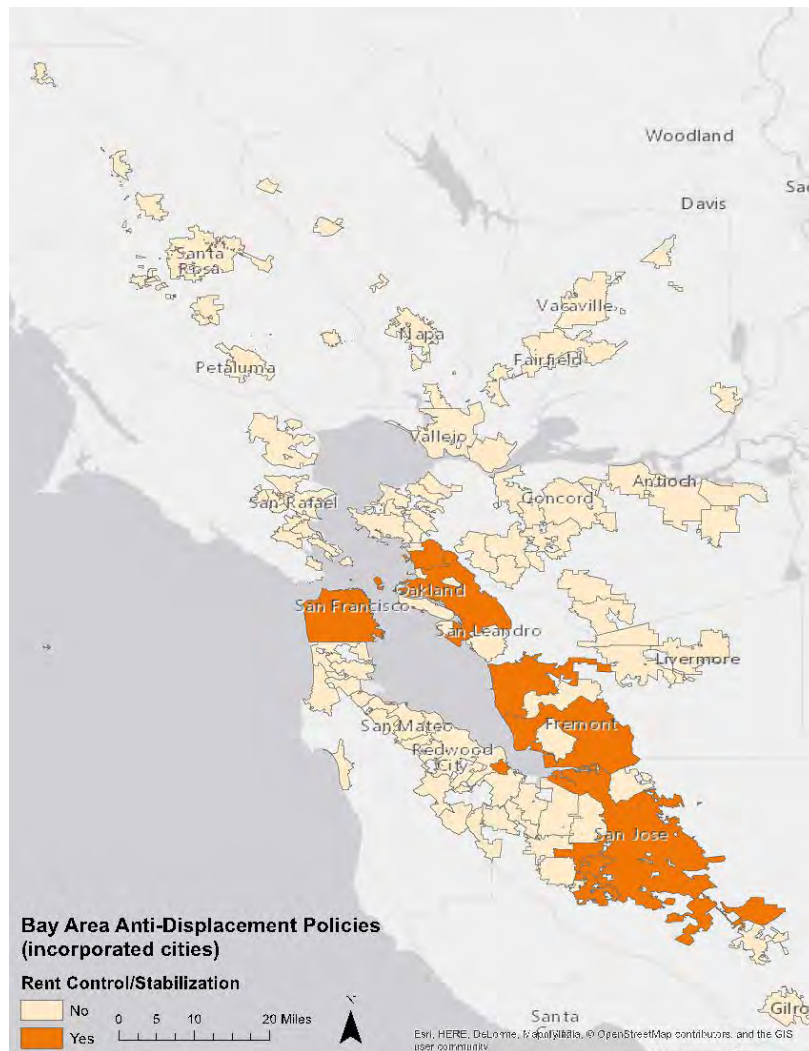

Figure 5.9: Rent Control Policies in the Bay Area

Source: UC Berkeley Internal Analysis

The California Tenants’ Rights guide classifies California cities’ rent control policies into groups: “Weak Rent Control” laws allow landlords to raise the rent generously, and even above the fixed amount unless a tenant protests to a rent board. These policies do not require landlords to register their units with the city. “Moderate-to-Strict Rent Control” laws require the landlord to prove they must raise rent beyond the threshold listed in the law, include a just-cause evictions ordinance, and require landlords to register units with the city (Portman and Brown 2013).

One stakeholder from San Jose said, “Rent Control has been implemented in San Jose and is in force for qualifying units. However, because there is high tenant turnover and no eviction protections, it has not been effective in keeping rents down overall.” Regarding Oakland’s rent control law, a stakeholder there commented that, though “there are weaknesses...at the end of the day, [it] is working.” One weakness, cited by a different stakeholder, is that the city lacks a registry of rent-controlled units, making it difficult to track them and ensure compliance (interview with authors). There have been no new rent control ordinances passed in the Bay Area since 1985. However, San Mateo County recently appointed a commission to study the policy and then promptly scaled back the study to be a request for only “a little” more information (Kinney 2015a; Kinney 2015b). In

Richmond, a just-cause evictions and rent control ordinance passed a first reading in July 2015, only to be voted down at the second reading amidst major pushback, though a revised version was ultimately passed (Swan 2015; Ioffe 2015). These examples show how difficult it is to pass new rent control ordinances. The stakeholder believes the Bay Area may be experiencing another “moment” where such policies may kick in, “because the crisis is so sharp and happened so quickly” (interview with authors).

In terms of directions for improving rent control policies, one expert thinks a key change would be shifting the onus of proving a rent increase is legal from tenants to landlords (where applicable): “If that were the case, you’d have to change the whole administration and in the long run it’d probably increase the registration fee because you’d now be registering units and...there’d be cases all the time. So, it would definitely change it” (interview with authors).

Other key components of a rent control policy, according to the expert, include anti-harassment provisions, disallowing owners from “effectively constructively [evicting] their tenants...And there has to be just-cause, because if you don’t have just-cause then, you know, they’ll just give people a 30-day notice. And if you have just-cause and no rent control, then they’ll just double the person’s rent. You know, so the two have to go hand in hand” (interview with authors).

Mobile Home Rent Control in Los Angeles

Although only a handful of mobile parks are located near transit, mobile home rent control is so widespread in the state that it is worth discussion. Most of the mobile home park construction in California took place in the 1960s and 1970s (Baar 2011). From 1960 to 1975, the number of mobile home park spaces in the state increased from about 150,000 to about 370,000. No mobile home parks have been constructed within the City of Los Angeles since the 1980s (Baar 2011; Zheng et al. 2007). A 1984 study commissioned by the city noted that no land was zoned for mobile home parks and that they were only permitted under special use permits. In Los Angeles County, the supply of mobile home park spaces has declined by about 10% since 1986, from 53,496 to 47,907 (Baar 2011).

The majority of mobile homes in the City of Los Angeles were manufactured before 1980, and only about 20% were manufactured within the last 25 years. By 2011, the City of Los Angeles had 57 mobile home parks with a total of 6,526 mobile home spaces (Baar 2011). In 2011, the average monthly rent of a mobile home park space in the City of Los Angeles was about \$615 (Baar 2011, p. i). In addition to space rents, most mobile home tenants reimburse park owners or directly pay for sewer, water, or trash collection expenses.

The rising housing and land prices in Los Angeles and other California jurisdictions impact the land (or pad) rents in many of the state’s mobile home parks (Zheng et al. 2007, p. 5). As a consequence, renters in many jurisdictions have launched efforts to have mobile home rent controls enacted into law. From 1983 to 2003 the number of mobile homes in California subject to rent controls increased (Zheng et al. 2007, p. 4). By 2005, over 90 California cities and eight counties had some sort of mobile home rent control (City of Banning 2005). In both the Los Angeles and Bay Area regions, rent control laws are more commonly adopted for mobile home parks than multi-family residential properties.

Mobile home park owners in the City of Los Angeles can increase space rents by only 10% when a mobile home is sold in-place to a new owner. This provision is the same in virtually all mobile home

parks, because mobile homes are sold in-place to incoming tenants, rather than being moved. The 10% ceiling under the mobile home space rent regulation differs from the regulations of apartment rents that permit unlimited rent increases upon a change in tenancy (Baar 2011). In the City of Los Angeles, owners may increase the rent by the consumer price index.

Under California state law, spaces covered by leases of one year or more that meet specified conditions are exempted from local rent regulations (Civil Code Sections 798-799.2.5). However, park owners may not require that current tenants enter into such leases and most local rent ordinances, including the City of Los Angeles ordinance, provide that prospective tenants cannot be required to enter an exempt lease as a condition for approval to move into the park (Baar 2011, 40).

Some have speculated that the implementation of rent controls in California jurisdictions may explain the declining shipments of mobile homes to the state (Hirsch and Rufolo 1999). However, while the decrease in mobile home park construction since the 1980s has been attributed to rent controls, it is important to note that since 1992, state law has exempted newly created mobile home park spaces from local rent regulations (California Civil Code Sec. 798.45 (1992)).

Case Studies

To better understand how these and other policies have helped avoid displacement in practice, we next consider several case studies of places that were vulnerable to but did not experience the gentrification or displacement we would have expected.

In the Bay Area, we profile neighborhoods in Chinatown (San Francisco), East Palo Alto, and San Jose. These neighborhoods (each occupying one or two census tracts) were chosen from among all the tracts that were low-income places at risk of gentrification or displacement¹⁵ in 1990-2000, but did not experience gentrification¹⁶ between 2000 and 2013, shown in Figure 5.10.

¹⁵ "At risk of gentrification" defined as: Population in 2013 over 500; Percent low income (80% or less than surrounding county's median income) greater than regional median (39%); Signs of vulnerability to gentrification/loss of low-income household (at least 4 out of 7): 1. Has rail station in tract 2. Percent of units in prewar buildings greater than regional median, 3. Loss of market-rate units affordable to low-income households greater than regional median (1990-2000), 4. Employment density greater than regional median (2000), 5. Rent increase greater than regional median (1990-2000), 6. Real estate sales value increase more than regional median (1990-2000), 7. Development of market rate-units greater than regional median (1990-2000).

¹⁶ Gentrification defined as: Growth in percent college-educated greater than region; Growth in median household income greater than region; Percent market-rate units built between 2000-2013 greater than regional median; At least one of the following: Single-family sales price per square foot greater than regional median, Multi-family sales price per square foot greater than regional median, Home values greater than regional median.



Figure 5.10: Census Tracts at Risk for Gentrification/Displacement in 1990 and 2000, but Did Not Experience Gentrification between 2000 and 2013

Source: UC Berkeley Analysis

In Los Angeles County, there are 80 Metro rail stations. Here, our focus is three Metro station areas: Chinatown, Hollywood/Western, and 103rd St./Watts Towers. Input from our Southern California Advisory Board and diversity of station-area conditions influenced the selection of the three case studies. The neighborhoods are defined as 2010 census tracts completely or partially within a half-mile radius of the transit station. The Chinatown and Hollywood/Western are mixed-use areas that are at risk of gentrification, while 103rd St./Watts Towers is a residential commuter neighborhood that is not gentrifying. Specific policies related to transit-oriented development are in place at Hollywood/Western to mitigate change, while more general policies linking greenhouse gas reduction to land use and transportation have been adopted in Chinatown. Economic and community development efforts have been proposed for Watts over the decades.

Chinatown, San Francisco

Chinatown is situated at the center of San Francisco's booming real estate market, with close proximity to the Financial District, Downtown, and affluent neighborhoods such as Russian Hill. Due to its prime location, it was expected that Chinatown would have succumbed to the pressures of development and speculation that have transformed surrounding areas and much of San Francisco. However, deliberate anti-displacement zoning policies, widespread rent control, and a well-organized community have preserved Chinatown as an Asian-American and low-income enclave.

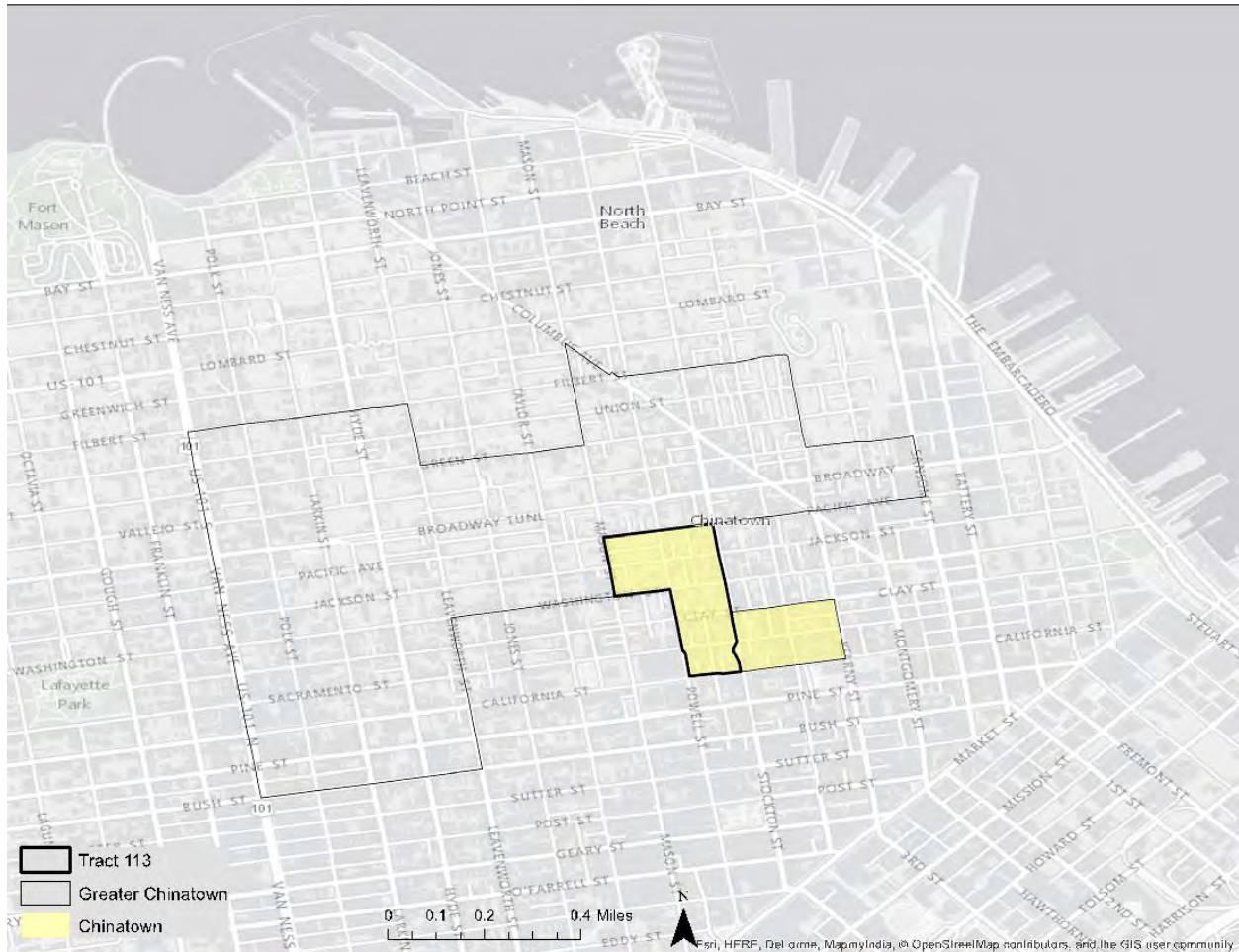

Figure 5.11: Tract 113, Chinatown, and Greater Chinatown

In this case study, we discuss Chinatown as a whole, but focus specifically on one census tract within this area: Tract 113, which closely mirrors the core of Chinatown (Figure 5.11). After outlining the history of Chinatown, we provide an overview of its demographic and housing characteristics, today and historically, before discussing the anti-displacement policies that have preserved the neighborhood.

History of Chinatown

As one of the oldest ethnic enclaves in the U.S., San Francisco's Chinatown has been a major immigrant gateway as well as a cultural, economic, and residential hub for the Bay Area's Chinese-American and Asian-American communities for over 150 years.

Chinatown's current location was established after the original neighborhood was destroyed in the 1906 earthquake and fire that razed over 80% of San Francisco. To this day, the official Chinatown neighborhood remains a relatively small land area (Figure 5.11). With the rapid growth of the Chinese--American population beginning in the 1960s, neighborhoods adjacent to the core area became home to many Chinese-American families, and businesses and institutions serving the Chinese-American community likewise began establishing themselves beyond the boundaries of Chinatown.

Much of Chinatown's housing was built as single-room occupancy (SRO) residential hotels or small rooms in commercial structures or community spaces. Chinese immigrants, who were barred from property ownership, were subjected to discriminatory housing practices by absentee landlords seeking to maximize profits. Housing was thus poorly maintained and often overcrowded (Yip 1985).

In the 1960s, the liberalization of U.S. immigration policy led to a population boom and subsequent shortage of affordable housing. Chinatown quickly became one of the densest neighborhoods in the country, with an overwhelming majority low-income renter population. SROs and other small residential units were often overcrowded, in poor condition, and yet still expensive for very low-income residents (Tan 2008).

The Chinese community's spatial segregation and social isolation contributed to the development of "an impenetrable social, political, and economic wall" between Chinatown and the rest of San Francisco (Wang 2007). While the neighborhood's insularity allowed for the formation of strong social networks and a self-sufficient system of community institutions, small businesses, and cultural activity (Yip 1985), it also reinforced a language barrier that still presents a challenge for socioeconomic integration and contributes to persistently high poverty and unemployment rates (Wang 2007).

Relative Demographic Stability, 1980-2013

Since the 1960s, Chinatown's population has included a large percentage of foreign-born, low-income Chinese-American and Asian-American families. The population in the tract increased by 13% between 1980 and 2009-2013 (from 2,840 to 3,204 residents), with a concurrent growth in the housing stock from 1,152 units to 1,617 units¹⁷.

Asians decreased in their share of the population from 86% in 1980 to 78% in 2009-2013. However, the proportion of residents who are foreign-born only decreased slightly in that same time frame: from 69% to 67%. Seniors (60 and older) have also consistently made up a significant share of the population.

¹⁷ Data in this section comes from the U.S. Census for the years 1980, 1990, 2000, and 2010, and the Geolytics database for 2013.

Poverty has increased as incomes have fallen: the poverty rate rose from 18% in 1980 to 26% in 2013, while median household income dropped from \$45,797 to \$23,261 (both in 2010 dollars). Today, Greater Chinatown is still primarily renter-occupied, though the share of owner-occupied housing units has grown slightly in recent years. With an estimated residential density of 85,000 people per square mile (Tan 2008), overcrowding and housing affordability remain pressing issues for the community: 19% of renter households are overcrowded (more than one person per room). Most (88%) housing units are rented, rather than owner-occupied. Median gross rent increased only slightly, from \$535 in 1980 to \$654 in 2013 (both in 2010 dollars). Even with these relatively low rents, 54% of renters pay more than 30% of their income on rent.

Rental prices have deviated significantly by area. Figure 5.12 shows that in contrast to other areas and San Francisco overall, median rent in Chinatown has remained exceptionally stable since 1990. This is primarily due to the large number of subsidized and rent-controlled units in Chinatown. This is powerful evidence of Chinatown’s unlikely preservation as a place affordable to low-income people.

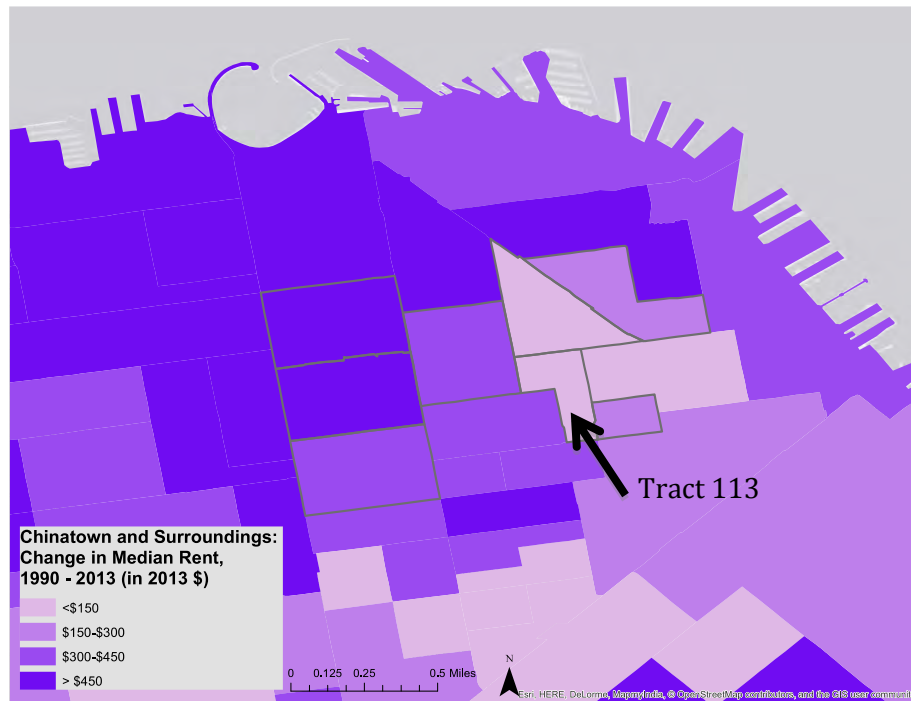

Figure 5.12: Change in Median Rent in Chinatown (Tract 113) and Surrounding Tracts

Anti-Displacement Policy in Chinatown

In the face of external pressures of gentrification, a number of key policies and planning efforts have uniquely allowed Chinatown to maintain its historic character and accessibility to low-income San Franciscans. One of the most influential and comprehensive policy changes took place in 1986, with the adoption of the City Planning Department’s official Chinatown Rezoning Plan as an amendment to the General Plan, which resulted in the designation of Chinatown as a mixed use area distinct from Downtown.

The Chinatown Resource Center (predecessor to the currently existing Chinatown Community Development Center), led this planning effort with the Chinese Chamber of Commerce and Asian Neighborhood Design. In the years prior, Chinatown Resource Center had worked tirelessly to stave

off infringing developers, many of whom sought to purchase land for office uses (Chinn 2014). From the mid-1970s to mid-1980s, approximately 1,700 residential units in Chinatown were converted to office use, and at the same time, an influx of capital from Asian firms drove up both commercial and residential rents (C. Li 2011). As these factors exacerbated the threat of displacement, the Chinatown Resource Center realized the unsustainability of this project-by-project approach and switched course toward advocating for structural changes to the neighborhood's land use policy in an attempt to slow development (Chinn 2014).

They organized residents behind a proposed set of zoning regulations that were originally conceived of as part of a Chinatown community planning process that took place over several years prior (Chinn 2014), during which the San Francisco Planning Department had proposed a new Downtown Plan, and housing experts across the city sought to limit the proliferation of office buildings to preserve affordable housing (C. Li 2011). With the growing threat of speculation and encroaching development from Downtown, residents, community-based organizations, and city officials all exhibited political will for policy change, agreeing that action must be taken to preserve Chinatown's character and culture for its existing residents (Chinn 2014).

The proposal, which specifically addressed the core portion of Chinatown, sought to downzone the neighborhood by setting lower height limits that would curb the neighborhood's development potential. Previous zoning had set limits at much higher than the prevailing scale of most existing buildings. This was due to the fact that Chinatown had originally been zoned as "a creature of downtown," resulting in regulations that did not align with the neighborhood's distinct character (Chinn 2014). The community's proposal was thus broadly viewed as a necessary, sensible shift toward land use policy that was indigenous to Chinatown and "was the single most important achievement of Chinatown CDC in its first 35 years," according to its longtime director (Chinn 2014; Chin 2015, p. 140).

The 1986 Rezoning Plan's central aim was to protect what the Planning Department acknowledged was a "virtually irreplaceable" resource of affordable housing in Chinatown. The plan effectively prohibited demolition, allowing it only "if that is the only way to protect public safety or for a specific use in which there is a high degree of community need," and furthermore banned conversion of residential buildings into different uses (San Francisco Planning Department, n.d.).

Chinatown's large stock of SROs was granted protection by the 1980 citywide Residential Hotel Ordinance, which made it very difficult for developers to convert residential hotel rooms to commercial use by requiring replacement of lost affordable units and mandating that 80 percent of the replacement cost be paid by developers to the City for conversions or demolitions (Fribourg 2009).

With these requirements in place, approximately 50% of the Chinatown Core's housing stock has remained SRO hotels (Tan 2008), and an estimated 92% of units are protected by the 1979 San Francisco Rent Control Ordinance (Figure 5.13) (San Francisco Department of Public Health). A portion of these were purchased and by CCDC to preserve as low-rent housing (Chin 2015, p. 115).

Figure 5.13 also shows that there has not been a single no-fault eviction in Chinatown. According to one expert, "a large majority of these units continue to be owned by individuals that care about preserving Chinatown such as ethnic Chinese landlords and family associations" (Eng 2015).

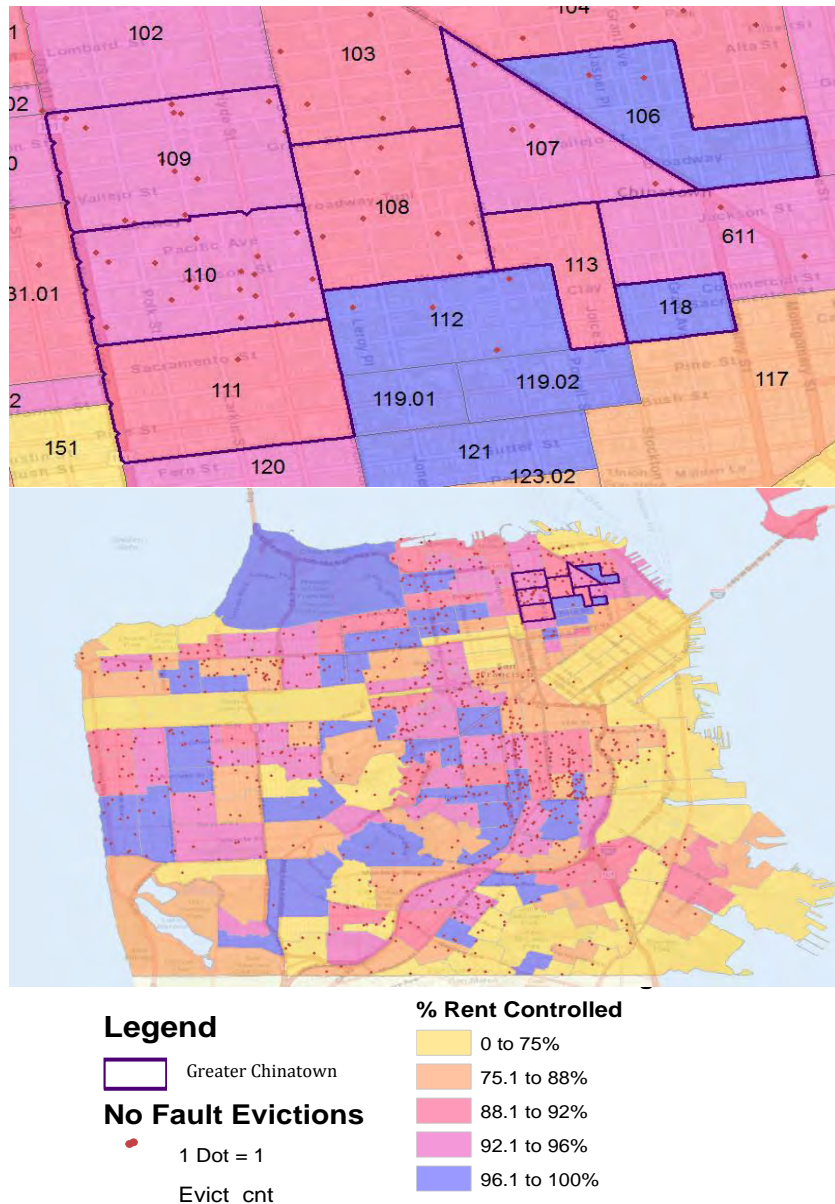

Figure 5.13: Instances of No-Fault Evictions and Percentage of Rent-Controlled Units in San Francisco by Census Tract and Chinatown and Surroundings

Source: San Francisco Department of Public Health

Thirty years later, the 1986 effort can thus be considered to have essentially achieved its policy objectives to “preserve the distinctive urban character of Chinatown” and “retain and reinforce Chinatown’s mutually supportive functions as a neighborhood, capital city, and visitor attraction” (San Francisco Planning Department, n.d.).

While these policies did effectively preserve existing affordable housing, the construction of new affordable housing in Chinatown—desperately needed for San Francisco overall—has been limited; the small stock of 342 subsidized and public units has not increased since 1990, despite increasing need (CHPC 2014). Thus, the neighborhood’s land use policy has given rise to other unresolved challenges of supplying sufficient housing in San Francisco. Plus, the housing in Chinatown is aging,

meaning there is a declining quality of housing as buildings have deteriorated (Chinn 2014). According to one stakeholder, the zoning limits in the area limit the ability to rebuild existing buildings as affordable housing—“if they fall in an earthquake, we lose that [affordable] housing” (interview with authors).

However, constraints surrounding both redevelopment and rehabilitation have made Chinatown somewhat less desirable to residential real estate speculators, limiting displacement (Chinn 2014). Since many buildings would likely require major rehabilitation and potentially demolition to allow for conversion into condos or tenancies in common, a conversion project would be a much more difficult and costly undertaking in Chinatown compared to other San Francisco neighborhoods that have been systematically impacted by such types of redevelopment. In some senses, then, Chinatown has avoided gentrification because other areas were—and continue to be—more susceptible to gentrification, or lucrative for speculators seeking to flip residential properties (Chinn 2014).

Community Resistance to Displacement

A profound sense of community identity persists among Asian-American residents as well as a broader set of Asian-American individuals who live outside the area yet remain deeply connected to Chinatown’s culture, institutions, and spaces. The driving force behind this sense of cohesion is a high rate of civic engagement, which has continued to shape Greater Chinatown’s built environment since the 1986 rezoning victory (Fujioka 2014). The presence of many non-profit organizations also helps with this community-building (Eng 2015).

Even before these successes, a cohesive Chinese-American community had begun forming in the 1960s, occurring in the context of the “fight against ‘urban renewal’” and through several major fights, including over the International Hotel, a playground, and the Mei Yuen Affordable Housing Project (Chin 2015).

With affordable housing as an unceasing concern in Greater Chinatown as well as all of the Bay Area, the Chinatown Community Development Center (CCDC) and other community-based organizations have formed resilient organizing networks with citywide reach. They have also brought their resident base into the broader movement around the right to the city. Recent campaigns have taken on the uptick in owner-move-in evictions that singled out elderly residents as well as Ellis Act evictions. Informed by a commitment to community-based neighborhood planning from the ground up, CCDC, together with tenant groups such as the 1,000-member Community Tenants Association, have won new eviction protections for seniors and residents with disabilities.

In preserving community spaces and connections throughout Chinatown, strong political engagement has also preserved tight social networks among Chinese-American residents. These social connections have also played a key role in the neighborhood’s ability to resist gentrification.

Conclusion

Despite its success, Chinatown faces ongoing challenges, including the opening of a new subway station there in 2019 (which could spur new gentrification) and eviction pressures in SRO-buildings and elsewhere as young professionals move in (Har 2015; Dineen 2015). While part of the broader picture of San Francisco’s affordability crisis, the unduplicated factors that shape Chinatown’s built form require a locally-tailored approach to preserving the neighborhood’s

livability and vibrancy. As with the 1986 Rezoning Plan, the neighborhood’s effectively mobilized resident base allows for potential solutions to new problems to be indigenous to the community. Continued organizing efforts by community groups like CCDC will be critical as both the population and the neighborhood’s infrastructure continue to evolve.

East Palo Alto, San Mateo County

East Palo Alto is located on the San Francisco Peninsula in the heart of Silicon Valley. It is a small city with a population of about 29,000, bordered by the affluent cities of Palo Alto and Menlo Park. A young city, it was incorporated in 1983 in the face of claims from critics that the city could not generate enough revenue to sustain itself. Peninsula Interfaith Action, an advocacy group, notes that incorporation was intended to ensure that, as a community of color, the city would be led by people of color (SFO/PIA 2014). Incorporation prevailed despite numerous lawsuits from special interest groups seeking to frustrate the process, and East Palo Altans have great pride in their rich history of community activism and their struggle to achieve self-determination. Strong protections for renters and support for affordable housing are crucial aspects of the city’s identity. As one interviewee active in the incorporation movement put it, “part of our political history is that we became a city and the first ordinance was to freeze the rents, [because] in the county there was nothing in place [to protect renters]” (interview with authors).

The city has long served as a pocket of affordability for low-income households who might otherwise be excluded from the affluent region. In recent years, two census tracts that comprise the bulk of the city (6119 and 6120¹⁸) have experienced less gentrification than would be expected (Figure 5.14).

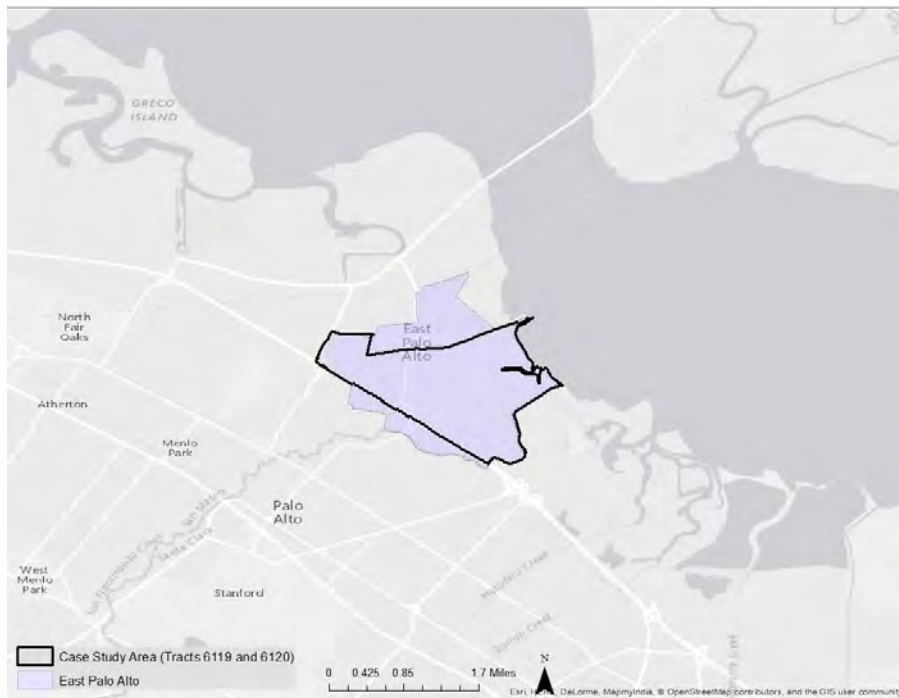

Figure 5.14: East Palo Alto and Case Study Area

¹⁸ In this case study, we refer to these tracts as “the case study area.”

With a focus on these two tracts, this case study outlines the anti-displacement policies in East Palo Alto that have helped limit gentrification there. The city has consistently enacted policies in favor of affordable housing. Tenant protections, inclusionary zoning, and housing subsidies help explain the lack of displacement in East Palo Alto. However, other factors, like a lack of good schools and access to amenities, a lingering perception of the city as unsafe, and overcrowding have also probably played a significant role in limiting gentrification.

Before discussing these policies and other factors in more detail, we outline the demographic and housing characteristics of East Palo Alto, which show how little gentrification has occurred.

Demographic and Housing Characteristics

The case study area's population grew by 22% (from 14,379 residents to 17,492 residents) between 1990 and 2013¹⁹. The area's population growth may be attributed to its access to job opportunities as well as the limited affordable housing opportunities in San Mateo County. Many residents who have moved to East Palo Alto within the past five to 15 years have done so because they get a job nearby, often with Stanford University in neighboring Palo Alto, which employs a large number of janitors and food service workers (SFO/PIA 2014). Residents have also arrived in the city after being displaced from neighboring jurisdictions, or because the relatively low cost of homes provided a home purchase opportunity for families (SFO/PIA 2014).

In this way, East Palo Alto has not only avoided the displacement of its existing residents, but has welcomed additional low-income households²⁰: their number increased from 2,102 to 2,298 from 1990 to 2013, when 58% of households were low-income. The vast majority of households in the case study area are families: 79% in 2013.

The population growth is largely due to an influx of 5,000 Latino residents between 1990 and 2013, who ultimately made up 61% of the population. Concurrently, the city lost much of its historic African-American community; their population decreased by 3,773 people—from 43% of the population to 14%—between 1990 and 2013. The racial demographics of the case study area are notably different from San Mateo County, which has a majority white and Asian/Pacific Islander population, with 40% of residents foreign-born as of 2013.

According to the California Employment Development Department, the annual income needed in San Mateo County to rent a two-bedroom fair-market apartment is \$71,800, a significantly higher figure than the case study area's estimated \$59,341 median income in 2013²¹ (Hepler 2014a). One stakeholder believed that there may be some under-reporting of income in this community given how many people work in the cash economy in fields such as construction (interview with authors). The total number of housing units in the case study area has grown between 1990 and 2013: from 3,819 to 4,247; the vacancy rate (vacant units divided by total units) also increased from 4% to 7%. The case study area is primarily single-family detached homes; these make up 74% of housing units; 51% of occupied housing units are rented. The housing stock is in fair condition: a

¹⁹ Unless otherwise noted, data in this case study comes from the 1980, 1990, 2000, and 2010 Census, accessed via the Geolytics Database, and from the 2009-2013 American Community Survey.

²⁰ Low-income defined as 80% or lower than the surrounding county's median income.

²¹ \$59,341 is the average of each tract's median incomes, which were \$63,105 in Tract 119 and \$55,577 in Tract 120. All figures in this sentence in 2013 dollars. Note that the median income has stayed about the same since 1990, when it was \$54,586 (in 2013 dollars).

stakeholder described the community as having about 40% of homes well-maintained by homeowners, another 40% experiencing neither deferred maintenance nor much “sprucing up,” and the rest in poor shape (interview with authors).

Median rent has doubled from 1990 to 2013: from \$882 to \$1,654 (in 2013 dollars.) These rents are still lower than in San Mateo County; East Palo Alto in fact offers some of the most affordable rents anywhere in the county.

While housing costs are lower than in San Mateo County and nearby cities, households face significant housing cost burdens: 73% of renter households pay more than 30% of their income towards rent.

One method East Palo Altans use to cope with high housing costs burdens is by living with family members or renting out rooms in their homes, as indicated by the high percentage of overcrowded units: 34% of rented units were overcrowded in 2013.²²

While presenting a risk for gentrification in the future, the city has remarkably held on to its low-income population. How did this happen? We turn to this question in the next sections.

Anti-Displacement Policies in East Palo Alto

The following policies are in place in East Palo Alto (11 of the 14 inventoried):

- Just-Cause Eviction Ordinance
- Rent Control
 - East Palo Alto is one of just a handful of cities in the Bay Area to have such an ordinance, and is the smallest by population of those cities. However, the Costa Hawkins state legislation explicitly excluded single-family homes from being covered under rent control policies; since 75% of the housing stock in the case study area is single-family homes, rent control likely was not the main reason for the neighborhood’s stability.
- Rent Review/Mediation Boards
- Preservation of Mobile Homes (Rent Stabilization Ordinance)
- Condominium Conversion regulations
 - These policies are very strict; one stakeholder believed there had been no applications in at least 9 years.
- Foreclosure Assistance
 - This is provided by a community development corporation in East Palo Alto and funded by the city, according to a stakeholder.
- Housing Development Impact Fee (or Jobs-Housing Linkage Fee)
 - The fee is quite substantial: \$21 per square foot, according to a stakeholder.
- Inclusionary Zoning/Housing
 - In East Palo Alto, the law applies only to ownership housing. While nothing has been entitled since 2013, prior to that time 80 below-market-rate homes were built through this policy, according to a stakeholder.
- Local Density Bonus Ordinance (above state requirements)
 - The ordinance was passed in 2008; since then, there has been “minimal” entitlement activity, according to a stakeholder.

²² Overcrowding is defined as having more than one person per room.

- Community Land Trusts
- First Source Hiring Ordinances

Which of these policies might be contributing to the lack of gentrification in the case study area?

Subsidies and Inclusionary Zoning

The city enacted a Below Market Rate Inclusionary Housing Program in 2002, requiring that at least 20% of residential units in all new buildings be made available to households making between 30% and 80% of the area median income. This program was undermined by legal challenges to inclusionary housing at the state level, but the City Council has now unanimously endorsed a housing impact fee for new market-rate developments in order to fund low-income housing (Dremann, 2014).

Subsidies and inclusionary zoning together produced seven affordable housing developments in this part of East Palo Alto between 1990 and 2013, according to a stakeholder. The addition of these units likely helped preserve the low-income population in the area.

Just-Cause Evictions

Several stakeholders cited renter protections, such as the just-cause evictions policy—which applies to single-family homes (unlike other rent control provisions), which comprise the bulk of housing units in the case study area—as a reason for the case study area’s stability. A legal services provider commented that, while in other areas outside the city there have been many cases of a landlord issuing a 60-day notice of eviction on a tenant who has paid rent on time and followed other guidelines, in East Palo Alto, this would not be allowed due to the just-cause evictions policy. In this way, the city has established a first defense against displacement.

Other Reasons for Stability of Low-Income Population

Besides these anti-displacement policies helping the community to avoid gentrification, several other aspects of the neighborhood seem likely to have played a role in limiting the gentrification, including low-quality schools and amenities, an (out-of-date) image of the city as unsafe and full of crime, and overcrowding.

Schools and Amenities

East Palo Alto residents attend school in the Ravenswood City School District, which also includes portions of Menlo Park and Palo Alto. The district has been “notorious for essentially not being able to figure out how to improve” their low scores, even after trying many things, according to a stakeholder, who believes that the poor quality of the school district may be dissuading higher-income people from moving into the neighborhood (interview with authors).

Furthermore, this part of the city lacks many amenities, including transit, and access to social institutions on the west side of the city is made difficult by the difficult-to-cross Highway 101 and University Avenue that run through the city. This kind of “in-between” place along hard urban edges often retains social diversity longer than more homogeneous neighborhoods (Talen 2006). Much of this part of the city has also lacked sidewalks, though that started changing in the late 1990s, according to a stakeholder (interview with authors).

Image as Unsafe

In the late 1980s and early 1990s, there was an “epidemic” of drugs and violence, making East Palo Alto infamous as a crime capital, a place where “you could drive into and have a cornucopia of drugs laid at your feet,” according to one stakeholder. While task forces and local social institutions helped to address these issues by the late 1990s, the reputation has stuck, so much so that an outside consultant told the city, as recently as 2011, that the perception of East Palo Alto as unsafe was scaring developers off.

Overcrowding

As discussed above, 34% of housing units are overcrowded in the case study area. In the face of significantly rising rents in East Palo Alto, such doubling or tripling up of families can help low-income families stay in their neighborhood. This is particularly true for single-family homes—the bulk of the housing stock here—where families can squeeze into a shed in the back, a garage, or more; this is easier to get away with than overcrowding in an apartment. A stakeholder recalled seeing “tell-tale signs” of overcrowding: a window in a garage, tape around a garage door, etc. This phenomenon helps explain some of the stability in the low-income population here: low-income families can hold on to their housing even with rising rents.

Conclusion

East Palo Alto is distinctive for its government’s commitment to ensuring the city remains affordable to low-income households, and for a strong legacy of community organizing that holds the City government accountable to that commitment. The city is home to many low-income households already burdened by their housing costs, and vulnerability is compounded for undocumented immigrants. Because so little affordable housing is available in surrounding cities, the stakes are high for households that leave. Numerous interviewees highlighted that households that cannot afford East Palo Alto may be forced to leave the region altogether, and are relocating as far away as Tracy, Manteca, and the Central Valley. This is why the city’s suite of anti-displacement policies is particularly important.

Diridon Station Area, San Jose

Within the Bay Area, San Jose stands out for long providing affordable homes for a wide range of incomes, and an ethnically diverse population including many immigrants. By annexing more and more land throughout the 20th- Century, San Jose’s sprawling housing development has “carried the burden of housing for decades” in Silicon Valley, in the words of former Mayor Chuck Reed (Hepler 2014b). It is now the biggest city in the Bay Area, and city leaders have their sights set on jobs, with a “jobs first” general plan meant to correct its jobs-housing imbalance.

One major site of attention is Diridon Station, a transit hub on the western edge of downtown San Jose, with stops for Caltrain, Amtrak, VTA light rail, Altamont Commuter Express (ACE), and multiple bus lines. The station is also a planned stop for BART’s extension to San Jose, and for high-speed rail. While there is significant vacant and non-residential land surrounding Diridon, there are also surrounding neighborhoods that are home to low- and middle-income residents where

displacement spurred by rising housing costs is a major concern. Despite San Jose’s strong track record of building housing, including deed-restricted affordable housing, housing costs in San Jose are now at an all-time high, while wages for low-income workers are stagnant.

However, one of the census tracts in the area (5019), while vulnerable for gentrification in 2000, had not experienced the gentrification expected as of 2013. This area is the focus of this case study (Figure 5.15). Housing production—market-rate and affordable—as well as rent stabilization are probably responsible for the lack of gentrification here.

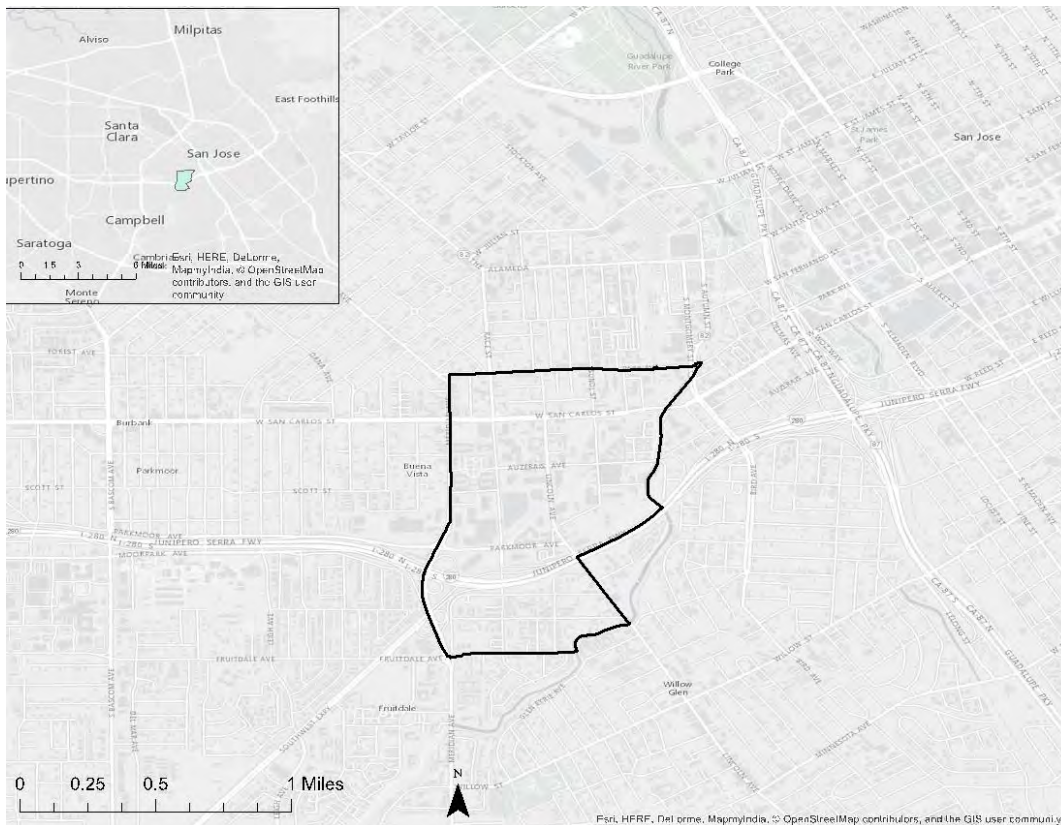

Figure 5.15: San Jose Diridon Station Case Study Area Map (Census Tract 5019)

Neighborhood Overview

The area surrounding Diridon Station is home to a wide range of neighborhoods and land uses, including industrial and commercial areas, residential neighborhoods dominated by single-family homes, new luxury condominium development, and lower-income renter communities. While Diridon Station itself is considered to be in downtown San Jose, Highway 87 creates a barrier between the station area and the denser parts of downtown; though one can walk or drive directly from the station to downtown, the highway limits high-density development in this area. This may be a stabilizing factor for the neighborhood (Talen 2006) .

The case study area, called West San Carlos, hosts a commercial corridor surrounded by older residential neighborhoods which have experienced varying levels of change. It has been slated as an “Urban Village” in the San Jose General Plan. A planner described this commercial corridor as “full service, with a gritty character... it is the most practical street in the whole city! ... [P]eople think of it as pretty funky, and we got push back from the community – we want to keep the funk.”

Demographic and Housing Changes

Several features of the case study area (Census Tract 5019) indicate it has experienced some change consistent with gentrification—population growth, much construction, fewer families, increased educational attainment and incomes, declining renter population, and increased rent—and some inconsistent with gentrification and displacement—increasing people of color, and, most significant, an increase in the number of low-income households.

The case study area showed a steady increase in population throughout the decades: from 2,220 in 1990 to 3,300 in 2000 to 5,745 in 2013. Enabling this population growth has been a significant spurt of construction, particularly in for-sale housing. Between 2000 and 2013, 1,087 new units of market-rate housing were built.²³ Of these, 589 were for-sale units, which comprise 76% of the owner-occupied housing stock in the area.

These new residents have been more likely not to be families, to be highly educated, and to earn higher salaries:

- Since 1980, the area has had a significantly lower percentage of family households than San Jose as a whole. Just under half of the households in the area were families in 2013. By way of comparison, three-quarters of San José's 300,000 households were family households in 2013.
- The case study area has seen major changes in educational attainment in the past 30 years. The percentage of residents with college degrees increased from 22% to 44% between 2000 and 2013.
- Accompanying this shift was an increase in median incomes: from \$47,891 to \$82,192, both in 2013 dollars, from 1990 to 2013.

The study area has been dominated by renter households since 1990, when 81% of occupied housing units were rented; in 2000, the figure was roughly the same, 85%. But by 2013, the figure had dropped to 67%, indicating an increase in owner-occupied housing units as new condominium units were built. However, the share of renter occupied units is still higher than in San Jose as a whole, where 42% of occupied housing units are rented.

Rents have been climbing in the study area (from \$1,073 in 1990 to \$1,404 in 2013, in 2013 dollars), although historically they have been lower than in the city as a whole. Yet advocates have expressed concern that it is really within the last several years that housing costs have skyrocketed, and the recently released draft Housing Element confirms that rents in the city at large are at an all-time high with the average rent now at \$2,169. This average underestimates the cost of newly constructed rental housing which can range between \$2,200-\$2,700 per month for a one-bedroom unit and between \$3,000-\$3,500 for a two-bedroom unit in North San Jose (City of San Jose 2014).

However, even in the face of all these signs of gentrification, the area has expanded its low-income population: the number of low-income households²⁴ has increased from 681 in 1990 to 1,092 in 2013. This change is concurrent with the loss of all the area's naturally affordable rental housing stock, from 184 units to none between 1990 to 2013. To stay in this area, some families are squeezing more people into their units to afford rent (17% of rented units were overcrowded in 2013); low-income households are paying a higher portion of their income to afford rent (49% pay

²³ Source: US Census 2000, American Community Survey 2009-2013, CHPC Dataset, 2014.

²⁴ Low-income defined as at or below 80% of the county's median income.

more than 30% of their income, in 2013); and others live in some of the many new subsidized affordable housing units constructed here (discussed below).

In terms of race/ethnicity, all racial groups have increased their numbers from 2000 to 2013, with Asian-Americans increasing the most dramatically (by 837 people—nearly 300%), African-Americans by 185%, while whites and Hispanic/Latinos increased at a lesser rate (whites by 36% and Hispanics by 21%) (Figure 5.16). Between 1990 and 2013, the percentage of residents who were not white increased from 46% to 72%.

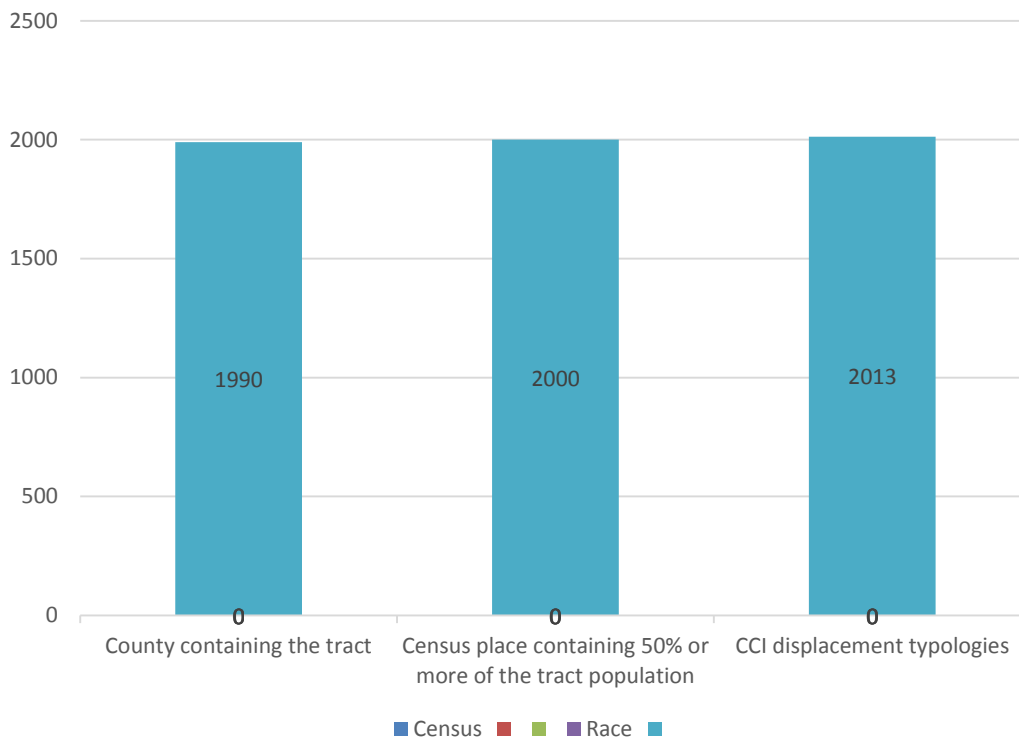

Figure 5.16: Race/Ethnicity and Population Change, 1990-2013

Source: U.S. Census 1980, 1990, 2000 (Geolytics 2014); American Community Survey 2009-2013

Anti-Displacement Policy

The city of San Jose has the following anti-displacement policies in place (of the 14 from our inventory):

- Rent Review Board
- Rent Stabilization
- Mobile Home Rent Control
- Housing Impact fee
- Inclusionary Zoning
- Foreclosure Assistance
- Housing Trust Fund

What is responsible for the area’s lack of displacement? We consider three possible contributing factors: market-rate housing production, affordable housing production, and rent control.

Housing Production

Besides these policies, a key to this area's success at not displacing low-income households seems to be its high levels of housing production. New, higher-income households could be living in these units, which may have taken pressure off the existing housing stock, allowing low-income households to stay there, albeit at higher rents, as discussed above.

Affordable Housing Production

Besides this increase in market rate supply, the case study area also gained 322 subsidized housing units between 1990 and 2000, including the following developments:

- Parkview Senior Apartments – 1998 – 138 units
- Parkview Family Apartments – 1997 – 88 units
- La Fenetre Apartments – 1995 – 50 units
- Willow Apartments – 1999 – 46 units

Overall, about 10% of housing units are subsidized.

Several city policies enable this production of affordable housing. The housing impact fee is too new to have funded these units, but the city's use of Federal funds (HOME, CDBG, and others) and its Housing Trust Fund have been available as sources for affordable development.

Rent Stabilization

A fair number of units (496) in this area fall under San Jose's rent stabilization ordinance (Figure 5.17). The protection of these units from dramatic rent increases likely helped low-income people continue to afford living in the area.

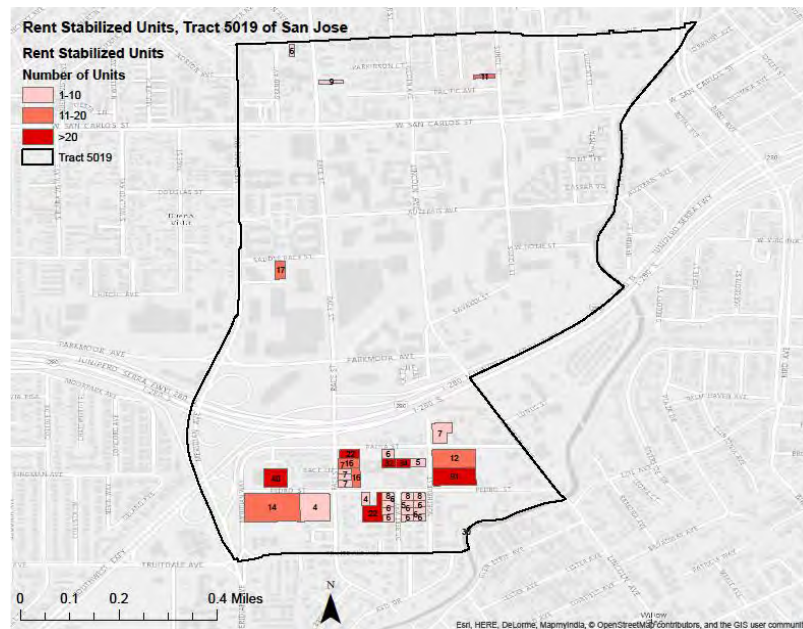

Figure 5.17: Rent Stabilized Units in Tract 5019, San Jose

Source: San Jose's Roster of Rent Controlled Units Through 1979, obtained through personal correspondence.

Conclusion

While housing production and rent stabilization seems to have helped this neighborhood retain its low-income population, one local expert thought it was reaching its “tipping point” when displacement would really kick in. The neighborhood is facing “encroachment” from all sides, with already-gentrified neighborhoods all around it. The expert thinks that the gritty and uneven character of West San Carlos has perhaps kept the neighborhood from gentrifying as dramatically as these surrounding places, but that in time it would, too. The development of more affordable housing (using the city’s funds from its linkage fees and affordable housing trust fund) could help retain the area’s low-income population in the face of such changes.

Chinatown, Los Angeles

Chinatown is a mixed-use, ethnic neighborhood at risk of gentrification with few formal transit-specific planning efforts to mitigate the changes taking place (See Task 2H). The area is considered an Asian-American enclave due to its high concentration of Asian-American residents (Mai, Randy & Chen, Bonnie, 2013); however, it also has considerable numbers of Latino residents (See Table 5.11). The neighborhood is disproportionately composed of renters, and is facing a housing affordability problem as the quality and type of its housing stock has changed while incomes have remained stagnant.

History of Chinatown

Anti-immigration sentiment and racial backlash often forced immigrants to settle in ethnic enclaves. In the 1800s, Chinese immigrants in Los Angeles were barred from citizenship and owning of property. As a result, many became tenants of major landowners around the El Pueblo Plaza area in Downtown Los Angeles. By the 1870s, a notable Los Angeles Chinatown was formed (Cheng and Knok, n.d.). In 1931, however, the construction of Union Station led to the displacement of this Chinese community and their relocation to Los Angeles’s historical Little Italy neighborhood, an area north of the Plaza.

In 1938, Peter Soohoo, a Los Angeles-born Chinese-American proposed the building of New Chinatown as a tourist attraction (Cheng and Knok n.d.). What began as an 18-unit commercial project soon expanded to more than 60 commercial and apartment units. The most famous remnant of these efforts is the East Gate.

By 1960, however, Chinatown had limited resources with few jobs, low wages, and high rents. Many residents worked as laborers in the local garment factories. According to the 1960 census, one-third of all housing in Chinatown was below required standards (W. Li 2009). By this time, those with higher incomes began to migrate to the San Gabriel Valley.

The 1965 immigration law and the end of the Vietnam War brought an influx of Southeast Asian refugees to Los Angeles Chinatown; they were poor, low-educated, and predominantly ethnic Chinese from Vietnam, Laos, and Cambodia (W. Li 2009). This new influx changed the demographics of Chinatown, which can be seen in the multilingual signs that exist today.

Today, Chinatown is typically defined as the area bound by the 110 Pasadena Freeway on the West, Cesar Chavez to the South, Alameda Street to the East, and Cottage Home Street to the North

(“Mapping LA: Chinatown” 2013). This case study focuses on the census tracts that lie partially or completely within a half- mile radius of the Chinatown Metro rail station (See Figure 5.18). Small businesses and local merchant shops in Los Angeles Chinatown continue to survive not only as shopping centers for residents but also as tourist shops for many visitors. Chinatown’s proximity to downtown Los Angeles also attracts many young professionals to the area. These businesses, however, have declined from their heyday due to competition from other Chinese establishments in the San Gabriel Valley.

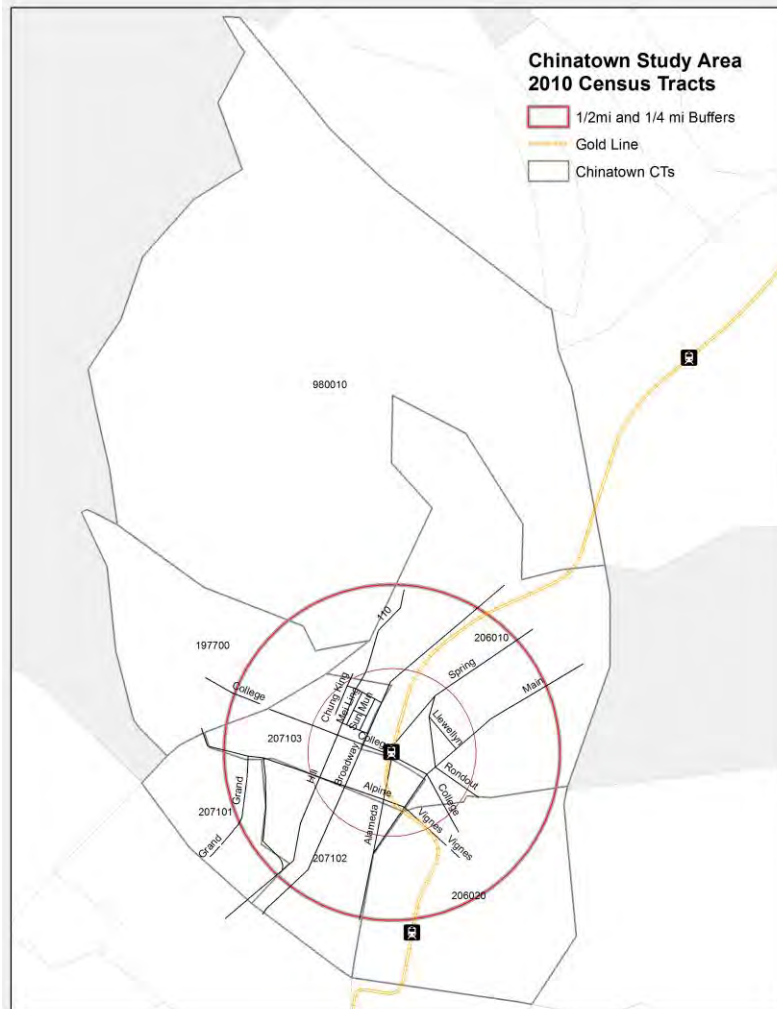

Figure 5.18: Chinatown, LA Study Area by Census Tract (2010 Boundaries)

Chinatown’s Demographics

The population in Chinatown has increased steadily since the 1960s (see Table 5.12). Today, the area is home to more than 23,000. Over the past three decades, the area has not only become more diverse but has also changed (Mai, Randy and Chen, Bonnie 2013). Chinatown is considered an Asian-American enclave due to its high concentration of Asians relative to Los Angeles County (Mai, Randy and Chen, Bonnie 2013). However, it was not until the 1990s that Asians became the majority in the neighborhood (54%). Since then, however, their share has declined to about 42% of residents. There is also a considerable Latino population in Chinatown, which has consistently

accounted for about one-third of residents for the past three decades. Over the years the share of Black residents has fluctuated and has been on a steady decline while that of Non-Hispanic whites has increased slightly. The share of immigrant residents has also been on a decline.

Table 5.12: Chinatown, LA Demographics

	1970	1980	1990	2000	2010	2009-2013
Total Population	17,715	20,509	18,166	26,144	23,954	23,120
Race/Ethnicity						
Asian	26%	38%	54%	40%	43%	42%
Black	18%	13%	7%	17%	14%	12%
NHW		10%	6%	10%	11%	13%
Hispanic		36%	32%	33%	31%	31%
Elderly (60 and older)	10%	10%	14%	13%	16%	16%
Foreign Born	34%	56%	63%	48%	48%	47%
Poverty Rate	24%	39%	31%	32%	41%	41%
Total Housing Units	4,113	4,365	5,136	5,389	6,718	6,724
Vacancy Rate	4.1%	2.3%	5.2%	4.4%	6.7%	11.6%
% Renters	83%	86%	88%	88%	91%	91%
Multi-Unit Housing	64%	74%	80%	79%	85%	85%
Mean HH Income (2013\$)		36,608	43,973	40,213		38,267
Mean Rent Range (2013\$)		606	851	713		1,017

Source: US2010 Project available at <http://www.s4.brown.edu/us2010/Researcher/Bridging.htm>; and 2009-2013 ACS tabulated by authors; data are for 2010 census tracts completely or partially within 1/2mi of the rail station.

Chinatown has a high prevalence of new construction on residential parcels (See Task 2H), and the development of multi-unit housing in the area has also been on the rise, increasing from 65% of the housing stock in 1970 to 85% by 2010. Median rents have almost doubled, from about \$600 in 1980 to more than \$1,000 by 2013. These trends signal a shift in the housing stock and affordability of the area as the quality and type of stock changes. Further, while Los Angeles has always been a majority renter metro area, with a percent of renters fluctuating between 51-52% since 1970 (Ray, Ong, & Jimenez 2014), residents in Chinatown are disproportionately renters, with the share of renters increasing from 81% in 1970 to over 90% by 2010.

Chinatown residents are facing a housing affordability problem. In 2013, more than half of Chinatown renters (55%) were burdened by housing costs. The area is also becoming increasingly poor, with the mean household income declining since 2000, a likely result of the recession. In 2013, about four out of 10 residents lived in poverty, double the ratio of 1970. This may be related to demographic shifts. For instance, the number of elderly residents in the area has more than doubled since the 1970s, and today they account for about 16% of the population.

Further, there is an income disparity. The average household income in Chinatown is less than half of the average household income in Los Angeles County (about \$38,300 compared to \$81,400, respectively in 2013). Understanding the housing needs of the poor and elderly is critical as the housing affordability and stock of the area changes. Chinatown has had affordable senior housing since the 1980s, but many of the affordable units have expired or are set to expire, and some affordable senior units are converting into market rate units (Chinatown Community for Equitable Development, personal communication, April 15, 2015).

Anti-Displacement Policies

Chinatown is within the boundaries of Los Angeles, and therefore the nine anti-displacement policies adopted in the city apply to Chinatown. These include condo conversion regulations, policies to encourage the preservation of mobile homes, affordable housing trust funds, local density bonuses, SRO preservation, rent stabilization and control, community land trusts, and a first source hiring ordinance. There are three plans that will impact development in Chinatown: the Central City North Community Plan, the CASP, and the Union Station Master Plan. The Central City North Community Plan is currently undergoing revisions and the Union Station Master Plan is currently being worked on (SEACA, personal communication, November 16, 2015). There is limited information publicly available on the future contents of these plans; therefore, this section will focus on the CASP.

The CASP was adopted in 2013, and is one of the city's newest community plans. It is also the first community plan to include regulatory controls to guide development near transit stations. The CASP is designed to serve as a blue print for all future TODs in the City of Los Angeles (SEACA, personal communication, November 16, 2015). There are three Gold Line rail stations located in the plan area: Chinatown, Heritage Square, and Lincoln/Cypress stations. The plan proposes lower-density development but encourages developers to take advantage of the California Affordable Housing Density Bonus program. The plan's development standards encourage a variety of housing types. Additional value is also added to property through land use/zoning changes, i.e. up-zoning, which can be leveraged to provide benefits for the community, including the provision of affordable housing, open space, and other community benefits. The CASP also created a unique Super Density bonus program from the city's and the state's. The city's allows up to a 35% density bonus in exchange for affordable housing; the CASP provides up to a 100% density bonus and provides incentives for extremely low-income housing. This is the first plan in the city to do so. (SEACA, personal communication, November 16, 2015).

The zoning section of the plan encourages affordable and mixed-income housing. There are also several benefits a developer could gain by providing affordable housing units. One incentive is the Floor Area Bonus: project applicants may obtain additional floor area rights by complying with the Affordable Housing Bonus Option and/or the Community Benefit Bonus Options.

The plan also outlines several "off-menu" incentives such as additional floor area. One of the requirements for qualifying for these additional bonuses mentions the need to show that the extra square footage is required to provide affordable units. In order to receive the variety of bonus options, the plan also states that developers shall sign and record a covenant that would guarantee affordability. Restricted Affordable Units are exempt from Unbundled Parking requirements.

Community Involvement, Response and Resistance to Displacement

Strong relationships between CBOs and public agencies in TOD areas are necessary to develop plans and policies to encourage development that provides equitable community benefits. In the Chinatown area, this discussion was mostly happening through the CASP.

The CASP was prompted by the development of three infrastructure improvements in the area: the development of a regional public park, the Los Angeles River Master Plan, and the extension of the Gold Line. These broader development efforts prompted public agencies to seek community engagement, including public meetings. While the plan does not mention displacement or gentrification explicitly, there is a strong emphasis on incorporating affordable housing in new

development through density bonuses. This emphasis is the result of organizing efforts by advocacy organization such as SEACA, who pushed for acknowledgement of gentrification and displacement in the writing of the plan (SEACA, personal communication November 16, 2015).

Further, while a community coalition was successful in pushing for strong environmental and economic justice goals in the revision of the CASP (Henao 2013), currently there is no active formal process for CBOs and public agencies to interact. Further, there are no active engagement efforts as part of the CASP.

CBOs have expressed concerns about residential and commercial gentrification. One concern is that a number of new neighborhood businesses are not catering to the needs of long-term Chinatown residents, such as providing culturally appropriate retail that meets the needs of the elderly, affordable food and retail, and in some cases, jobs (Mai, Randy & Chen, Bonnie, 2013). Representatives from CBOs indicated that new development and incoming retailers like Starbucks and Walmart are instead catering to new residents or more affluent commuters (SEACA, personal communication February 4, 2015). Flipping of commercial properties was also reported (Chinatown Community for Equitable Development, personal communication April 15, 2015). Between 2007-2014, at least 14 Ellis Act evictions have occurred in the census tracts within a half-mile of the transit station. One CBO representative reported that tenants are often offered "buyouts" and move out of their units (Chinatown Community for Equitable Development, personal communication April 15, 2015).

Currently, the major CBOs in Chinatown provide social and health services, and affordable housing, along with advocating for tenant rights and a higher minimum wage. Strategies include a mix of professional programs and efforts at capacity building for residents and other stakeholders. An organization playing an active role in the development of Chinatown is The Chinatown Service Center, which has created the Community Planning and Housing Division aimed at sustaining affordable housing and services for residents. They have completed two affordable housing projects: Casanova Gardens in 1999 and Cesar Chavez Gardens in 2003 ("Affordable Housing Services" n.d.). Additionally, the Chinese Chamber of Commerce and the Chinatown Business Improvement District have played significant roles in fostering business development in Chinatown to revitalize the area as a shopping, dining, and visitor destination ("The Organization" n.d.). However, there seems to be limited involvement in developing broader policy efforts to address displacement.

Hollywood/Western, Los Angeles

The Hollywood/Western Red Line station is a below-grade, subterranean stop located in East Hollywood in one of the most densely populated areas of Los Angeles. The neighborhood is notable as the home of ethnic enclaves, including Little Armenia and Thai Town. Most residents in the area are non-Hispanic white (many of Russian and Armenian descent), Latino, and immigrant. The neighborhood is a mixed-use, regional destination at risk of gentrification (See Task 2H). Certain formal planning efforts specifically focusing on the transit-oriented nature of new developments seek to mediate the risk of gentrification in the area.

History of Hollywood/Western

The Hollywood/Western Metro rail station is located near the intersection of Hollywood and Western Blvd. in East Hollywood (See Figure 5.19). East Hollywood was annexed to the City of Los

Angeles in 1910. Around this time, it was still a predominantly farming village and mostly populated by non-Hispanic whites (East Hollywood Neighborhood Council 2015). After its annexation, East Hollywood increasingly served the growing movie industry – which is still present in the area today.

During the 1920s, many immigrants around the world came to East Hollywood, including Russians escaping the Bolshevik Revolution and Armenians escaping the Armenian genocide. It was during the 1950s when most of the area's apartment buildings were built (East Hollywood Neighborhood Council 2015). The building of the Hollywood Freeway a few years earlier, however, had led to the destruction of many houses and relocation of residents.

Beginning in the 1960s, many immigrant communities from around the world settled in East Hollywood: from East Asia, Southeast Asia, Latin America, the former Soviet Union, and the Middle East. Each community continues to leave its mark on this neighborhood, including its ethnic businesses.

In 1992, East Hollywood was affected in the Los Angeles Riots as many of its businesses were looted. Additionally, the area sustained significant damage in the 1994 Northridge earthquake. However, the late 1990s saw a period of economic boom and recovery for East Hollywood, and in 1999 the Hollywood/Western station opened that linked the area to downtown Los Angeles. Part of the area's revitalization includes designations of “Thai Town” and “Little Armenia,” which represents the diversity of East Hollywood today.

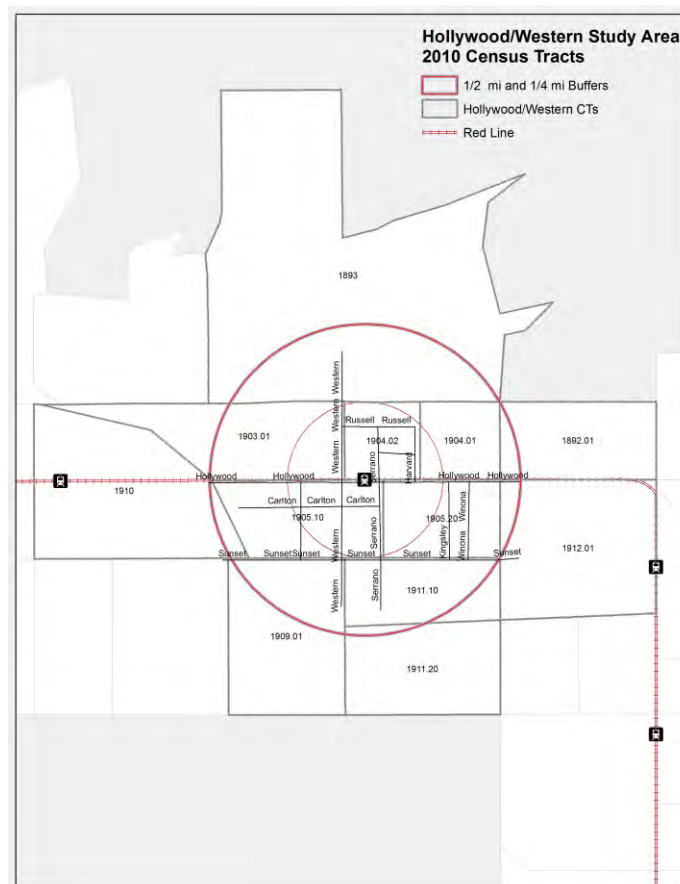

Figure 5.19: Hollywood/Western Study Area by Census Tract (2010 Boundaries)

Demographics

The population of the Hollywood/Western neighborhood has increased since the 1960s to more than 45,000 by 2013 (Table 5.13). Non-Hispanic whites make up the highest proportion of residents in the area at about 48%. While their proportion declined in the 1990s and 2000s, there has been a slight increase in the past decade. This group includes those of whites of European, American, or Middle Eastern descent (Armenians being the most prevalent in this group). Hispanics also make up a large percentage of Hollywood/Western (at 36%), although there has been a small decline since 1990 (when they represented 41% of the residents). Over the years, the share of Asian-American and black residents has remained steady at about 10% and 5%, respectively. Although the share of foreign-born residents has declined since 1990, immigrant residents still make up about half of the neighborhood's population. The number of elderly residents has been on the decline.

Table 5.13: Hollywood/Western Demographics

	1970	1980	1990	2000	2010	2009-2013
Total Population	32,963	41,488	50,128	48,839	44,739	45,455
Race/Ethnicity						
Asian	4%	9%	9%	10%	12%	10%
Black	1%	5%	4%	4%	5%	4%
NHW		58%	45%	41%	46%	48%
Hispanic		23%	41%	39%	35%	36%
Elderly (60 and older)	25%	19%	15%	14%	17%	15%
Foreign Born	30%	53%	64%	61%	53%	50%
Poverty Rate	15%	22%	27%	30%	25%	27%
Total Housing Units	18,884	19,603	20,022	19,849	21,100	21,088
Vacancy Rate	5.6%	4.5%	7.1%	3.5%	9.4%	8.3%
% Renter	86%	87%	88%	88%	90%	88%
Multi-Unit Housing	80%	82%	83%	83%	86%	84%
Mean HH Income (2013\$)		48,982	56,927	55,802		55,705
Mean Rent Range (2013\$)		732	923	811		1,035

Source: US2010 Project available at <http://www.s4.brown.edu/us2010/Researcher/Bridging.htm>; and 2009-2013 ACS tabulated by authors.

There are at least 21,000 units in the Hollywood/Western TOD area. The area continues to be densely populated with more than 80% of the stock multi-family housing. The mean rent has increased by over 40% since 1980 (from about \$730 in 1980 to over \$1,000 in 2013), which is not proportionally matched with the 14% increase in mean household income during the same period. The mean household income for those in this neighborhood is slightly over \$55,000, about \$25,000 less than the county average. This disproportionate trend becomes significant since 88% of residents in Hollywood/Western are renters. Moreover, about 59% are rent burdened, and about 37% spend half or more of their income on rent. Though less than in Chinatown, the poverty rate of residents in Hollywood/Western is still relatively high, with over one-fourth of the resident population living below the poverty line. Providing affordable housing in the Hollywood/Western neighborhood is important in maintaining the area's ethnic diverse history. Despite the existence of

some anti-displacement policies and efforts, about 9% of all residential parcels have seen some housing improvement, which suggests a possible gentrification (see Task 2H).

Anti-Displacement Policies

Because the Hollywood/Western case study area is located within the City of Los Angeles boundaries, the city's nine anti-displacement policies apply to this neighborhood.

Aside from the citywide ordinances, the Vermont Western Station Neighborhood Area Plan (SNAP) applies to the Hollywood/Western Station. The Vermont Western SNAP was adopted in 2001. It is a specific plan created to encourage TOD around the Red Line in East Hollywood, which applies to four stations: Hollywood/Western, Vermont/Beverly, Vermont/Santa Monica, and Vermont/Sunset. The SNAP permits greater heights and densities for mixed-use and residential projects, and reduces parking requirements by 15% for projects built within 1,500 feet of a station. The specific plan further reduces the cost of building TOD, mixed-use development by eliminating the requirement that developers provide additional parking when they change the use of a building.

SNAP regulations for residential areas are intended to conserve the scale of existing neighborhoods. In community centers located around Red Line stations the SNAP provides floor area incentives for commercial, hospital, and medical uses. Commercial corridors connecting the community centers are designated as mixed-use boulevards. The plan mandates equitable development through its community benefit elements. For example, the SNAP's childcare facility component requires mixed-use or commercial projects with 100,000 square feet or more of nonresidential floor area to include childcare facilities to accommodate the needs of employees.

There are three references to low-income and affordable housing within the TOD.

- Under the Purpose of the Plan, Section 2 D states that the plan intends to “Improve the quality of housing stock in the neighborhood through the construction of affordable housing units available for homeownership in Mixed Use buildings along transit corridors.”
- Section 6F.2b of the plan, states that two types of affordable housing developments are exempt from the Park First Program Fees. These include:
 - Senior Citizen and Student Housing. Residential units with fewer than three habitable rooms reserved exclusively for seniors or full-time students and which both (i) qualify as low- and very-low-income housing as defined by HUD and (ii) are subsidized with public funds and/or federal or state tax credits with affordability covenants of at least 30 years are exempt from the Parks First Trust Fund fee.
 - Low- and Very-Low-Income Housing. All residential units in a project containing low- and very-low-income residential units as defined by HUD that are subsidized with public funds and/or federal or state tax credits with affordability covenants of at least 30 years are exempt from the Parks First Trust Fund fee.

The plan calls for a walkable, transit-friendly urban community, with existing residential neighborhoods preserved, future population and commercial growth channeled into mixed-use buildings along transit corridors, and unique activity centers at each of the four subway stations. Public services, especially parks, childcare, community police stations, libraries, and schools are to be expanded and placed in sites among the neighborhoods and along commercial corridors.

One significant component of the plan that should be of interest to small and local businesses is the Local Jobs Incentives that are a set of policies and code incentives or exemptions for both small and larger businesses to come into and remain in the Plan Area. Live/work spaces, and small assembly

workshops are allowed to facilitate business start-ups. Existing commercial buildings are allowed lower parking standards in order to attract a wider range of tenants.

Community Involvement, Response and Resistance to Displacement

As the station areas become more desirable to live in, existing, long-term residents are at higher risk of eviction and displacement. Community-based organizations (CBOs) worry that real estate speculation will lead to development that may force out long-term, low-income renters. Stories of displacement from rising rents have been noted by neighborhood CBOs in Hollywood. An LA Voice organizer estimated that 30% of the Hollywood church congregation the organization serves moved to the San Fernando Valley because of rising rents in Hollywood (LA Voice, personal communication April 10, 2015).

CBOs in the area have developed valued partnerships with public agencies. In 2003, the Thai Community Development Center (Thai CDC) conducted a needs assessment of area (Thai Community Development Center 2003). The study related to the Vermont/Western TOD plan and found that East Hollywood is a community with especially sizable Latino, Armenian, and Thai populations. It is a predominately low-income community with a high density of smaller-than-average businesses, and a low rate of property ownership among business owners and local residents. Thai CDC worked with the city planning department and Councilmember Jackie Goldberg to organize various community stakeholders around the SNAP.

A Thai CDC staff member discussed an evaluation of the SNAP's impact conducted by the organization. The evaluation indicated that the specific plan had achieved many of its affordable housing and neighborhood preservation goals (Thai CDC, personal communication February 17, 2015). However, the staff member mentioned that some developers have objected to SNAP's local hiring and childcare space requirements. As a result, SNAP's community benefit elements may impede neighborhood economic development, if developers cannot obtain a variance from requirements. A Council District 13 staff member echoed these sentiments (personal communication April 16, 2015). He stated that the cost of providing community benefits might discourage developers from investing in the specific plan area. The staff member believes that TOD plans should not regulate development to the extent that they stifle economic growth.

Currently, Thai CDC, East Hollywood Neighborhood Council, and LA Metro are trying to form a partnership to create a small-business incubator near the Hollywood/Western Station (personal communication March 9, 2015). However, where CBOs are not actively involved in neighborhood councils, there is potential that they can be left out of the planning process. Further, limited opportunities and resources for community engagement have been identified as challenges to successful community planning around TODs by both CBOs and public agencies. CBOs felt the common forms of public input, such as public hearings and community plan updates, are ineffective at encouraging public participation and capturing the input of all interested parties. According to organizers from LA Voice, rigid public hearing agendas have constrained their capacity to advocate in formal public forums (LA Voice, personal communication April 10, 2015).

103rd St./Watts Towers, Los Angeles

The 103rd St./Watts Tower station is an at-grade stop on Metro's Blue Line that is located near the intersection of Grandee Avenue and 103rd St.. The station is situated in the heart of the Watts Neighborhood in South Los Angeles and is immediately adjacent to the historic Watts Tower Art

Center. The area gained an African-American majority in the 1940s as a result of the Great Migration from the American South. Presently, the area has a Latino majority with African-Americans retaining a significant minority. Of the station study areas, this stop, which opened in 1990, has been in operation the longest. The 103rd St./Watts Towers neighborhood shows some signs of residential gentrification, while commercial gentrification appears to be minimal.

History of Watts Neighborhood

Watts was first settled as Rancho La Tajuata in the early 1820s by Spanish Mexican settlers, and its economy was primarily based on agriculture until the arrival of the railroad station around the turn of the 19th Century. After the establishment of the station, the settlement grew rapidly, and the City of Watts was incorporated in 1907 (Watts Neighborhood Council 2015). It was annexed by the City of Los Angeles in 1926.

As a result of the Great Migration of African-Americans from the South for better opportunities, the area gained an African-American majority in the 1940s. During World War II, the city built several public housing projects for the new industrial workers, but by the 1960s these buildings housed almost exclusively African-American residents, since whites had moved out to suburban areas (Watts Neighborhood Council 2015).

The neighborhood suffered through the Watts uprisings in 1965, during which 75 people were injured and dozens of buildings burned (Queally 2015). Tensions rose due to racial profiling, discriminatory treatment, inadequate public services, and the passage in 1964 of Proposition 13, which repealed the Rumford Fair Housing Act (Queally 2015)²⁵. In the 1970s, a wave of gang-related violence arose that lasted until the early 2000s, but has since subsided (Empower LA 2015). Currently, many Latinos have settled in Watts, making up about 74% of the population, with African-Americans retaining a significant minority at 25%.

As a largely residential commuter district, the neighborhood is not proximate to the downtown central business district or other large employment areas. Unsurprisingly, the station area also has a low jobs-housing ratio (UCLA Comprehensive Project 2015). The area is a single-use zoned district, with absence of mixed-use development, and serves predominantly commuters, who travel to more job-rich employment areas (UCLA Comprehensive Project 2015). Figure 5.20 shows the study area boundaries.

²⁵ The Rumford Fair Housing Act of 1963 prohibited discrimination based on race, religion, color, national origin, and ancestry in private housing in California.

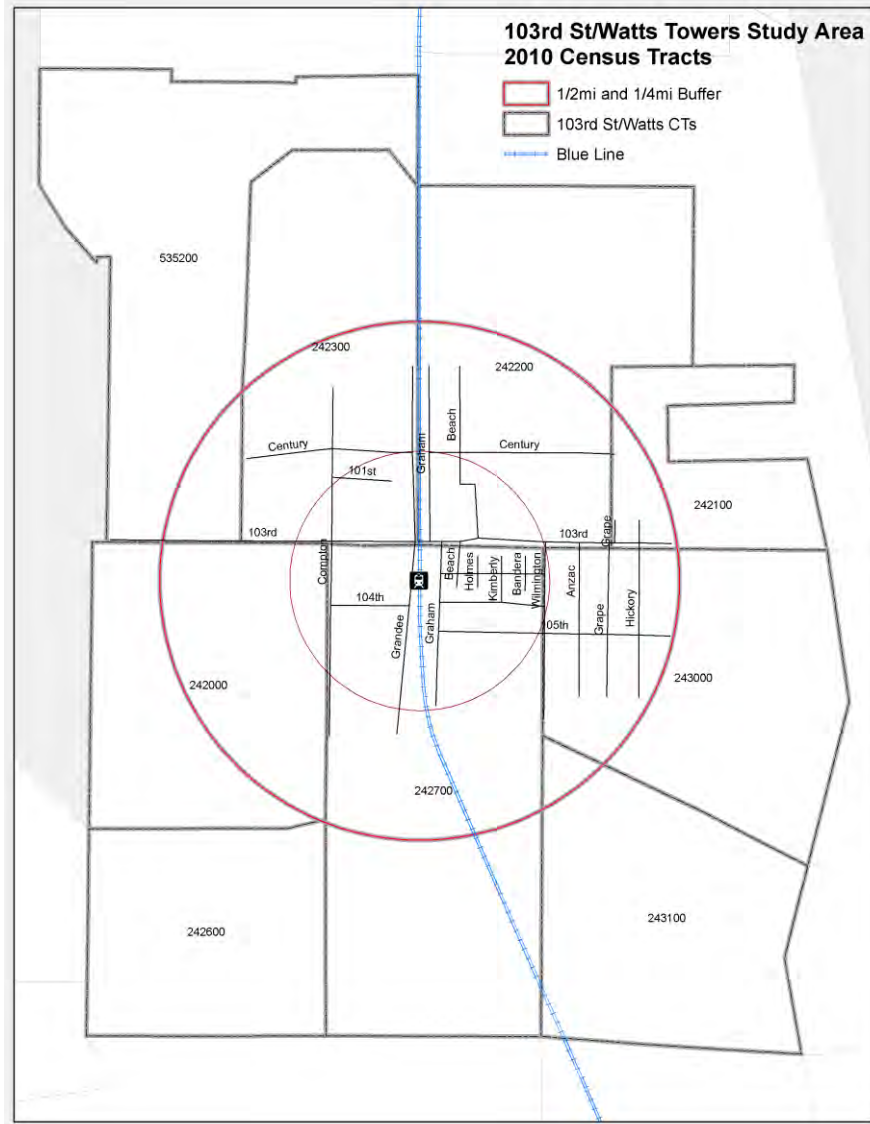

Figure 5.20: 103rd St./Watts Towers Study Area by Census Tract (2010 Boundaries)

Demographics

Of all the Los Angeles case studies, the 103rd St./Watts area has seen the greatest increase in population since the 1980s (Table 5.14). In 2013, Watts was home to more than 45,000 residents, which is a 46% increase since the lowest point in 1980. Historically, the area was an African-American community; however, by 2000, Latinos had become the majority. The considerable increase in the immigrant population coincides with the influx of Latinos.

The African-American community continues to have a considerable presence. About one-quarter of residents in the case study area are black, which is almost three-times the share for Los Angeles County (24% compared to 8%, respectively in 2013). Non-Hispanic whites and Asians are underrepresented in the area, with each accounting for no more than 1% of the population.

The share of the elderly population in the station area has declined since the 1980s and is currently at about 7%. The share of the population living below the federal poverty line, which was 51% in

1980, started declining until 2010, during a period of economic prosperity for the region. However, between 2010 and 2013, there was a jump of residents below the poverty line from 37% to 40%. The average household in Watts also makes about \$38,500, which is significantly below the county average.

Table 5.14: 103rd St./Watts Towers Demographics

	1970	1980	1990	2000	2010	2009-2013
Total Population	32,714	30,835	36,567	40,188	45,413	45,122
Race/Ethnicity						
Asian	0%	0%	0%	0%	0%	0%
Black	92%	85%	55%	37%	27%	24%
NHW		0%	0%	1%	1%	1%
Hispanic		14%	44%	62%	71%	74%
Elderly (60 and older)	9%	10%	8%	7%	7%	7%
Foreign Born	2%	9%	26%	34%	32%	32%
Poverty Rate	47%	51%	49%	47%	37%	40%
Total Housing Units	9,201	8,869	9,475	10,339	11,099	11,271
Vacancy Rate	7.1%	4.7%	4.8%	9.8%	7.3%	9.3%
% Renter	67%	68%	67%	66%	68%	69%
Multi-Unit Housing	32%	37%	38%	36%	34%	36%
Mean HH Income (2013\$)		29,118	33,436	42,042		38,513
Mean Rent Range (2013\$)		470	700	667		901

Source: US2010 Project available at <http://www.s4.brown.edu/us2010/Researcher/Bridging.htm>; and 2009-2013 ACS tabulated by authors.

The area has a lower percentage of renters than the other two case study neighborhoods, but the renters' share has increased about 3% since 2000. In 2013, 66% of renters were burdened by housing costs in 2013. Mean rents have increase by about \$300, while mean household income in the area has declined by more than \$3,500 since 1980.

The vacancy rate in the area is somewhat higher than that of Los Angeles County (9% compared to about 6% in 2013, respectively). As with the other case study areas, the number of multi-family housing units has increased over the years. The 103rd St./Watts Towers shows some signs of residential gentrification, while commercial gentrification in the neighborhood appears to be minimal. For instance, observations of the area indicate that Watts has a high rate of property turnover, with corresponding indicators of physical renovations to residential properties. Relative to the other case study areas, however, there may be a lower perception of gentrification due to a low presence of non-Hispanic whites (UCLA Comprehensive Project 2015).

The presence of institutional uses such as churches may also contribute to a difference between actual and perceived gentrification; 17% of surveyed land uses in Watts are characterized as institutional (UCLA Comprehensive Project 2015). The difficulty in adaptively reusing or demolishing these properties prevents significant land use changes. This can contribute to a

perceived lack of neighborhood change as these properties act as historical and cultural flagships (UCLA Comprehensive Project 2015).

Anti-Displacement Policies

The case study station falls within the boundaries of the Southeast L.A. Community Plan Implementation Overlay (CPIO) zone, which applies to the wider South Los Angeles area. However, it is worth mentioning that the area adjacent to the station is also covered by the South L.A. CPIO. Both plans are in draft form and have not been adopted. Both CPIOs have TOD sections and propose Floor Area to Ratio (FAR) incentives in order to encourage mixed-income projects.

The TOD section of the Southeast L.A. draft plan outlines the various benefits for 100% affordable, as well as mixed-income, housing in the different TOD subareas. Single-family homes are prohibited in some TOD subareas, while in other areas only mixed-use projects are permitted (meaning that 100% residential units are prohibited). Developers may utilize an R4 density for the purpose of calculating a baseline residential density when 100% of the dwelling units (minus any required manager unit) are set aside for households of moderate, low, very low or extra low income. Mixed-income housing projects that qualify for a density bonus may utilize additional incentives; for instance reducing the required parking for the entire project by 50% as a third parking option. There are also incentives for mixed-income housing (30 units or more).

The Jordan Downs Urban Village Specific Plan aims to create high-quality transit areas, protect community resources, and provide equitable economic opportunities. For example, the plan seeks to improve connectivity between the aging Jordan Downs public housing project and the 103rd St./Watts Towers station located a half-mile to the west. This plan has the potential to transform Jordan Downs into a mixed-income development. Importantly, the specific plan calls for a one-to-one replacement of existing affordable units. However, the redevelopment effort currently lacks the necessary funding (Garrison 2013).

Most of the formal planning efforts in Watts focus on new residential development. South Los Angeles CBOs like SAJE have noted many instances of illegal evictions and slum conditions in South Los Angeles (personal communication April 16, 2015). CBOs are able to mitigate some of the issues associated with displacement around station areas through organizing and education, policy research, community control of land, and community benefit agreements.

Community Involvement, Response and Resistance to Displacement

CBO representatives believe that Watts is underserved, and economic and community development efforts in the area have been largely unsuccessful. For instance, the area continues to have a need for more jobs (See task 2H), and poverty is on the rise (Table 5.143). Los Angeles Alliance for a New Economy (LAANE), a Los Angeles-based non-profit, has developed a TOD policy agenda encouraging equitable investments that provide good jobs and healthy options in South Los Angeles neighborhoods like Watts that have been overlooked (personal communication February 13, 2015).

Organizing has been used to advance community needs in specific developments or educate residents on the impacts of TOD. The focus of organizing efforts has ranged from renters' rights to technical aspects of city planning. For example, the United Neighbors in Defense Against Displacement (UNIDAD) coalition's organizing effort mobilized community members leading to the inclusion of affordable housing and community serving retail in the Grand Metropolitan development in South Los Angeles (SAJE, personal communication, 2015). It is a new private

project approved by the City Council in August 2015 that will create affordable housing and local jobs and promote economic development in the area. The effort was undertaken in collaboration with a number of community organizations, including SAJE and the Esperanza Community Housing Corporation with the Public Counsel legal firm negotiating the terms (SAJE personal communication, 2015).

Community Benefit Agreements (CBAs) have also been negotiated for a number of developments in and around TODs in the wider South LA by SAJE, Esperanza Community Housing, and other South Los Angeles CBOs. Included in CBAs are provisions for labor, community resources, and affordable housing benefits for low-income residents. These South Los Angeles CBAs are important examples of equitable TOD, although they are outside this study's station areas (Esperanza Community Housing, personal communication 2015).

Because developers may not incorporate community input when forming plans for a new project, CBOs seek other strategies to ensure that community input is prioritized. These efforts can involve community land trusts focused on affordable housing. Education is used as a means of uniting and empowering community members to ensure that development provides positive community outcomes. In South L.A., SAJE has regularly hosted the People's Planning School, an effort to shape policy and planning through grassroots community advocacy (UCLA Comprehensive Project 2015).

CBOs with the requisite resources have purchased and developed land for community use and to ensure perpetual housing affordability. TRUST South LA, believes that a CBO must own the land so that its community is considered a stakeholder by institutional organizations (personal communication, February 20, 2015). As an interviewee stated, the ability to purchase property gives CBOs a greater stake in the neighborhood (TRUST South LA, personal communication, February 20, 2015). Community-controlled land allows CBOs to better dictate what they and their constituents would like to see developed and allows them to have more control over the development process.

Chapter 5 Conclusion

The range of anti-displacement and affordable housing policies is wide. Some policies (like inclusionary zoning and condo conversions) have been adopted in many places; others (like rent control) in only a few. Bay Area cities generally have more policies on the books than cities in Los Angeles County, even though the latter is arguably less affordable.

Some policies show clear results, like those that fund affordable housing projects—you can see and count the units once they are built. There appears to be a correlation between cities with production policies in place and construction of more affordable housing: preliminary evidence that these policies may be working as intended. Others are difficult to track, like inclusionary zoning, or show their effectiveness only through counter-factuals (e.g., the amount of condo conversions would have been higher without laws on the books).

Stakeholders helped us see that political considerations are essential for understanding why some policies get implemented and others do not. They also drew our attention to many loopholes in the policies, showing the importance of interrogating the laws “on the ground” as compared to “on the books.” For example, condominium conversion ordinances can be limited by loopholes that allow developers to escape their rental housing replacement requirements and rent control laws can only

slightly slow the rising rents, given state law that insists on vacancy decontrol. Given these aspects of anti-displacement policy, assessing their effectiveness on a systematic basis is difficult, and an important direction for future research.

Regional funding for station area plans, at least in the Bay Area, has included requirements around affordable housing, and most plans do include goals around displacement and affordability. In Los Angeles, plans may not mention gentrification explicitly, but many include provisions around displacement and affordability. However, these plans have limited reach; many cities rely on their citywide policies to reach their TOD-specific goals; in the Bay Area, more grant funds have not gone to cities with more policies; and evaluation of these plans is very difficult.

Across our six case studies, a unifying feature is the key role community organizing plays in winning the passage and implementation of anti-displacement strategies. Besides this, the features of the neighborhoods vary considerably.

In San Francisco's Chinatown, neighborhood-level zoning and rental housing policies protected this area from the displacement occurring around it. In East Palo Alto, citywide tenant protection and affordable housing production policies helped limit displacement, but other features of the community—poor schools, lack of amenities, and an image of the neighborhood as unsafe—probably played a large role in limiting the amount of gentrification in the neighborhood, and in keeping displacement pressures at bay. Would the city's anti-displacement measures have prevented displacement if market conditions had encouraged more gentrification?

In San Jose's Diridon Station area, rent stabilization likely limited dramatic rent increases at nearly 500 units. Also, pro-market-rate housing production policies, while not explicitly anti-displacement, seemed to have allowed the scale of development necessary to accommodate the influx of higher-income residents without displacing existing residents.

Meanwhile, the Los Angeles case studies focused more on the role of station area plans in addressing displacement. While some of these plans indicate the need and desire from the part of the planners for more affordable housing, and offer incentives such as density bonuses to developers, it is very early to assess their effectiveness. Similar to the Bay Area, CBOs and non-profits in the Los Angeles area case studies are actively advocating against displacement and for more affordable housing and living-wage jobs.

From these case studies, it is clear that anti-displacement policies are important. However, they are rarely the whole story, and, instead, features of the neighborhood play an equally important role. Advocates need to consider the unique features of their place in deciding which policies to organize around.

Even with this plethora of policy options, it is not clear that the policies we have developed today, as currently implemented, come anywhere close to addressing the displacement occurring around transit, nor to filling the enormous gap in affordable housing. Stronger enforcement of existing policies, expansion of policies, and more organizing will be necessary to ensure the stability of low-income populations going forward.

Of 14 anti-displacement policies inventoried across the two regions, inclusionary zoning and condo conversion ordinances are most popular; rent control and just-cause policies are rarer. Bay Area cities generally have more policies on the books than cities in Los Angeles County. Yet, their effectiveness is not well-studied, and it remains unclear whether they can successfully scale up to

address the dire need for affordable housing in California. At present, many station area plans include requirements for the production of affordable housing, and often the reduction of displacement as well. However, the level of funding to date has been insufficient to produce significant amounts of housing and to stabilize the low-income communities living near transit. Case studies demonstrate the key role community organizing can play in winning the passage and implementation of anti-displacement strategies.

Conclusion

Fixed-rail transit has a significant impact on the stability of the surrounding neighborhood. In transit neighborhoods, housing costs tend to increase, changing the demographic composition of the area and resulting in the loss of low-income households. We find that low-income households both near and farther away from rail stations have lower VMT than high-income households, but that higher-income households either reduce their driving more in response to being near rail, or that there is no difference in VMT impacts between income categories when considered at a regional level.

Our findings generally confirm earlier research on gentrification and displacement, but extend previous work by explicitly linking transit investment to gentrification and displacement, and investigating how income and proximity to transit influence VMT.

Via several different models, we find a significant and positive relationship between TOD and gentrification, and in some cases the loss of affordable housing or low-income households as well. In general, TOD has a more significant impact in the core cities of the SF Bay Area and Downtown Los Angeles. Yet, the timeframe of impacts is less clear. In some cases, it seems to take decades, and in others, much less time. Moreover, other variables—such as historic housing stock and changes in affordability—compound the effects of TOD, sometimes with a more significant effect.

Proximity to rail is associated with lower VMT for both lower-income households and higher-income households. Given the lack of appropriate data, it is hard to predict how households will alter their VMT with displacement, for instance as high-income households replace low-income households near transit. In general, our study predicts that displacement induced by gentrification will either reduce net regional VMT or have no effect. However, increases of VMT may occur to the extent that very-low-income households are displaced by those of moderate income, or if gentrification results in a reduction of the population living near rail. More research is needed to understand the dynamic impacts that occur as residents adjust their travel behavior in new locations.

Since fixed-rail transit impacts neighborhood stability, and public investment subsidizes transit in California, it is appropriate for policy makers to take action that will reduce displacement. Yet, there is no simple recipe for mitigating displacement. The effectiveness of policy solutions varies by context, and it is unclear whether any of the existing approaches are sufficient to address displacement in the core neighborhoods where it is most prevalent. More research is needed to develop responsive policy tools, as well as to understand better the trade-offs between anti-displacement and VMT reduction goals.

Despite these remaining concerns, it is not too soon to begin incorporating these results into existing regional models (PECAS and UrbanSim) to analyze different investment scenarios and market conditions. We also recommend that practitioners begin to use our off-model tool to help identify the potential risk of displacement.

References

- Abraham, J.E., S. Cho, and G.T Hill. 2015a. "New Developments in the PECAS SD Module." HBA Spectro Incorporated.
- Abraham, J.E., S. Cho, and G.T Hill. 2015b. "Representing Displacement In PECAS." HBA Spectro Incorporated.
- Abraham, John Edward, Jamie Bridges, Charles Baber, Abdel Muhsen, and De Silva Dimantha. 2011. "Investigating Zoning Policy with the Baltimore PECAS Model." In *Proceedings of the 12th International Conference on Computers in Urban Planning and Urban Management*. Lake Louise, AB.
- Abraham, J.E., and J. D Hunt. 2007. "Random Utility Location, Production, and Exchange Choice ; Additive Logit Model ; and Spatial Choice Microsimulations." *Transportation Research Record*, no. 2003: 1–6.
- Acharya, Gayatri, and Lynne Lewis Bennett. 2001. "Valuing Open Space and Land-Use Patterns in Urban Watersheds." *The Journal of Real Estate Finance and Economics* 22 (2-3): 221–37. doi:10.1023/A:1007843514233.
- Adkins, William G. 1959. "Land Value Impacts Of Expressways In Dallas, Houston, And San Antonio, Texas." *Highway Research Board Bulletin*, no. 227. <http://trid.trb.org/view.aspx?id=134044>.
- Ben-Akiva, Moshe E., and Steven R. Lerman. 1987. *Discrete Choice Analysis: Theory and Application to Travel Demand*. MIT Press.
- Alameda County Transportation Commission. 2016. "Priority Development Area Investment and Growth Strategy : Alameda CTC." *Alameda County Transportation Commission*. Accessed October 20. http://www.alamedactc.org/app_pages/view/10385.
- Allbee, Allison, Jeffrey Lubell, and Rebecca Johnson. 2015. "Preserving, Protecting, and Expanding Affordable Housing: A Policy Toolkit for Public Health." ChangeLabSolutions. http://changelabsolutions.org/publications/affordable_housing_toolkit.
- American Planning Association. 2006. "Section 4.4 Model Affordable Housing Density Bonus." American Planning Association. <https://www.smartgrowthamerica.org/app/legacy/images/IH-model-ordinance-APA%20.pdf>.
- Anderson, Soren T., and Sarah E. West. 2006. "Open Space, Residential Property Values, and Spatial Context." *Regional Science and Urban Economics* 36 (6): 773–89. doi:10.1016/j.regsciurbeco.2006.03.007.
- Association of Bay Area Governments (ABAG). 2015. "Bay Area Housing Policy Databse v.1.0." <http://abag.ca.gov/planning/housing/research.html>.
- Association of Bay Area Governments (ABAG). 2016. "Final Regional Housing Need Allocation Adopted." Accessed October 20. <http://www.abag.ca.gov/planning/housingneeds/>.
- Association of Bay Area Governments (ABAG), and Metropolitan Transportation Commission (MTC). 2013. "Plan Bay Area: Strategy for a Sustainable Region." http://files.mtc.ca.gov.s3.amazonaws.com/pdf/Plan_Bay_Area_FINAL/pbafinal/index.html.
- Atkinson, Rowland. 2000. "Measuring Gentrification and Displacement in Greater London." *Urban Studies* 37 (1): 149–65. doi:10.1080/0042098002339.
- Atkinson, Rowland, Maryann Wulff, Margaret Reynolds, and Angela Spinney. 2011. "Gentrification and Displacement: The Household Impacts of Neighbourhood Change." Australian Housing and Urban Research Institute. https://www.ahuri.edu.au/_data/assets/pdf_file/0007/2122/AHURI_Final_Report_No160_Gentrification_and_displacement_the_household_impacts_of_neighbourhood_change.pdf.

- Atlanta Regional Commission. 2016. "Atlanta TOD Collaborative." *Atlanta Regional Commission*. Accessed October 20. <http://www.atlantaregional.com/land-use/transit-oriented-development/atlanta-tod-collaborative>.
- Baar, Kenneth. 2011. "The Economics of Mobilehome Ownership and Mobilehome Park Ownership in the City of Los Angeles and a Comparison of Local Regulations of Mobilehome Park Space Rents." commissioned by the City of Los Angeles.
- Bajic, Vladimir. 1983. "The Effects of a New Subway Line on Housing Prices in Metropolitan Toronto." *Urban Studies* 20 (2): 147–58. doi:10.1080/00420988320080291.
- Bakker, John. 2005. "Condominium Conversions: They're Back: A Brief Primer on Condominiums Conversions and Conversion Ordinances and Some Thoughts from One Suburban Battleground." <http://www.cacities.org/UploadedFiles/LeagueInternet/c5/c5e504c3-e261-4986-b983-c964db35d7c0.pdf>.
- Barton, Stephen. 1998. "The Success and Failure of Strong Rent Control in the City of Berkeley, 1978-1995." In *Rent Control: Regulation and the Rental Housing Market*, edited by W. Dennis Keating, Michael B. Teitz, and Andrejs Skaburskis. : Center for Urban Policy Research, Rutgers - The State University of New Jersey.
- Bates, Lisa. 2013. "Gentrification and Displacement Study: Implementing an Equitable Inclusive Development Strategy in the Context of Gentrification." <http://www.portlandoregon.gov/bps/article/454027>.
- Beauregard, Robert. 1986. "The Chaos and Complexity of Gentrification." In *Gentrification of the City Edited by Neil Smith and Peter Williams*. Boston: Allen & Unwin.
- Bianchini, F., J. Grove, and R. Evans. 1992. "Flagship Projects in Urban Regeneration." In *Rebuilding the City: Property-Led Urban Regeneration*, edited by P. Healy, S. Davoudi, S. Tavsanoglu, M. O'Toole, and D. Usher. London: Chapman & Hall.
- Bloom, Joshua. n.d. "Commercial District Gentrification." http://www.preservationnation.org/main-street/resources/public/RMS_Gentrification.pdf.
- Bluestone, Barry, Mary Huff Stevenson, and Russell Williams. 2008. *The Urban Experience: Economics, Society, and Public Policy*. 1 edition. Oxford ; New York: Oxford University Press.
- Bolitzer, B, and N. R Netusil. 2000. "The Impact of Open Spaces on Property Values in Portland, Oregon." *Journal of Environmental Management* 59 (3): 185–93. doi:10.1006/jema.2000.0351.
- Bostic, Raphael W., and Richard W. Martin. 2003. "Black Home-Owners as a Gentrifying Force? Neighbourhood Dynamics in the Context of Minority Home-Ownership." *Urban Studies* 40 (12): 2427–49. doi:10.1080/0042098032000136147.
- Boyd, Michelle. 2005. "The Downside of Racial Uplift: Meaning of Gentrification in an African American Neighborhood." *City & Society* 17 (2): 265–88. doi:10.1525/city.2005.17.2.265.
- Boyer, Christine. 1992. "Cities for Sale: Merchandising History at South Street Seaport." In *Variations on a Theme Park: The New American City and the End of Public Space*. Macmillan.
- Bridge, Gary, Tim Butler, and Loretta Lees. 2012. *Mixed Communities: Gentrification by Stealth?*. Policy Press.
- Briggs, Xavier de Souza, ed. 2005. *The Geography of Opportunity: Race and Housing Choice in Metropolitan America*. Washington D.C: Brookings Institution Press.
- Brinckerhoff, Parsons. 2001. "The Effect of Rail Transit on Property Values: A Summary of Studies." Project S 21439, Task 7. Cleveland, Ohio: NEORail II. https://drcog.org/documents/The_effect_of_Rail_Transit_on_Property_Values_Summary_of_Studies1.pdf.
- Brown, Ann. 2014. "Neighborhood Change Along the Orange Line." UCLA Lewis Center for Regional Policies. <http://www.lewis.ucla.edu/wp-content/uploads/sites/2/2014/11/ABrown-GIS-CompetitionPoster-final.pdf>.
- Brown-Saracino, Japonica. 2004. "Social Preservationists and the Quest for Authentic Community." *City & Community* 3 (2): 135–56. doi:10.1111/j.1535-6841.2004.00073.x.

- Brown-Saracino, Japonica. 2009. *A Neighborhood That Never Changes: Gentrification, Social Preservation, and the Search for Authenticity*. Fieldwork Encounters and Discoveries. Chicago: University of Chicago Press.
<http://www.press.uchicago.edu/ucp/books/book/chicago/N/bo8066321.html>.
- Bruch, Elizabeth E., and Robert D. Mare. 2006. "Neighborhood Choice and Neighborhood Change." *American Journal of Sociology* 112 (3): 667–709. doi:10.1086/507856.
- Bucholtz, Shawn, Jacqueline Geoghegan, and Lori Lynch. 2003. "Capitalization of Open Spaces into Housing Values and the Residential Property Tax Revenue Impacts of Agricultural Easement Programs." *Agricultural and Resource Economics Review* 32 (1).
<http://econpapers.repec.org/article/agsarerjl/31352.htm>.
- Burgess, Ernest Watson. 1925. "The Growth of the City." In *The City: Suggestions of Investigation of Human Behavior in the Urban Environment*, edited by Robert Ezra Park, 47–62. Chicago: University of Chicago Press.
- Calavita, Nico, and Kenneth Grimes. 1992. "The Establishment of the San Diego Housing Trust Fund: Lessons for Theory and Practice." *Journal of Planning Education and Research* 11 (3): 170–84. doi:10.1177/0739456X9201100302.
- Calavita, Nico, and Kenneth Grimes. 1998. "Inclusionary Housing in California: The Experience of Two Decades." *Journal of the American Planning Association* 64 (2): 150–69. doi:10.1080/01944369808975973.
- Calavita, Nico, Kenneth Grimes, and Alan Mallach. 1997. "Inclusionary Housing in California and New Jersey: A Comparative Analysis." *Housing Policy Debate* 8 (1): 109–42. doi:10.1080/10511482.1997.9521249.
- Calavita, Nico, Alan Mallach, and Lincoln Institute of Land Policy. 2010. "United States: From Radical Innovation to Mainstream Housing Policy." In *Inclusionary Housing in International Perspective: Affordable Housing, Social Inclusion, and Land Value Recapture*. Cambridge, Mass.: Lincoln Institute of Land Policy.
- California Coalition for Rural Housing, and Non-Profit Housing Association of Northern California. 2003. "Inclusionary Housing in California: 30 Years of Innovation."
<http://www.wellesleyinstitute.com/wp-content/uploads/2013/01/NPH-IHinCAfor30years2003.pdf>.
- California Department of Finance. 2015. "Housing, Permits & Starts, California and United States."
http://www.dof.ca.gov/HTML/FS_DATA/LatestEconData/FS_Construction.htm.
- California Department of Housing and Community Development (HCD). 2012. "Identification and Analysis of Developments At-Risk of Conversion." June. http://www.hcd.ca.gov/housing-policy-development/housing-element/ehh_atrisk.php.
- California Housing Partnership Corporation (CHPC). 2013. "Building and Preserving Affordable Homes Near Transit: Affordable TOD as a Greenhouse Gas Reduction and Equity Strategy. Working Paper." http://www.scanph.org/files/FullReport_CHPCAffordableTOD013113.pdf.
- California Housing Partnership Corporation (CHPC). 2015. "Update On California's Affordable Housing Crisis: The Critical Role of Housing Access and Affordability in Reducing Poverty." <http://chpc.net/wp-content/uploads/2015/11/1-2015StatewideHousingNeedReportFINAL.pdf>.
- Cao, Xinyu, and Daniel Chatman. 2015. "How Will Smart Growth Land-Use Policies Affect Travel? A Theoretical Discussion on the Importance of Residential Sorting." *Environment and Planning B: Planning and Design*, August, 0265813515600060. doi:10.1177/0265813515600060.
- Card, David, Alexandre Mas, and Jesse Rothstein. 2008. "Tipping and the Dynamics of Segregation." *The Quarterly Journal of Economics* 123 (1): 177–218. doi:10.1162/qjec.2008.123.1.177.
- Casazza, John. 1982. *Condominium Conversions*. Urban Land Institute.
- Caulfield, Jon. 1994. *City Form and Everyday Life: Toronto's Gentrification and Critical Social Practice*. University of Toronto Press. <http://www.jstor.org/stable/10.3138/j.ctt2ttx4p>.

- Center for Community Change. 2013. "City Housing Trust Funds 2013."
<http://housingtrustfundproject.org/wp-content/uploads/2013/09/City-htfund-admin-and-date-2013.pdf>.
- Center for Community Change. 2015. "County Housing Trust Funds 2015."
<http://housingtrustfundproject.org/wp-content/uploads/2015/05/County-htfund-admin-and-date-2015.pdf>.
- Center for Transit-Oriented Development (CTOD). 2004. "Hidden in Plain Sight: Capturing The Demand For Housing Near Transit." Reconnecting America.
<http://ctod.org/pdfs/2004HiddenPlainSight.pdf>.
- Center for Transit-Oriented Development (CTOD), Nelson Nygaard, and t, Community Design + Architecture CD+A. 2014. "TOD Policy Status Report." Prepared for Metropolitan Transportation Commission. http://files.mtc.ca.gov/pdf/Final-MTC-TOD-Policy-Update_2014.pdf.
- Cervero, Robert. 2004. *Transit-Oriented Development in the United States: Experiences, Challenges, and Prospects*. Transportation Research Board.
- Cervero, Robert. 2005. "Progressive Transport and the Poor: Bogota's Bold Steps Forward." *ACCESS Magazine* 1 (27). <http://escholarship.org/uc/item/3mj7r62w>.
- Cervero, Robert. 2006. "Effects of Light and Commuter Rail Transit on Land Prices: Experiences in San Diego County." *University of California Transportation Center*, September.
<http://escholarship.org/uc/item/75n1b5xc>.
- Cervero, Robert. 2013. "Transport Infrastructure and the Environment: Sustainable Mobility and Urbanism." *IURD Working Paper 2013-03*, October.
<http://escholarship.org/uc/item/3690j6pw>.
- Cervero, Robert, and Michael Duncan. 2002a. "Transit's Value-Added Effects: Light and Commuter Rail Services and Commercial Land Values." *Transportation Research Record: Journal of the Transportation Research Board* 1805 (January): 8–15. doi:10.3141/1805-02.
- Cervero, Robert, and Michael Duncan. 2002b. "Land Value Impacts of Rail Transit Services in Los Angeles County." Washington, D.C.: Prepared for National Association of Realtors Urban Land Institute.
<http://realtorbenefitsprogram.org/wps/wcm/connect/e7187a004e88a38db7bcf76019b6e772/losangeles.pdf?MOD=AJPERES&CACHEID=e7187a004e88a38db7bcf76019b6e772>.
- Cervero, Robert, and Michael Duncan. 2002c. "Benefits of Proximity to Rail on Housing Markets: Experiences in Santa Clara County." *Journal of Public Transportation*, June.
<http://www.nctr.usf.edu/2002/06/benefits-of-proximity-to-rail-on-housing-markets-experiences-in-santa-clara-county/>.
- Cervero, Robert, and Michael Duncan. 2004. "Neighbourhood Composition and Residential Land Prices: Does Exclusion Raise or Lower Values?" *Urban Studies* 41 (2): 299–315.
doi:10.1080/0042098032000165262.
- Chambers, Robert. 2005. "Pushed Out: A Call for Inclusionary Housing Programs in Local Condominium Conversion Legislation Comment." *California Western Law Review* 42: 355–76.
- Chapin, Timothy S. 2004. "Sports Facilities as Urban Redevelopment Catalysts: Baltimore's Camden Yards and Cleveland's Gateway." *Journal of the American Planning Association* 70 (2): 193–209.
doi:10.1080/01944360408976370.
- Chapple, Karen. 2009. "Mapping Susceptibility to Gentrification: The Early Warning Toolkit." Berkeley, CA: Center for Community Innovation.
<http://communityinnovation.berkeley.edu/reports/Gentrification-Report.pdf>.
- Chapple, Karen. 2014. "The Highest and Best Use? Urban Industrial Land and Job Creation." *Economic Development Quarterly* 28 (4): 300–313. doi:10.1177/0891242413517134.

- Chapple, Karen, Shannon Jackson, and Anne J. Martin. 2010. "Concentrating Creativity: The Planning of Formal and Informal Arts Districts." *City, Culture and Society*, Advancing the Creative Economy Approach for Urban Studies, 1 (4): 225–34. doi:10.1016/j.ccs.2011.01.007.
- Chapple, Karen, and Rick Jacobus. 2009. "Retail Trade as a Route to Neighborhood Revitalization." In *Urban and Regional Policy and Its Effects*. Vol. 2. Washington, D.C.: Brookings Institution Press. <http://www.rjacobus.com/resources/archives/Retail%20Trade%20Proof.pdf>.
- Chapple, Karen, Jake Wegmann, Alison Nemirow, and Colin Dentel-Post. 2012. "Yes in My Backyard: Mobilizing the Market for Secondary Units." <http://communityinnovation.berkeley.edu/reports/secondary-units.pdf>.
- Charles, Camille Zubrinsky. 2000. "Neighborhood Racial-Composition Preferences: Evidence from a Multiethnic Metropolis." *Social Problems* 47 (3): 379–407. doi:10.2307/3097236.
- Charles, Camille Zubrinsky. 2003. "The Dynamics of Racial Residential Segregation." *Annual Review of Sociology* 29: 167–207.
- Chaskin, Robert J. 2013. "Integration and Exclusion Urban Poverty, Public Housing Reform, and the Dynamics of Neighborhood Restructuring." *The ANNALS of the American Academy of Political and Social Science* 647 (1): 237–67. doi:10.1177/0002716213478548.
- Chatman, Daniel. 2003. "How Density and Mixed Uses at the Workplace Affect Personal Commercial Travel and Commute Mode Choice." *Transportation Research Record: Journal of the Transportation Research Board* 1831 (January): 193–201. doi:10.3141/1831-22.
- Chatman, Daniel G. 2009. "Residential Choice, the Built Environment, and Nonwork Travel: Evidence Using New Data and Methods." *Environment and Planning A* 41 (5): 1072–89. doi:10.1068/a41114.
- Chatman, Daniel G. 2013. "Does TOD Need the T?" *Journal of the American Planning Association* 79 (1): 17–31. doi:10.1080/01944363.2013.791008.
- Chatman, Daniel G. 2014. "Estimating the Effect of Land Use and Transportation Planning on Travel Patterns: Three Problems in Controlling for Residential Self-Selection." *Journal of Transport and Land Use* 7 (3): 47–56. doi:10.5198/jtlu.v7i3.729.
- Chatman, Daniel G., Nicholas K. Tulach, and Kyeongsu Kim. 2012. "Evaluating the Economic Impacts of Light Rail by Measuring Home Appreciation A First Look at New Jersey's River Line." *Urban Studies* 49 (3): 467–87. doi:10.1177/0042098011404933.
- Cheng, Suellen, and Munson Kwok. 2016. "History of Old Chinatown Los Angeles." *Los Angeles Old Chinatown Merchants Association*. Accessed October 21. <http://oldchinatownla.com/history.html>.
- Chen, Hong, Anthony Rufolo, and Kenneth Dueker. 1998. "Measuring the Impact of Light Rail Systems on Single-Family Home Values: A Hedonic Approach with Geographic Information System Application." *Transportation Research Record: Journal of the Transportation Research Board* 1617 (January): 38–43. doi:10.3141/1617-05.
- Chen, Kan, Elena G. Irwin, Ciriya Jayaprakash, and Keith Warren. 2005. "The Emergence of Racial Segregation in an Agent-Based Model of Residential Location: The Role of Competing Preferences." *Computational and Mathematical Organization Theory* 11: 333–38.
- Chinatown Business District. 2016. "Chinatown Business District: The Organization." Chinatown Los Angeles. Accessed October 20. <http://www.chinatownla.com/cbid.php>.
- Chinatown Service Center. 2016. "Affordable Housing Services." *Chinatown Service Center*. Accessed October 20. <http://cscla.org/services/family-services/affordable-housing/>.
- Chin, Gordon. 2015. *Building Community, Chinatown Style: A Half Century of Leadership in San Francisco Chinatown*. San Francisco, California: Friends of CCDC.
- Chinn, Alton. 2014. Interview.
- Chipman, Jonathan, Richard Wright, Mark Ellis, and Steven R. Holloway. 2012. "Mapping the Evolution of Racially Mixed and Segregated Neighborhoods in Chicago." *Journal of Maps* 8 (4): 340–43. doi:10.1080/17445647.2012.740431.

- City/County Association Of Governments Of San Iviateo Cot]Nty. 2014. "San Mateo County Priorify Development Area Investment and Growth Strategy." <http://ccag.ca.gov/wp-content/uploads/2014/06/CMEQ-042913-Full-Packet.pdf>.
- City of Banning. 2005. "California Jurisdictions with Mobilehome Park Rent Stabilization Ordinances." <http://www.ci.banning.ca.us/archives/48/Appendix%201%20-%20arentcontroljurisdictionmodified2.pdf>.
- City of San Jose. 2014. "City of San José Housing Element 2014-2023 - ADMINISTRATIVE DRAFT." <http://www.sanjoseca.gov/DocumentCenter/View/34556>.
- Civic Economics. 2012. "The Civic Economics of Retail: Ten Years of Studies." <http://nebula.wsimg.com/eb1a35cadd85dd440dcb5cb1eba005e?AccessKeyId=8E410A17553441C49302&disposition=0&alloworigin=1>.
- Clark, W. A. V., and W. F. J. Van Lierop. 1986. "Residential Mobility and Household Location Modelling." *Handbook of Regional and Urban Economics*. Elsevier Science Publishers. <http://econpapers.repec.org/bookchap/eeeregchp/1-03.htm>.
- Clark, William A. V., and Mark Fossett. 2008. "Understanding the Social Context of the Schelling Segregation Model." *California Center for Population Research*, June. <http://escholarship.org/uc/item/9nx9x9pf>.
- Clay, Phillip L. 1979. *Neighborhood Renewal: Middle-Class Resettlement and Incumbent Upgrading in American Neighborhoods*. Lexington, Mass: Lexington Books.
- Couch, Kenneth A., and David C. Wittenburg. 2001. "The Response of Hours of Work to Increases in the Minimum Wage." *Southern Economic Journal*, 171–77.
- Coulton, C. J., J. Chow, E. C. Wang, and M. Su. 1996. "Geographic Concentration of Affluence and Poverty in 100 Metropolitan Areas, 1990." *Urban Affairs Review* 32 (2): 186–216. doi:10.1177/107808749603200203.
- Crane, Jonathan. 1991. "The Epidemic Theory of Ghettos and Neighborhood Effects on Dropping Out and Teenage Childbearing." *American Journal of Sociology* 96 (5): 1226–59.
- Crooks, A. T. 2010. "Constructing and Implementing an Agent-Based Model of Residential Segregation through Vector GIS." *International Journal of Geographical Information Science* 24 (5): 661–75. doi:10.1080/13658810903569572.
- Crowder, Kyle, Jeremy Pais, and Scott J. South. 2012. "Neighborhood Diversity, Metropolitan Constraints, and Household Migration." *American Sociological Review* 77 (3): 325–53. doi:10.1177/0003122412441791.
- Crowder, Kyle, Matthew Hall, and Stewart E. Tolnay. 2011. "Neighborhood Immigration and Native Out-Migration." *American Sociological Review* 76 (1): 25–47. doi:10.1177/0003122410396197.
- Crowder, Kyle, and Scott J. South. 2005. "Race, Class, and Changing Patterns of Migration between Poor and Nonpoor Neighborhoods." *American Journal of Sociology* 110 (6): 1715–63. doi:10.1086/428686.
- Daniel, Frattin. 2013. "Governor Scuttles Palmer Fix." *Reuben, Junius & Rose*. October 17. http://www.reubenlaw.com/index.php/rj/singleUpdate/governor_scuttles_palmer_fix.
- Danyluk, Martin, and David Ley. 2007. "Modalities of the New Middle Class: Ideology and Behaviour in the Journey to Work from Gentrified Neighbourhoods in Canada." *Urban Studies* 44 (11): 2195–2210. doi:10.1080/00420980701520277.
- Dawkins, Casey, and Rolf Moeckel. 2014. "Transit-Induced Gentrification: Who Will Stay, and Who Will Go?" presented at the Transit, Transit Oriented Development, and Urban Form: A Bi-National Symposium Featuring Paris, France, and Washington, DC, October 18. http://smartgrowth.umd.edu/assets/tod_gentrification_v3.pdf.
- Debrezion, Ghebreegiabiher, Eric Pels, and Piet Rietveld. 2007. "The Impact of Railway Stations on Residential and Commercial Property Value: A Meta-Analysis." *The Journal of Real Estate Finance and Economics* 35 (2): 161–80. doi:10.1007/s11146-007-9032-z.

- Deweese, D. N. 1976. "The Effect of a Subway on Residential Property Values in Toronto." *Journal of Urban Economics* 3 (4): 357–69. doi:10.1016/0094-1190(76)90035-8.
- Diappi, Lidia, and Paola Bolchi. 2013. "Redevelopments and Gentrification: A MAS Model of the Urban Housing Market in Milan." In *Emergent Phenomena in Housing Markets*, edited by Lidia Diappi, 85–99. Physica-Verlag HD. http://link.springer.com/chapter/10.1007/978-3-7908-2864-1_4.
- Diaz, Roderick. 1999. "Impacts Of Rail Transit On Property Values." *RTD FasTracks Track 3 - Partnering*. http://www.rtd-fastracks.com/media/uploads/nm/impacts_of_rail_transit_on_property_values.pdf.
- Diaz, Roderick, and Donald Schneck. 2000. "Bus Rapid Transit Technologies in the Americas: An Overview." *Transportation Research Record: Journal of the Transportation Research Board* 1731 (January): 3–9. doi:10.3141/1731-01.
- Dineen, J. K. 2015. "Chinatown Hotel next up in S.F. Gentrification Wars." *SFGate*, March 27. <http://www.sfgate.com/bayarea/article/Chinatown-hotel-next-up-in-S-F-gentrification-6161916.php>.
- Dominie, Will. 2012. "Is Just Growth Smarter Growth? The Effects of Gentrification on Transit Ridership and Driving in Los Angeles' Transit Station Area Neighborhoods." UCLA.
- Doucouliagos, Hristos, and Tom D. Stanley. 2009. "Publication Selection Bias in Minimum-Wage Research? A Meta-Regression Analysis." *British Journal of Industrial Relations* 47 (2): 406–28.
- Dreier, Peter, John H. Mollenkopf, and Todd Swanstrom. 2004. *Place Matters: Metropolitcs for the Twenty-First Century*. University Press of Kansas.
- Dremann, Sue. 2014. "East Palo Alto Endorses Affordable-Housing Fee for Developers." *Palo Alto Weekly*, July 2. <http://www.paloaltoonline.com/news/2014/07/02/east-palo-alto-approves-developers-affordable-housing-fee>.
- Dube, Arindrajit, T. William Lester, and Barry Eidlin. 2007. "Firm Entry and Wages: Impact of Wal-Mart Growth on Earnings Throughout the Retail Sector." *Institute for Research on Labor and Employment*, August. <http://escholarship.org/uc/item/22s5k4pv>.
- Dubin, Robin A., and Allen C. Goodman. 1982. "Valuation of Education and Crime Neighborhood Characteristics through Hedonic Housing Prices." *Population and Environment* 5 (3): 166–81. doi:10.1007/BF01257055.
- DuBois, W. E. Burghardt. 2003. "The Health and Physique of the Negro American." *American Journal of Public Health* 93 (2): 272–76. doi:10.2105/AJPH.93.2.272.
- Duncan, Michael. 2008. "Comparing Rail Transit Capitalization Benefits for Single-Family and Condominium Units in San Diego, California." *Transportation Research Record: Journal of the Transportation Research Board* 2067 (December): 120–30. doi:10.3141/2067-14.
- Duncan, Michael. 2010. "The Impact of Transit-Oriented Development on Housing Prices in San Diego, CA." *Urban Studies*, May. doi:10.1177/0042098009359958.
- Dwyer, Rachel E. 2010. "Poverty, Prosperity, and Place: The Shape of Class Segregation in the Age of Extremes." *Social Problems* 57 (1): 114–37. doi:10.1525/sp.2010.57.1.114.
- East Hollywood Neighborhood Council. 2016. "The History of East Hollywood." *East Hollywood Neighborhood Council*. Accessed October 21. <http://www.easthollywood.net/history>.
- Ellen, Ingrid Gould, Keren Horn, and Katherine O'Regan. 2012. "Pathways to Integration: Examining Changes in the Prevalence of Racially Integrated Neighborhoods." *Cityscape* 14 (3): 33–53.
- Ellen, Ingrid Gould, and Brendan O'Flaherty. 2013. "Chapter 4. How New York and Los Angeles Housing Policies Are Different--and Maybe Why." In *New York and Los Angeles: The Uncertain Future*. New York: Oxford University Press.
- Ellen, Ingrid Gould, and Katherine M. O'Regan. 2011. "How Low Income Neighborhoods Change: Entry, Exit, and Enhancement." *Regional Science and Urban Economics* 41 (2): 89–97. doi:10.1016/j.regsciurbeco.2010.12.005.

- Ellen, Ingrid Gould, and Margery Austin Turner. 1997. "Does Neighborhood Matter? Assessing Recent Evidence." *Housing Policy Debate* 8 (4): 833–66. doi:10.1080/10511482.1997.9521280.
- Ellis, Mark, Steven R. Holloway, Richard Wright, and Christopher S. Fowler. 2012. "Agents of Change: Mixed-Race Households and the Dynamics of Neighborhood Segregation in the United States." *Annals of the Association of American Geographers* 102 (3): 549–70. doi:10.1080/00045608.2011.627057.
- Eng, Tiffany. 2015. "Living Histories and Thriving Families: Opportunities for Implementing a Cultural District Strategy in San Francisco's Chinatown." Berkeley, CA.
- Fainstein, Susan S. 2010. *The Just City*. Ithaca, NY: Cornell University Press.
- Farrell, Chad R., and Barrett A. Lee. 2011. "Racial Diversity and Change in Metropolitan Neighborhoods." *Social Science Research* 40 (4): 1108–23. doi:10.1016/j.ssresearch.2011.04.003.
- Ficano, Carlina Cochi. 2013. "Business Churn and the Retail Giant: Establishment Birth and Death from Wal-Mart's Entry*." *Social Science Quarterly* 94 (1): 263–91. doi:10.1111/j.1540-6237.2012.00857.x.
- Fischel, William A. 1985. *The Economics of Zoning Laws: A Property Rights Approach to American Land Use Controls*. Baltimore: Johns Hopkins University Press.
- Fischer, Claude S. 1984. *The Urban Experience*. 2 Sub edition. San Diego: Harcourt.
- Fischer, Claude S. 2010. *Made in America: A Social History of American Culture and Character*. University of Chicago Press.
- Fischer, Claude S. 2013. "Segregation by Culture." *Boston Review: A Political and Literary Forum*. December 4.
- Fischer, Claude S., Gretchen Stockmayer, Jon Stiles, and Michael Hout. 2004. "Distinguishing the Geographic Levels and Social Dimensions of U.S. Metropolitan Segregation, 1960-2000." *Demography* 41 (1): 37–59. doi:10.2307/1515212.
- Fishman, Charles. 2006. *The Wal-Mart Effect: How the World's Most Powerful Company Really Works—and How It's Transforming the American Economy*. Reprint edition. New York: Penguin Books.
- Florida, Richard. 2002. *The Rise Of The Creative Class: And How It's Transforming Work, Leisure, Community And Everyday Life*. First Printing edition. Princeton, N.J.: Basic Books.
- Fluit, Heather. 2015. "HUD Announces Final Rule on Affirmatively Furthering Fair Housing." *U.S. Department of Housing and Urban Development*. July 8. http://portal.hud.gov/hudportal/HUD?src=/press/press_releases_media_advisories/2015/HUDNo_15-084.
- Freeman, Lance. 2005. "Displacement or Succession? Residential Mobility in Gentrifying Neighborhoods." *Urban Affairs Review* 40 (4): 463–91. doi:10.1177/1078087404273341.
- Freeman, Lance. 2006. *There Goes the Hood: Views of Gentrification from the Ground Up*. Philadelphia, Pa: Temple University Press.
- Freeman, Lance, and Frank Braconi. 2004. "Gentrification and Displacement New York City in the 1990s." *Journal of the American Planning Association* 70 (1): 39–52. doi:10.1080/01944360408976337.
- Fribourg, Aimée. 2009. *San Francisco's Single-Room Occupancy (SRO) Hotels: A Strategic Assessment of Residents and Their Human Service Needs : A Study Conducted for the San Francisco Human Services Agency (SF-HSA), San Francisco, California*.
- Frieden, Bernard J., and Lynne B. Sagalyn. 1989. *Downtown, Inc., How America Rebuilds Cities*. Cambridge, Mass.
- Fry, Richard, and Paul Taylor. 2012. "The Rise of Residential Segregation by Income." *Pew Research Center's Social & Demographic Trends Project*. Accessed January 18. <http://www.pewsocialtrends.org/2012/08/01/the-rise-of-residential-segregation-by-income/>.
- Fujioka, Gen. 2014. Chinatown and Adjoining Neighborhoods.

- Furman Center for Real Estate and Urban Policy. 2006. "Housing Policy in New York City: A Brief History."
http://furmancenter.org/files/publications/AHistoryofHousingPolicycombined0601_000.pdf.
- Galster, George C. 2010. "The Mechanism(s) of Neighbourhood Effects: Theory, Evidence, and Policy Implications." In *Neighbourhood Effects Research: New Perspectives*, edited by Maarten van Ham, David Manley, Nick Bailey, Ludi Simpson, and Duncan Maclennan, 23–56. Springer Netherlands. http://link.springer.com/chapter/10.1007/978-94-007-2309-2_2.
- Gatzlaff, Dean H., and Marc T. Smith. 1993. "The Impact of the Miami Metrorail on the Value of Residences near Station Locations." *Land Economics* 69 (1): 54–66. doi:10.2307/3146278.
- Geoghegan, Jacqueline. 2002. "The Value of Open Spaces in Residential Land Use." *Land Use Policy* 19 (1): 91–98. doi:10.1016/S0264-8377(01)00040-0.
- Geolytics, Inc. 2014. "Geolytics Neighborhood Change Database in 2010 Boundaries." Somerville, NJ: Geolytics, Inc.
- Giuliano, G. 1989. "New Directions for Understanding Transportation and Land Use." *Environment and Planning A* 21 (2): 145–59. doi:10.1068/a210145.
- Giuliano, Genevieve. 1989. "New Directions for Understanding Transportation and Land Use." *eScholarship*. <http://escholarship.org/uc/item/3gz976p8>.
- Giuliano, Genevieve, and Ajay Agarwal. 2010. "Public Transit as a Metropolitan Growth and Development Strategy." *Urban and Regional Policy and Its Effects* 3: 205–52.
- Glaeser, Edward L. 2003. "Does Rent Control Reduce Segregation?" *Swedish Economic Policy Review* 10: 179–202.
- Glass, Ruth Lazarus. 1964. *London: Aspects of Change*. London: MacGibbon & Kee.
- Goetz, Edward. 1994. "Expanding Possibilities in Local Development Policy: An Examination of U.S. Cities." *Political Research Quarterly* 47 (1): 85–109. doi:10.1177/106591299404700105.
- Goetz, Edward. 2003. *Clearing the Way: Deconcentrating the Poor in Urban America*. Washington, D.C: Rowman & Littlefield Publishers.
- Goetz, Edward. 2013. *New Deal Ruins: Race, Economic Justice, and Public Housing Policy*. Ithaca, NY: Cornell University Press.
- Goldfarb Lipman LLP. 2015. "Law Alert: California Supreme Court Greenlights Affordable Housing Ordinances." <http://nonprohousing.org/wp-content/uploads/GL-LLP-Law-Alert-CA-Supreme-Court-Greenlights-Affordable-Housing-Ordinances.pdf>.
- Gose, Joe. 2014. "CONDO CONVERSION CRAZE." *National Real Estate Investor*. June 1. <http://nreionline.com/content/condo-conversion-craze>.
- Great Communities Collaborative. 2007. "Preventing Displacement Policy Fact Sheet." <http://www.greatcommunities.org/wp-content/uploads/pdf/2007%2011%20Preventing%20Displacement%20Policy%20Fact%20Sheet.pdf>.
- Greene, William H. 2002. *Econometric Analysis*. 5th edition. Boston: Pearson Education.
- Grier, George W, Eunice S Grier, United States, Department of Housing and Urban Development, and Office of the Secretary. 1978. *Urban Displacement: A Reconnaissance*. Bethesda, Md.: Grier Partnership.
- Guerra, Erick, Robert Cervero, and Daniel Tischler. 2011. "The Half-Mile Circle: Does It Best Represent Transit Station Catchments?" *University of California Transportation Center*, August. <http://escholarship.org/uc/item/68r764df>.
- Gyourko, Joseph, and Peter Linneman. 1989. "Equity and Efficiency Aspects of Rent Control: An Empirical Study of New York City." *Journal of Urban Economics* 26 (1): 54–74.
- Hackworth, Jason, and Josephine Rekers. 2005. "Ethnic Packaging and Gentrification The Case of Four Neighborhoods in Toronto." *Urban Affairs Review* 41 (2): 211–36. doi:10.1177/1078087405280859.

- Hall, Peter. 2002. *Cities of Tomorrow: An Intellectual History of Urban Planning and Design in the Twentieth Century*. 3 edition. Oxford, UK ; Malden, MA: Wiley-Blackwell.
- Halpern, Robert. 1995. *Rebuilding the Inner City*. New York: Columbia University Press.
- Haltiwanger, John, Ron Jarmin, and C. J. Krizan. 2010. "Mom-and-Pop Meet Big-Box: Complements or Substitutes?" *Journal of Urban Economics*, Special Issue: Cities and Entrepreneurship Sponsored by the Ewing Marion Kauffman Foundation (www.kauffman.org), 67 (1): 116–34. doi:10.1016/j.jue.2009.09.003.
- Hammer, Jon, and Hammer Ventures. 2004. "The Conversion Crusade." *The Daily Transcript*. June 29. <http://www.sddt.com/news/article.cfm?SourceCode=20040629rp>.
- Hamnett, Chris. 1991. "The Blind Men and the Elephant: The Explanation of Gentrification." *Transactions of the Institute of British Geographers* 16 (2): 173–89. doi:10.2307/622612.
- Hamnett, Chris. 2003. "Gentrification and the Middle-Class Remaking of Inner London, 1961–2001." *Urban Studies* 40 (12): 2401–26. doi:10.1080/0042098032000136138.
- Hannigan, John. 1998. *Fantasy City: Pleasure and Profit in the Postmodern Metropolis*. London ; New York: Routledge.
- Har, Janie. 2015. "San Francisco's Chinatown Clings to Roots amid Tech Boom." *SF Gate*. July 25. <http://www.sfgate.com/news/article/San-Francisco-s-Chinatown-clings-to-roots-amid-6403628.php?cmpid=email-mobile#photo-7902776>.
- Harrison Institute for Public Law, Georgetown University Law Center. 2006. "An Analysis of the Strengths and Deficiencies of Washington, D.C.'s Tenant Opportunity to Purchase Act." <http://content.knowledgeplex.org/kp2/cache/documents/1834/183436.pdf>.
- Helper, Lauren. 2014. "San Jose Mayor Chuck Reed on Housing Element Affordability, Urban Villages, Density." *Silicon Valley Business Journal*, October. <http://www.bizjournals.com/sanjose/news/2014/10/01/san-jose-sets-housing-vision-mayor-chuck-reed-on.html>.
- Henao, Lizzeth. 2013. "CASP: Community Involvement in Planning Yields Great(er) Results." *Alliance for Community Transit-Los Angeles*. February 4. <http://www.allianceforcommunitytransit.org/casp-community-involvement-in-planning-yields-greater-results-2/>.
- Hepler, Lauren. 2014. "Silicon Valley's Affordable Housing Crisis: The Shadow of Success." *Silicon Valley Business Journal. California*. <http://www.bizjournals.com/sanjose/print-edition/2014/01/31/silicon-valleys-affordable-housing.html>.
- Hess, Daniel Baldwin, and Tangerine Maria Almeida. 2007. "Impact of Proximity to Light Rail Rapid Transit on Station-Area Property Values in Buffalo, New York." *Urban Studies* 44 (5-6): 1041–68. doi:10.1080/00420980701256005.
- Hickey, Robert. 2013. "After the Downturn: New Challenges and Opportunities for Inclusionary Housing." *Inclusionary Housing: A Series of Research & Policy Briefs*. Center for Housing Policy. <http://www.centerforhousingpolicy.org/media/files/Solutions2013/IC-6.IZpaperflier.pdf>.
- Hickey, Robert. 2014. "Inclusionary Upzoning: Tying Growth to Affordability." <http://www.nhc.org/Inclusionary-Upzoning.pdf>.
- Hickey, Robert, and Lisa Sturtevant. 2015. "Public Land & Affordable Housing in the Washington DC Region: Best Practices and Recommendations." http://washington.uli.org/wp-content/uploads/sites/56/2015/02/ULI_PublicLandReport_Final020215.pdf.
- Hickey, Robert, Lisa Sturtevant, and Emily Thaden. 2014. "Achieving Lasting Affordability through Inclusionary Housing." <http://communitylandtrust.org/wp-content/uploads/2014/08/CLT-inclusion-july2014-LinLandInst.pdf>.
- Hipp, John R. 2012. "Segregation Through the Lens of Housing Unit Transition: What Roles Do the Prior Residents, the Local Micro-Neighborhood, and the Broader Neighborhood Play?" *Demography* 49 (4): 1285–1306. doi:10.1007/s13524-012-0121-0.

- Hirsch, Arnold Richard. 1983. *Making the Second Ghetto: Race and Housing in Chicago, 1940-1960*. CUP Archive.
- Hirsch, Werner Z., and Anthony M. Rufolo. 1999. "The Regulation of Immobile Housing Assets under Divided ownership1." *International Review of Law and Economics* 19 (3): 383–97. doi:10.1016/S0144-8188(99)00012-5.
- Hofmann, Michelle. 2005. "Condo Crazy, Again." *Los Angeles Times*, May 22. <http://articles.latimes.com/2005/may/22/realestate/re-condo22>.
- Howell, Kathryn Leigh. 2013. "Transforming Neighborhoods, Changing Communities : Collective Agency and Rights in a New Era of Urban Redevelopment in Washington, DC," December. <http://repositories.lib.utexas.edu/handle/2152/23193>.
- Huang, Qingxu, Dawn C Parker, Tatiana Filatova, and Shipeng Sun. 2013. "A Review of Urban Residential Choice Models Using Agent-Based Modeling." *Environment and Planning B: Planning and Design* 40: 1–29. doi:10.1068/b120043p.
- Huang, W. 1994. "The Effects of Transportation Infrastructure on Nearby Property Values: A Review of the Literature." IURD. <http://trid.trb.org/view.aspx?id=447572>.
- Hunt, J.D., and J.E. Abraham. 2005. "Design and Implementation of PECAS: A Generalized System for the Allocation of Economic Production, Exchange and Consumption Quantities." In *Integrated Land-Use and Transportation Models: Behavioural Foundations*, edited by Martin Lee-Gosselin and Sean Doherty. Amsterdam; Boston: Elsevier Science Ltd.
- Hunt, J.D., and J.E. Abraham. 2009. "PECAS - For Spatial Economic Modelling: Theoretical Formulation." HBA Specto Incorporated. <http://www.hbaspecto.com/pecas/downloads/files/PECASTheoreticalFormulation.pdf>.
- Hunt, J.D., J.E. Abraham, and S. Cho. 2011. "Development of PECAS Spatial Economic Model of Los Angeles." Bangalore, India. <http://www.hbaspecto.com/pecas/downloads/files/PECASTheoreticalFormulation.pdf>.
- Hunt, J.E., J.D. Abraham, D. De Silva, M. Zhong, J. Bridges, and J. Mysko. 2007. "Microsimulating Space Development in Baltimore." In *Proceedings of the 12th International Conference on Computers in Urban Planning and Urban Management*. Hong Kong.
- Hwang, Jackelyn, and Robert J. Sampson. 2014. "Divergent Pathways of Gentrification Racial Inequality and the Social Order of Renewal in Chicago Neighborhoods." *American Sociological Review* 79 (4): 726–51. doi:10.1177/0003122414535774.
- Hyra, Derek S. 2008. *The New Urban Renewal: The Economic Transformation of Harlem and Bronzeville*. Chicago: University Of Chicago Press.
- Imbroscio, David. 2012. "Beyond Mobility:the Limits of Liberal Urban Policy." *Journal of Urban Affairs* 34 (1): 1–20. doi:10.1111/j.1467-9906.2011.00578.x.
- Ioffe, Karina. 2015. "Richmond: Rent Control Ordinance Finalized." *East Bay Times*. August 6. <http://www.eastbaytimes.com/2015/08/06/richmond-rent-control-ordinance-finalized/>.
- Irwin, Elena G. 2002. "The Effects of Open Space on Residential Property Values." *Land Economics* 78 (4): 465–80. doi:10.3368/le.78.4.465.
- Irwin, Elena G., and Nancy E. Bockstael. 2001. "The Problem of Identifying Land Use Spillovers: Measuring the Effects of Open Space on Residential Property Values." *American Journal of Agricultural Economics* 83 (3): 698–704.
- Jackson, Jeremy, Benjamin Forest, and Raja Sengupta. 2008. "Agent-Based Simulation of Urban Residential Dynamics and Land Rent Change in a Gentrifying Area of Boston." *Transactions in GIS* 12 (4): 475–91. doi:10.1111/j.1467-9671.2008.01109.x.
- Jackson, Kenneth. 1987. *Crabgrass Frontier: The Suburbanization of the United States*. 1st ed. Oxford University Press, USA.
- Jacobus, Rick. 2015. "CA's Surprisingly Strong Stand in Support of Inclusionary Housing." *Rooflines*. June 16.

- http://www.rooflines.org/4165/cas_surprisingly_strong_stand_in_support_of_inclusionary_housing/.
- Jargowsky, Paul. 2001. "The Social Consequences of Income Inequality and Economic Segregation for Young Adults: Estimates Using Metropolitan Level Data."
- Jargowsky, Paul A. 1997. *Poverty and Place: Ghettos, Barrios, and the American City*. New York: Russell Sage Foundation.
- Jarzab, J. T., J. Lightbody, and E. Maeda. 2002. "Characteristics of Bus Rapid Transit Projects: An Overview." *Journal of Public Transportation* 5 (2). <http://trid.trb.org/view.aspx?id=726756>.
- Jencks, Christopher, Susan Mayer, Laurence E. Jr. Lynn, and Michael G. H. McGeary. 1990. "The Social Consequences of Growing Up in a Poor Neighborhood." In *Inner-City Poverty in the United States*. Washington, D.C.: National Academies Press. <http://www.nap.edu/catalog/1539>.
- Johnson, Andrew M. 2003. "Bus Rapid Transit and Land Use: Illuminating the Interaction." *Journal of Public Transportation* 6 (4). <http://trid.trb.org/view.aspx?id=684254>.
- Johnston, Robert A., and Michael C. McCoy. 2006. "Assessment of Integrated Transportation/ Land Use Models."
- Jones, Charisse. 2005a. "Soaring Numbers of Rentals Go Condo." *USA Today*. July 7. http://usatoday30.usatoday.com/news/nation/2005-07-06-condos-renters_x.htm.
- Jones, Charisse. 2005b. "Condo Conversions on Rise in U.S." *USA Today*. July 8. <http://the.honoluluadvertiser.com/article/2005/Jul/08/bz/507080344.html>.
- Joseph, Mark L. 2006. "Is Mixed-income Development an Antidote to Urban Poverty?" *Housing Policy Debate* 17 (2): 209–34. doi:10.1080/10511482.2006.9521567.
- Judson, Victoria A. 1983. "Defining Property Rights: The Constitutionality of Protecting Tenants from Condominium Conversion." *Harvard Civil Rights-Civil Liberties Law Review* 18: 179–230.
- Juergensmeyer, Julian, and Thomas Roberts. 2013. "Land Use Planning & Development Regulation Law." *Faculty Publications By Year*, January. http://readingroom.law.gsu.edu/faculty_pub/823.
- Kahn, Matthew E. 2007. "Gentrification Trends in New Transit-Oriented Communities: Evidence from 14 Cities That Expanded and Built Rail Transit Systems." *Real Estate Economics* 35 (2): 155–82. doi:10.1111/j.1540-6229.2007.00186.x.
- Karner, A., and D. Niemeier. 2012. "Alternative Scenarios, Affordable Housing, and Vehicle-Miles Traveled in the Bay Area. Unpublished Memorandum to Parisa Fatehi-Weeks of Public Advocates."
- Katz, Michael B. 2012. *Why Don't American Cities Burn? The City in the Twenty-First Century*. Philadelphia: University of Pennsylvania Press.
- Keating, Dennis, and Mitch Kahn. 2001. "Rent Control in the New Millennium." *NHI Shelterforce Online*. <http://www.nhi.org/online/issues/117/KeatingKahn.html>.
- Keating, W. Dennis, Michael B. Teitz, and Andrejs Skaburskis. 1998. *Rent Control: Regulation and the Rental Housing Market*. New Brunswick, N.J.: CUPR/Transaction.
- Kennedy, Maureen, and Paul Leonard. 2001. "Dealing with Neighborhood Changes: A Primer on Gentrification and Policy Choices." The Brookings Institution Center on Urban and Metropolitan Policy and PolicyLink. <http://community-wealth.org/content/dealing-neighborhood-changes-primer-gentrification-and-policy-choices>.
- Kilpatrick, John, Ronald Throupe, John Carruthers, and Andrew Krause. 2007. "The Impact of Transit Corridors on Residential Property Values." *Journal of Real Estate Research* 29 (3): 303–20. doi:10.5555/rees.29.3.lg5hq60530884755.
- Kim, Eunice. 2011. "Mitigating Displacement Due to Gentrification: Tools for Portland, Oregon." Tufts University. http://www.oregonmetro.gov/sites/default/files/Mitigating_displacement_pdx_tools_Eunice_Kim_2011.pdf.

- Kinney, Aaron. 2015a. "San Mateo County: Affordable Housing Crisis Inspires Talks about Rent Control." *The Mercury News*. March 1. <http://www.mercurynews.com/2015/03/01/san-mateo-county-affordable-housing-crisis-inspires-talks-about-rent-control/>.
- Kinney, Aaron. 2015b. "San Mateo County Supervisors Deal Blow to Rent Control Hopes." *The Mercury News*. March 17. <http://www.mercurynews.com/2015/03/17/san-mateo-county-supervisors-deal-blow-to-rent-control-hopes/>.
- Knaap, Gerrit J., Chengr Ding, and Lewis D. Hopkins. 2001. "Do Plans Matter? The Effects of Light Rail Plans on Land Values in Station Areas." *Journal of Planning Education and Research* 21 (1): 32–39. doi:10.1177/0739456X0102100103.
- Knight, Robert L., and Lisa L. Trygg. 1977. "Evidence of Land Use Impacts of Rapid Transit Systems." *Transportation* 6 (3): 231–47.
- Koebel, C. Theodore. 2002. "Analyzing Neighborhood Retail and Service Change in Six Cities." Blacksburg, VA: Center for Housing Research, Virginia Polytechnic Institute and State University.
- Kolko, Jed. 2011. "Employment Location, Neighborhood Change, and Gentrification." SSRN Scholarly Paper ID 1662548. Rochester, NY: Social Science Research Network. <https://papers.ssrn.com/abstract=1662548>.
- Kontokosta, Constantine E. 2013. "Mixed-Income Housing and Neighborhood Integration: Evidence from Inclusionary Zoning Programs." *Journal of Urban Affairs* 36 (4): 716–41. doi:10.1111/juaf.12068.
- Krysan, Maria, Mick P. Couper, Reynolds Farley, and Tyrone Forman. 2009. "Does Race Matter in Neighborhood Preferences? Results from a Video Experiment." *AJS; American Journal of Sociology* 115 (2): 527–59.
- Kushto, Emily R., and Joseph L. Schofer. 2008. "Travel and Transportation Impacts of Urban Gentrification: Chicago, Illinois Case Study." TRB meeting Impact of Changing Demographics on the Transportation System Conference, October. http://www.iti.northwestern.edu/publications/schofer/Kushto_and_Schofer-2008-Travel_and_Transportation_Impacts_of_Urban_Gentrification_Chicago_Illinois_Case_Study.pdf.
- L.A. Housing and Community Investment Department. 2014. "Affordable Housing Trust Fund." L.A. Housing and Community Investment Department. <http://lahd.lacity.org/lahdinternet/AffordableHousingTrustFund/tabid/126/Default.aspx>.
- Landis, John D. 2016. "Tracking and Explaining Neighborhood Socioeconomic Change in U.S. Metropolitan Areas Between 1990 and 2010." *Housing Policy Debate* 26 (1): 2–52. doi:10.1080/10511482.2014.993677.
- Landis, John, Subhrajit Guhathakurta, William Huang, and Ming Zhang. 1995. "Rail Transit Investments, Real Estate Values, and Land Use Change: A Comparative Analysis of Five California Rail Transit Systems." *University of California Transportation Center*, July. <http://escholarship.org/uc/item/2hf9s9sr>.
- Landry, Charles. 2008. *The Creative City: A Toolkit for Urban Innovators*. 2nd edition. New Stroud, UK : London ; Sterling, VA: Routledge.
- Lane, Michael, and Libby Seifel. 2015. "Untapped Resources: Potential Bay Area Sites for Affordable Transit-Oriented Development." The Non-Profit Housing Association of Northern California. http://nonprofithousing.org/wp-content/uploads/FINAL_Untapped-Resources-Full-Report.pdf.
- Lee, Barret A, and Peter B Wood. 1991. "Is Neighborhood Racial Succession Place-Specific?" *Demography* 28 (1): 21–40.
- Lees, L. 1996. "In the Pursuit of Difference: Representations of Gentrification." *Environment and Planning A* 28 (3): 453–70. doi:10.1068/a280453.
- Lees, Loretta. 2003. "Super-Gentrification: The Case of Brooklyn Heights, New York City." *Urban Studies* 40 (12): 2487–2509. doi:10.1080/0042098032000136174.

- Lees, Loretta, Tom Slater, and Elvin Wyly. 2008. *Gentrification*. 1 edition. New York: Routledge/Taylor & Francis Group.
- LePage, Andrew. 2004. "'Condo Craze' Sows Seeds of Controversy: Entry-Level Homes Increase but Apartments Decline." *Sacramento Bee*, September 13, sec. D1.
- Lerman, Steven R. 1977. "Location, Housing, Automobile Ownership, and Mode to Work: A Joint Choice Model." *Transportation Research Record* 610: 6–11.
- Lester, Thomas William. 2009. "Towards a Living Wage in the New Economy: The Politics and Economics of Building Labor Market Institutions at the Urban Scale." Ph.D., United States -- California: University of California, Berkeley.
<http://search.proquest.com/dissertations/docview/503636701/abstract/A5AD46F923A24F9EPQ/1>.
- Levinson, Herbert, Samuel Zimmerman, Jennifer Clinger, and G. Rutherford. 2002. "Bus Rapid Transit: An Overview." *Journal of Public Transportation* 5 (2).
 doi:<http://dx.doi.org/10.5038/2375-0901.5.2.1>.
- Levy, Diane K., Jennifer Comey, and Sandra Padilla. 2006. "Keeping the Neighborhood Affordable: A Handbook of Housing Strategies for Gentrifying Areas." Text.
<http://webarchive.urban.org/publications/411295.html>.
- Levy, Diane K., Z McDade, and Kassie Dumlao Bertumen. 2011. "Effects from Living in Mixed-Income Communities for Low-Income Families: A Review of the Literature." Text. January 28.
<http://www.urban.org/publications/412292.html>.
- Lewis-Workman, Steven, and Daniel Brod. 1997. "Measuring the Neighborhood Benefits of Rail Transit Accessibility." *Transportation Research Record: Journal of the Transportation Research Board* 1576 (January): 147–53. doi:10.3141/1576-19.
- Ley, David. 1994. "Gentrification and the Politics of the New Middle Class." *Environment and Planning D: Society and Space* 12 (1): 53–74. doi:10.1068/d120053.
- Ley, David. 1996. *The New Middle Class and the Remaking of the Central City*. Oxford University Press.
- Ley, David. 2003. "Artists, Aestheticisation and the Field of Gentrification." *Urban Studies* 40 (12): 2527–44. doi:10.1080/0042098032000136192.
- Ley, David, and Cory Dobson. 2008. "Are There Limits to Gentrification? The Contexts of Impeded Gentrification in Vancouver." *Urban Studies* 45 (12): 2471–98.
 doi:10.1177/0042098008097103.
- Lichter, Daniel T., Domenico Parisi, and Michael C. Taquino. 2012. "The Geography of Exclusion: Race, Segregation, and Concentrated Poverty." *Social Problems* 59 (3): 364–88.
 doi:10.1525/sp.2012.59.3.364.
- Li, Chuo. 2011. "Chinatown and Urban Redevelopment: A Spatial Narrative of Race, Identity, and Urban Politics 1950–2000." Ph.D., United States -- Illinois: University of Illinois at Urbana-Champaign. <http://search.proquest.com/dissertations/docview/920126026/abstract>.
- Li, Wei. 2009. *Ethnoburb: The New Ethnic Community in Urban America*. University of Hawaii Press.
- Lin, Jane. 2002. "Gentrification And Transit In Northwest Chicago." *Journal of the Transportation Research Forum* 56 (4). <https://trid.trb.org/view.aspx?id=728134>.
- Litman, Todd. 2007. "Build for Comfort, Not Just Speed: Valuing Service Quality Impacts in Transportation Planning." Victoria Transport Policy Institute. </view.aspx?id=1155071>.
- Litman, Todd. 2011. "Measuring Transportation: Traffic, Mobility and Accessibility." Victoria Transport Policy Institute. <http://www.vtpi.org/measure.pdf>.
- Logan, John R. 2013. "The Persistence of Segregation in the 21st Century Metropolis." *City & Community* 12 (2): 160–68. doi:10.1111/cico.12021.
- Logan, John R., and Harvey Lusk Molotch. 1987. *Urban Fortunes: The Political Economy of Place*. Berkeley, CA: University of California Press.

- Logan, John R., and Charles Zhang. 2010. "Global Neighborhoods: New Pathways to Diversity and Separation." *AJS; American Journal of Sociology* 115 (4): 1069–1109. doi:10.1086/649498.
- Los Angeles County Metropolitan Transportation Authority. 2015. "Los Angeles County Metropolitan Transportation Authority." http://media.metro.net/projects_studies/joint_development/images/JDP_policies_process_2015-07.pdf.
- Los Angeles Times. 2016. "Mapping LA: Chinatown." *Los Angeles Times*. Accessed October 20. <http://maps.latimes.com/neighborhoods/neighborhood/chinatown/>.
- Loukaitou-Sideris, Anastasia. 2002. "REGENERATION OF URBAN COMMERCIAL STRIPS: ETHNICITY AND SPACE IN THREE LOS ANGELES NEIGHBORHOODS." *Journal of Architectural and Planning Research* 19 (4): 334–50.
- Ludwig, Jens, Helen F. Ladd, Greg J. Duncan, Jeffrey Kling, and Katherine M. O'Regan. 2001. "Urban Poverty and Educational Outcomes [with Comments]." *Brookings-Wharton Papers on Urban Affairs*, 147–201.
- Lund, Hollie, Robert Cervero, and Richard Willson. 2004. "Travel Characteristics of Transit-Oriented Development in California." "Statewide Planning Studies"—FTA Section 5313 (b). <http://staging.community-wealth.org/sites/clone.community-wealth.org/files/downloads/report-lund-cerv-wil.pdf>.
- Lutzenhiser, Margot, and Noelwah R. Netusil. 2001. "The Effect of Open Spaces on a Home's Sale Price." *Contemporary Economic Policy* 19 (3): 291–98. doi:10.1093/cep/19.3.291.
- Mai, Randy, and Bonnie Chen. 2013. "The State of Chinatown Los Angeles." UCLA Urban Planning Minor's Program. <http://164.67.121.27/files/UP/chinatownfull.pdf>.
- Marcuse, Peter. 1986. "Abandonment, Gentrification, and Displacement: The Linkages in New York City." In *Gentrification of the City*, edited by Neil Smith and Peter Williams. London: Routledge.
- Marcuse, Peter. 1997. "The Enclave, the Citadel, and the Ghetto What Has Changed in the Post-Fordist U.S. City." *Urban Affairs Review* 33 (2): 228–64. doi:10.1177/107808749703300206.
- Marcuse, Peter. 2004. "The Future of Housing Advocacy and Research." *University of Toronto Centre for Urban and Community Studies: Research Bulletin* 25. http://citiescentre.webservices.utoronto.ca/Assets/Cities+Centre+2013+Digital+Assets/Cities+Centre/Cities+Centre+Digital+Assets/pdfs/researchbulletins/CUCS_RB_25_Marcuse_Futu.pdf
- Massey, Douglas S., and Nancy A. Denton. 1993. *American Apartheid: Segregation and the Making of the Underclass*. 1st Paperback Edition edition. Cambridge, Mass.: Harvard University Press.
- Massey, Douglas S., Jonathan Rothwell, and Thurston Domina. 2009. "The Changing Bases of Segregation in the United States." *The ANNALS of the American Academy of Political and Social Science* 626 (1): 74–90. doi:10.1177/0002716209343558.
- Max, Sarah. 2004. "School, What Is It Good for? When It Comes to Home Prices, Schools Matter. Buyers Will Pay a Premium to Live near Top Schools." *CNN Money*. August 30. http://money.cnn.com/2004/08/27/real_estate/buying_selling/schools/.
- McKinnish, Terra, Randall Walsh, and Kirk White. 2010. "Who Gentrifies Low-Income Neighborhoods?" Working Paper 14036. National Bureau of Economic Research. <http://www.nber.org/papers/w14036>.
- Meltzer, Rachel, and Jenny Schuetz. 2011. "Bodegas or Bagel Shops? Neighborhood Differences in Retail and Household Services." *Economic Development Quarterly*, 0891242411430328.
- Metropolitan Transportation Commission. 2005. "MTC Resolution 3434 Transit Oriented Development (TOD) Policy for Regional Transit Expansion Projects." http://mtc.ca.gov/sites/default/files/Resolution%203434%20TOD_policy.pdf.
- Metropolitan Transportation Commission. 2012a. "Resolution No. 4035." http://mtc.ca.gov/sites/default/files/Resolution%203434%20TOD_policy.pdf.

- Metropolitan Transportation Commission. 2012b. "Resolution No. 4035, Appendix A: Cycle 2 / OBAG 1 Program Project Selection Criteria and Programming Policy."
http://mtc.ca.gov/sites/default/files/Resolution%203434%20TOD_policy.pdf.
- Metropolitan Transportation Commission. 2012c. "Resolution No. 4035, Appendix A6: PDA Investment & Growth Strategy."
http://mtc.ca.gov/sites/default/files/Resolution%203434%20TOD_policy.pdf.
- Minton, Jeffrey James. 1996. "Rent Control: Can and Should It Be Used to Combat Gentrification." *Ohio NUL Rev.* 23: 823.
- Mohring, Herbert. 1961. "Land Values and the Measurement of Highway Benefits." *Journal of Political Economy* 69 (3): 236–49.
- Montojo, Nicole. 2015. "OBAG Funding Distribution Analysis: OneBayArea Grant Program, Analysis of Cycle II CMA Grants." Great Communities Collaborative.
- Moore, Keshia S. 2009. "Gentrification in Black Face?: The Return of the Black Middle Class to Urban Neighborhoods." *Urban Geography* 30 (2): 118–42. doi:10.2747/0272-3638.30.2.118.
- Mukhija, Vinit, Lara Regus, Sara Slovin, and Ashok Das. 2010. "Can Inclusionary Zoning Be an Effective and Efficient Housing Policy? Evidence from Los Angeles and Orange Counties." *Journal of Urban Affairs* 32 (2): 229–52. doi:10.1111/j.1467-9906.2010.00495.x.
- Mullins, J.A., E. Washington, and R.W. Stokes. 1990. "Land Use Impacts of the Houston Transitway System." *Transportation Research Record* 1237: 29–38.
- Munch, Jakob Roland, and Michael Svarer. 2002. "Rent Control and Tenancy Duration." *Journal of Urban Economics* 52 (3): 542–60. doi:10.1016/S0094-1190(02)00502-8.
- National Institute for Advanced Studies. 1981. "Market Generated Displacement: A Single City Case Study." National Institute for Advanced Studies.
<http://www.torontopubliclibrary.ca/detail.jsp?Entt=RDM1587388&R=1587388>.
- Nelson, A. C. 1992. "EFFECTS OF ELEVATED HEAVY-RAIL TRANSIT STATIONS ON HOUSE PRICES WITH RESPECT TO NEIGHBORHOOD INCOME." *Transportation Research Record*, no. 1359.
<https://trid.trb.org/view.aspx?id=371633>.
- Neumark, David, Junfu Zhang, and Stephen Ciccarella. 2008. "The Effects of Wal-Mart on Local Labor Markets." *Journal of Urban Economics* 63 (2): 405–30. doi:10.1016/j.jue.2007.07.004.
- Newman, Kathe, and Elvin K. Wyly. 2006. "The Right to Stay Put, Revisited: Gentrification and Resistance to Displacement in New York City." *Urban Studies* 43 (1): 23–57.
 doi:10.1080/00420980500388710.
- Newman, Sandra J., and Michael S. Owen. 1982. "Residential Displacement: Extent, Nature, and Effects." *Journal of Social Issues* 38 (3): 135–48. doi:10.1111/j.1540-4560.1982.tb01775.x.
- Newmark, Gregory, and Peter Haas. 2015. "Income, Location Efficiency, and VMT: Affordable Housing as a Climate Strategy." Chicago, Il: Center for Neighborhood Technology.
<http://www.cnt.org/sites/default/files/publications/CNT%20Working%20Paper%20revised%202015-12-18.pdf>.
- Noll, Roger G., and Andrew Zimbalist, eds. 1997. *Sports, Jobs, and Taxes: The Economic Impact of Sports Teams and Stadiums*. Washington D.C: Brookings Institution Press.
- Non-Profit Housing Association of Northern California. 2007. "Affordable by Choice: Trends in California Inclusionary Housing Programs." Non-Profit Housing Association of Northern California, California Coalition for Rural Housing, San Diego Housing Federation and the Sacramento Housing Alliance.
- Non-Profit Housing Association of Northern California. 2007. "Affordable by Choice: Trends in California Inclusionary Housing Programs." <http://www.wellesleyinstitute.com/wp-content/uploads/2013/01/NPH-IHinCA2006.pdf>.
- O'Connor, Alice. 2002. *Poverty Knowledge: Social Science, Social Policy, and the Poor in Twentieth-Century U.S. History*. Reprint edition. Princeton, N.J.: Princeton University Press.

- Oak Ridge National Laboratory. 2001. "Developing a Best Estimate of Annual Vehicle Mileage for 2009 NHTS Vehicles." Prepared for FHWA National Household Travel Survey. <http://nhts.ornl.gov/2009/pub/BESTMILE.pdf>.
- Oates, Wallace E. 1969. "The Effects of Property Taxes and Local Public Spending on Property Values: An Empirical Study of Tax Capitalization and the Tiebout Hypothesis." *Journal of Political Economy* 77 (6): 957–71.
- Ong, Paul, Chhandara Pech, and Rosalie Ray. 2014. "TOD Impacts on Businesses in Four Asian American Neighborhoods." UCLA Center for the Study of Inequality. http://www.urbandisplacement.org/sites/default/files/images/overall_tod_final.pdf.
- Osman, Suleiman. 2011. *The Invention of Brownstone Brooklyn: Gentrification and the Search for Authenticity in Postwar New York*. Oxford University Press.
- O'Sullivan, David. 2002. "Toward Micro-Scale Spatial Modeling of Gentrification." *Journal of Geographical Systems* 4 (3): 251–74. doi:10.1007/s101090200086.
- Ottens, Cale. 2013. "Condo Conversions Inch up in L.A." *Los Angeles Times*, August 9. <http://articles.latimes.com/2013/aug/09/business/la-fi-condo-conversion-20130809>.
- Ottensmann, John R., David H. Good, and Michael E. Gleeson. 1990. "The Impact of Net Migration on Neighbourhood Racial Composition." *Urban Studies* 27 (5): 705–17. doi:10.1080/00420989020080671.
- Owens, Ann. 2012. "Neighborhoods on the Rise: A Typology of Neighborhoods Experiencing Socioeconomic Ascent." *City & Community* 11 (4): 345–69. doi:10.1111/j.1540-6040.2012.01412.x.
- Page-Adams, Deborah, and Michael Sherraden. 1997. "Asset Building as a Community Revitalization Strategy." *Social Work* 42 (5): 423–34. doi:10.1093/sw/42.5.423.
- Pais, Jeremy, Scott J. South, and Kyle Crowder. 2012. "Metropolitan Heterogeneity and Minority Neighborhood Attainment: Spatial Assimilation or Place Stratification?" *Social Problems* 59 (2): 258–81. doi:10.1525/sp.2012.59.2.258.
- Palen, J. John, and Bruce London. 1984. "Introduction: Some Theoretical and Practical Issues Regarding Inner City Revitalization." In *Gentrification, Displacement, and Neighborhood Revitalization*. SUNY Press.
- Park, Robert Ezra. 1925. *The City: Suggestions of Investigation of Human Behavior in the Urban Environment*. Chicago: University of Chicago Press.
- Park, Robert Ezra. 1936. "Human Ecology." *American Journal of Sociology* 42 (1): 1–15. doi:10.2307/2768859.
- Pattillo, Mary. 2008. *Black on the Block: The Politics of Race and Class in the City*. Reprint edition. Chicago: University Of Chicago Press.
- Perk, Victoria A., and Martin Catala. 2009. "Land Use Impacts of Bus Rapid Transit: Effects of BRT Station Proximity on Property Values along the Pittsburgh Martin Luther King, Jr. East Busway." Washington, DC: Federal Transit Administration. http://www.nbrti.org/docs/pdf/Property%20Value%20Impacts%20of%20BRT_NBRTI.pdf.
- Peterson, Paul E. 1981. *City Limits*. University of Chicago Press.
- Pinjari, Abdul R., Chandra R. Bhat, and David A. Hensher. 2009. "Residential Self-Selection Effects in an Activity Time-Use Behavior Model." <http://www.sciencedirect.com/science/journal/01912615>. <https://repositories.lib.utexas.edu/handle/2152/23818>.
- Pitarre, Alyson. 2005. "Conversion Craze Hits the West." *Builder & Developer Magazine*, February.
- Plowman, Jonathan. 2014. "What Happens to Retail When Neighborhoods Gentrify? Evidence from California Metro Areas." University of California at Berkeley.
- Policy, Committee on National Urban, Commission on Behavioral and Social Sciences and Education, Division of Behavioral and Social Sciences and Education, and National Research Council. 1990. *Inner-City Poverty in the United States*. National Academies Press.

- Policy Link. 2008. "Equitable Development Toolkit: Transit Oriented Development."
http://www.policylink.org/sites/default/files/transit-oriented-development_0.pdf.
- Policy Link. 2015. "Equitable Development Toolkit: Local Hiring."
<http://policylink.org/sites/default/files/local-hiring.pdf>.
- Pollack, Stephanie, Barry Bluestone, and Chase Billingham. 2010. "Maintaining Diversity in America's Transit-Rich Neighborhoods: Tools for Equitable Neighborhood Change."
http://www.northeastern.edu/dukakiscenter/wp-content/uploads/2011/12/TRN_Equity_final.pdf.
- Polzin, Steven, and Michael Baltes. 2002. "Bus Rapid Transit: A Viable Alternative?" *Journal of Public Transportation* 5 (2). doi:<http://dx.doi.org/10.5038/2375-0901.5.2.3>.
- Popkin, S. J., L. F. Buron, D. K. Levy, and M. K. Cunningham. 2000. "The Gautreaux Legacy: What Might Mixed-Income and Dispersal Strategies Mean for the Poorest Public Housing Tenants?" *ResearchGate* 11 (4): 911–42.
- Porter, M. E. 1995. "The Competitive Advantage of the Inner City." *Long Range Planning* 28 (4): 132–132.
- Portman, Janet, and David W. Brown. 2013. *California Tenants' Rights*. Nolo.
- Powell, Benjamin, and Edward Peter Stringham. 2005. "The Economics of Inclusionary Zoning Reclaimed: How Effective Are Price Controls?" SSRN Scholarly Paper. Rochester, NY: Social Science Research Network. <https://papers.ssrn.com/abstract=1674474>.
- Powell, John, and Marguerite Spencer. 2002. "Giving Them the Old One-Two: Gentrification and the K.O. of Impoverished Urban Dwellers of Color." *Howard Law Journal*, January, 433.
- Pucher, J., and J. L. Renne. 2003. "SOCIOECONOMICS OF URBAN TRAVEL: EVIDENCE FROM THE 2001 NHTS." *Transportation Quarterly* 57 (3). <https://trid.trb.org/view.aspx?id=662423>.
- Queally, James. 2015. "Watts Riots: Traffic Stop Was the Spark That Ignited Days of Destruction in L.A." *Los Angeles Times*, July 29. <http://www.latimes.com/local/lanow/la-me-ln-watts-riots-explainer-20150715-htmlstory.html>.
- Quercia, Roberto G., and George C. Galster. 2000. "Threshold Effects and Neighborhood Change." *Journal of Planning Education and Research* 20 (2): 146–62. doi:10.1177/0739456X0002000202.
- Quigley, John. 1976. "Housing Demand in the Short Run: An Analysis of Polytomous Choice." NBER Chapters. National Bureau of Economic Research, Inc. <http://econpapers.repec.org/bookchap/nbrnberch/9079.htm>.
- Reardon, Sean F., and Kendra Bischoff. 2011. "Income Inequality and Income Segregation." *American Journal of Sociology* 116 (4): 1092–1153. doi:10.1086/657114.
- Reardon, Sean F., Stephen A. Matthews, David O'Sullivan, Barrett A. Lee, Glenn Firebaugh, Chad R. Farrell, and Kendra Bischoff. 2008. "The Geographic Scale of Metropolitan Racial Segregation." *Demography* 45 (3): 489–514.
- Reback, Randall. 2005. "House Prices and the Provision of Local Public Services: Capitalization under School Choice Programs." *Journal of Urban Economics* 57 (2): 275–301.
- Reconnecting America. 2007. "Station Area Planning Manual." *Reconnecting America*. November 1. <http://www.reconnectingamerica.org/resource-center/books-and-reports/2007/station-area-planning-manual/>.
- Reibel, Michael, and Moira Regelson. 2011. "Neighborhood Racial and Ethnic Change: The Time Dimension in Segregation." *Urban Geography* 32 (3): 360–82. doi:10.2747/0272-3638.32.3.360.
- Roback, Lori S. 1985. "Regulating Condominium Conversions: Do Municipal Ordinances Adequately Protect Tenants' and Owners' Constitutional Rights Comment." *Arizona State Law Journal* 1985: 935–72.
- Rodriguez, Daniel, and Felipe Targa. 2004. "Value of Accessibility to Bogotá's Bus Rapid Transit System." *Transport Reviews* 24 (5): 587–610. doi:10.1080/0144164042000195081.

- Rose, D. 1984. "Rethinking Gentrification: Beyond the Uneven Development of Marxist Urban Theory." *Environment and Planning D: Society and Space* 2 (1): 47–74. doi:10.1068/d020047.
- Sage Computing, Inc. 2009. "Revitalizing Foreclosed Properties with Land Banks." <http://www.huduser.org/portal/publications/landbanks.pdf>.
- Sampson, Robert J. 2012. *Great American City: Chicago and the Enduring Neighborhood Effect*. Reprint edition. Chicago; London: University Of Chicago Press.
- Sampson, Robert J., Jeffrey D. Morenoff, and Thomas Gannon-Rowley. 2002. "Assessing 'Neighborhood Effects': Social Processes and New Directions in Research." *Annual Review of Sociology* 28: 443–78.
- Sampson, Robert J., and Patrick Sharkey. 2008. "Neighborhood Selection and the Social Reproduction of Concentrated Racial Inequality." *Demography* 45 (1): 1–29.
- Sanders, Heywood T. 2002. "Convention Myths and Markets: A Critical Review of Convention Center Feasibility Studies." *Economic Development Quarterly* 16 (3): 195–210. doi:10.1177/08942402016003001.
- San Francisco Mayor's Office of Housing and Community Development. 2014. "SF Inclusionary Housing Program Completion and Pipeline Data 2014 Q1." <http://sf-moh.org/index.aspx?page=295>.
- San Francisco Planning Department. 1995. "San Francisco General Plan: Chinatown Area Plan." <http://generalplan.sfplanning.org/Chinatown.htm>.
- Santa Clara Valley Transportation Authority. 2014. "Santa Clara County Priority Development Area Investment and Growth Strategy." City/County Association of Governments of San Mateo County. <http://ccag.ca.gov/wp-content/uploads/2014/05/San-Mateo-County-PDA-Investment-Growth-Strategy-2014.pdf>.
- Schelling, Thomas C. 1971. "Dynamic Models of Segregation." *The Journal of Mathematical Sociology* 1 (2): 143–86. doi:10.1080/0022250X.1971.9989794.
- Schill, Michael H., Richard P. Nathan, and Harrichand Persaud. 1983. *Revitalizing America's Cities: Neighborhood Reinvestment and Displacement*. SUNY Press.
- Schuetz, Jenny. 2008. "The Effects of Inclusionary Zoning on Local Housing Markets: Lessons from the San Francisco, Washington DC and Suburban Boston Areas." Furman Center for Real Estate & Urban Policy. http://furmancenter.org/files/publications/IZPolicyBrief_LowRes.pdf.
- Schuetz, Jenny. 2014. "Do Rail Transit Stations Encourage Neighbourhood Retail Activity?" *Urban Studies*, September, 0042098014549128.
- Schwartz, Heather L., Liisa Ecola, Kristin J. Leuschner, and Aaron Kofner. 2012. "Is Inclusionary Zoning Inclusionary? A Guide for Practitioners." http://www.rand.org/content/dam/rand/pubs/technical_reports/2012/RAND_TR1231.pdf.
- Schwartz, Matt. 2015. "Two Proposals for Increasing the Value of the California Low Income Housing Tax Credit: Presentation to the Asembly COnmittee on Housing." March 11. http://www.chpc.net/dnld/ImprovingTheCA_LIHTC_2Proposals2015_03_09.pdf.
- Samuels, Alana. 2015. "Can Better Data Help Solve America's Housing Problems?" *The Atlantic*, July 8. <http://www.theatlantic.com/business/archive/2015/07/new-hud-rules-fair-housing/397997/>.
- SFO/PIA. 2014. "East Palo Alto Neighborhood Narrative." San Francisco Organizing Project/Peninsula Interfaith Action.
- Sharkey, Patrick. 2012. "Residential Mobility and the Reproduction of Unequal Neighborhoods." *Citiescape* 14 (3): 9–31.
- Sharkey, Patrick. 2013. *Stuck in Place: Urban Neighborhoods and the End of Progress toward Racial Equality*. 1 edition. Chicago: University Of Chicago Press.
- Shigley, Paul. 2009. "Court Rules L.A. Inclusionary Housing Mandate Violates State Law." *California Planning & Development Report*. August 20. <http://www.cp-dr.com/node/2401>.

- Smith, Neil. 1979. "Toward a Theory of Gentrification A Back to the City Movement by Capital, Not People." *Journal of the American Planning Association* 45 (4): 538–48.
doi:10.1080/01944367908977002.
- Smith, Neil. 1996. *The New Urban Frontier: Gentrification and the Revanchist City*. Psychology Press.
- Smith, V. Kerry, Christine Poulos, and Hyun Kim. 2002. "Treating Open Space as an Urban Amenity." *Resource and Energy Economics* 24 (1-2): 107–29.
- Steinberg, Darrell. 2008. *Sustainable Communities and Climate Protection Act, California Senate Bill 375*.
- Sugrue, Thomas J. 2005. *The Origins of the Urban Crisis: Race and Inequality in Postwar Detroit*. With a New preface by the author edition. Princeton: Princeton University Press.
- Sullivan, Daniel Monroe, and Samuel C. Shaw. 2011. "Retail Gentrification and Race: The Case of Alberta Street in Portland, Oregon." *Urban Affairs Review* 47 (3): 413–32.
doi:10.1177/1078087410393472.
- Swan, Rachel. 2015. "Rent Control Stalls in Richmond, at Least for Now." *SFGate*, July 30.
<http://www.sfgate.com/bayarea/article/Rent-control-stalls-in-Richmond-at-least-for-6413720.php>.
- Taggart, Kendall. 2012. "Explainer: The End of Redevelopment Agencies." *California Watch*. January 31. <http://californiawatch.org/dailyreport/explainer-end-redevelopment-agencies-14624>.
- Talen, Emily. 2006. "Design for Diversity: Evaluating the Context of Socially Mixed Neighbourhoods." *Journal of Urban Design* 11 (1): 1–32. doi:10.1080/13574800500490588.
- Tan, Bryant. 2008. "New Housing in Old Chinatown : Barriers and Incentives to Affordable Housing Development." Thesis, Massachusetts Institute of Technology.
<http://dspace.mit.edu/handle/1721.1/44346>.
- Taylor, Monique M. 2002. *Harlem Between Heaven And Hell*. Minneapolis: Univ Of Minnesota Press.
- Thai Community Development Center. 2002. "Surveying East Hollywood: A Profile and Needs Assessment of the Businss Community." Thai Community Development Center.
<http://thaicdc.org/research/swotfullreport.pdf>.
- The Growing Transit Communities Partnership. 2013. "The Growing Transit Communities Strategy." Growing Transit Communities and Puget Sound Regional Council.
<http://www.psrc.org/assets/9539/GTCStrategy.pdf>.
- The Watts Neighborhood Council. 2015. "History of Watts." The Watts Neighborhood Council.
<http://thewattsnc.com/history-of-watts/>.
- Tiebout, Charles M. 1956. "A Pure Theory of Local Expenditures." *Journal of Political Economy* 64 (5): 416–24.
- Torrens, Paul M., and Atsushi Nara. 2007. "Modeling Gentrification Dynamics: A Hybrid Approach." *Computers, Environment and Urban Systems* 31 (3): 337–61.
doi:10.1016/j.compenvurbsys.2006.07.004.
- Train, Kenneth. 2003. *Discrete Choice Methods with Simulation*. Cambridge University Press.
- Troy, Austin, and J. Morgan Grove. 2008. "Property Values, Parks, and Crime: A Hedonic Analysis in Baltimore, MD." *Landscape and Urban Planning* 87 (3): 233–45.
doi:10.1016/j.landurbplan.2008.06.005.
- Turner, Margery Austin. 2013. "Housing Discrimination against Racial and Ethnic Minorities 2012: Executive Summary." Text. June 11. <http://www.urban.org/publications/412838.html>.
- UCLA Comprehensive Project. 2015. "Oriented for Whom? Impacts of TOD on Six Los Angeles Neighborhoods." UCLA Department of Urban Planning.
http://www.urbandisplacement.org/sites/default/files/images/spring_2015_tod.pdf.
- U.S. Department of Housing and Urban Development (US HUD). 1979. "Displacement Report." Washington, D.C.: U.S. Department of Housing and Urban Development.
- U.S. Government Accountability Office (US GAO). 2001. "Mass Transit: Bus Rapid Transit Shows Promise." U.S. Government Accountability Office. <http://www.gao.gov/products/GAO-01-984>.

- Vandever, Roger C. 1980. "Conversion of Apartments to Condominiums: Social and Economic Regulations under the California Subdivision Map Act Comments." *California Western Law Review* 16: 466–99.
- Vigdor, Jacob L. 2001. "Does Gentrification Harm the Poor?" *Brookings-Wharton Papers on Urban Affairs*. <http://www.jstor.org/stable/25067387>.
- Vigdor, Jacob L. 2013. "Weighing and Measuring the Decline in Residential Segregation." *City & Community* 12 (2): 169–77. doi:10.1111/cico.12023.
- Voith, Richard. 1993. "Changing Capitalization of CBD-Oriented Transportation Systems: Evidence from Philadelphia, 1970–1988." *Journal of Urban Economics* 33 (3): 361–76. doi:10.1006/juec.1993.1021.
- Vuchic, Vukan. 2002. "Bus Semirapid Transit Mode Development and Evaluation." *Journal of Public Transportation* 5 (2). doi:<http://dx.doi.org/10.5038/2375-0901.5.2.4>.
- Wacquant, Loic. 1997. "'A Black City Within the White': Revisiting America's Dark Ghetto." *Black Renaissance* 2 (1): 141.
- Wacquant, Loïc J. D. 1997. "Three Pernicious Premises in the Study of the American Ghetto." *International Journal of Urban and Regional Research* 21 (2): 341–53. doi:10.1111/1468-2427.00076.
- Waddell, Paul. 2011. "Integrated Land Use and Transportation Planning and Modelling: Addressing Challenges in Research and Practice." *Transport Reviews* 31 (2): 209–29. doi:10.1080/01441647.2010.525671.
- Waddell, Paul, Liming Wang, and Xuan Liu. 2008. "UrbanSim: An Evolving Planning Support System for Evolving Communities." In *Planning Support Systems for Cities and Regions*, edited by Richard K. Brail. Cambridge, Mass: Lincoln Institute of Land Policy.
- Wang, L. Ling-chi. 2007. "Chinatown in Transition." *Amerasia Journal* 33 (1): 31–48. doi:10.17953/amer.33.1.3246116125188729.
- Wang, Yang, J.E. Abraham, J.D. Hunt, and Shengyi Gao. 2011. "Hedonic Regression of Local-Level Attraction Influences on Housing Price: Evidence from California Statewide Rent Modifier Estimation." In *Proceedings of the 12th International Conference on Computers in Urban Planning and Urban Management*. Lake Louise, AB.
- Wardman, Mark. 2004. "Public Transport Values of Time." *Transport Policy* 11 (4): 363–77. doi:10.1016/j.tranpol.2004.05.001.
- Wardrip, Keith. 2011. *Public Transit's Impact on Housing Costs: A Review of the Literature*.
- Waters, William G. 1992. *The Value of Time Savings for the Economic Evaluation of Highway Investments in British Columbia: Prepared for the Planning Services Branch, Ministry of Transportation and Highways, Victoria, B.C., Canada*. Centre for Transportation Studies, University of British Columbia.
- Watson, Tara. 2009. "Inequality and the Measurement of Residential Segregation by Income in American Neighborhoods." *Review of Income and Wealth* 55 (3): 820–44. doi:10.1111/j.1475-4991.2009.00346.x.
- Wegmann, Jake. 2012. "Affordable Housing Demand and Supply Analysis, 2010-2040."
- Wei, Fang, and Paul L. Knox. 2014. "Spatial Transformation of Metropolitan Cities." *Environment and Planning A* 46: 000–000.
- Weinberger, Rachel R. 2001. "Commercial Property Value and Proximity to Light Rail: A Hedonic Price Application." *University of California Transportation Center*, September. <http://escholarship.org/uc/item/3rb737r9>.
- Wilson, William J. 1987. *The Truly Disadvantaged: The Inner City, the Underclass, and Public Policy*. Chicago: University of Chicago Press.
- Wilson, William Julius, and Richard P. Taub. 2006. *There Goes the Neighborhood: Racial, Ethnic, and Class Tensions in Four Chicago Neighborhoods and Their Meaning for America*. Reprint edition. New York: Vintage.

- Winstead, Brock. 2006. "The Politics of Tenant Protections in Richmond, California." Center for Community Innovation. <http://communityinnovation.berkeley.edu/publications/Winstead-Politics-Tenant-Protections.pdf>.
- Winston, Francisca, and Chris Walker. 2012. "Predicting Gentrification in Houston's Low- and Moderate-Income Neighborhoods." LISC.
- Wirth, Louis. 1938. "Urbanism as a Way of Life." *American Journal of Sociology* 44 (1): 1–24.
- Wyly, Elvin, Kathe Newman, Alex Schafran, and Elizabeth Lee. 2010. "Displacing New York." *Environment and Planning. A* 42 (11): 2602.
- Xie, Yu, and Xiang Zhou. 2012. "Modeling Individual-Level Heterogeneity in Racial Residential Segregation." *Proceedings of the National Academy of Sciences* 109 (29): 11646–51. doi:10.1073/pnas.1202218109.
- Yang, Rebecca, and Paul A. Jargowsky. 2006. "SUBURBAN DEVELOPMENT AND ECONOMIC SEGREGATION IN THE 1990s." *Journal of Urban Affairs* 28 (3): 253–73. doi:10.1111/j.1467-9906.2006.00291.x.
- Yin, Li. 2009. "The Dynamics of Residential Segregation in Buffalo: An Agent-Based Simulation." *Urban Studies* 46 (13): 2749–70. doi:10.1177/0042098009346326.
- Yip, Christopher Lee. 1985. *San Francisco's Chinatown: An Architectural and Urban History*. University of California, Berkeley.
- Young, Allen. 2015. "Governor Signs Bill Creating Replacement for Redevelopment Agencies." *Sacramento Business Journal*. September 22. <http://www.bizjournals.com/sacramento/news/2015/09/22/governor-signs-bill-creating-replacement.html>.
- Zheng, Diehang, Yongheng Deng, Peter Gordon, and David Dale-Johnson. 2007. "An Examination of the Impact of Rent Control on Mobile Home Prices in California." *Journal of Housing Economics*, Special Issue on Macroeconomics and Housing, 16 (2): 209–42. doi:10.1016/j.jhe.2006.10.006.
- Zukin, Sharon. 1982. *Loft Living: Culture and Capital in Urban Change*. Johns Hopkins Studies in Urban Affairs. Baltimore: Johns Hopkins University Press.
- Zukin, Sharon. 1987. "Gentrification: Culture and Capital in the Urban Core." *Annual Review of Sociology* 13: 129–47.
- Zukin, Sharon. 1995. *The Cultures of Cities*. 1 edition. Cambridge, MA: Blackwell Publishers.
- Zukin, Sharon. 2009. *Naked City: The Death and Life of Authentic Urban Places*. Oxford University Press.
- Zukin, Sharon, Valerie Trujillo, Peter Frase, Danielle Jackson, Tim Recuber, and Abraham Walker. 2009. "New Retail Capital and Neighborhood Change: Boutiques and Gentrification in New York City." *City & Community* 8 (1): 47–64. doi:10.1111/j.1540-6040.2009.01269.x.

Appendices

Appendix A. Summary of Racial Transition and Succession Studies

Authors	Scale	Units of Analysis	Study Methods	Conclusions
Bostic and Martin (2003)	Nationwide (50 largest metros)	Census tract	The authors use census data from 1970 through 1990 to identify "gentrifiable" and gentrifying tracts. They then model different levels of black homeownership in these tracts over time.	Middle class black homeowners are found to be drivers of gentrification in the 1970s, though this finding loses significance in the 1980s.
Card et al. (2008)	Nationwide	Census tract	The authors use census data from 1970, 1980, 1990, and 2000 to estimate the existence of "tipping points" in neighborhood racial composition, beyond which changes in composition change more rapidly.	The authors find evidence of neighborhood tipping phenomena, with tipping points generally occurring when neighborhoods reach between 5% and 20% non-white. The specific point at which tipping occurs depends significantly on a variety of metro-level variables, including rates of violent crime, past incidences of riots, and measured racial animus.
Charles (2000)	Los Angeles	Individual survey respondents (N = 4,025)	Charles asks respondents of different races and ethnicities (white, black, Latino, Asian) whether they would prefer neighborhoods of various racial and ethnic compositions. The results are then regressed on a number of individual and neighborhood attributes.	Charles finds strong preference for same-race neighborhoods, with this preference particularly strong for white households. Additional modeling shows this preference to decline with graduate education and with younger respondent ages, and to increase with greater levels of racial stereotyping.
Charles (2003)	Literature Review	Mostly census tract and individual household	Charles reviews extant literature on various aspects of residential segregation, including the prevalence of segregation among different population groups, theories and empirics of neighborhood attainment, and patterns of individual neighborhood preference.	Looking specifically at neighborhood attainment, Charles differentiates between "spatial assimilation", which holds that different population groups integrate spatially in accordance with their SES attainment, and "place stratification", which holds that structural factors maintain patterns of spatial segregation, SES notwithstanding. While Charles finds much disagreement within the literature, there appears to be greater evidence for "place stratification" holding among black households.

Authors	Scale	Units of Analysis	Study Methods	Conclusions
Chipman, Wright, Ellis, and Holloway (2012)	Chicago	Census tract	Chicago neighborhoods are classified cross-sectionally according to race/ethnicity composition and tracked in their transitions from 1990 to 2010. The authors focus specifically on integrating descriptive results into an interactive mapping tool.	As with other studies the authors noted processes of diversification outside of Chicago's urban core, though they also noted a subset of "low-density, black-dominated tracts, whose numbers and locations barely changed during the past 20 years."
Crowder and South (2005)	Nationwide	Family	Using Panel Study of Income Dynamics longitudinal data from 1970 through 1997, the authors model the likelihood of black and white households transitioning between poor and non-poor tracts.	Across all years of the study, black-headed households are less likely than white-headed households to move from poor to non-poor tracts and more likely to move from non-poor to poor, after controlling for a number of factors. The racial discrepancy in both of these migration rates declined over time, however.
Crowder et al. (2011)	Nationwide	Family	The authors use Panel Study of Income Dynamics (PSID) data to follow panels individual households from 1968 through 2005. They model the likelihood of moving in terms of the immigrant presence in a given neighborhood.	The authors find that both native-born white and native-born black families are more likely to move out of neighborhoods with greater immigrant populations, with this result holding after controlling for a number of neighborhood and individual household variables.
Ellen, Horn, and O'Regan (2012)	Nationwide	Census tract	Census data from 1970 through 2010 is used to classify neighborhoods by race/ethnicity composition and to track the transitions between classifications.	There has been a steady increase in integrated neighborhoods, though a majority of non-integrated neighborhoods have remained so, and a substantial number of integrated neighborhoods have reverted to non-integrated status. Correlates of greater rates of integration include location in a central city and metropolitan growth.
Farrell and Lee (2011)	Nationwide (100 largest metros)	Census tract	Census data are used to categorize neighborhoods by race and ethnicity composition in 1990 and 2000, with transitions between classifications tracked.	Splitting neighborhoods cross-sectionally into those that are "dominant", "shared", "two-group", and "multi-group", the authors then look across time to classify neighborhoods as bifurcating, fragmenting, integrating, or "other". The authors find general trends toward diversification across metro areas, though they did note a subset of tracts experiencing a reduction of diversity through white out-migration.

Authors	Scale	Units of Analysis	Study Methods	Conclusions
Freeman and Rohe (2005)	Nationwide	Census tract	The authors identify tracts that received assisted housing (including public housing and housing units constructed under Section 236, Section 8, or the LIHTC program) between 1980 and 1990. The authors then use propensity score matching to test whether these tracts underwent greater racial transition than did comparable tracts that did not receive assisted housing units.	The authors find little evidence that the presence of assisted housing led to a greater outflow of white residents.
Glaeser (2003)	New York, New Jersey, California	Tenant, city	Glaeser examines the characteristics of tenants in rent-controlled units vs. non-rent-controlled units in New York City, as well examining aggregate statistics for California and New Jersey municipalities with and without rent control.	Rent control tenants in New York City are lower income, and older than tenants overall. They are also more likely to be white, casting doubt on rent control's ability to effect racial integration in the city. Looking at cities in California and New Jersey, Glaeser finds that cities with rent control in California saw less of an increase in rents and incomes than cities without, while the opposite was true for cities in New Jersey. Glaeser takes this as evidence that rent control might marginally increase economic integration in California, while it might be exasperating the concentration of poverty in New Jersey. The paper has little concrete to say with respect to racial segregation.
Hipp (2011)	Multiple cities for which violent crime data is available	Housing unit	The author uses American Housing Survey data from 1976 through 1999 to estimate probabilities of neighborhood out-migration and in-migration relative to crime rates.	Hipp finds that disparate levels of in- and out-migration by race contribute to different exposures to neighborhood crime by race and ethnicity. Controlling for a variety of individual and neighborhood characteristics, white households are more likely to exit neighborhoods with high and rising crime rates, while black and Latino households are more likely to enter into such neighborhoods.

Authors	Scale	Units of Analysis	Study Methods	Conclusions
Hipp (2012)	Nationwide	Housing unit	The author uses American Housing Survey data from 1985 to 1993 to predict the race of in-movers to a longitudinally tracked housing unit, based on racial characteristics of the surrounding census tract, an 11-household "micro-neighborhood", and of the prior occupants of the unit.	Same-race proportions at the micro-neighborhood level are better predictors of racial occupancy than are the comparable proportions at the tract level. Accounting for these neighborhood compositions, the race of the prior householder is still strongly predictive of the race of the new occupant. One explanation put forward for this phenomenon is a signaling mechanism, where new residents gain assurance that they belong in a given setting.
Krysan et al. (2009)	Metro Chicago and Detroit	Individual survey respondent (N = ~1,500)	Respondents of different races are shown videos of neighborhoods that vary by class signifiers and racial composition. The respondents were then asked to rate the desirability of the neighborhood.	Controlling for class, white respondents rate neighborhoods with black population and mixed population representation and less desirable than those with white population representation. Conversely, black respondents rated white neighborhoods as less desirable than black neighborhoods, but rated black neighborhoods as less desirable (though not statistically significantly) than mixed neighborhoods.
Lee and Wood (1991)	Nation-wide (58 central cities)	Census tracts	The authors used census data for 58 out of 60 central cities with populations greater than 250,000 in 1970 or 1980 to assess the trajectories of racially mixed neighborhoods during this time period.	The authors find significant variation in tract trajectories based on regional, city, and neighborhood factors. Framing transitions in terms of "succession", "stability", and "displacement", the authors find, for instance, that tracts across different regions that experience either displacement or stability tend to have greater initial population percentages of Hispanic and foreign born residents.
Logan and Zhang (2010)	Nationwide	Census tract	The authors track neighborhood race and ethnicity compositions from 1980 through 2000, looking to examine the role that "global neighborhoods" of high Asian and Hispanic residence play in integrating previously white neighborhoods.	While finding evidence for global neighborhoods, the authors also find that broad patterns of residential settlement are largely maintained through the avoidance by whites of "all-minority" areas, as well as of the out-migration of whites from more diverse neighborhoods.

Authors	Scale	Units of Analysis	Study Methods	Conclusions
McKinnish, Walsh, and White (2010)	Nationwide	Census tract	For both 1990 and 2000, the authors use confidential Census data to model household movements into and out of gentrifying neighborhoods (defined by baseline income and income change).	The authors find that largely middle-class black families carry out the income gentrification of low-income black neighborhoods. Conversely, gentrifying neighborhoods with low black populations see an increased outflow of high school-educated black households, though also with a substantial inflow of this same population group.
Ottensmann (1990)	South Bend, IN	Tract	The authors specify and run a set of simulation models to test the increase in neighborhood concentration of black residents between 1980 and 1990. The authors compare the concentration of black residents with and without the presence of black in-migration to the study metro.	The authors find that the in-migration of black residents is a major driver of greater black-white segregation.
Quercia and Galster (2000)	Literature Review	Primarily census tracts and block groups	The authors assess literature on neighborhood threshold effects, assessing theorized mechanisms for such thresholds, the neighborhood attributes on which such thresholds are conceptualized, the analytic methods by which thresholds are identified, and the actual empirical assessment of thresholds.	The authors find the "extant empirical literature" to be "sketchy", though they do see evidence for thresholds or "tipping points" along related socioeconomic measures, whereby neighborhoods have downward trajectories reinforced.
Reibel and Regelson (2011)	Nationwide (50 largest metros)	Census tract	The authors use a cluster analysis applied to neighborhoods based on their patterns of racial change between 1990 and 2000. They then analyze the distribution of these clusters, including specifying a model to account for the probability of a tract falling in a given cluster.	The authors find substantial regional variation in the prevalence of different transition types. Modeling this, they find that racially stable neighborhoods are more probable in the Northeast and South, transition from white to Hispanic less probably in the South and transition from white to black more probable in the south. They also find differences in transition probabilities based on racial/ethnic composition of metros (e.g. more "moderate integration" in metros with higher Asian population percentages) as well as locational characteristics of individual tracts (e.g. less integration in central cities).

Authors	Scale	Units of Analysis	Study Methods	Conclusions
Rosenblatt and Deluca (2012)	Baltimore	Family	The authors conduct interviews with families who have participated in Moving to Opportunity in Baltimore, seeking to understand why a large proportion of such participants moved back to high-poverty neighborhoods after program enrollment.	The authors note reports of families seeking to live in larger housing units in order to accommodate larger family sizes. These units were seen to be more affordable in high-poverty neighborhoods. Moreover, the interviewed families were able to move into such neighborhoods because of copying mechanisms developed during prior stays in distressed neighborhoods.
Sampson (2012)	Chicago	Family	Sampson uses longitudinal family survey data, as well as detailed information on the characteristics of neighborhoods, to model the neighborhood attainment of moving families.	A number of neighborhoods and household factors beyond mere race, income, and proximity are significantly predictive of where moving families end up. Specifically, similarities in perceived neighborhood disorder and closeness of elite and non-elite social network ties between origin and destination neighborhoods are associated with neighborhood destinations.
Sampson and Sharkey (2008)	Chicago	Family	The authors use longitudinal survey data to track movement of families originating in Chicago, analyzing these movements in terms of detailed survey responses given by the families and characteristics of the neighborhoods of origin and destination.	The authors find movement between neighborhoods to be heavily patterned by race and class, with aggregate flows of family movements serving to reinforce existing patterns of racial and economic segregation.

Appendix B. Summary of the Impact of Rail Transit Facilities on Residential and Commercial Property Values

Authors	Rail Mode	Location (Transit Facility)	Methodology Used	Extent of Property Value Impact	Major Conclusions
Ahlfedt (2013)	Light Rail (Jubilee Line & Docklands Light Railway)	London	Pre/Post Study	The study showed that for the average household a doubling of access to employment centers results in a utility effect that is equivalent to an increase in monthly income of £383 (in 2001 prices).	The model provides a better overview of potential funding possibilities for projects, particularly regarding contributions made by landlords levied on the predicted property price impact.
Armstrong (1995)	Commuter Rail (MBTA Fitchburg line)	Boston	Hedonic Price Models	Homes located in census tracts with rail stations had 6.7 per cent higher selling prices.	Proximity to the line (within 400 feet) coincided with a 20 per cent decrease in value, suggesting disamenity effects caused by frequent freight trains.
Armstrong and Rodriguez (2006)	Commuter rail	Four municipalities with commuter rail service, and three without commuter rail service.	Hedonic Price Models	Study finds a 10 per cent premium near stations.	There is a penalty between \$73 and \$290 per 100 feet closer to the right-of-way.
Bowes and Ihlanfeldt (2001)	Rapid Rail (MARTA)	Atlanta	Hedonic Price Models	Properties within a quarter of a mile from a station are found to sell for 19% less than properties beyond three miles from a station. And houses beyond three miles from a station sell on average for 4.7% more if the nearest station has a parking lot.	The positive effect of access to stations was generally greater than the negative effects of crime or the positive effects of retail, although within a quarter-mile radius some stations appeared to have net neutral or negative impacts.
Cervero (1996)	Heavy Rail	San Francisco Bay Area (Bay Area Rapid Transit)		+10-15% in rent for rental units within 1/4 mile of BART	Units within a quarter-mile of the Pleasant Hill Bart station rented for around \$34 more per month than comparable unit farther away.
Cervero and Duncan (2002)	Light and Commuter Rail	Santa Clara County	Hedonic Price Models	Large apartments within a quarter mile of station premiums as high as 45 percent, while land near commuter rail had a premium of about 20 per cent.	Apartments near light rail stops were more valuable than comparison properties.

Authors	Rail Mode	Location (Transit Facility)	Methodology Used	Extent of Property Value Impact	Major Conclusions
Chatman et al. (2012)	Light, Interurban Rail (River Line)	Southern New Jersey	Hedonic Price Models	Neutral to slightly negative.	The net impact of the line on the owned housing market is neutral to slightly negative. While lower-income census tracts and smaller houses seem to appreciate near the station.
Chen et al. (1998)	Light Rail	Portland	Hedonic Price Models	Property premium was estimated at about 10.5 per cent.	The value of accessibility to the station generally exceeded the nuisance of the line.
Duncan (2008)	Light Rail	San Diego	Hedonic Price Models	17 per cent premiums for condominiums and 6 per cent premiums for single-family homes within a quarter-mile of light rail stations.	Past research has shown that property near rail stations have a premium (between 0% and 10%) in many U.S. cities. However, most of these studies focus on single-family homes. This paper indicates that condominiums receive capitalization benefits in excess of 10%, and the benefits received by single-family properties fall within the more typical range (<10%).
Gatzlaff and Smith (1993)	Heavy Rail	Dade County, Florida (Miami Metrorail)	Pre/Post Study	At most a 5% higher rate of appreciation in real estate sales value compared to the rest of the City of Miami.	Residential values were only weakly impacted by the announcement of the new rail system. Higher priced neighborhoods have experienced greater increases in property values near Metrorail stations while declining ones have not
Gibbons and Machin (2005)	London Underground and Docklands Light Railway (late 1990s)	South East London	Hedonic Valuation Models	House prices rose by 9.3 percent more in places with transit than without.	The study suggests that households significantly value rail access and that these valuations are sizable as compared to the valuations of other local amenities and services.
Goetz et al. (2010)	Light Rail (Hiawatha Line)	Minneapolis	Pre/Post Study	Single-family homes within ½ - mile of a station sold for \$5,229 more after 2004 than homes farther from the station. The premium for multi-family properties was \$15,755 after the line opened.	This study demonstrates that completion of the Hiawatha Line has generated value and investment activity in the Minneapolis housing market.

Authors	Rail Mode	Location (Transit Facility)	Methodology Used	Extent of Property Value Impact	Major Conclusions
Hess and Almeida (2007)	Light Rail	Buffalo, New York	Hedonic Price Models	A premium of between 2 and 5 per cent of value was found.	There is a lower effect for properties in economically declining areas and higher effects in more prosperous areas.
Immergluck (2009)	Light Rail (Beltline)	Atlanta	Pre/Post Study	Single-family homes within one-quarter mile of the planned loop sold at a 15 to 30 percent premium compared to similar properties located more than two miles away.	The study found large increases in premiums for homes near the lower-income, southern parts of the Beltline TIF district between 2003 and 2005, which corresponded to initial media coverage of the planning process. The findings suggest that planning for the Beltline induced substantial speculation and gentrification.
Kahn (2007)	Light Rail	14 cities	Pre/Post Study	Neighborhoods close to new “walk-and-ride” stations saw home values increase more than 5 percent over 10 years, but home values near new “park-and-ride” stations fell by about 2 percent.	This article uses a 14-city census tract-level panel data set covering 1970 to 2000 to document significant heterogeneity in the effects of rail transit expansions across the 14 cities. Communities receiving increased access to new “walk-and-ride” stations experience greater gentrification than communities that are now close to new “park-and-ride” stations.
Knapp et al. (2001)	Light Rail	Portland	Pre/Post Study	Vacant parcels within one-half mile of the planned line sold at a 31 percent premium in the two years after plans were announced. The premiums for parcels within one mile were 10 percent.	The study find that plans for light rail investments have positive effects on land values in proposed station areas.
McDonald and Osuji (1995)	Southwest Side Rapid Transit Line	Chicago	Pre/Post Study	An increase of 17 per cent in value for properties within a half-mile of stations by examining comparative parcel sales from 1980 to 1990.	Alternatively, the increase was 1.9% (or \$126.75 per lot) per mile of distance to downtown Chicago for those sites within one-half mile of the stations.

Authors	Rail Mode	Location (Transit Facility)	Methodology Used	Extent of Property Value Impact	Major Conclusions
McMillan and McDonald (2004)	Rapid Transit Line (Downtown Chicago to Midway Airport)	Chicago	Pre/Post Study	Single-family homes near transit began selling for 4.2 percent more than homes one mile away in the 1980s. The premium increased to as much as 19.4 percent between 1991 and 1996 before correcting to just about 10 percent in later years.	House prices were being effected by proximity to the stations in the late 1980s and early 1990s— after the plans for the line were well known. The difference between the increase in the value of homes within the sample area as compared with properties farther away from the new transit stations was approximately \$216 million between 1986 and 1999.
Nelson (1992)	Heavy Rail	Atlanta, Georgia (MARTA East Line)	Hedonic Price Models	+\$1,000 on home prices for each 100 feet a house is closer to a rail station in low-income transit adjacent census tracts; a slight negative effect in high income tracts (although this may be due to proximity to industrial uses or to low income neighborhoods).	For lower income neighborhoods, the benefit effects of accessibility more than offset any nuisance effects. Higher value homes may be more sensitive to nuisance effects than by improvements in accessibility.
Pollack et al. (2010)	Fixed Rail	42 stations	Pre/Post Study	In 29 of the 42 station areas, the median home value increased by at least 20% more than in the region as a whole. Station area median gross rents outpaced the region by a similar margin in about 40 percent of cases.	The study affirm that transit can be a catalyst for neighborhood renewal, and that such improvements to neighborhood accessibility could potentially 'price out' current residents because of rising property values.
Weinberger (2001)	Light Rail	Santa Clara County, California	Explanatory hedonic models. The study design attempts to reconcile both longitudinal and cross-sectional effects in a single model.	A commercial property within ~ ¼-mile of a transit station would lease in 1993 for 13.8% more than other properties leased in the County in that year, if it were leased in 1997 it would command a 14.6% premium but only 5.2% in 1998.	The basic results indicate that after controlling for factors such as length and type of lease, building improvements, regional and local economic cycles, and location, properties that lie within a ~ ¼ mile of a light rail station command a higher lease rate than other properties in the County.

Appendix C. Summary of Studies on TOD and Gentrification

Authors	Location of Study	Time Period	Variables & Methods Used	Major Conclusions
Lin (2002)	Chicago	1975-1991 Study Periods: 1975-1980, 1980-1985 and 1985-1991.	Residential zoning densities; straight-line distances to the CBD, Lake Michigan and transit stations; annual changes in land values. Method: regression analysis	<ul style="list-style-type: none"> • Transit had influenced gentrification during two of the three periods studied, with large, negative and statistically significant coefficients relating changes in housing values to proximity to transit. • Weakness: Results are limited since gentrification is usually measured with a variety of indicators, yet Lin only took into account changes in land values
Kahn (2007)	14 cities	1970-2000	Property values; education level; proximity to walk-and-ride stations; proximity to park-and-ride stations; and proximity to any transit station interacted with the median household income. Methods: Three model structures for statistical analysis. Regression analysis to estimate the changes in housing prices at the four study periods: 1970, 1980, 1990 and 2000.	<ul style="list-style-type: none"> • The regression showed mixed results across the study sample - walk-and-ride stations having a positive effect on housing prices, and park-and-ride stations effecting housing prices negatively. • The results were inconclusive, and varied depending on the type of regression models used (OLS or IV), ultimately demonstrating that although gentrification did occur near some walk-and-ride stations, it did not appear near park-and-ride transit stations.

Authors	Location of Study	Time Period	Variables & Methods Used	Major Conclusions
Pollack et al. (2010)	12 cities	1990-2000	<p>Population; race; household income; gross rent; mobility status (whether residents have moved in the last 5 years); transit ridership; housing value; and number of cars per household.</p> <p>Variables were collected and analyzed at the census block group level.</p> <p>Method: Regression Analysis</p>	<ul style="list-style-type: none"> • Population, housing units, income, rents and home prices all increased in new rail station areas. • Car ownership increased. • A significant percentage of station areas saw transit use drop faster than the region.
Dominie (2012)	Los Angeles	1990-2010	<p>Two income variables (high- and low-income households); changes in race/ethnicity; occupation; and education.</p> <p>Method: Six Regression Models</p>	<ul style="list-style-type: none"> • Areas around transit in Los Angeles County, for the most part, were more likely to gentrify, • Greater increases in car-owning residents than the surrounding counties, and experienced resultant losses in transit ridership.

Appendix D. TOD Impacts in Los Angeles

Here we provide a brief overview of recent studies conducted by UCLA students, as well as nonprofit and public agencies related to TOD development and its impacts in Los Angeles neighborhoods.

UCLA Student Research

A UCLA study entitled *TOD Impacts on Businesses in Four Asian American Neighborhoods* focused on Chinatown, Thai Town, Little Tokyo, and Koreatown. Overall, this study was the first to examine the impact of TODs on small and ethnic businesses, thus expanding the way researchers should examine the impacts of government infrastructure investments on neighborhood change. Despite data limitations, the available information indicated that many local and Asian businesses did not proportionately benefit from development. There was considerable heterogeneity among the four communities in terms of impacts. From 2001 to 2011, businesses in Chinatown grew at a much lower rate relative to businesses in LA County, and the growth rate of Asian businesses showed a more drastic decrease in the TOD study area compared to that of LA County as well (Fang and Le, 2014). Koreatown only slightly lags behind Los Angeles County for all business and small business growth, thus this neighborhood is still very competitive and has potential for future growth (Cha et al. 2014). In Little Tokyo, the data implies that the TOD study area and LA County's overall business sectors are dynamic, though the study area saw lower rates of business growth and lower turnover (Hom, Toscano, and Yang, 2014). Finally, in Thai Town, the data suggests that while the overall business sector and small business subsector in the TOD Study Area are flourishing, Asian businesses are growing at a dismal rate (Macedo and Nem, 2014). Thus, the results are consistent with community concerns about a relative slowing of growth in small and Asian businesses. The study suggests that greater attention by government is needed to maintain the cultural characteristics of neighborhood and to support small local and ethnic businesses (Ong, Pech, and Ray 2014).

A second UCLA project focused on the analysis of transit-oriented development and fair and affordable housing, examining four LA neighborhoods: Boyle Heights, Westwood, the neighborhood around Sunset/Vermont, and the neighborhood around USC. All these TOD areas had distinctive characteristics.

- In Boyle Heights, racial/ethnic groups within the TOD Service Area earn far less than their respective racial/ethnic group in L.A. County at large. This pattern indicates that economic conditions have been a major factor driving the racial/ethnic distribution in the TOD Service Area, rather than explicit racial/ethnic discriminatory forces. Boyle Heights and the TOD Service Area both have a substantially higher proportion of affordable rental units than L.A. County at large. In addition to this, the median income in both areas is far lower than the county median. Due to these combined factors, the availability of affordable units provides residents with a relatively stable supply of housing, in turn lowering the rent burden in the area (Beltran et al., 2011).
- Around USC, there does not appear to be significant discrimination in housing on the basis of race or ethnicity, as Hispanic and Black/African American households are overrepresented in the USC neighborhood. However, an overrepresentation of African American and Hispanic households may be indicative of housing discrimination in other parts of the city or region. There is a strong supply of low-rent housing, yet a majority of households still pay more than 30 percent of income on housing costs (Lopez et al., 2011).

- In the Sunset/Vermont station area there was no significantly overrepresented or underrepresented racial ethnic group. Trends confirm that the area is actually moving towards representations more consistent with Los Angeles County. Sunset/Vermont does not appear to have a greater need for affordable housing than the County, as it has proportionately twice as many low rent units than the County. However, over 50% of renters in this neighborhood face rent burden.
- In Westwood, subtle housing discrimination practices seem to exist. The research found that Latinos/Hispanics and Blacks are underrepresented in the neighborhood. And the area has an inadequate supply of low-rent housing and a high housing burden among renters. Indeed, people who want to live and work here cannot afford to be here without paying more than 30% of their income on rent (Allen et al., 2011).

Non-Profit Studies

1. *Planning to Stay: A Community Created Master Plan for an Improved Transit Village in Westlake.* February 2010. Central City Neighborhood Partners.

This study focused on the Metro Red Line in Westlake Village in Los Angeles. This area is a low-income, immigrant community, predominantly composed of renters, near downtown Los Angeles. The proximity to downtown and good transit access has prompted significant development interest, which has caused hardship for many residents because of increasing rents. The report mentions the replacement of mom-and-pop businesses by chain and upscale establishments.

The report views resident participation as critical to prevent further displacement and maintain affordable housing:

Residents' leadership is especially critical in resolving the conundrum of improving the neighborhood without gentrifying it. The solution is likely a combination of aggressive affordable housing policy and strategic improvements crafted to improve the neighborhood more in the eyes of current residents, than in the view of new more affluent residents (2010:11)

The report asks the important question: "Are we planning a transit village, or does it already exist?" This area is already very transit-friendly, as it is within walking distance of the Metro, Rapid Bus and bus lines. It averages 33,594 residents per square mile, more than 4 times the city average. The commercial streets are aligned with neighborhood businesses, services and offices in multi-story mixed-use buildings with active street facades. The area already has four times more transit use than the City of Los Angeles and seven times more than Los Angeles County. Consequently, the goal of this study is not to plan a transit village, but rather to improve an existing one. Suggestions proposed include:

- A "Transit Investment Based Inclusionary Housing Zone" that would require 25% or greater affordable units in all new construction and major renovations within ½ mile of the Red Line station. If challenged in court, the authors of the report believe that this policy would be affirmed because the value of station-adjacent property is significantly increased by the enormous public investment in the station and line, thus creating a constitutional basis for requiring developers to provide affordable housing.
- Density bonus programs that provide an additional incentive to build more affordable units. Modeled after the City of West Hollywood's successful ordinance, the policy proposal offers progressively more density bonus as the developer provides more affordable housing, all

the way up to a 100% bonus for 100% affordable housing.

- Implementation of inclusive policies that ensure housing development rather than decrease the stock of affordable housing. It is critical to do this first, so that if later steps attract developer attention, their new projects will be certain to include ample affordable housing.
- Improvement of the neighborhood landscape starting with enhancements that serve current population such as a new DASH route (local shuttles), widened sidewalks, etc.

2. *Hollywood: A Comeback Story and Lessons Learned.* Beth Steckler and Lisa Payne. February 24, 2012.

The introduction of the Metro Red Line subway and three stations along Hollywood Boulevard in the heart of the redevelopment project area has served as a catalyst for development. The Community Redevelopment Agency (CRA) adopted a “bookend strategy” that at first focused investment around the stations with the assumption that it would then be easier to attract development to the rest of the project area.

However, by 2009 the demographics of Hollywood’s residents had changed: they owned more cars, composed smaller households, and had higher incomes than the previous area residents. Despite all the development, the study outlines that the number of people living in central Hollywood fell by about 10 percent, while population in the city grew by about 9 percent. Per capita income rose 34 percent in Hollywood, but only 2 percent citywide. And there was an increase in car ownership despite the easy availability of high-quality transit: The area witnessed a 32 percent decrease in car-free households, while households with one car increased by 15 percent. This information has implications for ridership on the transit system. All the numbers suggest that, despite the city’s extraordinary efforts to keep housing affordable, Hollywood is gentrifying.

Focusing on the case study of the Hollywood area, the report suggests the following 11 recommendations for TODs around metro stations in Los Angeles:

- Be bold in addressing big problems
- Get city agencies working together with the community
- Engage communities of interest to help address problems
- Tackle crime and problem properties
- Deliver on the promise of good jobs for the community
- Capture some of the increased property value
- Devise strategies for making streets and sidewalks clean
- Minimize displacement
- Seize opportunities for moving mission forward
- Get the parking right
- Advocate for local, regional, statewide, and federal policies.

3. *Creating Successful Transit-Oriented Districts in Los Angeles: A Citywide Toolkit for Achieving Regional Goals.* February 2010. Center for Transit-Oriented Development.

The Center for Transit-Oriented Development (CTOD) set out to determine why good TOD is or is not occurring around stations, and to strategize about ways that station area performance could be improved. CTOD examined the current success of transit-oriented districts through a data-driven analysis and a discussion with focus groups from five transit corridors in the city. They created a variety of tools measuring current performance including a station typology, station area profiles, and a set of regional screen maps that analyze demographic and economic conditions throughout the City.

The CTOD also conducted a case study analysis of five corridors that have clusters of stations, including: the Gold Line from Little Tokyo to Indiana; the Red Line from Vermont/Wilshire to Vermont/Sunset; the Orange Line from Sepulveda to Warner Center; the Expo Line from USC to Crenshaw; and a key portion of the proposed downtown streetcar alignment. CTOD invited stakeholders from these corridors to talk about the opportunities and challenges of TODs. Participants included staff from several city departments and various agencies including CRA-LA, the Planning Department, and LA Metro, as well as community members and organizations, institutional property owners and major employers, and planners, developers, and activists.

This report emphasizes that transit investment and transit-oriented districts are keys to enhancing affordable living. A 2009 study by the American Public Transportation Association found that households that used transit saved an average of \$10,000 in Los Angeles (2010: 4). Additionally, there is growing support for TOD from business interests. The authors emphasize that achieving TOD success requires the involvement of many public and private organizations.

According to the report, the demand for transit-oriented living in the Los Angeles region is strong and growing; nearly two-thirds of this demand is likely to come from households earning less than the city's median income (2010: 7). Already, transit serves many of the city's existing lower-income neighborhoods, offering residents regional access but increasing their vulnerability to displacement over time. (2010: 8). Furthermore, 22.4 percent of jobs in Los Angeles County are connected to transit (2010: 8).

The report stresses that since contracts on over 20,000 units of affordable housing will expire by 2014, housing preservation will be a key component of station area planning. Another means of protecting affordability is to proactively implement development plans for small parcel sizes near some transit stations. The chart below identifies different TOD strategies that relate to several topics (for example, Housing Affordability and Economic Development) that came about as a result of this project.

4. Preservation in Transit-Oriented Districts: A Study on the Need, Priorities, and Tools in Protecting Assisted and Unassisted Housing in the City of Los Angeles. May 2012. Prepared for the Los Angeles Housing Department. Prepared by: Reconnecting America.

For this study, four existing transit-oriented districts were selected as areas of focus for preservation activities over five years. The areas were chosen based on several factors:

- Median Household Income
- Percent of Renter-Occupied Households

- Potential Change in Market Strength Resulting from:
 - Proximity to Major Job Centers
 - Areas with Lower Transportation Costs
 - Rising Property Values
 - Transit Access to Downtown Los Angeles and Westwood Resulting from Measure R Investments
 - Historic Neighborhood Character (age of buildings)
- Vulnerability of Housing Stock:
 - Concentration of Income-Restricted, At-Risk Units
 - Concentration of Larger Buildings Subject to the Rent Stabilization Ordinance
 - Concentration of Smaller Buildings Subject to the Rent Stabilization Ordinance

The station area clusters chosen were along the Red Line, Purple Line, Venice Blvd. Central L.A Rapid Bus corridor (North of I-10), and Expo Line. The areas chosen exhibited a high confluence of vulnerability factors.

The study suggests that if transit investments manage to reduce congestion to major transit-oriented job centers like Downtown Los Angeles or Westwood, then workers in these places must be able to reach them by transit. Thus, the report proposes a comprehensive TOD strategy that might include the following:

- Affordable housing preservation;
- Coordinated land use regulations that leverage new transit-oriented development (both market rate and affordable);
- Provision of other amenities such as parks, quality schools, fresh food, etc.;
- Making last mile connections and investing in supportive pedestrian, bicycle, parking improvements and land use planning efforts; and
- Coordinated workforce and economic development strategy that considers both business attraction and job training near transit.

Appendix E. Summary of Simulation Models of Gentrification

Authors	Model Structure ¹	Model Setting	Mechanisms	Findings
O'Sullivan (2002)	Cellular automata	London	This model is explicitly posed as a spatial instantiation of the "rent gap" theory of gentrification. Each iteration of the model consists of spatially linked properties (the "cells" of the model) passing among states of "not for sale," "for sale," "seeking tenants," and "rented." The rent gap is operationalized as the amount by which the "condition" value of a given property is less than the average condition of spatially linked properties. This gap helps determine the investment in upgrading a property, which in turn helps determine the property's state, as well as values for sale price, rent price, and "neighborhood status."	Posed as an exploratory analysis, model outcomes are shown for a sample run of 60 years, with the author tracking the proportion of properties in each of the four different states, as well as average values occupant income, physical condition of properties, and neighborhood status. The model is able to generate alternate periods of stability and instability in these measures, with neighborhood change dependent on the inclusion of a neighborhood status feedback mechanism.
Torrens and Nara (2007)	Cellular automata and agent-based hybrid	Salt Lake City	The interactive units in this model are of three types: spatially fixed markets and properties, and spatially mobile residents. Residents choose among markets (large aggregations of properties) and then choose among nested properties. The decision whether or not to move, and subsequently where to move, is based on the preferences and economic statuses of residents, as well as of properties of both broader markets and individual properties. Real estate prices are subsequently adjusted based on location-specific vacancy rates.	The authors track five primary market-level outcomes in their model: total household population, average property values, the average economic status of residents, residential turnover, and resident ethnic profile. These outcomes are presented for four different model runs: a status quo scenario; a demand-based gentrification scenario, in which additional high-income households are exogenously input to the model; a supply-based gentrification scenario, in which additional high-value properties are exogenously input; and a scenario combining demand and supply gentrifying pressures. The model, specified in an exploratory way, is able to produce varying gentrification dynamics under these different scenarios.

¹ Mode structure is split into three broad types. "Cellular automata" models consist of spatially fixed units. The characteristics of these units (or automata) evolve according to the attributes of other, neighboring automata. The potential states of the automata, their updating rules, and their geometries of influence are all potentially complex. "Agent-based" models, on the other hand, consist of spatially mobile agents situated within a fixed or evolving environment. The agents move according to decision procedures that can be based on both characteristics of the environment and of other agents. Characteristics of agents themselves may be static or may change over time, and their movement may alter relevant aspects of the environment. Finally, hybrid models contain elements of both cellular automata and agent-based models. These models contain spatially mobile agents, but they also contain spatially fixed cells that evolve according to the actions of mobile agents, as well as in response to the characteristics of other spatially fixed cells.

Authors	Model Structure ¹	Model Setting	Mechanisms	Findings
Jackson, Forest, and Sengupta (2008)	Agent-based	Boston	Four distinct types of mobile agents -- professionals, students, non-professionals, and elderly -- interact with a simulated urban landscape, with movement decisions governed by neighborhood preferences and abilities to pay that vary between agent types. Additionally, rents charged for simulated housing units increase according to the presence of professionals, and students transition over time to either professionals or non-professionals.	Measured outcomes of the gentrification model include the proportion of residents by type in the modeled neighborhoods, as well as the average land rents in these areas. Geographic trends are analyzed in terms of their qualitative similarity to results predicted by theory, and multiple test parameters are tweaked to validate the model's conformity to theoretical expectations.
Eckerd and Reames (2012)	Cellular automata and agent-based hybrid	Abstract grid	The authors posit a model that incorporates both a real estate market that governs the price of simulated plots of land, as well as a preference mechanism the governs the location decisions of residential agents. While the specifics of both of these mechanisms are left vague, the authors specify that residential agents are to be heterogeneous with respect to both income and race, and that these two dimensions of "socioeconomic status" are to drive the gentrifying dynamics.	The work presented by the authors is meant only to lay out the foundation for a gentrification simulation. Thus, the authors have no concrete results. They do, however, explicitly describe the process by which model results are to be compared with empirical observations to validate the model's structure, behavior, and policy implications.
Diappi and Bolchi (2013)	Cellular automata and agent-based hybrid	Milan	This model consists of investors, small owners, and tenants as "active" agents, and buildings as "passive" or spatially fixed agents. Within the model, investors decide whether to generate new developments and owners decide on their level of property upkeep based on property- and neighborhood-level characteristics (with investor decisions framed around the familiar rent gap theory). These supply decisions are additionally influenced by two exogenous factors: macroeconomic cycles, and an "Alonso curve" rent gradient falling outward from the city center. Tenants make locational decisions within the resulting real estate market based on their individual preferences and abilities to pay.	The model is first validated by reproducing the observed spatial patterns of rent in Milan as they evolved from 1993 to 2003. The authors next use the model to predict future rent levels with and without a series of planned large-scale development projects. Finally, the authors use model results to posit rent gap dynamics as a potential explanation for cyclicity observed in aggregate rent levels.

Appendix F: Census Tract Datasets

Two census tract-based time series were developed with data on housing and demographic characteristics of non-transit and transit neighborhoods (areas within a half-mile radius of a fixed-rail transit station). As discussed below, we intended to use the Neighborhood Change Database (2010) to reconcile tract boundaries from 1980 to 2010; however, significant errors were found, and we instead went with the Brown Longitudinal Tract Database. Below we discuss some of the methods used and challenges faced when processing the datasets for the two regions.

While the team's original plan was to use Geolytics Neighborhood Change Database (2010) (NCDB) for this task, a major problem was encountered with the reported population counts in the NCDB. The problem that the team noticed from the onset is that Geolytics data revealed dramatic population changes for a number of census tracts in Los Angeles County and in the Bay Area that appeared to be anomalous. Populations were allocated to census tracts that generally do not have population or very few people. Table F.1 lists the tracts where the team spotted errors in the misallocation for Los Angeles. These were mainly the 9800 and 9990 tracts. The Bureau of Census provides the following definition for the tracts with code range in 9800s and 9900s:

The code range in the 9800s is new for 2010 and is used to specifically identify special land-use census tracts; that is, census tracts defined to encompass a large area with little or no residential population with special characteristics, such as large parks or employment areas. The range of census tracts in the 9900s represents census tracts delineated specifically to cover large bodies of water. This is different from Census 2000 when water-only census tracts were assigned codes of all zeroes (000000); 000000 is no longer used as a census tract code for the 2010 Census (https://www.census.gov/geo/reference/gtc/gtc_ct.html).

Because of some of the inaccuracies in the NTDB, the team decided to use Brown University's Longitudinal Tract Data Base (LTDB) and its crosswalks to reconcile the changes in tract boundaries from earlier time period. The Longitudinal Tract Data Base provides a crosswalk that allows one to normalize census tract data from previous years (1970-2000) to 2010 census tract boundaries to maximize comparability across the study period. In addition, the LTDB also includes both a selection of short- (Full Count) and long-form (Sample Count) variables from the 1970-2000 Censuses that are already normalized to 2010 boundaries. For any additional variables not provided by the LTDB, we downloaded the original raw data (through FactFinder2 or Social Explorer) and used LTDB's crosswalk normalize to 2010 boundaries. The census tract data in the database were obtained from five sources: the Longitudinal Tract Data Base, the 1990 U.S. Decennial Census, the 2000 U.S. Decennial Census, the 2010 U.S. Decennial Census, and the 2009-2013 American Community Survey (ACS).

Table F.1: Total Population Counts

Census Tract	Geolytics			Decennial Census
	1980	1990	2000	2010
6037980001	1,308	1,702	1,879	0
6037980002	2,695	3,251	3,195	0
6037980003	619	805	668	2
6037980004	365	637	616	169
6037980005	3,327	3,434	3,490	0
6037980006	277	343	112	0
6037980007	904	1,221	794	0
6037980008	1,746	2,489	2,723	145
6037980009	8,659	9,035	8,875	14
6037980010	4,453	4,831	4,634	164
6037980013	12	13	16	59
6037980014	3,494	4,097	3,957	239
6037980015	4,858	5,956	5,191	554
6037980018	70	89	91	1
6037980019	7,801	7,667	8,128	173
6037980020	2,072	2,393	2,372	0
6037980021	3,366	5,273	6,025	33
6037980022	3,815	3,642	3,622	4
6037980023	1,753	2,315	2,592	8
6037980024	5,167	5,151	5,253	186
6037980025	2,614	2,639	2,837	0
6037980026	3,957	4,019	5,214	20
6037980028	2,029	2,380	2,198	4
6037980030	2	2	2	0
6037980031	7,719	9,220	8,894	1,262
6037980033	138	4,704	24	61
6037990100	7,141	7,850	8,698	0
6037990200	81,334	81,046	78,104	0
6037990300	28,450	33,523	30,442	0

While we did our best to include variables that are consistent across all three time periods, we did encounter some inconsistencies in some key variables. One example is the data on mobility. For our analysis on neighborhood mobility, we relied on the 2009-13 ACS data on “Geographical Mobility by Selected Characteristics in the United States” to examine the demographic characteristics and socioeconomic status of those moving into TOD areas. The information is available for persons who moved within one year. Unfortunately, there are no comparable datasets in the 1990 and 2000 Decennial Censuses. What is available from the two Censuses is a table on “Year Householder Moved into Unit”. The universe, which is the householder, is different from the ACS mobility table, which reports estimates for persons. Another difference between the two tables is the reported mobility period. The ACS table provides estimates for those who moved within the last year, while the 1990 and 2000 dataset on “Year Householder Moved into Unit” reports estimates for those who moved within a year and three months. Additionally, the “Year Householder Moved into Unit” variable does not provide in details key characteristics of the mover that are important to this research. This includes information on the mover’s income, race, and education attainment level. The ACS 1-year mobility data provides this information.

Another major problem that we encountered was the household income brackets that were not inflation adjusted across data sets, thus creating "artificial" shifts in distribution by income. We were able to partially address this by using Social Explorer, which allowed us to adjust the income brackets for inflation, but we do not know the reasonableness of their estimated reallocation.

The team observed inaccuracies with the Geolytics NCDB data in the Bay Area similar to those in Los Angeles County. For certain tracts, especially those near water bodies, significant discrepancies

existed for population counts in the NCDB. For instance, in a census tract in the northern county of Marin that underwent changing tract boundaries between 2000 and 2010, the Geolytics database indicated a population spike from 281 in 2000 to 7809 in 2010 (Figure F.1). Through our interviews and contact with our partner CBO, we learned that few if any new units were added to the area during that decade, and barring the building of an entirely new community, a population growth of 2679% in an existing community seemed unbelievable.

After contacting Geolytics in search of an explanation or data fix and receiving little of either, we sought an alternative source of data in Brown University’s Longitudinal Tract Database (LTDB). Despite using seemingly similar methods, LTDB showed a gradual population growth from 1980. We therefore contacted Brown University to better understand the source of this difference, and they suggested that Geolytics used a less robust methodology, involving analysis of the street grid among other, less transparent methods. Although the LTDB appeared more robust for this single tract, we began to question the reliability of either dataset. Following UCLA’s methodology (Ong et al. 2014), we prepared a third dataset using block data from 1990 and 2000 and assigning it to 2010 tract boundaries – a methodology similar to those used by both Brown University and Geolytics.

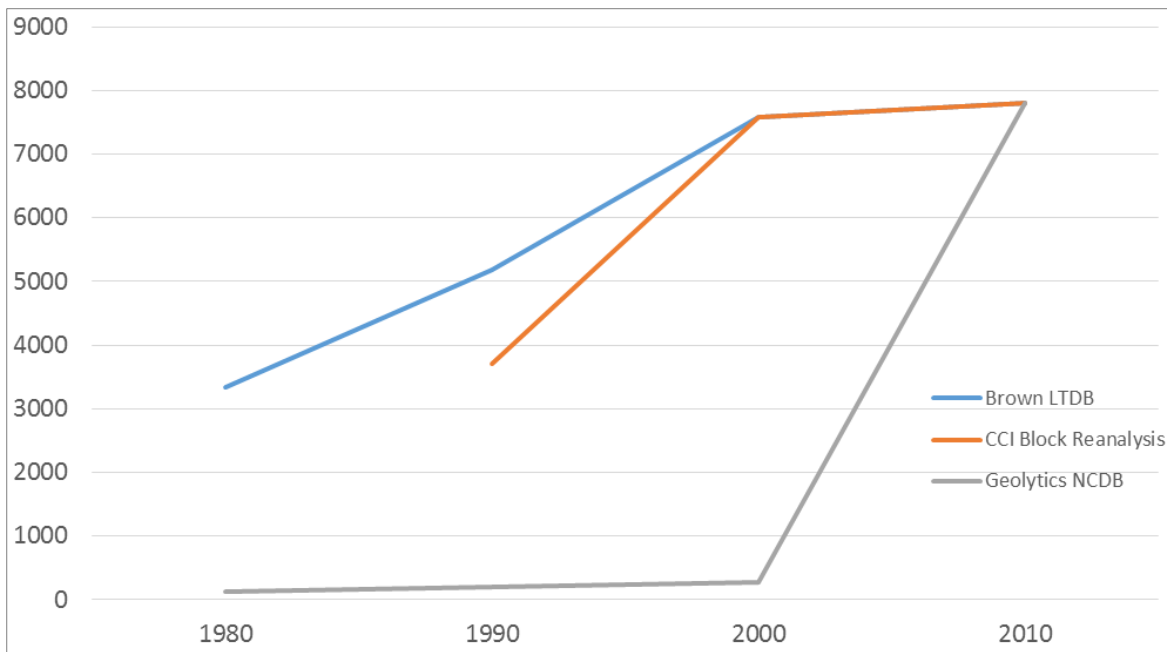

Figure F.1: Differences between Geolytics NCDB, Brown LTDB, and census block analysis for census Tract 1122.01, Marin County

When we compare the results from our analysis of block level population data, we find that Brown University’s LTDB aligns well with our results for 2000, but not for 1990. In contrast, Geolytic’s NCDB aligns better than Brown in 1990, but significantly worse in 2000 (Table F.2). As much of our analysis focuses on change since 2000, we chose to utilize the Brown LTDB dataset for the purposes of this research.

Table F.2: Correlation coefficients between Geolytics NCDB, Brown LTDB, and census block analysis for Bay Area tracts

	1990 Census Block Analysis	2000 Census Block Analysis
1990 Brown LTDB	0.696	-
1990 Geolytics NCDB	0.826	-
2000 Brown LTDB	-	0.993
2000 Geolytics NCDB	-	0.599

Appendix G: Parcel-Level Datasets

In an attempt to build a finer grain understanding of neighborhood change in the Bay Area and Los Angeles County, we set out to acquire datasets available at the parcel, rather than census tract, level. This involved purchasing Assessor and transaction data from Dataquick as well as acquiring data on subsidized housing from the U.S. Department of Housing and Urban Development (HUD) and the California Department of Housing and Community Development (HCD), and other data where available. One of the biggest limitations of this task was the uneven collection of data at the municipality level. Thus, while some cities have an abundance of fine-grain data (e.g., San Francisco), others collect very little or data is only available at the citywide level. Although this task originally envisioned acquiring housing discrimination complaints from the California Department of Fair Employment and Housing and with HUD, such data available to the public are only reported at the aggregated level (county or state), and the frequency is very low, limiting usefulness for this study. In addition to the assessor and subsidized housing data, we sought to acquire permits data, code violation data, and condo-conversion data to develop proxies for different types of displacement, as summarized in Table G.1, included in our original scope of work. Unfortunately, much of this data (especially permit and evictions data) was not actually available at the parcel level for our areas of analysis. The below sections detail the kind of data we were able to acquire, specifically paying attention to the assessor and transaction data.

Table G.3: Types of Displacement

Displacement Type	Sales	Permits-New	Permits-Rehab	Permits-Demo	Condo conversions	Code violations	Rent-Own conversions	Evictions	Subsidized housing
Economic	X	NA	NA						x
Physical	X			NA	x	NA	NA	x	x
Exclusionary	X	NA		NA	x		NA		x

NA = Indicates what is not available

G.1 Parcel Database for Los Angeles

The UCLA research team made several adjustments to Task 2H due to the unavailability of datasets in Los Angeles County. Numerous requests were made to obtain city data on building permits, demolitions, and code violations but the team was unsuccessful in acquiring these datasets. The fragmentation of Los Angeles County, which consists of a total of 89 different jurisdictions, made it difficult for the research team to track down all of the datasets.

Instead, the UCLA team had to rely on existing parcel datasets, which the team already has access to from other research projects. The UCLA team had access to a rich set of parcel data which goes as far back as 1999 and up to 2013. The parcel data was purchased from the Los Angeles County Assessor's office, which records data on parcel and structure characteristics as well as transaction information, including sale price and date of sale. Only the 2000, 2007 and 2013 parcel data were used for this project. Although not perfect, the Los Angeles County Assessor's parcel data was sufficiently complete to enable the team to leverage it in order to estimate the number of new construction projects, condo conversions, and properties that have gone through major renovations. Property sales data were derived from DataQuick (see description in Bay Area section below).

List of Substitutions

Permits-New → Newly constructed building imputed from LA County Assessor dataset

Permits-Rehab → Major renovations for single-family homes imputed from LA County Assessor dataset

Major Renovation/Improved Units

Our analysis of major renovations only looks at single-owner properties that were renovated between 2007 and 2012. The recording year was used as a proxy for the year the property was sold. We limit our sample to include properties that were sold in 2007 but remained with the same owner during the six-year period (2007-2012). To determine if the property was renovated, we looked at the changes in the property's improvement value between these two years. California's Prop 13 caps property taxes at 1% of the assessed value of a home at the time of purchase and prevents taxes from increasing more than 2% a year or more than the rate of inflation, whichever is less, unless there is a sale or major renovation. Anything beyond this would indicate some real improvement or renovation to the property.

For this study, a home is said to have been improved or experienced major renovation if it met the following criteria:

1. The percentage change in improvement value is greater than 10.7% (this is the rate of inflation between 2007 and 2012)
2. The amount in real dollar improvement is greater than or equal to \$5,000 (improved value in 2012 less improved value in 2007 times 1.107)

We aggregated all properties that were identified as being improved or that experienced major renovation, up to the census tract level.

New Construction of Residential Units

The 2013 County Assessor Parcel data was used to estimate the number of new residential units. Parcels with the first character of the use code either zero or with use code ranging from 01 to 09 are classified as residential properties. Table G.2 provides a breakdown of the types of residential property and their use codes.

Table G.4: County Assessor Use Codes and Corresponding Residential Property Types

Use Code	Description
01	single-family residence (one unit)
02	two units
03	three units
04	four units
05	five or more units
06	modular home
07	mobile home
08	rooming house
09	mobile home park

Using the "Year Built" variable, we define units that were constructed between 2005 and 2013 as "new". Since the parcel data does not include a "number of total units" variable for multi-family properties, we had to estimate the number of units for each parcel classified as "Five or More Units". We did this by dividing the property's square footage by 900. The 900 square feet is the

average size for a multi-family unit in Los Angeles County. Table G.3 gives an example of our calculation. We aggregated all “new residential units” up to the tract level.

Table G.5: Estimating the Number of Units for Parcels Classified as 5 Units or More

AIN	Use Code	Yr. Built	Tract10	BG10	SQ.FT	Est. Units
XXXXXXXXXX	0501	2005	265510	1	77,329	85

Estimated # of Units = Building sq. ft. / 900
77,329/900 = 85 units

Condo Conversion

Our analysis of condo conversions identified apartment units that were converted to condos between 2003 and 2013. Since the parcel data does not contain a variable denoting when the property was converted, we had to estimate this by merging together the 2003 and 2013 parcel datasets using the property’s Assessor Identification Number (AIN). Only parcels with the use code 10E (condo conversion) were kept in the dataset. If a parcel existed in 2013 but not in 2003 then we can assume that the conversion occurred between 2000 and 2013. If the parcel existed in both the 2000 and 2013 datasets then it is most likely that the conversion took place before the 2003 period. When a unit is converted from apartment to condo, it is given a new AIN. Prior to the conversion, the unit would not have had its own AIN, but instead the whole apartment structure itself would have had one unique AIN for the property.

Table G.4 provides a simple cross-tab between the 2007 and 2013 parcels. There were 47,919 parcels that were identified as condo conversion in 2007 and 52,890 in 2013. A total of 47,115 existed in both 2007 and 2013 parcel datasets which would indicate that the conversion took place prior to 2007. It is estimated that 4,971 units were converted between 2007 and 2013 (AIN contained in 2013 but not in 2007). The number of condo-converted units were aggregated up to the tract level.

Table G.6: Simple Cross-Tab of 2007 and 2013 Condo Conversion Data

	In_2013		Total
In_2007	0 (No)	1 (Yes)	
0 (No)	0	4,971	4,971
1 (Yes)	804	47,115	47,919

G.2 Parcel Database for the Bay Area

No consistent parcel level data was available for all Bay Area counties; therefore, the UC Berkeley team relied on the parcel data purchased from Dataquick for the construction of the database. A significant amount of data processing and cleaning was necessary to extract relevant indicators from this dataset. Data was purchased for current assessor data (equivalent to 2013), historical assessor data, which dates back to 2004, as well as transaction data, which dates back to 1988. From these datasets we intended to extract data on the frequency of sales and sales price of residential properties, land use changes including condominium conversions, new construction, and major renovations. Of this list, we were only able to extract the first two datasets, as the remaining indicators proved to be unreliable.

Transaction Data

After following the data cleaning procedures described in the Appendix to remove duplicates, outliers, non-monetary transactions, public agency sales (which could distort the calculation of sales values) among other cleaning procedures, we calculated residential sales price per square foot and then estimated the median sales price (and number of sales) per census tract. This data allows us to better understand the turnover and value appreciation by neighborhood.

Land Use Changes

For land use changes, we looked at the change in land use codes for each property between 2004 and 2013. The major limitation of this was that we were only able to match properties that did not change parcel numbers; this is a limitation because it is very common for parcel numbers to change, especially if any subdivision or parcel assembly has happened. In addition, Dataquick could not provide us with an algorithm for the changes in assessor numbers to match between years, as they argued that each County uses its own numbering system, which can change over time. Thus the land use change (including condominium conversions) was determined to be significantly underestimated from this technique. As an example, Table G.5 displays the counts of the total conversions between 2006 and 2011 (the last year for which we had reliable land use data). As a point of reference, there are approximately 2,206,509 parcels in the nine-county Bay Area. If this method of comparison were correct, land use changes would have only occurred on less than 2.5% of all parcels over a five-year period, which seems a bit low. Furthermore, when aggregating at the tract level for the purposes of modeling, these land use changes become virtually insignificant.

Table G.7: Land Use Changes between 2004 and 2013

From \ To	Agricultural	Commercial	Industrial	Residential	Miscellaneous	Vacant
Agricultural	X	71	37	689	125	383
Commercial	2	X	568	12,504	408	601
Industrial	36	567	X	1,117	154	310
Residential	335	1,175	78	X	641	2,851
Miscellaneous	282	6,279	214	1,839	X	1,248
Vacant	105	734	237	21,298	565	X

Similar results were found for condo conversions: according to this method only 6,143 parcels converted from other types of residential uses to condominiums. Based on the layouts of the current assessor data, we know that each condominium has a unique Assessor Parcel Number (APN), thus it is highly unlikely that this method of matching parcel numbers will give us an accurate portrayal of the total number of condominium conversions in the Bay Area.

New Construction

One method for calculating new construction from the parcel data is to use the field for “Year Built” by building and the number of residential units on site. However, the units in many cases are counted many times, especially in buildings of condominiums where each condominium has a unique parcel number. Thus when summed, for instance in a condo building of 20 units, the total would equal 400 units because total number of units is replicated each time. Number of units appears to be inaccurate even for non-condo buildings. For instance, in San Francisco, according to the Dataquick Assessor tables, there were 2,298 units developed over the period 2007-2013;

however, the City claims to have permitted 3,697 units, 1,606 were reported as having been built during that same time period in their Housing Element Annual Reports to HCD. When comparing data for San Francisco, where we have access to additional assessor data and land use data, the Dataquick assessor data claims that only 2,156 units were built during the 2007-2013-time period, whereas it appears that they permitted 16,826 units, and when we looked at assessor data that San Francisco Planning department cleaned, it appears that 7,545 residential units were developed during that time period. Because of these large discrepancies, we decided to abandon Dataquick as a source of data for new construction and instead rely on census data to estimate new units.

Major Renovations

Similar to the analysis described for the Los Angeles Region, the UC Berkeley team set out to analyze land-to-improvement values as a proxy for major renovations. Upon calculating and mapping these ratios for the Bay Area, however, it appeared that several counties applied a constant ratio for calculating improvement values. As illustrated in **Error! Reference source not found.**, virtually all of Alameda, Solano, and Sonoma counties have the same median improvement-to-land value for 2013 when estimated at the tract level. This led us to assume that the improvement value was not worth including in the analysis at the regional level.

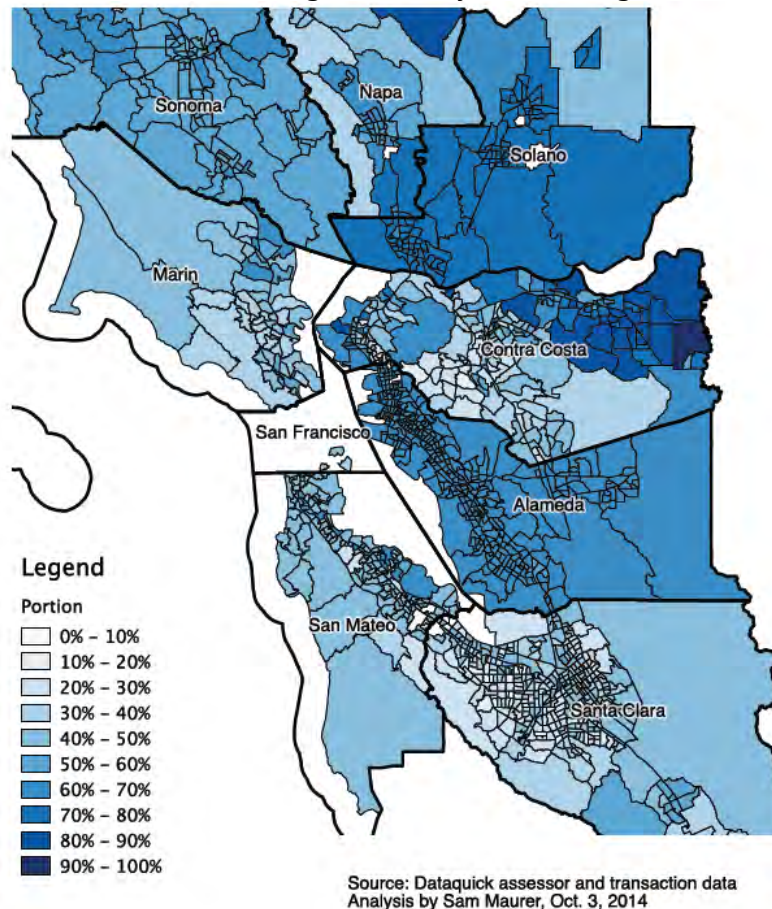

Figure G.1: Improvement to Land Value Ratio for 2013 in the Bay Area

Affordable Housing

We were able to obtain a detailed dataset on subsidized housing from the non-profit California Housing Partnership Corporation. This data was primarily derived from the U.S. Department of Housing and Urban Development Low-Income Housing Tax Credits (HUD LIHTC) datasets, but also contains buildings developed with other federal funding sources as well. This dataset allows us to calculate the number of subsidized housing units constructed by year and location, although it does exclude any units developed exclusively with funding (e.g., local redevelopment agency projects).

Parcel Data for San Francisco

Given the limited availability of parcel-level data at the regional scale, we sought to obtain more detailed data for the one county in the Bay Area that collects and makes public very detailed datasets: San Francisco County. For this county we were able to obtain the following datasets at the parcel/address level:

1. Fault and no-fault evictions since 1997
2. Below Market Rate units built under the City's Inclusionary Housing program since 1992
3. Housing permits for condominium conversions and for renovations since 1990
4. New housing construction from the local assessor/land use tables since 1990
5. Housing code violations since 2008

Appendix H. Data cleaning Protocol for DataQuick Assessor and Transaction Data

PART 1 – GENERAL FILTERS		
Issue	Analysis	Final criteria (SQL syntax)
Remove transactions from outside the 9-county San Francisco Bay Area		1. mm_fips_muni_code IN (1,13,41,55,75,81,85,95,97)
Remove transactions from prior to 1988 since the dataset is supposed to only go back to 1988 sales		2. (s.sr_date_transfer/10000) >= 1988
Remove non-residential transactions	<ul style="list-style-type: none"> These represent less than 10% of state-wide transactions provided by Dataquick, and only 2.2% after applying the other data filters 	3. SUBSTRING(a.use_code_std FROM 1 FOR 1) = 'R'
PART 2 – LINKING TRANSACTIONS TO ASSESSOR DATA		
Issue	Analysis	Final criteria (SQL syntax)
Basic identifiers have to be present in order for us to link transactions to census tracts	<ul style="list-style-type: none"> Census tracts are listed in the assessor table but not in the transactions table, so we match transactions to assessor records using the property id 8% of transactions have a missing or 0 property id, and 0.3% of current assessor records are missing a census tract These transactions will disappear automatically from the final statistics, but it's probably best to explicitly remove them so they don't affect how we're judging the other data cleaning filters There don't seem to be any zero values for the census tract 	1. sr_property_id IS NOT null 2. sr_property_id > 0 3. sa_census_tract != "" (varying syntax due to integer vs. character data fields)
Historical assessor data is sporadically incomplete, so it's probably best to pull square footage and use codes from the current assessor table, even though they could have changed or the property may no longer exist	<ul style="list-style-type: none"> Historical assessor data is missing for several entire counties in 2011 and 2012 In general, the historical tables are also less complete than the current assessor table When we match transactions to the next-year assessor tables, 1%–10% are missing, but when we match them to the current table, only < 1% are missing 	1. sales.sr_property_id = assessor.sa_property_id for matching the square footage and use codes
Square footage and use codes have to be present in order to calculate final statistics	<ul style="list-style-type: none"> After implementing the primary filters (arms-length, positive transfer value, property match in the assessor table), 3.5% of the Bay Area transactions have missing or zero square footage and < 1% are missing a use code We'll proactively remove these from the "clean" data tables 	1. sa_sqft IS NOT null 2. sa_sqft > 0 3. use_code_std != ""

PART 3 – PROPERTIES OF INDIVIDUAL TRANSACTIONS		
Issue	Analysis	Final criteria (SQL syntax)
Dataquick's arms-length flag may not be accurate, because it includes transactions with a transfer value of 0 and excludes some with a transfer value > 0	<ul style="list-style-type: none"> Cross-tabulation of transfer value and arms-length flag: <ul style="list-style-type: none"> (A) 38% - value > 0 and arms-length (B) 48% - value = 0 and non-arms-length (C) 12% - value > 0 and non-arms-length (D) 2% - value = 0 and arms-length Group D in particular calls Dataquick's methodology into question, but examples from Group C look ok (sales to trusts and other things we should be filtering out) All in all, it seems best to remove transactions Dataquick classifies as non-arms-length rather than trying to catch all of them using other filters We have to remove transactions with missing or 0 transfer values anyway, in order to calculate meaningful price statistics 	<ol style="list-style-type: none"> sr_arms_length_flag = '1' sr_val_transfer IS NOT null sr_val_transfer > 0
Only include resale and subdivision transaction types	<ul style="list-style-type: none"> For transactions with value > 0: <ul style="list-style-type: none"> 89% = R (resale) 10% = S (subdivision) 0.5% = C (construction) 0.5% = T (timeshare) none refinance, none missing 	<ol style="list-style-type: none"> sr_tran_type = 'R' OR sr_tran_type = 'S'
Possibly should filter by transaction document type	<ul style="list-style-type: none"> For transactions with value > 0: <ul style="list-style-type: none"> 46% = G (grant deed) 6% = U (trustees deed) 1% = Q (quitclaim) negligible H, W, T 47% missing Too many missing values to use this field 	<ol style="list-style-type: none"> NONE
Only include transactions representing full sale amount	<ul style="list-style-type: none"> For transactions with value > 0: <ul style="list-style-type: none"> 79% = F (full) 3% = P (partial, excluding liens etc.) 4% other (C, U) 14% missing (data dictionary indicates missing = assumed full) Overall, the data in this field doesn't seem reliable enough to use 	<ol style="list-style-type: none"> NONE
Remove trust transactions that Dataquick misclassified as arms-length	<ul style="list-style-type: none"> Pulled a sample of matching records and the filter works as expected 	<ol style="list-style-type: none"> sr_buyer NOT ILIKE '% trust%' sr_seller NOT ILIKE '% trust%' <p>(case-insensitive pattern matching where % matches any string of zero or more characters)</p>
Remove public agency transactions because they're often not at market prices	<ul style="list-style-type: none"> Filter works as expected, with > 90% of the matches being public agencies The false positives are entities with names like "First National Bank Daly City," but there doesn't seem to be any easy way to improve the pattern matching 	<ol style="list-style-type: none"> As above, with "county," "city," "agency," "redevelopment"

PART 4 – SETS OF RELATED TRANSACTIONS		
Issue	Analysis	Final criteria (SQL syntax)
Sets of transactions involving the same property id on the same day often represent different parts of a single sale (refinance, multiple loans, trust transactions, one to many owners or vice versa, etc.)	<ul style="list-style-type: none"> After applying all the prior filters, these duplicates represent about 1.0% of the remaining transactions (0.6% same price, 0.4% differing prices) The same-price duplicates are <i>mostly</i> transactions involving intermediaries, and the differing-price duplicates are <i>mostly</i> multi-part transactions, but the patterns aren't consistent enough for us to get reliable prices from these records 	<ol style="list-style-type: none"> After applying all the prior filters, group remaining transactions by <code>sr_property_id</code> and <code>sr_date_transfer</code> Remove all these transactions
Sets of residential transactions on a single day with the same document number but differing property id's represent subdivision or condo building sales, which often have incorrect price or square footage data	<ul style="list-style-type: none"> After applying all the prior filters, these duplicates represent about 1.2% of the remaining transactions (We have to group transactions by county here because document numbers can repeat across jurisdictions) Dataquick reps informed us that for residential condo and subdivision transactions involving multiple property id's, they record the total transaction price separately for each unit This looks correct based on the data, but it's hard to be certain 	<ol style="list-style-type: none"> After applying all the prior filters, group remaining residential transactions by <code>mm_fips_muni_code</code>, <code>sr_doc_nbr_fmt</code>, and <code>sr_date_transfer</code> If the dollar amounts match, only keep one of the transactions, and calculate price per square foot as <code>transaction price / total square footage</code> If the dollar amounts differ, calculate the price per square foot normally
PART 5 – PRICE OUTLIERS		
Issue	Analysis	Final criteria (SQL syntax)
Identify and filter out significant outliers in price per square foot, because these are likely to be errors that would bias aggregate calculations	<ul style="list-style-type: none"> We adjust prices to 2010 dollars using national headline CPI for the calendar year of the transaction² The residential price cutoffs work out to \$1054 for Alameda, \$794 for Contra Costa, \$1788 for Marin, \$1577 for Napa, \$2014 for San Francisco, \$1773 for San Mateo, \$1354 for Santa Clara, \$729 for Solano, and \$1260 for Sonoma, in 2010 dollars 	<ul style="list-style-type: none"> After applying all prior filters, adjust the remaining prices for CPI inflation Remove the top 0.1% of transactions by price per square foot, separately for each county

² http://www.bls.gov/data/inflation_calculator.htm

Appendix I. Sources and Definitions of Affordable Housing Data for Section 2E.2

In Los Angeles, we define affordable rental units as units with median gross rent of less than 80% of the county median; data comes from the 2000 Decennial census and the 2009-13 five-year ACS. For the Bay Area, we define these units as those where low-income households are paying less than 30% of their income on rent. Condo conversions include apartment units that have been converted to condos between 2003 and 2013. Data for Los Angeles comes from the Los Angeles County Assessor's office. Data on Section 8 units is derived from the U.S. Department of Housing and Urban Development's (HUD) Picture of Subsidized Households for years 2000 and 2013. Section 8 data from 2000 was adjusted to 2010 boundaries using Brown University's Longitudinal Tract Data Base's (LTDB) crosswalk. For Los Angeles, the LIHTC data comes from the California Tax Credit Allocation Committee (CTCAC). In the Bay Area, this data is derived from the California Housing Partnership Corporation that verified HUD and state Housing and Community Development (HCD) data and includes some non-LIHTC federally and state subsidized housing units (e.g., project-based Section 8). The placed-in-service variable was used to identify units constructed up to 2000 and 2014. Ellis Act evictions data, which primarily includes tenants evicted due to the conversion of rental units to condos, comes from the Los Angeles Housing Department and is only available for the City of Los Angeles. All units are normalized as fraction of the housing stock (divided by total housing units). The change represents the proportion after minus the proportion before.

Appendix J. Ground-Truthing Methodology for the SF Bay Area

Demographic and housing indicators associated with processes of residential displacement, and/or thought to influence susceptibility to such processes (Chapple 2009) were collected to each case study area. In addition to the secondary datasets, we used qualitative data that included archival research of newspaper articles, planning documents, and academic literature and interviews with community stakeholders based on questions regarding demographic, housing, and commercial change.

Blocks for the “groundtruthing” visual survey were selected by analyzing census Block data from 2000 and 2010 for demographic change, as well as data on sales, price increases, and new developments from 2010-2015 to determine property turnover and change. Eligible blocks were vetted with local stakeholders to narrow the candidates down to three to five that had experienced significant change over the past five to 10 years. The data gathered through this groundtruthing observation tool was subsequently compared to census figures and sales data from the county Assessor’s Office to verify, at a high level, the stories the secondary data and stakeholder interviews are telling about change in these areas.

We next present the observation tool developed for this groundtruthing exercise followed by detailed descriptions of each case study groundtruthing neighborhood and the results from comparing field observations with secondary data and interviews.

WORKSHEET: Visual Demonstration of Neighborhood Change

Instructions: Physically walk predetermined neighborhood blocks and note evidence of deterioration or improvement using Section One. Parcel or building specific information should be collected in Section Two. Each block should be named according to its main corridor (indicated on your map as the street with parcels on both sides). Bring a camera to take a photograph of each building. *One whole worksheet should be completed for each block section

Block Name: _____ Observer: _____
 Physical Observation date and time : ___/___/___ Start ___:___ AM/PM End ___:___ AM/PM

SECTION ONE: Block Overview and initial impressions

1. The primary land use for the block face is:
 Residential
 Commercial
 Institutional (school, hospital, churches):
 Industrial
 Other: _____

2. Public investment + existing public infrastructure:
 transit stops
 municipal street lighting
 on street residential permit parking
 street furniture (including parklets)
 bike racks
 public trash cans
 parking pay machines
 newly paved streets
 Other: _____

3. Describe any visible people, noting race or ethnicity, age, number, and activities they might be engaged in: _____

4. The # of signs discouraging disorder such as neighborhood watch, anti-littering/loitering/drug use/vandalism/graffiti: _____

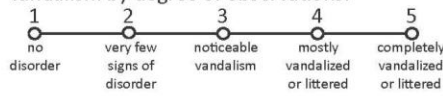
5. Physical disorder such as garbage, litter, graffiti, or vandalism by degree of observations:

6. Please describe indicators of international or immigrant presence (note ethnicity, signs in a foreign language, or locally-owned foreign/ethnic business).

7. Additional notes on block overview: _____

SECTION TWO: Block/Parcel Data

**located on the following pages*

Using your pre-printed parcel map, carefully walk the block and record your observations for each building. Allow for ~1.5 hours of field time. Be sure to take a photograph of each building for comparison with past year data later. 📷

APN/Parcel # _____	Street Address _____
<p>1. Does the building appear to be well-maintained?</p> <p style="text-align: center;"> <input type="radio"/> 1 <input type="radio"/> 2 <input type="radio"/> 3 <input type="radio"/> 4 <input type="radio"/> 5 <small>poor below average average above average new</small> </p> <p>2. The # of units the structure appears to have: _____ The # mailboxes _____ The # doorbells _____</p> <p>3. The # vehicles off-street vehicles present _____ <input type="checkbox"/> no off-street parking <input type="checkbox"/> existing driveway or parking lot <input type="checkbox"/> existing garage</p> <p>4. Notes on visible people, building, and outdoor space; incl. <i>implied</i> information about household size and composition: _____ _____ _____</p> <p>5. Building type and units: <input type="checkbox"/> Multi-family - apartment building <input type="checkbox"/> Multi-family - house <input type="checkbox"/> Single family - attached <input type="checkbox"/> Single family - detached <input type="checkbox"/> Mixed use <input type="checkbox"/> Public or subsidized project housing <input type="checkbox"/> Unknown, or other _____</p>	<p>6. Other building/occupant characteristics:</p> <input type="checkbox"/> Abandoned <input type="checkbox"/> For Sale sign <input type="checkbox"/> For Rent sign <input type="checkbox"/> Blinds or curtains - permanent <input type="checkbox"/> Blinds or curtains - temporary <input type="checkbox"/> Cracked windows <input type="checkbox"/> Bars on windows <input type="checkbox"/> Boarded windows <input type="checkbox"/> Dirty windows <input type="checkbox"/> Metal security door <input type="checkbox"/> Vegetable garden <input type="checkbox"/> New addition <input type="checkbox"/> New or maintained paint <input type="checkbox"/> New or updated front door <input type="checkbox"/> Ongoing renovation/construction <input type="checkbox"/> Fencing (<i>check all that apply</i>): New ___ Old ___ For safety ___ For aesthetics ___ <input type="checkbox"/> Security alarm signage <input type="checkbox"/> CCTV/Security cameras <input type="checkbox"/> Children/toys visible <input type="checkbox"/> Peeling/fading paint <input type="checkbox"/> Spraypaint/graffiti <input type="checkbox"/> Litter or debris <input type="checkbox"/> <i>Beware of Dog, Private, No Trespassing</i> signs <input type="checkbox"/> Signs of ethnicity

East Palo Alto

East Palo Alto is a small city in San Mateo County located about halfway between San Jose and San Francisco. With a population of about 29,000, East Palo Alto is bordered by the affluent cities of Palo Alto and Menlo Park. A young city, it was incorporated in 1983.

From 1980-2010, the case study area³ experienced several demographic changes:

- Population increased by 22%.
- Latinos increased from 14% to 63% of residents, while African-Americans decreased from 55% to 16% of residents.
- Housing cost burdens increased, from 25% of renters and 17% of owners being cost-burdened, to 51% and 49%, respectively.
- Overcrowding is a problem: 29% of housing units have more than one person per room.

East Palo Alto Ground-Truthing Results

On November, 14, 2014, two researchers from the UC Berkeley surveyed three blocks in the area: 2018, 4002, and 4003. On January 10, 2015, one of the same researchers, along with three community members, surveyed blocks 2002 and 5010.

At the parcel level, land use and number of units were very well-matched between assessor data and visual observation. The datasets also aligned in terms of level of investment and stability. One

³ Defined as census tracts 6118, 6119, 6120, and 6121, which cover the city in its entirety and encompass a small area outside it, as well.

thing not captured by secondary data but clear from visual inspection was a perceived lack of safety on most of the blocks.

There is not much variance among the blocks. Most have some sign of change—either high percent have sold, high percent have changed tenure, or property values appear to be rising—and also have signs of potential stability such as permanent curtains in the windows or children’s toys in the yard in addition to some signs of safety concerns.

Tables J.1-J.6 summarize secondary and ground-truthing data for the blocks; this data is analyzed below in the block-by-block comparisons.

Table J.1: Total Ground-Truthed Parcels for East Palo Alto

Block and Tract	# Parcels Ground-truthed
Block 2002, Tract 6119	38
Block 2018, Tract 6120	23
Block 4002, Tract 6121	8
Block 4003, Tract 6121	9
Block 5010, Tract 6121	21

Table J.2: Sales History and Assessed Value of Residential Parcels for East Palo Alto

Block	Median Year of Construction	Median Year of Last Sale	Percent Sold 2010-2014	Median Sale Price	Median Sale Price Per Square Foot	Assessed Value Per Square Foot (2013)
2002	1954	2006	28%	243,000	\$162.00	\$185.00
2018	1950	1999	33%	155,000	\$179.00	\$176.00
4002	1949	2010	88%	1,130,541	\$318.00	\$276.00
4003	1952	2010	82%	777,041	\$375.00	\$241.00
5010	1961	2010	68%	1,890,367	\$360.00	\$363.00
San Mateo County	1958	2001	16% ⁴	\$449,000	\$168	\$220

Source: Dataquick, 2014. These figures refer to all parcels in the area, including non-residential uses.

Table J.3: Assessor Data for East Palo Alto

Block	# Matched Parcels (2004-2014)	Average Change in Improvement to Land Ratio (2004-2014)	% Change Owner Occupancy (Rent to Own or Own to Rent, 2004-2014)	Average Change in Sq. ft. (2004-2014)
Block 2002	39	-11.7%	17.9%	1.8%
Block 2018	23	4.2%	21.7%	-2.2%
Block 4002	8	-30.3%	0.0%	1.7%
Block 4003	9	-49.1%	22.2%	2.4%
Block 5010	21	-36.7%	9.5%	2.4%

Source: Dataquick, 2014. These figures refer to all parcels in the area, including non-residential uses.

⁴ Percent Sold 2010-2013.

Table J.4: Census Data 2000 – 2010, East Palo Alto

Block	Population Growth (% change)	Average Household Size (% change)	Percent Change in Percent White	Percent Change in Percent Black	Percent Change in Percent Hispanic	Percent Change in Percent Family Households	Percent Change in Percent Rental Units
East Palo Alto	39.0%	-8.5%	1.8%	-9.0%	7.6%	-0.3%	8.6%
Block 2002	26.1%	0%	5%	-12%	14%	-5%	-20%

Source: Census, 2000-2010. Note: the missing blocks did not have consistent borders.

Table J.5: Census 2010 Demographics, East Palo Alto

Block	Population	Average Household Size	Percent White	Percent Black	Percent Hispanic	Percent Family Households	Percent Rental Units
2002	147	4.58	36%	18%	61%	82%	26%
2018	142	4.73	19%	6%	82%	90%	67%
4002	277	4.29	59%	8%	88%	73%	100%
4003	273	3.07	49%	5%	85%	62%	100%
5010	1434	2.92	36%	12%	68%	55%	100%

Source: Census, 2010.

Table J. 7: Summary of Parcel Matches and Primary Land Use, East Palo Alto

Block	Primary Land Use, based on Ground-truthing data	Percent Land Use Matched	Total Number of Units on Block		Percent of Parcels whose Number of Units match between Assessor Data and Visual Observation
			Assessor Data - Dataquick	Visual Observation Ground-truthing	
2002	Single-family residential	100%	39	44	100%
2018	Single-family residential	87%	28	34	96%
4002 & 4003	Multi-family residential	88%	200	155	94%
5010	Multi-family residential	90%	457	517	95%

Note: Percent Land Use Matched and Percent Units Matched take as their denominator only those parcels for which a land use or number of units was indicated by both assessor data and ground-truth data.

Comparison of East Palo Alto Data Analysis with Stakeholder Interviews

All of the case study tracts in East Palo Alto were lower-income; two were not losing low-income households, while two were had characteristic that were associated with gentrification and displacement outcomes identified in sections 2D and 2E, leading us to classify them as being at risk of gentrification and displacement.

Stakeholder interviews paint a slightly different picture. Of the three tracts east of Highway 101 (6118, 6119, 6120), stakeholder feedback indicates a greater risk than the secondary data presents of gentrification and displacement. There is concern, even with East Palo Alto’s strong renter protections, that the foreclosure crisis—which affected the many single-family owner-occupied

homes—and pressures in the surrounding areas could lead to gentrification or displacement in these areas. Plus, these renter protections are weakened in these areas since much of the housing is single-family homes, to which rent control does not apply.

In terms of the tract west of Highway 101 (6121), stakeholders described many issues that make them view this area as undergoing displacement, in contrast to what the secondary data may lead us to believe. This neighborhood is known as the Westside. Figure J.1 shows that the area contains the majority of the city's multi-family rental housing stock. Over half of the city's rent-controlled units are located on the Westside, the majority of which are owned by a single landlord, Equity Residential (EQR). In recent years, conflicts between tenant protections and landlord interests on the Westside have been the focus of major attention from the city, and led to significant instability for Westside residents. In 2008, Page Mill Properties, the former owner of the multi-family housing stock now owned by EQR, was involved in approximately 11 lawsuits with the city.

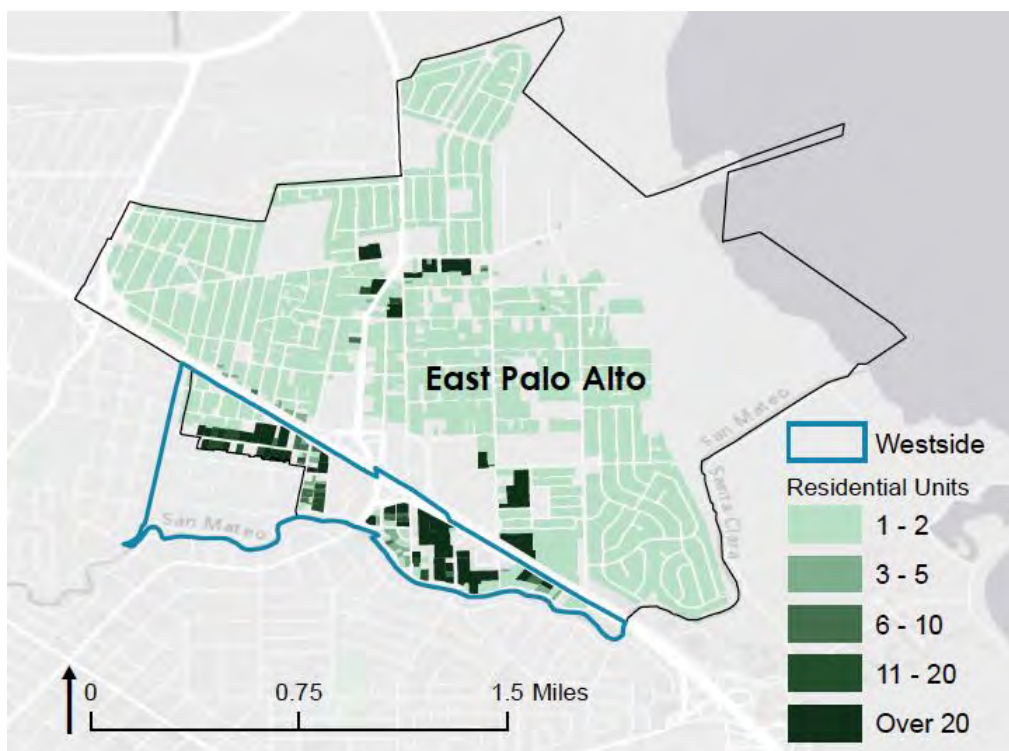

Figure J.1: Densities in East Palo Alto: Note the Westside Outlined in Blue

Just a year after Page Mill Properties began purchasing buildings in the Westside in 2006, tenants began complaining of harassment and steep rent hikes (Berstein-Wax 2010). In 2007 the company evicted 71 people. In 2008 another 99 people were evicted, an eviction rate 7.5 times greater than that of the rest of San Mateo County (Berstein-Wax 2009). When Page Mill defaulted on its loans and went into foreclosure in 2009, Wells Fargo took over the properties. The bank then sold the foreclosed portfolio to EQR, the largest publicly traded landlord in the United States, in December of 2011. After this acquisition, EQR now owns about half of the city's apartments, and two-thirds of its rent-controlled apartments and 15% of the total low-rent apartments in the County. The company issued 706 three-day eviction notices in the first six months of managing the apartments (LeVine 2014). Tenant organizers saw the excessive use of three-day notices as a form of harassment. It is

unclear however, how many of the eviction notices issued actually led to households leaving their apartments, and available sources of data are limited in this regard.

Direct evictions are also not the only pressure that residents of EQR apartments experience. The City of East Palo Alto was notified in 2013 that EQR was illegally painting curbs red in an effort to reduce parking around their buildings (Green 2013a). Advocates see this manipulation of parking supply, a precious commodity in East Palo Alto, as another form of harassment.

These issues in the Westside are not well-captured by secondary data. In this way, the ground-truthing exercise helps to illuminate other issues—either more recent than available data or just not captured in secondary data—that could be leading to displacement.

Conclusion

East Palo Alto is distinctive for its government’s commitment to ensuring the city remains affordable to low-income households, and for a strong legacy of community organizing that holds the city accountable to that commitment. While demographic data on its own shows few signs of gentrification and displacement, the experience of residents, activists, and city staff on the ground, show that housing pressure is very real here. The city is home to many low-income households already burdened by their housing costs, a vulnerability that is compounded for the large number of undocumented immigrants believe to have established households here. With much of the city’s rental housing owned by a single landlord, there are few alternatives for tenants facing evictions.

Marin City

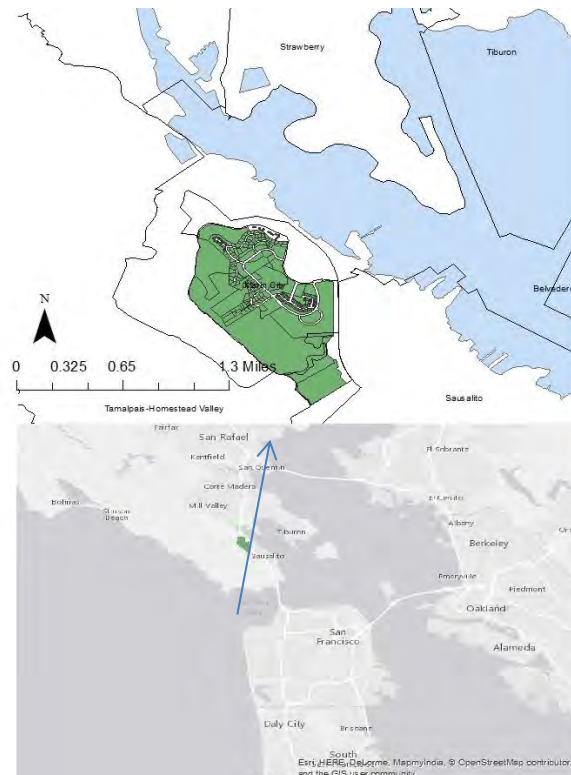

Figure J.2: Marin City Case Study Area (Census Tract 1290) in Green, with Vicinity Map

Marin City, located north of San Francisco in Marin County, is a small, historically African-American suburban community. It is bounded by the affluent cities of Sausalito to the south and Mill Valley to the north, Highway 101 to the east and the hills of Marin County to the west (Figure J.2). The entire area is quite small—it is only 1.2 miles across. It hosts high-rise public housing, townhouses, single-family homes, and a shopping center, all with a suburban feel and views of the Bay. The area is also host to older homes occupied by a diverse population in the hills and a significant stock of subsidized housing—604 units. Nearly half of these are in a collection of high-rise buildings called Golden Gate Village, which feature great views out on to Richardson Bay, a small inlet of the San Francisco Bay.

Over the last 30 years, Marin City has experienced gradual change: population has grown, the proportion of African-Americans has decreased, and median income and educational attainment have increased. Yet even with these changes, other aspects of the community—like homeownership—have remained stable. While the area has been stable in its housing stock overall, it has experienced significant commercial displacement: for instance, a popular weekly flea market was discontinued in 1996 when a large shopping center was developed.

Marin City Ground-Truthing Results

On November 11, a researcher from UC Berkeley performed the ground-truthing analysis in Marin City (see selected blocks, Figures J.3). The researcher walked the blocks there with a lifelong resident, and a former resident who directs a community organization.

The secondary data sets and ground-truthing data tell the same basic stories for each block. Parcels generally matched in terms of land uses and number of units, and the total number of units was fairly consistent across three data sources (Table J.7).

Finally, the quality and age of buildings were comparable between secondary sources and ground-truthing methods; however, safety perception and public investment cannot be ascertained from the secondary data sources; only from ground-truthing. Tables J.7-J.10 summarize the secondary and ground-truthing data that are used below in block-by-block comparisons.



Figure J.3: Map of Marin City with Three Ground-Truthing Blocks in Green
Note: All of the blocks fall in Marin County Census Tract 1290.

Table J.7: Parcel Mismatch among Datasets for Marin City

Block	# assessor parcels matched to ground-truth parcels, of total assessor parcels	# ground-truth parcels matched to assessor parcels, of total ground-truth parcels
1000	31 / 54	32 / 33
1004	38 / 50	38 / 49
1005	33 / 34	34 / 34

Table J.8: Sales History and Assessed Value of Residential Parcels in Marin City

Block	Median Year of Construction	Median Year of Last Sale	Percent Sold 2010-2013	Median Sale Price	Median Sale Price Per Square Foot	Assessed Value Per Square Foot (2013)
1000	1965	2005.5	30%	\$396,000	\$286	\$219
1004	1997	2001.5	20%	\$245,750	\$163	\$195
1005	1996	2000.5	26%	\$229,000	\$154	\$197
Marin City	1979	2002.5	21%	\$287,500	\$207	\$193
Marin County	1973	2003	22%	\$552,000	\$307	\$258

Source: Dataquick, 2014

Table J.9: Indicators of Marin City Neighborhood Change: Census Data/Demographics, 2000-2010

Block	Population Change (Percentage Change)	Average Household Size (Percentage Change)	Change in Percent White ⁵	Change in Percent Hispanic	Change in Percent Black	Change in Percent Family Households	Change in Percent Rental Units
1000	-24%	1%	55%	1085%	-33%	-11%	-5%
1004	62.6%	33%	407%	1715%	-71%	21%	-15%
1005	-85.7%	-15%	16%	-55%	-11%	3%	-74%
Marin City	-6%	Not Available	-25%	88%	0%	11%	17%
Marin County	2%	1%	-7%	40%	-7%	1%	3%

Note: Marin City is defined as Marin County Census Tract 1290. Source: US Decennial Census 2000, 2010

Table J.10 Summary of Parcel Matches and Primary Land Use in Marin City

Block	Primary Land Use, based on Ground-truthing data	Percent Land Use Matched	Total Number of Units on Block			Percent of Parcels whose Number of Units match between Assessor Data and Visual Observation
			Assessor Data - Dataquick	Visual Observation Ground-truthing	Census Data: Total Housing Units - 2010	
1000	Single-family residential	74%	81	71	87	65%
1004	Single-family residential	97%	105	104	133	95%
1005	Single-family residential	88%	32	34	33	100%

Note: Percent Land Use Matched and Percent Units Matched take as their denominator only those parcels for which a land use or number of units was indicated by both assessor data and ground-truth data.

Comparison of Marin City Data Analysis with Stakeholder Interviews

Marin City is a low-income tract that is not losing low-income households, nor does it have many risk factors for gentrification or displacement. The area’s ability to preserve its low-income population is likely related to the significant public housing stock in the city, host to nearly a third of the city’s residents, plus several other subsidized housing projects that bring the total number of subsidized units to 604—over half of the rental stock (*Department of Housing and Urban Development, 2014a*).

⁵ Note: For the blocks, this figure refers to all whites of one race, including those that are Hispanic. For the Marin City and Marin County figures, it refers to Non-Hispanic whites. The “Percent Change” figures all compare percentages over time; for example, in Marin City, the percent Non-Hispanic white in 2000 was 34%, which decreased to 25% in 2010—a -25% change.

However, stakeholder interviews paint a different picture of the neighborhood. Residents are very concerned that the public housing, situated on a hill with views of Richardson Bay, will be demolished in favor of private development, according to a long-time community organizer in the neighborhood. Other residents, interviewed on the street in front of their homes, commented that the population has been remarkably stable in the last 10-15 years.

Conclusion

While there is some variation among the secondary datasets, ground-truthing, and stakeholder interviews, these data sources tell very similar stories about the neighborhood overall. Even where they diverge the most the two can be reconciled by saying that the neighborhood, though stable in recent years is vulnerable to displacement (captured in residents' concerns about losing public housing units).

The Mission District

The Mission District is located in the southeastern region of San Francisco and is home to almost 52,000 of San Francisco's approximately 818,000 residents. Since the 1950s, the neighborhood has been San Francisco's Latino enclave. From 1980 to 2013, a period that has included two tech booms, the cost of living and of housing has risen dramatically in the Mission, which led to the displacement of long-time residents. During this time, the Mission District lost much of its industrial sector (Casique 2013).

Since 1980, the area has seen significant shifts in racial composition (a decrease in Latinos and increase in whites), proportion of family households (decreased), educational attainment (toward more highly educated people), median income (increasing), and rents (increasing)—all indicative of gentrification.

New residents were—and are still—attracted to the amenities provided by higher density, the cultural richness of the neighborhood, and transit access. Multiple bus lines as well as two BART stations (16th Street and 24th Street Mission Station) service the neighborhood for an easy commute to the financial district. The neighborhood is also close to the freeway and Caltrain, which provide accessibility to the greater region, including Silicon Valley.

Mission District Ground-Truthing Results

On November 14, 2014, a researcher from UC Berkeley Center, a community organizer, and a consultant with deep knowledge of the area walked four blocks in the Mission District (Figure 2H.8). Tables J.11 and J.12 describe the blocks using census data: Blocks 3003 and 1004 stand out in terms of real estate transactions and sales prices, while Block 1007 has seen rapid gains in the white population, and all of the blocks have experienced declines in average block size.

Of the sample blocks' 193 parcels recorded in the assessor dataset, field researchers were able to match 73% of these parcels on the ground. Of parcels for which the land use was indicated in assessor data and verifiable through ground-truthing, 87% matched. The total number of units on the four blocks ranged from 319 according to assessor data, to 421 according to ground-truthing, to 431 according to the Census.

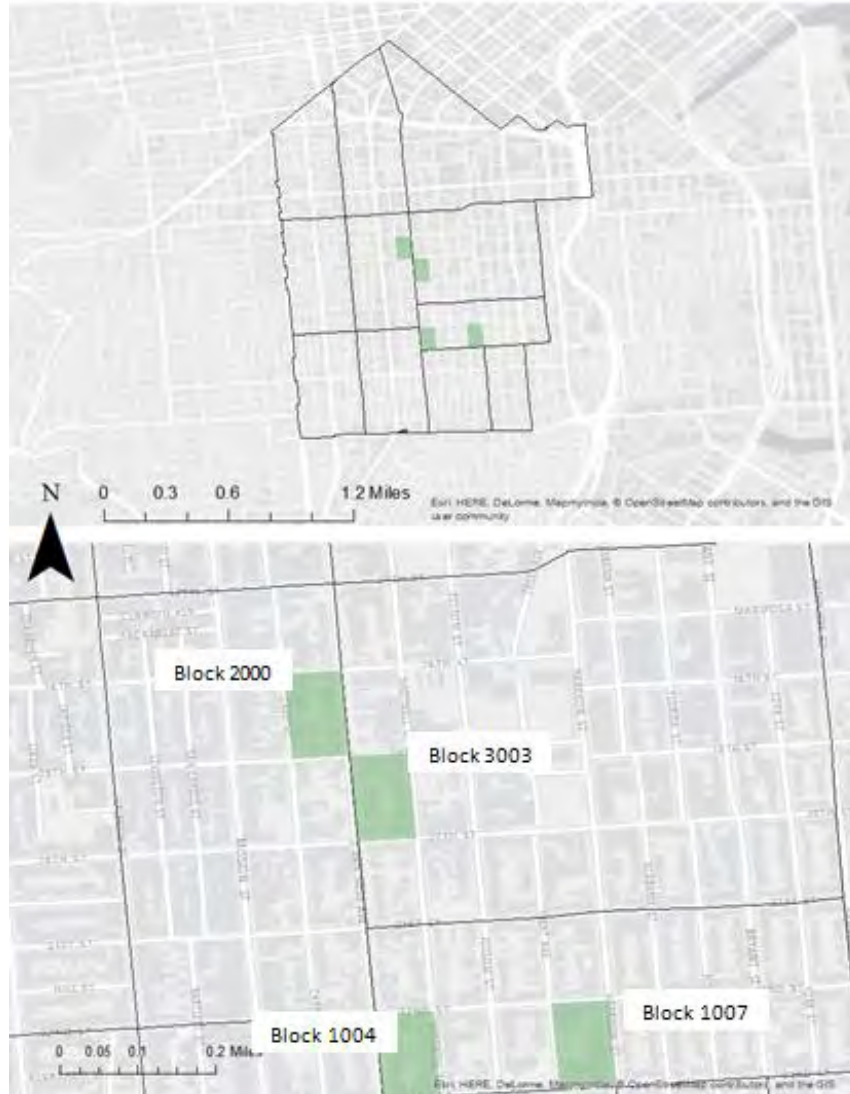

Figure J.4: Map of Mission District, with census tracts, and Four Ground-Truthing Blocks in Green

Table J.11 Sales History and Assessed Value of Residential Parcels in the Mission District

Block	Median Year of Construction	Median Year of Last Sale	Percent Sold 2010-2014	Median Sale Price	Median Sale Price Per Square Foot	Assessed Value Per Square Foot (2013)
3003	1985	2005	29%	\$578,500	\$491	\$465
2000	1903	1999	19%	\$697,500	\$256	\$205
1007	1933	2004	23%	\$925,000	\$216	\$161
1004 ⁶	1904.5	2007.5	42%	\$785,000	\$366	\$221
Mission	1912	2004	20%	\$585,000	\$314	\$235
SF	1932	2003	21%	\$520,000	\$337	\$277

Source: Dataquick, 2014. These figures refer to all parcels in the area, including non-residential uses.

⁶ Assessed value would likely be higher if the assessor data included new condominium buildings on the block.

Table J.12 Indicators of Neighborhood Change: Census Data/Demographics in the Mission District (Percentage Change From 2000–2010)

Block	Population	White Population	Asian Population	Hispanic Population	Average Household Size	Family Households
3003	-5%	14%	-22%	-11%	-13%	-12%
2000	-7%	-9%	-12%	-25%	-19%	-12%
1007	81%	111%	1 to 8 residents	-28%	-46%	7%
1004	-11%	19%	21%	-30%	-15%	-26%
Mission	-5%	16%	7%	-21%	Not available	40%
SF	4%	-2%	12%	11%	-2%	4%

Source: Decennial Census 2000 and 2010, accessed through NHGIS.

For each block, the total number of units based on three different datasets vary widely, as do the listed number of units for each parcel. Land uses, on the other hand, match fairly well on each block. These results suggest that some error may exist in either the census or assessor’s reported count of housing units and unit type, likely due to rapid or un-permitted changes to parcels. However, even with these discrepancies, the ground-truthing exercise confirmed the overall story of this neighborhood as one that has experienced and is still undergoing major gentrification and displacement.

Broadly, the secondary datasets and ground-truthing data paint similar pictures of change on these four blocks. Where the assessor data is ambiguous or reveals a mix of forces, as with Block 1004, so does the ground-truthing data. On one block (3003), the data sets align in terms of the broad story, but the ground-truthing takes the narrative deeper and reveals significant public investment and continued concerns about safety.

Block 1007 provides a cautionary example. On this block, the assessor dataset was missing a large number of parcels, most of them in two new condominium buildings. Without ground-truthing the block, we would have missed the major impact these buildings have on the feel of the street, and their implications for gentrification in the area. The block is a good example of a place in transition: running through its center is a relic of the area’s former industrial character, in the form of a warehouse and some older, poorly-maintained buildings; yet, at the same time, there are several better-maintained homes, two new high-priced condominium buildings, and a new, well-used and well-maintained park.

In terms of comparing datasets, unmatched parcels were a concern for three of four blocks; the number of units recorded per parcel usually did not match (Table J.13). This could be related to the high incidence of condominiums, and the rapid change in the area. On the other hand, when it came to land uses, there were consistent matches between ground-truthing and assessor data.

Table J.13: Parcel Mismatch among Datasets in the Mission District

Block and Census Tract	# assessor parcels matched to ground-truth parcels, of total assessor parcels	# ground-truth parcels matched to assessor parcels, of total ground-truth parcels
Block 3003, Tract 228.01	65 / 81	66 / 70
Block 2000, Tract 208	26 / 55	28 / 31
Block 1007, Tract 228.03	12 / 16	12 / 87
Block 1004, Tract 228.03	37 / 41	39 / 39

Most of the mismatch is not significant enough to skew results; however, three areas of discrepancy are significant. On Block 3003, 15 of the parcels in the assessor data did not appear in the ground-truthing geographic dataset. On Block 2000, 29 of the 55 parcels in the assessor data did not appear in the geographic data set. Finally, on Block 1007, almost all of the parcels from the geographic dataset did not appear in the assessor data. This is primarily the result of the Dataquick data missing over 40 parcels for one building (3000 23rd St.). Although it has many parcels, Dataquick lists it as having only one, with the use listed as an apartment building. Likewise for another building (2652 Harrison St.), while it has 20 parcels/units (condominiums, in this case), according to the geographic ground-truthing data, Dataquick lists it as a single parcel. This is almost definitely a glitch in the data or possibly a condo-conversion process that happened after 2013.

For two variables—land use and number of units—comparisons are made on a parcel-by-parcel basis; only parcels that appear in both datasets are used for this comparison (Table J.14).

Table J.14: Summary of Parcel Matches and Primary Land Use in the Mission District

Block	Primary Land Use, based on Observations	Percent Land Use Matched between observation & Assessor	Total Number of Units on Block			Percent of Parcels whose Number of Units match between Assessor Data and Visual Observation*
			Assessor Data - Dataquick	Visual Observation Ground-truthing	Census Data: Total Housing Units-2010	
3003	Residential: 50% condo, 21% multi-family	87%	81	134	121	44%
2000	Residential: 42% multi-family, rest condo and single-family	96%	100	85	121	38%
1007	Residential: condo, multi-family	71% (denominator is 7)	32	96	78	38% (denominator is 12)
1004	Residential: 45% multi-family, 38% condo	86%	106	106	111	32%

**Note: Percent Land Use Matched and Percent Units Matched take as their denominator only those parcels for which a land use or number of units was indicated by both assessor data and ground-truth data.*

The uses on the blocks vary: former industrial sites share the block with new condominium developments; unmaintained townhouses sit next to recently-renovated townhouses with expensive improvements; expensive cafes and grocery stores have opened next to long-time, low-cost diners.

All four blocks are mostly residential, with a mix of single-family homes, multi-family rental buildings, and condominium buildings, which are usually newer. There are a few non-residential uses on each block, including some light industry, stores, offices, and one church. Most structures are older, though there are some very new buildings. The neighborhood is diverse in terms of socioeconomic status (judging by the range of businesses) and race (judging by the signs in Spanish posted in a laundromat and observations of pedestrians).

Conclusion

Stakeholder interviews, secondary data sources, and visual observations of the Mission are all aligned in telling the same story of a neighborhood experiencing ongoing change of gentrification that began nearly two decades ago. Advocates in the community discussed the historical and ongoing influx of new residents and displacement of low-income people, as well as extensive community organizing and resistance in the face of such changes. Where the datasets diverge is in the number of units in each parcel and on each block (though land uses match well between visual observation and assessor data); even this divergence is consistent with what we know about the Mission: it has experienced rapid change that secondary data has not picked up yet.

Appendix K. Los Angeles Ground-Truthing Neighborhoods

Table K.1 provides a profile of the three case study areas, and how they compare with the TOD and County averages.

Table K.1: Profiles of Case Study Areas in Los Angeles Ground-Truthing

	Chinatown	Hollywood/Western	103rd/Watts Towers	All TOD average	County average
Income (2013)	34,088	45,600	40,376	51,471	81,416
Change in income 90-2013	-14%	-10%	13%	9%	-5%
Change in income 00-2013	-13%	-1%	-9%	7%	-6%
Change in income 90-00	-1%	-9%	24%	2%	1%
Largest race/ethnic group	Asian	White	Hispanic	Hispanic	Hispanic
Not Hispanic White (NHW)	9%	48%	1%	15%	28%
% point change in NHW	1%	-1%	0%	-3%	-13%
# HH	2,700	9,937	2,894	4,329	N/A
% HH with Child	29%	19%	56%	30%	37%
% Renter	93%	94%	63%	81%	53%
% Moderately Burdened (30%-50%)	26%	22%	25%	27%	26%
% Severely Burdened (50%+)	27%	37%	42%	31%	30%
Ellis Act Evictions 2007-2014	4	6	0	11	
Condo Conversions	0	11	0	44	
Jobs/Housing Balance	3.45	0.78	0.53	3.76	
# Businesses	1,101	1,338	266	1,536	
# Churches	18	19	28	20	
# HS Nonprofits	13	13	11	13	
Yearly Station Traffic Volume (All Boardings and Alightings)	1,119,344	3,327,704	1,178,918	2,723,794	
SNAP	Yes	Yes	Draft		

Source: Tabulated by authors from the 1990 and 2000 Decennial Censuses and the 2009-2013 American Community Survey; NCCS database on non-profits; Longitudinal Employment-Household Dynamics (LEHD) datasets; and data on ridership from Metro.

Chinatown (Gold Line)

The Chinatown Metro rail station is an elevated light-rail stop located at North Spring Street and College Street in the Chinatown neighborhood of downtown Los Angeles. The station opened in 2003 as an eastern extension of the Gold Line, connecting Pasadena, Downtown Los Angeles, and East Los Angeles. The Chinatown neighborhood is the result of the construction of the nearby Union Station in the 1930s, which forced residents to migrate north from what was originally considered Old Chinatown to the current location of New Chinatown. Confined in an ethnic enclave by legislation and racial backlash, many Chinese merchants developed family-owned, self-sustaining

“mom and pop” stores to survive within their community. Today, many small businesses and local merchant shops in Los Angeles Chinatown continue to thrive catering to the shopping needs of local residents but also as tourist destinations for many visitors.

Although Chinatown today is characterized as a multiethnic neighborhood, it is still majority Asian. Other ethnic groups whose members live there include Latinos, blacks, and whites. Nearly all the households (93%) are renters, with about 53% experiencing rent burden. The median household income in 2013 was a little more than \$34,000.

Our model identifies this area as having a high potential for gentrification. In addition, community groups believe that the area is at “high risk” of gentrification as they see the neighborhood experiencing a wider transformation, including the loss of traditional businesses⁷, and the offering of new housing options, public services, and activities that are inconsistent with the historical identity of this neighborhood. While the area is changing, it is not clear if the TOD is driving the changes. So far, there are few formal venues for CBOs to directly influence TOD planning and efforts in Chinatown.

Hollywood Blvd./Western Blvd. (Red Line)

The Hollywood Blvd./Western Blvd. Metro rail station is a heavy-rail subway station located in East Hollywood situated below grade. It opened in 1999. It is the only heavy-rail line in the case study areas and the one with the highest ridership. Hollywood/Western has one ground level entrance/exit with two subterranean levels. The station does not offer parking. The Hollywood/Western neighborhood is one of the most densely populated areas in the city and is located in the central region of Los Angeles. Beginning in the 1960s, many immigrants from around the world —East Asia, Latin America, the former Soviet Union, and the Middle East—settled there and formed communities. Each community continues to leave its mark on this neighborhood. Whites still make the largest racial group in the study neighborhood. East Hollywood was affected by the 1992 Los Angeles Riots and also sustained significant damage in the 1994 Northridge earthquake.⁸

Ninety-four percent of the residents here are renters in multi-family buildings. A high percentage of renters (about 59%) are burdened by the cost of housing, with renters spending at least 30% of their income on rent. The median household income in 2013 was \$45,600, about 55% of the county’s average.

The area is also known for the Barnsdall Art Park and Los Angeles Community College, and is considered one of Los Angeles’ largest hospital districts. Model results indicate that this area has a high potential for gentrification. The Hollywood/Western TOD is also part of the Vermont/Western Transit Oriented District Specific Plan (SNAP), implemented two years after the station opened. The SNAP offers a formal mechanism for community engagement and a means for CBOs to influence development.

103rd St./Watts Tower (Blue Line)

⁷ The 2013 State of Los Angeles Chinatown report provides insight into job concerns and is available at <http://www.aasc.ucla.edu/research/pdfs/statect.pdf>. Numerous news articles also document changes in the area; for instance, see: http://www.ladowntownnews.com/news/with-jia-chinatown-gets-a-million-apartment-complex/article_9fc95a96-a0d4-11e3-b308-0019bb2963f4.html

⁸ East Hollywood Neighborhood Council. (2015). The history of East Hollywood. Retrieved May 3, 2015, from <http://www.easthollywood.net/history>.

The 103rd St./Watts Tower Metro rail station is a light-rail station located at grade level at the intersection of 103rd St and Grandee Ave. in Watts in South Los Angeles. The station opened in 1990 and is the oldest of the case studies. The Watts area is a largely-residential commuter district, about 13 miles south of the downtown central business district and away from other large employment areas. Annexed by the City of Los Angeles in 1926, the area gained an African-American majority in the 1940s as a result of the Great Migration. The neighborhood suffered through the Watts uprisings in 1965, and a wave of gang-related violence arose in the following decade that lasted until the early 2000s, but has since subsided (Empower LA 2015). Presently, the area has a Latino majority (74%), with African-Americans retaining a significant minority at 25%.

Though the area has the lowest percentage of renters relative to the other case studies (at about 63%), it also has the greatest share of burdened renters (at 67%). The median income was \$40,376 in 2013, less than half of the county average (at \$81,416). Additionally, 103rd St./Watts has a low job-to-housing balance at only 0.53 jobs per resident employees. This means that residents in Watts commute outside of Watts to work, and that the area is more residential than commercial.

For years a disinvested and poor African-American neighborhood, Watts has experienced significant demographic transition in the last decades and is now predominately Latino. The gentrification model shows this area as undergoing little change. There has been an ongoing desire to promote local economic development by the public and private sector in the wider South Los Angeles area.⁹

⁹ The 2014 Watts Community Studio report provides insight into priorities of residents and public officials. See <http://wattscommunitystudio.files.wordpress.com/2014/01/wcs-final-report.pdf>. Talks of private investment include the opening of local eateries, among other activities. For instance, see: <http://la.eater.com/2015/1/20/7861851/roy-choi-locol-opening-watts-south-la-twitter>

Appendix L. Detailed Ground-Truthing Methodology for Los Angeles

Street and Census Blocks

Census blocks were selected by their proximity to the rail station regardless of land use or transaction activity. The boundaries for most census blocks coincided with street block segments. The groundtruthing exercise involved walking through the case study neighborhoods and documenting visual observations on each block. Researchers photographed each block and parcel of interest to supplement the findings.

Block-level evaluations aimed to capture indicators of gentrification on the street blocks surrounding the Metro rail stations. Surveyors assessed each block for:

Observable land use (e.g., single-family residential, commercial retail, institutional)

Visible public infrastructure (e.g., pedestrian lighting, bus shelters, bike infrastructure)

Characteristics of individuals and the observed level of diversity present on the block (e.g., age, race, gender)

- Physical disorder (e.g., graffiti, litter, neighborhood watch signs)
- Indicators of ethnic commercial presence (e.g., signs, goods, businesses)
- Signs of commercial gentrification (e.g., upscale coffee shops, yoga studios and other upscale recreational facilities, recent renovations)
- Signs of residential gentrification (e.g., new construction, recent renovations, upscale landscaping)

Indicators of commercial gentrification surveyed included specialty, high-end, or boutique stores and restaurants. Signs of residential gentrification included new construction, conspicuous or recent renovation of buildings (such as new paint, doors, windows, or patios), upscale landscaping or xeriscaping, and the presence of luxury or “green” vehicles parked in the driveway or on the street. The team selected these indicators after consulting with the UCLA research team and UC Berkeley research team that completed prior groundtruthing at San Francisco Bay Area transit stations.

Parcels

We identified parcels located on blocks with high rates of property activity compared to the nearby blocks. Using County Assessor data from DataQuick, we mapped parcels with new construction, renovation, or sales to single-family homes, multifamily buildings, and commercial properties between 2008 and 2013. We then identified the average number of parcels per block that experienced transactions during the five-year period. Any block within a half-mile radius of the station that exhibited a higher-than-average rate of property activity was included in the sample. For example, if the average number of parcels experiencing change in a station area was 15%, then any block in which more than 15% of parcels experienced change and which are fully within the half-mile boundary were included in the groundtruthing sample. Within each selected block, we visited parcels which met the described criteria to perform parcel-level inventory of building characteristics. This visual analysis included descriptions of:

- Building type (e.g., single-family, multi-family, strip mall)

- Building signs and markings (e.g., for sale, for rent, eviction notices)
- Occupancy status (e.g., occupied, not occupied, unable to judge)
- Building characteristics (e.g., newly constructed, older building and renovated, older building and not renovated)
- Overall building appearance (e.g. below average, average, above average)
- Physical appearance relative to its surroundings (e.g., roughly consistent, out of place and higher-end, out of place and lower-end)
- Physical signs of residential/commercial gentrification (e.g., new construction, recent renovations, upscale landscaping)

The instrument also accounted for signs of commercial gentrification, which include new construction, notable renovation, upscale landscaping, and upscale store frontage. Photographs supplemented these written observations. The instruments are included in Appendix II. The following survey documents are found in the appendices:

- Groundtruthing instruction sheet
- Block groundtruthing form
- Residential parcel groundtruthing form
- Commercial parcel groundtruthing form
- UCLA consent letter

Challenges

The research team experienced a number of challenges, including surveyor subjectivity, inconsistent numbers of cases between study areas, and sampling limitations. While in the field, it was difficult to consistently evaluate whether or not a building or parcel condition could be objectively considered as average, slightly below average, or slightly above average. Furthermore, working with a team of researchers increases the chance of discrepancy. To overcome this challenge, we beta-tested the instrument and at least two researchers groundtruthed each neighborhood to ensure consistency and to identify inconsistencies. In designing the survey, the research team expected observations of residents to be useful in observing changes to the neighborhood; however, the researchers observed very few residents, particularly in residential neighborhoods. For this reason, this study is complemented by Census data and surveys of transit and business users.

In conducting parcel-level analysis, researchers visited parcels that had been sold or substantially rehabilitated in the past five years, as determined by sales records, permits, and visual observations during fieldwork. The number of property sales varied dramatically between case study neighborhoods. In areas with relatively few transactions the research team selected any parcel that met the parcel selection criteria. Nonetheless, at least fifteen parcels are included for each station area, providing a sufficient sample to evaluate trends.

Estimated Units

Another challenge is that the Assessor's parcel data has incomplete information on the number of units in a given parcel. We complemented the Assessor information by using the land-use code to estimate the number of units. A single family residence was counted as one unit. We then identified condo units and constructed the number units for these using the second character of the property use code. We followed a similar process for multi-family units as we did for condos. We also estimated the number of estimate the number of units for parcels with use code 05 (five or more units) by dividing the building's square foot by 900 (900 is the average square feet per unit in LA). We compared the estimated numbers to those reported by DataQuick, which also has missing information on unit counts. The results are similar. See Figure L.1 below.

As the number of housing units in a TOD area increase, so does the discrepancy between census housing units and parcel estimates. One reason may be temporal, that is inconsistencies in year for the various datasets. We also use an average size of a unit across all areas to estimate the number of units for a given parcel; however, certain neighborhoods may have homes with significantly greater or smaller area footprint.

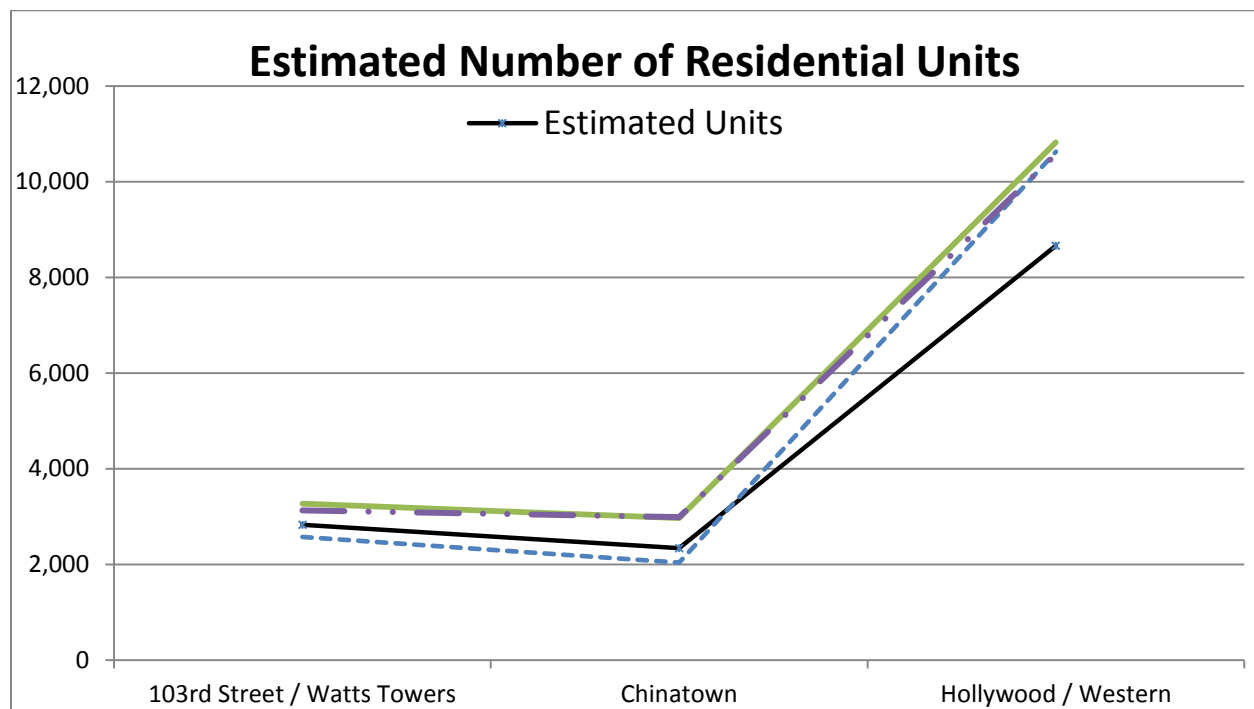

Figure L.1: Comparison of Estimated Units with Different Data Sources

Appendix M. Survey Instruments in Los Angeles

Groundtruthing Instruction Sheet

UCLA TOD Project*

Visual Observations of Neighborhood Change and Gentrification

MATERIALS:

Camera
Smartphone with a compass
UCLA informational letter
Clipboard and pen(s)
Name badge with UCLA logo
Parcel map with directions on where to survey

DRESS CODE: Please dress appropriately for conducting fieldwork as you are representing UCLA.

UCLA gear (no headgear including beanies, hats, visors, etc.) is optional
No shorts or short skirts
No offensive graphics or words
Comfortable shoes for long periods of walking and standing

INTRODUCTION: The purpose of this “groundtruthing” instrument is to gauge whether there are visual signs of neighborhood change that indicate gentrification. Some of the observations are subjective; therefore, it is important to go through training prior to conducting fieldwork.

Provide the following information to any person who asks about your observation activity:

“I am a graduate student in UCLA’s Urban Planning program. I am conducting a visual inventory of this neighborhood as a part of a project to study changes and development around transit stations. The information will be used to inform public agencies, community groups and other interested parties about these changes with the goal of enhancing neighborhood quality and ensuring that all stakeholders benefit.”

Please note that there are **three distinct forms** to note your observations (street segments, and residential parcels and commercial parcels).

INSTRUCTIONS:

Physically walk predetermined neighborhood blocks and note evidence of gentrification and improvement relative to other uses using **Section One**. Parcel or building specific information should be collected in **Section Two**. Each block should be named according to its main corridor (indicated on your map as the street with parcels on both sides).

Bring a **camera** (could use your smart phone camera if it produces decent images). **Code each block** and each **parcel** on the map with its own unique number, and include these numbers on the worksheets that you fill out. **Using compass** on smartphone, stand perpendicular to street segment and note the direction of the street (north, south, east or west).

One whole worksheet should be completed for each block section

Allow for ~1.5 hours of field time.

SECTION ONE: STREET SEGMENT OBSERVATIONS

The purpose of the street segment observations is to assess the characteristics and appearances of street segments. If possible, take photographs relevant to gentrification (e.g., images of older and more established buildings, businesses, and residents; images of newer buildings, businesses, and residents); list addresses for possible later comparison with historical images from Google Street View.

SECTION TWO: PARCEL OBSERVATIONS

The purpose of the parcel observations is to assess the characteristics and appearances of parcels. Using your pre-printed parcel map, carefully walk the block and record your observations for each assigned parcel and building. Use the appropriate form (residential and commercial). Be sure to take a photograph of the assigned buildings.

* Developed by Paul Ong with Silvia Jimenez, Anastasia Loukaitou-Sideris, Karolina Gorska and students from the 2015 Urban Planning Comprehensive Project for the study “Developing a New Methodology for Analyzing Potential Displacement.”

Block Groundtruthing Form

Block Name/Number: _____ Direction: _____ Parcel Number: _____ Location: _____
 Observer: _____ Physical Observation Date: _____ Start Time ____: ____ AM/PM End Time ____: ____ AM/PM

SECTION ONE: STREET SEGMENT OBSERVATIONS

1. Rough proportion of block face is (10% increments):

- Single Family Residential _____%
- Multifamily Residential _____%
- Retail _____%
- Commercial (Office Building) _____# _____%
- Institutional (school, hospital, religious): _____# _____%
- Industrial _____%
- Mixed use _____%
- Vacancies: _____%
- Other: _____

2. Existing public infrastructure:

- Bus stop shelter
- Pedestrian street lights
- On-street residential permit parking
- Street furniture (e.g. benches, parklets)
- Bike infrastructure (racks, lanes, etc)
- Public trash cans
- Parking meters
- Newly paved streets and sidewalks, traffic calming
- Other: _____

3. Describe any visible people

- How busy _____
- Dominant activity _____
- Dominant ethnicity _____
- Dominant age group _____
- Dominant gender _____
- Dominant life style _____
- Other: _____

4. Extent of visual social diversity (low, medium, high)

- Race/ethnicity _____
- Socioeconomic class _____
- Age _____
- Gender _____
- Social grouping (family, couples, friends, alone) _____
- Other: _____

5. Physical disorder such as garbage, litter, graffiti, or vandalism by degree of observations (circle 1-5):

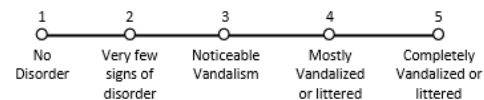

6. Signage discouraging/controlling disorder

- Neighborhood watch
 - Anti-littering/graffiti
 - Anti-loitering/drug use/vandalism
 - Anti-trespassing
 - Other: _____
- Prevalence: Rare Few Noticeable

7. Describe indicators of ethnic commercial presence:

- Non-English language signs
 - Signs of ethnic business
 - Signs of ethnic goods
 - Signs of ethnic institutions (school, hospital, churches): _____
 - Other: _____
- Prevalence: Rare Few Noticeable

8. Signs of commercial gentrification (trendy, high-end or upscale, boutique)

- Specialty coffee shops, bars, restaurants
 - Boutique stores
 - Yoga studios and similar recreational facilities
 - High-end grocery stores (e.g., Whole Foods, TJ)
 - Artsy spaces: _____
 - Other: _____
- Prevalence: Rare Few Noticeable

9. Diversity of commercial activities

- Predominantly older, well-established stores
 - Small majority of older, well-established stores
 - about an equal number of older and newer stores
 - Small majority of newer stores catering to gentrifiers
 - Predominantly newer stores catering to gentrifiers
- Comments: _____

10. Physical signs of residential gentrification

- New construction
 - Recent renovation to unit(s)
 - Upscale landscaping (e.g., fencing)
 - Upscale /luxury and "green" vehicles
 - Other: _____
- Prevalence: Rare Few Noticeable

11. Physical signs of commercial gentrification

- New construction
 - Recent renovation to unit(s)
 - Upscale/trendy landscaping (e.g., patio furniture, plant type)
 - Upscale/trendy store front
 - Upscale/trendy signage, ads, displays
 - Other: _____
- Prevalence: Rare Few Noticeable

12. Describe public art and aesthetics: _____

14. Additional notes on block overview (e.g., small dogs, dog waster bags): _____

Residential Parcel Groundtruthing Form

Observer: _____ Physical Observation Date: _____ Start Time ____:____ AM/PM Station: _____

SECTION TWO: RESIDENTIAL PARCEL OBSERVATIONS

APN/Parcel # _____ Street Address _____

- Building type and units:
 - Single family 2-4 multifamily
 - Non-residential 5 or more multifamily
 - Unable to judge: _____
- Occupancy status
 - Occupied
 - Partially occupied: _____
 - Not occupied:
 - Signs of abandoned: Yes No
 - Unable to judge: _____
- Building signs and markings
 - For sale signs: _____
 - For rent signs: _____
 - Eviction notices: _____
 - Other (explain): _____
- Building characteristics
 - Newly constructed
 - Older building:
 - Renovated Not renovated
 - Ongoing renovation
- Overall building appearance
- Physical Signs of Residential Gentrification
 - New construction
 - Recent renovation to unit(s)
 - Upscale/trendy landscaping (e.g., fencing, plant types)
 - Upscale/luxury and "green" vehicles
 - Other: _____
 - Prevalence: Rare Few Noticeable
- Building appearance relative to surroundings
 - Roughly consistent
 - Out of place, higher-end
 - Out of place, lower-end
 - Unable to judge: _____
- Notes on building and outdoor space: _____

- Photo number(s) or range: _____

APN/Parcel # _____ Street Address _____

- Building type and units:
 - Single family 2-4 multifamily
 - Non-residential 5 or more multifamily
 - Unable to judge: _____
- Occupancy status
 - Occupied
 - Partially occupied: _____
 - Not occupied:
 - Signs of abandoned: Yes No
 - Unable to judge: _____
- Building signs and markings
 - For sale signs: _____
 - For rent signs: _____
 - Eviction notices: _____
 - Other (explain): _____
- Building characteristics
 - Newly constructed
 - Older building:
 - Renovated Not renovated
 - Ongoing renovation
- Overall building appearance
- Physical Signs of Residential Gentrification
 - New construction
 - Recent renovation to unit(s)
 - Upscale/ trendy landscaping (e.g., fencing, plant type)
 - Upscale/luxury and "green" vehicles
 - Other: _____
 - Prevalence: Rare Few Noticeable
- Building appearance relative to surroundings
 - Roughly consistent
 - Out of place, higher-end
 - Out of place, lower-end
 - Unable to judge: _____
- Notes on building and outdoor space: _____

- Photo number(s) or range: _____

Commercial Parcel Groundtruthing Form

Observer: _____ Physical Observation Date: _____ Start Time ____:____ AM/PM Station: _____

SECTION TWO: COMMERCIAL PARCEL OBSERVATIONS

APN/Parcel # _____ Street Address _____

- Building type and units:
 - Multi-story ____# stories
 - Stand-alone
 - Strip mall
 - Unable to judge: _____
- Building Use (e.g., office, retail, minimart): _____
- Occupancy status
 - Occupied
 - Partially occupied: _____
 - Not occupied:
 - Signs of abandoned: Yes No
 - Unable to judge: _____
- Building signs and markings
 - Property "For sale" signs: _____
 - Property "For rent" signs: _____
 - Eviction notices: _____
 - Upscale/trendy signage, ads, displays
 - Other (explain): _____
- Building characteristics
 - Newly constructed
 - Older building:
 - Renovated Not renovated
 - Ongoing renovation
- Overall building appearance
- Physical Signs of Commercial Gentrification
 - New construction
 - Recent renovation to unit(s)
 - Upscale/trendy landscaping (e.g., patio furniture, plant types)
 - Upscale/trendy store front
 - Other: _____
 - Prevalence: Rare Few Noticeable
- Building appearance relative to surroundings
 - Roughly consistent
 - Out of place, higher-end
 - Out of place, lower-end
 - Unable to judge: _____
- Notes on building and outdoor space: _____
- Photo number(s) or range: _____

APN/Parcel # _____ Street Address _____

- Building type and units:
 - Multi-story ____# stories
 - Stand-alone
 - Strip mall
 - Unable to judge: _____
- Building Use (e.g., office, retail, minimart): _____
- Occupancy status
 - Occupied
 - Partially occupied: _____
 - Not occupied:
 - Signs of abandoned: Yes No
 - Unable to judge: _____
- Building signs and markings
 - Property "For sale" signs: _____
 - Property "For rent" signs: _____
 - Eviction notices: _____
 - Upscale/trendy signage, ads, displays
 - Other (explain): _____
- Building characteristics
 - Newly constructed
 - Older building:
 - Renovated Not renovated
 - Ongoing renovation
- Overall building appearance
- Physical Signs of Commercial Gentrification
 - New construction
 - Recent renovation to unit(s)
 - Upscale/trendy landscaping (e.g., patio furniture, plant types)
 - Upscale/trendy store front
 - Other: _____
 - Prevalence: Rare Few Noticeable
- Building appearance relative to surroundings
 - Roughly consistent
 - Out of place, higher-end
 - Out of place, lower-end
 - Unable to judge: _____
- Notes on building and outdoor space: _____
- Photo number(s) or range: _____

UCLA Consent Letter

UNIVERSITY OF CALIFORNIA, LOS ANGELES

BERKELEY • DAVIS • IRVINE • LOS ANGELES • RIVERSIDE • SAN DIEGO • SAN FRANCISCO



UCLA

SANTA BARBARA • SANTA CRUZ

CENTER FOR THE STUDY OF INEQUALITY
LUSKIN SCHOOL OF PUBLIC AFFAIRS
6368 PUBLIC AFFAIRS BUILDING
BOX 951656
LOS ANGELES, CALIFORNIA 90095-1656

15 March 2015

To Whom It May Concern,

Students at the UCLA Center for the Study of Inequality are conducting a visual inventory of this neighborhood as part of their Urban Planning Master's Program comprehensive research project. This project examines changes and developments around transit stations in the Los Angeles area. The information will be used to inform public agencies, community groups and other interested parties about these changes and developments. The goal of the study is to enhance neighborhood quality and ensure that all stakeholders benefit from transit development.

If you have questions about the credentials of the student, please contact the UCLA Department of Urban Planning at the Luskin School of Public Affairs at: 3250 Public Affairs Building, Box 951656, Los Angeles, CA 90095. Or alternatively, questions can be answered over the phone at (310) 825-4025.

If you have questions about the project, please contact me at 818-270-0497.

Thank you.

Sincerely yours,

A handwritten signature in black ink that reads "Silvia Jiménez".

Silvia Jiménez
Assistant Director,
Center for the Study of Inequality

Department of Urban Planning
Luskin School of Public Affairs
University of California Los Angeles
3250 Public Affairs Building
Box 951656
Los Angeles, CA 90095-1656
Phone: (310) 825-4025

Table M.1: Block Segment Observations for Case Study Areas

	Chinatown	Hollywood/ Western	103rd Street / Watts Towers
Total Block Segments	21	20	31
Land Uses			
Single Family	1%	4%	40%
Multifamily	6%	51%	31%
Retail	30%	12%	8%
Commercial	4%	2%	1%
Institutional	13%	2%	13%
Industrial	3%	0%	0%
Mixed-Use	21%	9%	0%
Vacant	21%	12%	6%
Other (e.g., park)	0%	9%	0%
Total	100%	101%	100%
Public infrastructure			
Bus Stop Shelter	5%	5%	16%
Ped. Street Lights	48%	20%	23%
Residential permit parking	10%	0%	0%
Street Furniture	43%	10%	16%
Bike Infra	5%	25%	19%
Public Trash Cans	43%	15%	10%
Parking Meters	38%	50%	0%
Street Improvements	14%	15%	42%
Visible People			
Busy	0%	10%	6%
Moderately busy	38%	35%	16%
Not busy	62%	50%	61%
Ethnicity	Asian, Latino, White	White, Latino, Black, Asian	Black, Latino
Physical Disorder			
Overall Rating	2.28	2.05	2.25
Neighborhood watch	0%	5%	6%
Anti-littering/graffiti	0%	5%	16%
Anti-loitering/drug use	0%	10%	3%
Anti-trespassing	10%	30%	39%
Other Signage	19%	30%	42%
Other Notes			
Ethnic Commercial Presence			
Non-English signs	67%	25%	10%
Ethnic businesses	52%	25%	10%
Ethnic goods	48%	15%	0%
Ethnic Institutions	14%	5%	0%

	Chinatown	Hollywood/ Western	103rd Street / Watts Towers
Commercial Gentrification			
Specialty food shops	5%	5%	0%
Boutique stores	0%	0%	0%
Yoga studios	0%	5%	0%
High end grocery stores	0%	0%	0%
Artsy spaces	0%	0%	0%
Other Notes	N/A		
Diversity of Commercial Activity	1.4	2.4	1.7
Physical Signs of Commercial Gentrification			
New Construction	5%	15%	6%
Recent Renovation to Units	81%	15%	6%
Scale 1-4	1.3	2.3	1.8
Upscale Landscaping	5%	5%	32%
Upscale/Green Vehicles	10%	0%	13%
Physical Signs of Residential Gentrification			
New Construction	5%	20%	9%
Recent Renovation to Units	57%	40%	84%
Scale 1-4	1.3	2.5	1.8
Upscale Landscaping	5%	50%	43%
Upscale/Green Vehicles	10%	35%	17%
Public Art/Aesthetics	Chinese themed decor, plazas and pedestrian street (blocked off to cars)	Poster billboards, mural on warehouse, Armenian genocide mural	Nice mural on corner of Wilmington& 103rd, public murals, trees

Table M.2: Commercial Parcels Observations for Case Study Areas

	Chinatown	Hollywood/ Western	103rd Street / Watts Towers
Commercial Parcels	7	2	3
Building Density			
Multistory Buildings	42.86%	100.00%	0.00%
Number of Stories	2	N/A	N/A
Standalone Building	14.29%	0.00%	100.00%
Strip mall	0.00%	0.00%	0.00%
Unable to Judge	14.29%	0.00%	0.00%
Building Use	N/A	N/A	N/A
Occupancy Status			
Occupied	85.71%	100.00%	33.33%
Partially Occupied	0.00%	0.00%	0.00%
Not Occupied	14.29%	0.00%	33.33%
Unable to Judge	0.00%	0.00%	33.33%
Signage Presence			
For sale signs	0.00%	0.00%	0.00%
For rent signs	0.00%	0.00%	0.00%
Eviction Notices	0.00%	0.00%	0.00%
Upscale signage	0.00%	50.00%	0.00%
Other	N/A	N/A	N/A
Building Improvements			
Newly Constructed	28.57%	100.00%	0.00%
Older Building	0.714285714	0.00%	100.00%
Renovated	0	0.00%	0.00%
Not Renovated	0.714285714	0.00%	100.00%
Ongoing Renovations	N/A	N/A	N/A
Exterior Appearance			
Overall Appearance	3.17	3.26	2.00
Recent Renovations (1-4)	7	2	1
Upscale Landscaping	0.00%	100.00%	0%
Upscale Vehicles	0.00%	50.00%	0%
Appearance in Neighborhood Context			
Out of place, higher	14.29%	100.00%	0.00%
Out of place, lower	0.00%	0.00%	33.33%
Roughly the same	71.43%	0.00%	66.67%
Unable to Judge	14.29%	0.00%	0.00%

Table M.3: Residential Parcels Observations for Case Study Areas

	Chinatown	Hollywood/ Western	103rd Street / Watts Towers
Residential Parcels	17	23	46
Land Use			
Single Family	47%	9%	72%
2-4 MF	29%	0%	28%
5+ MF	24%	87%	0%
Vacant Lot	0%	4%	0%
	100%	100%	100%
Occupancy Status			
Occupied	94%	87%	96%
Partially Occupied	0%	9%	2%
Not Occupied	0%	4%	2%
Unable to Judge	6%	0%	0%
	100%	100%	100%
Signage Presence			
For sale	0%	0%	2%
For rent	0%	4%	7%
Eviction Notices	0%	0%	0%
Newly constructed	0%	0%	0%
Other Signs	0%	0%	0%
Building Improvements			
Newly Constructed	65%	9%	24%
Older Building	35%	87%	76%
Renovated	24%	57%	30%
Not Renovated	12%	26%	46%
Ongoing Renovations	0%	4%	0%
	100%	100%	100%
Exterior Appearance			
Overall Appearance	3.647058824	3.260869565	3.413043478
Recent Renovations (1-4)	1.235294118	1.913043478	1.5
Upscale Landscaping	24%	43%	11%
Upscale Vehicles	0%	4%	0%
Appearance in Neighborhood Context			
Out of place, higher	6%	26%	22%
Out of place, lower	0%	9%	4%
Roughly the same	88%	61%	74%
Unable to Judge	0%	0%	0%

Appendix N. Interview Protocol for Los Angeles

The following section outlines the key questions used for this study, an outline to the interview approach, and information about the interviewed organizations and agencies. The research team also identified best practices for collaboration between CBOs and government agencies to minimize negative externalities. Results are presented as part of the 2015 UCLA Master’s in Urban and Regional Planning Comprehensive Project.¹⁰

Our intended interviewee for each CBO was the executive director or a CBO employee with specific experience or insight in the TOD process. The interviewees had to have worked for the CBO for a significant length of time or participated in multiple organizing campaigns. Table N.1 includes more information about the organizations that were interviewed.

Public agencies were the second group of organizations selected for this research study. For the purposes of our study, we limited the selection to public agencies that are involved in local or regional land use and transportation planning in Los Angeles. Additionally, the public agencies must have worked on projects related to TOD, from development planning to construction of the actual transit infrastructure. We excluded the Los Angeles Department of Transportation (LADOT) because our secondary research found that it has not been active in TOD, despite providing other transit services for much of the study area. Table N.2 identifies the 4 public agencies that were identified for interviews specifically in the study areas. Since these agencies are large organizations that have various missions across the LA region, we selected interviewees from multiple departments to collect insight from different perspectives.

Table N.1: Interviewed CBOs

Organization	Area Served	Year Est.	Approx. Annual Expenditures
Strategic Action for a Just Economy (SAJE)	South Los Angeles	1996	\$900,000 (2013)
Southeast Asian Community Alliance (SEACA)	Chinatown/Lincoln Heights	2002	N/A
Chinatown Community for Equitable Development (CCED)	Chinatown	2012	N/A
Thai Community Dev. Center	Thai Town / East Hollywood	1994	\$635,000 (2012)
Watts Community Studio	Watts / South Los Angeles	2011	N/A
Trust for Public Land	Greater Los Angeles Area/ National	1972	\$141 Million (2013)
LA Voice	Greater Los Angeles Area	2000	N/A

¹⁰ The 2015 Comprehensive Project, “Oriented for Whom? The Impacts of TOD on Six Los Angeles Neighborhoods,” is available online at: <http://luskin.ucla.edu/content/comprehensive-project>

Table N.2: Public Agency Interviews

Agency	Division Interviewed	No. of Interviewees	Area Served
Los Angeles County Metropolitan Transit Authority (LA Metro)	Joint Development Program	1	County of Los Angeles
City of Los Angeles	Department of planning	5	City of Los Angeles
City of Los Angeles	City Council District 13	1	City of Los Angeles
City of Los Angeles	Neighborhood Councils	2	City of Los Angeles

Strategic Actions for a Just Economy (SAJE)

SAJE is a community organizing and advocacy organization working on behalf of the current residents of South LA, particularly in the Figueroa Corridor. SAJE provides legal support to distressed renters, helps establish land trusts, and works to find positive solutions to conflicts between institutions and low-income city residents. SAJE works in partnership with other organizations to ensure that the fate of city neighborhoods is decided by those who live there, and accomplishes this in ways that are replicable and sustainable (Strategic Actions For a Just Economy 2015).

South East Asian Community Alliance (SEACA)

Launched in 2002, SEACA was founded on the principle of inclusion, and from the beginning, has been guided by a belief that individuals can improve and build power in their own communities. The organization was started due to a lack of resources targeting the needs of Southeast Asians. SEACA began as a youth leadership program and over the years have expanded programs to include youth organizing, creative arts and self-expression, and most recently, health and community building through food and gardening (SEACA 2015).

Thai Community Development Center (Thai CDC)

Thai CDC was established to begin addressing the health and human service needs of the Thai population living in Los Angeles. Thai CDC offers a broad range of services, including health and human services, legal services, senior services, and youth services. Since its establishment in 1994, Thai CDC has addressed the multifaceted needs of Thai immigrants in the Southern California region, who, at an estimated population of 100,000 are considered the largest number of Thais living abroad (Thai CDC, 2015).

Watts Community Studio

The Watts Community Studio is a research project supported by the City of Los Angeles' Council District 15 Office of Joe Buscaino. The project goal is to inform local planning and economic development policy by surveying the business owners and residents of Watts in order to find out what problems most concern the community and determine how the Council District can support positive change. In addition to surveys, WCS also aims to increase collaboration and organization between small businesses, community-based organizations and faith-based organizations by conducting focus groups (WCS 2015).

Chinatown Community for Equitable Development (CCED)

Chinatown Community for Equitable Development (CCED) is a multiethnic coalition that was founded in May 2012 (Nguyen 2014). CCED was founded to advocate for Chinatown's small businesses whose tenure and survival was threatened by the development of the Chinatown Wal-Mart. The organization's larger goals include preserving the cultural integrity and character of the neighborhood and advocating for the rights of long term residents to live and work in the area. While Chinatown has changed due to light rail expansion and the increased development interest it prompted, residents can be assured that CCED will provide them a voice in the development process.

Trust for Public Land

Trust for Public Land works to create greenspace in cities across the nation. The organization's Los Angeles office recently worked with the City and Watts community residents to transform an abandoned lot near the Metro Blue Line into community serving park space (Trust for Public Land, personal communication April 6, 2015). Development interest spurred by TOD can provide increased community amenities like greenspace in urban neighborhoods. The Trust for Public Land's efforts show that community driven advocacy can create these improvements in underinvested neighborhoods that need them most.

LA Voice

LA Voice was founded in the year 2000 and organizes to increase leadership capacity in Los Angeles working class communities (LA Voice). The organization is involved in a number of issues including housing and workers rights in rapidly changing Los Angeles neighborhoods (LA Voice, personal communication, April 10, 2015). The organization has also conducted community visioning exercises around Metro owned properties near the Metro Red Line. The organization's advocacy work has amplified the voices of low income residents so development and neighborhood improvements benefit all residents.

Key Interview Questions

How has Transit Oriented Development (TOD) impacted the study areas?

We asked questions about how TOD had impacted the study areas in question. Before proceeding to other interview questions, it was important to understand what changes due to TOD that the interviewees identified. This line of question provides an opportunity to better understand community experience through the eyes of those who live and work in the area. Assessing the perceived impacts on each study area enabled the team to compare the effects of TOD across geographic areas.

How effective have local communities been in controlling the outcomes of TOD?

The next set of questions pertains to how CBOs and agencies have influenced the outcomes of TOD in a geographic area. Our interview team was looking for both concrete examples of successful and unsuccessful campaigns or strategies to influence the results of TOD, as well as general issues that had arisen in specific areas that were experiencing TOD growth. In the end, the responses to this line of questioning form the basis for a set of recommendations to address ongoing concerns in the TOD process.

What is the relationship between CBOs and governmental agencies in the TOD process?

A key focus of study for the project is the amount of community input in the development of Metro's rail system. Ideally, there would be a high level of collaboration and coordination between the governmental agencies overseeing the construction of transit lines (and the subsequent urban growth patterns) and the local communities that experience these impacts. The research team was interested in understanding the degree of coordination (if any) between government agencies charged with the development of transit and the communities that they are ostensibly there to serve.

What more can be done to allow station area residents and community groups to influence the TOD process from conception, design, and realization?

Finally, our team was interested in what were the internal and external factors, such as staff availability or professional relationships that limited the effectiveness of CBOs and governmental agencies in impacting the TOD process. Governmental agencies are primarily responsible for the design and implementation of a transit system; CBOs can work through the public process or informal channels to minimize undesirable outcomes in the development.

Appendix O. Detailed Assessments for LA Ground-Truthing Case Studies

Chinatown Detailed Assessment

For the Chinatown case study, we surveyed 21 street block segments along the streets of Hill, Broadway, Spring, Alameda, Alpine, College, Llewellyn, Gin Ling, Mei Ling, and Sun Mun within the quarter-mile buffer from the station, and Grand and Cesar Chavez within the half-mile buffer (See Figure O.1). Additionally, we sampled 19 residential parcels and seven commercial parcels. Parcels observed included parcels on Stadium, Coronel, Bernard, Hill, Broadway, Yale, and Alpine (See Figure O.2). As mentioned above, our observed parcels had a 95% match with the assessor data in residential land use.

Our observations captured relatively little commercial change and only very early signs of residential gentrification. Most of the blocks surveyed were predominantly commercial, many (about 30%) with retail or mixed-use (about 21%). There was no new commercial construction visible in the surveyed blocks. About 80% of the commercial blocks had recent renovations; however, most of the renovations were minor. Only two blocks had signs of upscale landscaping, while we noticed "green" or upscale vehicles only in one block. We only observed one commercial "For Lease" sign. Similarly, in the seven commercial parcels surveyed, the buildings appeared as "average" while five parcels did not show any renovation, although two had newly constructed properties.

Chinatown, additionally, had the highest concentration of ethnic commercial presence of all the case study areas. About 50% of the blocks had indicators showing ethnic business and goods, and over 65% of commercial blocks (or 14 blocks) had non-English signs. Chinatown's commercial presence was comprised of primarily older, established businesses with very few indications of commercial gentrification (no new boutique stores, yoga studios, high-end grocery stores, artsy spaces, or the like). Over 70% of the commercial parcels surveyed appeared roughly the same in appearance to the surrounding neighborhood context, and none had upscale signage that looked out of place (e.g., appeals to a certain lifestyle or type of shopper). However, the area had the highest presence of specialty food shops of the case study areas, possibly targeting visitors and tourists.

Our observations differ from those of representatives from CBOs, who expressed concerns that a growing number of new neighborhood businesses are not catering to the needs of long-term Chinatown residents, such as culturally appropriate retail that meets the needs of the elderly, affordable food and retail, and in some cases, jobs. Representatives from CBOs indicated that new development and incoming retailers like Starbucks and Walmart are instead catering to new residents or more affluent commuters (Southeast Asian Community Alliance, SEACA, personal communication, February 4, 2015).

According to CBO representatives interviewed, business turnover and displacement has also led some long-term residents to leave their homes because they no longer feel a cultural and economic connection to Chinatown (SEACA, personal communication, February 4, 2015). With the increase in new development, the businesses that provide goods, services, and even jobs are getting displaced (SEACA, personal communication, February 4, 2015).

Our observations did capture some signs of residential gentrification, which coincided with CBO concerns and the findings of our gentrification model. We observed one block with new residential construction, one block that had properties with upscale landscaping, and two blocks that had upscale or green vehicles parked on the street (See Table AI.2 in Appendix I). About 57% of the surveyed blocks had residential renovations, which were mostly minor. These low numbers and percentages, however, are due to the fact that most blocks surveyed were commercial rather than residential – with the residential blocks surveyed being mostly along Grand and Cesar Chavez – since residential land uses were uncommon in the areas immediately adjacent to the Metro rail station.

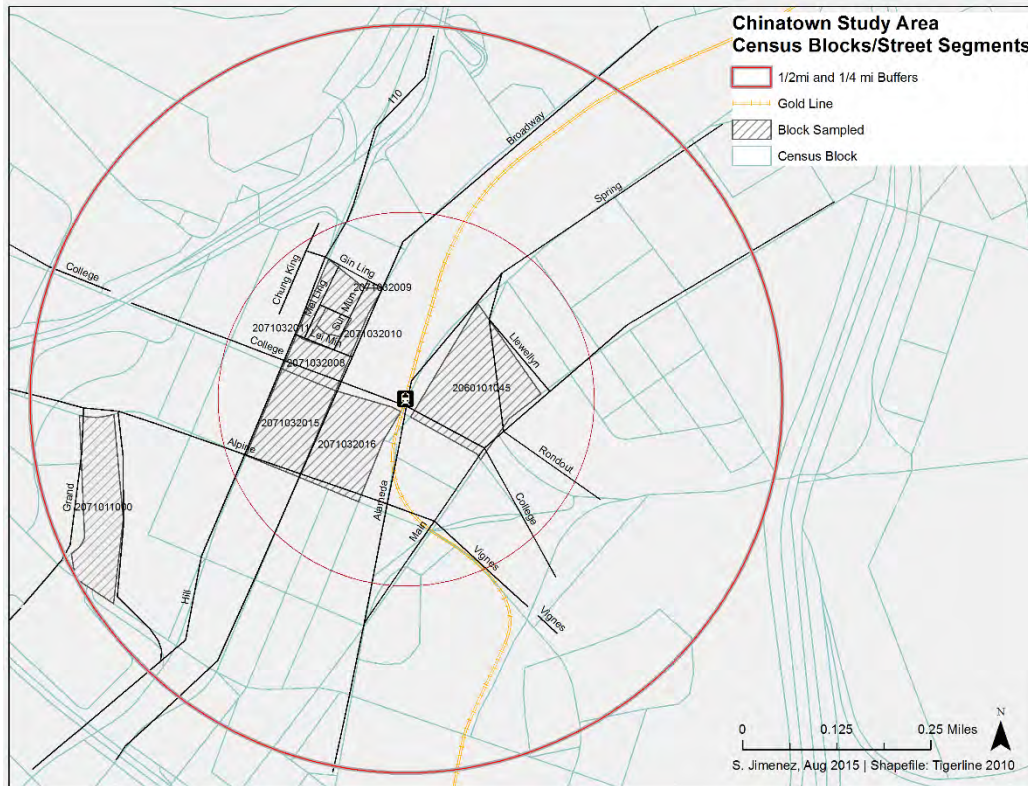

Figure 0.1: Blocks Surveyed for Chinatown Study Area

Of the residential parcels surveyed, eight were single-family, five were multi-family with less than five units, and four were multi-family with five or more units. Chinatown also had the highest prevalence of new construction on residential parcels. About 65% of the surveyed residential parcels appeared to have new construction, over twice the percentage for Watts and seven times the percentage for Hollywood, which may be attributed to Chinatown’s proximity to Downtown. This may indicate a quickly growing residential segment of the Chinatown area. Additionally, about one-fourth of residential parcels surveyed had upscale landscaping and one-fourth were newly renovated.

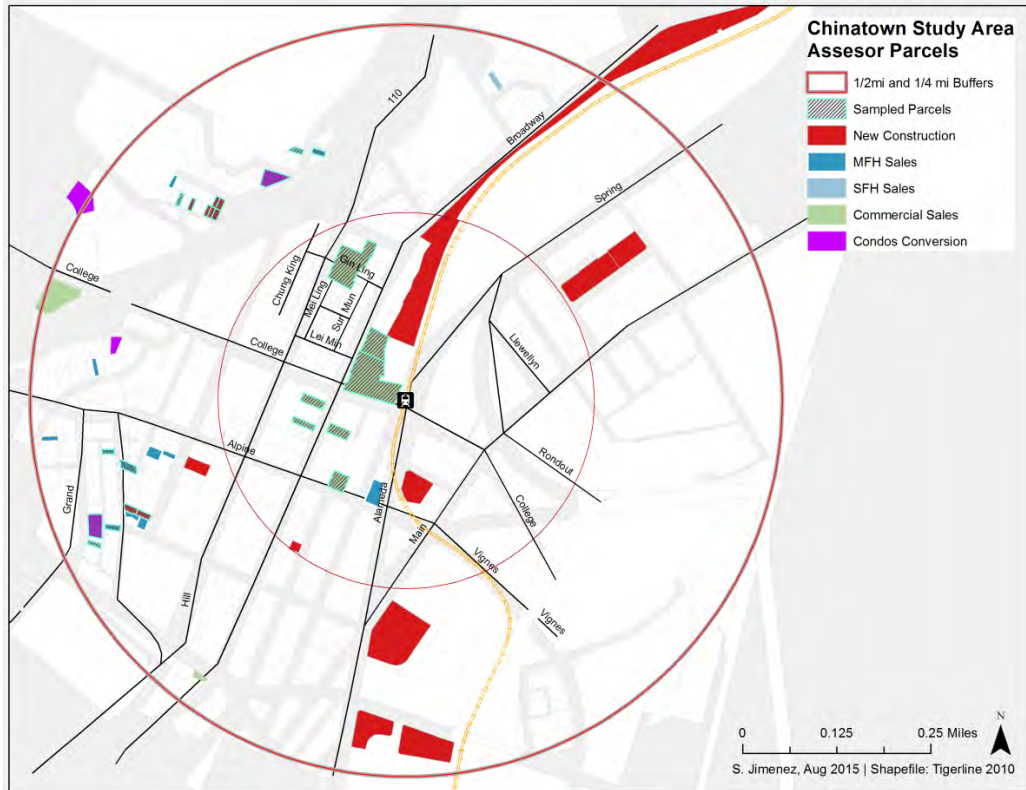

Figure O.2: Parcels Surveyed for Chinatown Study Area

A total of eight blocks had parking meters, two had residential permit parking, while three blocks had street or sidewalk improvements. Bus stop shelters and bike infrastructure were present on one block. Additionally, way finding signage and Chinatown banners were common. Chinese architecture, arches, and street art were also present. Although over 60% of the blocks observed did not have much pedestrian traffic, our observations captured a diverse population in the area, which included not only Asians but also Latinos and non-Hispanic whites.

In the recent decades, Chinatown has experienced change along the outskirts of the half-mile radius around the station, but not close to the station where most of the commercial parcels exist. Our observations captured some of the residential changes that have occurred along the outskirts. However, due to limited parcel sampling and the fact that some new developments are only forthcoming, we failed to pick up some of the changes that many community groups see and fear – such as the Grand Plaza development on Cesar Chavez Avenue or the newly proposed College Station development. Given the high number of renters in the area, CBOs worry that real estate speculation may force long-term, low-income renters out of the neighborhood.

Some affordable housing units are also threatened; Chinatown has had affordable senior housing since the 1980s but many of the affordable units have expired or are set to expire (Chinatown Community for Equitable Development, personal communication, April 15, 2015). As a result, according to CBO representatives, some affordable senior units are converting into market-rate units. This conversion is often initiated by landlords, who turn over the building and ask for higher rents when the affordability requirements expire. CBOs are concerned with how the conversion of affordable units into market-rate units may displace Chinatown’s long-term residents. They believe that real estate developers see an opportunity to attract higher returns on their developments,

which may have negative effects for a neighborhood like Chinatown that has many low-income residents.

Strong relationships between CBOs and public agencies in TOD areas are necessary to develop plans and policies to encourage development that provides community benefits through equity provisions. In the Chinatown area, this discussion is mostly happening through the city planning department's Cornfield Arroyo Seco Specific Plan (CASP), which includes density bonuses to encourage the development of affordable housing units.

Hollywood/Western Detailed Assessment

For the Hollywood/Western area, we surveyed 20 block segments, which included blocks along Hollywood, Western, Saint Andrews, Serrano, Carlton, Russell, and Harvard within the quarter-mile buffer from the station, and streets such as Sunset, Kingsley, and Winona within the half-mile buffer (See Figure 0.3). Additionally, we sampled 46 residential parcels and two commercial parcels. Parcels observed were on Hobart, Sunset, Loma Linda, Serrano, Carlton, Harold, Harvard, Garfield, Oxford, Gramercy, and Western (See Figure 0.4). Our observed parcels in this neighborhood had a 93% match with assessor data in residential land use.

Our gentrification model shows that only the area southwest of the Metro station appears to have gentrified in the last decade, while the area to the southeast has undergone little development or change. Further, no tracts north of the Metro station appear to be eligible for gentrification. Our ground-truthing observations, however, capture more signs of gentrification than those shown in the model.



Figure 0.3: Blocks Surveyed for Hollywood/Western Study Area

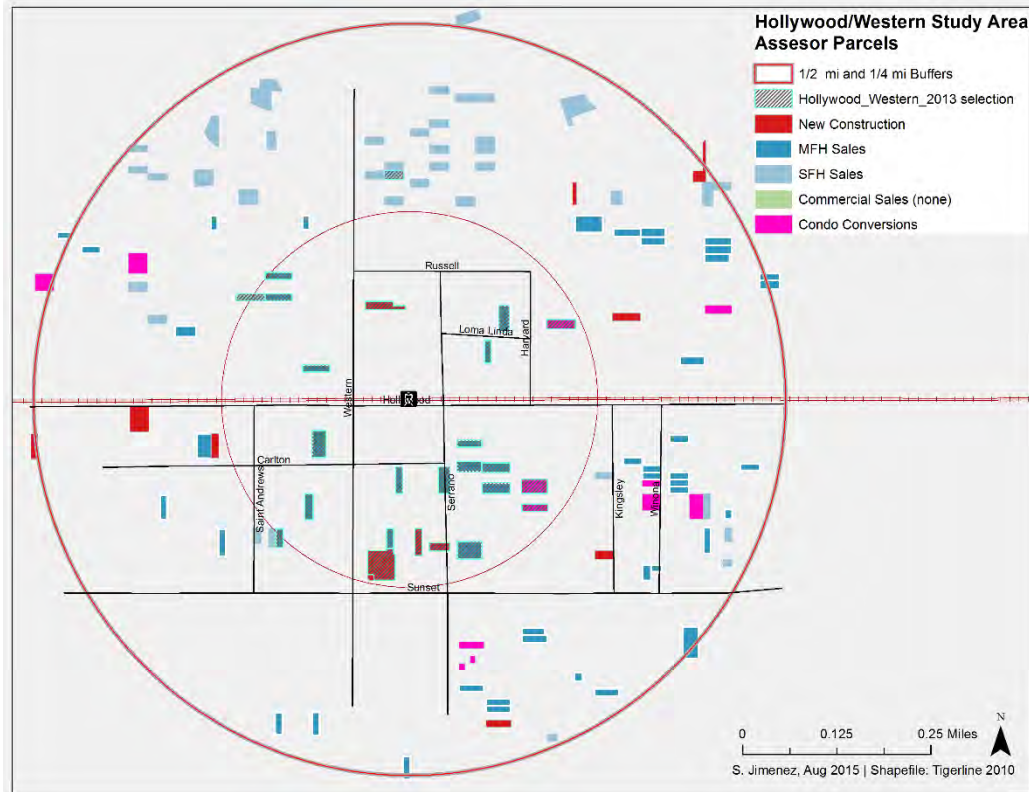

Figure O.4: Parcels Surveyed for Hollywood/Western Study Area

Hollywood/Western showed clear signs of late-stage commercial and residential gentrification. Surrounding the station itself are primarily commercial businesses, mostly retail or mixed-use. Although Hollywood/Western is still dominated by small, older, well-established stores, it also has indications of commercial gentrification. This area had the highest percentage of new construction in the commercial block surveyed – about 15%. About 15% of the surveyed blocks had minor or moderate renovations, while only one block had properties with some upscale landscaping (patio furniture, plants, and decorative fencing).

The two commercial parcels observed had both multi-story new constructions, making them out of context from the surrounding parcels. Additionally, one block had a yoga studio and one a specialty food shop, and one multi-story use building housed a Starbucks, a Crossfit specialty gym, and many brand-named retail stores, indicating some stereotypical signs of gentrification. One-fourth of the blocks surveyed having some non-English signs and ethnic businesses. These included mostly signs in Thai, which is expected, given the presence of Thai Town. Yet, upon one visit, the Thai restaurants seemed to cater towards a diverse and younger crowd. One block also housed an ethnic institution (a Korean church). Block segment observations also indicated signs of ethnic presence such as posters, a painted utility box, and a mural commemorating the Armenian genocide.

Additionally, Hollywood/Western showed multiple signs of residential gentrification. About 20% of the blocks surveyed had new construction, which is the highest amongst the case study areas, and about 40% showed signs of moderate renovation. Half of the blocks observed had upscale landscaping, the most amongst the case studies, and 35% had upscale or green vehicles. Moreover, many blocks had signs indicating territoriality – six blocks had anti-trespassing signs, while six

other blocks had other signage such as “Property closed to the public”, “Security camera”, or “Reserved parking.”

Of the residential buildings, 9% were new, 27% renovated, and 36% with ongoing renovations. The vast majority were ranked as average (61%), or above average (22%). Only two (9%) buildings were lower end and out of place relative to the neighborhood scale and character. Many of the residential blocks also had “for rent” signs, including one that “Welcomed Section 8.”

Hollywood/Western has less public infrastructure than Chinatown, but the highest percentage for bike infrastructure (25% or 4 blocks). Hollywood/Western had more pedestrian activity than the other case-study neighborhoods. About 10% of blocks were perceived as busy in terms of pedestrian traffic, while 35% were moderately busy. Whites, Latinos, blacks, and Asians were all observed walking or biking in the area.

Representatives of community-based groups interviewed noted the residential gentrification that the area is experiencing. One organizer estimated that 30 percent of a Hollywood church congregation has moved to San Fernando Valley because of rising rents in Hollywood (LA Voice, personal communication, April 10, 2015).

The Hollywood/Western TOD area has a high potential for gentrification. However, the gentrification impact may be moderated by community and CBO intervention and the implementation of the Vermont/Western Transit Oriented District SNAP adopted in 2001. The plan mandates equitable development through its community benefit elements. For example, SNAP’s child care facility component requires mixed-use or commercial projects with 100,000 square feet or more of nonresidential floor area to include childcare facilities to accommodate the needs of employees.

Thai Community Development Center (Thai CDC) and East Hollywood Neighborhood Council, along with Metro are trying to form a partnership to create a small business incubator near the Hollywood/Western Station (personal communication, March 9, 2015). However, where CBOs are not actively involved in neighborhood councils, there is potential that they may be left out of the planning process.

103rd St./ Watts Towers Detailed Assessment

For 103rd St./Watts Towers, we surveyed about 31 block segments, which included blocks on Century, 103rd St, 104th, 105th, Compton, Grandee, Graham, Beach, Holmes, Kimberly, Bandera, Wilmington, Anzac, Grape, and Hickory (Figure 0.5). Additionally, we sampled 46 residential parcels and three commercial parcels (Figure 0.6). The observed parcels had 89% match with assessor data in residential land use.

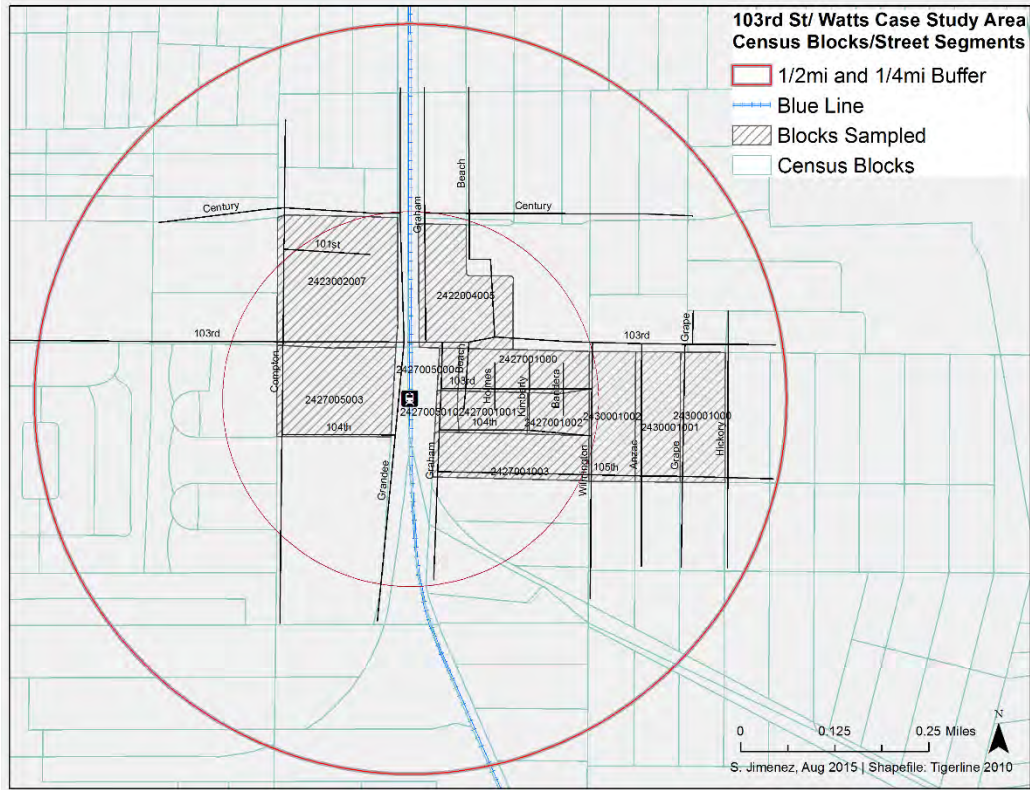

Figure 0.5: Blocks Surveyed for 103rd St./Watts Towers Study Area

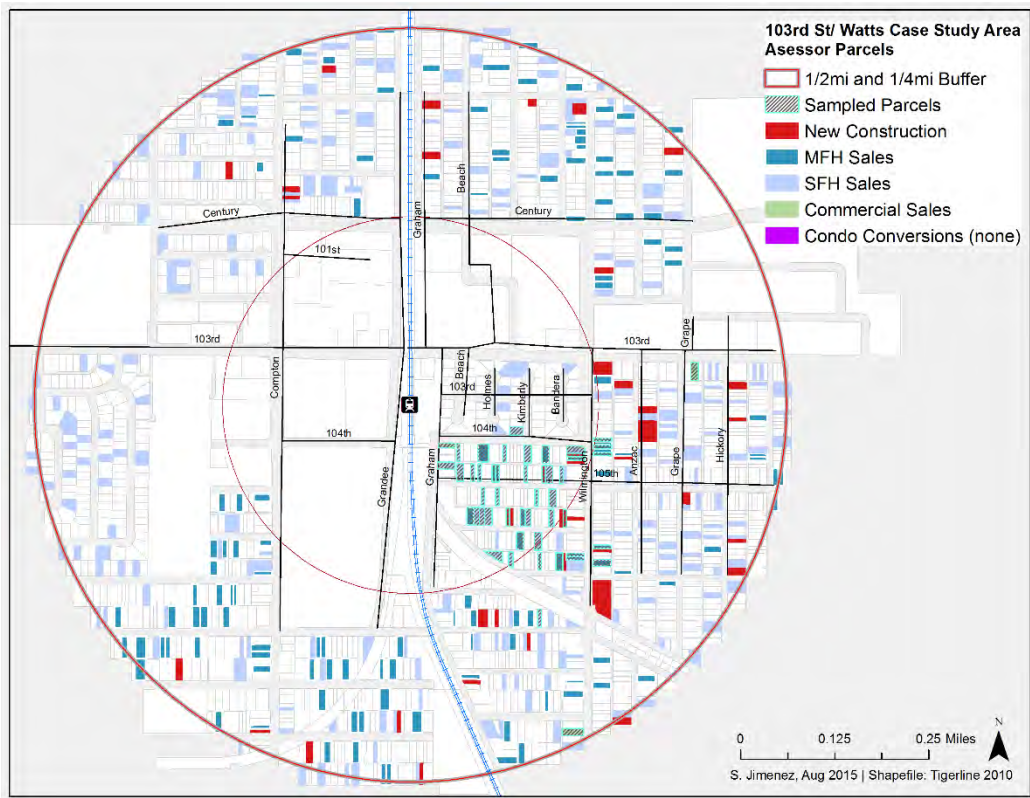

Figure 0.6: Parcels Surveyed for 103rd St/Watts Towers Study Area

Our model of gentrification shows that although 103rd St./Watts is eligible for gentrification in that it is a disadvantaged disinvested neighborhood, the area has little signs of development in the last decades. Our ground-truthing observations are consistent with this finding.

Although the oldest of the Metro rail stations in our study, it showed very few signs of commercial gentrification. Only about 6% of the surveyed block segments showed signs of new commercial construction with mostly minor, cosmetic renovations. The few newly constructed commercial properties housed mostly small mom-and-pop stores. There was only one block dominated by commercial and retail uses, the Martin Luther King Shopping Center; most of the businesses there appeared to cater to a lower-income demographic. Examples of retail establishments include Food 4 Less, Popeye's, Burger King, and small hair salons. Only one block had upscale landscaping or green vehicles (See Table AI.1 in Appendix I).

While commercial land uses were infrequently observed in Watts; we noticed a significant institutional presence, making up about 13% of the total observed land uses in the surveyed blocks. The largest institution is the Watts Health Center. Additionally, the surveyed area included the St. Lawrence of Brindisi Elementary School and St. Lawrence of Brindisi Church.

Residential development, on the other hand, did show some moderate signs of gentrification. A large proportion of the blocks surveyed were residential, about 40% single-family and 31% multi-family. About 9% of the blocks appeared to have new residential construction, mostly along Wilmington. Renovated homes were present on about 84% of the surveyed blocks. However, many renovations seemed to be minor and solely cosmetic. While there appears to have recently been a high amount of transactional activity in residential parcels, a change in ownership has only occasionally resulted in the improvement of a parcel's appearance.

Of the residential parcels, about 71% were single-family and the rest were multi-family containing between two and four units. In total, approximately a quarter of the residential units appeared to be newly constructed, and more than a third were either in the process of renovation or appeared to have been recently renovated. Additionally, roughly a fifth of the units appeared to be significantly more upscale than their surrounding units, while only two units were significantly downscale compared to their neighbors.

The 103rdSt./Watts Station had the most security signage compared to the other case study areas. Of the 31 blocks, two had neighborhood watch signs, five had anti-littering or graffiti signage, 12 had anti-trespassing signage, and 13 had other types of signs, such as "no parking," "security surveillance," and "beware of dog." Several houses also had bars on the windows, while the majority of houses had high fences or gates. The prominence of these characteristics indicated the need or desire for more safety in the area.

In regards to public infrastructure, seven blocks had pedestrian streetlights, six blocks had bike infrastructures, five blocks had bus stop shelters and street infrastructure, and three blocks had public trashcans. Thirteen of the blocks surveyed (42%) had sidewalk improvements. Trees and public murals were also present. However, the neighborhood also had signs of disorder such as alleyways and vacant lands serving as dumping grounds.

Our observations and model results echo the experience of community groups in the Watts neighborhood – confirming the lack of noticeable changes near the 103rd St./Watts Towers metro station. Not captured by the physical observations of the community or by the gentrification model,

however, is the day-to-day experience of some Watts residents. South Los Angeles CBOs have discussed many instances of illegal evictions and slum conditions in South Los Angeles (personal communication, April 16, 2015).

Since the area is gentrification-eligible but does not yet show major evidence of gentrification, proactive community-public partnerships, if formed early, may help prevent future displacement and achieve a more equitable development model. As TOD plans are developed for the area, community benefits should also be put in place through equity provisions. For example, one tool for potential collaboration is the Jordan Downs Urban Village Specific Plan, which has the goal to create high-quality transit areas, protect community resources, and provide equitable economic opportunities.¹¹ The Jordan Downs Urban Village Specific Plan aims to improve connectivity for the aging Jordan Downs public housing project, which is located a half-mile west of the rail station. This plan has the potential to transform Jordan Downs into a mixed-income development (City of Los Angeles, 2012).

¹¹ The specific plan is available online at: <http://cityplanning.lacity.org/staffrpt/initialrpts/CPC-2010-31.pdf>

Appendix P. Bay Area UrbanSim Models as Used in Plan Bay Area

This Appendix describes each of the models used in the Bay Area application of UrbanSim for the PlanBayArea project, and is intended as a more detailed reference for the base implementation for the current project. The changes in the preceding sections were applied to an updated version of the models as described below.

The sequence of the presentation of the models is organized approximately in the order of their execution within each simulated year, but in some cases they are grouped for clarity of exposition. All of the models operate as microsimulation models that update the state of individual agents and objects: households, businesses, parcels and buildings. The state of the simulation is updated by each model, and results are stored in annual steps from the base year of 2010 that the model uses as its initial conditions, to the end year of 2040 for each scenario that is simulated.

Business Transition Model

Objective

The Business Transition Model predicts new establishments being created within or moved to the region by businesses, or the loss of establishments in the region - either through closure of a business or relocation out of the region.

Employment is classified by the user into employment sectors based on aggregations of Standard Industrial Classification (SIC) codes, or more recently, North American Industry Classification (NAICS) codes. Typically sectors are defined based on the local economic structure. Aggregate forecasts of economic activity and sectoral employment are exogenous to UrbanSim, and are used as inputs to the model. The base year UrbanSim employment data for the MTC application were obtained from ABAG. The employment sectors adopted for this application are shown in Table AL.1. The Business Transition Model integrates exogenous forecasts of aggregate employment by sector with the UrbanSim database by computing the sectoral growth or decline from the preceding year, and either removing establishments from the database in sectors that are declining, or queuing establishments to be placed in the Business Location Choice Model for sectors that experience growth. If the user supplies only total employment control totals, rather than totals by sector, the sectoral distribution is assumed consistent with the current sectoral distribution. In cases of employment loss, the probability that an establishment will be removed is assumed proportional to the spatial distribution of establishments in the sector. The establishments that are removed vacate the space they were occupying, and this space becomes available to the pool of vacant space for other establishments to occupy in the location component of the model. This procedure keeps the accounting of land, structures, and occupants up to date. New establishments are not immediately assigned a location. Instead, new establishments are added to the database and assigned a null location, to be resolved by the Business Location Choice Model.

Algorithm

The model compares the total number of jobs by sector in the establishments table at the beginning of a simulation year, to the total number of jobs by sector specified by the user in the annual employment control totals for that year. If the control total value is higher, the model adds the

necessary number of establishments to the establishments table by sampling existing establishments of the same sector and duplicating them until enough jobs have been added. If the control totals indicate a declining job count for a sector then the appropriate number of establishments in the data are selected at random and removed. The role of this model is to keep the number of jobs in the establishments data in the simulation synchronized with aggregate expectations of employment in the region. In most current applications, control totals are separately specified for each sector and split by a proportion that is assumed to be home-based employment vs non-home-based employment. These two are handled by different model groups in the establishment location choice model.

Table P.1: Employment Sectors

Sector ID	Sector Description
1	Professional services
2	Finance, insurance, and real estate
3	Business services
4	Agriculture
5	Natural resources
6	Arts and recreation
7	Government
8	Other education
9	Logistics
10	Eating and drinking
11	Regional retail
12	Social services
13	Leasing
14	Heavy manufacturing
15	Health
16	Local retail
17	Transportation
18	Higher education
19	Utilities
20	Construction
21	Biotechnology
22	Light manufacturing
23	Information
24	Hotel
25	Tech manufacturing
26	Personal services
27	K-12 education
28	Unclassified

Configuration

The configuration of the Business Transition Model in the parcel model system is summarized in the following table:

Table P.2: Configuration of Business Transition Model

Element	Setting
Agent	Establishments
Dataset	Establishments
Model Structure	Rule Based

Data

The following tables are used in the Business Transition Model in the parcel version of UrbanSim.

Table P.3: Data Used by Business Transition Model

Table Name	Brief Description
annual_business_control_totals jobs	Annual aggregate control totals for employment by sector jobs (synthesized from ABAG zonal employment by sector)

Household Transition Model

Objective

The Household Transition Model (HTM) predicts new households migrating into the region, or the loss of households emigrating from the region.

The Household Transition Model accounts for changes in the distribution of households by type over time, using an algorithm analogous to that used in the Business Transition Model. In reality, these changes result from a complex set of social and demographic changes that include aging, household formation, divorce and household dissolution, mortality, birth of children, migration into and from the region, changes in household size, and changes in income, among others. The data (and theory) required to represent all of these components and their interactions adequately are complex, and although these behaviors have been recently implemented in UrbanSim they were not available for use within the time constraints of this project. In this application, the Household Transition Model, like the Business Transition Model described above, uses external control totals of population and households by type (the latter only if available) to provide a mechanism for the user to approximate the net results of these changes. Analysis by the user of local demographic trends may inform the construction of control totals with distributions of household size, age of head, and income. If only total population is provided in the control totals, the model assumes that the distribution of households by type remains static.

As in the business transition case, newly created households are added to a list of movers that will be located to submarkets by the Household Location Choice Model. Household removals, on the other hand, are accounted for by this model by removing those households from the housing stock,

and by properly accounting for the vacancies created by their departure. The household transition model is analogous in form to the business transition model described above. The primary household attributes stored on the household table in the database are shown in Table P.4. Income and persons are the most commonly used attributes to include in the control totals in order to be able to set household targets for income and household size distribution in future years.

Table P.4: Household Attributes

Characteristic	Description
Tenure	Rent or Own
Building Type	Single Family Detached, Single Family Duplex, Apartment, Townhouse, Group Quarters
Income	Annual Household Income
Persons	Total Persons in Household
Children	Number of Children (under 18) in Household
Race	Race of Head of Household
Workers	Number of Workers in Household
Vehicles	Number of Vehicles

Algorithm

The model compares the total number of households (by type) in the households table at the beginning of a simulation year, to the total number of households (by type) specified by the user in the annual household control totals for that year. If the control total value is higher, the model adds the necessary number of households to the household table by sampling existing households (of the same type) and duplicating them. If the control totals indicate a declining household count (by type) then the appropriate number of households in the data are selected at random and removed. The role of this model is to keep the household data in the simulation synchronized with aggregate expectations of population and households. Note that the model can be configured by the user's choice of specification of the annual control totals. If no household characteristics are included in the control totals, then the synchronization is done for the total number of households. Otherwise it is done by the categories present in the control totals.

Configuration

The configuration of the HTM in the parcel model system is summarized in the following table:

Table P.5: Configuration of Household Transition Model

Element	Setting
Agent	Household
Dataset	Household
Model Structure	Rule Based

Data

The following tables are used by the Household Transition Model in the parcel version of UrbanSim.

Table P.6: Data Used by Household Transition Model

Table Name	Brief Description
annual_household_control_totals	Annual aggregate control totals for households, optionally by type
households	Synthesized households
persons	Synthesized persons

Business Relocation Model

Objective

The Business Relocation Model predicts the relocation of establishments within the region each simulation year.

Employment relocation and location choices are made by firms. In the current version of UrbanSim, we use establishments as the units of analysis (specific sites/branches of a firm). The Business Relocation Model predicts the probability that establishments of each type will move from their current location or stay during a particular year. Similar to the economic transition model when handling job losses in declining sectors, the model assumes that the probability of moving varies by sector but not spatial characteristics. All placement of establishments is managed through the business location choice model.

As in the case of job losses predicted in the economic transition component, the application of this model requires subtracting jobs by sector from the buildings they currently occupy, and the updating of the accounting to make this space available as vacant space. These counts will be added to the unallocated new jobs by sector calculated in the economic transition model. The combination of new and moving jobs serve as a pool to be located in the employment location choice model. Vacancy of nonresidential space will be updated, making space available for allocation in the employment location choice model.

Since it is possible that the relative attractiveness of commercial space in other locations when compared with an establishment's current location may influence its decision to move, an alternative structure for the mobility model could use the marginal choice in a nested logit model with a conditional choice of location. In this way, the model would use information about the relative utility of alternative locations compared to the utility of the current location in predicting whether jobs will move. While this might be more theoretically appealing than the specification given, it is generally not supported by the data available for calibration. Instead, the mobility decision is treated as an independent choice, and the probabilities estimated by annual mobility rates directly observed over a recent period for each sector.

Algorithm

The Business Relocation Model is implemented as a cross-classification rate-based model, with a probability of moving by employment sector applied to each establishment, each simulation year. For example, if an establishment is in the retail sector, their probability of moving would be looked up by finding the retail sector entry in the `annual_business_relocation_rates` table. Let's assume the rate in the table is .25. This means there is a 25% chance the job will move in any given year, and 75% chance they will not move in that year. The model uses Monte Carlo Sampling to determine the outcome. It works by drawing a random number (from the uniform distribution, between 0 and 1), and comparing that random draw to the probability of moving for each household. So with our example establishment's probability of 0.75 that they will stay, if we draw a random number with a value higher than 0.75, we will predict that the job will move in that year.

The outcome of the model is implemented as follows. If an establishment is determined to be a mover because the random draw is greater than (1 - their move probability), then they are moved out of their current location. In practical terms, their `building_id`, which identifies where they are located, is simply reset to a null value. They remain in the jobs table but temporarily have no assignment to a location.

In the current application of the model in the Bay Area, the relocation rates for establishments was assumed to be zero, due to a combination of data limitations and time constraints to calibrate the model with non-zero relocation rates. This makes the location choices of businesses fixed once the establishment is assigned to a location.

Configuration

The configuration of the BRM is summarized in the following table:

Table P.7: Configuration of Business Relocation Model

Element	Setting
Agent	Establishment
Dataset	Establishment
Model Structure	Cross-classification rate-based Model

Data

The following tables are used in the Business Relocation Choice model:

Table P.8: Data Used by Employment Relocation Model

Table Name	Brief Description
<code>annual_business_relocation_rates</code>	Annual relocation rates for establishments by sector
<code>establishments</code>	establishments

Household Relocation Model

Objective

The Household Relocation Model predicts the relocation of households within the region each simulation year.

The Household Relocation Model is similar in form to the Employment Relocation Model described above. The same algorithm is used, but with rates or coefficients applicable to each household type. For households, mobility probabilities are based on the synthetic population from the MTC Travel Model. This reflects differential mobility rates for renters and owners, and households at different life stages.

Application of the Household Relocation Model requires subtracting mover households by type from the housing stock by building, and adding them to the pool of new households by type estimated in the Demographic Transition Model. The combination of new and moving households serves as a population of households to be located by the Household Location Choice Model. Housing vacancy is updated as movers are subtracted, making the housing available for occupation in the household location and housing type choice model.

An alternative approach configuration is to structure this as a choice model, and specify and estimate it using a combination of household and location characteristics. This could be linked with the location choice model, as a nested logit model. This was not possible to implement in this application due to limitations in the available household travel survey, which did not contain information on relocation of households from their previous residence to their current location.

Algorithm

The Household Relocation Model is implemented as a cross-classification rate-based model, with a probability of moving by age and income category applied to each household in the synthetic population, each simulation year. For example, if a household has head of age 31 and an income of 47,500, their probability of moving would be looked up by finding the interval within the age and income classes in the `annual_household_relocation_rates` table. Let's assume the rate in the table is .25. This means there is a 25% chance the household will move in any given year, and 75% chance they will not move in that year. The model uses Monte Carlo Sampling to determine the outcome. It works by drawing a random number (from the uniform distribution, between 0 and 1), and comparing that random draw to the probability of moving for each household. So with our example household's probability of 0.75 that they will stay, if we draw a random number with a value higher than 0.75, we will predict that the household will move in that year. The outcome of the model is implemented as follows. If a household is determined to be a mover because the random draw is greater than (1 - their move probability), then they are moved out of their current location. In practical terms, their `building_id`, which identifies where they are located, is simply reset to a null value. They remain in the household table but do not have a location.

Configuration

The configuration of the HRM is summarized in the following table:

Table P.9: Configuration of Household Relocation Model

Element	Setting
Agent	Household
Dataset	Household
Model Structure	Cross-classification rate-based Model

Data

The following tables are used in this model.

Table P.10: Data Used by Household Relocation Model

Table Name	Brief Description
annual_household_relocation_rates	Annual relocation rates for households by type
households	Synthesized households

Household Tenure Choice Model

Objective

The Household Tenure Choice Model predicts whether each household chooses to rent or own a housing unit each simulation year.

Algorithm

The Household Tenure Choice Model is structured as a choice model using a binary logit specification, and uses a combination of household characteristics to predict the relative probability of owning vs renting. A tenure outcome is predicted using Monte Carlo sampling as described previously, comparing a value drawn randomly from a uniform distribution to the probability of owning predicted by the binary logit model in order to assign a tenure status. Once a tenure is assigned, the household is active only in that side of the housing market: if they are determined to be a renter, then in the Household Location Choice Model they only consider rental housing units to locate in. Similarly for owner households, they only look at properties that are available for sale as owner-occupied units.

Configuration

The configuration of the HTCM is summarized in the following table:

Table P.11: Configuration of Household Tenure Choice Model

Element	Setting
Agent	Household
Dataset	Household
Model Structure	Binary Logit Model

Data

The following tables are used in this model.

Table P.12: Data Used by Household Tenure Choice Model

Table Name	Brief Description
households	Synthesized households

Business Location Choice Model

Objective

The Business Location Choice Model predicts the location choices of new or relocating establishments.

In this model, we predict the probability that an establishment that is either new (from the Business Transition Model), or has moved within the region (from the Business Relocation Model), will be located in a particular employment submarket. Submarkets are used as the basic geographic unit of analysis in the current model implementation. Each business has an attribute of space it needs based on the employment within the establishment, and this provides a simple accounting framework for space utilization within submarkets. The number of locations available for an establishment to locate within a submarket will depend mainly on the total square footage of nonresidential floorspace in buildings within the submarket, and on the density of the use of space (square feet per employee).

The model is specified as a multinomial logit model, with separate equations estimated for each employment sector. For both the business location and household location models, we take the stock of available space as fixed in the short run of the intra-year period of the simulation, and assume that locators are price takers. That is, a single locating establishment or household does not have enough market power to influence the transaction price, and must accept the current market price as given. However, the price is iteratively adjusted to account for market equilibrating tendencies as the aggregated demand across all agents increases in some submarkets and decreases in others. This topic is described in a later section on market price equilibration.

The variables included in the business location choice model are drawn from the literature in urban economics. We expect that accessibility to population, particularly high-income population, increases bids for retail and service businesses. We also expect that two forms of agglomeration economies influence location choices: localization economies and inter-industry linkages.

Localization economies represent positive externalities associated with locations that have other firms in the same industry nearby. The basis for the attraction may be some combination of a shared skilled labor pool, comparison shopping in the case of retail, co-location at a site with highly desirable characteristics, or other factors that cause the costs of production to decline as greater concentration of businesses in the industry occurs. The classic example of localization economies is Silicon Valley. Inter-industry linkages refer to agglomeration economies associated with location at a site that has greater access to businesses in strategically related, but different, industries. Examples include manufacturers locating near concentrations of suppliers in different industries, or distribution companies locating where they can readily service retail outlets.

One complication in measuring localization economies and inter-industry linkages is determining the relevant distance for agglomeration economies to influence location choices. At one level, agglomeration economies are likely to affect business location choices between states, or between metropolitan areas within a state. Within a single metropolitan area, we are concerned more with agglomeration economies at a scale relevant to the formation of employment centers. The influence of proximity to related employment may be measured using two scales: a regional scale effect using zone-to-zone accessibilities from the travel model, or highly localized accessibilities using queries of the area immediately around the given parcel. Most of the spatial queries used in the model are of the latter type, because the regional accessibility variables tend to be very highly correlated, and because agglomerations are expected to be very localized.

Age of buildings is included in the model to estimate the influence of age depreciation of commercial buildings, with the expectation that businesses prefer newer buildings and discount their bids for older ones. This reflects the deterioration of older buildings, changing architecture, and preferences, as is the case in residential housing. There is the possibility that significant renovation will make the actual year built less relevant, and we would expect that this would dampen the coefficient for age depreciation. We do not at this point attempt to model maintenance and renovation investments and the quality of buildings.

Density, the inverse of lot size, is included in the location choice model. We expect businesses, like households, to reveal different preferences for land based on their production functions and the role of amenities such as green space and parking area. As manufacturing production continues to shift to more horizontal, land-intensive technology, we expect the discounting for density to be relatively high. Retail, with its concentration in shopping strips and malls, still requires substantial surface land for parking, and is likely to discount bids less for density. We expect service firms to discount for density the least, since in the traditional urban economics models of bid-rent, service firms generally outbid other firms for sites with higher accessibility, land cost, and density.

We might expect that certain sectors, particularly retail, show some preference for locations near a major highway, and are willing to bid higher for those locations. Distance to a highway is measured in meters, using grid spatial queries. We also test for the residual influence of the classic monocentric model, measured by travel time to the CBD, after controlling for population access and agglomeration economies. We expect that, for most regions, the CBD accessibility influence will be insignificant or the reverse of that in the traditional monocentric model, after accounting for these other effects.

Estimation of the parameters of the model is based on a geocoded establishment file (matched to the parcel file to link employment by type to land use by type). A sample of geocoded establishments in each sector is used to estimate the coefficients of the location choice model. As

with the Household Location Choice Model, the application of the model produces demand by each employment type for building locations.

The independent variables used in the business location choice model can be grouped into the categories of real estate characteristics, regional accessibility, and urban-design scale effects as shown below:

- Real Estate Characteristics
 - Prices
 - Development type (land use mix, density)
- Regional accessibility
 - Access to population
 - Travel time to CBD, airport
- Urban design-scale
 - Proximity to highway, arterials
- Local agglomeration economies within and between sectors: center formation

Algorithm

Jobs to be located by this model are those that were added by the EmploymentTransitionModel or predicted to move by the EmploymentRelocationModel. The model selects all those jobs with no location, and identifies all available, vacant nonresidential space within the simulation year. Since the choice sets are generally too large, normally random sampling of alternatives is used to construct plausible sized choice sets. It then uses a Multinomial Logit Model structure to generate location choice probabilities across the choice set for each locating job. The location probabilities are used with Monte Carlo Sampling to make a determination for each job regarding which of the available locations they will choose. Once a job has chosen a location, that location is committed to the job (like a lease or purchase contract) and the space becomes unavailable for any other locating jobs, until such time as the occupying job is predicted to move.

In the current application, the Business Location Choice Model is run iteratively with a price adjustment component, to reflect a short-term price equilibration process.

Configuration

The configuration of the BLCM in the parcel model system is summarized in the following table:

Table P.13: Configuration of Employment Location Choice Model

Element	Setting
Agent	Establishment
Location Set	Employment submarkets - which are defined by jurisdiction, building type, and transit proximity.
Dependent Variable	Location of each establishment: <code>employment_submarket_id</code>
Model Type	Multinomial Logit Model
Estimation Method	Maximum Likelihood
Submodels	Sector - separate models are specified for groups of jobs by employment sector
Independent Variables	Attributes of submarkets: Price, density, accessibility, composition of households and employment

Data

The following tables are used by the Business Location Choice Model:

Table P.14: Data Used by Business Location Choice Model

Table Name	Brief Description
establishment	Establishments table with an inventory of employment
employment_sectors	Employment sectors, defined using NAICS or SIC classifications of industry
buildings	Buildings from which available non-residential sqft are evaluated for location
zones	Zones are used to compute density, social composition, and accessibility variables
travel_data	Skims from the travel model are used to compute accessibility variables

Household Location Choice Model

Objective

The Household Location Choice Model (HLCM) predicts the location choices of new or relocating renter and owner households.

In this model, as in the employment location model, we predict the probability that a household that is either new (from the transition component), or has decided to move within the region (from the household relocation model) and has determined whether to rent or own a unit (from the household tenure choice model), will choose a particular location defined by a residential submarket. As before, the form of the model is specified as multinomial logit, with random sampling of alternatives from the universe of submarkets with vacant housing.

For both the household location and business location models, we take the stock of available space as fixed in the short run of the intra-year period of the simulation, and assume that locators are price takers. That is, a single locating household does not have enough market power to influence the transaction price (or rent), and must accept the current market price as given. However, the price (or rent) is iteratively adjusted to account for market equilibrating tendencies as the aggregated demand across all agents increases in some submarkets and decreases in others. This topic is described in a later section on market price equilibration.

The model architecture allows location choice models to be estimated for households stratified by income level, the presence or absence of children, and other life cycle characteristics. Alternatively, these effects can be included in a single model estimation through interactions of the household characteristics with the characteristics of the alternative locations. The current implementation is based on the latter but is general enough to accommodate stratified estimation, for example by household income.

For the Bay Area application of the model, households are stratified by 4 income categories cross-classified with household size of 1, 2, 3 or more. Income and household size provide a strong basis

for differentiating among consumers with substantially different preferences and trade-offs in location choices.

We further differentiate households by their tenure choice, given the importance of this distinction for understanding the impacts of housing prices and rents on location choices. Predictions of tenure for each household are made by the Household Tenure Choice Model, discussed in Section 4.5.

The variables used in the model are drawn from the literature in urban economics, urban geography, and urban sociology. An initial feature of the model specification is the incorporation of the classical urban economic trade-off between transportation and land cost. This has been generalized to account not only for travel time to the classical monocentric center, the CBD, but also to more generalized access to employment opportunities and to shopping. These accessibilities to work and shopping are measured by weighting the opportunities at each destination zone with a composite utility of travel across all modes to the destination, based on the logsum from the mode choice travel model.

These measures of accessibility should negate the traditional pull of the CBD, and, for some population segments, potentially reverse it. In addition to these accessibility variables, we include in the model a net building density, to measure the input-substitution effect of land and capital. To the extent that land near high accessibility locations is bid up in price, we should expect that builders will substitute capital for land and build at higher densities. Consumers for whom land is a more important amenity will choose larger lot housing with less accessibility, and the converse should hold for households that value accessibility more than land, such as higher income childless households.

The age of housing is considered for two reasons. First, we should expect that housing depreciates with age, since the expected life of a building is finite, and a consistent stream of maintenance investments are required to slow the deterioration of the structure once it is built. Second, due to changing architectural styles, amenities, and tastes, we should expect that the wealthiest households prefer newer housing, all else being equal. The exception to this pattern is likely to be older, architecturally interesting, high quality housing in historically wealthy neighborhoods. The preference for these alternatives are accommodated through a combination of nonlinear or dummy variable treatment for this type of housing and neighborhood.

A related hypothesis from urban economics is that, since housing is considered a normal good, it has a positive income elasticity of demand. This implies that as incomes rise, households will spend a portion of the gains in income to purchase housing that is more expensive, and that provides more amenities (structural and neighborhood) than their prior dwelling. A similar hypothesis is articulated in urban sociology in which upward social mobility is associated with spatial proximity to higher status households. Both of these hypotheses predict that households of any given income level prefer, all else being equal, to locate in neighborhoods that have higher average incomes. (UrbanSim does not attempt to operationalize the concepts of social status or social assimilation, but does consider income in the location choice.)

The age hypothesis and the two income-related hypotheses are consistent with the housing filtering model, which explains the dynamic of new housing construction for wealthy households that sets in motion a chain of vacancies. The vacancy chain causes households to move into higher status neighborhoods than the ones they leave, and housing units to be successively occupied by lower and lower status occupants. At the end of the vacancy chain, in the least desirable housing stock and the least desirable neighborhoods, there can be insufficient demand to sustain the housing stock

and vacancies go unsatisfied, leading ultimately to housing abandonment. We include in the model an age depreciation variable, along with a neighborhood income composition set of variables, to collectively test the housing filtering and related hypotheses.

One of the features that households prefer is a compatible land use mix within the neighborhood. It is likely that residential land use, as a proxy for land uses that are compatible with residential use, positively influences housing bids. On the other hand, industrial land use, as a proxy for less desirable land use characteristics, would lower bids.

The model parameters are estimated using a random sample of alternative locations, which has been shown to provide consistent estimates of the coefficients. In application for forecasting, each locating household is modeled individually, and a sample of alternative cell locations is generated in proportion to the available (vacant) housing. Monte carlo simulation is used to select the specific alternative to be assigned to the household, and vacant and occupied housing units are updated in the cell.

The independent variables can be organized into the three categories of housing characteristics, regional accessibility, and urban-design scale effects as shown below.

- Housing Characteristics
 - Prices (interacted with income)
 - Development types (density, land use mix)
 - Housing age
- Regional accessibility
 - Job accessibility by auto-ownership group
 - Travel time to CBD and airport
- Urban design-scale (local accessibility)
 - Neighborhood land use mix and density
 - Neighborhood Employment

Algorithm

Households to be located by this model are those that were added by the HouseholdTransition-Model or predicted to move by the HouseholdRelocationModel. The model selects all those households of a specified tenure status (renter or owner) that need to find a housing unit, and identifies all available, vacant housing units within the simulation year that are of the appropriate tenure. Since the choice sets are generally too large, normally random sampling of alternatives is used to construct plausible sized choice sets. It then uses a Multinomial Logit Model structure to generate location choice probabilities across the choice set for each household. The location probabilities are used with Monte Carlo Sampling to make a determination for each household regarding which of the available locations they will choose. Once a household has chosen a location, that location is committed to the household (like a rental contract or closing on a purchase of a house) and the residential unit becomes unavailable for any other households, until such time as the occupying household is predicted to move.

Configuration

The configuration of the Household Location Choice Model is summarized in the following table:

Table P.15: Configuration of Household Location Choice Model

Element	Setting
Agent	Job
Location Set	Residential submarkets - which are defined by building type, school district, tenure, and transit proximity
Dependent Variable	Location of each household: submarket_id
Model Type	Multinomial Logit Model
Estimation Method	Maximum Likelihood
Submodels	Separate models can be specified for groups of households
Independent Variables	Attributes of households interacted with attributes of submarkets

Data

The following tables are used by the Household Location Choice Model.

Table P.16: Data Used by Household Location Choice Model

Table Name	Brief Description
households	Synthetic households table
buildings	Buildings from which available residential units are evaluated for location
zones	Zones are used to compute density, social composition, and accessibility variables
travel_data	Skims from the travel model are used to compute accessibility variables

Real Estate Price Model

Objective

The Real Estate Price Model (REPM) predicts the price per unit of each building. For residential units, the sale price is estimated for owner units, and the rent is estimated for rental units. UrbanSim uses real estate prices as the indicator of the match between demand and supply of land at different locations and with different land use types, and of the relative market valuations for attributes of housing, nonresidential space, and location. This role is important to the rationing of land and buildings to consumers based on preferences and ability to pay, as a reflection of the operation of actual real estate markets. Since prices enter the location choice utility functions for jobs and households, an adjustment in prices will alter location preferences. All else being equal, this will in turn cause higher price alternatives to become more likely to be chosen by occupants who have lower price elasticity of demand. Similarly, any adjustment in land prices alters the preferences of developers to build new construction by type of space, and the density of the construction.

We make the following assumptions:

1. Households, businesses, and developers are all price-takers individually, and market adjustments are made by the market in response to aggregate demand and supply relationships.
2. Location preferences and demand-supply imbalances are capitalized into land values. Building value reflects building replacement costs only, and can include variations in development costs due to terrain, environmental constraints or development policy.

Following on these assumptions and the best available theory regarding real estate price formation, we begin with a reduced-form hedonic regression model to establish the initial price and rent estimates based on structural and locational attributes, and combine this with a second step that incorporates short-term (within a year) market equilibrating tendencies.

Hedonic Price Regression

Real estate prices are modeled using a hedonic regression of the log-transformed property value per square foot on attributes of the parcel and its environment, including land use mix, density of development, proximity of highways and other infrastructure, land use plan or zoning constraints, and neighborhood effects. The hedonic regression may be estimated from sales transactions if there are sufficient transactions on all property types, and if there is sufficient information on the lot and its location. An alternative is to use tax assessor records on land values, which are part of the database typically assembled to implement the model. Although assessor records may contain biases in their assessment, they do provide virtually complete coverage of the land (with notable exceptions and gaps for exempt or publicly owned property).

The hedonic regression equation encapsulates interactions between market demand and supply, revealing an envelope of implicit valuations for location and structural characteristics. Prices are updated by UrbanSim annually, after all construction and market activity is completed. These end of year prices are then used as the values of reference for market activities in the subsequent year. The independent variables influencing land prices can be organized into site characteristics, regional accessibility, and urban-design scale effects, as shown below:

- Site characteristics
 - Development type
 - Land use plan
 - Environmental constraints
- Regional accessibility
 - Access to population and employment
- Urban design-scale
 - Land use mix and density
 - Proximity to highway and arterials

Algorithm

The Real Estate Price Model uses a hedonic regression structure, which is a multiple regression, estimated using Ordinary Least Squares (OLS), normally with the price specified as a log of price.

Configuration

The configuration of the REPM in the parcel model system is summarized in the following table:

Table P.17: Configuration of Real Estate Price Model

Element	Setting
Dataset	Buildings
Dependent Variable	Log of Price Per Unit (per housing unit for residential, per square foot for non-residential buildings)
Model Type	Regression
Submodels	Separate models are specified for each type of building
Independent Variables	Constant, and attributes of building: density, accessibility, zonal composition of households and employment

Data

These tables are used by the Real Estate Price Model:

Table P.18: Data Used by Real Estate Price Model

Table Name	Brief Description
buildings	Individual buildings located on parcels (can be many per parcel)
residential_units	Individual residential units located within a building
zones	Zones used in the travel model, for accessibility and density variables
travel_data	Zone-to-zone skims from the travel model, for accessibility variables
households	Household data, for socioeconomic and density variables
jobs	Employment data, for accessibility and density variables

Market Price Equilibration

Once initial market prices are estimated within a simulation year...

Real Estate Developer Model

Objective

The Real Estate Developer Model simulates the location, type and density of real estate development, conversion and re-development events at the level of specific parcels. The design draws partly on the parcel-level real estate development model created for the Puget Sound, which generates development proposals based on pre-defined templates. It generalizes the concept of templates to allow the developer model to configure multiple parameters of development projects in order to maximize profitability of development outcomes, subject to local physical, regulatory and market contexts.

Algorithm

This model is a process for evaluating a proforma for each building type allowed by zoning which should indicate the profitability of a development given a set of inputs which specify the context described above.

The proforma can be conceptualized as a spreadsheet implemented in Python code which performs cash flow analysis with standard financial discounting of cash flows. In this case, the developer model optimizes the building form so that it creates the building type and size which result in the greatest profitability (NPV) for each parcel.

The term developer model usually refers to this "outer loop" which optimizes the building form while the "pro forma" actually computes profitability based on cash flows given a specific set of inputs.

The code for the developer model is found in `urbansim_parcel/proposal.developer_model.py` is the controlling function for this module - `bform.py` stores the building form currently used, `profroma.py` does the cash flow accounting, and `devmdl_optimize.py` performs the optimization.

Below is the complete set of inputs - the first section is the set of modeled inputs (i.e. output from another model) and the second section are exogenous inputs which are basic attributes of the parcel. The output of the model is simple: a single net present value and the building type and size of the building which results in the specified optimized NPV.

For this application, the developer model runs each simulated year on all empty parcels, on all parcels within a PDA, on parcels within 800m of Caltrain and BART, and a sampled portion of the other parcels to capture redevelopment of parcels.

For redevelopment, demolition cost is computed through one of the following: the value of residential owner housing, a simple multiplier for residential rental housing, the price estimated for nonresidential sqft, and a land price based on the value of nearby building prices.

Policies enter the developer model by the zoning (primarily by allowed FAR and building types), and also with a parcel subsidy/fee that is specified for each parcel.

The Role of Accessibility

Accessibility is a very important influence in urban space, and it similarly plays an important role in UrbanSim. Almost all models in UrbanSim consider the effects of accessibility. But unlike the monocentric or spatial interaction models, in which the choice of workplace is exogenous and residential locations are chosen principally on the basis of commute to the city center or to a predetermined workplace, we deal with accessibility in a more general framework. Accessibility is considered a normal good, like other positive attributes of housing, which consumers place a positive economic value on. We therefore expect that consumers value access to workplaces and shopping opportunities, among the many other attributes they consider in their housing preferences. However, not all households respond to accessibility in the same way. Retired persons would be less influenced by accessibility to job opportunities than would working age households, for instance.

We operationalize the concept of accessibility for a given location as the distribution of opportunities weighted by the travel impedance, or alternatively the utility of travel to those destinations. A number of alternative accessibility measures have been developed in UrbanSim. The utility of travel is measured as the composite utility across all modes of travel for each zone pair, obtained as the logsum of the mode choice for each origin-destination pair. We will evaluate alternative accessibility measures during model estimation and make a final decision on which measures to use based on those results.

The accessibility model reads the logsum matrix from the travel model and the land use distribution for a given year, and creates accessibility indices for use in the household and business location choice models. The general framework is to summarize the accessibility from each zone to various activities for which accessibility is considered important in household or business location choice.

Since UrbanSim operates annually, but travel model updates are likely to be executed for two to three of the years within the forecasting horizon, travel utilities remain constant from one travel model run until they are replaced by the next travel model result. Although travel utilities remain constant, the activity distribution in these accessibility indices is updated annually, so that the accessibility indices change from one year to the next to reflect the evolving spatial distribution of activities.

Table P.19: Data Used by Real Estate Developer Model

Variable Name	Brief Description
PRICES	
single family	Price estimate for single-family housing
multi family	Price estimate for multi-family housing
rent single family	Rent estimate for single-family housing
rent multi family	Rent estimate for multi-family housing
office	Rent estimate for the office building type
retail	Rent estimate for the retail building type
industrial	Rent estimate for the industrial building type
ABSORPTION	
sales absorption	The absorption rate for sales units by building type
sales vacancy	The vacancy rate for sales units by building type
rent absorption	The absorption rate for rental units by building type
rent vacancy rates	The vacancy rate for rental units by building type
SIZES	
average lot size	Typical lot size in the zone for this parcel
sf unit size	Typical single-family unit size in the zone for this parcel
mf unit size	Typical multi-family unit size in the zone for this parcel
ZONING	
building types	Allowable building types for this parcel
FAR	Floor area ratio allowed for this parcel
height	Height limits for this parcel
max_dua	Max dwelling units for this parcel
POLICIES	
ISR	Whether to apply indirect source rule. ISR subsidies are user-specified
unit subsidy	User-specified per-unit subsidies
per sqft subsidy	User-specified per-unit subsidies for non-residential square feet

User-Specified Events

Given our current understanding, no model will be able to simulate accurately the timing, location and nature of major events such as a major corporate relocation into or out of a metropolitan area, or a major development project such as a regional shopping mall. In addition, major policy events, such as a change in the land use plan or in an Urban Growth Boundary, are outside the range of predictions of our simulation. (At least in its current form, UrbanSim is intended as a tool to aid planning and civic deliberation, not as a tool to model the behavior of voters or governments. We want it to be used to say "if you adopt the following policy, here are the likely consequences," but not to say "UrbanSim predicts that in 5 years the county will adopt the following policy.")

However, planners and decision-makers often have information about precisely these kinds of major events, and there is a need to integrate such information into the use of the model system. It is useful, for example, to explore the potential effects of a planned corporate relocation by introducing user-specified events to reflect the construction of the corporate building, and the relocation into the region (and to the specific site) of a substantial number of jobs, and examine the cumulative or secondary effects of the relocation on further residential and employment location and real estate development choices. Inability to represent such events, in the presence of knowledge about developments that may be 'in the pipeline,' amounts to less than full use of the available information about the future, and could undermine the validity and credibility of the planning process. For these reasons, support for three kinds of events has been incorporated into the system: development events, employment events, and policy events.

Appendix Q. SCAG PECAS Estimated Aggregated TOD Impacts

Overall Consumer Surplus Measures

The integration of economic modelling with random utility modelling in the PECAS formulation allows the calculation of composite utility measures that are consistent with Consumer Surplus (Producer Surplus) measures, which is the difference of the willingness to pay to the actual price paid for commodities. If a household pays \$1000 per month for their housing, while it is affordable and willing to pay \$1500, the household gains a surplus of \$500. These measures take into account households' and industries' tradeoffs between transportation, space/housing, technology/lifestyle, with error terms representing the advantages of variety and choice options (the *raison d'être* of large cities), with endogenous prices serving to balance supply and demand spatially.

In many modelling frameworks, the competing metrics of transportation services, land affordability, access to services and labor force mobility must be tabulated separately, and combined with care not to double-count into a measure of overall scenario performance. The PECAS AA module is designed to contain a complete representation of the spatial economy within a consistent theoretical framework, and, therefore, the relative tradeoffs between different elements of travel, location, land use, etc., are included in PECAS. This ability to combine the analysis is relevant in this study since gains in one dimension (e.g. better transit service) can be analyzed together with losses in other dimensions (e.g. less affordable housing). See (J.E. Abraham and Hunt 2007) for a detailed description of the comprehensive presentation of the economic system and its use for scenario comparison.

Benefits are calculated by comparing the SCAG PECAS version of “with” the estimated TOD-related parameters, *SD10*, against the *SDBU*, the version “without” parameters. The gains in consumer surplus due to the calibrated change in TOD desirability are shown in Table Q.1. The observed target displacement of low income households, changes in median income, and changes in rent in around TOD zones was achieved through changes in TOD attractiveness that caused a general increase in welfare of all types of households in the model. This is further investigated spatially in the following sections.

Net Rent Change

The AA module in PECAS is comprehensive in that it represents all of the transactions that occur in the economy, with both parties of a transaction - buyer and seller - represented. However, the landlords (and other property owners), and developers, are not represented in the AA module since they are normally modelled behaviorally in the SD module. When rents increase, there is a dis-benefit to the payers of rent (tenants), but it is a benefit to the receivers of rent (landlords or profits for developers).

The benefit to landlords/developers is calculated separately, as the net change in rent received, and is shown in Table Q.1 and Figure Q.1, separated into the housing types in the model. A decrease in the total rent charged for low density (single family) housing is apparent, and there is an increase in the rent charged for high-rise space.

The total benefit is \$1.647 billion, and it does not include any rent leakage to absentee landlords. In other words, the owner-occupied dwellings are represented as if they are rented to the owner household, so increases in owner-occupied home value are included as a mitigating dis-benefit in the consumer surplus measures of Table Q.1, and a corresponding benefit.

Table Q.1: Annual Gains and Losses due to Displacement

Activity		Consumer surplus change	Benefit per Household
Households	INC0010 2 or less	\$184.9 M	\$260
	INC0010 3 or more	\$39.8 M	\$342
	INC1025 2 or less	\$131.6 M	\$272
	INC1025 3 or more	\$110.1 M	\$307
	INC2550 2 or less	\$220.4 M	\$285
	INC2550 3 or more	\$236.1 M	\$300
	INC5075 2 or less	\$135.2 M	\$321
	INC5075 3 or more	\$177.8 M	\$341
	INC75100 2 or less	\$72.7 M	\$372
	INC75100 3 or more	\$119.0 M	\$387
	INC100150 2 or less	\$69.5 M	\$306
	INC100150 3 or more	\$115.2 M	\$352
	INC150m 2 or less	\$67.4 M	\$272
	INC150m 3 or more	\$81.7 M	\$286
Business	Office	\$1.4 M	
	Other	\$9.5 M	
	Goods	\$20.5 M	
	Services	\$30.4 M	
	Exporters	-\$0.2 M	
	Importers	-\$27.8 M	

Table Q. 2: Aggregate Rent Change

Space types	Rent Change
VL Luxury	-6.6 M
VL Economy	-1.5 M
L Luxury	-111.2 M
L Economy	-78.5 M
MD Separate Entrance	-1.3 M
MD Shared Entrance	-0.5 M
Higher Density	-0.8 M
High-rise	41.3 M
Urban MH	11.1 M



Figure Q.1: Aggregate Rent Change (visual representation of previous table)

Benefits Categorized by Commodity

A portion of the consumer surplus measures from the previous section is due to the changes of interaction between buyers and sellers. In the PECAS AA, the most frequently updated choice in its calculation process is the economic interactions between buyers and sellers, with one party usually travelling (e.g. to work, to school) and paying the transport cost. Figure Q shows the benefits and dis-benefits due to transactions. It is shown that much of the benefit is due to lower prices paid for low density single family dwellings (ResType3 and ResType4).

Notably, there are dis-benefits due to the transport costs of acquiring some household services including Retail, Restaurant, Personal Services, Education and Amusements. It is worth noting that *the zone-to-zone costs of transportation* were not changed in this analysis, and the same zone-to-zone travel time and cost matrix was used, while the attractiveness of TODs was instead simulated via a change in zonal attractiveness. Therefore, increases in transportation costs in Figure Q represent further distances travelled to certain types of personal services when households cluster closer to TODs. The current availability of retail service type space in TOD zones does not seem to be adequate to allow services to also cluster in TODs. It is important to allow for the development of non-residential space in adequate quantity to allow services to follow changes in household locations.

Spatial Benefit Measures

The impact of displacement on low income groups can better be understood through spatial maps. Figure Q.2 shows the benefit measures for the lowest income households. The outline color of the zone shows the downtown TOD and non-downtown TOD zones, while the interior coloring of the zones shows the estimated aggregate benefits for the household category.

Low income households are seen to be receiving benefits in the non-downtown TODs, with a substantially smaller negative impact in the downtown TODs. Outside of the TODs, low income households are receiving a small benefit.

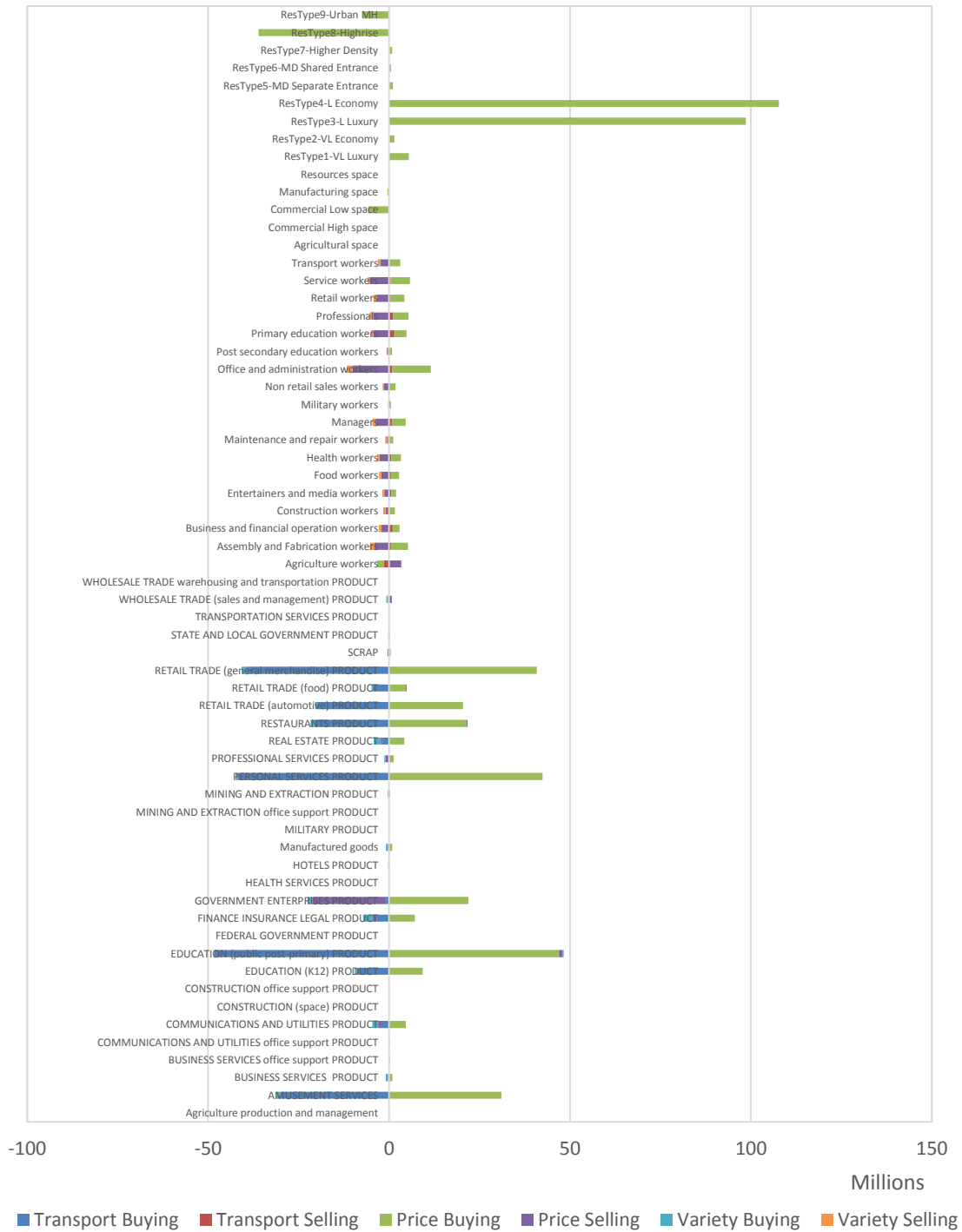

Figure Q.2: Benefits and Dis-benefits Due to Transactions

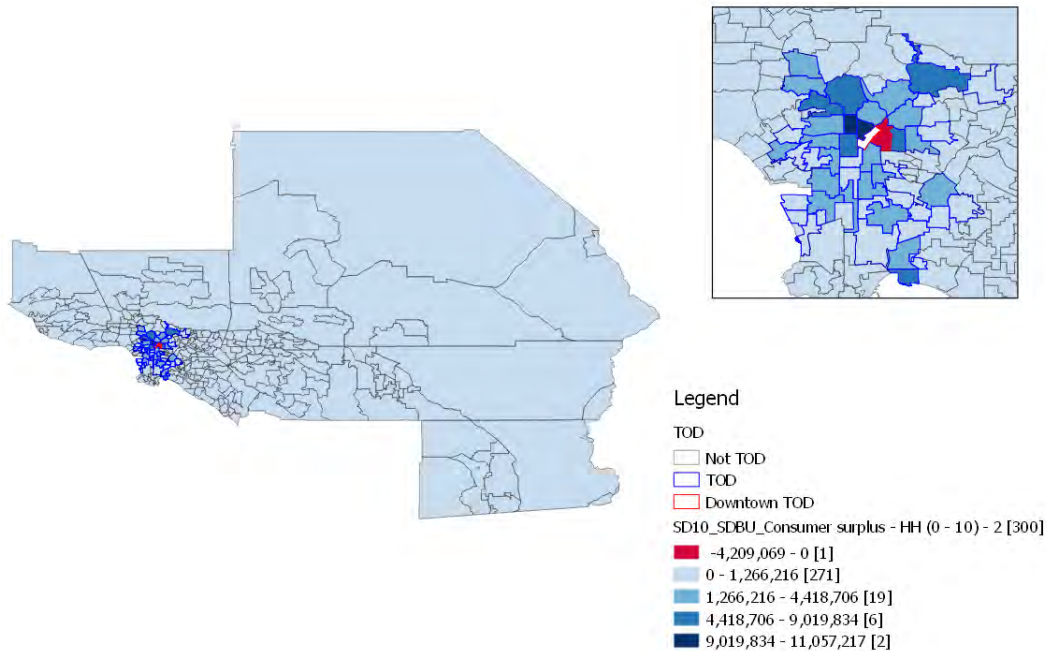

Figure Q.2: Benefit measures for Households with \$0 - \$10k income and 2 or less

Figure Q.4 shows the aggregate benefits to households in the 100-150k income group of size 3 or more. The aggregate benefits are smaller relative to that of the low income group and much of the benefit occurs in suburban zones. Even though the portion of wealthy people increases in the TOD zones in the scenario, these larger households (many with children) in the second highest income category are not generating most of their benefits from TOD zones. Rather, their benefits are predominantly due to effects in non-TOD zones, for instance slightly lower rents in the rest of the region could be benefitting these wealthier suburban households.

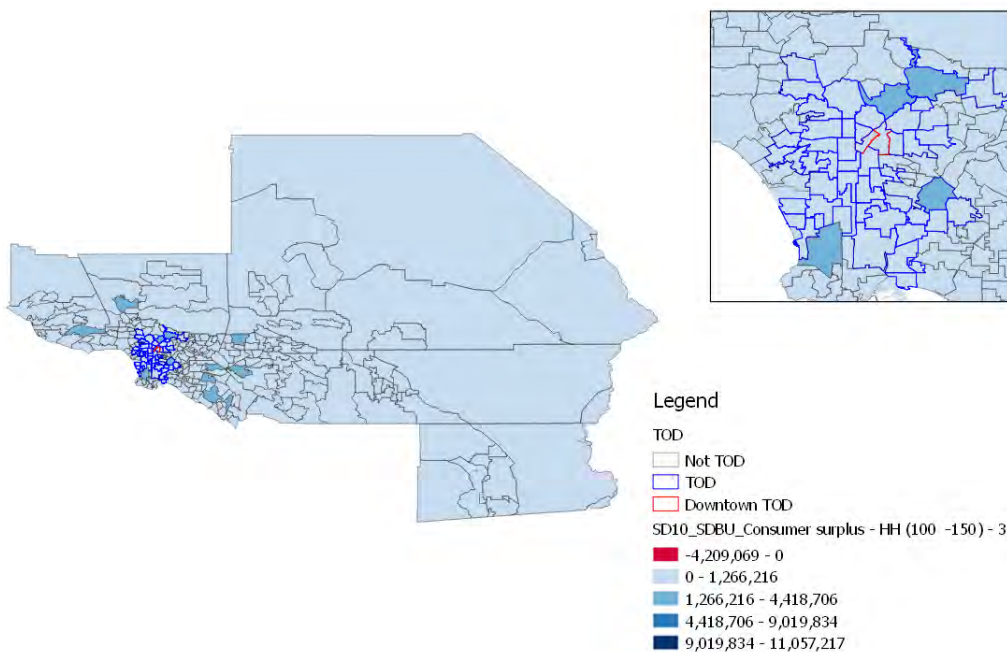

Figure Q.4: Benefits to households in \$100K - \$150k income and 3 or more

Housing Consumption Changes

The PECAS model represents housing choices, with flexibility in choice of dwelling type, the quantity of housing (measured in square feet) and the location of housing. Figure shows the changes in the amount of housing in square feet consumed by each household category with the scenario, in the TOD zones. There is an increase in space use associated with higher numbers of households in the TOD zones, with most of the increased use occurring in the Low Density Economy category (ResType4).

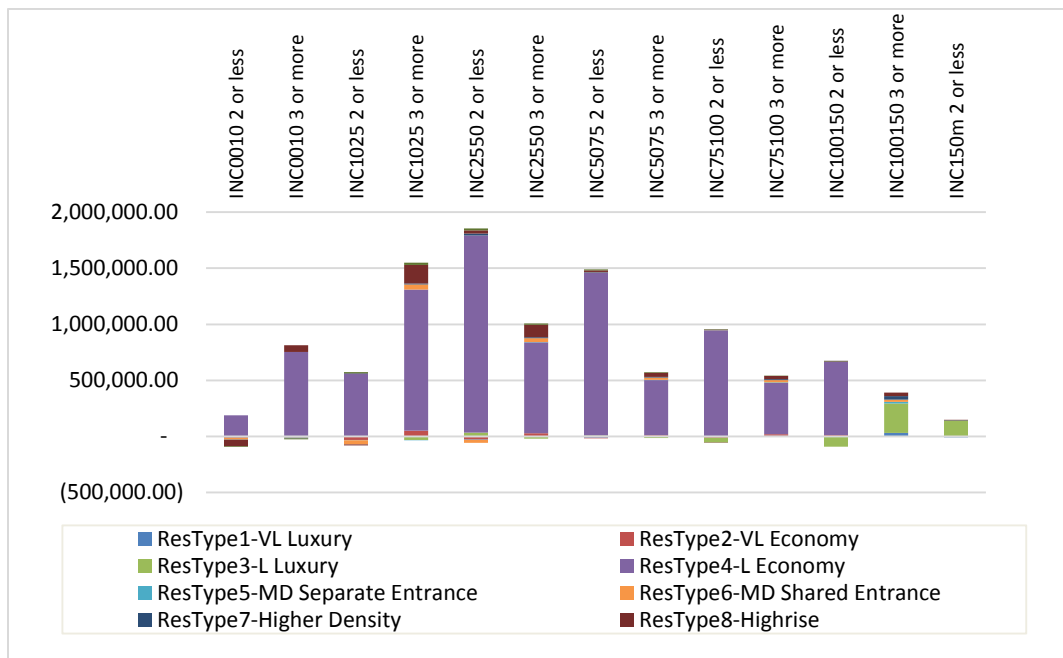

Figure Q.5: Change in Consumption of Housing in TOD zones (sq. ft.)

Figure shows the region-wide change in housing consumption. The lower income categories of households end up using less space overall, since they squeeze into the single family dwelling space dominant around the TOD zones. The higher income households use more space overall. The pattern of changes in high-rise space consumption indicates a displacement, with higher income households consuming more high-rise space, and thus lower income households consuming less space per household.

Figure shows the number of households in each space type in the TOD zones in each scenario, and Figure shows its changes. Households are moving predominantly into low density economy space and high-rise dwellings in these zones. This is a partial reflection of the existing housing stock in these zones. Households who prefer to move into TOD zones in the SD10 scenario will consume the existing types of space in TOD zones, which are predominantly low density (single family) “economy” dwellings.

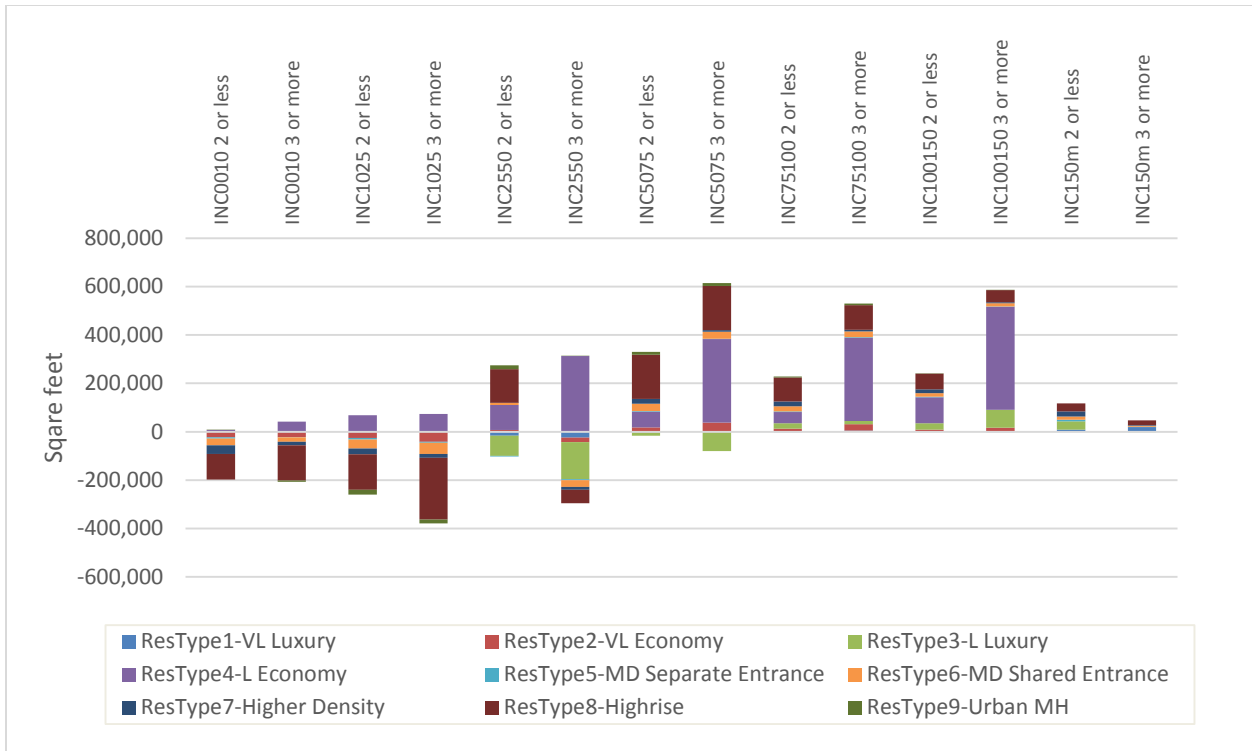

Figure Q.6: Change in Consumption of Housing in Region (sq. ft.)

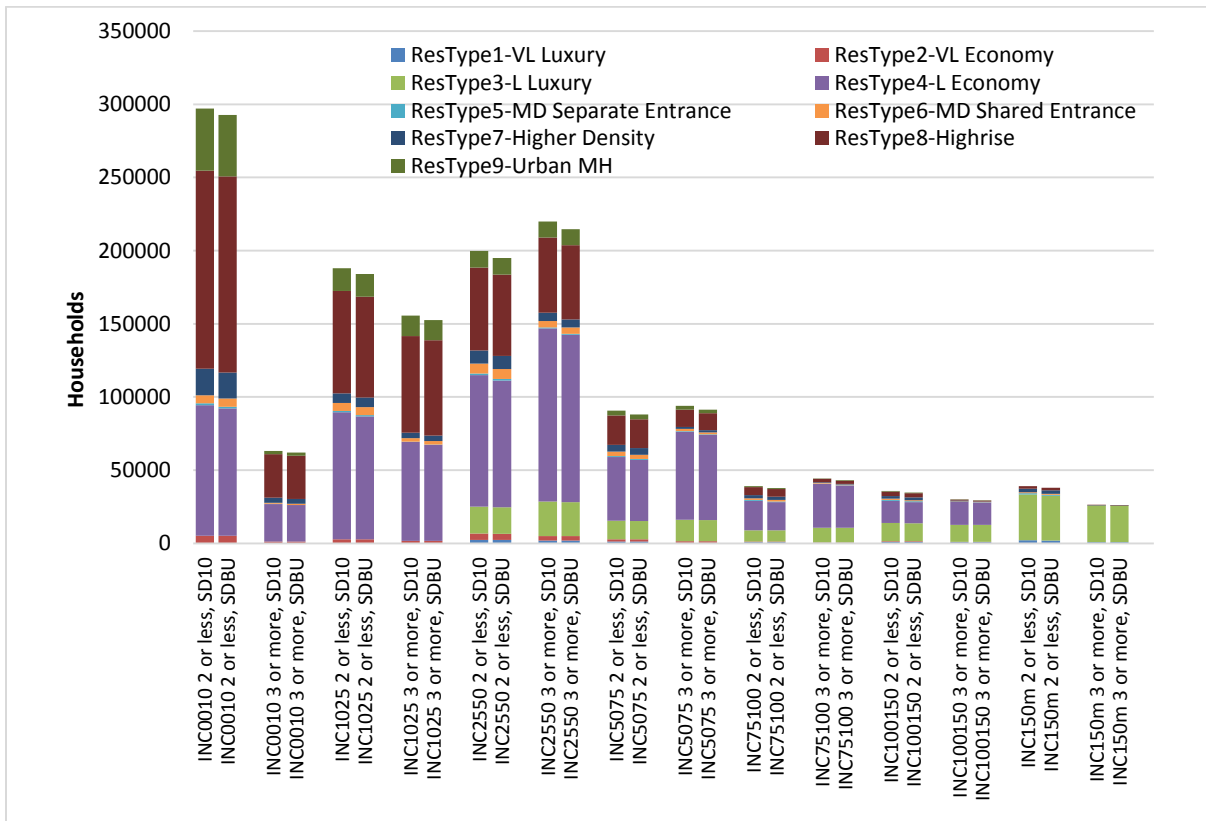

Figure Q.7 Number of Households in Each Housing Type in Each Scenario, in the TOD Zones

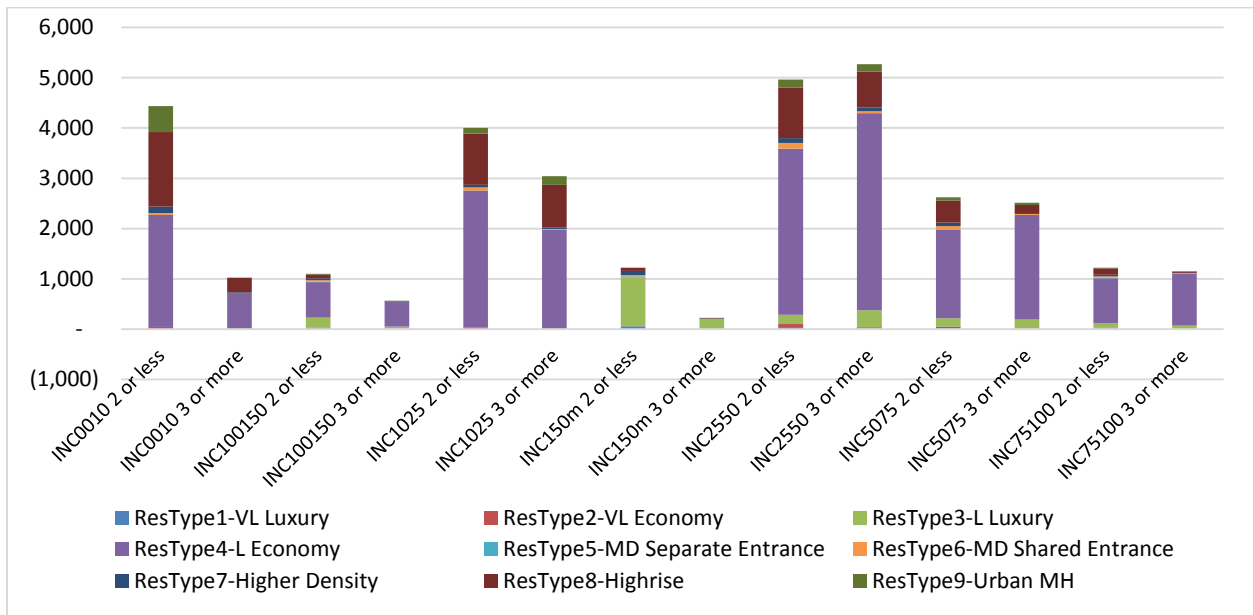

Figure Q.8: Shift in housing type in TOD zones

Figure shows the changes in the number of households in different types of space in the entire region. When households move to TOD zones in this scenario, most households choose the same type of housing that they were choosing in their former zones. A dominant shift is the move away from “luxury” single family dwellings (representing the larger dwellings) into high-rise and “economy” single family dwellings, representing the more modest single family dwellings that dominate the current stock of housing in the TOD zones.

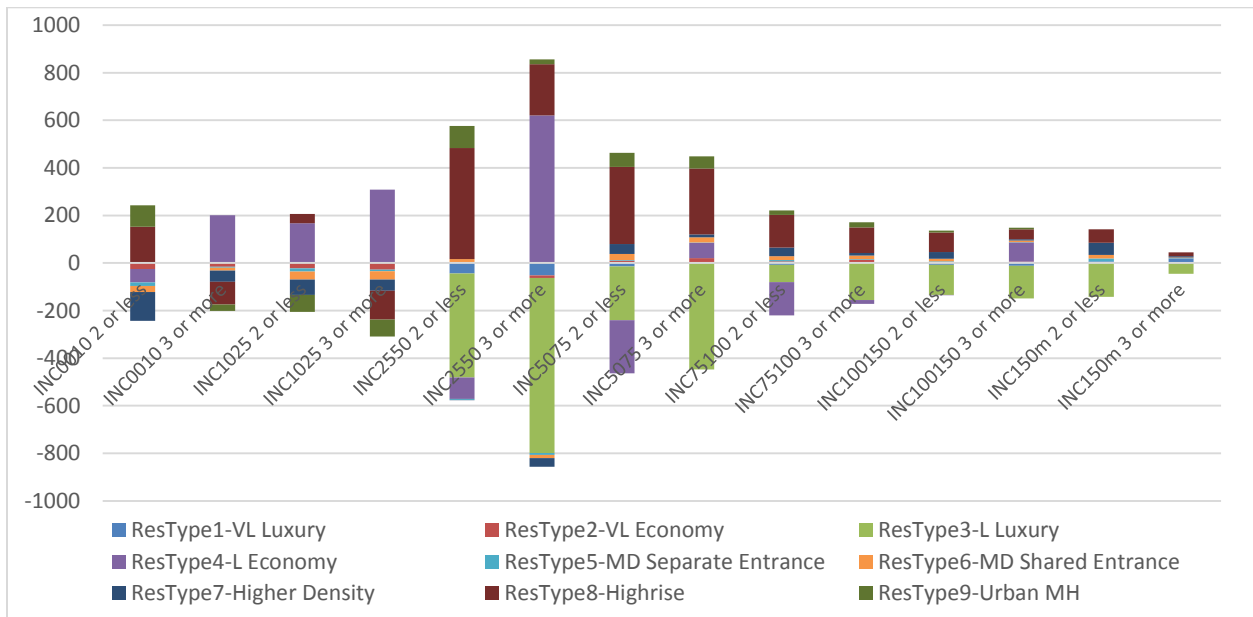

Figure Q.9: Shift in housing type region-wide

Appendix R. In- and Out- Migration Regression Results

We initially ran regressions for both in and out migration rates including an extensive list of control variables. Table R.1 presents the regression results for both regions. The model shows that once we control for all other observed factors, TODs, specifically Downtown TOD, seem to dampen out-migration (a negative coefficient) in Los Angeles. This indicates that fewer people are moving out. Although the direction of the coefficient is the same for the Bay Area, the relationship was not significant. This may have to do with how Downtown TOD was defined, as being any TOD within the city boundaries of San Francisco, San Jose, and Oakland, which encompassed nearly half of all TODs in the region. While the model does produce a positive coefficient on in-migration (indicating that people are moving in), for both TOD variables the value is not statistically significant in Los Angeles. In the Bay Area, in-migration was positively correlated with Downtown TODs, although it was not statistically significant. On the other hand, TODs appear to dampen in-migration outside of the three main cities. One of the problems with this larger model is that many of the variables are collinear, producing problems of multi-collinearity and endogeneity.

**Table R.1: In- and Out-Migration, Multivariate Regressions,
LA County and SF Bay Area 2009-13**

	In-Migration		Out-Migration	
	Los Angeles	Bay Area	Los Angeles	Bay Area
Intercept	2.930051 ***	0.0894008 *	2.120327 **	-0.11876 *
Median Age	-0.00339 ***	-0.0030345 ***	-0.00237 ***	0.00323 ***
Percentage of the Population Who are Female	-0.00065 **	0.0139567	-0.00019	-0.08772 *
Percentage of Population Between 25 and 35	0.000842 ***	0.1274436 ***	0.000678	-0.10029 **
Percentage of the Population 65 Years & Over	0.000166	0.0580711 *	-0.00105 **	-0.00527
Percent Currently Enrolled in College	0.000789 ***	0.1834657 ***	0.000713 ***	-0.11993 ***
Percent non-Hispanic black	-0.00006	0.0057104	-0.00015	0.01332
Percent Asian	0.000191 *	-0.0119541	0.000294 *	0.01703
Percent Hispanic or Latino	-0.00062 ***	-0.053071 ***	-0.00049 ***	0.06869 ***
Percent of the Population in Poverty	0.001105 ***	0.0892205 ***	0.000875 ***	-0.03032
Percent Renters	0.000951 ***	0.1125053 ***	0.000876 ***	-0.09859 ***
Percent Vacancy	0.00032	0.0047989	0.00086 ***	-0.06506 **
Percent of Renters That are Housing Burdened	0.000213 **	0.0331735 **	0.000164	-0.01575
Percent of Households With Children	-0.00018	0.0032998	-0.00076 ***	0.05627 *
Percent Female Headed Households	-0.00021		-0.0001	
Median Household Income (/10,000)	0.006448 **	0.0002876	0.000461	0.0047
Median Household Income Squared	-0.00021 **	0.0001503 *	0.000011	-0.00032 ***
20/80 Ratio (Household Income) ¹	-0.01486	0.0763761 ***	-0.01853	-0.08849 ***
Percent of Population Who are Foreign-Born	-0.00095 ***	-0.0818435 ***	-0.00103 ***	0.04187
Percent of Available Section 8 Units	-0.0005	0.0669784	-0.00052	-0.0436
Percentage of LIHTC Units	-0.00003	-0.0336884 *	-0.00032	0.05858 **
Percentage of Public Housing Units	-0.00037	-0.0948952 ***	-0.00131 ***	0.1004 **
Jobs to Household Ratio (LEHD, 2011)	0.000992 **	0.0004233	0.000261	-0.00028
Percent of the Population in Group Quarters	0.00264 ***	0.3606687 ***	0.002332 ***	-0.38737 ***
Percent of Residential Structures With 20 or More Units	0.000866 **	0.1003296 ***	0.000619 ***	-0.08144 ***
Percent of Residential Buildings Built Pre 1950	-0.00006	-0.0171072 ***	-0.0001	0.02137 **
Tracts Within a Mile of the Beach	0.013456 ***		0.003896	
Tracts Located on Hilly Areas	0.007143 *		0.004643	
Percent of Affordable Rental Units	-0.00038 ***	-0.0018706	-0.00033 **	0.01037
Area With Rent Regulation	-0.00635 **	-0.0034646	-0.00727 *	0.00345
Percent Open Space ²	-0.00003	-6.15E-07	-0.00001	8.94E-07
Tracts in North LA County	0.010927 *		0.001999	
CalEnviro Pollution Score	0.000017		0.00021	
Change in Median Gross Rent (06-10 - 09-13)	-0.01203	-0.0030426	-0.03363 ***	0.014 ***
Change in Median Home Value (06-10 - 09-13)	2.731555 ***	-0.0197218 **	1.908278 *	0.03138 ***
Joint Development Project	-0.01821 ***		-0.01318	
Downtown TOD ³	0.012943	0.0033894	-0.07127 ***	-0.00666
Other TOD Neighborhood	0.000033	-0.006383 **	-0.00104	0.0073
Adjusted R-Squared	0.56236	0.5939	0.38797	0.4317
n	2,224	1545	2,224	1545

*** P<.01, ** p<.05, *p<.10

¹ The entropy index was used for the Bay Area, which measures the degree of income inequality

² Open space density (per 1,000 population) was used for the Bay Area

³ For the Bay Area, Downtown TODs were considered any TODs (within <1/2 mile of a rail station) in SF, San Jose, and Oakland

Source: 2006-10, 2009-13 ACS

Tabulations by C.Pech & P. Ong, May 2015, M. Zuk Aug 2015

Appendix S. Average Daily VMT by Income and Rail Access

Table S.1: Statewide average daily household VMT by income and rail access, NHTS 2009, and CHTS 2010-2012

NHTS 2009							
	Near Rail		Away Rail		VMT difference		t-test
Income categories	VMT	N	VMT	N	% of VMT difference	Absolute VMT difference	
<\$50k	32.6	411	40.5	7,958	19.57%	7.92	3.08
\$50k-\$75k	49.4	115	60.4	3,116	18.14%	10.95	3.04
\$75k - \$100k	47.4	90	71.9	2,577	34.10%	24.53	5.76
>\$100k	60.5	159	80.4	5,244	24.69%	19.85	5.97
Did not report		72		1,483			
Total	41.9	847	58.0	20,378	27.88%	16.18	9.84
CHTS 2010-2012							
	Near Rail		Away Rail		VMT difference		t-test
Income categories	VMT	N	VMT	N	% of VMT difference	Absolute VMT difference	
<\$50k	16.6	882	28.6	13,481	42.08%	12.04	9.75
\$50k-\$75k	29.3	358	44.6	6,544	34.41%	15.36	4.66
\$75k - \$100k	29.6	287	50.4	5,581	41.31%	20.81	6.63
>\$100k	35.3	693	59.1	10,964	40.23%	23.78	13.06
Did not report		197		3,444			
Total	26.1	2,417	43.5	40,014	40.11%	17.46	18.16

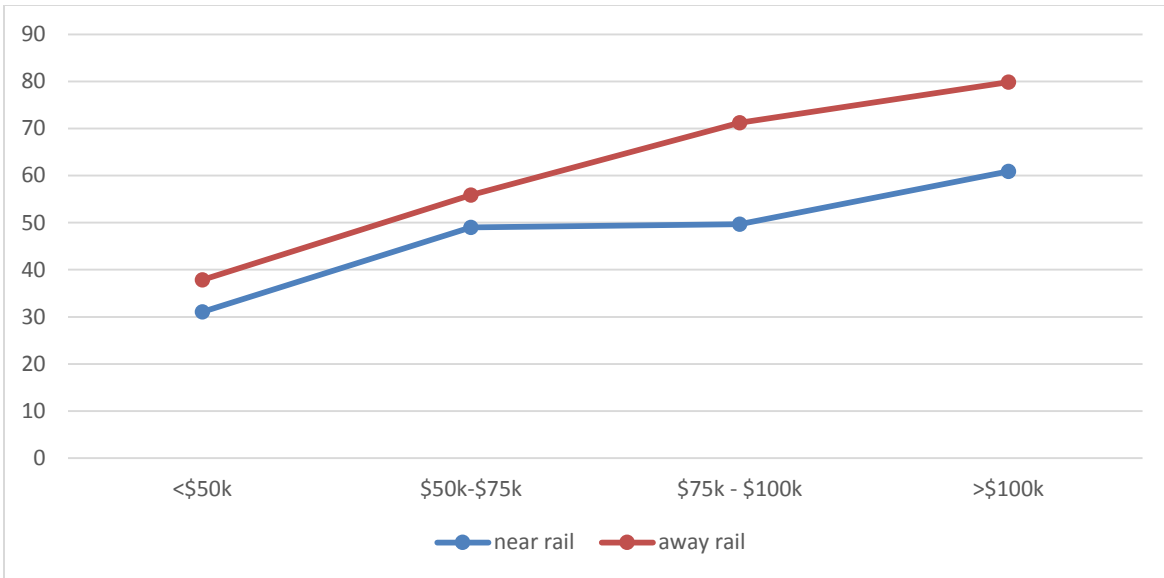

Figure S.1: Statewide average daily household VMT by income and rail access (NHTS 2009 data)

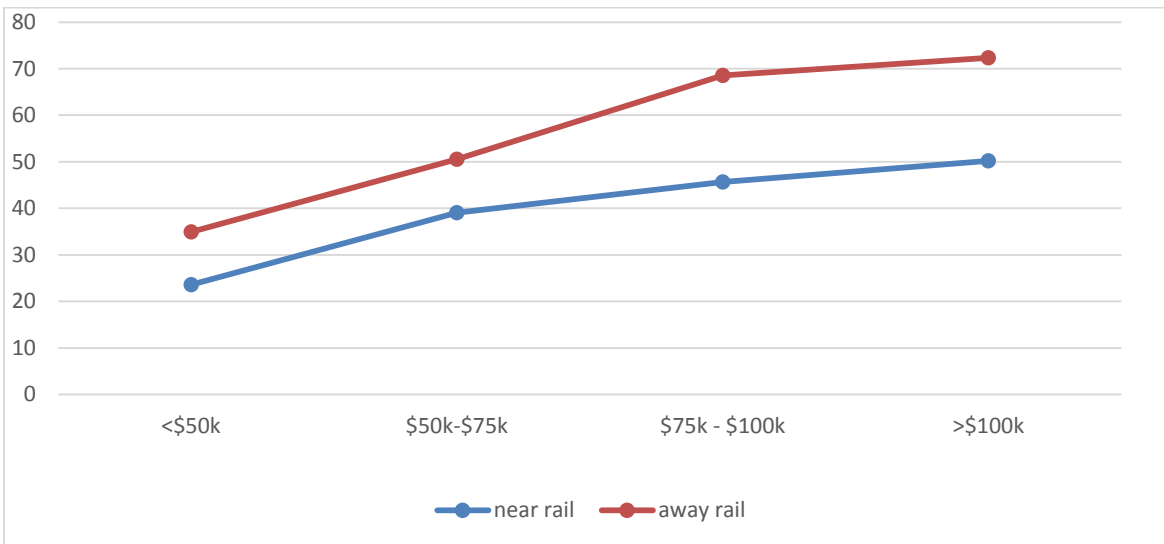

Figure S.2: Statewide average daily household VMT by income and rail access (CHTS data)

Table S.2 Average daily household VMT by income category and rail access, San Francisco Bay Area only, NHTS 2009, and CHTS 2010-2012

NHTS 2009							
	Near Rail		Away Rail		VMT difference		t-test
Income categories	VMT	N	VMT	N	% of VMT difference	Absolute VMT difference	
<\$50k	23.58	147	34.95	1,134	32.53%	11.37	4.12
\$50k-\$75k	39.04	63	50.52	636	22.72%	11.48	3.07
\$75k - \$100k	45.67	58	68.56	538	33.39%	22.89	4.18
>\$100k	50.22	99	72.34	1,311	30.58%	22.12	6.59
Total	36.91	367	56.23	3619	34.36%	19.32	10.04
CHTS 2010-2012							
	Near Rail		Away Rail		VMT difference		t-test
Income categories	VMT	N	VMT	N	% of VMT difference	Absolute VMT difference	
<\$50k	14.17	391	26.78	1,716	47.09%	12.61	7.13
\$50k-\$75k	22.69	244	36.67	1,234	38.12%	13.98	3.44
\$75k - \$100k	24.18	227	44.09	1,240	45.16%	19.91	6.81
>\$100k	31.85	564	54.42	3,635	41.47%	22.57	11.56
Total	23.36	1,426	38.31	7,825	39.02%	14.95	15.64

¹ This is insignificant.

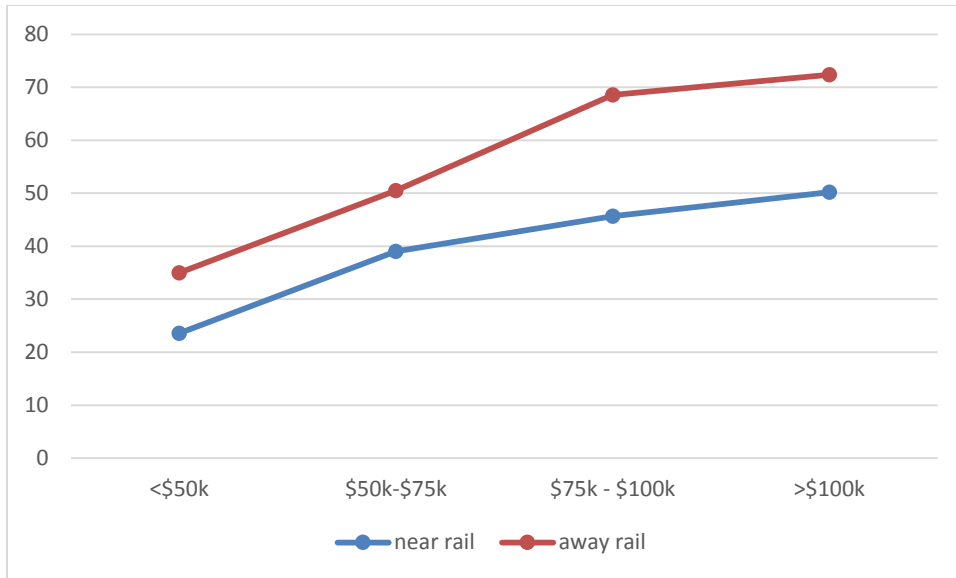

Figure S.3: Average daily household VMT by income and rail access, SF Bay Area only (NHTS data)

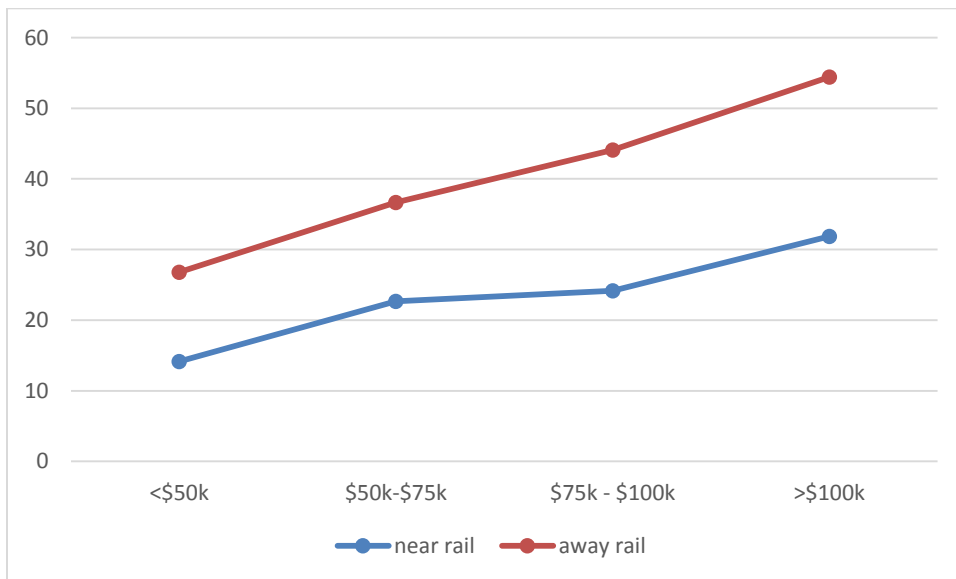

Figure S.4: Average daily household VMT by income and rail access, SF Bay Area only (CHTS data)

Table S.3: Average daily household VMT by income category and rail access, Los Angeles region only, NHTS 2009, and CHTS 2010-2012

NHTS 2009							
	Near Rail		Away Rail		VMT difference		t-test
Income categories	VMT	N	VMT	N	% of VMT difference	Absolute VMT difference	
<\$50k	28.06	117	38.53	2,677	27.17%	10.47	2.71
\$50k-\$75k	63.71	26	58.8	1,186	-8.35%	-4.91	(-0.44) ¹
\$75k - \$100k	50.12	10	74.36	925	32.60%	24.24	2.05
>\$100k	65.29	15	82.38	1,660	20.75%	17.09	2.32
Total	38.05	168	59	6,448	35.17%	20.64	5.85
CHTS 2010-2012							
	Near Rail		Away Rail		VMT difference		t-test
Income categories	VMT	N	VMT	N	% of VMT difference	Absolute VMT difference	
<\$50k	18.04	355	27.15	4,188	33.55%	9.11	4.75
\$50k-\$75k	38.28	105	39.78	2,130	3.77%	1.5	(0.23) ¹
\$75k - \$100k	35.25	74	46.27	1,951	23.82%	11.02	2.62
>\$100k	47.15	97	56.22	3,969	16.13%	9.07	(1.44) ¹
Total	26.57	631	34.58	12,238	23.16%	8.01	7.23

¹ This is insignificant

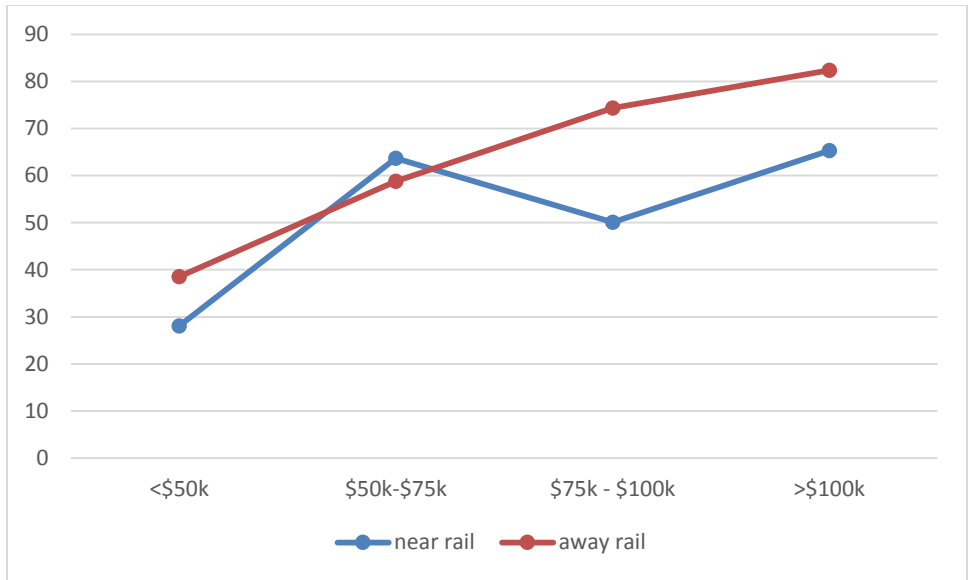

Figure S.5: Average daily household VMT by income and rail access, LA Region only (NHTS data)

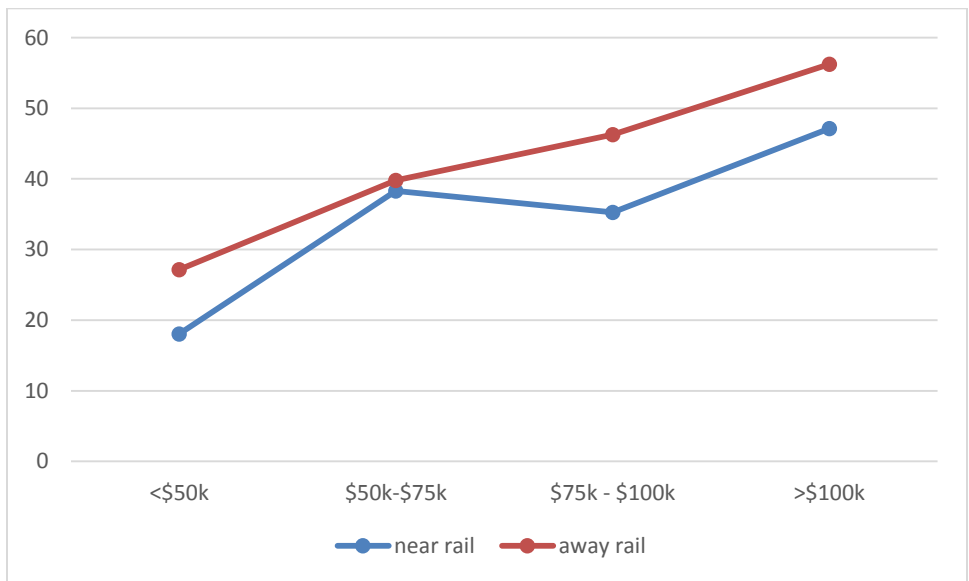

Figure S.6: Average daily household VMT by income and rail access, LA region only (CHTS data)

Table S.4: Average VMT for different mover's profiles, by income category

Recent mover (last 5 years) VMT by mover profile and income	\$0 to \$49,999		\$50,000 to \$99,999		\$100,000+		NA		Total N ³	Average VMT
	N	Avg VMT ¹	N	Avg VMT	N	Avg VMT	N	Avg VMT		
Away to Near ²	1,050	30	697	46	703	54	153	33	2,603	41
Away to Away	1,122	32	892	53	680	61	162	41	2,856	46
Near to Near	121	13	108	26	120	32	15	35	364	24
Near to Away	22	28	12	24	18	43	3	66	55	34
Total	2,315		1,709		1,521		333		5,878	

¹ Daily VMT aggregated to the household level, "complete households" only.

² Previous residential location defined at the zip code level.

"Near" is defined as having a rail station in the home zip code area.

³ 16% of households in the CHTS data moved in the previous five years. Previous address locations outside of California are excluded.

Table S.5: Predicted change in VMT for a stylized one-to-one displacement scenario

Change of low-income households in TOD area		-1000			
Change of high-income households in TOD area		1000			
		Uncontrolled Descriptive analysis		Tobit ^{1,2}	
		NHTS	CHTS	NHTS	CHTS
Before displacement	Average VMT for low-income households living near rail ²	34.61	15.61	22.7	2.5
	Average VMT for high-income households living away from rail	79.92	51.36	121.2	68.6
	Aggregate	114,530.0	66,970.0	143,900.0	71,100.0
After displacement	Average VMT for low-income households living away from rail	39.09	23.86	42.6	19.5
	Average VMT for high-income households living near rail	67.75	34.21	69.4	51.6
	Aggregate	106,840.0	58,070.0	112,000.0	71,100.0
% changes of aggregated VMT		-6.71%	-13.29%	-22.17%	0.00%

¹ Each VMT estimate comes from multiplying regression coefficients by the household income value along with average values for all other dependent variables included in the model.

² Some of the values predicted by the Tobit model could be small, due to this prediction is based on the average number for each parameter and is only for hypothetical scenarios. Therefore only the differences in VMT between before and after displacement is essential in explaining the net VMT impact of displacement.

Table S.6: Predicted VMT change for a stylized one-to-two displacement scenario

Change of low-income households in TOD area		-1000			
Change of high-income households in TOD area		500			
		Uncontrolled Descriptive analysis		Tobit	
		NHTS	CHTS	NHTS	CHTS
Before displacement	Average VMT for low-income households living near rail ²	34.61	15.61	22.7	2.5
	Average VMT for high-income households living away from rail	79.92	51.36	121.2	68.6
	Aggregate	74,570.0	41,290.0	83,300.0	36,800.0
After displacement	Average VMT for low-income households living away from rail	39.09	23.86	42.6	19.5
	Average VMT for high-income households living near rail	67.75	34.21	69.4	51.6
	Aggregate	72,965.0	40,965.0	77,300.0	45,300.0
% changes of aggregated VMT		-2.15%	-0.79%	-7.20%	23.10%

Table S.7: County median incomes and low-income threshold definitions

	1990	2000	2013
Median Household Income (2013 dollars)			
Los Angeles	\$63,423	\$58,982	\$55,909
Santa Clara	\$90,456	\$100,352	\$91,702
San Francisco	\$62,818	\$74,548	\$75,604
Median Household Income (2010 dollars)			
Los Angeles	\$59,618	\$55,443	\$52,554
Santa Clara	\$85,029	\$94,331	\$86,200
San Francisco	\$59,049	\$70,075	\$71,068
80% of Median Household Income (2010 dollars)			
Los Angeles	\$47,694	\$44,354	\$42,044
Santa Clara	\$68,023	\$75,465	\$68,960
San Francisco	\$47,239	\$56,060	\$56,854

Source: ACS 2009-2013; <http://data.bls.gov/cgi-bin/cpicalc.pl> to adjust 2013 dollars to 2010 dollars.

Appendix T. Anti-Displacement Strategies and Sources

Displacement Protection Policies

- **Just Cause Eviction:** Just cause eviction statutes are laws that protect tenants from eviction for an improper reason. Cities or states that have just cause eviction statutes allow landlords or owners to evict a tenant only for certain reasons, such as failure to pay rent or for violation of the lease terms.
- **Rent Stabilization (or rent control) (RSO):** The purpose of Rent Stabilization ordinances is to protect tenants from excessive rent increases, while at the same time allowing landlords a reasonable return on their investments (Los Angeles Municipal Code, Chapter XV). Such ordinances regulate the percentage of annual rent increase, but may allow rent to be reset at market-rate upon vacancy. Residential rental units covered by the RSO exclude single-family dwellings and exempt affordable housing units (ex. Section 8). RSO applies to the properties within the jurisdiction that were built prior to the policy implementation. In the City of Los Angeles for example the RSO applies to properties built prior to October 1, 1978.
- **Rent Mediation (or rent review boards):** Mediation helps the tenant and landlord reach a voluntary agreement on how to settle issues related to rent increases. The mediator normally does not make a binding decision in the case. In some jurisdictions all rent increases must also include a notice to the tenant of their right to mediation, and a tenant can file a mediation petition with the jurisdiction.
- **Preservation of Mobile Homes, part of the Rent Stabilization Ordinance:** Rent stabilization ordinances applicable to mobile homes, which are viewed as a source of affordable housing.
- **Single Room Occupancy (SRO) Preservation Ordinance:** Rent stabilization ordinances applicable to properties designated as “single room occupancy.”
- **Condominium Conversion Ordinance:** Many cities have enacted condominium conversion ordinances that impose substantive restrictions on the ability to convert apartment units into condominiums, such as prohibiting conversions unless the city or regional vacancy rate is above a certain fixed amount or requiring that a certain number of units must be sold to persons of very low, low and moderate incomes. The purpose of such ordinances is to protect the supply of rental housing.
- **Foreclosure Assistance:** local programs that assist residents with foreclosure.
- **First Source Hiring Ordinances:** Such ordinances ensure that city residents are given priority for new jobs created by municipal financing and development programs.

Affordable Housing Policies

- **Housing Development Impact Fee (or Jobs-Housing Linkage Fee):** A per square foot or per unit development fee levied on market rate residential development that is used to develop or preserve affordable housing. In-lieu fees are different from impact fees and are not as flexible because they relate only to required dedications where they can be appropriately used. Impact fees can be applied before new development is started or completed, which may allow costs to be transferred to future residents in the area. Finally, impact fees can be implemented earlier than in lieu fees so that the capital need matches the need for services (Juergensmeyer and Roberts 2013). A jobs-housing linkage is assessed on developments that will create low-wage jobs and require affordable housing for those workers.
- **Commercial Development Impact (or Linkage) Fee:** A per square foot development fee levied on non-residential development that is used to develop or preserve affordable housing.

- Affordable Housing Trust Fund: creates affordable rental housing for low and very low-income households by making long-term loans for new construction or for the rehabilitation of existing residential structures through a competitive process (L.A. Housing and Community Investment Department 2014).
- Inclusionary Zoning/Below Market Rate Housing: When a jurisdiction requires a certain percentage of housing units in market-rate developments to be affordably priced to income-specified households. In-Lieu Fees allow a developer to “buy out” of an inclusionary housing obligation. This may seem to defeat the purpose of inclusionary zoning, but the revenue from these fees is used to develop affordable units off-site.
- Local Density Bonus Ordinance: Additional density allowance given in return for affordable housing. The local density bonus is in addition to mandated State requirements.
- Community Land Trusts: Community land trusts are nonprofit, community-based organizations whose mission is to provide affordable housing in perpetuity by owning land and leasing it to those who live in houses built on that land.

Sources used to create the list of anti-displacement strategies

- ABAG (2014). *Affordable Housing Funding Gap Analysis*.
- Bates, LK. (2013). *Gentrification and Displacement Study: Implementing an Equitable Inclusive Development Strategy in the Context of Gentrification*. Commissioned by City of Portland, Bureau of Planning and Sustainability. www.portlandoregon.gov/bps/article/454027
- Causta Justa :: Just Cause (2014). *Development without Displacement: Resisting Gentrification in the Bay Area*. <http://www.cjjc.org/images/development-without-displacement.pdf>
- Chapple K. (2009). *Mapping Susceptibility to Gentrification: The Early Warning Toolkit*. University of California Center for Community Innovation. <http://communityinnovation.berkeley.edu/reports/Gentrification-Report.pdf>
- Cravens M, et al. (2009). *Development Without Displacement, Development with Diversity*. Association of Bay Area Governments. www.bayareavision.org/initiatives/dwd-final.pdf
- Damewood R, Young-Laing B. (2011). *Strategies to Prevent Displacement of Residents and Businesses in Pittsburgh’s Hill District*. www.prrac.org/pdf/Hill_District_Anti-Displacement_Strategies-final.pdf
- Great Communities Collaborative. (2007). “Preventing Displacement Policy Fact Sheet.” www.mapc.org/sites/default/files/Preventing%20Displacement%20Policy%20Fact%20Sheet.pdf
- Figueroa Corridor Coalition for Economic Justice and Los Angeles Coalition to End Hunger and Homelessness. (2002). *Share the Wealth: A Policy Strategy for Fair Redevelopment in L.A.’s City Center*. A Policy Paper Submitted to the Community Redevelopment Agency and the Los Angeles City Council. www.saje.net/atf/cf/%7B493B2790-DD4E-4ED08F4EC78E8F3A7561%7D/sharewealth2.pdf
- Levy DK, Comey J, Padilla S. (2006). *Keeping the Neighborhood Affordable: A Handbook of Housing Strategies for Gentrifying Areas*. The Urban Institute, Metropolitan Housing and Communities Policy Center. www.urban.org/uploadedPDF/411295_gentrifying_areas.pdf
- Mallach A. (2008). *Managing Neighborhood Change: A Framework for Sustainable and Equitable Revitalization*. Prepared for The National Housing Institute. www.nhi.org/pdf/ManagingNeighborhoodChange.pdf

Appendix U. Policies Adopted by each Los Angeles County City

Policy	#	%	Jurisdictions
Condo Conversion Regulations	24	27%	Agoura Hills, Beverly Hills, Burbank, Calabasas, Culver City, Diamond Bar, Glendale, Hermosa Beach, Huntington Beach, Inglewood, La Canada Flintridge, La Mirada, La Verne, Lakewood, Lawndale, Long Beach, LA City, Manhattan Beach, Pasadena, San Gabriel, Santa Monica, Sierra Madre, West Hollywood
Preservation of Mobile Homes	16	18%	Azusa, Calabasas, Carson, Gardena, Hawthorne, La Verne, Lakewood, LA City, LA County, Malibu, Palmdale, Paramount, Pomona, Santa Clarita, Santa Monica, West Covina
Inclusionary Zoning/ In-Lieu Fees	16	18%	Agoura Hills, Artesia, Calabasas, Claremont, Duarte, Glendale, Huntington Beach, La Verne, Long Beach, Malibu, Monrovia, Pasadena, Rancho Palos Verdes, San Fernando, Santa Monica, West Hollywood
Affordable Housing Trust Fund	7	8%	Calabasas, L.A. City, L.A. County, Long Beach, Pasadena, Santa Monica, West Hollywood
Local Density Bonus	7	8%	Alhambra, Arcadia, Beverly Hills, Downey, LA City, South Pasadena, West Covina
Just Cause	5	6%	Beverly Hills, Glendale, LA City, Santa Monica, West Hollywood
Rent Stabilization/Control	4	4%	Beverly Hills, LA City, Santa Monica, West Hollywood
SRO Preservation	4	4%	Cudahy, Huntington Beach, LA City, Pasadena
Commercial Development Impact Fee	3	3%	Calabasas, LA City (certain areas), West Hollywood
Housing Development Impact Fee	3	3%	La Verne, Pasadena, Rancho Palos Verdes
Rent Mediation	2	2%	Culver City, Gardena
Foreclosure Assistance	2	1%	Lancaster, L.A. County
Community Land Trusts	1	1%	City of Los Angeles
First Source Hiring Ordinance	1	1%	City of Los Angeles

Appendix V. Challenges facing Inclusionary Zoning

A 2013 Center for Housing Policy brief outlined the key challenges affecting policies going forward as follows (Hickey 2013):

1. *The Growing Difficulty of Applying Inclusionary Housing to Rental Properties*

Jurisdictions in California have generally responded in one of three ways to prohibitions on inclusionary rental units:

- a. **No longer applying inclusionary requirements to rental developments.** This appears to be the case for a majority of California jurisdictions with existing inclusionary policies.
- b. **Applying rental requirements only to developers that request some form of “assistance,” such as zoning modifications or upzoning.** In this case, the municipality conditions its assistance on voluntary compliance with inclusionary rental requirements. This approach is less impactful in places that have recently upzoned desirable development areas — since developers no longer need special approval for higher density — and in places that have made attractive zoning terms available “by right.”
- c. **Shifting to a fee-based policy (sometimes with the option to waive out of the fee by providing units).** Rather than require inclusionary units to be built as part of new market-rate developments, several jurisdictions are instead assessing an affordable housing fee on new rental development. Some jurisdictions offer developers the option to produce units on site as an alternative to paying the fee — in essence, the opposite of a traditional inclusionary zoning policy with the option to pay a fee in lieu of including affordable units.

2. *The Elimination of Redevelopment in California Undermined Many Inclusionary Housing Policies*

This decision led many jurisdictions in the state to stop enforcing inclusionary policies that were applied only to local redevelopment areas, while significantly decreasing funds for the staff who administer inclusionary housing programs in many municipalities.

3. *New Inclusionary Housing Policies Have Become Harder to Pass*

While most inclusionary policies remain on the books, the market decline has made it more difficult for advocates promoting inclusionary housing to pass new policies — particularly in areas that are not experiencing major upzoning or new transit investments.

4. *It May Get Harder to Support Inclusion Through In-Lieu Fees*

Most communities with inclusionary housing policies allow developers the option of satisfying their inclusionary requirements by paying an in-lieu fee. Often, the in-lieu fee is set low enough that developers prefer to pay the fee rather than produce the inclusionary units themselves.

The primary issue with an overreliance on in-lieu fees is that it can work against the goal of creating inclusive communities, particularly if fees are used to support affordable housing outside the area where new market-rate development is occurring.

A second challenge is that in-lieu fees are sometimes set too low to produce an equal number of affordable units elsewhere in the community — regardless of the setting (Hickey 2013, 12).

A third issue is that some communities lack local, affordable housing developers with the capacity to use fee revenues to produce new affordable homes.