

MATCH LINE A-A (SEE SHEET 2)

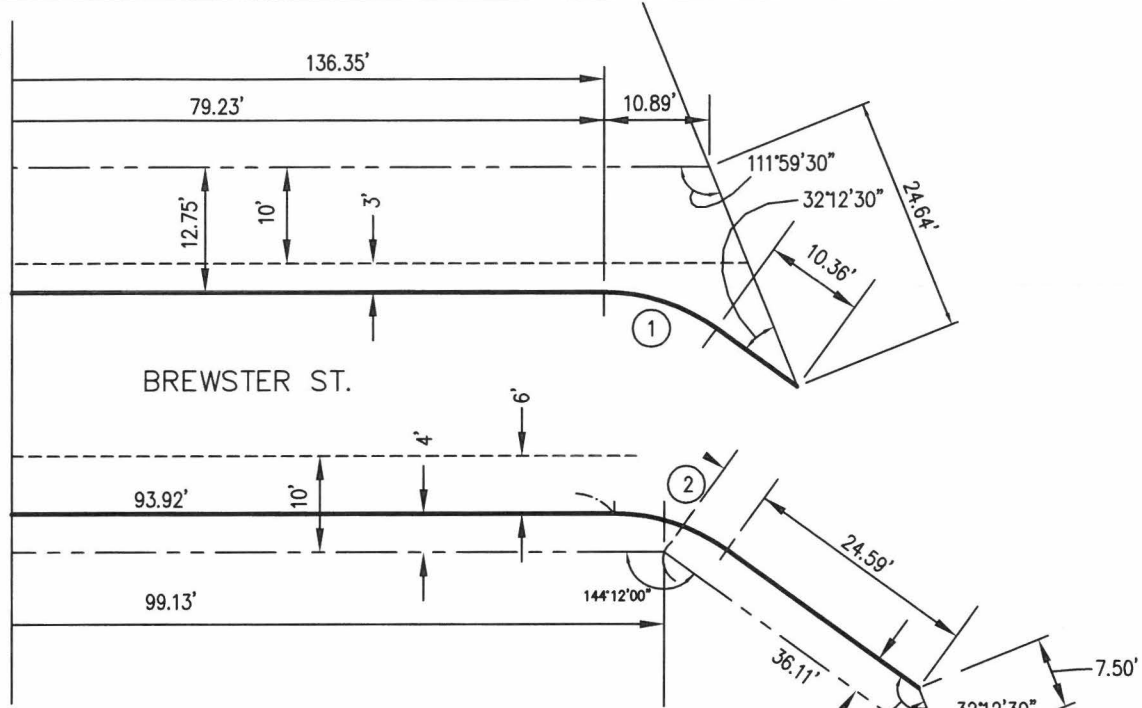

CURVE DATA			
CURVE	RADIUS	LENGTH	DELTA
1	20'	12.50'	35°48'00"
2	20'	12.50'	35°48'00"

REFERENCES:
 1. Q-20-554
 2. GIFT MAP NO. 3

LEGEND
 — PROPOSED OFFICIAL NEW CURB LINE
 = EXISTING OFFICIAL CURB LINE TO REMAIN
 - - - EXISTING CURB LINE TO BE REMOVED
 - - - PROPERTY LINE

ESMERALDA AVENUE

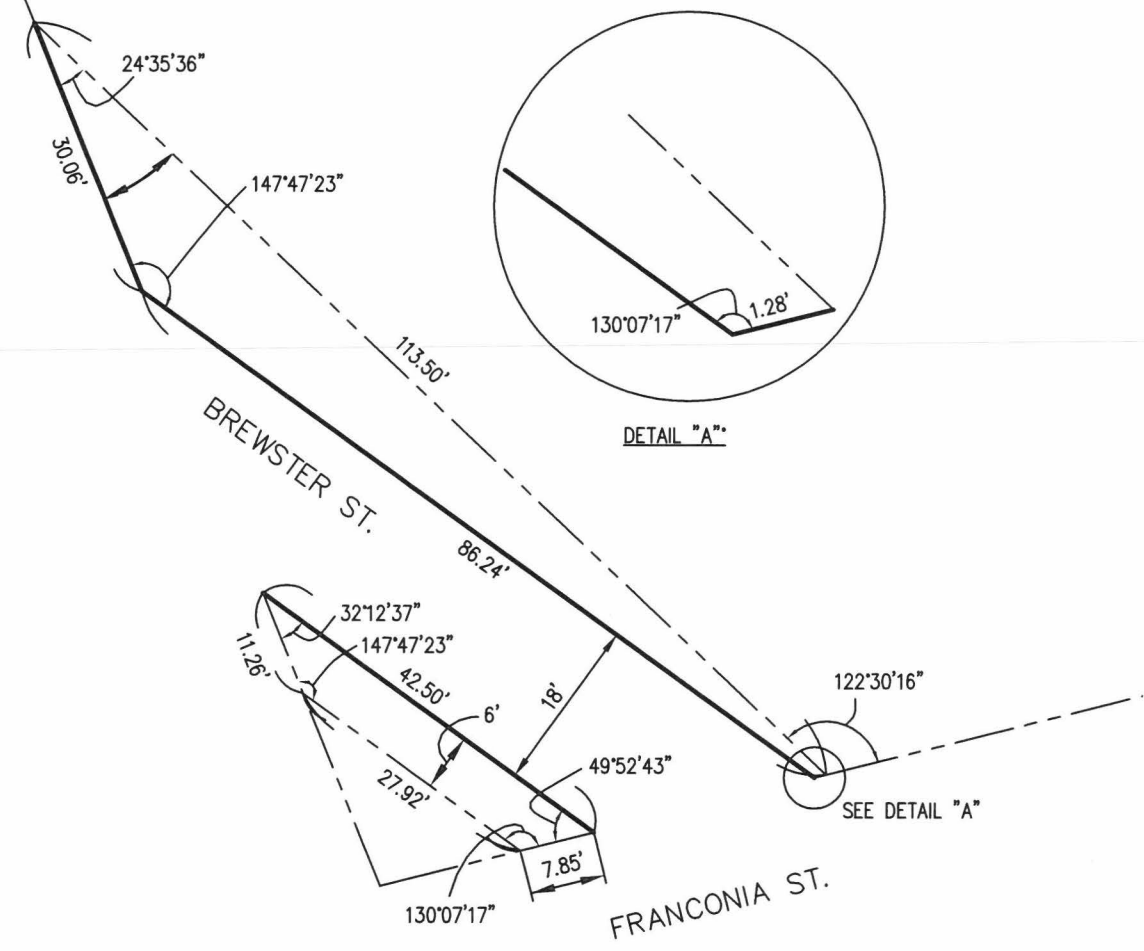

APPROVED:
Bruce R. Storrs
 BRUCE R. STORRS
 CITY & COUNTY SURVEYOR
 7/19/16
 DATE

CITY AND COUNTY OF SAN FRANCISCO
DEPARTMENT OF PUBLIC WORKS
 OFFICIAL SIDEWALK CHANGES ON BREWSTER ST. AND MARTIN AVE.
 BETWEEN RUTLEDGE ST. AND ESMERALDA AVE.
 FILE: Q-20-554 SHEET 1 OF 5 NOT TO SCALE CHANGE

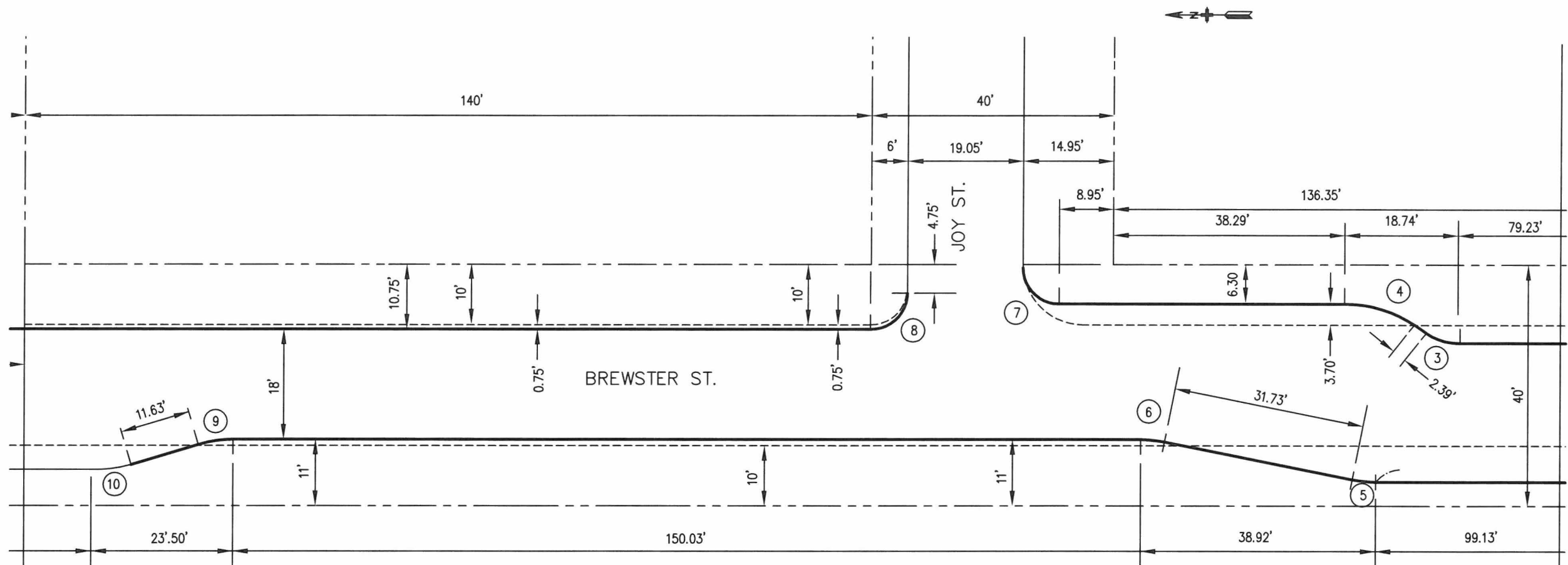

CURVE DATA			
CURVE	RADIUS	LENGTH	DELTA
3	10'	5.93'	33°57'19"
4	20'	11.85'	33°57'19"
5	20'	3.95'	11°18'36"
6	20'	3.95'	11°18'36"
7	6'	9.42'	90°00'00"
8	6'	9.42'	90°00'00"
9	20'	6.19'	17°43'49"
10	20'	6.19'	17°43'49"

- REFERENCES:
 1. Q-20-554
 2. GIFT MAP NO. 3

LEGEND

- PROPOSED OFFICIAL NEW CURB LINE
- - - EXISTING OFFICIAL CURB LINE TO REMAIN
- · · EXISTING CURB LINE TO BE REMOVED
- - - - - PROPERTY LINE

MATCH LINE B-B (SEE SHEET 3)

MATCH LINE A-A (SEE SHEET 1)



APPROVED:

Bruce R. Storrs
 BRUCE R. STORRS
 CITY & COUNTY SURVEYOR

7/19/16
 DATE

**CITY AND COUNTY OF SAN FRANCISCO
 DEPARTMENT OF PUBLIC WORKS**

OFFICIAL SIDEWALK CHANGES ON BREWSTER ST. AND MARTIN AVE.
 BETWEEN RUTLEDGE ST. AND ESMERALDA AVE.

FILE:	Q-20-554	SHEET 2 OF 5	NOT TO SCALE	CHANGE
-------	----------	--------------	--------------	--------



REFERENCES:
 1. Q-20-554
 2. GIFT MAP NO. 3

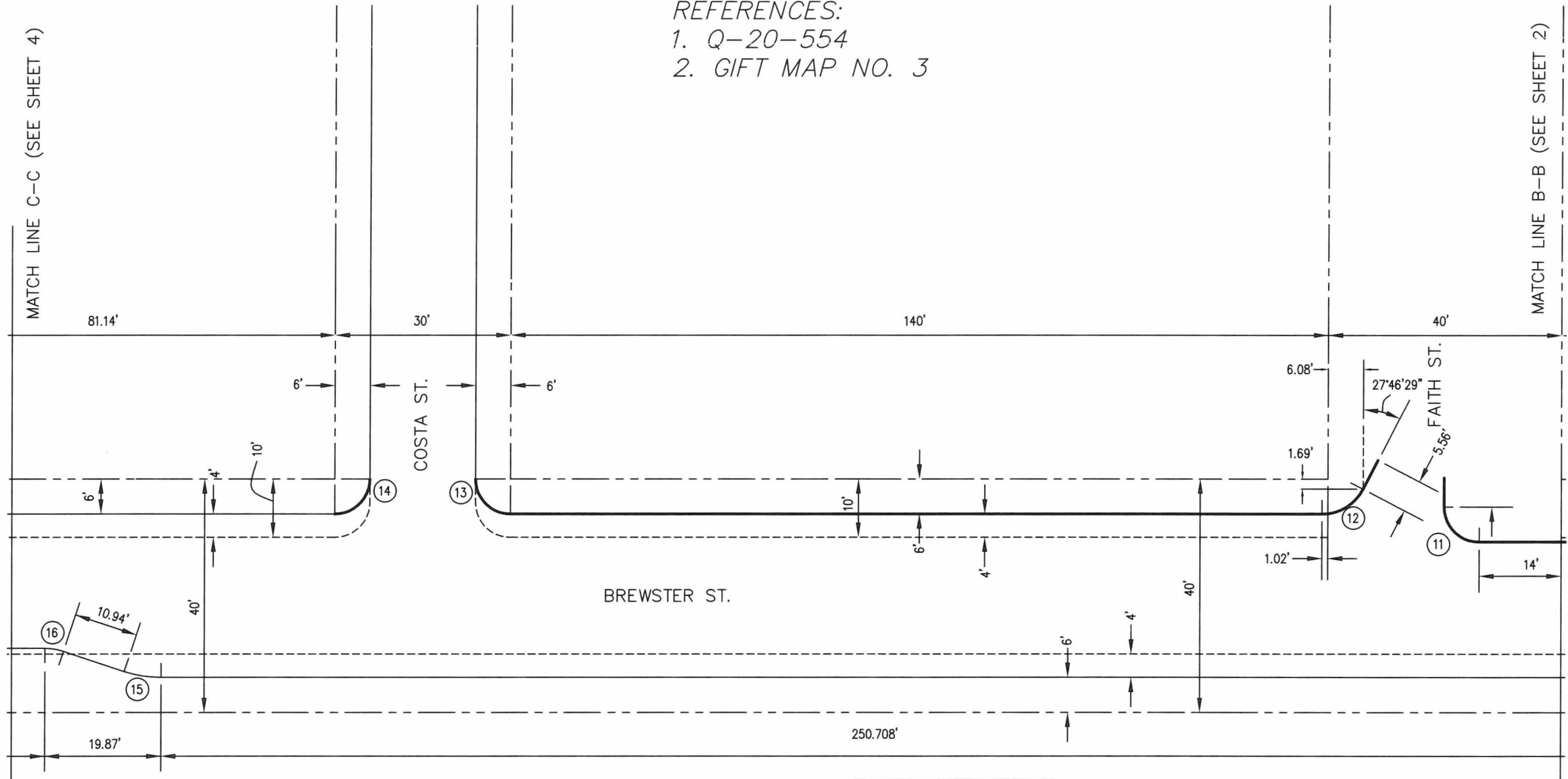

LEGEND

- PROPOSED OFFICIAL NEW CURB LINE
- EXISTING OFFICIAL CURB LINE TO REMAIN
- EXISTING CURB LINE TO BE REMOVED
- PROPERTY LINE

CURVE DATA			
CURVE	RADIUS	LENGTH	DELTA
11	6.00'	9.42'	90°00'00"
12	8.00'	8.73'	62°32'14"
13	6.00'	9.42'	90°00'00"
14	6.00'	9.42'	90°00'00"
15	20.00'	6.44'	18°26'16"
16	10.00'	3.22'	18°26'16"



APPROVED:

Bruce R. Storrs

BRUCE R. STORRS
 CITY & COUNTY SURVEYOR

7/19/16

DATE

CITY AND COUNTY OF SAN FRANCISCO
DEPARTMENT OF PUBLIC WORKS

OFFICIAL SIDEWALK CHANGES ON BREWSTER ST. AND MARTIN AVE.
 BETWEEN RUTLEDGE ST. AND ESMERALDA AVE.

FILE:

Q-20-554

SHEET 3 OF 5

NOT TO SCALE

CHANGE



CURVE DATA			
CURVE	RADIUS	LENGTH	DELTA
17	20.00'	11.98	34°18'17"
18	12.00'	11.27'	53°49'14"
19	20.00'	6.81'	19°30'37"
20	20.00'	5.96'	17°05'15"
21	10.00'	3.20'	18°18'54"

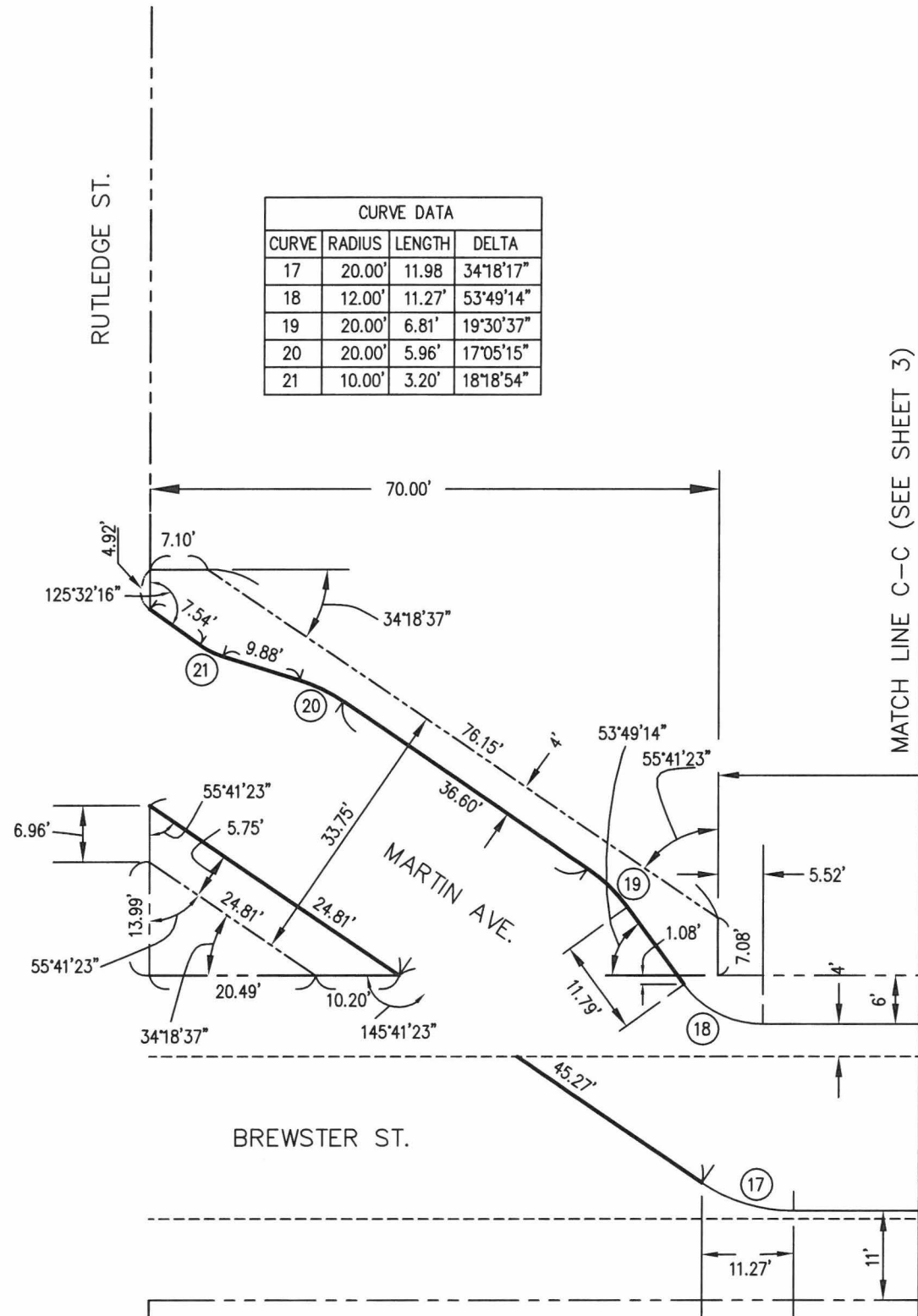

MATCH LINE C-C (SEE SHEET 3)

LEGEND

- PROPOSED OFFICIAL NEW CURB LINE
- - - EXISTING OFFICIAL CURB LINE TO REMAIN
- · - · - EXISTING CURB LINE TO BE REMOVED
- - - - - PROPERTY LINE

- REFERENCES:
1. Q-20-554
 2. GIFT MAP NO. 3



APPROVED:

Bruce R. Storrs
 BRUCE R. STORRS
 CITY & COUNTY SURVEYOR

7/19/16
 DATE

**CITY AND COUNTY OF SAN FRANCISCO
 DEPARTMENT OF PUBLIC WORKS**

OFFICIAL SIDEWALK CHANGES ON BREWSTER ST. AND MARTIN AVE.
 BETWEEN RUTLEDGE ST. AND ESMERALDA AVE.

FILE:	<i>Q-20-554</i>	SHEET 4 OF 5	NOT TO SCALE	CHANGE
-------	-----------------	--------------	--------------	--------

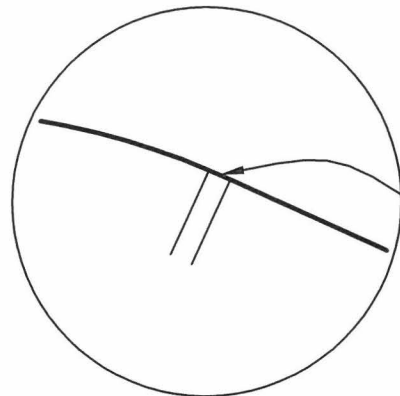

R = 20'
L = 0.606'
Δ = 1°44'05"

DETAIL "B"

- REFERENCES:
1. Q-20-554
2. GIFT MAP NO. 3

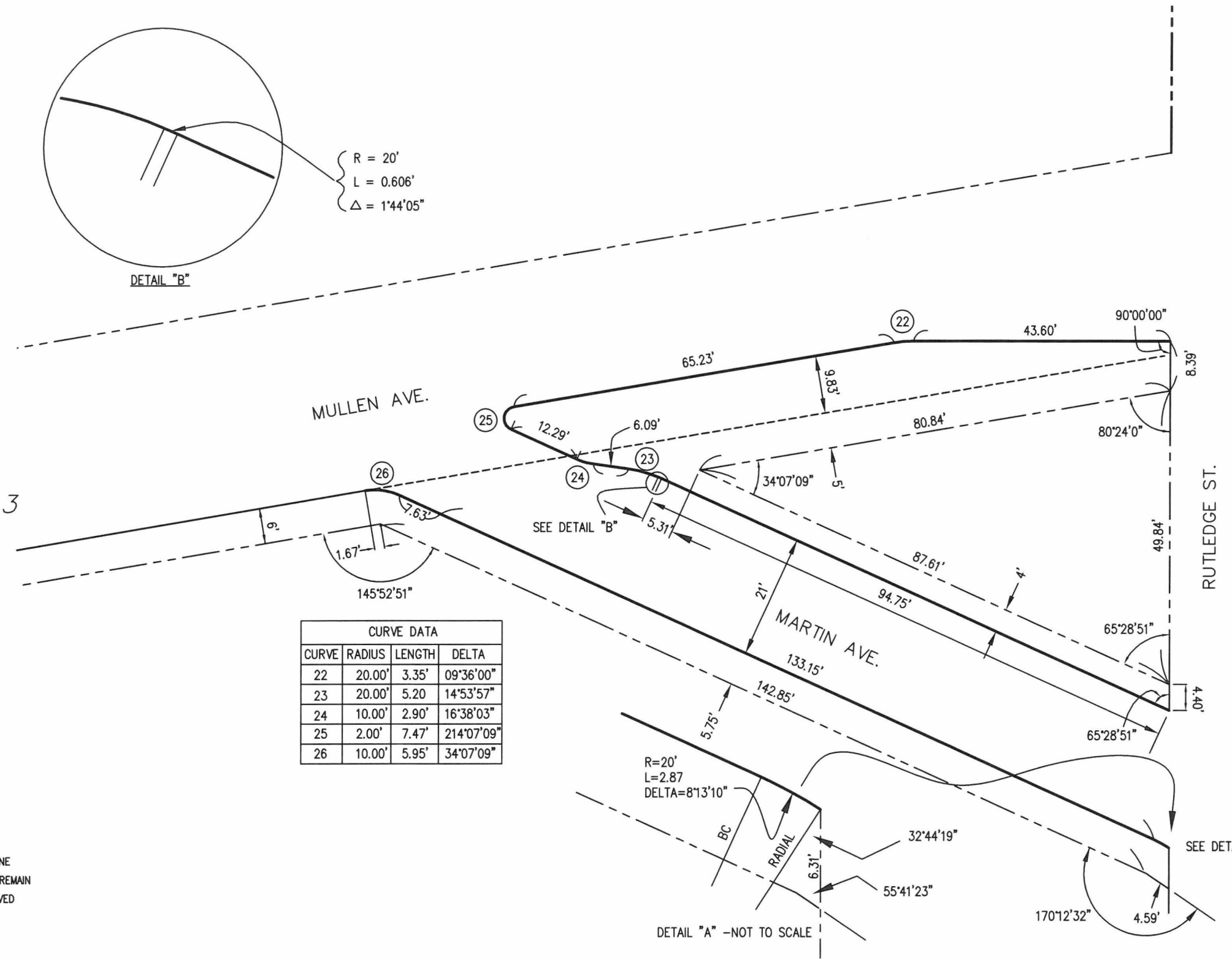

CURVE DATA			
CURVE	RADIUS	LENGTH	DELTA
22	20.00'	3.35'	09°36'00"
23	20.00'	5.20'	14°53'57"
24	10.00'	2.90'	16°38'03"
25	2.00'	7.47'	214°07'09"
26	10.00'	5.95'	34°07'09"

LEGEND

- PROPOSED OFFICIAL NEW CURB LINE
- EXISTING OFFICIAL CURB LINE TO REMAIN
- - - EXISTING CURB LINE TO BE REMOVED
- PROPERTY LINE

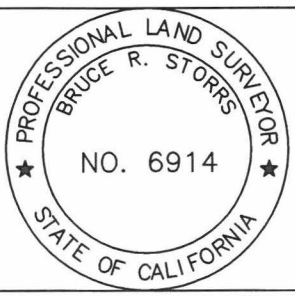

APPROVED:
Bruce R. Storrs
BRUCE R. STORRS
CITY & COUNTY SURVEYOR

7/19/16
DATE

CITY AND COUNTY OF SAN FRANCISCO
DEPARTMENT OF PUBLIC WORKS

OFFICIAL SIDEWALK CHANGES ON BREWSTER ST. AND MARTIN AVE.
BETWEEN RUTLEDGE ST. AND ESMERALDA AVE.

FILE:	Q-20-554	SHEET 5 OF 5	NOT TO SCALE	CHANGE
-------	----------	--------------	--------------	--------