

File No. 220645

Committee Item No. 1

Board Item No. 25

COMMITTEE/BOARD OF SUPERVISORS

AGENDA PACKET CONTENTS LIST

Committee: Government Audit and Oversight

Date: June 16, 2022

Board of Supervisors Meeting:

Date: June 28, 2022

Cmte Board

- Motion
- Resolution
- Ordinance
- Legislative Digest
- Budget and Legislative Analyst Report
- Youth Commission Report
- Introduction Form
- Department/Agency Cover Letter and/or Report
- MOU
- Grant Information Form 051622
- Grant Budget
- Subcontract Budget
- Contract/DRAFT Grant Agreement
- Form 126 – Ethics Commission
- Grant Application
- CA Arts Council Letter of Intent Award 111521
- Public Correspondence

OTHER

- Exhibit A - The Memorial at Harvey Milk Plaza SFAC Phase II
- Public Works Order 206570
- Mayor Memo 052322
- President Action Memo 060622
- _____
- _____
- _____

Prepared by: Jessica Perkinson

Date: June 10, 2022

Prepared by: Jessica Perkinson

Date: June 17, 2022

Prepared by: _____

Date: _____

1 [Accept and Expend Grant - California Arts Council - Design and Planning for Harvey Milk
2 Plaza - \$1,500,000]

3 **Resolution authorizing the Department of Public Works to accept and expend grant**
4 **funds in the amount of \$1,500,000 from the California Arts Council for the design and**
5 **planning of new improvements on or about Harvey Milk Plaza for the project term of**
6 **July 2022 through February 2023; authorizing the Public Works Director to enter into a**
7 **grant agreement with the California Arts Council regarding the same; authorizing the**
8 **Department of Public Works and the Clerk of the Board to take further actions**
9 **necessary under the grant agreement; and retroactively approving the submittal of the**
10 **grant application.**

11
12 WHEREAS, The Department of Public Works (“Department”) applied for a \$1,500,000
13 grant from the State of California, acting by and through the California Arts Council (“CAC”), to
14 partially fund the planning and design of potential new improvements on or about Harvey Milk
15 Plaza (“Design Project”), as further described in Public Works Order No. 206570 on file with
16 the Clerk of the Board of Supervisors in File No. 220645; and

17 WHEREAS, The new improvements on or about Harvey Milk Plaza may one day
18 include creating an iconic gateway to the Castro neighborhood, improving universal access
19 throughout the Harvey Milk Plaza site, improving onsite safety and security, and integrating
20 Harvey Milk memorial display fixtures, artwork, and sculptural landscape elements into the
21 plaza landscape and hardscape; and

22 WHEREAS, Subject to further study and design, and the completion of the Design
23 Project, the potential new improvements on or about Harvey Milk Plaza may include the
24 regrading, repaving, and re-landscaping of the Harvey Milk Plaza in coordination with the
25

1 SFMTA Castro/Market Muni Station elevator project, and may include improvements to the
2 SFMTA Castro/Market Muni station entry, entry stairs, fare gates, and elevator; and

3 WHEREAS, On or about November 15, 2021, the CAC transmitted a letter to the
4 Department notifying the City and County of San Francisco (“City” or “Grantee”) of the CAC’s
5 award of a “designated funding grant” in the amount of \$1,500,000 for the Design Project
6 (“Letter of Intent”), subject to additional guidelines and contract documents that require the
7 City’s passage of a resolution authorizing the acceptance and expenditure of the grant funds
8 (“Proposed Resolution”), the City’s satisfaction of other conditions and requirements set forth
9 in the grant application (“Application”), the City’s execution of a grant agreement with the CAC
10 (“Agreement”), and the City’s compliance with procedures established by the CAC; and

11 WHEREAS, The Department proposes to use the grant funds awarded by the CAC to
12 advance, expedite, and complete the Design Project and such funds shall not be used to
13 cover indirect costs; and

14 WHEREAS, The Application includes a form of “authorizing resolution” that prescribes
15 certain recitals and clauses, and those recitals and clauses are included herein; and

16 WHEREAS, The Legislature and Governor of the State of California have approved a
17 grant for the Design Project; and

18 WHEREAS, The CAC has been delegated the responsibility for the administration of
19 the grant project, setting up necessary procedures; and

20 WHEREAS, the Grantee will enter into an agreement with the State of California for the
21 Design Project; and

22 WHEREAS, To satisfy the requirements of Administrative Code, Section 10.170-1, the
23 Department transmitted Public Works Order No. 206570 to the Clerk of the Board of
24 Supervisors along with the following documents: (1) the Proposed Resolution, signed by the
25 Department, the Mayor or the Mayor’s designee, and the Controller; (2) the associated Grant

1 Information Form; (3) the Application; (4) the Letter of Intent; and (5) a cover letter to the Clerk
2 of the Board substantially conforming to the specifications of the Clerk of the Board (together
3 the “Legislative Package”), on file with the Clerk of the Board of Supervisors in File No.
4 220645; and

5 WHEREAS, In Public Works Order No. 206570, the Director of the Department: (1)
6 certified that the Department understands the assurances and certification in the Project
7 Information Form, (2) certified that the Department will have sufficient funds to operate and
8 maintain the Design Project, (3) certified that the Department has reviewed and understands
9 the General Provisions contained in the Project Agreement shown in the Procedural Guide;
10 and (4) appointed the Design Project’s Project Manager as the City’s agent to conduct all
11 negotiations and execute and submit all documents including, but not limited to Project
12 Information Form, agreements, payment requests, which may be necessary for the
13 completion of the Project, conditioned upon the Board’s approval of this resolution; and

14 WHEREAS, In Public Works Order No. 206570, the Director of the Department
15 requested and recommended that the Board of Supervisors approve the Proposed Resolution
16 and authorize the Department to enter into the Agreement on behalf of the City, and to
17 authorize the Department and the Clerk of the Board to take further actions, as may be
18 deemed necessary by the CAC before the Department may accept and expend the grant
19 funds for the Design Project; now, therefore, be it

20 RESOLVED, That the Board of Supervisors accepts the recommendations,
21 certifications, and determinations of the Department as set forth in Public Works Order No.
22 206570 and adopts the Department’s certifications and determinations as its own; and, be it

23 FURTHER RESOLVED, That the Board of Supervisors authorizes the Department to
24 accept and expend \$1,500,000 from the CAC for the Design Project; and, be it

25

1 FURTHER RESOLVED, That the Board of Supervisors certifies that the Department
2 understands the assurances and certification in the Project Information Form; and, be it

3 FURTHER RESOLVED, That the Board of Supervisors certifies that the Department
4 will have sufficient funds to operate and maintain the Design Project or will enter into an
5 agreement with another entity to perform said operation and maintenance; and, be it

6 FURTHER RESOLVED, That the Board of Supervisors certifies that the Department
7 has reviewed and understands the General Provisions contained in the Project Agreement
8 shown in the Procedural Guide; and, be it

9 FURTHER RESOLVED, That the Board of Supervisors authorizes the Director of the
10 Department to conduct all negotiations, and execute and submit all documents including, but
11 not limited to the Agreement, the Project Information Form, other agreements, payment
12 requests and so on, which may be necessary for the completion of the Design Project, and
13 the Board of Supervisors authorizes the Director of the Department to appoint the Design
14 Project's project manager as the Department's agent to implement the preceding
15 responsibilities and tasks related to the Design Project; and, be it

16 FURTHER RESOLVED, That the Board of Supervisors hereby waives inclusion of
17 indirect costs in the grant budget; and, be it

18 FURTHER RESOLVED, That the Board of Supervisors ratifies any administrative
19 action taken to date with respect to the grant funds, including but not limited to the submittal of
20 any applications and related materials; and, be it

21 FURTHER RESOLVED, That within 30 days of the execution of the Agreement by all
22 parties, the Department shall provide the final Agreement to the Clerk of the Board for
23 inclusion in File No. _____.

1
2
3
4
5
6
7
8
9
10
11
12
13
14
15
16
17
18
19
20
21
22
23
24
25

Approved: /s/
London Breed, Mayor

Approved: /s/
Ben Rosenfield, Controller

Recommended:

 /s/
Carla Short, Interim Director
Department of Public Works

n:\legana\as2022\2200463\01601755.docx

File Number: _____
(Provided by Clerk of Board of Supervisors)

Grant Resolution Information Form
(Effective July 2011)

Purpose: Accompanies proposed Board of Supervisors ordinances authorizing a Department to accept and expend grant funds.

The following describes the grant referred to in the accompanying resolution:

1. Grant Title: **California Arts Council - General Fund Designated Funding Grant Projects**
2. Department: **San Francisco Public Works**
3. Contact Person: **Bryan Dahl** Telephone: **(415) 350-4538**
4. Grant Approval Status (check one):
 Approved by funding agency Not yet approved
5. Amount of Grant Funding Approved or Applied for: **\$ 1,500,000.00**
6. a. Matching Funds Required: **NA**
b. Source(s) of matching funds (if applicable): **NA**
7. a. Grant Source Agency: **California Arts Council**
b. Grant Pass-Through Agency (if applicable): **N/A**
8. Proposed Grant Project Summary: **Harvey Milk Plaza – Design Phase**

The New Harvey Milk Plaza is a place like no other—as unconventional as the human rights figure himself. Equal parts memorial, celebration and call to action, it is here that visitors are introduced to Harvey Milk, learn about his story and mission, and then leave energized to create change in their own communities. The New Harvey Milk Plaza features a triangulated sculptural canopy which runs axially east/west through the site. This sculpture symbolizes the push and pull of Harvey Milk’s life, inspiring visitors to create a better future while simultaneously linking them to the past with a timeline embedded in the ground plane below the canopy. The sculptural canopy and timeline lead visitors on a journey through the plaza culminating in a grove of 11 ginkgo trees at its western edge which mark the 11 months Harvey Milk was in office. The New Harvey Milk Plaza will honor Harvey Milk, improve universal access throughout the site, create successful public space, and improve safety and security throughout the site, and become a new, iconic gateway to the Castro.

Regrade, repave, and re-landscape the current Harvey Milk Plaza in coordination with the MTA Castro Station elevator project, add a canopy over the Castro/Market Muni station entry, improve Muni station entry stairs, and below grade concourse up to the fare gates, and elevator. Add Harvey Milk memorial display fixtures, artwork and sculptural landscape elements integrated into the plaza landscape and hardscape.

In addition to being a memorial to Harvey Milk, the project paving and grading improves ADA accessibility, and enhances public safety and security with lighting, streetscape, and Muni station entry improvements.

9. Grant Project Schedule, as allowed in approval documents, or as proposed:
Start-Date: **July 2022** End-Date: **February 2023**

10. a. Amount budgeted for contractual services: **NA**
b. Will contractual services be put out to bid? **NA**
c. If so, will contract services help to further the goals of the Department's Local Business Enterprise (LBE) requirements? **NA**
d. Is this likely to be a one-time or ongoing request for contracting out? **NA**
11. a. Does the budget include indirect costs?
 Yes No
b. 1. If yes, how much? **N/A**
b. 2. How was the amount calculated?
c. 1. If no, why are indirect costs not included?
 Not allowed by granting agency To maximize use of grant funds on direct services
 Other (please explain):
c. 2. If no indirect costs are included, what would have been the indirect costs? **N/A. This grant is supporting direct services only (consultant work).**
12. Any other significant grant requirements or comments: **N/A**

****Disability Access Checklist****

13. This Grant is intended for activities at (check all that apply):

- | | | |
|---|--|---|
| <input type="checkbox"/> Existing Site(s) | <input checked="" type="checkbox"/> Existing Structure(s) | <input checked="" type="checkbox"/> Existing Program(s) or Service(s) |
| <input checked="" type="checkbox"/> Rehabilitated Site(s) | <input checked="" type="checkbox"/> Rehabilitated Structure(s) | <input checked="" type="checkbox"/> New Program(s) or Service(s) |
| <input type="checkbox"/> New Site(s) | <input checked="" type="checkbox"/> New Structure(s) | |

16. The Departmental ADA Coordinator or the Mayor's Office on Disability have reviewed the proposal and concluded that the project as proposed will be in compliance with the Americans with Disabilities Act and all other Federal, State, and local access laws and regulations and will allow the **full inclusion** of persons with disabilities, as described in the comments section:

Comments: Project must provide full accessibility as required for new construction as adopted by the USDOJ and USDOT, in accordance with the Sections 504 and 508 of the Rehabilitation Act of 1973, Title II of the Americans with Disabilities Act, the 2010 ADA Standards for Accessible Design, the USDOT adopted accessibility regulations for transportation facilities, and the accessibility provisions of the California Government Code, California Fire Code, and the California Building Code (CBC). Accessible routes such as walks and ramps shall be provided throughout the surface improvements - no stairways shall be provided in the surface improvements. (See CBC 11B-206.2.1 Site arrival points: "At least one accessible route shall be provided within the site from accessible parking spaces and accessible passenger drop-off and loading zones; public streets and sidewalks; and public transportation stops to the accessible building or facility entrance they serve. *Where more than one route is provided, all routes must be accessible.*") An accessible route shall be provided to the upper level of the proposed pedestal at the northeast corner of the site. Detailed surface grading of all elements is required to indicate all pedestrian routes adjoining the roadways (Collingwood St, Market St, & Castro St), adjacent facility entrances and exits, and within the site are accessible to the maximum extent that is technically feasible. Physical and electronic signs, exhibits and transportation information shall comply with applicable accessibility requirements.

Departmental ADA Coordinator or Mayor's Office of Disability Reviewer:

Kevin W. Jensen

(Name)

ADA/Disability Access Coordinator

(Title)

Date Reviewed: May 16, 2022

(Signature Required)

Overall Department Head or Designee Approval:

Carla Short

(Name)

Interim Director

(Title)

Date Reviewed: May 16, 2022

(Signature Required)

COST ESTIMATE FORM FOR DEVELOPMENT PROJECTS

All cost elements included should be consistent with the scope, site plan and CEQA documents. Add and delete project elements as applicable to your project.

Project Elements (SAMPLE ONLY)	Total Project Costs	General Fund Grant	Other Funding (if applicable)	Other Funding (if applicable)
NON-CONSTRUCTION COSTS				
Direct Project Management & Administration				
Staff Time (direct costs only)	\$1,440,000			
Incidental Charges	\$480,000	Ineligible		
Consultants	\$480,000			
Subtotal – Direct Management	\$2,400,000			
Planning, Design & Permitting				
Staff Time (direct costs only)	\$1,320,000			
Consultants	\$1,500,000	\$1,500,000		
Permit Costs	\$480,000			
Subtotal - Planning, Design & Permitting	\$3,300,000			
CEQA Compliance (if applicable)				
Staff Time (direct costs only)				
Consultants				
Subtotal – CEQA	\$240,000			
SUB-TOTAL Non-Construction Costs (not to exceed 25% of grant)				
CONSTRUCTION COSTS				
Component X (Specify)				
Component Y (Specify)				
Component Z (Specify)				
SUB- TOTAL Construction Costs	\$24,000,000			
Contingency (not to exceed 10% of grant)				
PROJECT GRAND TOTAL	\$30,300,000			

Category listing should be detailed and customized to fit the project. Each Funding source, whether In-Kind or cash should have its own column. Specify In-Kind or cash in each column heading. The General Fund Grant and Other Funding Sources should sum the Total Project Costs column. LS = Lump Sum

CALIFORNIA ARTS COUNCIL
GRANT AGREEMENT

Grantee Name: City of San Francisco

Project Title: Harvey Milk Plaza

Agreement Number: CIP-2021-10

Authority: Senate Bill No. 170 Specified Funding FY 2021-22

Program: General Fund Designated Funding Grant Projects

PROJECT DESCRIPTION

The New Harvey Milk Plaza is a place like no other—as unconventional as the human rights figure himself. Equal parts memorial, celebration and call to action, it is here that visitors are introduced to Harvey Milk, learn about his story and mission, and then leave energized to create change in their own communities. The New Harvey Milk Plaza features a triangulated sculptural canopy which runs axially east/west through the site. This sculpture symbolizes the push and pull of Harvey Milk’s life, inspiring visitors to create a better future while simultaneously linking them to the past with a timeline embedded in the ground plane below the canopy. The sculptural canopy and timeline lead visitors on a journey through the plaza culminating in a grove of 11 ginkgo trees at its western edge which mark the 11 months Harvey Milk was in office. The New Harvey Milk Plaza will honor Harvey Milk, improve universal access throughout the site, create successful public space, and improve safety and security throughout the site, and become a new, iconic gateway to the Castro.

Regrade, repave, and re-landscape the current Harvey Milk Plaza in coordination with the MTA Castro Station elevator project, add a canopy over the Castro/Market Muni station entry, improve Muni station entry stairs, and below grade concourse up to the fare gates, and

elevator. Add Harvey Milk memorial display fixtures, artwork and sculptural landscape elements integrated into the plaza landscape and hardscape.

In addition to being a memorial to Harvey Milk, the project paving and grading improves ADA accessibility, and enhances public safety and security with lighting, streetscape, and Muni station entry improvements.

A detailed project scope and activities, [REDACTED] are described and attached hereto as Exhibit A.

Grant Funds are to be used to support capital asset projects/programmatic project in accordance with the provisions contained in the Procedural Guide for Dedicated Funding Grant Projects and this Agreement.

TERMS AND CONDITIONS OF GRANT

Special Provisions

1. As conditions precedent to the State's obligation to make any construction funding available pursuant to this agreement, Grantee shall first provide evidence of compliance with CEQA.
2. As conditions precedent to the State's obligation to make any funding available pursuant to this agreement, Grantee shall first provide evidence of adequate land tenure and evidence that the project will be operated and maintained for a minimum of 25 years satisfactory to the State for all land to be improved under this agreement.

General Provisions

A. Definitions

1. The term "Act" means Senate Bill No. 170 (2021).
2. The term "Acquisition" means obtaining a fee interest or any other interest, including easements, leases, and development rights.

3. The term "Agreement" means this Grant Agreement.
4. The term "Application Guidelines" means the Procedural Guide for General Fund Specified Grant Projects.
5. The term "Development" means improvement, rehabilitation, restoration, enhancement, preservation, protection and interpretation or other similar activities.
6. The term "Fair Market Value" means the value placed upon the property as supported by an appraisal that has been reviewed and approved by the California Department of General Services (DGS).
7. The term "Grant" or "Grant Funds" means the money provided by the State to the Grantee in this agreement.
8. The term "Grant Agreement" means a contractual arrangement between the State and Grantee specifying the payment of funds by the State for the performance of specific project objectives within a specific project performance period by the Grantee.
9. The term "Grantee" means an applicant who has a signed agreement for grant funds.
(Grantee's Authorized Representative signature required on Grant Agreement.)
10. The term "Interpretation" means visitor-serving amenities that communicate the significance and value of natural, historical and cultural resources in a manner that increases the understanding and enjoyment of these resources, or other similar activities.
11. The term "Other Sources of Funds" means cash or in-kind contributions that are required or used to complete the project beyond the grant funds provided by this Agreement.
12. The term "Payment Request Form" means Invoice.
13. The term "Project" means the acquisition or development activity described in the application as modified by Exhibit A to be accomplished with grant funds.

15. The term "Project Scope" means the description or activity for work to be accomplished by the project.

16. The term "State" means the Secretary for California Arts Council or his/her representatives, or other political subdivision of the State.

B. Project Execution

1. Subject to the availability of funds in the Act, the State hereby grants to the Grantee a sum of money (Grant Funds) not to exceed the amount stated on the signature page in consideration of and on condition that the sum be expended in carrying out the purposes as set forth in the description of project in this Agreement and its attachments and under the Terms and Conditions set forth in this agreement.

2. [REDACTED]

3. [REDACTED]

4. [REDACTED]

Grant funds for planning and document preparation may be available sooner if included in the grant project scope (Exhibit A) and approved by the State. CEQA compliance shall be completed within one (1) year from the Grant Agreement start date, unless an extension is granted by the State.

Changes to the scope resulting from CEQA compliance are permitted provided the State determines that the project continues to meet all objectives of the General Fund

Specified Grant Project and is consistent with the intent cited in the original Application.

If a grantee's project is disapproved on grounds related to the California Arts Council's CEQA determination, the grantee shall have the option of either: (1) reimbursing the CAC for all state-reimbursed preliminary costs (e.g., planning, design, etc.), or (2) relinquishing any planning/design documents, including all copies, reproductions, and variations resulting from said funding, without a license to use or otherwise retain in any form.

5. Projects must comply with any applicable laws pertaining to prevailing wage and labor compliance.
6. Grantee certifies that the project does and will continue to comply with all current laws and regulations which apply to the project, including, but not limited to, legal requirements for construction contracts, building codes, environmental laws, health and safety codes, and disabled access laws. Grantee certifies that, prior to commencement of construction; all applicable permits and licenses (e.g., state contractor's license) will have been obtained.
7. Grantee shall provide access by the State upon 24-hours' notice to determine if project work is in accordance with the approved project scope, including a final inspection upon project completion.
8. Prior to the commencement of any work, Grantee agrees to submit in writing to the State for prior approval any deviation from the original project scope per Exhibit A and the application. Changes in project scope must continue to meet the need cited in the original application or they will not be approved. Any modification or alteration in the project as set forth in the application on file with the State must be submitted to the State for approval. Any modification or alteration in the project must also comply with all current laws and regulations, including but not limited to CEQA.
9. Grantee shall provide for public access and/or educational features where feasible.
10. Grantee must have (1) fee title, (2) leasehold, or (3) other interest to project lands and demonstrate to the satisfaction of the State that the proposed project will provide public benefits that are commensurate with the type and duration of the interest in land. Any acquisition of project lands by Grantee following award shall not involve eminent domain proceedings or threat of eminent domain proceedings.

11. Grantee shall promptly provide photographs of the site during and after implementation of project at the request of the State.

C. Project Costs

1. Grant funds provided to Grantee under this agreement will be disbursed in a single payment distribution for eligible costs. Payments are made as follows, but shall not exceed in any event the amount set forth on the signature page of this agreement:
 - a. **A single distribution payment of the total contract dollar amount will be made upon approval of the contract and submission of an invoice by the Grantee.** Grantee agrees to use any Grant Funds under the terms of this Agreement solely for the Project herein described.
 - b. The Grantee shall place these Funds in a separate interest-bearing account, setting up and identifying such account prior to the release of grant funds. Interest earned on Grant Funds shall be used on the Project, as approved by the State. Any overpayment of Grant Funds in excess of final project costs shall be returned to the State within sixty (60) days of completion of the Project or the end of the Project performance period as shown on the signature page, whichever is earlier.
2. Payment Documentation:
 - a. A payment request must be submitted using a completed Payment Request Form.
 - b. If the payment request package is incomplete, inadequate or inaccurate, the State will inform the Grantee and hold the payment request until all required information is received or corrected. Any penalties imposed on the Grantee by a contractor, or other consequence, because of delays in payment will be paid by the Grantee and is not reimbursable under this agreement.
3. Grant funds in this award have a limited period in which they must be expended. Grantee expenditures funded by the State must occur within the time frame of the Project Performance Period as indicated in this agreement.

4. The State reserves the right to request reimbursement of any funds spent on the project, even funds deemed eligible costs, if the project is not completed in accordance with the Grant Agreement and the guidelines.
5. [REDACTED] The total dollars of a category in the project budget may be increased by up to ten percent (10%) through a reallocation of funds from another category, without approval by the State. However, the Grantee shall notify the State in writing when any such reallocation is made and shall identify both the item(s) being increased and those being decreased. Any cumulative increase or decrease of more than ten percent (10%) from the original budget in the amount of a category must be approved by the State. In any event, the total amount of the grant funds may not be increased, nor may any adjustments exceed the limits for management costs as described in the Application Guidelines.

D. Project Administration

1. Grantee shall promptly provide project reports and/or photographs upon request by the State. In any event Grantee shall provide the State a report showing total final project expenditures with the final payment request and required closing documents.
2. Grantee shall make property and facilities acquired or developed pursuant to this agreement available for inspection upon request by the State.
3. Grantee shall use any income earned by the Grantee from use of the project to further project purposes, or, if approved by the State, for related purposes within the jurisdiction.
4. Grantee shall submit all documentation for project completion, including a notice of completion as applicable within ninety (90) days of project completion, but in no event any later than **September 30, 2023**.
5. This agreement may be amended by mutual agreement in writing between Grantee and State. Any request by the Grantee for amendments must be in writing stating the amendment request and reason for the request. The Grantee shall make requests in a timely manner and in no event less than sixty (60) days before the effective date of the proposed amendment.
6. Grantee must report to the State all sources of other funds for the project.

E. Project Termination

1. The State reserves the right to terminate a Grant Agreement for any reason at any time. There are no vested rights or entitlements to funding that a Grantee can or should rely upon, and once a notice of termination is provided to the Applicant, only authorized and eligible work prior to that notification of termination will be paid by the State.
2. Prior to the completion of project construction, either party may terminate this agreement by providing the other party with thirty (30) days' written notice of such termination. The State may also terminate this Grant Agreement for any reason at any time if it learns of or otherwise discovers that there is a violation of any state or federal law or policy by Grantee which affects performance of this or any other grant agreement or contract entered into with the State.
3. If the State terminates without cause the agreement prior to the end of the Project Performance Period, the Grantee shall take all reasonable measures to prevent further costs to the State under this agreement. The State shall be responsible for any reasonable and non-cancelable obligations incurred by the Grantee in the performance of the agreement prior to the date of the notice to terminate.
4. If the Grantee fails to complete the project in accordance with this agreement, or fails to fulfill any other obligations of this agreement prior to the termination date, the Grantee shall be liable for immediate repayment to the State of all amounts disbursed by the State under this agreement, plus accrued interest and any further costs related to the project. The State may, at its sole discretion, consider extenuating circumstances and not require repayment for work partially completed provided that the State determines it is in the State's best interest to do so. This paragraph shall not be deemed to limit any other remedies available to the State for breach of this agreement.
5. Failure by the Grantee to comply with the terms of this agreement or any other agreement under the Act may be cause for suspension of all obligations of the State hereunder.
6. Failure of the Grantee to comply with the terms of this agreement shall not be cause for suspending all obligations of the State hereunder if, in the judgment of the State, such failure was due to no fault of the Grantee. At the discretion of the State, any amount required to settle at minimum cost any irrevocable obligations properly incurred shall be eligible for reimbursement under this agreement.

7. Because the benefit to be derived by the State, from the full compliance by the Grantee with the terms of this agreement, is for the purposes as stated in the application for the people of the State of California, and because such benefit exceeds to an immeasurable and unascertainable extent the amount of money furnished by the State by way of grant funds under the provisions of this agreement, the Grantee agrees that payment by the Grantee to the State of an amount equal to the amount of the grant funds disbursed under this agreement by the State would be inadequate compensation to the State for any breach by the Grantee of this agreement. The Grantee further agrees therefore, that the appropriate remedy in the event of a breach by the Grantee of this agreement shall be the specific performance of this agreement, unless otherwise agreed to by the State.

F. Hold Harmless

1. Grantee shall waive all claims and recourses against the State, including the right to contribution for loss or damage to persons or property arising from, growing out of or in any way connected with or incident to this agreement, except claims arising from the gross negligence of State, its officers, agents and employees.
2. Grantee shall indemnify, hold harmless and defend State, its officers, agents and employees in perpetuity against any and all claims, demands, damages, costs, expenses or liability costs arising out of the project, including development, construction, operation or maintenance of the property described in the project description which claims, demands or causes of action arise under Government Code Section 895.2 or otherwise, including but not limited to items to which the Grantee has certified, except for liability arising out of the gross negligence of State, its officers, agents or employees. Grantee acknowledges that it is solely responsible for compliance with items to which it has certified.
3. Grantee and State agree that in the event of judgment entered against the State and Grantee because of the gross negligence of the State and Grantee, their officers, agents or employees, an apportionment of liability to pay such judgment shall be made by a court of competent jurisdiction. Neither party shall request a jury apportionment.

G. Financial Records

1. Grantee shall maintain satisfactory financial accounts, documents and records for the project and to make them available to the State for auditing at reasonable times. Grantee shall also retain such financial accounts, documents and records for three (3) years after final payment and one (1) year following an audit.

2. Grantee agrees that during regular office hours, the State and its duly authorized representatives shall have the right to inspect and make copies of any books, records or reports of the Grantee pertaining to this agreement or matters related thereto. Grantee shall maintain and make available for inspection by the State accurate records of all of its costs, disbursements and receipts with respect to its activities under this agreement.
3. Grantee shall use applicable Generally Accepted Accounting Principles, unless otherwise agreed to by the State.

H. Use of Facilities

1. The real property (including any portion of it or any interest in it) may not be sold or transferred without the written approval of the State of California, acting through the CAC or its successor, provided that such approval shall not be unreasonably withheld as long as the purposes for which the grant was awarded are maintained.
2. Grantee shall use the property for the purposes for which the grant was made and shall make no other use or sale or other disposition of the property. This agreement shall not prevent the transfer of the property from the Grantee to a Public Agency, if the successor public agency assumes the obligations imposed by this agreement.
3. If the use of the property is changed to a use that is not permitted by the agreement, or if the property is sold or otherwise disposed of, at the State's sole discretion, an amount equal to (1) the amount of the Grant (2) the Fair Market Value of the real property, or (3) the proceeds from the sale or other disposition, whichever is greater, may be reimbursed to the State. If the property sold or otherwise disposed of is less than the entire interest in the property funded in the Grant, an amount equal to either the proceeds from the sale or other disposition of the interest or the Fair Market Value of the interest sold or otherwise disposed of, whichever is greater, shall be reimbursed to the State.
4. The Grantee shall not use or allow the use of any portion of the real property for mitigation without the written permission of the State.
5. The Grantee shall not use or allow the use of any portion of the real property as security for any debt.

I. Nondiscrimination

1. During the performance of this grant, grantee and its subcontractors shall not unlawfully discriminate, harass or allow harassment, against any person because of sex, sexual orientation, race, color, religious creed, marital status, denial of family and medical care leave, ancestry, national origin, medical condition (cancer/genetic characteristics), age (40 and above), disability (mental and physical) including HIV and AIDS, denial of pregnancy disability leave or reasonable accommodation. Grantee and subcontractors shall ensure that the evaluation and treatment of all persons, and particularly their employees and applicants for employment are free from such discrimination and harassment. Grantee and its subcontractors shall comply with the provisions of the Fair Employment and Housing Act (Gov. Code, §12900 et seq.) and the applicable regulations promulgated thereunder (Cal. Code Regs, tit. 2, §7285.0 et seq.). The applicable regulations of the Fair Employment and Housing Commission implementing Government Code, §12990 (a)–(f), are incorporated into this grant by reference and made a part hereof as if set forth in full (Cal. Code Regs, tit. 2, §7285.0 et seq.). Grantee shall include this non-discrimination and compliance provisions of this clause in all subcontracts to perform work under the grant.
2. The Grantee shall not discriminate against any person on the basis of residence except to the extent that reasonable difference in admission or other fees may be maintained on the basis of residence and pursuant to law.
3. The completed project and all related facilities shall be open to members of the public generally, except as noted under the special provisions of this agreement or under provisions of the Act.

J. Application Incorporation

The Grant Guidelines and the Application and any subsequent changes or additions to the Application approved in writing by the State are hereby incorporated by reference into this agreement as though set forth in full in this agreement.

K. Severability

If any provision of this agreement or the application thereof is held invalid, that invalidity shall not affect other provisions or applications of this agreement which can be given effect without the invalid provision or application, and to this end the provisions of this agreement are severable.

L. Waiver

No term or provision hereof will be considered waived by either party, and no breach excused by either party, unless such waiver or consent is in writing and signed on behalf of the party against whom the waiver is asserted. No consent by either party to, or waiver of, a breach by either party, whether expressed or implied, will constitute consent to, waiver of or excuse of any other, different or subsequent breach by either party.

M. Assignment

Except as expressly provided otherwise, this agreement is not assignable by the Grantee either in whole or in part.

N. Disputes

If the Grantee believes that there is a dispute or grievance between Grantee and the State arising out of or relating to this agreement, the Grantee shall first discuss and attempt to resolve the issue informally with the Agency Grants Administrator. If the issue cannot be resolved at this level, the Grantee shall follow the following procedures:

1. If the issue cannot be resolved informally with the Agency Grants Administrator, the Grantee shall submit, in writing, a grievance report together with any evidence to the Director of the California Arts Council. The grievance report must state the issues in the dispute, the legal authority, or other basis for the Grantee's position and the remedy sought. Within ten (10) working days of receipt of the written grievance report from the Grantee, the Director shall make a determination on the issue(s) and shall respond in writing to the Grantee indicating the decision and reasons therefore. Should the Grantee disagree with the Director's decision, the Grantee may appeal to the Governor's office.
2. The Grantee must submit a letter of appeal to the Governor's office explaining why the Director's decision is unacceptable. The letter must include, as an attachment, copies of the Grantee's original grievance report, evidence originally submitted, and response from the Director. The Grantee's letter of appeal must be submitted within ten (10) working days of the receipt of the Director's written decision. The Governor's office or designee shall, within twenty (20) working days of receipt of Grantee's letter of appeal, review the

issues raised and shall render a written decision to the Grantee. The decision of the Governor's office or designee shall be final.

O. Audit Requirements

Grant projects are subject to audit by the State annually and for three (3) years following the final payment of grant funds. The audit shall include all books, papers, accounts, documents, or other records of the Grantee, as they relate to the project for which the grant funds were granted.

Please have Grantee's Authorized Representative sign and date below, and return in electronic format:

Grantee's Authorized Representative

(Date)

California Arts Council, Executive Director

(Date)



**City and County of San Francisco
Harvey Milk Plaza Project
Grant Application**

March 24,2022

PROJECT INFORMATION PACKAGE CHECKLIST

Grantee sends a completed Project Information Package to Agency. Grantees should keep a complete copy of the Project Information Package for future use and reference.

Provide the package in order shown in the following checklist, via email to the Agency Grants Administrator:

Description	Page #
Project Information Package Checklist (this page)	1
Project Information Form	2
Project Summary	3
Authorizing Resolution	4
Cost Estimate	5
Project Timeline	6
Property Data Sheet	N/A
Land Tenure/Site Control Documents	N/A
Photos of the Project Site	N/A
Site Plan, if applicable	N/A
CEQA Compliance Documents, if applicable	N/A
Payee Data Form (std. 204)	7

PROJECT INFORMATION FORM

Project Name Harvey Milk Plaza Project	Estimated Date of Completion: <u>January 2027</u> Grant Amount Requested: <u>\$1,500,000</u> Estimated Total Project Cost: <u>\$ 31,200,000</u> (State Grant and other funds and In-Kind donations)		
Grantee Name (with mailing address) Check one: Non-Profit <input type="checkbox"/> Local Public Agency <input checked="" type="checkbox"/> State Agency <input type="checkbox"/>	County San Francisco Project Address (or nearest cross street) 400 Castro Street- Harvey Milk Plaza		
	Senate Dist. 11	Assembly Dist. 17	US Congressional Dist. 12

Grantee's Representative Authorized in Resolution (Signature required at bottom of this page)

Name: Carla Shorts Title: Interim Director
 Phone: 628 271 3078 Email Address: Carla.short@sfdpw.org

Project Manager - Person with day to day responsibility for project (if different from authorized representative)

Name: Jumoke.akin-taylor@sfdpw.org Title: Project Manager
 Phone: 628 271-2823 mobile 510 284-7119 Email Address: Jumoke.akin-taylor@sfdpw.org

Brief Description of Project (Summarize major activities to be funded by this Grant)	Latitude	Longitude
<p>The New Harvey Milk Plaza is a place like no other—as unconventional as the human rights figure himself. Equal parts memorial, celebration and call to action, it is here that visitors are introduced to Harvey Milk, learn about his story and mission, and then leave energized to create change in their own communities.</p> <p><input type="checkbox"/> Design through Construction Documents/Permit set</p> <p><input type="checkbox"/> April 2022 – September 2022</p>		
	<p>Exempt from CEQA, pursuant to CEQA Guideline # _____ (Attach Notice of Exemption)</p> <p>CEQA Approval received from another public Agency Attach lead agency's resolution approving the project, along with the Notice of Determination, Negative Declaration, or Mitigated Negative Declaration, stamped by State Clearinghouse and County Clerk's Office</p> <p>CEQA is not complete, but a completed Draft Initial Study with Checklist is provided</p>	

I certify that the information contained in this project application, including required attachments, is complete and accurate

Signed: _____ Date _____
Grantee's Authorized Representative as shown in Resolution

Print Name: Carla Short **Print Title:** Interim Director

PROJECT SUMMARY

With your Project Information Package, submit a one-page summary that provides a description of the proposed project.

Grantees must comply with all current laws and regulations which apply to the Project, including, but not limited to, legal requirements for construction contracts, building codes, environmental laws, health and safety codes, and disabled access laws.

Grantee certifies that, prior to commencement of construction, all applicable permits and licenses (e.g., state contractor's license) will have been obtained.

The New Harvey Milk Plaza is a place like no other—as unconventional as the human rights figure himself. Equal parts memorial, celebration and call to action, it is here that visitors are introduced to Harvey Milk, learn about his story and mission, and then leave energized to create change in their own communities. The New Harvey Milk Plaza features a triangulated sculptural canopy which runs axially east/west through the site. This sculpture symbolizes the push and pull of Harvey Milk's life, inspiring visitors to create a better future while simultaneously linking them to the past with a timeline embedded in the ground plane below the canopy. The sculptural canopy and timeline lead visitors on a journey through the plaza culminating in a grove of 11 ginkgo trees at its western edge which mark the 11 months Harvey Milk was in office. The New Harvey Milk Plaza will honor Harvey Milk, improve universal access throughout the site, create successful public space, and improve safety and security throughout the site, and become a new, iconic gateway to the Castro.

Regrade, repave, and re-landscape the current Harvey Milk Plaza in coordination with the MTA Castro Station elevator project, add a canopy over the Castro/Market Muni station entry, improve Muni station entry stairs, and below grade concourse up to the fare gates, and elevator. Add Harvey Milk memorial display fixtures, artwork and sculptural landscape elements integrated into the plaza landscape and hardscape.

In addition to being a memorial to Harvey Milk, the project paving and grading improves ADA accessibility, and enhances public safety and security with lighting, streetscape, and Muni station entry improvements.

COST ESTIMATE FORM FOR DEVELOPMENT PROJECTS

All cost elements included should be consistent with the scope, site plan and CEQA documents. Add and delete project elements as applicable to your project.

Project Elements (SAMPLE ONLY)	Total Project Costs	General Fund Grant	Other Funding (if applicable)	Other Funding (if applicable)
NON-CONSTRUCTION COSTS				
Direct Project Management & Administration				
Staff Time (direct costs only)	\$1,440,000			
Incidental Charges	\$480,000	Ineligible		
Consultants	\$480,000			
Subtotal – Direct Management	\$2,400,000			
Planning, Design & Permitting				
Staff Time (direct costs only)	\$1,320,000			
Consultants	\$1,500,000	\$1,500,000		
Permit Costs	\$480,000			
Subtotal - Planning, Design & Permitting	\$3,300,000			
CEQA Compliance (if applicable)				
Staff Time (direct costs only)				
Consultants				
Subtotal – CEQA	\$240,000			
SUB-TOTAL Non-Construction Costs (not to exceed 25% of grant)				
CONSTRUCTION COSTS				
Component X (Specify)				
Component Y (Specify)				
Component Z (Specify)				
SUB- TOTAL Construction Costs	\$24,000,000			
Contingency (not to exceed 10% of grant)				
PROJECT GRAND TOTAL	\$30,300,000			

Category listing should be detailed and customized to fit the project. Each Funding source, whether In-Kind or cash should have its own column. Specify In-Kind or cash in each column heading. The General Fund Grant and Other Funding Sources should sum the Total Project Costs column. LS = Lump Sum

PROJECT TIMELINE

Activity Description	Timeline
Preliminary work on the project	April 2018- January 2021
Submit CEQA documents	February 2022
Submit final site design/plans/specifications	July 2022- February 2023
Submit evidence of bond acknowledgement sign	Month 20XX
Construction period	July 2024 July 2026
Submit Project Closeout package with Final Report to State	January 2027

PAYEE DATA RECORD

(Required when receiving payment from the State of California in lieu of IRS W-9)
 STD. 204 (Rev. 6-2003)

1	<p>INSTRUCTIONS: Complete all information on this form. Sign, date, and return to the State agency (department/office) address shown at the bottom of this page. Prompt return of this fully completed form will prevent delays when processing payments. Information provided in this form will be used by State agencies to prepare Information Returns (1099). See reverse side for more information and Privacy Statement.</p> <p>NOTE: Governmental entities, federal, State, and local (including school districts), are not required to submit this form.</p>		
2	PAYEE'S LEGAL BUSINESS NAME (Type or Print)		
	SOLE PROPRIETOR – ENTER NAME AS SHOWN ON SSN (Last, First, M.I.)		E-MAIL ADDRESS
	MAILING ADDRESS		BUSINESS ADDRESS
	CITY, STATE, ZIP CODE		CITY, STATE, ZIP CODE
3	<p>ENTER FEDERAL EMPLOYER IDENTIFICATION NUMBER (FEIN): <input type="text"/> <input type="text"/> - <input type="text"/> <input type="text"/> <input type="text"/> <input type="text"/> <input type="text"/> <input type="text"/> <input type="text"/> <input type="text"/></p> <p><input type="checkbox"/> PARTNERSHIP CORPORATION:</p> <p style="margin-left: 100px;"><input type="checkbox"/> ESTATE OR TRUST MEDICAL (e.g., dentistry, psychotherapy, chiropractic, etc.)</p> <p style="margin-left: 100px;">LEGAL (e.g., attorney services)</p> <p style="margin-left: 100px;">EXEMPT (nonprofit)</p> <p style="margin-left: 100px;">ALL OTHERS</p>		<p>NOTE: Payment will not be processed without an accompanying taxpayer I.D. number.</p>
<p>PAYEE ENTITY TYPE</p> <p>CHECK ONE BOX ONLY</p>	<p><input type="checkbox"/> INDIVIDUAL OR SOLE PROPRIETOR ENTER SOCIAL SECURITY NUMBER: <input type="text"/> <input type="text"/> <input type="text"/> - <input type="text"/> <input type="text"/> <input type="text"/> <input type="text"/> <input type="text"/> <input type="text"/> <input type="text"/></p> <p style="text-align:center; font-size:small;">(SSN required by authority of California Revenue and Tax Code Section 18646)</p>		
4	<p><input type="checkbox"/> California resident - Qualified to do business in California or maintains a permanent place of business in California.</p> <p><input type="checkbox"/> California nonresident (see reverse side) - Payments to nonresidents for services may be subject to State income tax withholding.</p> <p style="margin-left: 40px;">No services performed in California. Copy of Franchise Tax Board waiver of State withholding attached.</p>		
5	<p style="text-align:center;">I hereby certify under penalty of perjury that the information provided on this document is true and correct. Should my residency status change, I will promptly notify the State agency below.</p>		
	AUTHORIZED PAYEE REPRESENTATIVE'S NAME (Type or Print)		TITLE
	SIGNATURE	DATE	TELEPHONE ()
6	<p>Please return completed form to:</p> <p>Department/Office: _____</p> <p>Unit/Section: _____</p> <p>Mailing Address: _____</p> <p>City/State/Zip: _____</p> <p>Telephone: () _____ Fax: () _____</p> <p>E-mail Address: _____</p>		

**CALIFORNIA ARTS COUNCIL
GRANT AGREEMENT**

Grantee Name: City and County of San Francisco, Department of Public Works

Project Title: Harvey Milk Plaza Project

Agreement Number: 02-04-2022-0

Authority: Senate Bill No. 170 Specified Funding FY 2021-22

Program: General Fund Designated Funding Grant Projects

PROJECT DESCRIPTION

Brief Project Description

The New Harvey Milk Plaza is a place like no other—as unconventional as the human rights figure himself. Equal parts memorial, celebration and call to action, it is here that visitors are introduced to Harvey Milk, learn about his story and mission, and then leave energized to create change in their own communities. The New Harvey Milk Plaza features a triangulated sculptural canopy which runs axially east/west through the site. This sculpture symbolizes the push and pull of Harvey Milk’s life, inspiring visitors to create a better future while simultaneously linking them to the past with a timeline embedded in the ground plane below the canopy. The sculptural canopy and timeline lead visitors on a journey through the plaza culminating in a grove of 11 ginkgo trees at its western edge which mark the 11 months Harvey Milk was in office. The New Harvey Milk Plaza will honor Harvey Milk, improve universal access throughout the site, create successful public space, and improve safety and security throughout the site, and become a new, iconic gateway to the Castro.

A detailed project scope and activities [REDACTED] are described and attached hereto as Exhibit A.

Grant Funds are to be used to support capital asset projects/programmatic project in accordance with the provisions contained in the Procedural Guide for Dedicated Funding Grant Projects and this Agreement.

TERMS AND CONDITIONS OF GRANT

Special Provisions

Special Provisions, **if applicable EXAMPLES ONLY**: (see other Sample Special Provisions in B&G/Procedures–Various/Preparation of Grant Agreement)

1. Insert if California Environmental Quality Act (CEQA) (including Greenhouse Gas Emissions) has not yet been completed at time of Grant Agreement: As conditions precedent to the State's obligation to make any construction funding available pursuant to this agreement, Grantee shall first provide evidence of compliance with CEQA.
2. Insert if nonprofit: If the Grantee is a nonprofit organization and ceases to exist, all of its rights, title and interest in the real property shall vest in the State of California. The State may, at its discretion, identify an appropriate public or private entity to accept the right, title and interest in the real property in lieu of the State.
3. Insert if grantee has not yet obtained land tenure/site control: As conditions precedent to the State's obligation to make any funding available pursuant to this agreement, Grantee shall first provide evidence of adequate land tenure and evidence that the project will be operated and maintained for a minimum of 25 years satisfactory to the State for all land to be improved under this agreement.

General Provisions

A. Definitions

1. The term "Act" means Senate Bill No. 170 (2021).
2. The term "Acquisition" means obtaining a fee interest or any other interest, including easements, leases, and development rights.
3. The term "Agreement" means this Grant Agreement.
4. The term "Application Guidelines" means the Procedural Guide for General Fund Specified Grant Projects.
5. The term "Development" means improvement, rehabilitation, restoration, enhancement, preservation, protection and interpretation or other similar activities.
6. The term "Fair Market Value" means the value placed upon the property as supported by an appraisal that has been reviewed and approved by the California Department of General Services (DGS).
7. The term "Grant" or "Grant Funds" means the money provided by the State to the Grantee in this agreement.
8. The term "Grant Agreement" means a contractual arrangement between the State and Grantee specifying the payment of funds by the State for the performance of specific project objectives within a specific project performance period by the Grantee.
9. The term "Grantee" means an applicant who has a signed agreement for grant funds. *(Grantee's Authorized Representative signature required on Grant Agreement.)*
10. The term "Interpretation" means visitor-serving amenities that communicate the significance and value of natural, historical and cultural resources in a manner that increases the understanding and enjoyment of these resources, or other similar activities.
11. The term "Other Sources of Funds" means cash or in-kind contributions that are required or used to complete the project beyond the grant funds provided by this Agreement.
12. The term "Payment Request Form" means Invoice.
13. The term "Project" means the acquisition or development activity described in the application as modified by Exhibit A to be accomplished with grant funds.

14. The term "Project Budget" means the State approved cost estimate included as Exhibit A to this Agreement.
15. The term "Project Scope" means the description or activity for work to be accomplished by the project.
16. The term "State" means the Secretary for California Arts Council or his/her representatives, or other political subdivision of the State.

B. Project Execution

1. Subject to the availability of funds in the Act, the State hereby grants to the Grantee a sum of money (Grant Funds) not to exceed the amount stated on the signature page in consideration of and on condition that the sum be expended in carrying out the purposes as set forth in the description of project in this Agreement and its attachments and under the Terms and Conditions set forth in this agreement.

2. [REDACTED]

3. [REDACTED]

4. [REDACTED]

Grant funds for planning and document preparation may be available sooner if included in the grant project scope (Exhibit A) and approved by the State. CEQA compliance shall be completed within one (1) year from the Grant Agreement start date, unless an extension is granted by the State.

Changes to the scope resulting from CEQA compliance are permitted provided the State determines that the project continues to meet all objectives of the General Fund Specified Grant Project and is consistent with the intent cited in the original Application.

If a grantee's project is disapproved on grounds related to the California Arts

Council's CEQA determination, the grantee shall have the option of either: (1) reimbursing the CAC for all state-reimbursed preliminary costs (e.g., planning, design, etc.), or (2) relinquishing any planning/design documents, including all copies, reproductions, and variations resulting from said funding, without a license to use or otherwise retain in any form.

5. Projects must comply with any applicable laws pertaining to prevailing wage and labor compliance.
6. Grantee certifies that the project does and will continue to comply with all current laws and regulations which apply to the project, including, but not limited to, legal requirements for construction contracts, building codes, environmental laws, health and safety codes, and disabled access laws. Grantee certifies that, prior to commencement of construction; all applicable permits and licenses (e.g., state contractor's license) will have been obtained.
7. Grantee shall provide access by the State upon 24-hours' notice to determine if project work is in accordance with the approved project scope, including a final inspection upon project completion.
8. Prior to the commencement of any work, Grantee agrees to submit in writing to the State for prior approval any deviation from the original project scope per Exhibit A and the application. Changes in project scope must continue to meet the need cited in the original application or they will not be approved. Any modification or alteration in the project as set forth in the application on file with the State must be submitted to the State for approval. Any modification or alteration in the project must also comply with all current laws and regulations, including but not limited to CEQA.
9. Grantee shall provide for public access and/or educational features where feasible.
10. Grantee must have (1) fee title, (2) leasehold, or (3) other interest to project lands and demonstrate to the satisfaction of the State that the proposed project will provide public benefits that are commensurate with the type and duration of the interest in land. Any acquisition of project lands by Grantee following award shall not involve eminent domain proceedings or threat of eminent domain proceedings.
11. Grantee shall promptly provide photographs of the site during and after implementation of project at the request of the State.

C. Project Costs

1. Grant funds provided to Grantee under this agreement will be disbursed in a single payment distribution for eligible costs. Payments are made as follows, but shall

not exceed in any event the amount set forth on the signature page of this agreement:

- a. **A single distribution payment of the total contract dollar amount will be made upon approval of the contract and submission of an invoice by the Grantee.** Grantee agrees to use any Grant Funds under the terms of this Agreement solely for the Project herein described.
- b. The Grantee shall place these Funds in a separate interest-bearing account, setting up and identifying such account prior to the release of grant funds. Interest earned on Grant Funds shall be used on the Project, as approved by the State. Any overpayment of Grant Funds in excess of final project costs shall be returned to the State within sixty (60) days of completion of the Project or the end of the Project performance period as shown on the signature page, whichever is earlier.

2. Payment Documentation:

- a. A payment request must be submitted using a completed Payment Request Form.
- b. If the payment request package is incomplete, inadequate or inaccurate, the State will inform the Grantee and hold the payment request until all required information is received or corrected. Any penalties imposed on the Grantee by a contractor, or other consequence, because of delays in payment will be paid by the Grantee and is not reimbursable under this agreement.

3. Grant funds in this award have a limited period in which they must be expended. Grantee expenditures funded by the State must occur within the time frame of the Project Performance Period as indicated in this agreement.

4. The State reserves the right to request reimbursement of any funds spent on the project, even funds deemed eligible costs, if the project is not completed in accordance with the Grant Agreement and the guidelines.

5. [REDACTED] The total dollars of a category in the project budget may be increased by up to ten percent (10%) through a reallocation of funds from another category, without approval by the State. However, the Grantee shall notify the State in writing when any such reallocation is made and shall identify both the item(s) being increased and those being decreased. Any cumulative increase or decrease of more than ten percent (10%) from the original budget in the amount of a category must be approved by the State. In any event, the total amount of the grant funds may not be increased,

nor may any adjustments exceed the limits for management costs as described in the Application Guidelines.

D. Project Administration

1. Grantee shall promptly provide project reports and/or photographs upon request by the State. In any event Grantee shall provide the State a report showing total final project expenditures with the final payment request and required closing documents.
2. Grantee shall make property and facilities acquired or developed pursuant to this agreement available for inspection upon request by the State.
3. Grantee shall use any income earned by the Grantee from use of the project to further project purposes, or, if approved by the State, for related purposes within the jurisdiction.
4. Grantee shall submit all documentation for project completion, including a notice of completion as applicable within ninety (90) days of project completion, but in no event any later than **September 30, 2023**.
5. This agreement may be amended by mutual agreement in writing between Grantee and State. Any request by the Grantee for amendments must be in writing stating the amendment request and reason for the request. The Grantee shall make requests in a timely manner and in no event less than sixty (60) days before the effective date of the proposed amendment.
6. Grantee must report to the State all sources of other funds for the project.

E. Project Termination

1. The State reserves the right to terminate a Grant Agreement for any reason at any time. There are no vested rights or entitlements to funding that a Grantee can or should rely upon, and once a notice of termination is provided to the Applicant, only authorized and eligible work prior to that notification of termination will be paid by the State.
2. Prior to the completion of project construction, either party may terminate this agreement by providing the other party with thirty (30) days' written notice of such termination. The State may also terminate this Grant Agreement for any reason at any time if it learns of or otherwise discovers that there is a violation of any state or federal law or policy by Grantee which affects performance of this or any other grant agreement or contract entered into with the State.

3. If the State terminates without cause the agreement prior to the end of the Project Performance Period, the Grantee shall take all reasonable measures to prevent further costs to the State under this agreement. The State shall be responsible for any reasonable and non-cancelable obligations incurred by the Grantee in the performance of the agreement prior to the date of the notice to terminate.
4. If the Grantee fails to complete the project in accordance with this agreement, or fails to fulfill any other obligations of this agreement prior to the termination date, the Grantee shall be liable for immediate repayment to the State of all amounts disbursed by the State under this agreement, plus accrued interest and any further costs related to the project. The State may, at its sole discretion, consider extenuating circumstances and not require repayment for work partially completed provided that the State determines it is in the State's best interest to do so. This paragraph shall not be deemed to limit any other remedies available to the State for breach of this agreement.
5. Failure by the Grantee to comply with the terms of this agreement or any other agreement under the Act may be cause for suspension of all obligations of the State hereunder.
6. Failure of the Grantee to comply with the terms of this agreement shall not be cause for suspending all obligations of the State hereunder if, in the judgment of the State, such failure was due to no fault of the Grantee. At the discretion of the State, any amount required to settle at minimum cost any irrevocable obligations properly incurred shall be eligible for reimbursement under this agreement.
7. Because the benefit to be derived by the State, from the full compliance by the Grantee with the terms of this agreement, is for the purposes as stated in the application for the people of the State of California, and because such benefit exceeds to an immeasurable and unascertainable extent the amount of money furnished by the State by way of grant funds under the provisions of this agreement, the Grantee agrees that payment by the Grantee to the State of an amount equal to the amount of the grant funds disbursed under this agreement by the State would be inadequate compensation to the State for any breach by the Grantee of this agreement. The Grantee further agrees therefore, that the appropriate remedy in the event of a breach by the Grantee of this agreement shall be the specific performance of this agreement, unless otherwise agreed to by the State.

F. Hold Harmless

1. Grantee shall waive all claims and recourses against the State, including the right to contribution for loss or damage to persons or property arising from, growing out of or in any way connected with or incident to this agreement, except claims arising from the gross negligence of State, its officers, agents and employees.

2. Grantee shall indemnify, hold harmless and defend State, its officers, agents and employees in perpetuity against any and all claims, demands, damages, costs, expenses or liability costs arising out of the project, including development, construction, operation or maintenance of the property described in the project description which claims, demands or causes of action arise under Government Code Section 895.2 or otherwise, including but not limited to items to which the Grantee has certified, except for liability arising out of the gross negligence of State, its officers, agents or employees. Grantee acknowledges that it is solely responsible for compliance with items to which it has certified.
3. Grantee and State agree that in the event of judgment entered against the State and Grantee because of the gross negligence of the State and Grantee, their officers, agents or employees, an apportionment of liability to pay such judgment shall be made by a court of competent jurisdiction. Neither party shall request a jury apportionment.

G. Financial Records

1. Grantee shall maintain satisfactory financial accounts, documents and records for the project and to make them available to the State for auditing at reasonable times. Grantee shall also retain such financial accounts, documents and records for three (3) years after final payment and one (1) year following an audit.
2. Grantee agrees that during regular office hours, the State and its duly authorized representatives shall have the right to inspect and make copies of any books, records or reports of the Grantee pertaining to this agreement or matters related thereto. Grantee shall maintain and make available for inspection by the State accurate records of all of its costs, disbursements and receipts with respect to its activities under this agreement.
3. Grantee shall use applicable Generally Accepted Accounting Principles, unless otherwise agreed to by the State.

H. Use of Facilities

1. The real property (including any portion of it or any interest in it) may not be sold or transferred without the written approval of the State of California, acting through the CAC or its successor, provided that such approval shall not be unreasonably withheld as long as the purposes for which the grant was awarded are maintained.
2. Grantee shall use the property for the purposes for which the grant was made and shall make no other use or sale or other disposition of the property. This agreement shall not prevent the transfer of the property from the Grantee to a Public Agency, if the successor public agency assumes the obligations imposed by this agreement.

3. If the use of the property is changed to a use that is not permitted by the agreement, or if the property is sold or otherwise disposed of, at the State's sole discretion, an amount equal to (1) the amount of the Grant (2) the Fair Market Value of the real property, or (3) the proceeds from the sale or other disposition, whichever is greater, may be reimbursed to the State. If the property sold or otherwise disposed of is less than the entire interest in the property funded in the Grant, an amount equal to either the proceeds from the sale or other disposition of the interest or the Fair Market Value of the interest sold or otherwise disposed of, whichever is greater, shall be reimbursed to the State.
4. The Grantee shall not use or allow the use of any portion of the real property for mitigation without the written permission of the State.
5. The Grantee shall not use or allow the use of any portion of the real property as security for any debt.

I. Nondiscrimination

1. During the performance of this grant, grantee and its subcontractors shall not unlawfully discriminate, harass or allow harassment, against any person because of sex, sexual orientation, race, color, religious creed, marital status, denial of family and medical care leave, ancestry, national origin, medical condition (cancer/genetic characteristics), age (40 and above), disability (mental and physical) including HIV and AIDS, denial of pregnancy disability leave or reasonable accommodation. Grantee and subcontractors shall ensure that the evaluation and treatment of all persons, and particularly their employees and applicants for employment are free from such discrimination and harassment. Grantee and its subcontractors shall comply with the provisions of the Fair Employment and Housing Act (Gov. Code, §12900 et seq.) and the applicable regulations promulgated thereunder (Cal. Code Regs, tit. 2, §7285.0 et seq.). The applicable regulations of the Fair Employment and Housing Commission implementing Government Code, §12990 (a)–(f), are incorporated into this grant by reference and made a part hereof as if set forth in full (Cal. Code Regs, tit. 2, §7285.0 et seq.). Grantee shall include this non-discrimination and compliance provisions of this clause in all subcontracts to perform work under the grant.
2. The Grantee shall not discriminate against any person on the basis of residence except to the extent that reasonable difference in admission or other fees may be maintained on the basis of residence and pursuant to law.
3. The completed project and all related facilities shall be open to members of the public generally, except as noted under the special provisions of this agreement or under provisions of the Act.

J. Application Incorporation

The Grant Guidelines and the Application and any subsequent changes or additions to the Application approved in writing by the State are hereby incorporated by reference into this agreement as though set forth in full in this agreement.

K. Severability

If any provision of this agreement or the application thereof is held invalid, that invalidity shall not affect other provisions or applications of this agreement which can be given effect without the invalid provision or application, and to this end the provisions of this agreement are severable.

L. Waiver

No term or provision hereof will be considered waived by either party, and no breach excused by either party, unless such waiver or consent is in writing and signed on behalf of the party against whom the waiver is asserted. No consent by either party to, or waiver of, a breach by either party, whether expressed or implied, will constitute consent to, waiver of or excuse of any other, different or subsequent breach by either party.

M. Assignment

Except as expressly provided otherwise, this agreement is not assignable by the Grantee either in whole or in part.

N. Disputes

If the Grantee believes that there is a dispute or grievance between Grantee and the State arising out of or relating to this agreement, the Grantee shall first discuss and attempt to resolve the issue informally with the Agency Grants Administrator. If the issue cannot be resolved at this level, the Grantee shall follow the following procedures:

1. If the issue cannot be resolved informally with the Agency Grants Administrator, the Grantee shall submit, in writing, a grievance report together with any evidence to the Director of the California Arts Council. The grievance report must state the issues in the dispute, the legal authority, or other basis for the Grantee's position and the remedy sought. Within ten (10) working days of receipt of the written grievance report from the Grantee, the Director shall make a determination on the issue(s) and shall respond in writing to the Grantee indicating the decision and reasons therefore. Should the Grantee disagree with the Director's decision, the Grantee may appeal to the Governor's office.
2. The Grantee must submit a letter of appeal to the Governor's office explaining why the Director's decision is unacceptable. The letter must include, as an attachment,

copies of the Grantee's original grievance report, evidence originally submitted, and response from the Director. The Grantee's letter of appeal must be submitted within ten (10) working days of the receipt of the Director's written decision. The Governor's office or designee shall, within twenty (20) working days of receipt of Grantee's letter of appeal, review the issues raised and shall render a written decision to the Grantee. The decision of the Governor's office or designee shall be final.

O. Audit Requirements

Grant projects are subject to audit by the State annually and for three (3) years following the final payment of grant funds. The audit shall include all books, papers, accounts, documents, or other records of the Grantee, as they relate to the project for which the grant funds were granted.

Please have Grantee's Authorized Representative sign and date below, and return in electronic format:

Grantee's Authorized Representative

(Date)

California Arts Council, Executive Director

(Date)



Strengthening arts, culture,
and creative expression as the
tools to cultivate a better
California for all.

Gavin Newsom, **Governor**
Anne Bown-Crawford, **Executive Director**
1300 I Street, Suite 930, Sacramento, CA 95814
(916) 322-6555 | www.arts.ca.gov

November 15, 2021

City of San Francisco
San Francisco, CA 94102

Congratulations!

A designated funding grant has been awarded to the City of San Francisco in the amount of \$1,500,000.

We value your time and commitment to the arts and look forward to working with you. Your work plays an important role as we continue to demonstrate the power of creativity and culture throughout the state of California.

We are currently finalizing the guidelines and contract documents for the designated funding grants and will be in touch with you on next steps as soon as those are available.

In the meantime, please direct any questions about your grant to Kristin Margolis, Director of Legislative Affairs, at Kristin.Margolis@arts.ca.gov.

Thank you for the work you do in support of California communities through the arts!

We wish you the best of luck and much success in your work.

Sincerely,

Anne Bown-Crawford
Director

THE MEMORIAL AT HARVEY MILK PLAZA

San Francisco Arts Commission
Phase II Design Development
September 10, 2021



SF
Parks
Alliance

swa
San Francisco

Movement Timeline

1976 Muni Station Dedicated



1978
1979 Candlelight March & White Night Riots



1980 Station Officially Opens

1985 Station Entrance is Named "Harvey Milk Plaza"



1997 Rainbow Flag Installed

2000 SPUR/SFAC Design Competition



2016 SFMTA Project Announced



2016 FHMP is Formed
2017 Two Community Visioning Sessions

2017 FHMP/AIASF Design Competition

2018 Four Community Meetings w/ Architects
2018 Schematic Design Begins City Approvals



THE MEMORIAL AT HARVEY MILK PLAZA

For Reference: Previously Approved SFMTA Elevator Project

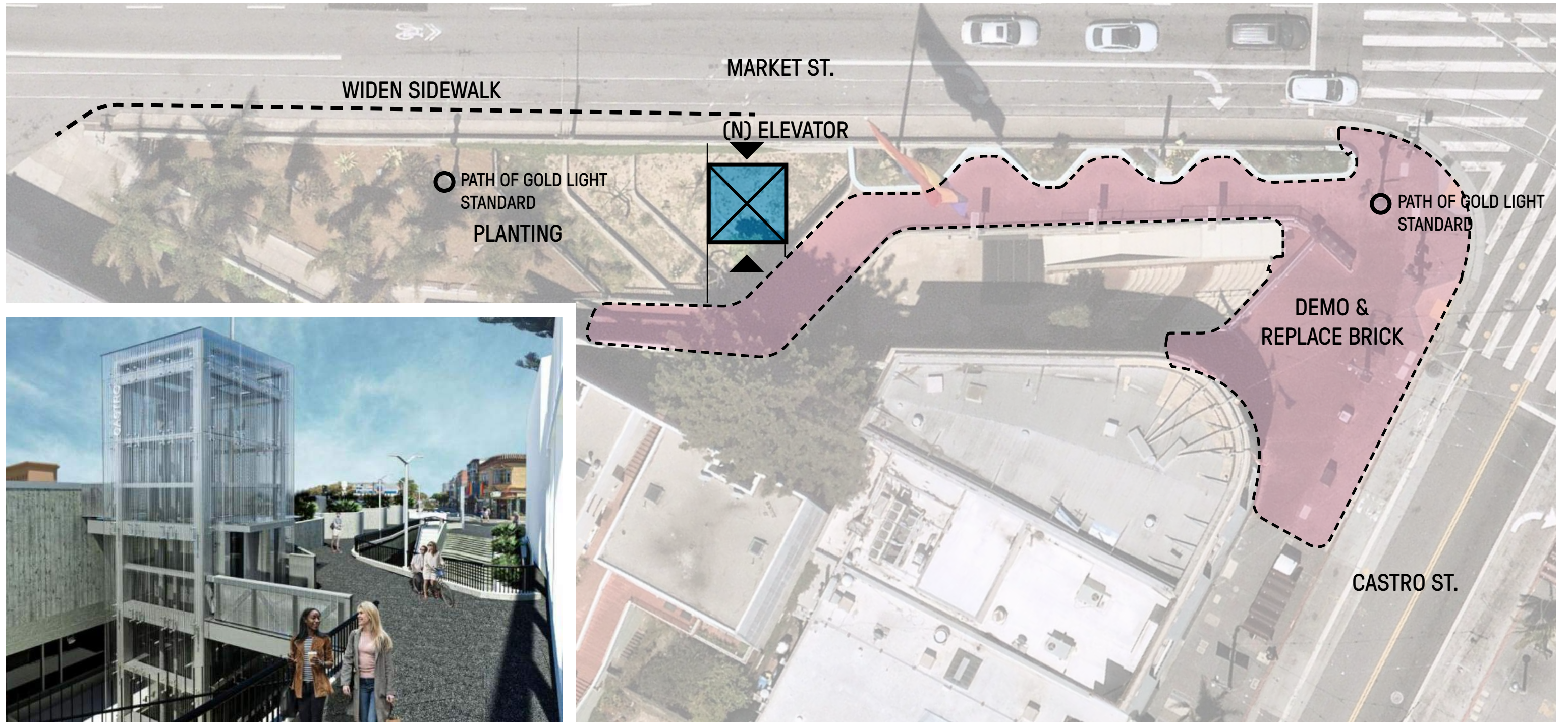

Approved Phase 1 Plan

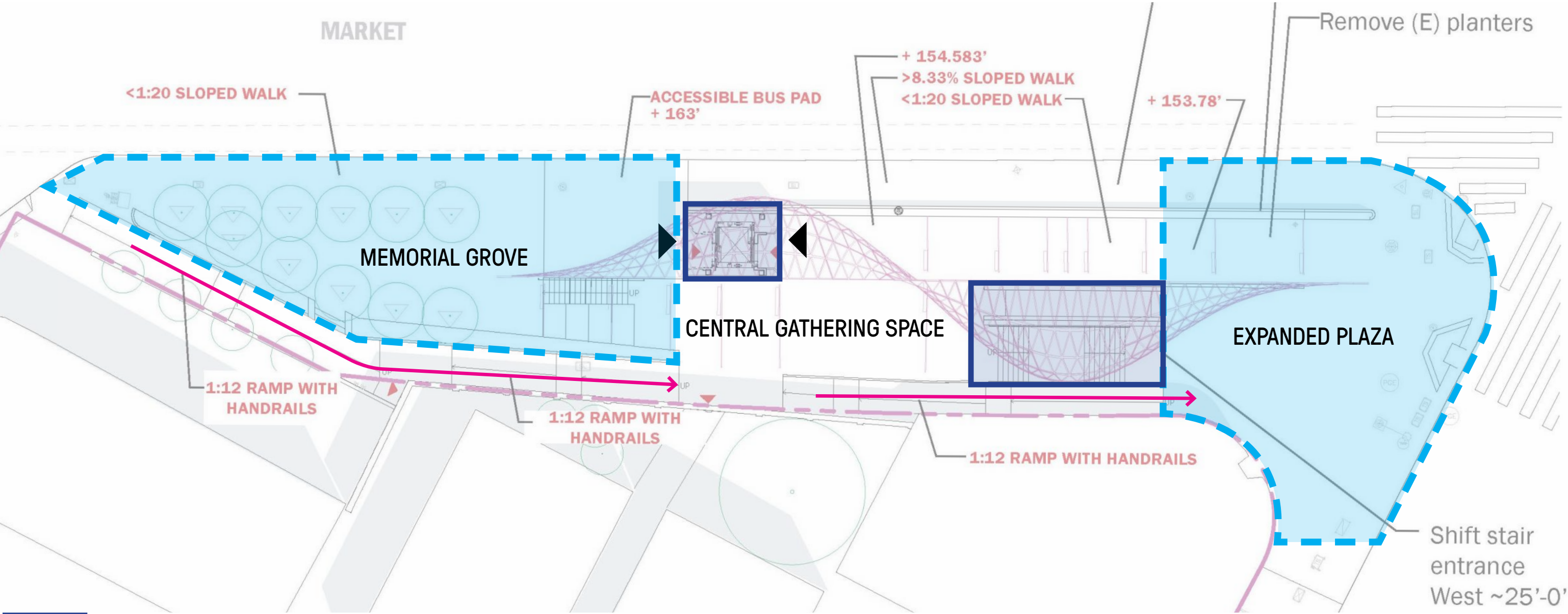

Commissioners Comments 12.17.2018

- 1) Moving forward with developing the ground plane plans, ADA compliant codes, and exploration of the canopy, along with the art and artist's role in its development.
- 2) Approaching the ground landscape, vertical improvements, and structural elements holistically.
- 3) Addressing the topographical issues of the plaza.

The Committee reiterated that the project team needed to approach the design holistically to connect the entire plaza. They encouraged the team to take ownership of the design so it may be successful and not dependent on just the art component.

Community Outreach and Process

City Wide Postering & Online Survey

About 370 posters were placed in the Castro District, Noe Valley, and along parts of the Mission. Posters were in English, Cantonese, and Spanish. Outreach Ambassadors strictly adhered to the Department of Public Works rules. Besides just placing posters on street poles, some were also placed on community bulletin boards and community-based organizations.



Harvey Milk Day 2021

Friends of Harvey Milk Plaza (FHMP) engaged with local community members during the street fair celebrating Harvey Milk Day in the Castro. Board members and the project design team answered questions about the project, listened to community thoughts, and invited the community to sign up for the online community meetings.



Community Meeting #1

Friends of Harvey Milk Plaza (FHMP) hosted two events to kick off a new community engagement effort building on the input the organization has been gathering since 2017. The goal was to start a conversation where the community can share thoughts and aspirations about creating a memorial for Harvey Milk at Harvey Milk Plaza, located at Castro and Market. To gather feedback and elevate community voices, we hosted two virtual town halls with the same content presented in English. Upon registration, people had the option to indicate any other language or accessibility needs, but none were noted.

	Thurs, April 15	Sat, April 17
Number of registrations	69	51
Number of attendees	54	20

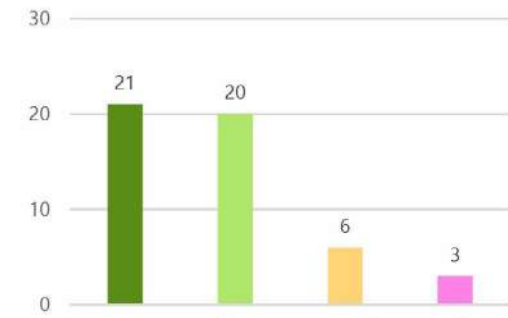
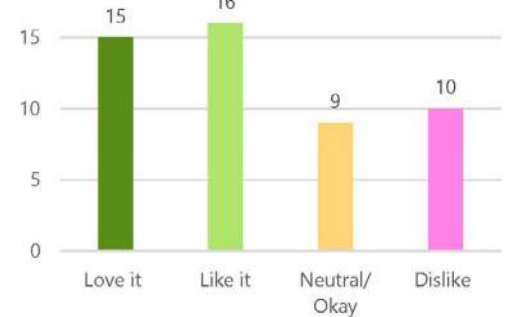
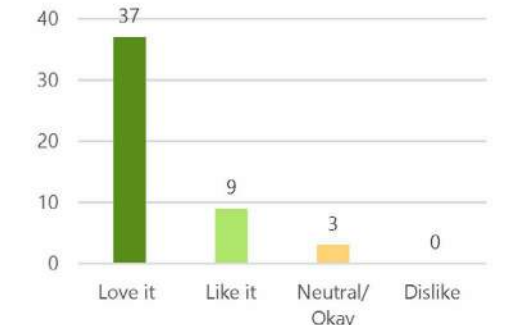

Community Outreach and Process

Community Meeting #2

While the goal of the April meetings was to start a conversation with the community, the goal the June meetings was to highlight how the project team incorporated community feedback and provide a space for input on the new designs.

To further gather feedback and elevate community voices, we hosted two virtual town halls with the same content presented in English. The team also launched a digital public engagement platform.

	Weds, June 23	Thurs, June 24
Number of registrations	118	86
Number of attendees	76	51



Posters at the site and in local window display inviting community members to participate in the community meetings. About 100 posters were placed along the corridor at the Harvey Milk Plaza, and on local community bulletin boards.

Online Engagement Platform

To further gather feedback and elevate community voices, we hosted two virtual town halls with the same content presented in English. The team also launched a digital public engagement platform, Neighborland, to collaborate with stakeholders in an accessible and participatory way. Results can be reviewed at <https://neighborland.com/harveymilk>

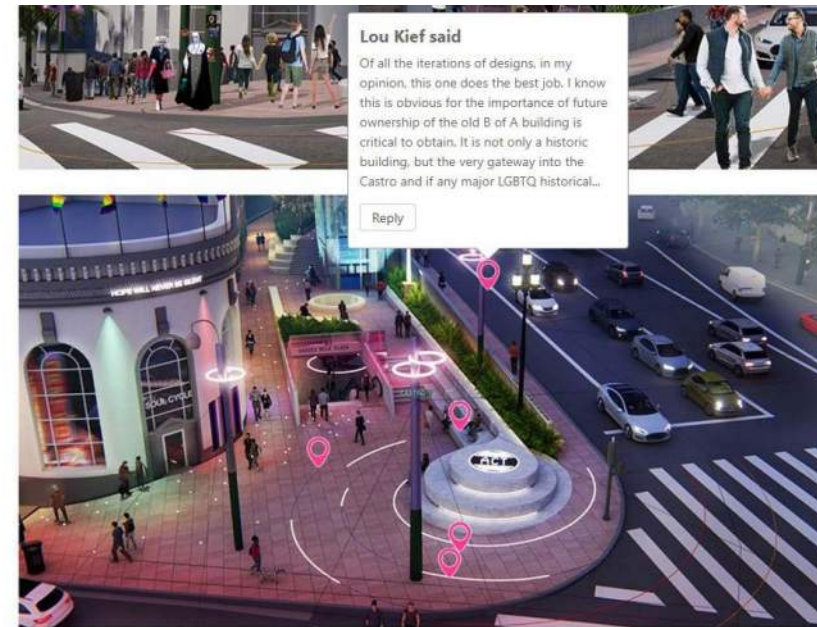

From Kathe Sw... to [All panelists and attendees:](#)

I love this design. The pedestal, the messaging, the candlelight idea—I think it reinvigorates his important legacy and makes it even more relevant today. As a long term resident of SF, I think memorials can change as the city changes.

Additional Stakeholder Outreach

In addition to the public community meetings the FHMP met with and shared the project for feedback with the following organizations, community groups, and stakeholders:

- The Castro Cultural District
- The Castro Merchants
- Duboce Triangle Neighborhood Association
- LYRIC Youth
- Eureka Valley Neighborhood Association
- Alice B Toklas Democratic Club
- Harvey Milk Democratic club
- Advocate and close friend of Harvey, Cleve Jones
- Photographer and close Friend of Harvey, Danny Nicoletta
- “Milk” Screenwriter Dustin Lance Black
- Original site Designer Howard Grant
- BART
- SFMTA

Key Community Feedback

1 Harvey Milk Memorial should be more...

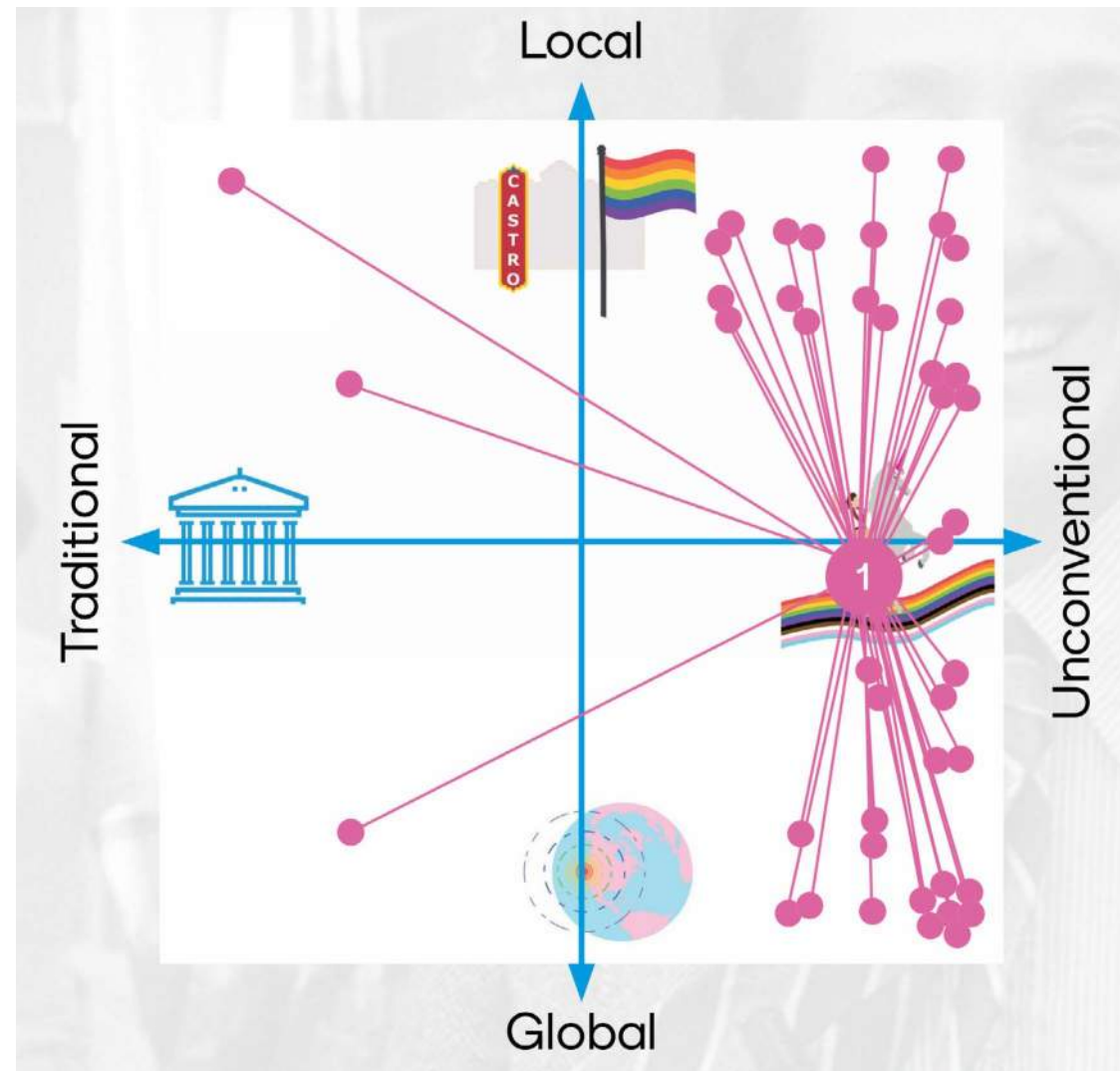
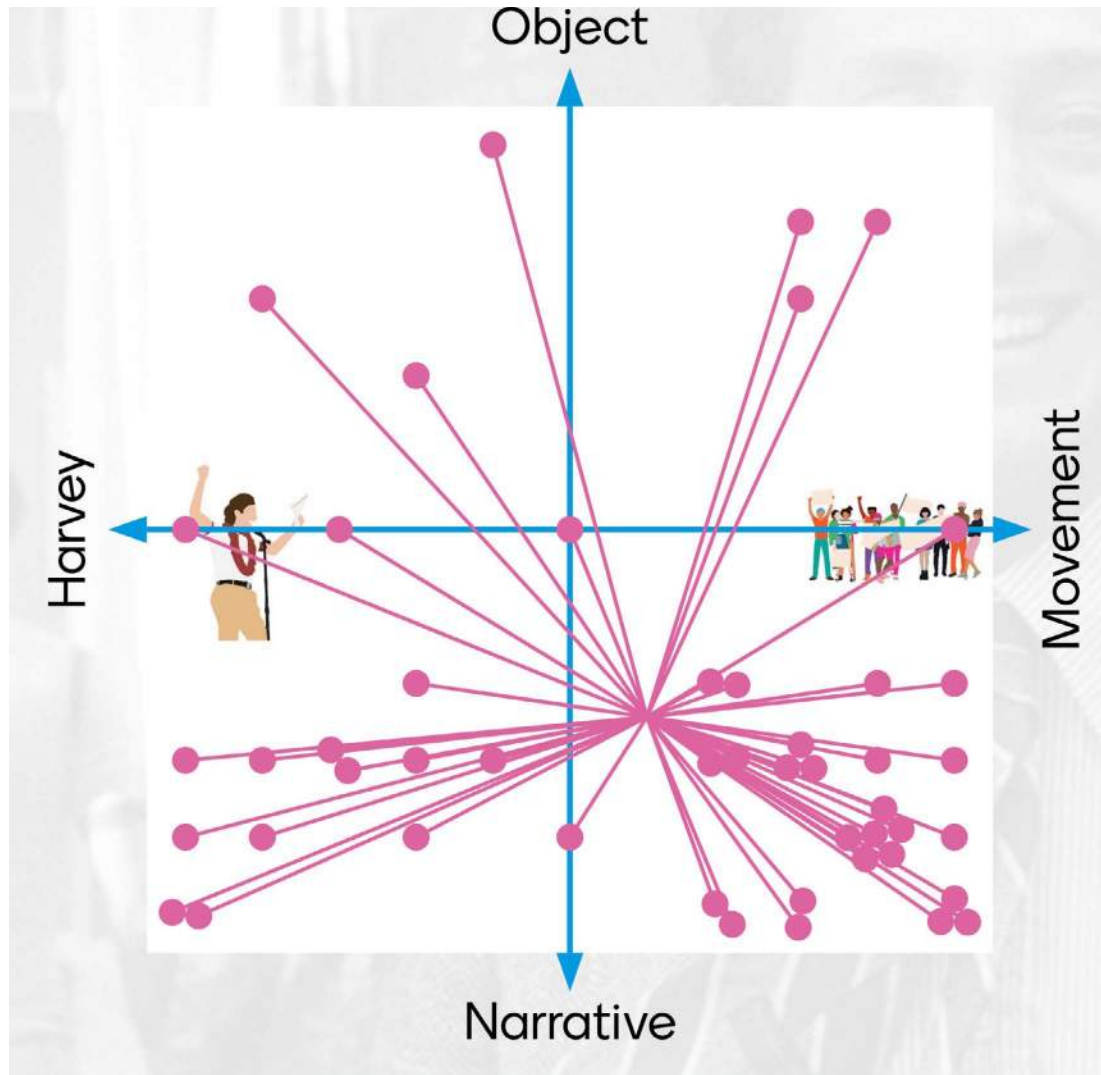

Community Expressed Goals

1. Honor Harvey Milk
2. Provide Gathering Space
3. Address Accessibility issues
4. Enhance Safety & Security
5. Enhance the Gateway/ Arrival experience

What type of Memorial are we creating?

The diagrams above depict community feedback on important fundamental questions that define the design of the memorial. The diagram on the left asked participants is the memorial should be more focused on Harvey Milk the person, or if it should be more representative of the movement we was part of, inspired, and that continues today. The second set of question on the same diagram depict the question of whether the memorial should be more of an object type of piece, ie. a singular element, or if the memorial should be more or a narrative or interpretive design. The community leaned toward movement and heavily toward narrative in terms of the type of memorial.

The second diagram displays whether the community is expecting a traditional type of memorial or something more unconventional, aligned with Harvey's personality and political style. The last set of questions was weather this memorial was for the local community or if this was for a global audience who has been inspired by Harvey Milk. The response of the community clearly display the desire for an unconventional memorial that is balances the needs of the local community and a broader global audience.

Existing Site Conditions



Memorial Concept

“The only recognizable feature of hope is action.”
- Grace Paley

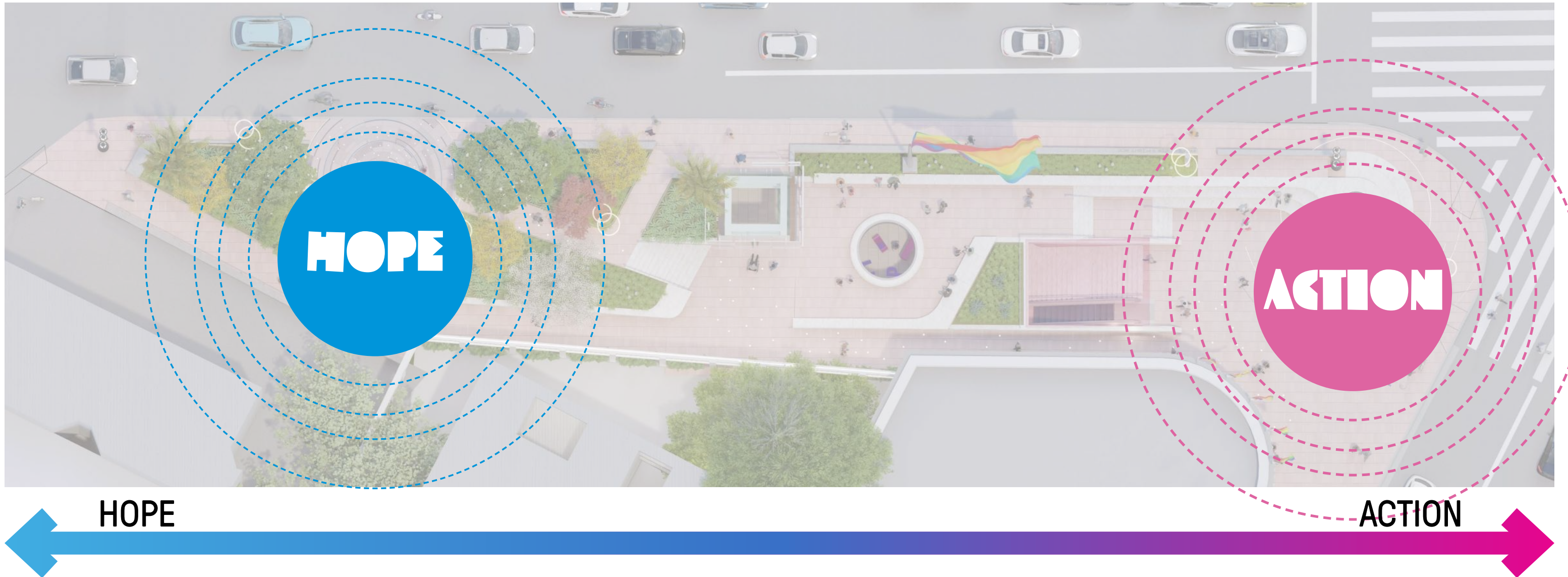

Hope & Action:

“You gotta give ‘em hope” are the words many come to associate with Harvey Milk today. Inspired by a conversation with Harvey’s friend and photographer Danny Nicoletta, the design team felt that the memorial could not focus on hope alone, but that in order to properly memorialize Harvey, action had to be properly represented on the site. Balancing the two unlike ends of the space, hope lives at the quieter end near Collingwood and manifests in a reflective grove. Action takes place at the corner of Castro and Market where the urban energy of the site converges. The concept of the memorial is focused on reflecting the needs of the community, at times we may come to the site in search of hope, and during others we may be drawn to Harvey Milk Plaza inspired by the need for action.

Harvey's Words: Quote Location Map

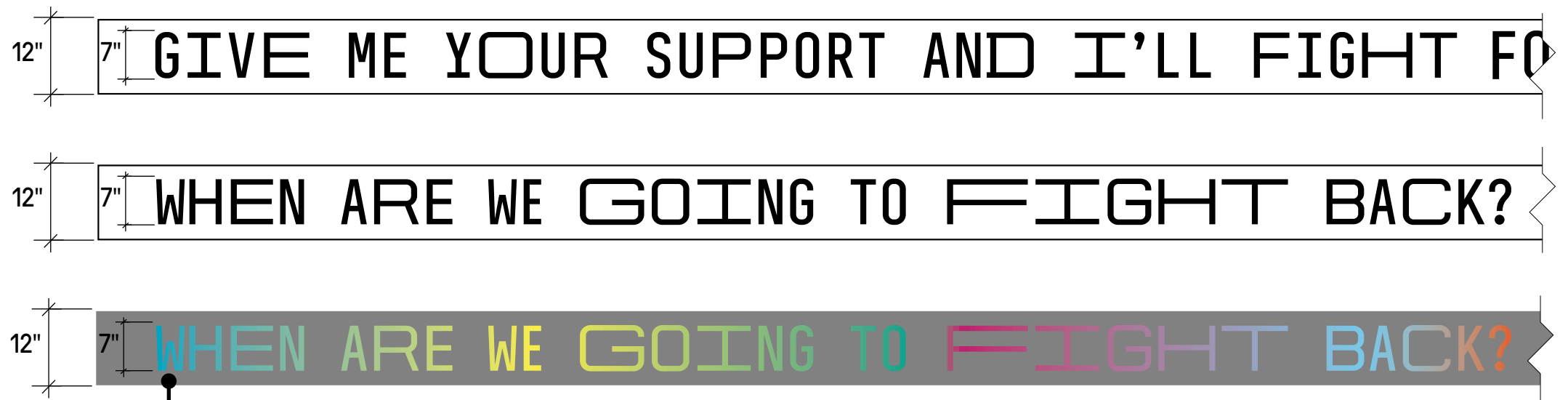
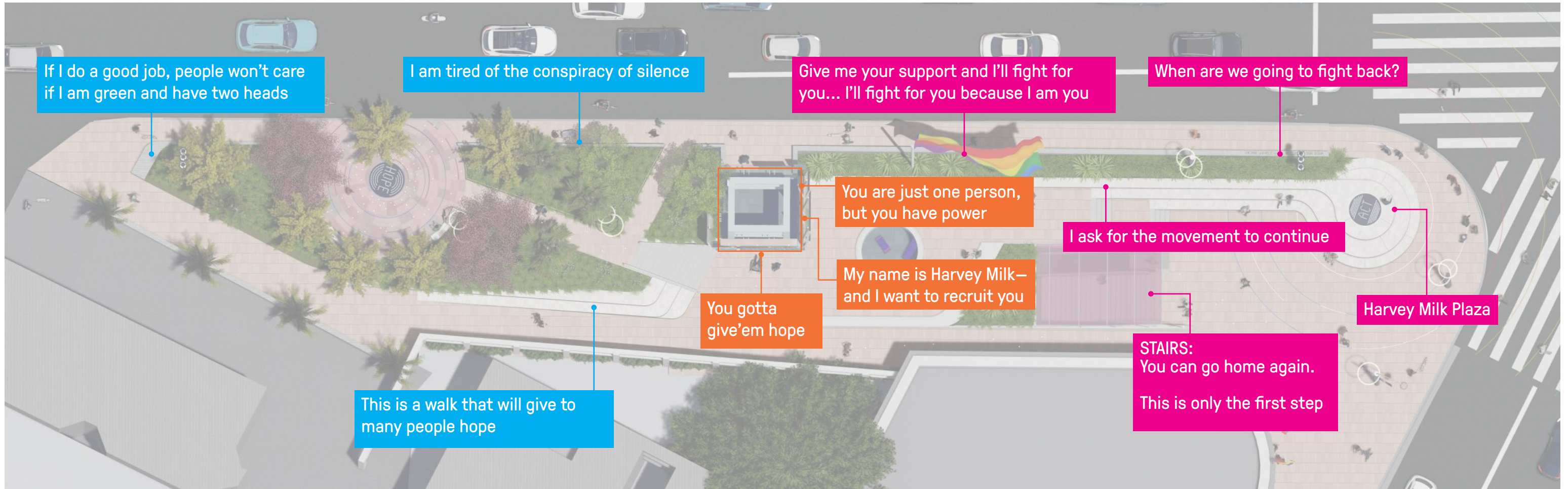

Inset anodized titanium

Site Plan: Plaza Level



Key

- 1. "PEDESTAL" SCULPTURE
- 2. EXPANDED PLAZA WITH EMBEDDED LIGHTING
- 3. "BULLHORN" CANOPY OVER STAIRS + ESCALATOR
- 4. HISTORICAL BUILDING
- 5. EXISTING CONCRETE RETAINING WALL
- 6. RELOCATED PATH OF GOLD LIGHT STANDARD
- 7. "BEACON" SFMTA ELEVATOR
- 8. EXISTING FLAGPOLE
- 9. CENTRAL TERRACE WITH "OCULUS" SKYLIGHT TO BELOW
- 10. EXISTING GATE AT CASTRO COMMONS CONDOS
- 11. MEMORIAL GROVE
- 12. LIGHTING ON EXISTING UTILITY POLE

Site Circulation & Grading

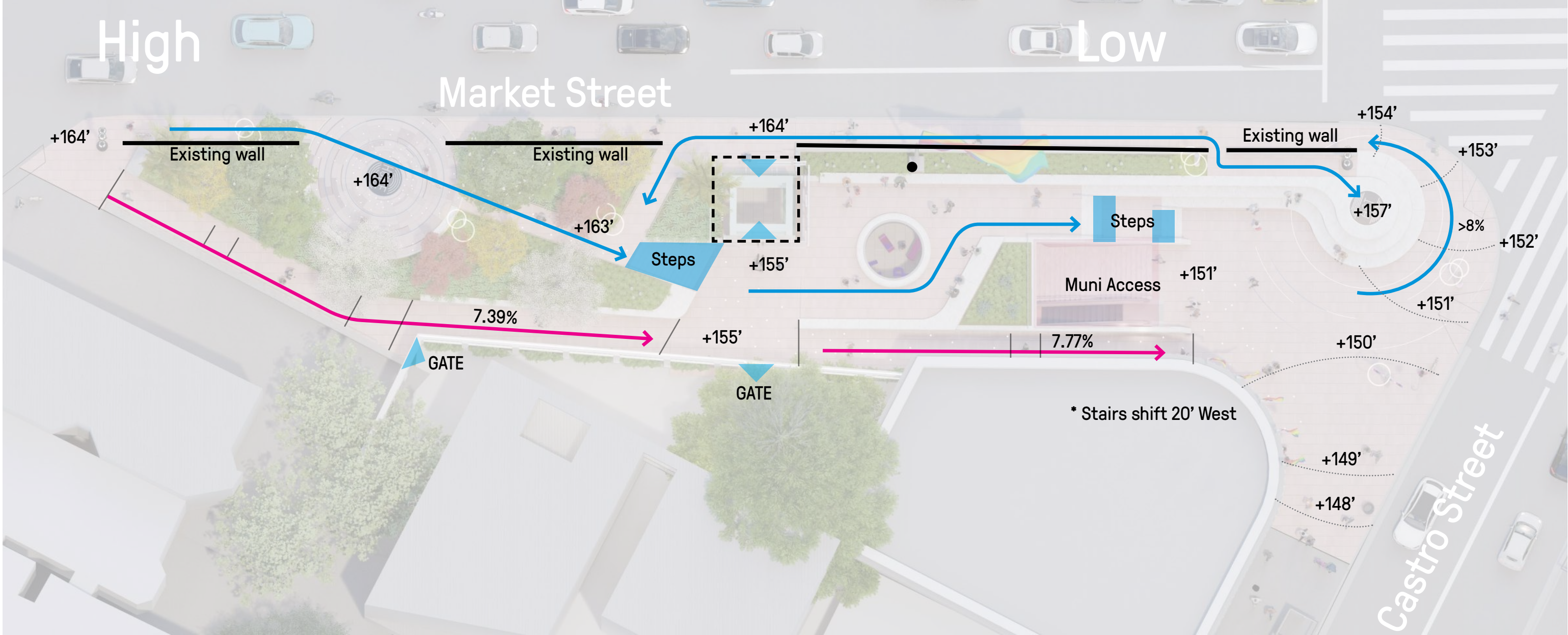

Circulation and Grading

With accessibility as a priority the new design provide a complete accessible path connecting Collingwood to Castro street. The design team is currently coordinating with SFMTA on potentially relocating the 35-bus stop to the western end of the site to ensure a completely accessible transit experience from the bus to the station below.



EXISTING
FLAGPOLE

GROVE

HISTORIC
BUILDING

BEACON +
ELEVATOR

OCULUS
SKYLIGHT WITH AUDIO / ART

BULLHORN CANOPY OVER
STAIRS + ESCALATOR

EXPANDED
PLAZA

PEDESTAL
SCULPTURE

HOPE WILL NEVER BE SILENT

SOUL CYCLE

STREET STATION

MILK PLAZA

Plaza Section

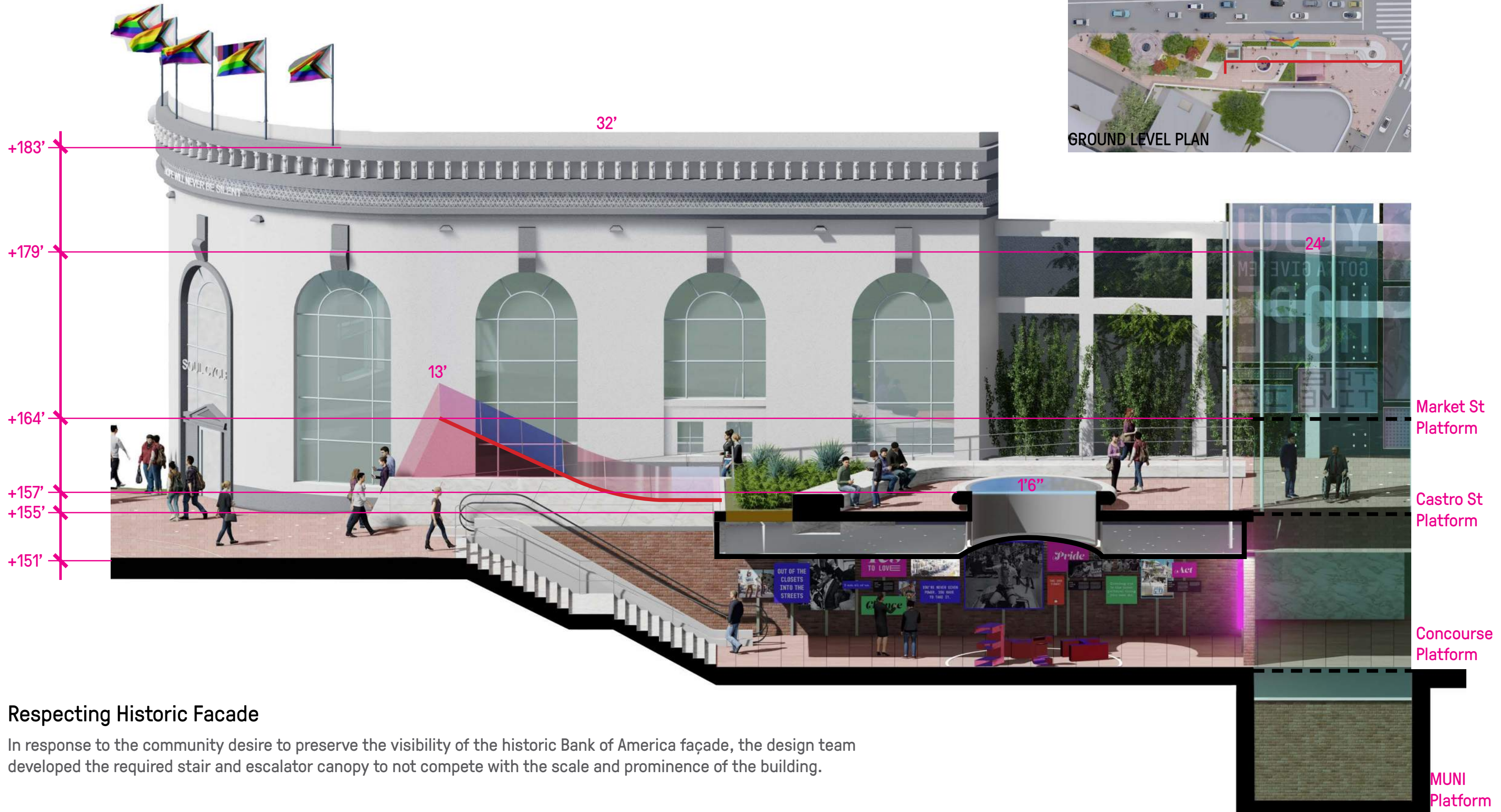

Respecting Historic Facade

In response to the community desire to preserve the visibility of the historic Bank of America façade, the design team developed the required stair and escalator canopy to not compete with the scale and prominence of the building.

Plaza Section

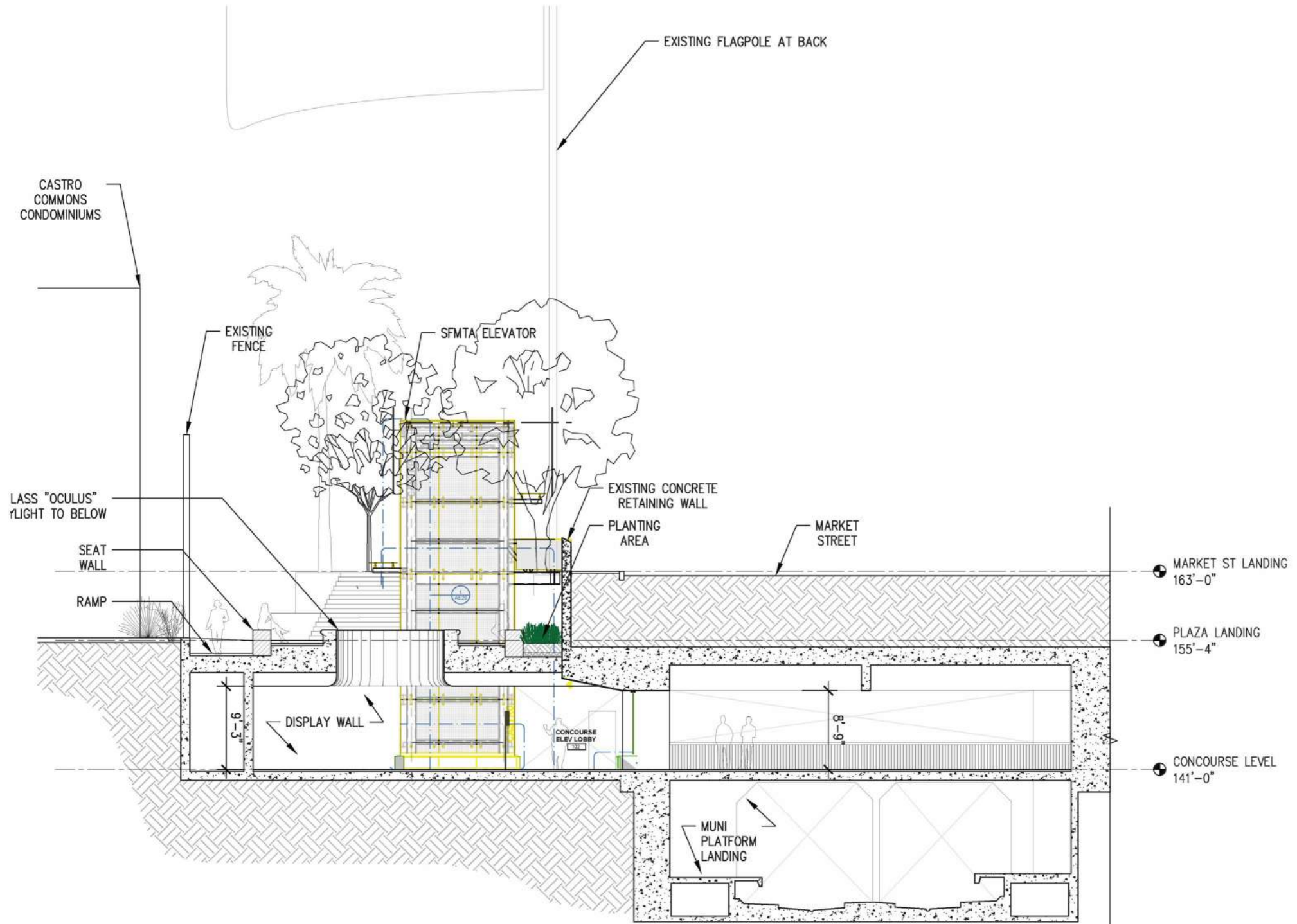
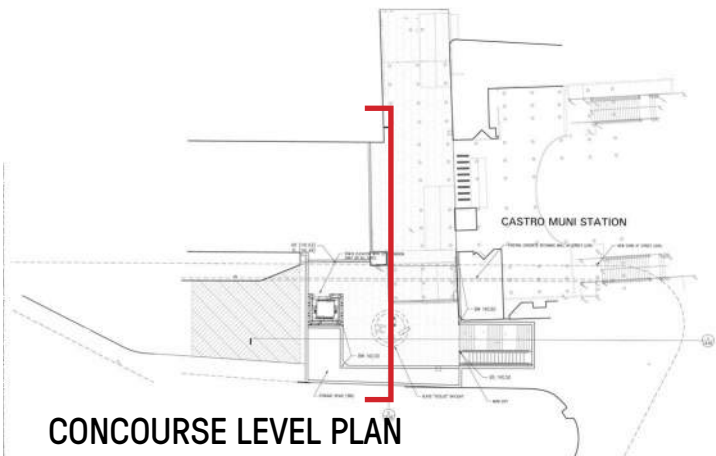

2 EAST SECTION ELEVATION (THROUGH CONCOURSE LOOK INTO WEST)
1:96

Eastern Plaza: Pedestal

Materiality

Pedestal & Seatwalls
 "Sierra White"
 Size Varies

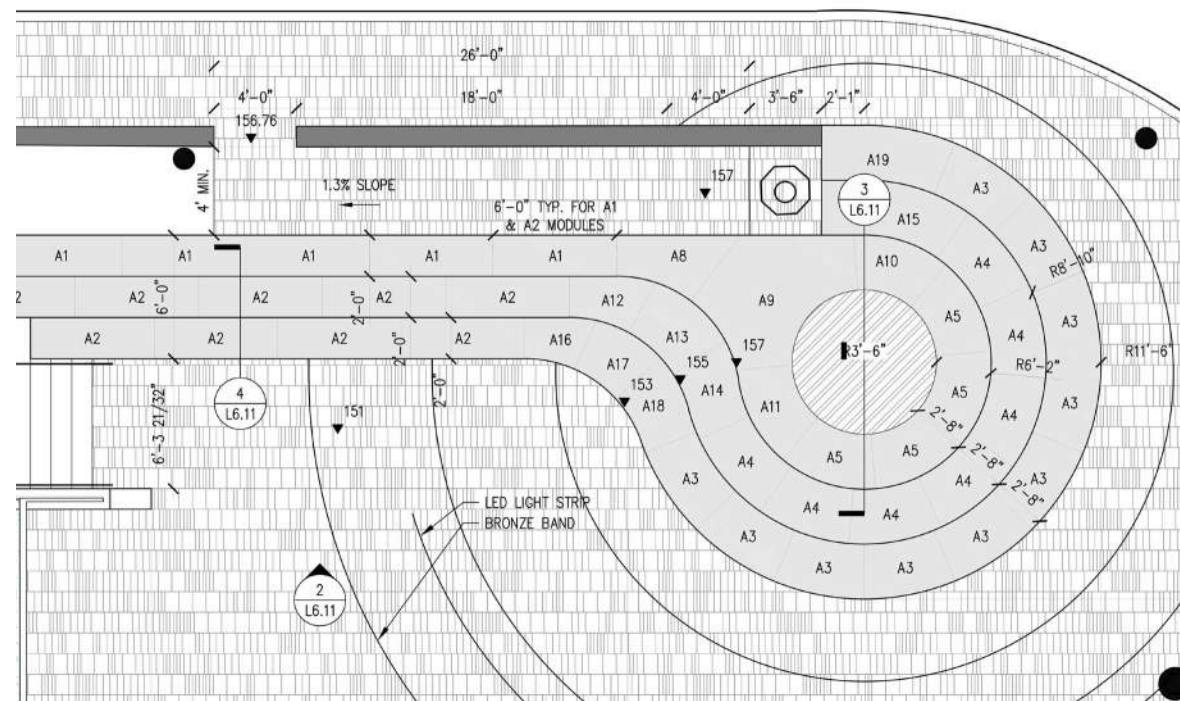
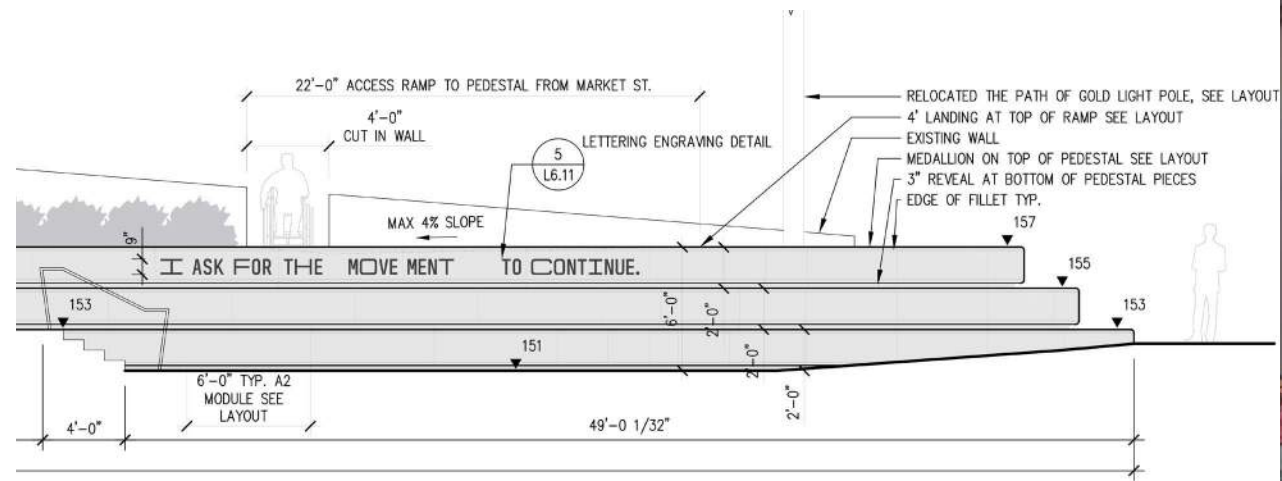

Eastern Plaza (Action)

The Pedestal literally elevates some of Milk's final words: "All I ask is for the movement to continue" – as recorded on the tapes he recorded privately with the intent that the contents be shared in the event of his death by assassination. Further, it highlights the history of gathering and collective action that has occurred at the intersection, and provides a focal point for large gatherings in the future. The Pedestal also serves as a narrative metaphor: traditionally, one might find atop a pedestal a statue of a historic figure cast in bronze, but at the Memorial at Harvey Milk Plaza, the community itself is being lifted up and celebrated.

Mandalas

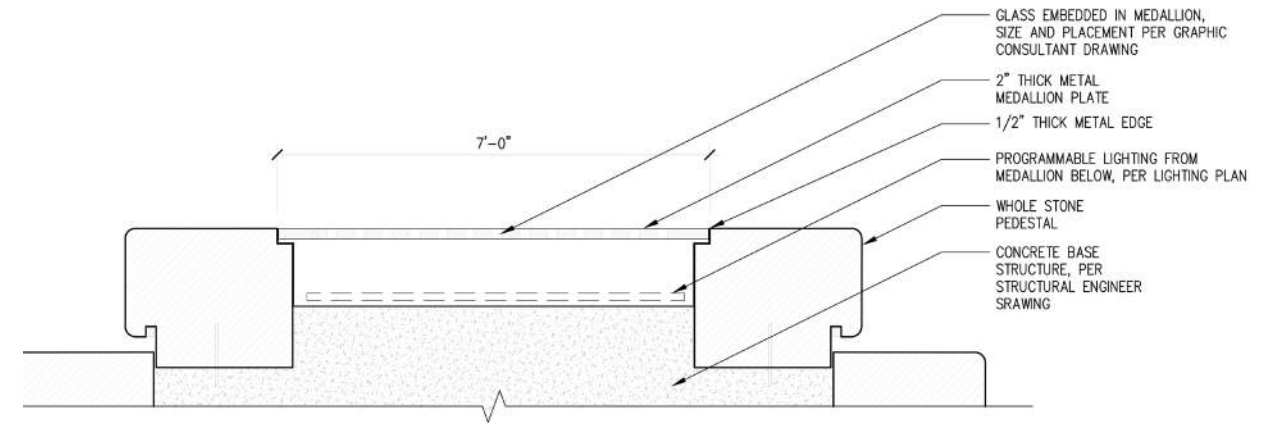
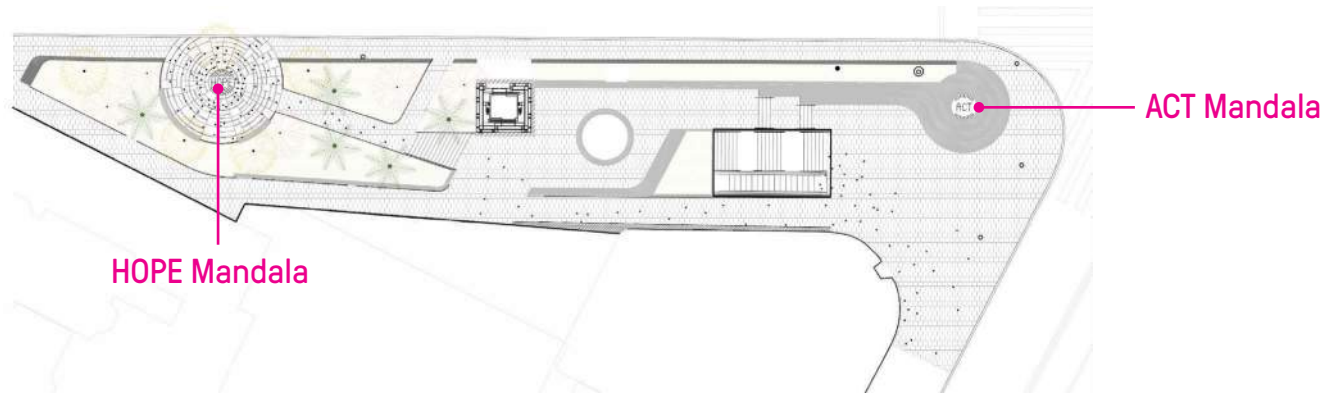

HOPE Mandala

ACT Mandala

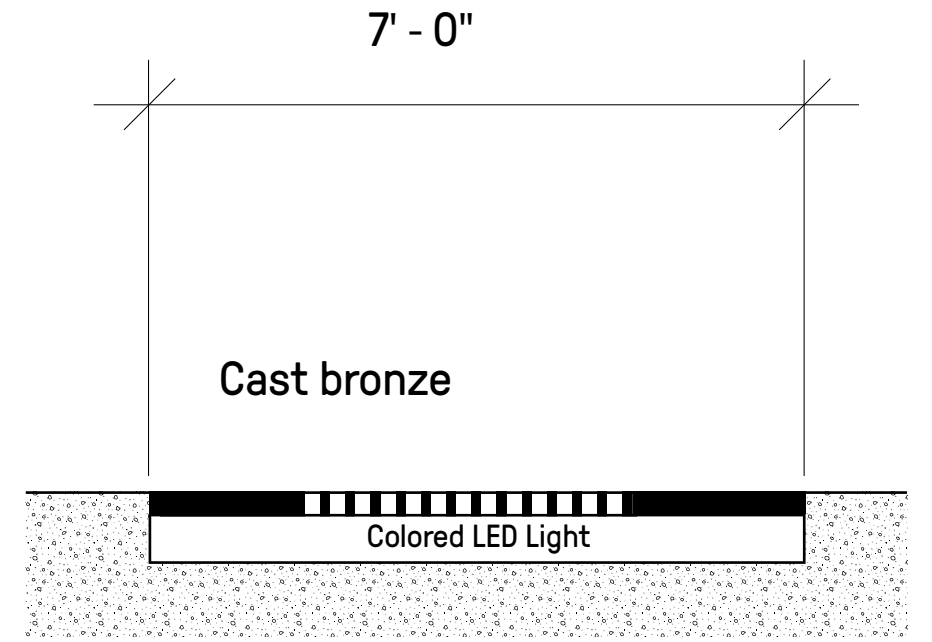
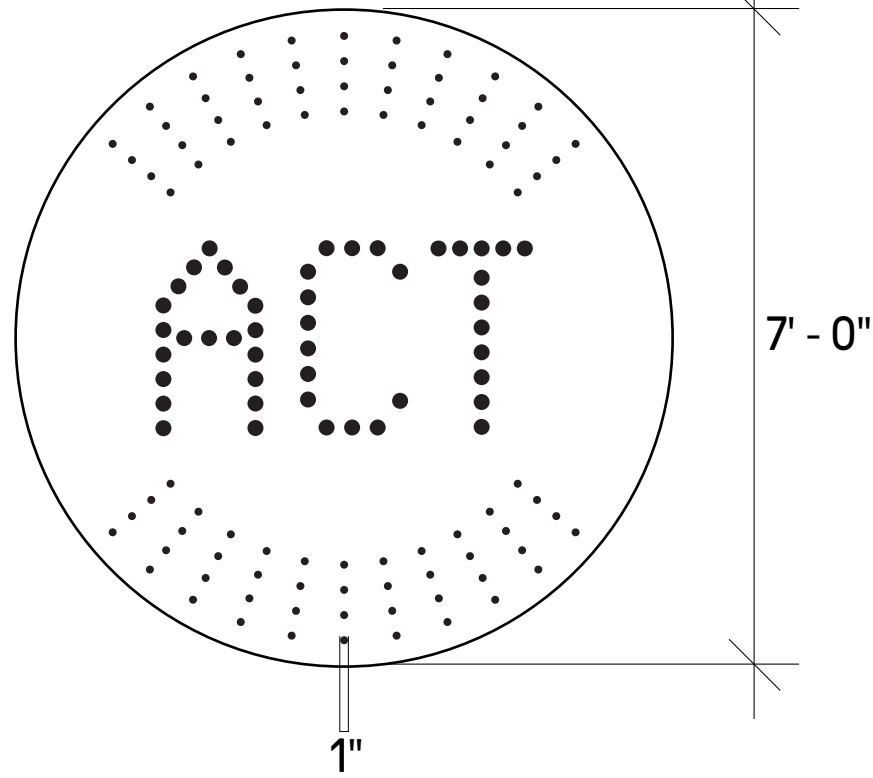
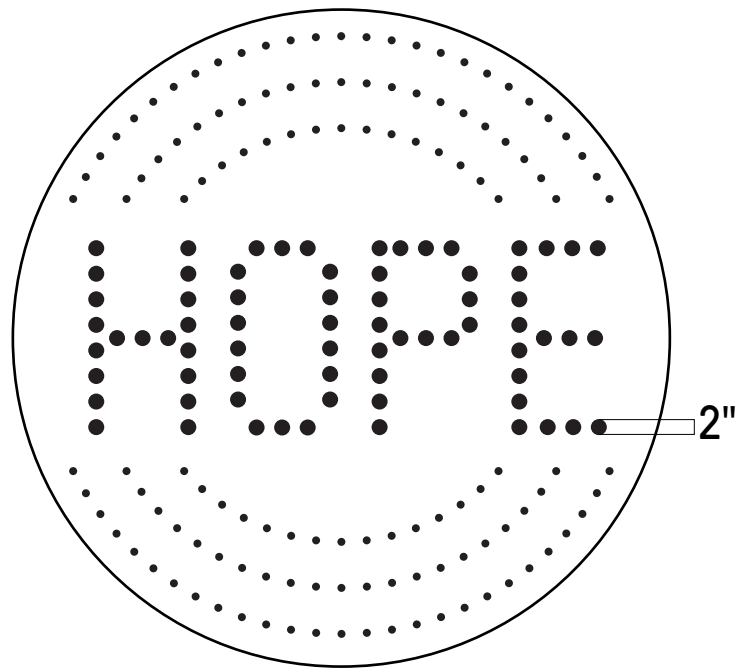

Scale: 1/2" = 1'



Eastern Plaza: Pole Graphic

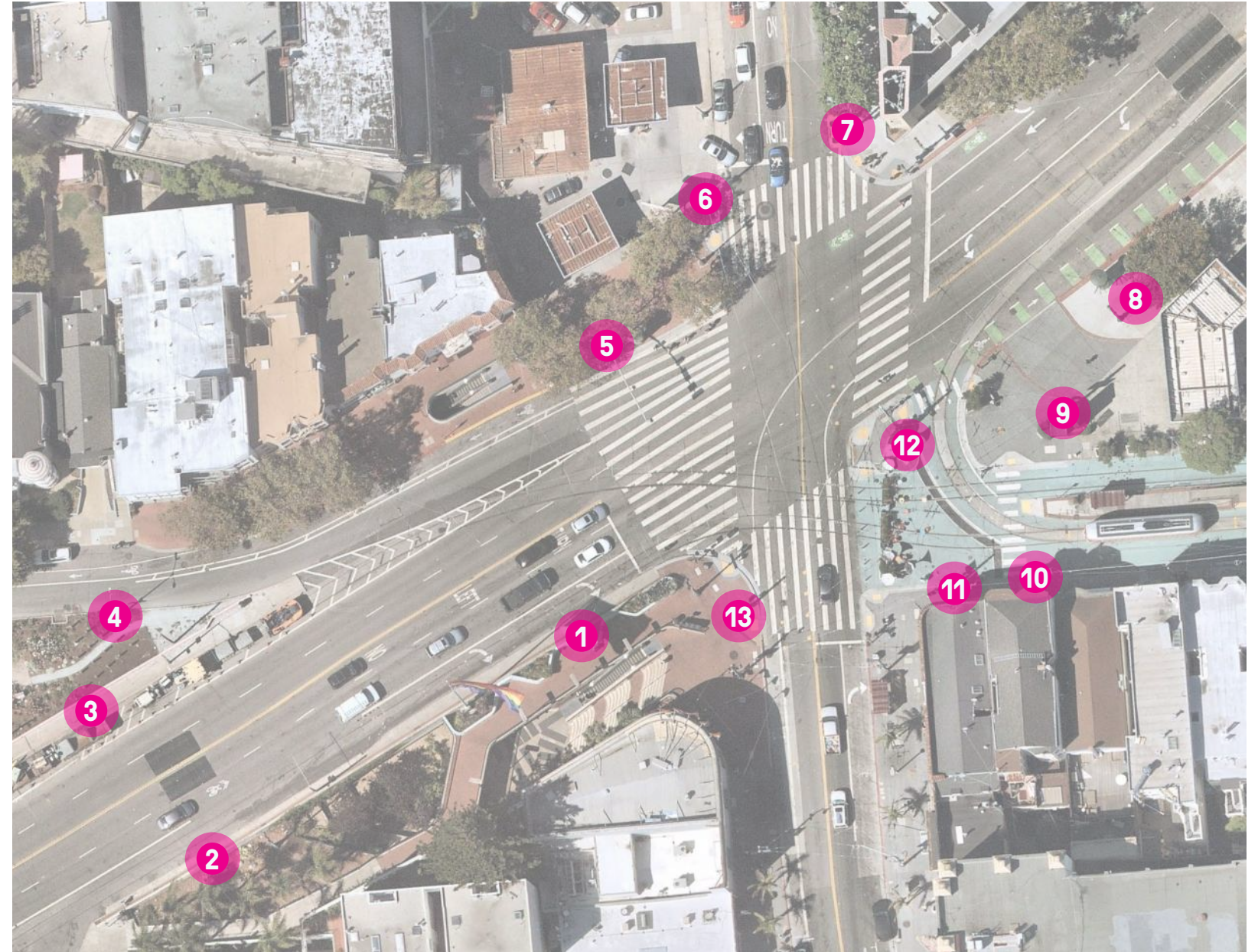
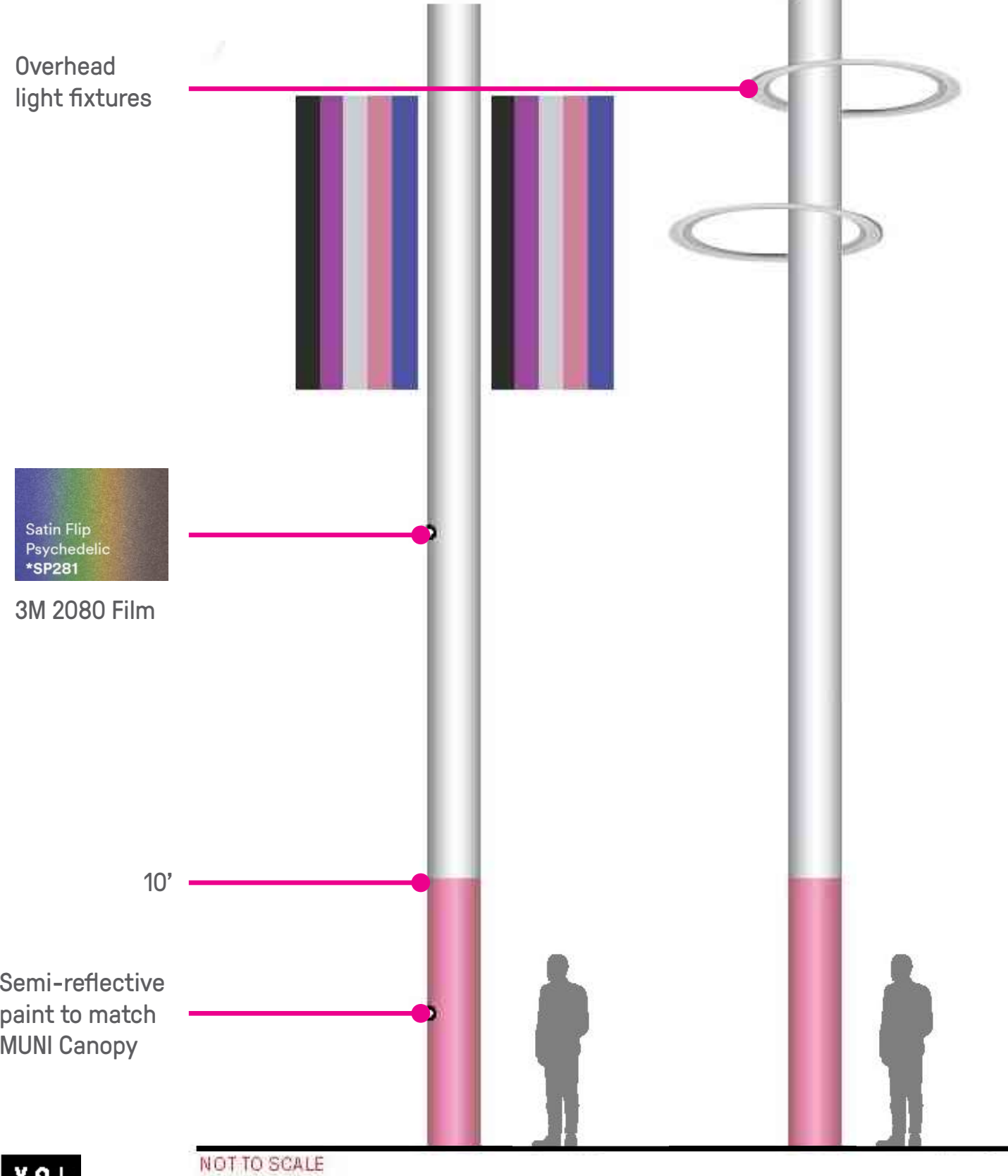

Light Poles:

The civic designation of Harvey Milk Plaza extends beyond the corner of Castro and Market, encompassing the entire intersection. Inspired by the goal of the community to enhance the gateway to the Castro, the pole graphic aims to stitch the divide of Market street by graphically uniting all corners of Harvey Milk Plaza. The upper portion of the poles is proposed to be wrapped in a film that exhibits many colors when hit with sunlight. Rather than introducing new light poles on the site, the design team has proposed locating the light fixtures on the existing poles, reducing the amount of infrastructure on an already compact site.

Eastern Plaza: Pole Graphic Inventory

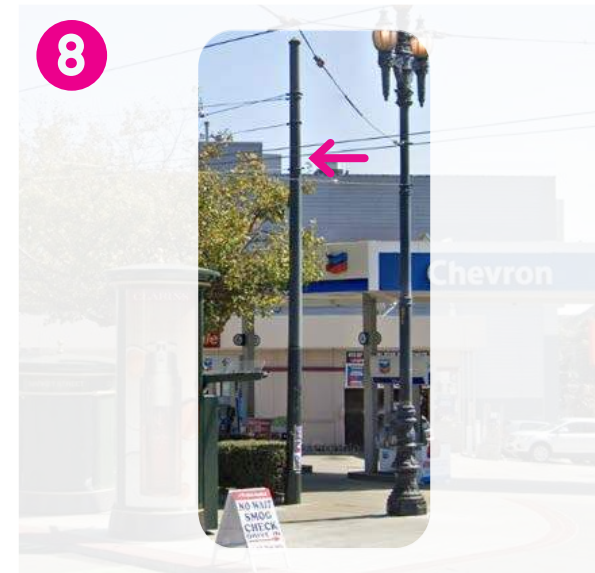
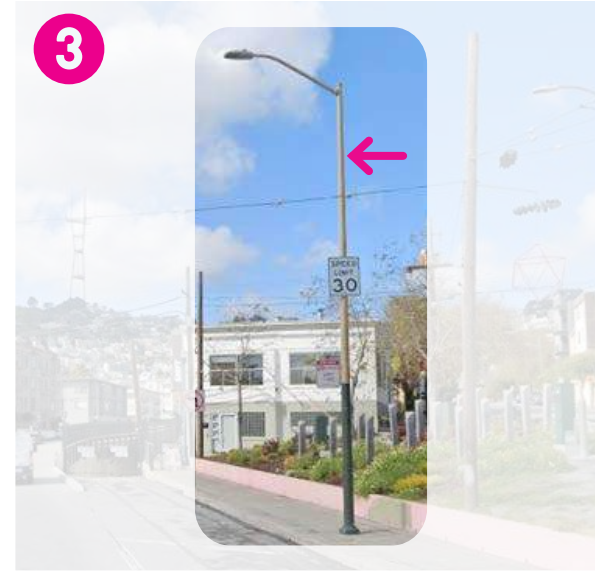

Eastern Plaza: Bullhorn Canopy

Materiality

Canopy Glass
Point Supported/
Structural Glass
Rose Film



Railings and Structure
Brushed Stainless
Size Varies



Security Gates
Size Varies

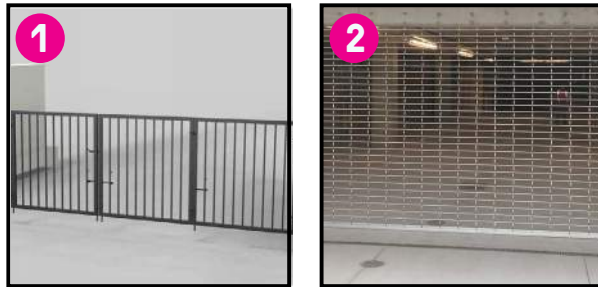

Bullhorn Canopy

In compliance with current code, the station stairs and an escalator are covered by a canopy that is securable. The canopy overhead serves a functional purpose and its form is a subtle nod to the shape of Harvey's famous bullhorn. The tinted Rose glass give the canopy more character while keeping it low and transparent to not obstruct the historic Bank of America (Currently Soulcycle) building facade.



Harvey Milk and his bullhorn (1977)

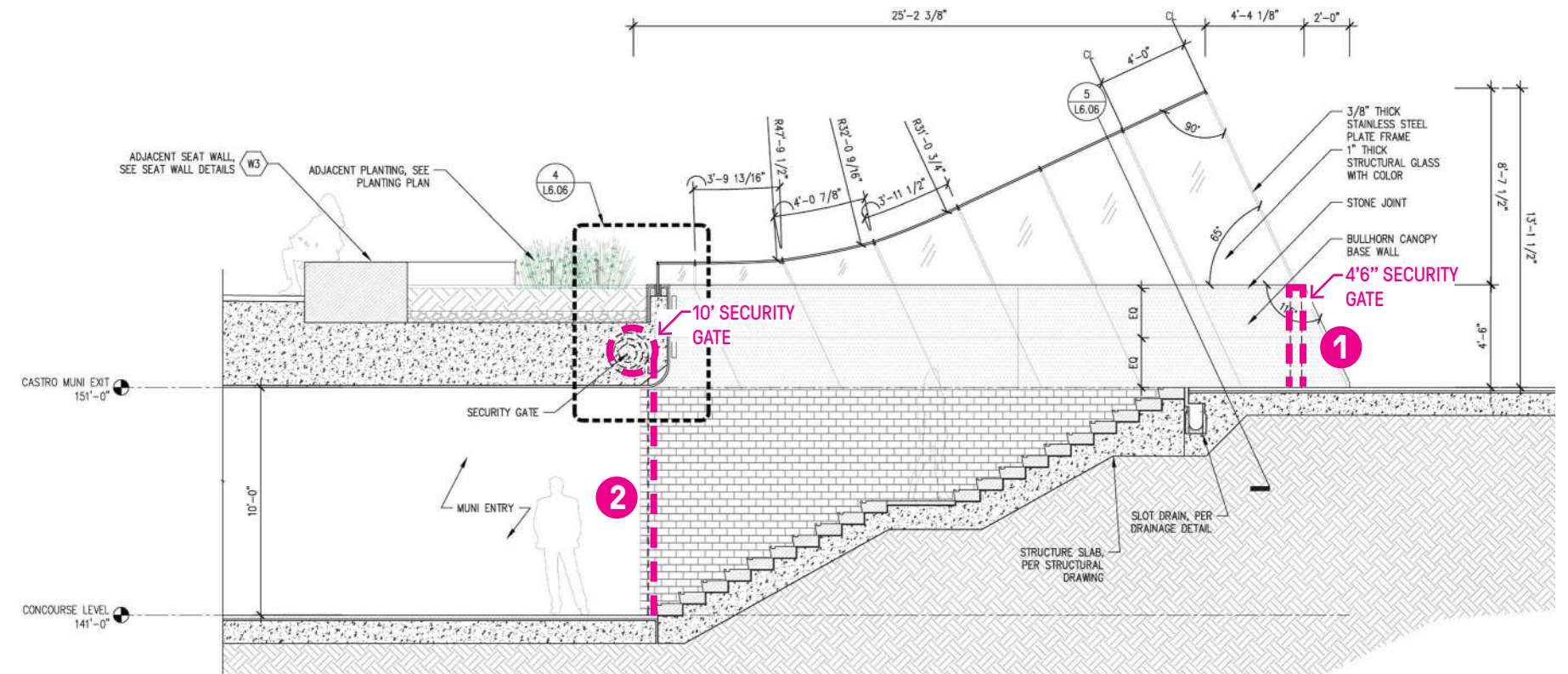

Eastern Plaza: Oculus

Materiality

Seatwalls
"Sierra White"
Size Varies



Structural Glass
Skylight

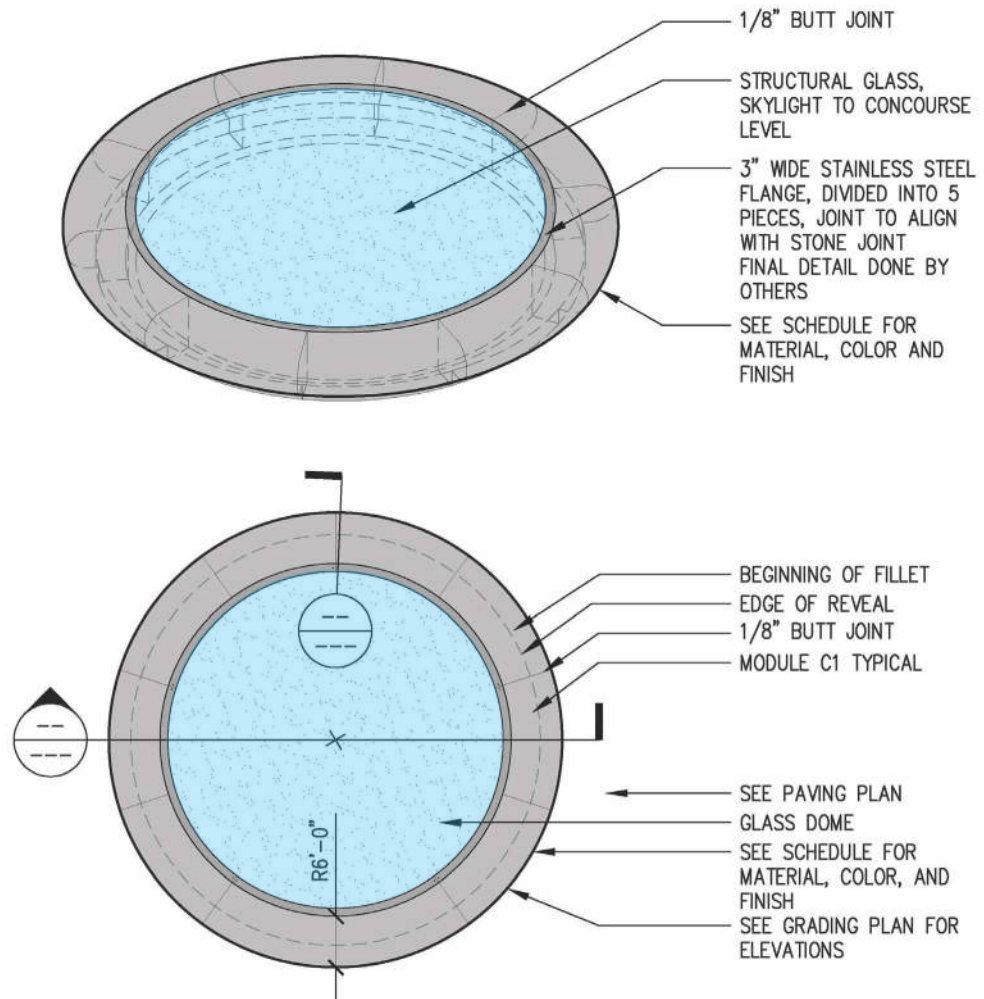

Oculus:

In addition to the expanded open plaza on the corner, the design creates a secondary gathering place at the base of the existing rainbow flag and the new beacon. Inspired by a camera lens, the oculus in the center of the terrace allows light into the station below and creates a visual connection between the plaza and concourse levels.

Eastern Plaza: Beacon

Materiality

Granite Paving
“Radiant Red”
*See pattern detail

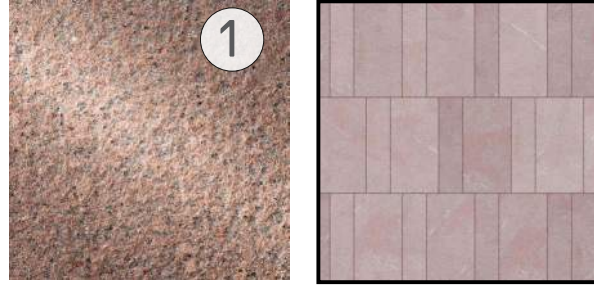

Dichroic Glass
Cool Film by 3M
*See Elevation



Transparent Digital
Art Screen
*See Reference

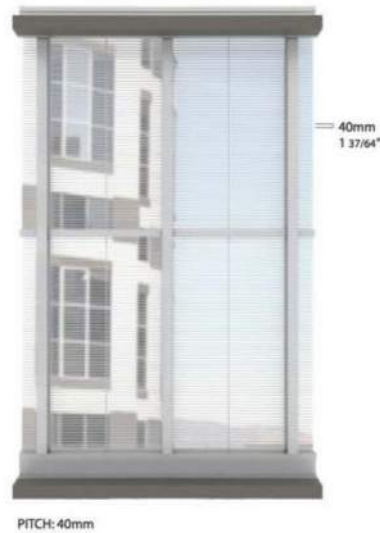

Beacon:

The form of the Beacon is inspired by the protest signs social justice movements have been using for decades – the same ones that littered Harvey’s Camera Shop, and we continue to see on the streets of San Francisco. This modular element is composed of several digital panels, some with dynamic displays that spotlight current inspirational messages of protest and celebration, and, when needed, of consolation.

A symbol of hope and progress, The Beacon’s flexibility will allow it to celebrate current and ongoing events and activism while reminding visitors of the work that has been undertaken previously in advancing the rights of all individuals.



Beacon Elevations

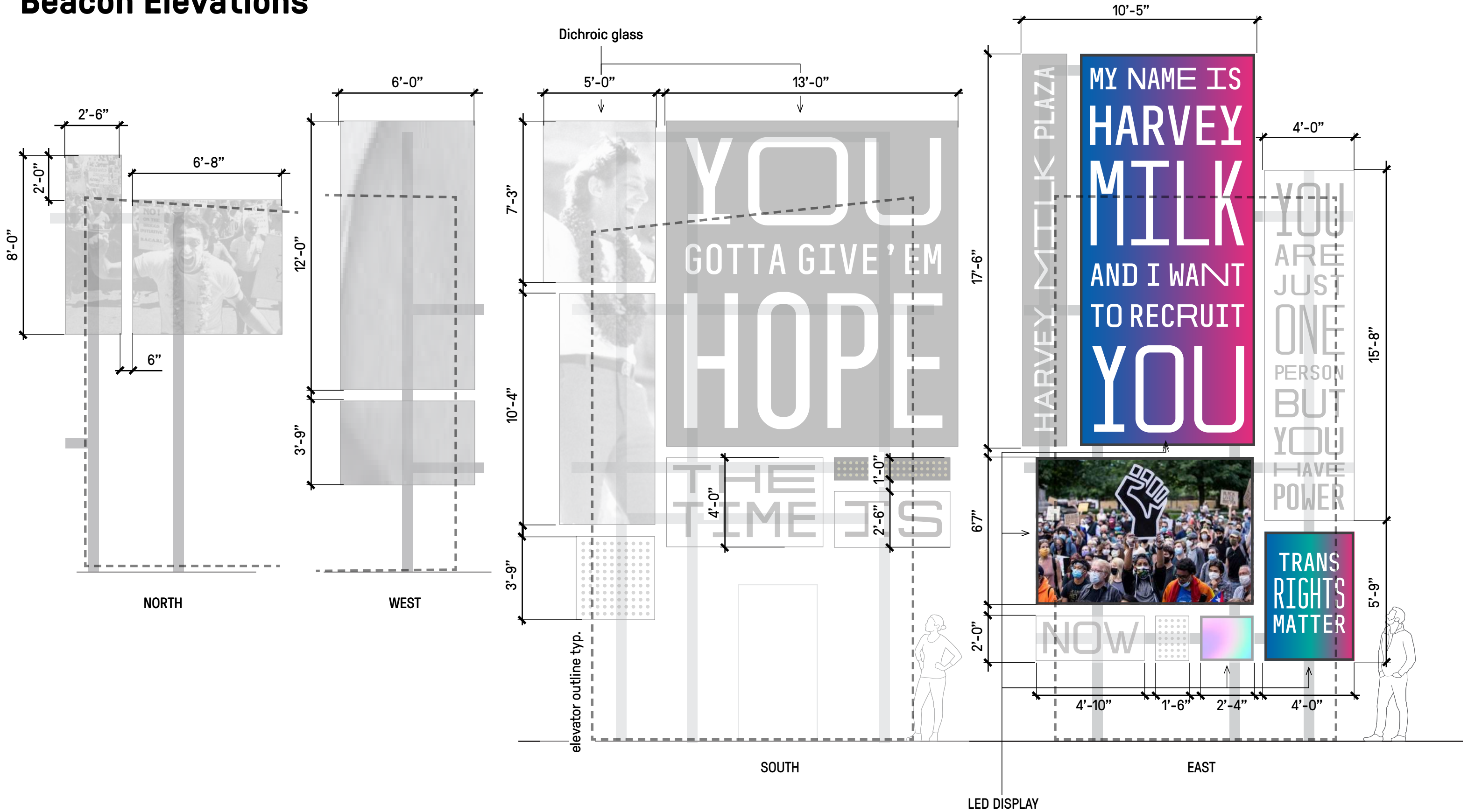

Digital Art Screen

Beacon (Visibility):

The Beacon acts as a digital monument that can be used to display visuals that tell the story not only of Harvey Milk, but also of the Castro's history, of queer culture, and of the victories and ongoing struggles of the movement. The design is modular, with panels of various sizes that reference the protest signs often present when the community gathers. The display is flexible and nimble, a dynamic beacon of inspiration and allows opportunity to spotlight inspirational messages of protest and celebration, and when needed, of consolation.

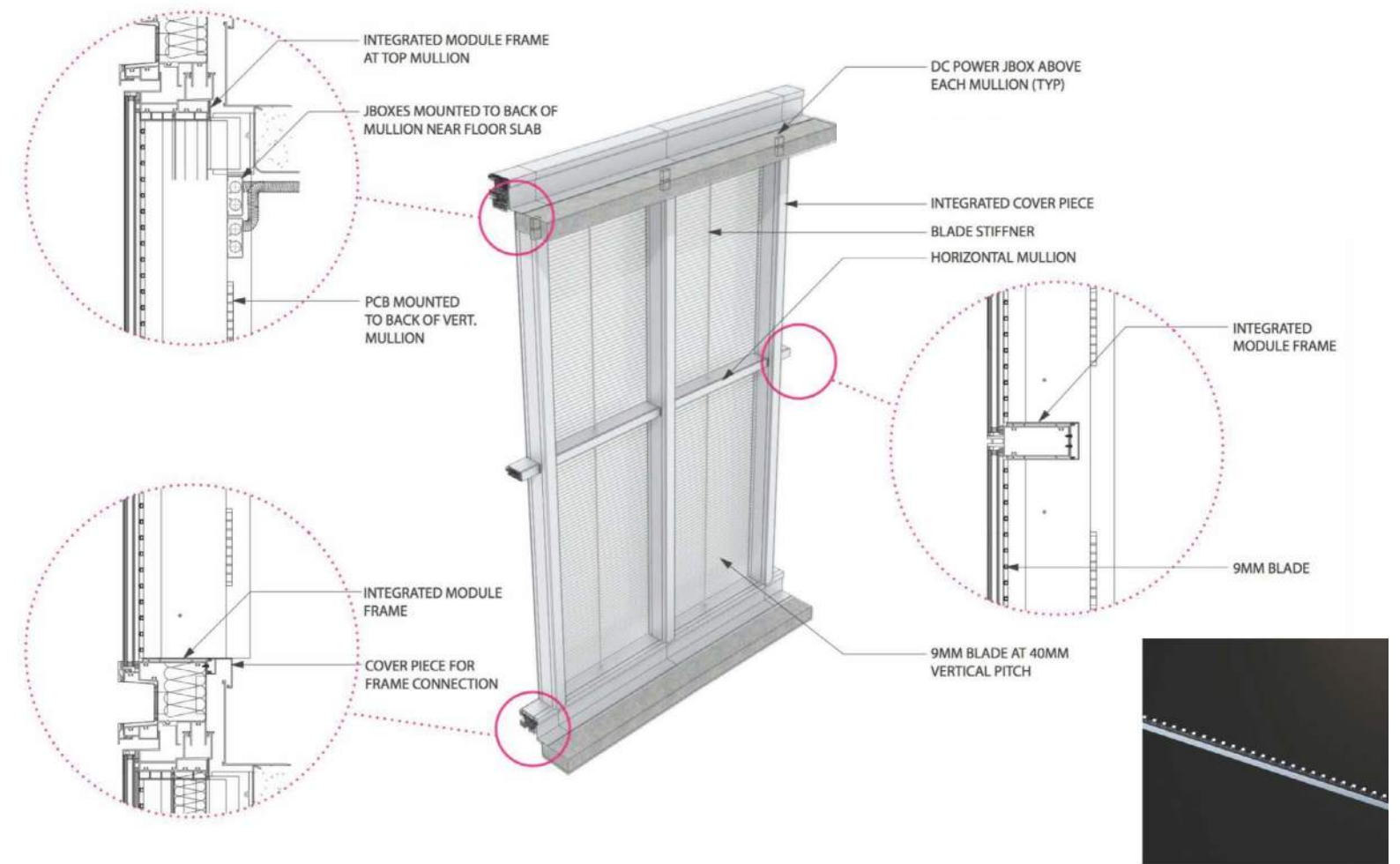

West Plaza: Grove

The Grove:

The Grove builds on community support for a green space on the western edge of the site. Harvey is the center of this space, but there are also other points of entry to his story that are celebrated here. Hope is the part of the Harvey Milk story that touches many of us so deeply. Conceptually, it fits naturally at this quieter end of the site, the design creates a setting that will encourage everyone to reconnect with the piece of hope that each of us carries with us.

Materiality:

Granite Paving
“Radiant Red”
*See pattern detail

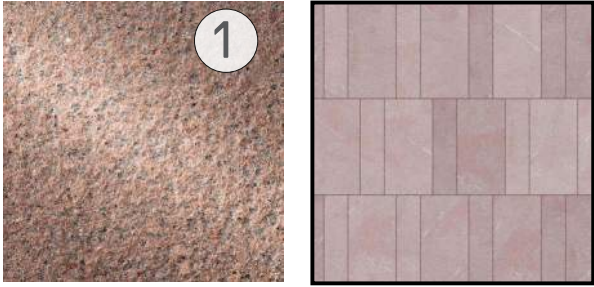

Stairs & Seatwalls
“Sierra White”
Size Varies



Cast Bronze
Strip in Paving
*See pattern detail

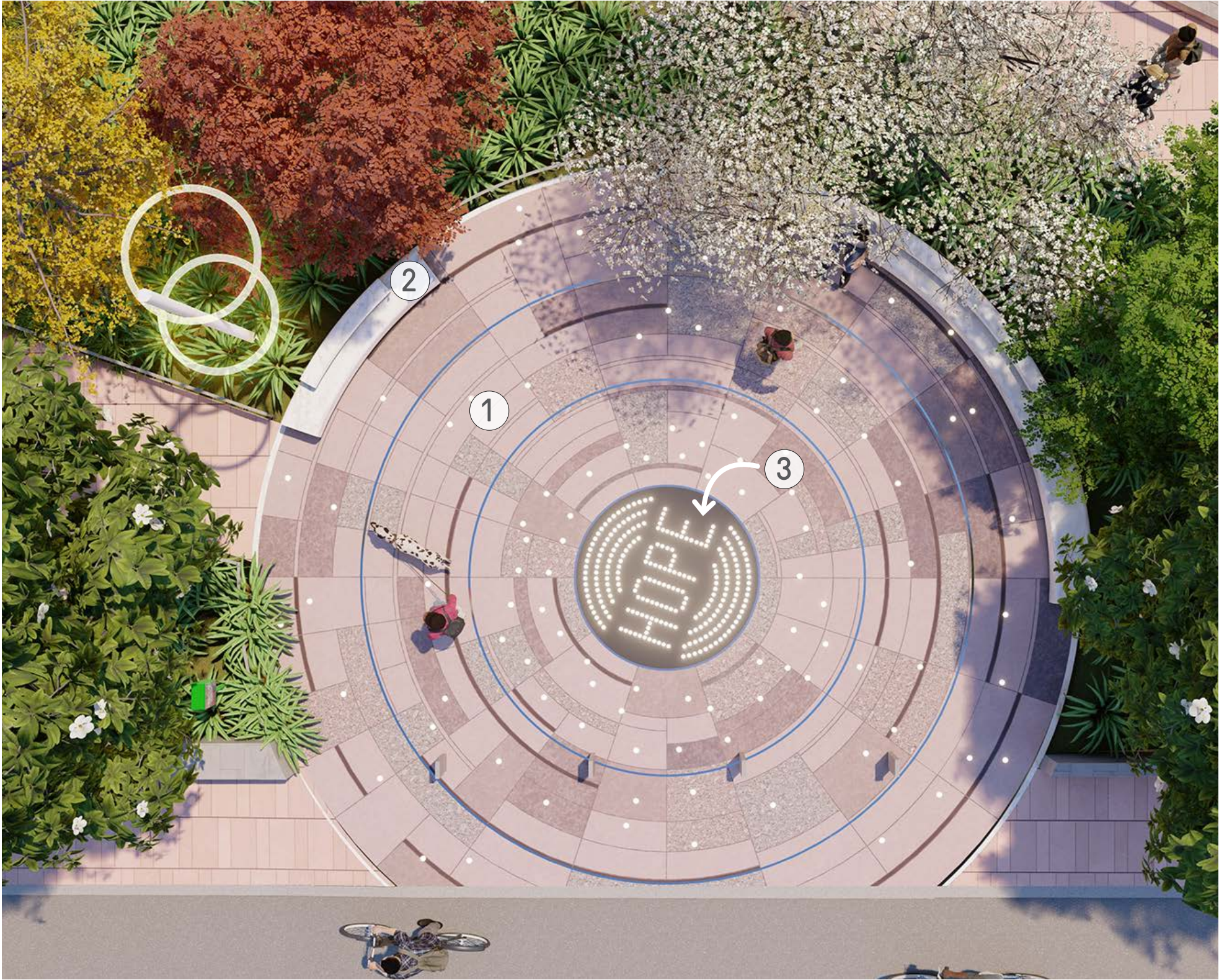
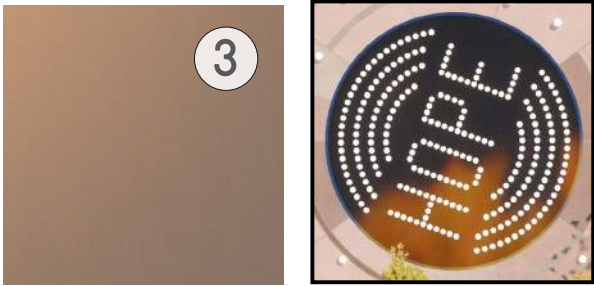

West Plaza: Grove Planting

Planting

Hornbeam Tree
Carpinus caroliniana



Moderate water use
Deciduous
20' tall
20' wide
Full/partial sun

Ginkgo Tree
Cinnamomum camphora



Low water use
Deciduous
50' tall
30' wide
Full/partial sun

Existing Palm Trees



Tupelo Tree
Nyssa sylvatica



Low water use
Deciduous
30' tall
20' wide
Full sun

White Fringetree
Chionathus virginicus



Moderate water use
Deciduous
20' tall
25' wide
Full sun

Magnolia Tree
Magnolia grandiflora
'little gem'



Moderate water use
Evergreen
20' tall
8' wide
Full sun

Scarlet Oak Tree
Quercus coccinea



Moderate water use
Deciduous
50' tall
40' wide
Full sun



Cousin Itt
Acacia Cognata
'Cousin Itt'



Low water use
Evergreen
2-3' tall
4-6' wide
Full/partial sun

Silver Torch
Cleistocactus strausii



Low water use
Evergreen
2-5' tall
Full sun

Cast Iron Plant
Aspidistra elatior



Low water use
Evergreen
2-3' tall and wide
Full shade

West Plaza: Grove

The Grove:

The Grove is planted with 11 trees, each with a symbolic meaning. Their number represents the months Harvey Milk served in his position as San Francisco Supervisor prior to his assassination, while each species has been chosen to represent places Harvey lived: a tree from his hometown in New York, a tree from Texas, where he spent a few of his younger years, and trees representing San Francisco. A dog waste station brings some humor to the project representative of Harvey's boisterous personality and highlighting his work at supervisor.

Screenprint on dichroic aluminum

Aluminum case

Waste bags

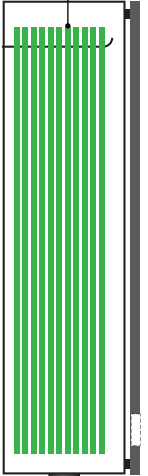

Hole for bags

Brushed stainless

Hinged door

FRONT

BACK

SIDE

SECTION

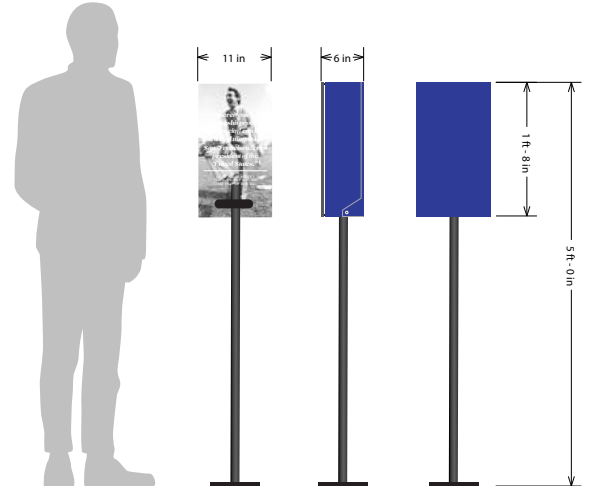

Site Plan: Concourse Level

Materiality

Granite Paving
 "Radiant Red"
 *See pattern detail



Pedestal & Seatwalls
 "Sierra White"
 Granite
 Size Varies



Match existing 3"x7"
 runningbond tile
 walls

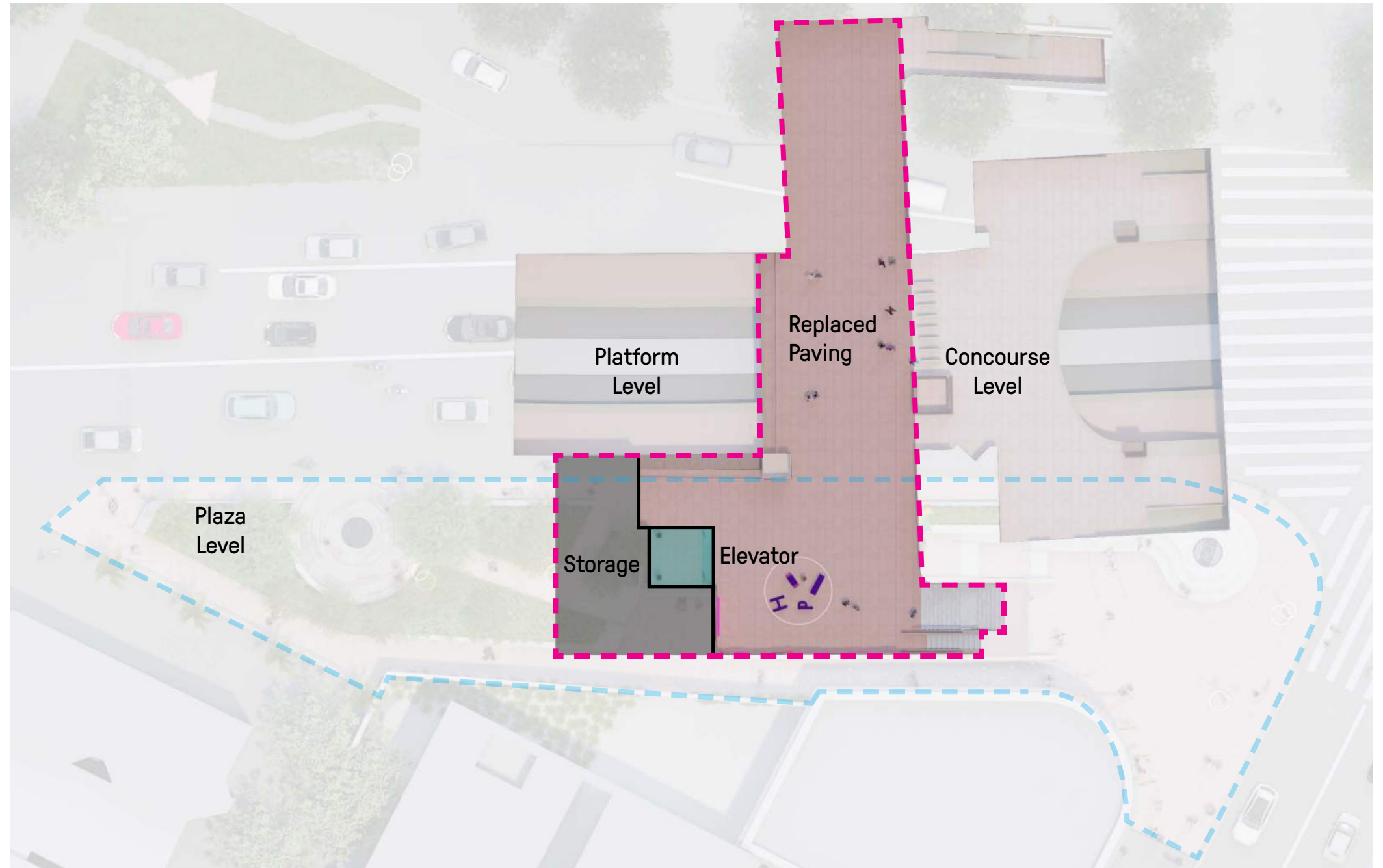

PAVER SIZES

PAVING MODULE

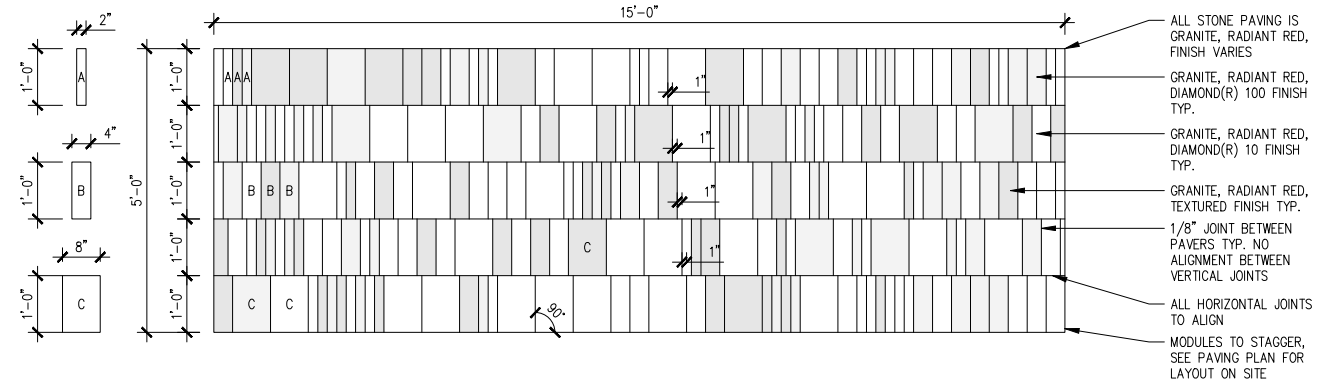



The Gallery (Voices of the Community):

This indoor space, partially inside Castro Muni Station, will provide flexible gallery space for art and exhibits that reflect the current conversation and priorities of the community around issues of representation and social justice. A more permanent art piece is located directly below the skylight and is envisioned to have an audio component that would envelop the viewer in the sound of both Harvey’s voice and the voices of the community that continue to echo his message.

Concourse Gallery

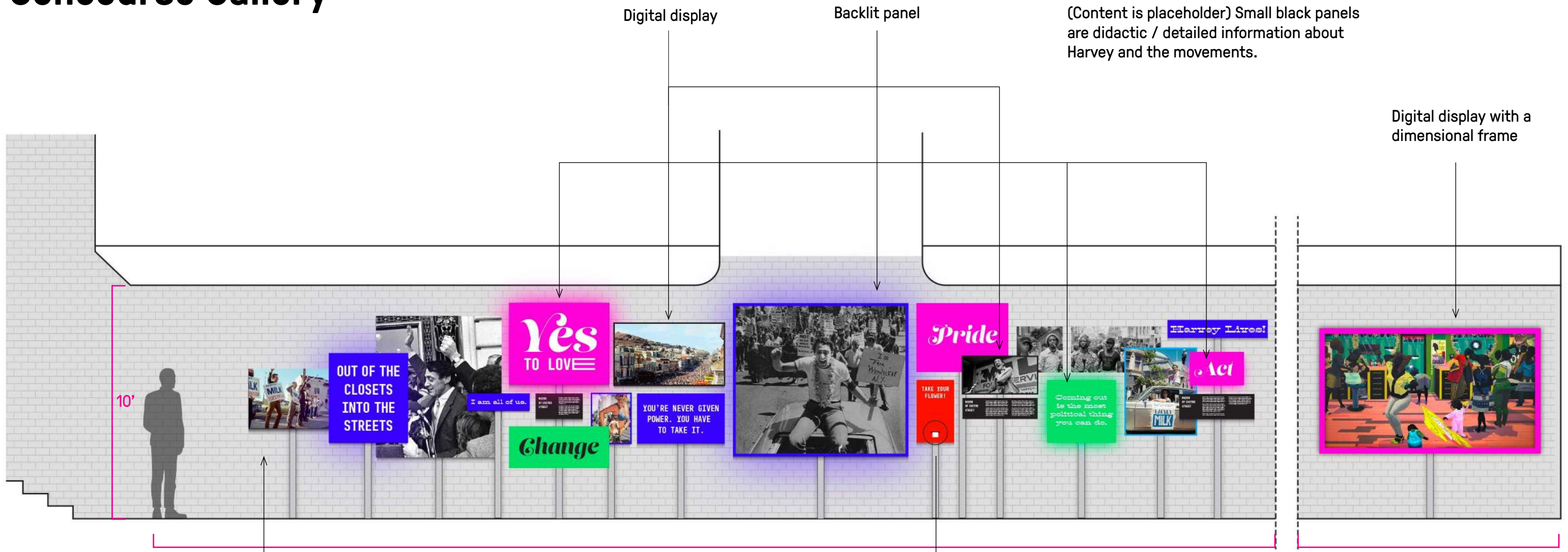

Scale= 1/4" = 1'

Panels mounted on brushed stainless posts. Posts are attached to wall; boards float as required for overlapping



Front: Illustrated flowers by curated artists



Back: A random act of kindness

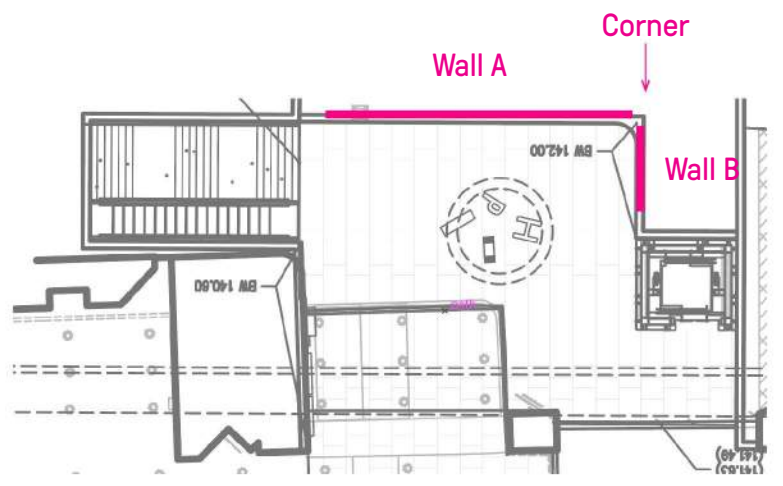

Content Walls:

The content of the walls is envisioned as a celebration of the history of activism in San Francisco. Activism has played such a large role in our community and city, in this space the history of action will be celebrated

Lighting:



Luminii Kurba “Horizontal Light”
Recessed wall toe lighting.



Landscape Forms: “Typology Ring”
Overhead light fixtures.



Design Plan “Goccia 2.7”
Path of Light in ground lighting.

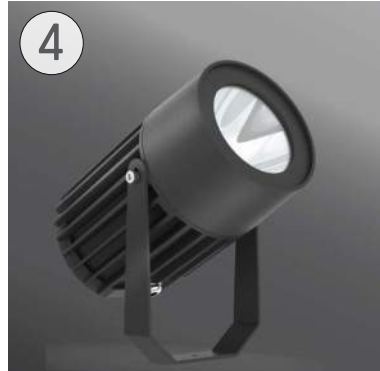

Ligman Lighting “Odessa 2”
Existing Pride Flag uplight.

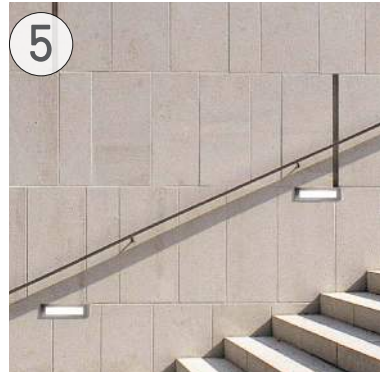

Bega Lighting “Luminaire: 22 132”
Staircase lighting.



Lighting:

On the night of November 27, 1978, the community gathered at the corner of Castro and Market to reflect on the assassination of Harvey Milk earlier in the day. Many expected there to be violence, instead the community walked in vigil from this corner to San Francisco City Hall, an event that would later be known as the Candlelight vigil. These were the first steps the community took without their leader. Arriving at City Hall the crowd was greeted by future supervisor Harry Brit who told the crowd one day there would be something special in San Francisco, and it would have Harvey’s name on it. The lighting in the paving play homage to this event celebrating the community coming together and tying the site together between hope and action.

East Plaza: Lighting



1
Luminii Kurba "Horizontal Light"
Recessed wall toe lighting.



2
Landscape Forms: "Typology Ring"
Overhead light fixtures.



3
Design Plan "Goccia 2.7"
Path of Light in ground lighting.



4
Ligman Lighting "Odessa 2"
Existing Pride Flag uplight.



Night rendering illustrating the candle light vigil lighting design.





THE MEMORIAL AT HARVEY MILK PLAZA



San Francisco Public Works
General – Director’s Office
49 South Van Ness Ave., Suite 1600
San Francisco, CA 94103
(628) 271-3160 www.SFPublicWorks.org

Public Works Order No: 206570

REQUESTING AND RECOMMENDING THAT THE BOARD OF SUPERVISORS APPROVE A RESOLUTION AUTHORIZING THE DEPARTMENT OF PUBLIC WORKS TO ACCEPT AND EXPEND GRANT FUNDS PROVIDED BY THE STATE OF CALIFORNIA, THROUGH THE CALIFORNIA ARTS COUNCIL, AS APPROVED IN SENATE BILL NO. 170 FOR FISCAL YEAR 2021-2022, FOR THE PLANNING AND DESIGN OF NEW IMPROVEMENTS ON OR ABOUT HARVEY MILK PLAZA

WHEREAS, On or about February 4, 2022, on behalf of the City and County of San Francisco (“City”), the Department of Public Works (“Department”) submitted to the State of California, acting by and through the California Arts Council (“Grantor”), an application requesting \$1,500,000 for the planning and design of potential new improvements on or about Harvey Milk Plaza (“Design Project”); and

WHEREAS, The new improvements on or about Harvey Milk Plaza may one day include creating an iconic gateway to the Castro neighborhood, improving universal access throughout the Harvey Milk Plaza site, improving onsite safety and security, and integrating Harvey Milk memorial display fixtures, artwork, and sculptural landscape elements into the plaza landscape and hardscape; and

WHEREAS, Subject to further study and design, and the completion of the Design Project, the potential new improvements on or about Harvey Milk Plaza may include the regrading, repaving, and re-landscaping of the Harvey Milk Plaza in coordination with the SFMTA Castro/Market Muni Station elevator project, and may include improvements to the SFMTA Castro/Market Muni station entry, entry stairs, fare gates, and elevator; and

WHEREAS, On or about November 15, 2021, the Grantor transmitted a letter to the Department notifying the City of Grantor’s award of a “designated funding grant” in the amount of \$1,500,000 for the Design Project (“Letter of Intent”), subject to additional guidelines and contract documents that require the City’s passage of a resolution authorizing the acceptance and expenditure of the grant funds (“Proposed Resolution”), the City’s satisfaction of other conditions and requirements set forth in the grant application (“Application”), the City’s execution of a grant agreement with the California Arts Council (“Agreement”), and the City’s compliance with procedures established by the CAC; and

WHEREAS, To satisfy the requirements of Administrative Code Section 10.170-1, the Department shall transmit this Order to the Clerk of the Board of Supervisors along with the following documents: (1) the Proposed Resolution, signed by the Department, the Mayor or the Mayor’s designee, and the Controller; (2) the associated Grant Information Form; (3) the Application; (4) the Letter of Intent; and (5) a cover letter to the Clerk of the Board substantially conforming to the specifications of the Clerk of the Board (together the “Legislative Package”); and

WHEREAS, The Department has reviewed the contents of the Legislative Package and the Grantor's requirements, including the requirements in the Resolution that the City: 1) certify that the Department understands the assurances and certification in the Project Information Form, 2) certify that the Department will have sufficient funds to operate and maintain the Design Project or will enter into an agreement with another entity to perform said operation and maintenance, 3) certify that the Department has reviewed and understands the General Provisions contained in the Project Agreement shown in the Procedural Guide, and 4) appoint a designated staff position to conduct all negotiations and execute and submit all documents including, but not limited to Project Information Form, agreements, payment requests, which may be necessary for the completion of the Design Project; therefore, it is hereby:

DETERMINED, That the Department hereby : 1) certifies that the Department understands the assurances and certification in the Project Information Form; 2) certifies that the Department will have sufficient funds to operate and maintain the Design Project or will enter into an agreement with another entity to perform said operation and maintenance; 3) certifies that the Department has reviewed and understands the General Provisions contained in the Project Agreement shown in the Procedural Guide; and 4) appoints the Design Project's project manager as the Director's agent to conduct all negotiations and execute and submit all documents including, but not limited to Project Information Form, agreements, payment requests, which may be necessary for the completion of the Design Project, conditioned upon the Board's approval of the Proposed Resolution; and, therefore, it is hereby:

REQUESTED and RECOMMENDED, That the Board of Supervisors approve the Proposed Resolution and authorize the Department of Public Works to enter into the Agreement on behalf of the City, and to authorize the Department and the Clerk of the Board to take further actions, as may be deemed necessary by the Grantor before the Department may accept and expend the grant funds for the Design Project, as set forth in the Legislative Package.

It is so ordered.

X

DocuSigned by:

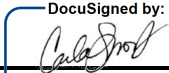

Short, Calia 073CF73A4EA6486...

Interim Director of Public Works

May 23, 2022

Angela Calvillo, Clerk of the Board
Board of Supervisors
1 Dr. Carlton B. Goodlett Place, Room 244
San Francisco, CA 94102

Dear Ms. Calvillo:

Attached please find a proposed Resolution for the Board of Supervisors approval which authorizes the Department of Public Works to accept and expend a grant of \$1,500,000 from California Arts Council for the design and planning of new improvements on or about Harvey Milk Plaza; authorizing the Public Works Director to enter into a grant agreement with the California Arts Council regarding the same; authorizing the Department of Public Works and the Clerk of the Board to take further actions necessary under the grant agreement; and retroactively approving the submittal of the grant application.

The following is a list of accompanying documents:

- Proposed Resolution
- Public Works Order No. 206570
- Grant Information Form
- Grant Agreement
- Grant Application
- Designated Funding Award Letter of Intent
- Exhibit A - The Memorial at Harvey Milk Plaza SFAC Phase II

The following person may be contacted regarding this matter: Tom Paulino, Tom.Paulino@sfgov.org; 415-554-6153.

Sincerely,



President, Board of Supervisors
District 10

City and County of San
Francisco

SHAMANN WALTON
MEMORANDUM

DATE: June 7, 2022

TO: Angela Calvillo, Clerk of the Board of Supervisors
Board of Supervisors Legislative Division

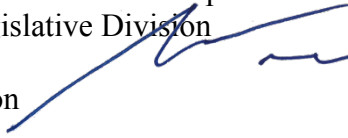
FROM: President Shamann Walton 

CC: Chair Dean Preston, Government Audit & Oversight
Anne Pearson, Deputy City Attorney
Tom Paulino, Mayor's Office
City Administrator's Office

SUBJECT: **Transferring Items from B&F to GAO**

Dear Madam Clerk and Legislative Division Staff,

I am hereby granting the request to transfer the following matters from the Budget & Finance Committee to the Government Audit & Oversight Committee due to the impacted schedule of the Budget & Finance Committee:

- 220544 [Agreement - LAZ Parking California, LLC - Parking Meter Coin and Parking Data Collection Services - Not to Exceed \$50,798,833
- 220554 [Real Property Lease Amendment - Evans Investment Partners, LLC - 750 and 752 Vallejo Street - \$120,792 Annual Base Rent - Estimated \$267,382 Tenant Improvement Cost]
- 220599 [Contract Amendment - Professional Contractor Supply (PCS) - Purchase of Hardware Supplies - \$11,500,000]
- 220600 [Contract - Lystek International Limited - Class A Biosolids Management Services - Not to Exceed \$22,400,000]
- 220601 [Contract - Kemira Water Solutions - Ferric Ferrous Chloride - Not to Exceed \$26,000,000]
- 220602 [Contract - TR International Trading Company - Ferric Ferrous Chloride - Not to Exceed \$28,000,000]
- 220603 [Contract - Univar Solutions USA Inc. - Sodium Hypochlorite - Not to Exceed \$74,000,000]
- 220604 [Contract - Univar Solutions USA Inc. - Sodium Bisulfite - Not to Exceed \$19,000,000]
- 220608 [Multifamily Housing Revenue Bonds - 700-730 Stanyan Street - Not to Exceed \$130,000,000]
- 220645 [Accept and Expend Grant - California Arts Council - Design and Planning for Harvey Milk Plaza - \$1,500,000]
- 220646 [Multifamily Housing Revenue Bonds - Sunnydale HOPE SF Block 3A - Not to

Exceed \$74,000,000]

- 220647 [Multifamily Housing Revenue Bonds - Building E Balboa Reservoir - 11 Frida Kahlo Way - Not to Exceed \$102,000,000]