

SECOND AMENDMENT TO LEASE

This Second Amendment to Lease (this "**Amendment**") is dated as of the latest date set forth beneath the parties' signatures below (the "**Effective Date**"), by and between CITY OF SAN FRANCISCO DOWNTOWN PARKING CORPORATION, a California nonprofit corporation ("**Landlord**"), and SPRINT SPECTRUM REALTY COMPANY, L.P., a Delaware limited partnership, successor-in-interest to SPRINT SPECTRUM, L.P., a Delaware limited partnership ("**Tenant**").

Recitals

A. Landlord and Tenant are parties to that certain Shops at Yerba Buena Lease dated as of February 18, 2004, as amended by that certain Amendment to Lease – Electric Utility Services dated effective as of April 2, 2007, and as further amended by that certain First Amendment to Lease dated effective as of September 26, 2007 (as so amended, the "**Lease**"), respecting that certain retail space commonly known as Suite F and Suite G1 located in the Shops at Yerba Buena, San Francisco, California and more fully described in the Lease (the "**Premises**").

B. Landlord and Tenant desire to amend the Lease as hereinafter set forth.

NOW, THEREFORE, for good and valuable consideration, the receipt and sufficiency of which are hereby acknowledged, the parties hereto agree as follows:

1. Definitions. Terms not otherwise defined herein have the meanings set forth in the Lease. The Lease as amended hereby and as may be further amended is referred to herein as the "**Amended Lease.**"

2. Installation of Rooftop Antenna. Tenant is hereby granted, subject to Article 10 of the Lease and the provisions of this Amendment, the right to install, secure, maintain, replace and operate on a portion of the rooftop space of the Structure described in that certain letter from Tenant to Landlord dated August 29, 2007 (the "**Roof**"), a copy of which letter is attached hereto as Exhibit A (the "**Installation Letter**"), within that certain 4 foot x 4 foot space described in the Installation Letter (the "**Roof Space**"), an antenna and non-penetrating roof mount as specified in the Installation Letter (collectively, the "**Antenna**"). In addition, but also subject to Article 10 and the provisions of this Amendment, Tenant shall have the right to install a coaxial cable leading from the Antenna to the Premises at Tenant's sole cost and expense and in a location, manner, material and size as specified in the Installation Letter or as otherwise may be approved by Landlord in its sole discretion (the "**Cable**"). The installation, use, maintenance, replacement, operation and removal of the Antenna and the Cable are subject to the following:

(a) The Antenna shall be used solely and exclusively by Tenant for purposes of enhancing Tenant's wireless communication signals within the Premises. Tenant shall not permit any other party to utilize the Antenna and/or Cable. Notwithstanding the foregoing, the use of Sprint or Nextel phones or

telecommunication devices by other parties within the Premises shall be considered part of Tenant's operations and is not a prohibited use.

(b) Tenant shall diligently service, repair, paint and maintain the Antenna and the Cable.

(c) No signs, whether temporary or permanent, shall be affixed, installed or attached to the Antenna or the Roof other than those required by Requirements. All signs required, if any, and the location thereof, shall be subject to Landlord's prior approval in writing.

(d) In the performance of any installation, alteration, repair, maintenance, removal and/or any other work with respect to the Roof Space or the Antenna, Tenant shall comply with all of the applicable provisions of the Amended Lease including, without limitation, those set forth in Articles 3, 9, 10, 13 and 14, and the provisions of this Amendment, all of which shall be applicable to the Roof Space as if the Roof Space were a part of the Premises. Without limiting the foregoing, Tenant, at its sole cost and expense, shall comply with all present and future laws, and with any reasonable requirements of any applicable fire rating bureau relating to the maintenance, use, installation and operation of the Antenna and the Cable. Tenant shall install, maintain and operate all of its equipment used in connection with the Antenna and the Cable in conformity with all laws and all regulations of all government agencies having jurisdiction over the installation, use and operation thereof including, without limitation, the Federal Aviation Administration and the Federal Communications Commission; provided, however, that if compliance with such laws or regulations would require a change in the size, configuration or location of the Antenna, then such changes shall be subject to Landlord's prior written consent.

(e) Any and all taxes, filing fees, charges or license fees imposed upon Landlord by virtue of the existence and/or use of the Antenna (including those shown to be specifically related to any increase in the assessed valuation of the Structure attributable to the Antenna), whether imposed by any local, state and/or federal government or any agency thereof, shall be exclusively borne by Tenant. Landlord agrees to cooperate reasonably with Tenant in any necessary applications for any necessary license or permits provided Landlord incurs no expense or liability in so doing.

(f) Between the hours of 8:00 a.m. and 6:00 p.m. and upon reasonable advance notice to Landlord, Monday through Friday (exclusive of holidays), Tenant may have access to the Roof Space for the sole purpose of servicing and maintaining the Antenna. Landlord shall have the right (in its sole discretion) to have its representative(s) accompany Tenant whenever it services or maintains the Antenna. Tenant shall not have any tools and/or materials stored in the Roof Space, and Tenant's employees and independent contractors shall comply with Landlord's rules and procedures in effect from time to time respecting access to

the Roof. If Tenant shall require access to any of the Roof Space, at times other than those specified in the first sentence of this paragraph (f), then except in the case of an emergency, Tenant shall give Landlord at least two full business days prior written notice of such requirement and shall pay all reasonable costs incurred by Landlord in connection therewith including, without limitation, any reasonable compensation paid to Landlord's employees or any independent contractors of Landlord.

(g) Prior to the expiration or earlier termination of the Term of the Amended Lease, Tenant shall remove the Antenna and the Cable, and shall restore and repair all damage to the Structure occasioned by the installation, maintenance or removal of the Antenna and the Cable. If Tenant fails to timely complete such removal, restoration and repair, all reasonable sums incurred by Landlord to complete such work shall be paid by Tenant to Landlord upon demand.

(h) Throughout the Term of the Amended Lease from and after the installation of the Antenna, Tenant shall annually inspect the Antenna. Tenant shall be solely responsible for preserving the water tight integrity of the Roof as may be caused by, or relates to, the installation, maintenance, operation and repair of the Antenna. Tenant shall be responsible for all leaks in the Roof directly arising out of or connected to its installation of Tenant's Antenna. Tenant's Antenna shall not exceed the applicable load-bearing capacity of the Roof Space.

(i) If, at any time during the Term, Landlord, in its sole judgment, shall determine that it is necessary to move the Antenna to another area of the Roof or another portion of the Structure, then Landlord may give notice thereof to Tenant (which notice shall have annexed thereto a plan on which such other area of the Roof or another portion of the Structure (the "**Substitute Space**") shall be substantially identified by hatching or otherwise). The Substitute Space with respect to the Antenna shall not be located in an area of the Roof or Structure in which the Antenna's reception would differ in a materially adverse way from the Antenna's reception in the initial Roof Space. Within thirty (30) days of receipt of Landlord's notice (or, if a governmental permit is required to be obtained for installation of the Antenna in the Substitute Space, then, within thirty (30) days of the obtaining of such permit (which Tenant shall make prompt application for, with Landlord's reasonable cooperation), Tenant, at its sole cost, shall move the Antenna to the Substitute Space which shall then become the Roof Space hereunder and the original Roof Space shall be deleted from the coverage of the Amended Lease.

(j) Tenant's operation or use of the Antenna shall not prevent or interfere with the operation or use of any equipment of (i) any tenant, occupant or licensee of the Structure whose equipment was installed prior to the installation of the Antenna or (ii) Landlord. If, at any time during the Term, Landlord shall reasonably determine that the Antenna causes interference with equipment of any

such tenant, occupant or licensee or of Landlord, then Landlord may so notify Tenant in writing ("**Interference Notice**"). Within twenty-four (24) hours following receipt of any such Interference Notice, Tenant shall discontinue use of the Antenna. Landlord reserves the right to disconnect the Antenna if, following delivery of an Interference Notice, Tenant fails to discontinue use of the Antenna within such twenty-four- (24-) hour period. Notwithstanding the foregoing, following Tenant's cessation of the use of the Antenna, Tenant may conduct brief tests to identify the cause of, and to determine how to eliminate, such interference. In the event the interference cannot be eliminated, Tenant may, at its election and at Tenant's sole cost and expense, propose to replace the Antenna with another antenna which would not cause such interference (the "**Replacement**"); provided, however, that prior to proceeding with the installation of any such Replacement, Tenant shall first demonstrate to Landlord's reasonable satisfaction that the proposed Replacement will cure the interference caused by the Antenna. Following such non-interference demonstration and, if a governmental permit is required to install the Replacement, then following Tenant's receipt of such permit (which Tenant shall be responsible for obtaining, with Landlord's cooperation but at no cost to Landlord), Tenant may replace the Antenna with the new non-interfering Replacement in accordance with the other terms and provisions of this Amendment. Following any such replacement, the Replacement shall then be deemed to be the Antenna hereunder.

(k) Tenant agrees that Landlord has made no warranties or representations as to the condition or suitability of the Roof Space or the Structure for the installation, use, maintenance or operation of the Antenna and the Cable, and Tenant agrees to accept same in its "as is" condition and without any work or alterations to be made by Landlord. Tenant expressly acknowledges and agrees that this Amendment does not permit Tenant to install any electrical power connections to the Roof Space and/or the Antenna, any which electrical connection shall be made to associated equipment to be located in the Premises as set forth in the Installation Letter.

3. No Other Changes. Except as otherwise expressly modified by the terms of this Amendment, the Lease shall remain unchanged and in full force and effect. Tenant hereto acknowledges that, as of the date hereof, Landlord is not in default in the performance of any of its obligations under the Lease and that Tenant has no claims or setoffs of any kind.

4. Counterparts. This Amendment may be executed in multiple counterparts, each of which shall be considered an original and all of which together shall comprise one and the same instrument.

[REMAINDER OF THIS PAGE INTENTIONALLY LEFT BLANK;
SIGNATURE BLOCKS ON FOLLOWING PAGE]

IN WITNESS WHEREOF, Landlord and Tenant have executed this Amendment effective as of the Effective Date.

LANDLORD

CITY OF SAN FRANCISCO DOWNTOWN
PARKING CORPORATION,
a California nonprofit corporation

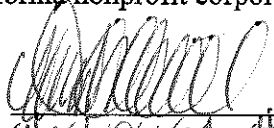
By: 
Name: ERIN VEA #211
Its: CRAN, BOARD OF TRUSTEES
Date: JAN 24, 2008

APPROVED:

By: 
Director of Property
CITY AND COUNTY OF
SAN FRANCISCO

Date: 2/1, 2008

TENANT

SPRINT SPECTRUM REALTY COMPANY, L.P.,
a Delaware limited partnership

By: 
Name: JOHN E. BEAUDOIN
Its: MANAGER, CONTRACTS
Date: JAN 15, 2008

Exhibit A

Installation Letter

(See attached copy.)

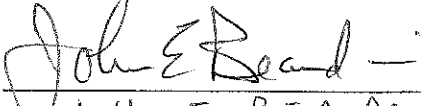

Sprint Nextel
Mailstop: KSOPHBD206-2B414
6300 Sprint Parkway
Overland Park, KS 66251-2650
Office: 913-794-2608 Fax: 913-794-0212

Kelee Limbach
Technical Project Manager

John Brown
Corporate Manager
Downtown Parking Corp.
Fifth & Mission/Yerba Buena Garage
833 Mission Street
San Francisco, CA 94103

August 29, 2007

RE: Sprint Nextel Repeater Antenna Request and Scope

Dear Mr. Brown,

In order to improve Sprint's cellular coverage inside its retail store at the Yerba Buena Garage, it is necessary to request approval for the installation of a repeater and associated antenna. The repeater will allow Sprint to more effectively demonstrate and sell its products and thus help to ensure a long term tenancy with the City. The purpose of this letter is to explain the equipment and scope of work involved. As you will see, it is a very simple concept and installation. The installation will probably take less than one week to complete.

A repeater system consists of three main parts; the exterior (donor) antenna, the repeater, and the coaxial cable connecting these two. The only equipment to be located outside of Sprint's store is the donor antenna and coaxial cable. The repeater itself will be located in the rear room of Sprint's leased space (inside the store). It will plug into a standard 120v outlet inside the store, so there will be no additional electrical bill. The entire system will be grounded and have a lightning protection kit installed.

The donor antenna will pick up a signal from a nearby cell tower and this signal is carried down into the store through the coaxial cable. The dimensions of the antenna are about 23 inches long by 3.25 inches across (see attached specification sheet). We propose to mount it on top of the central elevator/stairwell penthouse using a non-penetrating sled & ballast tripod mount. We will need a 4 ft x 4 ft square rooftop space for the mount. The tripod will be approximately 2-3 feet tall and given the height and location of the penthouse and its parapet wall, the antenna will not be visible from street level. Please refer to the attached photographs and specification sheets for further detail.

The coaxial cable is ½ inch diameter fire rated and will be encased in conduit per local code. Getting the cable down to the store can be accomplished by core drilling through the stairwell floors. All core drill locations will first be X-rayed to prevent damage to the building's infrastructure. Again, please refer to the attached photographs for further detail.

As you may know, our contractor, Candou Communications met with Simon Kwan, Architect to discuss the proposed equipment locations and to negate any visual or structural concerns. We hope this letter

along with the attached information sufficiently explains our intentions. Please do not hesitate to call with further inquiries.

Sincerely,

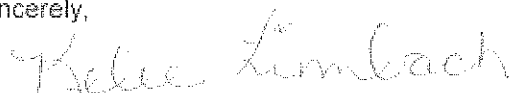
A handwritten signature in cursive script that reads "Kelee Limbach". The signature is written in dark ink and is positioned above the typed name.

Kelee Limbach
Project Manager

Cc: Mark Matt
Mikell Bennett

4' X 4' space for antenna to be mounted on sled & ballast tripod. Core drilling is proposed for coax cable entry down through all floors in order to hide the cable. Once down to 2nd floor parking level, the cable will run across the roof of garage to above Sprint store, then down into the store.

M I S S I O N S T R E E T



M I N N A S T R E E T

Roof Plan showing proposed location of antenna on top of elevator/stairway structure (No Scale).



Photo of elevator/stairway structure. Proposed antenna to be placed on top via sled/ballast mount.

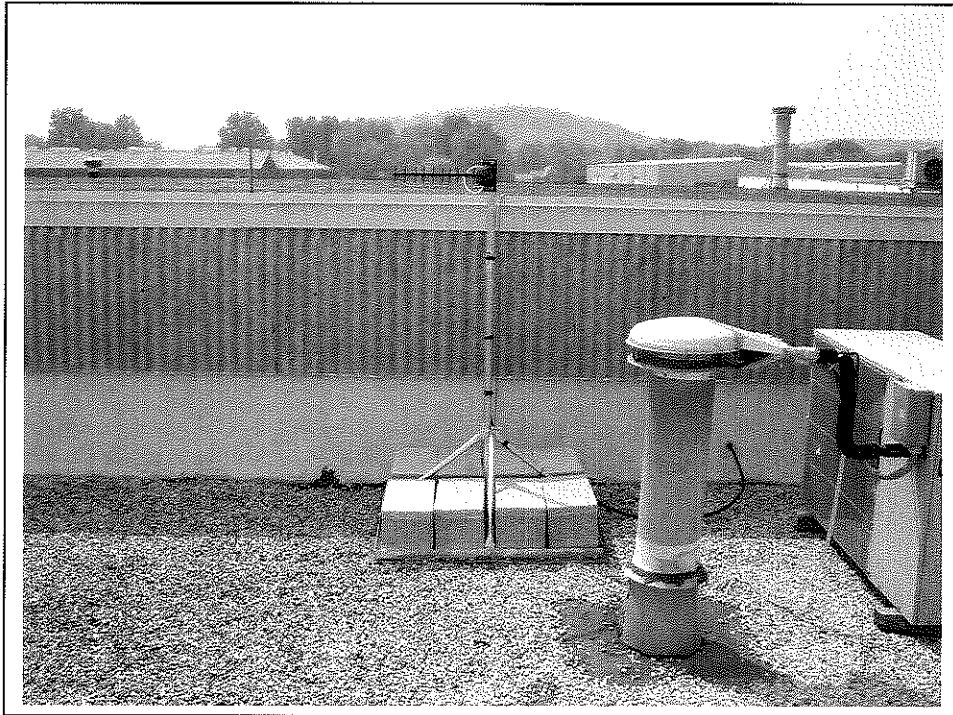

Example photograph of an antenna mounted on a non-penetrating tripod sled/ballast mount. A protective rubber mat is placed between the roof and the tripod sled.



Coax cable from antenna is proposed to reach the Sprint store via core drilling down through the center stairwell. All core drilling areas will first be X-rayed to eliminate damage to structural members or other building facilities such as electrical wiring. Coax cable will be 1/2" diameter fire rated and encased in a conduit per local code.

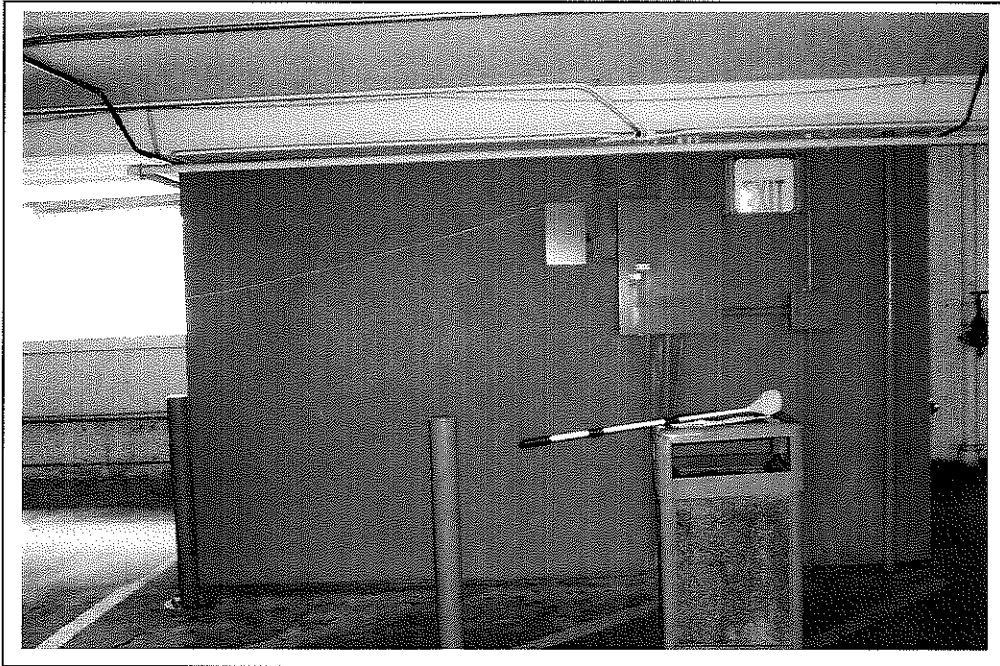

Coax cable is proposed to exit near this location on the 2nd floor level ceiling...

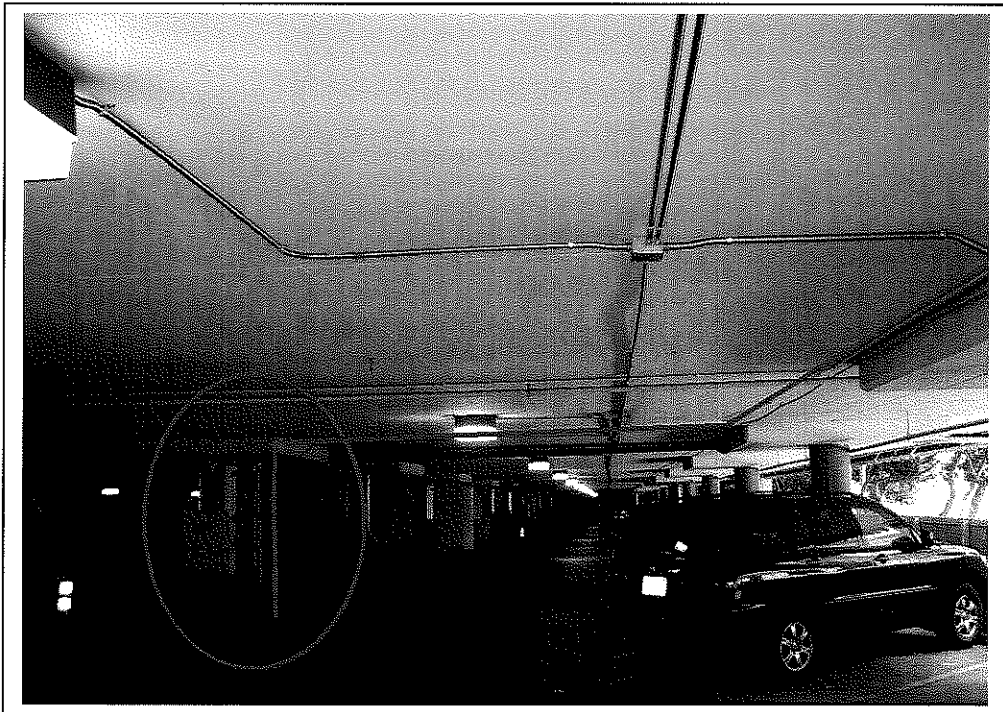

...and then run approximately 80 feet across the ceiling of the 2nd floor level garage over and down into the Sprint store location.



Proposed location of core drill from 2nd level parking down into Sprint store.
Note that there are existing core drills and a protective cage at this location.

1850 - 1990 MHz

ANT1920Y12-WR

YAGI ANTENNA 12.2 dBd / 14.3 dBi

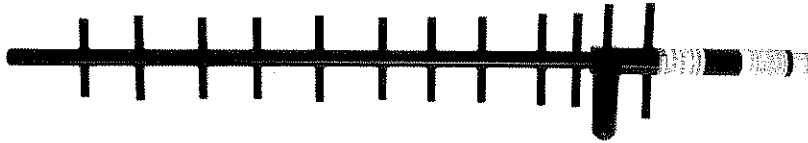

The Telewave ANT1920Y12-WR is a rugged, wide-band, high-gain Yagi antenna, designed for point-to-point or point-to-multipoint applications in any environment. The antenna uses twelve solid brass elements, and produces 12.2 dBd forward gain with exceptional front-to-back performance. Construction and design are optimized to prevent RF intermodulation, and ensure precise pattern control.

Each antenna is completely protected with Telewave's high-tech Tylan™ coating, which protects the antenna from corrosive gases, UV radiation, salt spray, acid rain

and wind-blown abrasives. The feed line is sealed within the antenna boom, and an RF-transparent radome protects the driven element from corrosion or icing.

The ANT1920Y12-WR includes a standard clamp set that allows the installer to configure the antenna for vertical or horizontal polarization. The universal mount option allows mounting to angled supports, and tilt adjustment. The standard clamp sets will attach to a support mast with a diameter of 0.5" to 1.5", and the universal mount can be attached to a supporting structure from 1" to 3.5".

ANT1920Y12-WR at 1895 MHz

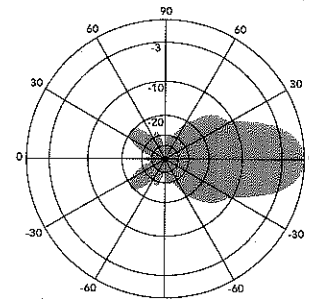

E-Plane
Gain: 12.0 dBd

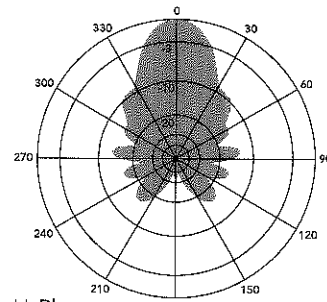

H-Plane
Gain: 12.0 dBd

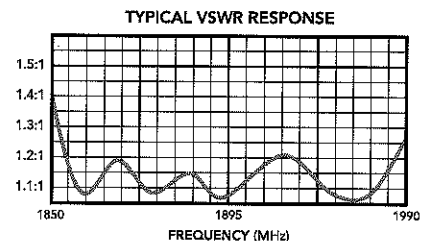

SPECIFICATIONS

Frequency (continuous)	1850-1990 MHz	Elements	12
Gain (typ)	12.2 dBd	Dimensions (L x H) in.	23 x 3.25
Power rating (typ)	500 watts	Antenna weight	2 lb.
Impedance / VSWR	50 ohms / 1.5:1 (max)	Shipping weight	6 lb.
Front to back ratio (min)	22 dB	Wind rating / with 0.5" ice	200 / 165
Beamwidth V / H	30° / 35°	Exposed area (flat plate equiv.)	0.2 ft. ²
Pattern / Polarization	Directional / Variable	Lateral thrust at 100 MPH	8.0 lb.
Termination	N Female or 7-16 DIN (opt)	(40 P/SF flat plate equiv.)	



660 Giguere Court, San Jose CA
1-800-331-3396 • 408-929-4400
www.telewave.com

All specifications subject
to change without notice
TWDS-7015 Rev. 2/07

Roof-Top Applications

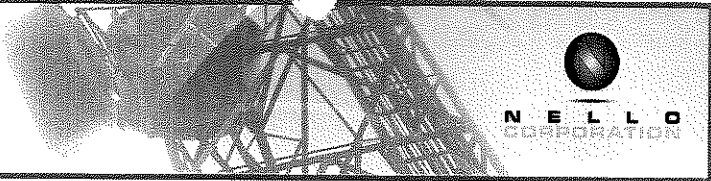

Non-Penetrating Flat Roof Mounts

Material	Pre galvanized	Design:	Designed for
Included:	mast, base and hardware		DSS support
Order	Rubber Mat	Mounts to:	n/a
Seperately:			

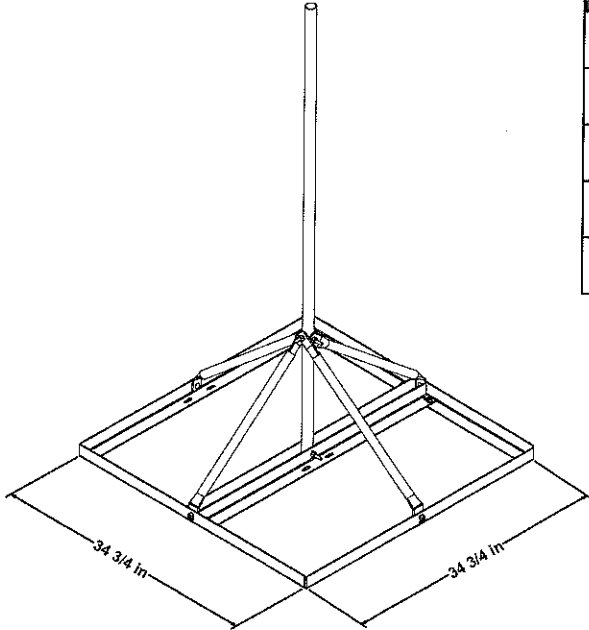

Part #	Description		
103489	Non-Penetrating FRM Roof Mount (1.25" O.D. Tubing, 60" Overall Mast Height)		

Roof - Top Applications

FIRST AMENDMENT TO LEASE

This First Amendment to Lease (this "**Amendment**") is dated as of the latest date set forth beneath the parties' signatures below (the "**Effective Date**"), by and between CITY OF SAN FRANCISCO DOWNTOWN PARKING CORPORATION, a California nonprofit corporation ("**Landlord**"), and SPRINT SPECTRUM REALTY COMPANY, L.P., a Delaware limited partnership, successor-in-interest to SPRINT SPECTRUM, L.P., a Delaware limited partnership ("**Tenant**").

Recitals

A. Landlord and Tenant are parties to that certain Shops at Yerba Buena Lease dated as of February 18, 2004, and as amended by that certain Amendment to Lease — Electric Utility Services dated effective as of April 2, 2007 (as so amended, the "**Lease**"), respecting that certain retail space commonly known as Suite F located in the Shops at Yerba Buena, San Francisco, California and more fully described in the Lease (the "**Original Premises**").

B. Landlord and Tenant desire to expand the premises demised under the Lease and amend certain terms and conditions of the Lease, all as hereinafter set forth.

NOW, THEREFORE, for good and valuable consideration, the receipt and sufficiency of which are hereby acknowledged, the parties hereto agree as follows:

1. Definitions. Terms not otherwise defined herein have the meanings set forth in the Lease.
2. Lease of Expansion Premises. Landlord hereby leases to Tenant, and Tenant hereby leases from Landlord, those certain premises deemed to consist of five hundred and twenty-seven (527) rentable square feet commonly known as Suite G1 of the Retail Center and depicted with diagonal hatching in Exhibit A, attached hereto and incorporated herein by this reference ("**Expansion Premises**"). Except to the extent expressly provided for otherwise in this Amendment, Tenant's leasing of the Expansion Premises shall be on the same terms and conditions as the leasing of the Original Premises as set forth in the Lease. The term of Tenant's leasing of the Expansion Premises shall commence on the Expansion Premises Delivery Date (as hereinafter defined) and shall expire on the Term Expiration Date. Tenant's obligation to pay Annual Rental and additional rental respecting the Expansion Premises shall begin on the date ("**Expansion Premises Rent Commencement Date**") which is the earlier of (a) the date on which Tenant opens the Expansion Premises for business to the public or (b) the date which is thirty (30) business days following the Expansion Premises Delivery Date. From and after the Expansion Premises Delivery Date, (i) the Expansion Premises shall be added to and constitute part of the premises leased by Tenant pursuant to the Lease, (ii) all references in the Lease to "**Premises**" shall refer to both the Original Premises and the Expansion Premises as depicted in Exhibit A and shall be commonly known as "Suite F" and "Suite G1" of the Retail Center, and (iii) the "**Floor Area of the Premises**" leased pursuant to the Lease shall be deemed to consist of a total of two thousand one hundred fifty-two (2,152) rentable square feet.

3. Tenant's Cost Proportionate Share. As of the Expansion Premises Rent Commencement Date, Tenant's Cost Proportionate Share shall be 8.83%.

4. Delivery of Expansion Premises. Landlord shall tender possession of the Expansion Premises to Tenant upon the completion by Landlord of the Stud Wall (as defined in Paragraph 6) ("**Expansion Premises Delivery Date**").

5. "AS IS" Condition of Expansion Premises. Except for the Landlord's Work (as defined in Paragraph 6) to be made to the Expansion Premises by Landlord pursuant to this Amendment, Tenant shall accept possession of the Expansion Premises from Landlord in its "AS IS" condition on the Expansion Premises Delivery Date. Landlord shall have no obligations whatsoever to undertake any alterations, additions, renovations or improvements of any nature whatsoever to the Expansion Premises other than the Landlord's Work. Notwithstanding anything to the contrary in the Lease, any damage to the Expansion Premises caused by Tenant's move-in shall be repaired or corrected by Tenant, at its expense. Tenant acknowledges and agrees that neither Landlord nor any employees, representatives, or agents of Landlord have made any representations or warranties as to the suitability or fitness of the Expansion Premises for the conduct of Tenant's business.

6. Landlord's Work. Landlord, at its sole cost and expense, shall construct a demising wall ("**Landlord's Work**") between Suite G1 and Suite G2 of the Retail Center in the location shown in Exhibit A, which Landlord's Work shall be completed in two phases consisting of (a) the framing and construction of a stud wall open to the Suite G2 side of the Premises prior to Landlord's tendering of Expansion Premises to Tenant (the "**Stud Wall**"), and (b) the finishing of the Stud Wall with installation of drywall and finishes pursuant to the specifications set forth in Exhibit B of the Lease. Following the completion of the Stud Wall and prior to the completion of the demising wall as provided in the preceding sentence, Landlord shall coordinate and cooperate with Tenant's contractor in Tenant's installation of applicable improvements within the Stud Wall. All work and materials furnished in connection with the making of the Landlord's Work shall be standard work and materials for the Retail Center, as set forth in Exhibit B of the Lease. If the Lease, as amended by this Amendment, is terminated prior to completion of the Landlord's Work for any reason due to the default by Tenant, Tenant shall pay to Landlord, within five (5) days of receipt of a statement therefor, all costs incurred by Landlord through the date of such termination in connection with the Landlord's Work.

7. Expansion Premises Tenant Improvement. Tenant shall, at its sole cost and expense, make interior improvements (collectively, the "**Expansion Premises Tenant Improvements**") to the Expansion Premises, subject to Landlord's prior written approval of the plans for such Expansion Premises Tenant Improvements pursuant to the review and approval procedures set forth in Exhibit B of the Lease and subject to terms and conditions relating to alterations and Improvements in the Lease, including, but not limited to, Article 10 of the Lease.

8. Annual Rental. Annual Rental payable by Tenant to Landlord for the Premises (including the Expansion Premises) commencing on the Expansion Premises Rent Commencement Date through the Term Expiration Date shall be as follows:

<u>Period</u>	<u>Monthly Rent</u>	<u>Annual Rental</u>
Expansion Premises Rent Commencement Date through May 31, 2008	\$8,690.85	\$104,290.20
June 1, 2008 through May 31, 2009	\$8,908.12	\$106,897.44

9. Expansion Rent Credit. Notwithstanding any provision to the contrary in the Lease, Tenant shall be entitled to an additional credit against the Annual Rental payable hereunder, provided that no Event of Default has occurred and is continuing hereunder on any date that such credit is to be applied as hereinafter set forth, which credit shall be in the aggregate amount of Fourteen Thousand Seven Hundred Fifty-Six and 00/100ths Dollars (\$14,756.00) (the "**Expansion Rent Credit**"). Subject to the provisions of this Paragraph 9, the Expansion Rent Credit shall be in equal monthly installments of Eight Hundred Nineteen and 78/100ths Dollars (\$819.78), which shall be applied over the eighteen (18) month period commencing with the first full monthly installment of the Annual Rental after the Expansion Premises Rent Commencement Date. If an Event of Default has occurred and is continuing on any of the foregoing dates for application of any portion of the Expansion Rent Credit, then Tenant shall not be entitled to apply the otherwise applicable portion of the Expansion Rent Credit then or at any time thereafter during the Term. If the Lease expires or is terminated by Landlord pursuant to Article 19 of the Lease prior to the application of the entire Expansion Rent Credit, then Tenant shall not be entitled to any portion of the Expansion Rent Credit that would have been available after the date of expiration or earlier termination, nor shall Tenant be entitled to assert any right to such portion of the Expansion Rent Credit which would have accrued after such expiration or earlier termination against any sums due Landlord. The Expansion Rent Credit granted under this Paragraph 9 is solely for the benefit of SPRINT SPECTRUM REALTY COMPANY, L.P. and shall not be transferable to any assignee or subtenant other than a parent, subsidiary or affiliate of SPRINT SPECTRUM REALTY COMPANY, L.P.

10. Brokers. Tenant represents and warrants to Landlord that neither it nor its officers or agents nor any one acting on behalf of it has dealt with any real estate broker in the negotiating or making of this Amendment, except Colliers International ("**Broker**"). Any and all brokerage fees due and payable to Broker shall be paid by Landlord pursuant to a separate agreement by and between Landlord and Broker. Tenant agrees to indemnify and hold Landlord harmless from any claim or claims, costs, or expenses, including attorneys' fees, incurred by Landlord in conjunction with any claim or claims of any real estate broker, agent or finder to a commission, finder's fee, or equivalent compensation in connection with this Amendment as a result of the acts of omissions of Tenant. The terms of this Paragraph 10 shall survive the expiration of or earlier termination of the Term.

11. Tenant Equipment Financing. Notwithstanding any provision of the Lease to the contrary, Tenant shall have the right from time to time to mortgage, pledge or encumber its merchandise, trade fixtures, equipment (exclusive of any equipment possession of which is granted pursuant to the leasehold created by the Lease as amended hereby and as may be hereafter amended) and personal property, in connection with financing and refinancing thereon by Tenant (any of which, an "**Equipment Financing**"). If requested by Tenant, Landlord shall enter into a waiver of lien rights and consent instrument in such form as may be reasonably

required by the party providing Equipment Financing and that is reasonably acceptable to Landlord (any, a "**Landlord Consent**"). In any such event, Tenant shall reimburse Landlord upon demand for all actual, out-of-pocket costs incurred by Landlord in connection with the review and approval of the proposed Landlord Consent including, without limitation, reasonable attorneys' fees and costs.

12. No Other Changes. Except as otherwise expressly modified by the terms of this Amendment, the Lease shall remain unchanged and in full force and effect. Tenant hereto acknowledges that, as of the date hereof, Landlord is not in default in the performance of any of its obligations under the Lease and that Tenant has no claims or setoffs of any kind.

13. Counterparts. This Amendment may be executed in multiple counterparts, each of which shall be considered an original and all of which together shall comprise one and the same instrument.

[REMAINDER OF THIS PAGE INTENTIONALLY LEFT BLANK;
SIGNATURE BLOCKS ON FOLLOWING PAGE]

IN WITNESS WHEREOF, Landlord and Tenant have executed this Amendment effective as of the Effective Date.

LANDLORD

CITY OF SAN FRANCISCO DOWNTOWN
PARKING CORPORATION, a California
nonprofit corporation

By: 

Its: PRESIDENT

Date: September 26, 2007

APPROVED:

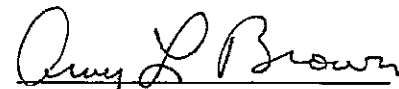
By: 
Director of Property
CITY AND COUNTY OF
SAN FRANCISCO

Date: September 26, 2007

TENANT

SPRINT SPECTRUM REALTY COMPANY, L.P.,
a Delaware limited partnership

By: 

Name: Timothy A. Diamond

Its: Director of Real Estate and Construction

Date: September 18, 2007

Exhibit A

Plan of Original Premises and Expansion Premises

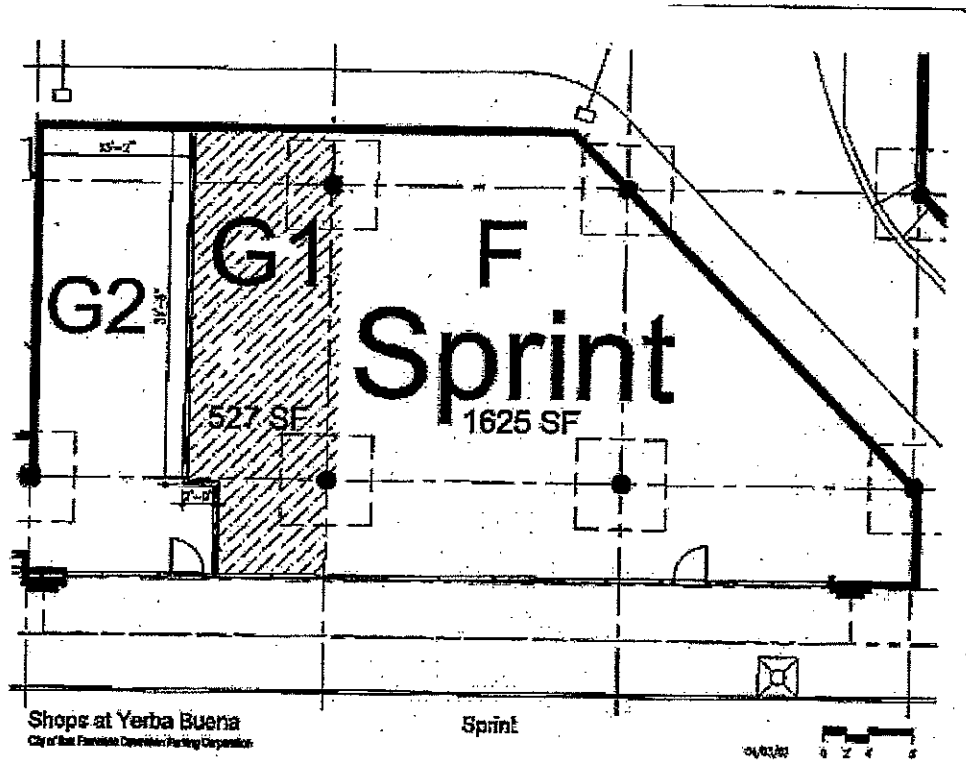

FIFTH & MISSION/YERBA BUENA GARAGE

City of San Francisco Downtown Parking Corporation
John R. Brown, Corporate Manager
833 Mission Street
San Francisco, California 94103-3006
Tel: 415-982-8522
Fax: 415-777-0447
www.fifthandmission.com

Board of Directors

Heather Hoell, President
Richard Mayer, Vice President
Steven Glick, Secretary/Treasurer
William Osterhaus Mary McCue
Mel Wasserman Natalie Berg
Carol Horn Dan Kelleher
Heather Almond Richard Shaff
Dan Goldes

July 3, 2008

Mr. Mark J. Matt
Sprint Nextel
Real Estate Manager
KSOPHK0110-1A450
Overland Park, KS 66251

Re: Amendment to Lease – Electric Utility Services

Dear Mr. Matt:

Please find enclosed one original fully executed copy of the above captioned Amendment for your use and record.

I'm not sure who else on your team needs or desires additional copies, if you could follow up with them and provide copies as needed it would be appreciated.

Thanks for your time and cooperation in working through this process.

Sincerely,

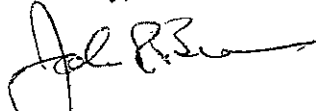

John R. Brown

cc: Laird Steverango, w/enclosure
Steven Ames, w/enclosure

✓ file: Contract, Sprint

FIFTH & MISSION/YERBA BUENA GARAGE

City of San Francisco Downtown Parking Corporation
John R. Brown, Corporate Manager
833 Mission Street
San Francisco, California 94103-3006
Tel: 415-982-8522
Fax: 415-777-0447
www.fifthandmission.com

Board of Directors

Heather Hoell, President
Richard Mayer, Vice President
Steven Glick, Secretary/Treasurer
William Osterhaus Mary McCue
Mel Wasserman Natalie Berg
Carol Horn Dan Kelleher
Heather Almond Richard Shaff
Dan Goldes

June 26, 2008

Mr. John Updike
Assistant Director of Property
City of San Francisco Real Estate Division
25 Van Ness Avenue
Suite 400
San Francisco, CA 94102

Re: Amendment to Lease -- Electric Utility Services between Downtown Parking Corporation ("Landlord") and Sprint Spectrum L.P. ("Tenant") for premises at 843 Mission Street, Suite F, San Francisco, CA 94103 (Store # 1022)

Dear John:

Please find enclosed five original copies of the above captioned Amendment to Lease for final execution by Director of Property.

This document has been negotiated and produced by our Real Estate Attorney, Laird Steverango, working in conjunction with our Real Estate Committee, Jerry Romani and myself. It is now ready for your final review and full execution by the City of San Francisco's Director of Property.

After you've had a chance to review the document, please have it signed in the spaces indicated, keep a copy for your file and return the remaining four originals to my attention for final disposition. Should you have any questions or additional considerations, please do not hesitate to call. For reference I can be reached at 415-982-8522 x 11.

Sincerely,

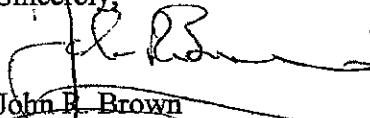

John R. Brown

file: Contract, Sprint/Nextel

AMENDMENT TO LEASE – ELECTRIC UTILITY SERVICES

This Amendment to Lease – Electric Utility Services (this “**Amendment**”) is entered into effective as of April 2, 2007 (“**Effective Date**”), by and between CITY OF SAN FRANCISCO DOWNTOWN PARKING CORPORATION, a California nonprofit corporation (“**Landlord**”), and SPRINT SPECTRUM REALTY COMPANY, L.P., a Delaware limited partnership, successor-in-interest to SPRINT SPECTRUM L.P., a Delaware limited partnership (“**Tenant**”).

Recitals

A. Landlord and Tenant are parties to that certain Shops at Yerba Buena Lease dated as of February 18, 2004 (the “**Lease**”), respecting that certain retail space commonly known as Suite F located in the Shops at Yerba Buena, San Francisco, California and more fully described in the Lease (“**Premises**”).

B. Prior to the Effective Date, electric utility services have been obtained by Tenant from Hetch Hetchy Water and Power (“**Hetch Hetchy**”), a division of the Public Utilities Commission of the City and County of San Francisco (the “**City**”). A dispute arose between the City, the sole shareholder of Landlord, and Pacific Gas & Electric Company (“**PG&E**”) as to whether electricity for the commercial tenants at the Fifth and Mission Street Garage, which commercial tenants include Tenant, may be provided by the City under the terms of the 1987 Interconnection Agreement (the “**1987 Agreement**”) between PG&E and the City. Such dispute was arbitrated, as required under the terms of the 1987 Agreement, before retired Judge Eugene Lynch. Judge Lynch concluded that the commercial tenants at the Fifth and Mission Street Garage may not be served by municipal power under the Raker Act, 38 Stat. 242 (1913) and therefore must be served by PG&E.

C. To implement the arbitration decision, PG&E and the City agreed that the leases with the commercial tenants at the Fifth and Mission Street Garage, including the Lease, shall be amended to comply with the arbitration decision and such decision’s interpretation of the application of California Public Utilities Commission Electric Rule 18 to the provision of electrical service to the Premises.

D. Landlord and Tenant desire to amend the Lease as hereinafter set forth to comply with the terms of the arbitration decision.

NOW, THEREFORE, for good and valuable consideration, the receipt and sufficiency of which are hereby acknowledged, the parties hereto agree as follows:

1. Definitions. Terms not otherwise defined herein have the meanings set forth in the Lease.

2. Effective Date. For electrical utility services to be provided to Tenant as contemplated by this Amendment, Landlord caused the installation of the Transformer Improvements (as hereinafter defined) to be completed. Landlord previously informed Tenant

that, as of the Effective Date, Tenant ceased to receive electrical utility services from Hetch Hetchy and, instead, began to receive electrical utility services in the manner contemplated by paragraph 3 of this Amendment below.

3. Utility Services. The last sentence of Article 6(a) of the Lease is hereby deleted in its entirety. The following new Article 6(e) is added to the Lease:

(e) All electrical utility services for the Structure, including the Retail Center and any other portion(s) of the Structure leased by Landlord from time to time to commercial tenants ("**Other Retail Spaces**"), shall be contracted for by Landlord with (A) PG&E or such other utility provider as may be selected by Landlord from time to time for the provision of interconnection and wheeling services ("**Utility Provider**") and (B) PG&E or such other energy provider as may be selected by Landlord from time to time for the provision of electrical energy services ("**Electrical Energy Provider**"). Tenant agrees that Landlord has the exclusive right and discretion to select both Utility Provider and Electrical Energy Provider and, notwithstanding any contrary provision in this Lease, Tenant may not obtain (1) electrical interconnection or wheeling services directly or indirectly from any utility provider other than Utility Provider nor (2) electrical energy services directly or indirectly from any energy provider other than Electrical Energy Provider. All of the Tenant Spaces together with any Other Retail Spaces are referred to herein collectively as the "**Retail Spaces**". Tenant acknowledges and agrees that Landlord may, from time to time at Landlord's election, select an Electrical Energy Provider for the Retail Spaces which differs from the Electrical Energy Provider selected by Landlord for the portions of the Structure excluding the Retail Spaces. The Electrical Energy Provider for the Retail Spaces so selected by Landlord is referred to herein as the "**Retail Energy Provider**". Landlord will cause the installation of two meters to measure the aggregate electrical usage of the Retail Spaces ("**Retail Load**") and Landlord's operational electrical usage ("**Operational Load**") for the portions of the Structure excluding the Retail Spaces ("**Non-Retail Area**"). Retail Energy Provider shall bill Landlord for the cost of electricity usage comprising the Retail Load and Utility Provider shall bill Landlord for cost of delivering such electricity to the Retail Spaces. The cost for electricity usage in the Premises shall be included within the rent, calculated as follows:

(I) Landlord shall calculate the cost for such electricity usage which shall include all charges for the electrical utility service including, without limitation, all federal, state and local taxes and fixture fees or similar fees, which may from time to time be imposed upon or payable by Landlord in connection with charges for electricity comprising the Retail Load and all charges for delivery of such electricity to the Retail Spaces (collectively, "**Retail Load Costs**").

(II) Landlord, exercising good faith business judgment, shall equitably allocate the Retail Load Costs among all of the tenants occupying the Retail

Spaces including Tenant. Landlord's allocation shall (A) take into account such factors or conditions as reasonably determined by Landlord exercising its good faith business judgment including, as appropriate but without limitation, (1) projected load for the electrical equipment installed in the Premises and other premises in the Retail Spaces, (2) changes in the aggregate Floor Area of the Retail Spaces, (3) changes in the portion of the aggregate Floor Area of the Retail Spaces that are leased and occupied and (4) any historical information concerning electrical usage in the Retail Spaces and (B) be binding on Tenant. Landlord reserves the right, from time to time, to make reasonable and non-discriminatory modifications to its methodology for equitably allocating the Retail Load Costs.

(III) Landlord shall estimate Tenant's allocated portion of the Retail Load Costs on a prospective basis, to be included into the Annual Rental, and which shall be based on Landlord's equitable allocation as determined pursuant to subparagraph (II) above and subject to adjustment from time to time; provided, however, during any consecutive twelve- (12-) month period, Landlord shall not make more than four (4) prospective adjustments of the Tenant's allocated portion of the Retail Load Costs. The then prospective allocated amount shall be payable in twelve (12) equal monthly installments, in advance, as part of the installments of Annual Rental due hereunder.

4. Transformer Improvements. Prior to the Effective Date, Tenant obtained electrical services through a secondary service connection to the Structure. Such electrical service was provided at a voltage which was at the appropriate service level for Tenant's use in the Premises. Charges for such electrical service included a depreciation charge for the cost of stepdown transformers owned by the City. From and after the Effective Date, electrical utility service will be provided to the Structure through a primary service connection at 12kV. To enable Tenant to continue to obtain electrical service at an appropriate service level voltage, Landlord has installed a stepdown transformer in the Common Areas. Such stepdown transformer, together with all electrical interconnection facilities necessary to obtain the primary service connection for the Structure, are collectively referred to herein as the "Transformer Improvements". Tenant acknowledges that, pursuant to Article 5(d)(x) of the Lease, Landlord is entitled to include in Tenant's Cost Proportionate Share of Common Area Costs, from and after the Effective Date, a depreciation charge to recover the cost of procuring and installing the Transformer Improvements ("Transformer Improvements Costs"). Landlord has determined that, instead of including such costs in Tenant's Cost Proportionate Share of Common Area Costs, the Transformer Improvements Costs are more equitably allocated to Tenant in a manner similar to the method used to allocate the Retail Load Costs pursuant to paragraph 3 above. Accordingly, from and after the Effective Date, Landlord shall depreciate the Transformer Improvements over their useful life, as reasonably determined by Landlord. The annual amount of such depreciation shall be equitably allocated by Landlord, in Landlord's good faith judgment, between the Retail Spaces and the Non-Retail Area, which allocation shall be based upon Landlord's estimates of the Retail Load and the Operational Load for the subject period. Landlord, exercising good faith business judgment, shall then equitably allocate that portion of the Transformer Improvements Costs which are so allocated to the Retail Spaces, in the aggregate, among all of the tenants occupying the Retail Spaces including Tenant. Such further

allocation shall be determined and adjusted in the same manner that the Retail Load Costs are allocated, and adjusted, pursuant to subparagraphs II and III of Article 6(e). The then prospective amount of such allocated Transformer Improvements Costs shall be included in, and as part of, the Annual Rent to be payable in twelve (12) equal monthly installments, in advance, due under the Lease as amended hereby.

5. No Other Changes. Except as otherwise expressly modified by the terms of this Amendment, the Lease shall remain unchanged and in full force and effect. Each party hereto acknowledges that, as of the date hereof, the other party is not in default in the performance of any of its obligations under the Lease and that such party has no claims or setoffs of any kind.

[REMAINDER OF THIS PAGE INTENTIONALLY LEFT BLANK]

6. Counterparts. This Amendment may be executed in multiple counterparts, each of which shall be considered an original and all of which together shall comprise one and the same instrument.

IN WITNESS WHEREOF the parties hereto have executed this Amendment on the dates set forth beneath each party's signature below and effective as of the Effective Date.

LANDLORD

CITY OF SAN FRANCISCO DOWNTOWN
PARKING CORPORATION,
a California nonprofit corporation

By: 

Name: Harold A. Hill

Its: Landlord

Date: May 1, 2008

APPROVED:

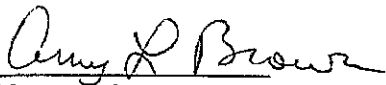
By: 
Director of Property
CITY AND COUNTY OF
SAN FRANCISCO

Date: June 30, 2008

TENANT

SPRINT SPECTRUM REALTY COMPANY, L.P.,
a Delaware limited partnership

By: 

Name: Mark J. Matt

Its: Real Estate Manager

Date: April 28, 2008

COMMENCEMENT AGREEMENT

STORE NUMBER: 1022

THIS AGREEMENT, made this 20th day of May, 2004 by and between City of San Francisco Downtown Parking Corporation, a California nonprofit corporation (herein "Landlord") and Sprint Spectrum L.P., a Delaware limited partnership (herein "Tenant").

WITNESSETH:

WHEREAS, Landlord and Tenant have entered into that certain Lease dated February 18, 2004 ("Lease") for a 1,625 square feet retail store located in the City of San Francisco, County of San Francisco, State of California, and

WHEREAS, Landlord and Tenant wish to set forth their agreements as to the commencement of the Term of the Lease.

NOW, THEREFORE, in consideration of the Premises as described in the Lease and the covenants set forth therein, Landlord and Tenant agree as follows:

- (a) The Initial Term of the Lease commenced on May 8, 2004.
- (b) The Initial Term of this Lease shall expire on May 31, 2009.
- (c) Tenant has two (2) option(s) of five (5) years which is to be exercised by the presentation of notice to Landlord by no later than one hundred eighty (180) days, prior to the expiration date.
- (d) The Rent Commencement Date under the Lease Agreement is May 8, 2004.
 - Days: 24
 - (i) Prorated Rent: \$ 4,717.74
- (e) Monthly rents payable during the first Lease Year are as follows:
 - (i) Minimum Rent: \$ 6,093.75

IN WITNESS WHEREOF, the parties hereto have executed this Agreement as of the day and year first above written.

LANDLORD:
CITY OF SAN FRANCISCO DOWNTOWN PARKING CORP.

By: *John L. Brown*
Its: Corporate Manager

TENANT:
SPRINT SPECTRUM L.P.

By: *Amy D. Murphy*
Its: Real Estate Negotiator

ARN 121810
PRN 285407

COMMENCEMENT AGREEMENT

STORE NUMBER: 1022

THIS AGREEMENT, made this 20th day of May, 2004 by and between City of San Francisco Downtown Parking Corporation, a California nonprofit corporation (herein "Landlord") and Sprint Spectrum L.P., a Delaware limited partnership (herein "Tenant").

WITNESSETH:

WHEREAS, Landlord and Tenant have entered into that certain Lease dated February 18, 2004 ("Lease") for a 1,625 square feet retail store located in the City of San Francisco, County of San Francisco, State of California, and

WHEREAS, Landlord and Tenant wish to set forth their agreements as to the commencement of the Term of the Lease.

NOW, THEREFORE, in consideration of the Premises as described in the Lease and the covenants set forth therein, Landlord and Tenant agree as follows:

- (a) The Initial Term of the Lease commenced on May 8, 2004.
- (b) The Initial Term of this Lease shall expire on May 31, 2009.
- (c) Tenant has two (2) option(s) of five (5) years which is to be exercised by the presentation of notice to Landlord by no later than one hundred eighty (180) days, prior to the expiration date.
- (d) The Rent Commencement Date under the Lease Agreement is May 8, 2004.
 - Days: 24
 - (i) Prorated Rent: \$ 4,717.74
- (e) Monthly rents payable during the first Lease Year are as follows:
 - (i) Minimum Rent: \$ 6,093.75

IN WITNESS WHEREOF, the parties hereto have executed this Agreement as of the day and year first above written.

LANDLORD:
CITY OF SAN FRANCISCO DOWNTOWN PARKING CORP.

By: John L. Brown

Its: Corporate manager

TENANT:
SPRINT SPECTRUM L.P.

By: Amy L. Murphy

Its: Real Estate Negotiator

ARN 121810
PRN 285407

SHOPS AT YERBA BUENA

LEASE

Landlord: CITY OF SAN FRANCISCO DOWNTOWN
PARKING CORPORATION, a California
nonprofit corporation

and

Tenant: SPRINT SPECTRUM, L.P.,
a Delaware limited partnership

SHOPS AT YERBA BUENA

LEASE

Table of Contents

	<u>Page</u> <u>Reference</u>
Article 1 - Premises, Term; Use and Construction of Improvements.....	4
Article 2 - Rental.....	7
Article 3 - Security Deposit	8
Article 4 - Taxes.....	8
Article 5 - Common Areas	9
Article 6 - Utility Services	13
Article 7 - Additional Construction	15
Article 8 - Subordination and Attornment	16
Article 9 - Repairs and Maintenance	17
Article 10 - Alterations	18
Article 11 - Fixtures and Personal Property.....	20
Article 12 - Laws and Ordinances	20
Article 13 - Insurance.....	21
Article 14 - Indemnification; Waiver.....	24
Article 15 - Damage and Destruction	25
Article 16 - Eminent Domain.....	27
Article 17 - Assignment and Subletting.....	27
Article 18 - Access to Premises	32
Article 19 - Defaults by Tenant	32
Article 20 - Surrender of Premises.....	35
Article 21 - Tenant's Conduct of Business	35
Article 22 - Rules and Regulations	36
Article 23 - Signage	36
Article 24 - Drug-Free Workplace.....	37
Article 25 - Attorneys' Fees.....	37
Article 26 - Transfer of Master Lease by Landlord.....	37
Article 27 - Notices	38
Article 28 - Remedies	38
Article 29 - Successors and Assigns	38
Article 30 - Representations.....	38
Article 31 - Waiver	38
Article 32 - Holding Over	39
Article 33 - Interpretation	39
Article 34 - No Right of Relocation.....	39

Article 35 - Waiver of Redemption	39
Article 36 - Fees	39
Article 37 - Lease Status	40
Article 38 - Recording	40
Article 39 - Force Majeure.....	40
Article 40 - Construction of Lease.....	41
Article 41 - Captions	41
Article 42 - Severability.....	41
Article 43 - Objection to Statements.....	41
Article 44 - Liability of Landlord	41
Article 45 - Execution of Documents	42
Article 46 - Corporate or Partnership Tenant	42
Article 47 - Entire Agreement.....	42
Article 48 - Time of Essence	42
Article 49 - Governing Law.....	43
Article 50 - Joint and Several Liability.....	43
Article 51 - No Light or Air Rights	43
Article 52 - Financial Statements.....	43
Article 53 - Survival.....	43
Article 54 - Tobacco Advertising Ban	43
Article 55 - Non-Discrimination Ordinances.....	43
Article 56 - Landlord Termination Rights.....	44
Article 57 - Charter Provisions	44
Article 58 - Communications Equipment	44

SCHEDULE 1	MASTER LEASE
SCHEDULE 2	LIST OF USE RESTRICTIONS
SCHEDULE 3	LOAD CAPACITY LETTER

EXHIBIT A	SITE PLAN OF RETAIL CENTER
EXHIBIT B	INITIAL IMPROVEMENT OF THE PREMISES
EXHIBIT B - 1	HVAC INSTALLATION AND DESIGN REQUIREMENTS
EXHIBIT B - 2	CONSTRUCTION RULES
EXHIBIT C	RULES AND REGULATIONS
EXHIBIT D	SIGNAGE LIMITATIONS

ADDENDUM TO LEASE – OPTIONS TO EXTEND TERM

SHOPS AT YERBA BUENA

LEASE

THIS LEASE ("**Lease**") is entered into by and between the landlord and tenant specified in the Basic Lease Information (hereinafter "**Landlord**" and "**Tenant**", respectively) as of the date ("**Lease Date**") specified in the Basic Lease Information.

BASIC LEASE INFORMATION

Date: This Lease is dated as of February 18, 2004, which is the date that it has been approved by the Director of Property of the City and County of San Francisco and set forth beneath his or her signature below

Landlord: City of San Francisco Downtown Parking Corporation, a California nonprofit corporation

Tenant: Sprint Spectrum, L.P., a Delaware limited partnership

Tenant's Trade Name: Sprint PCS, Sprint Communications Store or such other trade name as the original Tenant named above is then using in a majority of its retail outlets in California

Retail Center: Shops at Yerba Buena
San Francisco, California

Premises: Suite F in the Retail Center, as further described in Article 1(a) hereof

Floor Area of Premises: Approximately one thousand six hundred twenty-five (1,625) square feet

Rent Commencement Date:

The earlier of (a) the date that Tenant opens for business to the public in the Premises or (b) ninety (90) days following the date upon which both of the following have occurred: (i) this Lease has been fully executed by and delivered to the parties hereto, (ii) the Premises have been tendered to Tenant with Landlord's Work (as hereinafter defined) substantially completed such that the Premises are Ready for Occupancy (as hereinafter defined), which tender shall be made by written notice to Tenant in accordance with Article 27 hereof.

Term Commencement Date:

The Lease Date

Term Expiration Date:

The last day of the sixtieth (60th) month following the month in which the Rent Commencement Date occurs

Options to Extend:

Two (2) options to extend the Term by five (5) years each

Permitted Use:

Tenant shall use the Premises solely for the retail display and sale of wireless and wire-line communication devices, equipment, items and related accessories and services.

Annual Rental:

\$45.00 per square foot of Floor Area of the Premises per year (\$3.75 per square foot per month); subject to increase as set forth in Article 2(c)

Tenant's Cost Proportionate Share:

As determined in accordance with Articles 1(a)(iii) and 5(e) hereof

Tenant's Minimum Commercial General Liability Insurance (combined single) Limit:

Two Million Dollars (\$2,000,000.00)

Tenant's Minimum Employer's Liability Insurance Limit:

Five Hundred Thousand Dollars (\$500,000.00)

Tenant's Address for Notices:

Sprint Spectrum, L.P.
6391 Sprint Parkway
Mail Stop: KSOPHT0101-Z2000
Overland Park, KS 66251-2000
Attention: Retail Real Estate Notices,
ARN#121810

WITH COPIES TO:

Sprint Law Department
6391 Sprint Parkway
Mail Stop: KSOPHT0101-Z2020
Overland Park, KS 66251-2020
Attention: Real Estate Attorney,
ARN#121810

Landlord's Address for Notices:

City of San Francisco
Downtown Parking Corporation
833 Mission Street
San Francisco, CA 94103
Attention: Corporate Manager

AND

City of San Francisco
Downtown Parking Corporation
833 Mission Street
San Francisco, CA 94103
Attention: President

WITH COPIES TO:

Greene Radovsky Maloney & Share LLP
Four Embarcadero Center, Suite 4000
San Francisco, California 94111-4106
Attention: Laird P. Steverango

AND

Director of the Parking Authority
The City and County of San Francisco
25 Van Ness Avenue, Suite 410
San Francisco, CA 94102

AND

Real Estate Division
Office of the Director of Property
The City and County of San Francisco
25 Van Ness Avenue, Suite 400
San Francisco, CA 94102

Landlord's Address For Rental Payments:

City of San Francisco
Downtown Parking Corporation
833 Mission Street
San Francisco, CA 94103
Attn: Retail Center Manager

Landlord's Broker:

Colliers International

Tenant's Broker:

Colliers International

Security Deposit:

NONE

Advance Rent:

\$6,093.75

Interest Rate:

The lesser of (i) two percent (2%) per annum above the then-current "prime rate" or "reference rate" charged by Bank of America, or its successor, or (ii) the maximum rate permitted by applicable law.

In the event of any conflict between this Basic Lease Information and the other terms of this Lease, the other terms of this Lease shall control.

Article 1 - Premises, Term; Use and Construction of Improvements

(a) (i) Landlord leases to Tenant and Tenant leases from Landlord the premises (the "**Premises**") shown cross hatched on the site plan ("**Site Plan**") attached hereto and incorporated herein by reference as Exhibit "A", located in the Shops at Yerba Buena ("**Retail Center**") consisting of (A) certain retail spaces and storage areas ("**Tenant Spaces**") situated on the ground floor of the parking structure located in the City and County of San Francisco, California, on Mission Street between 4th Street and 5th Street (the "**Structure**"), which Tenant Spaces are outlined on the Site Plan, together with (B) the Common Areas (as hereinafter defined). The boundaries of the Premises shall consist of (1) the exterior face of exterior walls, (2) the centerline of any party walls, (3) the Structure's exterior building line with respect to the storefront and (4) the unfinished interior surface of the slab flooring and ceiling. The area contained in the Premises is set forth in the Basic Lease Information. The Site Plan is for informational purposes only, and is not a warranty, representation or agreement on the part of Landlord that the Retail Center will be exactly as indicated on such exhibit, will be continuously

occupied throughout the Term (as hereinafter defined) or that the other tenants or occupants of the Retail Center, if any, which now occupy space in the Retail Center will remain occupants of the Retail Center throughout the Term. Upon Landlord's substantial completion of its construction obligations, if any, for the Premises ("**Landlord's Work**", as more particularly described in Exhibit "B") such that the Premises are Ready for Occupancy, Tenant shall accept the Premises (including any mechanical, electrical, plumbing or fire protection systems) in an "as is" condition; provided, however, any Landlord's Work shall be performed in accordance with Exhibit B and all Requirements (as hereinafter defined) applicable to Landlord's Work. Tenant acknowledges and agrees that any portion of Landlord's Work identified in Exhibit "B" as "existing" or "as is" shall be delivered to Tenant in its "as is, where is, with all faults" condition on the Term Commencement Date and Landlord expressly disclaims any representation or warranty concerning the condition thereof including, without limitation, whether such portion of Landlord's Work complies with applicable Requirements. Notwithstanding the foregoing, Landlord shall perform that portion of Landlord's Work to be constructed or installed after the Term Commencement Date, in accordance with and as described in Sections I.B.3.a and I.B.5.c. of Exhibit "B" and in accordance with all applicable Requirements. The term "Ready for Occupancy" means that Landlord has substantially completed Landlord's Work and that such work shall be deemed complete, notwithstanding the fact that minor details of construction or mechanical adjustments which do not materially interfere with Tenant's Work (as defined in Exhibit "B") remain to be performed (items normally referred to as "punch-list" items). The Premises shall be deemed Ready for Occupancy even if certain other portions of the Retail Center have not been fully completed, provided such incomplete portions do not materially interfere with Tenant's efficient conduct of its business. Subject to the correction by Landlord of the punch-list items, Tenant shall be obligated to accept the Premises at such time as the Premises are Ready for Occupancy, so long as Landlord's Work is substantially in conformance with the provisions of Section I of Exhibit "B." It is Tenant's obligation to determine whether the Premises comply with those governmental laws and regulations applicable to Tenant's intended use of the Premises. Landlord makes no warranty as to the Premises' suitability for any particular use.

(ii) Landlord holds possession of the Premises under that certain Fifth and Mission Public Parking Garage Lease dated as of April 1, 1992, by and between The City and County of San Francisco, a California municipal corporation ("**City**"), as landlord, and Landlord, as tenant (the "**Master Lease**") a copy of which is attached hereto as Schedule 1 and incorporated herein by this reference. The leasehold of Tenant under this Lease is subject to, and Tenant shall (A) comply with and perform, all of Landlord's obligations under the Master Lease as they relate to Tenant's use of the Premises (other than the payment of rent or other charges payable by Landlord thereunder or any Landlord repairs or maintenance obligations as set forth herein) and (B) not perform, or caused to be performed, any act in violation of the Master Lease. Notwithstanding the foregoing, if any provision of this Lease is inconsistent with any provision of the Master Lease as it relates solely to the Premises (other than rents owed or Tenant's obligations pursuant to the terms hereof), the Master Lease shall control.

(iii) As soon as practicable after the execution of this Lease and substantial completion of Landlord's Work hereunder, Landlord shall cause its space analyst to compute the Floor Area of the Premises and shall inform Tenant of the Floor Area of the Premises as well as the calculated amounts for the Annual Rental and Tenant's Cost Proportionate Share by a supplemental instrument memorializing such matters. The term "**Floor Area**" shall mean (1) with respect to the Premises or any other portion of the Retail Center, the actual number of gross leasable square feet of floor space within the exterior face of exterior walls (except party walls, in which case the center thereof shall be used and except with respect to all storefronts, as to which the Structure's exterior building line shall be used) and (2) with respect to the Structure, the actual number of gross square feet of floor space within the exterior building line. No deductions shall be made from "Floor Area" computed under the foregoing definition by reasons of interior walls, columns, stairs, escalators, elevators, conveyors or other interior construction or equipment. The term "Floor Area" shall not include:

- (A) Parapets;
- (B) Surface finishes of and/or architectural ornamentation applied to exterior walls;
- (C) Canopy overhangs;
- (D) Utility and/or mechanical equipment vaults, rooms or areas
- (E) Any service delivery facilities, including docks and/or canopies, located outside of exterior walls;
- (F) Exterior stairways and ramps;
- (G) Floor space of any structures used exclusively for the maintenance of the Common Areas; and
- (H) Floor space occupied by any truck tunnels and ramps, or truck loading and unloading, truck parking or truck turnaround facilities.

Landlord's space analyst's computation of the Floor Area of the Premises shall be binding on Tenant.

(b) This lease shall be effective upon execution and the term of this Lease (the "**Term**") shall commence upon the Term Commencement Date set forth in the Basic Lease Information and shall end on the Term Expiration Date specified in the Basic Lease Information, unless extended or sooner terminated as set forth herein. As soon as the Rent Commencement Date has been determined, the parties shall execute a supplemental instrument memorializing the Term Commencement Date, the Rent Commencement Date and the Term Expiration Date.

(c) The Premises shall be used and occupied only for the Permitted Use and under the trade name specified in the Basic Lease Information and for no other purpose and under no other trade name whatsoever. Under no circumstances whatsoever shall the Premises be used in

contravention of the "List of Use Restrictions" attached hereto as Schedule 2, which list may be amended from time to time in Landlord's sole and absolute discretion.

(d) The Premises shall be improved in accordance with the provisions of Exhibit "B".

Article 2 - Rental

(a) Commencing on the Rent Commencement Date, but subject to the provisions of Article 2(d) below, Tenant shall pay as rental for the use and occupancy of the Premises, at the times and in the manner hereinafter provided, without deduction or set-off of any kind, the Annual Rental as set forth in the Basic Lease Information and as subsequently adjusted pursuant to this Article 2. The Annual Rental shall be payable in twelve (12) equal monthly installments, in advance, upon the first day of each month during the Term, commencing on the Rent Commencement Date. If the Rent Commencement Date is a day other than the first day of a month, then the monthly installment of the Annual Rental and all other rents payable by Tenant for the period from the Rent Commencement Date until the first day of the month next following shall be prorated, at the rate of one-thirtieth (1/30th) of such monthly installment per day, and paid on the Rent Commencement Date. All rentals and other sums due hereunder shall be paid or mailed to Landlord's address for rental payments set forth in the Basic Lease Information or to such other payee or address as Landlord may designate, in writing, to Tenant. No rental or other sums due hereunder shall be deemed paid until actually received by Landlord.

(b) Within fifteen (15) days of receipt by Tenant of a fully-executed counterpart of this Lease, Tenant shall pay to Landlord the sum specified in the Basic Lease Information as "**Advance Rent**". The Advance Rent shall be applied to Tenant's obligation to pay the Annual Rental for the first month or months for which the Annual Rental is due.

(c) The Annual Rental shall increase on the first day of the twelfth (12th) calendar month following the Rent Commencement Date ("**First Increase Date**") and on each anniversary of the First Increase Date during the Term, including any Option Term (as hereinafter defined) (each, including the First Increase Date, an "**Increase Date**"), which increase shall be in the amount of two and one-half percent (2.5%) of the Annual Rental in effect immediately preceding each such Increase Date; provided, however, that the Annual Rental upon the commencement of any Option Term shall be determined in accordance with the terms of the "Addendum to Shops at Yerba Buena Lease - Options to Extend Term" attached hereto.

(d) Notwithstanding any provision to the contrary in this Article 2, Tenant shall be entitled to a credit against the Annual Rental payable hereunder, provided that no Event of Default (as hereinafter defined) has occurred and is continuing hereunder on any date that such credit is to be applied as hereinafter set forth, which credit shall be in the aggregate amount of the product of (x) the number of square feet of Floor Area of the Premises and (y) Twenty-Eight Dollars (\$28.00) (the "**Rent Credit**"). Subject to the provisions of this Article 2(d), a portion of the Rent Credit in an amount equal to twenty-five percent (25%) of the Rent Credit (each such portion the "**Annual Credit**"), shall be applied against Tenant's obligation to pay installments of Annual Rental hereunder as follows: (i) the first Annual Credit shall be applied, following the application of the Advance Rent pursuant to Article 2(b) above, against those monthly

installments of Annual Rental first accruing after the Rent Commencement Date, prorated, as applicable, for any partial monthly installment of Annual Rental, and (ii) each of the second, third and fourth Annual Credits shall be applied ratably against the first two (2) monthly installments of Annual Rental due on and first following, respectively, the First Increase Date and each of the two next following Increase Dates. If an Event of Default has occurred and is continuing on any of the foregoing dates for application of any portion of the Rent Credit, then Tenant shall not be entitled to apply the otherwise applicable portion of the Rent Credit then or at any time thereafter during the Term. If this Lease is terminated by Landlord pursuant to Article 19 hereof prior to the application of the entire Rent Credit, then Tenant shall not be entitled to any portion of the Rent Credit that would have been available after the date of termination, nor shall Tenant be entitled to assert any right to such portion of Rent Credit which would have accrued after such termination against any sums due Landlord. The Rent Credit granted under this Article 2(d) is solely for the benefit of SPRINT SPECTRUM, L.P. and shall not be transferable to any assignee or subtenant other than a parent, subsidiary or affiliate of SPRINT SPECTRUM, L.P.

Article 3 - Security Deposit

[INTENTIONALLY OMITTED]

Article 4 - Taxes

(a) Tenant recognizes and understands that this Lease may create a possessory interest subject to property taxation and that Tenant may be subject to the payment of property taxes levied on such interest.

(b) Tenant agrees to pay taxes of any kind, including any possessory interest taxes, that may be lawfully assessed on the leasehold interest hereby created and to pay all other taxes, excises, licenses, permit charges and assessments based on Tenant's usage of the Premises that may be imposed upon Tenant by law, all of which shall be paid when the same become due and payable and before delinquency.

(c) Tenant agrees not to allow or suffer a lien for any such taxes to be imposed upon the Premises, the Retail Center, the Structure or upon any equipment or property located thereon without promptly discharging the same, provided that Tenant, if so desiring, may have reasonable opportunity to contest the validity of the same provided Tenant gives prior written notice of such contest to Landlord.

(d) San Francisco Administrative Code Sections 23.38 and 23.39 require City to report certain information relating to this Lease, and any renewals thereof, to the San Francisco County Assessor ("**Assessor**") within sixty (60) days after any such transaction, and that Tenant report certain information relating to any assignment of, or sublease under, this Lease to Assessor within sixty (60) days after such assignment or sublease transaction. Tenant agrees to provide, within thirty (30) days of receipt of a request therefor, such information as may be reasonably requested by Landlord to enable Landlord and City to comply with the foregoing reporting requirement, and any information required under the applicable Administrative Code Sections shall be deemed reasonable.

(e) Tenant shall pay before delinquency all taxes or other impositions levied or assessed upon its trade fixtures, improvements, merchandise, furniture, equipment and other personal property in, on or upon the Premises prior to delinquency, and shall deliver satisfactory evidence of such payment to Landlord upon Landlord's request. If any such items of property are assessed with property of Landlord, then such assessment shall be equitably divided by Landlord in good faith so that Tenant pays Tenant's equitable portion of such assessment.

Article 5 - Common Areas

(a) The "**Common Areas**" shall consist of all sidewalks, canopies, washrooms, and other facilities available for joint use, on a non-exclusive basis with patrons of the Structure, to all the tenants in the Retail Center, their employees, agents, customers, licensees and invitees, including, without limitation, any trash enclosure area in the Structure designated by Landlord for use in collecting, sorting, compacting and/or disposing of trash generated by Retail Center tenants, all as they may from time to time exist and be available; provided, however, that the "Common Areas" shall not include (i) any parking areas or traffic lanes within the Structure, (ii) any portion of the Structure adjacent to the Retail Center but used exclusively in connection with Landlord's operation of such parking areas including, without limitation, parking entrances and exits, pay station lobbies and related display cases, or (iii) any other portion of the Structure exclusive of the Retail Center ((i), (ii) and (iii) collectively, the "**Excluded Areas**").

(b) Subject to the provisions of this Article 5, Landlord grants to Tenant, its subtenants, licensees, concessionaires, suppliers, business invitees, customers, agents, representatives and employees, but only during the Term, the non-exclusive right, but not an easement, in common with others duly authorized by Landlord, to use the Common Areas as they exist from time to time and the various portions thereof, respectively, for the uses and purposes permitted by Landlord. It shall be the duty of Tenant to keep the Common Areas free and clear of any obstructions, barricades or barriers placed or created by Tenant or resulting from Tenant's operations or use of the Premises.

(c) The Common Areas shall be subject to the exclusive management and control of Landlord. Landlord shall have the right from time to time to designate, relocate and limit the use of particular areas or portions of the Common Areas, to add to and delete areas therefrom and to establish, promulgate and enforce such reasonable and non-discriminatory rules and regulations concerning the Common Areas as it may reasonably deem necessary or advisable for the proper and efficient management, operation, maintenance and use thereof, and Tenant shall comply with the same. Landlord shall have the right to close temporarily all or any portion of the Common Areas to such extent as may, in the sole discretion of Landlord, be necessary to prevent a dedication thereof or the accrual of any rights in any person.

(d) As used in this Lease, the term "**Common Area Costs**" means the total actual cost of all items of expense relating to operating, owning, managing, equipping, policing and protecting, lighting, repairing, replacing and maintaining the Retail Center. Any such costs and expenses incurred by Landlord for the Structure as a whole shall be equitably allocated by Landlord between the Excluded Areas and the Retail Center in Landlord's good faith judgment. Such Common Area Costs shall include, but not be limited to:

(i) Management fees, wages, salaries and other compensation and benefits, as well as any adjustment thereto, for employees, independent contractors and agents of Landlord performing work or furnishing services to or in connection with the operation of the Retail Center, but excluding compensation for any employees located off-site or not involved in the day-to-day management of the Retail Center.

(ii) Costs of operating, cleaning, sweeping and maintaining sidewalks; maintaining and replanting planter boxes and landscaping; repairing and replacing landscape sprinkler systems, directional signs and other signs and markers, fire protection systems, lights and light standards (including bulb replacement), drainage systems and utility systems which do not exclusively serve a particular tenant; janitorial services; operating and maintaining Retail Center signs including, without limitation, the canopy and/or storefront sign for the Premises; operating, maintaining and repairing any public address system and any security and/or alarm system which does not exclusively serve a particular tenant, including, without limitation, the expenses attributable to the hiring of any security personnel for the Retail Center; and any pest extermination services for the Common Areas.

(iii) Costs of repainting, replacing, maintaining and repairing any mechanical, plumbing, electrical, sprinkler systems, ceilings, floors, walls, lighting, fixtures and equipment servicing or located in the Common Areas.

(iv) Charges for electricity, water, sewer, telecommunication and other utility services servicing the Common Areas (not to exceed the charges of the local utility provider).

(v) Sales, use and excise taxes on goods and services to the extent purchased by Landlord for use in the operation of the Retail Center.

(vi) Subject to subsection (4) below, license, permit and inspection fees relating to the Retail Center.

(vii) Costs of purchasing or renting mechanical equipment, supplies, tools, materials, and uniforms for Retail Center personnel.

(viii) Reasonable fees and expenses for accountants or consultants retained, from time to time, if any, by Landlord for determining the allocation of various costs and expenses among tenants of the Retail Center.

(ix) Costs of any capital improvements, equipment or devices installed or paid for by Landlord to (A) conform with any applicable Requirements including, but not limited to, the Americans With Disabilities Act or (B) effect a labor saving, energy saving or other economy, amortized over the lesser of (1) ten (10) years, (2) the "pay back period" or (3) the useful life of such capital improvement, equipment or device (as reasonably determined by Landlord), as well as interest on the unamortized balance at the Interest Rate or such other rate as may have been paid by Landlord on borrowed funds. The "pay back period" shall be the period within which the anticipated savings from the

use of such capital improvement, equipment or device, as reasonably determined by Landlord, will equal the cost of the subject capital improvement, equipment or device.

(x) Depreciation or amortization of the costs of materials, tools, supplies and equipment purchased by Landlord to enable Landlord to supply services to the Retail Center which Landlord might otherwise contract for with a third party where such depreciation and amortization would otherwise have been included in the charge for such third party's services.

(xi) Costs and expenses of complying with air, water and noise quality and/or control statutes, laws, codes, rules and regulations, including, without limitation, statutes, laws, codes, rules and regulations relating to toxic substances and/or hazardous wastes.

(xii) Mass transit taxes, fees and charges, and business and/or rent taxes, fees and charges.

(xiii) Premiums, deductibles, self insurance, costs of adjustment and all other insurance costs incurred by Landlord.

Notwithstanding the foregoing, "Common Area Costs" shall not include the following, except as otherwise expressly provided in this Article 5:

(1) legal fees, brokerage fees, leasing commissions, advertising costs, promotional expenditures, architectural and engineering fees, and other similar expenses incurred in connection with the leasing of Tenant Spaces in the Retail Center;

(2) costs incurred due to a violation by Landlord of the terms and conditions of any lease with any tenant of the Retail Center or any violation by Landlord of law;

(3) legal fees, accounting fees, professional expenses and other related costs incurred in connection with disputes with tenants of the Retail Center or associated with the enforcement of the terms of any leases with such tenants (including, without limitation, unlawful detainer proceedings or proceedings for the collection of rent);

(4) costs (including permits, licensing and inspection fees) incurred in renovating or otherwise improving or altering space for tenants in the Retail Center and including such renovations to any vacant space in the Retail Center available or intended to be made available for leasing;

(5) costs related to any improvement to, or construction, alteration or repair of the Excluded Areas or any part thereof, excepting therefrom those costs incurred by Landlord in the performance of its obligations under Article 9(a) below.

(e) Effective on the Rent Commencement Date, Tenant shall pay to Landlord, upon demand, but not more often than once a month, a share of the Common Area Costs (based

on Landlord's reasonable, good faith estimates and subject to adjustment from time to time, as hereinafter provided), which share ("**Tenant's Cost Proportionate Share of Common Area Costs**") shall be equal to the product which results by multiplying (i) Common Area Costs by (ii) the percentage that the Floor Area of the Premises is of the Floor Area of all Retail Center stores constructed and available for lease in the Retail Center from time to time ("**Tenant's Cost Proportionate Share**"). Tenant's Cost Proportionate Share is subject to change from time to time proportional to changes in the aggregate Floor Area of the Retail Center.

(f) At least once a year, concurrently with the furnishing of such statement to the other tenants of the Retail Center, Landlord shall furnish to Tenant a reasonably detailed statement showing the total Common Area Costs for the calendar year just expired, the amount of Tenant's Cost Proportionate Share of Common Area Costs and payments made by Tenant during such calendar year. Landlord's failure to deliver any such statement shall not constitute a waiver of Landlord's right to later either bill Tenant for any balance due or, in lieu thereof, to subsequently adjust Tenant's Cost Proportionate Share to recoup the entire amount owed to Landlord for any particular year unless such failure shall extend beyond 365 days following the end of the applicable calendar year, in which case, any such balance due shall be waived and discharged. If Tenant's Cost Proportionate Share of Common Area Costs for such calendar year exceed Tenant's payments in accordance with Article 5(e) above, Tenant shall pay the deficiency to Landlord within twenty (20) days after receipt of such statement. If Tenant's payments in accordance with Article 5(e) above exceed Tenant's Cost Proportionate Share of Common Area Costs, as shown on such statement, Tenant shall receive a credit against rental payments next thereafter becoming due under this Lease, provided that, if the Term has expired, such excess shall promptly be refunded to Tenant.

(g) The annual determination and statement of Common Area Costs shall be made by or verified by an accounting or auditing officer of Landlord.

(h) Notwithstanding the availability of the Common Areas as they may from time to time exist and be available for the common benefit of all the tenants in the Retail Center, Landlord shall have the right to permit entertainment events and the placement of advertising and other displays in the Common Areas, which activities and uses may be of a temporary and/or permanent nature; provided, however, such activities shall not directly, materially obstruct visibility of, or directly, materially, adversely affect access to and from the Premises through, the existing storefront entrance.

(i) Notwithstanding anything to the contrary in this Article 5 or elsewhere in this Lease, Landlord shall not directly, materially obstruct visibility of, or directly, materially, adversely affect access to and from the Premises through, the existing storefront entrance. The foregoing shall not be deemed to prohibit or otherwise restrict the placement by Landlord of plantings, seating, directories, and other Retail Center amenities in the Common Areas adjacent to or in front of the Premises, provided doing so does not directly, materially obstruct visibility of, or directly, materially, adversely affect access to and from the Premises through, Tenant's existing storefront entrance. Moreover, the foregoing provisions of this paragraph shall not apply in instances where access or visibility is temporarily affected as a result of repairs, remodeling, renovation or other construction.

(j) Notwithstanding any contrary provision of this Lease, if Tenant is prevented from using for the conduct of its business, and does not use for the conduct of its business, the Premises or any material portion thereof, for seven (7) consecutive business days (the “**Eligibility Period**”) as a result of (i) any construction, repair, maintenance or alteration performed by Landlord after the Rent Commencement Date and not necessitated by the negligence or willful misconduct of any Tenant Party (as hereinafter defined), or (ii) the failure in any material respect of Landlord or its agents or contractors to provide to the Premises any of the utilities and services required to be provided under this Lease (including Article 6(a) below) and not caused by the negligence or willful misconduct of any Tenant Party or otherwise due to the occurrence of a casualty or condemnation or Unavoidable Delays (as hereinafter defined), (iii) any failure to provide access to the Premises and not caused by the negligence or willful misconduct of any Tenant Party or otherwise due to the occurrence of a casualty or condemnation or Unavoidable Delays, or (iv) because of the presence of hazardous materials or substances in, on or around the Retail Center, the Common Areas, the Structure, the Premises or the real property on which such improvements are located (the “**Real Property**”), which were not caused or introduced by any Tenant Party and which hazardous materials or substances pose a significant health risk to occupants of the Premises, then, in any and all such events, Tenant’s obligation to pay Annual Rental, Tenant’s Cost Proportionate Share of Common Area Costs and taxes shall be abated or reduced, as the case may be, from and after the first day following the last day of the Eligibility Period and continuing for such time that Tenant continues to be so prevented from using for the conduct of its business, and does not so use for the conduct of its business, the Premises or a material portion thereof, in the proportion that the Floor Area of the portion of the Premises that Tenant is prevented from using, and does not so use, bears to the total Floor Area of the Premises. The term “**Tenant Party**” shall mean Tenant and any subtenants or occupants of the Premises and their respective agents, contractors, subcontractors, employees, invitees or licensees. The term “**Unavoidable Delays**” shall mean Landlord’s inability to fulfill or delay in fulfilling any of its obligations under this Lease expressly or impliedly to be performed by Landlord or Landlord’s inability to make or delay in making any repairs, additions, alterations, improvements or decorations or Landlord’s inability to supply or delay in supplying any equipment or fixtures, if Landlord’s inability or delay is due to or arises by reason of strikes, labor troubles or by accident, or by any cause whatsoever beyond Landlord’s reasonable control, including governmental preemption in connection with a national emergency, Requirements or shortages, or unavailability of labor, fuel, steam, water, electricity or materials, or delays caused by Tenant or other tenants, mechanical breakdown, acts of God, enemy action, civil commotion, fire or other casualty.

Article 6 - Utility Services

(a) Tenant, at its sole cost, shall arrange for, and contract directly with, the applicable utility service provider to deliver any and all gas, telecommunications, telephone and all other utilities except for electricity and, except as otherwise provided in this Article 6(a), water (including sewer) required by Tenant for its use in the Premises. If Tenant desires water service for the Premises, then Tenant shall, at its sole cost and expense and in accordance with the provisions of Exhibit “B” either (i) connect to the existing one inch (1”) domestic water supply line located under the Premises (“**Structure Water Line**”) or (ii) if Tenant desires domestic water service through a supply line exceeding a one inch (1”) diameter, contract directly with the applicable utility service provider. If Tenant desires to connect to the Structure

Water Line in accordance with clause (i) of the preceding sentence, then Tenant shall notify Landlord in writing of such election concurrently with Tenant's delivery to Landlord of Tenant's executed counterparts of this Lease. In such event Landlord shall install, at Landlord's cost and expense as part of Landlord's Work, a submeter for such water service (the "**Water Submeter**"). Tenant shall maintain any such Water Submeter in good operating condition at Tenant's sole cost and expense. All water utility service provided to the Retail Center through the Structure Water Line shall be contracted for by Landlord. The cost for all water consumed on the Premises (including related sewer charges) as measured by such Water Submeter, if any, shall be billed to Tenant periodically by Landlord, consistent with the periodicity of billings received by Landlord from the applicable utility provider, and Tenant shall pay all such costs as additional rental hereunder within ten (10) days of the date of Landlord's invoice therefor, provided Tenant's charge shall not exceed the charge that would have been assessed had such charge been billed by the applicable utility provider directly to Tenant. For electrical service, Tenant, at its sole cost, shall arrange for, and contract directly with, the San Francisco Public Utilities Commission (the "**PUC**") including, without limitation, arranging with the PUC for the installation of a meter or meters for electrical service to the Premises in accordance with Exhibit "B".

(b) Subject to the provisions of Article 9(a) concerning Landlord's repair obligations concerning such utility lines, Landlord shall not be liable to Tenant in damages or otherwise, if utilities are interrupted or terminated because of Landlord's repairs, installations or improvements to the Common Areas, or any other cause whatsoever except for Landlord's intentional interruption or termination of utilities other than in connection with any such repairs, installations or improvements, nor shall any such interruption or termination relieve Tenant of the performance of any of its obligations hereunder or be construed as a constructive or actual eviction of Tenant from the Premises. No such interruption or termination shall entitle Tenant to terminate this Lease or stop making any rental, additional rental, or other payments due hereunder, except as otherwise specifically provided in Article 5(j) hereof.

(c) If any governmental entity promulgates or revises any statute, ordinance or building, fire or other code, or imposes mandatory controls or guidelines on Landlord or the Retail Center or any part thereof, relating to the use or conservation of energy, water, light, telecommunications services or electricity or the provision of any other utility or service provided with respect to this Lease, or if Landlord is required to make alterations to the Retail Center in order to comply with such mandatory controls or guidelines, Landlord shall comply with such mandatory controls or guidelines, or make such alterations to the Retail Center. Neither such compliance nor the making of such alterations shall in any event entitle Tenant to any damages, relieve Tenant of the obligation to pay any of the sums due hereunder, or constitute or be construed as a constructive or other eviction of Tenant.

(d) Tenant shall, on a periodic basis and no less frequently than reasonably required by Landlord from time to time, remove all trash and garbage from the Premises and deposit same in the trash compactor for the Retail Center (the "**Compactor**") located in the trash enclosure area (the "**Trash Enclosure**") on the Minna Street side of the Structure. Tenant shall also (i) separate all recyclable materials for collection as required by local ordinances or the trash collection contractor servicing the Retail Center and (ii) deposit such recyclable materials in the Trash Enclosure. Landlord shall contract for the regular removal of trash from the Compactor

and of recyclable materials from the Trash Enclosure, and shall bill Tenant monthly for Tenant's share of the cost of trash compaction and such removal, which share shall be (x) determined by Landlord, in Landlord's good faith judgment, based on Tenant's use of the Compactor through the current key card system that permits Tenant to use the Compactor or (y) as equitably determined by Landlord, in Landlord's good faith judgment, based on Tenant's use of the Compactor should such key card system no longer be in use, which determination shall be binding on Tenant, and Tenant shall pay all sums invoiced within twenty (20) days. Tenant shall ensure that (A) all of non-recyclable portion of its trash is deposited in the Compactor and not strewn on the ground adjacent thereto, (B) the recyclable portion of its trash is deposited in any applicable recycling bins located in the Enclosure Area or otherwise in the manner designated by Landlord from time to time and (C) the Compactor is operated by Tenant in the manner designated by Landlord from time to time.

Article 7 - Additional Construction

Subject to the terms of Article 5(j) hereof, Landlord shall have the right, at all times and from time to time throughout the Term, to:

- (i) alter the boundaries, change the area, size, level, location and/or arrangement of the Retail Center or any part thereof other than the Premises, including, without limitation, the Common Areas;
- (ii) construct other structures or improvements in the Common Areas (including, without limitation, kiosks), other portions of the Retail Center, and in the Structure and make alterations and additions thereto, or re-arrangements thereof, demolish parts thereof and/or construct additional buildings or facilities adjoining or proximate to the Retail Center;
- (iii) make changes and additions to the pipes, conduits and ducts or other structural and nonstructural installations in the Premises where desirable to serve the Common Areas, other premises in the Retail Center, or the Structure or to facilitate expansion or alteration of the Retail Center and/or the Structure (including, without limitation, the construction and erection of columns and support facilities; provided, however, the Floor Area of the Premises shall be remeasured by Landlord accordingly and an amendment to this Lease memorializing such change shall be entered into by Landlord and Tenant), but shall not unreasonably interfere with the use and enjoyment of the Premises beyond the extent necessarily incidental to such changes, additions and installations, and shall promptly repair any damage to the Premises arising in the course of such changes and additions;
- (iv) add additional real property to the Retail Center and/or Structure or remove real property therefrom;
- (v) temporarily obstruct or close off the Common Areas or any parts thereof for purpose of maintenance, repair, construction or expansion of the Retail Center and/or Structure; and
- (vi) grant easements in, on or across the Retail Center.

Article 8 - Subordination and Attornment

(a) This Lease shall be subject to and subordinated at all times to: (i) all ground or underlying leases which are now or may hereafter be executed affecting the Retail Center and/or the Structure (including, without limitation, the Master Lease), and (ii) the lien of all mortgages, deeds of trust and public financing indentures in any amount or amounts whatsoever now or hereafter placed on or against all or a portion of the Structure and/or the Retail Center or Landlord's interest or estate therein including, without limitation, that certain Indenture dated as of February 1, 1993, by and between Landlord and Bank of America National Trust and Savings Association, Trustee, as amended, respecting City of San Francisco Downtown Parking Corporation Parking Revenue Bonds, including \$15,800,000 Series 1993 Bonds (any, a **"Lender's Lien"**), all without the necessity of having further instruments executed on the part of Tenant to effectuate such subordination. Notwithstanding the foregoing, in the event of a (1) foreclosure of any Lender's Lien or of any other action or proceeding for the enforcement thereof, or of any sale thereunder, and if such Lender's Lien so provides, or (2) termination of the Master Lease, however such termination is caused, this Lease shall not be barred, terminated, cut off or foreclosed, nor shall the rights and possession of Tenant hereunder be disturbed if there is no Event of Default hereunder or any circumstances which, with the passage of time, would constitute an Event of Default hereunder but for Landlord's inability as result of applicable law to send a notice to Tenant respecting such default, and Tenant shall attorn to, as applicable, the purchaser at such foreclosure sale or other action or proceeding, or City, or, if requested by any such purchaser or City, enter into a new lease with such purchaser or City, as applicable, for the balance of the Term then remaining, upon the same terms and provisions as are contained in this Lease modified, with respect to any such attornment to City, to include any additional provisions required by City, in its sole discretion, to reflect City policies relating to City-owned property. Promptly following any such attornment to City, Tenant and Landlord shall execute an amendment to this Lease incorporating any such additional provisions into this Lease. Tenant shall execute and deliver within ten (10) days after demand such further documents or instruments evidencing the subordination of this Lease to such ground or underlying leases and to any such Lender's Lien as may reasonably be required by Landlord or by any lender or ground lessor. Except with respect to City, upon written request by Tenant, Landlord shall exercise commercially reasonable efforts to obtain from any ground lessor under a ground lease, mortgagee under a mortgage, or beneficiary under a deed of trust affecting the Retail Center a nondisturbance agreement in favor of Tenant on such ground lessor's, mortgagee's or beneficiary's commercially reasonable form, provided, Landlord's failure to obtain any such nondisturbance agreement shall not constitute a condition to the effectiveness of this Lease, nor a default hereunder, nor shall such failure relieve Tenant of the obligation to fully and timely perform its obligations hereunder. Tenant acknowledges that, if City's Director of Property approves this Lease in accordance with Article 56 below, which approval will be evidenced, if at all, by his/her signature below, such approval shall constitute City's agreement to be bound by the foregoing nondisturbance provision.

(b) Notwithstanding anything to the contrary set forth above, any beneficiary under any deed of trust or mortgagee under any mortgage may at any time subordinate its deed of trust or mortgage to this Lease in whole or in part, without any need to obtain Tenant's consent, by execution of a written document subordinating such deed of trust or mortgage to this Lease to the extent set forth in such document and thereupon this Lease shall be deemed prior to

such deed of trust or mortgage to the extent set forth in such document without regard to their respective dates of execution, delivery and/or recording. In that event, to the extent set forth in such document, the beneficiary under such deed of trust or the mortgagee under such mortgage shall have the same rights with respect to this Lease as would have existed if this Lease had been executed and a memorandum thereof recorded prior to the execution, delivery and recording of such deed of trust or mortgage.

Article 9 - Repairs and Maintenance

(a) Except as set forth in Article 9(b) below, Landlord shall repair and maintain the foundations, common utility lines and/or sprinkler mains, if any, and structural portions of the Retail Center, but Landlord shall not be liable to Tenant for any damage caused by the same being or becoming in need of repair or maintenance until Landlord has had a reasonable opportunity to repair the same after being notified of the need for such repair. Reimbursement of the cost of such work shall be governed by the provisions of Article 5.

(b) Tenant shall, at all times to Landlord's reasonable satisfaction and at Tenant's expense, keep all parts of the Premises, other than those to be repaired and/or maintained by Landlord, including, as applicable, Tenant's heating, ventilation and cooling ("HVAC") equipment, utility lines within the Premises and exclusively serving the Premises, and all equipment, fixtures, floor coverings and plate glass in good order and repair and in a clean, sanitary and safe condition and in accordance with all applicable laws, ordinances, orders, rules, regulations and requirements of (i) federal, state, county, municipal and other governmental or quasi-governmental agencies having or claiming jurisdiction over the Premises or the Real Property; (ii) the insurance underwriting board or insurance inspection bureau having or claiming jurisdiction; and (iii) all insurance companies insuring all or any part of the Premises or improvements or both ((i), (ii) and (iii), collectively, "**Requirements**"). Tenant shall, at Tenant's expense, maintain a contract for the regular repair and maintenance of the HVAC system with a contractor approved by Landlord in writing, such approval not to be unreasonably withheld.

(c) If Tenant refuses or neglects to make repairs and/or maintain the Premises, or any part thereof, in a first class condition (including, without limitation, any failure by Tenant to keep the Premises free of vermin or any other pests), Landlord shall have the right to make such repairs or perform such maintenance on behalf of or for the account of Tenant (i) immediately, in the event of an emergency or (ii) upon ten (10) days' written notice of its election to do so, in non-emergency circumstances, if Tenant does not commence to make such repairs and/or perform such maintenance during such ten- (10-) day period, or if Tenant after commencing same fails to diligently prosecute the same to completion. In any such event, the direct, actual cost of such work together with any incremental property management costs actually incurred by Landlord (not to exceed five percent (5%) of the cost of such work) shall be paid for by Tenant as additional rental within twenty (20) days of receipt of an invoice therefor. In addition, subject to any applicable waiver of subrogation provision contained in this Lease, Tenant shall reimburse Landlord, within twenty (20) days after receipt of invoice therefor, for the cost of any and all mechanical system, telecommunications facilities and/or structural repairs or replacements necessitated or occasioned by the acts, omissions or negligence of Tenant or any person claiming through or under Tenant, or any of its servants, employees, contractors, agents, visitors or

licensees, or by the use or occupancy or manner of use or occupancy of the Premises by Tenant or any such person. Any sums due Landlord which are not paid within twenty (20) days following receipt by Tenant of an invoice therefor shall bear interest at the Interest Rate from the date of the invoice until paid. Landlord shall not be liable for, and, subject to the terms of Article 5(j) hereof, there shall be no abatement of rent on account of, any interference with Tenant's business arising from any repairs, maintenance, alteration or improvement in or to any portion of the Premises, Common Areas, Retail Center and/or the Structure or in or to the fixtures, appurtenances or equipment therein.

(d) Tenant hereby expressly waives the right to make repairs at Landlord's expense as provided for in section 1942 of the California Civil Code, any amendment thereof or any law of similar import that may hereafter be enacted.

Article 10 - Alterations

(a) Except for incidental nonstructural Alterations which in the aggregate cost less than \$20,000 per calendar year and which are not readily visible from the Common Areas or the exterior of the Premises ("**Decorative Alterations**"), Tenant shall not make any alterations, modifications or improvements to the Premises (collectively, "**Alterations**") without the prior written consent of Landlord, which consent (i) may be withheld in Landlord's sole discretion for Alterations affecting any electrical, other utility, fire protection, life safety or other mechanical systems, telecommunications facilities or the structural integrity of the Retail Center and/or the Structure or the Premises storefront (collectively, "**Structural Alterations**"), but (ii) shall not be unreasonably withheld for any other Alterations. Subject to Landlord's right to require their removal as hereinafter provided in this Article 10(a), all Alterations and any improvements to the Premises comprising Tenant's Work (collectively, "**Improvements**") shall become the property of Landlord and shall be surrendered with the Premises upon the expiration or sooner termination of the Term. Unless otherwise agreed in writing, Landlord may require that any or all Improvements be removed by Tenant, at Tenant's expense, by the expiration or sooner termination of the Term, notwithstanding Landlord's consent to their installation; provided, however, at the time Landlord consents to any Alterations in accordance with the terms of this Article 10, Landlord shall inform Tenant which portions of such Alterations, if any, Landlord shall require be removed by Tenant, as provided above. Landlord may require Tenant to remove, at Tenant's expense and at any time, all or any part of the Improvements made without Landlord's consent required hereunder, if such consent is required hereunder. When applying for Landlord's consent, Tenant shall furnish complete plans and specifications for the desired Alterations. Prior to commencement of construction of the Alterations, Tenant shall deliver to Landlord any required building permit and other governmental authorization covering the Alterations. All Alterations shall be made by Tenant at Tenant's sole cost and expense. Tenant shall give Landlord at least ten (10) days' notice prior to commencing any Alterations to allow Landlord time to post a Notice of Non-Responsibility.

(b) Tenant shall require its contractor to maintain insurance in amounts and in such form as Landlord may reasonably require. Landlord and its property manager shall be named as additional insureds in the required policies. Any and all of the Improvements shall be completed in accordance with the applicable plans and specifications approved by Landlord, other than de minimis variances therefrom, shall be carried out in a good, workmanlike and

prompt manner, shall comply with all applicable Requirements, and shall be subject to monitoring and inspection by Landlord or its employees, agents or contractors. With respect to any Structural Alterations Tenant shall reimburse Landlord upon demand for all reasonable, actual, out-of-pocket costs incurred by Landlord in connection with the review and approval of the proposed Structural Alterations and for all costs incurred in monitoring construction of such Structural Alterations. Tenant shall not use any portion of the Common Areas or of the Excluded Areas in connection with the making of any Alterations, nor shall Tenant store any materials in such areas.

(c) If any Alterations which Tenant desires to construct would result in Landlord being required to make any alterations and/or improvements to other portions of the Retail Center and/or the Structure in order to comply with any applicable Requirements (including, without limitation, ordinances intended to provide full access to handicapped persons), then Tenant shall be precluded from making such Alterations unless Tenant agrees in writing to pay for all of Landlord's actual, reasonable costs (the "**Related Costs**") for such related alterations and/or improvements, including, without limitation, architectural, permitting, construction and construction management costs. Landlord's consent to any such Alterations shall be conditioned upon receipt of Tenant's advance payment in the amount of one hundred percent (100%) of the total estimated Related Costs. In the event of any subsequent increase in such estimate including, without limitation, as a result of any change orders reasonably requested by Landlord, Tenant shall pay to Landlord upon demand and receipt of an invoice therefor, one hundred percent (100%) of the amount of such increase. The balance, if any, of the actual Related Costs over such prior advance payment(s) received by Landlord from Tenant, shall be payable by Tenant as additional rental within twenty (20) days following receipt of Landlord's invoice therefor.

(d) Should construction of any Alterations by Tenant interfere with the harmonious labor relations in existence in the Retail Center, all such work shall be halted immediately by Tenant until such time as construction can proceed without any such interference.

(e) Tenant shall pay promptly for any work done by Tenant (or material furnished therefor) in, on or about the Premises. Tenant shall promptly give Landlord written notice of the recording of any lien against the Premises and/or the Retail Center or Structure in connection with any work done by or at the direction of Tenant. Tenant shall, within ten (10) business days after becoming aware of the filing of any lien against the Premises, cause the same to be discharged of record by payment, deposit, or bond in the amount required by a court of competent jurisdiction. If Tenant fails to cause such lien to be so discharged, then Landlord, in addition to any other rights or remedies, may, but shall not be obligated to, upon five (5) days' notice to Tenant, discharge the same by paying the amount claimed to be due or by procuring the discharge of such lien by deposit or by bonding proceedings and in any such event, Landlord shall be entitled, if Landlord so elects, to defend any such prosecution of an action for foreclosure of such lien by the lienor and to pay the amount of any judgment in favor of such lienor (plus interest, costs and allowances). Any amount paid by Landlord together with interest thereon at the Interest Rate and all costs and expenses, including reasonable attorneys' fees incurred by Landlord in connection therewith, shall be paid by Tenant to Landlord on demand.

Tenant's obligation to observe and perform any of the provisions of this Article 10 shall survive the expiration of the Term or the earlier termination of this Lease.

Article 11 - Fixtures and Personal Property

Any trade fixtures, signs and other personal property of Tenant shall remain the property of Tenant, and Tenant shall have the right, at any time, and from time to time, to remove any and all of its trade fixtures, signs and other personal property which it may have stored or installed in the Premises, including but not limited to counters, shelving, showcases, mirrors and other movable personal property. Tenant at its expense shall immediately repair any damage caused to the Premises by reason of the removal of any such trade fixtures, signs, and other personal property.

Article 12 - Laws and Ordinances

(a) Tenant shall comply with all laws, ordinances, orders and regulations affecting Tenant's use and occupancy of the Premises in accordance with the Permitted Use hereunder and the cleanliness, safety and operation thereof. Tenant shall comply with the regulations and requirements of any insurance underwriter, inspection bureau or similar agency with respect to such use of the Premises. Tenant shall permit Landlord to comply with such recommendations and requirements to the extent compliance is Landlord's obligation hereunder or pursuant to the subject recommendation or requirement.

(b) Tenant shall not: (i) permit any immoral, improper or objectionable practice to occur or be committed on the Premises; (ii) make use of or allow the Premises to be used for any purposes other than those permitted under Article 1 hereof or that might invalidate or increase the rate of insurance therefor; (iii) keep, use, or permit to be kept or used, on the Premises any flammable fluids, toxic or hazardous materials (other than reasonable amounts of such materials necessary for the operation of Tenant's business in the Premises) or explosives without the prior written permission of Landlord or engage in hazardous activities; (iv) use the Premises for any purpose whatsoever which creates a nuisance or interferes with the rights of other tenants of the Retail Center or with Landlord's operation and use of the Structure; (v) deface or injure the Structure or the Premises; (vi) commit or suffer any waste; or (vii) install any electrical equipment that overloads utility lines.

(c) Landlord and Tenant, as the case may be, shall comply with all laws now in force or enacted during the Term relating to the presence of asbestos and all other hazardous materials in the Retail Center.

(d) Tenant shall not cause or permit the escape, disposal or release of any biologically or chemically active or other hazardous substances or materials. Tenant shall not allow the storage or use of such substances or materials in any manner not sanctioned by law or by the highest standards prevailing in the industry for the storage and use of such substances or materials, nor allow to be brought into the Retail Center or the Structure any such materials or substances except to use in the ordinary course of Tenant's business, and then only after written notice is given to Landlord of the identity of such substances or materials. Without limitation, hazardous substances and materials shall include those described in the Comprehensive

Environmental Response, Compensation and Liability Act of 1980, as amended, 42 U.S.C. Section 9601 et seq., the Resource Conservation and Recovery Act, as amended 42 U.S.C. Section 6901 et seq., any applicable state or local laws and the regulations adopted under these acts. If any lender or governmental agency requires testing to ascertain whether there has been any release of hazardous materials and such hazardous material is discovered and determined to be caused by Tenant, any subtenant of Tenant, or their respective agents, employees or contractors, then the reasonable costs thereof shall be reimbursed by Tenant to Landlord upon demand as additional charges if such requirement applies to the Premises. In addition Tenant shall execute affidavits, representations and the like from time to time at Landlord's reasonable request concerning Tenant's actual knowledge and belief regarding the presence of hazardous substances or materials on the Premises. In all events, except to the extent due to the acts of Landlord, its agents, employees or contractors, Tenant shall indemnify, defend and hold Landlord harmless, in the manner provided in Article 14(a) hereof, from any release of hazardous materials on the Premises occurring while Tenant is in possession that is caused by Tenant, any subtenant of tenant or their respective agents, employees, contractors, licensees or invitees, or elsewhere if caused by Tenant or persons acting under Tenant. The covenants contained herein shall survive the expiration or earlier termination of this Lease.

Article 13 - Insurance

(a) Landlord shall maintain, or cause to be maintained, during the Term the insurance, if any, required by Section 16.1 of the Master Lease. Landlord may, at its election, also maintain all risk and extended coverage, business income, vandalism and malicious mischief and such other insurance as Landlord may elect (including, without limitation, earthquake and flood insurance if Landlord deems it prudent or desirable to maintain such insurance) insuring the improvements located on Landlord's property in the Retail Center, including the Premises and all appurtenances thereto (excluding Tenant's merchandise, trade fixtures, furnishings, equipment, personal property and leasehold improvements).

(b) Tenant shall maintain during the Term, (i) workers' compensation insurance as required by applicable state law and (ii) employer's liability insurance and commercial general liability insurance each with a per-occurrence limit of not less than the amount set forth in the Basic Lease Information. Tenant shall name Landlord, Landlord's property manager ("**Property Manager**"), if any (so long as any such Property Manager is identified in writing to Tenant), City, the Parking Authority of City, and the members, officers, agents and employees of each and, if Landlord elects, any lender designated by Landlord, as additional insured(s) on Tenant's commercial general liability insurance, which insurance shall be with companies licensed to do business in the State of California meeting the requirements of this Article 13. Such policy shall (i) provide that a minimum of thirty (30) days' written notice by mail from the insurance company prior to cancellation, termination or reduction in such insurance be provided to Landlord, the Director of Property of City, and the Director of the Parking Authority of City, all at their respective addresses set forth in the Basic Lease Information; (ii) provide that such insurance is primary to any other insurance available to such additional insureds with respect to claims covered under the policy and that such insurance applies separately to each insured against whom claim is made or suit is brought, but the inclusion of more than one insured shall not operate to increase the insurer's limit of liability; (iii) provide coverage for all insurable events occurring during the Term, regardless of when the related claims shall be first made

against Tenant and/or Landlord; (iv) contain a cross liability endorsement; and (v) contain provisions or an endorsement specifying coverage shall be extended to include blanket contractual liability, personal injury liability (including libel, slander, false arrest, and wrongful eviction) and broad form property damage. No liability insurance required pursuant to this Lease may be written on a claims-made basis without Landlord's prior written approval and, in any such event, Tenant shall continue to provide evidence of such coverage beyond the Term for a period mutually agreed upon by Landlord and Tenant at the expiration or earlier termination of the Term, but in no event shall such period be less than four (4) years. Tenant shall also obtain and maintain in force throughout the Term (including any extensions thereof), a policy of property insurance written on the Insurance Services Office Special Causes of Loss Form (or an insurer-specific equivalent "all-risks" form), including sprinkler leakage and plate glass coverage, for the full replacement value, covering all Tenant's goods and merchandise, trade fixtures, furniture, signs, decorations, furnishings, wall covering, floor covering, draperies, equipment, leasehold improvements and other items and personal property of Tenant located on or within the Premises. All exclusions and/or limitations pertaining to sewer and drain back-up, subsurface water, continuous seepage and damage to the interior without prior wind or hail damage to the Structure or Retail Center shall be removed. Coverage shall also be provided for loss due to the enforcement of building ordinances following a covered loss. Coverage for improvements and betterments shall apply to those made for Tenant at Landlord's expense, if any, as well as those made at Tenant's expense, and shall be for the full replacement value and not limited to Tenant's use value in such improvements and/or betterments. A deductible of not more than Five Thousand Dollars (\$5,000.00) per occurrence will be permitted for such property insurance.

(c) Tenant shall obtain certificates of insurance evidencing commercial general liability insurance, including completed operations, and workers' compensation insurance and employer's liability insurance from any contractor or subcontractor engaged for Alterations, repairs or maintenance during the Term. Such insurance shall be in forms and amounts and with companies reasonably satisfactory to Landlord.

(d) Tenant, on behalf of its insurance companies insuring the Premises, its contents, Tenant's other property or other portions of the Retail Center, waives any right of subrogation which such insurer or insurers may have against Landlord. Tenant shall secure an appropriate clause in, or an endorsement to, such insurance policies, pursuant to which the respective insurance companies waive subrogation or permit the insured, prior to any loss, to agree with a third party to waive any claim it might have against such third party.

(e) All Tenant policies provided for herein shall be issued by insurance companies with a Best's Rating of A:VIII or better. Tenant shall provide Landlord with evidence that each of the insurance policies required by this Article 13 is in full force and effect. Evidence of required property insurance shall be provided on the standard ACORD Evidence of Property Insurance form (ACORD 27) or an insurer-specific equivalent form. Evidence of required liability insurance shall be provided on the standard ACORD Certificate of Insurance form (ACORD 25-9) or an insurer-specific equivalent form. The required evidence of insurance shall also include copies of endorsements to the applicable policy specifying:

(i) the additional insureds under Tenant's commercial general liability insurance policy(ies) specified in Article 13(b) hereof;

(ii) that Tenant's commercial general liability insurance is primary and that any insurance available to Landlord shall be excess and not contributory;

(iii) that the insurer recognizes the waiver of subrogation set forth in Article 13(d) hereof; and

(iv) that the insurer agrees not to cancel or reduce the coverage of the policy without providing at least thirty (30) days' prior written notice to the parties specified in Article 13(b) hereof.

Such evidence of insurance must be on file with Landlord before Tenant takes possession of the Premises and at least ten (10) days prior to the expiration or cancellation of any such insurance policy. Failure to provide acceptable evidence of insurance shall authorize Landlord to procure such insurance in the amounts stated and charge the cost of same together with a One Hundred Dollar (\$100.00) service charge to Tenant, but only during the period of non-compliance.

(f) At Landlord's election, Tenant and Landlord shall review the coverage limits and types of insurance carried by Tenant pursuant to this Article 13. If during the Term the general commercial practice in the City and County of San Francisco is to carry liability insurance in an amount, or with a scope of coverage, materially greater than the amount or coverage then being carried by Tenant for risks comparable to those associated with the Premises, then the amounts or coverage carried by Tenant shall be increased to conform to such general commercial practice. Any such increase shall be memorialized in a supplemental instrument, and such increases shall not occur more often than once every three (3) years.

(g) Tenant and Landlord hereby waive and release any and all right of recovery, whether arising in contract or tort, against the other, including employees and agents, arising during the Term for any and all loss or damage to any property located within or constituting a part of the Structure, which loss or damage arises from the perils that could be insured against under the ISO Causes of Loss-Special Form Coverage (whether or not the party suffering the loss or damage actually carries such insurance, recovers under such insurance or self-insures the loss or damage) or which right of recovery arises from loss of earnings or rents resulting from loss or damages caused by such a peril. This mutual waiver is in addition to any other waiver or release contained in this Lease. Landlord and Tenant shall each have their insurance policies issued in such form as to waive any right of subrogation which might otherwise exist. Notwithstanding the foregoing, Tenant acknowledges that (i) Landlord shall not carry insurance on, and shall not be responsible for, (A) damage to any Improvements of Tenant; and (B) any loss suffered by Tenant due to interruption of Tenant's business, subject to the terms of Article 5(j) hereof; and (ii) the foregoing waiver shall not apply to limit Landlord's right to recover insurance deductibles as part of Tenant's Cost Proportionate Share of Common Area Costs.

(h) Notwithstanding the foregoing provisions of this Article 13, Tenant, so long as the Tenant in possession of the Premises is Sprint Spectrum, L.P., shall have the right to comply with and satisfy any or all of its obligations under this Article 13, in lieu of actually

obtaining the applicable insurance policy, by notifying Landlord in writing of Tenant's election to be a self-insurer as to the applicable insurance coverage; provided, however, that if Tenant's net worth ceases to be equal to or greater than \$100,000,000.00, then all of Tenant's rights to self-insure under this Article 13(h) shall terminate immediately, and Tenant shall thereafter comply, promptly and fully, with all of the other provisions of this Article 13. As evidence of such net worth, Tenant shall deliver to Landlord, on each anniversary of the Commencement Date, audited financial statements of SPRINT SPECTRUM, L.P. or such other evidence of such net worth as is reasonably acceptable to Landlord. If Tenant elects to self-insure pursuant to this Article 13(h), Tenant shall be liable to Landlord for the full equivalent of unconditional and unqualified insurance coverage which would have been available to Landlord, the Director of Property of City, and the Director of the Parking Authority of City if the applicable insurance policy had been obtained by Tenant from a third-party insurer, in full compliance with the provisions of this Article 13 (as applicable), and shall pay on behalf of or indemnify Landlord, the Director of Property of City, and the Director of the Parking Authority of City (as appropriate) all amounts which would have been payable by the hypothetical third-party insurer had Landlord, the Director of Property of City, and the Director of the Parking Authority of City been named as an additional insured under any insurance policy involved, with no deductible amount applicable to such policy. This right to self-insure has been granted at the specific request of SPRINT SPECTRUM, L.P., and in the knowledge by both parties that, as a result, there might be differences of opinion in the future as to the extent of coverage of such self-insurance; therefore, since Landlord would, under the terms of this Lease, otherwise have had the right to approve the form of the applicable insurance policies, the parties agree that, if Tenant elects to self-insure pursuant to the provisions of this Article 13(h), the provisions hereof shall be construed and interpreted so as to give Landlord all of the rights which it would have had if Tenant had complied fully with the provisions of this Article 13, other than this Article 13(h), and had obtained for Landlord the broadest coverage commercially available to Tenant.

Article 14 - Indemnification; Waiver

(a) Except to the extent caused solely and exclusively by the willful misconduct of Landlord, its agents or employees, Tenant shall indemnify, protect, defend and hold Landlord, Property Manager, if any, City, the Parking Authority of City, and their respective officers, representatives, agents and employees harmless from and against any and all losses, damages, claims, reasonable expenses (including reasonable attorneys' fees), judgments and direct or vicarious liability for any damage to any property or injury, illness or death of any person: (i) occurring in or on the Premises, arising at any time and from any cause whatsoever or (ii) occurring in, on, or about any part of the Retail Center or the Structure other than the Premises, to the extent such damage, injury, illness or death in this clause (ii) shall be caused by the negligence or willful misconduct of Tenant, its agents, servants, employees or licensees. The provisions of this Article 14 shall survive the expiration or earlier termination of this Lease with respect to any damage, injury, illness or death caused by an event, action or failure to act occurring prior to such expiration or termination.

(b) Landlord shall not be liable or responsible in any way for, and Tenant waives all claims against Landlord and assumes all risk with respect to or arising out of (i) any damages for which Tenant is required to insure or permitted to self-insure hereunder; (ii) any death or any injury of any nature whatsoever that may be suffered or sustained by Tenant or any employee,

licensee, invitee, guest, agent or customer of Tenant or any other person claiming through or under Tenant, from any causes whatsoever except if caused solely by the willful misconduct of Landlord, its agents or employees; and (iii) any loss, damage or injury to any property belonging to Tenant or its employees, agents, customers, licensees, invitees, guests or any other person except if caused solely by the willful misconduct of Landlord, its agents or employees. Except as may otherwise be provided in this Lease, without limiting the generality of the foregoing, Landlord shall not be liable for any damage or damages of any nature whatsoever including, without limitation, consequential damages or loss of profit or business opportunity caused by explosion, fire, theft or breakage, by any sprinkler, drainage or plumbing systems, by the failure for any reason to supply adequate drainage, by the interruption of any public utility or service, by steam, gas, water, rain or other substances leaking, issuing or flowing into any part of the Premises, by natural occurrence, acts of the public enemy, riot, strike, insurrection, war, court order, requisition or order of governmental body or authority, or for any damage or inconvenience which may arise as a result of repair, maintenance or alteration of any part of the Retail Center or the Structure, or by anything done or omitted to be done by any tenant, occupant or person in the Retail Center or the Structure.

Article 15 - Damage and Destruction

In the event of a fire or other casualty in the Premises, Tenant shall immediately give notice thereof to Landlord. Provided the Master Lease is not terminated as a result of such casualty in accordance with Section 17 thereof (in which event this Lease shall terminate upon any such termination of the Master Lease), the following provisions shall apply to fire or other casualty occurring in the Premises and/or the Retail Center or the Structure:

(a) If the damage is limited solely to the Premises, unless this Lease is otherwise terminated pursuant to the provisions of Article 15(b), (c) or (d) below, then Tenant shall be obligated to repair and rebuild the non-structural portions of the Premises at Tenant's sole cost and expense and shall proceed diligently to do so. For purposes of this Article 15, "non-structural portions of the Premises" includes, without limitation, infill block walls, stud walls, the Premises storefront and all Improvements, but excludes portions of the Premises consisting of primary structural elements of the Structure ("**Structural Premises Portions**") including, without limitation, elevator shafts, support columns and shear walls.

(b) If any portions of the Structure outside the boundaries of the Premises (the "**Non Premises Portions**") are damaged or destroyed (whether or not the Premises are also damaged or destroyed) or any Structural Premises Portions are damaged or destroyed, and the Non Premises Portions and/or Structural Premises Portions, as applicable, can be made tenantable with all damage repaired within one hundred eighty (180) days following the date of the damage or destruction ("**Casualty Date**"), and provided Landlord determines it is economically feasible to do so, then Landlord shall so inform Tenant within sixty (60) days following the Casualty Date and Landlord shall diligently proceed to repair such Non Premises Portions and/or such Structural Premises Portions; provided, however, that Landlord shall have no obligation to repair or restore any Improvements. If such damage cannot, in Landlord's reasonable opinion, be repaired within such one-hundred-eighty- (180-) day period, then Landlord may nonetheless elect, upon notice to Tenant within sixty (60) days after the Casualty Date, to repair such damage to the Non Premises Portions and/or the Structural Premises

Portions and shall thereafter diligently pursue the completion thereof. If Landlord so elects to repair such damage and even if, notwithstanding the provisions of Article 15(d) below, such repairs would require the demolition and reconstruction of the Premises in connection therewith (which reconstruction would be the obligation of Tenant, at Tenant's sole cost and expense, to the extent of the portions of the Premises other than the Structural Premises Portions), then this Lease shall remain in full force and effect, but otherwise Landlord shall notify Tenant within sixty (60) days following the Casualty Date of the termination of this Lease effective as of the date of such notice.

(c) If any damage to the Premises occurs during the final twenty-four (24) months of the Term and the cost to restore such damage exceeds twenty-five percent (25%) of the replacement cost of the Premises or, in Landlord's reasonable opinion, such damage cannot be repaired within one-hundred-eighty (180) days, then either Landlord or Tenant may terminate this Lease by notice to the other party within sixty (60) days after the occurrence of such damage and this Lease shall expire on the sixtieth (60th) day after the date of such notice, unless Tenant has the then-exercisable right under the Addendum to this Lease to extend the Term and exercises such right within sixty (60) days following the date of such damage or destruction. If Tenant exercises such right, then, subject to the other provisions of this Article 15, including, without limitation, Article 15(b) above, Landlord shall restore the Structural Premises Portions and Tenant shall restore the non-structural portions of the Premises in accordance with the terms of this Article 15.

(d) A total destruction of the Premises shall automatically terminate this Lease. In the event of a conflict between California Civil Code Sections 1932(1) and (2), 1933(4) and 1942 and this Lease with respect to any destruction of the Premises, the terms and provisions of this Lease shall control. Nothing herein shall obligate Landlord to perform any repairs or reconstruction except as set forth in Article 15(b).

(e) During any period when Tenant's use of the Premises is significantly affected by damage or destruction, rent and all other charges payable by Tenant hereunder shall abate in the proportion by which (x) the area of the part of the Premises the use of which is so affected bears to (y) the Floor Area of the Premises, beginning on the day on which the event causing the subject damage or destruction occurred until such time as the Premises are made tenantable, as reasonably determined by Landlord, and no portion of the rent so abated shall be subject to subsequent recapture; provided, however, that, subject to the terms of Article 13(g), there shall be no such abatement if the damage or destruction resulted in whole or in part from the negligence or willful acts of Tenant, its agents or employees.

(f) The proceeds from any insurance paid by reason of damage to or destruction of the Retail Center, the Structure or any part thereof, which is insured by Landlord, shall belong to and be paid to Landlord subject to the terms of any Lender's Lien.

(g) If this Lease is not terminated as provided above, then Tenant shall repair and replace its merchandise, trade fixtures, furnishings and equipment in a manner and to a condition at least equal to that which existed prior to its damage or destruction. Except as herein expressly provided to the contrary, this Lease shall not terminate nor shall there be any abatement of rent or other charges or items of additional rent as the result of a fire or other casualty.

Article 16 - Eminent Domain

(a) If all or any material portion of the Premises are taken under the power of eminent domain by any public or quasi-public authority, or if all or any material part of the Premises is sold or transferred in lieu thereof, this Lease shall terminate and expire as to the part so taken as of the date of such taking, and, in the case of a partial taking that results in a substantial interference with Tenant's business, either Landlord or Tenant may terminate this Lease as to the balance of the Premises by giving notice to the other, in writing, within thirty (30) days after the date of such taking; provided, however, that a condition to the exercise of such right to terminate by Tenant shall be that the portion of the Premises shall be of such extent and nature as substantially to handicap, impede and impair Tenant's use of the balance of the Premises for the purposes permitted by this Lease. If a material part of the Retail Center or of the Structure is condemned or taken or if substantial alteration or reconstruction of the Retail Center or of the Structure is, in Landlord's opinion, necessary or desirable as a result of a condemnation or taking, whether or not any portion of the Premises is condemned or taken, Landlord may terminate this Lease by written notice to Tenant within thirty (30) days after the date of such taking provided all other tenant leases for the affected portion of the Retail Center are likewise terminated.

(b) Landlord shall be entitled to any and all compensation, damages, income, rent, awards, or any interest therein whatsoever which may be paid or made in connection with a taking, and Tenant shall have no claim against Landlord for the value of any unexpired term of this Lease or otherwise. Tenant shall be entitled to initiate a separate action for its relocation costs (except with respect to any taking or partial taking by any governmental or quasi-governmental authority to which the waiver set forth in Article 34 applies), and for loss of Tenant's improvements and trade fixtures installed at Tenant's cost, provided any award to Tenant in such action does not reduce the award which would otherwise accrue to Landlord. In the event of a partial taking of the Premises which does not result in a termination of this Lease, the Annual Rental and all other charges payable by Tenant hereunder thereafter to be paid shall be equitably reduced by Landlord. Each party waives the provisions of any applicable statute allowing either party to petition the court of competent jurisdiction to terminate this Lease in the event of a partial taking of the Premises.

Article 17 - Assignment and Subletting

(a) Except as otherwise expressly provided in this Article 17, Tenant shall not transfer, assign, sublet, enter into license or concession agreements, change ownership or hypothecate this Lease or the Tenant's interest in and to the Premises (individually and collectively, a "**Transfer**") without first procuring the written consent of both Landlord and City, which consent may be withheld in either such party's sole discretion. Any attempted Transfer without the written consent of both Landlord and City shall be void unless such Transfer is expressly permitted with such consent pursuant to this Article 17. The prohibitions of this Article 17 shall apply to a Transfer when such transfer occurs by operation of law, legal process, receivership, bankruptcy or otherwise.

(b) If Tenant is a corporation, any dissolution, merger, consolidation or other reorganization of Tenant (excluding a reorganization where Tenant remains the controlling

party), or the sale or other transfer of a controlling percentage of the capital stock of Tenant (other than in a public offering) or the sale of fifty percent (50%) or more of the value of the assets of Tenant, shall be deemed a voluntary assignment of this Lease by Tenant. The phrase "controlling percentage" shall mean the ownership of, and the right to vote, stock possessing fifty percent (50%) or more of the total combined voting power of all classes of Tenant's capital stock issued, outstanding, and entitled to vote for the election of directors. The preceding two sentences shall not apply to corporations the stock of which is traded through an exchange or over the counter. If Tenant is a partnership, a withdrawal or change, whether voluntary, involuntary, or by operation of law, of any partner or partners owning a total of fifty percent (50%) or more of the partnership, or the dissolution of the partnership, shall be deemed a voluntary assignment of this Lease by Tenant. If Tenant is a limited liability company, a withdrawal or change, whether voluntary, involuntary or by operation of law, of either (i) any managing member or (ii) any member or members owning fifty percent (50%) or more of the total membership interests in the company, or the dissolution of the company, shall be deemed a voluntary assignment of this Lease by Tenant. If Tenant consists of more than one person, a purported assignment, voluntary, involuntary, or by operation of law, by any one of the persons executing this Lease shall be deemed a voluntary assignment of this Lease by Tenant.

(c) The consent by Landlord and City to any Transfer shall not constitute a waiver of the necessity for such consent to any subsequent Transfer. In no event shall any assignee or subtenant of Tenant or any subsequent assignee or subtenant be permitted to transfer, assign, sublet, enter into license or concession agreements, change ownership or hypothecate this Lease or its interest in and to the Premises or this Lease in whole or in part, or otherwise permit occupancy of all or any part thereof by anyone with, through or under it, without first procuring the written consent of Landlord and City.

(d) Each Transfer to which there has been consent shall be by instrument in writing, in form reasonably satisfactory to Landlord and City, and shall be executed by Tenant and the transferee, assignee, sublessee, licensee, concessionaire or mortgagee which shall agree in writing for the benefit of the Landlord to assume and be bound by, the terms, covenants and conditions of this Lease to be performed by Tenant. One executed copy of such written instrument shall be delivered to Landlord within ten (10) business days of the date of execution.

(e) If Tenant intends to effect a Transfer other than a hypothecation of this Lease, Tenant shall give prior written notice of such intent, specifying therein the proposed assignee, sublessee, licensee or concessionaire and providing such information with respect thereto including, without limitation, information concerning the principals thereof and such credit, financial and business experience information relating to the proposed assignee, sublessee, licensee or concessionaire as Landlord requires. Landlord shall within thirty (30) days after receipt of such notice and information elect in writing to (i) consent to the proposed Transfer; (ii) refuse to consent to the proposed Transfer; or (iii) cancel this Lease. By its approval of this Lease below, City agrees to consent or refuse to consent to any proposed Transfer within such thirty- (30-) day period. If Landlord elects to cancel this Lease, Tenant shall notify Landlord within fifteen (15) days thereafter in writing of Tenant's intention either to refrain from such proposed Transfer or to accept the cancellation of this Lease. If Tenant fails to deliver such notice to Landlord within such fifteen- (15-) day period, this Lease shall terminate thirty (30) days after the expiration of such fifteen- (15-) day period. If Tenant advises Landlord it intends

to refrain from such Transfer then Landlord's election to terminate this Lease shall be of no further force and effect. The period of time within which Landlord must respond to a request by Tenant for consent to an assignment of this Lease shall not begin to run until Tenant has provided to Landlord all of the information to which Landlord is reasonably entitled in order to evaluate the proposed transaction.

(f) Tenant shall reimburse Landlord upon demand for Landlord's reasonable, actual, out-of-pocket attorneys' fees and administrative expenses incurred in connection with the review, processing and/or preparation of any documentation of any requested Transfer which reasonable, actual, out-of-pocket, review, processing and/or preparation and attorneys' fees shall not exceed the aggregate amount of \$2,500 (the "**Expense Limit**"); provided, however, that such Expense Limit shall not apply to (i) any assignment or sublease in connection with the bankruptcy or reorganization of Tenant or that involves an amendment to this Lease, or (ii) all costs reasonably incurred in reviewing any plans and specifications for Alterations proposed to be made in connection therewith.

(g) If Landlord and City consent to a Transfer, then seventy-five percent (75%) of any sums or other economic consideration received by Tenant as a result of such Transfer (except reasonable leasing commissions and rental or other payments received which are attributable to the amortization of the cost of tenant improvements made to the subject space by Tenant, at Tenant's cost) whether denominated rent or otherwise, which exceed, in the aggregate, the total sums which Tenant is obligated to pay Landlord under this Lease (prorated as to any sublease, license or concession agreement to reflect obligations allocable to that portion of the Premises subject to such sublease, license or concession agreement) shall be payable to Landlord as additional rent under this Lease, without affecting or reducing any other obligation of Tenant hereunder. Tenant shall deliver to Landlord a statement within thirty (30) days after the end of each calendar year, and within thirty (30) days after the expiration or earlier termination of the Term, specifying with respect to the prior calendar year, (i) each sublease, assignment, licensing and/or concession agreement which was in effect during any portion of the year covered by such statement; and (ii) a computation in reasonable detail showing the amounts (if any) paid and payable by Tenant to Landlord pursuant to this subsection and applicable to (A) the year covered by such statement and (B) prior years.

(h) No Transfer shall release Tenant from its obligations or alter the primary liability of Tenant to pay the rental hereunder. The acceptance of rental by Landlord from any other person shall not be deemed to be a waiver by Landlord of any provision hereof. If any transferee defaults in the performance of any of the terms hereof, Landlord may proceed directly against Tenant without the necessity of exhausting its remedies against such transferee. Landlord and City may consent to subsequent transfers of this Lease or amendments or modifications to this Lease with transferees of Tenant, without obtaining Tenant's consent thereto, and such action shall not relieve Tenant of its liability under this Lease.

(i) If a petition is filed by or against Tenant for relief under the United States Bankruptcy Code, as amended (the "**Bankruptcy Code**"), and Tenant (including for purposes of this section Tenant's successor in bankruptcy, whether a trustee or Tenant as debtor in possession) assumes and proposes to assign, or proposes to assume and assign, this Lease pursuant to the provisions of the Bankruptcy Code to any person or entity who has made or

accepted a bona fide offer to accept an assignment of this Lease on terms acceptable to Tenant, then notice of the proposed assignment setting forth (i) the name and address of the proposed assignee, (ii) all of the terms and conditions of the offer and proposed assignment, and (iii) the adequate assurance of future performance of the Lease to be furnished by the proposed assignee, shall be given to Landlord by Tenant no later than twenty (20) days after Tenant has made or received such offer, but in no event later than ten (10) days prior to the date on which Tenant applies to a court of competent jurisdiction for authority and approval to effect the proposed assignment. The description of the adequate assurance of the proposed assignee's future performance in such notice shall include such financial and other information as is necessary to demonstrate that the financial condition and operating performance of the proposed assignee and its guarantors, if any, is similar to the financial condition and operating performance of Tenant and its guarantors, if any, as of the time Tenant became the Tenant under the Lease. Landlord shall have the prior right and option, to be exercised by notice to Tenant given at any time prior to the date on which the court order authorizing such assignment becomes final and non-appealable, to receive an assignment of this Lease upon the same terms and conditions, and for the same consideration, if any, as the proposed assignee, less any brokerage commissions which may otherwise be payable out of the consideration to be paid by the proposed assignee for the assignment of this Lease. If this Lease is assigned pursuant to the provisions of the Bankruptcy Code, Landlord: (A) may, in addition to its right to adequate assurance of future performance, require from the assignee a deposit or other security for the performance of its obligations under the Lease in an amount substantially the same as would have been required by Landlord upon the initial leasing to a tenant similar to the assignee; and (B) shall receive, as additional rent, the sums and economic consideration described in Article 17(g). Any person or entity to whom this Lease is assigned pursuant to the provisions of the Bankruptcy Code shall be deemed without further act or documentation to have assumed all of Tenant's obligations arising under this Lease on and after the date of such assignment. Any such assignee shall, upon demand, execute and deliver to Landlord an instrument confirming such assumption. No provision of this Lease shall be deemed a waiver of Landlord's rights or remedies under the Bankruptcy Code to oppose any assumption and/or assignment of this Lease, to require timely performance of Tenant's obligations under this Lease, or to regain possession of the Premises if this Lease has neither been assumed nor rejected within sixty (60) days after the date of entry of the bankruptcy court's order for relief or within such additional time as a court of competent jurisdiction may have fixed. In connection with any Bankruptcy proceeding, Landlord shall be entitled to recover any and all reasonable attorneys' fees incurred in such Bankruptcy proceeding or arising out of or in connection with any such proceeding. Notwithstanding anything in this Lease to the contrary, all amounts payable by Tenant to or on behalf of Landlord under this Lease, whether or not expressly denominated as such, shall constitute "rent" for the purposes of Section 502(b)(6) of the Bankruptcy Code.

(j) Notwithstanding anything to the contrary contained in this Article 17, Tenant shall have the right to assign this Lease or to sublet the Premises, without necessity of obtaining Landlord's consent but with substantially contemporaneous notice to Landlord, to:

(i) any successor to Tenant by merger, consolidation, or acquisition of all or substantially all of the assets or equity interests in Tenant, provided:

(A) such transfer is part of the sale as a going concern of all locations in California of Tenant's business operating under the same trade name as the Premises;

(B) the transferee shall assume in writing all the obligations and liabilities of Tenant under this Lease;

(C) Tenant shall remain liable for all the obligations and liabilities of Tenant under this Lease;

(D) the transferee shall not have a negative reputation in the general public's opinion;

(E) both Landlord and City shall not have had previous business with such transferee which resulted in any pattern of uncured defaults under any lease;

(F) there is not then existing an Event of Default under this Lease or any circumstances which, with the giving of notice or the passage of time or both, would constitute an Event of Default under this Lease;

(G) following the Transfer, the Premises will continue to be operated in accordance with all of the terms of this Lease including, without limitation, the trade name and use provisions hereof; and

(H) the transferee shall have the financial strength and stability and managerial and operational experience which in Landlord's reasonable business judgment will allow the transferee to perform all obligations under the Lease to be performed by Tenant, which requirement shall be deemed satisfied if the proposed transferee has a net worth of at least Ten Million Dollars (\$10,000,000.00) at the time of the transfer; and

(ii) any entity directly or indirectly controlling, controlled by, or under common control with Tenant, provided:

(A) following the transfer, the Premises will continue to be operated in accordance with all of the terms of this Lease including, without limitation, the trade name and use provisions hereof; and

(B) the net worth of the transferee is at least as high as the greater of (1) Tenant's net worth on the Lease Date or (2) Tenant's net worth immediately prior to such assignment or subletting.

The provisions of Article 17(g) shall not apply to any Transfer permitted under this Article 17(j).

Article 18 - Access to Premises

Upon telephonic notice to Tenant's on-site manager or other designated representative (except in an emergency, when no notice shall be required), Landlord, its agents, employees and any person authorized by Landlord, may enter the Premises at reasonable hours for the purpose of: (a) inspecting the condition of same; (b) making such repairs, additions or improvements thereto, or to the Structure, as Landlord may be permitted or required to make (including, without limitation, any repairs or improvements necessary for compliance with applicable laws, regulations, ordinances or rules); (c) exhibiting the same to prospective purchasers, lenders or, during the last twelve (12) months of the Term, prospective tenants; (d) determining whether Tenant is complying with its obligations hereunder; (e) supplying any service to be provided by Landlord to Tenant or to any other tenant of the Retail Center; and (f) placing notices, including, without limitation, notices of non-responsibility. Neither Tenant nor any person within Tenant's control shall interfere with such notices of non-responsibility. Except as otherwise provided in this Lease and in cases of emergency, Landlord shall not disturb Tenant's conduct of business. Except as may otherwise be provided in this Lease and subject to the terms of Article 5(j), Tenant hereby waives any claim for damages for any injury or inconvenience to or interference with Tenant's business, any loss of occupancy or quiet enjoyment of the Premises, and any other loss occasioned by such entry. If entry is desired by Landlord in non-emergency circumstances, Landlord shall so notify the on-site manager of Tenant telephonically at the telephone number for the Premises and after attempting to give or giving such telephonic notice, if the Premises are not made fully available for entry Landlord may (but shall not be obligated to) enter the Premises in any way reasonably necessary. Subject to the terms of Article 5(j), Landlord shall have the right to use any reasonable means to enter the Premises in an emergency, and no such entry by Landlord shall under any circumstance be construed or deemed to be a forcible or unlawful entry into, or a detainer of, the Premises or an eviction, actual or constructive, of Tenant from the Premises, or any portion thereof.

Article 19 - Defaults by Tenant

(a) The following shall each be deemed to be an event of default ("**Event of Default**") under this Lease:

(i) Tenant's failure to pay when due (1) any installment of the Annual Rental or of any Common Area Costs or (2) any insurance reimbursement; provided, the first two (2) times in any consecutive twelve- (12-) month period that such a failure occurs, such failure shall not constitute an Event of Default unless Tenant has failed to pay the overdue sums in full within ten (10) days after Tenant has been given written notice that such payment is overdue; or

(ii) Tenant's failure to pay any other sum when the same becomes due and payable if such failure continues for more than ten (10) days after written notice thereof from Landlord; or

(iii) Tenant's failure to perform or observe any other obligations of Tenant hereunder, or to comply with the Rules and Regulations (as hereinafter defined), if such failure continues for more than twenty (20) days after written notice thereof from

Landlord, unless such default cannot be reasonably cured within such twenty- (20-) day period and Tenant has within such period commenced and is pursuing the curing of such default with due diligence; or

(iv) Tenant's abandonment or, subject to the terms of Article 15 hereof, vacation of a substantial portion of the Premises, or failure to conduct its business in the manner prescribed herein for a continuous period in excess of five (5) business days; or

(v) Tenant's failure to vacate the Premises immediately upon termination of this Lease; or

(vi) The leasehold interest of Tenant is levied upon under execution or is attached by process of law or Tenant's failure to contest diligently the validity of any lien or claimed lien or to give sufficient security to Landlord to insure payment thereof or failure to satisfy any judgment rendered thereon and having the same released, and such default continues for twenty (20) days after written notice to Tenant; or

(vii) Tenant's becoming insolvent, admitting in writing its inability to pay its debts generally as they become due, filing a petition in bankruptcy or a petition to take advantage of any insolvency statute, making an assignment for the benefit of creditors, making a fraudulent transfer, applying for or consenting to the appointment of a receiver of itself or of the whole or any substantial part of its property, or filing or answering a petition seeking reorganization under the federal bankruptcy laws, as now in effect or hereafter amended, or any other applicable law or statute of the United States or any state thereof; or

(viii) A court of competent jurisdiction entering an order, judgment or decree adjudicating Tenant a bankrupt, or appointing a receiver of Tenant, or of the whole or any substantial part of its property without the consent of Tenant, or approving a petition filed against Tenant seeking reorganization or arrangement of Tenant under any applicable federal or state bankruptcy laws, as now in effect or hereafter amended, if such order, judgment or decree is not vacated, set aside or stayed within thirty (30) days from the date of entry thereof.

(b) Upon the occurrence of an Event of Default, Landlord, at any time thereafter, may give a written termination notice to Tenant, and on the date specified in such notice (which shall be not less than three (3) days after the giving of such notice), Tenant's right to possession shall terminate and this Lease shall terminate, unless on or before such date all arrears of rent and all other accrued sums payable by Tenant under this Lease (together with interest thereon at the Interest Rate) and all costs and expenses incurred by or on behalf of Landlord hereunder shall have been paid by Tenant and all other breaches of this Lease by Tenant at the time existing shall have been fully remedied to the satisfaction of Landlord. Upon such termination, in addition to any other rights and remedies to which Landlord may be entitled under applicable law, Landlord may recover from Tenant: (i) the worth at the time of award of the unpaid rent which had been earned at the time of termination; (ii) the worth at the time of award of the amount by which the unpaid rent which would have been earned after termination until the time of award exceeds the amount of such rent loss that Tenant proves could have been reasonably avoided; (iii) the worth

at the time of award of the amount by which the unpaid rent for the balance of the Term of this Lease after the time of award exceeds the amount of such rent loss that Tenant proves could be reasonably avoided; and (iv) any other amount necessary to compensate Landlord for all the detriment directly and proximately caused by Tenant's failure to perform its obligations under this Lease (but excluding consequential damages). Landlord shall not be entitled to recover lost opportunity costs or lost profits (except as computed pursuant to subparagraph (iii)). The "worth at the time of award" of the amounts referred to in clauses (i) and (ii) above shall be computed by allowing interest at the Interest Rate. The worth at the time of award of the amount referred to in clause (iii) above shall be computed by discounting such amount at a rate equal to the discount rate of the Federal Reserve Board of San Francisco at the time of award.

(c) Any and all property owned by or in the custody of Tenant may be removed from the Premises by Landlord and stored at the direction of Landlord at the risk, cost and expense of Tenant, and Landlord shall in no event be responsible for the value or preservation thereof. Tenant shall pay to Landlord, upon demand, all actual expenses incurred in such removal and all storage charges against such property.

(d) No act or thing done by Landlord or its agents during the Term shall be deemed a termination of this Lease or an acceptance of the surrender of the Premises, and no agreement to terminate this Lease or accept a surrender of the Premises shall be valid unless in writing signed by Landlord. Landlord's acceptance of any payments hereunder after the occurrence of an Event of Default shall not be construed as an accord and satisfaction, compromise or waiver of such default, unless Landlord so notifies Tenant in writing.

(e) All delinquent rentals and/or other sums due Landlord under the terms of this Lease shall bear interest from the date due until paid at the Interest Rate.

(f) TENANT ACKNOWLEDGES THAT LATE PAYMENT BY TENANT TO LANDLORD OF ANNUAL RENTAL, COMMON AREA COSTS, INSURANCE REIMBURSEMENT, UTILITY CHARGES, OPERATING COSTS OR ANY OTHER SUMS DUE HEREUNDER WILL CAUSE LANDLORD TO INCUR COSTS NOT CONTEMPLATED BY THIS LEASE, THE EXACT AMOUNT OF SUCH COSTS BEING EXTREMELY DIFFICULT AND IMPRACTICABLE TO FIX. SUCH COSTS INCLUDE, WITHOUT LIMITATION, PROCESSING AND ACCOUNTING CHARGES, AND LATE CHARGES THAT MAY BE IMPOSED ON LANDLORD BY THE TERMS OF ANY ENCUMBRANCE AND NOTE SECURED BY ANY ENCUMBRANCE COVERING THE PREMISES. THEREFORE, IF ANY INSTALLMENT OF ANNUAL RENTAL, COMMON AREA COSTS, INSURANCE REIMBURSEMENT OR ANY OTHER SUM DUE FROM TENANT IS NOT RECEIVED BY LANDLORD WHEN DUE, TENANT SHALL PAY TO LANDLORD ON DEMAND, AND IN ADDITION TO THE INTEREST PROVIDED HEREINABOVE, A SUM EQUAL TO SIX PERCENT (6%) OF THE OVERDUE AMOUNT AS A LATE CHARGE. THE PARTIES AGREE THAT THIS LATE CHARGE REPRESENTS A FAIR AND REASONABLE ESTIMATE OF THE COSTS THAT LANDLORD WILL INCUR BY REASON OF SUCH LATE PAYMENT BY TENANT. ACCEPTANCE OF ANY LATE CHARGE SHALL NOT CONSTITUTE A WAIVER OF TENANT'S DEFAULT WITH RESPECT TO THE OVERDUE AMOUNT, OR PREVENT LANDLORD FROM

EXERCISING ANY OF THE OTHER RIGHTS AND REMEDIES AVAILABLE TO LANDLORD.

SG
Landlord's Initials

MEL
Tenant's Initials

(g) Even though Tenant has breached this Lease and abandoned the Premises, this Lease shall continue in effect for so long as Landlord does not terminate Tenant's right to possession, and Landlord may enforce all its rights and remedies under this Lease, including the right to recover the rent as it becomes due under this Lease. Acts of maintenance or preservation or efforts to relet the Premises or the appointment of a receiver upon initiative of Landlord to protect Landlord's interest under this Lease shall not constitute a termination of Tenant's right to possession. No re-entry or taking possession of the Premises by Landlord shall be considered as an election to terminate this Lease, nor shall it cause a forfeiture of rent or other charges remaining to be paid during the balance of the Term hereof unless a written notice of such intent is given to Tenant or unless the termination hereof is decreed by a court of competent jurisdiction. Notwithstanding any reletting without termination by Landlord because of any default by Tenant, Landlord may at any time after such reletting elect to terminate this Lease for any such default.

Article 20 - Surrender of Premises

At the end of the Term or upon sooner termination of this Lease, Tenant shall peaceably deliver up to Landlord possession of the Premises "broom clean" and with no hazardous conditions or exposed utility connections therein, together with all Improvements not required by Landlord to be removed, pursuant to Article 10(a) hereof, in the same condition as received, or first installed, reasonable wear and tear and damage due to earthquake, fire or other casualty excepted. Tenant may, upon the expiration or sooner termination of this Lease, remove all counters, signs and other trade fixtures installed by Tenant, provided Tenant repairs any damage caused by such removal. Any property not so removed shall be deemed abandoned by Tenant and title to the same shall thereupon pass to Landlord.

Article 21 - Tenant's Conduct of Business

Tenant shall (i) be continuously open for business during Tenant's standard business hours of 9:00 a.m. to 8:00 p.m., Monday through Friday, 9:00 a.m. to 6:00 p.m., Saturday and 12 p.m. to 5 p.m., Sunday (excluding Easter Sunday, Thanksgiving Day, New Year's Day and Christmas Day), as such hours may be changed by Tenant from time to time, subject to Landlord's prior written approval (the "Tenant's Business Hours"); and (ii) have its display windows, signs and advertising displays adequately illuminated continuously during the Tenant's Business Hours and one-half (1/2) hour before and one-half (1/2) hour after Tenant's Business Hours. On the second (2nd) and each subsequent occasion during any consecutive twelve- (12-) month period on which (iii) for up to four (4) hours during any day Tenant is not open and conducting business during the Tenant's Business Hours, then Tenant shall pay, in addition to the Annual Rental and all other sums due hereunder, an amount equal to the per diem Annual Rental then in effect, calculated on the basis of a 30-day month; and (iv) for more than four (4) hours during any day Tenant is not open and conducting business as required hereunder

during the Tenant's Business Hours, then, at Landlord's option, Tenant shall pay, in addition to the Annual Rental and all other sums due hereunder, an amount equal to three (3) times the per diem Annual Rental then in effect, calculated on the basis of a 30-day month. Tenant acknowledges that failure to open and conduct business during Tenant's Business Hours will (A) be detrimental to the image of the Retail Center and (B) result in decreased traffic in the Retail Center, thereby potentially decreasing the sales volume of other tenants of the Retail Center. The exact amount of the damages caused by Tenant's failure to be open during Tenant's Business Hours is extremely difficult and impracticable to fix; therefore, the parties agree that the above-described sums represent fair and reasonable estimates of such damages.

Article 22 - Rules and Regulations

Tenant shall comply with the reasonable, non-discriminatory rules and regulations established by Landlord from time to time for the operation of the Retail Center (the "**Rules and Regulations**"). The Rules and Regulations in effect on the date of this Lease are attached hereto as Exhibit "C". Landlord shall, for the enforcement of the Rules and Regulations, have all remedies in this Lease provided for breach of the provisions hereof. Tenant shall not incur a charge nor shall this Lease be terminated with respect to the first two (2) violations of the Rules and Regulations occurring during any twelve (12) consecutive month period. With regard to the third and each subsequent violation of the Rules and Regulations occurring during any twelve (12) consecutive month period, Tenant shall pay Landlord as additional rental, in addition to, and not in lieu of, Landlord's other remedies, upon demand, One Hundred Dollars (\$100.00) per violation. Nothing contained in this Lease shall impose upon Landlord any obligation to enforce the Rules and Regulations or terms, covenants or conditions in any other lease against any other Retail Center tenant, and Landlord shall not be liable to Tenant for violation of the same by any other tenant, its employees, agents, visitors or licensees, provided that Landlord shall enforce the Rules and Regulations against Tenant in a non-discriminatory fashion.

Article 23 - Signage

Landlord shall have the absolute and unqualified right to determine the size, type, number and location of all signs, posters, advertisements and advertising materials and structures (collectively, "**Exterior Signage**") that are located within the Premises but readily visible to Retail Center patrons, on the exterior of the Premises or anywhere else in the Retail Center or the Structure, and may, in its absolute discretion, limit such Exterior Signage for all tenants of the Retail Center to a single location and a uniform style. All proposed Exterior Signage shall comply with the Retail Center signage limitations established by Landlord from time to time (the "**Signage Limitations**"). The Signage Limitations in effect at the date of this Lease are identified on Exhibit "D" attached hereto. Tenant shall not erect or display any Exterior Signage without first obtaining the written consent of Landlord, which consent may be withheld in Landlord's sole discretion. If Landlord shall consent to the erection or display of any such Exterior Signage by Tenant, Tenant shall obtain all necessary permits and approvals, including approval of City's Art Commission, if required, and shall pay all costs and expenses of such erection and display. Any Exterior Signage so erected or displayed by Tenant shall remain the property of Tenant. Tenant shall remove any such Exterior Signage at Tenant's sole cost and expense upon the expiration or earlier termination of this Lease or before such expiration or termination if required by City pursuant to the Master Lease. Notwithstanding the foregoing,

Landlord consents to the Exterior Signage shown and described on Exhibit "D-1" attached hereto, and Tenant may erect or display such Exterior Signage in accordance with and subject to the other terms of this Article 23, such as obtaining all necessary permits and approvals, other than Landlord's approval, and paying all related costs and expenses. Landlord shall add Tenant's name, at Landlord's expense, to any tenant directories located throughout the Retail Center and the Structure from time to time.

Article 24 - Drug-Free Workplace

Tenant acknowledges that pursuant to the federal Drug-Free Workplace Act of 1989, the unlawful manufacture, distribution, possession or use of a controlled substance is prohibited on the Premises or any portion of the Retail Center and/or the Structure. Tenant agrees that any violation of this prohibition by Tenant, its agents, employees, assigns or subtenants shall, notwithstanding any provision of Article 19 to the contrary, constitute a default under the Lease, and shall be deemed an Event of Default hereunder if such failure continues for more than five (5) days after Tenant receives written notice thereof from Landlord, unless such default cannot be reasonably cured within such five- (5-) day period and Tenant has within such period commenced and is pursuing the curing of such default with due diligence.

Article 25 - Attorneys' Fees

If either Landlord or Tenant fails to perform any of its obligations under this Lease or if a dispute arises concerning the meaning or interpretation of any provision of this Lease, the defaulting party or the party not prevailing in such dispute, as the case may be, shall pay any and all costs and expenses incurred by the other party in enforcing or establishing its rights hereunder (whether or not such action is prosecuted to judgment), including, without limitation, court costs and reasonable attorneys' fees. For purposes of this Lease, to the extent Landlord, at Landlord's sole election, utilizes the services of the City Attorney's Office of City ("City Attorney"), reasonable fees of attorneys of Landlord shall be based on the fees regularly charged by private attorneys with the equivalent number of years of experience in the subject matter area of the law for which the City Attorney's services were rendered, which private attorneys practice in law firms with approximately the same number of attorneys as employed by City Attorney and are located in the San Francisco Bay Area.

Article 26 - Transfer of Master Lease by Landlord

If Landlord's interest under the Master Lease is transferred by Landlord, then upon the assumption of this Lease by such successor, Landlord shall be released from any liability accruing after such transfer upon any of the agreements, obligations, covenants or conditions, express or implied, herein contained in favor of Tenant, and in such event Tenant shall look solely to the successor in interest of Landlord for performance hereunder. This Lease shall not be affected by any such transfer, however, and Tenant shall attorn to the transferee, which transferee shall be substituted for Landlord hereunder. Such release and attornment provided by this Article 26 shall be effective and self-operative without the execution of any further instruments on the part of any of the parties to this Lease.

Article 27 - Notices

Whenever in this Lease it is required or permitted that notice or demand be given or served by Landlord or Tenant to or on the other, such notice or demand shall be in writing and shall be given or served by personal service, certified or registered mail, or reputable overnight delivery service which provides written evidence of delivery and addressed as set forth in the Basic Lease Information. Notices or demands so served shall be deemed to be given or served on the date of delivery or first attempted delivery, if delivered by personal service, by certified or registered mail return receipt requested, postage prepaid or by any such overnight delivery service, charges billed to the sending party. Either party may change its address for notices or demands by written notice delivered in accordance with this Article 27.

Article 28 - Remedies

All rights and remedies of Landlord and Tenant herein created or otherwise existing at law or in equity are cumulative, and the exercise of one or more rights or remedies shall not be taken to exclude or waive the right to the exercise of any other. All such rights and remedies may be exercised and enforced concurrently and whenever and as often as deemed desirable.

Article 29 - Successors and Assigns

All covenants, promises, conditions, representations and agreements herein contained shall be binding upon and inure to the parties hereto and their respective heirs, executors, administrators, legal representatives, successors and assigns (subject to the limitations on transfer set forth in Article 17 hereof).

Article 30 - Representations

Neither Landlord, Landlord's agent nor any representative of Landlord, including any leasing agent acting on behalf of Landlord, has made any representation, promise or assurance with respect to the Retail Center (including the manner in which the same shall be operated, managed and maintained), the Premises, the making of this Lease, Tenant's projected or likely sales volume, customer traffic or profitability, and no claim or liability, or cause for termination, shall be asserted by Tenant against Landlord for, and Landlord shall not be liable by reason of, the breach of any representations, promises or assurances not expressly stated in this Lease.

Article 31 - Waiver

The failure of Landlord or Tenant to insist upon strict performance by the other party of any of the covenants, conditions and agreements of this Lease shall not be deemed a waiver of any of Landlord's or Tenant's rights or remedies and shall not be deemed a waiver of any subsequent breach or default by the other party of any of the covenants, conditions and agreements of this Lease.

Article 32 - Holding Over

If Tenant remains in possession of the Premises after the expiration or sooner termination of this Lease, all of the terms, covenants and agreements hereof shall continue to apply and bind Tenant so long as Tenant remains in possession insofar as the same are applicable, except that Tenant shall be deemed a tenant at sufferance and the Annual Rental shall be one hundred fifty percent (150%) of the sum of the monthly installments of the Annual Rental payable during the last twelve (12) months of the Term, prorated on a daily basis for each day that Tenant remains in possession, and Tenant shall indemnify Landlord against any and all claims, losses and liabilities for damages resulting from Tenant's failure to timely surrender possession, including, without limitation, any claims made by any succeeding tenant.

Article 33 - Interpretation

It is the parties' intention to create only the relationship of landlord and tenant, and no provision hereof, or act of either party hereunder, shall be construed as creating the relationship of principal and agent, partnership, joint venture or enterprise.

Article 34 - No Right of Relocation

(a) Tenant acknowledges that it will not be a displaced person at the time this Lease is terminated or expires by its own terms, and Tenant fully RELEASES, WAIVES AND DISCHARGES forever any and all claims against, and covenants not to file any action against, Landlord, City, the Parking Authority of City, their respective departments, commissions, officers, directors and employees, and all persons acting by, through or under each of them, under any laws, including, without limitation, any and all claims for relocation benefits or assistance under federal and state relocation assistance laws (including, but not limited to, California Government Code Sections 7260 et seq.).

(b) Without limiting the provisions of Article 17 hereof, Tenant shall cause any transferee, assignee, sublessee, licensee or concessionaire of or under this Lease (any, a "Transferee") expressly to waive any claim of entitlement to any and all relocation assistance and benefits in connection with this Lease. Tenant shall indemnify Landlord, City, and the Parking Authority of City in the manner provided in Article 14(a) hereof, with respect to any and all claims for relocation assistance or benefits by any Transferee.

Article 35 - Waiver of Redemption

Tenant expressly waives any and all rights of redemption granted by or under any present or future laws if Tenant is evicted or dispossessed for any cause, or if Landlord obtains possession of the Premises by reason of the violation by Tenant of any of the covenants and conditions of this Lease or otherwise. The rights given to Landlord herein are in addition to any rights that may be given to Landlord by any statute or otherwise.

Article 36 - Fees

Landlord and Tenant warrant and represent that they have not had negotiations with or dealt with any realtor, broker, agent or other person or entity in connection with the

negotiation and execution of this Lease, except for the broker set forth in the Basic Lease Information as Landlord's Broker and Tenant's Broker, which broker is acting as a dual agent for both Landlord and Tenant (the "Broker"), and each shall pay and hold the other harmless from any cost, expense or liability (including cost of suit and reasonable attorneys' fees) for any compensation, commissions or charges claimed by any other realtor, broker, agent or other person or entity with respect to this Lease and the negotiation thereof and arising out of the actions of the indemnifying party. Landlord agrees to pay a commission to the Broker pursuant to a separate agreement.

Article 37 - Lease Status

Tenant shall, at any time and from time to time, upon ten (10) days prior written request by Landlord, execute, acknowledge and deliver to Landlord a certificate certifying: (a) that Tenant has accepted the Premises (or, if Tenant has not done so, that Tenant has not accepted the Premises, and specifying the reasons therefor); (b) the Term Commencement Date, Rent Commencement Date and Term Expiration Date; (c) whether there are then existing any defaults by Landlord in the performance of its obligations under this Lease (and, if so, specifying the same); (d) that this Lease is unmodified and in full force and effect (or, if there have been modifications, that this Lease is in full force and effect, as modified, and stating the date and nature of each modification); (e) the capacity of the person executing such certificate, and that such person is duly authorized to execute the same on behalf of Tenant; (f) the date to which the Annual Rental, Common Area Costs and other sums payable hereunder have been paid; (g) that no notice has been received by Tenant of any default which has not been cured, except as to defaults specified in the certificate; (h) the amount of any security deposit and/or prepaid rent; and (i) such other matters as may be reasonably requested by Landlord. Any such certificate may be relied on by the party requesting same. If Tenant fails to provide such certificate within the ten- (10-) day period specified above, Landlord shall deliver a second written request for such certificate to Tenant, which shall provide that Tenant shall deliver such certificate within five (5) days of Tenant's receipt of such second written request. Tenant shall indemnify and hold Landlord harmless from and against all costs, damages, expenses, liabilities and fees including, without limitation, reasonable attorneys' fees and any consequential damages or lost profits, arising from or in any way related to or connected with Tenant's failure to deliver any such certificate within the time specified in this Article 37.

Article 38 - Recording

This Lease shall not be recorded.

Article 39 - Force Majeure

If either party is delayed or hindered in or prevented from the performance of any act required hereunder by reason of strikes, lockouts, labor troubles, inability to procure materials, failure of power, restrictive governmental laws or regulations, riots, insurrection, war or other reason of a like nature not the fault of or within the reasonable control of the party so delayed, hindered or prevented from performing, then performance of such act shall be excused for the period of delay and the period for the performance of any such act shall be extended for a period equivalent to the period of such delay. The provisions of this Article 39 shall not operate

to excuse Tenant from the prompt payment of any installment of the Annual Rental or excuse Tenant or Landlord from any other payments required by the terms of this Lease.

Article 40 - Construction of Lease

Tenant has read and understands all parts of this Lease. In the construction and interpretation of the terms of this Lease, the rule of construction that a document is to be construed most strictly against the party who prepared the same shall not be applied, it being agreed that both parties hereto have participated in the preparation of the final form of this Lease.

Article 41 - Captions

Captions used herein are for convenience and reference only, and shall in no way be deemed to explain, modify, amplify or aid in the interpretation, construction or meaning of the provisions of this Lease. The use of the terms "hereof," "hereunder," and "herein" shall refer to this Lease as a whole, inclusive of the exhibits, except when noted otherwise. The use of the masculine or neuter genders herein shall include the masculine, feminine and neuter genders. The singular form shall include the plural when the context so requires.

Article 42 - Severability

If any provision of this Lease or any term, paragraph, sentence, clause, phrase or word appearing herein (collectively, a "provision") is judicially or administratively held to be invalid or unenforceable for any reason, such holding shall not be deemed to affect, alter, modify or impair in any manner any other provision appearing herein and this Lease shall remain in full force and effect without the invalid or unenforceable provision. All charges, fees and other payments are deemed "additional rental" herein for the purpose of enforcing Landlord's remedies, and shall not be construed as "rent" in the event of imposition of rent controls.

Article 43 - Objection to Statements

Tenant's failure to object to any statement, invoice or billing rendered by Landlord within a period of one (1) year after receipt thereof shall constitute Tenant's acquiescence with respect thereto and shall render such statement, invoice or billing an account stated between Landlord and Tenant.

Article 44 - Liability of Landlord

(a) All liability of Landlord under this Lease shall be limited to its interest in the Retail Center and any judgments rendered against Landlord shall be satisfied solely out of such interest in the Retail Center (or rents, income or profits derived therefrom). No personal judgment shall lie against Landlord upon extinguishment of its interest in the Retail Center and no judgment so rendered shall give rise to any right of execution or levy against Landlord's assets. The provisions hereof shall inure to Landlord's successors and assigns. The foregoing provisions are not designed to relieve Landlord from the performance of any of Landlord's obligations under this Lease, but only to limit the personal liability of Landlord in case of recovery of a judgment against Landlord; nor shall the foregoing be deemed to limit Tenant's

rights to obtain injunctive relief or specific performance or to avail itself of any other right or remedy at law or under this Lease.

(b) No elective or appointive board, commission, member, officer, employee or other agent of Landlord, City or the Parking Authority of City shall be personally liable to Tenant, its successors and assigns, in the event of any default or breach by Landlord or for any amount which may become due to Tenant, its successors and assigns, or for any obligation of Landlord under this Lease.

Article 45 - Execution of Documents

(a) Except as otherwise expressly provided herein, Tenant's failure or refusal to execute and deliver to Landlord any document or instrument that is required under the terms of this Lease within twenty (20) days after Landlord's written request therefor, and after Landlord has given Tenant in writing another ten (10) days within which to execute and deliver the same shall, at Landlord's election, constitute an Event of Default hereunder.

(b) Tenant shall reimburse Landlord upon demand for all reasonable administrative and legal costs and expenses associated with the review, preparation and/or processing of any document executed at Tenant's request pursuant to or in connection with this Lease.

Article 46 - Corporate or Partnership Tenant

If Tenant is or will be a corporation or partnership, each of the persons executing this Lease on behalf of Tenant hereby covenants and warrants that Tenant is a duly authorized and existing entity, that Tenant is authorized to do business in the State of California; that Tenant has full power and authority to enter into this Lease; and that each and all of the persons executing this Lease on behalf of Tenant is duly authorized to do so. Upon Landlord's request, Tenant shall provide Landlord with evidence reasonably satisfactory to Landlord confirming the foregoing covenants and warranties.

Article 47 - Entire Agreement

This Lease, Exhibits "A," "B," "B-1," "B-2," "C" and "D" and Schedules 1, 2 and 3 and the Addendum to Shops at Yerba Buena Lease - Options to Extend Term attached hereto, each of which is incorporated herein by this reference, constitute the entire agreement between the parties with respect to the Premises. No amendment, modification of or supplement to this Lease shall be effective unless in writing and executed by Landlord and Tenant.

Article 48 - Time of Essence

Time is of the essence of this Lease and of all provisions hereof, except with respect to the delivery of possession of the Premises at the commencement of the Term.

Article 49 - Governing Law

This Lease shall be construed and enforced in accordance with the laws of the State of California.

Article 50 - Joint and Several Liability

If Tenant consists of more than one individual, partnership, corporation or other legal entity, then all such individuals, partnerships, corporations and/or entities shall be jointly and severally liable as Tenant hereunder.

Article 51 - No Light or Air Rights

Nothing herein contained shall be construed to grant to or create in Tenant any easements of light or air, Tenant's rights being limited to the use and occupancy of the Premises and the license to use the Common Areas as they may exist from time to time, all subject to the terms, covenants and conditions of this Lease.

Article 52 - Financial Statements

INTENTIONALLY OMITTED.

Article 53 - Survival

Tenant's obligation to pay the Annual Rental, taxes, Common Area Costs, insurance and all other charges due hereunder and applicable to the Term and any and all Tenant indemnities contained herein shall survive the expiration of this Lease.

Article 54 - Tobacco Advertising Ban

Tenant acknowledges and agrees that no advertising of cigarettes or tobacco products is allowed on any real property owned by or under the control of the City, including property which is the subject of this Lease. This prohibition includes the placement of the name of a company producing, selling or distributing cigarettes or tobacco products or the name of any cigarette or tobacco product in any promotion of any event or product. This prohibition does not apply to any advertisement sponsored by a state, local or nonprofit entity designed to communicate the health hazards of cigarettes or tobacco products or to encourage people not to smoke or to stop smoking.

Article 55 - Non-Discrimination Ordinances

Lessee agrees to comply fully with the provisions of Chapters 12B, 12C and 12D of the Administrative Code of City, as amended from time to time, relating to equal opportunity in employment and business practices. Such provisions are incorporated herein and by this reference made a part of this Lease as though fully set forth herein.

Article 56 – Landlord Termination Rights

Landlord shall have the right to terminate this Lease, effective immediately upon written notice to Tenant and without cost or penalty to Landlord, in the event any one of the following occurs: (i) a court of competent jurisdiction determines that Tenant, or any principal, owner, manager or partner of Tenant (collectively, a “**Tenant Affiliate**”), has engaged in fraudulent business practices; (ii) City or the Parking Authority of City (“**Authority**”) disbars, suspends or prevents a Tenant Affiliate from bidding on or entering into any contracts with City or Authority; or (iii) Tenant commits an event of default under any other contract with City or Authority, following any applicable notice and cure period.

Article 57 - Charter Provisions

All terms of this Lease shall be governed by and be subject to the fiscal and other provisions of the Charter of City, as now existing or hereafter amended.

THE SUBMISSION OF THIS LEASE FOR EXAMINATION DOES NOT CONSTITUTE A RESERVATION OF, OR OPTION FOR, THE PREMISES OR ANY OTHER SPACE WITHIN THE RETAIL CENTER, AND SHALL VEST NO RIGHT IN TENANT. THIS LEASE SHALL BECOME EFFECTIVE AS A LEASE ONLY UPON EXECUTION AND DELIVERY BY ALL PARTIES HERETO. NOTWITHSTANDING ANYTHING TO THE CONTRARY CONTAINED IN THIS LEASE, TENANT ACKNOWLEDGES AND AGREES THAT NO OFFICER OR EMPLOYEE OF LANDLORD HAS AUTHORITY TO BIND LANDLORD TO THIS LEASE UNLESS AND UNTIL (i) LANDLORD’S BOARD OF DIRECTORS, OR THE APPLICABLE COMMITTEE OF LANDLORD’S BOARD OF DIRECTORS, SHALL HAVE APPROVED THIS LEASE BY APPROPRIATE ACTION AND AUTHORIZED THE TRANSACTIONS CONTEMPLATED HEREBY AND (ii) CITY’S DIRECTOR OF PROPERTY SHALL HAVE APPROVED THIS LEASE AS TO FORM AND CONTENT. THEREFORE, ANY OBLIGATIONS OR LIABILITIES OF LANDLORD HEREUNDER ARE CONTINGENT UPON SUCH APPROVAL BY LANDLORD’S BOARD OF DIRECTORS, OR THE APPLICABLE COMMITTEE OF LANDLORD’S BOARD OF DIRECTORS, AND THIS LEASE SHALL BE NULL AND VOID UNLESS CITY’S DIRECTOR OF PROPERTY APPROVES THIS LEASE, IN THEIR RESPECTIVE SOLE AND ABSOLUTE DISCRETION, AND IN ACCORDANCE WITH ALL APPLICABLE LAWS. APPROVAL OF THIS LEASE BY ANY AGENT OR REPRESENTATIVE OF LANDLORD SHALL NOT BE DEEMED TO IMPLY THAT EITHER OF THE FOREGOING APPROVALS BY LANDLORD’S BOARD OF DIRECTORS, OR THE APPLICABLE COMMITTEE OF LANDLORD’S BOARD OF DIRECTORS, OR THE CITY’S DIRECTOR OF PROPERTY SHALL BE OBTAINED, NOR WILL ANY SUCH APPROVAL BY ANY AGENT OR REPRESENTATIVE OF LANDLORD CREATE ANY BINDING OBLIGATIONS ON LANDLORD.

Article 58- Communications Equipment

During the Term of this Lease (and any renewals or extensions thereof), Tenant shall have the right, without payment of any fee or charge therefor, to install and operate one (1) microwave transmitter-receiver or satellite dish (the “**Satellite Dish**”) of a weight, height and

width reasonably acceptable to Landlord to provide music to the Premises in connection with Tenant's use thereof; provided, however, the Satellite Dish may not be used for the provision of cellular phone or PCS signal transmission. Tenant's rights pursuant to this Article 58 are subject to the following:

(a) The precise location of the Satellite Dish shall be as approved by Landlord in its reasonable discretion within ten (10) days following receipt of Tenant's request to install the Satellite Dish on the Structure.

(b) Tenant shall pay any federal, state and local taxes applicable to the installation and use of the Satellite Dish and Tenant shall procure, maintain and pay for and obtain all fees, permits and governmental agency licenses necessary in connection with the installation, maintenance and operation of the Satellite Dish; provided, however, that Landlord shall reasonably cooperate, at no unreimbursed cost to Landlord, with the efforts of Tenant in connection with any governmental application or filing required thereby.

(c) Tenant shall be permitted, at its expense, but without separate charge other than any charges permitted to be imposed by Landlord under Article 5 hereof, to install a chaseway in the core of the Structure and to install, modify, alter, repair, maintain, operate and replace in such chaseway one (1) non-dedicated conduit for its cabling use. The location of such chaseway shall be subject to Landlord's approval in its sole discretion. All installations required in connection with such Satellite Dish shall be made by means of conduits, wires or cables that will pass through such chaseway, and all cables and wires located on the Structure used in connection with the Satellite Dish shall be covered by rust-proof conduits and attachments. The installation of the Satellite Dish shall be subject to Landlord's review and approval and shall conform to the engineering standards commonly used for installing similar microwave and satellite dishes on comparable buildings.

(d) Tenant, at its sole cost and expense, shall comply with all present and future laws, and with any reasonable requirements of any applicable fire rating bureau relating to the maintenance, use, installation and operation of the Satellite Dish. Tenant shall install, maintain and operate all of its equipment used in connection with the Satellite Dish in conformity with all laws and all regulations of all government agencies having jurisdiction over the installation, use and operation of the Satellite Dish, including, without limitation, the Federal Aviation Administration and the Federal Communications Commission; provided, however, that if compliance with such laws or regulations would require a change in the size, configuration or location of the Satellite Dish, such changes shall be subject to Landlord's prior written consent in accordance with subsection (a) above.

(e) Prior to the expiration or earlier termination of the Term of this Lease, Tenant shall remove the Satellite Dish and all wires and cables used in connection with the Satellite Dish, and shall restore and repair all damage to the Structure occasioned by the installation, maintenance or removal of the Satellite Dish. If Tenant fails to timely complete such removal, restoration and repair, all sums incurred by Landlord to complete such work shall be paid by Tenant to Landlord upon demand.

(f) Landlord makes no representations or warranties whatsoever with respect to the fitness or suitability of the Structure for the installation, maintenance and operation of the Satellite Dish, including, without limitation, with respect to the quality and clarity of any receptions and transmissions to or from the Satellite Dish and the presence of any interference with such signals, whether emanating from the Structure or otherwise.

(g) Tenant must contact the manager of the Structure prior to the date Tenant proposes to install the Satellite Dish on the Structure in order to make arrangements for the movement of any materials needed in connection with the installation of the Satellite Dish.

(h) Tenant shall provide adequate maintenance personnel in order to ensure the safe operation of the Satellite Dish. In addition, Tenant shall install, maintain and operate all of its equipment used in connection with the Satellite Dish in a fashion and manner so as not to interfere with the use and operation of any: (i) other television or radio equipment in the Structure; provided, however, any future Retail Center tenant shall not be permitted to install a similar satellite dish in such a manner as to interfere with Tenant's use and operation of Tenant's Satellite Dish; (ii) present or future electronic control system for any of the building systems or the operation of any elevators in the Structure; (iii) other transmitting, receiving or master television, telecommunications or microwave antenna equipment currently located on the Structure; or (iv) any radio communication system now used by Landlord. In addition, Tenant shall use its commercially reasonable efforts to ensure that Tenant will not interfere with any equipment installed by Landlord in the future.

[BALANCE OF THIS PAGE INTENTIONALLY LEFT BLANK;
SIGNATURE PAGE FOLLOWS.]

IN WITNESS WHEREOF the parties hereto have executed this Lease as of the dates set forth beneath each party's signature below.

LANDLORD

CITY OF SAN FRANCISCO, DOWNTOWN
PARKING CORPORATION,
a California nonprofit corporation

By: [Signature]

Its: President

Date: 2-20 2004

APPROVED:

By: [Signature]

Director of Property
CITY AND COUNTY OF
SAN FRANCISCO

Date: 2/18, 2004

TENANT

SPRINT SPECTRUM, L.P.,
a Delaware limited partnership

By: [Signature]

Its: MANAGER

By: _____

Its: _____

Date: 2-6, 2004

Schedule 1

MASTER LEASE

[See attached copy]

SAN FRANCISCO, CA RECORDER'S OFFICE
Bruce Jamison, Recorder
DOC - F296210

RECORDING REQUESTED BY, AND
WHEN RECORDED RETURN TO:

Thursday, February 18, 1993 10:38:36am
Rec 42.00 --- Pa 40.00
Stp 39.00 --- Mic 1.00
Amt 122.00
TOTAL -> \$122.00
REEL F818 IMAGE 0348

Orrick, Herrington & Sutcliffe
400 Sansome Street
San Francisco, CA 94111
Attn: Neil P. Casey, Esq.
LOT 67 BLOCK 3720

SP-210333 BJC

DOCUMENTARY TRANSFER TAX \$ 0
 COMPUTED ON FULL VALUE OF PROPERTY CONVEYED, OR
 COMPUTED ON FULL VALUE LESS LIENS & ENCUMBRANCES
REMAINING THEREON AT TIME OF SALE
Neil P. Casey
Signature of declarant or agent determining tax - firm name

FIFTH AND MISSION PUBLIC PARKING GARAGE
LEASE

BY AND BETWEEN

THE CITY AND COUNTY OF SAN FRANCISCO

AND

THE CITY OF SAN FRANCISCO DOWNTOWN
PARKING CORPORATION

Dated as of April 1, 1992

FIFTH AND MISSION PUBLIC PARKING GARAGE
LEASE

This lease dated for convenience as of April 1, 1992, by and between the City and County of San Francisco, a California municipal corporation ("Landlord"), and the City of San Francisco Downtown Parking Corporation, a California nonprofit corporation ("Tenant"), who agree as follows:

1. PREMISES

Landlord leases to Tenant and Tenant leases from Landlord the real property described in Exhibit A attached hereto (the "Site") and all buildings and improvements now or hereafter located thereon (the "Improvements" and together with the Site, the "Premises").

2. TERM

The term shall commence upon recordation hereof and shall expire 50 years after the date of commencement; provided, however, that this lease shall terminate upon the payment and retirement by Tenant of the indebtedness provided for in Section 4.2 hereof and the release of any indebtedness or other security for such indenture, whichever shall first occur.

3. SUITABILITY; ACCEPTANCE

Tenant acknowledges that Landlord has made no representations concerning the Improvements and Tenant represents that Tenant currently possesses a leasehold interest in the Improvements, is in possession of the Improvements and has examined the Improvements to determine their condition and

suitability for conduct of Tenant's business. By continuing its possession of the Improvements, Tenant shall be deemed to have accepted the Improvements as being in good condition and suitable for conduct of Tenant's business. Landlord shall have no obligation to alter, remodel, improve, repair, decorate or paint the Improvements or any part thereof, except as specifically provided in this lease.

4. PAYMENTS BY TENANT

4.1. Rent

At the commencement of this lease pursuant to Section 2, the Tenant shall pay One Dollar (\$1.00) to the Landlord in lawful money of the United States of America, as basic rent under this lease.

4.2. Indebtedness

Landlord hereby consents to Tenant's issuance of its indebtedness in such amount as may be necessary to finance the construction, alteration or improvement of all or part of the Premises. The Tenant hereby agrees to pay to the holder of all such indebtedness all amounts payable by the Tenant upon such indebtedness, together with interest thereon, in accordance with the terms thereof. Notwithstanding anything to the contrary contained herein, to the extent the terms and conditions contained in an indenture, other written instrument or related document securing any indebtedness issued by the Tenant for the purposes set forth in this subparagraph 4.2 (the "security instrument") conflict with any of the terms or conditions

contained in this lease, the terms and conditions of such security instrument shall control.

5. TAXES AND ASSESSMENTS

Tenant agrees to pay prior to delinquency all taxes and assessments of any kind, which lawfully may be imposed on the Premises or on Tenant, including (but not limited to) possessory interest taxes and non-property taxes. Tenant is hereby granted Landlord's consent to contest the validity or the amount of any such tax or assessment, if Tenant chooses to do so. Notwithstanding the foregoing, Landlord agrees to pay any future tax imposed upon the Premises or Tenant by the City together with any similar tax imposed by Landlord at any future date, so long as this lease is in effect.

Tenant acknowledges and understands that a possessory interest subject to property taxation may be created by this lease and that Tenant may be subject to the payment of property taxes levied on such possessory interest. Tenant further acknowledges that Tenant is familiar with San Francisco Administrative Code Sections 23.6-1 and 23.6-2, which require that Landlord submit a report, which includes specified information relating to the creation, renewal, sublease, or assignment of any such possessory interest, to the County Assessor within 60 days after any such transaction. Tenant agrees to provide to Landlord the information required by Section 23.6-2 within 30 days after any such transaction, if requested to do so by Landlord.

6. USE

6.1. Use of Premises

The Premises shall be used for a public off-street parking facility, except that Tenant may use the first floor frontage of the Premises along Mission, Fourth and Fifth Streets, for retail or other commercial uses. With the prior written consent of Landlord, Tenant may use other space in the Premises for commercial purposes as from time to time is determined by Tenant to be unsuitable or unnecessary for parking purposes, provided, however, that such usage does not cause interest on the indebtedness to be included in gross income for federal income tax purposes. The public off-street parking facility shall be operated for the benefit and convenience of the public, which shall have the right to use said facility at all times at rates and charges that are established as hereinafter provided.

6.2. Limitations on Use

Tenant's use of the Premises as provided in this lease shall be in accordance with the following:

(a) Tenant shall not do, bring, or keep anything in or about the Premises that will cause a cancellation of any insurance covering the Premises.

(b) Tenant shall comply with all laws concerning the Premises or Tenant's use of the Premises, including, without limitation, the obligation at Tenant's cost to alter, maintain, or restore the Premises in compliance and conformity with all laws relating to the condition, use, or occupancy of the Premises during the term.

(c) Tenant shall not use the Premises in any manner that will constitute waste, nuisance or unreasonable annoyance to owners or occupants of adjacent properties.

(d) Tenant shall not do anything on the Premises that will cause damage to the Premises. The Premises shall not be overloaded beyond its weight-bearing capacity.

7. MAINTENANCE

Except as provided in Sections 17 and 18, Tenant, at its cost, shall maintain the Premises in good condition. Landlord shall have no responsibility to maintain the Premises. Tenant waives the provisions of Civil Code Sections 1941 and 1942 with respect to Landlord's obligations for tenantability of the Premises and Tenant's right to make repairs and deduct the expenses of such repairs from rent.

8. DISBURSEMENTS

At all times during the term of this Lease, the trustee under the security instrument shall make all disbursements to pay costs of operation and maintenance upon the basis of certificates executed by the principal financial officer of the Tenant and delivered to the trustee under the security instrument, and bearing, by endorsement thereon, the approval of the Controller of the Landlord or his duly authorized representative.

The amounts to be disbursed and all disbursements actually made pursuant to the security instrument and this Lease (other than amounts required to be deposited pursuant to the security instrument) shall be subject to examination, audit and approval by the Controller of the Landlord, to whom any dispute

with respect thereto shall be submitted, and whose determination of such dispute shall be final. The provisions of this Section 8 shall not affect in any way the rights or duties of the trustee under the security instrument, which shall be governed exclusively by the security instrument.

The trustee under the security instrument shall render an annual accounting to the Landlord, the Parking and Traffic Commission of the City and County of San Francisco ("Commission") and the Tenant as soon as reasonably possible after April 30th of each year. The Tenant shall prepare and submit at least thirty (30) days prior to commencement of operation of the Premises a budget setting forth in reasonable detail the contemplated expenditures to be included in the operation of the Premises during the initial period from the date of this lease to and including the following 30th day of April and shall annually thereafter prepare and submit on or before the first day of each March a similar budget for each succeeding fiscal year or portion thereof during the term of this Lease. One (1) copy of each budget shall be filed with the trustee under the security instrument, one (1) copy shall be filed with the Controller of the Landlord and one (1) copy shall be filed with the commission. The said Controller shall review the budget and make such recommendations with respect thereto as he may deem advisable and deliver a copy thereof to the Tenant and the trustee under the security instrument. Each such budget shall be changed to conform to any recommendations of the Controller, and the Tenant shall conform to each budget with such changes, if

any, as shall have been recommended by the Controller. The Tenant shall, within ten (10) days after the end of each calendar month during the term of the lease, render to the trustee under the security instrument, the Controller and the Commission a correct, detailed and complete statement in writing on a form approved by the Controller showing all gross receipts and all costs of operation during such month. Such statement shall be signed and verified under oath and forwarded to the Controller and the Commission. The Tenant agrees to keep full, true and accurate books, records and accounts at all times during the term of this lease of the gross receipts and costs of operation and maintenance, the details of operation and of such other matters and to render such reports thereon as may be required by the Controller or the Commission, and the Landlord and its representatives shall at all times have the right to inspect, examine and audit all such records and accounts.

The term "costs of operation and maintenance" as used herein means all costs and expenses of operation and maintenance of the facilities, all taxes, including possessory interest taxes, and similar charges required to be paid by Tenant, all additions, betterment, improvements, renewals, uninsured costs of reconstruction, replacement or repair, if any, and all other costs and expenses of any kind or character incurred by or on behalf of the Tenant in connection with the use and operation of the Premises and all other costs and expenses approved by the Controller, including the fees of the trustee under the security instrument, administrative expenses, amounts paid as a fee or

otherwise to any professional operator employed by the Tenant, legal expense, all overhead expenses of the Tenant, bookkeeping and auditing costs, electric light and power charges, telephone, water, garbage and other public utility services, costs of advertising, costs of all insurance, bonds, compensation insurance, payroll taxes, costs of complying with any order of any governmental body required in connection with the use and operation of the Premises, any liability arising out of Tenant's obligations under subsection 24.4 of this Lease and all other expenses, whether similar or dissimilar, but excluding any charges or allowances for depreciation or amortization of the Tenant's interest in the Premises.

9. ALTERATIONS

All alterations and improvements that may be made by the Tenant shall comply with all building, electrical, plumbing, health and fire codes of the City and County of San Francisco. Tenant shall be allowed to make such alterations and improvements at its own expense, provided that plans for such work must be submitted to and approved in writing by Landlord's Director of the Department of Parking and Traffic before commencing such work. Unless otherwise provided by written agreement, all additions to and improvements and alterations of the Premises, except trade fixtures of any subtenants, shall become a part of the realty, and be the property of Landlord and remain upon and be surrendered with the Premises. Tenant agrees that if it or any subtenant shall make any alterations or improvements, they shall not be commenced until five days after Landlord has

received written notice from Tenant stating the date installation of the alterations is to commence, in order that the Landlord may post appropriate notices of non-responsibility. Tenant will at all times permit such notices to be posted and to remain posted for the time required by law.

10. MECHANICS' LIENS

Tenant shall pay all costs for construction done by it or caused to be done by it on the Premises. Tenant shall keep the Premises and all interests therein free and clear of all mechanics' liens and claims of mechanics' liens resulting from construction done by or for Tenant.

Tenant shall have the right to contest the correctness or the validity of any such lien if, immediately on demand by the Landlord, Tenant procures and records a lien release bond issued by a corporation authorized to issue surety bonds in California in an amount equal to one and one-half times the amount of the claim of lien. The bond shall meet the requirements of Civil Code Section 3143 and shall provide for the payment of any sum that the claimant may recover on the claim (together with costs of suit, if claimant recovers in the action).

11. UTILITIES AND SERVICES

Tenant shall make all arrangements for and pay for all utilities and services furnished to or used by it, including, but not limited to, gas, electricity, water, telephone service, janitorial service and trash collection, and for all connection charges, provided, however, that Landlord may elect to furnish some or all of the utility services required by Tenant and, in

such event, Tenant shall pay to Landlord the prevailing rates for all such utility services furnished to or used by Tenant together with reasonable charges for the connection and maintenance of such utility services.

12. OPERATION AND CONDITION OF PREMISES

Tenant agrees, at its own expense, to maintain and keep the Premises clean and in good condition and repair, to operate therein a first-class parking garage during the term of this lease and not to vacate or abandon the Premises during said term. Upon expiration or earlier termination of this lease, Tenant shall surrender the Premises, including the garage structure and any and all fixtures (except trade fixtures installed by subtenants), to Landlord free and clear of liens and encumbrances and in as good condition as when received except for ordinary wear and tear and damage by act of God, the elements, the public enemy or any casualty not included within the risks to be insured against under paragraph 15 hereof.

13. PUBLIC USE OF PARKING FACILITY

The public shall be entitled, as a matter of right, to use the Premises, except such part as is used for retail or other commercial purposes, as a public off-street parking facility subject to such rates, charges, hours of operation, regulations and restrictions as may be fixed and established from time to time by Landlord.

14. RATES, CHARGES, RULES AND REGULATIONS

(a) Subject to the terms and conditions of any security instrument, Landlord may from time to time establish and

thereafter modify all rates and charges for parking of vehicles by Tenant or any other person, firm or corporation, and reasonable rules and regulations for operation of the parking facility, including but not limited to, the hours and days of operation, restrictions on all-day and monthly parking, and the public uses and purposes permissible on or in the Premises. Tenant will at all times comply with said rates, charges, rules and regulations. All of the terms and provisions of this lease with respect to such rates and charges, hours and days of operation, restrictions on all day and monthly parking and public uses and purposes are subject to modification by Landlord.

(b) Upon application of Tenant, Landlord shall set and establish rates and charges for the parking of vehicles on the Premises which shall be adequate to insure that the gross receipts collected by Tenant, together with any funds that may be provided by Landlord, in its sole discretion, or by the City of San Francisco Uptown Parking Corporation, will at least equal the amounts sufficient to make such payments as may be required by any security instrument and the operation and maintenance expenses of the Premises plus any additional amount which may be required to be paid into a capital improvement reserve fund or to meet any debt service coverage test which may be established by any security instrument.

15. INDEMNITY AND EXCULPATION

15.1. Exculpation

Landlord shall not be liable to Tenant and Tenant waives all claims against Landlord for any damage to Tenant or

Tenant's property from any cause, excepting only any damage resulting solely and exclusively from willful misconduct of Landlord or Landlord's authorized representatives.

15.2. Indemnity

Tenant shall hold Landlord and Landlord's officers, agents and employees harmless from, and, if requested, shall defend them against, any and all claims, direct or vicarious liability, damage or loss arising out of: (a) any injury to or death of any person or damage to or destruction of any property occurring in, on or about the Premises, or any part thereof, from any cause whatsoever, or (b) any default by Tenant in the observance or performance of any of the terms, covenants or conditions of this lease, or (c) the use, occupancy or condition of the Premises or Tenant's activities therein. The foregoing indemnity obligation of Tenant shall include, but not be limited to, claims, liability, damage or loss predicated, in whole or in part, upon active or passive negligence of Landlord or Landlord's officers, agents or employees, and shall exclude only claims, liability, damage or loss resulting solely and exclusively from the willful misconduct of Landlord or Landlord's authorized representatives. The foregoing indemnity obligation of Tenant shall include reasonable attorneys' fees, investigation costs and all other reasonable costs and expenses incurred by Landlord from the first notice that any claim or demand is or may be made and, to the extent such costs are not covered by insurance, they shall be deemed an operation and maintenance expense of Tenant. The

provisions of this paragraph shall survive the termination of this lease with respect to any damage, destruction, injury or death occurring prior to such termination.

16. INSURANCE

16.1. Required by Security Instrument.

Tenant, at its cost, shall maintain such insurance during the term of this lease as is required by any security instrument:

16.2. Additional Insured.

Any property insurance that is so maintained by Tenant shall, in addition to other named insured, name Landlord as an insured, as its interest may appear. Any liability insurance that is so maintained by Tenant shall, in addition to other insured parties, name Landlord and Landlord's officers, agents and employees as additional or named insured and the policy shall contain cross-liability coverage.

16.3. Waiver of Subroqation

The parties release each other, and their respective authorized representatives, from any claims for damage to any person or to the premises or to the fixtures, personal property, Tenant's improvements or alterations of either Landlord or Tenant in or on the Premises that are caused by or result from risks insured against under any insurance policy carried by the parties and in force at the time of any such damage, to the extent such claims for damage are covered by such policy.

Each party shall cause each insurance policy obtained by it to provide that the insurance company waives all right of

recovery by way of subrogation against either party in connection with any damage covered by any policy. Neither party shall be liable to the other for any damage caused by fire or any of the risks insured against under any insurance policy required by this lease, to the extent such damage is covered by such policy.

16.4. General Insurance Matters

(a) All the insurance required under this lease shall:

(1) Be issued by insurance companies authorized to do business in the State of California, with a financial rating of at least an A + 3A status as rated in the most recent edition of Best's Insurance Reports.

(2) Be issued as a primary policy.

(3) Contain an endorsement requiring 30 days written notice from the insurance company to both parties and the Trustee before cancellation or change in the coverage, scope, or amount of any policy.

(b) Each policy, or a certificate of the policy, together with evidence of payment of premiums, shall be deposited with Landlord at the commencement of the term and, on renewal of the policy, not less than 20 days before expiration of the term of the policy.

17. DESTRUCTION

17.1 Destruction Due to Risk Covered by Insurance

If, during the term of this lease, the Premises are totally or partially destroyed from a risk required to be covered by the insurance described in Section 16, rendering the Premises totally or partially inaccessible or unusable, Tenant shall apply

the proceeds of such insurance as provided in an a security instrument issued by Tenant as provided in subsection 4.2 hereof and, if no such security instrument shall then be in effect, shall apply the proceeds as instructed in writing by Landlord.

17.2. Destruction Due to Risk Not Covered by Insurance

If, during the term of this lease, the Premises are totally or partially destroyed from a risk not required to be covered by the insurance described in Section 16, rendering the Premises totally or partially inaccessible or unusable, Tenant shall take such action as is required by a security instrument securing any indebtedness issued by Tenant as provided in subsection 4.2 hereof and, to the extent it is consistent with said security instrument, shall continue to operate the Premises in substantially the same manner as they were being operated immediately before destruction. Such destruction, in and of itself, shall not terminate this lease.

18. EMINENT DOMAIN

If, during the term of this lease, there is any taking of all or any part of the Premises or any interest in this lease by condemnation, the rights and obligations of the parties and the application of any moneys received in connection with such taking shall be determined as provided in any security instrument relating to any indebtedness issued by the Tenant as provided in subparagraph 4.2 hereof and, if none is then in effect, said rights, obligations and allocations shall be determined according to general California law.

19. ASSIGNMENT AND SUBLETTING

Landlord agrees that Tenant may at any time assign, mortgage or otherwise encumber Tenant's interest in this lease and leasehold estate as security for the payment of any indebtedness of the Tenant issued pursuant to subsection 4.2 hereof, subject to the condition that any such assignment, mortgage or other encumbrance shall provide that the assignee, mortgagee or person in whose favor such encumbrance shall be made (hereinafter called "Trustee") shall be obligated to perform the terms of this lease on Tenant's part to be performed while, but only while, such Trustee is in possession of the Premises. If a Trustee acquires Tenant's leasehold estate by foreclosure, deed in lieu of foreclosure or other lawful procedure, such Trustee shall hold the leasehold estate subject to all provisions of this lease and shall be bound to perform all obligations of Tenant hereunder and in accordance with the terms of the security instrument.

This lease may not be otherwise assigned, sublet, transferred or hypothecated by Tenant without the written consent of Landlord, which consent shall not be unreasonably withheld. No assignment (except any assignment for security purposes hereinabove provided for) shall be effective unless the assignee shall execute an assumption agreement in form, scope and substance satisfactory to Landlord, assuming all the obligations of Tenant hereunder. No subletting shall be effective unless the subtenant shall execute an agreement which provides that the sublease is subject and subordinate to the terms of this lease.

No assignment or subletting pursuant to this section 19 shall occur if such assignment or subletting would cause interest on the indebtedness to be included in gross income for federal income tax purposes.

Consent to any assignment, subletting, mortgage or other encumbrance, included the consent given herein, shall not be deemed to constitute consent to any other attempted assignment, subletting, mortgage or other encumbrance, except an assignment, mortgage or other encumbrance given as security for any indebtedness of Tenant issued pursuant to subsection 4.2 hereof.

20. DEFAULT

20.1. Tenant's Default

The occurrence of any of the following shall constitute a default by Tenant:

(a) Abandonment and vacation of the Premises (failure to occupy and operate the Premises for five consecutive days shall be deemed an abandonment and vacation).

(b) Failure to perform any other provision of this lease if the failure to perform is not cured within 30 days after notice has been given to Tenant. If the default cannot reasonably be cured within 30 days, Tenant shall not be in default of this lease if Tenant commences to cure the default within the 30 day period and diligently and in good faith continues to cure the default.

(c) Either: (1) the failure of Tenant to pay its debts as they become due, or the written admission of Tenant of

its inability to pay its debts, or a general assignment by Tenant for the benefit of creditors; or (2) the filing by Tenant of a petition in voluntary bankruptcy seeking reorganization, arrangement, liquidation, or other relief under any state or federal law relating to bankruptcy, insolvency, or reorganization or seeking or consenting to the appointment of a trustee, receiver, or liquidator of Tenant or of any substantial part of Tenant's assets; or (3) entry by a court of competent jurisdiction of an order, judgment or decree declaring Tenant an insolvent or adjudging Tenant a bankrupt, or appointing a trustee or receiver for Tenant or of the whole or any substantial part of the Premises, or approving a petition filed against Tenant seeking reorganization of Tenant under any applicable law or statute of the United States of America or any state thereof, if such order, judgment or decree shall not be vacated or set aside or stayed within 60 days from the date of the entry thereof; or (4) the attachment, execution or other judicial seizure of substantially all of Tenant's assets located at the Premises or of Tenant's interest in this lease, unless such seizure is discharged within ten days.

Notices given under this paragraph shall specify the alleged default and the applicable lease provisions, and shall demand that Tenant perform the provisions of this lease or pay the rent that is in arrears, as the case may be, within the applicable period of time, or quit the Premises. No such notice shall be deemed a forfeiture or a termination of this lease unless Landlord so elects in the notice.

The purpose of the notice requirements set forth in this subsection is to extend the notice requirements of the unlawful detainer statutes of California.

20.2. Landlord's Remedies

If Tenant commits a default, Landlord shall have the following remedies, in addition to all other rights and remedies allowed by law, subject, however, to the rights of the holders of any indebtedness secured by a security instrument:

(a) The right to terminate this Lease, in which event Tenant shall immediately surrender possession of the Premises and pay to Landlord all rental and other amounts payable by Tenant hereunder to the date of such termination.

(b) The remedies described in California's Civil Code section 1951.2, including, but not limited to, the right to recover the worth at the time of award of the amount by which the unpaid rent for the balance of the term after the time of award exceeds the amount of rental loss that Tenant proves could be reasonably avoided.

(c) The remedy described in California Civil Code section 1951.4 (lessor may continue the lease in effect after lessee's breach and abandonment and recover rent as it becomes due, if lessee has the right to sublet or assign, subject only to reasonable limitations.)

20.3. Trustee's Right to Cure Defaults

In the event of a default under subsection 20.1, Landlord shall give written notice to any Trustee under the security instrument of the occurrence and nature of the default.

Such Trustee shall have all of the rights to cure the default that are given to such Trustee under the security instrument.

Such Trustee shall give written notice to Landlord of its address and the existence and general nature of its security interest. Notice of default mailed by first class mail to the Trustee at the address so given to Landlord shall be sufficient compliance with Landlord's obligation to notify such Trustee of defaults. Failure of such Trustee to give notice to Landlord of its address shall constitute a waiver of such Trustee's right to receive notices of default and to cure any default.

21. SIGNS

Tenants shall not have the right to place, construct, or maintain any sign, advertisement, awning, banner, or other exterior decoration without Landlord's written consent, which Landlord shall not unreasonably withhold.

Any sign that Tenant shall be permitted to place, construct and maintain shall comply with all laws, and Tenant shall obtain all permits and approvals required by such laws, including, if necessary, approval of the Art Commission of the City and County of San Francisco. Landlord makes no representation with respect to Tenant's ability to obtain such approvals. If requested by Landlord, Tenant at its cost shall remove all signs placed by it on the Premises at the expiration or earlier termination of this lease.

Landlord shall have the right to use for its signs, or for signs placed thereon by others with Landlord's consent, the exterior walls of the Premises.

22. LANDLORD'S ENTRY ON PREMISES

(a) Landlord and its authorized representatives shall have the right to enter the Premises at all reasonable times for any of the following purposes:

(1) To determine whether the Premises are in good condition and whether Tenant is complying with its obligations under this lease.

(2) To do any necessary maintenance and to make any restoration to the Premises that Landlord has the right or obligation to perform.

(3) To serve, post, or keep posted any notices required or allowed under the provisions of this lease.

(4) to shore the foundations, footings, and walls of the Premises and to erect scaffolding and protective barricades around and about the Premises, but not so as to prevent entry to the Premises, and to do any other act or thing necessary for the safety or preservation of the Premises if any excavation or other construction is undertaken or is about to be undertaken on any adjacent property or nearby street. Landlord's right under this provision extends to the owner of the adjacent property on which excavation or construction is to take place and the adjacent property owner's authorized representatives.

(b) Landlord may enter the Premises at any time, without notice, in the event of an emergency. Landlord shall have the right to use any and all means which Landlord may deem proper to open the doors in an emergency in order to obtain entry to the Premises. Any entry to the Premises by any of said means,

or otherwise, shall not under any circumstances be construed or deemed to be a forcible or unlawful entry into, or a detainer of the Premises, or an eviction of Tenant from the Premises or any portion of them.

(c) Landlord shall not be liable in any manner for any inconvenience, disturbance, loss of business, nuisance, or other damage arising out of Landlord's entry on the Premises as provided in this Section 22, except damage resulting from the active negligence or wilful misconduct of Landlord or its authorized representatives.

(d) Landlord shall conduct its activities on the Premises as allowed in this Section 22 in a manner that will cause the least possible inconvenience, annoyance, or disturbance to Tenant and any approved subtenants.

23. MANAGEMENT OF THE PREMISES

During the term of this lease Tenant shall employ, as a professional operator, a person, firm or corporation with a staff experienced in the management and operation of public parking facilities. Tenant's selection of such operator shall be subject to approval by Landlord of: (i) the identity of the operator; (ii) the manner in which such operator is selected, by bid or otherwise, and (iii) the terms of the contract engaging such operator. The terms of the contract shall comply with the Internal Revenue Code of 1986, as amended, and the rules and regulations promulgated thereunder and under the Internal Revenue Code of 1954, as amended, relating to obligations the interest on which is excluded from gross income for federal tax purposes.

The operation of a public parking facility on the Premises is subject to the provisions of the San Francisco Charter Section 7.204, and the San Francisco Administrative Code, Chapter 6, Sections 6.33 through 6.45, inclusive, relating to working conditions and payment of prevailing wages, and said sections are incorporated herein by this reference and made a part hereof as though fully set forth herein. Any employee performing services in connection with the operation of the parking facility, whether as now existing or as heretofore or at any time hereafter enlarged and whether the employee be employed by Tenant or by the professional operator mentioned above, shall be paid not less than the highest general prevailing rate of wages, shall be subject to the same hours and working conditions, and shall receive the same benefits as in each case are provided for similar work in private employment performed in San Francisco, California.

24. COMPLIANCE WITH LAWS

24.1. Nondiscrimination Provisions

Tenant shall not, in the operation and use of the Premises, discriminate against any person or group of persons because of race, color, creed, national origin, ancestry, age, sex, sexual orientation, disability or acquired immune deficiency syndrome (AIDS) or AIDS related condition (ARC). The provisions of Chapters 12B and 12C of the San Francisco Administrative Code, relating to nondiscrimination by parties contracting with the City and County of San Francisco, are incorporated herein by this reference and made a part hereof as though fully set forth herein.

Tenant agrees to comply with all provisions of said Chapters 12B and 12C that apply to tenants of the City and County of San Francisco.

24.2. South Africa Divestment Ordinance.

(a) Incorporation by Reference. Article XIX, Section 10.210 through 10.220, inclusive, of the San Francisco Administrative Code, and any amendments thereto, are incorporated herein by reference. Noncompliance by Tenant with any of the provisions of said Article shall be deemed a material breach of this lease.

(b) Tenant declares that it is not the government of South Africa, a person or business entity organized under the laws of South Africa or a person or entity doing business in South Africa. Tenant further declares that it does not have a prohibited ownership interest as defined in Section 10.211 of Article XIX of the San Francisco Administrative Code. Landlord reserves the right to terminate this lease for default if Tenant violates the terms of this clause.

(c) Liquidated Damages. In the event Tenant fails to comply in good faith with any of the provisions of Article XIX of the San Francisco Administrative Code, Tenant shall be liable for liquidated damages for each violation in an amount equal to Tenant's net profit on the contract, or 10 percent of the total amount of the contract, or \$1,000.00, whichever is greatest. Tenant acknowledges and agrees that the liquidated damages assessed shall be payable to the City and County of San Francisco

upon demand and may be set off against any monies due to Tenant from any contract with the City and County of San Francisco.

24.3. Conflict of Interest

Tenant represents that it is familiar with the provisions of Section 8.105 of the San Francisco Charter and Sections 1090 through 1098 and 87100 through 87103.6 of the California Government Code, all of which relate to prohibited conflicts of interest in connection with government contracts. Tenant certifies that it knows of no facts that constitute a violation of said sections, or any of them, and agrees to immediately notify Landlord if Tenant shall at any time obtain knowledge of facts constituting such a violation.

24.4. Hazardous Material

(a) As used in this Lease, "hazardous material" shall mean any substance, water or material which has been determined by any state, federal, or local government authority to be capable of posing a risk of injury to health, safety and property including, but not limited to, all of those materials, wastes and substances designated as hazardous or toxic by the United States Environmental Protection Agency, the City and County of San Francisco, the United States Department of Labor, the United States Department of Transportation, the California Department of Environmental Protection and any other governmental agency now or hereafter authorized to regulate materials and substances in the environment.

(b) Tenant shall not cause or permit any Hazardous Material to be brought upon, kept or used in or about the

Premises by Tenant, its agents, employees, contractors or invitees, without the prior written consent of Landlord, which Landlord shall not unreasonably withhold as long as Tenant demonstrates to Landlord's reasonable satisfaction that such Hazardous Material is necessary or useful to Tenant's operation and will be used, kept and stored in a manner that complies with all laws regulating any such Hazardous Material. If Tenant breaches the obligations stated in the preceding sentence, or if the presence of Hazardous Material on the Premises caused or permitted by Tenant results in contamination of the Premises, or if contamination of the Premises by Hazardous Material causes damage for which Tenant is legally liable to Landlord, then Tenant shall indemnify, defend and hold Landlord harmless from any and all claims, judgments, damages, penalties, fines, costs, liabilities or losses which arise during or after the lease term as a result of such contamination including, without limitation, diminution in value of the Premises, damages for the loss or restriction on use of rentable or usable space or of any amenity of the Premises, damages arising from any adverse impact on marketing of any such space, and sums paid in settlement of claims, attorneys' fees, consultant fees and expert fees. This indemnification of Landlord by Tenant includes, without limitation, costs incurred in connection with any investigation of site conditions or any clean-up, remedial, removal or restoration work required by any federal, state or local governmental agency or political subdivision because of Hazardous Material present in the soil or ground water on or under the

Premises. Without limiting the foregoing, if the presence of any Hazardous Material on the Premises caused or permitted by Tenant results in any contamination of the Premises, Tenant, at its sole expense, shall promptly take all action that is necessary to return the Premises to the condition existing prior to the introduction of such Hazardous Material onto the Premises; provided that Landlord's approval of such actions shall first be obtained, which approval shall not be unreasonably withheld as long as such actions would not potentially have any material adverse effect upon the Premises.

24.5. Charter Provisions

The terms and provisions of this lease shall be governed by and be subject to the provisions of the charter of the City and County of San Francisco as now existing or hereafter amended.

24.6. Laws and Regulations

Tenant, at Tenant's cost and expense, shall comply with all laws, judicial decisions, orders and regulations of federal, state, county and municipal governments and the departments, courts, commissions, boards and officers thereof pertaining to Tenant's use and occupation of the Premises in effect either at the time of execution of this lease or at any time during the term.

25. NOTICE

Any notice, demand, request, consent, approval, or communication that either party desires or is required to give to the other party or any other person shall be in writing and either

served personally or sent, prepaid, by either: (a) first-class mail; (b) certified mail with a return receipt requested; (c) overnight delivery service; or (d) facsimile transmissions. Any notice, demand, request, consent, approval, or communication that either party desires or is required to give to the other party shall be addressed to the other party as follows:

To Landlord: Director of Property
 Department of Real Estate
 City and County of San Francisco
 25 Van Ness Avenue, Room 400
 San Francisco, CA 94102

With A Copy To: Director of the Department of Parking
 and Traffic
 City and County of San Francisco
 25 Van Ness Avenue, Room 410
 San Francisco, CA 94102

To Tenant: Downtown Parking Corporation
 244 Kearny Street
 San Francisco, CA 94108
 Attention: Paul Newman, Esq.

Either party may change its address by notifying the other party of the change of address. Notice shall be deemed communicated within forty-eight (48) hours from the time of mailing if mailed as provided in this section or within twenty-four (24) hours from the time it is delivered to the delivery service if sent by overnight delivery service.

26. WAIVER

No delay or omission in the exercise of any right or remedy of Landlord on any default by Tenant shall impair such a right or remedy or be construed as a waiver.

The receipt and acceptance by Landlord of delinquent rent shall not constitute a waiver of any other default; it shall

constitute only a waiver of timely payment for the particular rent payment involved.

No act or conduct of Landlord, including, without limitation, the acceptance of the keys to the Premises, shall constitute an acceptance of the surrender of the Premises by Tenant before the expiration of the term. Only a notice from Landlord to Tenant shall constitute acceptance of the surrender of the Premises and accomplish a termination of the lease.

Landlord's consent to or approval of any act by Tenant requiring Landlord's consent or approval shall not be deemed to waive or render unnecessary Landlord's consent to or approval of any subsequent act by Tenant.

Any waiver by Landlord of any default must be in writing and shall not be a waiver of any other default concerning the same or any other provision of the lease.

27. RECORDATION; QUITCLAIM DEED

This lease shall be recorded.

Tenant shall execute and deliver to Landlord on the expiration or termination of this lease a quitclaim deed to the Premises, in recordable form, designating Landlord as transferee.

28. SURRENDER OF PREMISES

On expiration of the term, Tenant shall surrender to Landlord the Premises and all Tenant's improvements and alterations in good condition (except for ordinary wear and tear occurring after the last necessary maintenance made by Tenant and except for destruction of the Premises covered by Section 16.)

Tenant shall make an inventory of all its personal property and shall surrender to Landlord all such personal property within the time periods stated in this section.

29. TIME OF ESSENCE

Time is of the essence of each provision of this lease.

30. CONSENT OF PARTIES

Except as expressly provided otherwise, whenever consent or approval of either party is required, that party shall not unreasonably withhold such consent or approval.

31. EXERCISE OF LANDLORD'S RIGHTS

All rights, powers and privileges of Landlord under this lease may be exercised, on behalf of Landlord, by Landlord's Director of the Department of Parking and Traffic without the approval or consent of the Board of Supervisors, or any other board, commission or officer of the City and County of San Francisco, except when such approval or consent is expressly required by charter or ordinance of the City and County of San Francisco or by other applicable law.

32. SUCCESSORS

This lease shall be binding on and inure to the benefit of the parties and their successors, except as provided in Section 19.

33. REAL ESTATE BROKERS; FINDERS

Each party represents that it has not had dealings with any real estate broker, finder, or other person, with respect to this lease in any manner.

Each party shall hold harmless the other party from all damages resulting from any claims that may be asserted against the other party by any broker, finder, or other person, with whom the indemnifying party has or purportedly has dealt.

34. STATUS OF PARTIES ON TERMINATION

Except as provided in Section 20, if a party elects to terminate this lease as allowed herein, the parties shall be released from further liabilities and obligations on the date the lease terminates.

35. LABOR AND MATERIALS

All labor to be performed and materials to be furnished in the operations of the Tenant hereunder shall be at the cost and expense of Tenant, and Landlord shall not be chargeable with, or liable for, any part thereof; and Tenant shall protect and defend Landlord's property against liens of every character arising from Tenant's operations thereon.

36. EXHIBITS

All exhibits referred to are attached to this lease and incorporated by reference.

37. INTERPRETATION OF LEASE

37.1. California Law

This lease shall be construed and interpreted in accordance with the laws of the State of California.

37.2. Integrated Agreement; Modification

This lease contains all the agreements of the parties and cannot be amended or modified except by a written agreement.

37.3. Provisions are Covenants and Conditions

All provisions, whether covenants or conditions, on the part of Tenant shall be deemed to be both covenants and conditions.

37.4. Captions; Table of Contents

The captions and the table of contents of this lease shall have no effect on its interpretation.

37.5. Singular and Plural

When required by the context of this lease, the singular shall include the plural.

37.6. Joint and Several Obligations

"Party" shall mean Landlord or Tenant; and if more than one person or entity is Landlord or Tenant, the obligations imposed on that party shall be joint and several.

37.7. Severability

The unenforceability, invalidity, or illegality of any provision shall not render the other provisions unenforceable, invalid, or illegal.

38. PARCEL MAP

Landlord hereby covenants to institute forthwith all necessary action with respect to the Site under Section 751.01 et seq. of the California Code of Civil Procedure and further covenants to prosecute such action diligently to completion. Upon completion of said proceedings, Landlord covenants to file a

parcel map with respect to the Site pursuant to and in accordance with Section 66410 et seq. of the California Government Code.

RECOMMENDED:

DEPARTMENT OF PARKING AND
TRAFFIC OF THE CITY AND
COUNTY OF SAN FRANCISCO

By: John E. Newlin
JOHN E. NEWLIN
Director

RECOMMENDED:

Rudolf Nothenberg
RUDOLF NOTHENBERG
Chief Administrative Officer

RECOMMENDED:

REAL ESTATE DEPARTMENT
Anthony J. Delucchi
ANTHONY J. DELUCCHI
Director of Property

APPROVED AS TO FORM:

LOUISE H. RENNE
City Attorney

By: Larry Wight
Deputy City Attorney

LANDLORD:

CITY AND COUNTY OF SAN FRANCISCO

By: Frank M. Jordan
FRANK M. JORDAN
Mayor

ATTEST:

John L. Taylor
JOHN L. TAYLOR
Clerk, Board of Supervisors

TENANT:

CITY OF SAN FRANCISCO
DOWNTOWN PARKING CORPORATION

Jack Z. Richardson
President

ATTEST:

Paul Newman

EXHIBIT A

That certain building located in the City and County of San Francisco, commonly known as the Fifth and Mission Garage, bordered by Fifth Street, Mission Street, Fourth Street, and Minna Street (the "Improvements"), together with all right, title and interest in and to the land lying under the Improvements (the "Footprint"), together with a non-exclusive easement for ingress and egress over all land now or hereafter owned by Landlord bordered by and fronting on Fifth Street, Mission Street, Fourth Street, and Minna Street, in the City and County of San Francisco (the "Easement"), together with all of Landlord's present or future right, title, and interest in and to the legal parcel of land in the City and County of San Francisco, bordered by and fronting on Fifth Street, Mission Street, Fourth Street, and Minna Street (the "Future Parcel"). The Improvements, the Footprint, the Easement, and the Future Parcel are collectively referred to herein as the "Premises").

The Premises includes, but is not limited to, that certain real property located in the City and County of San Francisco, more particularly described as follows:

PARCEL ONE:

BEGINNING at the point of intersection of the southeasterly line of Mission Street with the northeasterly line of Fifth Street; running thence northeasterly along said line of Mission Street 675 feet; thence at a right angle southeasterly 160 feet to the northwesterly line of Minna Street; thence at a right angle southwesterly along said line of Minna Street 675 feet to the northeasterly line of Fifth Street; thence at a right angle northwesterly along said line of Fifth Street 160 feet to the point of beginning.

BEING a portion of 100 Vara Block No. 372.

For the purpose of this description the lines of Mission, Minna and Fifth Streets are as they formerly existed prior to the widening of said Streets pursuant to the widening of said Streets in Accordance with Resolution No. 43-59, Approved January 26, 1959 by the Board of Supervisors and Delineated upon Map Showing such widening recorded in Map Book "S", page 44, in the office of the Recorder of the City and County of San Francisco, State of California.

PARCEL TWO:

BEGINNING at the point of intersection of the southwesterly line of Fourth Street with the southeasterly line of Mission Street; running thence southeasterly along said line of Fourth Street 160 feet to the northwesterly line of Minna Street; thence at a right angle southwesterly along said line of Minna Street 150 feet; thence at a right angle northwesterly 160 feet to the southeasterly line of Mission Street; thence at a right angle northeasterly along said line of Mission Street 150 feet to the point of beginning.

BEING a portion of 100 Vara Block No. 372.

Schedule 2

LIST OF USE RESTRICTIONS

1. No sale of whole-bean coffee nor of espresso coffee drinks nor, except as an incidental use in conjunction with a restaurant or food service use, of drip or filter coffee.

Schedule 3

LOAD CAPACITY LETTER

[See attached copy]

MURPHY BURR CURRY, INC.
CONSULTING STRUCTURAL ENGINEERS

February 7, 2000

Project # 98019.11

Simon Kwan
Fee Munson Ebert
500 Montgomery Street
San Francisco, CA 94111
Fax: (415) 434-2409

Subject: 5th & Mission Garage, San Francisco, CA
Existing Concrete Slab Live Load Capacity

Dear Simon:

Per your request we have re-evaluated the live load capacity of the existing ground floor concrete slab which will support the proposed restaurant areas. The slab capacity calculations previously completed in March of 1998 were based on the slab areas and minimum material strengths shown on the original design drawings. Our revised capacity calculations are based upon actual material strengths determined by testing carried out by Consolidated Engineering Laboratories on February 2, 2000.

Both the steel reinforcing and concrete were material tested for actual strength. The testing showed that the steel reinforcing had a higher average yield stress (49.3 ksi) than specified in the design drawings (40 ksi). The presence of lightweight concrete was verified in the portion of the floor between the stair (Line 26) and the 4th & Mission lobby (Line 31), and normal weight concrete was verified in the remaining portion west of the stair (Line 26). The average strengths of the concrete were determined to be as follows: lightweight is 4,110 psi strength and normal weight is 6,080 psi strength. These material strengths were used in our analysis.

We performed a structural analysis of the existing floor slab and determined it to be capable of supporting a maximum of 100 psf live load. No modifications or strengthening of the slab are required. This maximum capacity was determined using standard live load reduction procedures contained in the current 1998 San Francisco Building Code (SFBC). The minimum design live load for new restaurant and retail areas is 100 psf according to this edition of the SFBC. Therefore, the concrete slab areas may be used to support the proposed restaurant areas. Since the design area loading is the absolute maximum for the given structure, the following limitations shall be adhered to:

1. Mechanical or kitchen equipment weights shall not exceed 100 psf.
2. Weight of floor finishes shall not exceed 2 psf.
3. Partition walls are to be of a lightweight material, with area loading not exceeding 10 psf.

Please call if you have any further questions regarding the slab capacity.

Sincerely,
Murphy Burr Curry, Inc.



David Kallmeyer, C.E.
Senior Associate

EXHIBIT "A"

SITE PLAN OF RETAIL CENTER

[See attached copy]

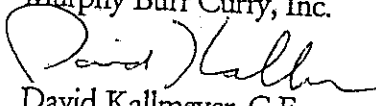
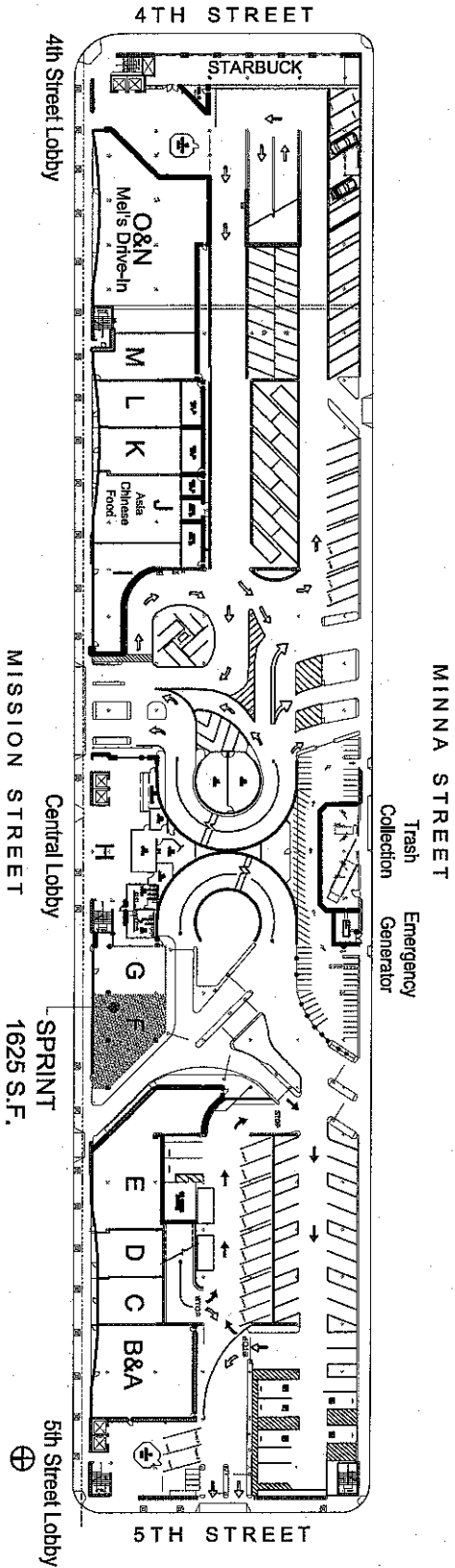
EXHIBIT A



Shops at Yerba Buena

Fifth & Mission Yerba Buena Garage
 City of San Francisco Downtown Parking Corporation

KDA Architects, Inc.
 101 Townsend St., No. 206
 San Francisco, CA 94107
 T (415) 615-0000, F (415) 615-0001

JANUARY 15, 2004

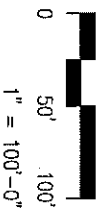
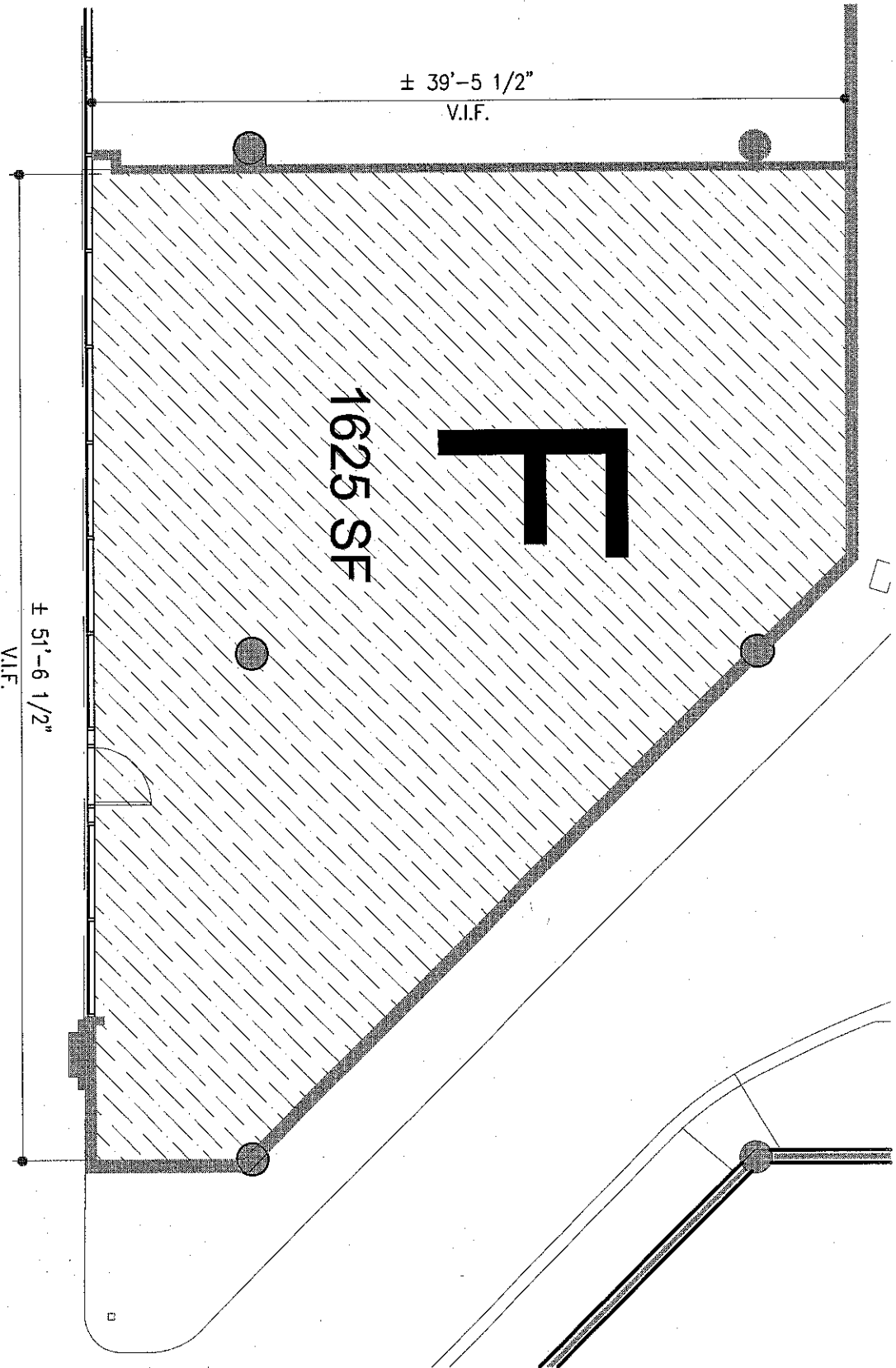

EXHIBIT A



Shops at Yerba Buena

Fifth & Mission Yerba Buena Garage
City of San Francisco Downtown Parking Corporation

JANUARY 15, 2004

KDA Architects, Inc.
101 Townsend St., No. 206
San Francisco, CA 94107
T (415) 615-0000, F (415) 615-0001



EXHIBIT "B"

INITIAL IMPROVEMENT OF THE PREMISES

This Exhibit "B" delineates the responsibilities of Landlord and Tenant with respect to the design and construction of initial improvements to the Premises. Unless otherwise defined herein, capitalized terms in this Exhibit "B" have the meanings set forth in the Lease.

I. LANDLORD'S WORK

A. GENERAL

1. Landlord shall provide Tenant with two (2) sets of the Tenant Layout/Design Package (the "**Tenant Package**"). The Tenant Package shall contain at least the following information:
 - a. Dimensional plans for the Premises, including approximate sizes and shapes of columns and any blockout areas of slab omitted.
 - b. Approximate locations of existing utility service connections.
 - c. Plans for the Premises' storefront, including specifications for the storefront sign supports.
 - d. Design requirements for HVAC for the Premises.
2. Tenant shall verify all dimensions and conditions in the field, and Landlord is not responsible for any discrepancies between the Tenant Package and existing field conditions.

B. PREMISES -- SHELL AND UTILITIES

Landlord shall provide the following improvements to the Premises described in this Section I ("**Landlord's Work**").

1. Structure: Concrete, concrete block and/or steel-stud with Exterior Insulation Finish System exterior walls, concrete ceiling and concrete floor (all in an "as is" condition).
2. Floor: Concrete slab with "as is" finish.

3. Walls and Partitions:

- a. Demising Partition(s). 24 gauge metal-stud partition(s) centered on the line(s) dividing the Premises from adjacent space(s), which dividing lines may not coincide with column centerlines.
- b. Rear Service Doors. Existing service door, if any, shall remain unless Tenant requests in writing that any such service door be removed or relocated, in which event (i) such removal or relocation shall be performed by Tenant, at its expense, as part of Tenant's Work and (ii) any such new location shall be subject to Landlord's approval, which may be withheld in Landlord's sole discretion.

4. Storefront: Existing storefront for the Premises to remain. Initial keying will be provided by Landlord at Landlord's expense. Future rekeying shall be done by Landlord at Tenant's cost.

5. Utilities:

- a. General. Utility connections as existing, if any, in the Retail Center and/or the Structure are described below in this Section I.B.5. Landlord shall perform no additional work respecting utility connections as part of Landlord's Work. All additional utility connections required by Tenant to serve the Premises shall be designed and installed by Tenant, at Tenant's cost as part of Tenant's Work (as hereinafter defined), in such a manner as not to impinge upon any traffic aisle, parking space or service area in the Structure and subject to Landlord's approval as set forth in Section II below.
- b. HVAC. Landlord has designated locations at which Tenant may, at Tenant's election as part of Tenant's Work in accordance with Section II.B.9 below, install 10-inch diameter ceiling mounted fresh air intake near the front of the Premises as shown on Exhibit "B-1" (4/ME-4).
- c. Electricity. Landlord shall furnish a meter socket ("**Meter Socket**") in the main electrical equipment room of the Retail Center rated at 200AMP, 120v/208v, 3-phase, 4-wire for installation of Tenant's electrical meter in accordance with Article 6(a) of the Lease. Tenant may, at Tenant's election and sole cost and in addition to the Meter Socket, furnish and install a meter socket appropriate for an electrical load in excess of the foregoing specifications, subject to the maximum permitted by Title 24 of the California Building Code ("**Additional Meter**").

Socket"). Notwithstanding the foregoing, in no event shall the electrical load allocated to the Premises through the Meter Socket and any such Additional Meter Socket exceed the limit set forth in Section II.C.2.e.(1) c) below.

d. Plumbing.

(1) Water Service. Domestic water service not exceeding a one inch (1") diameter is available in existing locations stubbed out beneath the Premises within the Structure. Subject to the provisions of Section I.B.5.a. above, Tenant may, as part of Tenant's Work, connect to such existing domestic water service through a Water Submeter (as defined in Article 6(a)). If Tenant's Plans require domestic water service with a diameter exceeding one inch (1") in connection with the Permitted Use specified in the Basic Lease Information, then Tenant shall, at Tenant's sole cost, furnish and install its own water meter and apply for a separate water service line from the applicable utility company.

(2) Sanitary Sewer. An existing 4" diameter sewer line is stubbed out under the Common Areas of the Retail Center along Mission Street.

f. Signage. Existing storefront sign supports together with an electrical conduit (without wire) from a main electrical equipment room subpanel to a junction box located at such supports, consistent with the Tenant Package.

II. TENANT'S WORK

A. GENERAL

Tenant shall construct, furnish and install, at Tenant's sole cost and expense unless otherwise provided in the Lease, all improvements not included in Landlord's Work necessary to finish the Premises in condition suitable to prepare the Premises for business as a first-class establishment consistent with the use set forth in the Basic Lease Information ("**Tenant's Work**"), which Tenant's Work shall be in strict accordance with design specifications and criteria set forth herein and in the Tenant Package. Any deviation, except minor changes, in construction from such design specifications and criteria or from Tenant's Plans as approved by Landlord, or any deviation affecting the structure or systems of the Retail Center and/or Structure shall constitute a material default under the Lease. Tenant shall make no changes, modifications or alterations in Landlord's Work without Landlord's prior written consent.

B. PREMISES FINISH WORK

Tenant's Work shall include, without limitation, the following:

1. Ceilings: All suspended ceilings and required framing and seismic supports include lighting covers and other cosmetic effects.
2. Walls and Wall Finishes: Drywall installation (including firetaping, if and as required by applicable codes) for all demising walls, construction of all partition walls within the Premises and finishing work on all walls including, without limitation, painting, papering, paneling and decoration.
3. Doors: All doors and hardware within the Premises (but excluding the front entry door and rear service door provided as part of Landlord's Work). Customization of the area surrounding the exterior of the Premises front entry (through distinctive pilasters and transom ornamentation) consistent with the Tenant Package.
4. Floors and Coverings: All floor coverings and/or floor finishes and leveling of the existing concrete slab (if required).
5. Furniture, Fixtures: Furniture, furnishings, trade fixtures and all equipment and personal property required by Tenant.
6. Electrical and Equipment Connections: Electrical and mechanical connection of all merchandising, lighting (including, if applicable, Tenant's signage), floor and wall fixtures, trade fixtures, equipment and other personal property for Tenant's use and occupancy of the Premises. All conduits shall be concealed within walls, unless such conduits are located in areas of the Premises not visible to the public.
7. Plumbing: All plumbing, including connections to Retail Center and/or Structure utility systems. If utilizing water service, Tenant shall provide, at Tenant's expense, (i) any water consumption meter that Tenant requires in lieu of the Water Submeter in a size and model approved by Landlord and (ii) all necessary venting through ceiling slab penetrations. If water service to the Premises is required by Tenant, soil line connections and any necessary grease traps, sumps or similar fixtures shall be provided and installed by Tenant and subject to Landlord's approval. The sewer line will be run and stubbed out under the Premises by Tenant at a location selected by Landlord. No mechanical garbage disposal equipment or device is permitted in the Premises unless approved in writing by Landlord, which approval shall not be unreasonably withheld. All piping shall be concealed, unless such piping occurs in areas of the Premises not visible to the public.

8. Mechanical Equipment: All mechanical equipment, including exhaust venting, located within the Premises, including all electrical, mechanical and structural work required for these items.
9. HVAC: All HVAC equipment and related work, including, without limitation, furnishing and installing HVAC package unit(s), distributing ductwork, diffusers, return air grills and related work all in accordance with the Tenant Package. The location and design of all components of the HVAC system shall further be in accordance with the "HVAC Installation and Design Requirements" attached hereto as Exhibit "B-1". If Tenant provides bathrooms, Tenant shall furnish all toilet exhausts and related work. A split-system heat pump with remote condensing unit on 2nd level of the Structure shall be used unless an alternate energy-efficient system is approved by Landlord. If appropriate, as determined by Landlord, Tenant shall provide a mechanical exhaust system, including a make-up air system, in all high heat, moisture and odor-producing areas. Any cooking exhaust hood shall be Econovent or its equivalent in energy design.
10. Electrical Systems and Equipment: All meter(s), transformers, interior distribution panels, lighting panels, power panels, conduit, outlet boxes, switches, outlets, wiring (including wiring from the Meter Socket and any Additional Meter Socket to the Premises), lighting fixtures and lamping within the Premises.
11. Protection/Intercommunication/Alarms: All fire and other protection systems, including, but not limited to, alarm monitoring intercommunications, security alarms, fire extinguishers, all fire protection system connections, sprinkler lines, distribution lines, sprinkler heads and alarms meeting the requirements of Landlord and all governing insurance-rating bureaus, local fire departments or any other authority having jurisdiction (collectively, "**Fire Authorities**"). The installation and location of these systems are subject to Landlord's written approval, which approval may be withheld in Landlord's sole discretion. Should Tenant's interior partitioning necessitate changes or alterations in the fire protection sprinkler system for the Structure, such changes and alterations shall be made by Landlord's contractors at Tenant's expense, provided Landlord's contractors' rates shall be reasonable and competitive in the marketplace taking into account any prevailing wage ordinances applicable to Landlord. Tenant is required to connect to the Retail Center and/or Structure's life safety system, if any, at Tenant's cost. If required by any applicable statute, law, regulation and/or ordinance or if appropriate, as determined by Landlord, a smoke and/or heat detector shall be installed in the Premises, at Tenant's expense. Such smoke and/or heat detector shall be connected to the Retail Center's central system, if any, by

Landlord's contractor at Tenant's expense, provided Landlord's contractors' rates shall be reasonable and competitive in the marketplace taking into account any prevailing wage ordinances applicable to Landlord.

12. Telephone Conduits: All conduits, conductors, cabinets and outlets, as required by the utility company or necessary for Tenant's use, all of which items shall be concealed within the Premises' walls.
13. Temporary Utility Service: During the performance of Tenant's Work, Tenant shall provide and pay for temporary utility connections for all utility services. Landlord shall pay for all utilities used during this period.
14. Fees: All licenses, fees, permits, connection and meter charges (other than the charges for utility usage described in Section II.B.13 above), taxes and other charges necessary for Tenant to perform Tenant's Work and open the Premises for business shall be paid by Tenant.

C. DESIGN AND CONSTRUCTION CRITERIA

All Tenant's Work shall conform strictly to the following design and construction criteria, as well as the criteria contained in the Tenant Package.

1. General:
 - a. The Premises are located in the City and County of San Francisco, California. All design and construction work shall comply with all applicable statutes, ordinances, regulations, laws and codes of City, County, State, federal, and all other duly-constituted authorities, including, without limitation, the Americans with Disabilities Act.
 - b. Only new and first class materials shall be used in Tenant's Work.
 - c. All construction must (i) conform to the "Type Construction" classification of applicable building codes and (ii) be performed with all requisite permits.
 - d. All design and construction shall meet with the approval of Landlord or its designated representative, which approval may be withheld in Landlord's sole discretion if deemed by Landlord to be detrimental to the Retail Center and/or Structure or Landlord.

2. Retail Center and/or Structure:

a. Floors.

- (1) No cutting or penetration shall occur without Landlord's prior written consent.
- (2) All floor-covering materials shall be selected or adapted in thickness to conform with the level of adjacent floors.
- (3) Carpeting and/or other quality floors such as pavers, wood or pure vinyl shall be used in Tenant's public areas.
- (4) The weight of floor finishes, fixtures and/or equipment shall not exceed the Retail Center load capacity as described in that certain letter from Murphy Burr Curry, Inc., Consulting Structural Engineers, a copy of which is attached to the Lease as Schedule 3.

b. Columns. Interior columns may be furred or treated as desired by Tenant, subject to Landlord's prior written approval.

c. Ceiling. Tenant shall provide all interior finishes at Tenant's cost.

d. Exterior Walls. No awnings or other projections of any kind shall be attached to the exterior walls of the Premises.

e. Utilities.

(1) Electric

- a) Power capacity shall be 200 Amperes, 120v/208v, 3-phase, 4-wire meter socket, 3 pole breaker spaces; provided, however, that Tenant shall have the option to install an Additional Meter Socket for loads in excess of 200 Amperes in accordance with the terms of Section I.B.5.c. above.
- b) Tenant shall provide fixtures and equipment that meet electrical code standards and do not compromise electrical systems of the Structure and/or Retail Center.

- c) Total electrical load for all equipment and lighting shall not exceed 15.0 watts per square foot of Floor Area in the Premises.

(2) Emergency Lighting.

- a) All exit signs shall be illuminated and shall be battery -equipped for emergency purposes. Signs shall be of sufficient number and located as required by the local Fire Marshall and Building Department of the City and County of San Francisco, and other government agencies.
- b) Approved emergency lighting units shall be provided in sufficient quantity to produce lighted pathways to each exit from the Premises.

(3) Plumbing.

a) Hot Water Heaters:

- 1) All hot water heaters shall be electric, glass-lined and subject to Landlord's prior written approval as to manufacturer and type. In addition to the primary hot water heater, Tenant shall be allowed to install a one (1) gallon insinkerator for heating hot water.
- 2) The maximum capacity shall not exceed 20 gallons without Landlord's permission. Water heaters shall be equipped with temperature and pressure relief valve and piping as required by applicable code and shall be seismically braced.
- 3) All hot water heaters shall be set in a galvanized metal pan, which shall be drain-connected to a sewer line.

b) Sanitary Sewer:

- 1) Connections to sewer laterals are to be provided beneath the Premises in locations acceptable to Landlord and that do not interfere with motor vehicle movement or

parking use in the Structure level located beneath the Retail Center.

- 2) Accessible clean-outs shall be provided according to applicable codes.
 - 3) Tenant shall provide toilet facilities unless it is reasonably determined by Landlord that the Premises have access to sufficient common toilet facilities in the Common Areas in accordance with the applicable City codes. If required by any applicable law or regulation, separate toilet facilities shall be provided for male and female employees.
 - 4) Toilet room fixturing must conform to the handicap requirements of all applicable law.
 - 5) Plumbing fixtures and fittings shall be of commercial quality.
- (4) Fire Extinguisher. Tenant shall install fire extinguishers as required by the Fire Authorities.
 - (5) Life Safety. All life safety systems shall be installed in compliance with all applicable laws. If required by City, Tenant shall provide a fire protection system for the Premises, which system shall be engineered and approved by all Fire Authorities.
 - (6) Telephone. Tenant shall install a conduit from the Retail Center's main distribution panel to a location approved by Landlord either under the Premises or within a Premises demising wall, which approval shall be subject to the standards for Structural Alterations set forth in Article 10 of the Lease.
3. Sign Criteria. Subject to the terms of the Lease, all signs shall be designed in accordance with the Signage Limitations and be subject to Landlord's approval in accordance with the Lease.

III. PROCEDURE FOR COMPLETION OF TENANT'S PLANS AND SPECIFICATIONS

A. ISSUANCE OF TENANT PACKAGE

No later than two (2) business days following execution of the Lease, Landlord shall furnish Tenant with two (2) sets of the Tenant Package. In the event of any conflict between the terms of the Lease (and exhibits) and the Tenant Package, the terms of the Lease (and exhibits) shall control.

B. NOTIFICATION OF ARCHITECT'S AND ENGINEER'S NAMES

Tenant's architect and engineers are: J. Steven Carrillo, California Architect License No. C11,222; Duane S. Henderson, California Mechanical Engineer License No. M 028118; Craig R. Lanham, California Electrical Engineer License No. E-014380, whose addresses are 1321 Howe Avenue, Suite 202, Sacramento, CA 95825; 8325 Lenexa Dr., Suite 400, Lenexa, KS 66214-1695; 8325 Lenexa Dr., Suite 400, Lenexa, KS 66214-1695, respectively, and whose telephone and fax numbers are 916/922-0550 and 916/922-4576; 913/307-5300 and 913/307-5300, respectively (collectively, "**Tenant's Architect**"). If the immediately preceding section is not completed prior to execution of the Lease, Tenant shall provide such information within two (2) business days following execution. Tenant shall retain such architect's administrative services or a Landlord-approved construction manager throughout the construction phase of the Premises. Landlord must approve tenant's architect and engineers in writing prior to preparation of the Plans or any drawings described below. Designers who are not licensed will not be permitted to prepare construction documents.

C. SUBMITTAL OF PLANS

1. Within thirty (30) business days following execution of the Lease, Tenant shall cause its architect to prepare and deliver to Landlord for Landlord's approval, which shall not be unreasonably withheld, two (2) sets of schematic drawings which shall include, without limitation, the following:
 - a. Schematic floor plans and interior elevation(s).
 - b. Reflected ceiling plan showing lights, sophist, and ceiling materials.
 - c. Outline specifications.
 - d. Graphic elements of Tenant's storefront and signage design (identification and/or symbol including color, materials and means of illumination, if any).

Within ten (10) business days after receipt of the schematic drawings, Landlord shall either (i) approve same or (ii) disapprove such drawings specifying, in reasonable detail, any nonconformity with the Letter of Intent. If so disapproved, Tenant shall, within five (5) business days after

receipt of Landlord's disapproval, cause Tenant's architect to revise the schematic drawings to conform same to the Letter of Intent and resubmit them to Landlord. Landlord shall, within five (5) business days after receipt of Tenant's architect's revised schematic drawings, advise Tenant of further changes, if any, required for Landlord's approval. The foregoing process shall continue until Landlord has approved the revised schematic drawings.

2. Within ten (10) business days following Landlord's approval of Tenant's schematic drawings, Tenant shall cause Tenant's architect to prepare and deliver to Landlord for Landlord's approval, which approval shall not be unreasonably withheld, two (2) sets of design development drawings, which shall include, without limitation, the following:

- a. Exterior elevations, sections and details.
- b. Interior elevations, sections and details.
- c. Floor plans and details.
- d. Architectural finish schedule.
- e. Reflected ceiling plan.
- f. Electrical and power plans (single line).
- g. Mechanical and plumbing plans (single line).
- h. Graphic elements as per Section III.C.1.d above.
- i. Outline specifications.

Tenant's design development drawings shall be subject to the same approval procedure as set forth in Section III.C.1. above for Tenant's schematic drawings.

3. Within ten (10) business days following Landlord's approval of Tenant's design development drawings, Tenant shall cause Tenant's architect to prepare four (4) sets and one (1) reproducible set of Tenant's plans and four (4) sets of specifications (blue-line drawings will not be acceptable) (such plans and specifications collectively, the "**Plans**") in sufficient detail to obtain necessary permits and solicit construction bids. Such Plans shall be subject to Landlord's approval, which shall not be unreasonably withheld, using the procedure set forth in Section III.D. below. Notwithstanding anything to the contrary in the Lease, if any terms of the Plans as approved by Landlord are inconsistent with terms of

the Lease, the terms of the Plans as so approved shall control. Tenant shall promptly provide sample finishes and colors, if requested by Landlord in connection with Landlord's review.

4. All drawings described in this Section III.C. and the Plans shall (i) comply with the design criteria established by Landlord in the Tenant Package and this Exhibit "B" and (ii) be consistent with Landlord's Work, including, without limitation, any mechanical, electrical, plumbing and life safety systems for the Retail Center and/or Structure.

D. RETURN AND RESUBMITTAL OF PLANS

Within ten (10) business days after receipt of the Plans, Landlord shall return to Tenant one (1) set of prints with either (i) Landlord's disapproval (in which case, such returned set shall set forth, in reasonable detail, Landlord's required modifications) or (ii) Landlord's approval. If Tenant, upon receipt of Tenant's Plans bearing Landlord's disapproval with required modifications, desires to take exception thereto, Tenant may do so in writing within three (3) business days of the date of receipt (the "Protest Period"). Unless such protest is received by Landlord within the Protest Period, (i) Landlord's required modifications shall be conclusively deemed approved by Tenant and (ii) Tenant shall cause Tenant's architect to prepare four (4) sets of prints and one (1) reproducible set of Plans revised to incorporate Landlord's modifications, which revised Plans shall be resubmitted to Landlord before the end of the Protest Period for approval. If Tenant protests Landlord's required modifications, Tenant shall, within two (2) business days of such protest, submit revised Plans (in the manner set forth in Section III.C.3. above) containing Tenant's proposed alternative modifications. Landlord shall either disapprove or approve such revised Plans in accordance with this Section III.D. Such process shall continue until Landlord has approved the revised Plans.

E. LANDLORD'S APPROVAL

1. All approvals and consents hereunder required of Landlord shall be invalid unless obtained in writing except as expressly set forth herein.
2. Tenant shall pay to Landlord, upon demand, a fee equal to the greater of (i) Five Hundred Dollars (\$500) or (ii) the reasonable, actual, out-of-pocket costs incurred by Landlord not to exceed two percent (2%) of the construction cost for Tenant's Work to compensate Landlord for the cost of review and approval of the Plans and of monitoring the performance of Tenant's Work.
3. Neither review nor approval by Landlord of any proposed Plans or of the resulting final Plans shall constitute a representation or warranty by Landlord that such Plans either (i) are complete or suitable for their

intended purpose or (ii) comply with applicable laws, ordinances, codes, regulations, or any requirements of the Fire Authorities. Landlord disclaims, and Tenant acknowledges and agrees that Landlord shall not have, any responsibility or liability whatsoever to Tenant or to any other person or entity claiming by, through or under Tenant relating to such completeness, suitability or compliance.

IV. PROCEDURES FOR CONSTRUCTION OF PREMISES BY TENANT

A. PRIOR TO COMMENCEMENT OF CONSTRUCTION

1. Tenant's contractor and subcontractor must be approved by Landlord, which approval shall not be unreasonably withheld, and Tenant shall submit to Landlord, at least twenty (20) business days prior to the commencement of construction, the following:
 - a. The name, address, telephone number, facsimile number and license number of the general contractor that Tenant intends to use. Tenant shall also submit to Landlord references and such other information regarding the general contractor as Landlord may reasonably require. The names of the primary subcontractors for structural, mechanical, electrical, HVAC and life safety work that Tenant's general contractor intends to engage for Tenant's Work shall also be provided.
 - b. The construction cost breakdown and total costs for the completion of Tenant's Work.
 - c. The estimated commencement date of construction and the date of projected completion.
 - d. Evidence of the insurance required by Section IV.C. below.
2. All contractors engaged by Tenant shall be bondable, licensed contractors, possessing good labor relations, capable of performing quality workmanship and working in harmony with each other's contractor and contractors engaged by other tenants of the Retail Center or by Landlord.
3. All building, utility connection, sign and other permits required for Tenant's Work shall be obtained and paid for by Tenant prior to the commencement of construction.
4. Landlord shall have the right to post in a conspicuous location on the Premises and to record with the County of San Francisco, a Notice of Nonresponsibility.

B. CONSTRUCTION PERIOD

1. Tenant, at its cost and expense, shall cause all Tenant's Work to be performed in accordance with all applicable codes, which compliance is Tenant's responsibility. Landlord's approval of the Plans shall not be interpreted as a statement of compliance with code requirements.
2. Tenant shall not attach or cause to be attached to any wall or structural member any equipment that may, by virtue of its size or weight, cause structural damage thereto. Tenant's Work shall not (i) exceed any loading limit set forth in the plans and specifications for the floor of the Retail Center and/or Structure nor (ii) in any way affect the structural integrity of the Retail Center and/or Structure.
3. Subject to the terms of Article 10(a) of the Lease, Landlord's written approval shall be obtained by Tenant prior to the undertaking of any construction work that (i) deviates (other than in minor respects) from the approved Plans or (ii) requires any modifications whatsoever to Landlord's Work and/or the systems or utility lines for the Structure and/or Retail Center or (iii) involves other work not explicitly shown on the approved Plans. Tenant's Work shall not harm or overload any Landlord's Work or systems of the Retail Center and/or Structure.
4. Storage of Tenant's contractors' construction materials, tools and equipment shall be confined within the Premises and in areas designated for such purposes by Landlord, and should such materials, tools and equipment be assigned space or spaces outside the Premises, they shall be moved to such other space as Landlord directs from time to time to avoid interference or delays with other work. In no event shall any materials or debris be stored in the Structure or the Common Areas. Workspace exterior to the Premises, if available, will be allocated upon request to Tenant's contractors by Landlord in Landlord's reasonable determination. Tenant's contractors shall not run pipes or conduits over or through any other tenant's premises or any portion of the Structure except as directed by Landlord.
5. Tenant shall be responsible for all items of work necessary to coordinate Tenant's Work in its entirety. Tenant acknowledges that other construction may be in progress at the Retail Center and/or Structure and that conflicts between Tenant's Work and such other work shall be subject to final resolution by Landlord's Tenant Coordinator (or Landlord's other construction representatives) and Tenant's construction manager.
6. Tenant's contractors shall perform Tenant's Work in a manner and at times so as not to impede or delay Landlord's Work or interfere with other tenants. Tenant shall conduct its labor relations and its relations with its

contractors and agents in such a manner as to avoid all strikes, picketing and boycotts of, on, or about the Premises, the Retail Center and/or the Structure. If, during the performance of Tenant's Work, any of Tenant's employees, contractors or agents strike, or if picket lines or boycotts or other visible activities objectionable to Landlord are established or conducted or carried out against Tenant or its employees, contractors or agents, or any of them, on or about the Premises or the Retail Center and/or the Structure, Tenant shall immediately close the Premises to the public and, to the extent allowed by law, remove all employees, contractors and agents therefrom until the dispute giving rise to such strike, picket line, boycott, or objectionable activity has been settled to Landlord's satisfaction. Any delays in the completion of the Premises and, if applicable, the commencement of the Lease term and any damage to any work caused by Tenant's contractor shall be at the cost and expense of Tenant.

7. Tenant shall be fully responsible for the operations and activities of its general contractor and all subcontractors employed by the general contractor, the sign and fixturing contractors and other individuals or contractors employed by Tenant in the completion of the Premises.
8. Any such contractor and/or individual shall expeditiously repair any damage caused by it or its subcontractors.
9. Subject to the terms of Section III.E.2 above, if additional administrative costs are incurred in monitoring construction of Tenant's Work because the Plans are not consistent with any Structure or Retail Center systems, such additional costs may be charged to Tenant by Landlord in Landlord's sole discretion.
10. Tenant is fully responsible for all removal of dirt and construction debris, all at Tenant's cost and expense, when and as required by the Construction Rules attached hereto as Exhibit "B-2" (the "**Construction Rules**"). Tenant is further responsible for promptly replacing, at Tenant's sole cost, any Retail Center trees damaged in the course of Tenant's Work.
11. The provisions of Article 14 of the Lease shall apply to any claims for personal injury or property damage arising during the performance of Tenant's Work.
12. All work undertaken by Tenant and its agents, employees and contractors shall be in strict compliance with the Construction Rules, but if such rules conflict with other terms of the Lease, such terms of the Lease shall control.

13. Tenant shall keep the Premises free and clear of all claims and liens and if any such lien is filed in connection with Tenant's Work, shall discharge same as provided in Article 10(e) of the Lease.
14. Tenant expenses incurred by Landlord in connection with Tenant's Work shall be due immediately upon receipt of Landlord's invoice therefor and shall be delinquent if not paid within thirty (30) days from the invoice date. Late charges determined in accordance with Article 19(g) of the Lease will apply to any such invoice not paid within twenty (20) days following the date thereof. Interest at the Interest Rate shall apply to delinquent invoices in the manner set forth in Article 19(e) of the Lease.

C. REQUIRED INSURANCE BY TENANT

Tenant shall obtain and keep in force, or cause to be obtained and kept in force, the following insurance coverages throughout the performance of Tenant's Work:

1. Tenant's General Contractor's and Subcontractors' Required Minimum Coverages and Limits of Liability.
 - a. Workers' Compensation, as required by state law, and including Employer's Liability Insurance, with a limit of not less than One Million Dollars (\$1,000,000), and any insurance required by any Employee Benefit Acts or other applicable statutes so as to protect the general contractor and subcontractors from any and all liability under such acts or statutes.
 - b. Commercial General Liability Insurance (including Contractor's Protective Liability) and Comprehensive Automobile Liability Insurance, with a minimum combined single limit of liability of Two Million Dollars (\$2,000,000). The Commercial General Liability Insurance shall provide for explosion, collapse, and underground coverage. The Comprehensive Automobile Liability Insurance shall insure against all claims or casualties in connection with the ownership, maintenance and operation of automotive equipment that is owned, hired or non-owned. All such insurance shall insure Tenant's general contractor against any and all claims for bodily injury, including death resulting therefrom and damage to or destruction of property of any kind whatsoever and to whomsoever belonging and arising from its operations under the construction contract and whether such operations are performed by Tenant's general contractor, subcontractors or any of their subcontractors, or by anyone directly or indirectly employed by any of them.

2. Tenant's Protective Liability Insurance. Tenant shall provide Owner's Protective Liability Insurance, with a minimum combined single limit of liability of One Million Dollars (\$1,000,000), which insurance shall insure Tenant against any and all liability to third parties for damages because of bodily injury liability (or death resulting therefrom) and property damage liability of others, or a combination thereof, that may arise from work in connection with the Premises, and other liability for damages the general contractor and/or subcontractors are required to insure against under any provisions herein.
3. Tenant's Builder's Risk Insurance -- Completed Value Builder's Risk Material Damage Insurance Coverage. Tenant shall provide an "All Physical Loss" Builder's Risk Insurance policy on Tenant's Work covering one hundred percent (100%) of the replacement cost thereof.
4. Additional Insureds. All insurance policies required under this Section IV.C. shall include Landlord, City and Landlord's lenders, if any, and agents, as additional insureds, except Workers' Compensation Insurance, which shall contain an endorsement waiving all rights of subrogation against Landlord and/or City. No reduction, modification or cancellation of any such insurance coverage shall be undertaken without thirty (30) days' prior written notice to Landlord.

D. CERTIFICATE OF ACCEPTANCE

Within twenty (20) days after completion of Tenant's Work, Landlord shall inspect the Premises and, if the condition of the Premises is acceptable, shall issue a Certificate of Acceptance of the Premises. The issuance of such a Certificate shall be contingent upon all of the following:

- a. The satisfactory completion of Tenant's Work in accordance with the approved Plans, as determined by Tenant's Architect in good faith and evidenced by a Notice of Completion from Tenant's Architect.
- b. The lien period for Tenant's Work shall have expired and no liens in connection with same shall have been filed; or, if such lien period has not expired, Tenant shall have furnished Landlord with unconditional waivers of liens and sworn statements from Tenant's general contractor and all major subcontractors that they have been compensated in full.
- c. Submittal by Tenant to Landlord of a detailed breakdown of Tenant's final total construction costs, together with receipted evidence showing payment thereof, satisfactory to Landlord.

- d. Submittal by Tenant to Landlord of copies of warranties for not less than one (1) year against defects in workmanship, materials and equipment with respect to mechanical, plumbing and electrical items connected to Retail Center and/or Structure systems costing One Thousand Dollars (\$1,000) or more, such warranties to be reasonably satisfactory to Landlord (including submittal of extended warranties, where required by Landlord).
- e. Submittal by Tenant to Landlord of a Certificate of Occupancy or other written evidence reasonably available from governmental authorities showing compliance with any and all other laws, orders and regulations of any and all governmental authorities having jurisdiction over the Premises.
- f. Submittal by Tenant of two (2) complete sets of "as built" Plans (one (1) reproducible) covering all of Tenant's Work.
- g. If pursuant to the terms hereof, Tenant is required to use any Landlord's contractor to perform any work to be performed by Tenant hereunder, the cost therefor shall be reasonable and competitive in the marketplace taking into account any prevailing wage ordinances applicable to Landlord.

EXHIBIT "B-1"

HVAC INSTALLATION AND DESIGN REQUIREMENTS

[See attached copy]

EXHIBIT "B-1"

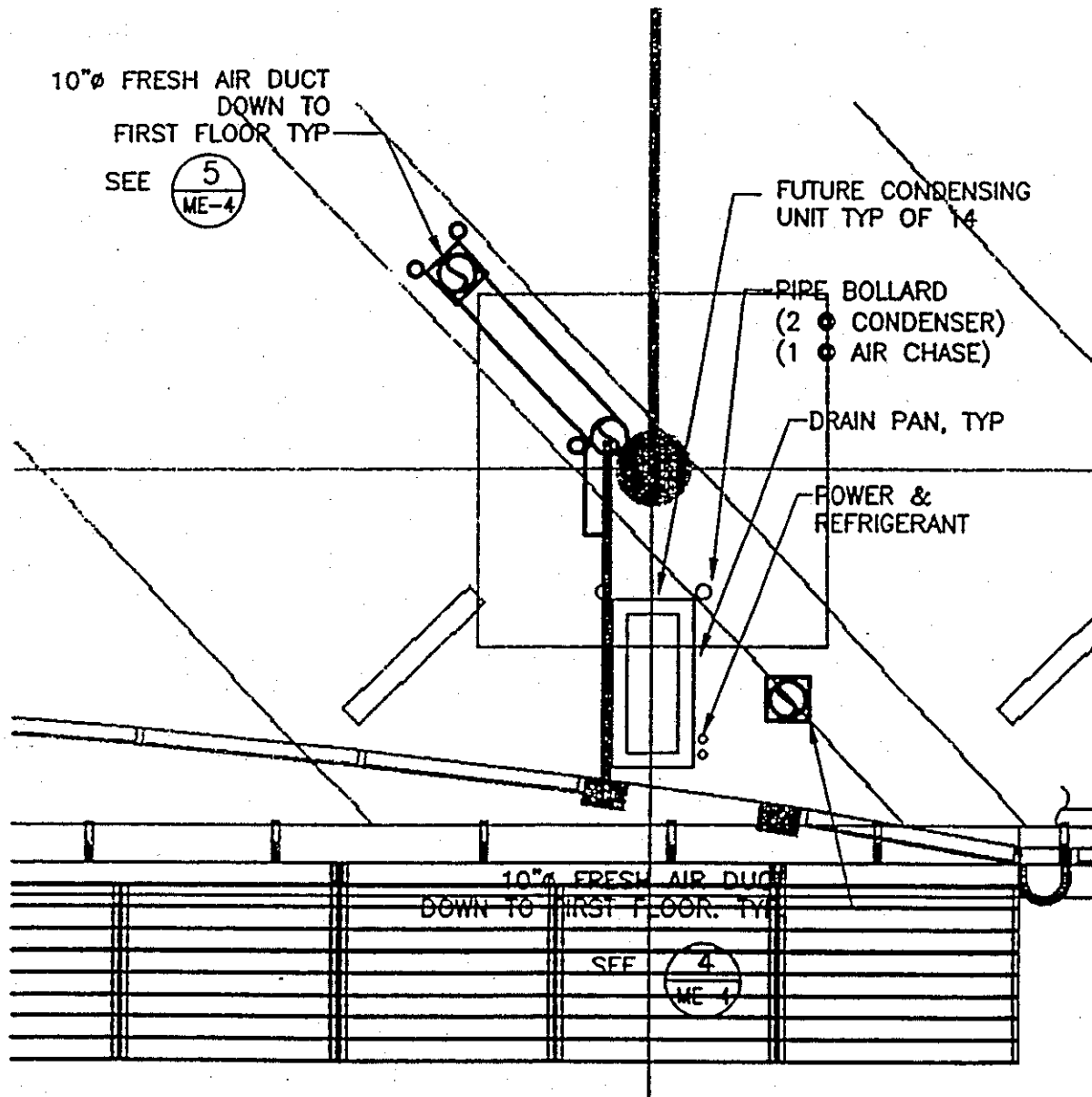

TYPICAL MECHANICAL / ELECTRICAL LAYOUT ON 2ND FLOOR

EXHIBIT "B-1"

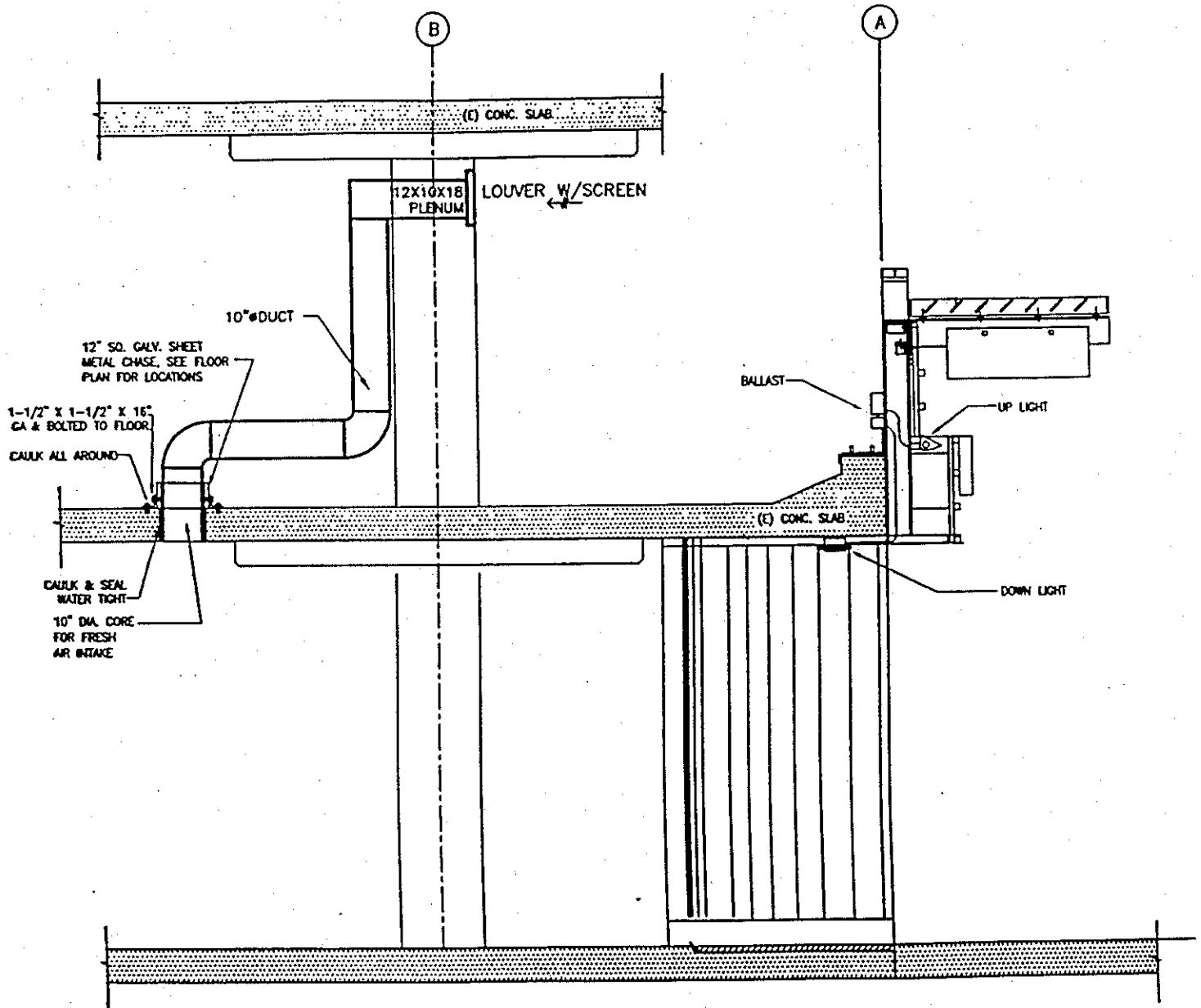

5/ME-5 MECHANICAL / ELECTRICAL DETAIL

EXHIBIT "B-1"

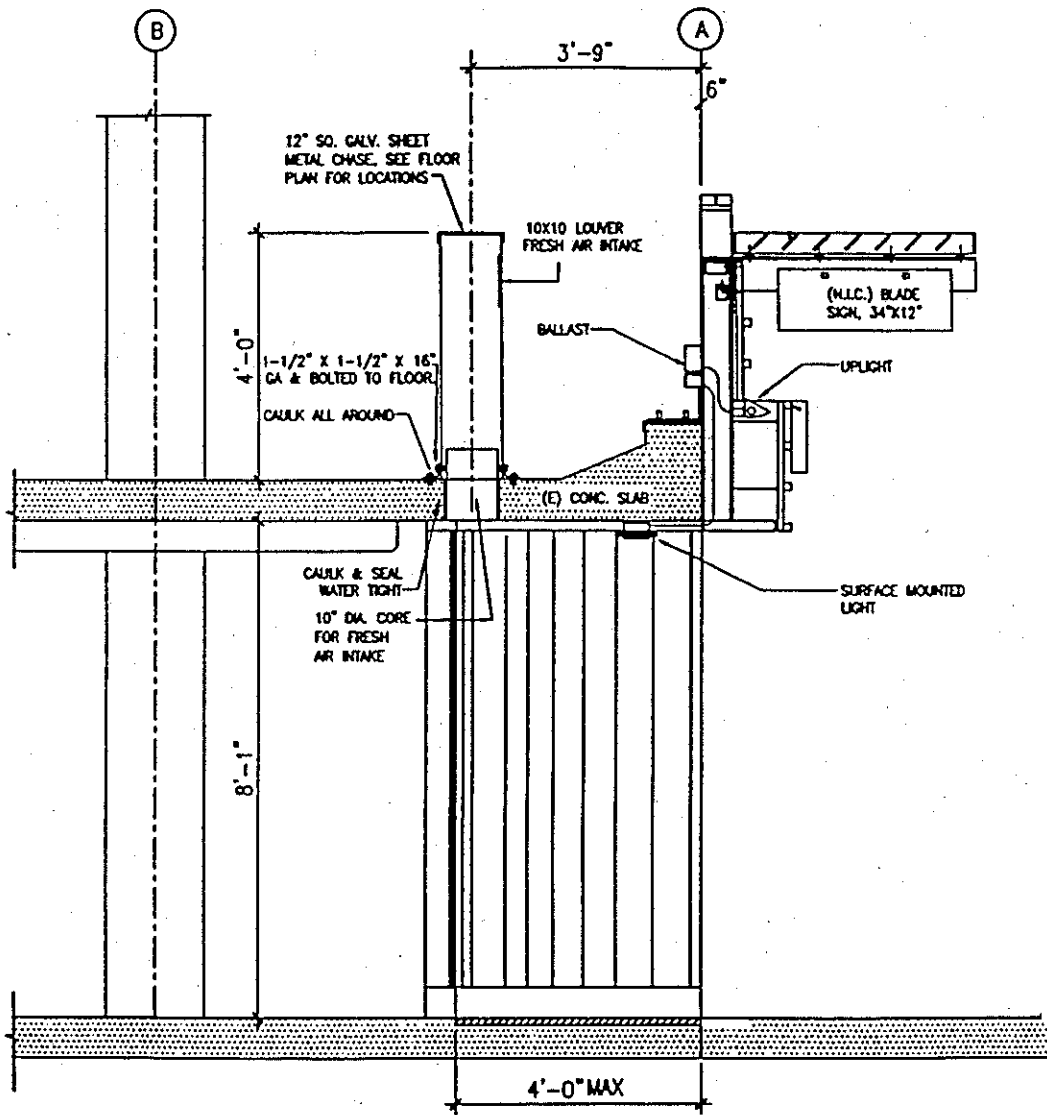

4/ME-4 MECHANICAL / ELECTRICAL DETAIL

EXHIBIT "B-2"

CONSTRUCTION RULES

1. All work to be performed shall be coordinated with the management of the Retail Center and/or Structure or Landlord's other designated representative.
2. Any changes to the approved Plans shall be made in writing and approved by Landlord before proceeding.
3. If a deadline is set for completion of work, it shall be completed in that time agreed upon between Tenant and Landlord. Starting time and completion date of any project shall be put in the Plans.
4. All Tenant construction activity shall be confined to the Premises (including all equipment, tools and materials). At no time shall Tenant permit any equipment, materials or tools to be placed into any other tenant space without written approval of Landlord.
5. Common Areas and any portion of the Structure shall not be used by Tenant or by Tenant's contractors without the written approval of Landlord. All deliveries shall be scheduled so that materials are stocked in the Premises prior to normal business hours of the Retail Center and/or Structure. No deliveries of bulk materials shall be made through the Common Areas and/or the Excluded Areas during such business hours.
6. No parking shall be permitted in any traffic lane within the Structure and any vehicles owned or operated by Tenant or Tenant's contractors parked therein will be either ticketed and/or towed away at Tenant's expense.
7. Any tools, equipment gang boxes or similar items, left in either the Common Areas or the Excluded Areas by Tenant or Tenant's contractors will be removed and the labor costs incurred by Landlord for such removal will be charged to Tenant.
8. Retail Center and/or Structure doors opening on Common Areas are not to be propped open at any time. Security and maintenance personnel are instructed to remove any doorstops.
9. All Premises doors shall be made secure at the completion of each workday.
10. Workers are not permitted to transport tools or materials in wheelbarrows or wheeled vehicles in the Common Areas or the Excluded Areas during normal business hours for the Retail Center or the Structure, as applicable.
11. All temporary partitions and dustproof barriers will be furnished by Tenant and must remain intact at all times. Should any panel be removed, torn or otherwise displaced or damaged, it shall be promptly reattached or repaired by Tenant.

12. All barricades in front of the Premises during Tenant's Work shall be made dustproof so that no dust filters through such barricades into other parts of the Retail Center and/or the Structure. All painting shall be shielded and other parts of the Retail Center and/or the Structure shall be protected from all odors, fumes and spray. During any construction activity on the storefront, Retail Center trees along Mission Street will be shielded from damage by use of appropriate barricades. All barricades shall be maintained in a clean condition at all times.
13. Any (i) construction activity (e.g., painting and scaffolding) in the Retail Center and/or the Structure in front of or outside the Premises or (ii) construction activities such as jackhammering and "shot" type mechanical fasteners which create excessive or explosive noise must be either completed no later than 30 minutes prior to, or commenced after, Retail Center Hours, as established by Landlord from time to time in Landlord's reasonable discretion (the "**Retail Center Hours**"). Any construction material or equipment connected with Tenant's Work in the Common Areas after commencement of Retail Center Hours will be removed by Landlord and labor costs for removing such material shall be charged to Tenant.
14. The Premises shall be kept clean and free of hazardous conditions and in compliance with all O.S.H.A. safety regulations.
15. Any debris related to Tenant's Work found in either the Common Areas, the Excluded Areas, any unoccupied tenant spaces and/or any public areas, unattended by Tenant or Tenant's contractors will be removed by Landlord and Tenant will be charged for the cost of removing such debris. Any dirt or debris caused by Tenant's Work outside of the Premises must be cleaned up no later than 30 minutes prior to commencement of Retail Center Hours. Tenant shall arrange for daily removal of dirt and construction debris. No individual trash or storage containers will be allowed in the Common Areas or in the Excluded Areas without Landlord's permission. Any containers provided by Landlord to Tenant for construction debris shall be at Tenant's expense. Where Landlord does not provide containers for removal of debris, Tenant or Tenant's general contractor shall arrange independently for trash removal service after obtaining Landlord's approval.
16. All tools, equipment or construction materials left outside of the Premises shall become the property of Landlord.
17. Construction workers are not permitted to eat in the Common Areas or in the Excluded Areas.
18. Tenant and Tenant's contractors shall comply with Landlord's hazardous material use requirements as set forth in Articles 12(c) and 12(d) of the Lease.
19. Tenant shall provide Landlord with an emergency contact list from Tenant's general contractor prior to commencement of Tenant's Work.

20. All fire alarms, sprinklers and smoke detectors are to remain operational at all times unless both the San Francisco Fire Department and the Retail Center manager consent to disconnection in writing.

EXHIBIT "C"

RULES AND REGULATIONS

1. The sidewalks, halls, passages, exits and entrances of the Retail Center and/or Structure shall not be obstructed by Tenant or used by it for any purpose other than for ingress to and egress from the Premises.
2. The Premises shall not be used for lodging or sleeping and, unless ancillary to a restaurant or other food service use specifically authorized in the Lease, no cooking shall be done or permitted by Tenant on the Premises, except that use of a microwave oven and the preparation of coffee, tea, hot chocolate and similar items for Tenant and its employees shall be permitted.
3. Any person or persons employed by Tenant to do janitorial work shall be subject to and under the control and direction of Landlord or Landlord's property manager, if any, while in the Retail Center and/or Structure and outside the Premises.
4. Tenant shall not use or keep in the Premises or the Retail Center and/or the Structure any kerosene, gasoline or flammable or combustible fluid or materials or use any method of heating or air-conditioning other than as approved in connection with Tenant's Work.
5. Tenant shall not use, keep or permit or suffer the Premises to be occupied or used in a manner offensive to Landlord or other occupants of the Retail Center and/or the Structure by reason of excessive noise, obnoxious odors and/or excessive vibrations, or materially interfere in any way with other tenants or those having business in the Retail Center and/or the Structure.
6. In the case of invasion, mob, riot, public excitement or other circumstances rendering such action advisable in Landlord's opinion, Landlord reserves the right to prevent access to the Retail Center and/or the Structure during the continuance of same by such action as Landlord may deem appropriate, including closing entrances to the Retail Center and/or the Structure.
7. Tenant shall see that the doors of the Premises are closed and securely locked at such time as Tenant's employees leave the Premises.
8. The Common Areas toilet rooms, toilets, urinals, wash bowls and other apparatus shall not be used for any purpose other than that for which they were constructed, no foreign substance of any kind whatsoever shall be deposited therein, and any damage resulting to same from Tenant's misuse shall be paid for by Tenant.
9. Except with the prior consent of Landlord, Tenant shall not use or permit the use of any sidewalk or Common Areas adjacent to the Premises for the sale of any goods or

provision of any service. In no event shall Tenant use or permit the use of any of the Excluded Areas for any such purpose.

10. Except as otherwise provided in the Lease, Tenant shall not install any radio or television antenna, loudspeaker or other device outside the Premises, including on the exterior walls of the Retail Center and/or the Structure.
11. Tenant shall not use in the Premises, or in the Common Areas, any handtrucks except those equipped with rubber tires and side guards or such other material-handling equipment as Landlord may approve. No other vehicles of any kind shall be brought by Tenant into the Retail Center and/or the Structure or be kept in or about the Premises.
12. Tenant shall store all its trash, garbage and recyclable materials within the Premises until the periodic removal of same by Tenant to the Compactor and Trash Enclosure, as applicable, no less frequently than as reasonably required from time to time by Landlord. No material shall be placed in the Retail Center's and/or the Structure's trash boxes or receptacles directly by Tenant or Tenant's agents or employees. No material may be placed by Tenant in the Compactor or Trash Enclosure, as applicable, if such material is of such nature that it may not be disposed of in the ordinary and customary manner of removing and disposing of trash and garbage or recyclable materials, as applicable, in the City and County of San Francisco without being in violation of any law or ordinance governing such disposal or recycling.
13. All loading and unloading of merchandise, supplies, materials, garbage and refuse and delivery of same to the Premises shall be made only (i) during times that do not interfere in other than a de minimis respect with Landlord's use and operation of the Structure, as determined by Landlord and (ii) through such Structure entryways as Landlord may designate, at Landlord's election, from time to time.
14. Canvassing, soliciting, peddling or distributing handbills or any other written material in the Retail Center and/or the Structure is prohibited and Tenant shall cooperate to prevent same.
15. Tenant shall not permit the use or operation of any coin operated machines on the Premises, including, without limitation, vending machines, video games, pinball machines, or pay telephones without the prior written consent of Landlord.
16. Tenant shall immediately, upon request from Landlord (which request may be oral), reduce its lighting in the Premises for temporary periods designated by Landlord, when required in Landlord's judgment to prevent overloads of the mechanical or electrical systems of the Retail Center and/or the Structure.
17. Landlord reserves the right to select the name of the Retail Center and/or the Structure and to make such change or changes of name as it may deem appropriate from time to time, and Tenant shall not refer to the Retail Center and/or the Structure by any name other than: (i) the names selected by Landlord (as same may be changed from time to

time), or (ii) the postal address, approved by the United States Postal Service. Tenant shall not use the name of the Retail Center and/or the Structure in any respect other than as an address of its operation in the Retail Center, without the prior written consent of Landlord.

18. Tenant requests will be attended to only upon application by telephone or in person at the office of the Retail Center. Employees of Landlord shall not perform any work or do anything outside of their regular duties unless under special instructions from Landlord.
19. Landlord may waive any one or more of these Rules and Regulations for the benefit of any particular tenant or tenants, but no such waiver by Landlord shall be construed as a waiver of these Rules and Regulations in favor of any other tenant or tenants, nor prevent Landlord from thereafter enforcing any such Rules and Regulations against any or all of the tenants of the Retail Center, provided such waivers are not given in a discriminatory manner.
20. Wherever the word "Tenant" occurs in these Rules and Regulations, it is understood and agreed that it shall include Tenant's agents, employees, invitees and guests. Wherever the word "Landlord" occurs in these Rules and Regulations, it is understood and agreed that it shall include Landlord's agents and employees.
21. These Rules and Regulations are in addition to, and shall not be construed in any way to modify, alter or amend, in whole or part, the terms, covenants, agreements and conditions of the Lease. In the event of any conflict with the terms of the Lease, the Lease shall control.
22. Landlord reserves the right to make such other and reasonable rules and regulations as in its sole judgment may from time to time be needed for the safety, care and cleanliness of the Retail Center and/or the Structure, and for the preservation of good order therein.
23. Tenant shall not affix or maintain upon the glass panes and supports of the storefront windows (and within twenty-four (24) inches of any window), doors and the exterior walls of the Premises, any signs, advertising placards, names, insignia, trademarks, descriptive material or any similar item or items, and Landlord shall have the right, without prior notice to Tenant and without any liability for damage to the Premises reasonably caused thereby, to remove any of the same from the Premises.
24. No awning or other projections, excluding signage, shall be attached to the outside walls of the Premises.
25. The outside areas immediately adjoining the Premises shall be kept clear at all times by Tenant, and Tenant shall not place nor permit any obstructions, garbage, refuse, merchandise or displays in such areas.
26. In connection with any use of the Common Areas, Tenant shall not:

- (i) Vend, peddle or solicit orders for sale or distribution of any merchandise, device, service, periodical, book, pamphlet or other matter whatsoever;
- (ii) Exhibit any sign, placard, notice or other written material;
- (iii) Distribute any circular, booklet, handbill, placard or other material;
- (iv) Solicit membership in any organization, group or association or contribution for any purpose;
- (v) Parade, patrol, picket, demonstrate or engage in any conduct that might tend to interfere with or impede the use of any of the Common Areas or of the Structure by any customer, business invitee or employee, create a disturbance, attract attention or harass, annoy, disparage or be detrimental to the interest of any of the retail establishments within the Retail Center and/or the Structure.
- (vi) Use any Common Areas for any purpose when none of the retail establishments within the Retail Center and/or the Structure is open for business or employment;
- (vii) Use any sound-making device (including sound trucks) of any kind or create or produce in any manner excessive noise or sound that is annoying, unpleasant or distasteful to customers, business invitees or employees situated within the Retail Center and/or the Structure;
- (viii) Deface, damage or demolish any sign, light, standard or fixture, landscaping material or other improvement within the Retail Center and/or the Structure or the property of customers, business invitees, or employees situated within the Retail Center and/or the Structure; or
- (ix) Panhandle, beg or solicit funds.

EXHIBIT "D"

SIGNAGE LIMITATIONS

(See attached copy of "Shops at Yerba Buena
Storefront & Signage Design Guidelines dated June 10, 1998")

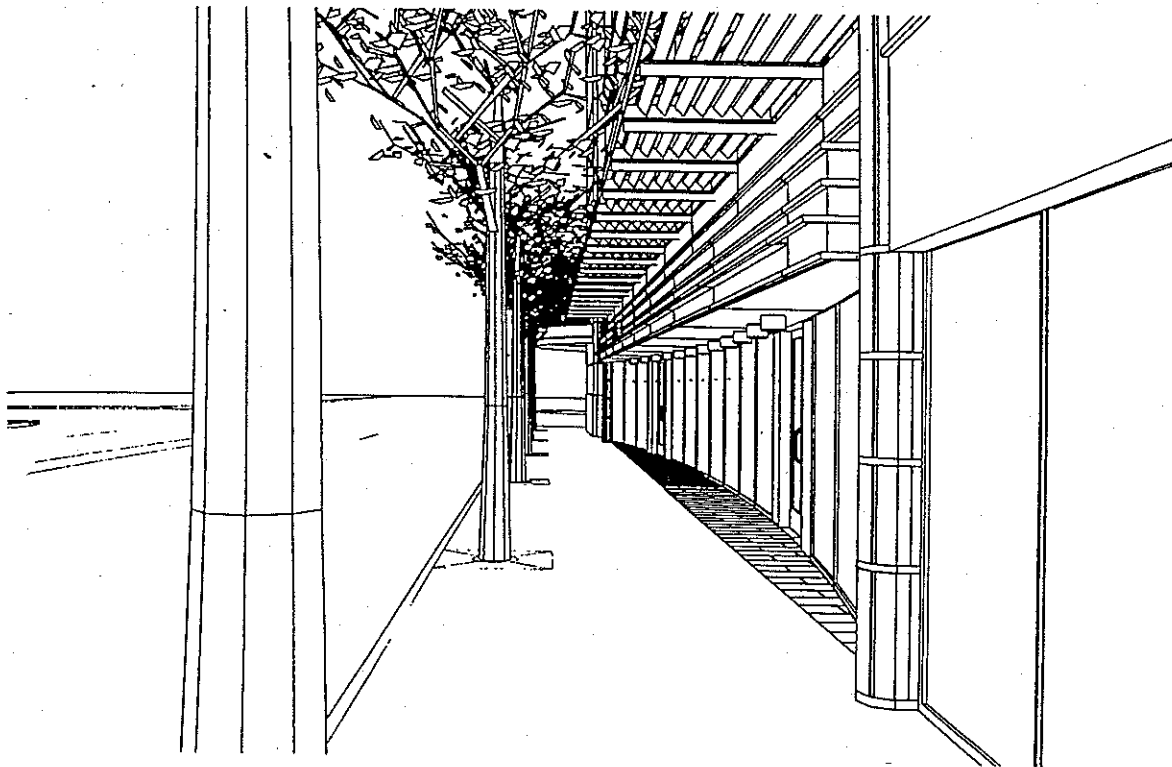

**YERBA BUENA SHOPS
STOREFRONT & SIGNAGE DESIGN GUIDELINES**

Fee Munson Ebert in association with SZFM Design Studio
June 10, 1998

TABLE OF CONTENTS

INTRODUCTION

STORE DESIGN APPROVAL PROCESS

ELEMENTS OF STOREFRONTS

Portal Entries

Display Windows

Materials

Lighting / Security

STOREFRONT DESIGN GUIDELINES

EXAMPLES OF STOREFRONT TYPES AND FOOTPRINTS

PHOTOGRAPHIC STOREFRONT EXAMPLES

SIGNAGE DESIGN REQUIREMENTS

TYPES OF ALLOWABLE SIGNS

SIZE OF SIGNS

DESCRIPTION OF EACH SIGN TYPE

EXAMPLES OF SIGN TYPES

INTRODUCTION

Retail spaces at the shops at Yerba Buena have a lot in common. To start with, there is great visibility and direct street presence, flexibility in size and amount of storefront, and opportunity for adequate signage, regardless of the size of the store. With these benefits come a certain responsibility to all neighboring tenants; i.e., a need to fit within the overall architectural facade while highlighting their own identities.

The image we have in mind for the shops at Yerba Buena is like a finely crafted book, embossed with intriguing filigree and the promise of discovery inside. It is our intent to establish these criteria for tenants to use in a unique and diverse way to present a richly embroidered tapestry of city life. Whereas shopping malls traditionally discourage individuality through the use of severely restrictive design guidelines, we encourage creativity on the part of the tenants, while respecting the limitations in these guidelines.

The storefront and signage, or the 'facade', is the most essential architectural element capable of communicating the function and character of the store. The word 'facade' comes from the Latin word 'facies' which is synonymous with the words 'face' and 'appearance.'

Quality storefront entries are vital to the success of your store and the street as a whole. The combination of storefronts, signage, and "viewable" merchandise makes up the lively excitement of the shopping experience. Uncontrolled, these can become a visual jungle. Conversely, over-control produces dull, lifeless uniformity.

This document is divided into two main sections: Storefront and Signage Design Guidelines.

We want tenants to pick and choose from allowable signs those types of signs which will best suit their logo and style. However, just because a sign is allowable does not mean that a tenant may have all the signs allowed for that location combined.

We believe the guidelines presented in this booklet provide a balanced approach to achieve overall harmony without sacrificing individuality, and seek a colorful communications collage which informs, stimulates, delights, and amuses.

The intent of these guidelines is not to be "over-restrictive" to achieve a uniform look like the typical shopping centers. On the contrary, since signage reflects the unique personality of the store, we strongly encourage tenants to use their allotted signage creatively, with imagination and style.

STORE DESIGN APPROVAL PROCESS

Summary

These signage requirements and approvals process are being reviewed by the City of San Francisco. The guidelines are specific to 'Shops at Yerba Buena and may differ from the general requirements for signage in other parts of the City. However, as signage is an integral part of the redevelopment of the downtown area, these more specific requirements have been adopted. The Landlord (through his Project Designer) must approve any and all signage prior to submittal to the City. The City will not issue signage permits without wet-stamped original documents indicating the Landlord's approval.

The Signage Design Approvals Process can be summarized into these basic steps:

- A. Tenant obtains signed off approval from Landlord.
- B. Tenant submits signed off approval documents to the City for permit approval.
- C. Tenant submits shop drawings (if necessary) to Landlord for approval.
- D. Tenant directs signage to be fabricated and installed after Landlord's approval, City approval, and Landlord's shop drawing approvals are obtained.
- E. Tenant obtains Landlord's and City's final approval in an on-site inspection of completed signage.

Step A

- Read this booklet in its entirety before proceeding with signage design.
- If you have any questions, please contact the Landlord.
- Develop a schematic signage proposal and submit to the Landlord for review. Requirements for submission include $\frac{1}{2}$ " = 1'-0" scale drawings (or larger) showing size, overall design relative to the storefront, materials, and color, and a completed area calculation form.
- Upon receiving preliminary approval from the Landlord, proceed with detail drawings.
- Submit a minimum of four (4) sets of final detail drawings and an updated area calculation form to the Landlord for design review and approval. Incomplete submissions to the Landlord will be returned without review! The final submission must include the size and dimensions of all signs, letter heights, materials, specified colors and color chips, mounting details of all signs, graphic representation of all signage in relation to the storefront(s), including exact location of signs, and any other specified requirements which may be listed by the Landlord in previous reviews (such as material samples, etc.) which may be deemed necessary for the Landlord to determine the quality of the finished signage.
- The Landlord will retain two (2) complete sets on file in his office. Only when the final design sets have been returned with the Landlord's wet stamp may the tenant apply for City approval. Special conditions on the approval may be noted for further review by the Landlord; please see Step C below.

Step B

- Submit ____ () sets of the approved and wet-stamped signage design sets to the City for approval.

Step C

- Submit shop drawings, to the Landlord for approval. The Landlord will inform the tenant on the comments line of the approvals form if this step is required.

Step D

- Fabricate and install only after all required approvals, including shop drawing approvals, have been obtained.

Step E

- Contact the Landlord upon completion of installation of signage for on-site inspection and final approval. Tenants may be required to redo signage if a sign does not conform with the design drawings approved by the Landlord and the City of San Francisco.

ELEMENTS OF STOREFRONTS

PORTAL ENTRIES

Portals mark the transition from the public exterior to the private interior. They can be useful tools as elements of merchandise representation for the store at 'Shops at Yerba Buena.' Beside signage, they are the only means available to each tenant to express identity, uniqueness and style. A good portal design not only, makes an entrance as noticeable as possible, but also encourages hesitant shoppers to come into the store and browse.

DISPLAY WINDOWS

Display windows are a main element in most successful storefronts. Regardless of the 'openness' of the storefront, a window is still the primary means of giving passersby a feel of what's inside. They act as a 'menu' of the store, highlighting items that may not be usually associated with the store. These display windows may be enclosed or open into the store (with numerous variations in between). A display with closed windows must be continually changed. Whether closed or open, lighting of the interior of the display windows must be sufficient to compensate for the bright daylight outside.

MATERIALS

One of the most important elements in fashioning the store's image is the choice of materials used to create the portal entry. Some materials, such as wood, can be used to create a more traditional feel. Other materials, such as stainless steel and aluminum, are often used to create a more modern or contemporary look. Materials such as granite and marble convey a more solid, expensive, or even classical image.

Maintenance, cost and versatility of each material should also play a role in the selection of a storefront. While wood is usually reasonable in cost, it also entails painting or polishing in order to maintain its condition. While not as durable as marble or granite, wood and aluminum are more versatile. Stainless steel has a much greater durability, but frequently can be higher in cost with some maintenance required.

The other main component of entry portal materials is glass. Glass can come in many types and colors, and has multiple uses. Transparent glass is extremely important for displaying the store's merchandise. Other glass, such as opaque, frosted or translucent, can be used to frame merchandise on display or create interesting images. Glass bricks or blocks can also be used as a structural medium as well as for decorative purposes. The importance of using glass creatively cannot be overstated.

LIGHTING / SECURITY

All doors at entry portals must be serviced by either key or integrated combination lock. Additional security devices such as electronic surveillance monitors, light beams and cameras must be concealed from view. Decals announcing the use of such equipment may be permitted on the storefront.

All stores must have display lighting which needs to be on a separate circuit and must stay on until 10:00 p.m. or later. These lights are typically low-watt efficiency fixtures located in the front of the store. The lighting should illuminate at least the first 10 ft. on inside storefront. The display lights are to be set on timers and should stay on until 10:00 p.m. each night or later, as the landlord determines. In addition, all stores are required to have night lighting.

STOREFRONT DESIGN GUIDELINES

You should think of the portal as your store's face. Just as your face gives an impression of who you are, your portal is the first close impression a shopper will receive of the quality and character of your store. He or she will decide whether or not to enter your store based on the impression made by your portal. Instinctively shoppers make rapid, often subjective decisions regarding the contents, quality and even the character of the owner and employees based on first impressions made by the portal. In deciding what type of impression you want to make, have a clear vision of what your store is about, and be consistent with that image. We are encouraging you to use your imagination and be creative.

All spaces can have portals based on 5' modules. When a tenant moves in, there may be a temporary door which is to be removed and replaced with their own modified portal or the tenant may install fixed glass at the existing door location and open a portal entry at another module. We are providing some examples for your use but remember these are only examples - use your imagination and design your portal to your desire.

- Locate your space number on the location map, you will notice that there are four different areas, labeled A, B, C, D, E, and F. For example, if your space number is in area A look at Area A Elevations.
- Refer to the pages showing Portal Location, to see the different options for the portal's location, depending on how many modules your storefront may have.
- Turn to pages titled Portal Elevations and you will see examples of single and double portal entry zones. You can see these elevations in plan on the page titled Portal Plan.
- Refer to the Photographic Storefront Design Examples for ideas.

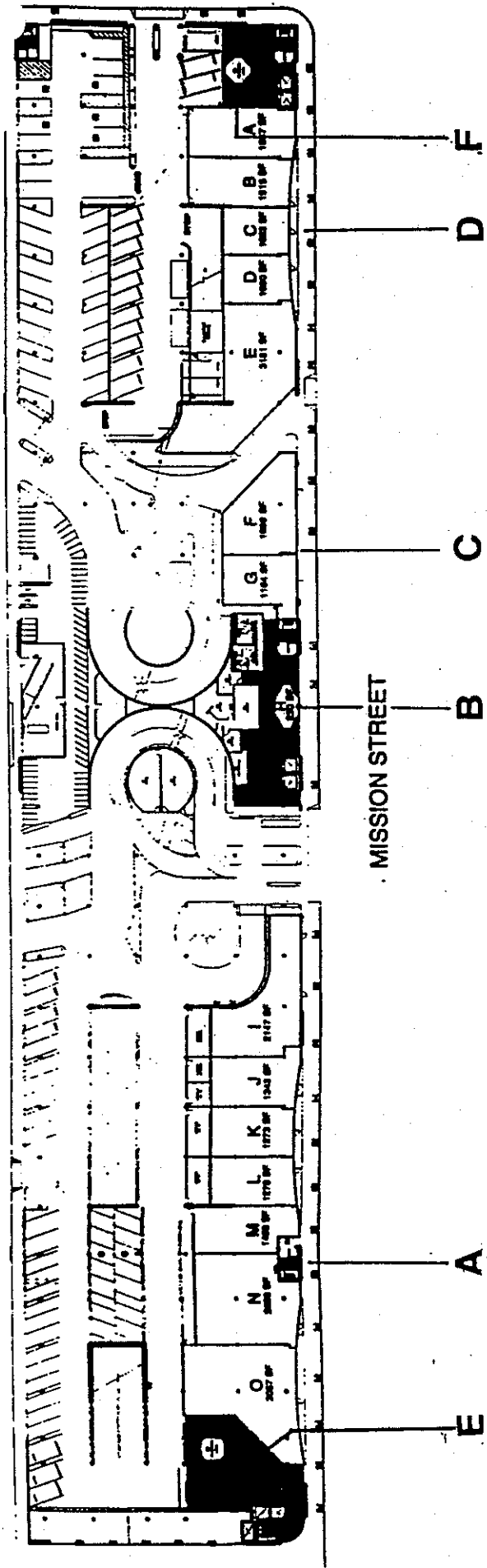

LOCATION MAP

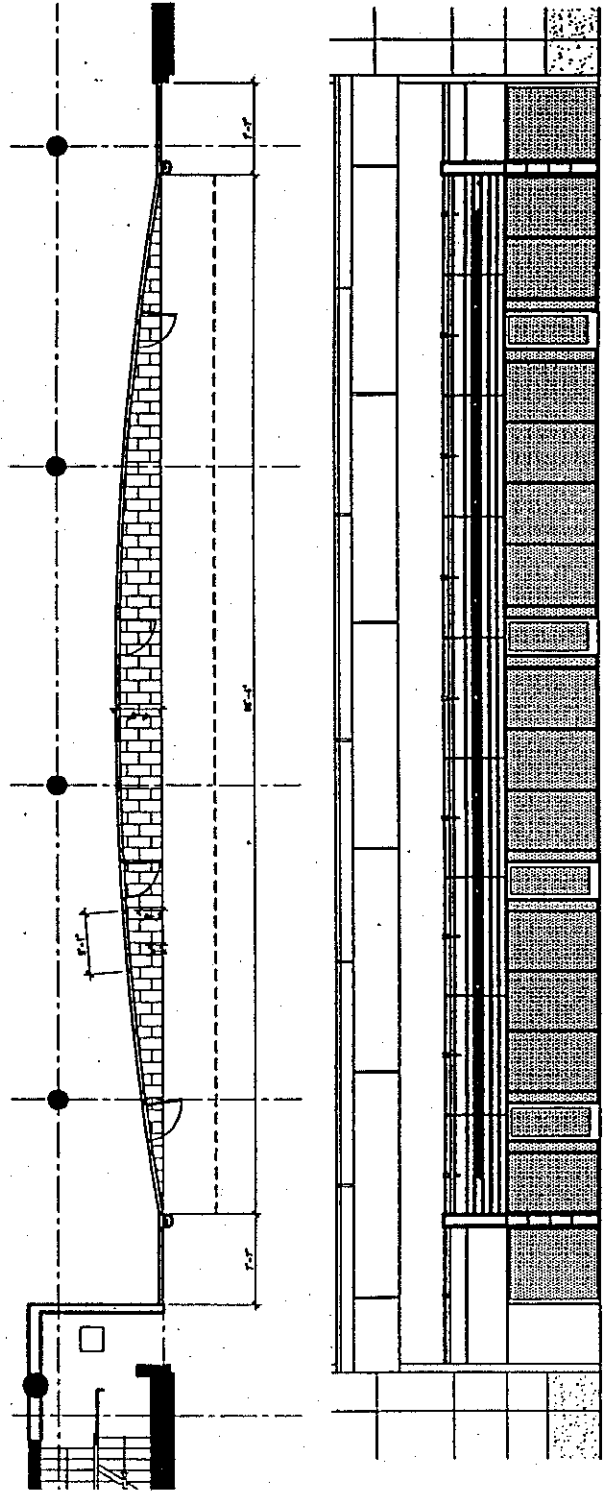
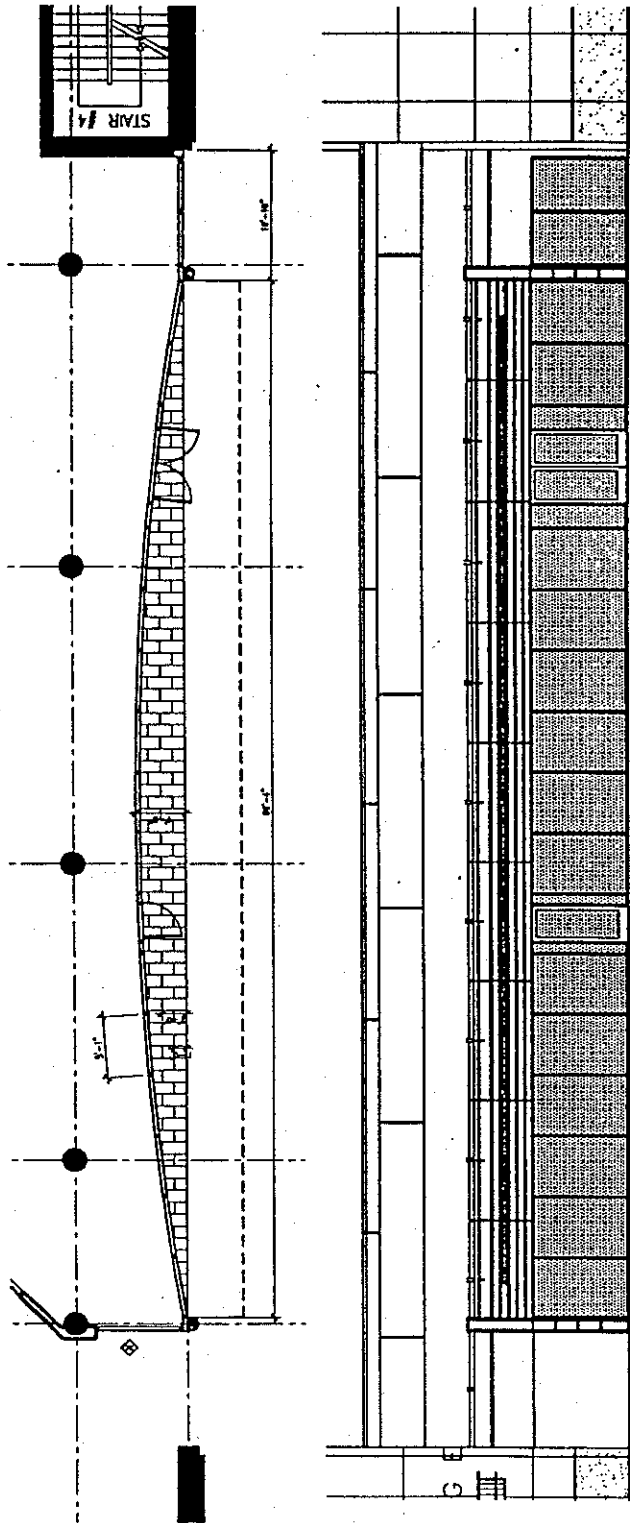

AREA A ELEVATIONS

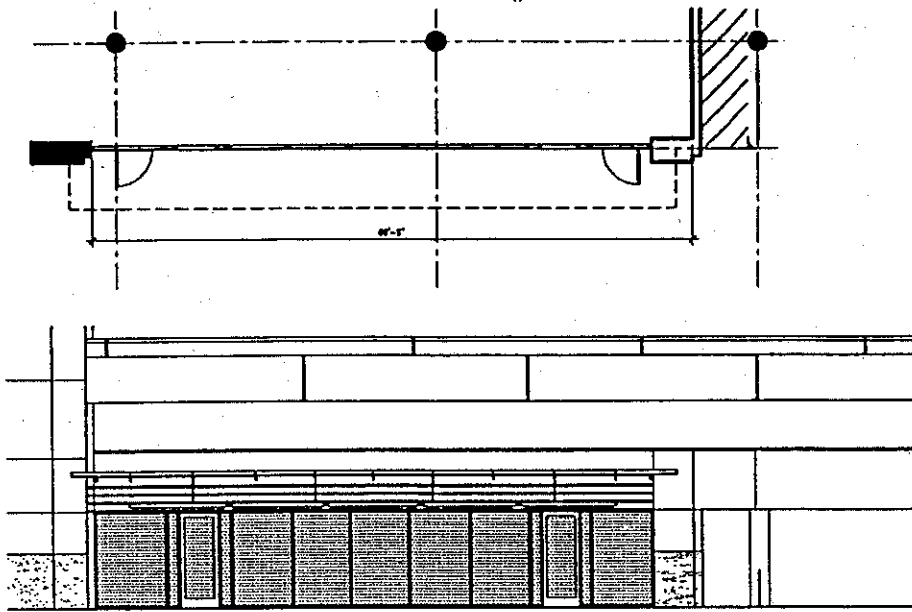

B

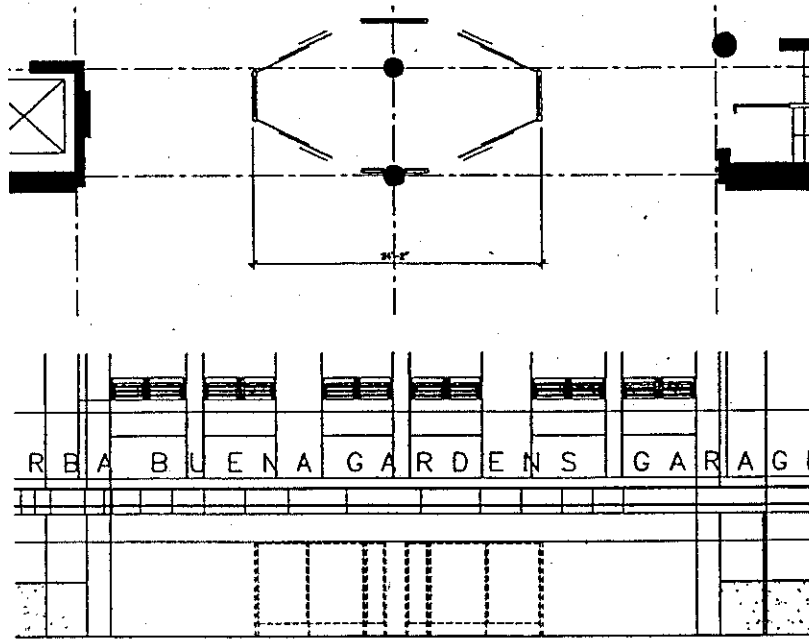

B

AREA B ELEVATIONS

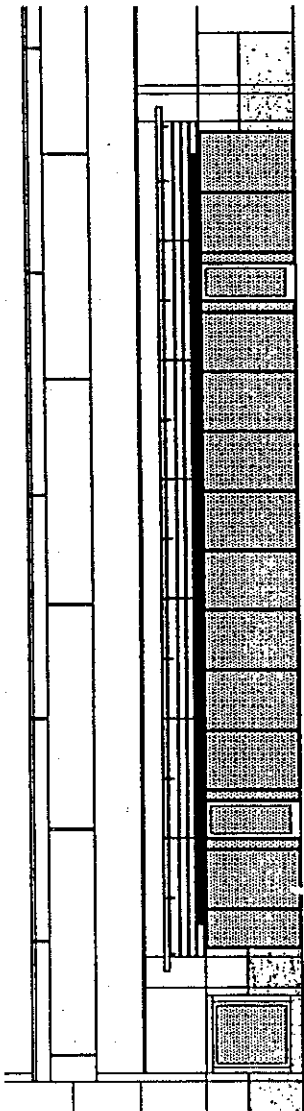
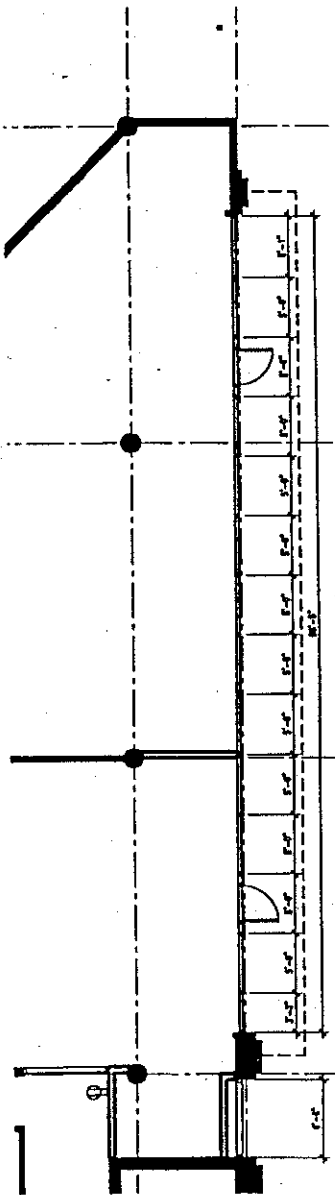

C

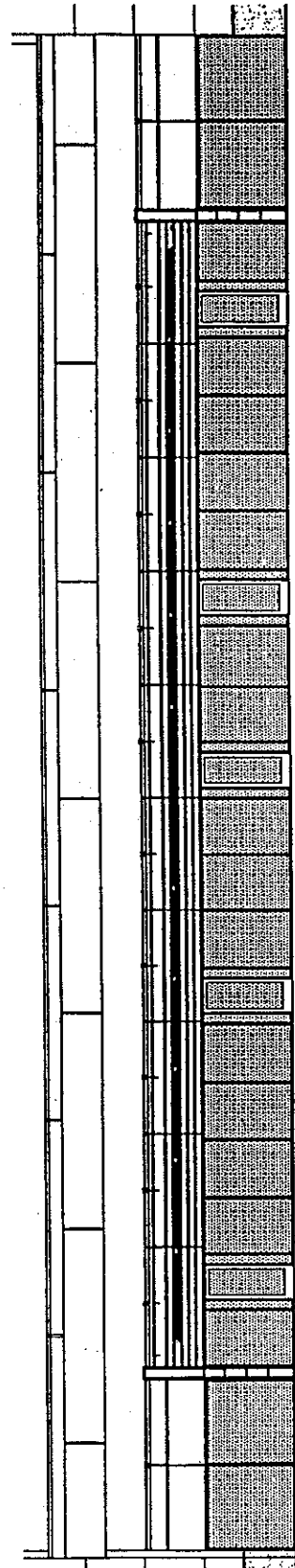
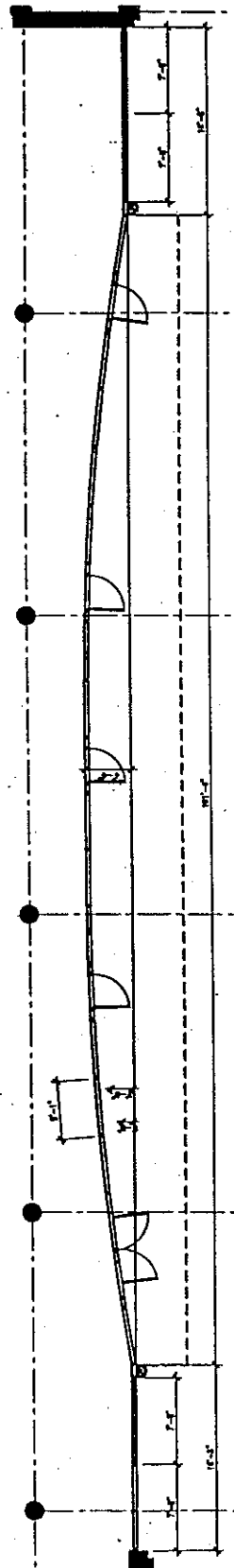

D

AREA C & D ELEVATIONS

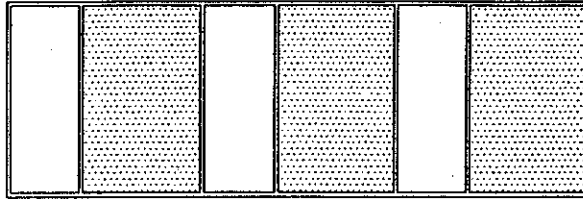

4th STREET LOBBY STOREFRONT DISPLAY

E

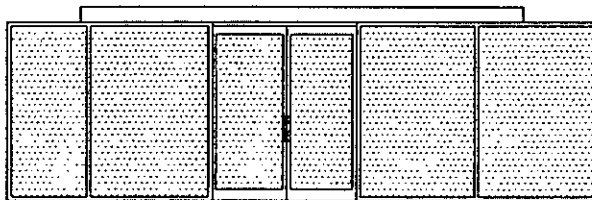

5th STREET LOBBY STOREFRONT ENTRY

F

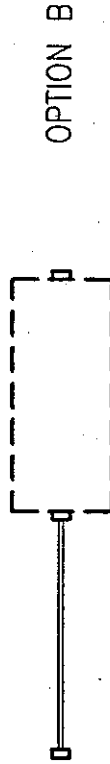
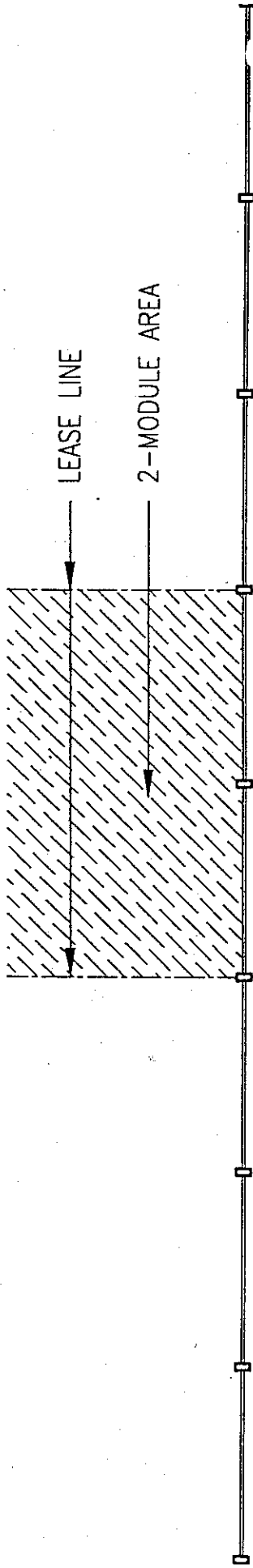

PORTAL LOCATION IS SUBJECT TO ADJACENT TENANT'S PORTAL LOCATION. NO TWO PORTALS MAY BE ADJACENT TO EACH OTHER. CURVED STOREFRONTS HAVE BEEN REPRESENTED STRAIGHT FOR SIMPLICITY. A PORTAL MAY NOT FALL NEXT TO A CONCRETE WALL OR COLUMN.

2-MODULE STOREFRONT - PORTAL LOCATION

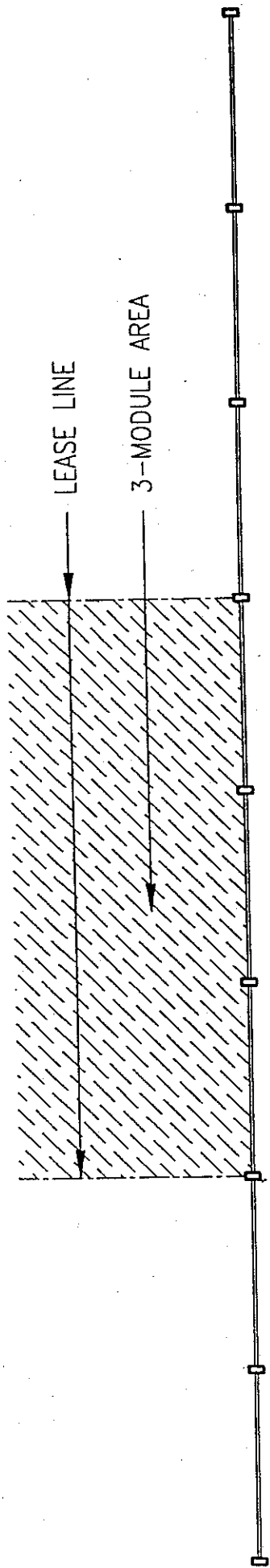

OPTION A



OPTION B



OPTION C

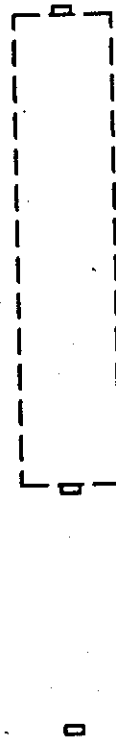

PORTAL LOCATION IS SUBJECT TO ADJACENT TENANT'S PORTAL LOCATION. NO TWO PORTALS MAY BE ADJACENT TO EACH OTHER.
 CURVED STOREFRONTS HAVE BEEN REPRESENTED STRAIGHT FOR SIMPLICITY.
 A PORTAL MAY NOT FALL NEXT TO A CONCRETE WALL OR COLUMN.

3-MODULE STOREFRONT - PORTAL LOCATION

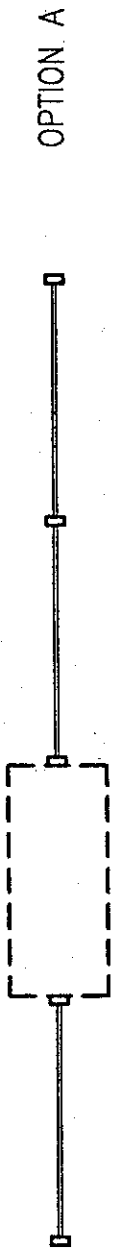
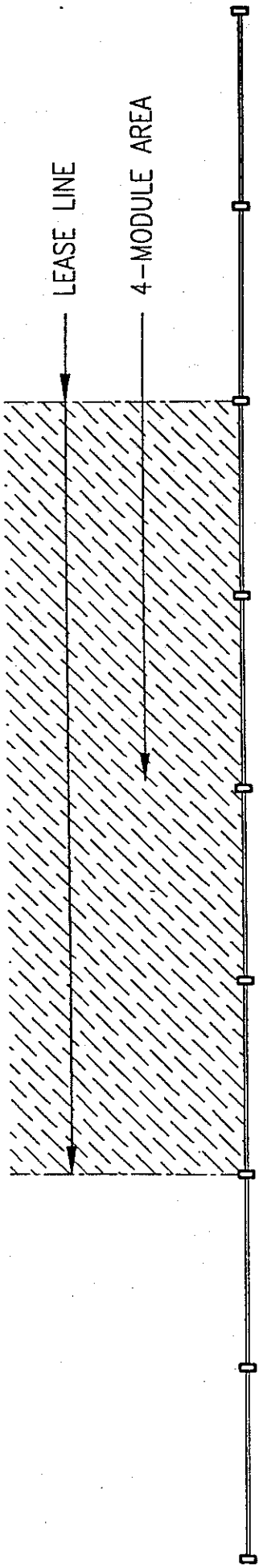

CURVED STOREFRONTS HAVE BEEN REPRESENTED STRAIGHT FOR SIMPLICITY.

4-MODULE STOREFRONT - PORTAL LOCATION

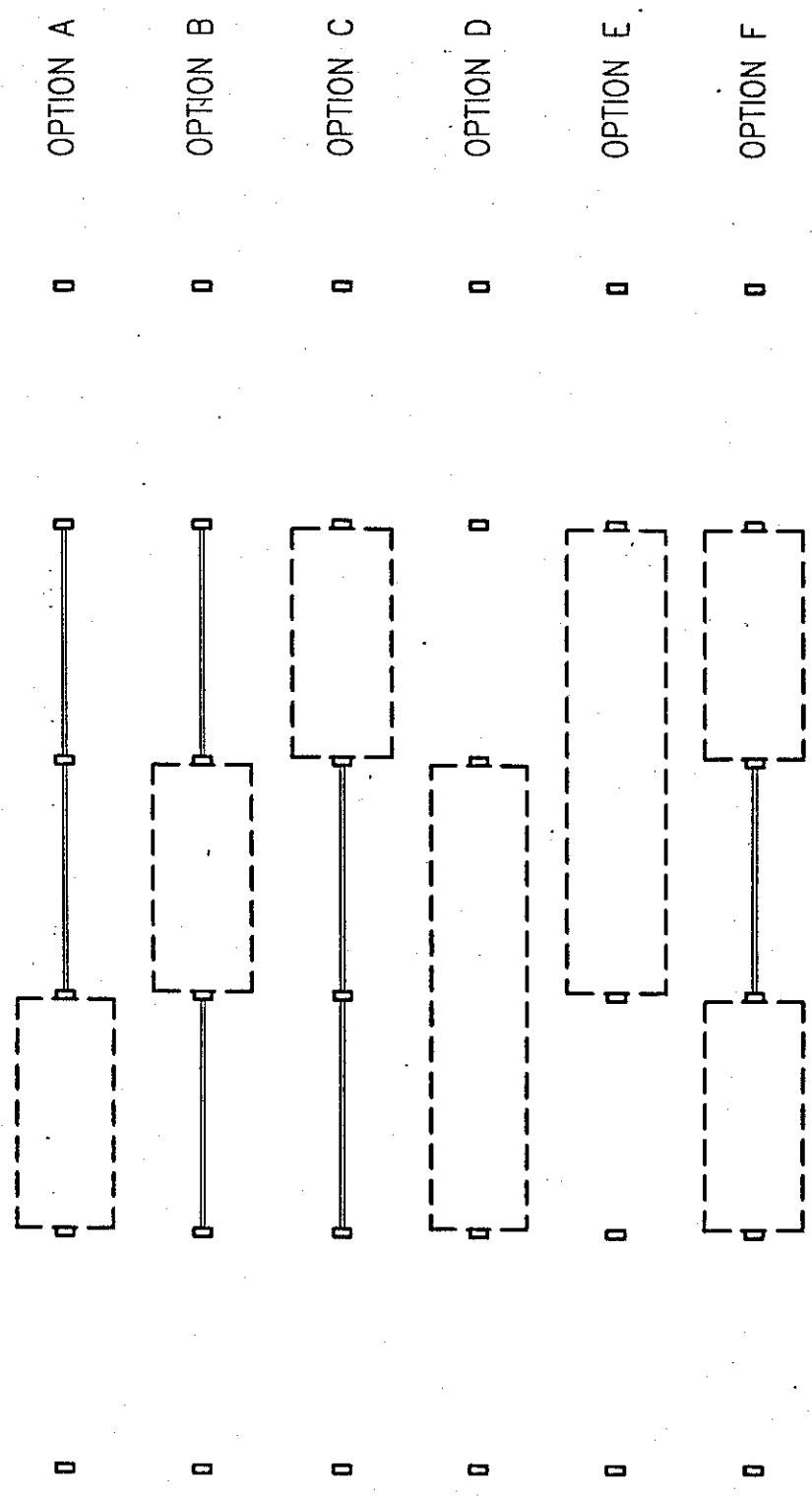
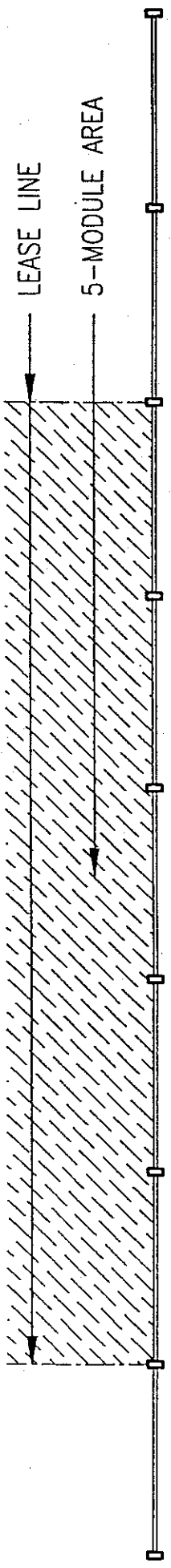

CURVED STOREFRONTS HAVE BEEN REPRESENTED STRAIGHT FOR SIMPLICITY.

5-MODULE STOREFRONT - PORTAL LOCATION

OPTION E



OPTION F

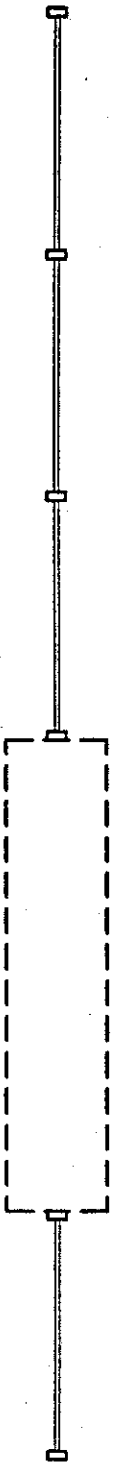

OPTION F

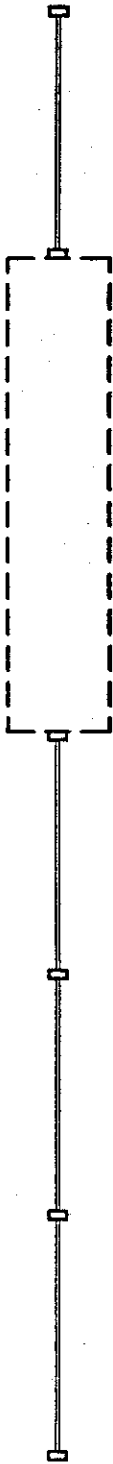

OPTION G

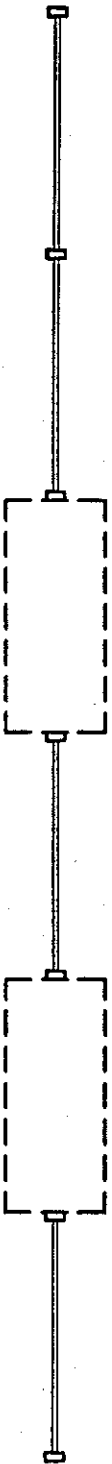

OPTION

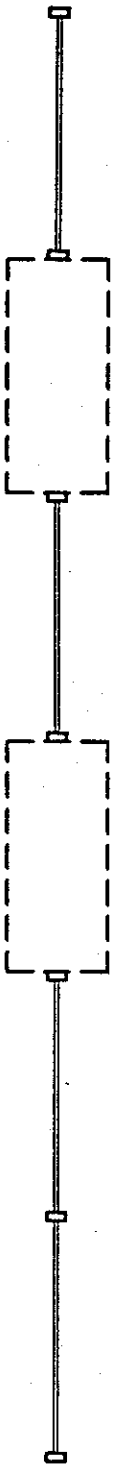

CURVED STOREFRONTS HAVE BEEN REPRESENTED STRIAIGHT FOR SIMPLICITY.

6-MODULE STOREFRONT - PORTAL LOCATION

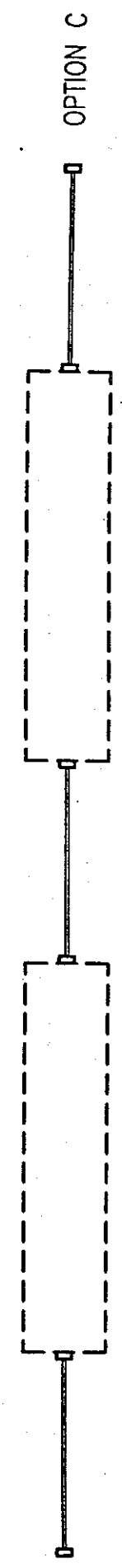
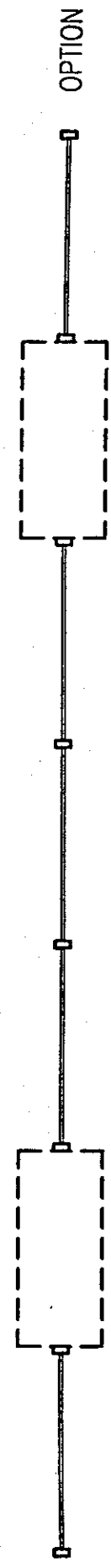
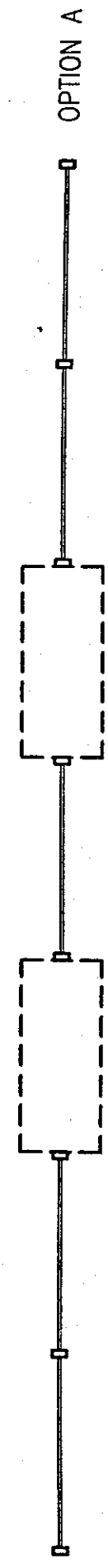
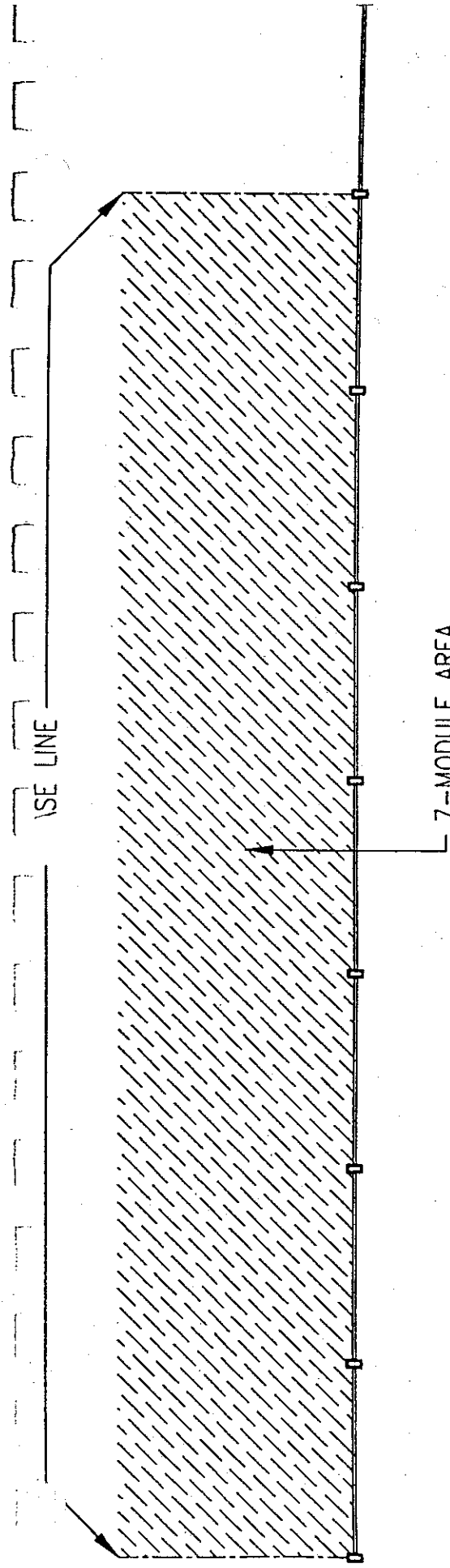

7-MODULE STOREFRONT - PORTAL LOCATION
8-MODULE OR MORE IS SIMILAR

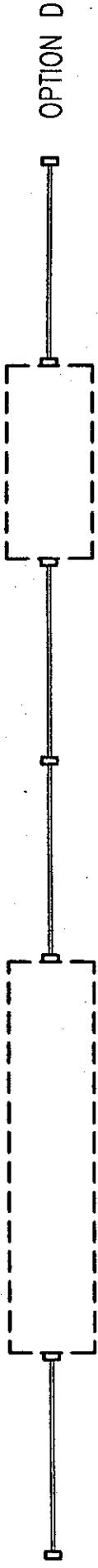

CURVED STOREFRONTS HAVE BEEN REPRESENTED STRAIGHT FOR SIMPLICITY.
 SINGLE OR DOUBLE PORTALS MUST BE SYMMETRICAL ABOUT THE CENTERLINE OF THE SPACE.

7-MODULE STOREFRONT - PORTAL LOCATION
8-MODULE OR MORE IS SIMILAR

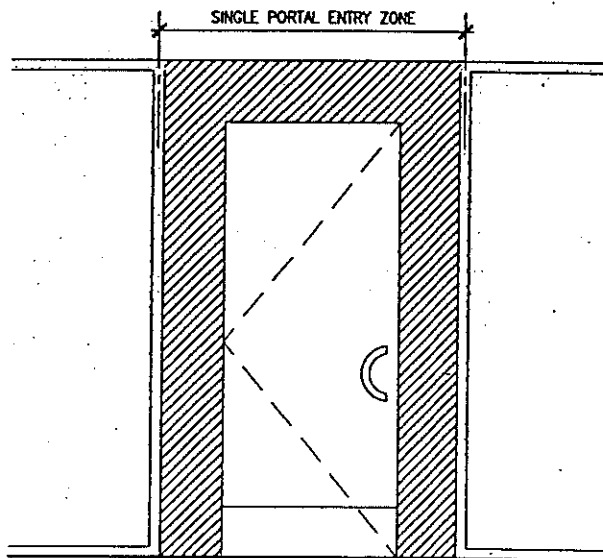
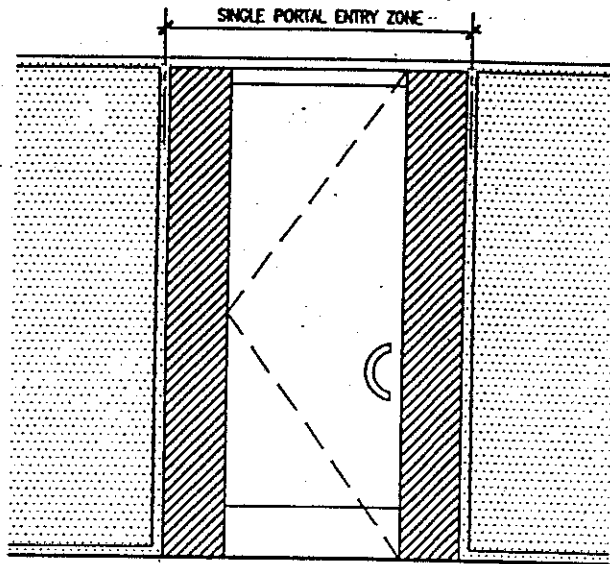

PORTAL ELEVATIONS

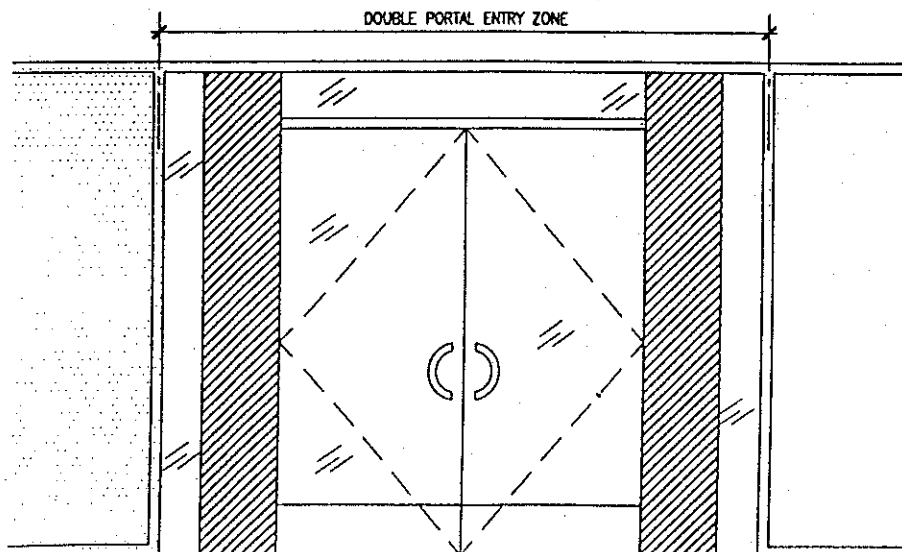
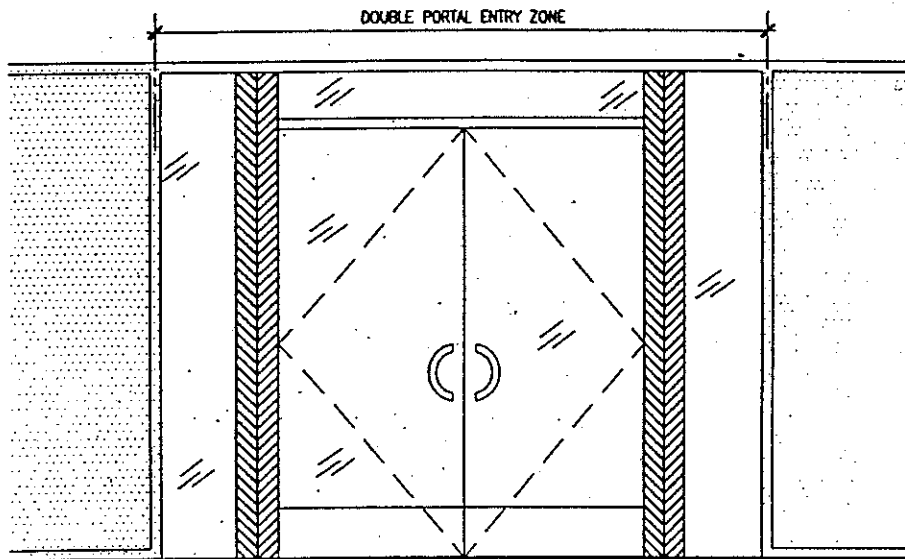
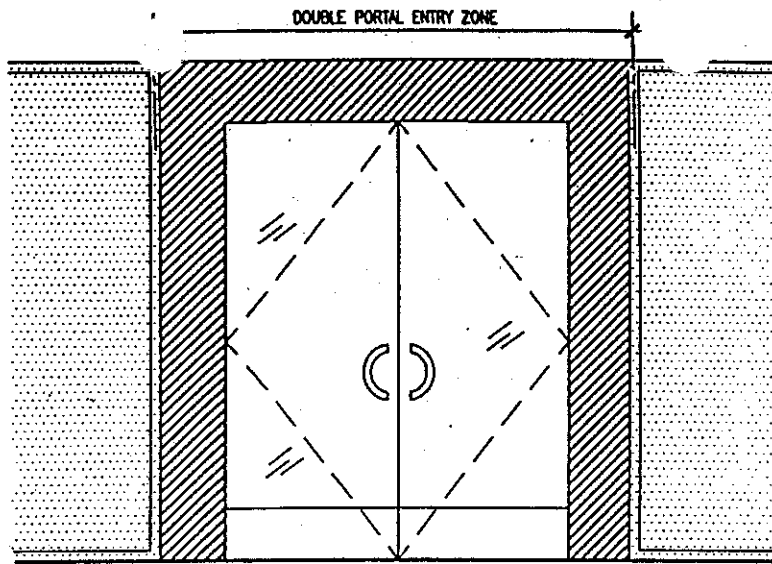

PORTAL ELEVATIONS

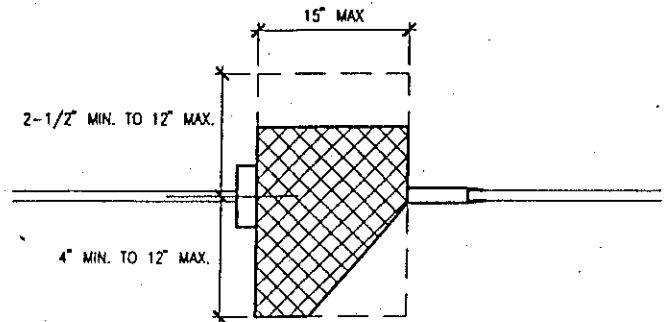
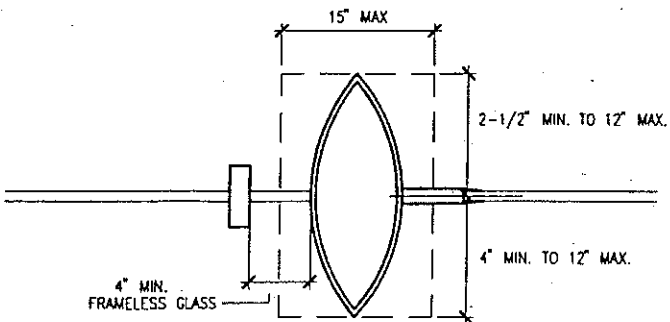
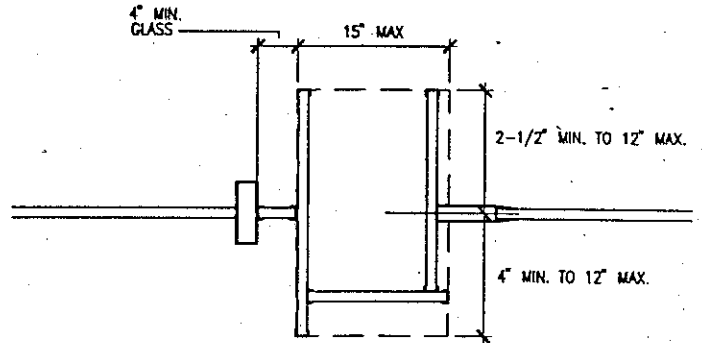
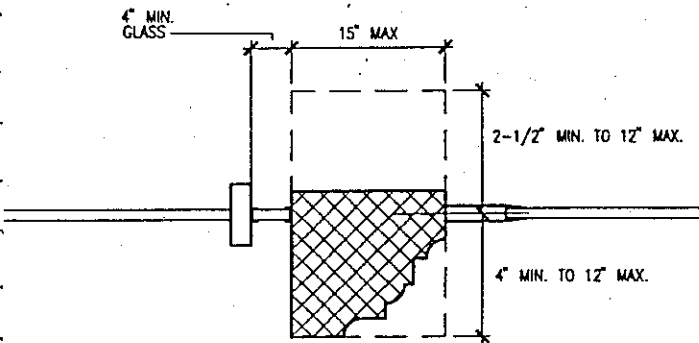
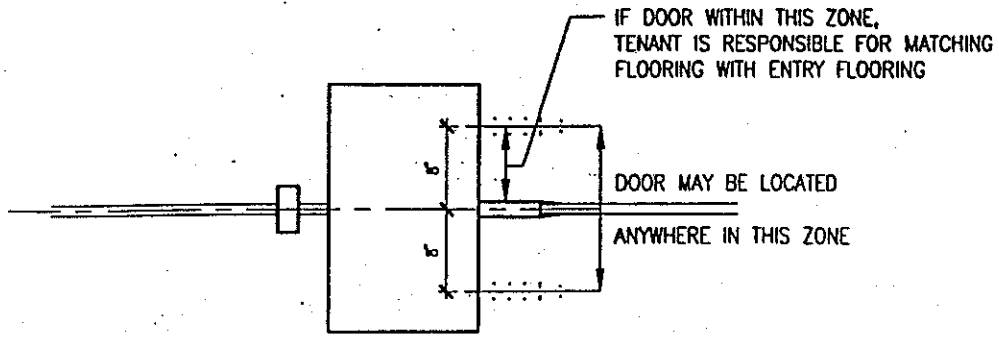

PORTAL PLANS

Photographic Storefront Design Examples

These are some of the many examples of portal designs at other retail locations. They have been included as a reference only, and are not representative of portals that meet our exact guidelines.

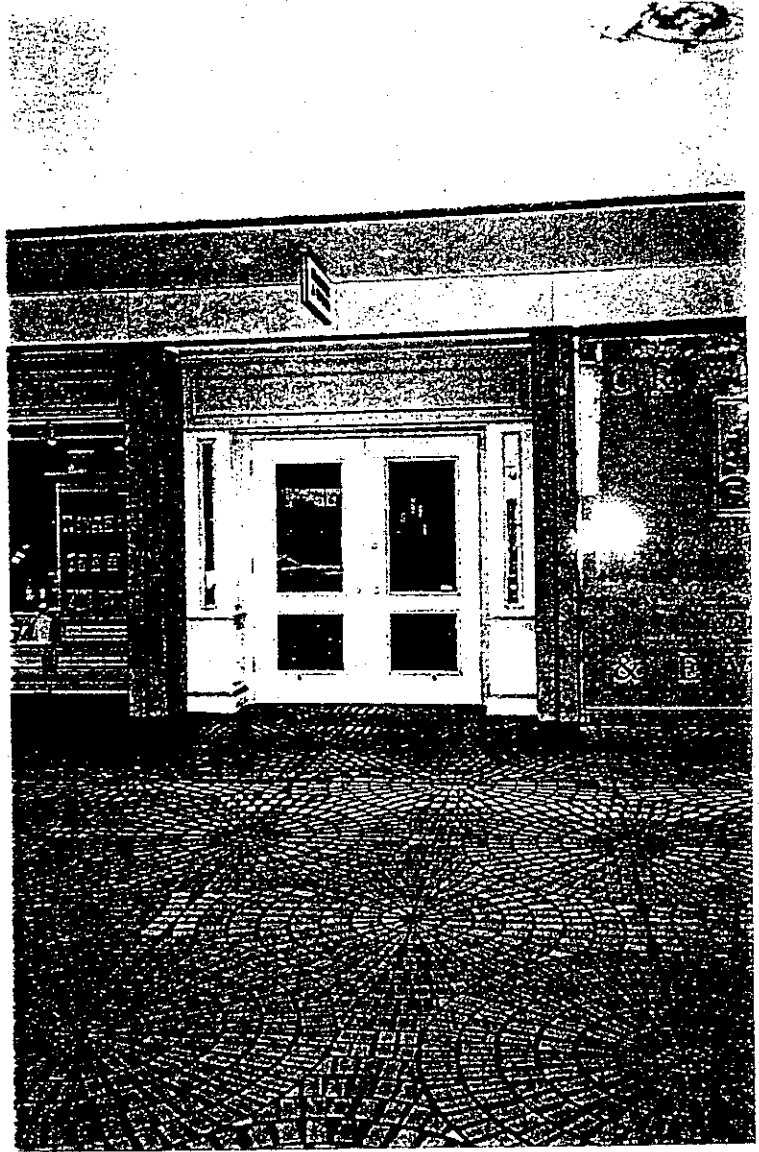



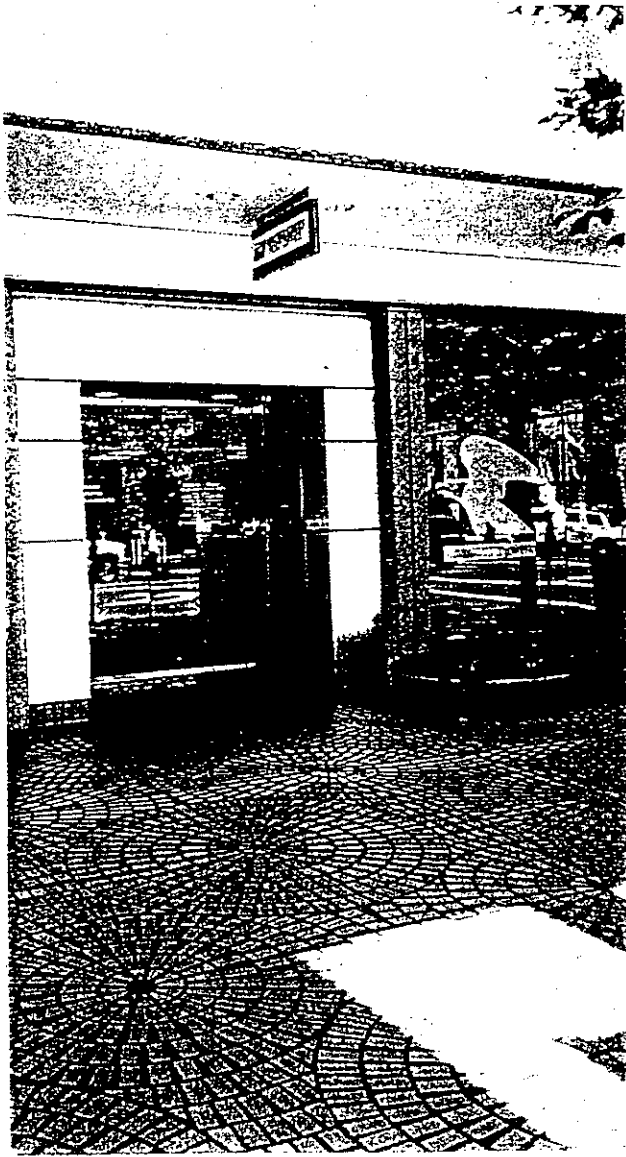

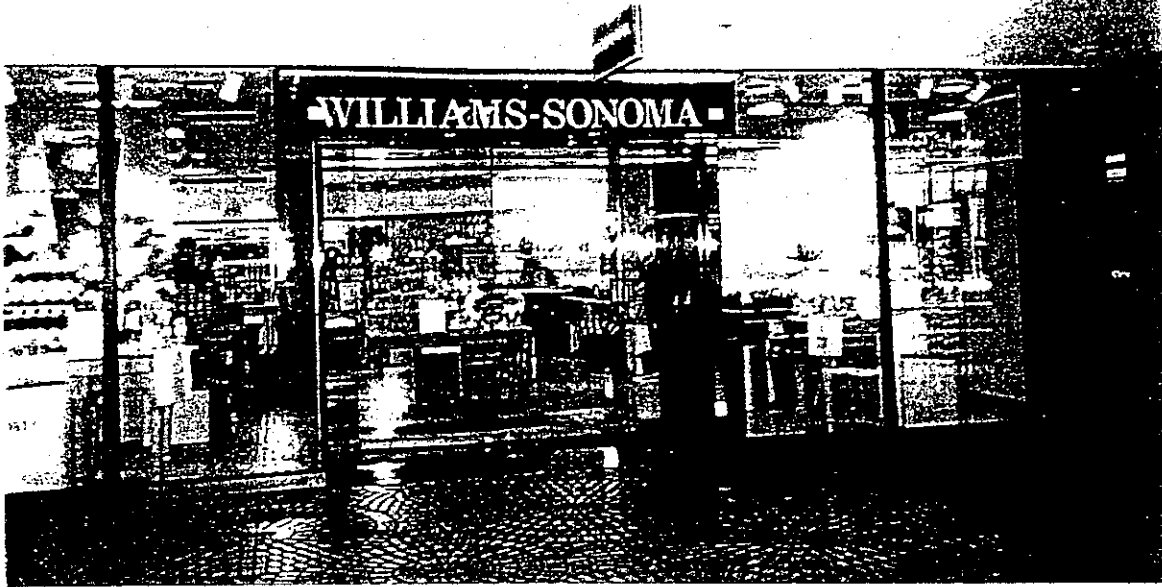

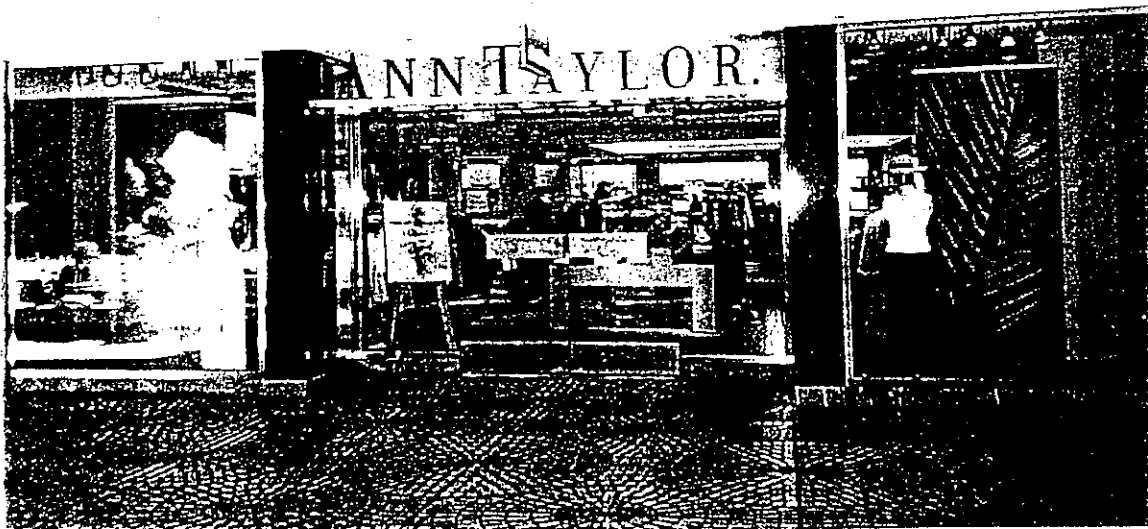

SIGNAGE DESIGN REQUIREMENTS

General

- All tenants are allowed 1.2 square feet of total signage for each lineal foot of frontage (along Mission Street), not to exceed 100 square feet of signage, with a minimum of 25 square feet of signage. (For tenants with additional frontage along the interior of the structure, add 0.6 square feet for each lineal foot of additional interior frontage.)
- Signage must be fabricated and mounted with durable materials to minimize the effects of the elements, vandalism, etc. Tenants must maintain all signage in good, clean condition (periodically polished or washed if applicable, rust-free, re-painted or touched up if necessary, etc.) Broken or damaged signage must be immediately taken down and fixed or replaced immediately for public safety reasons.
- Timers must be provided for all illuminated signs. Signs must stay lit until 10:00 p.m. or until the close of business, whichever is later.
- All ballast boxes, transformers, cross overs, conduit, raceways and support mechanisms must be concealed from public view.

Prohibited Signs

- Flashing or moving lights, graphics or other imagery is not allowed.
- Vacuum-formed or injection-molded plastic signs.
- Signs employing luminous or day-glo painted paper or cardboard, hung behind or around storefront glazing.
- Advertising or descriptive signs, including placards, banners, pennants, names, insignia, trademarks or other descriptive or promotional material affixed to or around show windows, doors, or exterior walls of a storefront.
- Internally illuminated "box" signs.
- Individually (front) illuminated channel letters.

TYPES OF ALLOWABLE SIGNS

The following types of signs are allowed at 'Shops at Yerba Buena.' However, **NOT ALL SIGNS ARE ALLOWABLE AT ALL LOCATIONS!** Tenants must refer to the attached drawings, identify their specific location and determine which of the following signs are allowed for that location. The tenant may choose to use any or all types provided the overall allowance does not exceed the limit for that space. Please note that there are some specific locations where a particular type of sign is mandatory.

- Storefront Window Graphics (all locations)

- **Entry Transom Signs (all portals)**
- **Blade Signs (permitted in most locations)**
- **Wall Signs (only permitted in certain locations)**

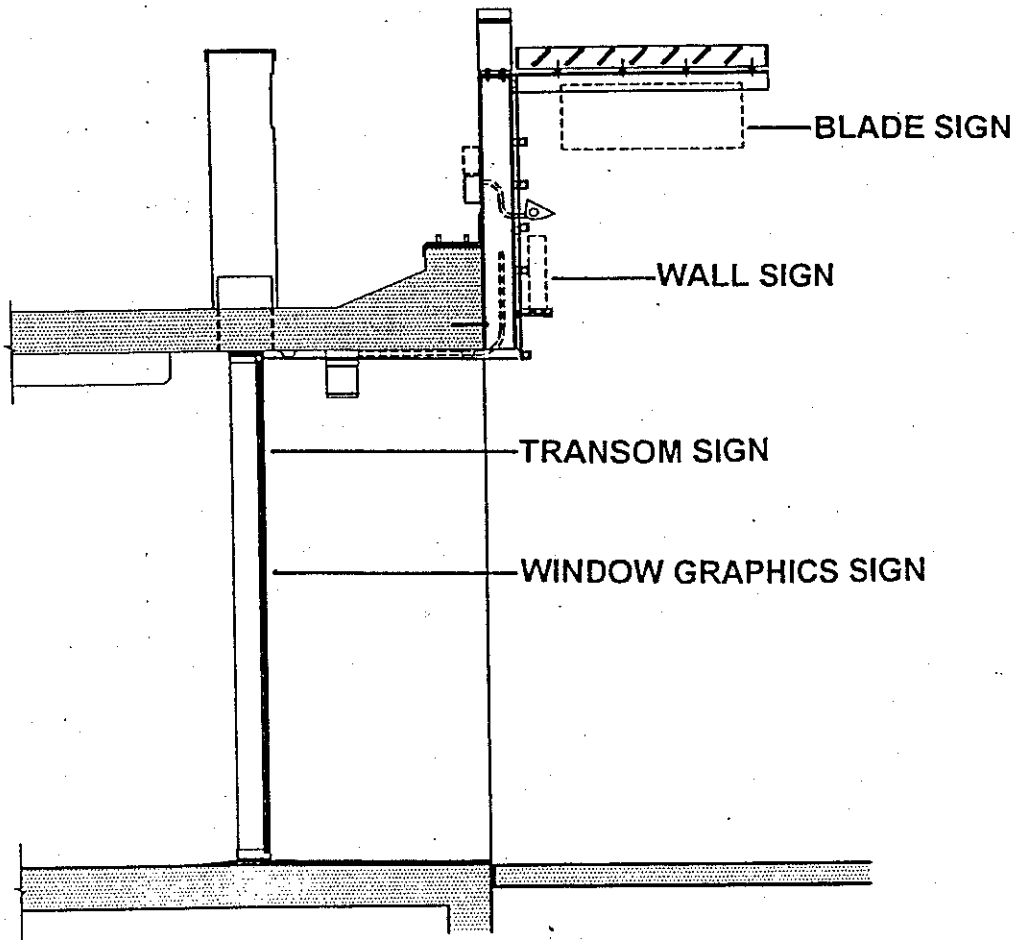

DESCRIPTIONS OF EACH SIGN TYPE

Each of the 10 types of signs utilized at 'Shops at Yerba Buena' is described in the following section with examples. Remember, all signs must be professionally done by recognized artists, crafts people, or signmakers. The quality and consideration given to your store is not only a reflection of you, but of the Square as well.

Storefront Window Graphics

Storefront window graphics are located on the storefront plan and encompass a wide variety of sizes, shapes and materials. They may be something as simple as metal leaf letters or ready made decals on glass. They may be as creative as mixed media and neon signs which float across the store window. Other applications of window signs are silkscreen, sandblasting, and laminating.

Signs may also be hung behind the storefront window. These signs usually are made from transparent material such as glass or plexiglass with paint, or other graphics applied. Opaque signs may also be used (as long as they are small, and do not block out an interior view of the store from the storefront). In any case window signs usually give more specific information about the store, for example; what type of food is served, books sold or services rendered, hours of operation, pricing, credit cards accepted, and so on. Designers of window signs should keep in mind that they are read from relatively close proximity and often from both inside and outside the store. Mounting hardware, electrical connections, and details must be carefully considered and concealed wherever possible.

Transom Signs

Transom signs are located on the portals entries above the height of the door.

Typically, transom signs are pin mounted, carved, or fabricated signs with painted letters. Most are spot lit from above.

Blade Signs

Historically, shop owners, aware not all patrons were literate, suspended images of products sold over the storefront for all to see. The shoe maker had a giant boot, the book seller had a big open book, the butcher had an image of a cow or chicken, and so on. The color, charm and character of these images lining the shopping street contributed immeasurably to the excitement and life of the town.

Typically blade signs are opaque, two- or three-dimensional, carved signs. These signs may be spot lit from a remote lighting source.

Wall Signs

Wall signs are any graphic or written store identification which has been applied to the building facade above the storefront. Wall signs can only be located on sides having customer entrances.

Plain box signs are not allowed. Individual self supporting pin-mounted letters over a decorative background are allowed.

Types of illumination allowed for signage is as follows:

- halo-lit letters - individual letters with lights illuminating the wall to create a silhouette effect
- edge lit letters - illuminated for letters only - where only the edges of the letters are lit

SIZE OF SIGNS

Each type of sign has a maximum overall size (either length and height or area). In addition, some signs have restricted letter size. Size of lettering is also dependent upon the style of lettering used in the signage.

Types of Signs	Maximum Overall Size	Maximum Letter Size**	
		Light	Heavy
Window Graphics	20% of area****	10"	6"
Transom Signs	NA	13"	10"
Blade Signs	must be 2'-10" x 1' h *	9"	9"
Wall Signs	15' x 1'-2" h	13"	10"

*Larger letters that are an integral part of the logo may exceed letter size requirements.

**Average Size - If logo or signage lettering contains one or more larger letters along with a series of smaller letters, maximum sizes will be determined using an average sizing method.

***Heavy and Light Letters - When looking at signs one can make a determination whether a sign appears 'heavy' or 'light.' A heavy feeling is achieved by using letters with short, broad strokes. A light feeling is achieved by thin, graceful, curving lines or 'outline' letters. Specifically, letter stroke widths equal to or greater than 1-1/2" are considered heavy. Stroke widths less than 1-1/2" are considered light. To that end we have provided incentives for their use in the design guidelines.

****No one window sign may occupy more than 50% of any window module.

EXAMPLES OF SIGNAGE



STRUCTURE

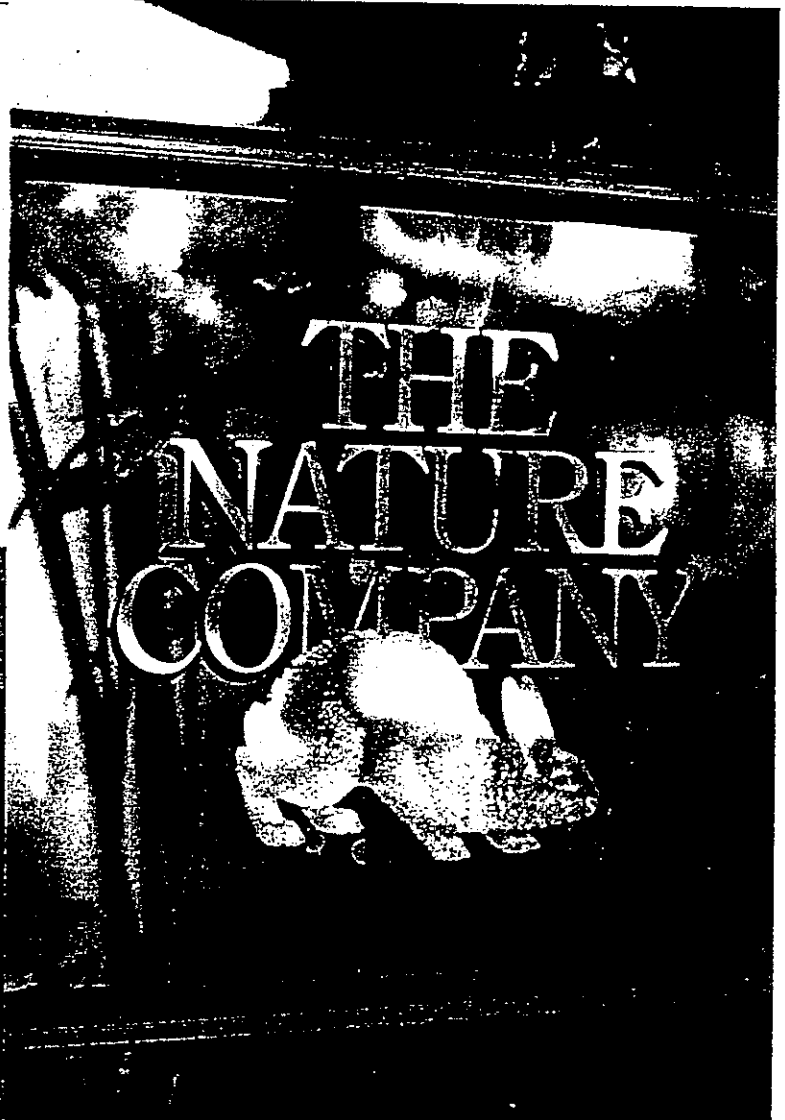

THE
NATURE
COMPANY

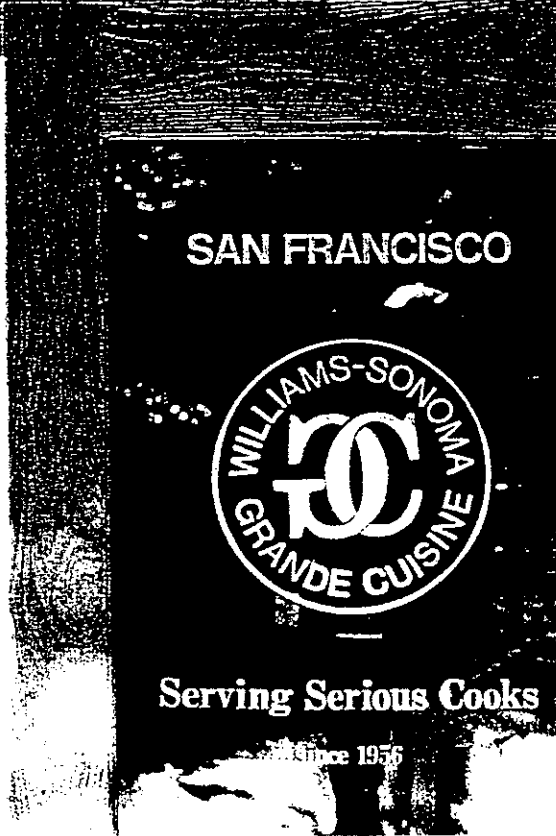

SAN FRANCISCO



Serving Serious Cooks

Since 1956

Transom Signs

Transom signs appear on a number of portal entries, refer to Photographic Storefront Design Examples.

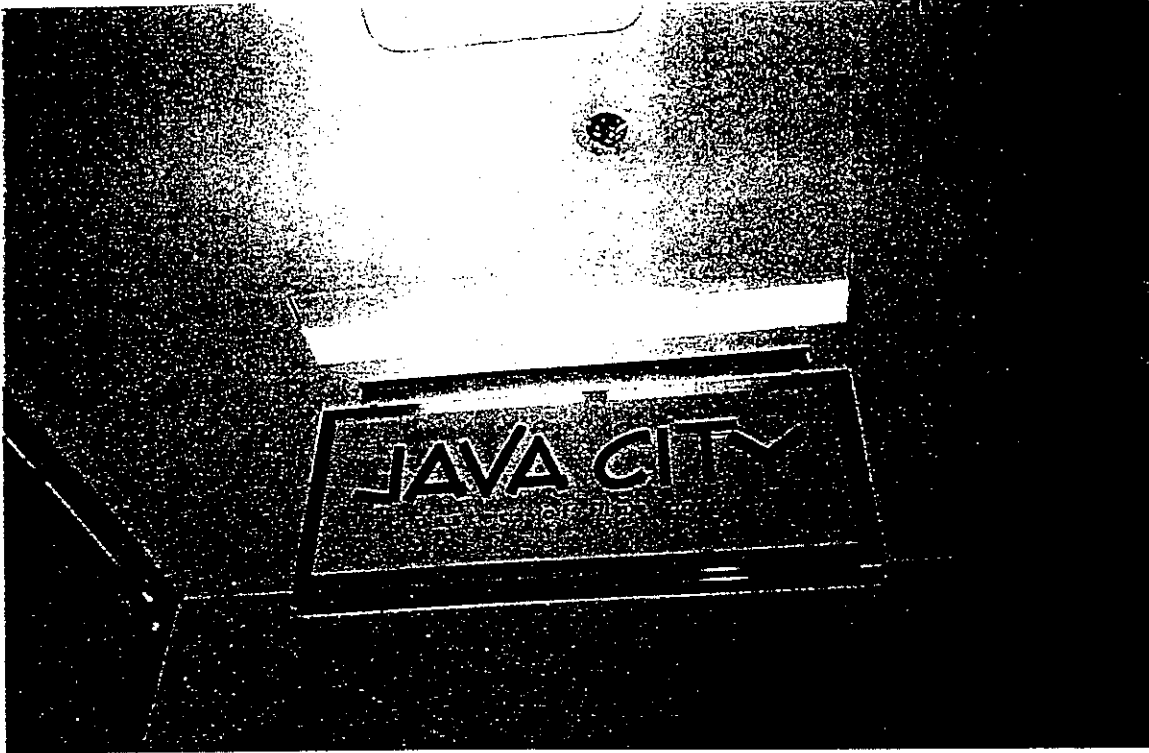

Blade Signs



Wall Signs



Wall Signs

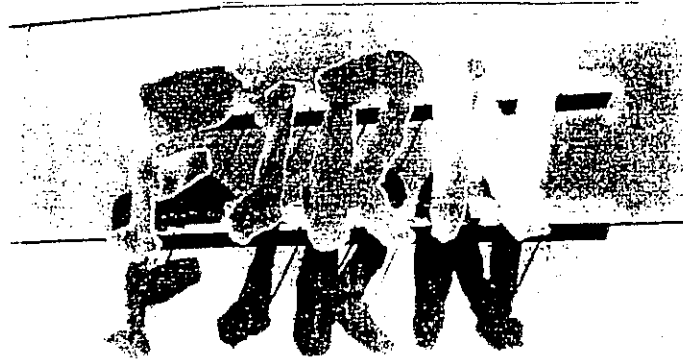

ADDENDUM TO SHOPS AT YERBA BUENA LEASE
OPTION TO EXTEND TERM

Tenant is given the option to extend the Term hereof for three (3) additional consecutive five-(5)-year periods (each, an **“Option Term”**) following expiration of the initial term stated in the Basic Lease Information (the **“Initial Term”**), by giving written notice of exercise of each such option (the **“Option Notice”**) to Landlord not less than six (6) but not more than twelve (12) months before the expiration of the Initial Term or the first or second Option Term, as the case may be. Notwithstanding the foregoing, if Tenant is in default on the date of giving an Option Notice, Tenant shall have no right to extend the Term and this Lease shall expire at the end of the Initial Term or the first or second Option Term, as the case may be; or if Tenant is in default on the date any Option Term is to commence, the subject Option Term shall not commence. The Annual Rental for the first (1st) year of the first Option Term and, if applicable, for the second and third Option Terms shall be the greater of (a) one hundred three percent (103%) of the Annual Rental payable for the twelve (12) months immediately preceding the month in which the applicable Adjustment Date (as hereinafter defined) occurs; or (b) the fair market rental (**“Fair Market Rental”** as hereinafter defined) of the Premises at the commencement of the applicable Option Term (any, an **“Adjustment Date”**). At the commencement of the second (2nd) and each successive year in the applicable Option Term, the Annual Rental shall be increased in accordance with Article 2(c) of the Lease.

(i) **“Fair Market Rental”** shall mean the rate being charged to retail tenants renewing existing leases for comparable space in the City and County of San Francisco, California, with similar amenities, taking into consideration only the following: size, location, proposed term of the lease, extent of services to be provided and the time that the particular rate under consideration became or is to become effective. In determining the **“Fair Market Rental”**, no consideration shall be given to payment of leasing commissions, tenant improvement allowances, **“free rent”** or any other terms or conditions of leases of comparable space. Fair Market Rental as of the Adjustment Date shall be determined by Landlord, approved by City, and written notice of the amount thereof (the **“Notice”**) shall be given to Tenant not later than thirty (30) days after receipt of the Option Notice, subject to Tenant’s right to arbitration as hereinafter provided. Failure on the part of Tenant to demand arbitration within thirty (30) days after receipt of the Notice from Landlord shall bind Tenant to the Fair Market Rental as determined by Landlord. Should Tenant elect to arbitrate and should the arbitration not be concluded prior to the Adjustment Date, Tenant shall pay the Annual Rental to Landlord after the Adjustment Date, adjusted to reflect the Fair Market Rental as Landlord has so determined (if such Annual Rental is to be based upon the Fair Market Rental pursuant to the preceding paragraph). If the amount of the Fair Market Rental as determined by arbitration is greater than or less than Landlord’s determination, then any adjustment required to adjust the amount previously paid shall be made by payment by the appropriate party within ten (10) days after such determination of Fair Market Rental.

(ii) If Tenant disputes the amount claimed by Landlord as Fair Market Rental, Tenant may require that Landlord submit the dispute to arbitration. The

Addendum

Page 1

arbitration shall be conducted and determined in the City and County of San Francisco, California in accordance with the then prevailing rules of the American Arbitration Association or its successor for arbitration of commercial disputes, except that the procedures mandated by such rules shall be modified as follows:

(A) Tenant shall make demand for arbitration in writing within thirty (30) days after service of the Notice, specifying therein the name and address of the person to act as the arbitrator on Tenant's behalf. The arbitrator shall be a real estate appraiser with at least five (5) years' full-time commercial appraisal experience who is familiar with the Fair Market Rental of retail space in the City and County of San Francisco, California. Failure on the part of Tenant to make the timely and proper demand for such arbitration shall constitute a waiver of the right thereto. Within ten (10) business days after the service of the demand for arbitration, Landlord shall give notice to Tenant specifying the name and address of the person designated by Landlord to act as arbitrator on its behalf, which arbitrator shall be similarly qualified. If Landlord fails to notify Tenant of the appointment of its arbitrator, within or by the time specified, then the arbitrator appointed by Tenant shall be the arbitrator to determine the Fair Market Rental for the Premises.

(B) If two arbitrators are chosen pursuant to Paragraph (ii)(A) above, the arbitrators so chosen shall meet within ten (10) business days after the second arbitrator is appointed and shall appoint a third arbitrator, who shall be a competent and impartial person with qualifications similar to those required of the first two arbitrators pursuant to Paragraph (ii)(A) above. If they are unable to agree upon such appointment within five (5) business days after expiration of such ten- (10-) business-day period, the third arbitrator shall be selected by the parties themselves. If the parties do not so agree, then either party, on behalf of both, may request appointment of such a qualified person by the then-president of the San Francisco Real Estate Board. The three arbitrators shall decide the dispute, if it has not been previously resolved, by following the procedures set forth in Paragraph (ii)(C) below.

(C) The Fair Market Rental shall be fixed by the three arbitrators in accordance with the following procedures. Each of the arbitrators selected by the parties shall state, in writing, his determination of the Fair Market Rental supported by the reasons therefor and shall make counterpart copies for each of the other arbitrators. The arbitrators shall arrange for a simultaneous exchange of such proposed resolutions. The role of the third arbitrator shall be to select which of the two proposed resolutions most closely approximates his determination of Fair Market Rental. The third arbitrator shall have no right to propose a middle ground or any modification of either of the two proposed resolutions. The resolution he chooses as that most closely approximating his determination of the Fair Market Rental shall constitute the decision of the arbitrators and shall be final and binding upon the parties.

Addendum

Page 2

(D) In the event of a failure, refusal or inability of any arbitrator to act, his successor shall be appointed by him, but in the case of the third arbitrator, his successor shall be appointed in the same manner as that set forth herein with respect to the appointment of the original third arbitrator. The arbitrators shall attempt to decide the issue within ten (10) business days after the appointment of the third arbitrator. Any decision in which the arbitrator appointed by Landlord and the arbitrator appointed by Tenant concur shall be binding and conclusive upon the parties, except that such arbitrators shall not attempt by themselves to mutually ascertain the Fair Market Rental and any such determination, in a manner other than that provided for in Paragraph (ii)(C) hereof, shall not be binding on the parties. Each party shall pay the fees and expenses of its respective arbitrator and both shall share the fees and expenses of the third arbitrator. Attorneys' fees and expenses of counsel and of witnesses for the respective parties shall be paid by the respective party engaging such counsel or calling such witnesses.

(E) The arbitrators shall have the right to consult experts and competent authorities for factual information or evidence pertaining to a determination of Fair Market Rental, but any such consultation shall be made in the presence of both parties with full right on their part to cross-examine. The arbitrators shall render the decision and award in writing with counterpart copies to each party. Except for the establishment of Fair Market Rental as herein provided, the arbitrators shall have no power to modify the provisions of this Lease.

EXHIBIT "D-1"

TENANT'S APPROVED SIGNAGE

See attached copy of Exhibit D-1 "Sprint Store Exterior Signage Guidelines" ("Tenant's Guidelines") which are subject to the following restrictions:

1. Section I "Pylon Signage" of Tenant's Guidelines is hereby deleted in its entirety and replaced with "Intentionally Omitted".
2. The maximum size of the wall sign contemplated under Section III "Channel Signs" and Section IV "Capsule Signs" of Tenant's Guidelines shall be fifteen (15) feet long and one (1) foot two (2) inches high with a maximum letter height of thirteen (13) inches.
3. The maximum overall size of the window decal contemplated under Section V "Sprint Store Window Decal" of Tenant's Guidelines shall not exceed twenty percent (20%) of the glass area with a maximum letter height of six (6) inches.

If there is any conflict between the terms of Tenant's Guidelines and the terms of the restrictions set forth above, the terms of such restrictions shall control.

EXHIBIT D-1

Sprint Store Exterior Signage Guidelines

Preferred Placement of Exterior Signage shown for entire store front

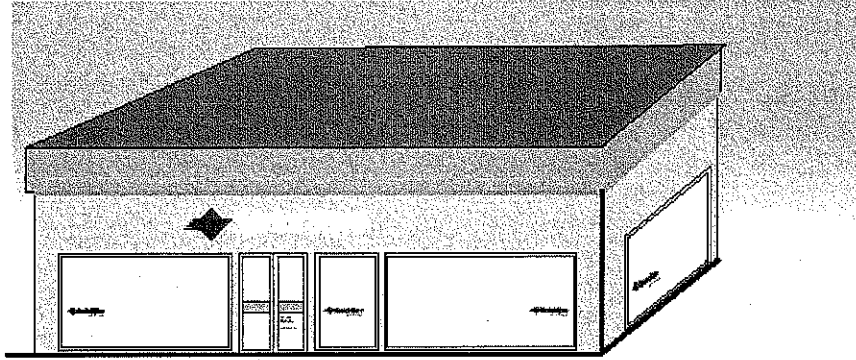

I. Pylon Signage

Horizontal (Preferred)

Vertical (Alternate)

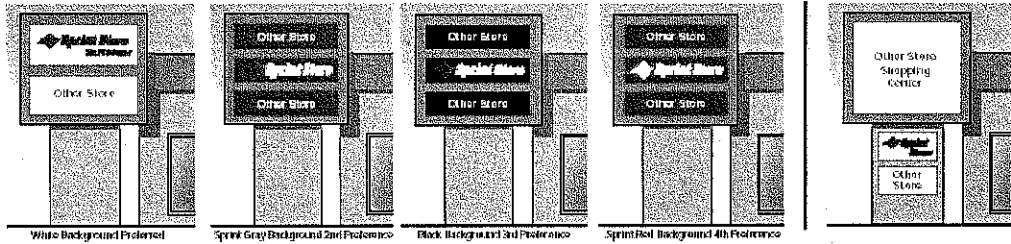

A. Presentation

Where possible, stores should implement a horizontally aligned pylon sign for maximum visual impact. However, if horizontal space is constrained, a vertically aligned sign is acceptable. If space allows and readability is not affected, use the horizontal version with "The PCS Center" tag line in Sprint Red, Pantone 485. A minimum distance of one-eighth the height of the diamond (1/8X) should be utilized for clear space between the Sprint Store identifier and the edge of the pylon signage. If Pantone 485 is not an option, consult the Brand Group for alternatives.

Original Artwork

Original artwork is required for production. Please use the examples provided here or contact the Sprint PCS Marketing Communications Brand Development Group at 913-765-5545 to order an electronic version of the Sprint Store artwork.



Sprint Store Exterior Signage Guidelines

II. Store Identifier

A. Staging

A minimum unobstructed area equal to half the height of the Sprint diamond symbol (1/2X) should surround the outermost points of the Sprint Store visual identifier (right). There will be exceptions for pylon and capsule signs. In other situations where this compromises the visibility of the sign, contact the Sprint PCS Marketing Communications Brand Development Group to discuss alternate recommendations.

B. Color

Diamond Logo: Use original artwork for production (see back cover). Color must be the equivalent of Sprint Red, Pantone 485. The fill color between the recessed lines on

the diamond should match the background the signage will appear on. The recessed lines should appear as if they're a raised portion of the building, and not a part of the signage.

For capsule and pylon signage, the fill between the stripes should match the background as well. Raceway box should be the same color as facade or background.

Sprint Store Logotype: Use original artwork for production (see back cover). Letters should always appear in white.

The only exception to this rule is for pylon signage set on a white background, in which case the letters or (logotype) should be set in Sprint Gray, Pantone 425.

Trimcap & Returns: Black or Sprint Gray, Pantone 425, are the preferred colors for trimcap and returns.

Horizontal

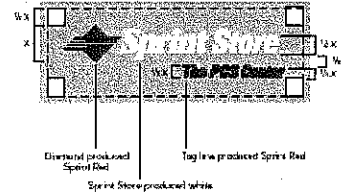

Vertical

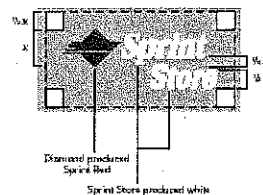

III. Channel Letter Sign

A. Horizontal (Preferred)

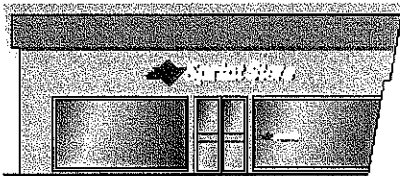

B. Vertical (Alternate)

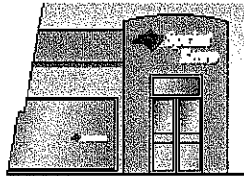

Presentation

Where possible, stores should implement a horizontally aligned sign for maximum visibility. However, if the most desirable signage location has a limited horizontal area, a vertically aligned sign is acceptable.

IV. Capsule Sign

A. Horizontal (Preferred)

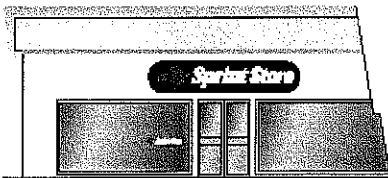

B. Vertical (Alternate)

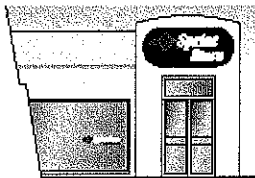

When to Use

If the exterior color of the building provides insufficient contrast for white lettering, encapsulated signage may be used. This involves mounting a black elliptical substrate to the facade before installing the channel letters. The thickness of this element should be between 2 and 3 inches. Channel letters used on capsule signs must follow the guidelines above. A minimum distance of one-eighth the height of the diamond (1/8X) should be utilized for clear space between the Sprint Store identifier and the edge of the capsule signage.



Sprint Store Exterior Signage Guidelines

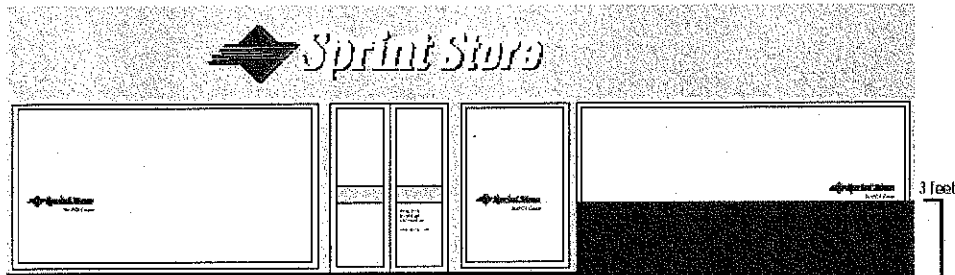

To maintain the Sprint PCS "clarity" message, it is important that the placement of the exterior signage provide immediate identification of a Sprint Store without interfering with in-store graphics or providing unnecessary visual noise. A maximum of one window decal will be allowed per 20 feet of exterior wall area.

V. Sprint Store Window Decal

A typical retail store front window is 4 feet wide. By using a decal 3 feet in length, there will be 80% coverage per 4-foot window identifying the store.

A. A 3-foot decal placed at waist level (3 feet from the ground) on windows just to the right or left of the door will identify the store and at the same time, not disrupt the view of other items that may at times be visible through the window.

B. If the wall exceeds 3 feet up from the ground, place decal one diamond's width up from where the window begins. Displaying decals just outside the door gives customers the opportunity to see store identification just as they enter the store.

C. Limited repetition of the decal on subordinate windows will reinforce the identification of the store while maintaining a clear, open and easy appearance. These secondary decals should be positioned to define the "territory" of the Sprint Store by providing identification at its farthest left and right points. This gives an immediate brand message to sidewalk traffic, letting passersby know as soon as they enter Sprint Store territory.

One 3-foot decal should always appear in close proximity to the store entrance. The decal should be measured from the most left edge of the diamond to the "e" in store.



D. When a window is less than 3 feet in width, a decal measuring 2 feet in width should be displayed (using the same rule of measure). Windows less than 2 feet in width should not display a decal.

The preferred placement of the 3-foot decal is on the window to the immediate right of the door. In this position, the far left edge of the diamond should be a diamond's width apart from the left edge of the window and 3 feet up from the ground (not the bottom of the window) measuring from the bottom-most point of the diamond.

Placement with window to the immediate right of the door.

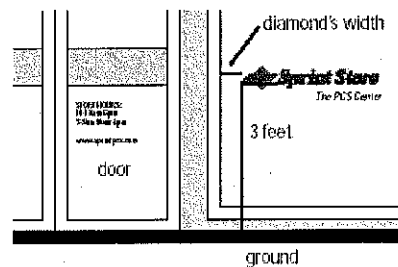

E. If there is no window to the right of the door, the preferred alternate placement is on the window to the immediate left of the door. In this position, the "e" in "Store" of the decal should be a diamond's width from the right edge of the window frame and 3 feet up from the ground. If the door is flanked by narrow sidelight windows, the decal should appear to the immediate right or left of the sidelight.

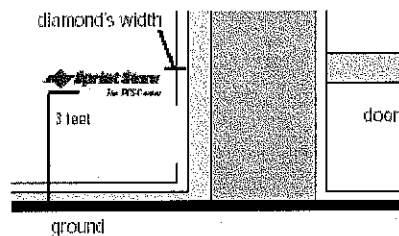

Sprint Store Exterior Signage Guidelines

VI. Frequency of Decals

Placement with window to the immediate left of the door.

A. When there is at least 20 feet of window area to the left or right of a door, a secondary decal should be used. This decal should be positioned one diamond width in from the farthest window edge (right and left). If there is greater than 20 feet of window area on both sides of the door, a secondary decal should be placed on each side. If there is less than 20 feet of window area on one side of the door, a secondary decal should not be placed on that side.

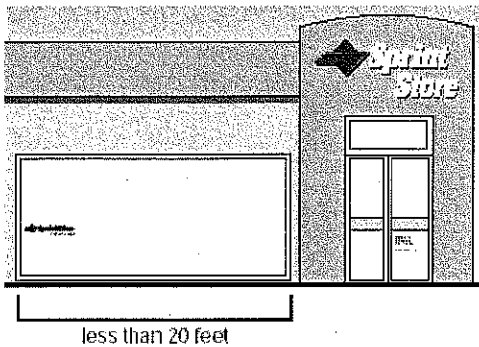

Exterior walls with no doors and less than 20 feet of window area should have one secondary decal placed at the edge of the window closest to the store front. Exterior walls with no doors and more than 20 feet of window area should have two secondary decals—one at the farthest right edge of the window and one at the farthest left edge of the window. In either case the logo should be placed a diamond's width from the edge of the window frame and 3 feet up from the ground.

B. If the wall consists of smaller windows, separated by solid structure, (brick or stucco) a maximum of one window decal will be allowed per 20 feet of exterior wall area.

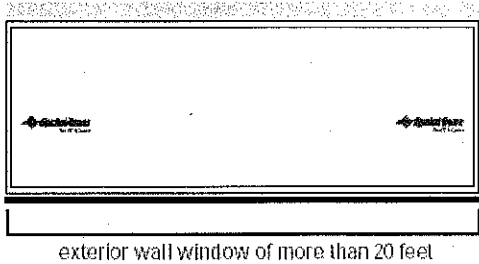

VII Preferred Window Decal Colors

A. Depending on the tint of the windows at an individual store location, the Sprint Store logotype should be set in either white or Sprint Gray depending on which color will provide adequate contrast. The diamond Sprint logo and "The PCS Center" must be positioned in Sprint Red in all scenarios.

VIII. Sprint Store Hours

A. For stores with double door entrances the sign should be displayed on the door to the right (approximately 2 1/2 feet up from the ground). The size of the store hour text should be 70% the size of the text "The PCS Center" of the decal. Store hours should be set in either white or gray. Use same color chosen for window decal.

B. Stores with multiple entrances should display hours at only one entrance per exterior wall.

IX. Sprint PCS Web Site Address

A. The Sprint PCS web site URL (www.sprintpcs.com) should be displayed a double line space below the store hours and left justified and sized according to the same guidelines as the store hours (see diagram). The URL, however should be the color of PMS 485 red to match the red in the decal. Like the store hours, the same standards apply regarding left side window and repeated window placement.

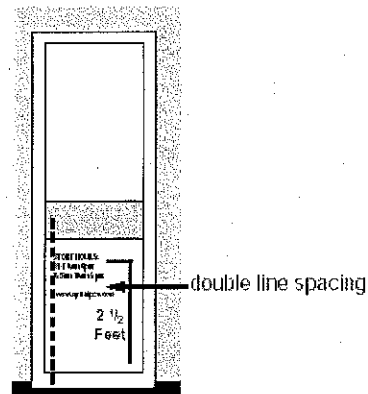

left justified

Addendum for Sprint PCS Store and Service Center Locations

Permanent Signage

Permanent exterior signage for locations where the Sprint Store has been split into separate sales and service areas should follow the guidelines set forth in the Sprint Store Exterior Signage Guidelines (LIT 5285). Signage affixed to the building and pylon signage should mirror the presentation of that in our proprietary retail stores.

Window Decal

An alternate window decal presentation should be utilized at these locations featuring the "Sprint PCS Store and Service Center" identifier. The guidelines for color should and placement can be referenced in the Sprint Store Exterior Signage Guidelines. The width of the "Sprint PCS Store and Service Center" identifier should follow the same rule of measure as the Sprint Store Window Decal.

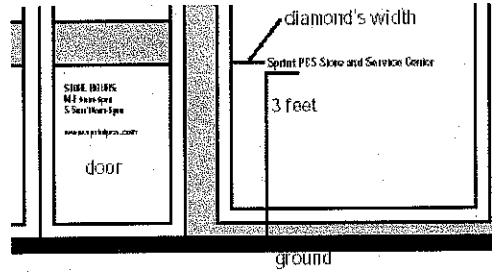

ADDENDUM TO SHOPS AT YERBA BUENA LEASE
OPTIONS TO EXTEND TERM

Tenant is given the option to extend the Term hereof for two (2) additional consecutive five- (5-) year periods (each, an **"Option Term"**) following expiration of the initial term stated in the Basic Lease Information (the **"Initial Term"**), by giving written notice of exercise of each such option (the **"Option Notice"**) to Landlord not less than six (6) but not more than twelve (12) months before the expiration of the Initial Term or the first Option Term, as the case may be. Notwithstanding the foregoing, if an Event of Default has occurred and is continuing on the date of giving an Option Notice or if an Event of Default under the Lease would have occurred and be continuing but for Landlord's inability as result of applicable law to send a notice to Tenant respecting such default, Tenant shall have no right to extend the Term and this Lease shall expire at the end of the Initial Term or the first Option Term, as the case may be; or if an Event of Default has occurred and is continuing on the date either Option Term is to commence or if an Event of Default under the Lease would have occurred and be continuing but for Landlord's inability as result of applicable law to send a notice to Tenant respecting such default, the subject Option Term shall not commence. The Annual Rental for the first (1st) year of the first Option Term shall be Fifty-Three and 04/100 Dollars (\$53.04) per square foot of Floor Area of the Premises per year (\$4.42 per square foot per month). The Annual Rental for the first (1st) year of the second Option Term shall be the greater of (a) one hundred three percent (103%) of the Annual Rental payable for the twelve (12) months immediately preceding the month in which the applicable Adjustment Date (as hereinafter defined) occurs; or (b) the fair market rental (**"Fair Market Rental"** as hereinafter defined) of the Premises at the commencement of the second Option Term (the **"Adjustment Date"**). At the commencement of the second (2nd) and each successive year in the applicable Option Term, the Annual Rental shall be increased in accordance with Article 2(c) of the Lease.

(i) **"Fair Market Rental"** shall mean the rate being charged to retail tenants renewing existing leases for comparable space in the City and County of San Francisco, California, with similar amenities, taking into consideration only the following: size, location, proposed term of the lease, extent of services to be provided and the time that the particular rate under consideration became or is to become effective. In determining the "Fair Market Rental", no consideration shall be given to payment of leasing commissions, tenant improvement allowances, "free rent" or any other terms or conditions of leases of comparable space. Fair Market Rental as of the Adjustment Date shall be determined by Landlord, approved by City, and written notice of the amount thereof (the **"Notice"**) shall be given to Tenant not later than thirty (30) days after receipt of the Option Notice, subject to Tenant's right to arbitration as hereinafter provided. Failure on the part of Tenant to demand arbitration within thirty (30) days after receipt of the Notice from Landlord shall bind Tenant to the Fair Market Rental as determined by Landlord. Should Tenant elect to arbitrate and should the arbitration not be concluded prior to the Adjustment Date, Tenant shall pay the Annual Rental to Landlord after the Adjustment Date, adjusted to reflect the Fair Market Rental as Landlord has so determined (if such Annual Rental is to be based upon the Fair Market Rental pursuant to the preceding paragraph). If the amount of the Fair Market Rental as determined by arbitration is greater than or less than Landlord's determination, then any adjustment

required to adjust the amount previously paid shall be made by payment by the appropriate party within ten (10) days after such determination of Fair Market Rental.

(ii) If Tenant disputes the amount claimed by Landlord as Fair Market Rental, Tenant may require that Landlord submit the dispute to arbitration. The arbitration shall be conducted and determined in the City and County of San Francisco, California in accordance with the then prevailing rules of the American Arbitration Association or its successor for arbitration of commercial disputes, except that the procedures mandated by such rules shall be modified as follows:

(A) Tenant shall make demand for arbitration in writing within thirty (30) days after service of the Notice, specifying therein the name and address of the person to act as the arbitrator on Tenant's behalf. The arbitrator shall be a real estate appraiser with at least ten (10) years' full-time commercial appraisal experience who is familiar with the Fair Market Rental of retail space in the City and County of San Francisco, California. Failure on the part of Tenant to make the timely and proper demand for such arbitration shall constitute a waiver of the right thereto. Within ten (10) business days after the service of the demand for arbitration, Landlord shall give notice to Tenant specifying the name and address of the person designated by Landlord to act as arbitrator on its behalf, which arbitrator shall be similarly qualified. If Landlord fails to notify Tenant of the appointment of its arbitrator, within or by the time specified, then the arbitrator appointed by Tenant shall be the arbitrator to determine the Fair Market Rental for the Premises.

(B) If two arbitrators are chosen pursuant to Paragraph (ii)(A) above, the arbitrators so chosen shall meet within ten (10) business days after the second arbitrator is appointed and shall appoint a third arbitrator, who shall be a competent and impartial person with qualifications similar to those required of the first two arbitrators pursuant to Paragraph (ii)(A) above. If they are unable to agree upon such appointment within five (5) business days after expiration of such ten- (10-) business-day period, the third arbitrator shall be selected by the parties themselves. If the parties do not so agree, then either party, on behalf of both, may request appointment of such a qualified impartial person by the then-president of the San Francisco Real Estate Board (or next officer who is not an employee, agent, or broker for Landlord or Tenant or related to any such person, if the president falls within such category). The three arbitrators shall decide the dispute, if it has not been previously resolved, by following the procedures set forth in Paragraph (ii)(C) below.

(C) The Fair Market Rental shall be fixed by the three arbitrators in accordance with the following procedures. Each of the arbitrators selected by the parties shall state, in writing, his determination of the Fair Market Rental supported by the reasons therefor and shall make counterpart copies for each of the other arbitrators. The arbitrators shall arrange for a simultaneous exchange of such proposed resolutions. The role of the third arbitrator shall be to

select which of the two proposed resolutions most closely approximates his determination of Fair Market Rental. The third arbitrator shall have no right to propose a middle ground or any modification of either of the two proposed resolutions. The resolution he chooses as that most closely approximating his determination of the Fair Market Rental shall constitute the decision of the arbitrators and shall be final and binding upon the parties.

(D) In the event of a failure, refusal or inability of any arbitrator to act, his successor shall be appointed by him, but in the case of the third arbitrator, his successor shall be appointed in the same manner as that set forth herein with respect to the appointment of the original third arbitrator. The arbitrators shall attempt to decide the issue within ten (10) business days after the appointment of the third arbitrator. Any decision in which the arbitrator appointed by Landlord and the arbitrator appointed by Tenant concur shall be binding and conclusive upon the parties, except that such arbitrators shall not attempt by themselves to mutually ascertain the Fair Market Rental and any such determination, in a manner other than that provided for in Paragraph (ii)(C) hereof, shall not be binding on the parties. Each party shall pay the fees and expenses of its respective arbitrator and both shall share the fees and expenses of the third arbitrator. Attorneys' fees and expenses of counsel and of witnesses for the respective parties shall be paid by the respective party engaging such counsel or calling such witnesses.

(E) The arbitrators shall have the right to consult experts and competent authorities for factual information or evidence pertaining to a determination of Fair Market Rental, but any such consultation shall be made in the presence of both parties with full right on their part to cross-examine. The arbitrators shall render the decision and award in writing with counterpart copies to each party. Except for the establishment of Fair Market Rental as herein provided, the arbitrators shall have no power to modify the provisions of this Lease.