

# OPERATION & MAINTENANCE MANUAL

**1395 22<sup>ND</sup> STREET**  
SAN FRANCISCO, CA

SUBMITTED BY



11535 N. DAVIS RD.  
LODI, CA 95242  
PHONE: (925)298-0288  
FAX: (925)298-0988  
[www.marinaco.com](http://www.marinaco.com)

# Table of Contents

1. Irrigation Guarantee
2. Planting Guarantee
3. List of Materials & Equipment
4. Catalog Cut Sheets
5. Controller Manual
6. As-Built

# **IRRIGATION GUARANTEE**

## GUARANTEE FOR SPRINKLER IRRIGATION SYSTEM

We hereby guarantee that the irrigation system we have furnished and installed is free from defects in materials and workmanship including settling of backfill areas below grade, and the work has been completed in accordance with the drawings and specifications, with ordinary wear and tear and unusual abuse or neglect excepted. We agree to repair or replace any defects in material or workmanship which may develop during the period of one year from the date of acceptance and also to repair or replace any damage from the repairing or replacing of such defects at no additional costs to Build Group. We shall make such repairs or replacements within a reasonable time, as determined by Build Group, after receipt of written notice. In the event of our failure to make such repairs or replacements within a reasonable time after receipt of written notice from Build Group, we authorize Build Group to proceed to have said repairs or replacements made at our expense and we will pay the costs and charges thereof upon demand.

PROJECT: 1395 22<sup>nd</sup> Street  
CONTRACTOR: Marina Landscape, Inc  
ADDRESS: 11535 N. Davis Rd., Lodi, Ca 95242  
PHONE NO: (925)298-0288

DATE OF ACCEPTANCE: \_\_\_\_\_

BY: \_\_\_\_\_  
Gerardo Almanza, Project Manager

# PLANTING GUARANTEE

## GUARANTEE FOR PLANT MATERIAL

We hereby guarantee that the plant material we have furnished and installed is free from defects in materials and workmanship. With the exception of damages, theft by others or inadequate maintenance by others, we hereby warranty the trees for a period of one year from date of acceptance for the project listed below.

We agree to provide replacement plant material during the warranty period at no additional costs to Build Group. We shall provide such replacement within a reasonable time, as determined by Build Group, after receipt of written notice.

PROJECT: 1395 22<sup>nd</sup> Street  
CONTRACTOR: Marina Landscape, Inc.  
ADDRESS: 11535 N. Davis Rd., Lodi, CA 95242  
PHONE NO: (925) 298-0288

DATE OF ACCEPTANCE: \_\_\_\_\_

BY: \_\_\_\_\_  
Gerardo Almanza, Project Manager

**LIST OF  
MATERIALS AND  
EQUIPMENT**

# MARINA

MARINA LANDSCAPE, INC.  
11535 N. DAVIS RD.  
LODI, CA 95242  
PHONE: (925)298-0288  
FAX: (925)298-0988

PROJECT NAME: 1395 22ND STREET  
LOCATION: San Francisco, CA  
PROJECT NO: 361719

<u>SECTION</u>	<u>ITEM</u>	<u>MANUFACTURER</u> <u>PIPE &amp; FITTINGS</u>	<u>MODEL NO.</u>
	SUPPLY LINE	PACIFIC PLASTIC OR EQUAL	SCH 40 PVC PURPLE
	LATERAL LINE	PACIFIC PLASTIC OR EQUAL	SCH 40 PVC PURPLE
	CONDUIT	PACIFIC PLASTIC OR EQUAL	SCH 40 GREY PVC
	SUPPLY LINE FITTINGS	LASCO OR EQUAL	SCH 40 FITTINGS
	LATERAL LINE FITTINGS	LASCO OR EQUAL	SCH 40 FITTINGS
	NIPPLES	LASCO OR EQUAL	SCH 80 NIPPLES W/MOLDED THREADS
		<b>VALVES</b>	
	MASTER CONTROL VALVE	SUPERIOR	3100 - 2"
	REMOTE CONTROL VALVE	RAINBIRD	PESB SERIES
	GATE VALVE	NIBCO	T113
	DRIP ZONE KIT VALVE	RAINBIRD	XCZ-100-PRB-COM
	FLOW SENSOR	IRRITROL	FS-B150
		<b>VALVE BOXES</b>	
	6" ROUND VALVE BOX	NDS	107 PBCR
	RECTANGULAR VALVE BOX	NDS	113 PBCR
	JUMBO VALVE BOX	NDS	217 PBCR
	10" ROUND VALVE BOX	NDS	111 PBCR
		<b>SOLVENT CEMENT &amp;PRIMER</b>	
	SOLVENT CEMENT	IPS	711
	PRIMER	IPS	P-70
	SOLVENT CEMENT & FLEX PIPE	IPS	795
		<b>DRIPLINE</b>	
	SUBSURFACE DRIPLINE	HUNTER	ECO-WRAP-0.6-GPH



SUBSURFACE DRIP SYSTEM	HUNTER	ECO-MAT
FLUSH VALVE	KBI OR EQUAL	SCH. 40 1/2" BALL VALVE
AIR RELIEF VALVE	HUNTER	PLD-AVR
	<b>SPRAY HEADS &amp; BUBBLERS</b>	
BUBBLER	RAINBIRD	1402
SPRINKLER HEADS	HUNTER	PROS-12-CV-PRS40-MP2000-F,H,T,Q
SPRINKLER HEADS	HUNTER	PROS-12-CV-PRS40-MP1000-F,H,T,Q
	<b>IRRIGATION CONTROLLER</b>	
IRRIGATION CONTROLLER	RAINMASTER	EGP-TW
RAIN SENSOR	IRRITROL	RS 500
DECODERS	RAINMASTER	TW-D-1, TW-D-2, TW-D-4
LIGHTNING	RAINMASTER	TW-LA-1
CONNECTORS	RAINMASTER	TW-SPLICE
2-WIRE	RAINMASTER	TW-CAB-14
GROUND ROD KIT	PAIGE	GROUND ROD KIT
	<b>MISCELLANEOUS</b>	
SAND BACKFILL	WCS&G	SE 30
SWING JOINT @ SPRAYHEAD	LASCO OR EQUAL	SCH. NIPPLES 80 W/MARLEXSTREET ELL
FLEX PIPE	SALCO OR EQUAL	1/2" IPS FLEX PIPE
DRAIN ROCK	WCS&G	3/4" CRUSH
ID TAGS	CHRISTY'S	ID-STD-YI
RECLAIMED ID TAGS	CHRISTY'S	ID-MAX-P2-RC006

# **CATALOG CUT SHEET**

## Pacific Plastics

# Reclaimed Water Sch40 Purple Solvent Weld

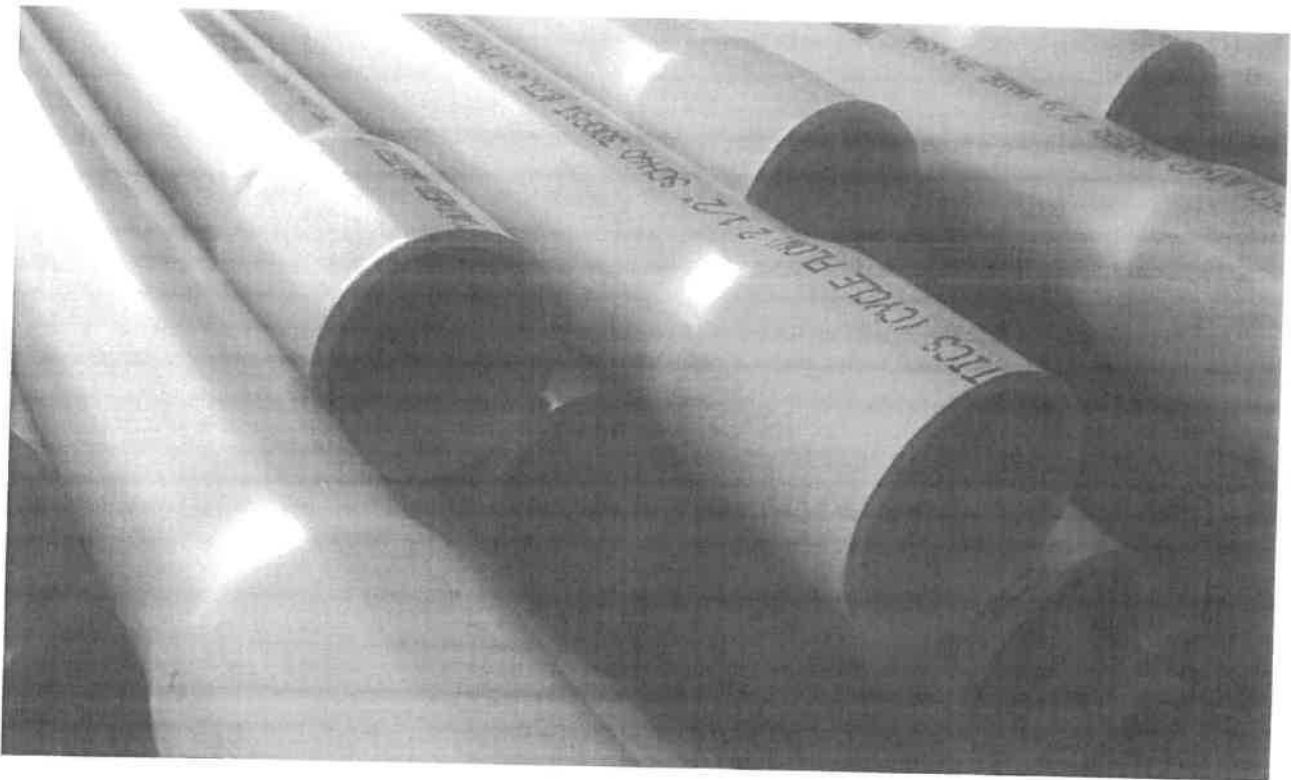

## Specification

Pacific Plastics IPS Schedule series of PVC pipe is produced for use in reclaimed water applications in which the maximum operating temperature is 140° F. The compound is PVC 1120 Type 1 Grade 1, with a cell class of 12454B, per ASTM D1784.

The Schedule series listed below is produced in strict compliance to ASTM D1785. It is listed with NSF and complies with NSF/ANSI Standard 14 and Standard 61.

Sch40 pipe is installed per ASTM D2855. The joints should conform to ASTM D2672, the solvent cement to ASTM D2564 and the primer to ASTM F656.

Cycle Flow Sch40 for use in Reclaimed Water applications:

- Sizes 1/2" – 8" are produced in Purple color, 20 foot lengths and Belled End.

The outside diameter and wall thickness of Sch40 pipe are measured in accordance to ASTM D2122 and are shown in the following tables:

Size	Dimensions			
	OD	T	C	PSI
1/2	0.840	0.109	1.00	600
3/4	1.050	0.113	1.25	480
1	1.315	0.133	1.50	450
1 1/4	1.660	0.140	1.75	370
1 1/2	1.900	0.145	2.00	330
2	2.375	0.154	2.25	280
2 1/2	2.875	0.203	2.50	300
3	3.500	0.216	3.25	260
4	4.500	0.237	4.00	220
6	6.625	0.280	6.00	180
8	8.625	0.322	6.00	160

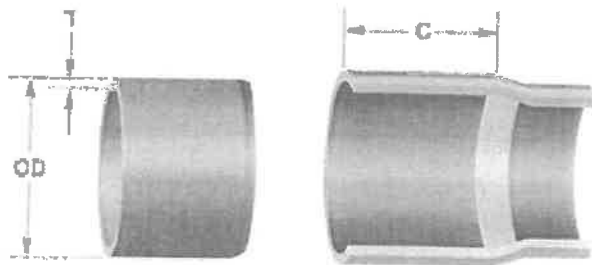

**Size** – Inch

**OD** – Outside Diameter

**T** – Wall Thickness

**C** – Approximate Bell Depth

**PSI** – Pressure Rating

# Certification

This is to certify that, in this category of PVC pipe, all the products manufactured by Pacific Plastics have been inspected, sampled and tested in accordance with the following specifications and have been found to meet or exceed the requirements of those specifications.

## Raw Materials

- PVC1120 Type1 Grade1
- Cell Class 12454
- ASTM D1784 Specification for Rigid PVC Compounds
- NSF Listed

## PVC Pipe

- Sch40 Purple
- Solvent Weld Belled End
- ½" – 8" IPS
- ASTM D1785 Specification for PVC Pipe
- ASTM D2672 Specification for IPS PVC Pipe Joints using solvent cement
- Complies with NSF / ANSI Standard 14
- Complies with NSF / ANSI Standard 61



## Reclaimed Water Sch40 Purple Solvent Weld

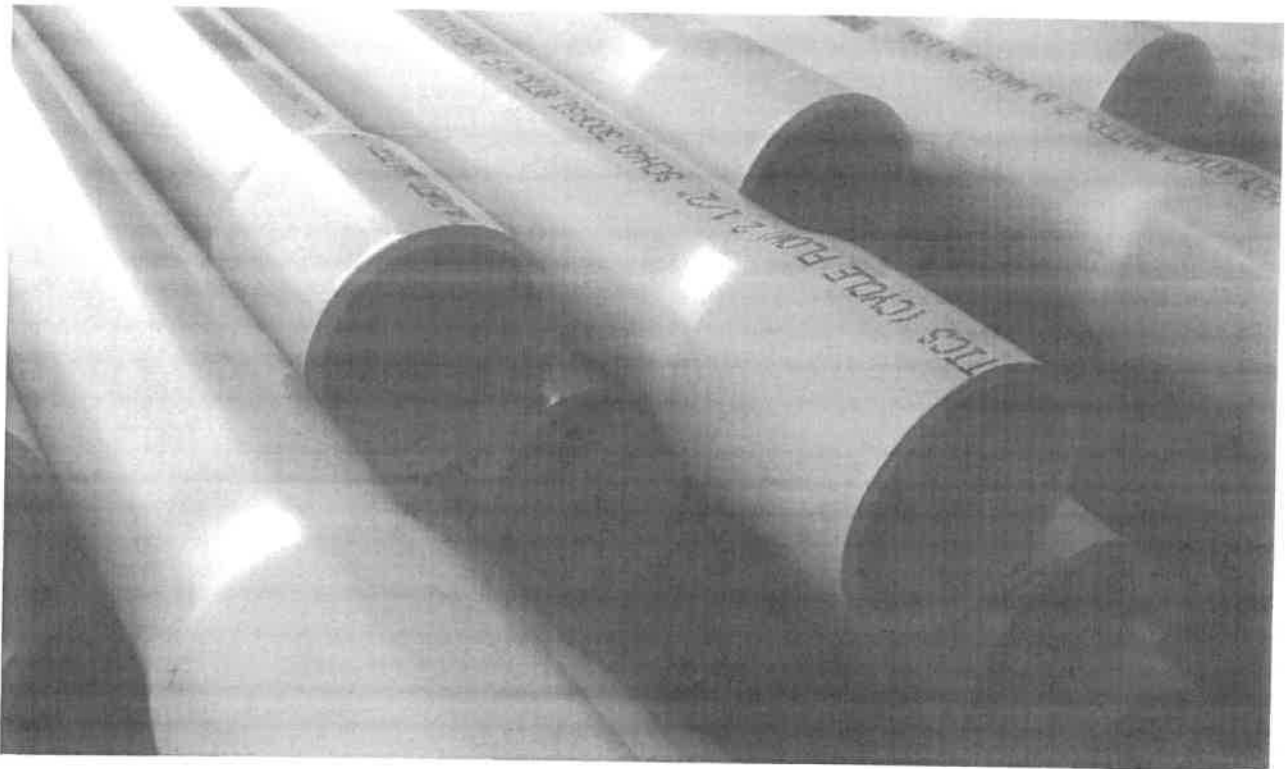

### Specification

Pacific Plastics IPS Schedule series of PVC pipe is produced for use in reclaimed water applications in which the maximum operating temperature is 140° F. The compound is PVC 1120 Type 1 Grade 1, with a cell class of 12454B, per ASTM D1784.

The Schedule series listed below is produced in strict compliance to ASTM D1785. It is listed with NSF and complies with NSF/ANSI Standard 14 and Standard 61.

Sch40 pipe is installed per ASTM D2855. The joints should conform to ASTM D2672, the solvent cement to ASTM D2564 and the primer to ASTM F656.

Cycle Flow Sch40 for use in Reclaimed Water applications:

- Sizes 1/2" – 8" are produced in Purple color, 20 foot lengths and Belled End.

The outside diameter and wall thickness of Sch40 pipe are measured in accordance to ASTM D2122 and are shown in the following tables:

Size	Dimensions			
	OD	T	C	PSI
1/2	0.840	0.109	1.00	600
3/4	1.050	0.113	1.25	480
1	1.315	0.133	1.50	450
1 1/4	1.660	0.140	1.75	370
1 1/2	1.900	0.145	2.00	330
2	2.375	0.154	2.25	280
2 1/2	2.875	0.203	2.50	300
3	3.500	0.216	3.25	260
4	4.500	0.237	4.00	220
6	6.625	0.280	6.00	180
8	8.625	0.322	6.00	160

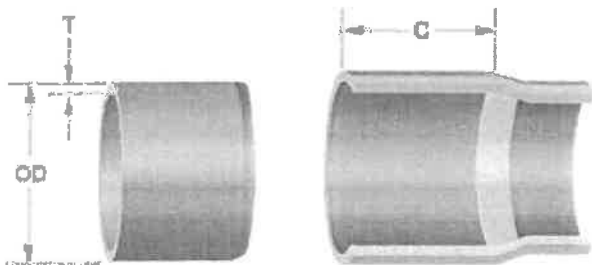

**Size** – Inch

**OD** – Outside Diameter

**T** – Wall Thickness

**C** – Approximate Bell Depth

**PSI** – Pressure Rating

# Certification

This is to certify that, in this category of PVC pipe, all the products manufactured by Pacific Plastics have been inspected, sampled and tested in accordance with the following specifications and have been found to meet or exceed the requirements of those specifications.

## Raw Materials

- PVC1120 Type1 Grade1
- Cell Class 12454
- ASTM D1784 Specification for Rigid PVC Compounds
- NSF Listed

## PVC Pipe

- Sch40 Purple
- Solvent Weld Belled End
- ½" – 8" IPS
- ASTM D1785 Specification for PVC Pipe
- ASTM D2672 Specification for IPS PVC Pipe Joints using solvent cement
- Complies with NSF / ANSI Standard 14
- Complies with NSF / ANSI Standard 61



## Pacific Plastics

# Electrical Conduit Sch40 Grey Solvent Weld

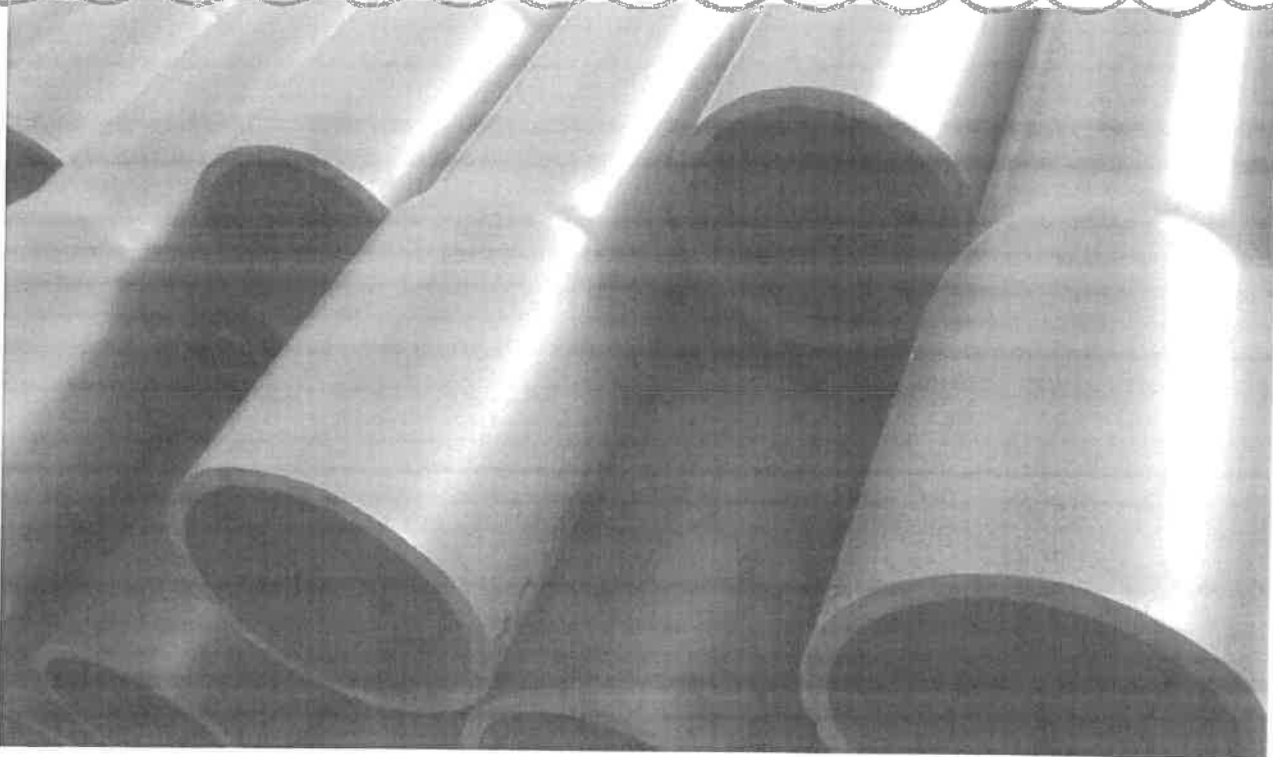

## Specification

Pacific Plastics Electrical Conduit is produced for the conveyance of electrical wires, above or below ground. The compound is PVC 1120 Type 1 Grade 1, with a cell class of 12454B per ASTM D1784.

Our Sch40 Electrical Conduit is produced in strict compliance to UL 651 and NEMA's TC-2. It is rated for 90° C wiring and can be installed both in the underground and above ground applications.

Sizes of 1/2" – 6" are produced in Grey color, 20 foot and 10 foot lengths Belled End.

The dimensions of the Sch40 conduit per UL 651 are shown in the following table:

Size	OD	Dimensions	
1/2	0.840	0.109	1.00
3/4	1.050	0.113	1.25
1	1.316	0.133	1.50
1 ¼	1.660	0.140	1.75
1 ½	1.900	0.145	2.00
2	2.375	0.154	2.25
2 ½	2.875	0.203	2.50
3	3.500	0.216	3.25
4	4.500	0.237	4.00
5	5.625	0.258	4.00
6	6.625	0.280	6.00

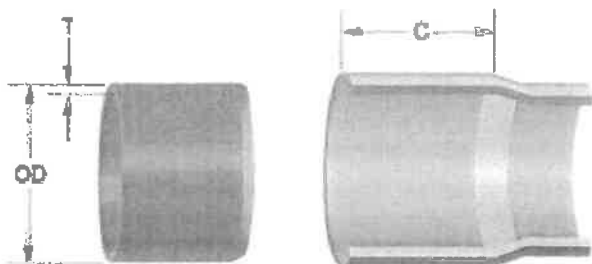

- OD** – Outside Diameter
- T** – Wall Thickness
- C** – Approximate Bell Depth

## Certification

This is to certify that, in this category of PVC pipe, all the products manufactured by Pacific Plastics have been inspected, sampled and tested in accordance with the following specifications and have been found to meet or exceed the requirements of those specifications.

### Raw Materials

- PVC1120 Type1 Grade1

- Cell Class 12454
- ASTM D1784 Specification for Rigid PVC Compounds

### **PVC Pipe**

- Sch40 Grey
- Solvent Weld Belled End
- ½" – 6" IPS
- Sunlight resistant per UL651
- Rated for use with 90°C wiring
- UL651 & NEMA TC 2
- NFS Listed

Supply Line  
Fittings

**LASCO<sup>®</sup>**  
Fittings, Inc.

## SUBMITTAL SHEET

**SCHEDULE 40 PVC**

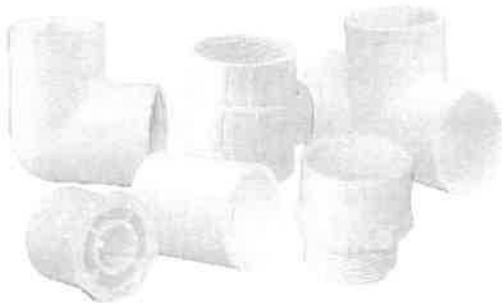

LASCO Fittings, Inc., an Aalberts Industries company, specializes in the production and sale of injection molded fittings for Irrigation, Plumbing, Industrial, Pool/Spa and Retail markets. LASCO Fittings, Inc. operates a 26-acre manufacturing facility in Brownsville, TN. With eight Regional Distribution Facilities strategically located within the United States, LASCO provides worldwide distribution and overnight service.

### Injection Molded PVC Pipe Fittings in sizes 3/8" through 12"

LASCO Fittings, Inc.'s comprehensive line of PVC fittings offers a variety of injection molded configurations in Schedule 40 sizes 3/8" through 12" conforming to ASTM D 2466.

#### STANDARDS AND SPECIFICATIONS – Schedule 40

ASTM D-1784 – Rigid Poly (Vinyl Chloride) (PVC) Compounds and Chlorinated Poly Vinyl Chloride) (CPVC) Compounds.

ASTM D-2466 – Socket Type Poly (Vinyl Chloride) (PVC) Plastic Pipe Fittings, Schedule 40.

ASTM F-1970 – Standard Specification for Special Engineered Fittings, Appurtenances or Valves for use in Poly (Vinyl Chloride) (PVC) or Chlorinated Poly (Vinyl Chloride) (CPVC) Systems.

MATERIAL – LASCO Schedule 40 Fittings are produced from PVC Type 1, Cell Classification 12454-B.

– O-rings are produced from a Buna-N (Nitrile) material.

LISTINGS – NSF/ANSI Standard 61, Annex G: Drinking Water System Components Weighted average lead content of  $\leq 0.25\%$  and is in compliance with California's Health & Safety Code Section 116875 (commonly known as AB1953) NSF/ANSI Standard 14: Plastics Piping system Components and Related Materials. Includes /ANSI Standard 61, Annex G

DO NOT USE LASCO FITTINGS FOR COMPRESSED AIR OR GASES.  
DO NOT TEST PVC PIPING SYSTEMS WITH COMPRESSED AIR OR GASES.  
DO NOT USE FITTINGS WITH LIQUIDS NOT RECOMMENDED BY LASCO.  
MODIFICATIONS OF FITTINGS VOIDS THE WARRANTY.



#### Limited Warranty

LASCO Fittings, Inc. products are warranted to be free from manufacturing defects in materials and workmanship. They are warranted against rot, rust, and electrolytic corrosion for a period of three years from date of installation. If LASCO products prove defective due to manufacturing defects in material or workmanship during that period, the manufacturer will provide new replacement units of the same type and size. No remedy will be granted under this warranty if LASCO products are not used strictly in accordance with LASCO's directions with respect to use and storage or if the products have been modified in any way. THE MANUFACTURER'S LIABILITY UNDER EXPRESSED OR IMPLIED WARRANTY OR FOR ANY REASON IS LIMITED TO FURNISHING REPLACEMENT UNITS OR GRANTING A CREDIT FOR DEFECTIVE UNITS. NO LABOR EXPENSE OR CONSEQUENTIAL DAMAGES WILL BE PAID BY LASCO. THIS WARRANTY IS IN LIEU OF ALL OTHER GUARANTEES AND WARRANTIES, EXPRESSED OR IMPLIED, INCLUDING BUT NOT LIMITED TO, WARRANTIES OF MERCHANTABILITY AND FITNESS FOR PURPOSE, EXCEPT FOR ANY WARRANTIES IMPLIED BY LAW FOR NONCOMMERCIAL CONSUMERS. ANY SUCH WARRANTIES ARE LIMITED TO THE DURATION OF THIS WRITTEN WARRANTY.

414 Morgan Street • Brownsville, TN 38012  
(731) 772-3180 | [www.lascofittings.com](http://www.lascofittings.com)

*This specification is provided for reference only. LASCO Fittings, Inc. reserves the right to change any portion of this specification without notice and without incurring obligation to make such changes to LASCO products previously or subsequently sold. Please visit our website [www.lascofittings.com](http://www.lascofittings.com) for the most current information.*



Lateral Line  
Fittings

**LASCO<sup>®</sup>**  
Fittings, Inc.

## SUBMITTAL SHEET

**SCHEDULE 40 PVC**



LASCO Fittings, Inc., an Aalberts Industries company, specializes in the production and sale of injection molded fittings for Irrigation, Plumbing, Industrial, Pool/Spa and Retail markets. LASCO Fittings, Inc. operates a 26-acre manufacturing facility in Brownsville, TN. With eight Regional Distribution Facilities strategically located within the United States, LASCO provides worldwide distribution and overnight service.

### Injection Molded PVC Pipe Fittings In sizes 3/8" through 12"

LASCO Fittings, Inc.'s comprehensive line of PVC fittings offers a variety of injection molded configurations in Schedule 40 sizes 3/8" through 12" conforming to ASTM D 2466.

#### STANDARDS AND SPECIFICATIONS – Schedule 40

ASTM D-1784 – Rigid Poly (Vinyl Chloride) (PVC) Compounds and Chlorinated Poly Vinyl Chloride) (CPVC) Compounds.

ASTM D-2466 – Socket Type Poly (Vinyl Chloride) (PVC) Plastic Pipe Fittings, Schedule 40.

ASTM F-1970 – Standard Specification for Special Engineered Fittings, Appurtenances or Valves for use in Poly (Vinyl Chloride) (PVC) or Chlorinated Poly (Vinyl Chloride) (CPVC) Systems.

**MATERIAL –** LASCO Schedule 40 Fittings are produced from PVC Type 1, Cell Classification 12454-B.  
– O-rings are produced from a Buna-N (Nitrile) material.

**LISTINGS –** NSF/ANSI Standard 61, Annex G: Drinking Water System Components Weighted average lead content of  $\leq 0.25\%$  and is in compliance with California's Health & Safety Code Section 116875 (commonly known as AB1953) NSF/ANSI Standard 14: Plastics Piping system Components and Related Materials. Includes /ANSI Standard 61, Annex G

DO NOT USE LASCO FITTINGS FOR COMPRESSED AIR OR GASES.  
DO NOT TEST PVC PIPING SYSTEMS WITH COMPRESSED AIR OR GASES.  
DO NOT USE FITTINGS WITH LIQUIDS NOT RECOMMENDED BY LASCO.  
MODIFICATIONS OF FITTINGS VOIDS THE WARRANTY.



#### Limited Warranty

LASCO Fittings, Inc. products are warranted to be free from manufacturing defects in materials and workmanship. They are warranted against rot, rust, and electrolytic corrosion for a period of three years from date of installation. If LASCO products prove defective due to manufacturing defects in material or workmanship during that period, the manufacturer will provide new replacement units of the same type and size. No remedy will be granted under this warranty if LASCO products are not used strictly in accordance with LASCO's directions with respect to use and storage or if the products have been modified in any way. THE MANUFACTURER'S LIABILITY UNDER EXPRESSED OR IMPLIED WARRANTY OR FOR ANY REASON IS LIMITED TO FURNISHING REPLACEMENT UNITS OR GRANTING A CREDIT FOR DEFECTIVE UNITS. NO LABOR EXPENSE OR CONSEQUENTIAL DAMAGES WILL BE PAID BY LASCO. THIS WARRANTY IS IN LIEU OF ALL OTHER GUARANTEES AND WARRANTIES, EXPRESSED OR IMPLIED, INCLUDING BUT NOT LIMITED TO, WARRANTIES OF MERCHANTABILITY AND FITNESS FOR PURPOSE, EXCEPT FOR ANY WARRANTIES IMPLIED BY LAW FOR NONCOMMERCIAL CONSUMERS. ANY SUCH WARRANTIES ARE LIMITED TO THE DURATION OF THIS WRITTEN WARRANTY.

414 Morgan Street • Brownsville, TN 38012  
(731) 772-3180 | [www.lascofittings.com](http://www.lascofittings.com)

*This specification is provided for reference only. LASCO Fittings, Inc reserves the right to change any portion of this specification without notice and without incurring obligation to make such changes to LASCO products previously or subsequently sold. Please visit our website [www.lascofittings.com](http://www.lascofittings.com) for the most current information.*



Nipples

**LASCO<sup>®</sup>**  
Fittings, Inc.

# SUBMITTAL SHEET

## NIPPLES SCHEDULE 80 PVC & CPVC

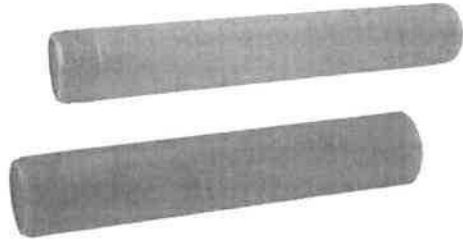

LASCO Fittings, Inc., an Aalberts Industries company, specializes in the production and sale of injection molded fittings for Irrigation, Plumbing, Industrial, Pool/Spa and Retail markets. LASCO Fittings, Inc. operates a 26-acre manufacturing facility in Brownsville, TN. With eight Regional Distribution Facilities strategically located within the United States, LASCO provides worldwide distribution and overnight service.

### Injection Molded PVC Nipples in sizes 1/2" through 4"

LASCO Fittings, Inc.'s line of PVC injection molded and machine threaded PVC Nipples offers a variety of configurations in sizes 1/4" through 4" in diameter and lengths ranging from 1 3/8" through 36".

#### STANDARDS AND SPECIFICATIONS – PVC & CPVC Nipples

ASTM D-2464 – Threaded Poly (Vinyl Chloride) (PVC) Plastic Pipe Fittings, Schedule 80.

ASTM F-437 – Threaded Chlorinated Poly (Vinyl Chloride) (CPVC) Plastic Pipe Fittings.

ASTM D-1784 – Rigid Poly (Vinyl Chloride) (PVC) Compounds and Chlorinated Poly (Vinyl Chloride) (CPVC) Compounds.

ASTM D-1785 – Poly (Vinyl Chloride) (PVC) Plastic Pipe, Schedules 40, 80, and 120.

**MATERIAL –** LASCO Schedule 80 Fittings are produced from PVC Type 1, Grade 1, Cell Classification 12454-B. LASCO CPVC Fittings are produced from Type IV, Grade 1, Cell Classification 23447-B.

DO NOT USE LASCO FITTINGS FOR COMPRESSED AIR OR GASES.  
DO NOT TEST PVC PIPING SYSTEMS WITH COMPRESSED AIR OR GASES.  
DO NOT USE FITTINGS WITH LIQUIDS NOT RECOMMENDED BY LASCO.  
MODIFICATIONS OF FITTINGS VOIDS THE WARRANTY.



#### Limited Warranty

LASCO Fittings, Inc. products are warranted to be free from manufacturing defects in materials and workmanship. They are warranted against rot, rust, and electrolytic corrosion for a period of three years from date of installation. If LASCO products prove defective due to manufacturing defects in material or workmanship during that period, the manufacturer will provide new replacement units of the same type and size. No remedy will be granted under this warranty if LASCO products are not used strictly in accordance with LASCO's directions with respect to use and storage or if the products have been modified in any way. THE MANUFACTURER'S LIABILITY UNDER EXPRESSED OR IMPLIED WARRANTY OR FOR ANY REASON IS LIMITED TO FURNISHING REPLACEMENT UNITS OR GRANTING A CREDIT FOR DEFECTIVE UNITS. NO LABOR EXPENSE OR CONSEQUENTIAL DAMAGES WILL BE PAID BY LASCO. THIS WARRANTY IS IN LIEU OF ALL OTHER GUARANTEES AND WARRANTIES, EXPRESSED OR IMPLIED, INCLUDING BUT NOT LIMITED TO, WARRANTIES OF MERCHANTABILITY AND FITNESS FOR PURPOSE, EXCEPT FOR ANY WARRANTIES IMPLIED BY LAW FOR NON COMMERCIAL CONSUMERS. ANY SUCH WARRANTIES ARE LIMITED TO THE DURATION OF THIS WRITTEN WARRANTY.

414 Morgan Street • Brownsville, TN 38012  
(731) 772-3180 | [www.lascofittings.com](http://www.lascofittings.com)

*This specification is provided for reference only. LASCO Fittings, Inc reserves the right to change any portion of this specification without notice and without incurring obligation to make such changes to LASCO products previously or subsequently sold. Please visit our website [www.lascofittings.com](http://www.lascofittings.com) for the most current information.*





# Master Valves

## Master Valve Solutions for Every Application

Superior is a recognized leader in the manufacture of normally open and normally closed master valves. Performance options include "No Minimum Flow" feature to handle full-flow, low-flow, and extreme low-flow conditions.

- **Industry's Most Complete Line of Master Valves!**  
Master valves are available in normally open and normally closed design options.
- **"No Minimum Flow" Capability**  
Selected models include "No Minimum Flow" feature, which ensures reliable opening and closing of the valve in extreme high or low-flow scenarios.
- **Industry's Widest Range of Sizes**  
Selected Superior master valves are available in 3/4" through 3" sizes.

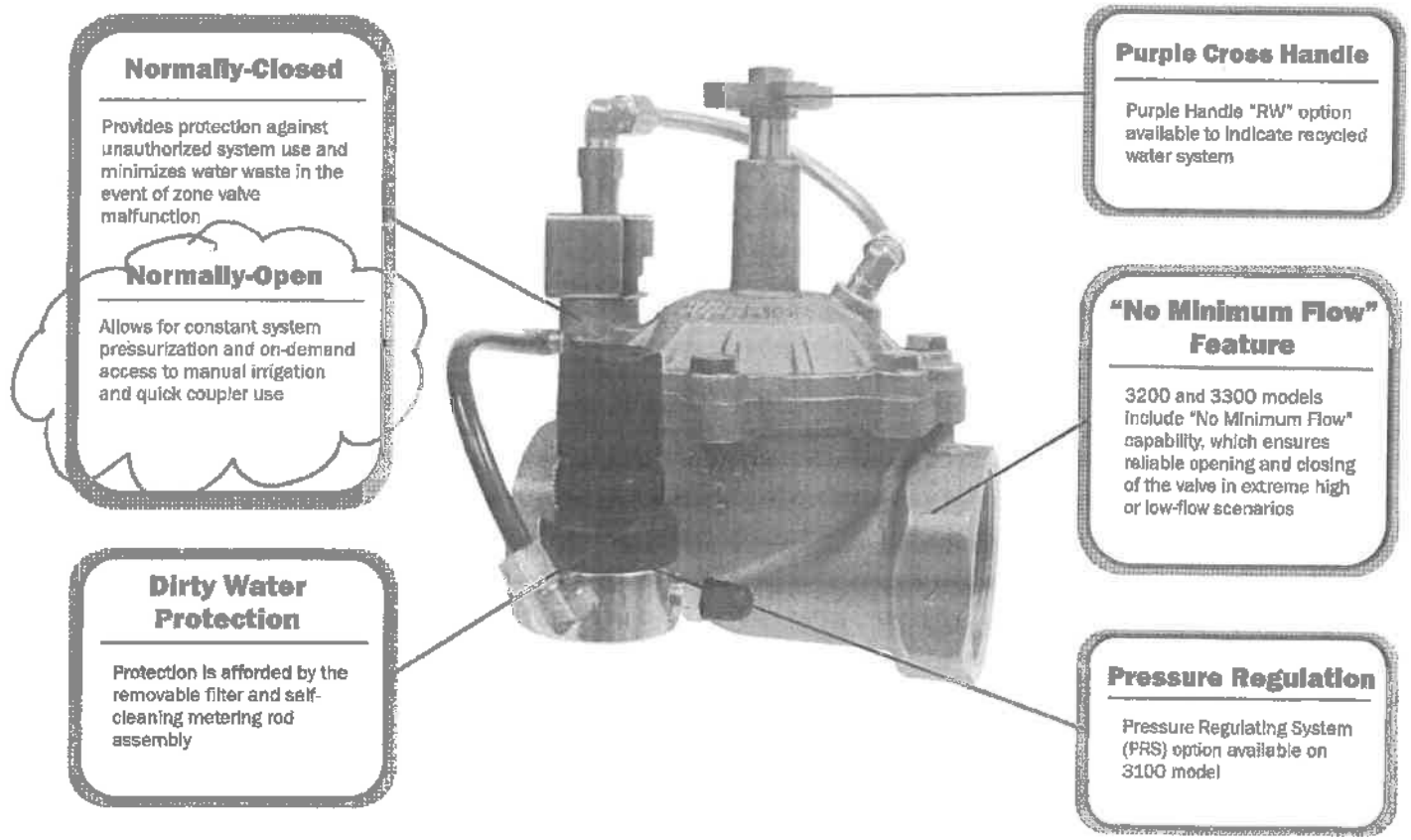

## Normally Closed Master Valves

### 3000

Normally Closed



Size	Models	Dimensions (Inches)	
		Height	Length
1"	3000100	4-1/2	4-3/8
1-1/4"	3000125	5-1/2	5
1-1/2"	3000150	8	6
2"	3000200	9	7
2-1/2"	3000250	10	11-5/8
3"	3000300	10	11-5/8

**Operating Ranges**

Flow: 5 - 320 gpm  
Pressure: 20 - 200 psi

## Normally Open Master Valves

### 3100

Normally Open



Size	Models	Dimensions (Inches)	
		Height	Length
1"	3100100	4-1/2	4-3/8
1-1/4"	3100125	5-1/2	5
1-1/2"	3100150	8	6
2"	3100200	9	7
2-1/2"	3100250	10	11-5/8
3"	3100300	10	11-5/8

PRS = Pressure Regulation System

**Operating Ranges**

Flow: 5 - 320 gpm  
Pressure: 20 - 200 psi



### 3200

Normally Closed, "No Minimum Flow" Feature



**NEW SIZES AVAILABLE!**  
3/4" & 1"

Size	Models	Dimensions (Inches)	
		Height	Length
3/4"	3200075	3.75	6
1"	3200100	4.5	6
1-1/2"	3200150	8	6
2"	3200200	9	7
2-1/2"	3200250	10	11-5/8
3"	3200300	10	11-5/8

**Operating Ranges**

Flow: 0 - 360 gpm  
Pressure: 20 - 150 psi

### 3300

Normally Open, "No Minimum Flow" Feature



Size	Models	Dimensions (Inches)	
		Height	Length
1-1/2"	3300150	8	7
2"	3300200	9	7
2-1/2"	3300250	10	11-5/8
3"	3300300	10	11-5/8

**Operating Ranges**

Flow: 0 - 360 gpm  
Pressure: 20 - 150 psi

### Pressure Loss in PSI

GPM	0	2.5	5	10	15	20	30	40	50	60	70	80	90	100	120	140	160	200	240	260	320	360	
3/4"	0	0.01	0.45	1.75	4	7																	
1"	0	0.04	0.16	0.75	1.5	2.6	5.7	10															
1-1/4"				0.48	0.85	1.9	3.5	5.3	7.6	10.1													
1-1/2"				0.45	1	1.7	2.65	3.8	5.1	6.6	8.3	10.9											
2"						0.53	0.82	1.2	1.8	2.05	2.8	3.2	4.6	6.3	8	13.9							
2-1/2"												2.38	2.45	2.5	2.9	4	6	8.2	10.7	13.2			
3"												2.38	2.45	2.5	2.9	4	6	8.2	10.7	13.2			

**RW Option Available**  
Reclaimed Water Cross Handle available by adding "RW" to the valve model number (ex. 3000100RW)

### Solenoid Specifications

**Standard 24 VAC**

In-rush current: .45 A (10.8 VA)  
Holding current: .30 A (7.2 VA)

**Optional 110 VAC**

In-rush current: .95 mA (10.5 VA)  
Holding current: .65 mA (7.2 VA)



## PEB and PESB Series Valves

Designed to Outperform. Engineered to Outlast.

Pressure surges? Effluent water? Clogging debris? No problem. PEB and PESB Series valves offer long life and efficient, trouble-free performance—even under harsh conditions. Constructed of heavy-duty, glass-filled nylon, these valves resist clogging. And the PESB model features a patented scrubber to actively fight dirt, debris and particles.

### Features

- Body constructed of durable glass-filled nylon for long life and heavy-duty performance at 200 psi (13.80 bar) pressure
- Stainless steel studs molded into the body. Bonnet can be attached and removed more easily without damaging threads
- One-piece solenoid design with captured plunger and spring for easy servicing. Prevents loss of parts during field service
- External bleed protects the solenoid ports from debris when system is flushed
- Internal bleed operates the valve without allowing water into the valve box; allows pressure regulator to be adjusted without turning on the valve at the controller first
- Low flow operating capability (0.25 gpm; 0.06 m<sup>3</sup>/h; 1.2 l/m) for a wide range of applications. For flows below 5 gpm (1.14 m<sup>3</sup>/h; 19.2 l/m) or any Xerigation® application, install Rain Bird Y filter upstream
- Slow closing to prevent water hammer and subsequent system damage
- PESB only: Scrubber scrapes its stainless steel screen clean to break down grit and plant material. Prevents debris build-up and clogging

### Options (order separately)

- Accommodates optional, field installed PRS-D pressure regulating module to ensure optimum sprinkler performance
- Optional purple flow control handles for non-potable water applications
  - PEB-NP-HAN1 (1")
  - PEB-NP-HAN2 (1½" and 2")
- Accepts latching solenoid for use with Rain Bird battery-operated controllers up to 150 psi (10.35 bar)

### Operating Range

- Pressure: 20 to 200 psi (1.38 to 13.80 bar)
- Flow: 0.25 to 200 gpm (0.06 to 45.40 m<sup>3</sup>/h; 1.2 to 757 l/m)

- Flow with PRS-D: 5 to 200 gpm
- (1.14 to 45.40 m<sup>3</sup>/h; 19.2 to 757 l/m)
- Temperature: up to 150° F (66° C)

### Electrical Specifications

- Power: 24 VAC 50/60 Hz (cycles/sec) solenoid
- Inrush current: 0.41 A (9.84 VA) at 60 Hz
- Holding current: 0.28 A (6.72 VA) at 60 Hz
- Coil resistance: 30-39 Ohms
- Compatible with ESP-LXD decoders

PEB and PESB Series Valve Pressure Loss (psi)

Flow GPM	100-PEB 1"	150-PEB 1½"	200-PEB 2"
0.25	0.8	-	-
0.5	1.0	-	-
1	1.3	-	-
5	1.7	-	-
10	1.8	-	-
20	2.9	3.9	-
30	5.6	3.6	-
40	10.0	3.5	-
50	15.6	3.6	4.8
75	-	5.4	4.5
100	-	9.6	5.2
125	-	14.6	8.2
150	-	21.2	11.8
175	-	-	15.5
200	-	-	19.5

PEB and PESB Series Valve Pressure Loss (bar)

Flow m <sup>3</sup> /h	Flow l/m	100-PEB 2.5 cm	150-PEB 3.8 cm	200-PEB 5.1 cm
0.06	1	0.05	-	-
0.3	5	0.09	-	-
0.6	10	0.10	-	-
1.2	20	0.12	-	-
3	50	0.15	-	-
6	100	0.32	0.26	-
9	150	0.68	0.24	-
12	200	-	0.26	0.33
15	250	-	0.33	0.32
18	300	-	0.42	0.32
21	350	-	0.57	0.34
24	400	-	0.74	0.41
27	450	-	0.92	0.51
30	500	-	1.14	0.64
33	550	-	1.38	0.77
36	600	-	-	0.90
39	650	-	-	1.04
42	700	-	-	1.18
45	757	-	-	1.34

#### Notes

1) Loss values are with flow control fully open.

2) PRS-D module recommended for all flow ranges.

#### Recommendations

1) Rain Bird recommends flow rates in the supply line not to exceed 7.5 ft./sec. (2.29 m/s) in order to reduce the effects of water hammer.

2) For flows below 5 gpm (1.14 m<sup>3</sup>/h; 19.2 l/m), Rain Bird recommends use of upstream filtration to prevent debris from collecting below the diaphragm.

3) For flows below 10 gpm (2.27 m<sup>3</sup>/h; 37.8 l/m) Rain Bird recommends the flow control stem be turned down two full turns from the fully open position.

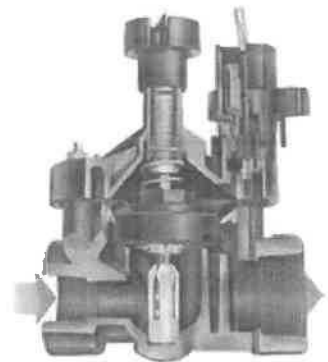

PESB Cutaway

### Dimensions

Size	Height	Length	Width
100	6½" (16.5 cm)	4" (10.2 cm)	4" (10.2 cm)
150	8" (20.3 cm)	6" (15.2 cm)	6" (15.2 cm)
200	8" (20.3 cm)	6" (15.2 cm)	6" (15.2 cm)

Note: The PRS-D option adds 2" (5.1 cm) to valve height.

### Models

- 100PEB and 100PESB 1" (26/34)
- 150PEB and 150PESB 1½" (40/49)
- 200PEB and 200PESB 2" (50/60)

BSP threads available, specify when ordering.

### How To Specify

#### 100 - PEB - PRS-D

Size	Model	Optional Feature
100 1" (26/34)	PEB	PRS-Dial: pressure regulating module
150 1½" (40/49)	PESB: scrubber model	(must be ordered separately)
200 2" (50/60)		

Note: Valve and PRS-Dial module must be ordered separately. For non-U.S. applications, it is necessary to specify NPT or BSP thread type.

## Specifications

The electric remote control valve shall be a normally closed 24 VAC 50/60 Hz (cycles/sec) solenoid actuated globe pattern design. The valve pressure rating shall not be less than 200 psi (13.80 bar). The valve shall have the following characteristics (circle one):

Flow rate: \_\_\_\_\_ gpm    m<sup>3</sup>/h    l/m

Pressure loss not to exceed: \_\_\_\_\_ psi    bar

The valve body shall be constructed of heavy-duty glass-filled UV-resistant nylon and have stainless steel studs and flange nuts; diaphragm shall be of nylon reinforced nitrile rubber.

The valve shall have both internal and external manual open/close control (internal and external bleed) to manually open and close the valve without electrically energizing the solenoid. The valve's internal bleed shall prevent flooding of the valve box.

The valve shall house a fully-encapsulated, one-piece solenoid. The solenoid shall have a captured plunger with a removable retainer for easy servicing and a leverage handle for easy turning. This 24 VAC 50/60 Hz solenoid shall open with 19.6 VAC minimum at 200 psi (13.80 bar). At 24 VAC, average inrush current shall not exceed 0.41 amps. Average holding current shall not exceed 0.28 amps.

The valve shall have a brass flow control stem for accurate manual regulation and/or shut-off of outlet flow. The valve must open or close in less than 1 minute at 200 psi (13.80 bar), and less than 30 seconds at 20 psi (1.38 bar).

The PESB valve shall have a self-cleaning stainless steel screen designed for use in dirty water applications.

The valve construction shall be such as to provide for all internal parts to be removable from the top of the valve without disturbing the valve installation.

## Optional Feature Specification

### PRS-D Pressure Regulating Module:

100PEB-PRS-D    100PESB-PRS-D

150PEB-PRS-D    150PESB-PRS-D

200PEB-PRS-D    200PESB-PRS-D

When so indicated on the design, the 1", 1½" and 2" electric remote control plastic valves shall have a pressure regulating module (PRS-D) capable of regulating outlet pressure between 15 and 100 psi (±3 psi) (1.04 and 6.90 bar (±0.21 bar)).

The PRS-D module shall have an adjusting knob for setting pressure and Schrader valve connection for monitoring pressure. The pressure shall be adjustable from the PRS-D when the valve is internally manually bled or electrically activated.

### Non-Potable Flow Control Handle \*

PEB-NP-HAN1 - Fits 1"

PEB-NP-HAN2 - Fits 1½" and 2"

When so indicated on the design, the valve shall have a purple flow control handle to indicate to the user that non-potable water is being used. There shall be no difference between the black and purple handles except for the color.

\*Rain Bird offers the PESB-R reclaimed water valve and conversion kits for reclaimed water application. Please see Tech Spec D37336B, the Rain Bird catalog, or visit [www.rainbird.com](http://www.rainbird.com) for more information.

Plastic Electric Remote Control PEB or PESB Valve (with PRS-D)

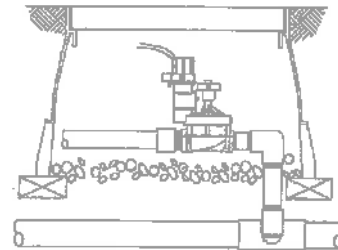

**Rain Bird Corporation**  
6991 E. Southpoint Road  
Tucson, AZ 85756  
Phone: (520) 741-6100  
Fax: (520) 741-6522

**Rain Bird Technical Services**  
(800) RAINBIRD (1-800-724-6247)  
(U.S. and Canada)

**Rain Bird Corporation**  
970 West Sierra Madre Avenue  
Azusa, CA 91702  
Phone: (626) 812-3400  
Fax: (626) 812-3411

**Specification Hotline**  
800-458-3005 (U.S. and Canada)

**Rain Bird International, Inc.**  
1000 West Sierra Madre Ave.  
Azusa, CA 91702  
Phone: (626) 963-9311  
Fax: (626) 852-7343

The intelligent Use of Water™  
[www.rainbird.com](http://www.rainbird.com)

### Class 125 Bronze Gate Valves

Screw-In Bonnet • Non-Rising Stem • Solid Wedge

125 PSI/8.6 Bar Saturated Steam to 353° F/178° C  
200 PSI/13.8 Bar Non-Shock Cold Working Pressure

CONFORMS TO MSS SP-80

#### MATERIAL LIST

PART	SPECIFICATION
1. Handwheel Nut	300 Series Stainless Steel
2. Identification Plate	Aluminum
3. Handwheel	a. Malleable Iron ASTM A 47 (T-113) b. Bronze (T-113-BHW) c. Bronze Cross (T-113-K)
4. Stem	Silicon Bronze ASTM B 371 Alloy C69400 or ASTM B 99 Alloy C65100
5. Packing Nut	Bronze ASTM B 62 or ASTM B 584 Alloy C84400 or Brass ASTM B 16
6. Packing Gland	Bronze ASTM B 62 or ASTM B 584 Alloy C84400 or Brass ASTM B 16
7. Packing	Aramid Fibres with Graphite
8. Stuffing Box	Bronze ASTM B 62
9. Bonnet	Bronze ASTM B 62
10. Body	Bronze ASTM B 62
11. Wedge	Bronze ASTM B 62

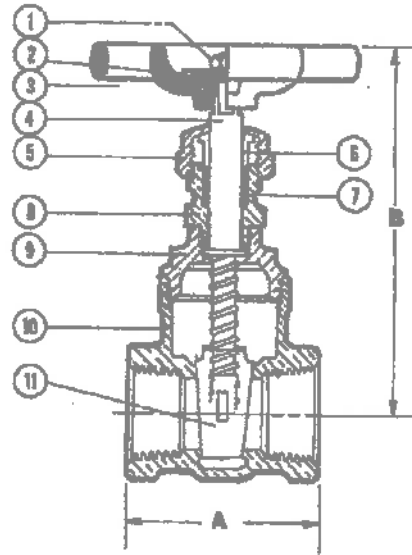

T-113  
NPT x NPT

#### DIMENSIONS—WEIGHTS—QUANTITIES

Size	Dimensions				T-113		Master Cir. Qty.	
	A		B		Lbs.	Kg.		
In.	mm.	In.	mm.	In.	mm.			
¼ †	8	1.69	43	3.38	86	0.74	0.33	50
⅜ †	10	1.69	43	3.38	86	0.71	0.32	50
½ †	15	1.94	49	3.63	92	0.82	0.37	50
¾	20	2.06	54	3.91	99	1.10	0.50	50
1	25	2.44	62	4.69	119	1.82	0.82	30
1¼	32	2.63	67	5.22	133	2.40	1.09	20
1½	40	2.88	72	6.25	159	3.51	1.59	10
2	50	3.06	78	7.06	179	4.93	2.24	10
2½	65	4.13	105	8.41	224	9.96	4.52	5
3	80	4.50	114	10.00	254	14.40	6.53	4

† No packing gland, packing only in these sizes.

Freezing Weather Precaution – Subsequent to testing a piping system, valves should be in an open position to allow complete drainage.

Drip Zone Kit  
Valve



TECH SPECS

## High Flow Commercial Control Zone Kits with Pressure-Regulating, Quick-Check Basket Filters

**XCZ-100-PRB-COM**



1" Kit - Now 24% Shorter

**XCZ-150-PRB-COM**

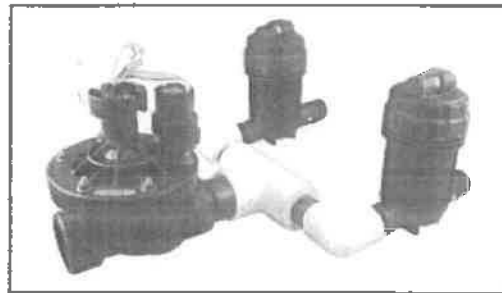

1 1/2" Kit - Now 22% Shorter

*Rain Bird simplifies drip with the highest flow control zone kits on the market. Both kits contain time-tested Rain Bird valves and now also feature the new and innovative Pressure Regulating, Quick-Check Basket Filter.*

The simplest and most reliable Control Zone Kits for a wide range of commercial drip irrigation applications.

### Benefits

- **Reduces Installation Labor Costs** – Fewer joints to complete which reduces assembly time.
- **Reduces Ongoing Maintenance Cost** – The high capacity filter with Indicator bubble ensures the filter will be cleaned only when needed.
- **Improves reliability** – The kits are made up of high quality components including the PESB (scrubber) valve and the 40 psi (2,8 bars) Pressure-Regulating, Quick-Check Basket Filter. The Indicator bubble shows when the filter needs to be cleaned.
- **Saves Time for Specifiers** – One part number to specify, one part number to order. Overall pressure loss, and pressure rating of the entire assembly is provided.

### Features

#### Scrubber Valve

- **Debris Tolerant** – Plastic scrubber scrapes the stainless steel screen to clean and break down grit and organic materials.
- **Easy Servicing** – One-piece solenoid with captured plunger and spring prevents loss

of parts during field service.

- **Protects Down Stream Components** – Slow closing prevents water hammer and subsequent system damage.
- **Rugged Construction** – The body is made from impact resistant glass-filled polypropylene and the cap is constructed of glass-filled nylon.
- **Long Life** – The diaphragm is reinforced with fabric which adds strength and durability.

#### Pressure-Regulating, Quick-Check Basket Filter

- **Efficient Design** – Combines filtration and pressure regulation in one compact unit.
- **Increases Reliability** – Fewer connection points means less chance of leaking.
- **Reduces Costs** – Combined parts mean less assembly time, and compact size means smaller valve boxes.
- **Reduces Maintenance** – Save labor time with the simple-to-check indicator bubble and easy-to-clean stainless steel filter.
- **Protects Drip Irrigation Components** – Comes standard with a 200 mesh (75 micron) stainless-steel filter element.
- **Rugged Construction** – The body is made of durable, glass-filled nylon. Stainless steel studs, molded into the body, resist thread damage.
- **Easy to Access** – The filter design allows the

element to be accessed vertically while preventing debris from falling into the line.

#### Additional Elements

- **1" Control Zone comes with PVC Tee** – This kit includes a pre-glued "Tee" and is partially assembled with all threads pre-taped.
- **1 1/2" Control Zone comes with PVC Tee** – This kit includes a pre-glued "Tee" and is partially assembled with all threads pre-taped.

#### Quick-Check Filter



"Filter is Clean"

"Filter is Dirty"



## 1" Commercial Control Zone Kit with PR Basket Filter

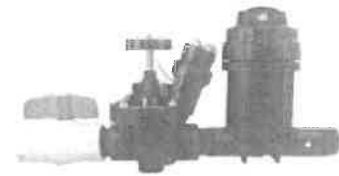

Model: X CZ-100-PRB-COM

### Specifications

Control zone kit shall be Rain Bird's 1" Commercial Control Zone Kit with PR Basket Filter. It shall contain a 1" ball-type shut-off valve, a 1" automatic irrigation control valve with self-scrubbing feature, and Pressure-Regulating, Quick-Check Basket Filter. The system shall be pressure rated to 150 psi (10,3 bar) and be capable of flow rates of 3.0 to 20.0 gpm (11,4 to 75,7 l/m).

The PR Basket Filter shall contain a 200 mesh, stainless-steel filter and a built-in 40 psi (2,8 bar) pressure regulator. The body of the unit shall be constructed of impact resistant glass-filled polypropylene and the cap of glass-filled nylon with a UV resistant polyurethane indicator window. The unit shall incorporate an indicator window that shows when the filter needs to be cleaned.

The automatic irrigation control valve shall be normally closed, solenoid activated at 24 VAC 50/60 Hz, and balance pressure type. The valve body and bonnet shall be constructed of high impact, weather resistant plastic, stainless steel, and other chemical / UV resistant materials. The valve shall have a diaphragm constructed of durable Buna-N rubber with a clog-resistant metering orifice. The valve shall have one 90 mesh (200 micron) filter attached to the solenoid base. The kit shall be manufactured by Rain Bird Corporation of Azusa, California.

Model: X CZ-100-PRB-COM High Flow Kit with 1" PESB Valve, a Pressure Regulating, Quick-Check Basket Filter (a 40 psi Pressure Regulator built-in) with 200 mesh (75 micron) screen, a shut-off ball valve and a schedule 80 PVC nipple.

### Operating Range

- Flow: 3.0 to 20.0 gpm (11,4 to 75,7 l/m)
- Pressure: 15 to 150 psi (1,0 to 10,3 bar)
- Regulating Pressure: 40 psi (2,7 bar)
- Temperature: up to 150° F (66° C)
- Filtration: 200 mesh (75 micron)\*

\* Can be replaced with 100 mesh Rain Bird filter, available separately

X CZ-100-PRB-COM	
Flow (gpm)	Minimum Inlet for Regulated Outlet Pressure (psi)†
3.0	42.0
5.0	44.0
10.0	47.3
15.0	53.0
20.0	62.5

X CZ-100-PRB-COM Metric	
Flow (L/m)	Minimum Inlet for Regulated Outlet Pressure (bar)†
11,4	2,9
18,9	3,0
37,9	3,3
56,8	3,6
75,7	4,3

† Note: Regulated outlet pressure is ±10% of nominal

### Electrical Specifications

- 24 VAC 50/60 Hz (cycles/sec) solenoid
- Inrush current: 0.41 A (9.48 VA) at 60 Hz
- Holding current: 0.28 A (6.72 VA) at 60 Hz
- Coil resistance: 30-39 ohms

### How to Specify/Order

#### X CZ-100-PRB-COM

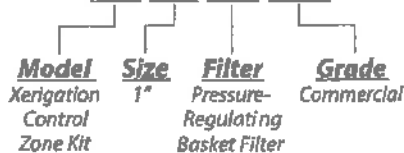

### The High Flow 1" Commercial Zone Kit Dimensions

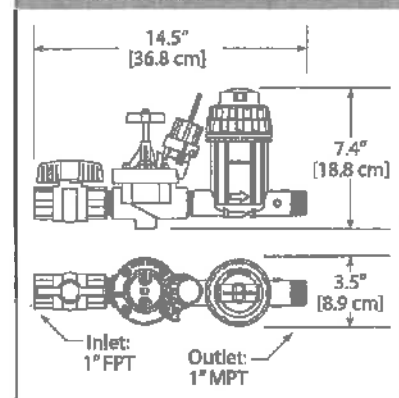

### Dimensions

Length: 14.5 in [36.8 cm]  
 Width: 3.5 in [8.9 cm]  
 Height: 7.4 in [18.8 cm]



## 1 1/2" Commercial Control Zone Kit with PR Basket Filler



Model: XCZ-150-PRB-COM

### Specifications

High Flow Commercial Control Zone Kit for zones with flows from 15.0 to 40.0 GPM (56,8 to 151,4 l/m).

Control zone kit shall be Rain Bird's 1 1/2" Commercial Control Zone Kit with Rain Bird's 1 1/2" PESB valve, two Pressure-Regulating, Quick-Check Basket Filters with built-in 40 psi pressure regulators and 200 mesh (75 micron) stainless steel screens.

The filter shall be two 1" Pressure-Regulating, Quick-Check Basket Filter bodies constructed of heavy-duty, glass-filled, UV resistant polypropylene capable of withstanding pressures of not less than 150 psi (10,3 bars). The design shall be a basket style body with jar-top cap. The cap shall incorporate an indicator that goes from green to red during operation when the filter element needs cleaning. The filter elements shall be constructed of a durable stainless steel mesh attached to a glass-filled polypropylene frame and shall be a standard 200-mesh (75 micron). The screen shall be serviceable for cleaning purposes by unscrewing the cap from the body and removing the filter element.

The control zone kit shall have two In-line pressure regulators built into the Basket Filter. The pressure regulators shall be constructed of durable, UV resistant non-corrosive material able to accommodate an inlet pressure rating of not less than 150 psi (10,3 bars). The pressure regulating device is a normally open device that allows full flow with little pressure loss unless the inlet pressure is greater than the preset level. As the Inlet pressure increases above the preset level it compresses a spring and begins to reduce the downstream pressure. The Inline pressure regulator shall have a preset outlet pressure of approximately 40 psi (2,8 bars).

The control zone kit shall have a 1 1/2" PESB series automatic irrigation control valve. The pressure rating not to be less than 150 psi (10,3 bars). The valve body and bonnet shall be constructed of high-impact, weather-resistant plastic, stainless steel and other chemical/UV resistant materials. The valve

XCZ-150-PRB-COM	
Flow (gpm)	Minimum Inlet for Regulated Outlet Pressure (psi)†
15.0	40.0
20.0	49.0
25.0	50.2
30.0	53.5
35.0	56.1
40.0	60.7

shall have a diaphragm constructed of a durable Buna-N rubber material reinforced with nylon. The kit shall be manufactured by Rain Bird Corporation of Azusa, California.

Model: XCZ-150-PRB-COM High Flow Kit with 1 1/2" PESB Valve, two Pressure Regulating, Quick-Check Basket Filters (with 40 psi Pressure Regulator built into each one) with 200 mesh (75 micron) screens and a schedule 40 PVC tee.

#### Operating Range

- Flow: 15.0 to 40.0 gpm (56,8 to 151,4 l/m)
- Inlet Pressure: 20 to 150 psi (1,4 to 10,3 bar)
- Regulating Pressure: 40 psi (2,8 bars)
- Temperature: up to 150° F (66° C)
- Filtration: 200 mesh (75 micron)\*

\*Can be replaced with 100 mesh Rain Bird filter, available separately

#### Electrical Specifications

- 24 VAC 50/60 Hz (cycles/sec) solenoid
- Inrush current: 0.41 A (9.48 VA) at 60 Hz
- Holding current: 0.28 A (6.72 VA) at 60 Hz
- Coil resistance: 30-39 ohms

XCZ-150-PRB-COM		Metric
Flow (L/m)	Minimum Inlet for Regulated Outlet Pressure (bar)†	
56,8	2,8	
75,7	3,4	
94,7	3,5	
113,6	3,7	
132,5	3,9	
151,4	4,2	

† Note: Regulated outlet pressure is ±10% of nominal

### The High Flow 1 1/2" Commercial Zone Kit Dimensions

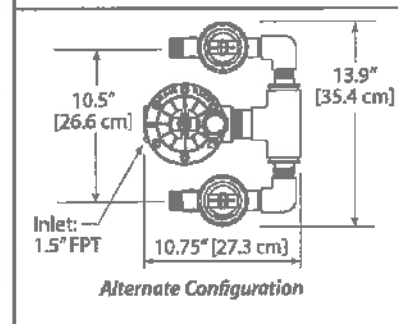
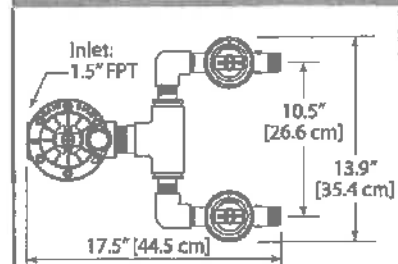

### How to Specify/Order

#### XCZ-150-PRB-COM

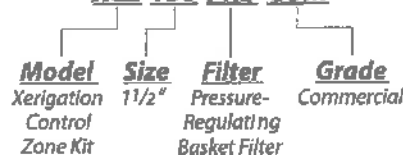

#### Dimensions

- Length: 17.5 in ( 44.5 cm)
- Width: 13.9 in (35.4 cm)
- Height: 7.4 in (18.8 cm) (Top configuration)
- Length: 10.75 in ( 27.3 cm)
- Width: 13.9 in (35.4 cm)
- Height: 7.4 in (18.8 cm) (Alternate configuration)



## Replacement Stainless Steel Screen Elements

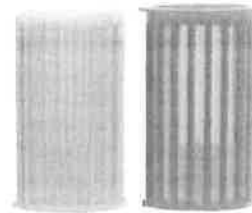

QKCHK-200M QKCHK-100M

### Stainless Steel Screen Elements

The \_\_\_\_\_ mesh stainless steel screen element shall be used inside the Pressure-Regulating, Quick-Check Basket Filter and shall be constructed of stainless steel welded to a color-coded, glass-filled polypropylene frame. The screen element shall be used in the 1" model and match the filtration requirements of the emission device or sprinkler. Screen mesh sizes shall be designated by the following color code: red – 100 and natural – 200 mesh. The stainless steel screen element shall be supplied by Rain Bird Sprinkler Mfg Corporation, Azusa, California.

### Filter Elements

- QKCHK-100M  
(100 mesh / 150 micron, red housing)
- QKCHK-200M  
(200 mesh / 75 micron, white housing)

### How to Specify/Order

#### Basket Filter Elements

#### QKCHK-100M

**Model**  
Quick-Check  
Filter

**Size**  
100M: 100 Mesh  
200M: 200 Mesh

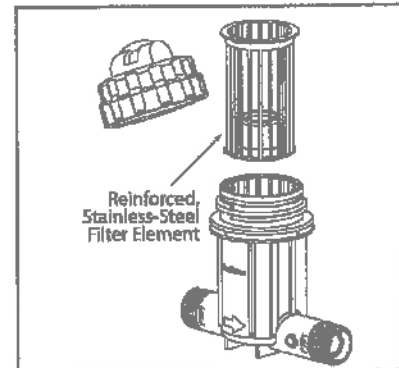

#### Stainless Steel Screen Element Dimensions (Inches)

Filter Size	Diameter	Height	Area of Filtration (in <sup>2</sup> )
1"	2.5"	4"	16.26"

#### Stainless Steel Screen Element Dimensions (Metric)

Filter Size	Diameter	Height	Area of Filtration (in <sup>2</sup> )
2,54 cm	3,35 cm	10,16 cm	41,30 cm

### Rain Bird Corporation

Contractor Division  
970 West Sierra Madre Avenue, Azusa, CA 91702  
Phone: (626) 963-9311 Fax: (626) 812-3411

### Rain Bird Corporation

Commercial Division  
6991 E. Southpoint Road, Tucson, AZ 85706  
Phone: (520) 741-6100 Fax: (520) 741-6522

### Rain Bird International, Inc.

145 North Grand Avenue, Glendora, CA 91741  
Phone: (626) 963-9311 Fax: (626) 963-4287

### Rain Bird Technical Services

(800) 247-3782 (U.S. only)

### Specification Hotline

800-458-3005 (U.S. and Canada)

[www.rainbird.com](http://www.rainbird.com)

The Intelligent Use of Water™ – Visit [www.rainbird.com](http://www.rainbird.com)  
to learn about our efforts

\*Registered Trademark of Rain Bird Corporation  
©2008 Rain Bird Corporation 11/08

D39843

# FLOW SENSORS

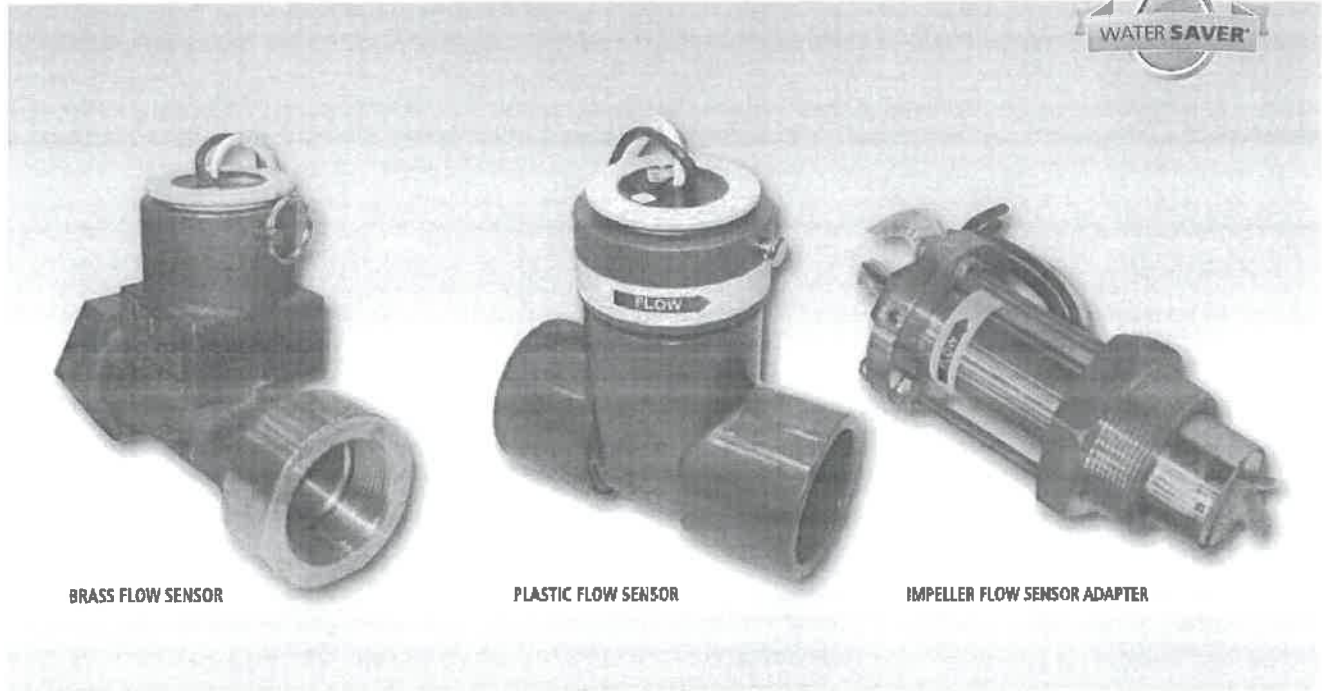

BRASS FLOW SENSOR

PLASTIC FLOW SENSOR

IMPELLER FLOW SENSOR ADAPTER

**F**low sensors can be used in conjunction with any Sentar II™, Rain Master™ DX2 Evolution, or Rain Master Eagle™ controllers (including Eagle Plus™) to automatically detect line breaks and flow limits at point of connection (POC) and for individual stations. Should a break or leak occur, the flow sensor will alert the controller to shut down the master valve to prevent significant landscape damage. The controller then notifies the operator of a problem with an audible alert and text message in the display.

## KEY FEATURES & BENEFITS

### BRASS FLOW SENSOR ADAPTER

Sizes 1" thru 2.5". Flow ranges from 2 GPM to 160 GPM, NPT connections, rated up to 400 psi

### PLASTIC FLOW SENSOR ADAPTER

Sizes 1.5" thru 4". Flow ranges from 5 GPM to 500 GPM, Schedule 80 PVC "slip" glue connections, rated up to 100 psi

### IMPELLER FLOW SENSOR ADAPTER

For all pipe materials and sizes up to 40" in diameter. Mounts in a 2" NPT threaded outlet (NPT) or pipe saddle (not included). Must be field-calibrated onsite. Flow may be set from 2 GPM to 500 GPM – call factory for specific settings. 400psi maximum operating pressure



### FLOW SENSORS SELECTION CHART

FLOW SENSOR MODEL	PIPE CONNECTION SIZE	SUGGESTED OPERATING RANGE	MAXIMUM WATER PRESSURE	K VALUE	OFFSET VALUE	BODY MATERIAL	CONNECTION TYPE
FS-B100	1"	2-40 GPM	400 psi	109	27	Bronze	NPT female
FS-B125	1 ¼"	3-60 GPM	400 psi	209	32	Bronze	NPT female
FS-B150	1 ½"	4-80 GPM	400 psi	291	24	Bronze	NPT female
FS-B200	2"	10-100 GPM	200 psi	750	0	Bronze	NPT female with copper male adapter
FS-B250	2 ½"	16-160 GPM	200 psi	1021	370	Bronze	NPT female
FS-150	1 ½"	5-100 GPM	100 psi @ 68F	457	0	PVC	Slip
FS-200	2"	10-200 GPM	100 psi @ 68F	776	104	PVC	Slip
FS-300	3"	20-300 GPM	100 psi @ 68F	2268	483	PVC	Slip
FS-400	4"	40-500 GPM	100 psi @ 68F	3752	834	PVC	Slip
FS-INSERT-B	3 to 40 inches	Varies, call factory	400 psi	Varies, call factory		Requires pipe saddle with 2" female NPT	

### WHY USE A FLOW SENSOR?

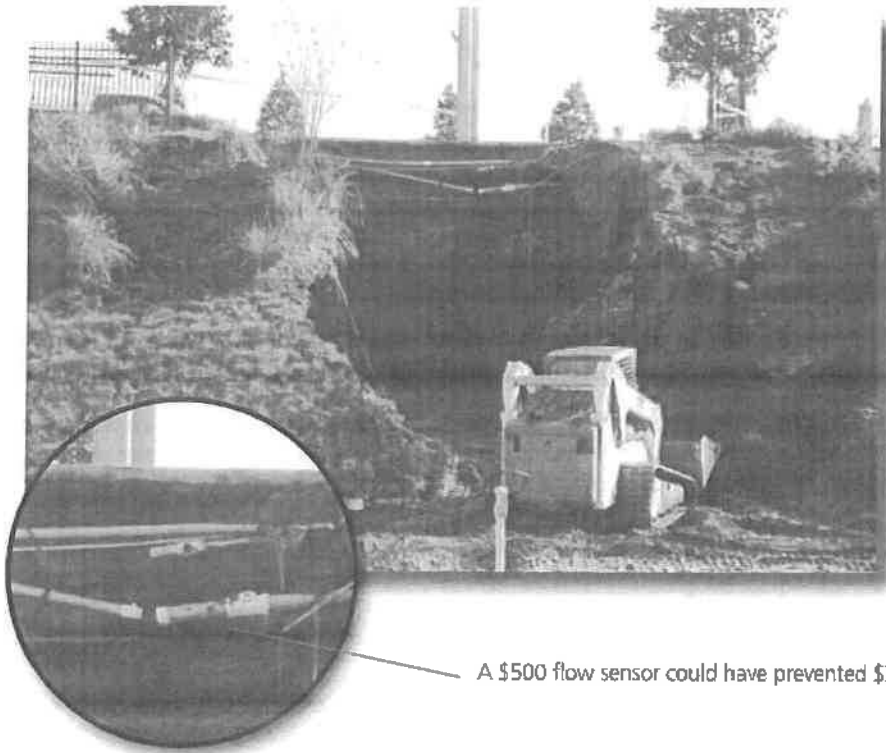

A \$500 flow sensor could have prevented \$250,000 damage

We reserve the right to improve our products and make changes in the specifications and designs without notice and without incurring obligation. Products depicted in this brochure are for demonstration purposes only. Actual products offered for sale may vary in design and features.



## NDS STANDARD SERIES VALVE BOXES – RESIDENTIAL/COMMERCIAL GRADE

### Standard Series Valve Boxes by NDS

NDS valve, meter and access boxes are offered in a wide range of sizes from the 6-inch round valve box to the 17" x 30" rectangular box. They are available with black, green, purple, gray and sand covers with designations including Irrigation control valve, water, sewer, electric, reclaimed water, cable TV, telephone and others.

- Covers are identified with ICV (Irrigation Control Valve) designation, unless otherwise specified
- Overlapping covers prevent dirt and grass from settling between body and cover
- The bayonet twist-on cover ensures easy removal on 7-inch and 10-inch round covers
- 6" Snap cover and body available
- The 10-inch round and all rectangular boxes include a brass insert, so bolts may be easily added for lockdown
- UV Inhibitors prevent discoloration and deterioration, such as cracking or blistering
- Standard cover color and designations: ICV – Green, Water – Black, Sewer – Green, CATV – Black, Reclaimed – Purple, Telephone – Black, Electric – Gray
- Brass nut on boxes for bolt-down capability
- Injection-molded of structural foam polyolefin with a melt index between 10-12

### NDS Standard Series 6" Round Valve Boxes

**Specifications:** The NDS STANDARD SERIES 6" round body is tapered and has a minimum wall thickness of 0.200". The body has a double wall at the top cover seat area with a minimum thickness of 0.130". The bottom of the body has a 0.250" flange. The 6" round cover has an average thickness of 0.187".

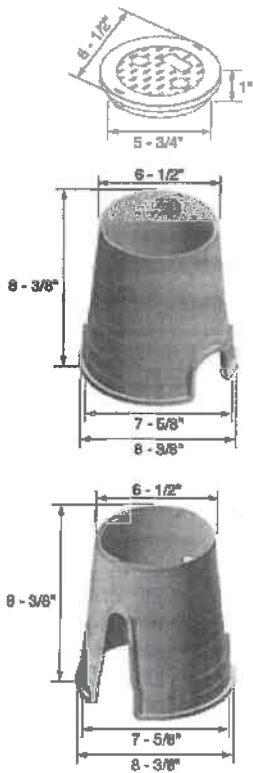

VALVE BOXES

Part No.	Description - Material	Color (Box/Cover)	Pallet Qty.	Wt. Ea. lbs.	Product Class
<b>Box &amp; Cover</b>					
107BC SLV	6" Round Box, Round Overlapping Cover - ICV	Black/Green	400	30.0	20ND
107BC SAND	6" Round Box, Round Overlapping Cover - ICV	Sand/Sand	250	1.50	20ND
107BC BRN	6" Round Box, Round Overlapping Cover - ICV	Black/Brown	250	1.60	20ND
107BC	6" Round Box, Round Overlapping Cover - ICV	Black/Green	250	1.50	20ND
107BCH	6" Round Snap-in Valve Box, Round Snap-In Overlapping Cover - ICV	Black/Green	250	1.50	20ND
107BCER	6" Round ICV Box and Cover	Black/Green	250	1.60	20ND
107BC CTR	6" Round ICV Box and Cover	Black/Green	108	1.05	20ND
107BCW	6" Round Box, Overlapping Box, Solid Plastic Cover - Water	Black/Green	250	1.50	20NM
107BC SAND	6" Round Box, Round Overlapping Cover - ICV	Sand/Sand	250	1.50	20ND
107EBC	6" Round Emitter Box, Round Overlapping Cover - Emitter Box	Black/Green	250	1.50	20ND
107BCR	6" Round Box, Round Overlapping Cover - Reclaimed Water	Black/Purple	250	1.50	20ND
107PBCR	6" Round Box, Overlapping Cover - Reclaimed Water	Purple/Purple	250	1.50	20ND
107EBCR	6" Round Emitter Box, Round Overlapping Cover - Emitter Box	Black/Purple	250	1.50	20ND
107BCS	6" Round Box, Overlapping Cover - Sewer	Black/Green	250	1.50	20HS
<b>Cover Only</b>					
107C BRN	6" Round Overlapping Cover - ICV	Brown	800	0.40	20ND
107C	6" Round Overlapping Cover - ICV	Green	800	0.40	20ND
107C SAND	6" Round Overlapping Cover - ICV	Sand	800	0.40	20ND
107CN	6" Round Snap-in Overlapping Cover - ICV	Green	1200	0.40	20ND
107CS	6" Round Overlapping Cover - Sewer	Green	800	0.40	20NM
107CR	6" Round Overlapping Cover - Reclaimed Water	Purple	800	0.40	20ND
107CW	6" Round Overlapping Cover - Water	Green	800	0.40	20NM
<b>Box Only</b>					
107B	6" Round Box	Black	250	1.10	20ND
107PB	6" Round Box	Purple	250	1.10	20ND
107B SAND	6" Round Box	Sand	250	1.10	20ND
106B	6" Round Snap-in Valve Box	Black	250	1.10	20ND
107EB	6" Round Emitter Box	Black	250	1.10	20ND



NDS STANDARD SERIES VALVE BOXES – RESIDENTIAL/COMMERCIAL GRADE

NDS Standard Series 14" x 19" Rectangular Valve Boxes

**Specifications:** The NDS STANDARD SERIES 14" x 19" body is tapered and has a minimum wall thickness of 0.200". The body has a double wall at the top cover seat area with a minimum thickness of 0.250". The cover seat area has 16 structural support ribs on the underside of the seat, each with a minimum thickness of 0.250". The bottom of the body has a 0.500" flange. The 14" x 19" cover has an average thickness of 0.250". The valve box has a 3/8" 304 Brass nut for the bolt-down as a standard feature.

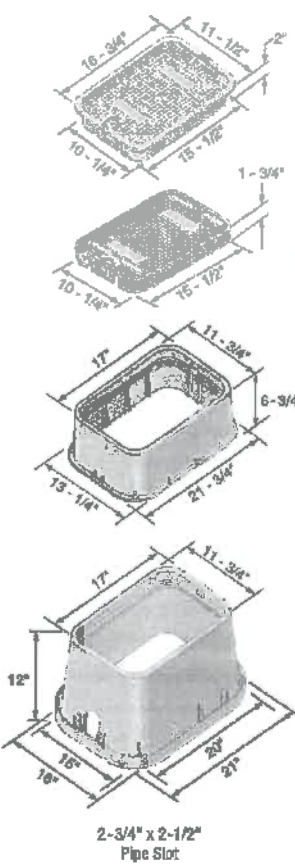

VALVE BOXES

Item No.	Description - Material	Color (Box/Cover)	Pallet Qty.	Wt. Ea. (lb.)	Product Class
<b>Box &amp; Cover</b>					
113BC	14" x 19" Box, Overlapping Cover - ICV	Black/Green	76	8.00	20ND
113BCB	12" x 17" ICV Box and Bolted Cover	Black/Green	78	8.00	20ND
113BC CTN	12" x 17" Valve Box Overlap ICV Cover	Black/Green	48	9.32	20ND
113BC SAND	14" x 19" Box, Overlapping Cover - ICV	Sand/Sand	76	8.00	20ND
113BCR	14" x 19" Box, Overlapping Cover - Reclaimed Water	Black/Purple	76	8.00	20ND
113BCR	14" x 19" Box, Overlapping Cover - Reclaimed Water	Purple/Purple	76	8.00	20ND
113BCBW	14" x 19" Box, Overlapping Bolt-Down Cover - Water	Black/Black	76	8.10	20NM
113BCBS	14" x 19" Box, Overlapping Bolt-Down Cover - Sewer	Black/Green	76	8.10	20NM
113BCE	14" x 19" Box, Overlapping Cover - Electrical	Black/Green	76	8.00	20NM
113BCDS	14" x 19" Box, Drop-in Cover - Sewer	Black/Green	76	8.00	20NM
115	14" x 19" x 6" Box, Extension, Overlapping Cover - ICV	Black/Green	48	8.00	20ND
115TBC	14" x 19" x 6" Tapered Box, Overlapping Cover - ICV	Black/Green	96	6.00	20ND
116	14" x 19" x 6" Box, Extension, Overlapping Cover - ICV	Green/Green	48	8.00	20ND
116TBC	14" x 19" x 6" Tapered Box, Overlapping Cover - ICV	Green/Green	96	6.00	20ND
116TBC SAND	14" x 19" x 6" Tapered Box, Overlapping Cover - ICV	Sand/Sand	96	6.00	20ND
<b>Cover Only</b>					
113C	14" x 19" Overlapping Cover - ICV	Green	300	2.00	20ND
113C SAND	14" x 19" Overlapping Cover - ICV	Sand	300	2.00	20ND
113CR	14" x 19" Overlapping Cover - Reclaimed Water	Purple	300	2.00	20ND
113CE	14" x 19" Overlapping Cover - Electrical	Green	300	2.00	20NM
<b>Box Only</b>					
113B	14" x 19" Box	Black	76	6.00	20NM
114B-SAND	14" x 19" Box	Sand	76	6.00	20ND
113PB	14" x 19" Box	Purple	76	6.00	20ND
113-6	14" x 19" x 6" Extension	Black	48	4.00	20ND
116TB	14" x 19" x 6" Tapered Box	Green	96	4.00	20ND
116-SAND	14" x 19" x 6" Extension	Sand	48	8.00	20ND
116TB SAND	14" x 19" x 6" Tapered Box	Sand	96	4.00	20ND
1138B	2-1/2" x 3/8" SS Bolt	Steel	600 of 100	0.10	20NM
114B	14" x 19" Box	Green	76	6.00	20ND



## NDS PRO SERIES VALVE BOXES – COMMERCIAL GRADE

### NDS Pro Series 13" x 20" Jumbo Rectangular Valve Boxes

**Specifications:** The NDS PRO SERIES 13" x 20" body is tapered and has a minimum wall thickness of 0.250". The body has a double wall at the top cover seat area with a minimum thickness of 0.250". The cover seat area has 16 structural support ribs on the underside of the seat, each with a minimum thickness of 0.250". The bottom of the body has a 0.500" flange. The 13" x 20" cover has an average thickness of 0.250". The valve box has a 3/8" 304 Brass nut for the bolt-down as a standard feature.

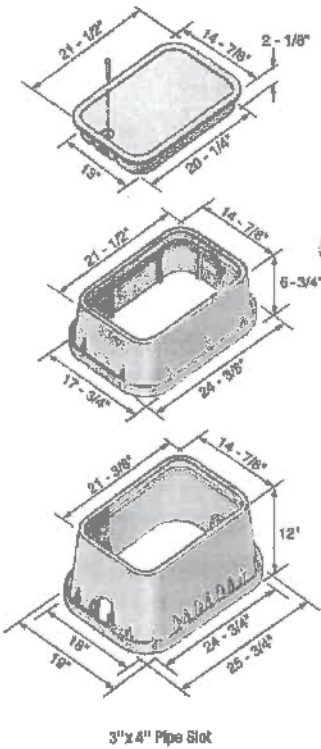

Part No.	Description - Marking	Color (Box/Cover)	Pallet Qty.	Wt. Ea. Lbs.	Product Class
<b>Box &amp; Cover</b>					
218BC BRN	13" x 20" Jumbo Box, Overlapping Cover - ICV	Black/Brown	56	14.00	20PR
218BC	13" x 20" Jumbo Box, Overlapping Cover - ICV	Green/Green	56	14.00	20PR
218BCS	13" x 20" Jumbo Box, Overlapping Bolt-Down Cover - ICV	Green/Green	56	14.10	20PR
220	13" x 20" x 6" Jumbo Extension, Overlapping Cover - ICV	Green/Green	32	11.00	20PR
217PBCR	13" x 20" Jumbo Box, Overlapping Cover - Reclaimed Water	Purple/Purple	56	14.00	20PR
218BCW	13" x 20" Jumbo Box, Overlapping Cover - Water	Green/Green	56	14.00	20PB
218BCS	13" x 20" Jumbo Box, Overlapping Cover - Sewer	Green/Green	56	14.00	20PR
218BCBS	13" x 20" Jumbo Box, Overlapping Bolt-Down Cover - Sewer	Green/Green	56	14.10	20PR
<b>Cover Only</b>					
217C BRN	13" x 20" Overlapping Cover - ICV	Brown	180	5.00	20PR
217C	13" x 20" Overlapping Cover - ICV	Green	180	5.00	20PR
217CW	13" x 20" Overlapping Cover - Water	Green	180	5.00	20PR
217CS	13" x 20" Jumbo Overlapping Cover - Sewer	Green	180	5.00	20PR
217CR	13" x 20" Jumbo Overlapping Cover - Reclaimed Water	Purple	180	5.00	20PR
<b>Box Only</b>					
218B	13" x 20" Jumbo Box	Green	56	9.00	20PR
21B-6	13" x 20" x 6" Jumbo Extension	Green	32	6.00	20PR
1198B	2-1/2" x 3/8" SS Bolt	Steel	(Eq of 16)	0.10	20MM

VALVE BOXES

We put water in its place

## NDS STANDARD SERIES VALVE BOXES – RESIDENTIAL/COMMERCIAL GRADE

### NDS Standard Series 10" Round Valve Boxes

**Specifications:** The NDS STANDARD SERIES 10" round body is tapered and has a minimum wall thickness of 0.200". The cover seat area has 6 structural support ribs on the underside of the seat, each with a minimum thickness of 0.250". The bottom of the body has a 0.500" flange. The 10" round cover has an average thickness of 0.250". The valve box has a 5/16" 304 Brass nut for the bolt-down as a standard feature.

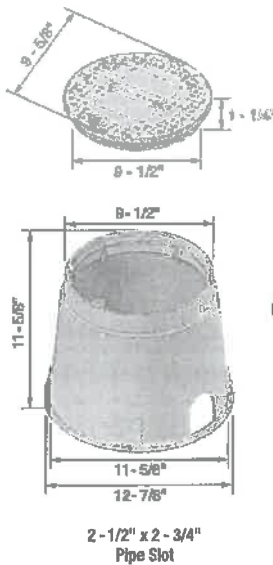

Part No.	Description - Marking	Color (Box/Cover)	Pallet Qty.	Wt. Ea. lbs.	Product Class
<b>Box &amp; Cover</b>					
111BC	10" Round Box, Round Overlapping Cover - ICV	Black/Green	180	3.00	20ND
111BCB	10" Round Box, Round Overlapping Bolt-Down Cover - ICV	Black/Green	180	3.00	20ND
111BC CTN	10" Round ICV Box and Cover	Black/Green	72	3.90	20ND
111BC SAND	10" Round Box, Round Overlapping Cover - ICV	Sand/Sand	180	3.00	20ND
111BCR	10" Round Box, Round Overlapping Cover - Reclaimed Water	Black/Purple	180	3.00	20ND
111BCBR	10" Round ICV Box and Cover	Black/Green	180	3.00	20NM
111PBCR	10" Round Box, Round Overlapping Cover - Reclaimed Water	Purple/Purple	180	3.00	20ND
111BCW	10" Round Box, Round Overlapping Cover - Water	Black/Green	180	3.00	20NM
111BCS	10" Round Box, Overlapping Cover - Sewer	Black/Green	180	3.00	20NM
111BCBS	10" Round Box, Overlapping Bolt-Down Cover - Sewer	Black/Green	180	3.00	20NM
<b>Cover Only</b>					
111C	10" Round Overlapping Cover - ICV	Green	300	1.00	20ND
111C SAND	10" Round Overlapping Cover - ICV	Sand	300	1.00	20ND
111CR	10" Round Overlapping Cover - Reclaimed Water	Purple	300	1.00	20ND
111CE-EY	10" Round Overlapping Cover - Electrical	Gray	300	1.00	20NM
111CW	10" Round Overlapping Cover - Water	Green	300	1.00	20NM
111CS	10" Round Overlapping Cover - Sewer	Green	300	1.00	20NM
<b>Box Only</b>					
111B	10" Round Box	Black	180	2.00	20NM
111B SAND	10" Round Box	Sand	180	2.00	20ND
111PB	10" Round Box	Purple	180	2.00	20ND
111BB	1-1/4" x 5/16" SS Bolt	Steel	(Bag of 10)	0.10	20ND
112S	10" Round Box	Green	180	2.00	20ND

VALVE BOXES



**GENERAL DESCRIPTION:**

WELD-ON® 711™ is an industrial grade, gray, low VOC emission, heavy bodied, medium setting, high strength PVC solvent cement for all classes and schedules of pipe and fittings with interference fit through 12 Inch (315 mm) diameter, including Schedule 80. It has good gap filling properties and its medium set allows more working time in warm weather.

**APPLICATION:**

WELD-ON 711 is for use on all types of PVC plastic pipe applications, Type I and Type II. It is suitable for use with potable water pressure systems, irrigation, turf, conduit, sewer, drain, waste and vent systems. Ideal for use on Industrial piping systems.

Detailed directions on making solvent cemented joints are printed on the container label. An installation DVD/CD covering solvent cementing is available. It not only describes the basic principles of solvent cementing, but also covers the handling, storage and use of our products. It is highly recommended that the installer review the instructions supplied by the pipe and fitting manufacturer.

**NOTE:** WELD-ON solvent cements must never be used in a PVC system using or being tested by compressed air or gases; including air-over-water booster.

**AVAILABILITY:**

This product is available in ½ pint (237 ml), pint (473 ml), quart (946 ml) and gallon (3.785 l) metal cans. For detailed information on containers and applicators, see our current Price List.

**STANDARDS AND CERTIFICATION LISTINGS:**



- Meets ASTM D 2564 Standard
- Meets SCAQMD Rule 1188/316A
- Compliant with LEED® (Leadership in Energy and Environmental Design). When using this WELD-ON Low VOC product, credit can be claimed for LEED Green Building Rating System - Indoor Environmental Quality.
- Listed by NSF International for compliance with ASTM D 2564, NSF/ANSI Standard 14 and NSF/ANSI Standard 61 for use in potable water, drain, waste, vent and sewer applications.
- Meets CSA standards B137.3 and B181.2 for use in pressure and non-pressure potable water, drain, waste, and vent applications.
- Listed by IAPMO for compliance with ASTM D 2564 and applicable sections of the latest edition of the Uniform Plumbing Code®

**SPECIFICATIONS:**

COLOR: Gray  
RESIN: PVC  
SPECIFIC GRAVITY: 0.966 ± 0.04  
BROOKFIELD VISCOSITY: Minimum 1,600 cP @ 73° ± 2°F (23° ± 1°C)

**SHELF LIFE:**

3 years in tightly sealed containers. The date code of manufacture is stamped on the bottom of the container. Stability of the product is limited by the evaporation of the solvent when the container is opened. Evaporation of solvent will cause the cement to thicken and reduce its effectiveness. Adding of thinners to change viscosity is not recommended and may significantly change the properties of the cement.

**QUALITY ASSURANCE:**

WELD-ON 711 is carefully evaluated to assure that consistent high quality is maintained. Fourier transform infrared spectroscopy, gas chromatography, and additional in depth testing ensures each batch is manufactured to exacting standards. A batch identification code is stamped on each can and assures traceability of all materials and processes used in manufacturing this solvent cement.

**SHIPPING:**

<b>For One Liter and Above</b>	<b>For Less than One Liter</b>
Proper Shipping Name: Adhesive	Proper Shipping Name: Consumer Commodity
Hazard Class: 3	Hazard Class: ORM-D
Identification Number: UN 1133	
Packing Group: II	
Label Required: Flammable Liquid	

**SAFETY AND ENVIRONMENTAL PRECAUTIONS:**

This product is flammable and considered a hazardous material. In conformance with the Federal Hazardous Substances Labeling Act, the following hazards and precautions are given. Purchasers who repackage this product must also conform to all local, state and federal labeling, safety and other regulations. VOC emissions do not exceed 510 grams per liter.

**DANGER: EXTREMELY FLAMMABLE. VAPOR HARMFUL.  
MAY BE HARMFUL IF SWALLOWED. MAY IRRITATE SKIN OR EYES.**

Keep out of reach of children. Do not take internally. Keep away from heat, spark, open flame and other sources of ignition. Vapors may ignite explosively. Solvent cement vapors are heavier than air and may travel to source(s) of ignition at or near ground or lower level(s) and flash back. Keep container closed when not in use. Store between 40°F (5°C) and 110°F (44°C). Avoid breathing of vapors. Use only in well-ventilated area. If confined or partially enclosed, use forced ventilation. When necessary, use local exhaust ventilation to remove harmful airborne contaminants from employee breathing zone and to keep contaminants below 25 ppm TWA. Atmospheric levels must be maintained below established exposure limits contained in Section II of the Material Safety Data Sheet (MSDS). If airborne concentrations exceed those limits, use of a NIOSH approved organic vapor cartridge respirator with full face-piece is recommended. The effectiveness of an air-purifying respirator is limited. Use it only for a single short-term exposure. For emergency and other conditions where short-term exposure guidelines may be exceeded, use an approved positive pressure self-contained breathing apparatus. Do not smoke, eat or drink while working with this product. Avoid contact with skin, eyes and clothing. May cause eye injury. Protective equipment such as gloves, goggles and impervious apron should be used. Carefully read Material Safety Data Sheet and follow all precautions. Do not use this product for other than intended use.

"SARA Title III Section 313 Supplier Notification": This product contains toxic chemicals subject to the reporting requirements of Section 313 of the Emergency Planning and Community Right-to-Know Act (EPCRA) of 1986 and of 40CFR372. This information must be included in all MSDS that are copied and distributed for this material.

**FIRST AID:**

- Inhalation:** If overcome with vapors, remove to fresh air. If not breathing, give artificial respiration. If breathing is difficult, give oxygen. Call physician.
- Eye Contact:** Flush with plenty of water for 15 minutes and call a physician.
- Skin Contact:** Wash skin with plenty of soap and water for at least 15 minutes. If irritation develops, get medical attention.
- Ingestion:** If swallowed, give 1 or 2 glasses of water or milk. Do not induce vomiting. Contact physician or poison control center immediately.

**SPECIAL PRECAUTION:**

Do not use a dry granular calcium hypochlorite as a disinfecting material for water purification in potable water piping systems. The introduction of granules or pellets of calcium hypochlorite with PVC and CPVC solvent cements and primers (including their vapors) may result in a violent chemical reaction if a water solution is not used. It is advisable to purify lines by pumping chlorinated water into the piping system – this solution will be nonvolatile. Furthermore, dry granular calcium hypochlorite should not be stored or used near solvent cements and primers.

**IMPORTANT NOTE:**

This product is intended for use by skilled individuals at their own risk. These suggestions and data are based on information we believe to be reliable. Installers should verify for themselves that they can make satisfactory joints under varying conditions. Toward this end, it is highly desirable that they receive personal instruction from trained instructors or competent, experienced installers. Contact IPS® Corporation or your supplier for additional information or instructions.

**WARRANTY:**

IPS® Corporation ("IPS Corp.") warrants that all new IPS Corp. products shall be of good quality and free from defects in material and workmanship for the shelf life as indicated on the product. If any IPS Corp. product becomes defective, or fails to conform to our written limited warranty under normal use and storage conditions, then IPS Corp. will, without charge, replace the nonconforming product. However, this limited warranty shall not extend to, nor shall IPS Corp. be responsible for, damages or loss resulting from accident, misuse, negligent use, improper application, or incorporation of IPS Corp. products into other products. In addition, any repackaging of IPS Corp. products also shall void the limited warranty. IPS Corp. shall not be responsible for, nor does this limited warranty extend to, consequential damage, or incidental damage or expense, including without limitation, injury to persons or property or loss of use. Please refer to our standard IPS Corp. Limited Warranty for additional provisions.



455 W. Victoria Street  
Compton, CA 90220 U.S.A.  
Tel: 310.898.3300  
Fax: 310.898.3392

500 Distribution Parkway  
Collierville, TN 38017 U.S.A.  
Tel: 901.853.5001  
Fax: 901.853.5008

Customer Service: 800.888.8312  
[www.ipscorp.com](http://www.ipscorp.com)



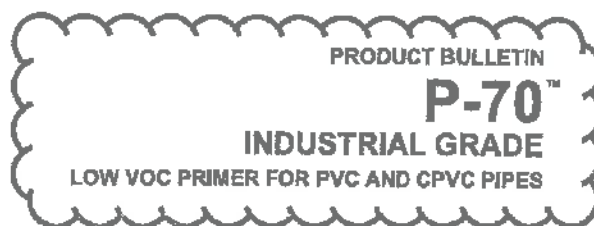

**GENERAL DESCRIPTION:**

WELD-ON® P-70™ is an Industrial grade, low VOC emission, non-bodied, fast acting, primer. The strong, aggressive action of P-70 primer rapidly softens and dissolves the joining surfaces of PVC and CPVC pipe and fittings. The benefit of this priming action is especially noticeable on parts being joined together in cold weather. Available in clear and purple; the latter allows easy identification when used on the joining surfaces.

**APPLICATION:**

WELD-ON P-70 primer, when used in conjunction with appropriate WELD-ON solvent cements, will make consistently strong, well-fused joints. It is essential that the joining surfaces of pipe and fittings be softened and remains softened prior to assembly. The main function of the primer is to expedite the penetration and softening of the surfaces. Its rate of penetration into the joining surfaces is more rapid than that of solvent cement alone. P-70 primer is suitable for use with all types, classes and schedules of PVC and CPVC pipe and fittings. It is specially recommended for use on Schedule 80 and large pipe size.

Detailed directions on making solvent cemented joints are printed on the container label. An installation DVD/CD covering solvent cementing is available. It not only describes the basic principles of solvent cementing, but also covers the handling, storage and use of our products. It is highly recommended that the installer review the instructions supplied by the pipe and fitting manufacturer. **NOTE:** WELD-ON solvent cements must never be used in a CPVC system using or being tested by compressed air or gases; including air-over-water booster.

**AVAILABILITY:**

Both WELD-ON P-70 clear and purple primers are available in ¼ pint (118 ml), ½ pint (237 ml), pint (473 ml), quart (946 ml) and gallon (3.785 l) metal cans. For detailed information on containers and applicators, see our current Price List.

**STANDARDS AND CERTIFICATION LISTINGS:**



- Meets ASTM F 656 Standard
- Meets SCAQMD Rule 1168/316A
- Compliant with LEED® (Leadership in Energy and Environmental Design). When using this WELD-ON low VOC product, credit can be claimed for LEED Green Building Rating System – Indoor Environmental Quality.
- Listed by NSF International for compliance with ASTM F 656, NSF/ANSI Standard 14, and NSF/ANSI Standard 61 for use on potable water, drain, waste, vent and sewer applications.
- **WELD-ON P-70 Purple Only** - Listed by IAPMO for compliance with ASTM F 656 and applicable sections of the latest edition of the Uniform Plumbing Code®.

**SPECIFICATIONS:**

COLOR: Clear or Purple  
SPECIFIC GRAVITY: 0.858 ± 0.040  
BROOKFIELD VISCOSITY: Water Thin

**SHELF LIFE:**

3 years in tightly sealed containers. The date code of manufacture is stamped on the bottom of the container. Stability of the product is limited by the evaporation of the solvent when the container is opened. Adding of solvents is not recommended and may significantly change the properties of the primer.

**QUALITY ASSURANCE:**

WELD-ON P-70 primer is carefully evaluated to assure that consistent high quality is maintained. Fourier transform Infrared spectroscopy, gas chromatography, and additional in depth testing ensures each batch is manufactured to exacting standards. A batch identification code is stamped on each can and assures traceability of all materials and processes used in manufacturing this product.

**SHIPPING:**

**For One Liter and Above**

Proper Shipping Name: Flammable Liquid  
n.o.s. (Methyl Ethyl Ketone, Tetrahydrofuran)  
Hazard Class: 3  
Identification Number: UN 1993  
Packing Group: II  
Label Required: Flammable Liquid

**For Less than One Liter**

Proper Shipping Name: Consumer Commodity  
Hazard Class: ORM-D

**SAFETY AND ENVIRONMENTAL PRECAUTIONS:**

This product is flammable and considered a hazardous material. In conformance with the Federal Hazardous Substances Labeling Act, the following hazards and precautions are given. Purchasers who repackage this product must also conform to all local, state and federal labeling, safety and other regulations. VOC emissions do not exceed 550 grams per liter.



**DANGER: EXTREMELY FLAMMABLE. VAPOR HARMFUL.  
MAY BE HARMFUL IF SWALLOWED. MAY IRRITATE SKIN OR EYES.**

Keep out of reach of children. Do not take internally. Keep away from heat, spark, open flame and other sources of ignition. Vapors may ignite explosively. Solvent cement vapors are heavier than air and may travel to source(s) of ignition at or near ground or lower level(s) and flash back. Keep container closed when not in use. Store between 40°F (5°C) and 110°F (44°C). Avoid breathing of vapors. Use only in well-ventilated area. If confined or partially enclosed, use forced ventilation. When necessary, use local exhaust ventilation to remove harmful airborne contaminants from employee breathing zone and to keep contaminants below 25 ppm TWA. Atmospheric levels must be maintained below established exposure limits contained in Section II of the Material Safety Data Sheet (MSDS). If airborne concentrations exceed those limits, use of a NIOSH approved organic vapor cartridge respirator with full face-piece is recommended. The effectiveness of an air-purifying respirator is limited. Use it only for a single short-term exposure. For emergency and other conditions where short-term exposure guidelines may be exceeded, use an approved positive pressure self-contained breathing apparatus. Do not smoke, eat or drink while working with this product. Avoid contact with skin, eyes and clothing. May cause eye injury. Protective equipment such as gloves, goggles and impervious apron should be used. Carefully read Material Safety Data Sheet and follow all precautions. Do not use this product for other than intended use.

"SARA Title III Section 313 Supplier Notification": This product contains toxic chemicals subject to the reporting requirements of Section 313 of the Emergency Planning and Community Right-to-Know Act (EPCRA) of 1986 and of 40CFR372. This information must be included in all MSDS that are copied and distributed for this material.

**FIRST AID:**

**Inhalation:** If overcome with vapors, remove to fresh air. If not breathing, give artificial respiration. If breathing is difficult, give oxygen. Call physician.

**Eye Contact:** Flush with plenty of water for 15 minutes and call a physician.

**Skin Contact:** Wash skin with plenty of soap and water for at least 15 minutes. If irritation develops, get medical attention.

**Ingestion:** If swallowed, give 1 or 2 glasses of water or milk. Do not induce vomiting. Contact physician or poison control center immediately.

**SPECIAL PRECAUTION:**

Do not use a dry granular calcium hypochlorite as a disinfecting material for water purification in potable water piping systems. The introduction of granules or pellets of calcium hypochlorite with PVC and CPVC solvent cements and primers (including their vapors) may result in a violent chemical reaction if a water solution is not used. It is advisable to purify lines by pumping chlorinated water into the piping system – this solution will be nonvolatile. Furthermore, dry granular calcium hypochlorite should not be stored or used near solvent cements and primers.

**IMPORTANT NOTE:**

This product is intended for use by skilled individuals at their own risk. These suggestions and data are based on information we believe to be reliable. Installers should verify for themselves that they can make satisfactory joints under varying conditions. Toward this end, it is highly desirable that they receive personal instruction from trained instructors or competent, experienced installers. Contact IPS® Corporation or your supplier for additional information or instructions.

**WARRANTY:**

IPS® Corporation ("IPS Corp.") warrants that all new IPS Corp. products shall be of good quality and free from defects in material and workmanship for the shelf life as indicated on the product. If any IPS Corp. product becomes defective, or fails to conform to our written limited warranty under normal use and storage conditions, then IPS Corp. will, without charge, replace the nonconforming product. However, this limited warranty shall not extend to, nor shall IPS Corp. be responsible for, damages or loss resulting from accident, misuse, negligent use, improper application, or incorporation of IPS Corp. products into other products. In addition, any repackaging of IPS Corp. products also shall void the limited warranty. IPS Corp. shall not be responsible for, nor does this limited warranty extend to, consequential damage, or incidental damage or expense, including without limitation, injury to persons or property or loss of use. Please refer to our standard IPS Corp. Limited Warranty for additional provisions.



455 W. Victoria Street  
Compton, CA 90220 U.S.A.  
Tel: 310.898.3300  
Fax: 310.898.3392

500 Distribution Parkway  
Cofferville, TN 38017 U.S.A.  
Tel: 901.853.5001  
Fax: 901.853.5008

Customer Service: 800.888.8312  
[www.ipscorp.com](http://www.ipscorp.com)





**GENERAL DESCRIPTION:**

WELD-ON® 795™ is a clear, or blue, low VOC emission, medium bodied, fast setting, high strength PVC solvent cement for all flex to flex and flex to rigid pipe and fittings with interference fit through 6 inch (160 mm) diameter, Schedule 80 through 3 Inch (80 mm) diameter.

**APPLICATION:**

WELD-ON 795 is specially formulated to contain an elastomer which provides great joint flexibility. It cures rapidly with the dissipation of the solvent at room temperature, resulting in a very strong, flexible, water resistant bond. WELD-ON 795 is widely used in all aspects of the pool & spa industry including, but not limited to, pump, pipe, fittings and valves connections as well as for bonding PVC hose to rigid PVC fittings. It is also excellent for joining flexible vinyl to itself.

Detailed directions on making solvent cemented joints are printed on the container label. An installation DVD/CD covering solvent cementing is available. It not only describes the basic principles of solvent cementing, but also covers the handling, storage and use of our products. It is highly recommended that the installer review the instructions supplied by the pipe and fitting manufacturer.

**NOTE:** WELD-ON solvent cements must never be used in a PVC system using or being tested by compressed air or gases; including air-over-water booster.

**AVAILABILITY:**

Clear cement is available in ¼ pint (118 ml), ½ pint (237 ml), pint (473 ml), quart (946 ml) and gallon (3.785 l) metal cans. Blue cement is available in quart (946 ml) and gallon (3.785 l) metal cans. For detailed information on containers and applicators, see our current Price List.

**STANDARDS AND CERTIFICATION LISTINGS:**



- Meets ASTM D 2564 Standard.
- Meets SCAQMD Rule 1168/316A.
- Compliant with LEED® (Leadership in Energy and Environmental Design). When using this WELD-ON low VOC product, credit can be claimed for LEED Green Building Rating System – Indoor Environmental Quality.
- Listed by NSF International for compliance with ASTM D 2564, NSF/ANSI Standard 14, and NSF/ANSI Standard 61 for use on potable water, drain, waste, vent and sewer applications.
- Listed by IAPMO for compliance with applicable sections of the latest edition of the Uniform Plumbing Code®, for potable water applications.

**SPECIFICATIONS:**

COLOR:	Clear or Blue
RESIN:	PVC
SPECIFIC GRAVITY:	0.940 ± 0.040
BROOKFIELD VISCOSITY:	Minimum 500 cP @ 73° ± 2°F (23° ± 1°C)

**SHELF LIFE:**

3 years in tightly sealed containers. The date code of manufacture is stamped on the bottom of the container. Stability of the product is limited by the evaporation of the solvent when the container is opened. Evaporation of solvent will cause the cement to thicken and reduce its effectiveness. Adding of thinners to change viscosity is not recommended and may significantly change the properties of the cement.

**QUALITY ASSURANCE:**

WELD-ON 795 is carefully evaluated to assure that consistent high quality is maintained. Fourier transform infrared spectroscopy, gas chromatography, and additional in depth testing ensures each batch is manufactured to exacting standards. A batch identification code is stamped on each can and assures traceability of all materials and processes used in manufacturing this solvent cement.

**SHIPPING:**

<b>For One Liter and Above</b>	<b>For Less than One Liter</b>
Proper Shipping Name: Adhesive	Proper Shipping Name: Consumer Commodity
Hazard Class: 3	Hazard Class: ORM-D
Identification Number: UN 1133	
Packing Group: II	
Label Required: Flammable Liquid	

## SAFETY AND ENVIRONMENTAL PRECAUTIONS:

This product is flammable and considered a hazardous material. In conformance with the Federal Hazardous Substances Labeling Act, the following hazards and precautions are given. Purchasers who repackage this product must also conform to all local, state and federal labeling, safety and other regulations. VOC emissions do not exceed 510 grams per liter.

**DANGER: EXTREMELY FLAMMABLE. VAPOR HARMFUL.  
MAY BE HARMFUL IF SWALLOWED. MAY IRRITATE SKIN OR EYES.**

Keep out of reach of children. Do not take internally. Keep away from heat, spark, open flame and other sources of ignition. Vapors may ignite explosively. Solvent cement vapors are heavier than air and may travel to source(s) of ignition at or near ground or lower level(s) and flash back. Keep container closed when not in use. Store between 40°F (5°C) and 110°F (44°C). Avoid breathing of vapors. Use only in well-ventilated area. If confined or partially enclosed, use forced ventilation. When necessary, use local exhaust ventilation to remove harmful airborne contaminants from employee breathing zone and to keep contaminants below 25 ppm TWA. Atmospheric levels must be maintained below established exposure limits contained in Section II of the Material Safety Data Sheet (MSDS). If airborne concentrations exceed those limits, use of a NIOSH approved organic vapor cartridge respirator with full face-piece is recommended. The effectiveness of an air-purifying respirator is limited. Use it only for a single short-term exposure. For emergency and other conditions where short-term exposure guidelines may be exceeded, use an approved positive pressure self-contained breathing apparatus. Do not smoke, eat or drink while working with this product. Avoid contact with skin, eyes and clothing. May cause eye injury. Protective equipment such as gloves, goggles and impervious apron should be used. Carefully read Material Safety Data Sheet and follow all precautions. Do not use this product for other than intended use.

"SARA Title III Section 313 Supplier Notification": This product contains toxic chemicals subject to the reporting requirements of Section 313 of the Emergency Planning and Community Right-to-Know Act (EPCRA) of 1986 and of 40CFR372. This information must be included in all MSDS that are copied and distributed for this material.

### FIRST AID:

- Inhalation:** If overcome with vapors, remove to fresh air. If not breathing, give artificial respiration. If breathing is difficult, give oxygen. Call physician.
- Eye Contact:** Flush with plenty of water for 15 minutes and call a physician.
- Skin Contact:** Wash skin with plenty of soap and water for at least 15 minutes. If irritation develops, get medical attention.
- Ingestion:** If swallowed, give 1 or 2 glasses of water or milk. Do not induce vomiting. Contact physician or poison control center immediately.

### SPECIAL PRECAUTION:

Do not use a dry granular calcium hypochlorite as a disinfecting material for water purification in potable water piping systems. The introduction of granules or pellets of calcium hypochlorite with PVC and CPVC solvent cements and primers (including their vapors) may result in a violent chemical reaction if a water solution is not used. It is advisable to purify lines by pumping chlorinated water into the piping system - this solution will be nonvolatile. Furthermore, dry granular calcium hypochlorite should not be stored or used near solvent cements and primers.

### IMPORTANT NOTE:

This product is intended for use by skilled individuals at their own risk. These suggestions and data are based on information we believe to be reliable. Installers should verify for themselves that they can make satisfactory joints under varying conditions. Toward this end, it is highly desirable that they receive personal instruction from trained instructors or competent, experienced installers. Contact IPS® Corporation or your supplier for additional information or instructions.

### WARRANTY:

IPS® Corporation ("IPS Corp.") warrants that all new IPS Corp. products shall be of good quality and free from defects in material and workmanship for the shelf life as indicated on the product. If any IPS Corp. product becomes defective, or fails to conform to our written limited warranty under normal use and storage conditions, then IPS Corp. will, without charge, replace the nonconforming product. However, this limited warranty shall not extend to, nor shall IPS Corp. be responsible for, damages or loss resulting from accident, misuse, negligent use, improper application, or incorporation of IPS Corp. products into other products. In addition, any repackaging of IPS Corp. products also shall void the limited warranty. IPS Corp. shall not be responsible for, nor does this limited warranty extend to, consequential damage, or incidental damage or expense, including without limitation, injury to persons or property or loss of use. Please refer to our standard IPS Corp. Limited Warranty for additional provisions.



455 W. Victoria Street  
Compton, CA 90220 U.S.A.  
Tel: 310.898.3300  
Fax: 310.898.3392

500 Distribution Parkway  
Collierville, TN 38017 U.S.A.  
Tel: 901.853.5001  
Fax: 901.853.5008

Customer Service: 800.888.8312  
[www.ipscorp.com](http://www.ipscorp.com)





Subsurface Irrigation **Under Turf, Gardens, Shrubs, Trees**

## FEATURES

- High distribution uniformity surpassed only by the Eco-Mat
- Promotes healthier plant roots
- Eliminates overspray onto sidewalks, buildings, or vehicles
- Ideal for difficult areas between flagstone and pavers
- Use with PLD-Loc or barbed PLD fittings
- Fleece-wrapped professional landscape dripline
- Transports water faster and more uniformly than bare dripline
- Pressure compensating
- Check valves keep the line charged up to 5' and prevent low point drainage
- Fleece fully moistens in less than 3 minutes and conserves water that bare dripline cannot
- Recommended for use with all Hunter Drip Control Zone Kits
- Warranty period: 5 years (plus 2 additional years for environmental stress cracking)



**Eco-Wrap**

For maximum run length distances for the Eco-Mat® or Eco-Wrap, reference the Maximum Run Length Chart on page 169. Use 0.6 GPH for flow and 12" emitter spacing.

## OPERATING SPECIFICATIONS

- Minimum filtration 120 mesh; 125 microns
- Operating pressure range: 15 to 50 PSI
- Compatible with PLD-LOC and 17 mm insert barb fittings

### ECO-WRAP TECHNICAL SPECIFICATIONS

ECO-WRAP	17 mm
Flow and Spacing	0.6 GPH and 12"
Roll Length	250'
Operating Pressure	15 to 50 PSI
Minimum Filtration	120 mesh; 125 microns

MICRO

ECO-MAT® ECO-WRAP™ PLD FITTINGS MLD IH RISERS PSE MULTI-PORT RIGID RISERS DRIP ZONE TUBING MICRO SPRAYS RZWS



Subsurface Irrigation **Under Turf, Gardens, Small Shrubs**

**FEATURES**

- Water-saving with nearly 100% distribution uniformity
- Promotes healthier plant roots
- Eliminates overspray onto sidewalks, buildings, or vehicles
- Perfect for irrigating difficult areas
- Use with PLD-Loc or barbed PLD fittings
- The polypropylene wrap protects against root intrusion without using toxic chemicals or metal byproducts
- Water holding capacity of 0.5 gal/yd<sup>2</sup>
- Pressure compensating
- Check valves keep the line charged up to 5' and prevent low point drainage
- Recommended for use with all Hunter Drip Control Zone Kits
- For maximum water savings, use with Hunter Soil-Click®
- Warranty period: 5 years (plus 2 additional years for environmental stress cracking)

**ECO-MAT TECHNICAL SPECIFICATIONS**

ECO-MAT	17 mm
Flow and Spacing	0.6 GPH and 12"
Roll Length	100' or 295'
Width	32"
ft <sup>2</sup>	100' roll is 266 ft <sup>2</sup> , 295' roll is 785 ft <sup>2</sup>
Operating Pressure	15 to 50 PSI
Minimum Filtration	120 mesh; 125 microns
Lateral Row Spacing	14"

**OPERATING SPECIFICATIONS**

- Minimum filtration 120 mesh; 125 microns
- Operating pressure range: 15 to 50 PSI
- Compatible with PLD-LOC and 17 mm insert barb fittings
- Recommended installation depth range 4" to 12"

For maximum run length distances for the Eco-Mat or Eco-Wrap, reference the Maximum Run Length Chart on page 124. Use 0.6 GPH for flow and 12" emitter spacing.

MICRO

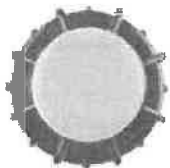
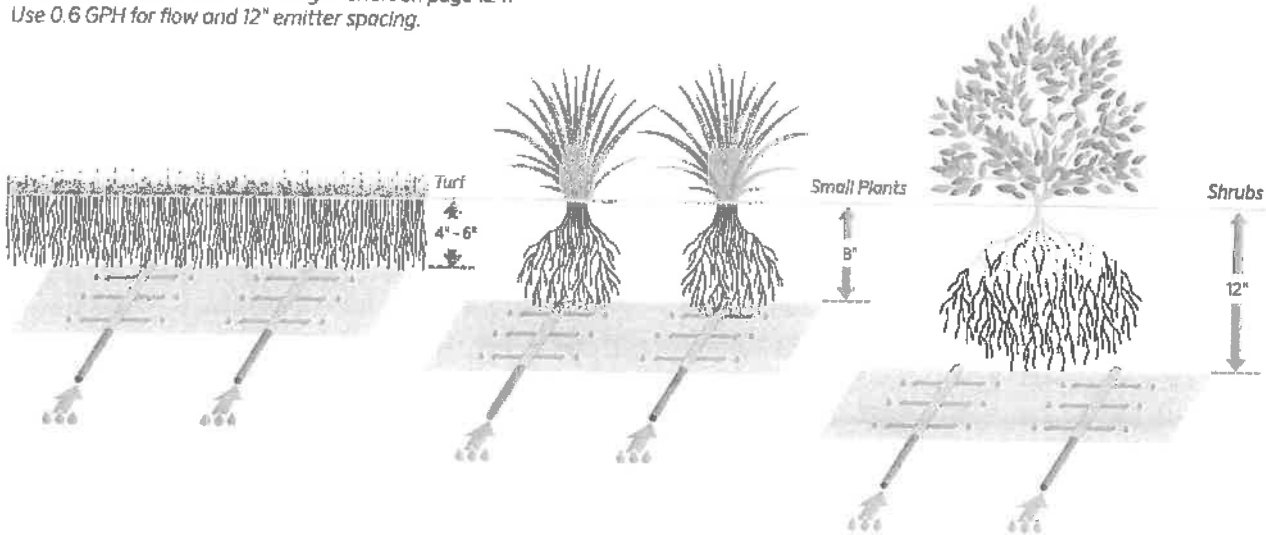

**Eco-Indicator**

Pair with Eco-Mat and Eco-Wrap subsurface systems. Offers a visual signal that the system is operating. Requires 12 PSI minimum. Yellow, easy-to-see indicator stem with 6" pop up height.

Flush Valve



**The Professional's Choice**

**King Bros. Industries**  
 29101 The Old Road, Valencia, CA 91355  
 Toll Free: (800) 325-9468 Fax: (661) 257-4320  
 E-mail: valves@kbico.com Web: www.kbico.com

# PVC Schedule 40 Economy Ball Valves

**Features:**

- EPDM O'rings.
- Viton O'rings available.
- Meets/Exceeds ASTM schedule 40 socket and material standards.
- Made of High-Impact PVC Type II material.
- Molded in the USA by KBI.
- 150 psi working pressure (tested to 500 psi static @ 72°F)  
Nominal operating pressure.
- NSF Standard listed.

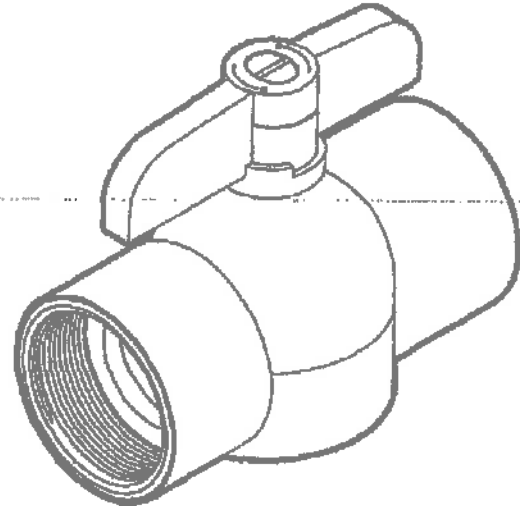

Models		Size	A	L	H	W	Case	Weight
Socket	Thread							
EBV-0500-S	EBV-0500-T	1/2"	2.3"	2.7"	2.1"	1.2"	36	5.2
EBV-0750-S	EBV-0750-T	3/4"	2.6"	3.1"	2.4"	1.4"	24	5.4
EBV-1000-S	EBV-1000-T	1"	3.2"	3.5"	2.7"	1.7"	18	6.2
EBV-1250-S	EBV-1250-T	1 1/4"	4.2"	4.9"	4.0"	2.0"	6	4.2
EBV-1500-S	EBV-1500-T	1 1/2"	4.2"	5.2"	4.0"	2.5"	6	4.4
EBV-2000-S	EBV-2000-T	2"	5.2"	6.0"	5.0"	2.7"	6	7.6

**FEATURES COMMON TO KBI PVC PRODUCTS**

- NSF listed \*
- IAPMO (UPC) listed \*
- Molded in the USA by KBI
- Limited LIFETIME Warranty
- 150 psi working pressure (tested to 500 psi static @ 72°F)
- Meets/Exceeds ASTM Standards
- Made with Hi-Impact PVC Type II Cell Class 15344-C
- \* See individual products for details



# FITTINGS

Fittings: 16-18 mm Dripline  
Uses: Barbed and Premium Fittings

## BARBED FITTINGS

- Acetal material
- Dual barb provides stronger hold than single barb
- Ideal for use with Eco-Mat®, Eco-Wrap™, PLD
- Fits 17 mm dripline and tubing
- Brown color to match PLD dripline
- No clamps necessary
- Warranty period: 1 year

## OPERATING SPECIFICATIONS

- Maximum pressure: 60 PSI

## PLD-LOC

- High quality glass-filled polypropylene
- Easy push-on installation, threads lock it into place
- Easier and faster than other fittings
- Fits multiple sizes of dripline and tubing (Inside diameter range from 0.520" to 0.620")
- Brown color blends in with dripline and landscape
- Reusable and ideal for drip irrigation maintenance
- Warranty period: 2 years

## OPERATING SPECIFICATIONS

- Maximum pressure: 60 PSI

## FITTINGS



**PLD-075**  
1/4" MPT x 17 mm Barb



**PLD-050**  
1/2" MPT x 17 mm Barb



**PLD-ELB**  
17 mm Barb Elbow



**PLD-CPL**  
17 mm Barb Coupling



**PLD-CAP**  
17 mm Barb x 1/4" MPT  
with Cap



**PLD-TEE**  
17 mm Barb Tee



**PLD-075-TBTEE**  
17 mm Barb Tee x  
3/4" Thread



**PLD-BV**  
17 mm Barb Shut-off Valve



**PLD-AVR**  
1/2" Air/Vacuum Relief Valve

## FITTINGS



**PLD-LOC 075**  
3/8" Male Pipe Thread x Loc



**PLD-LOC 050**  
1/2" Male Pipe Thread x Loc



**PLD-LOC ELB**  
Locking Elbow



**PLD-LOC CPL**  
Locking Coupler



**PLD-LOC CAP**  
End Cap x Loc



**PLD-LOC TEE**  
Locking Tee



**PLD-LOC FHS**  
3/4" Female Hose Swivel  
x Loc

MICRO

## Bubbler Heads

### Adjustable Full-Circle Bubbler

#### 1300A-F

Designed for tree, shrub and flower areas.

#### Operating Range

- Flow: 1.0 to 2.3 gpm (0.23 to 0.52 m<sup>3</sup>/h; 0.06 to 0.14 l/s)
- Spacing: 1 to 3 feet (0.3 to 0.9 m)
- Pressure: 10 to 60 psi (0.7 to 4.0 bar)

#### Dimensions

- 1/2 inch (15/21) female threaded inlet
- Height: 1 inch (2.5 cm)
- Top diameter: 1 inch (2.5 cm)



1300A-F

1300A-F			
Nozzle	Pressure psi	Flow gpm	
F	10	1.0	
	20	1.4	
	30	1.7	
	40	1.9	
	50	2.1	
	60	2.3	

1300A-F			METRIC
Nozzle	Pressure bar	Radius m <sup>3</sup> /h	Flow l/m
F	0.7	0.23	3.6
	1.0	0.26	4.2
	1.5	0.30	4.8
	2.0	0.34	5.4
	2.5	0.39	6.0
	3.0	0.43	7.2
	3.5	0.48	7.8
	4.0	0.52	8.4
4.1	0.53	8.4	

### Pressure Compensating Full-Circle Bubblers

#### 1400 Series

Designed for irrigating tree, shrub and flower areas where pressure compensation is required.

#### Operating Range

- Flow: 0.25 to 2.0 gpm (0.06 to 0.46 m<sup>3</sup>/h; 0.02 to 0.13 l/s)
- Spacing: 1 to 3 feet (0.3 to 0.9 m)
- Pressure: 20 to 90 psi (1.5 to 6.0 bar)

#### Dimensions

- Same as 1300A-F

#### Models and Specifications

- 1401: 0.25 gpm (0.06 m<sup>3</sup>/h; 0.02 l/s); full circle, trickle pattern
- 1402: 0.5 gpm (0.11 m<sup>3</sup>/h; 0.03 l/s); full circle, trickle pattern
- 1404: 1.0 gpm (0.23 m<sup>3</sup>/h; 0.06 l/s); full circle, umbrella pattern
- 1408: 2.0 gpm (0.46 m<sup>3</sup>/h; 0.12 l/s); full circle, umbrella pattern



1400 Series

#### How To Specify

### 1404

Model  
1300A-F  
1401  
1403  
1404  
1408



## Specifications

### 1300A-F Adjustable Flood Bubbler

The bubbler body shall be constructed of durable UV-resistant plastic. It shall have a plastic inlet filter screen to protect the nozzle against clogging, and a stainless steel adjusting screw, capable of shutting off the bubbler and regulating the flow.

The bubbler shall have a ½ inch (15,21) female threaded inlet for connecting to the piping system riser.

The bubbler shall be as manufactured by Rain Bird Corporation, Glendora, California.

### 1401, 1402, 1404, 1408 Pressure Compensating Flood Bubbler

The bubbler shall have a "trickle" pattern (1401 & 1402 models) or an "umbrella" pattern (1406 & 1408 models) discharge.

The bubbler assembly shall have a plastic inlet filter screen to protect the nozzle against clogging.

The pressure compensating bubbler shall be of a permanently assembled design constructed of durable, UV-resistant plastic with an integral rubber flow washer for regulating the flow rate at an operating pressure range of 20 to 90 psi (1,5 to 6,0 bar).

The pressure compensating bubbler shall have a ½ inch (15,21) female threaded inlet for connection to the piping system riser.

The pressure compensating bubbler shall be as manufactured by Rain Bird Corporation, Glendora, California.

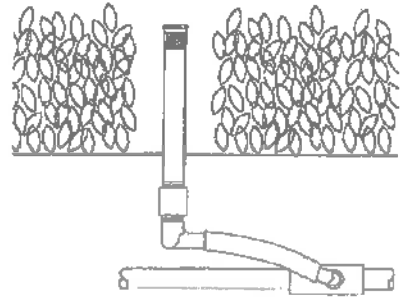

**Rain Bird Corporation**  
6991 E. Southpoint Road  
Tucson, AZ 85756  
Phone: (520) 741-6100  
Fax: (520) 741-6522

**Rain Bird Technical Services**  
(800) RAINBIRD (1-800-724-6247)  
(U.S. and Canada)

**Rain Bird Corporation**  
970 West Sierra Madre Avenue  
Azusa, CA 91702  
Phone: (626) 812-3400  
Fax: (626) 812-3411

**Specification Hotline**  
800-458-3005 (U.S. and Canada)

**Rain Bird International, Inc.**  
1000 West Sierra Madre Ave.  
Azusa, CA 91702  
Phone: (626) 963-9311  
Fax: (626) 852-7343

The Intelligent Use of Water™  
[www.rainbird.com](http://www.rainbird.com)

## PRS40

PRESSURE REGULATED

Models: Shrub, 4", 6", 12"  
Pressure Regulation: 40 PSI

### FEATURES

- Models: Shrub, 4", 6", 12"
- Gray identification cap for easy field ID
- Innovative directional flush plug design
- 6" and 12" models come standard as no side inlet, ensuring proper installation with check valve
- Drain check valve installed (14' of elevation) comes standard
- Warranty period: 5 years
- ▶ Co-molded wiper seal
- ▶ Heavy-duty spring
- ▶ Industry's strongest spray body
- ▶ Innovative seal design
- ▶ Pro-Spray check valve
- ▶ Pressure regulated to 40 PSI
- ▶ FloGuard™ technology

### OPERATING SPECIFICATIONS

- Operational pressure range: 15 to 100 PSI

### FACTORY INSTALLED OPTIONS

- Reclaimed water ID cap
- FloGuard technology available for check valve models

### USER INSTALLED OPTIONS

- Reclaimed water ID cap (P/N 458562)
- Snap-on reclaimed cover (P/N PROS-RC-CAP)
- ▶ = Advanced Feature descriptions on page 52



#### PRS40 Reclaimed

PRS40 models include optional factory-installed purple reclaimed caps



#### Related Solutions: MP Rotator

PRS40 is designed specifically for the MP Rotator®



**PROS-00-PRS40**  
Retracted height: 4½"  
Inlet size: ½"



**PROS-04-PRS40-CV**  
Retracted height: 5¾"  
Pop-up height: 4"  
Exposed diameter: 2¼"  
Inlet size: ½"

SPRAYS



**PROS-06-PRS40-CV**  
Retracted height: 8¾"  
Pop-up height: 6"  
Exposed diameter: 2¼"  
Inlet size: ½"



**PROS-12-PRS40-CV**  
Retracted height: 16½"  
Pop-up height: 12"  
Exposed diameter: 2¼"  
Inlet size: ½"

### PRS40 - SPECIFICATION BUILDER: ORDER 1 + 2

#### 1 Model

- PROS-00-PRS40** = 40 PSI regulated shrub adapter
- PROS-04-PRS40-CV** = 40 PSI regulated 4" pop-up with drain check valve
- PROS-06-PRS40-CV** = 40 PSI regulated 6" pop-up with drain check valve
- PROS-12-PRS40-CV** = 40 PSI regulated 12" pop-up with drain check valve

#### 2 Specialty Options

- (blank)** = No option
- R** = Factory-installed reclaimed body cap
- F** = FloGuard technology
- F-R** = FloGuard technology with reclaimed body cap

#### Examples:

- PROS-04-PRS40-CV** = 4" Pop-up regulated at 40 PSI, drain check valve
- PROS-06-PRS40-CV-F** = 6" Pop-up regulated at 40 PSI, drain check valve, with FloGuard technology
- PROS-12-PRS40-CV-R** = 12" Pop-up regulated at 40 PSI, drain check valve, reclaimed body cap

# MP ROTATOR®

MP ROTATOR

## FEATURES

- Radius can be reduced up to approximately 25% on all models
- Easy arc adjustment
- Color-coded for easy identification
- Removable filter screen ensures hassle-free service
- Wind-resistant multi-stream technology
- ▶ Automatic matched precipitation
- ▶ Double-pop
- ▶ Distribution uniformity
- ▶ Low precipitation rate

## OPERATING SPECIFICATIONS

- Recommended operating pressure: 40 PSI
- Recommended filtering when operating on dirty water

## OPTIONS

- Specify Pro-Spray® PRS40 pop-up for accurate pressure regulation at 40 PSI
- Adding "HT" will specify male threaded nozzles
- ▶ = Advanced Feature descriptions on page 81

### MP ROTATOR - SPECIFICATION BUILDER: ORDER 1 + 2

1 Model	2 Options
MP-1000-90 = 8' to 15' radius, adjustable from 90° to 210°	(blank) = No option
MP-1000-210 = 8' to 15' radius, adjustable from 210° to 270°	HT = Male threaded version (Not available in 3500 and 1000-210)
MP-1000-360 = 8' to 15' radius, 360°	
MP-2000-90 = 13' to 21' radius, adjustable from 90° to 210°	
MP-2000-210 = 13' to 21' radius, adjustable from 210° to 270°	
MP-2000-360 = 13' to 21' radius, 360°	
MP-3000-90 = 22' to 30' radius, adjustable from 90° to 210°	
MP-3000-210 = 22' to 30' radius, adjustable from 210° to 270°	
MP-3000-360 = 22' to 30' radius, 360°	
MP-3500-90 = 31' to 35' radius, adjustable from 90° to 210°	
MP-LCS-515 = Left corner strip, 5' x 15'	
MP-RCS-515 = Right corner strip, 5' x 15'	
MP-SS-530 = Side strip, 5' x 30'	
MP-CORNER = 8' to 15' radius, adjustable from 45° to 105°	

Examples:  
 MP-1000-210 = 8' to 15' radius, adjustable from 210° to 270°  
 PROS-06 - PRS40-CV - MP-2000-90 = 6" pop-up regulated at 40 PSI, drain check valve, with MP 2000-90.

Radius 8' to 35'

### MP1000 8' to 15' radius

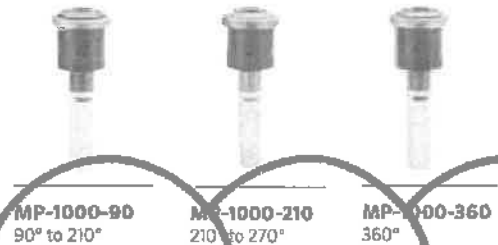

### MP2000 13' to 21' radius



### MP3000 22' to 30' radius

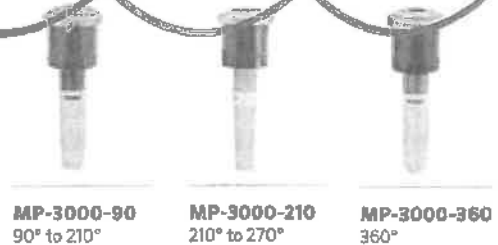

### MP3500 31' to 35' radius



MP ROTATOR PERFORMANCE DATA

Arc	Pressure PSI	MP-1000 Radius: 8' to 15' Adjustable Arc and Full-Circle ● Maroon: 90° to 210° ● Lt. Blue: 210° to 270° ● Olive: 360°					MP-2000 Radius: 13' to 21' Adjustable Arc and Full-Circle ● Black: 90° to 210° ● Green: 210° to 270° ● Red: 360°					MP-3000 Radius: 22' to 30' Adjustable Arc and Full-Circle ● Blue: 90° to 210° ● Yellow: 210° to 270° ● Grey: 360°				
		Radius ft.	Flow GPM	Flow GPH	Precip in/hr ■ ▲		Radius ft.	Flow GPM	Flow GPH	Precip in/hr ■ ▲		Radius ft.	Flow GPM	Flow GPH	Precip in/hr ■ ▲	
90°	25	--	--	--	--	--	17	0.34	20.4	0.45	0.52	25	0.71	42.6	0.44	0.51
	30	12	0.17	10.2	0.45	0.52	18	0.38	22.8	0.45	0.52	27	0.76	45.6	0.40	0.46
	35	13	0.19	11.4	0.43	0.50	19	0.40	24.0	0.43	0.49	28	0.82	49.2	0.40	0.46
	40	14	0.21	12.6	0.41	0.48	20	0.43	25.8	0.41	0.48	30	0.86	51.6	0.37	0.42
	45	14	0.23	13.8	0.45	0.52	21	0.46	27.6	0.40	0.46	30	0.90	54.0	0.39	0.44
	50	15	0.25	15.0	0.43	0.49	21	0.47	28.2	0.41	0.47	30	0.95	57.0	0.41	0.47
180°	25	--	--	--	--	--	16	0.6	36.0	0.45	0.52	25	1.44	86.4	0.44	0.51
	30	12	0.34	20.4	0.45	0.52	17	0.64	38.4	0.43	0.49	27	1.58	94.8	0.42	0.48
	35	13	0.38	22.8	0.43	0.50	18	0.71	42.6	0.42	0.49	28	1.70	102.0	0.42	0.48
	40	14	0.42	25.2	0.41	0.48	19	0.77	46.2	0.41	0.47	30	1.82	109.2	0.39	0.45
	45	14	0.44	26.4	0.43	0.50	20	0.85	51.0	0.41	0.47	30	1.93	115.8	0.41	0.48
	50	15	0.50	30.0	0.43	0.49	21	0.91	54.6	0.40	0.46	30	2.04	122.4	0.44	0.50
210°	25	--	--	--	--	--	16	0.72	43.2	0.46	0.54	25	1.68	100.8	0.44	0.51
	30	12	0.40	24.0	0.46	0.53	17	0.75	45.0	0.43	0.49	27	1.84	110.4	0.42	0.48
	35	13	0.45	27.0	0.44	0.51	18	0.81	48.6	0.41	0.48	28	1.99	119.4	0.42	0.48
	40	14	0.49	29.4	0.41	0.48	19	0.86	51.6	0.39	0.45	30	2.12	127.2	0.39	0.45
	45	14	0.51	30.6	0.43	0.50	20	0.91	54.6	0.38	0.43	30	2.25	135.0	0.41	0.48
	50	15	0.57	34.2	0.42	0.48	21	0.98	58.8	0.37	0.42	30	2.37	142.2	0.43	0.50
270°	25	--	--	--	--	--	16	0.87	52.2	0.44	0.50	25	2.19	131.4	0.45	0.52
	30	12	0.48	28.8	0.43	0.49	17	0.95	57.0	0.42	0.49	27	2.37	142.2	0.42	0.48
	35	13	0.53	31.8	0.40	0.46	18	1.03	61.8	0.41	0.47	28	2.55	153.0	0.42	0.48
	40	14	0.63	37.8	0.41	0.48	19	1.10	66.0	0.39	0.45	30	2.73	163.8	0.39	0.45
	45	14	0.67	40.2	0.44	0.51	20	1.17	70.2	0.38	0.43	30	2.89	173.4	0.41	0.48
	50	15	0.72	43.2	0.41	0.47	21	1.23	73.8	0.36	0.41	30	3.06	183.6	0.44	0.50
360°	25	--	--	--	--	--	16	1.20	72.0	0.45	0.52	25	2.88	172.8	0.44	0.51
	30	12	0.69	41.4	0.46	0.53	17	1.28	76.8	0.43	0.49	27	3.15	189.0	0.42	0.48
	35	13	0.77	46.2	0.44	0.51	18	1.37	82.2	0.41	0.47	28	3.40	204.0	0.42	0.48
	40	14	0.84	50.4	0.41	0.48	19	1.48	88.8	0.39	0.46	30	3.64	218.4	0.39	0.45
	45	14	0.88	52.8	0.43	0.50	20	1.57	94.2	0.38	0.44	30	3.86	231.6	0.41	0.48
	50	15	0.98	58.8	0.42	0.48	21	1.68	100.8	0.37	0.42	30	4.07	244.2	0.44	0.50
55	15	1.01	60.6	0.43	0.50	21	1.74	104.4	0.38	0.44	30	4.27	256.2	0.46	0.53	

Pressure PSI	MP-3500 Radius: 31' to 35' Adjustable Arc ● Light Brown: 90°					MP-3500 Radius: 31' to 35' Adjustable Arc ● Light Brown: 180°					MP-3500 Radius: 31' to 35' Adjustable Arc ● Light Brown: 210°				
	Radius ft.	Flow GPM	Flow GPH	Precip in/hr ■ ▲		Radius ft.	Flow GPM	Flow GPH	Precip in/hr ■ ▲		Radius ft.	Flow GPM	Flow GPH	Precip in/hr ■ ▲	
25	33	1.04	62.4	0.37	0.42	33	2.21	132.6	0.39	0.45	33	2.59	155.4	0.39	0.45
30	34	1.13	67.8	0.38	0.43	34	2.24	134.4	0.37	0.43	34	2.84	170.4	0.41	0.47
35	34	1.21	72.6	0.40	0.47	34	2.65	159.0	0.44	0.51	34	3.08	184.8	0.44	0.51
40	35	1.28	76.8	0.40	0.46	35	2.86	171.6	0.45	0.52	35	3.29	197.4	0.44	0.51
45	35	1.38	82.8	0.43	0.50	35	3.10	186.0	0.49	0.56	35	3.54	212.4	0.48	0.55
50	35	1.43	85.8	0.45	0.52	35	3.21	192.6	0.50	0.58	35	3.76	225.6	0.51	0.59
55	35	1.50	90.0	0.47	0.54	35	3.28	196.8	0.52	0.60	35	3.94	236.4	0.53	0.61

**Bold** = Optimal pressure for the MP Rotator is 40 PSI. This can easily be achieved by using the MP Rotator with the Hunter PRS40 Spray Body, pressure regulated at 40 PSI

MP ROTATOR

MP ROTATOR

**MP ROTATOR PERFORMANCE DATA**

- **MP-LCS-515:** Ivory, MP Left Corner Strip
- **MP-RCS-515:** Copper, MP Right Corner Strip
- **MP-SS-530:** Brown, MP Side Strip

	Pressure PSI	Radius ft.	Flow GPM	Flow GPH
<b>MP Left Corner Strip</b>	30	4 x 14	0.19	11.4
	35	5 x 15	0.21	12.6
	<b>40</b>	<b>5 x 15</b>	<b>0.22</b>	<b>13.2</b>
	45	5 x 15	0.23	13.8
	50	6 x 16	0.25	15.0
	55	6 x 16	0.26	15.6
<b>MP Right Corner Strip</b>	30	4 x 14	0.19	11.4
	35	5 x 15	0.21	12.6
	<b>40</b>	<b>5 x 15</b>	<b>0.22</b>	<b>13.2</b>
	45	5 x 15	0.23	13.8
	50	6 x 16	0.25	15.0
	55	6 x 16	0.26	15.6
<b>MP Side Strip</b>	30	4 x 28	0.38	22.8
	35	5 x 30	0.41	24.6
	<b>40</b>	<b>5 x 30</b>	<b>0.44</b>	<b>26.4</b>
	45	5 x 30	0.47	28.2
	50	6 x 32	0.49	29.4
	55	6 x 32	0.51	30.6

**Bold** = Recommended Pressure

**Notes:** Strip pattern radius can be adjusted by 25%. MP Rotator is designed to maintain matched precipitation after radius adjustment. Optimal pressure for the MP Rotator is 40 PSI. This can easily be achieved by using the MP Rotator with the Hunter PRS40 Spray Body, pressure regulated at 40 PSI.

**MP ROTATOR PERFORMANCE DATA**

- **MP Corner**  
Radius: 8' to 15'  
Adjustable Arc
- Turquoise: 45° to 105°

Arc	Pressure PSI	Radius ft.	Flow GPM	Flow GPH
<b>45°</b>	25	---	---	---
	30	12	0.17	10.2
	35	13	0.18	10.8
	<b>40</b>	<b>14</b>	<b>0.19</b>	<b>11.4</b>
	45	14	0.21	12.6
	50	14	0.22	13.2
	55	15	0.23	13.8
<b>90°</b>	25	11	0.31	18.6
	30	12	0.34	20.4
	35	13	0.36	21.6
	<b>40</b>	<b>14</b>	<b>0.39</b>	<b>23.4</b>
	45	14	0.41	24.6
	50	15	0.43	25.8
	55	15	0.46	27.6
<b>105°</b>	25	11	0.36	21.6
	30	12	0.39	23.4
	35	13	0.42	25.2
	<b>40</b>	<b>14</b>	<b>0.45</b>	<b>27.0</b>
	45	14	0.48	28.8
	50	15	0.51	30.6
	55	15	0.53	31.8

**Bold** = Recommended Pressure

**MP Strips**



**MP-LCS-515**  
Left Corner Strip  
5' x 15'



**MP-RCS-515**  
Right Corner Strip  
5' x 15'



**MP-SS-530**  
Side Strip  
5' x 30'

**MP Corner**



**MP-CORNER**  
Corner  
8' to 15'

**Male Threaded**



**MP-HT**  
Male Threaded

**MP Accessories**



**MPTOOL**  
Adjusts all MP Rotators



**MPSTICK**  
Snaps onto any length of 1" PVC to allow standing adjustment. PVC pipe not included.

**MP TOOL: For Easy Adjustments**

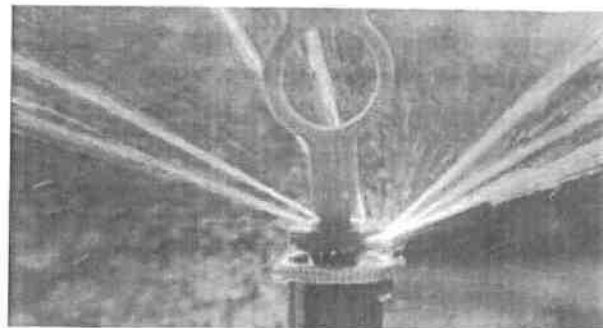

# PRS40

PRESSURE REGULATED

Models Shrub, 4", 6", 12"  
Pressure Regulation. 40 PSI

## FEATURES

- Models: Shrub, 4", 6", 12"
- Gray identification cap for easy field ID
- Innovative directional flush plug design
- 6" and 12" models come standard as no side inlet, ensuring proper installation with check valve
- Drain check valve installed (14' of elevation) comes standard
- Warranty period: 5 years
- ▶ Co-molded wiper seal
- ▶ Heavy-duty spring
- ▶ Industry's strongest spray body
- ▶ Innovative seal design
- ▶ Pro-Spray check valve
- ▶ Pressure regulated to 40 PSI
- ▶ FloGuard™ technology

## OPERATING SPECIFICATIONS

- Operational pressure range: 15 to 100 PSI

## FACTORY INSTALLED OPTIONS

- Reclaimed water ID cap
- FloGuard technology available for check valve models

## USER INSTALLED OPTIONS

- Reclaimed water ID cap (P/N 458562)
- Snap-on reclaimed cover (P/N PRO5-RC-CAP)
- ▶ = Advanced Feature descriptions on page 52



**PRS40 Reclaimed**  
PRS40 models include optional factory-installed purple reclaimed caps



**Related Solutions: MP Rotator**  
PRS40 is designed specifically for the MP Rotator®



**PRO5-00-PRS40**  
Retracted height: 4½"  
Inlet size: ½"



**PRO5-04-PRS40-CV**  
Retracted height: 5½"  
Pop-up height: 4"  
Exposed diameter: 2¼"  
Inlet size: ½"

SPRAYS



**PRO5-06-PRS40-CV**  
Retracted height: 8¾"  
Pop-up height: 6"  
Exposed diameter: 2¾"  
Inlet size: ½"



**PRO5-12-PRS40-CV**  
Retracted height: 16½"  
Pop-up height: 12"  
Exposed diameter: 2¾"  
Inlet size: ½"

## PRS40 - SPECIFICATION BUILDER: ORDER 1 + 2

### 1 Model

- PRO5-00-PRS40** = 40 PSI regulated shrub adapter
- PRO5-04-PRS40-CV** = 40 PSI regulated 4" pop-up with drain check valve
- PRO5-06-PRS40-CV** = 40 PSI regulated 6" pop-up with drain check valve
- PRO5-12-PRS40-CV** = 40 PSI regulated 12" pop-up with drain check valve

### 2 Specialty Options

- (blank)** = No option
- R** = Factory-installed reclaimed body cap
- F** = FloGuard technology
- F-R** = FloGuard technology with reclaimed body cap

### Examples:

- PRO5-04-PRS40-CV** = 4" Pop-up regulated at 40 PSI, drain check valve
- PRO5-06-PRS40-CV-F** = 6" Pop-up regulated at 40 PSI, drain check valve, with FloGuard technology
- PRO5-12-PRS40-CV-R** = 12" Pop-up regulated at 40 PSI, drain check valve, reclaimed body cap

# MP ROTATOR®

MP ROTATOR

## FEATURES

- Radius can be reduced up to approximately 25% on all models
- Easy arc adjustment
- Color-coded for easy identification
- Removable filter screen ensures hassle-free service
- Wind-resistant multi-stream technology
- ▶ Automatic matched precipitation
- ▶ Double-pop
- ▶ Distribution uniformity
- ▶ Low precipitation rate

## OPERATING SPECIFICATIONS

- Recommended operating pressure: 40 PSI
- Recommended filtering when operating on dirty water

## OPTIONS

- Specify Pro-Spray® PRS40 pop-up for accurate pressure regulation at 40 PSI
- Adding "HT" will specify male threaded nozzles
- ▶ = Advanced Feature descriptions on page 81

Radius 8' to 35'

MP1000 8' to 15' radius



MP-1000-90  
90° to 210°

MP-1000-210  
210° to 270°

MP-1000-360  
360°

MP2000 13' to 21' radius



MP-2000-90  
90° to 210°

MP-2000-210  
210° to 270°

MP-2000-360  
360°

MP3000 22' to 30' radius



MP-3000-90  
90° to 210°

MP-3000-210  
210° to 270°

MP-3000-360  
360°

MP3500 31' to 35' radius



MP-3500-90  
90° to 210°

### MP ROTATOR - SPECIFICATION BUILDER: ORDER 1 + 2

#### 1 Model

MP-1000-90 = 8' to 15' radius, adjustable from 90° to 210°

MP-1000-210 = 8' to 15' radius, adjustable from 210° to 270°

MP-1000-360 = 8' to 15' radius, 360°

MP-2000-90 = 13' to 21' radius, adjustable from 90° to 210°

MP-2000-210 = 13' to 21' radius, adjustable from 210° to 270°

MP-2000-360 = 13' to 21' radius, 360°

MP-3000-90 = 22' to 30' radius, adjustable from 90° to 210°

MP-3000-210 = 22' to 30' radius, adjustable from 210° to 270°

MP-3000-360 = 22' to 30' radius, 360°

MP-3500-90 = 31' to 35' radius, adjustable from 90° to 210°

MP-LCS-515 = Left corner strip, 5' x 15'

MP-RCS-515 = Right corner strip, 5' x 15'

MP-SS-530 = Side strip, 5' x 30'

MP-CORNER = 8' to 15' radius, adjustable from 45° to 105°

#### Options

(blank) = No option

HT = Male threaded version  
(Not available in 3500 and 1000-210)

#### Examples:

MP-1000-210 = 8' to 15' radius, adjustable from 210° to 270°

PROS-06 - PRS40-CV - MP-2000-90 = 6" pop-up regulated at 40 PSI, drain check valve, with MP 2000-90.

MP ROTATOR PERFORMANCE DATA

Arc	Pressure PSI	MP-1000 Radius: 8' to 15' Adjustable Arc and Full-Circle ● Maroon: 90° to 210° ● Lt. Blue: 210° to 270° ● Olive: 360°					MP-2000 Radius: 13' to 21' Adjustable Arc and Full-Circle ● Black: 90° to 210° ● Green: 210° to 270° ● Red: 360°					MP-3000 Radius: 22' to 30' Adjustable Arc and Full-Circle ● Blue: 90° to 210° ● Yellow: 210° to 270° ● Gray: 360°				
		Radius ft.	Flow GPM	Flow GPH	Precip in/hr ■ ▲		Radius ft.	Flow GPM	Flow GPH	Precip in/hr ■ ▲		Radius ft.	Flow GPM	Flow GPH	Precip in/hr ■ ▲	
90°	25	--	--	--	--	--	17	0.34	20.4	0.45	0.52	25	0.71	42.6	0.44	0.51
	30	12	0.17	10.2	0.45	0.52	18	0.38	22.8	0.45	0.52	27	0.76	45.6	0.40	0.46
	35	13	0.19	11.4	0.43	0.50	19	0.40	24.0	0.43	0.49	28	0.82	49.2	0.40	0.46
	40	14	0.21	12.6	0.41	0.48	20	0.43	25.8	0.41	0.48	30	0.86	51.6	0.37	0.42
	45	14	0.23	13.8	0.45	0.52	21	0.46	27.6	0.40	0.46	30	0.90	54.0	0.39	0.44
	50	15	0.25	15.0	0.43	0.49	21	0.47	28.2	0.41	0.47	30	0.95	57.0	0.41	0.47
180°	25	--	--	--	--	--	16	0.6	36.0	0.45	0.52	25	1.44	85.4	0.44	0.51
	30	12	0.34	20.4	0.45	0.52	17	0.64	38.4	0.43	0.49	27	1.58	94.8	0.42	0.48
	35	13	0.38	22.8	0.43	0.50	18	0.71	42.6	0.42	0.49	28	1.70	102.0	0.42	0.48
	40	14	0.42	25.2	0.41	0.48	19	0.77	46.2	0.41	0.47	30	1.82	109.2	0.39	0.45
	45	14	0.44	26.4	0.43	0.50	20	0.85	51.0	0.41	0.47	30	1.93	115.8	0.41	0.48
	50	15	0.50	30.0	0.43	0.49	21	0.91	54.6	0.40	0.46	30	2.04	122.4	0.44	0.50
210°	25	--	--	--	--	--	16	0.72	43.2	0.46	0.54	25	1.68	100.8	0.44	0.51
	30	12	0.40	24.0	0.46	0.53	17	0.75	45.0	0.43	0.49	27	1.84	110.4	0.42	0.48
	35	13	0.45	27.0	0.44	0.51	18	0.81	48.6	0.41	0.48	28	1.99	119.4	0.42	0.48
	40	14	0.49	29.4	0.41	0.48	19	0.86	51.6	0.39	0.45	30	2.12	127.2	0.39	0.45
	45	14	0.51	30.6	0.43	0.50	20	0.91	54.6	0.38	0.43	30	2.25	135.0	0.41	0.48
	50	15	0.57	34.2	0.42	0.48	21	0.98	58.8	0.37	0.42	30	2.37	142.2	0.43	0.50
270°	25	--	--	--	--	--	16	0.87	52.2	0.44	0.50	25	2.19	131.4	0.45	0.52
	30	12	0.48	28.8	0.43	0.49	17	0.95	57.0	0.42	0.49	27	2.37	142.2	0.42	0.48
	35	13	0.53	31.8	0.40	0.46	18	1.03	61.8	0.41	0.47	28	2.55	153.0	0.42	0.48
	40	14	0.63	37.8	0.41	0.48	19	1.10	66.0	0.39	0.45	30	2.73	163.8	0.39	0.45
	45	14	0.67	40.2	0.44	0.51	20	1.17	70.2	0.38	0.43	30	2.89	173.4	0.41	0.48
	50	15	0.72	43.2	0.41	0.47	21	1.23	73.8	0.36	0.41	30	3.06	183.6	0.44	0.50
360°	25	--	--	--	--	--	16	1.20	72.0	0.45	0.52	25	2.88	172.8	0.44	0.51
	30	12	0.69	41.4	0.46	0.53	17	1.28	76.8	0.43	0.49	27	3.15	189.0	0.42	0.48
	35	13	0.77	46.2	0.44	0.51	18	1.37	82.2	0.41	0.47	28	3.40	204.0	0.42	0.48
	40	14	0.84	50.4	0.41	0.48	19	1.48	88.8	0.39	0.46	30	3.64	218.4	0.39	0.45
	45	14	0.88	52.8	0.43	0.50	20	1.57	94.2	0.38	0.44	30	3.86	231.6	0.41	0.48
	50	15	0.98	58.8	0.42	0.48	21	1.68	100.8	0.37	0.42	30	4.07	244.2	0.44	0.50
55	15	1.01	60.6	0.43	0.50	21	1.74	104.4	0.38	0.44	30	4.27	256.2	0.46	0.53	

MP ROTATOR

Pressure PSI	MP-3500 Radius: 31' to 35' Adjustable Arc ● Light Brown: 90°					MP-3500 Radius: 31' to 35' Adjustable Arc ● Light Brown: 180°					MP-3500 Radius: 31' to 35' Adjustable Arc ● Light Brown: 210°				
	Radius ft.	Flow GPM	Flow GPH	Precip in/hr ■ ▲		Radius ft.	Flow GPM	Flow GPH	Precip in/hr ■ ▲		Radius ft.	Flow GPM	Flow GPH	Precip in/hr ■ ▲	
25	33	1.04	62.4	0.37	0.42	33	2.21	132.6	0.39	0.45	33	2.59	155.4	0.39	0.45
30	34	1.13	67.8	0.38	0.43	34	2.24	134.4	0.37	0.43	34	2.84	170.4	0.41	0.47
35	34	1.21	72.6	0.40	0.47	34	2.65	159.0	0.44	0.51	34	3.08	184.8	0.44	0.51
40	35	1.28	76.8	0.40	0.46	35	2.86	171.6	0.45	0.52	35	3.29	197.4	0.44	0.51
45	35	1.38	82.8	0.43	0.50	35	3.10	186.0	0.49	0.56	35	3.54	212.4	0.48	0.55
50	35	1.43	85.8	0.45	0.52	35	3.21	192.6	0.50	0.58	35	3.76	225.6	0.51	0.59
55	35	1.50	90.0	0.47	0.54	35	3.28	196.8	0.52	0.60	35	3.94	236.4	0.53	0.61

**Bold = Optimal pressure for the MP Rotator is 40 PSI.** This can easily be achieved by using the MP Rotator with the Hunter PR540 Spray Body, pressure regulated at 40 PSI.



MP ROTATOR

**MP ROTATOR PERFORMANCE DATA**

- MP-LCS-515: Ivory, MP Left Corner Strip
- MP-RCS-515: Copper, MP Right Corner Strip
- MP-SS-530: Brown, MP Side Strip

	Pressure PSI	Radius ft.	Flow GPM	Flow GPH
<b>MP Left Corner Strip</b>	30	4 x 14	0.19	11.4
	35	5 x 15	0.21	12.6
	40	<b>5 x 15</b>	<b>0.22</b>	<b>13.2</b>
	45	5 x 15	0.23	13.8
	50	6 x 16	0.25	15.0
<b>MP Right Corner Strip</b>	30	4 x 14	0.19	11.4
	35	5 x 15	0.21	12.6
	40	<b>5 x 15</b>	<b>0.22</b>	<b>13.2</b>
	45	5 x 15	0.23	13.8
	50	6 x 16	0.25	15.0
<b>MP Side Strip</b>	30	4 x 28	0.38	22.8
	35	5 x 30	0.41	24.6
	40	<b>5 x 30</b>	<b>0.44</b>	<b>26.4</b>
	45	5 x 30	0.47	28.2
	50	6 x 32	0.49	29.4
	55	6 x 32	0.51	30.6

**Bold = Recommended Pressure**

**Notes:** Strip pattern radius can be adjusted by 25%. MP Rotator is designed to maintain matched precipitation after radius adjustment. Optimal pressure for the MP Rotator is 40 PSI. This can easily be achieved by using the MP Rotator with the Hunter PRS40 Spray Body, pressure regulated at 40 PSI

**MP ROTATOR PERFORMANCE DATA**

- MP Corner  
Radius: 8' to 15'  
Adjustable Arc
- Turquoise: 45° to 105°

Arc	Pressure PSI	Radius ft.	Flow GPM	Flow GPH
<b>45°</b>	25	--	--	--
	30	12	0.17	10.2
	35	13	0.18	10.8
	40	14	0.19	11.4
	45	14	0.21	12.6
	50	14	0.22	13.2
<b>90°</b>	25	11	0.31	18.6
	30	12	0.34	20.4
	35	13	0.36	21.6
	40	<b>14</b>	<b>0.39</b>	<b>23.4</b>
	45	14	0.41	24.6
	50	15	0.43	25.8
<b>105°</b>	25	11	0.36	21.6
	30	12	0.39	23.4
	35	13	0.42	25.2
	40	14	<b>0.45</b>	<b>27.0</b>
	45	14	0.48	28.8
	50	15	0.51	30.6
	55	15	0.53	31.8

**Bold = Recommended Pressure**

**MP Strips**



**MP-LCS-515**  
Left Corner Strip  
5' x 15'



**MP-RCS-515**  
Right Corner Strip  
5' x 15'



**MP-SS-530**  
Side Strip  
5' x 30'

**MP Corner**



**MP-CORNER**  
Corner  
8' to 15'

**Male Threaded**



**MP-HT**  
Male Threaded

**MP Accessories**



**MPTOOL**  
Adjusts all MP Rotators



**MPSTICK**  
Snaps onto any length of 1" PVC to allow standing adjustment. PVC pipe not included.

**MP TOOL: For Easy Adjustments**

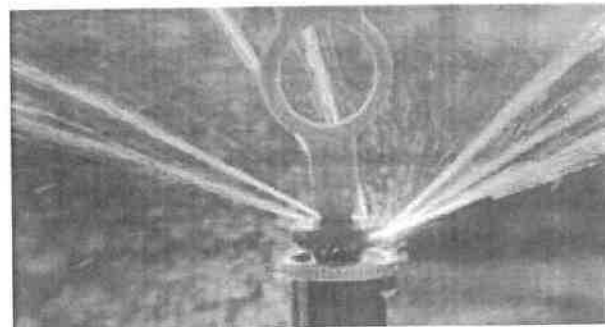

**RAIN MASTER**  
CONTROL SYSTEMS

## Twice 2-wire CENTRAL CONTROL

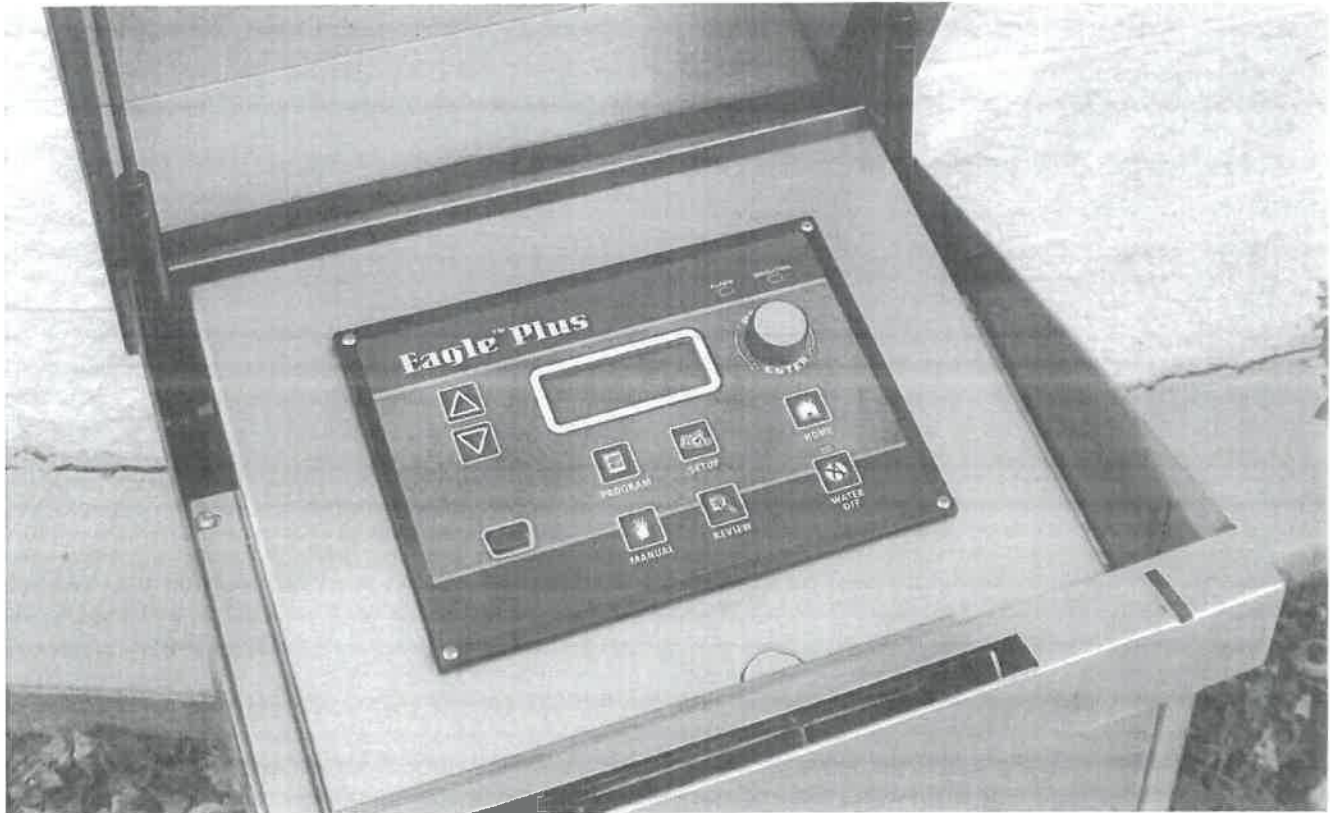

UP TO 200 STATIONS, WITH 100 DECODERS OR LESS

Unlike other two-wire systems, the Rain Master® 2-wire protocol provides a two-way communication link between the controller, decoders and valves. This provides the means for testing and diagnostic capabilities within the 2-wire system. The simplicity of the 2-wire field installation, coupled with the enhanced capability of the Rain Master Twice controllers, sets a new precedent for 2-wire control within the irrigation industry.

### KEY FEATURES & BENEFITS

**EVAPOTRANSPIRATION (ET) BASED SCHEDULING**   
Maximizes water saving and irrigation efficiency

**FLOW SENSING AND CONTROL**   
Monitors system flow and responds to upper, lower, unscheduled and no flow conditions

**2-WIRE INTERFACE MODULE**  
Provides 2-wire capability for any Irritrol Rain Master Eagle controller

**DECODER TWO-WAY COMMUNICATION**  
Provides troubleshooting diagnostics to retain system integrity

**PROGRAMMABLE DECODERS**  
Provides flexibility in programming decoder identification

**DECODER LEDS FOR EASY TROUBLE SHOOTING**

AVAILABLE FOR DX2, EAGLE™ & EAGLE™ PLUS SYSTEMS

# RAIN MASTER<sup>TM</sup>

## CONTROL SYSTEMS

### TWICE LOOP CONFIGURATION

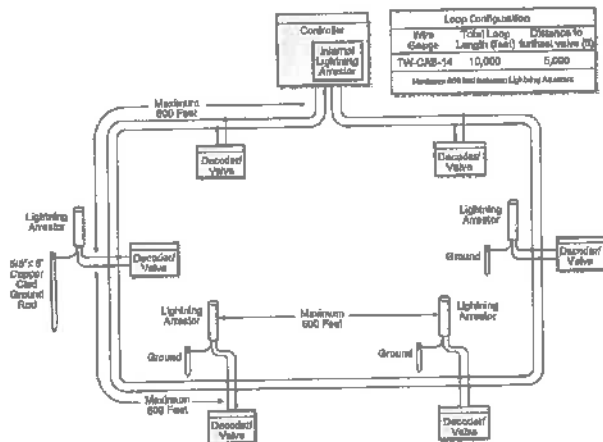

### TWICE STRAIGHT LINE CONFIGURATION

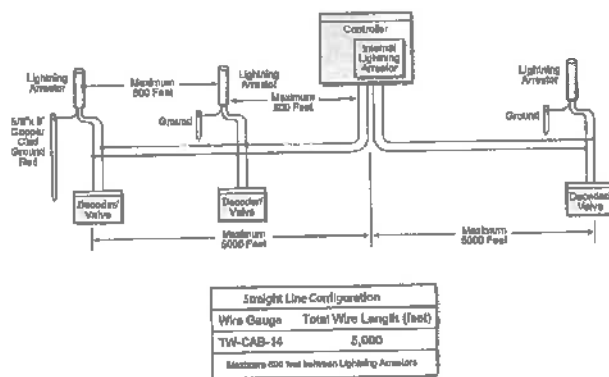

### TWICE WIRE CONNECTION DETAIL

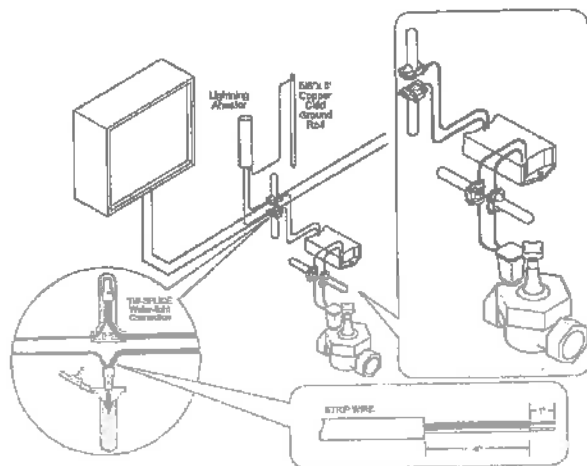

We reserve the right to improve our products and make changes in the specifications and designs without notice and without incurring obligation. Products depicted in this brochure are for demonstration purposes only. Actual products offered for sale may vary in design and features.

### MODULES

- Easy-to-read LED status indication for every command
- LED also displays valve activation and diagnostic reporting
- Troubleshooting capabilities:
  - LED decoder "active" indication
  - LED valve power "on" indication
  - Two-way communication verification

### DECODERS

- Each decoder has a unique address (programmable at the interface module)
- Decoders will automatically shut off if communication is lost
- Wire fault detection automatically shuts down any valve
- Valves can be operated up to 100' radius of the decoder

### ELECTRICAL SPECIFICATIONS

- Input power: 105-130V ac, 50/60 Hz, 0.5 amp maximum, 1 amp idle
- Output power: 24V ac, 1.5 amps maximum total output or (36 VA) 1.0 amp per station or master valve
- UL, CUL, and FCC approved

### SPECIFYING INFORMATION

Model	Controller Description
TW-DX48-PWM	DX2, up to 48 stations, painted wall mount
TW-DX48-SWM	DX2, up to 48 stations, stainless wall mount
TW-DX48-SPED	DX2, up to 48 stations, stainless steel security pedestal
TW-DX48-UFEN	DX2, up to 48 stations, stainless steel ultimate front entry enclosure
TW-EG136*	Eagle, up to 36 decoders, steel wall mount
TW-EG136-SB*	Eagle, up to 36 decoders, stainless steel wall mount
TW-EG136-SPED*	Eagle, up to 36 decoders, 14 gauge stainless steel security pedestal
EGP-TWI*	Eagle Plus, up to 200 stations, painted wall mount
EGP-TWI-S*	Eagle Plus, up to 200 stations, stainless steel pedestal
EGP-TWI-SPED*	Eagle Plus, up to 200 stations, 14 gauge stainless steel security pedestal
EGP-TWI-PSB*	Eagle Plus, up to 200 stations, 14 gauge stainless steel security pedestal

\* Remove "i" for standalone option

### DIMENSIONS

- TW model: H: 10" W: 13" D: 4.5"
- TW & SB model: H: 17.5" W: 13" D: 4.5"
- TW-SPED model: H: 35" W: 16" D: 14"

### OPTIONAL 2-WIRE DECODERS AND ACCESSORIES

Model	Description
• TW-D-1	Single valve AC decoder
• TW-D-2	Dual valve AC decoder
• TW-D-4	Quad valve AC decoder
• TW-LA-1	Lightning arrester (every 600 feet)
• TW-SPICE	1/4-gauge water-tight connectors
• TW-CAB-14	14-gauge (red/black) Polycoated (blue) wire

# RAINSENSOR™ SERIES RAIN AND FREEZE SENSORS

WIRED/WIRELESS

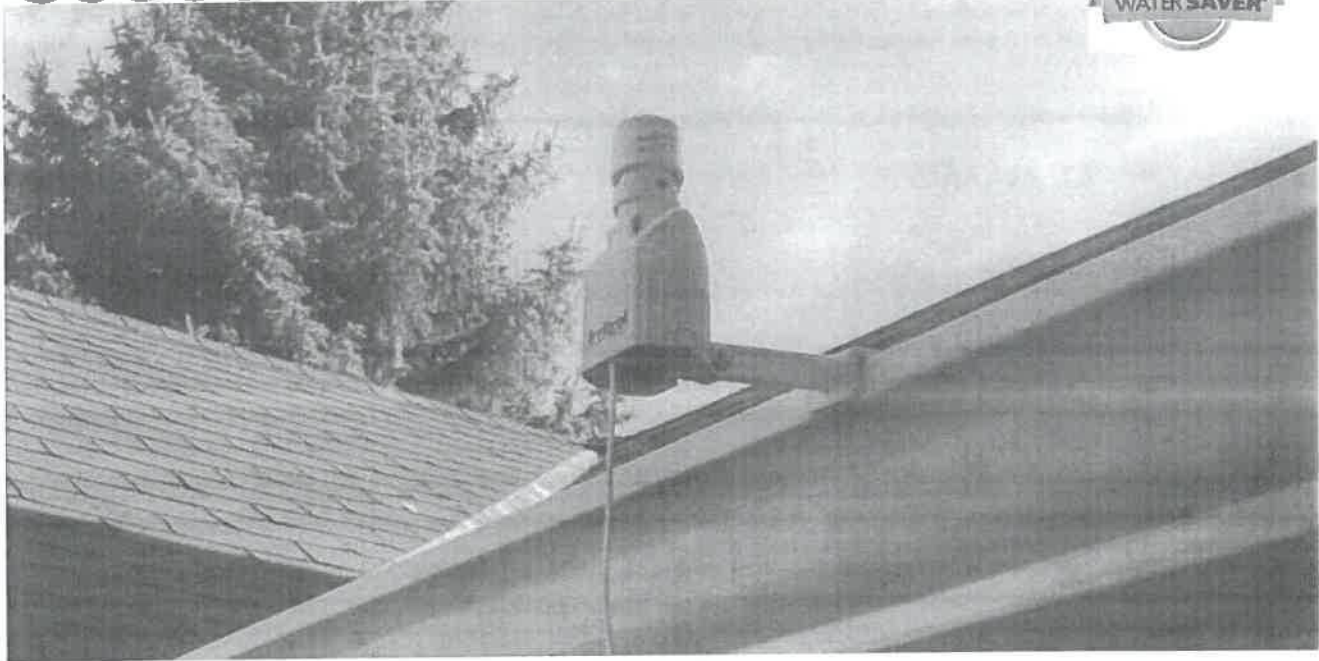

Taking water management to the next level, Irritrol's proven RainSensor™ Series makes watering in the rain a mistake of the past. The reliable wireless and wired rain sensors conserve water by preventing irrigation during or after sufficient rainfall, while the wireless rain/freeze sensor also helps reduce vegetation damage and icing conditions when the temperature drops below a predetermined set point. With its compact design and host of convenient features, the RainSensor Series is the perfect compliment to any standard controller.

## KEY FEATURES & BENEFITS

### WIRELESS MODELS

Require less labor for the installer

### CONSTANT COMMUNICATION BETWEEN TRANSMITTER AND RECEIVER

Assures that even after a controller power outage, the controller is continually updated with the sensor's "wet" or "dry" status

### VERSATILE MOUNTING OPTIONS

Requires no special tools – Quick-Clip™ gutter bracket and ½" conduit adapter included

### SIGNAL STRENGTH INDICATOR

Ensures correct installation, communication link and signal integrity (wireless models)

### SMART BYPASS™ FOR EASY SYSTEM OVERRIDE

Allows for temporary deactivation while automatically resetting on next activation (wireless models)

### FULLY ADJUSTABLE SHUTOFF POINTS

From 1/8" to 3/4" of accumulated rainfall

### DRY-OUT RATE ADJUSTMENT FOR RESET DELAY

Allows for setting the ideal dryout time

### PATENTED WIRELESS TECHNOLOGY

Unsurpassed by the competition

### SUPERIOR PATENTED WIRELESS TECHNOLOGY

Press once to temporarily deactivate rain sensor; automatically resets on next activation

Illuminates "RED" when the rain sensor is activated

Blinking light alerts user when attention is required, e.g., need batteries replaced, no communication

Illuminates "GREEN" to ensure a good signal



### SPECIFYING INFORMATION

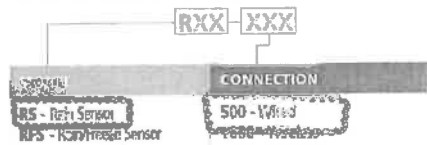

Example: A wireless rain/freeze sensor = RFS1000

### ADDED FEATURES

#### RS1000/RFS1000

- Compatible with nearly all controllers
- Visual sensor status and alert indicators verify consistent operation
- Slide/snap-on cover provides additional protection to weather-proof receiver from the elements
- Power failure memory protection
- Three-year warranty

#### RFS1000

- Rain and freeze sensors fully integrated into one unit
- Highly accurate 41°F digital activation point

#### RS500

- Compatible with virtually all controllers
- 25-foot cable (UV-resistant, white jacket included) provides installation flexibility
- Easy, tool-free conversion to normally open operation
- Five-year warranty

### OPERATING SPECIFICATIONS

- Sensor type: industry-standard hygroscopic discs
- Rain sensitivity: adjustable nominal  $\frac{1}{8}$ " to  $\frac{3}{4}$ "
- Operating temperature: -20°F to 120°F
- Housing material: UV-resistant engineered polymer
- Wireless only features:
  - Transmission range: over 300 feet line-of-sight
  - Frequency: 418 MHz
  - Battery: Two CR2032 3V cells, 5-year life (typical)

### ELECTRICAL SPECIFICATIONS

- Receiver power: 22-28 V ac/V dc, 100mA (to be used with Class 2, UL-approved transformer)
- Load rating: normally open or normally closed — 3A @ 24 V ac
- UL Listed, FCC, CE, IC

### MODELS

Model	Description
RS1000	Wireless rain sensor
RFS1000	Wireless rain/freeze sensor
RS500	Wired rain sensor

### DIMENSIONS

- Transmitter: H: 1 1/2", W: 1 3/4", D: 3 3/8"
- Receiver: H: 1 1/2", W: 1", D: 3"

### OPTIONAL ACCESSORIES

- RS1000-RX rain receiver for multiple controllers
- RFS1000-RX rain/freeze receiver for multiple controllers
- RSCAP cap/disk/spindle assembly
- RSBATT-TX battery pack (includes 2 batteries)

We reserve the right to improve our products and make changes in the specifications and designs without notice and without incurring obligation. Products depicted in this brochure are for demonstration purposes only. Actual products offered for sale may vary in design and features.

**RAIN MASTER**  
CONTROL SYSTEMS

# Twice 2-wire

## CENTRAL CONTROL



UP TO 200 STATIONS, WITH 100 DECODERS OR LESS

Unlike other two-wire systems, the Rain Master® 2-wire protocol provides a two-way communication link between the controller, decoders and valves. This provides the means for testing and diagnostic capabilities within the 2-wire system. The simplicity of the 2-wire field installation, coupled with the enhanced capability of the Rain Master Twice 2-wire controllers, sets a new precedent for 2-wire control within the irrigation industry.

## KEY FEATURES & BENEFITS

**EVAPOTRANSPIRATION (ET) BASED SCHEDULING**   
Maximizes water saving and irrigation efficiency

**FLOW SENSING AND CONTROL**   
Monitors system flow and responds to upper, lower, unscheduled and no flow conditions

**2-WIRE INTERFACE MODULE**  
Provides 2-wire capability for any Irritrol Rain Master Eagle controller

**DECODER TWO-WAY COMMUNICATION**  
Provides troubleshooting diagnostics to retain system integrity

**PROGRAMMABLE DECODERS**  
Provides flexibility in programming decoder identification

**DECODER LEDS FOR EASY TROUBLE SHOOTING**

**AVAILABLE FOR DX2, EAGLE™ & EAGLE™ PLUS SYSTEMS**

# RAIN MASTER CONTROL SYSTEMS

## TWICE LOOP CONFIGURATION

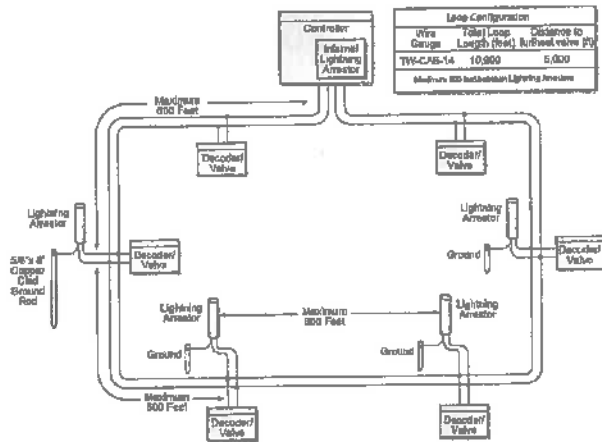

## TWICE STRAIGHT LINE CONFIGURATION

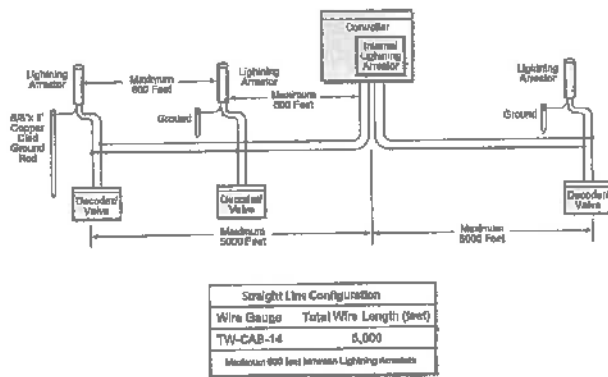

## TWICE WIRE CONNECTION DETAIL

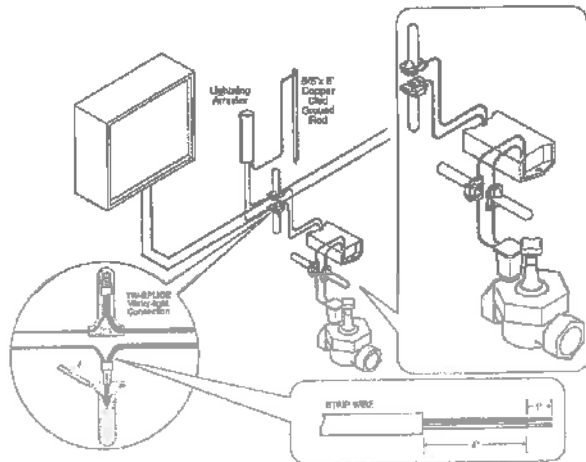

We reserve the right to improve our products and make changes in the specifications and designs without notice and without incurring obligation. Products depicted in this brochure are for demonstration purposes only. Actual products offered for sale may vary in design and features.

## MODULES

- Easy-to-read LED status indication for every command
- LED also displays valve activation and diagnostic reporting
- Troubleshooting capabilities:
  - LED decoder "active" indication
  - LED valve power "on" indication
  - Two-way communication verification

## DECODERS

- Each decoder has a unique address (programmable at the interface module)
- Decoders will automatically shut off if communication is lost
- Wire fault detection automatically shuts down any valve
- Valves can be operated up to 100' radius of the decoder

## ELECTRICAL SPECIFICATIONS

- Input power: 105-130V ac, 50/60 Hz, 0.5 amp maximum, 1 amp idle
- Output power: 24V ac, 1.5 amps maximum total output or (36 VA) 3.0 amp per station or master valve
- UL, CUL, and FCC approved

## SPECIFYING INFORMATION

Model	Controller Description
TW-DX48-PWM	DX2, up to 48 stations, painted wall mount
TW-DX48-SWM	DX2, up to 48 stations, stainless wall mount
TW-DX48-SPED	DX2, up to 48 stations, stainless steel security pedestal
TW-DX48-UFEN	DX2, up to 48 stations, stainless steel ultimate front entry enclosure
TW-EGi36*	Eagle, up to 36 decoders, steel wall mount
TW-EGi36-SB*	Eagle, up to 36 decoders, stainless steel wall mount
TW-EGi36-SPED*	Eagle, up to 36 decoders, 14 gauge stainless steel security pedestal
EGP-TWi*	Eagle Plus, up to 200 stations, painted wall mount
EGP-TWi-S*	Eagle Plus, up to 200 stations, stainless steel pedestal
EGP-TWi-SPED*	Eagle Plus, up to 200 stations, 14 gauge stainless steel security pedestal
EGP-TWi-PSB*	Eagle Plus, up to 200 stations, 14 gauge stainless steel security pedestal

\*Remove "i" for standalone option

## DIMENSIONS

- TW model: H: 10" W: 13" D: 4.5"
- TW & SB model: H: 17.5" W: 13" D: 4.5"
- TW-SPED model: H: 35" W: 16" D: 14"

## OPTIONAL 2-WIRE DECODERS AND ACCESSORIES

Model	Description
• TW-D-1	Single valve AC decoder
• TW-D-2	Dual valve AC decoder
• TW-D-4	Quad valve AC decoder
• TW-LA-1	lightning arrester (every 600 feet)
• TW-SPLICE	14-gauge water-tight connectors
• TW-CAB-14	14-gauge (red/black) Polycoated (blue) wire

**RAIN MASTER®**  
CONTROL SYSTEMS

# Twice 2-wire

## CENTRAL CONTROL

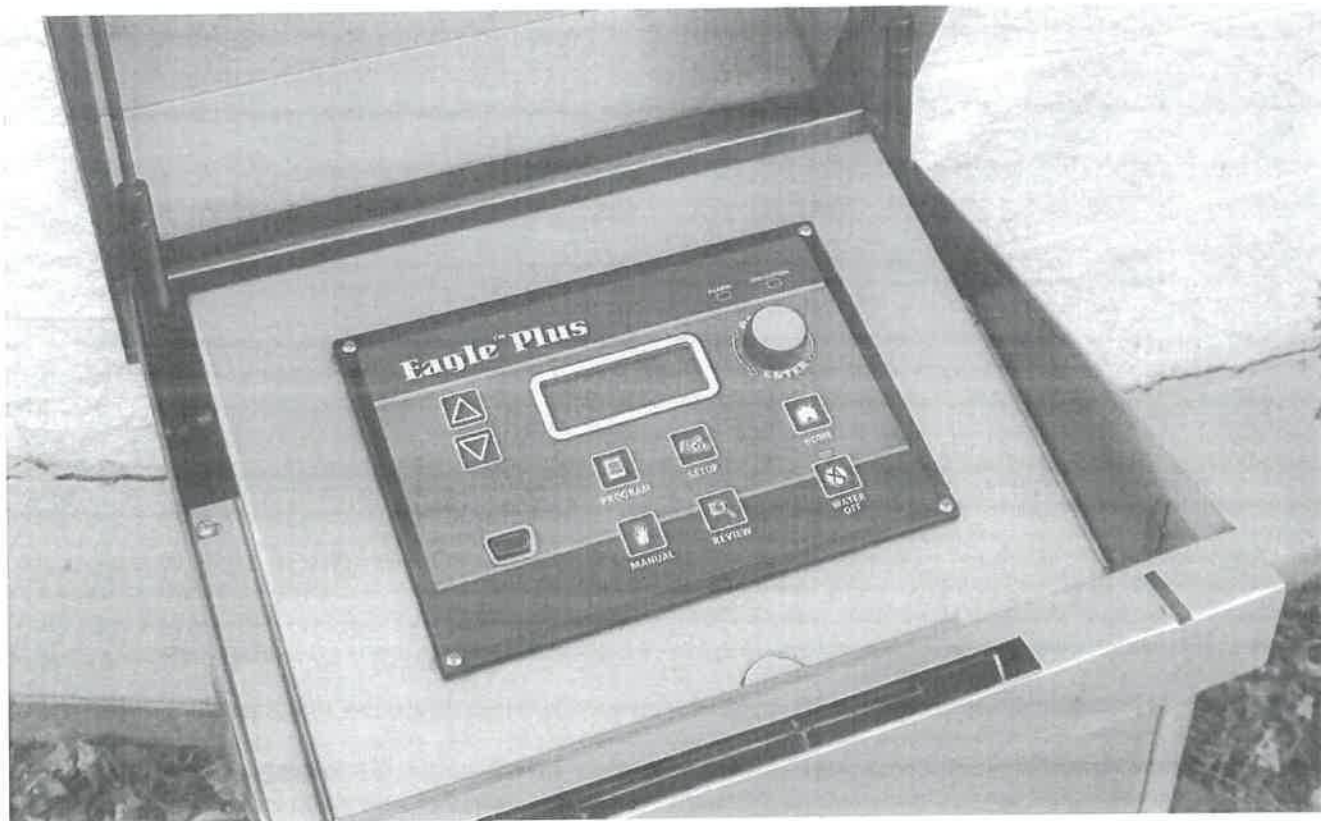

UP TO 200 STATIONS, WITH 100 DECODERS OR LESS

Unlike other two-wire systems, the Rain Master® 2-wire protocol provides a two-way communication link between the controller, decoders and valves. This provides the means for testing and diagnostic capabilities within the 2-wire system. The simplicity of the 2-wire field installation, coupled with the enhanced capability of the Rain Master Twice 2-wire controllers, sets a new precedent for 2-wire control within the irrigation industry.

## KEY FEATURES & BENEFITS

**EVAPOTRANSPIRATION (ET) BASED SCHEDULING**   
Maximizes water saving and irrigation efficiency

**FLOW SENSING AND CONTROL**   
Monitors system flow and responds to upper, lower, unscheduled and no flow conditions

**2-WIRE INTERFACE MODULE**  
Provides 2-wire capability for any Irritrol Rain Master Eagle controller

**DECODER TWO-WAY COMMUNICATION**  
Provides troubleshooting diagnostics to retain system integrity

**PROGRAMMABLE DECODERS**  
Provides flexibility in programming decoder identification

**DECODER LEDS FOR EASY TROUBLE SHOOTING**  
**AVAILABLE FOR DX2, EAGLE™ & EAGLE™ PLUS SYSTEMS**



# RAIN MASTER<sup>TM</sup>

## CONTROL SYSTEMS

### TWICE LOOP CONFIGURATION

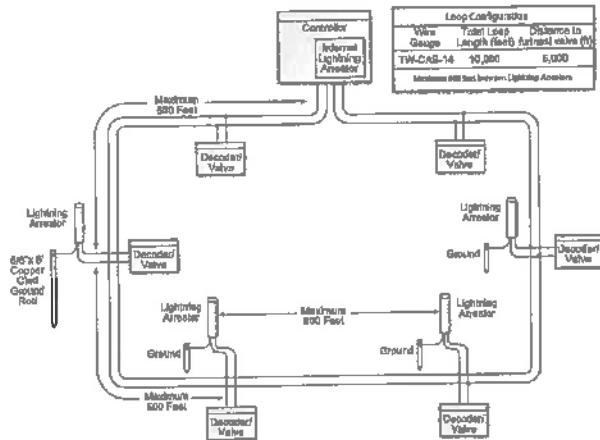

### TWICE STRAIGHT LINE CONFIGURATION

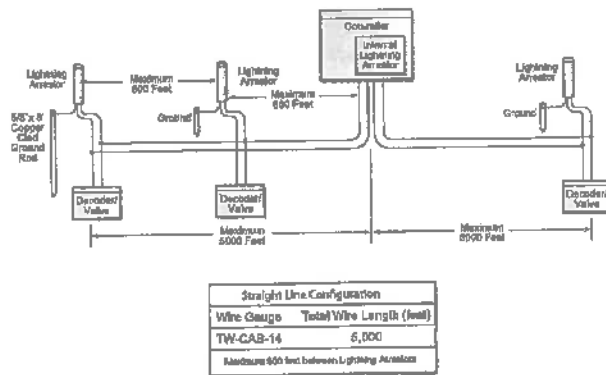

### TWICE WIRE CONNECTION DETAIL

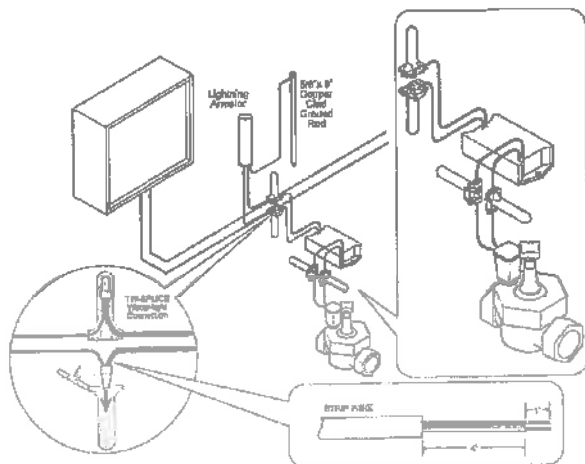

We reserve the right to improve our products and make changes in the specifications and designs without notice and without incurring obligation. Products depicted in this brochure are for demonstration purposes only. Actual products offered for sale may vary in design and features.

### MODULES

- Easy-to-read LED status indication for every command
- LED also displays valve activation and diagnostic reporting
- Troubleshooting capabilities:
  - LED decoder "active" indication
  - LED valve power "on" indication
  - Two-way communication verification

### DECODERS

- Each decoder has a unique address (programmable at the interface module)
- Decoders will automatically shut off if communication is lost
- Wire fault detection automatically shuts down any valve
- Valves can be operated up to 190' radius of the decoder

### ELECTRICAL SPECIFICATIONS

- Input power: 105-130V ac, 50/60 Hz, 0.5 amp maximum, 1 amp idle
- Output power: 24V ac, 1.5 amps maximum total output or (36 VA) 1.0 amp per station or master valve
- UL, CUL, and FCC approved

### SPECIFYING INFORMATION

Model	Controller Description
TW-DX48-PWM	DX2, up to 48 stations, painted wall mount
TW-DX48-SWM	DX2, up to 48 stations, stainless wall mount
TW-DX48-SPED	DX2, up to 48 stations, stainless steel security pedestal
TW-DX48-UFEN	DX2, up to 48 stations, stainless steel ultimate front entry enclosure
TW-EG136*	Eagle, up to 36 decoders, steel wall mount
TW-EG136-SB*	Eagle, up to 36 decoders, stainless steel wall mount
TW-EG136-SPED*	Eagle, up to 36 decoders, 14 gauge stainless steel security pedestal
EGP-TWI*	Eagle Plus, up to 200 stations, painted wall mount
EGP-TWI-S*	Eagle Plus, up to 200 stations, stainless steel pedestal
EGP-TWI-SPED*	Eagle Plus, up to 200 stations, 14 gauge stainless steel security pedestal
EGP-TWI-PSB*	Eagle Plus, up to 200 stations, 14 gauge stainless steel security pedestal

\*Remove "i" for standalone option

### DIMENSIONS

- TW model: H: 10" W: 13" D: 4.5"
- TW & SB model: H: 17.5" W: 13" D: 4.5"
- TW-SPED model: H: 35" W: 16" D: 14"

### OPTIONAL 2-WIRE DECODERS AND ACCESSORIES

Model	Description
• TW-D-1	Single valve AC decoder
• TW-D-2	Dual valve AC decoder
• TW-D-4	Quad valve AC decoder
• TW-LA-1	Lightning arrestor (every 600 feet)
• TW-SPLICE	14-gauge water-tight connectors
• TW-CAB-14	14-gauge (red/black) Polycoated (blue) wire

**RAIN MASTER**  
CONTROL SYSTEMS

# Twice 2-wire

## CENTRAL CONTROL



UP TO 200 STATIONS, WITH 100 DECODERS OR LESS

Unlike other two-wire systems, the Rain Master® 2-wire protocol provides a two-way communication link between the controller, decoders and valves. This provides the means for testing and diagnostic capabilities within the 2-wire system. The simplicity of the 2-wire field installation, coupled with the enhanced capability of the Rain Master Twice controllers, sets a new precedent for 2-wire control within the irrigation industry.

## KEY FEATURES & BENEFITS

**EVAPOTRANSPIRATION (ET) BASED SCHEDULING**   
Maximizes water saving and irrigation efficiency

**FLOW SENSING AND CONTROL**   
Monitors system flow and responds to upper, lower, unscheduled and no flow conditions

**2-WIRE INTERFACE MODULE**  
Provides 2-wire capability for any Irritrol Rain Master Eagle controller

**DECODER TWO-WAY COMMUNICATION**  
Provides troubleshooting diagnostics to retain system integrity

**PROGRAMMABLE DECODERS**  
Provides flexibility in programming decoder identification

**DECODER LEDS FOR EASY TROUBLE SHOOTING**

**AVAILABLE FOR DX2, EAGLE™ & EAGLE™ PLUS SYSTEMS**

# RAIN MASTER<sup>®</sup>

## CONTROL SYSTEMS

### TWICE LOOP CONFIGURATION

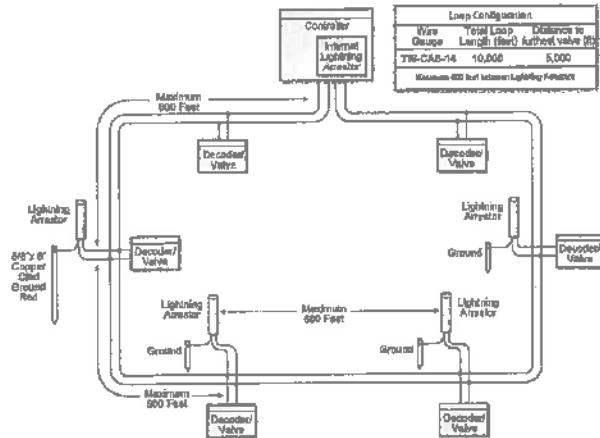

### TWICE STRAIGHT LINE CONFIGURATION

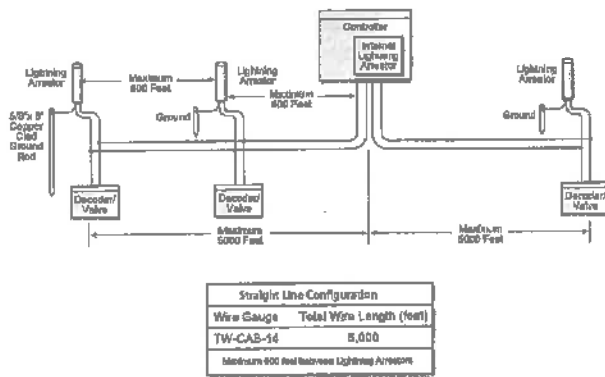

### TWICE WIRE CONNECTION DETAIL

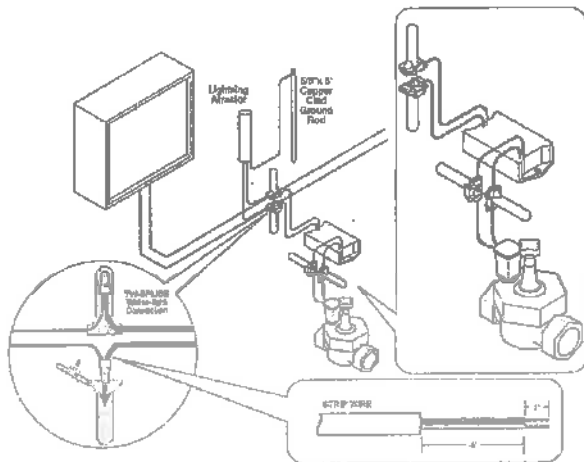

We reserve the right to improve our products and make changes in the specifications and designs without notice and without incurring obligation. Products depicted in this brochure are for demonstration purposes only. Actual products offered for sale may vary in design and features.

### MODULES

- Easy-to-read LED status indication for every command
- LED also displays valve activation and diagnostic reporting
- Troubleshooting capabilities:
  - LED decoder "active" indication
  - LED valve power "on" indication
  - Two-way communication verification

### DECODERS

- Each decoder has a unique address (programmable at the interface module)
- Decoders will automatically shut off if communication is lost
- Wire fault detection automatically shuts down any valve
- Valves can be operated up to 100' radius of the decoder

### ELECTRICAL SPECIFICATIONS

- Input power: 105-130V ac, 50/60 Hz, 0.5 amp maximum, 1 amp idle
- Output power: 24V ac, 1.5 amps maximum total output or (36 VA) 1.0 amp per station or master valve
- UL, CUL, and FCC approved

### SPECIFYING INFORMATION

Model	Controller Description
TW-DX48-PWM	DX2, up to 48 stations, painted wall mount
TW-DX48-SWM	DX2, up to 48 stations, stainless wall mount
TW-DX48-SPED	DX2, up to 48 stations, stainless steel security pedestal
TW-DX48-UFEN	DX2, up to 48 stations, stainless steel ultimate front entry enclosure
TW-EGI36*	Eagle, up to 36 decoders, steel wall mount
TW-EGI36-SB*	Eagle, up to 36 decoders, stainless steel wall mount
TW-EGI36-SPED*	Eagle, up to 36 decoders, 14 gauge stainless steel security pedestal
EGP-TWI*	Eagle Plus, up to 200 stations, painted wall mount
EGP-TWI-S*	Eagle Plus, up to 200 stations, stainless steel pedestal
EGP-TWI-SPED*	Eagle Plus, up to 200 stations, 14 gauge stainless steel security pedestal
EGP-TWI-PSB*	Eagle Plus, up to 200 stations, 14 gauge stainless steel security pedestal

\*Remove "i" for standalone option

### DIMENSIONS

- TW model: H: 10" W: 13" D: 4.5"
- TW & SB model: H: 17.5" W: 13" D: 4.5"
- TW-SPED model: H: 35" W: 16" D: 14"

### OPTIONAL 2-WIRE DECODERS AND ACCESSORIES

Model	Description
• TW-D-1	Single valve AC decoder
• TW-D-2	Dual valve AC decoder
• TW-D-4	Quad valve AC decoder
• TW-LA-1	Lightning arrestor (every 600 feet)
• TW-SPLICE	1/4-gauge water-tight connectors
• TW-CAB-T4	1/4-gauge (red/black) Polycoated (blue) wire

**RAIN MASTER®**  
CONTROL SYSTEMS

# Twice 2-wire

## CENTRAL CONTROL

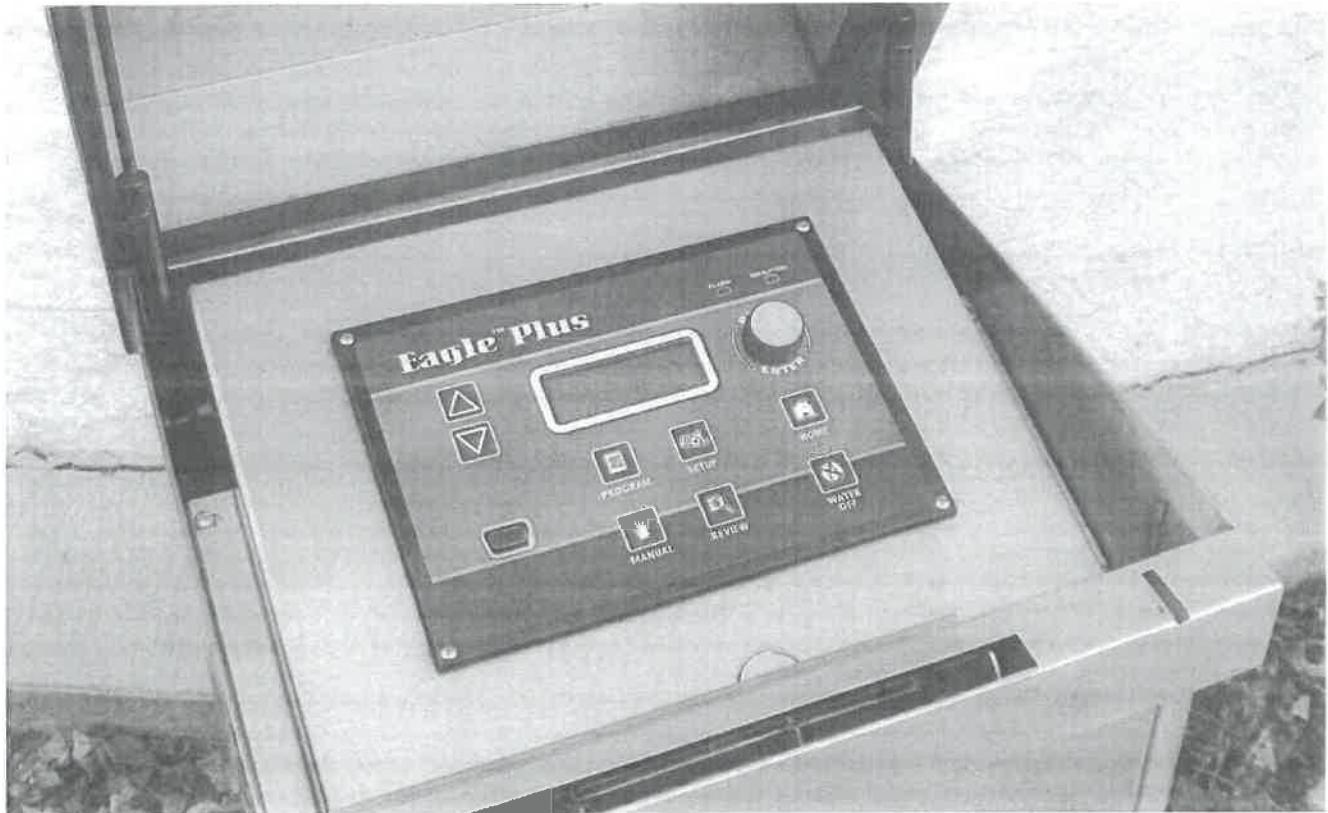

UP TO 200 STATIONS, WITH 100 DECODERS OR LESS

Unlike other two-wire systems, the Rain Master® 2-wire protocol provides a two-way communication link between the controller, decoders and valves. This provides the means for testing and diagnostic capabilities within the 2-wire system. The simplicity of the 2-wire field installation, coupled with the enhanced capability of the Rain Master Twice controllers, sets a new precedent for 2-wire control within the irrigation industry.

## KEY FEATURES & BENEFITS

**EVAPOTRANSPIRATION (ET) BASED SCHEDULING**   
Maximizes water saving and irrigation efficiency

**FLOW SENSING AND CONTROL**   
Monitors system flow and responds to upper, lower, unscheduled and no flow conditions

**2-WIRE INTERFACE MODULE**  
Provides 2-wire capability for any Irritrol Rain Master Eagle controller

**DECODER TWO-WAY COMMUNICATION**  
Provides troubleshooting diagnostics to retain system integrity

**PROGRAMMABLE DECODERS**  
Provides flexibility in programming decoder identification

**DECODER LEDS FOR EASY TROUBLE SHOOTING**  
**AVAILABLE FOR DX2, EAGLE™ & EAGLE™ PLUS SYSTEMS**

# RAIN MASTER<sup>SM</sup>

## CONTROL SYSTEMS

### TWICE LOOP CONFIGURATION

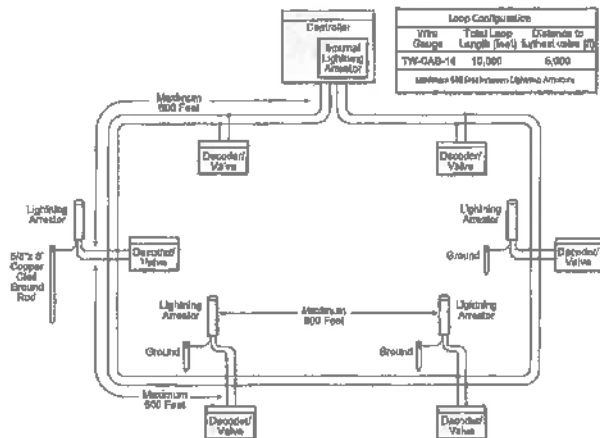

### TWICE STRAIGHT LINE CONFIGURATION

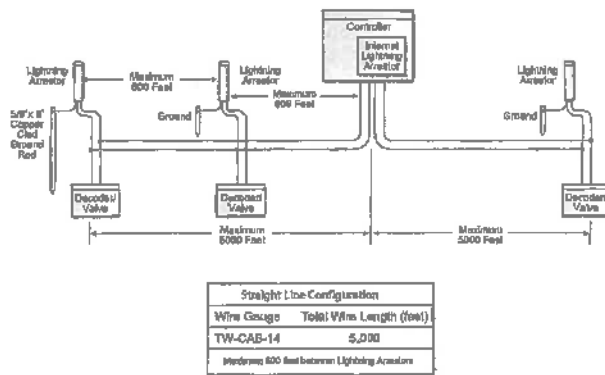

### TWICE WIRE CONNECTION DETAIL

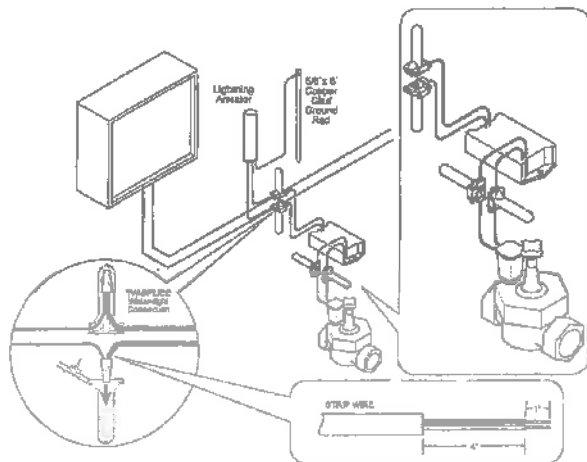

We reserve the right to improve our products and make changes in the specifications and designs without notice and without incurring obligation. Products depicted in this brochure are for demonstration purposes only. Actual products offered for sale may vary in design and features.

### MODULES

- Easy-to-read LED status indication for every command
- LED also displays valve activation and diagnostic reporting
- Troubleshooting capabilities:
  - LED decoder "active" indication
  - LED valve power "on" indication
  - Two-way communication verification

### DECODERS

- Each decoder has a unique address (programmable at the interface module)
- Decoders will automatically shut off if communication is lost
- Wire fault detection automatically shuts down any valve
- Valves can be operated up to 100' radius of the decoder

### ELECTRICAL SPECIFICATIONS

- Input power: 105-130V ac, 50/60 Hz, 0.5 amp maximum, 1 amp idle
- Output power: 24V ac, 1.5 amps maximum total output or (36 VA) 1.0 amp per station or master valve
- UL, CUL, and FCC approved

### SPECIFYING INFORMATION

Model	Controller Description
TW-DX48-PWM	DX2, up to 48 stations, painted wall mount
TW-DX48-SWM	DX2, up to 48 stations, stainless wall mount
TW-DX48-SPED	DX2, up to 48 stations, stainless steel security pedestal
TW-DX48-UFEN	DX2, up to 48 stations, stainless steel ultimate front entry enclosure
TW-EGI36*	Eagle, up to 36 decoders, steel wall mount
TW-EGI36-SB*	Eagle, up to 36 decoders, stainless steel wall mount
TW-EGI36-SPED*	Eagle, up to 36 decoders, 14 gauge stainless steel security pedestal
EGP-TWI*	Eagle Plus, up to 200 stations, painted wall mount
EGP-TWI-S*	Eagle Plus, up to 200 stations, stainless steel pedestal
EGP-TWI-SPED*	Eagle Plus, up to 200 stations, 14 gauge stainless steel security pedestal
EGP-TWI-PSB*	Eagle Plus, up to 200 stations, 14 gauge stainless steel security pedestal

\*Remove "I" for standalone option

### DIMENSIONS

- TW model: H: 10" W: 13" D: 4.5"
- TW & SB model: H: 17.5" W: 13" D: 4.5"
- TW-SPED model: H: 35" W: 16" D: 14"

### OPTIONAL 2-WIRE DECODERS AND ACCESSORIES

Model	Description
• TW-D-1	Single valve AC decoder
• TW-D-2	Dual valve AC decoder
• TW-D-4	Quad valve AC decoder
• TW-LA-1	Lighting arrestor (every 600 feet)
• TW-SPLICE	1/4-gauge water-tight connectors
• TW-CAB-14	14-gauge (red/black) Polycoated (blue) wire

P.O. Box 368

Union, NJ 07083-0368, 908-687-7810, 800-327-2443, Fax: 908-687-8860



spec P7345D - Rev 3

## GROUNDING, BONDING AND SHIELDING PRODUCTS



### COPPER GROUND PLATES

- Made to National Electrical Code® requirements
- 4" x 96" x 0.064" Solid Copper with 25 feet of 6AWG bare copper wire welded to the plate. Paige part number 182199L
- 4" x 36" x 0.064" Solid Copper with 10 feet of 10AWG bare copper wire welded to the plate. Paige part number 182201

### COPPER-CLAD GROUND RODS

- UL® listed
- 5/8" Diameter x 8' Long. Paige part number 182000
- 5/8" Diameter x 10' Long. Paige part number 182007

### GROUND ROD CLAMPS, CAST BRONZE

- UL® listed
- For 5/8" Diameter ground rods. Paige part number 182005

### BARE COPPER WIRE

- Soft-Annealed, uncoated copper, 14AWG - 2AWG.
- 250, 500, and 1,000 foot spools. Custom lengths possible.
- Solid or stranded.
- Paige part numbers:

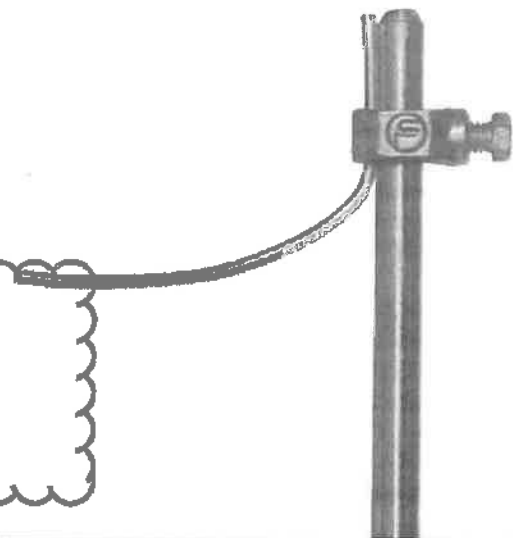

	Wire Size (AWG)									
	18	16	14	12	10	8	6	4	2	1/0
Solid	160120	160137	160248	160364	160465	160629	160635	160678	160738	-
Stranded	-	-	-	160365	160466	160630	160636	160679	160739	160074

## CADWELD PLUS "ONE-SHOT"

- Permanently welds multiple bare copper wires together or bare copper wire to 5/8" diameter ground rods, so the connection doesn't loosen or corrode
- UL® listed. Exothermic reaction welding process meets National Electrical Code® requirements



PLUSCU



PG11L

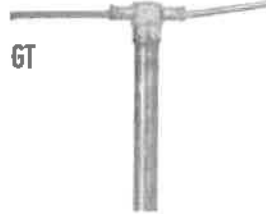

GT



NT



GR



NX

CADWELD CONNECTIONS			
Wire Sizes (AWG)	No. of Connections	Cadweld Part No.	Paige Part No.
6 & 8	1	GR1161GPLUS	1820037P
6 & 8	2	GT1161GPLUS	1820039P
6 & 8	3	NT1161GPLUS	1820038P
6 & 8	4	NX1161GPLUS	1820060P
4	1	GR1161LPLUS	1820043P
4	2	GT1161LPLUS	1820053P
4	3	NT1161LPLUS	1820054P
4	4	NX1161LPLUS	1820061P
6 & 8	4	PG11LPLUS	1820074P
PLUSCU Battery Control Unit			1820040CU

## GROUND ENHANCEMENT MATERIALS/EARTH CONTACT BACKFILLS

- Superior conductive material that improves the effectiveness of ground rods/plates.
- It permanently reduces resistance-to-ground, regardless of soil conditions.
- Ideal for use in dry conditions, rocky ground and sandy soils.
- 50 pound bags
- PowerSet™ hardens when wetted and can be used in any application. Paige part number 1820058.
- PowerFill™ is non-hardening and must be used in non-porous soils. Paige part number 1820059.



SAND BACKFILL

## Sand

- Washed Plaster
- Washed Masonry
- Washed Concrete
- Dry Plaster
- Fill Dirt
- Fill Sand
- Playground Sand



- SE 30 Sand
- B20 Sand
- Gas Sand
- SDG&E Sand
- White Sand
- Screened Fill Sand

## Rock

- Birdseye
- 5/16" Chip
- Pea Gravel
- #4 Gravel
- 3/8" Crushed
- 1/2" Crushed
- 3/4" Crushed
- #3 Gravel
- 1" Crushed
- #67 Rock
- 1-1/2" Crushed
- #2 Gravel
- Salt & Pepper Gravel
- 3" Minus
- 6" Minus
- Rip Rap
- (All Facing Classes)

## Base & Permeable

- 3/4" Class 2 Base
- 3/4" Class 1 Base
- CAB
- CMB
- (Crushed Misc Base)
- Recycled Base
- Class 2 Permeable
- FAA Base
- Cold Mix
- Hot Asphalt

## Concrete Mixes

- Premix
- 3/8" Concrete Mix
- 1/2" Concrete Mix
- 3/4" Concrete Mix

## Landscape Materials

- 3/4" Gold
- White Rock
- Pink Rock
- Red Lava
- Arizona River Rock
- Top Soil
- Compost
- Soil Mix
- Planter Mix
- Top Soil Mix
- Sports Mix
- Screened D.G.
- (Decomposed Granite)
- Stabilized D.G.
- (Decomposed Granite)
- 50/50 Sand & Fine Seedcover
- Path Mix
- Recreation Sand
- Decorative Cobble

## Erosion Control

- Sand Bags
- (Bulk or Palletized)
- Entrance Rock
- Straw Waddle
- Silt Fence



**WEST COAST**  
SAND & GRAVEL INC  
www.wcsg.com

Los Angeles | Ventura | Orange | Inland Empire

**800.522.0282** Fax: 714.562.2758

San Diego County

**800.266.2837** Fax: 619.561.3916

Palm Springs | Indio | Phoenix

**866.923.4772** Fax: 760.399.5939

Central California | Northern California

**800.734.3053** Fax: 916.386.8179

Golf & Turfgrass Sales

**800.734.3053 | 866.923.4772**

Hazardous Materials Hauling

**714.743.1134**

**Get a Quote!**

## Sports Turf Materials

- USGA Spec Sand
- USGA Bridging Gravel
- Bunker Sand
- Augusta White
- Desert Tan
- P.S. 50/50
- P.S. 75-25
- Top Dressing
- Divot Greens
- SoCal Distributor - Dakota Peat Moss
- Custom Blending (Any & All)
- Hilltopper Mound Mix
- MSU Infield Mix
- Track Fines

## Hazardous Hauling

- Export Materials

## Hourly Trucking

Serving all of California & Arizona with Quality Sand & Gravel Since 1968



Swing Joint w  
Sprayhead

**LASCO**  
Fittings, Inc.

# SUBMITTAL SHEET

**NIPPLES SCHEDULE 80 PVC & CPVC**

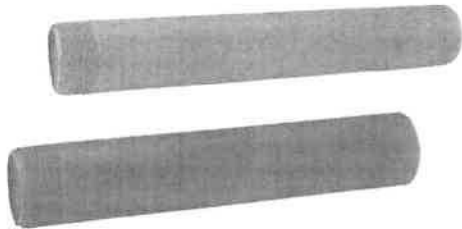

LASCO Fittings, Inc., an Aalberts Industries company, specializes in the production and sale of injection molded fittings for Irrigation, Plumbing, Industrial, Pool/Spa and Retail markets. LASCO Fittings, Inc. operates a 26-acre manufacturing facility in Brownsville, TN. With eight Regional Distribution Facilities strategically located within the United States, LASCO provides worldwide distribution and overnight service.

## Injection Molded PVC Nipples in sizes 1/2" through 4"

LASCO Fittings, Inc.'s line of PVC injection molded and machine threaded PVC Nipples offers a variety of configurations in sizes 1/4" through 4" in diameter and lengths ranging from 1 3/8" through 36".

### STANDARDS AND SPECIFICATIONS – PVC & CPVC Nipples

ASTM D-2464 – Threaded Poly (Vinyl Chloride) (PVC) Plastic Pipe Fittings, Schedule 80.

ASTM F-437 – Threaded Chlorinated Poly (Vinyl Chloride) (CPVC) Plastic Pipe Fittings.

ASTM D-1784 – Rigid Poly (Vinyl Chloride) (PVC) Compounds and Chlorinated Poly (Vinyl Chloride) (CPVC) Compounds.

ASTM D-1785 – Poly (Vinyl Chloride) (PVC) Plastic Pipe, Schedules 40, 80, and 120.

MATERIAL – LASCO Schedule 80 Fittings are produced from PVC Type 1, Grade 1, Cell Classification 12454-B. LASCO CPVC Fittings are produced from Type IV, Grade 1, Cell Classification 23447-B.

DO NOT USE LASCO FITTINGS FOR COMPRESSED AIR OR GASES.  
DO NOT TEST PVC PIPING SYSTEMS WITH COMPRESSED AIR OR GASES.  
DO NOT USE FITTINGS WITH LIQUIDS NOT RECOMMENDED BY LASCO.  
MODIFICATIONS OF FITTINGS VOID THE WARRANTY.



### Limited Warranty

LASCO Fittings, Inc. products are warranted to be free from manufacturing defects in materials and workmanship. They are warranted against rot, rust, and electrolytic corrosion for a period of three years from date of installation. If LASCO products prove defective due to manufacturing defects in material or workmanship during that period, the manufacturer will provide new replacement units of the same type and size. No remedy will be granted under this warranty if LASCO products are not used strictly in accordance with LASCO's directions with respect to use and storage or if the products have been modified in any way. THE MANUFACTURER'S LIABILITY UNDER EXPRESSED OR IMPLIED WARRANTY OR FOR ANY REASON IS LIMITED TO FURNISHING REPLACEMENT UNITS OR GRANTING A CREDIT FOR DEFECTIVE UNITS. NO LABOR EXPENSE OR CONSEQUENTIAL DAMAGES WILL BE PAID BY LASCO. THIS WARRANTY IS IN LIEU OF ALL OTHER GUARANTEES AND WARRANTIES, EXPRESSED OR IMPLIED, INCLUDING BUT NOT LIMITED TO, WARRANTIES OF MERCHANTABILITY AND FITNESS FOR PURPOSE, EXCEPT FOR ANY WARRANTIES IMPLIED BY LAW FOR NONCOMMERCIAL CONSUMERS. ANY SUCH WARRANTIES ARE LIMITED TO THE DURATION OF THIS WRITTEN WARRANTY.

414 Morgan Street • Brownsville, TN 38012  
(731) 772-3100 | [www.lascofittings.com](http://www.lascofittings.com)

*This specification is provided for reference only. LASCO Fittings, Inc. reserves the right to change any portion of this specification without notice and without incurring obligation to make such changes to LASCO products previously or subsequently sold. Please visit our website [www.lascofittings.com](http://www.lascofittings.com) for the most current information.*



**LASCO®**  
Fittings, Inc.

# SUBMITTAL SHEET

**SCHEDULE 40 PVC**



LASCO Fittings, Inc., an Aalberts Industries company, specializes in the production and sale of injection molded fittings for Irrigation, Plumbing, Industrial, Pool/Spa and Retail markets. LASCO Fittings, Inc. operates a 26-acre manufacturing facility in Brownsville, TN. With eight Regional Distribution Facilities strategically located within the United States, LASCO provides worldwide distribution and overnight service.

## Injection Molded PVC Pipe Fittings in sizes 3/8" through 12"

LASCO Fittings, Inc.'s comprehensive line of PVC fittings offers a variety of injection molded configurations in Schedule 40 sizes 3/8" through 12" conforming to ASTM D 2466.

### STANDARDS AND SPECIFICATIONS – Schedule 40

ASTM D-1784 – Rigid Poly (Vinyl Chloride) (PVC) Compounds and Chlorinated Poly Vinyl Chloride (CPVC) Compounds.

ASTM D-2466 – Socket Type Poly (Vinyl Chloride) (PVC) Plastic Pipe Fittings, Schedule 40.

ASTM F-1970 – Standard Specification for Special Engineered Fittings, Appurtenances or Valves for use in Poly (Vinyl Chloride) (PVC) or Chlorinated Poly (Vinyl Chloride) (CPVC) Systems.

**MATERIAL –** LASCO Schedule 40 Fittings are produced from PVC Type 1, Cell Classification 12454-B.

– O-rings are produced from a Buna-N (Nitrile) material.

**LISTINGS –** NSF/ANSI Standard 61, Annex G: Drinking Water System Components Weighted average lead content of  $\leq 0.25\%$  and is in compliance with California's Health & Safety Code Section 116875 (commonly known as AB1953) NSF/ANSI Standard 14: Plastics Piping system Components and Related Materials. Includes /ANSI Standard 61, Annex G

DO NOT USE LASCO FITTINGS FOR COMPRESSED AIR OR GASES.

DO NOT TEST PVC PIPING SYSTEMS WITH COMPRESSED AIR OR GASES.

DO NOT USE FITTINGS WITH LIQUIDS NOT RECOMMENDED BY LASCO.

MODIFICATIONS OF FITTINGS VOIDS THE WARRANTY.



### Limited Warranty

LASCO Fittings, Inc. products are warranted to be free from manufacturing defects in materials and workmanship. They are warranted against rot, rust, and electrolytic corrosion for a period of three years from date of installation. If LASCO products prove defective due to manufacturing defects in material or workmanship during that period, the manufacturer will provide new replacement units of the same type and size. No remedy will be granted under this warranty if LASCO products are not used strictly in accordance with LASCO's directions with respect to use and storage or if the products have been modified in any way. THE MANUFACTURER'S LIABILITY UNDER EXPRESSED OR IMPLIED WARRANTY OR FOR ANY REASON IS LIMITED TO FURNISHING REPLACEMENT UNITS OR GRANTING A CREDIT FOR DEFECTIVE UNITS. NO LABOR EXPENSE OR CONSEQUENTIAL DAMAGES WILL BE PAID BY LASCO. THIS WARRANTY IS IN LIEU OF ALL OTHER GUARANTEES AND WARRANTIES, EXPRESSED OR IMPLIED, INCLUDING BUT NOT LIMITED TO, WARRANTIES OF MERCHANTABILITY AND FITNESS FOR PURPOSE, EXCEPT FOR ANY WARRANTIES IMPLIED BY LAW FOR NONCOMMERCIAL CONSUMERS. ANY SUCH WARRANTIES ARE LIMITED TO THE DURATION OF THIS WRITTEN WARRANTY.

414 Morgan Street - Brownsville, TN 38012  
(731) 772-3180 | [www.lascofittings.com](http://www.lascofittings.com)

*This specification is provided for reference only. LASCO Fittings, Inc. reserves the right to change any portion of this specification without notice and without incurring obligation to make such changes to LASCO products previously or subsequently sold. Please visit our website [www.lascofittings.com](http://www.lascofittings.com) for the most current information.*



## LOW VOLUME TUBING

### DISTRIBUTION TUBING

Model	Description	Quantity
<b>POLYETHYLENE MICRO TUBING</b>		
SLV-PE-125-063-3500	0.125" x 0.063"	3,500' coil
SLV-PE-128-076-3500	0.128" x 0.076"	3,500' coil
SLV-PE-176-105-2000	0.176" x 0.105"	2,000' coil
SLV-PE-187-125-100	0.187" x 0.125"	100' coil
SLV-PE-187-125-1000	0.187" x 0.125"	1,000' coil
SLV-PE-188-128-3000	0.188" x 0.128"	3,000' coil
SLV-PE-220-160-100	0.220" x 0.160"	100' coil
SLV-PE-220-160-1000	0.220" x 0.160"	1,000' coil
SLV-PE-220-160-2500	0.220" x 0.160"	2,500' coil
SLV-PE-225-155-2500	0.225" x 0.155"	2,500' coil
SLV-PE-250-125-2000	0.250" x 0.125"	2,000' coil
SLV-PE-250-170-100	0.250" x 0.170"	100' coil
SLV-PE-250-170-1000	0.250" x 0.170"	1,000' coil
SLV-PE-250-170-2000	0.250" x 0.170"	2,000' coil
SLV-PE-272-188-1500	0.272" x 0.188"	1,500' coil
SLV-PE-275-210-1500	0.275" x 0.210"	1,500' coil
SLV-PE-307-250-1000	0.307" x 0.250"	1,000' coil
SLV-PE-350-250-500	0.350" x 0.250"	500' coil
SLV-PE-350-250-1000	0.350" x 0.250"	1,000' coil
SLV-PE-375-250-750	0.375" x 0.250"	750' coil
SLV-PE-455-375-1000	0.455" x 0.375"	1,000' coil
SLV-PE-455-375-CL24	0.455" x 0.375" x 24"	24' cut

#### VINYL MICRO TUBING

SLV-PVC-187-125-100	0.187" x 0.125"	100' coil
SLV-PVC-187-125-2000	0.187" x 0.125"	2,000' coil
SLV-PVC-220-160-100	0.220" x 0.160"	100' coil
SLV-PVC-220-160-1000	0.220" x 0.160"	1,000' coil
SLV-PVC-220-160-2500	0.220" x 0.160"	2,500' coil
SLV-PVC-250-170-100	0.250" x 0.170"	100' coil
SLV-PVC-250-170-1000	0.250" x 0.170"	1,000' coil
SLV-PVC-250-170-2000	0.250" x 0.170"	2,000' coil

### SUPPLY TUBING

Model	Description	Quantity
<b>SUPRA FLEX™ POLY SUPPLY TUBING</b>		
SLV-PE-620-520-100	.620" x .520"	100' coil
SLV-PE-620-520-500	.620" x .520"	500' coil
SLV-PE-620-520-1000	.620" x .520"	1,000' coil
SLV-PE-700-600-100	.700" x .600"	100' coil
SLV-PE-700-600-500	.700" x .600"	500' coil
SLV-PE-700-600-1000	.700" x .600"	1,000' coil
SLV-PE-700-600-CL24	.700" x .600"	24' cut length
SLV-PE-710-620-100	.710" x .620"	100' coil
SLV-PE-710-620-500	.710" x .620"	500' coil
SLV-PE-710-620-1000	.710" x .620"	1,000' coil
SLV-PE-840-820-100	.840" x .820"	100' coil
SLV-PE-840-820-500	.840" x .820"	500' coil
SLV-PE-840-820-1000	.840" x .820"	1,000' coil
SLV-PE-1174-1050-250	1.174" x 1.050"	250' coil
SLV-PE-1200-1060-250	1.200" x 1.060"	250' coil

#### A/R FLEX PVC TUBING - FOR USE WITH RECYCLED/RECLAIMED WATER

SLV-PVC-AR-050-500	1/2" Irrigation Size Hose (3/4" IPS)	500' Coil
SLV-PVC-AR-IPS-050-200	1/2" IPS	200' Coil
SLV-PVC-AR-IPS-075-200	3/4" IPS	200' Coil
SLV-PVC-AR-IPS-100-100	1" IPS	100' Coil

www.salcodrip.com

More Sizes Available Upon Request

### FLEXIBLE IPS HOSE

Model	Description	Quantity
<b>FLEXIBLE IPS HOSE</b>		
SLV-PVC-IPS-050-100	1/2" IPS	100' coil
SLV-PVC-IPS-050-200	1/2" IPS	200' coil
SLV-PVC-IPS-075-100	3/4" IPS	100' coil
SLV-PVC-IPS-075-200	3/4" IPS	200' coil
SLV-PVC-IPS-100-100	1" IPS	100' coil



Model	Description	Quantity
<b>NON-ALGAECIDE FLEXIBLE IPS HOSE</b>		
SLV-PVC-NA-IPS-050-CL24	1/2" IPS	24" cut length
SLV-PVC-NA-IPS-050-CL30	1/2" IPS	30" cut length
SLV-PVC-NA-IPS-050-CL36	1/2" IPS	36" cut length
SLV-PVC-NA-IPS-050-CL48	1/2" IPS	48" cut length
SLV-PVC-NA-IPS-050-CL60	1/2" IPS	60" cut length
SLV-PVC-NA-IPS-075-CL24	3/4" IPS	24" cut length
SLV-PVC-NA-IPS-075-CL30	3/4" IPS	30" cut length
SLV-PVC-NA-IPS-075-CL36	3/4" IPS	36" cut length
SLV-PVC-NA-IPS-075-CL42	3/4" IPS	42" cut length
SLV-PVC-NA-IPS-075-CL48	3/4" IPS	48" cut length
SLV-PVC-NA-IPS-075-CL60	3/4" IPS	60" cut length
SLV-PVC-NA-IPS-100-CL36	1" IPS	36" cut length
SLV-PVC-NA-IPS-100-CL60	1" IPS	60" cut length

Drain Rock

## Sand

- Washed Plaster
- Washed Masonry
- Washed Concrete
- Dry Plaster
- Fill Dirt
- Fill Sand
- Playground Sand
- SE 30 Sand
- B20 Sand
- Gas Sand
- SDG&E Sand
- White Sand
- Screened Fill Sand

## Rock

- Birdseye
- 5/16" Chip
- Pea Gravel
- #4 Gravel
- 3/8" Crushed
- 1/2" Crushed
- 3/4" Crushed
- #3 Gravel
- 1" Crushed
- #67 Rock
- 1-1/2" Crushed
- #2 Gravel
- Salt & Pepper Gravel
- 3" Minus
- 6" Minus
- Rip Rap
- (All Facing Classes)

## Base & Permeable

- 3/4" Class 2 Base
- 3/4" Class 1 Base
- CAB
- CMB
- (Crushed Misc Base)
- Recycled Base
- Class 2 Permeable
- FAA Base
- Cold Mix
- Hot Asphalt

## Concrete Mixes

- Premix
- 3/8" Concrete Mix
- 1/2" Concrete Mix
- 3/4" Concrete Mix

## Landscape Materials

- 3/4" Gold
- White Rock
- Pink Rock
- Red Lava
- Arizona River Rock
- Top Soil
- Compost
- Soil Mix
- Planter Mix
- Top Soil Mix
- Sports Mix
- Screened D.G.
- (Decomposed Granite)
- Stabilized D.G.
- (Decomposed Granite)
- 50/50 Sand & Fine Seedcover
- Path Mix
- Recreation Sand
- Decorative Cobble

## Erosion Control

- Sand Bags
- (Bulk or Palletized)
- Entrance Rock
- Straw Waddle
- Silt Fence



**WEST COAST**  
SAND & GRAVEL INC  
www.wcsg.com

Los Angeles | Ventura | Orange | Inland Empire

**800.522.0282** Fax: 714.562.2758

San Diego County

**800.266.2837** Fax: 619.561.3916

Palm Springs | Indio | Phoenix

**866.923.4772** Fax: 760.399.5939

Central California | Northern California

**800.734.3053** Fax: 916.386.8179

Golf & Turfgrass Sales

**800.734.3053 | 866.923.4772**

Hazardous Materials Hauling

**714.743.1134**

**Get a Quote!**

## Sports Turf Materials

- USGA Spec Sand
- USGA Bridging Gravel
- Bunker Sand
- Augusta White
- Desert Tan
- P.S. 50/50
- P.S. 75-25
- Top Dressing
- Divot Greens
- SoCal Distributor - Dakota Peat Moss
- Custom Blending (Any & All)
- Hilltopper Mound Mix
- MSU Infield Mix
- Track Fines

## Hazardous Hauling

- Export Materials

## Hourly Trucking

Serving all of California & Arizona with Quality Sand & Gravel Since 1968

ID TAGS



# IRRIGATION ID TAGS STANDARD YELLOW



## PRODUCT SPECIFICATIONS

**PRODUCT TYPE:** Valve Identification Tag

**DESCRIPTION:** *Christy's*™ Standard ID Tags are ideal for high-visibility point-of-use identification. The top hole has been designed to pass a 16 gauge or smaller solenoid "pigtail" wire, or it can be attached to hose bibbs, valves, or handles with a nylon tie, or to the lid of a valve box with a bolt (not included). The hole can also be drill enlarged. The outlet reinforcement on our marking tags has 180LB. pull out resistance. This provides for an easily installed, virtually vandal-proof, custom identification product.

Through the use of custom designed plates, we can accommodate almost any request. A sampling of our current special legends and logos is listed on the following pages. Additionally, our marking tags are available in a variety of colors, to conform to both locally developed standards, as well as APWA and AWWA national standards. With our standard Alpha-Numeric numbering, the valve or marking designation can be seen from a distance of up to 50 feet.

Our standard yellow tags, (Irrigation Industry Standard) can accommodate up to three 1-1/8" alpha-numeric characters per side. We commonly provide standard sequences ranging from A1 . . . A36 through Z1 . . . Z36. In addition, we can accommodate practically any special alpha-numeric numbering requirement. This allows for logical and consistent zone, controller, valve or area sequence identification.

For Example:(A1A, A1B, A1C . . . A1Z) (AAA, AAB, AAC . . . AAZ) (C26,C27 . . . C99) (125,126,127...)

### SPECIFICATIONS:

**Short Form:** *Christy's*™ Standard size Identification Tags are to be provided as designated in the plans, conforming to the noted size, color and legend specifications listed.

**Standard Specification:** Identification Tags provided, will be manufactured from polyurethane Behr Desopan, incorporating an integral attachment neck and reinforced attachment hole and will be capable of withstanding 180LBS. pull out resistance.

The Identification tag shall be approximately 2.25" X 2.75" (*Christy's*™ Standard Tag ) in size. All lettering shall be hot-stamped in black and capable of withstanding outdoor usage. The standard alpha-numeric designations shall incorporate alpha-numeric lettering 1-1/8" in height. Special lettering, designations or stampings will be the maximum size available based on the manufacturers judgement and will be hot-stamped as well

The tag color will be \_\_\_\_\_ (Yellow, Purple, Blue, Green, Red or White).

The marking tag will be \_\_\_\_\_ (Single or Double) side stamped with the following designation, message or identification sequence \_\_\_\_\_ (see styles on following pages or design template below) or *Christy's*™ style # \_\_\_\_\_. The marking tag shall be manufactured by T. Christy Enterprises, Inc., Anaheim, CA. (800-258-4583).

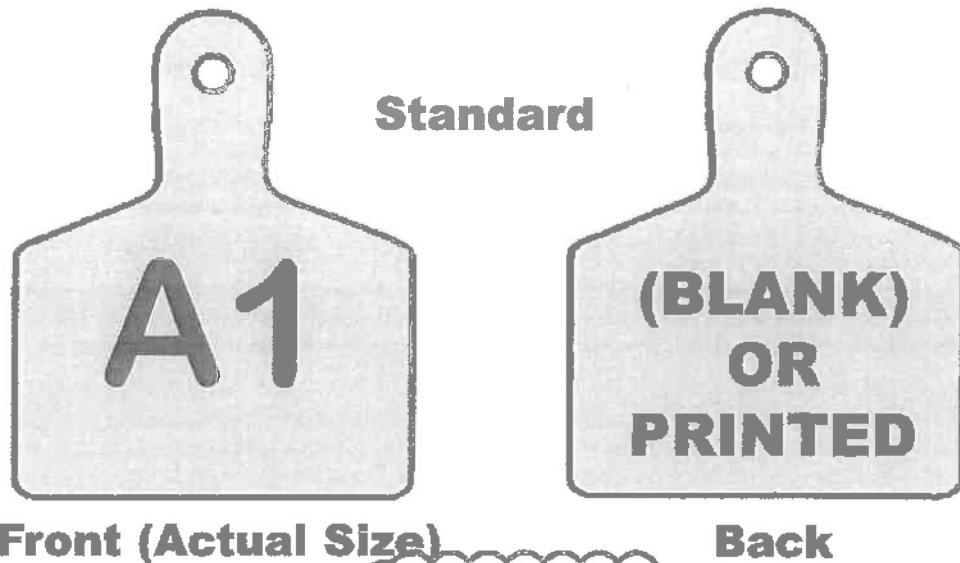

ID-STD-XX

**COLOR**  
 B - BLUE    G - GREEN  
 P - PURPLE   R - RED  
 Y - YELLOW   W - WHITE

**STAMPING**  
 1 - Single Sided  
 2 - Double Sided

**Our yellow tag (ID-STD-Y1) is a standard in the irrigation industry for valve sequence identification.**

### DESIGN TEMPLATE

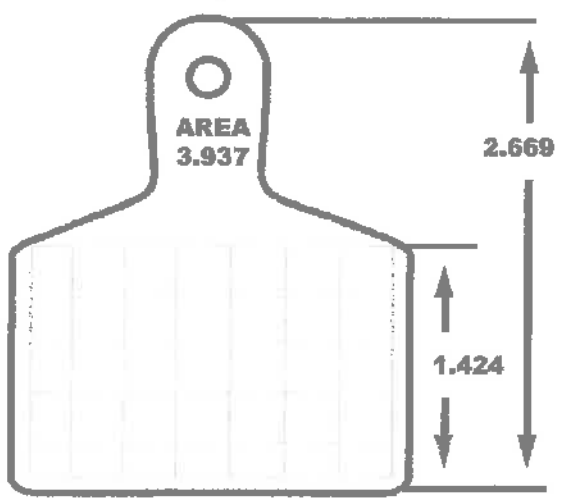

Our standard size tag will accommodate up to three characters per side for valve identification purposes.

**STANDARD**

**IRRIGATION ID TAGS  
RECYCLED/RECLAIMED**

**Christy's™**

**PRODUCT  
SPECIFICATIONS**



**PRODUCT TYPE:** Valve Identification Tag - Recycled/Reclaimed Maxi

**DESCRIPTION:** *Christy's™* Maxi size Recycled/Reclaimed ID Tags are ideal for high-visibility point-of-use identification. The top hole has been designed to pass a 16 gauge or smaller solenoid "pigtail" wire, or it can be attached to hose bibbs, valves, or handles with a nylon tie, or to the lid of a valve box with a bolt (not included). The hole can also be drill enlarged. The outlet reinforcement on our marking tags has 180LB. pull out resistance. This provides for an easily installed, virtually vandal-proof, custom identification product.

Through the use of custom designed plates, we can accommodate almost any request. Our purple Maxi size tags are industry standard for marking systems using Recycled/Reclaimed water. Style number RC005 is in English and style number RC006 is bilingual.

Our Maxi size tag can accommodate up to four characters per side. We commonly provide standard sequences ranging from A1 . . . A36 through Z1 . . . Z36. In addition, we can accommodate practically any special alpha-numeric numbering requirement. This allows for logical and consistent zone, controller, valve or area sequence identification.

For Example:(A1A, A1B, A1C . . .A1Z) (AAA, AAB, AAC . . .AAZ) (C26,C27. . .C99) (125,126,127....)

**SPECIFICATIONS:**

**Short Form:** *Christy's™* Maxi size, Recycled/Reclaimed Identification Tags are to be provided as designated in the plans, conforming to the noted size, color and legend specifications listed.

**Standard Specification:** Identification Tags provided, will be manufactured from polyurethane Behr Desopan, incorporating an integral attachment neck and reinforced attachment hole and will be capable of withstanding 180LBS. pull out resistance.

The identification tag shall be approximately 3" x 4" (*Christy's™* Maxi Tag ) in size. All lettering shall be hot-stamped in black and capable of withstanding outdoor usage. The standard alpha-numeric designations shall incorporate alpha-numeric lettering 1-1/8" in height. Special lettering, designations or stampings will be the maximum size available based on the manufacturers judgement and will be hot-stamped as well

The tag color will be Purple.

The marking tag will be \_\_\_\_\_ (Single or Double) side stamped with the following designation or message (see styles on following pages or design template below) or *Christy's™* style #: 005, 006, 009 or 011. The marking tag shall be manufactured by T. Christy Enterprises, Inc., Anaheim, CA. (800-258-4583)

# Specifying A Stock Legend Maxi Tag

**ID-MAX-PX-RC XXX**

**NOTE:** Please make a selection from each category for the requested tag.

## STAMPING

- 1 - SINGLE SIDED
- 2 - DOUBLE SIDED

## SUFFIX #

Suffix # indicates exact wording on both front and back of MAXI tag. See page 10 for a list of 3 digit suffix numbers that are available.

**EX: ID-MAX-P2-RC006**

## MAXI

This is our most common tag for identifying Recycled/Reclaimed water systems.



**Front**



**Back**

## DESIGN TEMPLATE

Maxi size can accommodate up to four 1-1/4" characters per side.

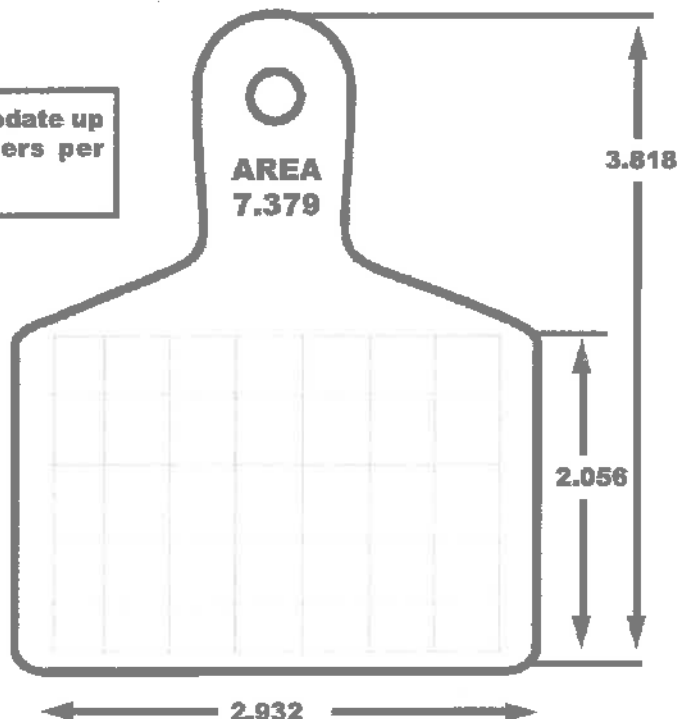

**MAXI**



# STOCK MAXI TAGS



**NOTE: Must Specify Alpha-Numeric Sequence**



# **CONTROLLER MANUAL**

# **RAIN MASTER™ EAGLE PLUS**

## **User's Guide**

- **Installation**
- **Setup**
- **Programming**
- **Operation**
- **Troubleshooting**



**Irritrol®**

## **Introduction**

Thank you for choosing the Irritrol Rain Master Eagle Plus controller for your landscape irrigation system. We at Irritrol take great pride in developing and building the finest irrigation products in the world, and are confident that your new Rain Master Eagle Plus will provide the control features, resource management tools, ease of use and robust design for years of dependable service.

## **Programming Features**

- Station Run Time from 1 minute to 23 hours and 59 minutes, in 1-minute increments.
- Station delay setting from 1 minute to 19 minutes and 59 seconds.
- Cycle run time, Maximum Cycle time, and Soak time on a per-station basis
- Pump activation independent of the master valve on a per-program basis
- Program stacking or single program operation
- Watering day routine options on a per-program basis include:  
14-Day , Skip Days and Odd/Even-numbered days.
- Definable watering window from 1 minute to 24 hours.
- Cycle-and-Soak or standard run time programming on a per-program basis.
- Copy functions for program-to-program and station run time.
- Programmable Master Valve and a Pump output control capabilities:

## **Automatic Watering Operations**

- Evapotranspiration (ET) based scheduling.
- Percentage adjustment on a per-program basis to allow an increase or decrease of all station runtimes within that program from 0 – 300% in 1% increments.
- Calculated station run time executed to the nearest second.
- Programmable Water Off to postpone irrigation from 1 to 9 days.
- Automatic minimization of the water window by dynamically scheduling station starts when other stations are in the Soak mode.

## **Evapotranspiration (ET) Features**

- ET processing on a per program basis.
- Multiple ET sources as the basis for its ET calculations:
  - Historical ET data
  - Manually entered ET data
  - Weather Center II weather station
  - Internet (with iCentral communication enabled).

### **Control Module Features**

- Non-volatile memory retains all controller setup and programming information during power outages or seasonal shutdowns.
- A real-time clock with non-volatile backup to maintain the current date and time during power outages without the need of batteries.
- Automatically monitors all critical operating voltages and resets microprocessor during power “brown-out” or error conditions.
- Automatic electronic fuse resets automatically - eliminates fuses or circuit breakers.
- Automatic resumption of watering programs after power outage from the point of interruption.
- Automatically detects problems on all output and input circuits.
- Built-in self-test for internal circuitry.
- Robust surge protection on field output circuits.

### **Input Monitoring Features**

- Rain sensor ready—accepts rain sensor or weather station input.
- Connectivity and input for two flow-sensing devices.
- Programmable flow sensor pipe sizes for standard Rain Master flow sensors and non-standard pipe sizes.
- Programmable flow monitoring for:
  - Mainline flow limit
  - Unscheduled flow limit
  - Single-station flow limit
  - Sample delay
  - Measured station flow.

### **Two-Wire Decoder System Control Features**

*(Two-Wire Decoder System Models Only)*

- Two-Wire Decoder board installs in place of standard station output boards
- Fully integrated Two-Wire Decoder capabilities
- Provides control of up to 100 decoders for a total of 202 field outputs
- Auto detection and configuration during power-up
- Decoder programming and monitoring capabilities include:
  - Decoder and station number association
  - Output current
  - Station short/open circuit
  - Decoder presence detection.

**Table of Contents**

- ❖ **Control Module Overview .....2**
- ❖ **Controller Interior Component Overview .....4**
- ❖ **Selecting the Controller Setup Options .....6**
  - ◆ Setting the Current Time and Date .....7
  - ◆ Setting a Security Access Code .....9
  - ◆ Setting the Program Stack Option .....11
  - ◆ Setting the Station Delay Option ..... 12
  - ◆ Setting the Master Valve Option ..... 13
  - ◆ Setting the Regional Options ..... 14
  - ◆ Setting the Odd/Even Day Option ..... 15
  - ◆ Setting the Audible Alert Option ..... 16
  - ◆ Setting the Timed Water-Off Mode .....17
  - ◆ Setting the Water Window Duration ..... 18
- ❖ **Selecting the Program Setup Options ..... 19**
  - ◆ Setting the Program Type Option .....20
  - ◆ Setting the Program Odd/Even Days Option .....21
  - ◆ Setting the Program Master Valve/Pump Control Options ..... 22
  - ◆ Setting the Program Weather Options ..... 23
- ❖ **Selecting the ET Setup Options ..... 24**
- ❖ **Selecting the Flow Sensor Setup and Operation Options ..... 25**
  - ◆ Setting the Usage Option ..... 26
  - ◆ Setting the Standard/Custom Sensor Options ..... 26
  - ◆ Setting the Flow Limits Options .....27
  - ◆ Setting the Delay Option ..... 28
  - ◆ Setting the Learned Flow Options ..... 28
  - ◆ Resetting the Flow Totalizer ..... 29
- ❖ **Setting the Communications Options ..... 30**
- ❖ **Two-Wire Decoder System Setup .....31**
  - ◆ Programming the Decoders .....31
  - ◆ Two-Wire Decoder System Setup .....31
  - ◆ Programming the Decoders .....31
  - ◆ Testing the Two-Wire Decoder System ..... 33
  - ◆ Single Station Test ..... 33
  - ◆ Find Decoders Test ..... 34
  - ◆ All Stations Test ..... 35

❖ <b>Programming for Automatic Operation</b> .....	<b>36</b>
♦ Creating a New Program .....	36
♦ Setting a Two-Week Watering Schedule .....	37
♦ Setting a Skip-Day Watering Schedule .....	37
♦ Setting Program Start Times .....	38
♦ Assigning the Station Run Time .....	38
♦ Setting a Cycle and Soak Station Run Time .....	39
❖ <b>Modifying a Program:</b> .....	<b>41</b>
♦ Adjusting Program Percent Value .....	42
♦ Deleting a Program .....	42
❖ <b>Copying a Program or Runtime</b> .....	<b>43</b>
♦ To Copy a Program .....	43
♦ To Copy a Run Time .....	44
❖ <b>Review Mode</b> .....	<b>45</b>
♦ Program Review .....	45
♦ Alarm Review.....	46
♦ Comm Review .....	46
♦ Flow Review .....	46
♦ Irrigation Review .....	47
♦ ET Review .....	47
❖ <b>Manual Watering Operations</b> .....	<b>48</b>
♦ Manual Station Operation .....	48
♦ Manual Program Operation .....	49
♦ Manual Multi-Station Operation .....	50
♦ Manual Test Functions.....	51
❖ <b>Alarms Feature</b> .....	<b>52</b>
♦ Alarm Categories .....	52
♦ Field Wire Fault Detection .....	52
♦ Flow Detection .....	52
♦ Clearing Alarms .....	53
♦ Analyzing Alarms .....	54
♦ General Alarms .....	54
♦ Flow Sensor Alarms .....	56
♦ Rain Sensor or Weather Station Alarms .....	58
♦ Two-Wire Decoder System Alarms .....	59
❖ <b>Appendix A - General Specifications</b> .....	<b>62</b>
❖ <b>Appendix B - Flow Sensor Specifications</b> .....	<b>63</b>
❖ <b>Appendix C - Error Code Reference Chart</b> .....	<b>64</b>
❖ <b>Appendix D - FCC Rules-Electromagnetic Compatibility</b> .....	<b>65</b>

## Control Module Overview



### 1 - Large LCD Display

The large format LCD display presents all setup, programming, system control and monitoring functions in an interactive menu-driven format.

**Note:** To conserve power, the LCD backlight dims automatically after five minutes of inactivity. The backlight is restored automatically with any controller input.

The Home screen is displayed by default when the controller is in the standby mode to provide basic controller status information.

The top line of the **Home** screen provides the current day (1), current time (2), and week 1 or week 2 of the two-week watering schedule (3). When equipped for iCentral communications, an antenna symbol (4) with signal strength indication bars will be shown.



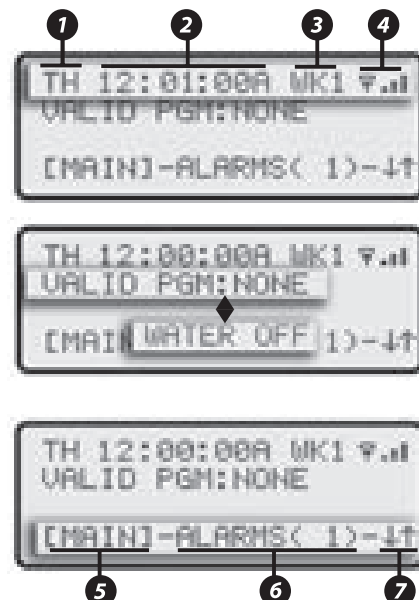

The second line indicates the current number of configured automatic programs: None or 1–8 for standard systems, or 1–16 for Two-Wire systems. When the controller is in the Water Off mode, WATER OFF is displayed.

The bottom line of the **Home** screen provides: Main menu access (5), the pending number of alarms (6), and display sequence arrow(s) (7).





## 2 - Screen Sequence Keys

The **NEXT**  and **BACK**  screen sequence keys are associated with the corresponding  and  arrow symbols when displayed. Pressing a sequence key steps forward or backward through a multiple-screen sequence.

## 3 - Irrigation and Alarm Monitors

The Irrigation LED monitor illuminates to indicate system watering activity. The Alarm LED monitor illuminates when a system Alarm or Alert is generated. The Alarm monitor LED will remain illuminated until cleared by the user. An audible Alert option can be enabled that will “chirp” every six seconds to indicate one or more Alarm and or Alert conditions.

## 4 - Selection Dial

The selection **Dial** is the main user-interface component, providing a single rotary/push-button dial to select and input all controller setup and operating features.

## 5 - Direct Access Menu Keys

Direct access to each primary menu function is provided by pressing the corresponding selection key as follows:

**PROGRAM**  **Key** – Selects the MAIN PROGRAM menu. Provides program-related options including: new program setup, existing program review, program modification, deletion, and copy functions.

**SETUP**  **Key** – Selects the MAIN SETUP menu. Provides access to all setup option menus including: CONTROLLER operating options, FLOW monitor setup, PROGRAM operating options, COMM setup, ET setup, and TWO-WIRE system setup.

**MANUAL**  **Key** – Selects the MANUAL OPERATIONS menu enabling manual control operations including: SINGLE STATION and MULTI-STATION operation, PROGRAM operation and multiple TEST functions.

**REVIEW**  **Key** – Selects the REVIEW menu for quick access to all controller PROGRAM details, historical data logs for IRRIGATION events, ALARM events, FLOW results, ET rates, iCentral communications and controller software version.

**HOME**  **Key** – Returns directly to the HOME menu from any location within the menu hierarchy.

**6 - WATER OFF**  **Key** – Terminates all automatic watering activity. When selected, all current automatic controller operation shuts down and remains off until the WATER OFF mode is released. The Water Off LED monitor illuminates when the controller is in the WATER OFF mode.

**7 - Pro Max Remote Control Receptacle** – Provides easy access for connection and remote operation with the (optional) Pro Max remote control system.

## Controller Interior Component Overview



**1 - Master Valve/Pump/Sensor Module**

This module provides connections for all auxiliary components including: pump (1), master valve (2), field common (3), two flow sensors (3), a Weather Center II (5) or a rain/freeze sensor (6), and a 24 VAC power source.

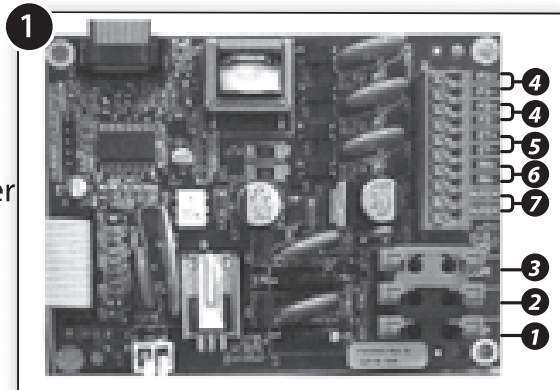

**2 - Station Output Module**

*(standard configuration)*

Each output module provides connections for eight station outputs (1) and two field commons (2). Up to six station output modules can be installed for a total of 48 station outputs.

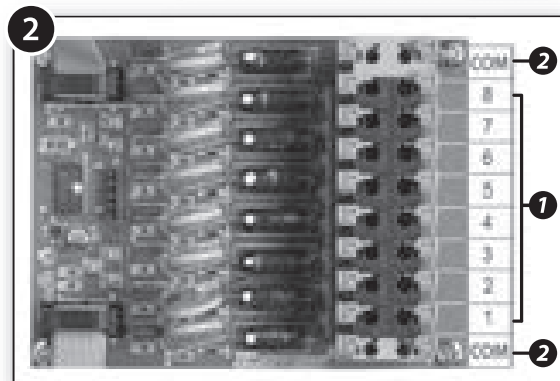

**3 - Main Power Connection**

Terminal block (wall-mount models) or junction box provide connections for Line, Neutral, and Equipment Ground wiring. Pedestal models provide On/Off switch and power outlet.

**4 - Two-Wire Decoder Module (optional)**

A single Two-Wire Decoder module replaces the 8-station output board(s) and connects to the control module via a two-wire, plug-in cable assembly. The Decoder module provides two separate decoder control wire pairs (1) and a quick-disconnect terminal block to facilitate decoder programming (2).

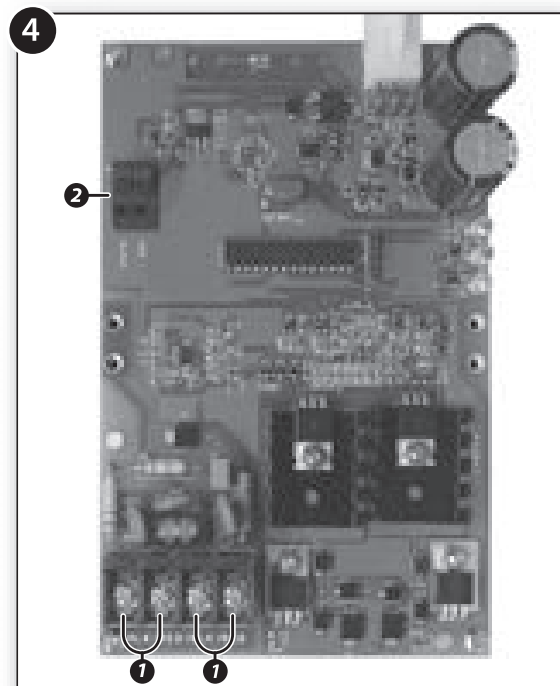

**5 - iCentral with GSM Communications Modem (optional)**

The iCentral modem mounts on the back of the control module to provide wireless communications capability with the iCentral control system.

**6 - iCentral Antenna (optional)**

External antenna (optional) provides unity gain and 200 watt power-handling capacity for long-range communication. (Pedestal antenna location indicated but not shown in illustration.)

## Selecting the Controller Setup Options

The controller setup options determine how the controller displays and manages the various tasks required to control and monitor your irrigation system.

A set of default controller setup and operating options is established on initial power-up. The table below lists the various controller setup menu items, the available options and the factory default settings.

Setup Menu	Option	Default
Current Time	Numeric Value, AM/PM	12:00:00 a.m.
Current Date	Alpha/Numeric	Thursday, 01/ 01/2009
Clock Format	12- or 24-Hour	12-Hour
Access Code	4-Digit Numeric	0000
Program Stacking	Yes or No	Yes
Stacking Limits	1 to 8 Programs	3 Programs
Station Delay	0–19 min, 0–59 sec	0 min, 0 sec
Master Valve Config.	NC or NO	NC (normally closed)
Units Format	U.S. Standard or Metric	U.S. Standard
Date Format	mm/dd/yy or dd/mm/yy	mm/dd/yy
Odd/Even Days Off	Yes or No	No
Rain Days Off	1–9 or None	None
Water Window	0–24 Hours	24 (12:00 a.m.–11:59 p.m.)
Audible Alarm	On or Off	Off

**Note:** Synchronizing the controller with the current date and time should be accomplished first. The remaining settings can be changed at any time. Some of the settings will influence corresponding programming and controller operations. These features are explained in detail within the applicable section of the User’s Guide.

Upon initial power-up and after the controller has been without power for an extended period of time, the SETUP DATE/TIME screen is displayed by default. Enter the actual time and date per the following step-by-step procedure. When you have completed this initial procedure, you will be familiar with the Eagle Plus menu structure and how the multifunctional Dial allows you to easily navigate to select, change, adjust and enter the various controller programming and setup options.

**⚠ IMPORTANT:** All setup and programming selections must be entered (saved to memory) by pressing the Dial *before* pressing any of the Direct Access keys. The controller will disregard any selection that has not been saved.

**Note:** An audible “chirp” tone is generated each time a valid Key or Dial entry is made. An invalid action is indicated by the chirp tone four times in rapid succession.

## Setting the Current Time and Date

**Note:** Menu items displayed between dashes can be selected. Turn the **Dial** in either direction to choose (bracket) the menu item, then press the **Dial** to select.

1. The controller will display the SETUP DATE/TIME screen upon initial power up.
 

```

                SETUP DATE/TIME:
                DATE: [01/01/09] ←
                TIME: -12:00AM-
                FORMAT: -12 HOUR- ↑
            
```
  
2. Press the **SETUP**  key to display the SETUP menu.
 

```

                SETUP:
                [CONTROLLER] ← FLOW-
                -PROGRAM-      -COMM-
                -ET-          -TWO-WIRE- ↑
            
```
  
4. Press the **Dial** to select the CONTROLLER menu. The DATE/TIME option is chosen by default.
 

```

                SETUP CONTROLLER:
                [DATE/TIME] ← ACCESS-
                -STACK-      -DELAY-
                -MVALUE-     -MORE- ↓↑
            
```
  
5. Press the **Dial** to select and display the SETUP DATE/TIME screen. The DATE option is chosen by default.
 

```

                SETUP DATE/TIME:
                DATE: [01/01/09] ←
                TIME: -12:00AM-
                FORMAT: -12 HOUR- ↑
            
```

**Note:** In this procedure example, the date and time will be changed from the default settings to June 15, 2011, 2:45.
  
6. Press the **Dial** – the Month digits (01) will begin flashing.
 

```

                SETUP DATE/TIME:
                DATE: [01/01/09]
                TIME: -12:00AM-
                FORMAT: -12 HOUR- ↑
            
```
  
7. Turn the **Dial** to display the current month (06 = June), then press the **Dial** to enter the change. The Day digits (01) will begin flashing.
 

```

                SETUP DATE/TIME:
                DATE: [06/01/09]
                TIME: -12:00AM-
                FORMAT: -12 HOUR- ↑
            
```
  
8. Turn the **Dial** to display the current day (15), then press the **Dial** to enter the change. The Year digits (09) will begin flashing.
 

```

                SETUP DATE/TIME:
                DATE: [06/15/09]
                TIME: -12:00AM-
                FORMAT: -12 HOUR- ↑
            
```
  
9. Turn the **Dial** to display the current year (11), then press the **Dial** to enter the change.
 

```

                SETUP DATE/TIME:
                DATE: [06/15/11] ←
                TIME: -12:00AM-
                FORMAT: -12 HOUR- ↑
            
```

10. Turn the **Dial** right one step to choose Time, then press the **Dial** to select. The current hour digits will begin flashing.

```
SETUP DATE/TIME:  
DATE: -06/15/11-  
TIME: [12:00AM]  
FORMAT: -12 HOUR- ↑
```

11. Turn the **Dial** to display the current hour (02:), then press the **Dial** to enter the change. The minutes digits will begin flashing.

```
SETUP DATE/TIME:  
DATE: -06/15/11-  
TIME: [02:00AM]  
FORMAT: -12 HOUR- ↑
```

12. Turn the **Dial** to display the current minute (:45), then press the **Dial** to enter the change. The AM designator will begin flashing.

```
SETUP DATE/TIME:  
DATE: -06/15/11-  
TIME: [02:45AM]  
FORMAT: -12 HOUR- ↑
```

13. Turn the **Dial** to display PM, then press the **Dial** to enter the change.

```
SETUP DATE/TIME:  
DATE: -06/15/11-  
TIME: [02:45PM]  
FORMAT: -12 HOUR- ↑
```

14. Press the **HOME**  key to exit the SETUP menu.

*Note: The initial Alarms shown on the Home screen are generated by default during the power-up process and not indicative of a problem. Clear the Alarms as follows:*

- Turn the **Dial** right one step to choose ALARMS.
- Press the **Dial** to select ALARMS.
- The cause of the alarm will be displayed. Press the **Dial** as needed to clear the alarms.

```
TH 02:45:39P WK1 7.11  
VALID PGM: NONE  
-MAIN → [ALARMS< 1>]
```

```
TH 02:45:39P WK1 7.11  
POWER RESTORED  
→ [CLEAR] ↑
```

## Setting a Security Access Code

This feature enables the user to establish an access code that must be entered to gain access to various controller functions.

The access code can be any four-digit number between 0001 and 9999. After the code has been established, a security level is applied that determines which of the controller functions can remain accessible without entering the code.

- **All** – Disables access code requirement – enables unrestricted controller use.
- **Restricted** – Requires access code to unlock Program and Setup functions. Manual, Review and Water Off functions remain unrestricted.
- **No Access** – Requires access code to unlock all controller functions.

1. Press the **SETUP**  key to display the SETUP menu. The CONTROLLER option is chosen by default. Press the **Dial** to select CONTROLLER.

```

SETUP:
[CONTROLLER]←FLOW-
-PROGRAM-      -COMM-
-ET-           -TWO-WIRE-↑
    
```

The SETUP CONTROLLER menu is displayed with the DATE/TIME option chosen by default.

```

SETUP CONTROLLER:
[DATE/TIME]←ACCESS-
-STACK-      -DELAY-
-MVALUE-    -MORE-↓↑
    
```

2. Turn the **Dial** right one step to choose the ACCESS option.

```

SETUP CONTROLLER:
-DATE/TIME→[ACCESS]
-STACK-      -DELAY-
-MVALUE-    -MORE-↓↑
    
```

3. Press the **Dial** to select and display the SETUP ACCESS screen.

***Note:** Select an access code that's easy to recall, then keep a copy of it written down for reference if needed. If you forget or misplace your code, contact Technical Support at 1-800-777-1477.*

```

SETUP ACCESS
ENTER EXISTING CODE:
→[XXXX]
↑
    
```

4. Press the **Dial** to begin. Four zeros will be displayed with the first digit flashing. Either turn the **Dial** to change this digit, or press the **Dial** to select the next digit in sequence. Repeat for all four digits.

```

SETUP ACCESS
ENTER EXISTING CODE:
  [0000]
  ↑
  ↑
    
```

***Note:** All four digits of the access code must be selected and saved to retain the code in memory. Exiting this procedure before entering the last digit restores the default or previous access code.*

```

SETUP ACCESS
ENTER EXISTING CODE:
  [0123]
  ↑
  ↑
    
```

5. Entering the fourth access code digit prompts the next screen in the access setup sequence. Turn the **Dial** to choose the LEVEL option, then press the **Dial** to select.
6. Turn the **Dial** to display the preferred security level: RESTRICTED, NO ACCESS or ALL, then Press the **Dial** to enter the selection.

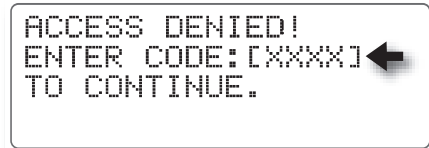
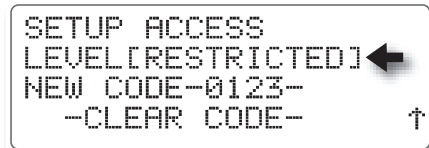
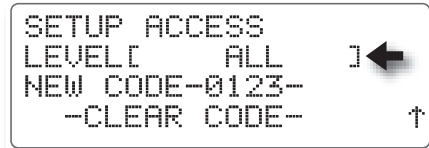

*Note: Once the access code has been entered, the controller functions will remain accessible until midnight. The access code must be entered each time once the restrictions have been applied to gain controller access. If attempting to enter an incorrect access code, the ACCESS DENIED screen will be displayed.*

7. When finished, press the **HOME**  key to return to the HOME screen.

**To Clear and Reset the Current Access Code:**

1. Starting from the SETUP ACCESS screen (shown at right), turn the **Dial** to choose CLEAR CODE, then press the **Dial** to select.
2. A safety screen is prompted. Turn the **Dial** to choose the **Yes** option, then press the **Dial** to delete the access code.
3. To reset the access code, repeat access code setup procedure, beginning at step 4.
4. When finished, press the **HOME**  key to return to the HOME screen.

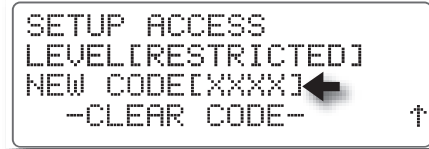
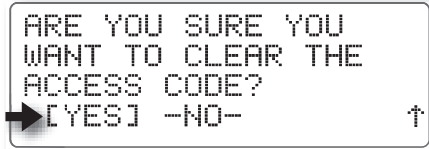
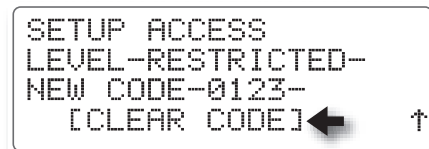



## Setting the Program Stack Option

This controller setup option enables you to specify whether multiple irrigation programs can run simultaneously, or must be “stacked” or constrained to run one at a time in chronological order.

By default, Program Stack is a global option, established for all programs, but can be disabled for individual programs as preferred. The Program Stack range is adjustable from 1– 8 programs. When the Stack option is disabled for a specific program, that program is allowed to run simultaneously with other programs.

**⚠ Caution:** Before disabling the Stack option, it is very important to consider the total current load and flow demand imposed on the system during simultaneous multiple-program operations.

1. Press the **SETUP**  key to display the SETUP menu. The CONTROLLER menu item is chosen by default. Press the **Dial** to select.

```

SETUP:
[CONTROLLER]←FLOW-
-PROGRAM-      -COMM-
-ET-           -TWO-WIRE-↑
    
```

2. The SETUP CONTROLLER menu is displayed. Turn the **Dial** right two steps to choose STACK.

```

SETUP CONTROLLER:
-DATE/TIME-  -ACCESS-
[STACK]←    -DELAY-
-MVALUE-    -MORE-↓↑
    
```

3. Press the **Dial** to display the SETUP PROGRAM STACK screen. The **Program** option is chosen by default. Press the **Dial** to select. The program number will begin flashing.

```

SETUP PROGRAM STACK:
PROGRAM[ 1]←
STACK-YES-
STACKING LIMIT-1- ↑
    
```

4. Turn the **Dial** to display the preferred program number (1–8 for standard systems, or 1–16 for two-wire decoder systems). Press the **Dial** to enter the number.

```

SETUP PROGRAM STACK:
PROGRAM[ 4]←
STACK-YES-
STACKING LIMIT-1- ↑
    
```

5. Turn the **Dial** right one step to choose the STACK option, then press the **Dial** to select. The current option will begin flashing. Turn the **Dial** to display the preference, then press the **Dial** to enter.

```

SETUP PROGRAM STACK:
PROGRAM- 4-
STACK[YES]←
STACKING LIMIT-1- ↑
    
```

*Note: The Stacking Limit option is applicable only with the Yes option selected.*

6. Turn the **Dial** right one step to choose STAKING LIMIT, then press the **Dial** to select. The current number will begin flashing. Turn the **Dial** to display the preferred number from 1–8, then press the **Dial** to enter the selection.



```

SETUP PROGRAM STACK:
PROGRAM- 4-
STACK-YES-
STACKING LIMIT[2]←↑
    
```

7. When finished, press the **HOME**  key to return to the HOME screen.

### Setting the Station Delay Option

Irrigation systems that utilize a pump station and/or slow-closing valves may require a delay or dwell time to occur between the station operating sequence. The Station Delay feature enables you to enter a delay period from 1 second to 19 minutes. Note that the Station Delay period is applied globally to all station operating sequences.

1. Press the **SETUP**  key to display the SETUP menu. The CONTROLLER menu item is chosen by default. Press the **Dial** to select.
2. The SETUP CONTROLLER menu is displayed. Turn the **Dial** right 3 steps to choose DELAY.
3. Press the **Dial** to display the SETUP STATION DELAY screen. The MINUTES option is chosen by default. If the preferred delay period is less than 1 minute, turn the **Dial** right one step to choose **Seconds**.
4. Press the **Dial** to select. The current value (0 by default) will begin flashing.
5. Turn the **Dial** to display the SECONDS value. Press the **Dial** to enter.
6. When finished, press the **HOME**  key to return to the HOME screen.

```
SETUP:  
[CONTROLLER]←FLOW-  
-PROGRAM-      -COMM-  
-ET-           -TWO-WIRE-↑
```

```
SETUP CONTROLLER:  
-DATE/TIME-  -ACCESS-  
-STACK-      →[DELAY]  
-MVALUE-     -MORE-↓↑
```

```
SETUP STATION DELAY:  
MINUTES[ 0]←(0-19)  
SECONDS- 0- (0-59)  
↑
```

```
SETUP STATION DELAY:  
MINUTES- 0- (0-19)  
SECONDS[ 0]←(0-59)  
↑
```

```
SETUP STATION DELAY:  
MINUTES- 0- (0-19)  
SECONDS[10]←(0-59)  
↑
```

## Setting the Master Valve Option

When a master valve is utilized in the irrigation system to control the main line water supply, it is imperative that the Master Valve configuration option corresponds correctly to either a Normally Open or a Normally Closed valve. The default Master Valve configuration option is Normally Closed.

For example, if a system flow limit is exceeded, the controller will turn off power to the master valve, causing it to close, when configured for Normally Closed operation. When configured for a Normally Open master valve, the controller will apply constant power to the valve, causing it to remain closed.

1. Press the **SETUP**  key to display the SETUP menu. The CONTROLLER menu item is chosen by default. Press the **Dial** to select.

```

SETUP:
[CONTROLLER] ← FLOW-
-PROGRAM-      -COMM-
-ET-           -TWO-WIRE- ↑
    
```

2. The SETUP CONTROLLER menu is displayed. Turn the **Dial** right 4 steps to choose MVALVE, then press the **Dial** to select.

```

SETUP CONTROLLER:
-DATE/TIME-  -ACCESS-
-STACK-     -DELAY-
[MVALVE] ←  -MORE- ↓ ↑
    
```

3. The SETUP MASTER VALVE screen is displayed. The NORMAL CLOSE option is chosen by default. Press the **Dial** to select. The option will begin flashing.

```

SETUP MASTER VALVE:
TYPE[NORMAL CLOSE] ←
                                     ↑
    
```

4. Turn the **Dial** to display the NORMAL OPEN option, then press the **Dial** to enter.

```

SETUP MASTER VALVE:
TYPE[NORMAL OPEN ] ←
                                     ↑
    
```

5. When finished, press the **HOME**  key to return to the HOME screen.

### Setting the Regional Options

Regional options enable you to configure the display information for various regional options including: units of measure, display language and date format. The chart below provides the Regional options and the default settings.

Units	Language	Date Format
English Metric	- English (default) - Spanish - French - German - Italian	MM/DD/YY (month, day, year) - default) DD/MM/YY (day, month, year)

**Note:** Regional option availability differs for Domestic and International controller models. Domestic models provide optional selection of the Date Format only.

1. Press the **SETUP**  key to display the SETUP menu. The CONTROLLER menu item is chosen by default. Press the **Dial** to select.

```

SETUP:
[CONTROLLER]←FLOW-
-PROGRAM-      -COMM-
-ET-           -TWO-WIRE-↑
    
```

2. The SETUP CONTROLLER menu is displayed. Turn the **Dial** right 5 steps to choose MORE, then press the **Dial** to select.

```

SETUP CONTROLLER:
-DATE/TIME-  -ACCESS-
-STACK-      -DELAY↓
-MVALUE-     →[MORE]↓↑
    
```

**Note:** Pressing the **NEXT**  key will also access the next screen in sequence (indicated by the down arrow ↓ symbol).

3. The SETUP MORE screen is displayed with the REGION option chosen by default. Press the **Dial** to select.

```

SETUP MORE:
[REGION]←ODD/EVEN-
-SOUND-      -WATER OFF-
-WATER WINDOW- ↑
    
```

4. The SETUP REGION menu screen is displayed with the DATE FORMAT chosen by default.

```

SETUP REGION:
UNITS-ENGL. -
LANGUAGE-ENGLISH-
DATE FORMAT[MM/DD]←
    
```

5. Press the **Dial** to select. Turn the **Dial** to display the preferred option, then press the **Dial** to enter the selection.

```

SETUP REGION:
UNITS-METRIC-
LANGUAGE-ENGLISH-
DATE FORMAT[MM/DD]←
    
```

6. When finished, press the **HOME**  key to return to the HOME screen.

## Setting the Odd/Even Day Option

By default, the Odd/Even calendar day scheduling option is disabled. In order to utilize this control feature in the Program Setup options, it must first be enabled in the Controller Setup options.

**Note:** For additional information regarding the function and implementation of the Odd/Even feature, refer to Program Setup Options on page 21.

1. Press the **SETUP**  key to display the SETUP menu. The CONTROLLER menu item is chosen by default. Press the **Dial** to select.

```

SETUP:
[CONTROLLER]←FLOW-
-PROGRAM-      -COMM-
-ET-           -TWO-WIRE-↑
    
```

2. The SETUP CONTROLLER menu is displayed. Turn the **Dial** right 5 steps to choose MORE, then press the **Dial** to select.

```

SETUP CONTROLLER:
-DATE/TIME-  -ACCESS-
-STACK-      -DELAY↓
-MVALUE-     →[MORE]↕↑
    
```

**Note:** Pressing the **NEXT**  key will also access the next screen in sequence (indicated by the down arrow ↕ symbol).

3. The SETUP MORE screen is displayed with the REGION option chosen by default. Turn the **Dial** right one step to choose the ODD/EVEN option, then press the **Dial** to select.

```

SETUP MORE:
-REGION→[ODD/EVEN]
-SOUND-      -WATER OFF-
-WATER WINDOW-↑
    
```

5. The SETUP ODD/EVEN screen is displayed with WATERING - NO chosen by default.

**Note:** For this option, it is preferable to set TYPE first, and then set the WATERING - YES/NO option. (See step 6 below.)

```

SETUP ODD/EVEN:
WATERING[NO ]←
TYPE-ODD -↑
    
```

6. Turn the **Dial** to choose TYPE, then press the **Dial** to select. Turn the **Dial** to display EVEN or ODD, then press the **Dial** to enter.

```

SETUP ODD/EVEN:
WATERING -NO -
TYPE[EVEN]←↑
    
```

7. Turn the **Dial** left one step to choose WATERING, then press the **Dial** to select. Turn the **Dial** to display YES, then press the **Dial** to select.

```

SETUP ODD/EVEN:
WATERING[YES]←
TYPE[EVEN]↑
    
```

A WARNING screen will be displayed. Press the **Dial** to select OK, or turn **Dial** to choose CANCEL, then press the **Dial** to return to the previous screen.

```

WARNING: YOU HAVE
ELECTED TO WATER ON
EVEN CALENDAR DAYS
ONLY. [OK]←CANCEL-↑
    
```

8. When finished, press the **HOME**  key to return to the HOME screen.

### Setting the Audible Alert Option

The Audible Alert option is Off by default. When enabled, an Alarm condition will trigger an Alert “chirp” tone every six seconds until the Alarm condition is cleared.

1. Press the **SETUP**  key to display the SETUP menu. The CONTROLLER menu item is chosen by default. Press the **Dial** to select.

```
SETUP:
[CONTROLLER]←FLOW-
-PROGRAM-      -COMM-
-ET-           -TWO-WIRE-↑
```

2. The SETUP CONTROLLER menu is displayed. Turn the **Dial** right 5 steps to choose MORE, then press the **Dial** to select.

```
SETUP CONTROLLER:
-DATE/TIME-  -ACCESS-
-STACK-      -DELAY↓
-MVALVE-     →[MORE]↓↑
```

**Note:** Pressing the **NEXT**  key will also access the next screen in sequence (indicated by the down arrow ↓ symbol).

3. The SETUP MORE screen is displayed with the REGION option chosen by default. Turn the **Dial** right two steps to choose SOUND, then press the **Dial** to select.

```
SETUP MORE:
-REGION-     -ODD/EVEN-
[SOUND]←    -WATER OFF-
-WATER WINDOW-↑
```

4. The SETUP SOUND screen is displayed with the OFF option selected by default.
5. Press the **Dial** to select, then turn the **Dial** to display ON. Press the **Dial** to enter the selection.

```
SETUP SOUND:
AUDIBLE ALARM[OFF]←
↑
```

6. When finished, press the **HOME**  key to return to the HOME screen.

## Setting the Timed Water-Off Mode

This feature provides a means of placing the controller in the Water Off mode for a timed duration from 1 to 9 days.

**Note:** The Water Off mode can be terminated at any time by any one of the following methods:

- Press the **WATER OFF** key.
- Reset the Water Off day duration to NONE.
- Choose TURN WATER ON from the MAIN menu, then press the **Dial** to select TURN WATER OFF.

1. Press the **SETUP**  key to display the SETUP menu. The CONTROLLER menu item is chosen by default. Press the **Dial** to select.

```

SETUP:
[CONTROLLER] ← FLOW-
-PROGRAM-      -COMM-
-ET-           -TWO-WIRE- ↑
  
```

2. The SETUP CONTROLLER menu is displayed. Turn the **Dial** right 5 steps to choose MORE, then press the **Dial** to select.

**Note:** Pressing the **NEXT**  key will also access the next screen in sequence (indicated by the down arrow ↓ symbol).

```

SETUP CONTROLLER:
-DATE/TIME-  -ACCESS-
-STACK-      -DELAY ↓
-MVALUE-     → [MORE] ↓ ↑
  
```

3. The SETUP MORE screen is displayed with the REGION option chosen by default. Turn the **Dial** right three steps to choose WATER OFF, then press the **Dial** to select.

```

SETUP MORE:
-REGION-  -ODD/EVEN-
-SOUND- → [WATER OFF]
-WATER WINDOW- ↑
  
```

4. The SETUP WATER OFF screen is displayed. Press the **Dial** to select [None], then turn the **Dial** to display 1 to 9 days.

```

SETUP WATER OFF:
NUMBER OF DAYS
CONTROLLER REMAINS
IN WATER OFF [ 4 ] ← ↑
  
```

5. Press the **Dial** to enter. The controller will switch to the WATER OFF mode and the LED indicator will illuminate.

**Note:** If a 1-day duration is selected, the WATER OFF mode will be automatically released at the day change (Midnight).

6. When finished, press the **HOME**  key to return to the HOME screen.

### Setting the Water Window Duration

This option enables you to define a specific period (or window) of time within the 24-hour day to complete all scheduled watering activity. Once established, any scheduled watering activity that would either start or continue running outside of the window will be ignored. Built-in programming alerts will be displayed if a water window scheduling conflict occurs. By default, the Water Window setting is 24 hours.

**Note:** When decreasing the Water Window, it is important to consider that an increase in station run time through the use of the Percent Adjust and/or ET control features, can extend program watering duration beyond the Water Window limit, resulting in an Alarm condition.

1. Press the **SETUP**  key to display the SETUP menu. The CONTROLLER menu item is chosen by default. Press the **Dial** to select.



2. The SETUP CONTROLLER menu is displayed. Turn the **Dial** right 5 steps to choose MORE, then press the **Dial** to select.

**Note:** Pressing the **NEXT**  key will also access the next screen in sequence (indicated by the down arrow ↓ symbol).

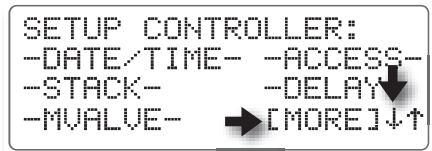

3. The SETUP MORE screen is displayed with the REGION option chosen by default. Turn the **Dial** right four steps to choose WATER WINDOW, then press the **Dial** to select.

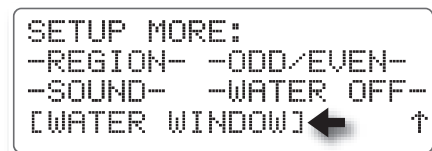

4. The SETUP WATER WINDOW screen will be displayed. Press the **Dial** to select START time. Turn the **Dial** to display the preferred start time hour, then press the **Dial** to enter. The minutes digits will begin flashing.

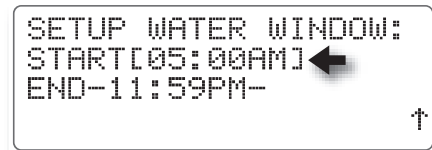

5. Turn the **Dial** to display the preferred start time minutes. Press the **Dial** to enter. The AM/PM indicator will begin flashing (12-hour mode only). Turn the **Dial** to display the AM/PM preference, then press the **Dial** to enter.

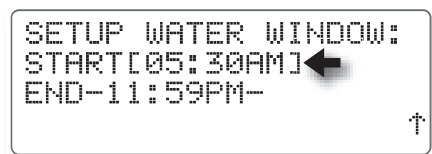

6. Turn the **Dial** right one step to choose the END time. Set the END time using the same procedure as the START time.

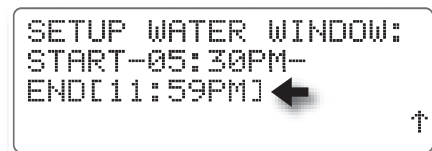

7. When finished, press the **HOME**  key to return to the HOME screen.



## Selecting the Program Setup Options

Within the Controller Setup menu options, the selections made applied universally to all active programs. Within the Program Setup options, operating parameters specific to each program are established.

The table below lists the various available Program Setup options and the factory default settings.

Setup Program Menu	Option	Default
Type	- Water Days: 14-Day/Skip Day - Irrigation/Non-Irrigation - Cycle and Soak: Yes/No	14-Day Irrigation No
Odd/Even Days	- Enabled/Disabled	Disabled
Weather	- ET: Enabled/Disabled - Rain Sensor: Yes/No	Disabled No

### Program Type

- **Water Days** – A 14-day schedule is the default option that enables individual days of a recurrent, two-week schedule to be assigned. The Skip-Day option constrains active days to a specified interval, ranging from every day (skip 0 days), to once every 31 days (skip 30 days).
- **Irrigation/Non-Irrigation** – Programs can be defined for either irrigation control or non-irrigation control; e.g., outdoor lighting or filter pumps as preferred.
- **Cycle/Soak** – The Cycle and Soak option enables a delay period to be interspersed with the station run time to help reduce runoff due to a low absorption rate or to prevent furrowing and seed loss during an initial turf grow-in period.

### Odd/Even Days



When enabled, either Odd- or Even-day watering is specified. Within the individual Program Setup options, the specified option (Odd or Even) is displayed with a YES/NO option. Selecting YES assigns the schedule to the program; selecting NO ignores the schedule.

***Note:** The Odd/Even day scheduling option must be enabled within the Controller Setup options to be selectable within the Program Setup options.*

### Master Valve /Pump:

This option enables/disables concurrent operation of the Master Valve (MV) and/or Pump on a per-program basis. By default, both Master Valve and Pump output controls are assigned to all irrigation programs and disabled for all non-irrigation programs.

**Setting the Program Type Option**

1. Press the **SETUP**  key to display the SETUP menu. The CONTROLLER menu item is chosen by default. Press the **Dial** to select.
2. Turn the **Dial** right two steps to choose PROGRAM, then press the **Dial** to select.
3. The SETUP PROGRAM menu screen is displayed with TYPE chosen by default. Press the **Dial** to select.
4. The next SETUP PROGRAM screen in sequence is displayed with the program number chosen by default. Press the **Dial** to select. Turn the **Dial** to display the preferred program number, then press the **Dial** to enter.
5. Turn the **Dial** right one step to choose the WATER DAYS. The 14 DAY option is displayed by default. Press the **Dial** to select.
6. Turn the **Dial** to display SKIP DAY or 14 DAY option as preferred, then press the **Dial** to enter the selection.
7. Turn the **Dial** right one step to choose the Program TYPE option, then press the **Dial** to select.
8. Turn the **Dial** to display NON IRRIGATION (i.e. for outdoor lighting) or IRRIGATION option, then press the **Dial** to enter the selection.
9. Turn the **Dial** right one step to choose the CYCLE /SOAK option.
10. Turn the **Dial** to display the YES or NO option, then press the **Dial** to enter the selection.
11. When finished, press the **HOME**  key to return to the HOME screen.

```

SETUP:
[CONTROLLER]←FLOW-
-PROGRAM-      -COMM-
-ET-           -TWO-WIRE-↑
    
```

```

SETUP:
-CONTROLLER-  -FLOW-
[PROGRAM]←    -COMM-
-ET-         -TWO-WIRE-↑
    
```

```

SETUP PROGRAM:
[TYPE]← -ODD/EVEN-
-MV/PUMP- -ET SETUP
                                     ↑
    
```

```

SETUP PROGRAM:→[ 1]
WATER DAYS- 14 DAY-
TYPE- IRRIGATION -
CYCLE/SOAK- NO- ↑
    
```

```

SETUP PROGRAM: - 2-
WATER DAYS[ 14 DAY ]
TYPE- IRRIGATION ←
CYCLE/SOAK- NO- ↑
    
```

```

SETUP PROGRAM: - 2-
WATER DAYS[SKIP DAY]
TYPE- IRRIGATION ←
CYCLE/SOAK- NO- ↑
    
```

```

SETUP PROGRAM: - 2-
WATER DAYS-SKIP DAY-
TYPE[ IRRIGATION]←
CYCLE/SOAK- NO- ↑
    
```

```

SETUP PROGRAM: - 2-
WATER DAYS-SKIP DAY-
TYPE[NON-IRRIGATION]
CYCLE/SOAK- NO- ↑
    
```

```

SETUP PROGRAM: - 2-
WATER DAYS-SKIP DAY-
TYPE- IRRIGATION -
CYCLE/SOAK[ NO]← ↑
    
```

```

SETUP PROGRAM: - 2-
WATER DAYS-SKIP DAY-
TYPE- IRRIGATION -
CYCLE/SOAK[YES]← ↑
    
```

## Setting the Program Odd/Even Calendar Days Option

**Note:** To assign program(s) to an Odd or Even numbered calendar day schedule, the Odd /Even schedule option must be established first within the Controller setup parameters. Refer to page 15 for Controller Odd/Even setup procedures.

**Note:** Programs can only be assigned to an Odd OR Even schedule, as specified within Controller setup parameters. In other words, one program can not be assigned to an Even schedule and another program assigned to an Odd schedule.

**Note:** When the Odd/Even program option is enabled, watering will NOT occur on the 31st day of the month or Leap Day (February 24).

1. Press the **SETUP**  key to display the SETUP menu. The CONTROLLER menu item is chosen by default. Press the **Dial** to select.

```

SETUP:
[CONTROLLER] ← FLOW-
-PROGRAM-      -COMM-
-ET-           -TWO-WIRE- ↑
    
```

2. Turn the **Dial** right two steps to choose PROGRAM, then press the **Dial** to select.

```

SETUP:
-CONTROLLER-  -FLOW-
[PROGRAM] ←  -COMM-
-ET-         -TWO-WIRE- ↑
    
```

3. The SETUP PROGRAM menu screen is displayed with the TYPE option chosen by default. Turn the **Dial** right one step to choose the ODD/EVEN option, then press the **Dial** to select.

```

SETUP PROGRAM:
-TYPE- → [ODD/EVEN]
-MV/PUMP- -ET SETUP
                                     ↑
    
```

4. The program number is chosen by default. Press the **Dial** to select, then turn the **Dial** to display the preferred program number. Press the **Dial** to enter the selection.

```

SETUP PROGRAM: [ 1 ] ←
ODD/EVEN: ENABLED
EVEN-YES
                                     ↑
    
```

5. Turn the **Dial** right one step to choose the YES/NO option. By default the Odd or Even option is not selected for programs.

```

SETUP PROGRAM: - 1-
ODD/EVEN: ENABLED
EVEN[NO ] ←
                                     ↑
    
```

6. To assign the EVEN day option to this program, press the **Dial** to select NO. The option will begin flashing. Turn the **Dial** to display YES, then press the **Dial** to enter the selection.

```

SETUP PROGRAM: - 1-
ODD/EVEN: ENABLED
EVEN[NO ] ←
                                     ↑
    
```

7. Repeat this procedure for each program number as required, beginning at step 4.
8. When finished, press the **HOME**  key to return to the HOME screen.

**Setting the Program Master Valve/Pump Control Options**

*Note: By default, the master valve and pump control options are enabled for all programs. Disabling these functions may be required for non-irrigation programs. See page 13 for Master Valve/Pump configuration and setup procedures.*

1. Press the **SETUP**  key to display the SETUP menu. The CONTROLLER menu item is chosen by default. Press the **Dial** to select.

```

SETUP:
[CONTROLLER] ← FLOW-
-PROGRAM-      -COMM-
-ET-           -TWO-WIRE- ↑
    
```

2. Turn the **Dial** right two steps to choose PROGRAM, then press the **Dial** to select.

```

SETUP:
-CONTROLLER- -FLOW-
[PROGRAM] ← -COMM-
-ET-         -TWO-WIRE- ↑
    
```

3. Press the **Dial** to display the SETUP PROGRAM menu screen. TYPE is chosen by default.

```

SETUP PROGRAM:
[TYPE] ← -ODD/EVEN-
-MV/PUMP- -ET SETUP
                                     ↑
    
```

4. Turn the **Dial** right two steps to choose MV/PUMP.

```

SETUP PROGRAM:
-TYPE-      -ODD/EVEN-
[MV/PUMP] ← -ET SETUP
                                     ↑
    
```

5. Press the **Dial** to display the MASTER VALVE and PUMP screen. The program number is chosen by default.

```

SETUP PROGRAM: [ 1] ←
MASTER VALVE-YES-
PUMP-YES-
                                     ↑
    
```

6. Press the **Dial** to select the program number. Turn the **Dial** to display the preferred program number, then press the **Dial** to enter.

```

SETUP PROGRAM: - 1-
MASTER VALVE[YES] ←
PUMP-YES-
                                     ↑
    
```

7. Turn the **Dial** right one step to choose the MASTER VALVE option. YES is selected by default. To disable MASTER VALVE operation for this program, press the **Dial** to select, turn the **Dial** to display NO, then press the **Dial** to select.

```

SETUP PROGRAM: - 1-
MASTER VALVE[NO] ←
PUMP-YES-
                                     ↑
    
```

8. Turn the **Dial** right one step to choose the PUMP option. YES is selected by default. To disable PUMP operation for this program, turn the **Dial** to display NO, then press the **Dial** to select.

```

SETUP PROGRAM: - 1-
MASTER VALVE-NO -
PUMP[NO] ←
                                     ↑
    
```

9. Repeat this procedure for each program as preferred, beginning at step 5.

10. When finished, press the **HOME**  key to return to the HOME screen.

### Setting the Program Weather Options

The optional ET (Evapotranspiration) and/or Rain Sensor control features are disabled by default for all programs. In order to utilize either of these features, they must first be enabled within the Weather option screen.

**Note:** When ET is enabled for a program, a Percent Adjustment applied to that program will be ignored. Refer to *Modify Program options*, page 41 for additional information.

1. Press the **SETUP**  key to display the SETUP menu. The CONTROLLER menu item is chosen by default. Press the **Dial** to select.
 

```

                SETUP:
                [CONTROLLER] ← FLOW-
                -PROGRAM-   -COMM-
                -ET-       -TWO-WIRE- ↑
            
```
2. Turn the **Dial** right two steps to choose PROGRAM, then press the **Dial** to select.
 

```

                SETUP:
                -CONTROLLER- -FLOW-
                [PROGRAM] ← -COMM-
                -ET-       -TWO-WIRE- ↑
            
```
3. Turn the **Dial** right two steps to choose the WEATHER option. Press the **Dial** to display the ET and RAIN SENSOR option screen. The program number is chosen by default.
 

```

                SETUP PROGRAM:
                -TYPE-       -ODD/EVEN-
                -MV/PUMP → [WEATHER]
                                     ↑
            
```
4. Press the **Dial** to select. The program number will begin flashing. Turn the **Dial** to display the preferred program number, then press the **Dial** to enter the selection.
 

```

                SETUP PROGRAM: [ 2 ] ←
                ET-DISABLED-
                RAIN SENSOR- NO -
                                     ↑
            
```
5. Turn the **Dial** right one step to choose the ET option. DISABLED is selected by default.
 

```

                SETUP PROGRAM: - 2-
                ET[DISABLED] ←
                RAIN SENSOR- NO -
                                     ↑
            
```
6. Press the **Dial** to select. Turn the **Dial** to display the ENABLED option. Press the **Dial** to enter the selection.
 

```

                SETUP PROGRAM: - 2-
                ET[ENABLED] ←
                RAIN SENSOR- NO -
                                     ↑
            
```
7. Turn the **Dial** right one step to choose the RAIN SENSOR option. NO is selected by default.
 

```

                SETUP PROGRAM: - 2-
                ET-ENABLED -
                RAIN SENSOR[ NO ] ←
                                     ↑
            
```
8. Press the **Dial** to select. Turn the **Dial** to display the YES option to enable the option for this program.
 

```

                SETUP PROGRAM: - 2-
                ET-ENABLED -
                RAIN SENSOR[ YES ] ←
                                     ↑
            
```
9. Repeat this procedure for each program number as preferred, beginning at step 4.
10. When finished, press the **HOME**  key to return to the HOME screen.

## Selecting the ET Setup Options

All required ET configuration parameters are provided within the ET Setup Menu screen. The table below lists the available ET setup options and default settings.

ET Setup Menu	Option	Default
Manual Adjust	No or .010 – .490	No
Reference ET	.00–.50	.10
Reference Month	Jan–Dec	Jan
ET	.00–.50	.10
Source	Historic, Internet or Weather Station	Historic

1. Press the **SETUP**  key to display the SETUP menu. The CONTROLLER menu item is chosen by default.

```

SETUP:
[CONTROLLER] ← FLOW-
-PROGRAM-      -COMM-
-ET-           -TWO-WIRE- ↑
    
```

2. Turn the **Dial** right four steps to choose ET, then press the **Dial** to select.

```

SETUP:
-CONTROLLER- -FLOW-
-PROGRAM-    -COMM-
[ET] ←      -TWO-WIRE- ↑
    
```

3. Press the **Dial** to display the SETUP ET menu screen. The MANUAL option is chosen by default.

```

SETUP ET: MANUAL [NO ]
REFERENCE-.10-
MONTH-JAN- ET-.10-
SOURCE- HISTORIC - ↑
    
```

4. Press the **Dial** to select. The default value will begin flashing. Turn the **Dial** to change the value to the preferred setting. Press the **Dial** to save.

```

SETUP ET: MANUAL-NO -
REFERENCE[.20] ←
MONTH-JAN- ET-.10-
SOURCE- HISTORIC - ↑
    
```

5. Turn the **Dial** to choose the next option to be adjusted. Repeat the procedure beginning at Step 3.
6. When finished, press the **HOME**  key to return to the HOME screen.

## Selecting the Flow Sensor Setup and Operation Options

The Eagle Plus can support two separate flow sensors to continuously monitor main line and individual station flow rates. If a flow rate is detected outside the specified parameter, an Alarm condition is triggered.

The controller supports Standard and Custom flow sensor configurations. The Standard option applies factory-default K and Offset values for Rain Master flow sensors. The Custom option enables K and Offset values to be set as preferred.

The table below lists the flow sensor setup options, and default settings.

Flow Setup Menu	Option	Default
Sensors (Material/Size)	Bronze: 1.0", 1.25", 1.5", 2.0" & 2.5" PVC: 1.5", 2.0", 3.0" & 4.0"	1.5" PVC
Usage	None, Flow 1, Flow 2, Flow 1 & Flow 2	Flow 1
Type	Standard or Custom	Standard
Delay	1–6 Minutes	2 Minutes
Flow Limits	Station: 0–999 GPM Main: 1–5000 GPM Unscheduled: 0–999 GPM	200 GPM 500 GPM 200 GPM
Learned Flow	1–All	1
Limit Adjust	5–80%	20%
Totalizer	0–999,999 Gallons	0 Gallons

### Set the Sensor Enable/Disable Option

1. Press the **SETUP**  key to display the SETUP menu. The CONTROLLER menu item is chosen by default.

```

SETUP:
[CONTROLLER] ← FLOW-
-PROGRAM-      -COMM-
-ET-           -TWO-WIRE- ↑
    
```

2. Turn the **Dial** right one step to choose FLOW, then press the **Dial** to select and display the SETUP FLOW screen.

```

SETUP:
-CONTROLLER- [FLOW ←
-PROGRAM-      -COMM-
-ET-           -TWO-WIRE- ↑
    
```

3. The SENSORS option is chosen by default. Press the **Dial** to select.

```

SETUP FLOW:
SENSORS [DISABLED] ←
USAGE-FLOW1 ONLY -
-MORE- ↓ ↑
    
```

4. Turn the **Dial** to display ENABLED, then press the **Dial** to enter the selection.

```

SETUP FLOW:
SENSORS [ENABLED ] ←
USAGE-FLOW1 ONLY -
-MORE- ↓ ↑
    
```

**Note:** SENSORS ENABLED must be selected to access the remaining Flow setup features.

**Setting the Usage Option**

1. Turn the **Dial** to choose the USAGE option. The FLOW 1 ONLY option is selected by default. Press the **Dial** to select.
2. Turn the **Dial** to display the preferred option (FLOW 1, FLOW 2, FLOW 1 & 2 or NONE). Press the **Dial** to enter the selection.
3. Turn the **Dial** to choose the MORE option or press the **Next**  key.

```

SETUP FLOW:
SENSORS -ENABLED -
USAGE[FLOW1 ONLY ] ←
                    -MORE-↓↑
    
```

```

SETUP FLOW:
SENSORS -ENABLED -
USAGE[FLOW2 ONLY] ←
                    -MORE-↓↑
    
```

```

SETUP FLOW:
SENSORS -ENABLED -
USAGE-FLOW2 ONLY-
                    →[MORE]↓↑
    
```

**Setting the Standard/Custom Sensor Options**

1. The SETUP FLOW menu is displayed with the SENSORS option chosen by default. Press the **Dial** to select SENSORS.
2. The SETUP FLOW SENSOR screen is displayed, with the sensor number option chosen by default. Press the **Dial** to select, then turn the **Dial** to display SENSOR 1 or 2. Press the **Dial** to enter the selection.
3. Turn the **Dial** to choose the STANDARD for Rain Master flow sensor or CUSTOM for alternate flow sensor makes. Press the **Dial** to select.

```

SETUP FLOW:
[SENSOR] ←-DELAY-
-LIMITS- -LEARN-
-TOTALIZER-
                                     ↑
    
```

```

SETUP FLOW SENSOR[2]
TYPE:
-STANDARD- -CUSTOM-
                                     ↑
    
```

```

SETUP FLOW SENSOR-2-
TYPE:
[STANDARD] ←-CUSTOM-
                                     ↑
    
```

**• For Rain Master Flow Sensors:**

4. The sensor SIZE option is chosen. Press the **Dial** to select, then turn the **Dial** to display the actual sensor size. Press the **Dial** to enter the selection.

```

SETUP FLOW SENSOR 2
SIZE[ 2.00 INCH ] ←
                                     ↑
    
```

**• For Alternate Flow Sensors:**

4. The sensor OFFSET value option is chosen by default. Press the **Dial** to select, then turn the **Dial** to display the preferred value (0–999). Press the **Dial** to enter the selection.
5. Turn the **Dial** to choose the K value. Press the **Dial** to select, then turn the **Dial** to display the preferred value (0–32767). Press the **Dial** to enter the selection.

```

SETUP FLOW SENSOR 2
OFFSET=[109] ←
K=-      0-
                                     ↑
    
```

```

SETUP FLOW SENSOR 2
OFFSET=-109-
K=[ 779] ←
                                     ↑
    
```



## Setting the Flow Limits Options

Flow rate alarm criteria are based on the flow rate values specified in the LIMITS screen. In most cases, the factory default values can serve as a starting point until the actual flow rate values are known. Using the Learned Flow procedure provided on **Page 28**, will enable the actual flow rate values to be automatically acquired and entered in Flow Limits screen in lieu of setting the values manually.

1. Press the **Back**  key to step back to the SETUP FLOW menu. Turn the **Dial** to choose LIMITS.
2. The **Station** number option is chosen by default. Press the **Dial** to select, then turn the **Dial** to display the preferred station number. Press the **Dial** to enter.
3. Turn the **Dial** to choose the STATION flow limit. Press the **Dial** to select, then turn the **Dial** to display the preferred value from 0 to 999. Press the **Dial** to enter the selection.

```

SETUP FLOW:
-SENSOR- -DELAY-
[LIMITS] ← LEARN-
-TOTALIZER- ↑
  
```

```

SETUP LIMITS: (GPM)
STATION[ 2 ] ← 200-
MAIN LINE-500-
UNSCHEDULED-200- ↑
  
```

```

SETUP LIMITS: (GPM)
STATION- 2- [175] ←
MAIN LINE-500-
UNSCHEDULED-200- ↑
  
```

**⚠ IMPORTANT:** When the PROGRAM STACKING option is not used, multiple programs/stations are allowed to operate simultaneously. The MAIN LINE flow limit must be set to correspond with the maximum cumulative flow rate during multi- program operation.

4. Turn the **Dial** to choose the **Main Line** flow limit. Press the **Dial** to select, then turn the **Dial** to display the preferred value from 0 to 9999. Press the **Dial** to enter.

```

SETUP LIMITS: (GPM)
STATION- 2- -175-
MAIN LINE[450] ←
UNSCHEDULED-200- ↑
  
```

**Note:** Setting the *Unscheduled flow limit* establishes the maximum allowable flow through the main line while the irrigation system is static. If the flow rate exceeds the limit, an Alarm is triggered and the system will shut down until the cause is resolved. A small or zero value for unscheduled flow is generally sufficient unless supplemental irrigation is used; i.e., via a quick-coupler or gate valve. In this case, the *Unscheduled flow limit* must be set at the maximum supplemental flow rate.

5. Turn the **Dial** to choose the UNSCHEDULED flow limit. Press the **Dial** to select, then turn the **Dial** to display the preferred value from 0 to 999. Press the **Dial** to enter the selection.

```

SETUP LIMITS: (GPM)
STATION- 2- -175-
MAIN LINE- 450-
UNSCHEDULED[ 0 ] ← ↑
  
```

### Setting the Delay Option

The Delay time entered in this setup screen determines how long a station will run before the flow data is sampled.

**Note:** An extra 10 seconds will be added to the selected Delay time.

1. Press the **BACK**  key to step back through the menu sequence to the SETUP FLOW menu.

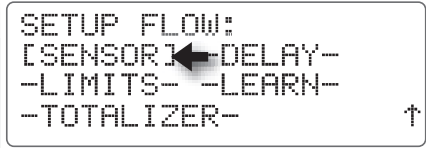

2. Turn the **Dial** right one step to choose the DELAY option. Press the **Dial** to select.

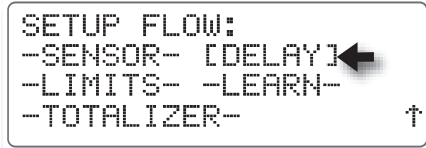

3. The SETUP FLOW DELAY screen is displayed with the delay time chosen by default. Press the **Dial** to select, then turn the **Dial** to display the preference from 1 to 6 minutes. Press the **Dial** to enter the selection.

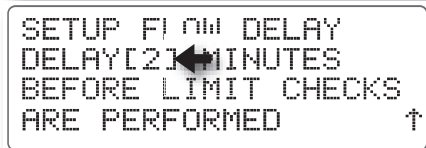

### Setting the Learned Flow Options

During the Learned Flow procedure, each station assigned to a selected program is operated in sequence for the run time specified in the Delay option screen. An additional 10 seconds is added at the end of the delay period in which the nominal flow rate is acquired. To help prevent false threshold Alarms due to typical variations in flow rate, the controller establishes the maximum flow rate value by increasing the nominal flow rate by a specified percentage factor from 5 to 80%.

**Note:** To utilize the learned flow feature, at least one valid automatic watering program must be defined.

1. Press the **BACK**  key to step back to the SETUP FLOW menu. Turn the **Dial** to choose the **Learn** option, then press the **Dial** to enter the selection.

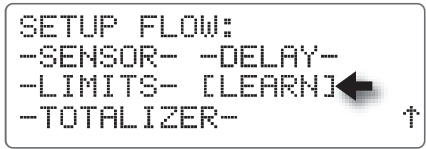

**Note:** Established programs can be selected by number, or when more than one valid program exists, the ALL option will be displayed. When the ALL option is selected, all valid programs will run one at a time in numeric sequence.

2. The SETUP LEARNED FLOW menu is displayed, with the program number option chosen by default. Press the **Dial** to select, then turn the **Dial** to display a specific program number, or select **All** to run all programs in sequence.

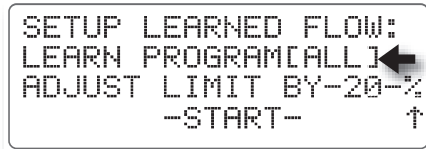

- Turn the **Dial** to choose the ADJUST LIMIT value. Press the **Dial** to select, then turn the **Dial** to display the preferred increase from 5 to 80%. Turn the **Dial** to choose START, then press the **Dial** to select.

```

SETUP LEARNED FLOW:
LEARN PROGRAM-ALL-
ADJUST LIMIT BY[20]%-START-  ↑  ↑
    
```

- A WARNING screen is displayed. The station run time (DELAY) time plus 10 seconds is indicated, and the START option is chosen by default.

```

WARNING: EACH
STATION WILL TURN ON
FOR: 130
[START] ← -CANCEL-  ↑
    
```

*Note: Choosing and selecting the CANCEL option discontinues the procedure and reverts to the SETUP LEARNED FLOW screen.*

- Press the **Dial** to start the operation. A status screen will be displayed identifying the station number being tested, the current flow rate, and the run time remaining.

```

SETUP LEARNED FLOW:
ADJUST LIMIT BY 20%
STATION: 1 154 GPM
TIME: 01:05 [ABORT] ← ↑
    
```

*Note: Choosing and selecting the ABORT option discontinues the procedure and reverts to the SETUP LEARNED FLOW screen.*

### Resetting the Flow Totalizer

All flow sensor data is stored in the controller memory and can be reviewed at any time. The flow totalizer feature monitors the flow data registered by each flow sensor and displays the combined total volume. The totalizer can be set to display flow data in GAL (gallons), CCF (100 cubic feet), or ACRE-FEET (ACF) as preferred. The RESET feature enables the totalizer to be reset to zero and begin compiling total flow data from that point forward.

- Press the **BACK**  key to step back to the SENSOR FLOW menu. Turn the **Dial** to choose the TOTALIZER option. Press the **Dial** to select.

```

SETUP FLOW:
-SENSOR- -DELAY-
-LIMITS- -LEARN-
[TOTALIZER] ←  ↑
    
```

- The GAL (gallons) display units option is chosen by default. To select an alternate unit of measure, press the **Dial** to select, then turn the **Dial** to display the preferred option. Press the **Dial** to enter the selection.

```

SETUP TOTALIZER:
FROM 02/18/10 01:00PM
TOTAL=21440 → [GAL]
-RESET TOTAL-  ↑
    
```

*Note: The TOTAL will be automatically converted to the equivalent unit measure.*

- Turn the **Dial** to choose RESET TOTAL. Press the **Dial** to reset the totalizer to 0. The previous date and time will be updated to the current date and time. All data will be logged beginning at this time and date.

```



SETUP TOTALIZER:
FROM 04/08/11 02:33PM
TOTAL=0 -CCF-
[RESET TOTAL] ←  ↑
    
```

## Setting the Communications Options

**Note:** The iCentral™ interface board and external antenna must be installed to access and utilize the following controller functions.

The Eagle Plus can take full advantage of the iCentral capabilities when equipped with the optional iCentral interface board and antenna. Additional functions include, remote programming, ZipET™ evapotranspiration data, and the Smart Alerts™, comprehensive alert messaging.

The straight-forward communication setup options include: Enable, Disable, and Test. The communications test checks signal strength and two-way communications with the iCentral. The 60-second test is monitored as it progresses. When testing has concluded, the relative signal strength is rated as: Excellent, Good, Fair, Poor, or None. In addition, a CSQ value from 0–32 is provided.

1. Press the **SETUP**  key to display the SETUP menu. Turn the **Dial** to choose COMM.
2. Press the **Dial** to display the SETUP COMMUNICATION screen. The ENABLED option is chosen by default.
3. Turn the **Dial** to select START, then press the **Dial** to initiate the test.
4. The count-down screen will be displayed.
  - To terminate the test, press the **BACK**  key.
  - The results will be displayed at the conclusion.

```
SETUP:  
-CONTROLLER- -FLOW-  
-PROGRAM-    →[COMM]  
-ET-         -TWO-WIRE-↑
```

```
SETUP COMMUNICATION:  
COMM[ENABLED] ←  
COMM CARD: PRESENT  
COMM TEST-START- ↑
```

```
SETUP COMMUNICATION:  
COMM-ENABLED -  
COMM CARD: PRESENT  
COMM TEST[START] ← ↑
```

```
COMMUNICATION TEST:  
TIME REMAINING: 53  
↑
```

```
COMMUNICATION TEST  
SIG STRENGTH: GOOD  
ICENTRAL TEST: PASS  
CSQ: 10  
↑
```

```
COMMUNICATION TEST  
SIG STRENGTH: POOR  
ICENTRAL TEST: FAIL  
CSQ: 1  
↑
```

**Note:** If the signal strength is NONE or POOR, and/the or the CSQ number is low, and/or FAIL is indicated, contact Rain Master technical support at 1-800-777-1477 for recommended troubleshooting procedures.

## Two-Wire Decoder System Setup

When the Eagle Plus is equipped with the Two-Wire Decoder interface board, access to the Two-Wire setup menu options become available. The setup functions for the Two-Wire Decoder system include:

- **Program Decoder** – Provides Decoder programming and setup options.
- **Show Stations** – Retrieves and displays current station address information.
- **Test** – Provides multiple test functions for Decoder station address verification.

*Note: If the decoder board is not installed or a hardware malfunction has occurred, the prompt screen shown at right will be displayed.*

```

SETUP TWO-WIRE
TWO-WIRE BOARD NOT
FUNCTIONING OR NOT
PRESENT.
  
```

### Programming the Decoders

Rain Master decoders are available in 1-, 2-, and 4-station output models, and as shipped from the factory, have no pre-defined station assignments. To be recognized by the Eagle Plus controller, each station must be addressed as either a station number from 0 – 200, a Master Valve, or a Pump control. To facilitate decoder programming, a quick-connect terminal block is provided on the Two-Wire Decoder board.

*Note: The Eagle Plus enables the decoders to be temporarily connected and programmed without disconnecting power. Confirm the Power LED on the Decoder board is illuminated before continuing. If it is not illuminated, confirm that power is on and the Decoder board is properly connected to Control Module.*

**⚠ CAUTION: Red and Black decoder wires must be connected to the decoder board terminal block in the correct orientation. Damage to the decoder and/or controller may result from crossing the wire connection.**

1. Insert the red and black decoder leads into the corresponding quick-release terminal connectors as indicated below.

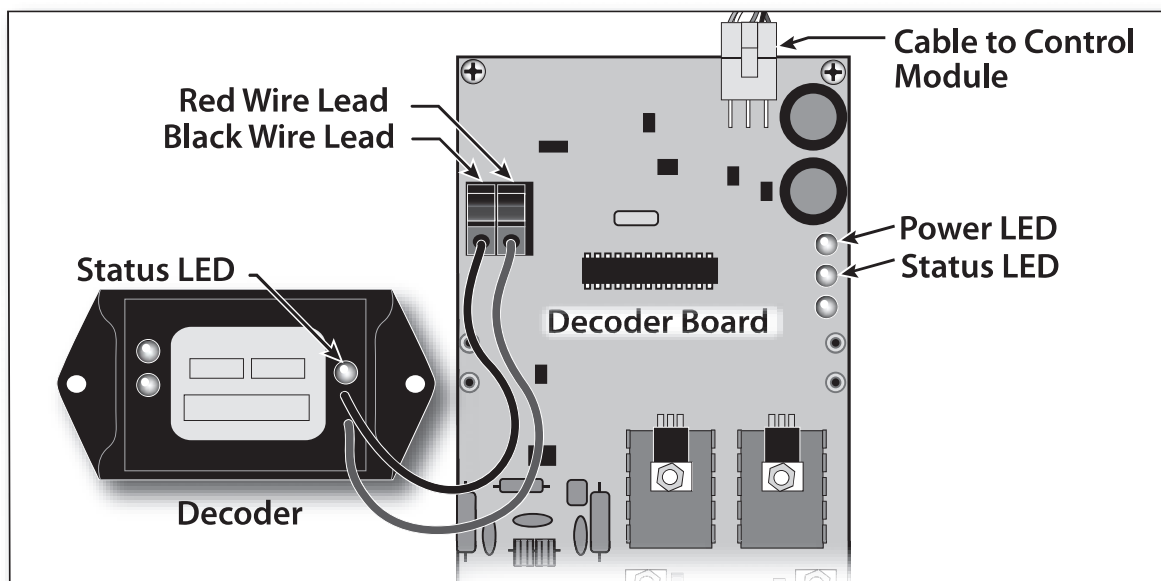

- Press the **SETUP**  key to display the SETUP menu. The CONTROLLER menu item is chosen by default. Turn the **Dial** right five steps to choose the TWO-WIRE menu option, then press the **Dial** to select.

```

SETUP:
-CONTROLLER-  -FLOW-
-PROGRAM-      -COMM-
-ET-           → [TWO-WIRE] ↑
    
```

- The SETUP TWO-WIRE menu screen is displayed with PROGRAM DECODER option chosen by default. Press the **Dial** to select. Status LEDs on the Decoder Board and Decoder should begin blinking to confirm communication.

```

SETUP TWO-WIRE
[PROGRAM DECODER] ←
-SHOW STATIONS-
-TEST-                ↑
    
```

**Note:** If the Decoder Status LED does not illuminate periodically, confirm the red and black lead wires are properly connected to the terminal block. A faulty decoder is indicated if the Status LED does not illuminate.

- The PROGRAM DECODER screen is displayed with the NEW ADDRESS option chosen.

**Note:** In this example, NONE indicates that decoder station slot 1 (of 4 available slots) has no programmed address.

```

PROGRAM DECODER:
CURRENT ADDRESS: NONE
NEW ADDRESS [NONE] ←
→ 1- OF 4 -PROGRAM- ↑
    
```

- To select a different decoder station slot number, turn the **Dial** to choose the slot number, then press the **Dial** to select. Turn the **Dial** to display the preferred number, then press the **Dial** to enter the selection.

```

PROGRAM DECODER:
CURRENT ADDRESS: NONE
NEW ADDRESS [NONE]
→ 2] OF 4 -PROGRAM- ↑
    
```

- Press the **Dial** to choose NEW ADDRESS. Turn the **Dial** to display the preferred address (001–200, MV, PMP or NONE), then press the **Dial** to enter. In this example, station number 12 will be assigned to decoder station slot 2 of 4.

```

PROGRAM DECODER:
CURRENT ADDRESS: NONE
NEW ADDRESS [012] ←
-2- OF 4 -PROGRAM- ↑
    
```

- Turn the **Dial** to choose PROGRAM, then press the **Dial** to begin the procedure. Within a few moments the results will be displayed. If programming was successful, OK will be momentarily displayed in the upper right corner, and the next decoder station number in sequence will be displayed. If programming was not successful, FAIL will be displayed and an Alarm will be generated.

```

PROGRAM DECODER:
CURRENT ADDRESS: NONE
NEW ADDRESS-012-
-2- OF 4 [PROGRAM] ← ↑
    
```

```

PROGRAM DECODER: OK ←
CURRENT ADDRESS: FAIL ↑
NEW ADDRESS-012-
-3- OF 4 [PROGRAM] ↑
    
```

**Note:** To clear the Alarm, refer to Resolving Alarms, page 52.

- Repeat the programming procedure for all decoder stations as required.

## Testing the Two-Wire Decoder System

The Two-Wire Decoder system test feature provides methods of testing the decoder installation to easily verify communication, station assignment and operating status and log the results. The following test options are available:

- **Single Station:** Tests a selected Decoder station number.
- **Find Decoders:** Searches communication path for all responding Decoders.
- **All Programmed:** Tests all decoder stations (1–200, Master Valve or Pump) that have been defined within a program.
- **All Stations:** Tests all decoder stations, Master Valve and Pump controls.
- **Alarm Logging Options:** Test results can be logged as Alarms indicating Pass and/or Fail as selected.
  - **Log Fail Alarm:** When selected, a decoder station that fails the test criteria will be logged.
  - **Log Pass Alarm:** When selected, a decoder station that passes the test criteria will be logged

### Single Station Test

1. Press the **SETUP**  key to display the SETUP menu. Turn the **Dial** to choose the TWO-WIRE option, then press the **Dial** to select.
2. The SETUP TWO-WIRE menu screen is displayed with the PROGRAM DECODER option chosen by default. Turn the **Dial** to choose the TEST option, then press the **Dial** to select.
3. The SETUP TWO-WIRE TEST screen is displayed with SINGLE STATION test type chosen by default.
4. Turn the **Dial** to choose the LOG FAILURES option. To change the current setting, press the **Dial** to select, then turn the Dial to display the preference. Repeat this procedure for the LOG PASS option as preferred.
5. Turn the **Dial** to choose GO, then press the **Dial** to continue.

```

SETUP:
--CONTROLLER-  --FLOW-
--PROGRAM-     --COMM-
-ET-           ->[TWO-WIRE]↑
    
```

```

SETUP TWO-WIRE
--PROGRAM DECODER-
--SHOW STATIONS-
[TEST]←↑
    
```

```

SETUP TWO-WIRE TEST
TYPE[SINGLE STATION]
LOG FAILURES-YES-←
LOG PASS-YES-  -GO-↑
    
```

```

SETUP TWO-WIRE TEST
TYPE-SINGLE STATION-
LOG FAILURES[NO ]←
LOG PASS-YES-  -GO-↑
    
```

```

SETUP TWO-WIRE TEST
TYPE-SINGLE STATION-
LOG FAILURES-NO -
LOG PASS-YES-   ->[GO]↑
    
```

- The SINGLE STATION TEST screen will be displayed with STATION 1 chosen by default.

To change the station selection, press the **Dial** to select, turn the **Dial** to display the preferred station number, then press the **Dial** to enter.

```
SINGLE STATION TEST
STATION[ 1]←
                    -GO-↑
```

- Turn the **Dial** to choose GO, then press the **Dial** to start the test.

*Note: The test will take approximately 3 minutes.*

```
SINGLE STATION TEST
STATION- 1-
                    →[GO]↑
```

- The test results will be displayed. Based on the Alarm Log options selected, an alarm may be generated.

*Note: To pause or stop the test, turn the Dial to choose STOP, then press the Dial to pause the test. To resume the test, press the Dial again.*

*To terminate the test, press the BACK  key.*

```
SETUP TWO-WIRE TEST:
TESTING STATION: 12
TESTING CURRENT: .18
VERSION: 0 →[STOP]↑
```

- Press the **HOME**  key to return to the Home screen. Turn the **Dial** to choose ALARMS, then press the **Dial** to review the Alarm screen.

```
WE 02:47:41P WK1 7.11
VALID PGM:NONE
-MAIN-[ALARMS( 1)]
```

- Turn the **Dial** to choose CLEAR, then press the **Dial** to clear the alarm.

*Note: Clearing alarms removes the screen prompts and turns off the Alarm LED indicator. Logged alarm information is accessed from the REVIEW menu screen.*

```
06/16 WE 02:48:01P
STATION 12
DECODER FOUND
                    [CLEAR] ↑
```

**Find Decoders Test**

- Press the **SETUP**  key to display the SETUP menu. Turn the **Dial** to choose the TWO-WIRE option, then press the **Dial** to select.

```
SETUP:
-CONTROLLER- -FLOW-
-PROGRAM-    -COMM-
-ET-        →[TWO-WIRE]↑
```

- The SETUP TWO-WIRE menu screen is displayed with the PROGRAM DECODER option chosen by default. Turn the **Dial** to choose TEST, then press the **Dial** to select.

```
SETUP TWO-WIRE
-PROGRAM DECODER-
[SHOW STATIONS]←
-TEST- ↑
```

- The SETUP TWO-WIRE TEST screen is displayed with SINGLE STATION test type chosen by default. Press the **Dial** to select, then turn the **Dial** to display FIND DECODERS.

```
SETUP TWO-WIRE TEST
TYPE[FIND DECODERS ]
LOG FAILURES-YES- →
LOG PASS-YES- -GO-↑
```



- Turn the **Dial** to choose the LOG FAILURES option. To change the current setting, press the **Dial** to select, then turn the **Dial** to display the preference. Repeat this procedure for the LOG PASS option as preferred.

```

SETUP TWO-WIRE TEST
TYPE-SINGLE STATION-
LOG FAILURES[NO ] ←
LOG PASS-YES- -GO- ↑
    
```

- Turn the **Dial** to choose GO, then press the **Dial** to begin the test.

**Note:** The test will take approximately 3 minutes.

```

SETUP TWO-WIRE TEST
TYPE-SINGLE STATION-
LOG FAILURES-NO -
LOG PASS-YES- → [GO] ↑
    
```

- The test results will be displayed. Based on the Alarm Log options selected, an alarm may be generated.

```

SETUP TWO-WIRE TEST:
TESTING STATION: 12
TESTING CURRENT: .18
VERSION: 0 → [STOP] ↑
    
```

**Note:** To pause or stop the test, turn the **Dial** to choose STOP, then press the **Dial** to pause the test. To resume the test, press the **Dial** again. To terminate the test, press the **BACK**  key.

```

WE 02:47:41P WK1 7.00
VALID PGM:NONE
-MAIN-[ALARMS( 1)]
    
```

- Press the **HOME**  key to return to the Home screen. Turn the **Dial** to choose ALARMS, then press the **Dial** to review the Alarm screen.

### All Stations Test

**Note:** To run the ALL STATIONS test, refer to the FIND DECODERS test procedure on the previous page. Select the ALL STATIONS option in lieu of FIND DECODERS in step 3.

### Show Stations

- Press the **SETUP**  key to display the SETUP menu. Turn the **Dial** to choose the TWO-WIRE option, then press the **Dial** to select.

```

SETUP:
-CONTROLLER- -FLOW-
-PROGRAM- -COMM-
-ET- → [TWO-WIRE] ↑
    
```

- The SETUP TWO-WIRE menu screen is displayed with the PROGRAM DECODER option chosen by default. Turn the **Dial** to choose SHOW STATIONS, then press the **Dial** to begin.



```

SETUP TWO-WIRE
-PROGRAM DECODER-
[SHOW STATIONS] ←
-TEST- ↑
    
```

**Note:** The test will take approximately 3 minutes.

```

CALCULATING
    
```

- The controller will search for all stations assigned to any of the 16 watering programs. The results will be display on one or more sequential screens Press the **NEXT**  and **BACK**  keys to access and review the screens.

```

SHOW PROGRAMMED
TWO-WIRE STATIONS:
1, 3, 5, 7, 10-37, 40, 44
49-57, 59-83, 87-108 ↓
    
```

## Programming for Automatic Operation

The Eagle Plus enables you to define up to 8 automatic programs for a conventional control system, or up to 16 programs for a decoder system.

A program is comprised of the following three primary operating parameters that must be established to create a valid program:

- An active day schedule
- A program start time
- A station run time.

The operating options selected within the various Setup menus are applied to the programs to further define and regulate controller operations.

**⚠ IMPORTANT: A program becomes valid only after all three primary operating parameters have been entered. Once a valid program is entered, all user-defined program values will remain intact. Failing to enter all three parameters correctly, or prior to the display timing-out, will invalidate that program. It is recommended to always confirm the valid program status whenever creating or modifying programs.**

### Creating a New Program

#### Setting a Two-Week Watering Schedule

1. Press the **PROGRAM**  key to display the PROGRAM menu. The MODIFY menu item is chosen by default. Turn the **Dial** to choose the NEW option, then press the **Dial** to select.
2. The NEW PROGRAM screen is displayed with the program number chosen by default. To change the program number assignment, press the **Dial** to select, then turn the **Dial** to change the program number. Press the **Dial** to enter the selection.
3. Turn the **Dial** to choose CREATE PROGRAM, then press the **Dial** to select.

**Note:** If the program number selected is already an established (valid) program, a prompt screen will be displayed. Selecting YES will overwrite the existing program; selecting NO will leave the program unchanged. Repeat Step 2 and 3 to select an available program number, then continue to Step 4.

```
PROGRAM:
-MODIFY-  [NEW] ←
-REVIEW-  -DELETE-
-COPY-                                         ↑
```

```
NEW PROGRAM → [ 3 ]
VALID PGM: 1-3
-CREATE PROGRAM-                               ↑
```

```
NEW PROGRAM    - 3-
VALID PGM: 1-3

[CREATE PROGRAM] ← ↑
```

```
ARE YOU SURE YOU
WANT TO DELETE
EXISTING PROGRAM  3?
-YES- [NO] ←     ↑
```

4. The two-week schedule screen is displayed with S (Sunday) of W1 (Week 1) chosen by default.
5. To select the day, press the **Dial** (an X will appear), or to skip the day, turn the **Dial** to the preferred day, then press the **Dial** to select. **Note:** Pressing the **Dial** repeatedly toggles the selection ON and OFF.
6. Continue to define the remaining days of the two-week schedule in this manner. **Note:** The asterisk next to W1 or W2 indicates the current week of the two-week watering cycle and is not pertinent to the programming procedure.
7. When the two-week schedule is set, select OK, or press the **NEXT**  key to display the START TIME setup screen.

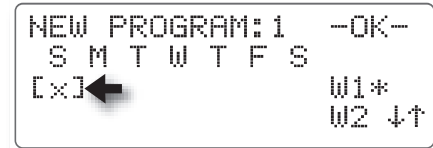
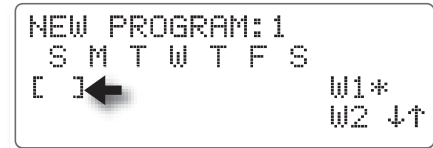

### Setting a Skip-Day Watering Schedule

**Note:** The **Skip Days** scheduling option will not be available for the selected program unless it is initially assigned to the program within the **Program Setup** menu > **Type** options. See page 20 for **Skip Day** information and setup procedures.

1. Turn the **Dial** to choose the SKIP DAYS value. Press the **Dial** to select, then turn the **Dial** to display the number of days between active watering days (0–30). Press the **Dial** to enter. **Note:** To water every day, select 0. To water every-other-day, select 1, etc.
2. Turn the **Dial** to choose the START delay value. Press the **Dial** to select, then turn the **Dial** to display the number of days before starting the skip day cycle (0–30). Press the **Dial** to enter. **Note:** To start the watering day cycle today select 0; to start tomorrow select 1, etc.
3. When the SKIP DAY setup values are set, select OK, or press the **NEXT**  key to display the START TIME setup screen.

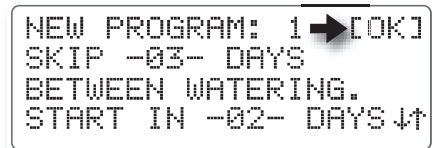
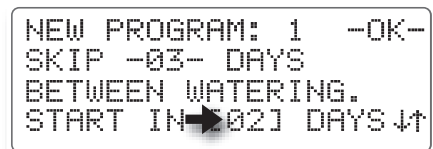
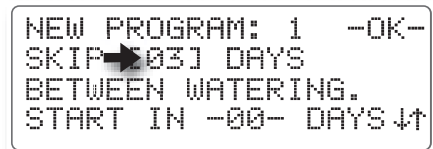

**Setting Program Start Times**

1. Each program can have up to 8 start time assignments. START TIME 1 is selected by default.
2. Turn the **Dial** to choose HH:MM. The start time will default to 12:00AM with the hour digits selected (blinking).
3. Turn the **Dial** to set the start time hour, then press the **Dial** to enter. The minutes digits will begin blinking. Set the start time minutes and AM/PM designator in the same manner.
4. START TIME 2 is prompted as START TIME 1 is entered. Continue to assign up to 8 start times for this program as preferred.
5. When finished, choose and select OK, or press the **NEXT**  key to display the STATION RUN TIME setup screen.

```
NEW PROGRAM: 1
TOTAL START TIMES:1
START TIME[1]←
-HH:MM - -DELETE-↓↑
```

```
NEW PROGRAM: 1
TOTAL START TIMES:0
START TIME-1-
[12:00AM]←DELETE-↓↑
```

```
NEW PROGRAM: 1 -OK-
TOTAL START TIMES:0
START TIME-1-
[ 6:15AM]←DELETE-↓↑
```

```
NEW PROGRAM: 1 -OK-
TOTAL START TIMES:1
START TIME-2-
[HH:MM ]←DELETE-↓↑
```

*Note: To clear the displayed start time, choose and select the DELETE option.*

**Assigning the Station Run Time**

*Note: If the CYCLE AND SOAK option was selected for the program, continue at Setting a Cycle and Soak Station Run Time on the next page.*

1. STATION 1 is selected by default. To change the station number, press the **Dial** to select. Turn the **Dial** to display the preferred station number, then press the **Dial** to enter the selection.
2. Turn the **Dial** to choose the station run time value, then press the **Dial** to select. The hours digit is selected and will begin blinking.
3. Turn the **Dial** to display the preferred run time hours (0–23), then press the **Dial** to enter. The minutes digits will be selected. Turn the **Dial** to select the run time minutes (0–59), then press the **Dial** to enter.
4. The next station number in sequence will be prompted. Continue to assign additional stations to this program as preferred.

```
NEW PROGRAM: 1
STATION [ 1]←
RUNTIME-00:00- ↓↑
```

```
NEW PROGRAM: 1
STATION - 1-
RUNTIME[ 0:00]← ↓↑
```

```
NEW PROGRAM: 1
STATION- 1-
RUNTIME[ 1:15]← ↓↑
```

```
NEW PROGRAM: 1 [OK]
STATION- 2-←
RUNTIME-00:00- ↓↑
```

5. Press the **NEXT**  key to display the PROGRAM summary screen.

***Note:** If the program is not valid, press the **BACK**  key to recall, correct, and/or adjust the various program setup parameters as necessary. When the summary screen indicates that the program is valid, choose and select OK.*

```
PROGRAM: 1 NOT VALID
TOTAL RUNTIME: 00:00
                [OK] ↑
```

```
PROGRAM: 1 IS VALID
TOTAL RUNTIME: 06:45
                → [OK] ↑
```

### Setting a Cycle and Soak Station Run Time

***Note:** The Cycle and Soak scheduling option will not be available for the selected program unless it is initially assigned to the program within the PROGRAM SETUP> TYPE menu. See page 20 for the Cycle and Soak setup procedure.*

1. Station 1 is selected by default. To change the station number, press the **Dial** to select. Turn the **Dial** to display the preferred station number, then press the **Dial** to select.

```
NEW PROGRAM: 1
STATION[ 1 ] ←
MAX-0:00-SOAK-0:00-
RUNTIME-00:00-   ↓↑
```

**⚠ Important:** Any station assigned to the program with a 0:00 MAX or SOAK time value will not operate during the program watering cycle.

2. Turn the **Dial** to choose the MAX run time value, then press the **Dial** to select. The hour digit is selected and will begin blinking. Turn the **Dial** to display the run time (0–9 hours), then press the **Dial** to select.

```
NEW PROGRAM: 1
STATION- 1-
MAX[ 1:00 ] SOAK-0:00-
RUNTIME-00:00-   ↓↑
```

3. The minutes digits will be selected (blinking). Turn the **Dial** to select the run time minutes (0–59), then press the **Dial** to enter.

```
NEW PROGRAM: 1
STATION- 1-
MAX[ 1:05 ] SOAK-0:00-
RUNTIME-00:00-   ↓↑
```

4. Turn the **Dial** to choose the SOAK time value, then press the **Dial** to select. The hour digit is selected and will begin blinking. Turn the **Dial** to display the soak time (0–9 hours), then press the **Dial** to select.

```
NEW PROGRAM: 1
STATION- 1-
MAX- 1:05-SOAK[ 2:00 ]
RUNTIME-00:00-   ↓↑
```

5. The minutes digits will be selected. Turn the **Dial** to select the RUN TIME minutes (0–59), then press the **Dial** to enter.

```
NEW PROGRAM: 1
STATION- 1-
MAX- 1:05-SOAK[ 2:30 ]
RUNTIME-00:00-   ↓↑
```

6. Turn the **Dial** to choose the RUN TIME value, then press the **Dial** to select. The hours digits are selected and will begin blinking. Turn the **Dial** to display the run time (0–23 hours), then press the **Dial** to enter. The minutes digits will be selected.

```
NEW PROGRAM: 1
STATION- 1-
MAX-1:05-SOAK-2:30-
RUNTIME[00:00]  ↓↑
```

7. Turn the **Dial** to select the RUN TIME minutes (0–59), then press the **Dial** to enter the selection.

```
NEW PROGRAM: 1
STATION- 1-
MAX-1:05-SOAK-2:30-
RUNTIME[04:50]  ↓↑
```

8. The next station number in sequence will be prompted. Continue to assign additional stations to this program as preferred. When finished, choose and select OK, or press the **NEXT**  key to display the PROGRAM summary screen.

```
NEW PROGRAM: 1  -OK-
STATION- 2- ←
MAX-0:00-SOAK-0:00-
RUNTIME[00:00]  ↓↑
```

***Note:** The Program summary screen enables you to quickly verify the status and total run time of the program. If the program is not valid, press the **BACK**  key to recall, correct and/or adjust the various program setup parameters as necessary.*

```
PROGRAM: 1 NOT VALID
TOTAL RUNTIME:00:00
                [OK] ↑
```

```
PROGRAM: 1 IS VALID
TOTAL RUNTIME:06:45
                →[OK] ↑
```

9. When finished, choose and select OK to complete the setup requirements for the selected program.

## Modifying a Program

The Modify Program feature provides a convenient way to access and adjust any parameter of an established program including:

- **Days** – Two-Week and Skip Days schedules
- **Runtime** – Station run time assignment
- **Start** – Start time assignments
- **Percent** – Run Time adjustment by percentage for all assigned stations.

1. Press the **PROGRAM**  key to display the PROGRAM menu. The MODIFY menu item is chosen by default. Press the **Dial** to select.
2. The program number is chosen by default. To change the program number assignment, press the **Dial** to select, then turn the **Dial** to display the preferred number. Press the **Dial** to enter the selection.
3. Turn the **Dial** to choose a portion of the program to be modified. Press the **Dial** to display the initial modification screen.

```
PROGRAM:
[MODIFY]←--NEW-
--REVIEW-- --DELETE-
--COPY--                                     ↑
```

```
MODIFY PROGRAM[1]←
--DAYS--      --RUNTIME--
--START--     --PERCENT--
                                               ↑
```

```
MODIFY PROGRAM-1-
[DAYS]←      --RUNTIME--
--START--     --PERCENT--
                                               ↑
```

**Note:** The PROGRAM setup options defined for DAYS, STATION RUN TIMES and START TIMES are utilized for the modification procedures. To assist in the modification process, refer to the corresponding PROGRAM SETUP procedures, beginning on page 36

### Adjusting Program Percent Value

To account for changes in season or weather, the total operating duration for any established program cycle time can be easily increased or decreased by a percentage factor from 0%–300%, in 1% increments. The run time for each station assigned to the program will be modified by the percentage change.

**⚠ IMPORTANT:** Increasing the program cycle duration can result in a conflict with other scheduled watering programs and/or the defined Water Window duration. The recommended method of increasing run time by percentage is to make small, incremental changes while monitoring the results over a period of time.

1. From the MODIFY PROGRAM menu screen, turn the **Dial** to choose PERCENT, then press the **Dial** to select.
2. Turn the **Dial** to choose the PERCENT value. Press the **Dial** to select, then turn the **Dial** to display the preferred percent value (0–300). Press the **Dial** to enter the selection.
3. Repeat procedure for each program as needed.



### Deleting a Program

The Delete Program feature provides a convenient method of accessing and clearing all established operating parameters from a specified program.

1. Press the **PROGRAM**  key to display the PROGRAM menu. Turn the **Dial** to choose the DELETE option, then press the **Dial** to select.
2. Turn the **Dial** to choose the PROGRAM number. Press the **Dial** to select, then turn the **Dial** to display the PROGRAM number to delete. Press the **Dial** to enter the selection.
3. A decision screen will be prompted with the YES option chosen. To complete the Delete function, press the **Dial** to enter YES. To abort the Delete function and return to the previous screen, choose and select the NO option.

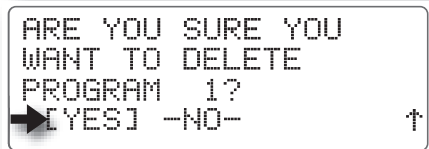
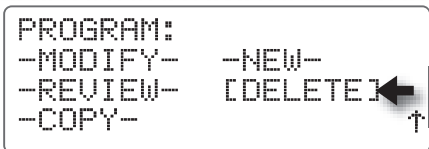



## Copying a Program or Runtime

The Copy function provides a convenient method of transferring all program setup parameters\* from one program to another, or to apply a specific station run time to multiple stations. When setting up multiple programs with similar attributes, the copy functions will not only reduce the setup time by eliminating redundant tasks, but will help ensure consistency throughout the overall watering program setup structure.

**\*Note:** Program attributes include: watering day schedule, station run time, cycle and soak time, start times and percent adjust factor.

### To Copy a Program:

1. Press the **PROGRAM**  key to display the PROGRAM menu. Turn the **Dial** to choose the COPY option, then press the **Dial** to select.

```
PROGRAM:
-MODIFY-  -NEW-
-REVIEW-  -DELETE-
[ COPY ] ← ↑
```

2. Turn the **Dial** to choose the **Copy Program** option, then press the **Dial** to select.

```
COPY FUNCTION:
[ COPY PROGRAM ] ← ↑
-COPY RUNTIME-
```

3. Press the **Dial** to choose the COPY PROGRAM number. Press to select, then turn the **Dial** to display the PROGRAM number to be copied from. Press the **Dial** to enter the selection.

```
COPY PROGRAM [ 1 ]
          TO
PROGRAM [ 1 ] ← ↑
          -OK-
```

4. Turn the **Dial** to choose the TO PROGRAM number. Press to select, then turn the **Dial** to display the recipient program number. Press the **Dial** to enter the selection.

```
COPY PROGRAM- 1-
          TO
PROGRAM [ 2 ] ← ↑
          -OK-
```

5. Turn the **Dial** to choose OK, then press the **Dial** to enter the selection.

```
COPY PROGRAM- 1-
          TO
PROGRAM [ 2 ] ← ↑
          [ OK ]
```

**Note:** A decision screen will be prompted with the OK option chosen by default.

To complete the Copy function, press the Dial to begin the Copy function. To abort the Copy function and return to the previous screen, choose and select the CANCEL option.

```
WARNING: PROGRAM 2
WILL BE OVERWRITTEN
→ [ OK ] -CANCEL- ↑
```

6. Upon completion of the copy function, the initial COPY FUNCTION screen will be displayed. Repeat the procedure for additional programs as preferred.

```
COPY FUNCTION:
[ COPY PROGRAM ]
[ COPY RUNTIME ] ↑
```

**To Copy a Run Time:**

1. Press the **PROGRAM**  key to display the PROGRAM menu. Turn the **Dial** to choose the COPY option, then press the **Dial** to select.

```
PROGRAM:
-MODIFY-  -NEW-
-REVIEW-  -DELETE-
[COPY]← ↑
```

2. Turn the **Dial** to choose the COPY RUNTIME option, then press the **Dial** to select.

```
COPY FUNCTION:
[COPY PROGRAM]
[COPY RUNTIME]← ↑
```

3. The COPY RUN TIME screen is displayed with the run time value chosen. Press the **Dial** to select, then turn the **Dial** to display the preferred run time hours (0–23). Repeat to select the run time minutes (0–59).

```
COPY RUNTIME[00:15]
TO PROGRAM- 1- ↑
BEGIN STATION- 1-
END STATION- 1-OK-↑
```

4. Turn the **Dial** to choose TO PROGRAM. Press the **Dial** to select, then turn the **Dial** to display the recipient program number. Press the **Dial** to enter the selection.

```
COPY RUNTIME-00:15-
TO PROGRAM[ 1]←
BEGIN STATION- 1-
END STATION- 1-OK-↑
```

*Note: All station numbers, inclusive from the BEGIN and END station numbers entered, will receive the specified run time assignment.*

5. Turn the **Dial** to choose BEGIN STATION. Press the **Dial** to select, then turn the **Dial** to display the preferred beginning station number. Press the **Dial** to enter the selection.

```
COPY RUNTIME-00:15-
TO PROGRAM- 1-
BEGIN STATION[ 9]←
END STATION- 1-OK-↑
```

6. Turn the **Dial** to choose END STATION. Press the **Dial** to select, then turn the **Dial** to display the preferred station number. Press the **Dial** to enter the selection.

```
COPY RUNTIME-00:15-
TO PROGRAM- 1-
BEGIN STATION- 9-
END STATION[ 18]←↑
```

7. Turn the **Dial** to choose OK, then press **Dial** to begin the Copy function.

```
COPY RUNTIME-00:15-
TO PROGRAM- 1-
BEGIN STATION- 9-
END STATION- 18[OK]↑
```

8. Upon completion of the copy function, the initial COPY FUNCTION screen will be displayed. Repeat the procedure for additional programs as preferred.

```
COPY FUNCTION:
[COPY PROGRAM]
[COPY RUNTIME]← ↑
```

## Review Mode

The Review mode feature provides a convenient method of accessing all current controller program structure information, as well as historical records of prior irrigation activity, flow rates and ET values and wireless communications activity.



The REVIEW menu options include direct **Program** setup parameters, historical data logs for **Irrigation** activity, **Alarm** events, **Flow** rates, **ET** values, iCentral **Communication** protocol data and **S/W** (controller configuration).

*Note: All information displayed on the Review screens is provided for reference and evaluation only. No changes or deletions to programming, operating, configuration or Alarm events can be made while the controller is in the Review mode.*

### Program Review

The Program review screens, accessible from both the PROGRAM and REVIEW menus, access the following information for each irrigation program:

- Total program run time duration
- Program run time Adjust % factor
- Active watering day schedule
- Total assigned start times
- Total assigned station numbers
- Individual station run time assignment
- Cycle and Soak duration time (when applicable)

1. Press the **REVIEW**  key to display the REVIEW menu. The PROGRAM option is chosen by default.
2. Press the **Dial** to select. The REVIEW PROGRAM screen is displayed with the PROGRAM number chosen. Press the **Dial** to select, then turn the **Dial** to display the preferred program number. Press the **Dial** to enter the selection.
3. Press the **NEXT**  and **Back**  keys to navigate through the sequence of PROGRAM REVIEW screens.

```
PROGRAM:
-MODIFY-  -NEW-
[REVIEW]← -DELETE-
-COPY-      ↑
```



```
REVIEW:
[PROGRAM]← -ALARM-
-IRRIGATION- -FLOW-
-COMM-  -ET-  -S/W- ↑
```

```
REVIEW PROGRAM 11←
TOTAL STATIONS: 7
TOTAL RUNTIME:
2 HRS 24 MINUTES ↕
```

*Note: The PROGRAM number option is provided on the top line of each review screen to access information for any program as preferred.*

**Alarm Review**

The alarm event archive will retain a maximum of 220 records. All alarm events are stored in chronological first-in, first-out order. When the archive reaches capacity, the oldest event record drops off as a new record enters.



1. Press the **REVIEW**  key to display the REVIEW menu. The PROGRAM option is chosen by default. Turn the **Dial** to choose ALARM, then press the **Dial** to select.
2. The alarm archive screen will be displayed with a summary the last Alarm event. Press the **NEXT**  and **BACK**  keys to navigate through the sequence of review screens.

```
REVIEW:
-PROGRAM-   → [ALARM]
-IRRIGATION- -FLOW-
-COMM-      -ET-  -S/W- ↑
```

```
01/02 FR 10:23:37AM
STATION 147
DECODER NOT FOUND
↓↑
```

**Communication Review Screens**

*Note: COMM review information (listed on four consecutive screens) provides comprehensive technical data pertaining to wireless communications configuration and activity.*

1. Press the **REVIEW**  key to display the REVIEW menu. The PROGRAM option is chosen by default. Turn the **Dial** to choose COMM, then press the **Dial** to select.
2. Press the **NEXT**  key to access the remaining review screen sequence.

```
REVIEW:
-PROGRAM-      -ALARM-
-IRRIGATION-   -FLOW-
[COMM] ← -ET-  -S/W- ↑
```

```
REVIEW COMM
S8901260580015370817
MDM S/N:50399736
→ [MORE] ↓↑
```

**Flow Review**

The Flow data archive retains up to 12 months of data records and compiled for review by month. The first of two review screens provides the selections for month and display units, with the total flow represented for each of two flow sensors. The second screen displays the sum total for both flow sensors.

1. Press the **REVIEW**  key to display the REVIEW menu. The PROGRAM option is chosen by default. Turn the **Dial** to choose FLOW, then press the **Dial** to enter the selection.
2. The initial REVIEW FLOW screen is displayed with flow data for the current month. To change the month, press the **Dial** to select, then turn the **Dial** to display the preferred month. Press the **Dial** to enter the selection.
3. To use alternate display UNITS, turn the **Dial** to choose UNITS. Press the **Dial** to select, then turn the **Dial** to display the preference. Press the **Dial** to enter the selection.

```
REVIEW:
-PROGRAM-      -ALARM-
-IRRIGATION- → [FLOW]
-COMM-      -ET-  -S/W- ↑
```

```
REVIEW FLOW: [JUN] ←
UNITS-GALLONS -
FLOW1=XXXXXXXX
FLOW2=XXXXXXXX
↓↑
```



```
REVIEW FLOW: -JUN-
UNITS[GALLONS] ←
FLOW1=XXXXXXXX
FLOW2=XXXXXXXX
↓↑
```

4. Press the **NEXT** key access the second review screen displaying the flow data total for both sensors (if applicable). The same preference options for MONTH and UNITS are provided.

```
REVIEW FLOW: [JUN] ←
UNITS-GALLONS ←
TOTAL F1+F2=XXXXXXXX
                ↓↑
```

### Irrigation Review

A record of the last 25 automatic irrigation programs are stored in chronological order with the latest event displayed first. When the archive reaches capacity, the earliest event record is deleted as a new event is recorded.

1. Press the **REVIEW**  key to display the REVIEW menu. The PROGRAM option is chosen by default. Turn the **Dial** to choose IRRIGATION, then press the **Dial** to select.
2. A summary of the most recent operation is displayed. Press the **NEXT**  and **BACK**  keys to navigate through the review screens.

```
REVIEW:
-PROGRAM-      -ALARM-
[IRRIGATION] ← -FLOW-
-COMM- -ET- -S/W- ↑
```

```
PROGRAM 1 START
06/03 TH 01:45AM
END
06/03 TH 03:15AM ↓↑
```

### Configuration Review

1. Press the **REVIEW**  key. Turn the **Dial** to choose S/W, then press the **Dial** to select.

A summary of the current configuration is provided.



```
REVIEW:
-PROGRAM-      -ALARM-
-IRRIGATION-   -FLOW-
-COMM- -ET- [S/W] ←↑
```

```
REVIEW CONFIGURATION
TYPE: CONVENTIONAL
FIRMWARE: V0.0.0
MAX STATION: 48 ↑
```

### ET Review

All ET data provided to the controller via the Internet or a Weather Center II weather station is retained for a rolling 14-day period.

The ET data received via the Internet (HISTORIC) is displayed in inches and sent to the controller at midnight of the current day. ET data received from the weather station (WXSTATION) is displayed as a number of pulses accumulated by the weather station since midnight.

1. Press the **REVIEW**  key to display the REVIEW menu. The PROGRAM option is chosen by default. Turn the **Dial** to choose ET, then press the **Dial** to select.
2. Press the **Dial** to advance or press the **BACK**  key to retract the review screen sequence.

```
REVIEW:
-PROGRAM-      -ALARM-
-IRRIGATION-   -FLOW-
-COMM- → [ET] -S/W- ↑
```

```
ET: SOURCE=HISTORIC
01/06 ET=.10
01/05 ET=.10
01/04 ET=.10 [MORE] ←
```

## Manual Watering Operations

The Eagle Plus features a full complement of manual control options enabling the irrigation system to be operated whenever and however supplemental watering is preferred.

The manual control options enable you to operate the system by:

- STATION – Operate an individual station for a specified run time.
- PROGRAM – Operate specified watering program(s).
- MULTI-STATION – Operate up to six stations simultaneously for a specified run time.
- TEST – Operate a specified group of stations in numeric sequence for a specified run time.

*Note: When stations or programs are selected for manual operation, the controller determines if there is an association with the Master Valve and/or Pump output. If an association exists with any selected station or program, the Master Valve and/or Pump output will be activated during the manual operation. In Multi-Station manual mode, the Master Valve and/or Pump output can be selected independently as preferred.*

### Manual Station Operation

1. Press the **MANUAL**  key to display the MANUAL OPERATIONS menu screen. The STATION option is selected by default.
2. Press the **Dial** to select. The STATION number option is chosen by default. Press the **Dial** to select, then turn the **Dial** to display the preferred number. Press the **Dial** to select.
3. Turn the **Dial** to choose the RUNTIME value. Press the **Dial** to select, then turn the **Dial** to display the hour digits (00–23). Press the **Dial** to select, then turn the **Dial** to display the minutes digits (00–59). Press the **Dial** to enter the selection.
4. Turn the **Dial** to choose START, then press the **Dial** to begin the manual operation. The MANUAL OPERATIONS status screen will be displayed.

```
MANUAL OPERATIONS:  
[STATION]←PROGRAM-  
-MULTI STATION-  
-TEST-
```

```
MANUAL OPERATIONS:  
STATION- 1-  
RUNTIME[01:25]←  
-START- ↑
```

```
MANUAL OPERATIONS:  
STATION- 1-  
RUNTIME[01:25]←  
-START- ↑
```

```
MANUAL OPERATIONS:  
STATION- 1-  
RUNTIME-01:25-  
[START]← ↑
```

5. Three manual control options are provided on the status screen:

- STOP - Toggles station operation OFF and ON.
- NEXT - Turns off the current station, resets the run time, and turns on the next station in numeric sequence.
- PREVIOUS - Turns off the current station and turns on the previous station in numeric sequence.

```
STATION: 1 01:24:58
MVALUE:ON PUMP:OFF
          →[STOP]
-NEXT- -PREVIOUS- ↑
```

Turn the **Dial** to choose the control option, then press the **Dial** to select.

6. When finished, press the **HOME**  key to return to the HOME screen.

**Manual Program Operation**

1. Press the **MANUAL**  key to display the MANUAL OPERATIONS menu screen. The STATION option is selected by default.

```
MANUAL OPERATIONS:
[STATION]←PROGRAM-
-MULTI STATION-
-TEST-
```

2. Turn the **Dial** right one step to choose PROGRAM. Press the **Dial** to select. The next MANUAL OPERATIONS screen in sequence will be displayed

```
MANUAL OPERATIONS:
-STATION- [PROGRAM]
-MULTI STATION- →
-TEST-
```

3. The PROGRAM number option is chosen by default. Press the **Dial** to select, then turn the **Dial** to display the preferred number. Press the **Dial** to select.

```
MANUAL OPERATIONS:
PROGRAM [1]←
-START-
↑
```

4. Turn the **Dial** to choose START, then press the **Dial** to begin the manual operation. The MANUAL OPERATIONS status screen will be displayed.

```
PROGRAM 1
STATION: 1 00:58:01
MVALUE:ON PUMP:OFF
          →[STOP]
```

**Note:** Selecting STOP displays a decision screen. Manual operation will not be terminated unless the YES option is selected. Selecting YES will terminate any additional programs in the queue. Selecting NO steps back to the status screen.

5. When finished, press the **HOME**  key to return to the HOME screen.

```
ARE YOU SURE YOU
WANT TO ABORT THE
CURRENT PROGRAMS?
[YES]←NO-
```

**Manual Multi-Station Operation**

1. Press the **MANUAL**  key to display the MANUAL OPERATIONS menu screen. The STATION option is selected by default.
2. Turn the **Dial** right two steps to choose MULTI-STATION. Press the **Dial** to select. The next screen in sequence will be displayed.
3. The MANUAL STATION number is chosen by default. Press the **Dial** to select, then turn the **Dial** to display a STATION number, MV or PMP to be included in the operation. Press the **Dial** to enter the selection.
4. Repeat this procedure to include up to five additional outputs. The selections are displayed as they are entered.

***Note:** To clear the current station list, select CLR (located between PMP and 1), then press the **Dial** to refresh the screen.*

5. Turn the **Dial** to choose the RUNTIME value. Press the **Dial** to select, then turn the **Dial** to display the hour digits (00–23). Press the **Dial** to select, then turn the **Dial** to display the minutes digits (00–59). Press the **Dial** to enter the selection.
6. Turn the **Dial** to choose START, then press the **Dial** to begin the manual operation. The status screen will be displayed indicating the station list and the remaining run time. To terminate the operation, press the **Dial** to select STOP.

***Note:** If flow sensing is operational, the indicated total flow will be displayed in the status screen.*

7. When finished, press the **HOME**  key to return to the HOME screen.

```
MANUAL OPERATIONS:
[STATION]←PROGRAM-
-MULTI STATION-
-TEST-
```

```
MANUAL OPERATIONS:
-STATION- -PROGRAM-
[MULTI STATION]←
-TEST-
```

```
MANUAL STATION:[ 1]
RUNTIME-00:00-
STATIONS:1
-START-↑
```

```
MANUAL STATION:[ 11]
RUNTIME-00:00-
STATIONS:1-3,6,9,11
-START-↑
```

```
MANUAL STATION:[CLR]
RUNTIME-00:00-
STATIONS:NONE
-START-↑
```

```
MANUAL STATION:- 11-
RUNTIME[00:20]←
STATIONS:1-3,6,9,11
-START-↑
```

```
MANUAL STATION:- 11-
RUNTIME-00:20-
STATIONS:1-3,6,9,11
-START-↑
```

```
STATIONS:1-3,6,9,11
00:20:07
FLOW=1747 GPM [STOP]
↑
```



### Manual Test Functions

The manual Test function enables a group of stations to be selected and operated in numeric order for a specified run time.

1. Press the **MANUAL**  key to display the MANUAL OPERATIONS menu screen. The STATION option is selected by default.
2. Turn the **Dial** right three steps to choose TEST. Press the **Dial** to select. The next screen in sequence will be displayed.
3. The beginning station number of the test group is chosen by default. Press the **Dial** to select, then turn the **Dial** to display the preferred station number. Press the **Dial** to enter the selection.
4. Turn the **Dial** to choose the group ending station number\*. Press the **Dial** to select, then turn the **Dial** to display the preferred station number. Press the **Dial** to enter the selection.

*\*Note: The ending station number will be limited to the controller station count configuration.*

5. Turn the **Dial** to choose the RUN TIME value. Press the **Dial** to select, then turn the **Dial** to display the preferred run time duration from 01–59 minutes. Press the **Dial** to enter the selection.
6. Turn the **Dial** to choose START, then press the **Dial** to begin the manual operation.
7. Three manual control options are provided on the status screen:
  - STOP - Toggles station operation OFF and ON.
  - NEXT - Turns off the current station, resets the run time, and turns on the next station in numeric sequence.
  - PREVIOUS - Turns off the current station and turns on the previous station in numeric sequence.

Turn the **Dial** to choose the control option, then press the **Dial** to select.

8. When finished, press the **HOME**  key to return to the HOME screen.

```
MANUAL OPERATIONS:
[STATION]←PROGRAM-
-MULTI STATION-
-TEST-
```

```
MANUAL OPERATIONS:
-STATION- -PROGRAM-
-MULTI STATION-
[TEST]←
```

```
MANUAL TEST OF
STATION[ 9]←TO- 48-
RUN TIME-01-MINS
          -START-↑
```

```
MANUAL TEST OF
STATION- 9- TO[ 18]
RUN TIME-01-MINS
          -START-↑
```

```
MANUAL TEST OF
STATION- 9- TO- 18-
RUN TIME[05]MINS
          ↑ -START-↑
```

```
MANUAL TEST OF
STATION- 9- TO[ 18]
RUN TIME-05-MINS
          →[START]↑
```

```
STATION: 1 01:24:58
MVALUE:ON PUMP:OFF
          →[STOP]
-NEXT- -PREVIOUS- ↑
```

## Alarms Feature

The Alarms feature provides important, timely information regarding a condition or event that requires user attention. Whenever one or more alarm conditions occur, the Alarm LED indicator illuminates and is accompanied by a brief description of the root cause. An optional “chirp” tone can be enabled that will sound once every six seconds until the alarm notices have been cleared. Clearing alarm notices is important since a pending alarm condition may affect future automatic irrigation.

**⚠ IMPORTANT: Depending on the cause of the alarm, clearing the alarm notification does not necessarily resolve or eliminate the root cause.**

All alarm events are archived in a read-only buffer as they occur. The archive stores up to 220 Alarm events and cannot be emptied. Alarms are compiled in chronological order with the most recent event displayed first. Once the buffer is full, the oldest event drops off as a new one enters. The Alarm archive is accessed from REVIEW menu screen.

### About Field Wire and Flow Alarms

**Field Wire Fault Detection:** The Eagle Plus can detect a short in the field wire and instantly turn off that station. The controller will automatically advance from the faulty station to the next programmed station during a watering cycle.

The display will report the fault condition any time a field wire fault occurs. Additionally, the Alarm LED indicator will illuminate and the audible alert (when enabled) will sound until all Alarms are cleared.

**Flow Detection:** When operating in conjunction with one or two system flow sensors, the controller will provide the following watchdog functions:

- ❖ Upon detection of **catastrophic high-flow**, the controller will trigger an alarm and respond automatically as follows:
  - ◆ Shut down all active stations.
  - ◆ Shut down a normally-open master valve.
  - ◆ Prohibit all program cycle starts until the alarm is cleared.
- ❖ Upon detection of **unscheduled flow**, the controller will trigger an alarm and respond automatically as follows:
  - ◆ Shut down a normally-open master valve.
  - ◆ Prohibit all program cycle starts until the alarm is cleared.
- ❖ Upon detection of flow outside the established **upper or lower flow limits**, the controller will trigger an alarm and respond automatically as follows:
  - ◆ Shut down the defective station and prohibit its operation until the alarm is cleared.
  - ◆ Advance to the next station in the program sequence.

## Clearing Alarms

Clearing an alarm notice will remove it from the HOME screen, turn off the alarm LED indicator and silence the audible alert tone. A record of the alarm event will be stored in alarm archive until automatically deleted.

*Note: The procedure for clearing alarms is slightly different if more than 10 alarm conditions are indicated. Use the following procedures to clear alarms as applicable.*

### To clear 10 Alarms or less:

1. From the Home screen, turn the **Dial** to choose ALARMS, then press the **Dial** to select.
2. The first Alarm condition is displayed. Press the **Dial** to clear the Alarm. The next Alarm condition will be displayed. Press the **Dial** to clear each remaining Alarm.

```
TU 07:56:14P WK1 7.00
VALID PGM: 4
-MAIN- [ALARMS< 2>]
```

```
06/03 TU 07:56:10PM
SERVICE ESTABLISHED
->[CLEAR]↕↑
```

### To clear more than 10 Alarms:

1. From the Home screen, turn the **Dial** to choose ALARMS, then press the **Dial** to select.
2. The first Alarm condition is displayed. Press the **Dial** to clear the Alarm.
3. The next screen provides the option to clear one or all remaining Alarms. To clear all remaining Alarms, turn the **Dial** to choose CLEAR ALL ALARMS, then press the **Dial** to clear the Alarms.

```
TU 07:56:14P WK1 7.00
VALID PGM: 4
-MAIN- [ALARMS< 12>]
```

```
06/03 TU 07:56:10PM
SERVICE ESTABLISHED
->[CLEAR]↕↑
```

```
YOU HAVE 011 ACTIVE
ALARMS.
-CLEAR THIS ALARM-
[CLEAR ALL ALARMS]←↑
```

**Analyzing Alarms**

The table below represents a variety of alarm notices that may be encountered for various controller input and output hardware configurations.

♦ Generic	♦ Flow Sensor	♦ Two-Wire Decoder
1 – Power Restored	1 – Main Line Flow	1 – Two-Wire Board Failure
2 – Configuration Error	2 – Station Flow (over)	2 – Two-Wire Field Wire Overcurrent Detected
3 – Configuration Change	3 – Station Flow (under)	3 – Station (#) Decoder Not Found
4 – MV Sensor Board Failure	4 – Unscheduled Flow	4 – Station (#) Open Circuit At Solenoid
5 – Program (#) Start Time Falls Outside Water Window		5 – Station (#) Short Circuit at Solenoid
6 – Electrical Short		6 – Station (#) Decoder Comm Error
7 – Wireless Service Disruption		7 – Two-Wire Decoder Programming Failure
8 – Output Board: (#) Failure		8 – Two-Wire Decoder Failure
	♦ Rain/Weather Sensor	
	1 – Rain Sensor: Wet	
	2 – Hourly Rain Limit Exceeded	
	3 – Daily Rain Limit Exceeded	
	4 – Weather Station Out of Range	

To assist in quickly locating a particular condition, the alarms are categorized by controller hardware configuration. Use the listed number and description to locate the specific condition and accompanying relevant information from the following examples.

**♦ Generic**

**1 – Power Restored**

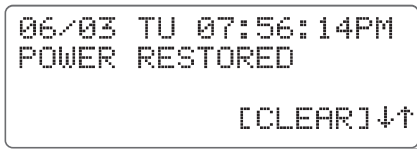

This Alarm occurs whenever power to the controller has been lost and restored, and is provided for reference only.

**2 – Configuration Error**

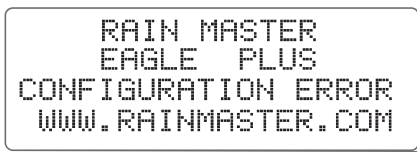

This alarm notice occurs if the controller has failed to detect if the controller is configured for conventional output or a two-wire decoder system.

- The controller will make multiple attempts to detect the output configuration.
- If a valid configuration is not detected, the controller will remain inoperable.
- Contact Rain Master technical service at 1-800-777-1477.

### 3 – Configuration Change

```
11/03 FR 11:32:05AM
MAX STATION IS: 48
MAX STATION WAS: 40
[CLEAR]↓↑
```

This alarm occurs each time a controller configuration change is detected including:

- A change in the station count is detected such as adding/removing an output board.

### 4 – Master Valve, Pump or Sensor Error

```
11/03 SU 16:06:39
MV SENSOR BOARD
FAILURE EC=###
[CLEAR]↓↑
```

This Alarm indicates the Master Valve board has either failed or has data in it that is out of range or non-existent.

*Note: See Appendix C - Error Code Reference Chart on page 64 for additional EC information. Contact Rain Master technical service at 1-800-777-1477.*

### 5 – Program Start Time Falls Outside Water Window

```
10/19 FR 09:20:13AM
PROGRAM 05 STARTTIME
FALLS OUTSIDE WATER
WINDOW. [CLEAR]↓↑
```

This Alarm indicates that a start time for a specified program will fall outside the established limits of the Water Window.

- The controller will not start a program outside of Water Window and will terminate programs when the end of the Water Window is reached.

### 6 – Electrical Short

```
07/15 MO 10:00:00AM
STATION 26
ELECTRICAL SHORT
[CLEAR]↓↑
```

This Alarm indicates a short circuit or excessive current draw has been detected on a specific station output.

- The station will be turned off and will not operate in any subsequent program watering cycles until the alarm is cleared.
- The next programmed station in sequence will start.

## 7 – Wireless Service Disruption

```
01/23 SU 06:06:39AM  
SERVICE ESTABLISHED  
  
[CLEAR]↓↑
```

This alarm occurs whenever wireless service is established or re-established with the network carrier.

- A counter is associated with this Alarm that determines how many times this event must occur during the current day before the alarm is sent. The default value is 1, with a maximum value of 100 (established in the iCentral).

*Note: If the value is set to 100, this Alarm will never be sent to iCentral again.*

## 8 – Output Board Failure

```
10/19 FR 03:30:05PM  
OUTPUT BOARD:6  
FAILURE EC=###  
  
[CLEAR]↓↑
```

This Alarm indicates the controller has detected an output board failure while attempting to activate one or more station outputs on the board.

- The offending output board number is indicated.

*Note: A two- or three-digit Failure EC code number is provided for use by customer service personnel only.*

### ◆ Flow Sensor Alarms

#### 1 – Main Line Flow

```
05/18 SU 02:09:06PM  
MAIN LINE  
MEASURED=764 GPM  
LIMIT:350 [CLEAR]↓↑
```

This alarm indicates the main line flow has exceeded the established upper flow limit.

Once the controller detects this alarm:

- All currently operating stations will be shut down.
- No irrigation programs/stations will irrigate until this alarm is cleared. All non-irrigation programs shall remain operational.
- Shuts down a Normally-Open Master Valve.

## 2 – Station High-Flow

```
04/05 FR 22:19:26
STATION ### HI FLOW
MEASURED=364 GPM
LIMIT:346 [CLEAR]↓↑
```

This alarm indicates that a station flow has exceeded the established upper flow limit.

Once the controller detects this condition:

- The station will be turned off and restricted from running in any subsequent program watering cycles until the alarm is cleared.
- The next station in sequence assigned to the program will operate.

## 3 – Station No-Flow

```
05/18 SU 02:09:15PM
STATION 169 NO FLOW
MEASURED=0 GPM
[CLEAR]↓↑
```

This alarm indicates a station flow that is less than the established flow range.

Once the controller detects this condition:

- The station will be turned off.
- The next station (if any) of this program will operated.
- The station will be restricted from running in any subsequent program watering cycles until the alarm is cleared.

## 4 – Unscheduled Flow

```
08/27 TH 11:47:13AM
UNSCHEDULED FLOW
MEASURED=36 GPM
LIMIT:32 [CLEAR]↓↑
```

This alarm indicates that flow in the main line has been detected at an unscheduled time.

Once the controller detects this event:

- All operating programs are terminated.
- No scheduled programs will start until this alarm is cleared.
- The controller will not generate a another alarm for this event until the current Alarm is cleared.
- Shuts down a Normally-Open Master Valve.

◆ **Rain Sensor or Weather Station Alarms**

**1 – Rain Sensor Status Change**



This alarm occurs when the rain sensor status has changed from Dry to Wet, or Wet to Dry.

- When a WET condition is detected during a program watering cycle, the program will continue running, but all field outputs associated with the program will be turned off.
- The controller will continue running all scheduled watering programs, but no field outputs will be energized while the WET condition is detected.
- If the sensor status changes to DRY while the program is running, station output will be reinstated enabling any current station operation to resume for the duration of the remaining run time.

**2 – Hourly Rain Limit Exceeded**

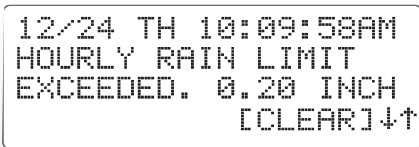

This alarm occurs when the weather station determines that the established *hourly* rainfall limit has been exceeded.

- All watering programs will be suspended until the Rain Hold mode has been released.
- The controller will not generate another alarm for this event until the current alarm is cleared.

**3 – Daily Rain Limit Exceeded**

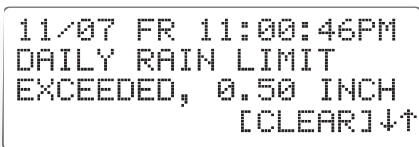

This alarm occurs when the weather station determines that the established *daily* rainfall limit has been exceeded.

- All watering programs will be suspended until the Rain Hold mode has been released.
- The controller will not generate another alarm for this event until the current alarm is cleared.



## 4 – Weather Station Out of Range

```
10/13 FR 04:30:05AM
WX STATION OUT OF
RANGE ET=.50
[CLEAR]↓↑
```

This alarm indicates the Weather Station is reporting the maximum ET rate has been exceeded and attention is required.

- This **Alarm** condition will not be reported more than once per day.
- The maximum value reported from a weather station is 0.50 maximum.
- The **Alarm** event occurs if the weather station reads more than the maximum 50 rate of pulses per 24-hour period.
- The historic ET value for the current month will be used for ET computation in lieu of the indicated value.

## ◆ Two-Wire Decoder System Alarms

### 1 – Two-Wire Board Failure

```
03/09 FR 13:30:05
TWO WIRE BOARD
FAILURE EC=###
[CLEAR]↓↑
```

This alarm indicates an error has occurred pertaining to the Two-Wire Decoder output board.

**Note:** See Appendix C - Error Code Reference Chart on page 64 for additional EC information. Contact Rain Master technical service at 1-800-777-1477.

### 2 – Two-Wire Field Wiring Over-current Detected

```
07/15 MO 10:00:35AM
TWO WIRE FIELD
WIRING OVERCURRENT
DETECTED. [CLEAR]↓↑
```

This alarm indicates higher than normal current load is detected on the decoder communication/power two-wire cable.

- All stations will be turned off.
- All subsequent watering programs will be canceled.

**Note:** Wait two minutes before clearing alarm and retrying the two-wire system.

### 3 – Station (#) Decoder Not Found

```
07/15 MO 10:00:21AM  
STATION 153  
DECODER NOT FOUND  
[CLEAR]↓↑
```

This alarm event occurs if the controller attempts to operate a decoder station number that either does not exist or is not recognized by the controller.

- This alarm occurs exclusively during Test mode operations.

### 4 – Station (#) Open Circuit at Solenoid

```
07/15 MO 10:00:00AM  
STATION 109  
OPEN CIRCUIT AT  
SOLENOID [CLEAR]↓↑
```

This alarm indicates an open-circuit condition exists on the specified decoder station solenoid connection.

- The station will be turned off, and the next station in sequence will start.
- The controller will not attempt to operate the station until the alarm is cleared.

### 5 – Station (#) Short Circuit at Solenoid

```
07/15 MO 10:00:05AM  
STATION 109  
SHORT CIRCUIT AT  
SOLENOID [CLEAR]↓↑
```

This alarm indicates a short-circuit condition exists on the specified decoder station solenoid connection.

- The station will be turned off, and the next station in sequence will start.
- The controller will not attempt to operate the station until the alarm is cleared.

### 6 – Station (#) Decoder Comm Error

```
07/15 MO 10:02:25AM  
STATION 99  
DECODER COMM ERROR  
[CLEAR]↓↑
```

This alarm indicates the controller cannot communicate successfully with the specified decoder station.

- The alarm will be reported each time the controller attempts to operate the station.
- This alarm condition is not indicated during Test mode operations.

## 7 – Station (#) Decoder Programming Failure

```
07/15 MO 10:04:13AM  
TWO-WIRE DECODER  
PROGRAMMING FAILURE  
[CLEAR]↓↑
```

This alarm is recorded during the decoder programming process indicating an error occurred, preventing the decoder from being successfully programmed.

- The alarm will be reported each time programming the decoder is attempted.

## 8 – Station (#) Decoder Failure

```
07/15 MO 10:07:08AM  
TWO-WIRE DECODER  
FAILURE EC=###  
[CLEAR]↓↑
```

This alarm indicates the two-wire decoder system is inoperable.

- The alarm will be reported each time programming the decoder is attempted.

**Note:** See Appendix C - Error Code Reference Chart on page 64 for additional EC information. Contact Rain Master technical service at 1-800-777-1477.

## **Appendix A - General Specifications**

### **Cabinet Dimensions:**

- Wall Mount: 11" W x 16" H x 5.625" D (27,9cm W x 40,6cm H x 14,29cm D)
- Pedestal Mount:
  - PSB: 16.5" W x 38" H x 17.25" D (41,9cm W x 96,5cm H x 43,8cm D)
  - SPEB: 16" W x 34" H x 16" D (40,6cm W x 86,4cm H x 40,6cm D)

### **Temperature Range:**

- Operating: +14°F to +140°F (-10°C to +60°C)
- Storage: -22°F to +149°F (-30°C to +65°C).

### **Power Specifications:**

- Internal Transformer, Class 2, UL Listed, CSA Certified (or equivalent)
  - Input: 120 VAC ± 10%, 50/60 Hz
  - Output: 24 VAC ± 10%, 50/60 Hz
- Maximum Load Per Station: 0.5A @ 24 VAC @ 77° (25°C)
- Maximum Load Per Master Valve: 0.5A @ 24 VAC @ 77°F (25°C)
- Maximum Load Per Pump Output: 0.5A @ 24 VAC @ 77°F (25°C)
- Total Maximum Load: 1.5A @ 24 VAC.

### **Output Surge Protection** (excluding 2-wire decoder models):

6KV common, 1KV normal.

### **Controller Memory:**

The Eagle Plus utilizes NVRAM (Non-volatile Random Access Memory) technology to protect all user-defined program and setup data from loss in the event of a power failure. Time and date settings will be maintained without power for approximately 30 days.

## Appendix B - Flow Sensor Specifications

The Eagle Plus controller supports the complete line of Irritrol flow sensor models listed in the following tables.

### PVC Sensor Body Material

Sensor Model #	FS-150	FS-200	FS-300	FS-400
Pipe Size	1½"	2"	3"	4"
Operating Range	5-100 GPM	10-200 GPM	20-300 GPM	40-500 GPM
Max. Water Press.*	100 psi	100 psi	100 psi	100 psi
K-Value	457	776	2268	3752
Offset Value	0	104	483	834
Connection Type	Slip	Slip	Slip	Slip

\*Maximum water pressure @ 68° F (20°C).

### Bronze Sensor Body Material

Sensor Model #	FS-8100	FS-8125	FS-8150	FS-8200	FS-8250
Pipe Size	1"	1¼"	1½"	2"	2½"
Operating Range	2-40 GPM	3-60 GPM	4-80 GPM	10-100 GPM	16-160 GPM
Max. Water Press.	400 psi	400 psi	400 psi	200 psi	200 psi
K-Value	109	209	291	750	1021
Offset Value	27	32	24	0	370
Connection Type	NPT Female	NPT Female	NPT Female	NPT Female*	NPT Female

\*Includes copper male adapter.

*Note: In addition to the standard models listed above, an impeller-type flow sensor adapter, Model # FS-INSERT-B, is available to accommodate pipe sizes from 3 to 40" (7.6 to 102cm). Requires pipe saddle with 2" female NPT inlet.*

**Appendix C -Error Code Reference Chart**

The chart below provides a cross reference of EC error code numbers, included in various alarm screens, to the root cause of the alarm. This information is primarily used for system troubleshooting to help Rain Master service personnel quickly identify and resolve most controller operating issues that may be encountered.

<b>2-Wire Base Error Codes</b>		<b>2-Wire Decoder Error Codes</b>	
<b>EC #</b>	<b>Cause</b>	<b>EC #</b>	<b>Cause</b>
2.....	OVER CURRENT	3 .....	NO RESPONSE
4.....	I2C ERROR	7 .....	CHECKSUM ERROR
5.....	ILLEGAL COMMAND	64 .....	OVER CURRENT
6.....	COMMAND REJECTED	65 .....	SHORT CIRCUIT
8.....	MORE DATA READY	66 .....	OPEN CIRCUIT
11 .....	FRAME ERROR	67 .....	I2C ERROR
12 .....	TWO WIRE MODE FAULT	68 .....	ILLEGAL COMMAND
15 .....	UNIT BUSY	69 .....	COMMAND REJECTED
16 .....	REMOTE LOGIN	70 .....	PARTIAL READING
223 .....	CHKSUM CALC ERROR	71 .....	FRAMING ERROR
224 .....	ADDRESS ERROR	72 .....	LIMIT EXCEEDED
230 .....	UNIT EXISTS	73 .....	PORTS EXCEEDED
231 .....	COMM ERROR	74 .....	LOW STARTUP VOLTAGE
		75 .....	DATA READY
		76 .....	BELOW LOWER LIMIT
		77 .....	DATA OVERFLOW
		78 .....	NO AC VOLTAGE
		220 .....	QTY SENT ERROR
		221 .....	QTY RECEIVED ERROR
		222 .....	CHKSUM CALC ERROR
		232 .....	FOUND
		233 .....	NOT FOUND
		234 .....	PROG ERROR
<b>2-Wire Bridge Error Codes</b>		<b>Output Board Error Codes</b>	
<b>EC #</b>	<b>Cause</b>	<b>EC #</b>	<b>Cause</b>
9.....	SLOW POWERUP	4.....	COMMUNICATION ERROR
10 .....	OVER CURRENT	255.....	LOST COMMUNICATION
13 .....	CHECKSUM		
14.....	NO RESPONSE		
<b>MV Sensor Board Error Codes</b>		<b>iCentral Error Codes</b>	
<b>EC #</b>	<b>Cause</b>	<b>EC #</b>	<b>Cause</b>
40 .....	SHORT	100.....	COMMUNICATION ERROR
41 .....	ET		
42 .....	READ ET		
43 .....	RAIN		
44 .....	TRIAC		
45 .....	FLOW1		
46 .....	FLOW2		
47 .....	MV/PUMP		

## **Appendix D - FCC Rules - Electromagnetic Compatibility**

This equipment generates and uses radio frequency energy and if not installed and used properly, that is, in strict accordance with the manufacturer's instructions, may cause interference to radio and television reception. It has been type tested and found to comply with the limits for a FCC Class B computing device in accordance with the specifications in Subpart J of Part 15 of FCC Rules, which are designed to provide reasonable protection against such interference in a residential installation. However, there is no guarantee that interference will not occur in a particular installation. If this equipment does cause interference to radio or television reception, which can be determined by turning the equipment off and on, the user is encouraged to try to correct the interference by one or more of the following measures:

- Reorient the receiving antenna.
- Relocate the irrigation controller with respect to the receiver.
- Move the irrigation controller away from the receiver.
- Plug the irrigation controller into a different outlet so the irrigation controller and receiver are on different branch circuits.

If necessary, the user should consult the dealer or an experienced radio/television technician for additional suggestions. The user may find the following booklet prepared by the Federal Communications Commission helpful:

"How to Identify and Resolve Radio-TV Interference Problems". This booklet is available from the U.S. Government Printing Office, Washington, DC 20402. Stock No. 004-000-00345-4.

**Notes:**



**Notes:**

***Irritrol***<sup>®</sup>

[www.irritrol.com](http://www.irritrol.com) • [www.rainmaster.com](http://www.rainmaster.com)